

ONE HUNDRED YEARS OF INNOVATION



SINCE 1918

GILL[®]

ATHLETICS



GILLATHLETICS.COM 800.637.3090

WHAT'S INSIDE

02 JUMPS

- 02 Landing Systems
- 08 Standards
- 12 Box Collars, Base Pads & Platforms
- 14 Raised Runways & Pit Garages
- 16 Crossbars & Accessories
- 18 Vaulting Poles
- 24 Vault Accessories

26 SPRINTS & HURDLES

- 26 Starting Blocks
- 30 Hurdles
- 33 Hurdle Accessories

34 THROWS

- 34 Discus
- 37 Hammers & Shots
- 38 Javelins
- 44 Throw Training & Accessories

48 MEETS

- 48 Displays
- 50 Measuring Devices & Cameras
- 52 Track Accessories & Maintenance
- 58 Cross Country & Impact Tents

60 TRAINING

- 60 Plyometrics
- 62 Agility Training
- 64 Speed Development
- 67 Core Strength
- 68 Bodyweight Training
- 70 Weight Bars & Plates
- 72 Jump Training & Testing
- 74 Flexibility & Rehab

78 FACILITIES

- 76 Vault Boxes
- 78 Takeoff Boards & Curbing
- 80 Sand Pit Forms & Covers
- 82 Steeplechase
- 84 Circles & Toeboards
- 86 Discus & Shot Cages
- 92 Hammer Cages
- 98 VersaCom Boxes & Track Shelter
- 100 Ballstops

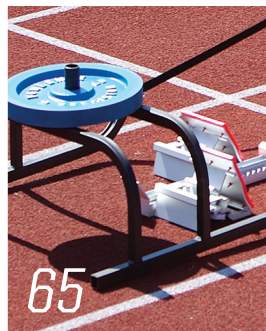
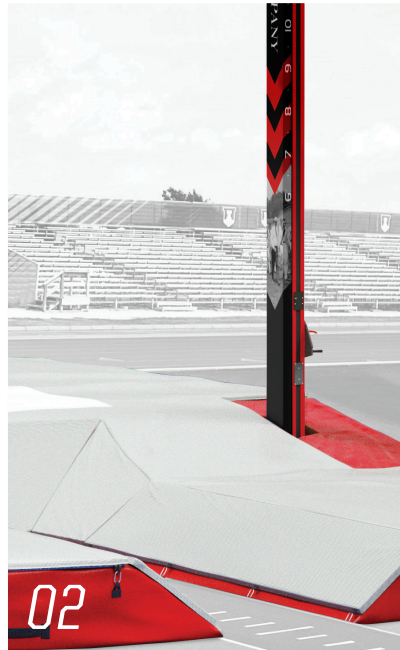

2018 Litanis Sports Group, Inc. Gill Athletics, PowerMax, Pacer are all registered trademarks of Gill Athletics, Inc. Gill Essentials, Maximus, SafetyMax, AGX, CarbonFX, PacerFXV, Carbon Mystic, Pacer Mystic, Skypole Carbon, Skypole, Continuum, Fusion, Hollowood Star, Orbiter, OTE, Tru-Flight, Track Wagon, Coach's Eye, are all trademarks of Gill Athletics, Inc. NCAA is a registered trademark of The National Collegiate Athletic Association.

CHECK OUT OUR GREAT **NEW** PRODUCTS

Featured here and online at: www.GILLATHLETICS.com / *TheFutureIsHere*

Prices effective from October 1, 2017 through September 30, 2018

ONE HUNDRED YEARS

Harry Gill, an unknown athlete, became an overnight sensation when he won the American All-Around Championship in 1900. Impressively, this was Gill's first ever All-Around competition and his competitors became spectators as his performance led to a record setting score. Gill collected many medals and set world class marks in 5 events, but more importantly he acquired invaluable insight that fueled his next endeavor:

In 1904, Gill began his legendary coaching career at the University of Illinois. There he established a coaching career so successful it was without equal and his reputation in the track and field world was unimpeachable. Gill authored the book, *Track and Field Athletics: For Coach and Contestant* that for years served as the sports standard coaching manual. In this book he wrote "a great deal of care should be taken in selecting the equipment used by track and field athletes. Their performance depends on the implements they have in

which and with which to compete - and good equipment helps considerably in making the best performances."

Unsatisfied with the quality of track equipment available, it was in 1918 that he crafted the first piece of his own track equipment, the ash javelin. In four short years, the company bearing his name was the first to manufacture a complete line of track and field equipment. The most enduring of all of Gill's accomplishments is his line of track and field equipment. Gill's company is responsible for a long list of innovative equipment that has been instrumental in elevating the sport and performance of track athletes worldwide.

100 years later we have never wavered from Coach Gill's vision and consider it a great honor to be stewards of his legacy.

100 Years of Quality.
100 Years of Dependability.
100 Years of Innovation.

Harry L. Gill

SINCE 1918
GILL
ATHLETICS

LANDING SYSTEMS

For 100 years, Gill Athletics has been the leader of innovation in the sport of track & field. Our pole vault and high jump landing systems are engineered by collegiate athletes, professionals and coaches. We are honored that the NCAA® and NFHS® have both partnered with us as we work together to elevate each athlete's journey and deliver a first-class experience.



SIDE CARBINER CONNECTION:

Top Pad is connected to base pads with carbiner side attachments, eliminating any obstruction on top of the pit. This exclusive attention to detail provides an obstruction-free landing area with athletes' safety in mind.

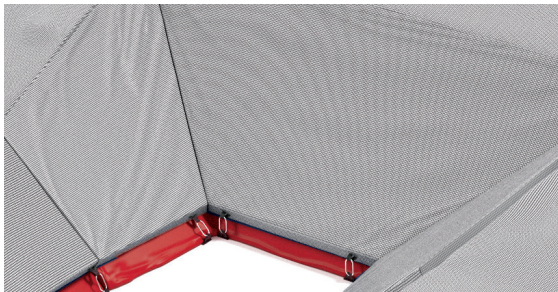

OPTIMAL PIT ENTRY ANGLE:

An ASTM approved vault box collar changes the slope of the tri-slant area when vaulting poles rotate. Gill's thoughtful pit entry design accounts for the box collar's effect by featuring a vaulter friendly angle.



GILL LANDING AREA FEATURES

Top Pads

EDGE-TO-EDGE TOP PAD: Aesthetic and functional design eliminates spike contact with base units and unevenness at the edge of the pit. This Gill exclusive feature will increase the life of your new pit and improve safety near the edges.

TUFMESH PLUS CASING: Using exclusive 17 x 11 1000 denier material increases the life of your top pad and stands up to repeated use better than any on the market.

2" DURALIFE FOAM: Soft and durable foam creates confidence in every practice. Coaches can teach with assurance because of this industry leading design.

V-LOOP VINYL STRAP: Designed to evenly distribute the force from the athlete's landing, V-Loop straps eliminate tears compared to traditionally designed pits that put undue stress on the seams.

REVERSIBLE: Extend the life of your pit, Gill's top pads are designed to use either side safely and easily.

Vinly Base Units

ALL VINYL BASE: Exclusive to Gill landing systems, this unique design keeps water out of your pit better than old-school mesh top units used by the competition. To extend the life of your pit you keep water out of the foam. Gill's all-vinyl design gets results.

COMPLETE INTERCHANGEABILITY: NEW design provides reversible sections for maximum interchangeability. This adds years to the life of your pit by maximizing the usage and size of the athlete's landing area.

QUADRUPLE DURALIFE LAYER FOAM: Athletes need to know they are landing safely and comfortably. Gill's new QUADRUPLE Duralife foam is 25% softer than others yet with firmness necessary for the safest landings.

DUAL COATED VINYL: Evenly distributed 1000 x 1000 denier polyester fabric is bonded on both sides with 18oz knife-coated PVC vinyl. This exclusive fabric design eliminates vinyl delamination seen in other pits after years of use. This creates the most durable casing on the market that is lighter than the other pits.

STITCHING: Gill's entire landing system is stitched with the industry's strongest 210 bonded polyester thread. Simply put, your new Gill pit comes triple stitched with the toughest thread in the industry to hold up to high volume practices.

GRIP STRIP FASTENING SYSTEM: A pit is safest when constructed as an integrated system. Gill's Grip Strip Fastening System will keep your base sections functioning as one unit season after season.

ECO-SMART COMPRESS PACKS: Gill Athletics cares about the environment and your budget. All landing systems are expertly packed and shipped utilizing Compress-Pack shipping, reducing freight volume lowering fuel consumption and shipping costs. Pits restore to original size and shape minutes after unpacking.

12 YEAR WARRANTY: A long-term warranty is only as dependable as the company standing behind it. And after 100 years, you can count on Gill to stand behind your landing system for years to come. If any failure occurs in the first 12 years, under normal use and care, we will repair or replace the damaged part. Essentials™ line includes 5 year warranty.

CUSTOM COLOR AND GRAPHICS: Choose from over 100 unique vinyl casing and top pad color combinations offered at NO EXTRA CHARGE! Select your vinyl casing (xx) and top pad (yy) color combination. Add distinction with multi-color graphics on the top pad, weather cover, or both.

CUSTOMIZABLE LANDING SYSTEMS

Casing (XX)

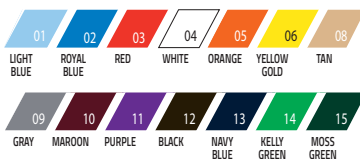

Top Pad (YY)



CUSTOM GRAPHIC PRINTING

Add logo or school name to any landing system top pad or weather cover. Multi-color graphic is screen printed on 5' x 5' area. **Vector artwork must be provided.**

9451	Top Pad Graphic	\$1000
9452	Weather Cover Graphic	\$1000

*To specify color with order, use the two-digit number of your color selection to replace XX & YY in the item number.

POLE VAULT LANDING SYSTEMS

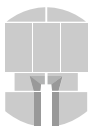

OFFICIAL EQUIPMENT SUPPLIER TO THE
2018 TRACK & FIELD CHAMPIONSHIPS

AGX M4 PV LANDING SYSTEM

- 21' 6" x 31' 2" x 32" // 6.55m x 9.50m x 0.81m
- 2" Top Pad
- 19' 10" in back of the vault box
- Meets IAFF, NCAA and NFHS specifications

66817CXXYY Landing System \$26755

6681702CXX Weather Cover \$2500



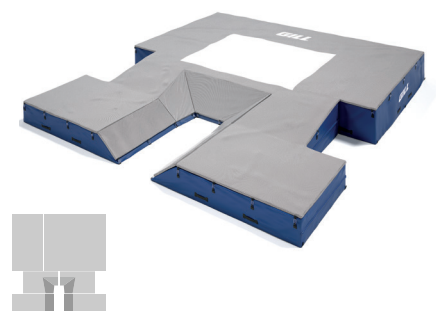
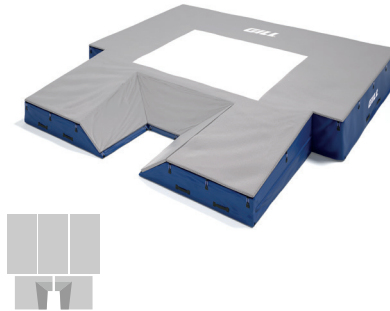

ESSENTIALS PV LANDING SYSTEM

- 19' 9" x 20'2" x 26" // 6.02m x 6.15m x 0.66m
- Skirted Mesh Top Holds Unit in Place
- Royal blue vinyl with gray top pad only
- **Meets NFHS specifications**

653 Landing System \$10975

65302 Weather Cover \$1250

VP300 Essentials PV Valuepack \$13800

INCLUDED: Essentials PV System, Weather Cover, 7100 Essentials PV Standards, 715F Base Pads, 523 Essentials PV Crossbar

S1 PV LANDING SYSTEM

- 20' x 20' 2.5" x 28" // 6.1m x 6.16m x 0.71m
- 2" Top Pad
- 16' 7" in back of the vault box
- **Meets NFHS specifications**

65417CXXYY Landing System \$14480

6541702CXX Weather Cover \$1560

VP65417CXXYY S1 PV Valuepack \$18020

INCLUDED: S1 PV System, Weather Cover, 7110 Scholastic PV Standards, 715F Base Pads, 523 Essentials PV Crossbar

S4 PV LANDING SYSTEM

- 21' 6" x 24' x 28" // 6.55m x 7.32m x 0.71m
- 2" Top Pad
- 16' 7" in back of the vault box
- **Meets NFHS specifications**

65817CXXYY Landing System \$17325

6581702CXX Weather Cover \$1850

VP65817CXXYY S4 PV Valuepack \$21060

INCLUDED: S4 PV System, Weather Cover, 7110 Scholastic PV Standards, 715F Base Pads, 523 Essentials PV Crossbar

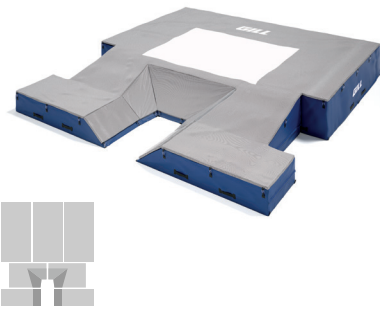

G1 PV LANDING SYSTEM

- 20' x 21'11" x 32" // 6.10m x 6.68m x 0.81m
- 2" Top Pad
- 16' 7" in back of the vault box
- **Meets NCAA and NFHS specifications**

66217CXXYY Landing System \$18220

6621702CXX Weather Cover \$1900

VP66217CXXYY G1 PV Valuepack \$25035

INCLUDED: G1 PV System, Weather Cover, 7141 National PV Standards, 715V Base Pads, 526 Gill International PV Crossbar

G4 PV LANDING SYSTEM

- 21' 6" x 24' x 32" // 6.55m x 7.32m x 0.81m
- 2" Top Pad
- 16' 7" in back of the vault box
- **Meets NCAA and NFHS specifications**

66317CXXYY Landing System \$20125

6631702CXX Weather Cover \$2080

VP66317CXXYY G4 PV Valuepack \$25035

INCLUDED: G4 PV System, Weather Cover, 7141 National PV Standards, 715V Base Pads, 526 Gill International PV Crossbar

G6 PV LANDING SYSTEM

- 21' 6" x 27' x 32" // 6.55m x 8.23m x 0.81m
- 2" Top Pad
- 19'7" in back of the vault box
- **Meets IAFF, NCAA and NFHS specifications**

66517CXXYY Landing System \$22200

6651702CXX Weather Cover \$2290

VP66517CXXYY G6 PV Valuepack \$25035

INCLUDED: G6 PV System, Weather Cover, 7141 National PV Standards, 715V Base Pads, 526 Gill International PV Crossbar

CUSTOMIZABLE SYSTEMS

See color charts on page 3 to replace the XX and YY in the item numbers.

GILL 12 YEAR WARRANTY

On all Gill Landing Systems (excludes Essentials). Call for Details.



HIGH JUMP LANDING SYSTEMS

G4 HJ LANDING SYSTEM

- 20' x 13' 2" x 28" // 6.10m x 4.01m x 0.71m
- 2" Top pad
- Added safety cutout
- Meets IAFF, NCAA and NFHS specifications



64417CXXYY Landing System \$9470

6441702CXX Weather Cover \$1400



OFFICIAL EQUIPMENT SUPPLIER TO THE
2018 TRACK & FIELD CHAMPIONSHIPS

AGX M4 HJ LANDING SYSTEM

- 27' 2" x 13' 2" x 28" // 8.3m x 4.01m x 0.71m
- 2" Top pad
- Added safety cutout
- Meets IAFF, NCAA and NFHS specifications



64817CXXYY Landing System \$12515

6481702CXX Weather Cover \$1600

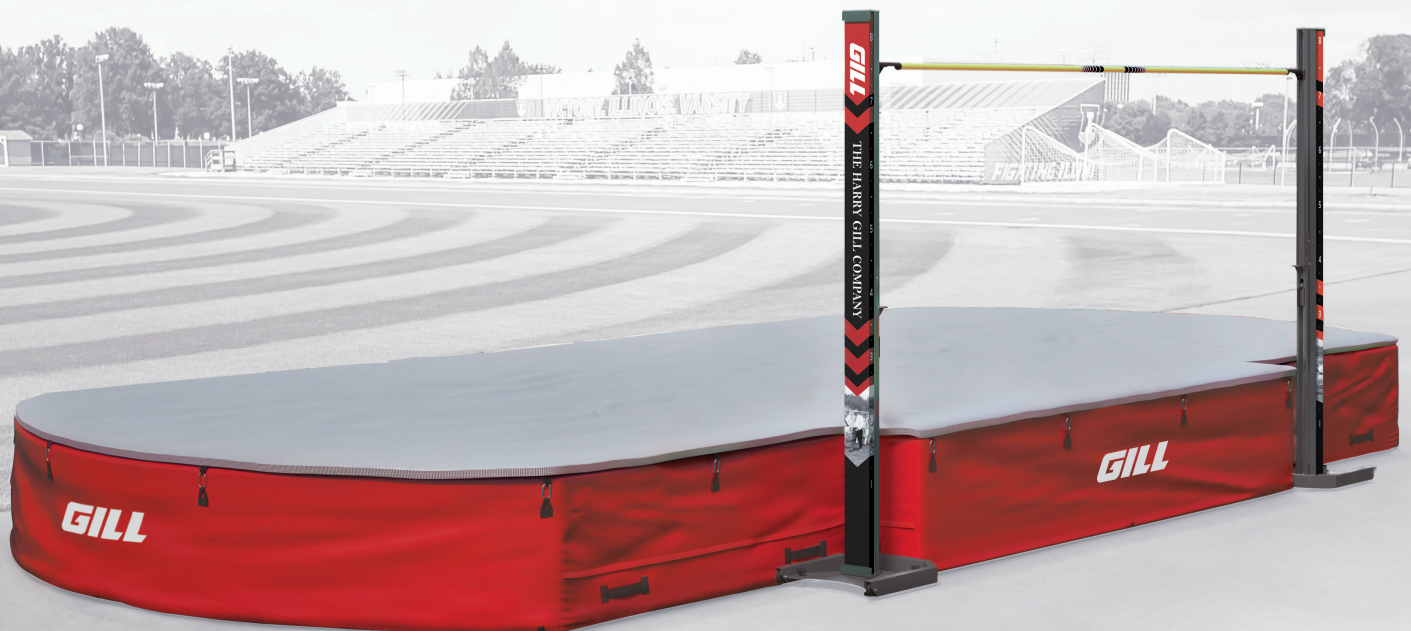



ESSENTIALS HJ LANDING SYSTEM

- 16' x 8" x 24" // 4.88m x 2.44m x 0.61m
- Skirted mesh top holds unit in place
- Royal blue vinyl with gray top pad only
- **Meets NFHS specifications**
- **5 year warranty**

640A Landing System **\$3930**

640A02 Weather Cover **\$619**

VP405 Essentials HJ Valuepack **\$4805**

INCLUDED: Essentials HJ System, Weather Cover, 700 Essentials HJ Standards, 522 Essentials HJ Crossbar



S1 HJ LANDING SYSTEM

- 16'6" x 8' x 26" // 5.03m x 2.44m x 0.66m
- 2" Top pad
- **Meets NFHS specifications**

64117CXXYY Landing System **\$5455**

6411702CXX Weather Cover **\$829**

VP64117CXXYY S1 HJ Valuepack **\$6825**

INCLUDED: S1 HJ System, Weather Cover, 7040 Scholastic HJ Standards, 522 Essentials HJ Crossbar



S4 HJ LANDING SYSTEM

- 16' 6" x 10' x 26" // 5.03m x 3.05m x 0.66m
- 2" Top pad
- Added safety cutout
- **Meets NCAA and NFHS specifications**

64217CXXYY Landing System **\$6890**

6421702CXX Weather Cover **\$1040**

VP64217CXXYY S4 HJ Valuepack **\$8420**

INCLUDED: S4 HJ System, Weather Cover, 7040 Scholastic HJ Standards, 522 Essentials HJ Crossbar



G1 HJ LANDING SYSTEM

- 18' x 10' x 26" // 5.49m x 3.05m x 0.66m
- 2" Top pad
- Added safety cutout
- **Meets IAFF, NCAA and NFHS specifications**

64617CXXYY Landing System **\$7800**

6461702CXX Weather Cover **\$1200**

VP64617CXXYY G1 HJ Valuepack **\$9760**

INCLUDED: G1 HJ System, Weather Cover, 705 Collegiate HJ Standards, 525 Gill International HJ Crossbar



CUSTOMIZABLE SYSTEMS

See color charts on page 3 to replace the XX and YY in the item numbers.

GILL 12 YEAR WARRANTY

On all Gill Landing Systems (excludes Essentials). Call for Details.

POLE VAULT STANDARDS



ESSENTIALS™ POLE VAULT STANDARDS

- Full steel tubing construction gives added strength
- Height adjustment: 6' to 16'
- Reads both English and Metric measurements
- Upright detaches from base rails for improved storage
- Wide stance base for added stability
- 75mm bar rest pins and 8 base anchors included
- Meets NFHS specifications
- 5 year warranty

7100 Standards \$1000/pr



SCHOLASTIC POLE VAULT STANDARDS

- Heavy gauge steel tubing for added strength
- Height adjustment: 7' to 18'
- Reads both English and Metric measurements
- Upright detaches from base rails for improved storage
- Wide stance base for added stability
- 55mm and 75mm bar rest pins and 8 base anchors included
- Meets NFHS and NCAA specifications

7110 Standards \$1535/pr



ALUMINUM POLE VAULT STANDARDS

- Aluminum construction for superior corrosion resistance
- Height adjustment: 7' to 18'
- Reads both English and Metric measurements
- Upright detaches from base rails for improved storage
- Wide stance base for added stability
- 55mm and 75mm bar rest pins and 8 base anchors included
- Meets NFHS and NCAA specifications

7130 Standards \$1925/pr



NATIONAL POLE VAULT STANDARDS

- Unique fluted aircraft quality aluminum construction
- Height adjustment: 5' to 21'
- Reads both English and Metric measurements
- Wide stance base for added stability
- 55mm bar rest pins included
- 7142 is compatible with base pads with off center cut out
- Meets NFHS, NCAA, USATF, and IAAF specifications, IAAF certified

7141 Standards IAAF \$4180/pr

7142 Standards for Offset Base Pad IAAF \$4180/pr

REPLACEMENT BAR REST PINS

P71430 55mm NCAA Pin \$11/ea

P71429 75mm HS Pin \$11/ea

REPLACEMENT CONCRETE ANCHORS

- Required by NFHS rule 7-5-10
- Set of 8

7115 \$63

OFFSET EXTENSION

- Adds additional 2' to Gill standards: 7110, 7130, and 7141
- Fits any standards with 1.25" square offsets
- Comes in safety orange color

71252 \$99/pr



PV STANDARD UPRIGHT PAD

- Protects pole, competitors and standards from harm
- Fits snug around the standard facing the inside of the pit
- Open back allows for setting of height and tightening of knobs
- High density foam in vinyl casing
- See chart at right for colors

731109CXX \$349/ea





INTERNATIONAL POLE VAULT STANDARDS

- Extruded aluminum construction for maximum corrosion resistance
- Height adjustment: 3' to 21'
- Extra offset Extensions are not needed
- Choose between English or Metric internal measuring tape
- Hand crank height adjustment utilizing durable pulley system
- Eye-level readout window display
- Unique adjustment window for initial calibration to correct for uneven surfaces
- Wide stance base for added stability including adjustable leveling pads
- Meets NFHS, NCAA, USATF, and IAAF specifications, IAAF certified

730110  \$7180/pr

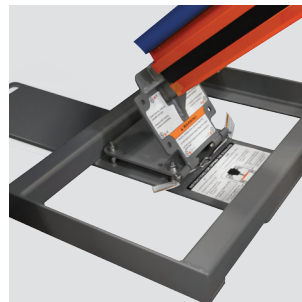
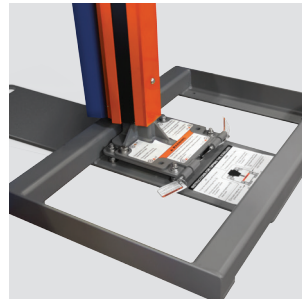

OFFICIAL EQUIPMENT SUPPLIER TO THE 2018 TRACK & FIELD CHAMPIONSHIPS

AGX M4 POLE VAULT STANDARDS

- Dual hand crank system simplifies and speeds up height transitions
- Height range from 6' to 21'
- Exclusive 2" safety pad increases safety of athletes and reduces vaulting pole damage
- Dual positional locking system; Practice Mode creates quick bar height changes while Competition Mode locks in peg height during jumps
- Internal measuring tape displays Metric and English units
- Quick hand crank crossbar depth adjustment from 0cm to 80cm
- Exclusive customizable offset width between pins from 4.30m-4.37m
- Steel base for stability during use and Easy-Port hinge technology for quicker location movement
- Strong aluminum profile increases aesthetics, functionality, and customization
- Customize 2" safety pad with choice of color and graphics
- Use the two-digit number of your vinyl color selection to replace XX in the item number
- Use the two-digit number of your powder coat color selection to replace YY in the item number
- Meets NFHS, NCAA, and IAAF specifications

740110CXXYYSP \$19000/pr

GILL 10 YEAR LIMITED WARRANTY
On all Standards (excludes Essentials). Call for Details.

CUSTOMIZABLE STANDARDS

Vinyl (xx)



Powder Coat (yy)



*Gray and Black powder coat available in Gloss or Flat



HIGH JUMP STANDARDS

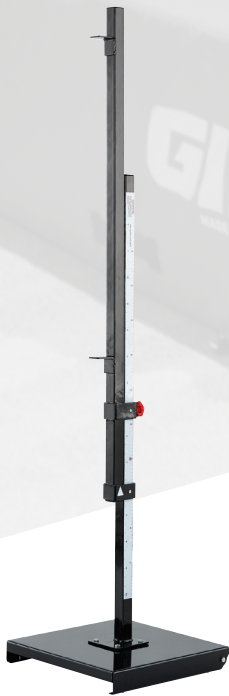

ESSENTIALS™ HIGH JUMP STANDARDS

- Square steel construction with durable black powder coat finish
- Weighted base includes wheels for easy mobility
- Height adjustment: 2' to 8'
- Reads both English and Metric measurements
- Meets NFHS and NCAA specifications
- 5 year warranty

700 Standards \$339/pr

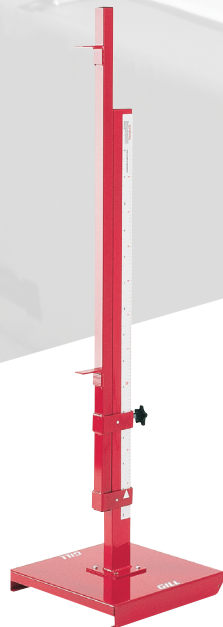

SCHOLASTIC HIGH JUMP STANDARDS

- Strong rectangular steel construction with durable red powder coat finish
- Weighted base includes wheels for easy mobility
- Height adjustment: 2' to 8'
- Reads both English and Metric measurements
- Meets NFHS and NCAA specifications

7040 Standards \$689/pr



ALUMINUM HIGH JUMP STANDARDS

- Aluminum construction for superior corrosion resistance
- Flat base includes wheels for easy mobility
- Height adjustment: 2' to 8'
- Reads both English and Metric measurements
- Meets NFHS and NCAA specifications

7060 Standards \$772/pr



COLLEGIATE HIGH JUMP STANDARDS

- Upright designed with heavy gauge steel for maximum durability
- Riser designed with lightweight aircraft aluminum
- Upper riser guide adds extra stability at higher heights
- Cast aluminum bar rests, upper and lower riser guides
- Weighted base includes wheels for easy mobility
- Height adjustment: 2' to 8'
- Reads both English and Metric measurements
- Meets NFHS, NCAA and IAAF specifications, IAAF certified

705 Standards IAAF \$967/pr

HIGH JUMP MULTI-BAR REST ATTACHMENT

- Eliminates need for time wasting raising and lowering of standards at practice
- Designed to fit most high jump standards
- Six bar rest pads at 3" increments
- 1 3/4" x 1 3/4" openings with a 22" overall length

71254 \$65/pr



HIGH JUMP STANDARD BASE PADS

- Provides additional safety during high jump event
- 2" thick foam pad encased in yellow vinyl

707 \$213/pr



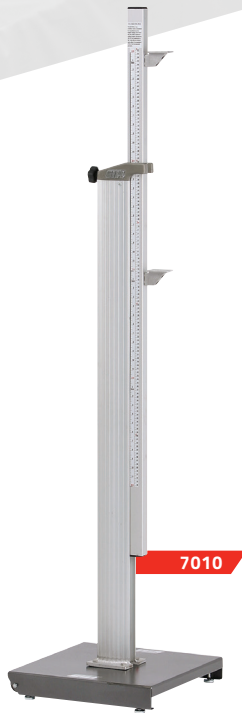

7010



730120C03

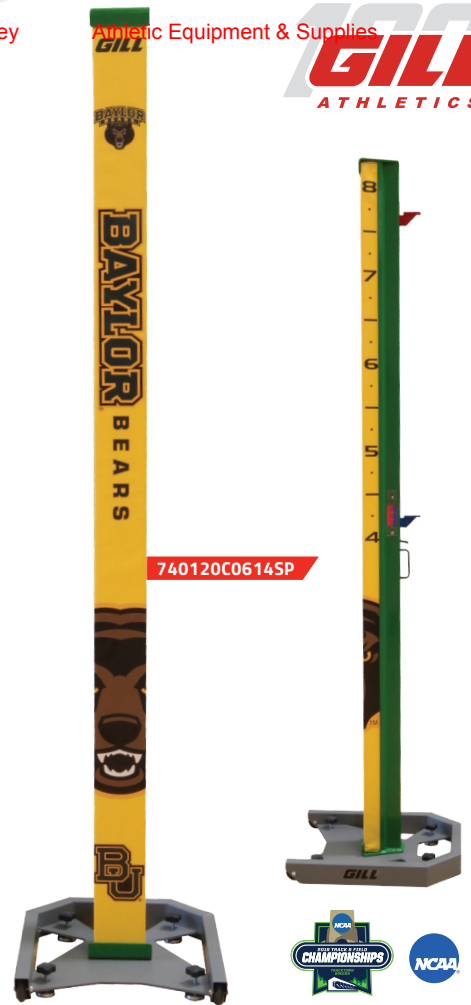

740120C0614SP



OFFICIAL EQUIPMENT SUPPLIER TO THE 2018 TRACK & FIELD CHAMPIONSHIPS

NATIONAL HIGH JUMP STANDARDS

- Unique fluted aircraft quality aluminum uprights and extruded risers
- Cast aluminum upper riser guide with fixed clamping knob
- Upper riser guide adds extra stability at higher heights
- Cast aluminum bar rests, upper and lower riser guides
- Weighted base includes wheels for easy mobility and leveling pads
- Height adjustment: 3' to 9'
- Reads both English and Metric measurements
- Use the two-digit number of your powder coat color selection (Page 9) to replace XX in the item number
- Meets NFHS, NCAA and IAAF specifications, IAAF certified

7010	Gray	\$1285/pr
7010CXX	Choose Color	\$1410/pr

INTERNATIONAL HIGH JUMP STANDARDS

- Regal extruded aluminum construction design
- Fully encapsulated riser ensures maximum stability at higher heights
- Superior inner channel design for raising/lowering crossbar increases longevity
- Unique adjustment readout for initial calibration to correct for uneven surfaces
- Weighted base includes wheels for easy mobility
- Height adjustment: 1" to 8' 6"
- Reads both English and Metric measurements
- Use the two-digit number of your powder coat color selection (Page 9) to replace XX in the item number
- Meets NFHS, NCAA and IAAF specifications, IAAF certified

730120CXX	Standards	\$1770/pr
-----------	-----------	-----------

AGX M4 HIGH JUMP STANDARDS

- Simple height adjustments with unique thumb button and handle assist
- Choose your team's powder coat color for complete customization
- Customize exclusive 2" safety pad with choice of color and graphics
- High-visible English or Metric unit height indicator display for fans, coaches, and athletes
- Eye-level height indicator color coordinated with dual bar rest system
- Exclusive steel powder coated base with wheels for increased stability and easy transportation
- Height range from 1' to 8' 3"
- Use the two-digit number of your vinyl color selection (Page 9) to replace XX in the item number
- Use the two-digit number of your powder coat color selection (Page 9) to replace YY in the item number
- Meets NFHS, NCAA, and IAAF specifications

740120CXXYYSP	Standards	IAAF	\$2060/pr
---------------	-----------	------	-----------

GILL 10 YEAR LIMITED WARRANTY

On all Standards (excludes Essentials). Call for Details.

CUSTOMIZABLE STANDARDS

See color charts on page 9 to replace the XX and YY in the item numbers.

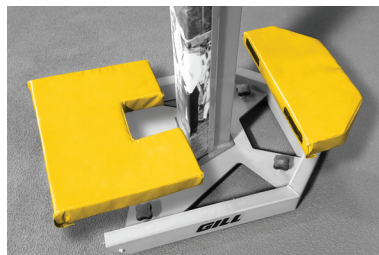

M4 HIGH JUMP BASE PADS

Specifically designed for AGX M4 High Jump Standards.

- Use the two-digit number of your vinyl color selection (Page 9) to replace XX in the item number

708CXX	\$257/pr
--------	----------

ACCESSORIES & PADS

SAFETYMAX+™ VAULT BOX COLLAR

- Compatible with any style of landing system
- Spike Plate to reduce collar from slipping
- Complies with ASTM standard F2949
- Meets the 2014 NCAA and 2015 NFHS rule

719 SafetyMax+ Vault Box Collar \$565

71904 Spike Plate Kit \$189



VAULT PERIMETER PAD

- High school rule requires covering over all exposed hard surfaces surrounding the PV landing area
- 4' x 8' pad is 2" thick high density foam

716 \$271



VAULT BOX COLLAR

- Vault Box Collar for international and USATF use only
- Does not meet current NFHS and NCAA rules

717 \$299



LANDING SYSTEM TIE-DOWN KIT

- Decrease the chances of pit 'flying' away
- Increase safety and security of your pits
- Straps sold individually for custom solution

7081 With Concrete Anchors \$48

7082 With Grass Anchors \$48



STANDARD BASE PADS

- Fits 28" tall Gill systems and all standards with center-mounted uprights

61517CXX \$939/pr



ANGLED BASE PADS

- Fits 32" tall Gill systems and all standards with center-mounted uprights
- Adjustable measurement scale on top of pad
- Meets IAAF specifications

61617CXX \$1410/pr



SLOPED AGX M4 BASE PADS

Specifically designed for AGX M4 Pole Vault Standards.

61717CXX \$1410/pr

CUSTOMIZABLE BASE PADS

See color charts on page 3 to replace the XX in the item numbers.



ALUMINUM PIT CART

- Deck of cart measures 5' x 10'
- Constructed of quality aluminum planking
- Pneumatic caster wheels have a 12" diameter for easy travel over smooth and rough surfaces
- Deck height is optimal 19"

768 \$2470

WOOD DECK PIT CART

- Deck of cart measures 4' x 8'
- Constructed of MDO exterior plywood for improved weather resistance
- Pneumatic caster wheels have a 12" diameter for easy travel over smooth and rough surfaces
- Deck height is 16"

767 \$1275

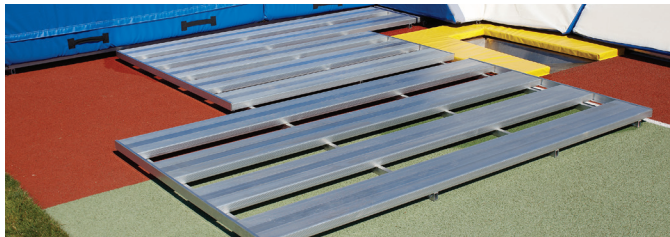

ALUMINUM PLATFORMS FOR LANDING SYSTEMS

- Support PV and HJ pits above the ground to prevent water damage
- Corrosion resistant aluminum
- Consist of individual, easy to carry and convenient to store pallets
- Quickly assembled and disassembled

733641	Fits 64117 High Jump System	\$2360
733642	Fits 64217 High Jump System	\$2305
733644	Fits 64417 High Jump System	\$4600
733646	Fits 64617 High Jump System	\$2720
733648	Fits 64817 High Jump System	\$6600
733654	Fits 65417 Pole Vault System	\$5365
733662	Fits 66217 Pole Vault System	\$5500
733663	Fits 66317 and 65817 Pole Vault System	\$6900
733665	Fits 66517 Pole Vault System	\$7260
733668	Fits 66817 Pole Vault System	\$8000



POLYMER PLATFORMS FOR LANDING SYSTEMS

- Support PV and HJ pits above the ground to prevent water damage
- Corrosion resistant rubber that reduces the tendency of pit migration during use
- Consist of individual, easy to carry and convenient to store pieces
- Quickly assembled and disassembled

734641	Fits 64117 High Jump System	\$1670
734642	Fits 64217 High Jump System	\$2010
734644	Fits 64417 High Jump System	\$4100
734646	Fits 64617 High Jump System	\$2140
734648	Fits 64817 High Jump System	\$4470
734654	Fits 65417 Pole Vault System	\$4470
734662	Fits 66217 Pole Vault System	\$4600
734663	Fits 66317 and 65817 Pole Vault System	\$5560
734665	Fits 66517 Pole Vault System	\$6600
734668	Fits 66817 Pole Vault System	\$7000



WATER SHED INSERT

- Guaranteed to increase the life of your HJ and PV pits
- Prevents water pooling on your pit which destroys your foam

709 \$72

GILL RAISED RUNWAYS

In the past, these types of runway systems have been priced upwards to \$75k! You can now have this product at a fraction of that price. The Gill Raised Runway allows for the flexibility to design runways that will accommodate the pole vault, long jump and triple jump for all levels of competition and practice.

The basic unit is an 8' x 4' general runway section. Specialized sections incorporate a vault box or take-off board trays and blanking lids. The construction of each section is welded aluminum, with 1/2" plywood decking. Track surfacing is not included, so you can have your preference on surfacing.

Adjunct products for the Raised Runway include the Soft Shell Sand Pit Form for the long and triple jump (sand not included), and a pole vault pit elevating system.

CALL TODAY!

LET US HELP YOU PIECE TOGETHER THE **RAISED RUNWAY** SYSTEM THAT BEST FITS YOUR NEEDS.

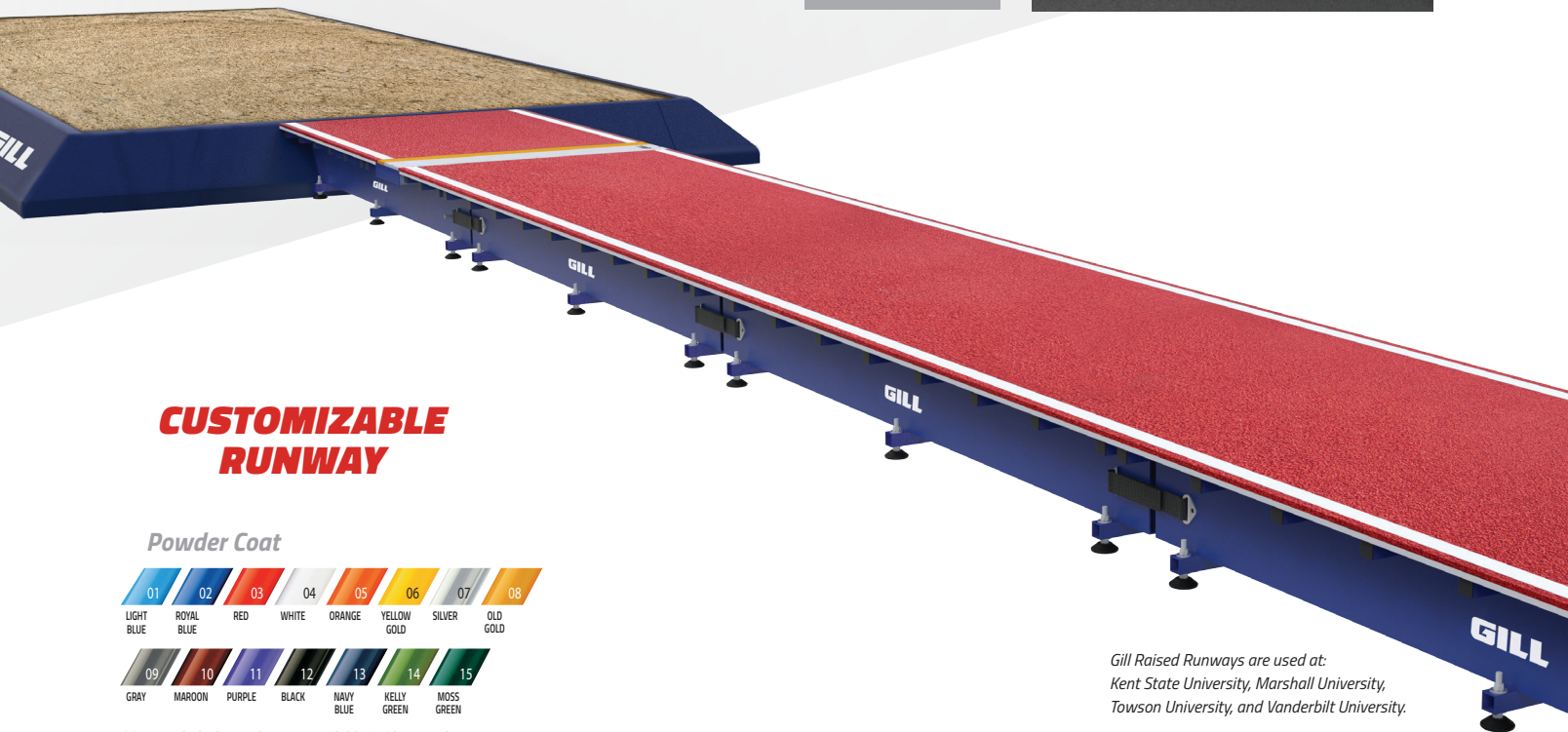
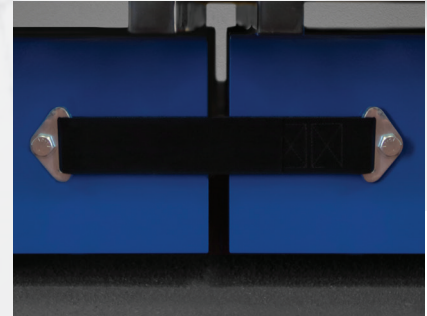

CUSTOMIZABLE RUNWAY

Powder Coat



*Gray and Black powder coat available in Gloss or Flat

Gill Raised Runways are used at:
Kent State University, Marshall University,
Towson University, and Vanderbilt University.

GILL PIT GARAGES

PROTECT YOUR
INVESTMENT



PIT GARAGES

- Protect your PV or HJ investment from the elements
- Keep rain, snow, and vandals away
- Easily moves on and off position with the help of a few people
- Use the two-digit number of your color selection to replace XX in the item number
- **Factory Installation required**

881018CXX	10' X 18' Pits or Smaller	\$8465
881425CXX	14' X 25' Pits or Smaller	\$12000
882120CXX	21' X 20' Pits or Smaller	\$13500
883022CXX	30' X 22' Pits or Smaller	\$15400
GILLINSTALLHJG	High Jump Pit Garage Factory Installation	\$3000
GILLINSTALLPVG	Pole Vault Pit Garage Factory Installation	\$4000

COLORS



CROSSBARS



AGX™ CROSSBARS

- Exclusive half moon profile ends lower the center of gravity of the bar
- Heaviest crossbar the rules allow
- Shorter, more stable, end pieces redesigned for improved performance
- Features durable thick-walled pulltruded fiberglass rod
- Meets NFHS, NCAA and IAAF specifications, IAAF certified



529	High Jump		\$130
530	Pole Vault		\$136



3-PIECE CROSSBARS

- Crossbar kit that ships by UPS instead of truck
- Reduced shipping charges
- Can be shipped UPS overnight
- Utilizes same durable thick-walled pulltruded fiberglass as International Crossbars
- Meets NFHS and NCAA specifications



INSPECT CROSSBARS FOR
VISIBLE AND CONCEALED DAMAGE
BEFORE ACCEPTING DELIVERY

CROSSBARS ARE NOT
GUARANTEED AGAINST BREAKAGE

531	High Jump		\$133
532	Pole Vault		\$133



GILL® INTERNATIONAL CROSSBARS

- Features durable thick-walled pulltruded fiberglass rod
- Minimum sag
- Order sets of three to help offset expensive shipping costs
- Meets NFHS, NCAA and IAAF specifications, IAAF certified

525	High Jump		\$99/ea
5253	High Jump (3)		\$288/set
526	Pole Vault		\$99/ea
5263	Pole Vault (3)		\$288/set
52113	Replacement Crossbar End		\$12



ESSENTIALS™ CROSSBARS

- Features durable pulltruded fiberglass rod
- Excellent choice for high school competitions
- Order sets of three to help offset expensive shipping costs
- Meets NFHS specifications

522	High Jump		\$65/ea
5223	High Jump (3)		\$189/set
523	Pole Vault		\$65/ea
5233	Pole Vault (3)		\$189/set
52116	Replacement Crossbar End		\$12



E73705



E73710



PV/HJ MEASURING STICK

- Remove guesswork of manual measuring devices with scientific laser device
- Ergonomic 59" tall measuring stick brings laser readout closer to eye level
- Use for both High Jump and Pole Vault events
- Simple to use: Utilize viewfinder to line up crossbar and press the button
- Measure in either English or Metric units
- Minimum measurement is 1.54m (5' 1/8"), No maximum measurement

ELASTIC CROSSBAND

- Training crossbar for PV and HJ
- Bright fluorescent orange elastic tubing
- 1" diameter foam sections

528 \$20

E73705	Stick and Laser	\$957
E73706	Stick Only	\$96
E73710	Laser Only	\$885



PUTTER UPPER

- Simplest crossbar placer ever made
- Fits over the end of any vaulting pole

710390 \$18



TELESCOPING CROSSBAR PLACER

- Facilitate easy placement of crossbars at all heights
- Telescoping pole extends 6' to 12' in 6" increments
- Thumb lock and release mechanism allows for quick adjustment

950 \$124



HIGH JUMP MEASURING ROD

- English scale side has 1/8" resolution
- Metric scale side has 1cm resolution
- Unit folds down to 49" long and weighs 4 1/2 lb

722 \$170

VAULTING POLES

PACERFXV™

Gill's flagship vaulting pole is made from an S-fiberglass and is designed to be consistent through the series of poles. This creates a smooth transition for a vaulter moving from one pole to the next. The PacerFXV is the only pole on the market with a **one year warranty**, and performs well for all styles of jumpers.

11' 6" (3.50M)

ITEM #	TEST WT	TIP
735041	90 lb	21
735045	100 lb	21
735050	110 lb	21
735054	120 lb	21
735059	130 lb	18
735063	140 lb	18

\$419

12' (3.60M)

ITEM #	TEST WT	TIP
736041	90 lb	21
736045	100 lb	21
736050	110 lb	21
736054	120 lb	21
736059	130 lb	18
736063	140 lb	18

\$439

12' 6" (3.75M)

ITEM #	TEST WT	TIP
737545	100 lb	21
737547	105 lb	21
737550	110 lb	21
737552	115 lb	18
737554	120 lb	18
737557	125 lb	18
737559	130 lb	18
737561	135 lb	18
737563	140 lb	16
737566	145 lb	16
737568	150 lb	16
737570	155 lb	16

\$469

13' (4.00M)

ITEM #	TEST WT	TIP
740050	110 lb	18
740052	115 lb	18
740054	120 lb	18
740057	125 lb	18
740059	130 lb	18
740061	135 lb	18
740063	140 lb	16
740066	145 lb	16
740068	150 lb	16
740070	155 lb	16
740073	160 lb	13

\$519

13' 6" (4.15M)

ITEM #	TEST WT	TIP
741554	120 lb	16
741557	125 lb	16
741559	130 lb	16
741561	135 lb	16
741563	140 lb	16
741566	145 lb	16
741568	150 lb	13
741570	155 lb	13
741573	160 lb	13
741575	165 lb	13
741577	170 lb	10
741580	175 lb	10

\$549

14' (4.25M)

ITEM #	TEST WT	TIP
742557	125 lb	16
742559	130 lb	16
742561	135 lb	13
742563	140 lb	13
742566	145 lb	13
742568	150 lb	13
742570	155 lb	13
742573	160 lb	13
742575	165 lb	10
742577	170 lb	10
742580	175 lb	10
742582	180 lb	7

\$559



CARBON FIBER TECHNOLOGY

This combination of carbon fiber and PacerFXV technology creates the perfect formula for the advanced and technical vaulter. The Carbon FX is designed to match the length and flex needs of your series of poles, and generates a **substantially lighter carry weight**.



14' 6" (4.40M)

ITEM #	TEST WT	TIP
744059	130 lb	13
744061	135 lb	13
744063	140 lb	10
744066	145 lb	10
744068	150 lb	10
744070	155 lb	10
744073	160 lb	10
744075	165 lb	10
744077	170 lb	7
744080	175 lb	7
744082	180 lb	7
744084	185 lb	5
		\$569

15' (4.60M)

ITEM #	TEST WT	TIP
746057	125 lb	13
746059	130 lb	13
746061	135 lb	13
746063	140 lb	10
746066	145 lb	10
746068	150 lb	10
746070	155 lb	10
746073	160 lb	10
746075	165 lb	7
746077	170 lb	7
746080	175 lb	7
746082	180 lb	5
		\$609

15' 6" (4.70M)

ITEM #	TEST WT	TIP
747068	150 lb	10
747070	155 lb	10
747073	160 lb	7
747075	165 lb	7
747077	170 lb	5
747080	175 lb	5
747082	180 lb	4
747084	185 lb	4
747086	190 lb	4
747088	195 lb	4
		\$679

16' 1" (4.90M)

ITEM #	TEST WT	TIP
749073	160 lb	10
749075	165 lb	10
749077	170 lb	7
749080	175 lb	7
749082	180 lb	5
749084	185 lb	5
749086	190 lb	4
749088	195 lb	4
749091	200 lb	4
		\$719

16' 5" (5.00M)

ITEM #	TEST WT	TIP
750073	160 lb	10
750075	165 lb	7
750077	170 lb	7
750080	175 lb	7
750082	180 lb	7
750084	185 lb	5
750086	190 lb	5
750088	195 lb	4
750091	200 lb	4
		\$789

16' 9" (5.10M)

ITEM #	TEST WT	TIP
751084	185 lb	5
751086	190 lb	5
751088	195 lb	4
751091	200 lb	4
751093	205 lb	4
		\$839

15' (4.60M)

ITEM #	TEST WT	TIP
846063	140 lb	10
846066	145 lb	10
846068	150 lb	10
846070	155 lb	10
846073	160 lb	10
846075	165 lb	10
846077	170 lb	10
846080	175 lb	10
846082	180 lb	10
846084	185 lb	7
846086	190 lb	7
		\$750

15' 6" (4.70M)

ITEM #	TEST WT	TIP
847068	150 lb	10
847070	155 lb	10
847073	160 lb	10
847075	165 lb	10
847077	170 lb	10
847080	175 lb	10
847082	180 lb	7
847084	185 lb	7
847086	190 lb	5
847088	195 lb	5
		\$788

16' 1" (4.90M)

ITEM #	TEST WT	TIP
849073	160 lb	10
849075	165 lb	10
849077	170 lb	10
849080	175 lb	10
849082	180 lb	7
849084	185 lb	7
849086	190 lb	5
849088	195 lb	5
849091	200 lb	5
		\$826

16' 5" (5.00M)

ITEM #	TEST WT	TIP
850077	170 lb	10
850080	175 lb	7
850082	180 lb	7
850084	185 lb	7
850086	190 lb	5
850088	195 lb	5
850091	200 lb	4
850093	205 lb	4
850095	210 lb	4
		\$892

16' 9" (5.10M)

ITEM #	TEST WT	TIP
851084	185 lb	5
851086	190 lb	5
851088	195 lb	4
851091	200 lb	4
851093	205 lb	4
851095	210 lb	4
		\$921

VAULTING POLES ARE NOT GUARANTEED AGAINST BREAKAGE

INSPECT VAULTING POLES FOR VISIBLE AND CONCEALED DAMAGE BEFORE ACCEPTING DELIVERY



MYSTIC™

The Mystic's S-fiberglass and lightweight design produce the perfect pole for beginner vaulters. Its integrated design allows for *smoother and more consistent transitions*, making it the perfect pole to vault through the entire series or transition to the PacerFXV.

10' (3.10M)

ITEM #	TEST WT	TIP
631032	70 lb	21
631036	80 lb	21
631041	90 lb	21
631045	100 lb	21
631050	110 lb	21
631054	120 lb	21
631059	130 lb	21
\$369		

10' 6" (3.25M)

ITEM #	TEST WT	TIP
632536	80 lb	21
632541	90 lb	21
632545	100 lb	21
632550	110 lb	18
632554	120 lb	18
632559	130 lb	16
632563	140 lb	16
\$379		

11' (3.35M)

ITEM #	TEST WT	TIP
633536	80 lb	21
633541	90 lb	21
633545	100 lb	18
633550	110 lb	18
633554	120 lb	18
633559	130 lb	18
633563	140 lb	16
633568	150 lb	16
\$389		

11' 6" (3.50M)

ITEM #	TEST WT	TIP
635041	90 lb	18
635045	100 lb	18
635050	110 lb	18
635054	120 lb	18
635059	130 lb	16
635063	140 lb	16
635068	150 lb	16
\$409		

12' (3.60M)

ITEM #	TEST WT	TIP
636041	90 lb	18
636043	95 lb	18
636045	100 lb	18
636047	105 lb	18
636050	110 lb	18
636052	115 lb	18
636054	120 lb	18
636057	125 lb	18
636059	130 lb	16
636061	135 lb	16
636063	140 lb	16
636066	145 lb	16
636068	150 lb	13
\$439		

VAULTING POLES ARE NOT GUARANTEED AGAINST BREAKAGE

INSPECT VAULTING POLES FOR VISIBLE AND CONCEALED DAMAGE BEFORE ACCEPTING DELIVERY

CARBON MYSTIC™



CARBON FIBER TECHNOLOGY

This pole combines the Mystic pattern with the advantages of a carbon fiber pole. Offering a *light carry weight*, small diameter, and faster recoil, the Carbon Mystic is ideal for vaulters who need a more aggressive pole.

ALL NEW LOOK!

12' 6" (3.75M)

ITEM #	TEST WT	TIP
637545	100 lb	18
637547	105 lb	18
637550	110 lb	18
637552	115 lb	18
637554	120 lb	18
637557	125 lb	16
637559	125 lb	16
637561	135 lb	16
637563	140 lb	16
637566	145 lb	13
637568	150 lb	13
637570	155 lb	13
637573	160 lb	13
\$459		

13' (4.00M)

ITEM #	TEST WT	TIP
640050	110 lb	16
640052	115 lb	16
640054	120 lb	16
640057	125 lb	16
640059	130 lb	16
640061	135 lb	13
640063	140 lb	13
640066	145 lb	13
640068	150 lb	13
640070	155 lb	13
640073	160 lb	13
\$469		

HOW TO CHOOSE YOUR POLE TIPS

Visit our online guide: www.gillathletics.com/poletips

COMPETITION POLE TIPS

Tough, durable polyurethane for a softer plant and long lasting performance.



700002, 700004, 700005, 700007, 700010,
700013, 700016, 700018, and 700021

\$10/ea

13' (4.00M)

ITEM #	TEST WT	TIP
940054	120 lb	21
940057	125 lb	21
940059	130 lb	21
940061	135 lb	21
940063	140 lb	21
940066	145 lb	18
940068	150 lb	18
940070	155 lb	18
940073	160 lb	18
\$531		

13' 6" (4.15M)

ITEM #	TEST WT	TIP
941557	125 lb	18
941559	130 lb	18
941561	135 lb	18
941563	140 lb	18
941566	145 lb	18
941568	150 lb	18
941570	155 lb	18
941573	160 lb	16
941575	165 lb	16
941577	170 lb	16
\$569		

14' (4.25M)

ITEM #	TEST WT	TIP
942559	130 lb	18
942561	135 lb	18
942563	140 lb	18
942566	145 lb	16
942568	150 lb	16
942570	155 lb	16
942573	160 lb	13
942575	165 lb	13
942577	170 lb	13
942580	175 lb	13
942582	180 lb	13
\$607		

14' 6" (4.40M)

ITEM #	TEST WT	TIP
944061	135 lb	16
944063	140 lb	16
944066	145 lb	16
944068	150 lb	13
944070	155 lb	13
944073	160 lb	13
944075	165 lb	13
944077	170 lb	13
944080	175 lb	13
944082	180 lb	13
\$655		

SKYPOLE

The Skypole's is uniquely designed to 'slow down' the vaulting motion. This pole is Engineered to 'roll' into the pit easier allowing vaulters to rotate into a more vertical position. These easy roll characteristics make Skypole the *preferred pole for high school vaulters*.

11' (3.35M)

ITEM #	TEST WT	TIP
110090	90 lb	21
110100	100 lb	21
110110	110 lb	21
110120	120 lb	21
110130	130 lb	21
110140	140 lb	21
110150	150 lb	18
		\$379

11' 6" (3.50M)

ITEM #	TEST WT	TIP
116090	90 lb	21
116100	100 lb	21
116110	110 lb	21
116120	120 lb	21
116130	130 lb	21
116140	140 lb	21
116150	150 lb	21
		\$409

12' (3.60M)

ITEM #	TEST WT	TIP
120100	100 lb	21
120110	110 lb	21
120120	120 lb	21
120130	130 lb	18
120140	140 lb	18
120150	150 lb	16
120160	160 lb	16
		\$429

12' 6" (3.75M)

ITEM #	TEST WT	TIP
126115	115 lb	21
126120	120 lb	21
126125	125 lb	21
126130	130 lb	18
126135	135 lb	18
126140	140 lb	16
126145	145 lb	16
126150	150 lb	16
126155	155 lb	16
126160	160 lb	16
		\$449

13' (4.00M)

ITEM #	TEST WT	TIP
131115	115 lb	18
131120	120 lb	18
131125	125 lb	18
131130	130 lb	18
131135	135 lb	18
131140	140 lb	16
131145	145 lb	16
131150	150 lb	16
131155	155 lb	16
131160	160 lb	13
131165	165 lb	13
131170	170 lb	13
131175	175 lb	13
131180	180 lb	10
131185	185 lb	10
131190	190 lb	7
		\$469

VAULTING POLES ARE NOT GUARANTEED AGAINST BREAKAGE

INSPECT VAULTING POLES FOR VISIBLE AND CONCEALED DAMAGE BEFORE ACCEPTING DELIVERY

PACER® ONE

The Pacer® One is a *versatile, economical pole* perfect for beginner and intermediate athletes. This pole's pattern slows down the bend to give the vaulter time to get in position.

9' (2.75M)

ITEM #	TEST WT	TIP
527527	60 lb	21
527532	70 lb	21
527536	80 lb	21
527541	90 lb	21
527545	100 lb	21
		\$239

10' (3.10M)

ITEM #	TEST WT	TIP
531032	70 lb	21
531036	80 lb	21
531041	90 lb	21
531045	100 lb	21
531050	110 lb	21
531054	120 lb	21
531059	130 lb	21
		\$264

11' (3.35M)

ITEM #	TEST WT	TIP
533536	80 lb	21
533541	90 lb	21
533545	100 lb	21
533550	110 lb	21
533554	120 lb	21
533559	130 lb	21
533563	140 lb	21
533568	150 lb	21
		\$299

12' (3.60M)

ITEM #	TEST WT	TIP
536041	90 lb	21
536045	100 lb	21
536050	110 lb	21
536054	120 lb	21
536059	130 lb	18
536063	140 lb	18
536068	150 lb	16
		\$319

13' (4.00M)

ITEM #	TEST WT	TIP
540050	110 lb	18
540054	120 lb	18
540059	130 lb	18
540063	140 lb	16
540068	150 lb	16
540073	160 lb	13
		\$349

14' (4.25M)

ITEM #	TEST WT	TIP
542559	130 lb	16
542563	140 lb	13
542568	150 lb	13
542573	160 lb	10
542577	170 lb	10
542582	180 lb	7
		\$369



ALL NEW LOOK!

13' 6" (4.15M)		
ITEM #	TEST WT	TIP
136120	120 lb	18
136125	125 lb	18
136130	130 lb	16
136135	135 lb	16
136140	140 lb	16
136145	145 lb	16
136150	150 lb	13
136155	155 lb	13
136160	160 lb	13
136165	165 lb	13
136170	170 lb	10
136175	175 lb	10
136180	180 lb	10
136185	185 lb	7
136190	190 lb	7
136195	195 lb	5
		\$499

14' (4.25M)		
ITEM #	TEST WT	TIP
140120	120 lb	16
140125	125 lb	16
140130	130 lb	16
140135	135 lb	16
140140	140 lb	13
140145	145 lb	13
140150	150 lb	13
140155	155 lb	13
140160	160 lb	10
140165	165 lb	10
140170	170 lb	10
140175	175 lb	7
140180	180 lb	7
140185	185 lb	5
140190	190 lb	5
140195	195 lb	4
140200	200 lb	4
		\$519

14' 6" (4.40M)		
ITEM #	TEST WT	TIP
146140	140 lb	10
146145	145 lb	10
146150	150 lb	10
146155	155 lb	10
146160	160 lb	10
146165	165 lb	10
146170	170 lb	7
146175	175 lb	7
146180	180 lb	5
146185	185 lb	4
146190	190 lb	4
		\$549

15' (4.60M)		
ITEM #	TEST WT	TIP
150145	145 lb	10
150150	150 lb	10
150155	155 lb	10
150160	160 lb	7
150165	165 lb	7
150170	170 lb	5
150175	175 lb	5
150180	180 lb	5
150185	185 lb	4
150190	190 lb	4
		\$579

HOW TO CHOOSE YOUR POLE TIPS

Visit our online guide: www.gillathletics.com/poletips

COMPETITION POLE TIPS

Tough, durable polyurethane for a softer plant and long lasting performance.



700002, 700004, 700005, 700007, 700010,
700013, 700016, 700018, and 700021

\$10/ea

PACER®

PACER® TRAINING POLE

- Designed for drills used by vaulters at all levels
- Excellent for learning and practicing a proper plant and take-off from a short run
- Not valid for competition

10' 9" (3.27M)		
ITEM #	TEST WT	TIP
7109090	70-90 lb	21
		\$359

12' (3.60M)		
ITEM #	TEST WT	TIP
7120110	90-110 lb	18
		\$369
7120130	110-130 lb	18
		\$409

13' (4.00M)		
ITEM #	TEST WT	TIP
7130150	130-150 lb	16
		\$459

13' 6" (4.15M)		
ITEM #	TEST WT	TIP
7136160	140-160 lb	16
		\$489
7136180	160-180 lb	10
		\$519

POLE BAGS & ACCESSORIES

CUSTOM POLE BAG

- Customize for your school's personality!
- Holds up to five vaulting poles
- Shoulder strap for ease of transportation
- Heavy duty vinyl and leather reinforced ends for long life
- Made to fit 6" corrugated drain tube (not included)
- Use the two-digit number of your vinyl color selection (Page 9) to replace the XX in the item number

8008##CXX 10'-18' Custom Pole Bag \$499

*Use two-digit number of desired pole bag length to replace '##' in part number. 10'-18' lengths available.



800801

800802

8008##CXX

700717

PACER DELUXE TEAM POLE BAG

- Holds up to 20 vaulting poles (10 sleeved, 10 unsleeved)
- Heavy duty nylon outer with a dense inner 1/2" thick foam fused with a hard plastic shell for strength
- 10 durable sewn-in pole sleeves
- Soft rubber handles and seams

700714 14' Team Pole Bag \$689

700715 15' Team Pole Bag \$769

700716 16' Team Pole Bag \$829

700717 17' Team Pole Bag \$869

ESSENTIALS™ POLE BAG

- Holds up to five vaulting poles
- Heavy duty polyester for long life
- Maximum length is 15'
- Made to fit 6" corrugated drain tube (not included)

800801 \$109

ELITE POLE BAG

- Holds up to five vaulting poles
- Heavy duty vinyl and leather reinforced ends for long life
- Adjustable from 14' 6" to 17' 6"
- Made to fit 6" corrugated drain tube (not included)

800802 \$199

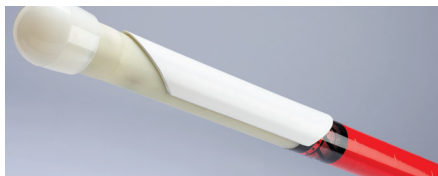

POLE PROTECTOR SLEEVE

Slips on easily to provide maximum protection against damage caused by pole contact with the upper edges of the vault box

700255 \$7.30

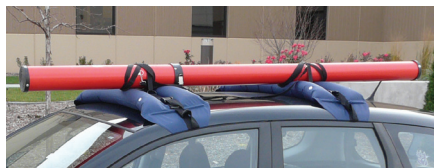

HANDIRACK™ INFLATABLE ROOF RACK

- Can be used to transport vaulting poles and/or javelins
- Economical alternative to installing a permanent after market roof rack
- Includes 2-HandiRack twin tubes with 5 metal D-ring anchor points, 2x3m webbing tie-downs, air pump and travel bag

700800 \$149

PACER® GIZMO

- Practice vaulting while safely on the ground
- Allows athlete to mimic complex movements that occur in the air while firmly on your feet
- Three cord system to accommodate your specific level of strength and coordination
- Vault specific training device designed to take you to the next level

700231 Small Grip \$238

700232 Large Grip \$238



VAULT TRAINER SYSTEM

- Unique device for beginner and intermediate vaulters
- Allows athlete to acclimate the body to positions occurring during peak vault height
- Strengthens muscle groups for effective push off
- Helps to coordinate grip and pole positions while rotating around pole for push off

TA190 \$309





INTERNATIONAL POLE CART

- Built to hold all the vaulting poles you own
- Made of sturdy steel with high end design
- Dual purposed wheels switch from swivel to locked position in a snap

733180	<i>Cart</i>	\$926
735	<i>Tow Bar Kit</i>	\$143



CHALK STAND

- Store chalk during practice and competition
- Lightweight stand features a wide opening for hands, a pocket for extra chalk, and rungs for hanging accessories or resting vaulting poles

WE305	<i>Chalk Stand</i>	\$257
700250	<i>1 lb Sports Chalk</i>	\$15



PORTABLE POLE RACK

- Convenient way to store and protect your poles during meets and practice
- Free standing pole rack made of heavy duty steel with durable powder coat finish

725	\$161
------------	--------------

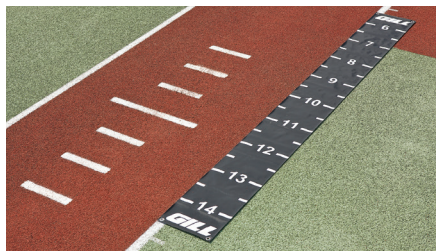

PV TAKEOFF INDICATOR

- Large easy to read numbers
- Easily identify the take-off step placement

TA189	\$22
--------------	-------------



VAULT BOX POWER PUMP

- Battery powered by 3 "D" cell batteries (not included)
- Pump fully submersible
- Empties a water filled vault box in less than five minutes

72001	\$132
--------------	--------------



GILL® PR SLIDING VAULT BOX

- Sliding vault box allows vaulters to perfect the run, plant, and take-off
- Pole carriage, run mechanics, tempo, and step placement are more effectively learned using this training tool
- Tip proof design has a built in handle, a zero mark molded into the side for placement accuracy
- Constructed of a high-impact thermoplastic

2531	\$519
-------------	--------------



GRRRIP PLUS LOTION & SPRAY

- Scientifically formulated mixture developed to enhance hand-grip up to 75% better
- Fluid mixes with natural skin oils to create a moisture barrier yet still allows the skin to breathe
- More convenient and cleaner than chalk

700253	<i>Lotion</i>	\$10
700254	<i>Spray</i>	\$10



POLE VAULT GRIP TAPE

- 12 ½ yard roll of colored adhesive tape
- 1 ½" width

700259	<i>White (15 yds)</i>	\$8.30
700260	<i>Red</i>	\$8.30
700261	<i>Maroon</i>	\$8.30
700262	<i>Gold</i>	\$8.30
700263	<i>Green</i>	\$8.30
700264	<i>Royal</i>	\$8.30
700265	<i>Purple</i>	\$8.30
700266	<i>Black</i>	\$8.30
700267	<i>Pink</i>	\$8.30



GRAPHIC POLE VAULT GRIP TAPE

- 20 yard roll of adhesive design tape
- Camo/flag designs come in 2" width
- Jolly Roger design comes in 1" width

700273	<i>USA Flag</i>	\$16
700271	<i>Pink Camo</i>	\$16
700272	<i>Winter Camo</i>	\$16
700274	<i>Jolly Roger</i>	\$16

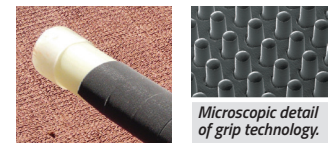

NINJA ELITE POLE VAULT GRIP TAPE

- Lab-designed with thousands of gripping 'fingers'
- Grip lighter and hold tighter
- No additional substances needed (chalk, sticky spray, etc)
- Slip resistant, vibration dampening and easy release properties
- Water and oil resistant

700281	<i>9' x 1"</i>	\$20
---------------	----------------	-------------

FUSION™

FASTER STARTS THROUGH ADVANCED TECHNOLOGY

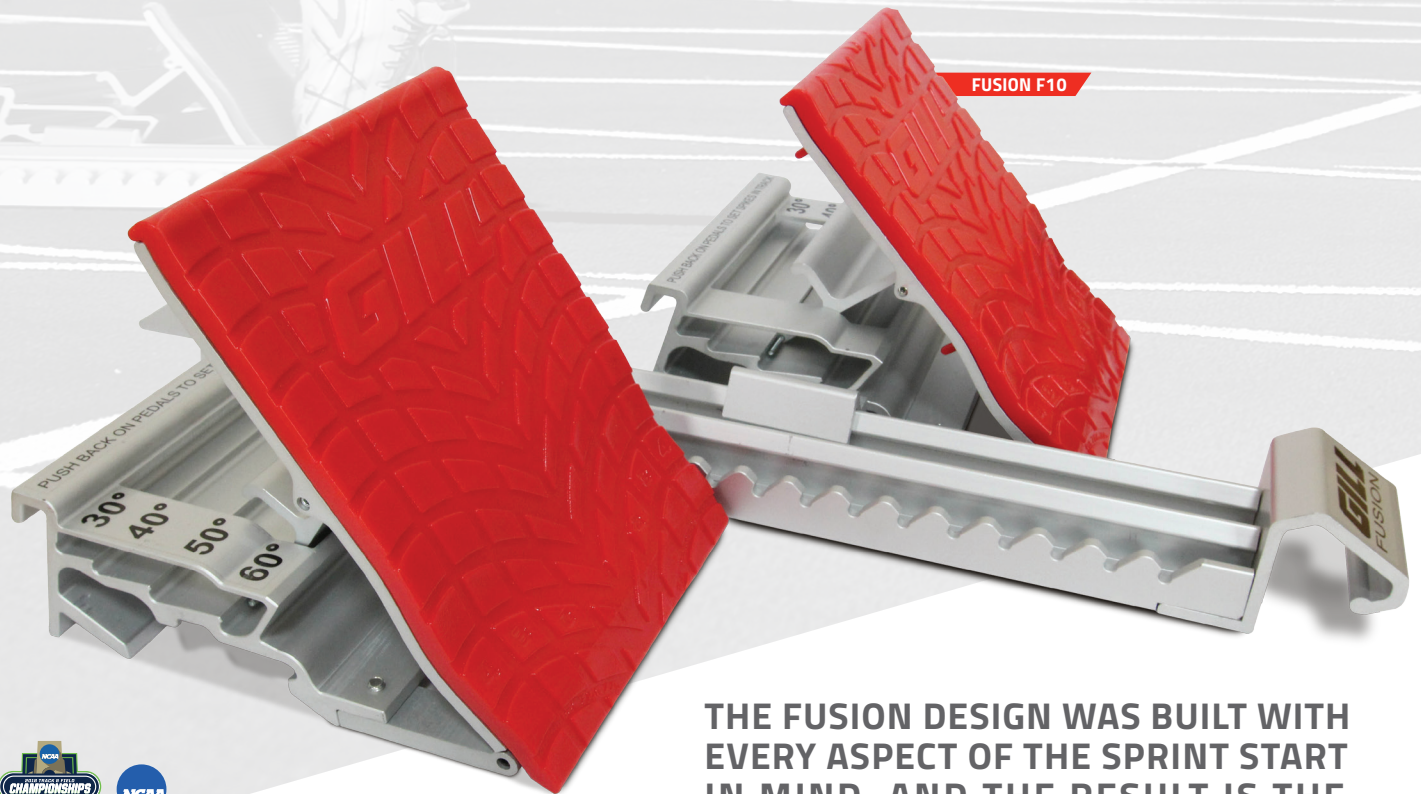

FUSION F10

THE FUSION DESIGN WAS BUILT WITH EVERY ASPECT OF THE SPRINT START IN MIND, AND THE RESULT IS THE BEST STARTING BLOCK IN EXISTENCE.



OFFICIAL EQUIPMENT SUPPLIER TO THE
2018 TRACK & FIELD CHAMPIONSHIPS

FUSION™ F10 STARTING BLOCK

- Exclusive 8" x 10" pedal allows full heel support for the best starts
- Precise and consistent foot placement is ensured using integrated pedal markings
- Angled spikes in base of pedals guarantee no slipping
- Built in handle allows for easy carriage between locations
- Pedals adjustable to 30°, 40°, 50°, 60°
- Meets NFHS, NCAA and IAAF specifications, IAAF certified

730183C02	Royal Blue		\$483
730183C03	Red		\$483
730183C05	Orange		\$483
730183C12	Black		\$483
730183C15	Dark Green		\$483



Adjust Fusion pedals to four different angles to fit your starting style.



Handle provides easy transport.



MORE FUSION COLOR OPTIONS

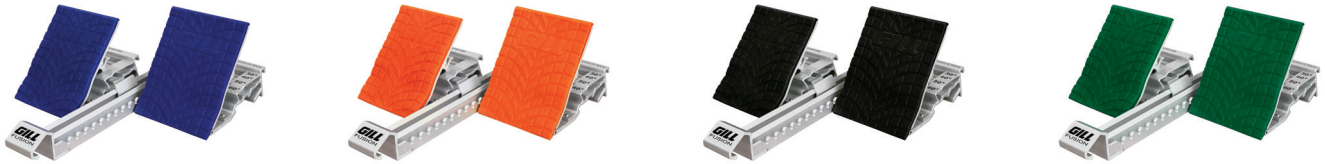

FUSION™ F8 STARTING BLOCK

- Exclusive 8" x 8" pedals designed for a more aggressive acceleration pattern
- Meets NFHS, NCAA and IAAF specifications, IAAF certified

730182C02	Royal Blue		\$452
730182C03	Red		\$452
730182C05	Orange		\$452
730182C12	Black		\$452
730182C15	Dark Green		\$452

FUSION™ F4 STARTING BLOCK

- Standard 4" x 8" pedals
- Meets NFHS, NCAA and IAAF specifications, IAAF certified

730181C02	Royal Blue		\$380
730181C03	Red		\$380
730181C05	Orange		\$380
730181C12	Black		\$380
730181C15	Dark Green		\$380

MOYE™ PEDAL ADAPTER

Converts any Fusion block into a Moyer style block

730168 \$65



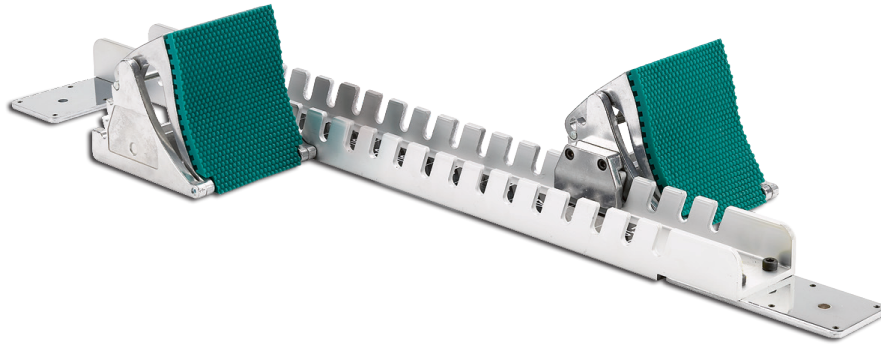

NATIONAL STARTING BLOCK

- Aircraft aluminum rail with cast aluminum pedals
- Pedals adjust to 45°, 55°, 65°, 75°
- Ruled decal in rail allows quick, easy, repeatable pedal set-up
- Includes ½" needle spikes for synthetic tracks
- *Meets NFHS, NCAA and IAAF specifications, IAAF certified*

730155  \$300

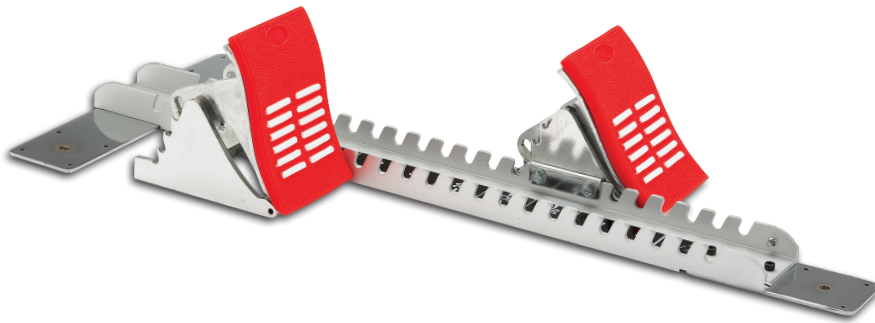

COLLEGIATE STARTING BLOCK

- Aircraft aluminum construction for maximal lifespan
- Pedals adjust to 45°, 55°, 65°, 75°
- Ruled decal in rail allows quick, easy, repeatable pedal set-up
- Includes ½" needle spikes for synthetic tracks
- *Meets NFHS and NCAA specifications*

410 \$191



SCHOLASTIC STARTING BLOCK

- Polished steel rail with cast aluminum pedals
- Pedals adjust to 45°, 55°, 65°, 75°
- Ruled decal in rail allows quick, easy, repeatable pedal set-up
- Includes ½" needle spikes for synthetic tracks
- *Meets NFHS and NCAA specifications*

412 \$129



ALL SURFACE STARTING BLOCK

- One piece, sixteen gauge steel with no loose parts
- Slightly wider pedals allow for a wider stance
- Fixed angle pedals with rubber pads
- Change pedal positions with simple Pedal Snap Lock
- Sixteen needle spikes eliminate slipping
- *Meets NFHS specifications*

414 \$95

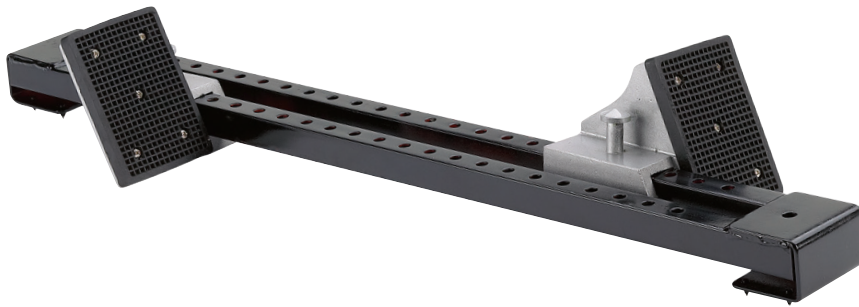

ESSENTIALS™ STARTING BLOCK

- One piece, all steel construction with durable black powder coat finish
- Standard width pedals with rubber pads
- Change pedal positions with simple Spring Lock Adjustment
- Features built in spikes to eliminate slipping
- *Meets NFHS specifications*

416 \$76

VP416 \$844

INCLUDED: (1) Essentials Block Cart, (8) Essentials Starting Blocks



INDOOR STARTING BLOCK

- No nails, pins or holes needed to hold in place
- Foot pressure on the flaps provide a non-slip start

417 \$32



GILL® INTERNATIONAL STARTING BLOCK CART

- Holds up to 10 starting blocks horizontally
- Handle is included for easy transport
- Includes a storage shelf for loose pedals and accessories
- Steel construction with durable, architectural gray powder coat finish

733190 \$1500

GILL® TRANSPORTER STARTING BLOCK CART

- Holds up to 16 starting blocks; any style
- Large wheels make transportation easy
- Steel construction with durable black powder coat finish

9311 \$699



ESSENTIALS™ BLOCK CART

- Holds up to 10 starting blocks; any style
- Steel construction with durable black powder coat finish

923 \$267

CONTINUUM™

THE WORLD'S FASTEST HURDLE IS ALSO THE WORLD'S SAFEST



OFFICIAL EQUIPMENT SUPPLIER TO THE 2018 TRACK & FIELD CHAMPIONSHIPS

CONTINUUM™ C4 AUTOMATIC HURDLES

The Continuum™ hurdle is designed to be the safest, fastest, and most unobtrusive hurdle that the rules will allow, all accomplished by placing the gateboard directly over the pivot point (tip-over-fulcrum).

- Internal leg weight from Continuum looping mechanism creates the most reliable hassle-free automatic hurdle on the market
- Redesigned robust frame features reinforced gusseted elbows for unparalleled strength
- Exclusive extrusion gatetubes allow for graphic customization
- Unique inner leg height indicator for no-mistake height settings (30", 33", 36", 39", 42")
- Internalized height mechanism creates whole-unit hurdle reducing maintenance and upkeep
- *Meets NFHS, NCAA and IAAF specifications*

1041CXX	41" Continuum C4	\$514
1047CXX	47" Continuum C4	\$514

CONTINUUM™ C4 MANUAL HURDLES

Includes all high-end features from the Auto C4 except with manual weight adjustments.

1141CXX	41" Continuum C4 Manual	\$390
1147CXX	47" Continuum C4 Manual	\$390



Easy trigger mechanism creates zero-click continuous transitions from height to height.

GILL 5 YEAR LIMITED WARRANTY

On all Hurdles (excludes Essentials). Call for Details.

Automatic Hurdle U.S. Patent #9,486,714
Manual Hurdle U.S. Patent #9,427,677

CUSTOM GATEBOARD PRINTING

Customize your hurdle boards with four color printing and show off your hurdles!

946	59 or Less Hurdles	\$60/order
	60 or More Hurdles	FREE



STANDARD GATEBOARD PRINTING

Customize your hurdle boards with standard gateboard printing. Block letters printed in single color.

945	59 or Less Hurdles	\$30/order
	60 or More Hurdles	FREE





COLLEGIATE ALUMINUM HURDLE

- Constructed of thick extruded aircraft aluminum
- Free sliding weights adjust quickly to official pullover resistance at all heights
- Aluminum powder coated gatetubes and Lexan® gateboard
- Easy stack design for better stacking and portability
- Adjustable heights: 30", 33", 36", 39", 42"
- *Meets NFHS and NCAA specifications*
- *Available in master's competition hurdle sizes*

4060CXX	41" Hurdle	\$199
406047CXX	47" Hurdle	\$218
406035CXX	35" Hurdle	\$228

CUSTOMIZABLE HURDLES

Gatetubes available in a variety of bright and durable powder coat colors at no extra cost.



**To specify color with order, use the two-digit number of your color selection to replace XX in the item number.
Gray and Black powder coat available in Gloss or Flat



NATIONAL ALUMINUM HURDLE

- Constructed of thick extruded aircraft aluminum
- Manual weight adjustment to meet precise official pullover force at each height
- Aluminum powder coated gatetubes and Lexan® gateboard
- Easy stack design for better stacking and portability
- Adjustable heights: 30", 33", 36", 39", 42"
- *Meets NFHS, NCAA and IAAF specifications, IAAF certified*

406CXX	41" Hurdle	\$220
40647CXX	47" Hurdle	\$229
40635CXX	35" Hurdle	\$238



ELITE HIGH SCHOOL HURDLE

- Best selling high school hurdle that sets the premier standard for elite programs
- Aluminum square tube construction
- Welded cross support design provides unrivalled durability
- Aluminum powder coated gatetubes and Lexan® gateboard
- Gatetubes allow for GRAPHIC customization
- Adjustable heights: 30", 33", 36", 39", 42"
- **Meets NFHS specifications**
- **Ships assembled**

402CXX	41" Elite High School Hurdle	\$166
402CXXSP	41" Hurdle with Gatetube Graphics	\$176

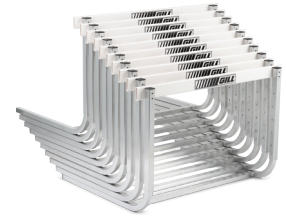

Easy stack design for better stacking and portability

CUSTOMIZABLE GATETUBES

See color charts on page 31 to replace the XX in the item numbers.

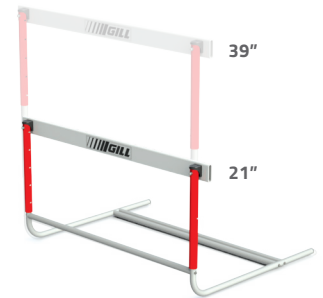

HIGH SCHOOL HURDLE

- Powder coated steel U-shaped single cross support design
- Single cross support allows for easy carriage and unhindered plyometric drills
- Aluminum powder coated gatetubes and Lexan® gateboard
- Adjustable heights: 30", 33", 36", 39", 42"
- **Meets NFHS specifications**
- **Assembly required**

403CXX	41" Hurdle	\$140
40335CXX	35" Hurdle	\$186

SCHOLASTIC ALUMINUM HURDLE

- All aluminum design provides unmatched value for high school programs
- Aluminum powder coated gatetubes and Lexan® gateboard
- Adjustable heights: 30", 33", 36", 39", 42"
- **Meets NFHS specifications**
- **Assembly required**

411CXX	41" Hurdle	\$118
---------------	------------	--------------

ESSENTIALS™ HURDLE

- Strong all steel construction
- Economical hurdle that meets official pullover resistance at all heights
- Rigid double-crossbar design ensures superior durability
- PVC gateboard
- Adjustable heights: 27", 30", 33", 36", 39", 42"
- **Meets NFHS specifications**
- **1 year warranty**
- **Assembly required**

400CXX	41" Hurdle	\$99
---------------	------------	-------------

TRIPLE GATETUBE HURDLE

- Strong all steel construction
- Hurdle adjusts for competition heights and shorter heights for training purposes
- Lexan® Gateboard
- Adjustable heights: 21", 24", 27", 30", 33", 36", 39"
- **Meets NFHS specifications**
- **1 year warranty**
- **Assembly required**

404CXX	41" Hurdle	\$103
---------------	------------	--------------



GILL® FLIGHT HURDLE CART

- World's most convenient and efficient hurdle cart
- Four wheel design provides superior moveability compared to corner cutting three wheel designed carts
- Sturdy steel construction with durable black powder coat finish
- Efficiently supports up to 10 hurdles at a time

4630	41" Hurdle Cart	\$318
733631	47" Hurdle Cart	\$421



HURDLE CART WEATHER COVER

733630CXX	41" Cart Weather Cover	\$260
733631CXX	47" Cart Weather Cover	\$260
733630CXXSP	41" Cart Weather Cover with Graphics	\$305
733631CXXSP	47" Cart Weather Cover With Graphics	\$305

CUSTOMIZABLE



*To specify color with order, use the two-digit number of your color selection to replace XX in the item number.



HURDLE PORTER

- Easy convenient way to move 8-10 hurdles
- Steel construction with durable black powder coat finish
- Compatible with 'L' shaped hurdles only

4210	41" Hurdle Porter	\$318
42147	47" Hurdle Porter	\$524



HURDLE CART

- Unique walk-in design
- Steel construction with durable black powder coat finish
- Large swivel casters for easy transportation
- Compatible with both rocker and 'L' shaped hurdles

4010	41" Hurdle Cart (Holds 8-10)	\$421
4020	41" Hurdle Cart (Holds 18-20)	\$751
4036	35" Hurdle Cart (Holds 8-10)	\$751

REPLACEMENT GATEBOARDS

Durable Lexan® gateboards. Hardware not included.

P40347	41" Gateboard	\$32
P40349	41" Ribbed Gateboard	\$38
40353	47" Ribbed Gateboard	\$41



FOAM HURDLE BOARD GUARD

- Easily attaches to hurdle for maximum protection against injury

403BG	Guard	\$11/ea
403BG10	Guards (10)	\$110/set



HURDLE STRIDE CHECKER

- Improve's athlete's take-off distance
- Provides the coach with immediate feedback on athlete's take-off

4031	\$199
------	-------

HURDLE HEIGHT DECAL

- Decal that includes indicators for 30", 33", 36", 39", 42" positions
- Designed to improve accuracy of meet volunteers and athlete practices
- Compatible with all hurdle brands (excluding Gill Continuum)

948	Hurdle Height Decal (set of 10)	\$10/set
-----	---------------------------------	----------



DISCUS

PACER AND OTE DISCUSES HAVE BEEN USED TO SET WORLD RECORDS AND WIN CHAMPIONSHIPS FOR YEARS.

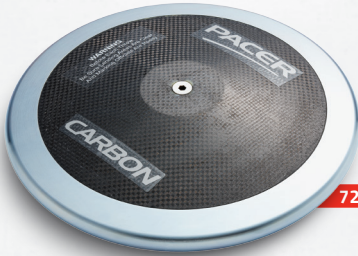

720211



82420



2203



2202



720201



817

PACER® CARBON DISCUS

- Recommended for elite throwers
- Carbon side plates
- Steel alloy rim
- Meets NFHS, NCAA and IAAF specifications, IAAF certified

720213	1.0K		88%	\$413
720212	1.6K		91%	\$440
720211	2.0K		93%	\$467

PACER® ORANGE DISCUS

- Recommended for advanced throwers
- Orange ABS plastic side plates
- Steel alloy rim
- Meets NFHS, NCAA and IAAF specifications, IAAF certified

82410	1.0K		84%	\$222
82415	1.5K		84%	\$236
82416	1.6K		83%	\$240
82417	1.75K		86%	\$246
82420	2.0K		89%	\$258

OTE™ VHM DISCUS

- Recommended for advanced throwers
- Red anodized aluminum side plates
- Steel alloy rim
- Meets NFHS, NCAA and IAAF specifications, IAAF certified

2103	1.0K		76%	\$268
2163	1.6K		82%	\$279
2203	2.0K		89%	\$308

OTE™ HM DISCUS

- Recommended for advanced throwers
- Precision aluminum side plates
- Steel alloy rim
- Meets NFHS, NCAA and IAAF specifications, IAAF certified

2102	1.0K		72%	\$230
2162	1.6K		78%	\$238
2202	2.0K		82%	\$265

PACER® GOLD DISCUS

- Recommended for advanced throwers
- Gold ABS plastic side plates
- Bronze alloy rim
- Meets NFHS, NCAA and IAAF specifications, IAAF certified

720203	1.0K		78%	\$339
720202	1.6K		81%	\$370
720201	2.0K		84%	\$380

PACER® BLACK DISCUS

- Recommended for intermediate throwers
- ABS plastic side plates
- High quality steel rim
- Meets NFHS, NCAA and IAAF specifications, IAAF certified

819	1.0K		80%	\$184
818	1.6K		85%	\$192
817	2.0K		85%	\$211



HOLLOWOOD STAR™ DISCUS

- Recommended for intermediate throwers
- Straight grained hard rock maple side plates
- High quality steel rim
- Meets NFHS, NCAA and IAAF specifications, IAAF certified

313	1.0K	IAAF	65%	\$291
305	1.6K		74%	\$318
300	2.0K	IAAF	75%	\$329



PACER® GHOST DISCUS

- Recommended for intermediate throwers
- Clear plated discus
- Stainless steel rim
- Meets NFHS, NCAA and IAAF specifications

720310	1.0K	80%	\$184
720316	1.6K	80%	\$195
720320	2.0K	80%	\$205

ESSENTIALS™ DISCUS

- Recommended for beginner throwers
- ABS plastic side plates
- High quality steel rim
- Meets NFHS, NCAA and IAAF specifications

82310	1.0K	Pink	58%	\$49
82316	1.6K	Green	61%	\$64
82320	2.0K	Green	67%	\$73



GILL® BLUE DISCUS

- Recommended for beginner throwers
- ABS plastic side plates
- High quality steel rim
- Meets NFHS, NCAA and IAAF specifications

816	1.0K	75%	\$76
815	1.6K	75%	\$86
814	2.0K	75%	\$102

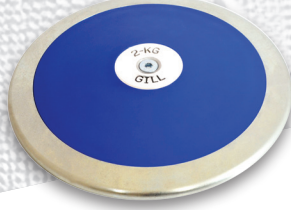

GILL® RED DISCUS

- Recommended for intermediate throwers
- ABS plastic side plates
- High quality steel rim
- Meets NFHS, NCAA and IAAF specifications

312	1.0K	78%	\$86
309	1.6K	80%	\$98
303	2.0K	80%	\$116



RUBBER DISCUS

- Solid one-piece construction
- Tough, durable rubber
- Meets NFHS specifications

310	1.0K	\$19
307	1.6K	\$20
302	2.0K	\$21



INDOOR RUBBER DISCUS

- Solid one-piece rubber construction
- Won't scuff floors or walls
- Meets NFHS specifications

311	1.0K	\$21
308	1.6K	\$23
304	2.0K	\$30



RUBBER DISCUS WITH HANDSTRAP

- Adjustable hand strap
- For training only
- Warning: Practice in a protective cage

81310	1.0K	\$26
81316	1.6K	\$30
81320	2.0K	\$33



COMPETITOR WOOD DISCUS

- Recommended for beginner throwers
- Laminated wood side plates
- High quality steel rim
- Meets NFHS, NCAA and IAAF specifications

317	1.0K	54%	\$59
31601	1.5K	65%	\$61
316	1.6K	67%	\$62
31602	1.75K	68%	\$63
315	2.0K	69%	\$67
81025	2.5K	70%	\$103

OFFICIAL
COMPETITION
REFERENCE GUIDE

High School Girls/Women: 1.0K
High School Boys: 1.6K
College Men: 2.0K



HAMMERS



TRAINING THROWING WEIGHTS

- Top quality turned iron
- Strong steel handle

3920	20 lb	\$189
3925	25 lb	\$227
3935	35 lb	\$252

PACER® STAINLESS STEEL HAMMERS

- Includes wire, handle and ball
- Meets NFHS, NCAA and IAAF specifications
- IAAF Certified

738940	4K		95mm	\$150
738120	12 lb		103mm	\$160
738160	16 lb		110mm	\$185

TURNT IRON HAMMERS

- Includes wire, handle and ball
- Meets NFHS, NCAA and IAAF specifications

3693	3K (6.6 lb)	\$59
36935	3.5K (7.7 lb)	\$60
3694	4K (8.8 lb)	\$63
36945	4.5K (9.9 lb)	\$68
3695	5K (11 lb)	\$74
3612	12 lb	\$71
3696	6K (13.2 lb)	\$76
3614	14 lb	\$77
3616	16 lb	\$78
3618	18 lb	\$88
3620	20 lb	\$94

ORBITER™ - TUNGSTEN

- Smaller diameter tungsten-filled shell
- New and improved textured handle
- New Kevlar weight bag is the lightest and most durable bag on the market.
- Plastic injection NBR collar reduces damage potential and allows uninhibited rotation
- 1 year warranty

4959	20 lb	\$2100
4958	35 lb	\$3500
495910	20 lb Repl. Ball	\$1900
M613	20 lb Repl. Bag	\$66
495810	35 lb Repl. Ball	\$3300
M614	35 lb Repl. Bag	\$74

ORBITER™ - LEAD

- Plastic injection NBR collar reduces damage potential and allows uninhibited rotation
- Sewn strap bag made out of double layered seatbelt polyester material
- New textured handle is the widest the rules allow for increased throwing performance
- 1 year warranty

4947	12 lb	\$249
4948	16 lb	\$259
4949	18 lb	\$279
4950	20 lb	\$319
4952	25 lb	\$329
4954	30 lb	\$339
4955	35 lb	\$419
495010	20 lb Repl. Ball	\$207
M620	20 lb Repl. Bag	\$65
495510	35 lb Repl. Ball	\$252
M635	35 lb Repl. Bag	\$99
491021	Repl. Handle, Black	\$36



SHOTS



PERFECT BALANCE SHOTS

- Engineered with exacting specifications for balance
- 100% sweet spot design gives uncompromised throwing distance
- Turned iron material for maximum durability
- Meets NFHS, NCAA and IAAF specifications

3894	4K	IAAF	108mm	\$192
3812	12 lb		115mm	\$218
3816	16 lb	IAAF	128mm	\$244

OFFICIAL COMPETITION REFERENCE GUIDE



PACER® STAINLESS STEEL SHOTS

- Machine turned for precision shape and weight
- Meets NFHS, NCAA and IAAF specifications, IAAF certified

735940	4K		95mm	\$121
735941	4K	IAAF	109mm	\$141
735120	12 lb		103mm	\$138
735160	16 lb		110mm	\$157
735163	16 lb	IAAF	129mm	\$192

High School Girls/Women: 4K
High School Boys: 12 lb
College Men: 16 lb



BRASS SHOTS

- Machine turned brass for unmatched design and feel
- Meets NFHS, NCAA and IAAF specifications

3594	4K	95mm	\$145
3512	12 lb	103mm	\$175
3516	16 lb	110mm	\$190

TRAINING SHOTS

- Cast iron material for maximum durability
- Uniform size of diameter allows for ideal training
- Keep the same size diameter as you train with variable weights



TS10830	3K	108mm	\$35
TS10835	3.5K	108mm	\$41
TS10845	4.5K	108mm	\$52
TS10850	5K	108mm	\$58
TS11510	10 lb	115mm	\$49
TS11511	11 lb	115mm	\$52
TS11513	13 lb	115mm	\$63
TS11514	14 lb	115mm	\$71
TS11516	16 lb	115mm	\$85
TS12813	13 lb	128mm	\$58
TS12814	14 lb	128mm	\$63
TS12815	15 lb	128mm	\$69
TS12817	17 lb	128mm	\$77
TS12818	18 lb	128mm	\$83
TS12820	20 lb	128mm	\$96



INDOOR SOFTSHELL SHOTS

- Polyvinyl plastic shell has softer feel for athlete preference
- Fine lead shot filled to exact weights
- Meets NFHS, and IAAF specifications, IAAF certified
- 1 year warranty

3106	6 lb	\$72
3193	3K (6.6 lb)	\$89
3108	8 lb	\$78
3194	4K (8.8 lb)	\$80
3195	5K (11 lb)	\$104
3112	12 lb	\$94
3196	6K (13.2 lb)	\$110
3114	14 lb	\$104
3115	15 lb	\$113
3116	16 lb	\$122
3118	18 lb	\$124



INDOOR HARDSHELL SHOTS

- Polyethylene shell will last season after season
- Fine lead shot filled to exact weights
- Meets NFHS, NCAA and IAAF specifications, IAAF certified
- 1 year warranty

3206	6 lb	\$72
3293	3K (6.6 lb)	\$79
3208	8 lb	\$81
3294	4K (8.8 lb)	\$84
3210	10 lb	\$95
3295	5K (11 lb)	\$97
3212	12 lb	\$100
3296	6K (13.2 lb)	\$102
3214	14 lb	\$102
3215	15 lb	\$107
3216	16 lb	\$115
3218	18 lb	\$126



CAST IRON SHOTS

- 4K and 12 lb shots guaranteed legal weight and size
- Meets NFHS, NCAA and IAAF specifications

3306	6 lb	\$18
3393	3K (6.6 lb)	\$20
3308	8 lb	\$21
3394	4K (8.8 lb)	\$25
3310	10 lb	\$29
3395	5K (11 lb)	\$31
3312	12 lb	\$31
3396	6K (13.2 lb)	\$36
3314	14 lb	\$41
3315	15 lb	\$42
3316	16 lb	\$43
3318	18 lb	\$50
3320	20 lb	\$55



TURNED SHOTS

- Machine turned for precision shape and weight
- Meets NFHS, NCAA and IAAF specifications, IAAF certified

34941	4K	100mm	\$64
34944	4K	104mm	\$51
34943	4K	IAAF 108mm	\$54
34121	12 lb	108mm	\$75
34122	12 lb	115mm	\$61
34161	16 lb	120mm	\$96
34162	16 lb	125mm	\$84
34163	16 lb	IAAF 128mm	\$71

JAVELINS



The choice of elite throwers worldwide! OTE javelins are handmade in the USA by the master artisans who are following in the tradition of the world's greatest name in javelin development: Dick Held. The performance potential of OTE javelins is unsurpassed, being used for numerous championship wins and world records.

CHOOSING A JAVELIN

STEP 1 Decide if you are purchasing a Rubber Tipped, 600g women's, or 800g men's javelin.

STEP 2 Consider the technical proficiency of the athlete. Javelin throwers who are skilled at flying the javelin will get farther throws when they throw through the point using OTE javelins. Throwers who occasionally miss accurate flights should switch between OTE and Pacer to help learn the fine points of flying the javelin. Beginners will learn quicker with the Gill or Tru-Flight javelins, and if possible, should occasionally try an OTE to see if they understand how to really make it fly.

STEP 3 Once you have decided which javelin will best maximize your athlete's potential, choose a light, medium, or max relative flex javelin. Generally speaking; the stiffer the javelin, the longer the throw, assuming it is thrown precisely through the point.

THROW FURTHER

	ATHLETE'S ABILITY	JAVELIN FORGIVENESS
STIFF 4.4 FLEX 100M	High	Low
	↑	↓
Low		
SOFT 12.6 FLEX 40M		

Use this chart for help on how to choose the best javelin. Call our experts at 800.637.3090 for more details.



Nordic Sport javelins are a trademark among throwers worldwide. The Nordic javelins have been seen at the highest level, winning World Championship and Olympic medals. The materials and construction of the javelins is of the utmost importance. The Nordic Sport javelins are all manufactured with the famous Nordic finish and Nordic quality. Gill Athletics is proud to be the exclusive North American distributor of all Nordic javelins. Gill manufactures the elite OTE javelins, as well as the championship level Pacer javelins. Both Gill and Nordic provide different level javelins as well as rubber tipped javelins.



Built by the same master craftsmen that make the OTE javelins, Pacer javelins are built to slightly more generous tolerances. These javelins are built for performance and durability, and are suitable for high level competition. Pacer is the brand of choice for coaches seeking great value.



This lower price point line of javelins is recommended for high school level competition offering unsurpassed value. The best quality javelin for a budget-conscious program, Tru-Flight javelins allow athletes to have more efficient practice sessions by purchasing multiple javelins at nearly the same price as a singular higher-priced javelin!



CARBON 1

**WORLD'S
FIRST
ONE-PIECE
CARBON
JAVELIN**



Gill Athletics is proud to introduce the world's first one-piece carbon javelin. The revolutionary **OTE Carbon 1** is designed after the iconic Legend Tailwind javelin, which was used by current world record holder Jan Zelezny, who threw 98.48 meters in 1996.

The Carbon 1 is our stiffest javelin yet with a flex of 4.4 but still allows the right amount of forgiveness for the athlete to throw. This javelin has the quickest dampening rate on the market, allowing for a longer flight with little to no vibration.

THE FUTURE IN JAVELIN TECHNOLOGY IS HERE



THE **ONLY** SINGLE-PIECE
CARBON JAVELIN IN THE WORLD



CARBON
FIBER
TECHNOLOGY



THICKER GRIP CORD FOR
MAXIMUM PERFORMANCE



600G JAVELINS



2663H	Intermediate		Headwind	40m	7.2 flex	\$429
2663T	Intermediate		Tailwind	40m	7.2 flex	\$449
2684H	Special		Headwind	50m	6.9 flex	\$459
2684T	Special		Tailwind	50m	6.9 flex	\$479
2690H	Xtra		Headwind	60m	6.5 flex	\$489
2690T	Xtra		Tailwind	60m	6.5 flex	\$509
2695H	Competition		Headwind	70m	6.1 flex	\$519
2695T	Competition		Tailwind	70m	6.1 flex	\$539
2000H	Carbon-ST		Headwind	100m	4.4 flex	\$1000
2000T	Carbon-ST		Tailwind	100m	4.4 flex	\$1030



7917606C	Olympia Carbon 600		Universal	5.9 flex	\$1180
7917603C	Diana Carbon 600		Headwind	5.3 flex	\$1175
7961600	Comet Alu 600		Universal	12.1 flex	\$113
7925600	Viking 600		Universal	11.1 flex	\$209
7915600	Nordic Classic 600		Tailwind	8.5 flex	\$377
7917600A	Master Alu 600		Universal	7.9 flex	\$449
7917602	Diana Classic 600		Headwind	7.7 flex	\$539
7917601	Diana Classic 600		Universal	7.2 flex	\$962



760005	Litania®	Light	40m	8.2 flex	\$249
760011	Comet 45	Medium	45m	7.4 flex	\$409
760012	Comet 55	Max	55m	7.0 flex	\$419



35064	Tru-Flight 40	Light	40m	8.6 flex	\$179
35065	Tru-Flight 50	Medium	50m	8.3 flex	\$199



HEADWIND VS. TAILWIND



HEADWIND (H) A headwind version of an OTE javelin describes a streamlined tip designed to help cut through the wind. This javelin tip, because of its small surface area, will have self-correcting characteristics when a thrower misses the point, adding valuable distance to a missed throw. The headwind version is ideal for 'power' throwers who lack perfect technique but make up for it with strength and torque.



TAILWIND (T) A tailwind version of an OTE javelin describes a thicker, more blunted tip that increases the surface area in front of the javelin. When a thrower hits the point with a tailwind version of an OTE javelin, it will mimic the old rules style javelins, with a beautiful floating flight and greater distances. This tailwind version is ideal for 'finesse' throwers who lack high outputs of power, yet throw at a high technical level.



800G JAVELINS



2860H	Intermediate		Headwind	60m	7.1 flex	\$482
2860T	Intermediate		Tailwind	60m	7.1 flex	\$512
2870H	Special		Headwind	70m	6.9 flex	\$519
2870T	Special		Tailwind	70m	6.9 flex	\$549
2890H	Xtra		Headwind	80m	6.7 flex	\$630
2890T	Xtra		Tailwind	80m	6.7 flex	\$660
2885H	Competition		Headwind	90m	6.3 flex	\$670
2885T	Competition		Tailwind	90m	6.3 flex	\$700
3000H	Carbon-ST		Headwind	100m	4.4 flex	\$1000
3000T	Carbon-ST		Tailwind	100m	4.4 flex	\$1030



7916808C	Orbit Carbon 800		Tailwind		5.0 flex	\$1205
7916800C	Champion Carbon 800		Headwind		4.8 flex	\$1215
7916803C	Airglider Carbon 800		Universal		4.5 flex	\$1215
7961800	Comet Alu 800		Universal		11.4 flex	\$129
7922800	Viking 800		Universal		10.4 flex	\$247
7912800A	Master Classic 800		Headwind		7.8 flex	\$566
7913800	Master 800		Universal		7.5 flex	\$530
7916802	Super Elite Classic 800		Tailwind		7.0 flex	\$899
7916800	Champion Steel 800		Headwind		6.4 flex	\$1080
7916803	Airglider Steel 800		Universal		6.1 flex	\$1145



780005	Litania®		Light	50m	8.7 flex	\$329
780050	Astro 50		Light	50m	7.8 flex	\$412
780060	Astro 60		Medium	60m	7.4 flex	\$422
780031	Astro 70		Max	70m	7.0 flex	\$440







35085	Tru-Flight 50		Light	50m	8.6 flex	\$199
35086	Tru-Flight 60		Medium	60m	8.3 flex	\$209
35087	Tru-Flight 70		Max	70m	7.7 flex	\$219



600G RUBBER TIPPED JAVELINS

800G RUBBER TIPPED JAVELINS

	2663R	Intermediate RT	40m	7.2 flex	\$429
	2690R	Xtra RT	60m	6.5 flex	\$489
	7968600	Classic Alu RT 600	Light	8.8 flex	\$185
	7955600	Javelin High School 600	Universal	Medium	\$279
	7965600	Javelin HS Diana 600	Universal	Max	\$359
	760055R	Litania® RT	40m	8.2 flex	\$249
	760211R	Comet 45RT	45m	7.4 flex	\$409
	760212R	Comet 55RT	55m	7.0 flex	\$419
	35164R	Tru-Flight 40RT	40m	8.6 flex	\$179
	35165R	Tru-Flight 50RT	50m	8.3 flex	\$199



	2860R	Intermediate RT	60m	7.1 flex	\$482
	2870R	Special RT	70m	6.9 flex	\$519
	2890R	Xtra RT	80m	6.7 flex	\$630
	7968800	Classic Alu RT 800	Light	8.7 flex	\$225
	7952800	Javelin High School 800	Universal	Medium	\$309
	7916822	High School Master 60 800	Universal	Medium	\$359
	7962800	Javelin HS Elite 800	Universal	Max	\$467
	7916902	High School Master 70 800	Universal	Max	\$368
	780055R	Litania® RT	50m	8.7 flex	\$379
	780250R	Astro 50RT	50m	7.5 flex	\$412
	780260R	Astro 60RT	60m	7.4 flex	\$422
	780033R	Astro 70RT	70m	7.0 flex	\$440
	35185R	Tru-Flight 50RT	50m	8.6 flex	\$199
	35186R	Tru-Flight 60RT	60m	8.3 flex	\$209

RUBBER TIPPED STATES: ALABAMA, NEW JERSEY, NORTH DAKOTA, AND WASHINGTON

500G JAVELINS

750005	Masters Plus	Light	40m	\$371
7925500	Viking 500 	Light	11.6 flex	\$189
7961500	Comet Alu 500 	Light	12.6 flex	\$108

700G JAVELINS

770005	Masters Plus	Light	45m	\$402
7914703	Super Elite 700 	Medium	6.8 flex	\$872
7914706	Master 700 	Medium	7.4 flex	\$494
7924700	Viking 700 	Light	10.7 flex	\$225
2780T	OTE Tailwind		80m	\$502
2780H	OTE Headwind		80m	\$479

J-FORCE TRAINING JAVELINS



- 700g weighted training javelin designed with 800g dimensions
- 700g is the ideal tool for injury recovery training
- 900g weighted training javelin designed with 800g dimensions
- 900g is the perfect tool for specific strength adaptation

780700	700g Training Javelin	\$499
780900	900g Training Javelin	\$549



ALL SURFACE TRAINING JAVELINS

- Designed for indoor, outdoor, turf and more surfaces
- Get the balance and weight of a competition implement with a durable metal shaft and REAL grip cord
- Cost effective way to get more practice implements in your training inventory

34610	600g	\$83
34710	700g	\$83
34810	800g	\$83
34910	900g	\$83

REAL GRIP CORD!



INDOOR TRAINING JAVELINS

- Air drag cones increase resistance to shorten throw for indoor facilities
- Aluminum shaft with rubber tip for maximum durability

TA1198	600g	\$116
TA1199	800g	\$117



PETRANOFF JAVELINS

- Designed by former world record holder Tom Petranoff (99.72m)
- Advance from 300g to 800g model

TA1193	300g Stubby	\$40
TA1194	400g Stubby	\$43
TA1195	500g Long Tom	\$50
TA1196	600g Long Tom	\$53
TA1187	700g Turbo Spier	\$78
TA1188	800g Turbo Spier	\$75



ARCHY ALL SURFACE TRAINING MAT

- Specifically designed to help isolate the shoulder for javelin-specific exercises
- Three different sides create a multi-use training tool for core, flexibility, and technique
- Anti-skid material on bottom of Archy

TA2000 \$323



TRAINING & ACCESSORIES

SAVE MONEY WITH VALUEPACKS!



BOYS' THROWS HIGH SCHOOL

307	1.6K Gill Rubber Discus (1)
815	1.6K Gill Blue Discus (1)
309	1.6K Gill Red Discus (1)
82316	1.6K Gill Essentials Discus (1)
3312	12 lb Cast Iron Shot (1)
34121	12 lb, 108mm Turned Iron Shot (1)
931	Shot/Discus Carriers (2)

VP200 \$411

GIRLS' THROWS HIGH SCHOOL/COLLEGE

310	1K Gill Rubber Discus (1)
816	1K Gill Blue Discus (1)
312	1K Gill Red Discus (1)
82310	1K Gill Essentials Discus (1)
3394	4K Cast Iron Shot (1)
34941	4K, 100mm Turned Iron Shot (1)
931	Shot/Discus Carriers (2)

VP100 \$349



JOJO SELF MARKING TRAINING DISCUS

- Economical training discus that marks the distance thrown
- Patented chamber emits self-marking chalk at landing
- Comes complete with discus, marking chalk, and chamber engagement tool

82610	1.0K	\$103
82616	1.6K	\$107
82620	2.0K	\$113



SCHOLASTIC SHOT CARRIER

- Heavy woven polyethylene rope with plastic handle
- Holds 1 shot put

928 \$9



TRAINING DISCUS

- Customize your training with variable weight
- Easy and quick transition from weight to weight
- **Not competition legal, for training only**

812	0.85K-1.20K	\$109
811	1.40K-1.80K	\$123
810	1.75K-2.20K	\$149



2-SHOT CARRIER

- High quality vinyl shot carrier
- Features a plastic handle and convenient shoulder strap
- Snap top closure
- Holds 2 shot puts with room to spare

929 \$16



DISCUS CARRIER

- High quality vinyl discus carrier
- Features a plastic handle and convenient shoulder strap
- Holds 2 discuses or shot puts

931 \$14



DELUXE UNIVERSAL IMPLEMENT CARRIER

- Holds any of the three standard throwing implements
- Stores and protects: Shot Put (1), Discus (2), or Hammer (1)
- Great value to protect your throwing investment

9282 \$40



IMPLEMENT CARTS

9313	Shot Cart (Holds 24)	\$566
9314	Discus Cart (Holds 30)	\$566
9315	Javelin Cart (Holds 26)	\$566
9316	Hammer Cart (Holds 18)	\$566
9312	Discus/Shot/Hammer Combo Cart	\$679



HAMMER WIRES

32200	20" Wire	\$10
32300	30" Wire	\$10
32370	37" Wire	\$10
32375	37 1/2" Wire	\$10
32380	38" Wire	\$10
32385	38 1/2" Wire	\$10
32390	39" Wire	\$10
32395	39 1/2" Wire	\$10



USA HAMMER GLOVES

- Designed to endure the toughest throwers
- Seamless outside finger designed for unobtrusive fit
- High quality genuine leather

31918	Left	Small	\$20
31917	Right	Small	\$20
31919	Left	Medium	\$20
31922	Right	Medium	\$20
31920	Left	Large	\$20
31923	Right	Large	\$20
31921	Left	X-Large	\$20
31924	Right	X-Large	\$20



ADD ON WEIGHT

- Use for either hammer or indoor throwing weights
- Economical way to add variable weight to your training without buying more implements
- Adjustable from .5 lb to 2.5 lb

3603	Add on Weight	\$24
------	---------------	------

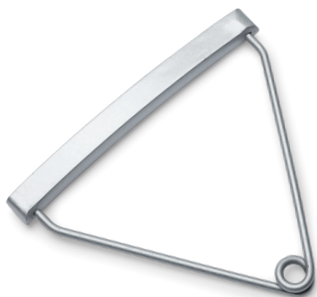

HAMMER HANDLE (ALUMINUM GRIP)

32020	IAAF Approved	\$20
-------	---------------	------



SPORTS CHALK

- 1 lb box
- Eight 2 ounce blocks

700250	\$15
--------	------



TRACK WAGON™

- Conveniently haul a variety of track equipment from storage to the track
- Gates fold down for added convenience
- Large pneumatic tires for rugged terrain travel
- 500 lb capacity to haul even the heaviest of track equipment
- 48" long x 24" wide x 12" deep x 25" tall

937	Track Wagon	\$257
-----	-------------	-------



JAVEE JAVELIN TRAINER

- Excellent training aid to develop javelin specific strength, flexibility, range of motion
- Use for static and dynamic stretching and warm up routines
- Improve functional length limits for reduced chance of muscle and tendon injuries
- Variable resistance provided by three strong elastic cords
- Grip diameter specific to 600g and 800g sizes

TA1820	600g	\$71
TA1821	800g	\$71



OTE™ DELUXE JAVELIN BAG

- Holds up to six javelins
- Two hardshell inserts wrapped in 1/4" lightweight closed cell foam to protect your investment
- Soft rubber handles and seams held with strong 2" webbing
- Men's length 9'; Women's length 8'

700706	600g Bag	\$499
700708	800g Bag	\$529



PACER® ADJUSTABLE BAG

- Holds three to five javelins
- Heavy duty Cordura nylon for durability
- Universal fit adjusts between 600g and 800g javelins

700801	\$118
--------	-------



HARDSHELL JAVELIN TUBE

- Holds five to seven javelins
- ABS plastic material gives piece of mind when transporting valuable javelins
- Universal fit adjusts between 600g and 800g javelins

700804	\$109
--------	-------



JAVELIN BACK BRACE

- Used by javelin throwers around the world
- Supports throwers and helps them throw far and safe

4581	\$32
------	------



NORDIC BACK BRACE

1086292	S, 22" - 28.5"	\$154
1086293	M, 28" - 34.5"	\$154
1086294	L, 34" - 40.5"	\$154
1086295	XL, 40" - 46.5"	\$154
1086296	XXL, 46.5"+	\$154



NORDIC ELBOW BRACE

1086392	S, 7.5" - 9"	\$72
1086393	M, 8.5" - 12"	\$72
1086394	L, 11.5" - 14"	\$72
1086395	XL, 13.5" - 15"	\$72

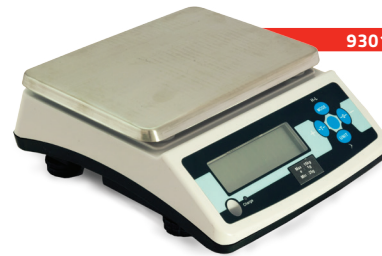

93015

93021

ESSENTIALS™ IMPLEMENT SCALE

- Large 55 lb capacity scale with 'easy press' buttons
- Includes digital auto calibration and full range tare/zero function
- Read out in English or Metric system

93010 Essentials™ Implement Scale \$100

GILL® IMPLEMENT SCALES

- Quickly, easily and accurately measure the weight of any track implement
- Works for javelin, discus, hammer, shot, and indoor weight
- Easy zero reset for calibration prior to weighing
- Read out in English or Metric system

93015	Up to 15K/33 lb	\$399
93020	Up to 20K/44 lb	\$686
93021	Scale Ring	\$21



IMPLEMENT CERTIFICATION KITS

- Official-friendly redesign assures each implement meets specifications
- Each gauge is laser cut stainless steel for extreme accuracy and permanency
- Labeled tabs on each gauge helps organize the process
- Redesigned hammer gauge is easier to use and more durable
- Javelin diameter gauge will not damage javelins like old-style javelin gauges from competitors
- Self-contained unit packaged in one convenient wheeled case; including hammer gauge

93050	High School Certification Kit (1K, 1.6K discuses; 4K, 12 lb shot put)	\$1260
93065	Javelin Certification Kit (all javelin competitions)	\$999
93075	NCAA Certification Kit (1K, 2K discuses; 4K, 16 lb shot put; 4K, 16 lb hammer; all javelin competitions)	\$3270
93080	IAAF Certification Kit (1K, 1.5K, 1.75K, 2K discuses; 4K, 5K, 6K, 16 lb shot put and hammer; all javelin competitions)	\$3645



INDOOR THROWING WEIGHT GAUGE

- Easily check the length of indoor weight throw implements
- Adjustable knob assists in the quick calibration of the gauge before each use

93035 \$279



SHOT/HAMMER RETRIEVER

- Ideal for quick, painless pick-up of shots and hammers
- Multi-adjustment height for ergonomic use

940 \$51

SHOT AND DISCUS MARKERS

- Large three square-inch writing surface
- Ample room to write athlete's name or number
- Extra strong pointed base for fast placement
- 7 1/2" long
- 18 gauge steel

932W	Marker	\$5/ea
932W12	Markers (12)	\$30/set



ELECTRONICS & INDICATORS



OFFICIAL EQUIPMENT SUPPLIER TO THE 2018 TRACK & FIELD CHAMPIONSHIPS

TIMER AND DISPLAY

- Lightweight with rugged rubber bumpers for increased durability
- Countdown timer has various pre-programmed times
- Three brightness intervals adjust to your specific needs
- Also used as an elapsed time clock for CC, road races, and the track
- Countdown can be set for durations up to 99 minutes
- Anti-glare 6" x 3" digits
- Includes tripod, 120V adapter plug, and 12V internal battery
- External battery can be connected if needed
- Connect to Gill Ultrasonic Wind Gauge to display wind reading continuously or at 10 second intervals



E49821	Single Sided	\$1030
E49822	Double Sided	\$1390
E39820B	Optional External Battery	\$75
E39824	Replacement Tripod	\$76



ULTRASONIC WIND GAUGE 2.0

- Redesigned for ultimate ease and accuracy
- Highly visible backlit display improved for officials accuracy
- Use as standalone, or designed for smooth interface with Lynx systems
- Special cable from Lynx required for Lynx interface
- Includes tripod, AC adapter, and padded protective case
- IAAF: ultrasonic wind gauges shall be used at all International Competitions (Rule 1.1 (a) through (h))

E49810 **\$2315**



COMPACT WIND GAUGE KIT

- When interface with timing system is not required, Compact Wind Gauge Kit is a cost friendly alternative
- Meets requirements for NFHS and NCAA wind gauge rules
- Includes tripod and carry case

E39815 **\$370**



COMPACT WIND INDICATOR

- Designed to indicate relative strength of wind at point of use
- Unintrusive economical design, gets the job done without breaking the budget
- Guides athletes to jump safer (pole vault) and farther (long jump/triple jump)

726 **\$154**



2 DIGIT ELECTRONIC DISPLAY

- Multi-use electronic display upgrades your facility and saves your budget!
- Use as a PV standard indicator, wind reading indicator unit, or lap counter.
- 6" digits with 3 stage dimming feature
- Quality carry/storage case included
- Lap Counter Display Stand sold separately

E49872	2 Digit Electronic Display	\$514
728	Lap Counter Display Stand	\$299



PERFORMANCE INDICATORS

- 9" numerals
- Rotates 360° for visibility
- 5' 9" tall
- Aluminum construction with 18" square steel roll away base
- Powder coated black

727	2 Digit Lap Counter w/ Bell	\$559
724	2 Digit Pole Vault Display	\$589
729	4 Digit Scholastic Performance Indicator	\$749
730210	5 Digit National Performance Indicator	\$889



LED SCROLLING DISPLAY

- Displays event standings, upcoming races and more
- Update information easily with provided software
- Software is designed to run in background when using Lynx, scrolls track event times/places as Lynx System files results
- Sixteen 4" tall characters maximum displayed at one time
- Power options: 120V power cord (included) or 12V battery (sold separately)
- Carrying case included

E39860	Scrolling Display	\$2080
E39820B	12V Battery	\$75
E39855	Replacement Tripod for Single Unit	\$267



GILL 9" DIGIT RACE CLOCKS

- Six digit race clocks in 9" digit options
- Count-up/count-down capability in seconds or hundredths of seconds
- Features end-mounted controls for direct operation
- Power options: 120V AC (included) or external 12V battery (sold separately)
- *Optional carrying case available (sold separately)*
- *Tripod and remote control included*

E39851	Race Clock	\$1600
E39853	Double-Sided Race Clock	\$2250
E39858	Carrying Case	\$483
E39820B	12V Battery	\$75

MEASURING DEVICES



865

SECTOR LINE MARKING TAPE

- Makes sector setup quick and easy
- Rolls out using dispensing spool and secures to grass with ground staples
- Kit includes: 2 rolls of white tape, 2 dispensing spools, and 20 ground staples

865	Complete Kit	\$123
8651	Dispensing Spool	\$16
8652	Staples (10)	\$12
8653	130 yds. White Tape	\$44
8654	130 yds. Orange Tape	\$44
8655	130 yds. Yellow Tape	\$44



971

STEEL MEASURING TAPES

- Coated with durable epoxy finish
- C = closed reel; O = open reel

980	50' (15m)	C	\$29
981	100' (30m)	C	\$38
983	300' (90m)	O	\$119
971	330' (100m)	O	\$120

MEASURING TAPE KIT

For all your measuring needs, includes:

- 988 (1)
- 985 (2)
- 984 (1)

982	Measuring Tape Kit	\$96
-----	--------------------	------



985

FIBERGLASS MEASURING TAPES

- Vinyl coated fiberglass tape with high tensile strength for durability
- More flexible than cloth tapes and won't kink or break when twisted or stepped on
- Measures in both English and Metric units
- C = closed reel; O = open reel

984	50' (15m)	C	\$11
985	100' (30m)	C	\$18
987	165' (50m)	C	\$26
986	200' (60m)	O	\$35
988	300' (90m)	O	\$51
989	330' (100m)	O	\$55



LASER LJ/TJ MEASURING DEVICE

- Simply align the targeting laser with landing, push the button, and read the measurement
- Improved green targeting laser for improved visibility on sunny days
- Measures in English or Metric units
- Rail is aluminum with sturdy steel wheeled bases

E73730 \$3000

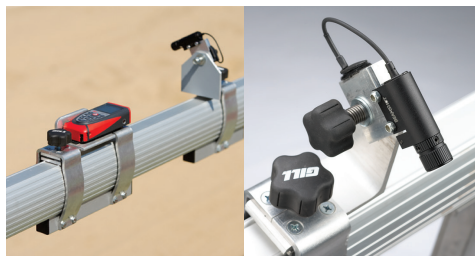

LASER DISTANCE MEASURING SYSTEM

- Accurate laser measuring device for horizontal and vertical jumps as well as throws
- Center the mounted laser after each attempt and aim at the target
- Accurate readings to the nearest 1/8"
- Fully compliant with NFHS, NCAA and IAAF specifications

E737 \$3090

EVERYTHING YOU NEED IN ONE SIMPLE PACKAGE

ETHERLYNX VISION™ CAMERA PACKAGES BY LYNX

- **All packages contain everything you need.** Each package is a complete photofinish and timing solution for your track meets. All you add are the athletes and a computer!
- **All systems can run on any Windows computer** equipped with an Ethernet connection
- **All systems include the new FinishLynx EASYALIGN™ technology** that shows a full-frame video view of the finish line for fast and accurate camera placement
- **All systems take full color pictures** for easier athlete identification
- **All systems use power-over-Ethernet**, so no dedicated AC power is required at the camera location. A single Ethernet cable transfers all data AND provides camera power
- **All packages include LYNXPAD Meet Management software** - this integrates with multiple online meet entry websites, including Athletics.net and DirectAthletics.com



THE SCHOLASTIC SOLUTION

- 5L510 EtherLynx™ Camera
- 600 Standard Frame Rate
- 6mm fixed lens

INCLUDES:

All camera connection and power cables

Custom FinishLynx Carrying Case

Tech Support & 1-year renewable warranty

Camera Tripod and mounting hardware

FinishLynx Lite software with support for RadioLynx Wireless Start (E39916)

E39905 \$5000

THE BRONZE SOLUTION

- 5L500 Vision EtherLynx™ Camera
- 1000 Standard Frame Rate
- Manual Zoom lens

INCLUDES EVERYTHING FROM THE SCHOLASTIC SOLUTION, PLUS:

Full FinishLynx32 software with support for RadioLynx Wireless Start (E39916), Lynx Software Plug-in(s), multiple FinishLynx Cameras, IdentiLynx 2-D video camera, scoreboard interface for display of running time & results, and wind gauge interface for automatic wind reading data import

E39906 \$7500

THE SILVER SOLUTION

- 5L500 Vision EtherLynx™ Camera
- 2000 Standard Frame Rate
- Motorized Zoom lens

INCLUDES EVERYTHING FROM THE BRONZE SOLUTION, PLUS:

Automatic capture & virtual photocell plug-in

High resolution (2000 fps) images

Remote positioner (remote camera adjustment)

Motorized lens (remote lens adjustment)

E39903 \$11300

THE GOLD SOLUTION

- 5L500 Vision EtherLynx™ Camera
- 2000 Standard Frame Rate
- Motorized Zoom lens

INCLUDES EVERYTHING FROM THE SILVER SOLUTION, PLUS:

RadioLynx Wireless Start System

Power over Ethernet network switch

IdentiLynx full frame video camera

9-digit alphanumeric scoreboard

E39901 \$17000

THE MVP SOLUTION

- 5L500 Vision EtherLynx™ Camera
- 2000 Standard Frame Rate
- Motorized Zoom lens

INCLUDES EVERYTHING FROM THE GOLD SOLUTION, PLUS:

IAAF approved sonic wind gauge

A second 1000 fps 5L500 Vision EtherLynx™ camera (reverse angle/alternate finish line)

E39920 \$25000

* FinishLynx Systems are licensed and cannot be returned.

TRACK ACCESSORIES



LJ & TJ TAKE OFF BOARD MARKERS

- Guides athletes to the horizontal jumps take-off board
- Made of safe collapsible plastic material

730310 \$99/set



GILL® LANE MARKERS

- Lightweight markers are easy to stack and carry
- Stable 3-sided design provides great visibility
- Convenient hand hole for quick set up
- 28" tall

730320 Lanes 1-8 \$999/set

730329 Lane 9 Only \$149/ea

7303210 Lane 10 Only \$149/ea



GILL® DISTANCE MARKERS

- Lightweight durable plastic material
- Stable 3-sided design provides 360 degree visibility
- 18" letter height

Individual Markers \$119

730512 12m/39'

730530 30m/98'

730514 14m/46'

730540 40m/131'

730516 16m/52'

730550 50m/164'

730518 18m/59'

730560 60m/197'

730520 20m/66'

730570 70m/230'

730522 22m/72'

730580 80m/262'

730524 24m/79'

730590 90m/295'



HORIZONTAL DISTANCE INDICATOR BOARDS

- Visual gauge of jump distance
- Made of safe collapsible plastic material
- Lightweight for easy transportation and storage
- Custom graphic options available for \$50 charge

730721 LJ Boards English (16'-30') \$459

730722 LJ Boards Metric (5m-9m) \$459

730741 TJ Boards English (38'-55') \$559

730742 TJ Boards Metric (12m-17m) \$559



SCHOLASTIC DISTANCE MARKERS

- Ultra light expanded vinyl material
- 13" x 16" with quick stack & light carry characteristics
- 11" letter height

941 Set of 13

\$479

Individual Markers

\$37

941030 30"

941100 100'

941035 35'

941120 120'

941040 40'

941140 140'

941045 45'

941160 160'

941050 50'

941180 180'

941055 55'

941200 200'

941060 60'

BATONS

Individual	\$3.70	Set of 8	\$29
43101	Gold	431018	Gold
43102	Orange	431028	Orange
43104	Silver	431048	Silver
43105	Red	431058	Red
43106	Purple	431068	Purple
43107	Green	431078	Green
43108	Blue	431088	Blue
43109	Black	431098	Black
433	White Plastic (1)	430	Assorted





TEAR TAG NUMBERS

- Made of Tyvek® material for unsurpassed durability
- 7 1/2" x 7 1/2" numbers feature a 3 1/4" numeral and 2" detachable tag
- Sets of 100

92300	#001-100	\$39
92301	#101-200	\$39
92302	#201-300	\$39
92303	#301-400	\$39
92304	#401-500	\$39



CUSTOMIZED COMPETITOR'S NUMBERS

- Feature your school name and/or event
- Made of Tyvek material for unsurpassed durability
- Sets of 100
- Orders less than 500 are 1-color only

730400	5 1/2" x 7 1/2"	\$54/set
730410	7 1/2" x 7 1/2" * * with Detachable Tag	\$59/set



HIP NUMBERS

- Necessary for photo finish timing
- 3 1/2" digit on a 4" x 3" label
- No-residue adhesive labels

921	Hip Numbers 1-9 (25 of each)	\$23/set
922	Hip Numbers 1-18 (25 of each)	\$36/set

SAFETY PINS

910	144 ct.	\$10
91010	1440 ct.	\$50

COMPETITOR'S NUMBERS

- Made of 100 lb 'Tuff Tear' paper tag stock
- 5 1/2" x 8 1/2"
- Sets of 100

Competitor's Numbers \$15/set

900	#001-100	903	#301-400	909	#901-900
901	#101-200	904	#401-500		
902	#201-300				



INDIVIDUAL HIP NUMBERS

Sets of 100		\$10	Rolls of 250		\$21
92101	#1	92110	#10	92201	#1
92102	#2	92111	#11	92202	#2
92103	#3	92112	#12	92203	#3
92104	#4	92113	#13	92204	#4
92105	#5	92114	#14	92205	#5
92106	#6	92115	#15	92206	#6
92107	#7	92116	#16	92207	#7
92108	#8	92117	#17	92208	#8
92109	#9	92118	#18	92209	#9
				92210	#10
				92211	#11
				92212	#12
				92213	#13
				92214	#14
				92215	#15
				92216	#16
				92217	#17
				92218	#18

BEST VALUE!



SPIKE KIT

Storage case and 1500 spikes

- 4 x 842 spikes
- 3 x 840 spikes
- 2 x 83602 spikes
- 2 x 83601 spikes
- 2 x 843 spikes
- 2 x 838 spikes
- 1 x 846 t-handle wrench

850 \$150



STEELEX SPIKES

- Case hardened steel with blue coat provides extreme durability and extended life
- Hex-base for easier installation and removal
- Bags of 100

83500	1/4" Spike Wrench	\$10
83511	Spikes: 1/8"	\$14
83512	Spikes: 3/16"	\$14
83513	Spikes: 1/4"	\$14
83514	Spikes: 3/8"	\$14



PYRAMID NEEDLE BLANK

SPIKES

Bags of 100, unless otherwise noted

842	Pyramid: 1/4"	\$10
8401	Needle: 1/8"	\$10
83601	Needle: 3/16"	\$10
838	Needle: 1/4"	\$10
839	Needle: 3/8"	\$10
840	Pyramid: 1/8"	\$10
83602	Pyramid: 3/16"	\$10
841	Pyramid: 1/2"	\$10
843	Pyramid: 3/8"	\$10
844	Pyramid: 5/8"	\$10
848	Blanks	\$10
837	Javelin: 1" (20 ct.)	\$10

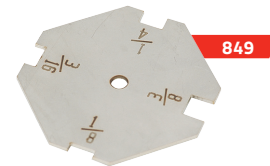

846



SPIKE WRENCHES

845	3-Way	\$5
846	T-Handle	\$11
849	Spike Gauge	\$27

35W MEGAPHONE

35W Megaphone with range of up to 500 meters.
Requires 10 "C" batteries (not included).

E39847 \$103



ELECTRONIX STARTING DEVICE

- Battery operated starting pistol eliminates the need for blanks
- Pistol comes with auxiliary cable and case
- Strobe light tip flashes when the gun is fired to offer a visual signal for hand timing
- Uses three "AA" batteries (not included)
- Connects to a megaphone or speaker to sound (not included)
- *FinishLynx and Eagle Eye compatible!*

E39846 \$219



ALPHA COMPETITION STARTING PISTOLS

- Zinc-aluminum frame finished in rust resistant nickel
- High strength heat-treated steel parts promise trouble free usage
- Bright orange grips and barrel cap eliminate confusion with a firearm
- Rugged and reliable with swing out cylinder for easy load and unload
- Holds 6 rounds
- *Lifetime warranty*
- *Special overnight shipping required for all pistols*

425	.22 Cal. Pistol	\$339
426	.32 Cal. Pistol	\$349

GILL® COMPETITION STARTING PISTOLS

- Inexpensive yet durable starting pistols
- Feature free spinning cylinder necessitating to cock the hammer before firing
- Holds 8 rounds
- *Special overnight shipping required for all pistols*

42510	.22 Cal.	\$145
42610	.32 Cal. (holds 5 rds.)	\$155
42515	.22 Cal. Plastic (only works with crimped blanks)	\$79

MEGAPHONE

Adjustable volume with trigger on/off switch. Uses eight "AA" batteries, not included.

732 \$119

STARTING BLANKS

42701	.22 Cal. Crimped (100 rds.)	\$40
429	.32 Cal. Gator Blanks (50 rds.)	\$60
42801	.32 Cal. Crimped (100 rds.)	\$90
39603	Pyro Bright Shells (50 rds.)	\$55



STARTING PISTOL HOLSTER

Keep your gun safe and convenient. Attaches to your belt.

42310 \$30



PISTOL CLEANING KIT

Maintain your starting gun with this 7 piece cleaning kit in a plastic storage box.

42320 \$41

STARTERS SLEEVE

Highly visible from any part of the track. Bright orange with elastic at both ends for a sure fit.

423 \$12

EAR PROTECTION FOR OFFICIALS

Ear protection for starting officials.

42330 \$28



TIMEKEEPING FOR ANY SIZE EVENT

SEIKO S149 STOPWATCH WITH PRINTER

- 300 dual split memory
- Saves multiple events into memory
- Large-sized 3 line display
- Auto start function
- Prints 13 digits per line at 1.5 per second
- Battery life indicator
- Includes 2 rolls of paper
- **3 year warranty**



37801	<i>Stopwatch and Printer</i>	\$514
37805	<i>Paper Refills (5)</i>	\$12

MORE DETAILS

www.gillathletics.com/stopwatches

ULTRAK L10 MULTI-LANE TIMER

- Compatible with Hytek Meet Management Software
- Times races with up to 10 lanes
- Times road races with up to 8,000 participants
- Prints bib number, lane, place, and time
- Includes linkgate, eliminating tangled cords to L10
- Includes Windows interface and 2 rolls of paper
- **2 year warranty**

37932	<i>8-Lane Timer</i>	\$751
37934	<i>Extra Button</i>	\$24
37935	<i>Paper Refills (3)</i>	\$27

ULTRAK 310

- Functions: start, stop, reset
- Measures 10 hours
- **3 year warranty**



33106	<i>Set of Six</i>	\$54
--------------	-------------------	-------------



ROBIC SILVER 2.0

- Event, lap or split timing
- 1/100 second precision to 10 hours
- Two finish time memory recall
- **1 year warranty**

37923	\$19
--------------	-------------



ULTRAK 350 SOLAR

- Cumulative split and time out capabilities
- Measures to 24 hours
- **3 year warranty**

380	\$24
------------	-------------



ROBIC SC-505W

- Twelve (12) memory recall
- Lap, split or single event timing
- 1/100 second resolution to 24 hours
- **1 year full factory warranty**

37603	<i>Single</i>	\$29
37604	<i>Set of Six</i>	\$168



ROBIC SC-606W

- 50 dual split memory recall
- Lap, split or dual split timing
- Multi-function countdown timer; stop, repeat or count-up modes
- **1 year full factory warranty**

37602	\$39
--------------	-------------



ULTRAK 830 HEAT INDEX

- Accurately calculates temperature, humidity, heat index and dew point
- 30 dual split recallable memory
- Measures to 10 hours with 1/100 second resolution
- Solar powered with back-up lithium battery
- **5 year warranty**

3830	\$43
-------------	-------------



BEST SELLER!

ULTRAK 495

- 100 dual split recallable memory
- Measures up to 10 hours
- Continuous display of event time
- Allow for split in recall mode
- Water resistant
- **5 year warranty**

37904	<i>Black</i>	\$47
37904Y	<i>Yellow</i>	\$47



ROBIC SC-899

- Up to 540 memory recall
- 3 fully loaded time keeping modes
- 1/100 second precision to 1 hour
- Speed timer in mph/kph
- On-demand EL backlight for low light or no light use
- Lithium battery
- **1 year warranty**

37611	\$66
--------------	-------------



ULTRAK BTS - BLUETOOTH STOPWATCH

- Compatible with both Apple and Android smartphones
- 750 dual split memory recall, measuring to 10 hours in 1/100 second precision
- Countdown timer, pacer, stroke frequency and calendar functions
- **5 year warranty**

37912	\$103
--------------	--------------

TRACK ACCESSORIES

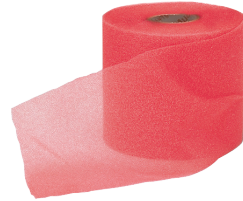

FINISH LINE TAPE

- Lightweight and easy to break
- 50 yd roll

974 \$5



INTERNATIONAL FINISH POSTS

- Heavy duty steel with folded square bases
- Wheeled bases for easy mobility
- Big, bold letters indicate finish for clear visibility

721 \$519



STARTER'S ROSTRUM

- Provides starting official with enough height to view all lanes
- Stable design for safety

857 \$1555



CAMERA MOUNT POLE

- No pre-determined heights for custom settings

E39917 *Portable* \$974

E39918 *Ground Sleeve* \$974



TAPE STAKE KIT

- Handy tool attaches to end of measuring tape for convenient use
- Used for all throwing events and all horizontal jumping events
- Set of 4

970 \$54/set



TIMERS AND JUDGES STAND

- Holds 10 people seated or 20 standing
- Five rows of 48" long steps
- Rail support along back for safety
- Red enamel finish with galvanized seats, footrests and backrest
- Easy mobility provided by 8" diameter wheels on back

995 \$1399

TRACK MAINTENANCE

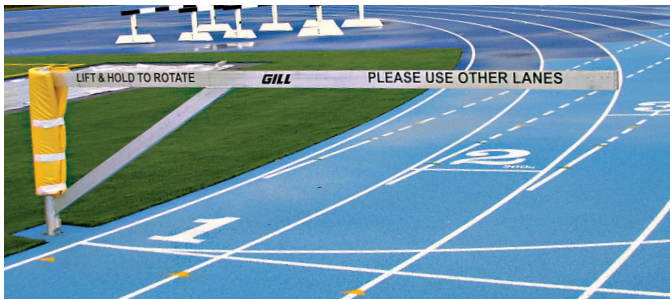

3-LANE TRACK GATE

- Discourage joggers from using three inside lanes causing premature and uneven wear
- Easy lift and rotate to allow training on inside lanes
- Locks into place
- Includes ground sleeve
- Available in custom color, see chart on page 84

8540	3-Lane Track Gate	\$1290
8540CXX	3-Lane Track Gate; color	\$1420
8540P	Track Gate Post Padding	\$116

CROSSOVER ZONE®

- Lighter and easier to handle than other 'conveyor belt rubber' systems
- Protects against steel tipped cleats, shoes and equipment wheels
- Rain drains through

493667	7.5' x 30'	\$949
493668	7.5' x 40'	\$1050
493663	15' x 30'	\$1130
493664	15' x 40'	\$1250
493651	15' x 75'	\$1565
493652	15' x 100'	\$1600
493653	15' x 125'	\$1800

TRACK REPAIR KITS

- Repair worn areas of track or field event area
- Includes 18.5 lb of rubber granules and 1 gallon of single-solution, no-mix polyurethane adhesive
- Approximate 11 sq ft coverage

8700	Black Repair Kit	\$493
8701	Red Repair Kit	\$493
8702	Royal Blue Repair Kit	\$493
8703	Green Repair Kit	\$493

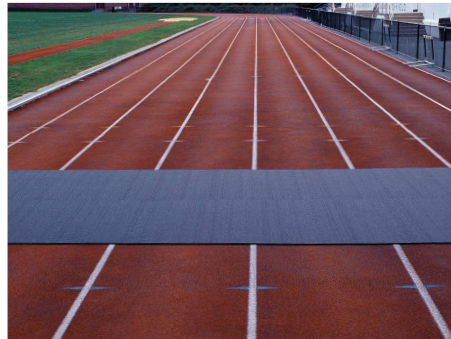

INDOOR/OUTDOOR RUNWAY SURFACE

- Install quickly over worn runway or create a runway where none exists
- No bonding necessary, but can be done if required
- Custom Length (25' minimum) (no returns)

49036	10mm x 36"	\$7/ln ft
49048	10mm x 48"	\$9/ln ft
49136	12mm x 36"	\$8/ln ft
49148	12mm x 48"	\$10/ln ft



SURFACE ROLLER

452	Complete Roller	\$116
452R	Replacement Roller	\$67



PIT RAKE

451	Pit Rake	\$82
-----	----------	------



QUICKIE SAND PIT BROOM

453	Sand Pit Broom	\$44
-----	----------------	------



PIT SHOVEL

450	Pit Shovel	\$43
-----	------------	------

CROSS COUNTRY KIT

Includes: 24 chute posts, 2-110' lengths of chute rope with pennants, 9 directional flags (3 red, 3 blue, 3 yellow) and 9 flag poles.

960	Complete Kit	\$524
961	4' Chute Post	\$11/ea
962	Chute Rope and Pennants (110')	\$28
9650	Flag Pole, Red Flag (Left Turn)	\$36
9660	Flag Pole, Blue Flag (Straight)	\$36
9670	Flag Pole, Yellow Flag (Right Turn)	\$36
96501	Replacement Red Flag (Left Turn)	\$11
96601	Replacement Blue Flag (Straight)	\$11
96701	Replacement Yellow Flag (Right Turn)	\$11

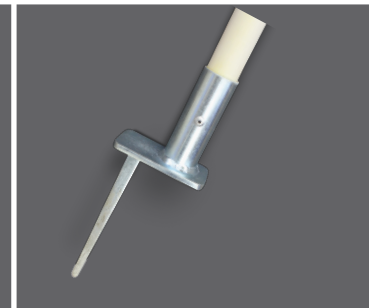

TURF CHUTE POST

- 12 lb non-invasive chute posts are ideal for turf or golf course

968	Turf Chute Post	\$50/ea
962	Chute Rope and Pennants (110')	\$28

CROSS COUNTRY FINISH LINE BANNER

- Heavy duty vinyl banner attaches to fiberglass uprights
- Width is adjustable from 6'-12'
- Clearance height is 7'

969 \$288

CC PACE WHEEL

- Find your athlete's recent race/time trial in the 'Current Fitness' window and that's it!
- Pace wheel reveals aerobic base training pace, marathon race pace, lactate threshold pace, Vo2 max development intervals, and running economy repetitions

998 \$20

DISTANCE MEASURING WHEELS

- Lightweight durable construction
- Wheel has rubber tread for accurate measurement on any surface
- Measures up to 10,000 units

977	English Units	\$99
978	Metric Units	\$99



ELECTRONIC MEASURING WHEEL

- Durable long-lasting steel frame
- Electronic 7-digit LCD readout is backlit for low light usage
- Patent-pending 'thumb-up' grip ensures less wrist strain and superior control

9701 \$299



DUAL XC MEASURING WHEEL & COURSE MARKER

- Measure and mark simultaneously
- Lightweight tool features a trigger under the pistol grip
- Trigger activates spray paint (not included)
- English units only

9702 \$176



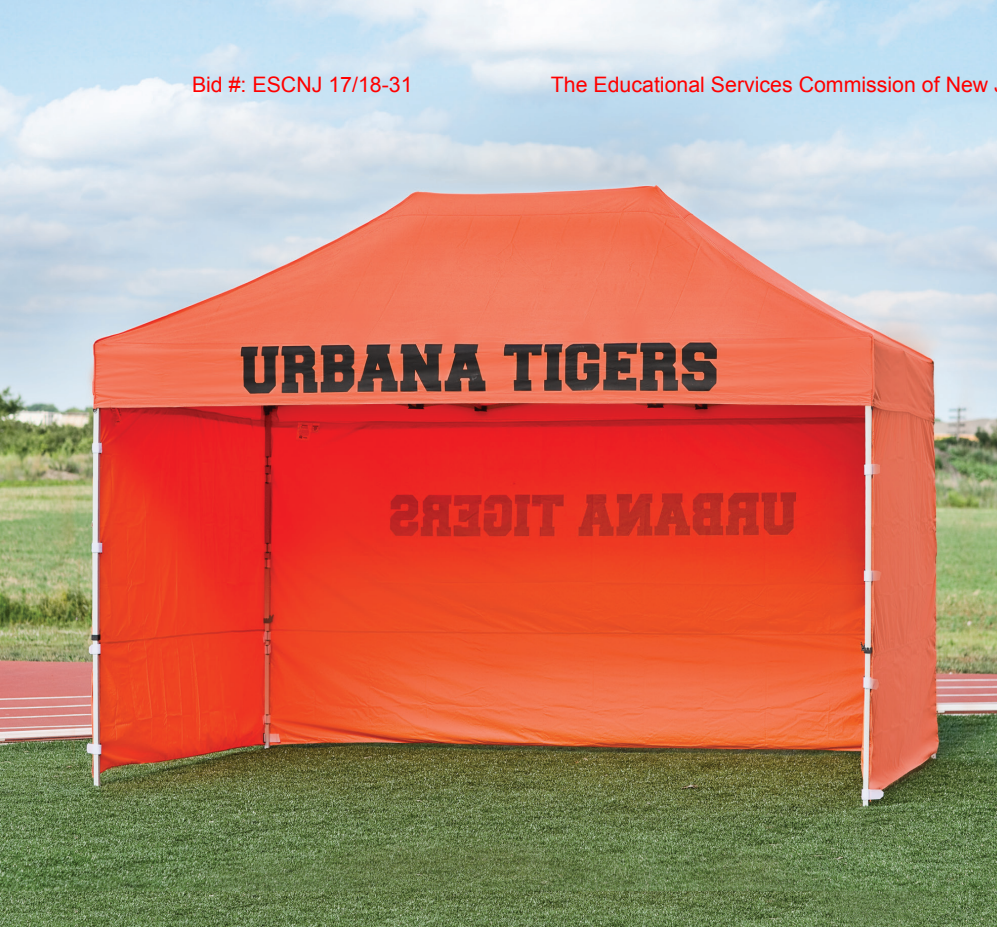

IMPACT TENTS

- Commercial grade steel frame
- 500 denier polyester canopy and walls
- Water, UV light, and fire resistant
- Roller bag: 600 denier polyester with scuff resistant and waterproof finish
- Tent stake kit and dust coverbag included
- Sidewalls, roller bags, and graphics sold separately

COLORS



TENT CANOPY

955210	10' x 10' Tent Canopy	\$725
955215	10' x 15' Tent Canopy	\$878
955220	10' x 20' Tent Canopy	\$1200

SIDE WALL

955210S	10' Solid Side Wall	\$129
955215S	15' Solid Side Wall	\$199

ROLLER BAG

955210B	10' Tent Roller Bag	\$87
955215B	15' Tent Roller Bag	\$119
955220B	20' Tent Roller Bag	\$133

CUSTOM GRAPHICS

Stand out from the crowd with custom screen printed graphics available in 1 to 5 locations! Tent graphic worksheet and vector graphics are all that is needed to show your team pride today! *Price covers 1 to 5 locations, per logo, per color.*

955201	Graphic 10" x 100"	\$349
955202	Graphic 40" x 60"	\$449
955203	Graphic 50" x 90"	\$599

ACCESSORIES

9552SK	Stake Kit	\$47
9552WB	Weight Bags (4) (Recommended)	\$59



TOTE BASKET

809	\$16
-----	------

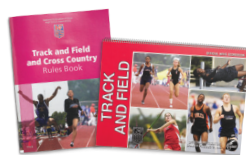

BOOKS

98901	T&F / XC Rules Book	\$13
98902	T&F Scorebook	\$21



STRIKEALERT

- Provides warning for strikes as far away as 40 miles
- Audible alarm and corresponding LED light illuminates to warn you of strike
- Comes with belt clip and runs on single AA battery for up to 100 hours

ELD1000	\$135
---------	-------



OFFICIALS' FLAGS

- Highly visible heavy duty nylon attached to a wooden dowel
- Flags measure 14" x 13"

730270	Red/White	\$16
730271	Yellow/White	\$16



PLYOMETRICS



STEEL PLYOBXES

- 1" square steel tubing
- Plywood top platform with 10mm rubber surface
- Anti-skid rubber on base corners prevents slipping and protects floors
- Tapered design allows for stacking and stability

TA3060	6" Plyobox	\$99
TA312	12" Plyobox	\$112
TA318	18" Plyobox	\$125
TA324	24" Plyobox	\$137
TA330	30" Plyobox	\$150
TA336	36" Plyobox	\$162
TA342	42" Plyobox	\$174
TA301	4pc. Plyobox Set (12", 18", 24" & 30")	\$509
TA300	6pc. Plyobox Set (12", 18", 24", 30", 36" & 42")	\$839



LAUNCH PAD

- Allows for more jumps per session
- Steel construction with welded support braces
- Synthetic track material on jump surface
- Track spikes can be installed to ensure no slipping if needed

TA1921 \$699

PLYO RUNWAY MAT

Surface reduces stress of impact on joints and muscles during explosive training sessions.

TA303 3'W x 6'L x 1/2" thick \$89



ARCHED JUMP BOX

- Convex jumping box made of lightweight steel that is easy to carry to and from practices
- Covered in synthetic track material to simulate the same feelings as your track and runways
- 8" high in the middle by 30" wide and 47" long

TA193 \$617



SOFT PLYOBXES

- Standard 28" x 28" blocks
- 3" block is built with 2.2# density polyethylene foam, other sizes with 1.8# which provides stability, shock attenuation, and performance
- Secured for stacking with industrial strength Velcro®
- Durable vinyl cover with two reinforced handles for portability
- Each box weighs less than 28 lb

TA203	3" Soft Plyobox	\$107
TA206	6" Soft Plyobox	\$146
TA212	12" Soft Plyobox	\$207
TA218	18" Soft Plyobox	\$296
TA224	24" Soft Plyobox	\$356
TA225	Set of 5, 1 of Each Size	\$1020



POWER PAD

- A truly innovative training tool
- Sprint, jump, hop, and rehab all within the confines of the low-impact, energy absorbing power pad

TA194 \$772



FLAT JUMP PLATFORM

- Made of lightweight aluminum and covered with synthetic track material
- Easy to transport between practices
- Track spikes can be installed to ensure no slipping if needed
- Platform is 5" x 34" x 19"

TA198 \$411

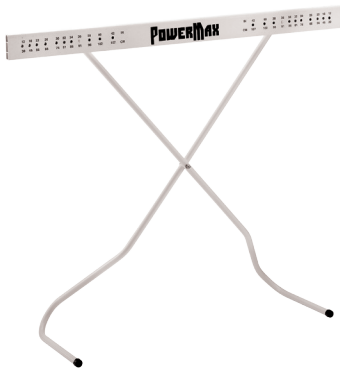

POWERMAX® VERSA-HURDLE

- Built-in safety feature causes the hurdles to collapse upon impact
- Adjustable from 12" to 42"
- 18 gauge tube steel with durable gate board

100	Hurdle	\$40/ea
101	Versa-Hurdle Bag	\$22



FOAM TRAINING HURDLE

- Ideal training hurdle made of forgiving foam
- Heavy enough to remain upright, yet light enough to be completely portable
- Durable vinyl covering allows for indoor and outdoor use
- Heights: 30", 33", 36", & 39"

409 \$159



SMART HURDLE

Smart Hurdles have a three point base for superior stability on all surfaces. Smart Hurdles are durable, lightweight, and easy to carry.

TA18544	21-36" Adjustable Hurdle	\$73
TA18545	27-42" Adjustable Hurdle	\$82



AGILITY ROCKER HURDLES

Weighted base allows hurdles to rock back into the starting position.

TA1676	6" Hurdle	\$20/ea
TA1678	8" Hurdle	\$20/ea
TA16710	10" Hurdle	\$21/ea
TA16712	12" Hurdle	\$21/ea

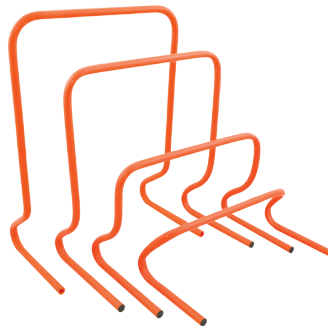

STEP HURDLES

Constructed of durable, lightweight PVC tubing

TA167	6" Hurdle	\$11/ea
TA1675	6" Hurdles (5)	\$51/set
TA166	12" Hurdle	\$12/ea
TA1665	12" Hurdles (5)	\$58/set
TA16618	18" Hurdle	\$17/ea
TA166185	18" Hurdles (5)	\$84/set
TA16624	24" Hurdle	\$20/ea
TA166245	24" Hurdles (5)	\$95/set



VARIABLE HEIGHT STEP HURDLES

The 2-in-1 hurdle can quickly and easily be adjusted to 2 heights (8"-12") and folds flat for storage.

TA1662	2-in-1 Hurdles	\$12/ea
TA16625	Set of 5 with Bag	\$63
TA16601	Mesh Carry Bag (Holds 5 Hurdles)	\$6.50

The 3-in-1 step hurdle adjusts from (6"-12"-18") and may be disassembled for storage. perform lateral agility moves, forward moves for speed, or plyometrics jumps.

TA1663	3-in-1 Hurdles	\$34/ea
TA16635	Set of 5 with Bag	\$170
TA16601	Mesh Carry Bag (Holds 5 Hurdles)	\$6.50



STEP-UP BOX

Perform weighted step-ups safely on this adjustable box. Four height adjustments: 14", 16", 18", and 20". Reinforced plywood top coated with artificial turf. 20" x 28" top. Ships assembled.

WE160 14"H x 29"W x 28"L, 53 lb \$399

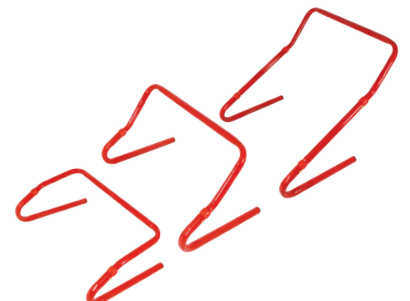

AGILITY TRAINING



TA1226



TA1227

POWERMAX® WEIGHT VEST

- Holds soft double stitched ½ lb weights
- Purchase additional ½ lb packs to fill short vest up to 20 lb or the long vest up to 40 lb
- Moveable shoulder straps 2 ¾" wide with 5 ½" of adjustability
- Short vest fits up to a 40" chest/waist, 18" L x 16" W, long vest fits up to a 57" chest/waist, 23" L x 16" W

TA1226	Short 10 lb Vest	\$100
TA1227	Long 20 lb Vest	\$160
TA1228	10 weight packs (5 lb)	\$27
TA12281	20 weight packs (10 lb)	\$53
TA12282	40 weight packs (20 lb)	\$105

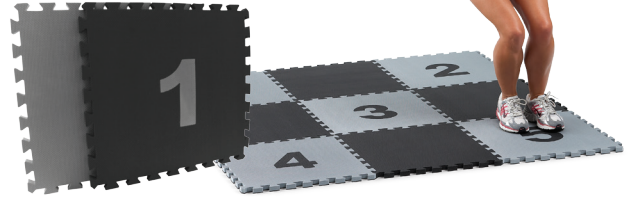

POWERMAX® DRILL MAT

- Press the squares in place to customize the PowerMax Drill Mat
- Create a variety of simple or challenging patterns for the performance of agility drills
- Nine 50cm squares included.

TA142 \$103

BASIC DOT DRILL MAT

- Economical alternative to TA142 drill mat
- Measures 3' x 4' x ¾"
- 5 integrated rubber dots

TA1425 \$92



POWERMAX® WEB LADDER

- Sewn nylon ladder is 16' L x 18" W
- Slats every 18"
- Includes storage bag and 4 ground stakes

TA1696 \$26



POWERMAX® AGILITY LADDERS

- 15' ladder comes in two 7' 6" sections with 10 slats total
- 30' ladder comes in four 7' 6" sections
- Easily connect with other ladders
- 20" wide with 18" between slats, not adjustable
- Includes 1 agility ladder & carry bag

TA1691	15' Agility Ladder	\$50
TA1681	30' Agility Ladder	\$83
TA1682	15' Double Ladder	\$42



POWERMAX® AGILITY DOMES

- Multicolored Domes Are Ideal To Mark An Agility Course
- Durable Impact Resistant Polyethylene
- Includes 40 Domes (10 In Each Color) And Storage Rack

TA1852 \$71



SMART INDOOR LADDER

- 15' Ladder
- Non-slip rubber, great for gym floors
- Rolls up for storage

TA1685 \$75



POWERMAX® ACCELERATION LADDER

- Incrementally increase stride length and frequency
- Increasing stride spacing from 12" to 69"
- All red rungs, black sides, and a carry bag

TA168 37'6" X 20" \$72



AGILITY POLES

- 5' tall poles force athletes to maintain posture
- Includes 4 bases and 4 poles
- Add sand or water to base for additional stability

TA1850 \$90



AGILITY RINGS

- Create patterns to challenge footwork or set a pattern of acceleration
- Can be used on a variety of surfaces, ideal on textured surfaces

TA1693 Set of 12 \$49



AGILITY DOTS

- Dots are easy to store and transport
- Easy to see bright colors

TA1694 Set of 6 \$25

TA128



SPEED ROPES

- Stainless steel cable encased in plastic
- Ball bearing in handles for quick turnover
- Fixed length
- Includes carry bag for easy storage
- Padded handles for comfort

TA128 9' Speed Rope \$15

TA1281 10' Speed Rope \$17

BEGINNER SPEED ROPES

- These PVC ropes feature lightweight plastic handles and high-spin swivels

TA1271 7' (Green) \$4.90

TA1272 8' (Blue) \$5.30

TA1273 9' (Red) \$5.60

TA1274 10' (Yellow) \$6.10



SPEED DEVELOPMENT

MAX BELT

- Features a 3" wide padded heavy-duty Cordura nylon
- Reinforced stitching
- Multiple nylon attachment loops
- Stainless steel hardware

TA1500	S-M (24" - 32" waist)	\$28
TA1501	L-XL (33" - 42" waist)	\$30
TA1503	XXL (43" - 52" waist)	\$31



BULLET BELT™ SYSTEM

- For resistance to improve starting and acceleration mechanics
- Hook & loop closure for easy release giving a contrast workout from resistance to free running
- Adjustable belt

TA138	Bullet Belt System	\$109
TA1382	Extra Belt	\$53

POP BELT™

- The Bullet Belt "Pop" release is the basic design in the Bullet Belt series
- Used to train explosive sport-specific skills

TA1383	\$65
--------	------

BULLET BELT SPEED PULLEY

This two-person over-speed trainer features a unique safety release if towed athlete cannot maintain pace. Comes with 30m of cord and a Bullet Belt universal web belt.

TA1381	Bullet Belt Speed Pulley	\$179
--------	--------------------------	-------



RESISTANCE TETHER

- Improve speed with resistance running
- Harness attaches to 10' long nylon web cord with handle
- Includes nylon cord and a 3" wide hook & loop closure belt adjustable to 42" waist, and carry bag

TA150	\$42
-------	------

DUAL RESISTANCE TETHER

- One athlete runs while the other provides resistance
- Includes nylon strap attached to two 3" wide hook & loop closure belts adjustable to 42" waist, and carry bag

TA1521	\$44
--------	------

TIRE TETHER

- Can be used to drag tires of different sizes for varied workouts
- Includes nylon strap and hardware to attach tire, 3" wide hook & loop closure belt adjustable to 42" waist, and carry bag
- Tire not included

TA1384	\$49
--------	------



SPRINT START SLED

- Unique design provides for clearance over and around virtually all starting blocks
- Olympic style weight plates may be added to increase resistance. Includes sled, 11' leads, and 3" wide hook & loop closure belt adjustable up to 42" waist
- Designed by University of Idaho head coach Tim Cawley

TA1541 \$308



POWERMAX® SLED

Provides lower body resistance that develops speed and strength for all athletes in all sports. Add the desired weight to determine resistance. Load up to 200 lb. 15" tall post fits 4 Olympic bumper plates. Includes sled, 11' leads, 3" wide hook & loop closure belt adjustable to 42" waist, and instructions. **Weights not included.**

TA154	<i>Sled w/Belt</i>	\$157
TA156	<i>Sled and Shoulder Harness</i>	\$162
TA15401	<i>Additional Waist Belt</i>	\$28
TA15402	<i>Additional Pair of Leads</i>	\$32
TA156H	<i>Shoulder Harness and Leads</i>	\$35



LOW DRAG SPEED SLED

- Ideal sled to add incremental resistance to your athletes
- Easy storage
- Weighs less than 7 lb each
- Includes waist belt, nylon leads, carabiners and sled

TA157 \$99



POWERMAX® VARIABLE RESISTANCE CHUTE

The PowerMax VR Chute features a hook & loop closure baffle panel that can be opened or closed to achieve desired resistance. Open the baffle for reduced resistance or close to increase it.

TA163M	<i>S/M</i>	<i>Gray</i>	\$59
TA163XL	<i>L/XL</i>	<i>Black</i>	\$72



TC-TIMER SYSTEM

The TC-Timer is a wireless timing device that enables athletes and coaches to measure time, speed, count repetitions, input test data and save it all in the TC-Timer memory.

- Sends radio transmissions up to 1,000 feet
- Accurate to the 100th of a second
- Equipped with 5 different radio frequencies allowing multiple systems to be used in the same area
- All components fit neatly into a small lumbar pack

E38720	<i>TC Timer System</i>	\$1955
E38721	<i>Pair, Additional TC Gates</i>	\$823
E38724	<i>Replacement Tripod</i>	\$82
E38726	<i>Replacement Remote</i>	\$936
E38710	<i>Speed-Trap 1 Timing System</i>	\$813



POWERMAX® PUSH/PULL SLED

The PowerMax Push/Pull Sled is great for versatility and adjustability in speed training.

- USA made 11 gauge steel frame sled
- Space-saving design that is less than 7" high when folded
- Replaceable/removable runners for use on a variety of surfaces
- Quick release pins for fast set-up and breakdown
- Adjustable width push posts (12-21" W x 32" H) and multiple push/pull options
- Sled weighs 45 lb (empty)
- Holds up to 300 lb, center post fits four 45 lb bumper plates

TA155C12 *Sled w/Belt + Harness*
24" W x 35" L x 35" H (w/post) **\$449**

SPEED DEVELOPMENT



DYNAMIC TRAINER

- Develop maximum strength and power for running
- Keeps resistance around the hips or torso
- 10' elastic tube is covered with nylon webbing, can stretch up to 30'

TA158 \$132

DUAL SPEED TRAINER

This two-person assisted overspeed and resistance running kit is very effective for speed gains. The overspeed training provided to the rear athlete increases both stride length and frequency. *Includes 20' latex tubing, two 3" wide hook & loop closure belts adjustable to 42" waist, and carry bag.*

TA164	20' Medium Tubing	\$117
TA165	20' Heavy Tubing	\$123

POWERMAX® HIP FLEXOR

- Strengthen hip flexors and upper quadriceps
- Offers resistance to muscle groups during any training session and maintains athlete's pure running form
- Up to three ¾ lb weight bars attached to thigh belts
- Includes thigh belts, six ¾ lb weight bars, 3" wide hook & loop closure belt adjustable to 42" waist, and carry bag

TA1511 \$79



WALL BALL TARGET

- Helps avoid damaging the wall while exercising
- Target is powder coated steel with slightly angled surface

TA1300 20" X 20" \$132



POWERMAX® SAND BAG SET

- Leak proof inner bags hold 20 lb of sand securely (sand not included)
- Inner bags are pre-marked for easy measurement
- Five strategically placed padded handles
- Set includes inner and outer bags, holds up to 80 lbs

TA12241 \$105

SINGLE-SIDED RACK

- Powder-coated steel rack holds up to 5 balls

TA129 52" x 11" x 14" (7 lb) \$112

DOUBLE-SIDED RACK

- Powder-coated steel rack holds up to 10 balls

TA1292 63" x 22.5" x 9" (27 lb) \$151



Fits Powermax® V2 Medicine Balls

PORTABLE POWER JUMPER

- Increases explosive power
- Provides resistance with all plyometric jumps and runs
- Includes 2 resistance cables (5') with foam cushioned padding (24") and 2 multi-way cable pocket handles

TA1605 \$50

CORE STRENGTH



POWERMAX® MED BALLS V2

- 18 oz. flexible moisture resistant polyurethane shell textured for grip
- Hand-sewn casing design and expert ball construction
- Dimensionally stable, balanced, and maintains the impact absorbing properties
- **One year warranty**

TA1362	6 lb	Ø 14"	\$79
TA1363	8 lb	Ø 14"	\$84
TA1364	10 lb	Ø 14"	\$90
TA1365	12 lb	Ø 14"	\$97
TA1366	14 lb	Ø 14"	\$101
TA1367	16 lb	Ø 14"	\$107
TA1368	18 lb	Ø 14"	\$112
TA1369	20 lb	Ø 14"	\$118



NON-BOUNCE MED BALLS

Material is made from durable PVC.

TA13204	4 lb	Ø 9"	\$15
TA13206	6 lb	Ø 9"	\$17
TA13208	8 lb	Ø 9"	\$21
TA13210	10 lb	Ø 9"	\$25
TA13215	15 lb	Ø 9"	\$33
TA13220	20 lb	Ø 9"	\$36
TA13225	25 lb	Ø 9"	\$53
TA13230	30 lb	Ø 10 1/4"	\$62
TA13240	40 lb	Ø 10 1/4"	\$89
TA13250	50 lb	Ø 10 1/4"	\$123



MAX-CORE BALLS

- The handles enable user to perform numerous exercises
- 10 1/2" diameter
- Color coded for weight identification
- 1" x 1 1/4" grip

TA1350	6 lb	Ø 9"	\$65
TA1351	8 lb	Ø 10 1/2"	\$71
TA1352	10 lb	Ø 10 1/2"	\$79
TA1353	12 lb	Ø 10 1/2"	\$95
TA1354	14 lb	Ø 10 1/2"	\$111
TA1355	16 lb	Ø 10 1/2"	\$129
TA1356	18 lb	Ø 10 1/2"	\$138
TA1357	20 lb	Ø 10 1/2"	\$163



POWERMAX® GRIP BALLS

Durable rubber shell with filler and comfortable built in rubber handle. Will not harm rubber floors. Balls are Ø 8" (diameter), grip is 1" x 1 1/4".

TA4002	2 lb	\$30
TA4004	4 lb	\$36
TA4006	6 lb	\$46
TA4008	8 lb	\$53
TA4010	10 lb	\$60



POWERMAX® RUBBER MED BALLS

Synthetic rubber balls suitable for all sports. Can be used indoor and outdoor. Color coded for easy weight identification.

TA106	1K Purple	Ø 6.5"	\$27
TA108	2K Yellow	Ø 7.5"	\$35
TA109	3K Green	Ø 9.5"	\$42
TA110	4K Red	Ø 9.5"	\$51
TA111	5K Blue	Ø 10.5"	\$59
TA112	6K Orange	Ø 11"	\$65
TA131	7K Gray	Ø 11.5"	\$79
TA132	8K Black	Ø 12"	\$93



POWERMAX® SWING BALLS

Rubber stopper added for improved durability. Color coded for easy weight identification.

TA1332	2K Yellow	Ø 7.5"	\$62
TA1333	3K Green	Ø 9.5"	\$73
TA1334	4K Red	Ø 9.5"	\$87
TA1335	5K Blue	Ø 9.5"	\$102

BODYWEIGHT TRAINING

					
12' Long	\$309.00 00113120	\$252.00 00199012	\$729.00 00115120	\$295.00 00118120	\$599.00 00119120
16' Long	\$319.00 00113160	\$263.00 00199016	\$879.00 00115160	\$309.00 00118160	\$759.00 00119160
20' Long	\$329.00 00113200	\$271.00 00199020	\$1,019.00 00115200	\$329.00 00118200	\$899.00 00119200
24' Long	\$339.00 00113240	\$282.00 00199024	\$1,169.00 00115240	\$349.00 00118240	\$1,039.00 00119240



HEMP CLIMBING ROPES

This 1-1/2" rope contains 12-18% mineral oil lubricant by weight for long life and is securely attached within a heavy-duty steel fitting for years of durability. Optional rubber knots attached every 12". Collegiate ropes are finished with a vinyl boot.

SOFT DACRON ROPES

Soft Dacron ropes are ideal for elementary physical education programs. The no-twist spun Dacron material is easier on hands than hemp ropes and will wear better than cotton. Hypoallergenic.

ROPE ATTACHMENT METHODS



3 1/2" OD PIPE CLAMP

10970000 \$15



STAPLE PLATE

10340000 For Wood Beams \$21
10341000 For Concrete Beams \$34



STEEL I-BEAM CLAMP

10100100 Fits ≤8" Beams \$48
10100200 Fits ≤17" Beams \$68

ROPE ACCESSORIES

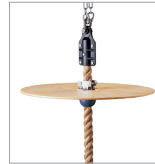

TAMBOURINE

3/8" lacquered plywood tambourine restricts climbing height. Clamp permits fast removal & easy adjustment.

00198000 \$139



ROPE HOIST

Hoist is complete with wall brackets, ceiling attachment, heavy-duty cord and weight. Installs easily, ready to use.

00104000 \$238

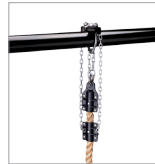

SAFETY GUARD

Safety guard prevents the rope from falling if a part fails or wears out.

00110000 \$132



POWERMAX CONDITIONING ROPES

Ropes help athletes with power generation, strength endurance, and increased cardio development.

- 1.5" or 2" Thicknesses
- Synthetic Fibers
- Optional bracket fits up to 2.125" rope, made of .125" flat steel and round bar
- Finished handles prevent shedding and blistering

TA1606	1.5" Synthetic Rope – 30'	\$218
TA1607	1.5" Synthetic Rope – 40'	\$257
TA1608	1.5" Synthetic Rope – 50'	\$305
TA1617	2" Synthetic Rope – 30'	\$242
TA1613	Rope Wall Bracket	\$25





00196010

WALL-MOUNTED CHINNING BARS

- 50" wide by 21" tall with 1" grip diameter
- Bar is 22" away from wall/ceiling
- 48" mounting centers
- **Black powder coat finish**
- **Hardware not included**

WE179 \$201



WE179

MULTI-STATION WALL-MOUNTED CHINNING BARS

- 10' long chinning bar with three stations
- Mounts 16" away from the wall
- 1" solid steel diameter grip with a durable zinc plated finish
- Design allows for continuous chinning bar installations in 10' long increments with optional add-on section

00196010 10' Solid Steel Chinning Bar \$589
 00196013 10' 3 Piece Steel Chinning Bar \$589



ADJUSTABLE CHINNING BAR

- 1" Grip diameter
- Bar is 22" away from wall/ceiling
- 48" Mounting centers
- Black powder coat finish
- Hardware not included

00197100 \$369



POWERMAX® FITNESS RINGS

- Package contains two durable Lexan® plastic Ø1.1" rings, two 19' straps with stainless hardware and a handy carrying bag
- 1 3/8" wide heavy-duty nylon web straps with leveling markings for quick adjustment

TA1598 \$85



WALL ATTACHED LADDER

- Designed to encourage participants of all age levels to develop strength and coordination
- Fabricated of 12' steel contoured side rails with 12 plated steel rungs
- Includes wood pads and mounting hardware

00125100 \$1830



PEG BOARD CLIMBERS

- 1 1/2" Thick gloss finished hardwood
- Rectangle has 11 holes spaced on 10" centers. Holes are arranged in 2 rows with staggered alignment
- Square has 16 holes spaced on 7 1/2" centers in a 4 x 4 grid pattern
- Two ø1 1/2" x 6 1/2" wood pegs included
- Mount directly to the wall or use optional mounting brackets
- Hardware not included

00188 Rectangle 15" x 60" \$452
 00189 Square 30" x 30" \$452
 001881 Pair, Mounting Brackets \$133
 001891 Pair, Wood Pegs \$22



AB BUSTER STRAPS

- Improve core strength and stability with suspended core exercises
- Heavy duty woven nylon with steel grommets and carabiners
- Straps are padded with a washable brushed lining for comfort

WE242 \$85

WEIGHT BARS & PLATES

POWER BAR

- 86" Black oxide steel
- 45 Lb weight
- 32 Mm grip diameter
- 1200 Lb weight rating
- Lifetime warranty against bending

WT1203 \$329

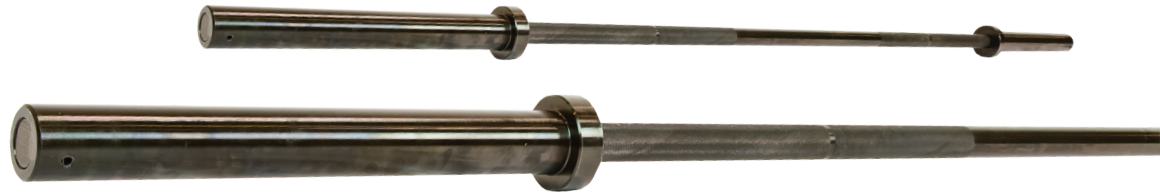

20 KG TRAINING BAR

- 86" Zinc plated steel
- 20 Kg / 44 lb weight
- 30 Mm grip diameter
- 1000 Lb weight rating
- Bushing
- One year warranty

WT1214 \$161

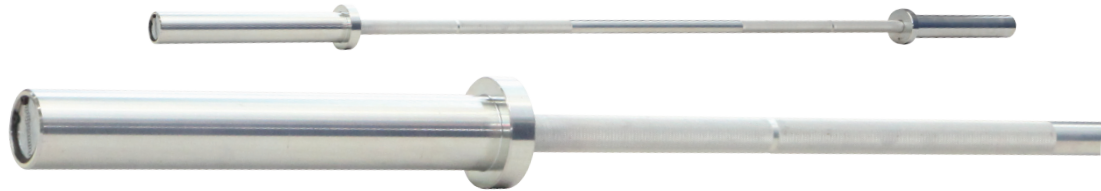

15 KG TRAINING BAR

- 79" Black oxide steel
- 15 Kg / 33 lb weight
- 25 Mm grip diameter
- 170,000 Psi tensile strength
- 22 Needle bearing
- One year warranty

WT1215 \$93

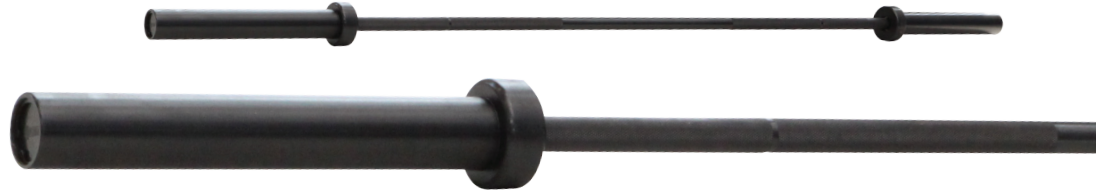

CAMBERED SQUAT BAR

This bar allows squats to be done in a more vertical posture, producing intensified quadriceps involvement. Cambered end design relieves much of the lower back stress normally associated with a back squat. All steel design with padded shoulder harness.

WT129	Cambered Squat Bar	\$379
WT1291	Replacement Neck Pad	\$15
WT1292	Replacement Shoulder Pad	\$8



PRO BAR WRAP PAD

- Protects shoulders and back during lifting exercises.
- Black nylon cover with high quality foam insert
- 14" Long

WE310 \$15



MANTA RAY

- Prevents painful pressure points during back squats.
- Durable polyurethane material
- Quickly snaps onto the bar
- Distributes weight over a larger area

WE3111 \$56



STING RAY

- Use the sting ray during front squats to relieve pressure on the shoulders.
- Durable polyurethane material
- Quickly snaps onto the bar
- Distributes weight over a larger area

WE3112 \$56



STEEL SPRING COLLARS

Traditional, functional steel spring collar

WT131 \$13

SOLID RUBBER BUMPER PLATES

Bumper plates are the ideal tools for any lift from a standing position. Designed to impact the ground without creating damage to the floor, these new plates are thinner for those who wish to lift larger loads.

- 100% Rubber plates with solid steel insert
- Fit any olympic-style bar
- Colored plates feature colors to help guide weight selection
- Plates are sold in pairs
- Standard plate size 18" diameter



ROLLING BUMPER STAND

- Rugged casters allow for easy transport
- Stores up to ten 45 lb bumper plates
- Removable center post for easy load/unload
- Laser cut 1/2" steel base

WE528 36"H x 24"W x 24"D, 25 lb \$170



FLAT UTILITY BENCH

- Constructed of 11 gauge, 2" welded sq-uare steel tubing. Fixed uprights
- Firm Foam Padding On 3/4" Plywood With Durable Stitch Seamed Vinyl
- Assembly Required

WE100 18"H x 16"W x 48"L, 32 lb \$166



LEATHER LIFTING BELT

- Top Quality 3/4" Thick, 4" Wide Cowhide
- Soft Suede Lining
- Seamless Roller Buckle

\$40

WE320S 24-33" **WE320L** 38-44"
WE320M 31-37" **WE320XL** 45-51"



WRIST STRAPS

Provides support for Olympic lifts, overheadwork, and bench presses.

WE31912 12" Wrist Straps \$17/pr
WE31924 24" Wrist Straps \$24/pr

JUMP TRAINING & TESTING



STANDING LONG JUMP TEST MAT

- Non slip mat provides a soft landing surface that makes marking the distance of the jump easy
- Both English and Metric units
- Heavy enough to prevent any sliding, rolls up for easy storage
- Measures jumps to 10' 5"

TA197 \$535

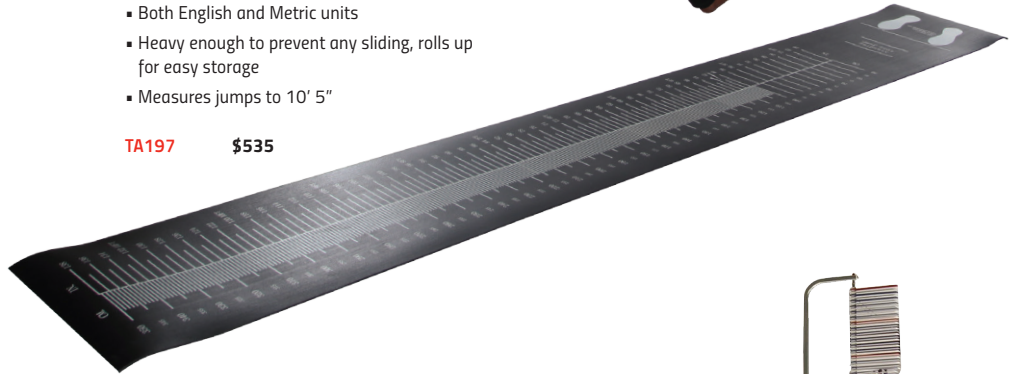

POWERMAX® ELECTRONIC VERTICAL JUMP TESTER

- Measures from 7' to 12' in ½" increments
- Light up dots on the height scale and digital display immediately show the exact jump height
- Data is downloadable to any computer
- Height decal offers quick "zero" marking
- Standing height measuring strip helps establish base height of reach prior to jump

TA199CXX \$1400

CUSTOMIZABLE

See color charts on page 79 to replace the XX in the item number.

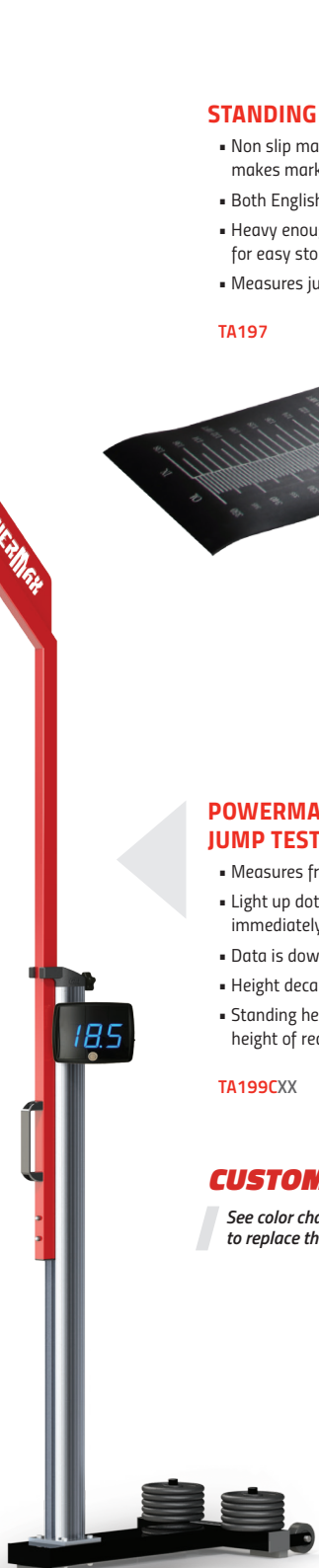

VERTEC MEASURING DEVICE

- An effective, easy-to-use jump training tool
- Measures from 6-12'
- Height scale and color coded vanes offer half-inch measurement for immediate feedback
- Handy, attachable rod to align or reset vanes

TA195 \$674



STRIDE CHECKER

- Improve stride length and frequency
- 30M long with segmented markings
- Usable on most surfaces
- Includes storage bag

TA1695 \$45



PRO WRIST ROLLER

- Most effective way to strengthen hands, forearms, and wrists
- Heavy 12" long ø1.25" Pipes
- Clip on attachment for standard plates

WE312 \$47



COACH BEEPER

- Digital electronic cadence beeper
- Helps a coach to work more exclusively with additional athletes
- Enhances athlete's ability to train more effectively
- Enables athletes to concentrate on several critical training techniques to enhance speed and strength

TA145 \$999



VERTICAL JUMP TEST MAT

- Gives a true vertical height measurement
- Waist belt attaches to measuring tape (included) and to mat
- Fast, accurate, and easy to use

TA196 \$319



EXPLOSIVE CALVES

- Train while you play
- Adds resistance to movement involving contraction of the calf muscle
- Includes two knee straps and two 6" light elastic cords

TA16560 \$55



POWERWHEEL

Challenging unique exercises for your abs, obliques, back, hips and glutes

TA364 \$71



POWERMAX® ADJUSTABLE ANKLE WEIGHTS

Made of the same stretchable neoprene as our PowerMax Weight Vest these ankle weights can be adjusted to fit anyone.

TA1861 1 Pair, 5 lb Ankle Weights \$39

TA1862 1 Pair, 10 lb Ankle Weights \$48

FLEXIBILITY & REHAB



POWERMAX® PROFESSIONAL TUBING

- Adjustable from 4' (maximum) down to desired length
- Color coded for resistance identification

TA1736	Light Tubing, Magenta	\$11
TA1737	Medium Tubing, Orange	\$12
TA1738	Heavy Tubing, Red	\$12



POWERMAX® STABILITY BALLS

- Excellent for balance, abdominal work, and stretching
- Fabricated from durable vinyl, supports 500 lb
- Ships Deflated

TA1805	55 cm Ball (5' - 5' 8")	\$26
TA1806	65 cm Ball (5' 8" - 6' 2")	\$29
TA1807	75 cm Ball (6' 2"+)	\$33



POWERMAX® MINI BANDS

2" W x 13" L

TA1741L	10 Light Bands (Red)	\$28
TA1741M	10 Medium Bands (Gray)	\$37
TA1741H	10 Heavy Bands (Black)	\$42



POWERMAX® FITNESS BANDS

- Effective for rehab, fitness, flexibility, and training
- Boxed rolls can be cut to length
- 6" wide cut bands

TA1726	5 yd Roll, Light	\$14
TA1727	5 yd Roll, Medium	\$20
TA1728	5 yd Roll, Heavy	\$24



POWERMAX® STRENGTH BANDS

- Resistance determined by thickness & width
- 41" long, seamless latex rubber
- Layered construction helps prevent breakage
- Sold individually

TA17110	XX-Light 35 lb Resistance (.5"), Red	\$11
TA17160	X-Light 50 lb Resistance (.75"), Orange	\$17
TA17170	Light 65 lb Resistance (1"), Violet	\$20
TA17120	Medium 80 lb Resistance (1.5"), Blue	\$30
TA17130	Heavy 150 lb Resistance (2"), Green	\$43
TA17140	X-Heavy 175 lb Resistance (3"), Black	\$59
TA17150	Super 200 lb Resistance (4"), Yellow	\$73



ANKLE-FLEX STRAPS

Ankle-Flex Straps hold the sprinter's foot in the flexed position for improved ground strike efficiency and lower leg swing resistance. *Sold in pairs.*

TA1485 \$24/pr



STRETCHRITE™

TA1780 \$26



STRETCH OUT STRAP

TA1781 \$6



BOSU® BALANCE TRAINER

- Fitness / health professional version
- Includes program manual, training video, & free pump

TA1790 \$179



36" POWERMAX® FOAM ROLLER

TA3620 6" D X 36" L \$31



18" POWERMAX® 2-IN-1 FOAM ROLLER

Roller consists of a solid high density inner core roller and an outer texture snap-on sleeve.

TA1826 6" D X 18" L \$44



THE STICK

TA1830 24" Stick \$51

TA1831 18" Stick \$41



POWERMAX® BALANCE PAD

- Soft eva foam material
- Great for balance & coordination activities

TA1803 17"L x 10"W x 23/8"H \$31



ROLL-UP EXERCISE MAT

- Soft, durable foam with textured surface
- Roll-up for portability and storage

TA304 24"W x 70"L x .125"H \$22



TRIGGER POINT GRID ROLLERS

The grid foam roller features distrodensity™ zones, matrix technology, and an environmentally friendly design.

TA1835 13"L x 5"D \$44



AEROBIC FLOOR MAT

- Use for low impact situations
- Great for ab/floor workouts
- 3P compliant (California)

TA30826 42"W x 72"L x 2"H \$91

VAULT BOXES

ALUMINUM VAULT BOX

- Welded aluminum construction
- Reinforced backstop for prolonged life
- Once installed you will never have to remove it
- *Meets NFHS, NCAA and IAAF specifications, IAAF certified*

502  \$489

ALUMINUM VAULT BOX LID

- Compatible with all Gill vault boxes
- Reinforced with two 1/2" angled vertical supports to prevent sagging
- 50201: Recessed design for 1/2" (12mm) track surface
- 50202: Flush design with no added track surface

50201	Lid-Recessed Mount	\$429
50202	Lid-Flush Mount	\$459

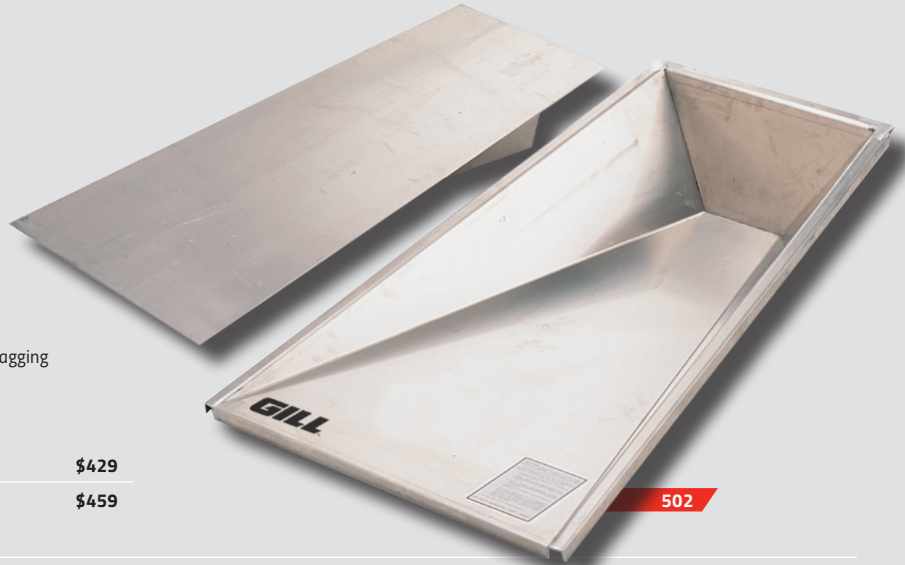

STEEL VAULT BOX

- Twelve gauge steel with fold and weld construction
- Flanged edges and flared sides for secure installation
- Finished with durable white powder coat
- *Meets NFHS, NCAA and IAAF specifications, IAAF certified*

500  \$359

UNIVERSAL VAULT BOX LID

- Compatible with all Gill vault boxes
- Constructed of 11 gauge hot rolled steel
- Features anti-slip designed surface
- Finished with durable white powder coat

503 \$309

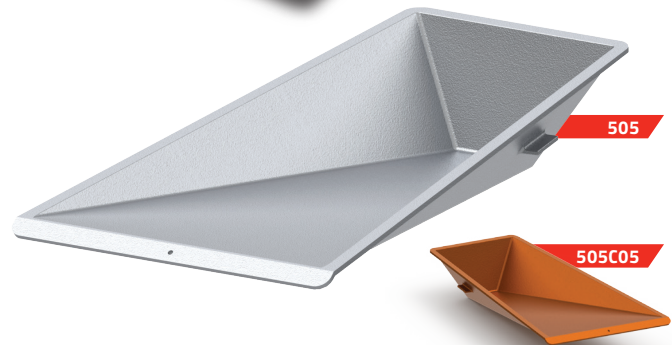

STAINLESS STEEL VAULT BOX AND LID

- Box: Stainless steel alloy fold and weld construction for corrosion resistance
- Lid: 12 gauge 304 stainless steel plate with 2 angled vertical supports to prevent sag
- Lid: Recessed design for 1/2" (12mm) track surface
- Lid intended for use with stainless steel vault box for best corrosion resistance
- *Meets NFHS and NCAA specifications*

504	Vault Box	\$759
50401	Vault Box Lid	\$549

CAST ALUMINUM VAULT BOX

- 100% cast aluminum construction with a wall thickness of 3/8"
- Standard durable white powder coat finish; Orange powder coat option available
- Inside corners rounded for unhindered pole rotation
- Guaranteed against cracking or warping
- *Meets NFHS, NCAA and IAAF specifications, IAAF certified*

505	White 	\$799
505C05	Orange 	\$869

SOFTER IS SAFER

SKYDEX™ SOFT VAULT BOX



PATENTED SKYDEX MATERIAL

SKYDEX VAULT BOX VS STANDARD VAULT BOX

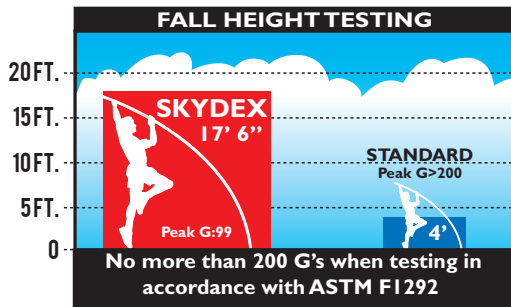

SKYDEX™ SOFT VAULT BOX

- Exclusive Skydex designed vault box represents quantum leap forward in pole vault safety
- Patented Skydex material greatly increases safety with no effect on vaulter experience
- Enhanced safety with integrated Skydex Smarter Cushioning technology in design of vault box
- Tests show fall of 17' 6" into Skydex box would equal 4' fall in standard vault box
- Redesigned for easier installation
- *Meets NFHS, NCAA and IAAF specifications, IAAF certified*

507	Vault Box	\$3000
50701	Vault Box Lid - Flush	\$649

SAFETYMAX™ VAULT BOX

- Tray is made of 12 gauge steel with box bottom utilizing Skydex Smarter Cushioning technology
- Thermoformed white HMWPE 1/8" sheet on top of Skydex material
- Enhances safety of pole vault event with no effect on vaulter experience
- When combined with 719 SafetyMax+ Vault Box Collar (page 12) creates the safest vault facility
- *Meets NFHS, NCAA and IAAF specifications*

50810	\$1370
-------	--------

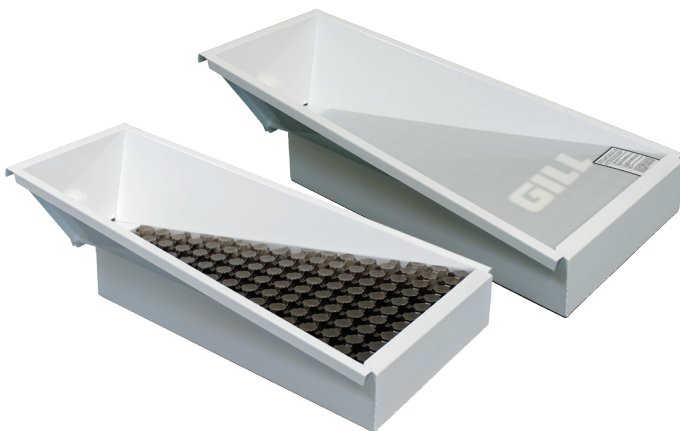

TAKE-OFF BOARDS & CURBING

PREPARE FOR TAKE-OFF WITH GILL BOARDS



TAKE-OFF BOARD SYSTEMS

With the Gill Adjustable Take-Off Board Systems you get ease of installation, ease of use and dependable peak performance.

Gill Take-Off Board systems are the easiest and fastest boards to install in the market. **Complete system** comes with installation tray, adjustable folded aluminum base, reversible long lasting take-off board and foul board, and functional blanking lid ready to accept track surfacing.

- 8" take-off board and 4" foul board creates 12" system
- Exclusive easy-adjust leveling system for both horizontal and vertical axis
- Composite for longer lifespan
- Composite boards made of Polyboard®, an environmentally friendly, waterproof material that will not split or crack while offering jumpers great grip
- **Meets NFHS, NCAA and IAAF specifications**

4350S	Complete NCAA System	\$885
4351S	Complete IAAF System	\$916
P435007	Replacement 4" NCAA Foul Board	\$54
P435107	Replacement 4" IAAF Foul Board	\$85
P435005	Replacement 8" Take-Off Board	\$143
P435205	Replacement 12" Take-Off Board	\$133
4352S	12" Take-Off Board and Tray	\$450
P435008	Replacement Leveling Base Board	\$318
435021	Replacement 12" Blanking Board Assembly	\$473
P435015	Replacement 12" Installation Tray	\$178
439	1 lb Plasticine Brick - Yellow	\$6.70

STANDARD 8" TAKE-OFF BOARD SYSTEMS

- 8" take-off board system
- Complete system: Installation tray, aluminum leveling board and reversible take-off board
- Composite for longer lifespan
- Composite boards made of Polyboard®, an environmentally friendly, waterproof material that will not split or crack while offering jumpers great grip
- Blanking lid sold separately
- Meets NFHS and NCAA specifications

444S	Complete Standard 8" Take-Off Board System	\$411
44420	Blanking Lid Assembly	\$107
44405	Replacement Take-Off Board	\$205
P44402	Replacement Leveling Base Board	\$213
443	Replacement Installation Tray	\$360



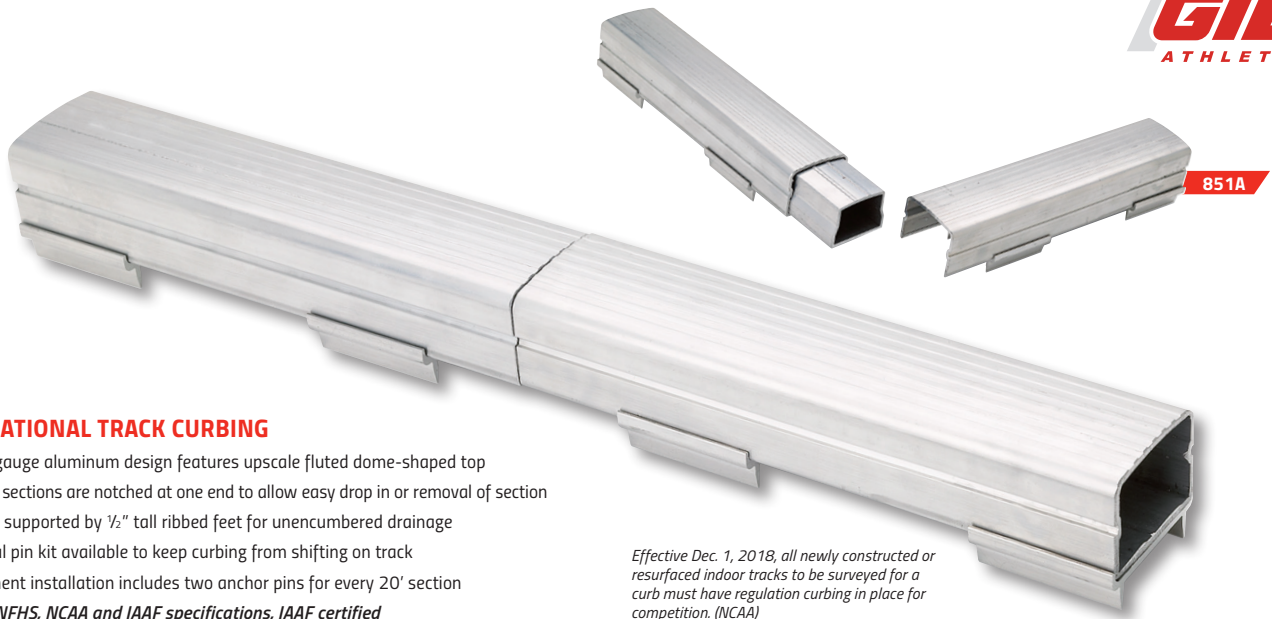

INTERNATIONAL TRACK CURBING

- Heavy gauge aluminum design features upscale fluted dome-shaped top
- Curbing sections are notched at one end to allow easy drop in or removal of section
- Curbing supported by ½" tall ribbed feet for unencumbered drainage
- Optional pin kit available to keep curbing from shifting on track
- Permanent installation includes two anchor pins for every 20' section
- *Meets NFHS, NCAA and IAAF specifications, IAAF certified*

Effective Dec. 1, 2018, all newly constructed or resurfaced indoor tracks to be surveyed for a curb must have regulation curbing in place for competition. (NCAA)

NON-PERMANENT INSTALLATION CURBING

851A	Plain		\$9.30/ln ft
852A	Anodized		\$14/ln ft
852P	Powder Coated		\$12/ln ft
851P	Base Pins (12)		\$170/set

PERMANENT INSTALLATION CURBING

853A	Plain		\$9.80/ln ft
854A	Anodized		\$14/ln ft
854P	Powder Coated		\$14/ln ft

CUSTOMIZABLE



*Gray and Black powder coat available in Gloss or Flat



HIGH SCHOOL TAKE-OFF BOARD SYSTEM

- 19 ½" take-off board system
- Complete System: Installation tray, aluminum base board, and reversible take-off board
- Composite for longer lifespan
- Composite boards made of Polyboard®, an environmentally friendly, waterproof material that will not split or crack while offering jumpers great grip
- *Meets NFHS specifications*

441TS	Complete HS System	\$463
44105	Replacement 19 ½" Take-Off Board	\$115
442	Replacement Installation Tray	\$442



CONVERSION BOARD

- Convert a Gill 19 ½" take-off board system to an 8" system
- Includes 8" composite take-off board, black vultrak, and baseboard

441C \$299

SAND PIT FORMS & COVERS

Sand pit forms hold more than just sand, they hold value. With four different options of Sand Catcher locations and two practical Sand Catcher Cover options, you can design the horizontal jump facility that will perfectly meet your needs.

Choose from one of four sand catcher locations: no sides, two sides, two sides and back, or all four sides. Choosing Sand Catchers on the sides will cut unnecessary costs and eliminate potential trip hazards, providing more than ample storage space for overflow sand.

Choose from one of two Sand Catcher Cover systems: traditional grate and mat or Gill (exclusive) Recessed Lid. When you consider the main function of a Sand Catcher system is not to catch sand but to store it, the Recessed Lid system is rapidly becoming the choice of facilities worldwide, as it is designed to receive track surfacing to match your track facility. When coupled with the 730148 Aluminum Sand Pit Cover, a complete logical design emerges for your world class jumps facility.

No matter which combination you choose; with the Gill Functional-Form, you can rest assured that you have chosen the finest product (with the easiest installation) available.

FORM WITH RECESSED CATCHERS

CATCHERS ON	FORM #	Length	Price
4 SIDES	F46225	25'	\$18510
	F46228	28'	\$20070
	F46231	31'	\$20800
3 SIDES	F46124	24'	\$15390
	F46127	27'	\$16120
	F46130	30'	\$17990
2 SIDES	F46023	23'	\$12900
	F46026	26'	\$14770
	F46029	29'	\$15910

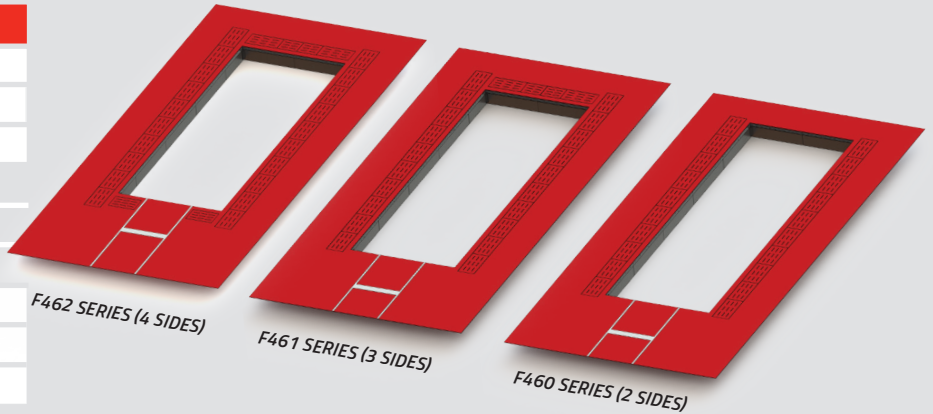

FORM WITH GRATE & MAT CATCHERS

CATCHERS ON	FORM #	Length	Price
4 SIDES	F44225	25'	\$17680
	F44228	28'	\$19760
	F44231	31'	\$20390
3 SIDES	F44124	24'	\$14690
	F44127	27'	\$15390
	F44130	30'	\$17060
2 SIDES	F44023	23'	\$11650
	F44026	26'	\$13000
	F44029	29'	\$13520

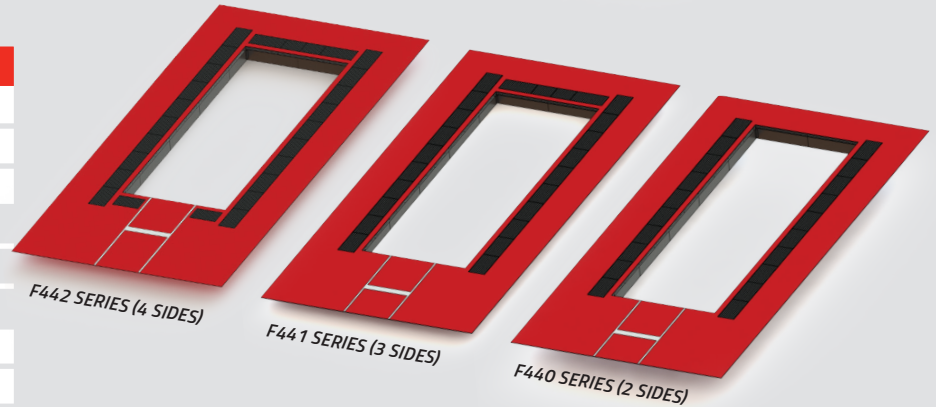

FORM WITHOUT CATCHERS

WITH LEDGE	FORM #	Length	Price
	F42023	23'	\$5100
	F42026	26'	\$5620
	F42029	29'	\$5830

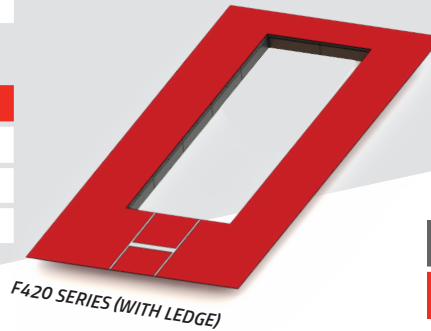

ALL FORMS ARE 9' 8" WIDE

FAST INSTALLATION

READY-FIT ALUMINUM SAND PIT COVERS

F44023C	23' Cover	\$7320	F44026C	26' Cover	\$8280	F44029C	29' Cover	\$9230
F44124C	24' Cover	\$7650	F44127C	27' Cover	\$8610	F44130C	30' Cover	\$9560
F44225C	25' Cover	\$7950	F44228C	28' Cover	\$8900	F44231C	31' Cover	\$9960



COLORS



ADDITIONAL COVER COLORS AVAILABLE!
Additional charge applies. See page 3 for color options. (Gray is standard.)

BALLASTED LJ/TJ SAND PIT COVERS

- Exclusive Vipol Matrix mesh material or solid vinyl polyester
- Anchoring system: Vinyl wrapped galvanized steel chain perimeter
- Ballasted pit covers are custom sized and sold by the square foot (no returns)
- Dimension certification form must be submitted with order

493680	Mesh Vinyl	\$4.50/sq ft
493682	Solid Vinyl	\$3.90/sq ft

LJ/TJ SAND PIT COVERS

- Keep your sand pit clean and dry with solid vinyl sand pit covers or choose mesh if rain is not an issue
- Constructed of vinyl coated woven polyester
- Anchoring system: Bags filled with sand placed in pouches to weigh cover down
- Optional 5' x 5' multi-color graphic available
- Graphic worksheet and vector artwork must be provided

730147	Mesh 11' 9" x 25' 6"	\$989
730147L	Mesh 11' 9" x 31' 6"	\$1200
730147V	Vinyl 11' 9" x 25' 6"	\$1040
730147VL	Vinyl 11' 9" x 31' 6"	\$1400
9453	Graphic Option	\$699

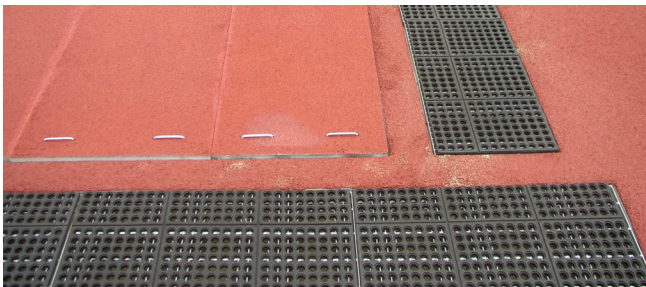

TRADITIONAL GRATE & MAT SAND CATCHER COVER SYSTEM

- Combination of 1" x 1/8" galvanized steel bar grating and perforated rubber overlay
- Creates strong combination for stamping off sand yet light enough for easy handling
- Standard unit measures 18" x 36" x 1 5/8" and requires a ledge around perimeter to rest on
- For perfect fit, installer may make one or more field cuts
- Sold per 18" x 36" sections only

730149	\$165/section
--------	---------------

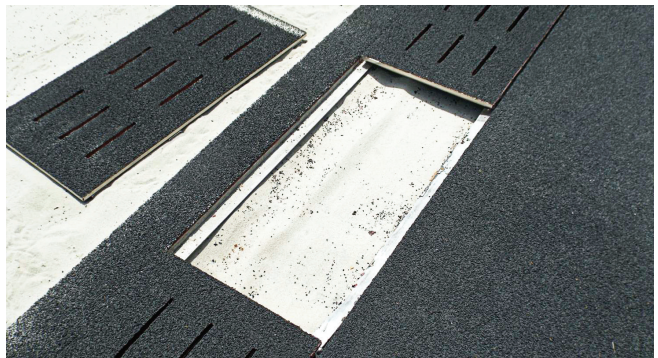

RECESSED SAND CATCHER COVER SYSTEM

- Recessed cover design for 1/2" (12mm) track surface
- Constructed of 1/8" aluminum sheet metal
- Standard unit measures 18" x 36" and requires a ledge around perimeter to rest on
- Special lengths available between 18" and 35" long

73015036	\$159/section
----------	---------------



LJ/TJ ALUMINUM SAND PIT COVER

- Each panel made from 9.5" x 1.75" x .125" aluminum planking framed with 2 3/8" x 1 1/2" x 3/16" aluminum angle
- Panels have four flush mount handles
- Recessed design for 1/2" (12mm) track surface

730148	\$34/sq ft
--------	------------

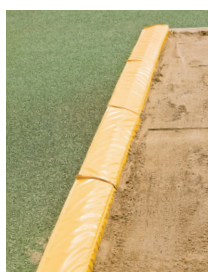

PERIMETER PADDING SYSTEM

- Greatly reduce possibility of injury caused by impact with sand pit edging
- Modular pads install on any sand pit quickly and conveniently
- Critical location of pads is along sides of sand pit
- Each pad is 36" long

730	\$85
-----	------

STEEPLECHASE



FUNCTIONAL-FORM STEEPLECHASE WATER JUMP SYSTEMS

Gill Athletics has greatly simplified the installation of steeplechase water jump reservoirs with these Functional-Form systems. With the Functional-Form, installation precision is ensured to meet NFHS, NCAA and IAAF specifications. Structure is fabricated of specially folded 1/8" aluminum to maximize strength and includes designed inner wall supports that allow the concrete to flow through and set evenly.

- F500: Compatible with 740144 water jump barrier
- F510: Compatible with 740134 water jump barrier
- Both models compatible with 730146 aluminum water jump cover
- Both models come standard with valve option: installed front wall valve to be connected with an outgoing pipe to the drain source
- Meets NFHS, NCAA and IAAF specifications

F500 Surface Mount Form **\$5510**

F510 Ground Sleeve Form **\$5510**

SAVE MONEY WITH VALUEPACKS!

VALUEPACK - SURFACE MOUNT

Package includes:

- F500 Steeplechase Water Jump Form
- 740144 Steeplechase Water Jump Barrier-surface mount version

VPF500 **\$7970**

VALUEPACK - GROUND SLEEVE

Package includes:

- F510 Steeplechase Water Jump Form with integrated ground sleeves
- 740134 Steeplechase Water Jump Barrier-ground sleeve version

VPF510 **\$7620**

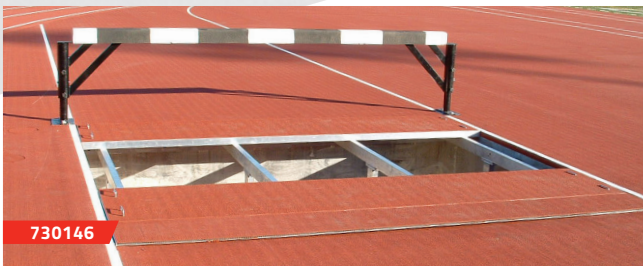

730146

WATER JUMP COVERS

- Each panel made from 9.5" x 1.75" x .125" aluminum planking framed with heavy duty aluminum angle
- Panels have four flush mount handles
- Recessed design for 1/2" (12mm) track surface
- Understructure supported with 4" x 2" aluminum beams

730146 **\$7930**

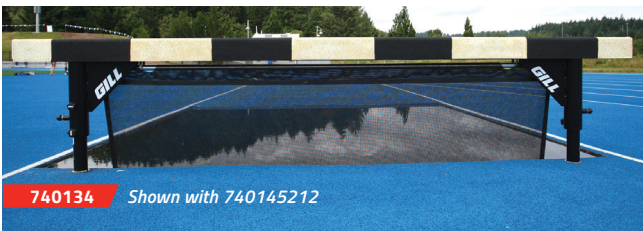

740134 Shown with 740145212



STEEPLECHASE WATER JUMP BARRIERS

- Barrier beam is 4" x 4" square steel tubing with synthetic track material
- Pull pin design makes barrier height change a snap
- Welded gusset adds needed strength support to the beam
- Adjustable to three heights: 30", 33", 36"
- Aluminum water jump barrier seal available
- Meets NFHS, NCAA and IAAF specifications
- Surface mount barrier is IAAF certified

740134 Water Jump Barrier w/ Ground Sleeves **\$2185**

740144 Water Jump Barrier w/ Surface Mount  **\$2545**

730145B Aluminum Water Jump Barrier Seal **\$607**

MESH WATER JUMP BARRIER SEALS

- Add color and design to your steeplechase water jump
- Lightweight design will ease water barrier height change

740145202 Royal Blue **\$299**

740145203 Red **\$299**

740145204 White **\$299**

740145209 Gray **\$299**

740145212 Black **\$299**

740145204SP White Mesh with Graphics **\$499**

COLORS



ROYAL BLUE RED WHITE GRAY BLACK



STEEPLECHASE BARRIER WITH DROP DOWN WHEELS

- Barrier beam is 4" x 4" square steel tubing with synthetic track material
- Wheels easily set and retract with a finger lever and lift on each end
- Drop down wheels make this the most maneuverable barrier on the market
- Pull pin design makes barrier height change a snap
- Welded gusset adds needed strength support to the beam
- Adjustable to three heights: 30", 33", 36"
- Meets NFHS, NCAA and IAAF specifications, IAAF certified

740135	1 x 5m Barriers, 3 x 4m (4)	IAAF	\$11495/set
740135131	4m Barrier; 13' Width	IAAF	\$3050/ea
740135161	5m Barrier; 16' 5" Width	IAAF	\$3325/ea

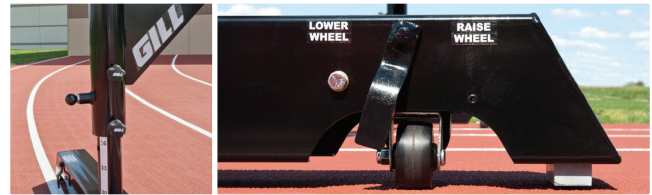

STEEPLECHASE BARRIER

- Barrier beam is 4" x 4" square steel tubing with synthetic track material
- Pull pin design makes barrier height change a snap
- Welded gusset adds needed strength support to the beam
- Adjustable to three heights: 30", 33", 36"
- Optional wheel kit for manual addition of wheels for transportation
- Meets NFHS, NCAA and IAAF specifications, IAAF certified

740140	1 x 5m Barriers, 3 x 4m (4)	IAAF	\$8620/set
740140131	4m Barrier; 13' Width	IAAF	\$2150/ea
740140161	5m Barrier; 16' 5" Width	IAAF	\$2430/ea
74014050	Wheels (4)		\$215/set

GILL 5 YEAR LIMITED WARRANTY
On all Steeplechase Barriers. Call for Details.

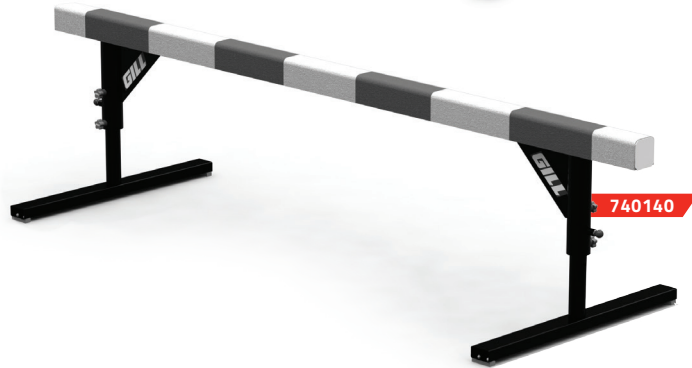

6' TRAINING BARRIER

740140061	6' Training Steeplechase Barrier		\$1720
740135061	6' Training Barrier w/Drop Down Wheels		\$2860

STEEPLECHASE LANE GATE

- Harness the power of a Track Lane Gate and the functionality of a Steeplechase Barrier
- Steeplechase Barrier is ground sleeve or surface mounted to inside of track curbing
- Swing out for steeplechase running event, swing in for easy removal and storage
- Use as a Track Lane Gate to lengthen the life of lanes 1-4 on your track

740142	Ground Sleeve		\$9205
740141	Surface Mount		\$9515



CIRCLES & TOEBOARDS



ALUMINUM CIRCLES

- Four sections of 1" x 3/4" extruded aluminum angle
- Designed to be cast into concrete
- Discus circle can also be mounted to surface
- Compatible with toeboards 358, 363
- *Meets NFHS, NCAA and IAAF specifications*

369	Shot/Hammer Circle	\$209
370	Discus Circle	\$219



ALUMINUM CIRCLES WITH 2" ANGLE PROFILE

- Two sections of 2" x 2" extruded aluminum angle
- Designed to be cast into concrete
- Compatible with toeboards 358, 363
- *Meets NFHS, NCAA and IAAF specifications*

374	Shot/Hammer Circle	\$479
375	Discus Circle	\$499

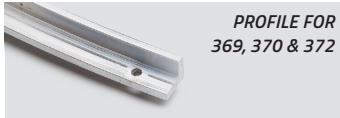

PROFILE FOR
369, 370 & 372



PROFILE FOR
371 & 373



PROFILE FOR
374 & 375



364 with 373

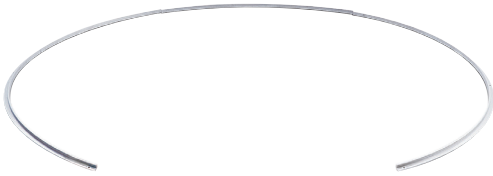

ALUMINUM SHOT CIRCLE

- Three sections of 1" x 3/4" extruded aluminum angle
- Designed to be mounted on top of concrete surface
- Anchor bolts included
- Compatible with toeboards 359, 364
- *Meets NFHS specifications*

372	\$199
-----	-------



POWDER COATED STEEL DISCUS CIRCLE

- Three sections of 3/4" x 1 1/2" flat powder coated steel
- Designed to be mounted on top of concrete surface
- Anchor bolts included
- *Meets NFHS specifications*

371	\$269
-----	-------



POWDER COATED STEEL SHOT CIRCLE

- Four sections of 3/4" x 1 1/2" flat powder coated steel
- Designed to be mounted on top of concrete surface
- Anchor bolts included
- Compatible with toeboards 359, 364
- *Meets NFHS specifications*

373	\$239
-----	-------

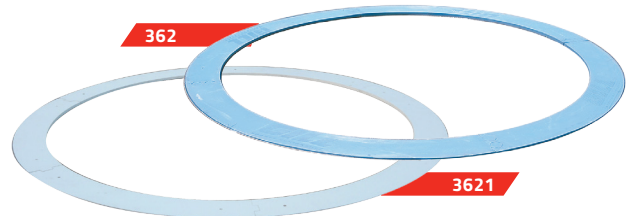

HAMMER CONVERSION CIRCLE

- Converts a discus ring into a hammer ring
- Four piece: blue PVC material
- Six piece: white recycled plastic with interlocking sections
- *Meets NFHS, NCAA and IAAF specifications, IAAF certified*

362	4 Piece System		\$929
3621	6 Piece System		\$799



ALUMINUM CIRCLES WITH CROSS BRACING

- Two sections of 1/4" x 3" extruded aluminum with welded bracing
- Bolt together to maintain form during in-ground installation
- Hardware included
- Compatible with toeboards 358, 363
- *Meets NFHS, NCAA and IAAF specifications, IAAF certified*

366	Shot/Hammer Circle		\$629
366C04	Shot/Hammer Circle; white		\$679
367	Discus Circle		\$639
367C04	Discus Circle; white		\$689

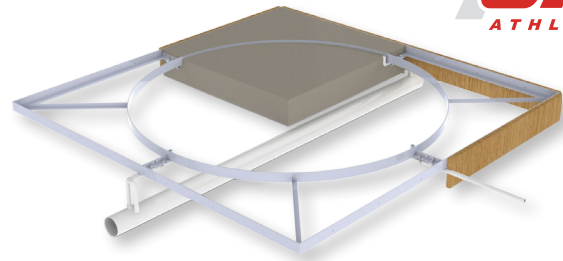

ALUMINUM CIRCLE FORMS

- Four sections of 2" x 3" aluminum angle
- Bolt together form for in-ground installation
- Aluminum exterior bracing creates a strong frame
- Center open for smooth concrete pour and crack-resistant finish
- Inner circle is 1/4" x 3" flat aluminum bar
- Compatible with toeboards 358, 363
- *Meets NFHS, NCAA and IAAF specifications*

3741	Shot/Hammer Circle Form	\$2250
3751	Discus Circle Form	\$2670



SYNTHETIC SHOT TOEBOARD FOR DEPRESSED PAD

- Molded low density polyethylene designed for 3/4" depressed surface
- Compatible with circles 366, 369, 374, 3741
- *Meets NFHS, NCAA and IAAF specifications*

358 \$319

SYNTHETIC SHOT TOEBOARD FOR LEVEL PAD

- Molded low density polyethylene designed for surface mount shot circles
- Compatible with circles 372, 373
- *Meets NFHS specifications*

359 \$319



ALUMINUM SHOT TOEBOARD FOR DEPRESSED PAD

- Cast aluminum designed for a 3/4" depressed surface
- Compatible with circles 366, 369, 374, 3741
- *Meets NFHS, NCAA and IAAF specifications, IAAF certified*

363 \$499

ALUMINUM SHOT TOEBOARD FOR LEVEL PAD

- Cast aluminum designed for surface mount shot circles
- Compatible with circles 372, 373
- *Meets NFHS specifications*

364 \$499



SYNTHETIC PLUGS

- Keeps debris and standing water out of throwing circles
- Constructed of 3/4" thick rubber and made to fit snug inside depressed circles
- Plugs come in sections for easier handling

37001	Shot Circle Plug	\$419
37002	Discus Circle Plug	\$709



INDOOR SHOT/WEIGHT THROW CIRCLE

- Constructed of 3/4" plywood with steel hinges and handles
- Foldaway handles for easy handling and storage
- Laminated weather proofed marine plywood toeboard (sold separately)
- Optional three piece 3/4" 7-ply birch plywood throwing surface (sold separately, not shown)
- *Meets NFHS, NCAA and IAAF specifications*

368	Indoor Shot/Weight Throw Circle	\$969
3680	Wood Shot Toeboard for Indoor Circle	\$459
3681	Shot Throwing Surface	\$369

DISCUS CAGES

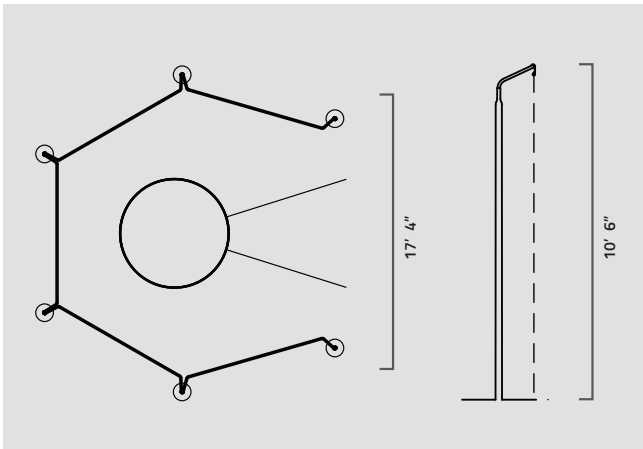

PRO-DOWN DISCUS CAGE

- Poles: (6) 2 3/8" outside diameter 12 gauge steel poles
- Net: Knotless weather treated nylon net with 180 lb break strength
- Net height: 10' 6"
- Five galvanized steel top rungs eliminate net sag
- **Meets NFHS specifications**

80401	Cage with Ground Sleeves	\$1700
80402	Cage with Plates	\$2700
80405	Replacement Net	\$1070

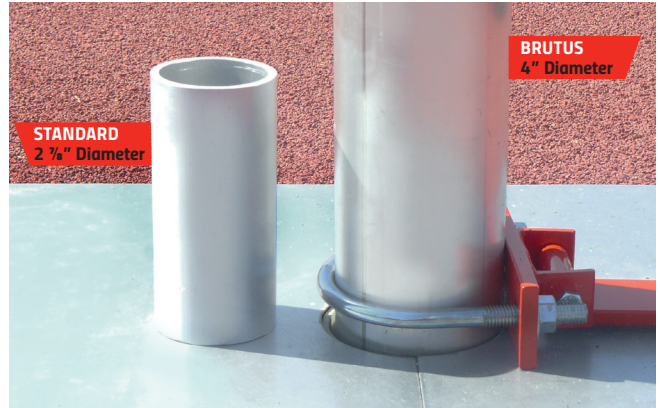

BRUTUS DISCUS CAGE

- For high wind areas that need extra strength discus cages
- Made of Hammer Cage strength 4" outside diameter .218" thick wall aluminum poles
- Products with CXX include Powder Coat option, use the two-digit number from the color chart on page 84 to replace the XX in the product number
- **Meets NFHS and NCAA specifications**

9010	6 Pole High School Cage	\$4430
9010CXX	6 Pole High School Cage with Custom Color	\$5275
9020	7 Pole High School Cage	\$5150
9020CXX	7 Pole High School Cage with Custom Color	\$5870
9021	7 Pole High School Cage w/ Rear Door Access	\$5460
9021CXX	7 Pole High School Cage w/ Rear Door Access with Custom Color	\$6180
732150	8 Pole NCAA Cage w/ Rear Door Access	\$8200
732150CXX	8 Pole NCAA Cage w/ Rear Door Access with Custom Color	\$9000



DISCUS SECTOR NET

- Effective at stopping shot or discus from rolling or skipping outside of the sector
- 2' tall by 60' long 320 lb break strength discus net
- Held by 3/4" diameter steel net poles and ground stakes
- Polyethylene net spools included for convenient storage and handling

731135 \$370

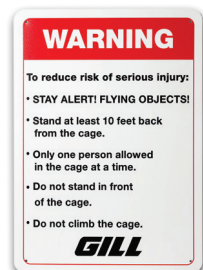

REPLACEMENT WARNING SIGN

M2322 \$11

STANDARD OPTION

COLOR OPTION

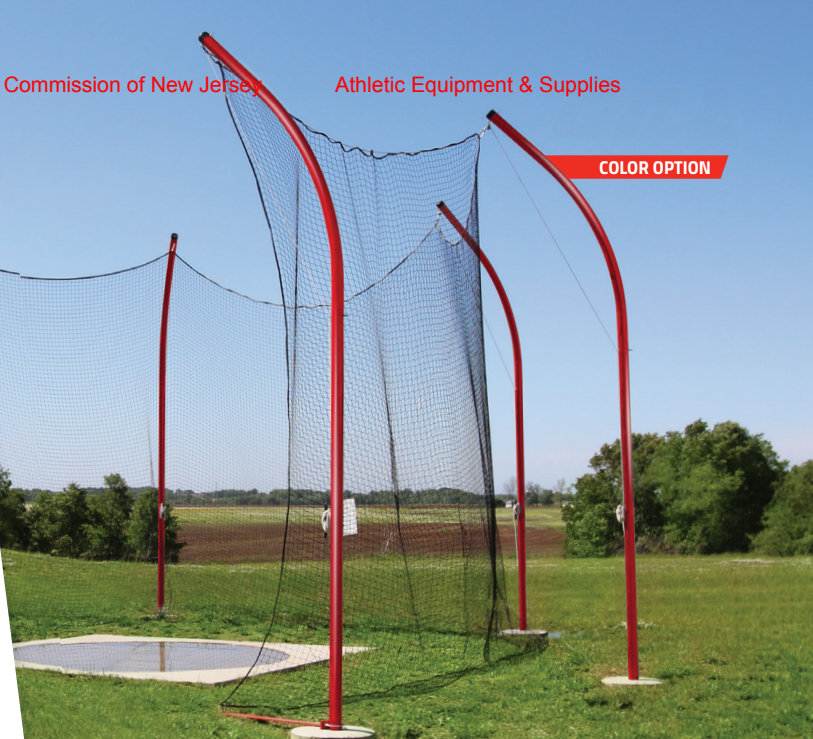

COLOR OPTIONS AVAILABLE!

Transform Your Cages with Custom Powder Coat Options.

CUSTOMIZABLE

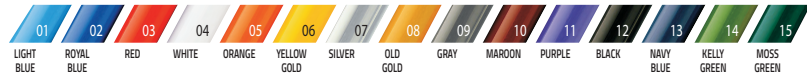

*To specify color with order, use the two-digit number of your color selection to replace XX in the item number.
 *Gray and Black powder coat available in Gloss or Flat

7 POLE DESIGN

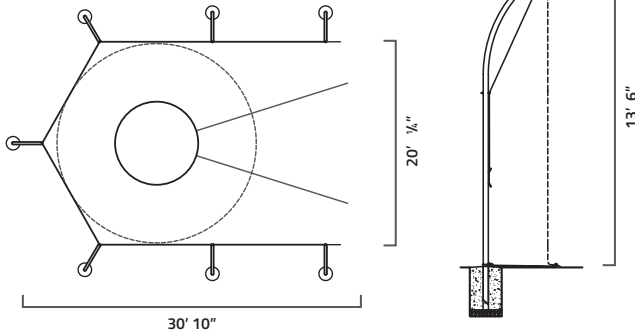

6 POLE DESIGN

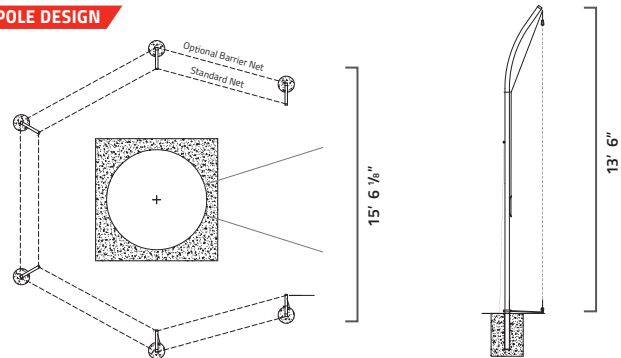

HIGH SCHOOL ALUMINUM DISCUS CAGE

8010	6-Pole Cage	\$2985
8010CXX	6-Pole Cage with Custom Color	\$3705
M2055	Replacement Main Net	\$729
80102	Barrier Net	\$389
8020	7-Pole Cage	\$3325
8020CXX	7-Pole Cage with Custom Color	\$4120
80201A	Replacement Main Net	\$629
80202A	Barrier Net	\$519
8021	7-Pole Cage w/ Rear Door Access	\$4325
8021CXX	7-Pole Cage w/ Rear Door Access with Custom Color	\$5045
80211	Replacement Main Net	\$819
80212	Barrier Net w/ Rear Door Access	\$499

HIGH SCHOOL STEEL DISCUS CAGE

8030	6-Pole Cage	\$2700
M2055	Replacement Main Net	\$729
80302	Barrier Net	\$419

SPECIFICATIONS

- Aluminum poles: 2 7/8" outside diameter 6063-T6 (Ultimate-30ksi, Yield-25ksi) with rolled offset for safety
- Steel poles: 2 1/2" square A513 (Ultimate-42ksi, Yield-30ksi) with rolled offset for safety
- Nets: 180 lb break strength
- Net height: 13' 6"
- Meets NFHS specifications

DISCUS & SHOT CAGES



732130
OPTIONAL BARRIER NET SHOWN

GILL EXCLUSIVE PRODUCT
REAR DOOR ACCESS SYSTEM

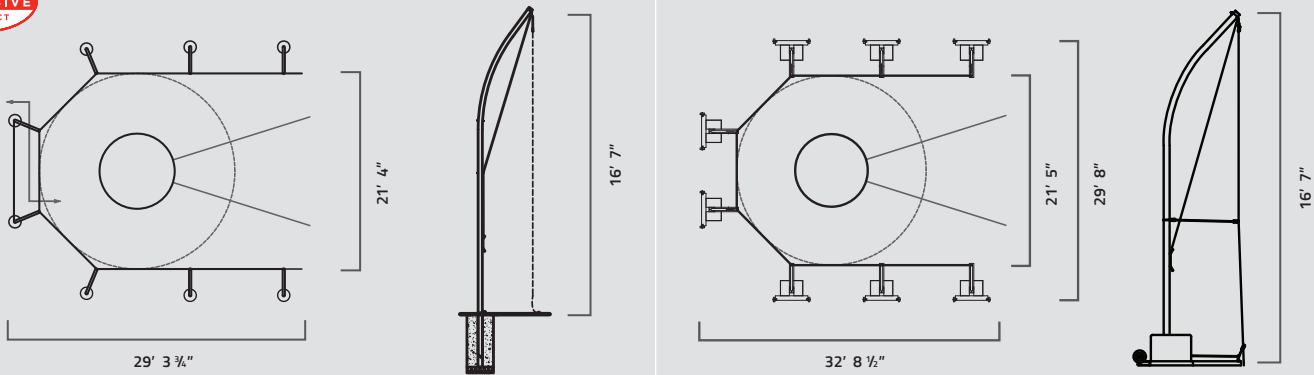

NCAA ALUMINUM DISCUS CAGE

- Poles: (8) 6063-T6 aluminum net poles
- Net: Weather treated nylon 6 net with 340 lb break strength
- Rear door access net standard
- Net height: 16' 7"
- Rear net support tubes prevent net sag
- 18" hinged net arms secure net at all eight poles
- 36" deep ground sleeves
- Meets NCAA specifications

732130	Cage	\$5250
732130CXX	Cage with Custom Color	\$6180
732133	Replacement Main Net	\$1490
732132	Optional Barrier Net (8')	\$1150

NCAA PORTABLE DISCUS CAGE

- Designed for set up and removal as needed
- Poles: (8) 2 1/2" outside diameter schedule 40 aluminum net poles
- Net: Weather treated nylon 6 net with 340 lb break strength
- Net height: 16' 7"
- Bases: A500 Grade B steel with wheels for transportability and weighted with 5 gallon jugs to be filled with sand or water
- Meets NCAA specifications

732230	Cage	\$10300
732230CXXYY	Cage with Custom Color	\$11330
732131A	Replacement Main Net	\$1120



8050

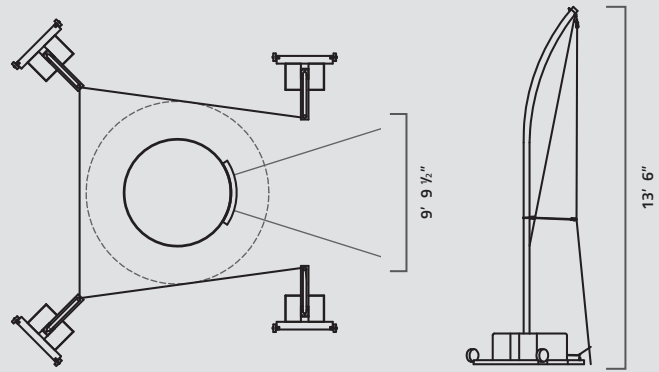
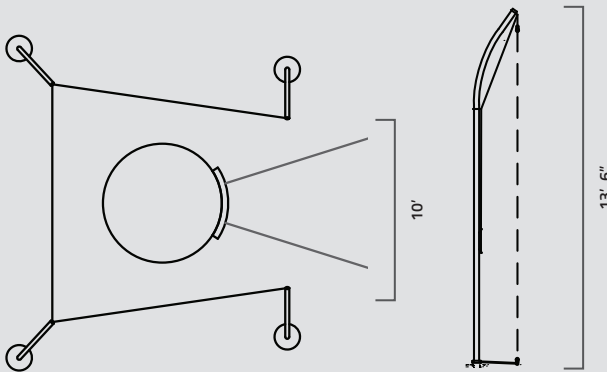

SHOT CAGE

- Poles: (4) 6063-T6 aluminum or A513 steel
- Net: Weather treated nylon 6 net with 180 lb break strength
- Net height: 13' 6"
- 18" hinged net arms secure net at front two poles with ground stakes used at back poles
- 20" deep ground sleeves

805	<i>Steel Cage</i>	\$2150
8050	<i>Aluminum Cage</i>	\$2600
8050CXX	<i>Aluminum Cage with Custom Color</i>	\$2935
M2054	<i>Replacement Main Net</i>	\$741

PORTABLE SHOT CAGE

- Designed for set up and removal as needed
- Poles: (4) 6063-T6 aluminum net poles
- Net: #42A knotless nylon netting with 180 lb break strength
- Net height: 13' 6"
- Bases: A500 Grade B steel with wheels for transportability and weighted with 5 gallon jugs to be filled with sand or water

732260	<i>Cage</i>	\$5870
732260CXXYY	<i>Cage with Custom Color</i>	\$6490
M2054	<i>Replacement Main Net</i>	\$741

DISCUS & PORTABLE CAGES



732250

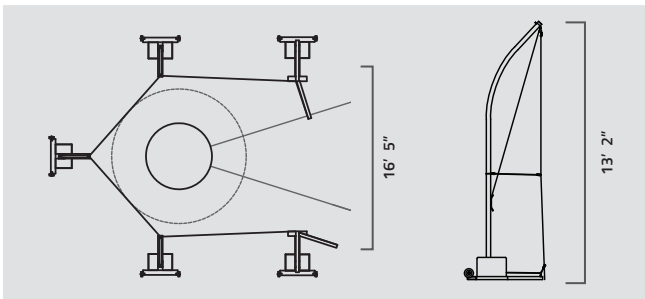

NCAA PORTABLE INDOOR CAGE

- Designed for set up and removal as needed
- Poles: (5) 6063-T6 aluminum net poles
- Net: #42A knotless nylon netting with 561 lb break strength
- Net height: 13' 2"
- Doors: repositionable with wired front design for longer life
- Bases: A500 Grade B steel with wheels for transportability and weighted with 5 gallon jugs to be filled with sand or water
- **Meets NCAA specifications**

732250	Cage	\$11535
732250CXXYY	Cage with Custom Color	\$12770
732251	Replacement Main Net	\$1770
731152	Replacement Door Net	\$249



732220

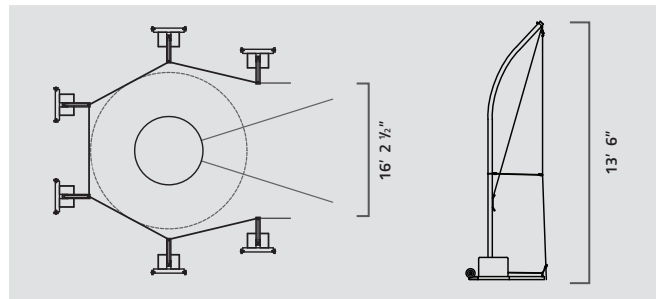

HIGH SCHOOL PORTABLE DISCUS CAGE

- Designed for set up and removal as needed
- Poles: (6) 6063-T6 aluminum net poles
- Net: #504 knotless nylon netting with 180 lb break strength
- Net height: 13' 6"
- Bases: A500 Grade B steel with wheels for transportability and weighted with 5 gallon jugs to be filled with sand or water

732220	Cage	\$7520
732220CXXYY	Cage with Custom Color	\$8445
M2055	Replacement Main Net	\$729

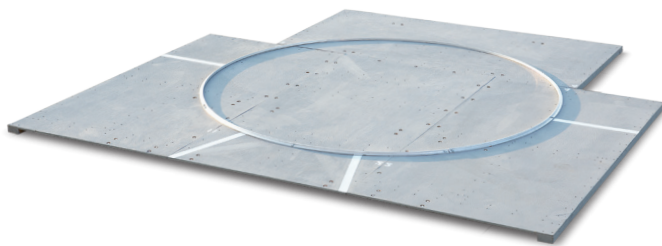

PORTABLE DISCUS PLATFORM

- Wood platform with aluminum circle
- Constructed of 1/2" marine grade plywood with pressure treated 2' x 5' and 2' x 6' lumber
- Platform breaks down into eight pieces for storage space of 8' x 4'
- Weighs in excess of 400 lb
- Gray marine coat finish

3710	\$4900
------	--------

GILL EXCLUSIVE PRODUCT REAR DOOR ACCESS SYSTEM

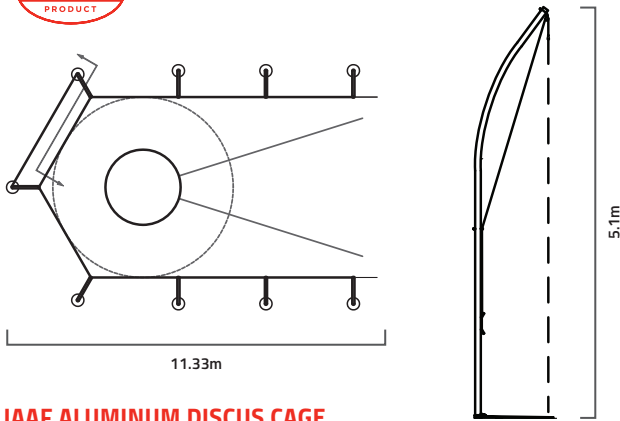

IAAF ALUMINUM DISCUS CAGE

- Poles: (9) 6063-T6 aluminum net poles
- Net: Weather treated nylon 6 net with 340 lb break strength
- Rear door access net standard
- Net height: 5.1m
- Rear net support tubes prevent net sag
- 18" hinged net arms secure net at all nine poles
- 36" deep ground sleeves
- IAAF certified

732140	Cage		\$6030
732140CXX	Cage with Custom Color		\$7000
732143	Replacement Main Net		\$1790
732142	Optional Barrier Net (8')		\$759

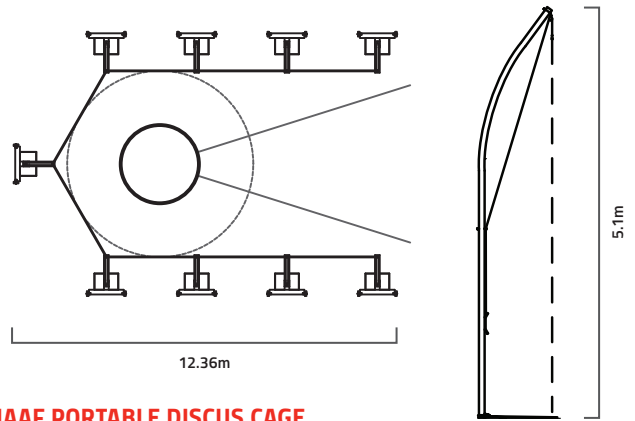

IAAF PORTABLE DISCUS CAGE

- Designed for set up and removal as needed
- Poles: (9) 6063-T6 aluminum net poles
- Net: Weather treated #42A knotless net with 340 lb break strength
- Net height: 5.1m
- Bases: A500 Grade B steel with wheels for transportability and weighted with 5 gallon jugs to be filled with sand or water
- IAAF certified

732240	Cage		\$13390
732240CXXYY	Cage with Custom Color		\$14420
732141A	Replacement Main Net		\$1340

GILL EXCLUSIVE PRODUCT REAR DOOR ACCESS SYSTEM



IAAF TALL DISCUS/HAMMER CAGE

- Poles: (8) 6063-T6 aluminum net poles
- Doors: (2) Galvanized steel door hinge poles and 10m tall aluminum moveable doors
- Net: Weather treated nylon 6 net with 340.7kg break strength
- Rear door access net standard
- Main net: 23' 3.5"/7.1m, Door net: 32' 10"/10m
- Required Cage Pole Braces included
- 48" deep ground sleeves
- Ground sleeve kit sold separately for quick shipability
- IAAF certified

732215	Cage		\$34000
73221501	Ground Sleeve Kit		\$2280
732216	Replacement Main Net		\$9400
732217	Replacement Door Net		\$2080
732218	Optional Barrier Net (8')		\$1680

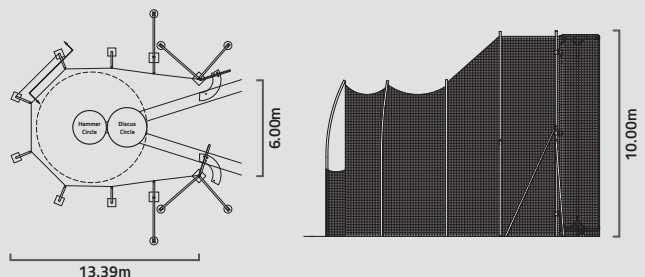

HAMMER CAGES

WHY BUY GILL HAMMER CAGES? SAFETY, CONVENIENCE, & LONGEVITY!

Gill hammer cages have three exclusive features that increase safety and decrease liability. These features combined with an industry best five year cage warranty from Gill Athletics keeps your facility at the top of the class. Doesn't your facility deserve the best?

WIRED FRONT DOOR DESIGN

With a wired front door design your cage will look new for years to come. No more bent front pole from errant throws, and decrease the likelihood of bounce backs from implements.

DOOR HINGE LOCK BOLT

Suggested from the top track designer in America, this unique feature keeps your front doors from tweaking and misaligning from the door hatch location.

REAR DOOR ACCESS

Keep your athletes away from the danger zone of the front cage while increasing the speed of repetitions.

GILL 5 YEAR LIMITED WARRANTY

On all Cages. Call for Details.

CUSTOM COLOR OPTIONS AVAILABLE

Transform your cages with custom powder coat options. See page 86 for details.

MAXIMUS™ HAMMER CAGE

732210	Cage	\$33060
732210CXXYY	Cage with Custom Color	\$35020
73221001	Ground Sleeve Kit	\$1720
732103	Optional Barrier Net (8')	\$799

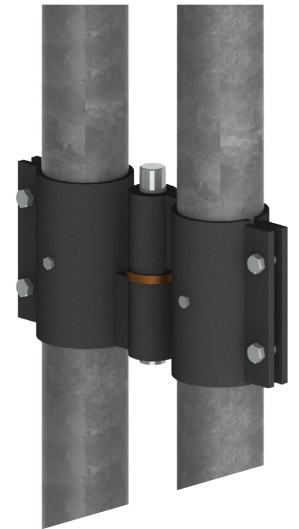
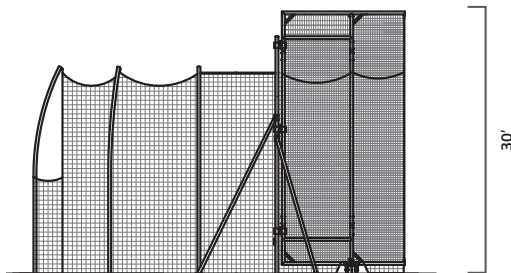

GILL EXCLUSIVE REAR DOOR ACCESS SYSTEM PRODUCT

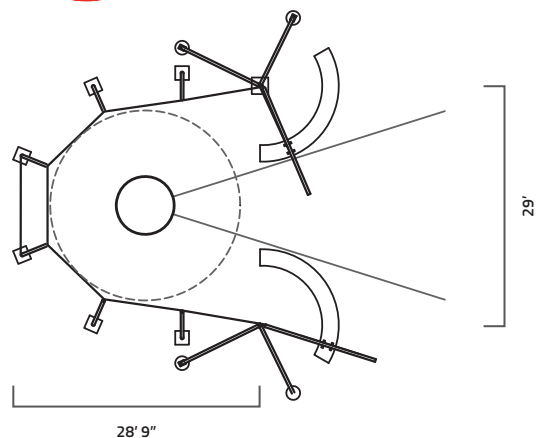



MAXIMUS™ DOUBLE RING HAMMER CAGE

732211	Cage	\$35000
732211CXXYY	Cage with Custom Color	\$40000
73221101	Ground Sleeve Kit	\$2120
732108	Optional Barrier Net (8')	\$879

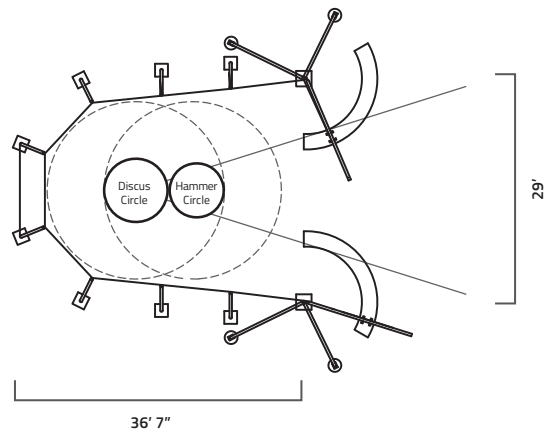
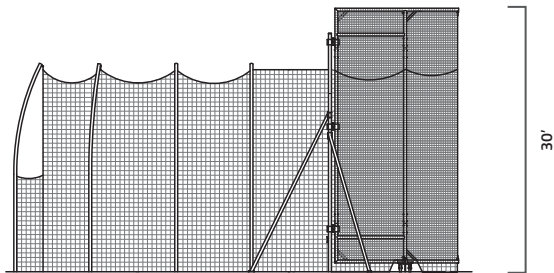

HAMMER & DISCUS CAGES

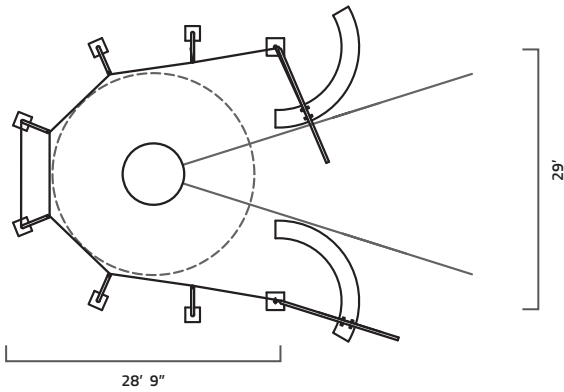

GILL EXCLUSIVE PRODUCT REAR DOOR ACCESS SYSTEM

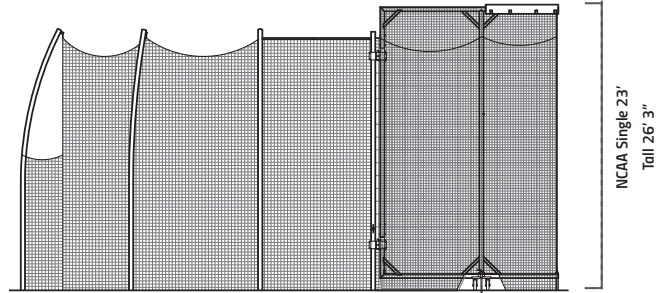

NCAA HAMMER/DISCUS CAGE

- Single Ring Design for Discus Circle and Hammer Conversion Circle
- Poles: (6) 6063-T6 aluminum net poles
- Doors: (2) Galvanized steel door hinge poles and 7m tall aluminum moveable doors
- Net: Weather treated nylon 6 net with 749 lb break strength
- Rear door access net standard
- Main net: 20' 6"/6.25m, Door net: 23'/7m
- 40" deep ground sleeves
- Ground sleeve kit sold separately for quick shipability
- **Meets NCAA specifications**

732100	Cage	\$26000
732100CXXYY	Cage with Custom Color	\$30000
73210001	Ground Sleeve Kit	\$1730
732101	Replacement Main Net	\$7310
732102	Replacement Door Net	\$2270
732103	Optional Barrier Net (8')	\$799
732104	Hammer Cage Door Bracing	\$2000

NCAA TALL HAMMER/DISCUS CAGE

- Single Ring Design for Discus Circle and Hammer Conversion Circle
- Poles: (6) 6063-T6 aluminum net poles
- Doors: (2) Galvanized steel door hinge poles and 7m tall aluminum moveable doors
- Net: Weather treated nylon 6 net with 749 lb break strength
- Rear door access net standard
- Required cage door bracing included
- Main net: 23'/7m, Door net: 26' 3"/8m
- 48" deep ground sleeves
- Ground sleeve kit sold separately for quick shipability
- **Meets NCAA specifications**

732200	Tall Cage	\$29000
732200CXXYY	Tall Cage with Custom Color	\$30000
73220001	Ground Sleeve Kit	\$1770
732201	Replacement Main Net	\$7560
732202	Replacement Door Net	\$2500
732103	Optional Barrier Net (8')	\$799



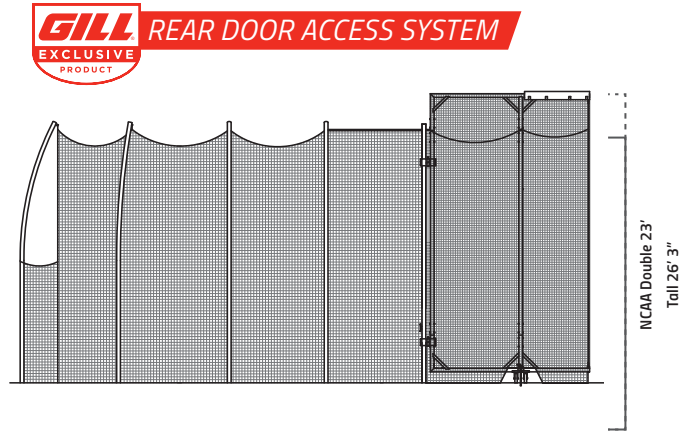
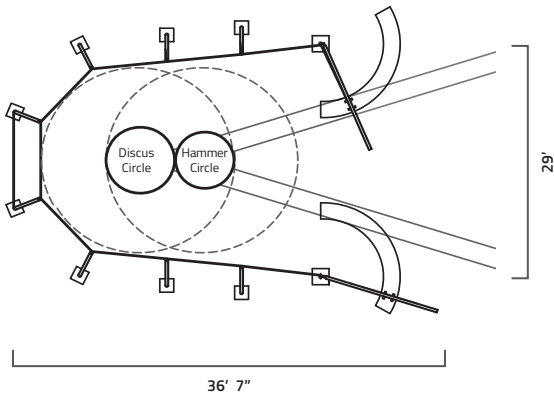

NCAA DOUBLE RING HAMMER/DISCUS CAGE

- Double Ring Design for Discus and Hammer Circle
- Poles: (8) 6063-T6 aluminum net poles
- Doors: (2) Galvanized steel door hinge poles and 7m tall aluminum moveable doors
- Net: Weather treated nylon 6 net with 749 lb break strength
- Rear door access net standard
- Main net: 20' 6"/6.25m, Door net: 23'/7m
- 40" deep ground sleeves
- Ground sleeve kit sold separately for quick shipability
- **Meets NCAA specifications**

732105	Cage	\$28100
732105CXXYY	Cage with Custom Color	\$30000
73210501	Ground Sleeve Kit	\$2130
732106	Replacement Main Net	\$8740
732102	Replacement Door Net	\$2270
732108	Optional Barrier Net (8')	\$879
732104	Hammer Cage Door Bracing	\$2000

NCAA TALL DOUBLE RING HAMMER/DISCUS CAGE

- Double Ring Design for Discus and Hammer Circle
- Poles: (8) 6063-T6 aluminum net poles
- Doors: (2) Galvanized steel door hinge poles and 7m tall aluminum moveable doors
- Net: Weather treated nylon 6 net with 749 lb break strength
- Rear door access net standard
- Required cage door bracing included
- Main net: 23'/7m, Door net: 26' 3"/8m
- 48" deep ground sleeves
- Ground sleeve kit sold separately for quick shipability
- **Meets NCAA specifications**

732205	Tall Cage	\$30900
732205CXXYY	Tall Cage with Custom Color	\$31930
73220501	Ground Sleeve Kit	\$2220
732206	Replacement Main Net	\$7480
732202	Replacement Door Net	\$2500
732108	Optional Barrier Net (8')	\$879



OUTDOOR THROWING NET

- Get the maximum number of reps with the minimal amount of retrieval
- Provides the perfect set up for working on throwing technique for shot put, discus and javelin (weighted balls)
- Bottom of main net has a pocket to catch implements before they hit the ground, preventing damage and making retrieval easier
- Side nets offer additional errant throw protection
- Poles: 4" diameter, 1/8" wall, T6 aluminum tube in 40" deep ground sleeves
- Nets are 749 lb test weather treated knotted nylon
- Main net is 20' x 20'

731300 \$2600

HAMMER CAGE PADDING

- For use at front half of top horizontal member of cage door
- Provides damage protection and minimizes hammer rebound
- Vinyl encased high density foam with hook and loop attachment
- Use the two-digit number of your vinyl color selection (Page 9) to replace the XX in the item number
- **All Gill hammer cages include two pads**

731109CXX Hammer Cage Padding \$349/ea

LOOKING FOR A HAMMER CONVERSION CIRCLE?

See Page 84.

HAMMER & DISCUS CAGES



THOR 10 HAMMER/DISCUS CAGE

- Poles: (4) Combination of steel and aluminum to withstand up to 74mph winds
- Doors: (2) 9m x 3m swing arm doors
- Net: 1 3/8" square mesh woven poly cord with 771 lb break strength
- Main net height: 23'7m, Door net height: 32'10"/9m
- Net is secured by net rails across entire cage and 14 rope anchors
- 59" deep ground sleeves
- IAAF Certified

732310 Thor 10 Hammer/Discus Cage 

\$37080

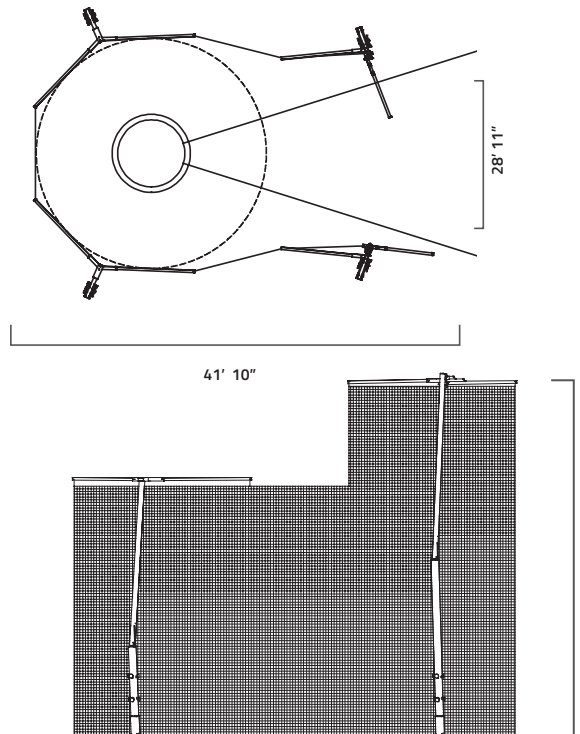

GILL 5 YEAR LIMITED WARRANTY
 On all Cages. Call for Details.

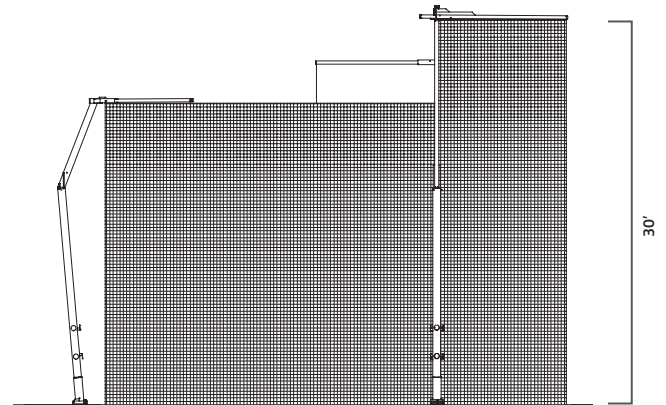
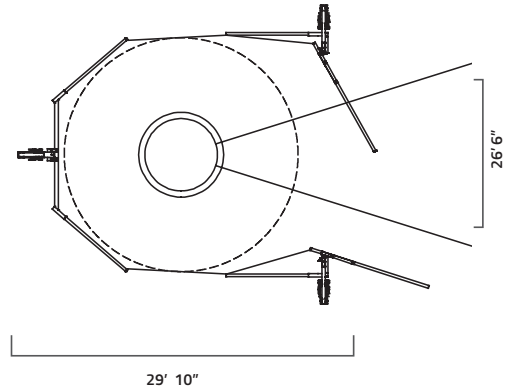

THOR 9 HAMMER/DISCUS CAGE

- Poles: (3) Combination of steel and aluminum to withstand up to 74mph winds
- Doors: (2) 10m x 2m swing arm doors
- Net: 1 3/4" square mesh woven poly cord with 771 lb break strength
- Main net height: 23'7m, Door net height: 29'6"/10m
- Net is secured by net rails across entire cage and 14 rope anchors
- 59" deep ground sleeves
- **IAAF Certified**

732309 Thor 9 Hammer/Discus Cage **\$32960**



APOLLO DISCUS CAGE

- Poles: (3) Combination of steel and aluminum to withstand up to 62mph winds
- Net: 1 3/4" square mesh woven poly cord with 352 lb break strength
- Net height: 18'
- Net is secured by 14 hanging points and 8 rope anchors
- 36" deep ground sleeves
- **IAAF Certified**

732301 Apollo Discus Cage **\$10300**



VERSACOM BOXES

CONNECTING IT ALL TOGETHER

The *VersaCom Box* provides a junction for electricity and cable hookups. This box can be put in virtually any location around performance areas of varying surfaces. The open bottom of the *VersaCom Box* provides adequate drainage and conduit entry, while the hand holes in the cover allow easy access.

- Divider plates in full size version, provided to help keep electrical equipment segregated
- Main box structure is made of 1/4" thick folded aluminum
- Lid is constructed of 1/4" aluminum plates for maximum support and durability

The *VersaCom Box - Synthetic Version* allows material to be bonded or poured onto the top of the lid to match the surrounding surface. The F91033 and F93033 versions have black Vultrak bonded to the lid. This addition is usually for asphalt applications (this material can also be painted).

The *VersaCom Box - Turf Version* features a supplied aluminum top to allow artificial turf to be glued on the jobsite, and is tethered to the box. This top is reinforced with multiple aluminum plates for maximum strength and durability. Factory installed turf infill retainment brushes keep infill out of the box.



SOLD SEPARATELY

VERSACOM RISER

The *VersaCom Riser* has the same dimensions as a full-size *VersaCom Box*. The riser attaches to the bottom creating a box that is twice as deep.

F90010 *Versacom Riser* **\$499**

VERSACOM BOXES		FULL SIZE 30" L x 18" W x 14" D		HALF SIZE 15" L x 18" W x 14" D	
SYNTHETIC VERSIONS	<i>Synthetic</i>	F910	\$969	F930	\$669
	<i>Black Vultrak (Factory Installed)</i>	F91033	\$1149	F93033	\$789
TURF VERSION	<i>Turf</i>	F960	\$879	F970	\$699

PORTABLE TRACK SHELTER

Steel frame is mounted on swivel casters. 360 degree seating surrounds a center storage shelf. Roof frame is constructed of aluminum bracing with architectural gray powder coat. Canopy is tensioned with a one-piece vinyl wrap. Custom color and graphic application available on canopy top.

542359XXSP Portable Track Shelter w/ Graphics \$5000

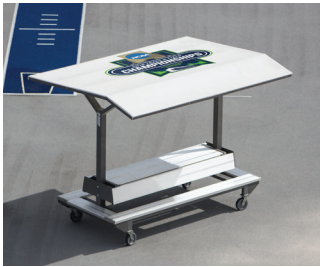

CUSTOMIZABLE

Vinyl



*Specify vinyl color with order, use the two-digit number of your color selection to replace XX in the item number.

PORTABLE PRESS TOWER

Multi-use tower can be used for coaching, filming, press and media. Non-skid decking. 5'-9" platform height. 4' x 10'-6" platform size with an overall size of 7' x 10'-6". Anodized aluminum bench with back moves forward and back. 16" pneumatic wheels— two locking and two swivel wheels. Optional soft enclosure for inclement weather.

- Weather Resistant Top Cover Available in Colors
- Heavy Duty Aluminum Construction
- 3 Year Warranty

542359XX	Press Tower	\$14840
542300XX	Removable Side Curtain	\$1410
54230000	Towing Kit	\$469



BALLSTOPS



CUSTOMIZABLE

Powder Coat



*Gray and Black powder coat available in Gloss or Flat

12' - 40' TALL BALLSTOP SYSTEMS

- 12', 15' and 20' use 4" diameter, 1/8" wall aluminum tube - #504 knotless netting
- 25' and 30' use 6" Sch 40 aluminum tube - #36 knotted netting
- 35' and 40' use 6" Sch 40 steel tube - #36 knotted netting
- All Poles 12'-40' have a vertical support cable for additional net support
- Ground sleeves included
- All poles are now powder coated in architectural black - Other colors available for an additional cost**

739012	12' Ball Stop; Straight Pole Starter (20' x 12')	\$1480
732012A	12' Ball Stop; Straight Pole Add-On (20' x 12')	\$844
739015	15' Ball Stop; Straight Pole Starter (20' x 15')	\$1590
739015A	15' Ball Stop; Straight Pole Add-On (20' x 15')	\$905
739120	20' Ball Stop; Straight Pole Starter (20' x 20')	\$1680
739120A	20' Ball Stop; Straight Pole Add-On (20' x 20')	\$1030
739020	20' Ball Stop; Offset Pole Starter (20' x 20')	\$1760
739020A	20' Ball Stop; Offset Pole Add-On (20' x 20')	\$1070
739025	25' Ball Stop; Straight Pole Starter (20' x 25')	\$4285
739025A	25' Ball Stop; Straight Pole Add-On (20' x 25')	\$2480
739030	30' Ball Stop; Straight Pole Starter (20' x 30')	\$4715
739030A	30' Ball Stop; Straight Pole Add-On (20' x 30')	\$2750
739035	35' Ball Stop; Straight Pole Starter (20' x 35')	\$4685
739035A	35' Ball Stop; Straight Pole Add-On (20' x 35')	\$2760
739040	40' Ball Stop; Straight Pole Starter (20' x 40')	\$5335
739040A	40' Ball Stop; Straight Pole Add-On (20' x 40')	\$3150

10' TALL BALLSTOP SYSTEMS

The 10' Tall Ballstop Systems were designed to be set up and removed as needed and are available as above ground or in ground installation.

- Net: #504 Weather treated 1 3/16" square mesh with 1/4" roped edge and 180 lb break strength
- Net is supported at the top and held in place at the bottom by 1/8" vinyl covered steel cable
- The 8062 is a portable system which uses a platform base with wheels that is weighted down by four 5 gallon jugs (included)
- The 807 is installed in aluminum ground sleeves (caps are included for use when poles are removed)
- Purchase one starter unit and as many additional units as needed to reach your desired overall length (Sold in 20' lengths)**
- All poles are now powder coated in architectural black - Other colors available for an additional cost**

8062	Portable Starter Unit (10' x 20')	\$1780
8062A	Portable Additional Unit (10' x 20')	\$1040
807	Sleeved Starter Unit (10' x 20')	\$586
807A	Sleeved Additional Unit (10' x 20')	\$421

SINCE 1918

GILL

ATHLETICS



Coach Gill helped organize the first NCAA Track & Field Championship in 1921. His team won that inaugural national title. We are proud to honor Harry Gill's legacy and vision for the sport through Gill Athletics' role as the official equipment supplier for the NCAA Track & Field Championships.

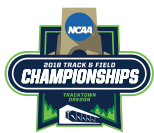

Gill Athletics is the official equipment supplier of the 2018 NCAA Track & Field Championships.





601 Mercury Drive
Champaign, IL 61822
USA

OFFICIAL
PARTNER



OFFICIAL TRACK & FIELD
EQUIPMENT SUPPLIER



INNOVATORS IN THE SPORT OF **TRACK & FIELD**

GILLATHLETICS.COM 800.637.3090