

MODEL SYSTEM 1A

10,000 LB. CLEAR FLOOR TWO POST LIFT



TO MEET THE ONE AND ONLY NATIONAL SAFETY STANDARD FOR VEHICLE LIFTS

THE LIFT YOU CAN'T WEAR OUT



MOHAWK

Americas Best Lift Investment...

Still proudly designed, welded and manufactured in the U.S.A.



Bid Term: 11/16/18 - 11/15/20

NJ State Approved Co-op #65MCESCCPS

MOHAWK SYSTEM I

SOLID, SAFE, PROVEN & CERTIFIED
HEAVY DUTY LIFTS FOR...
HEAVY DUTY SERVICE

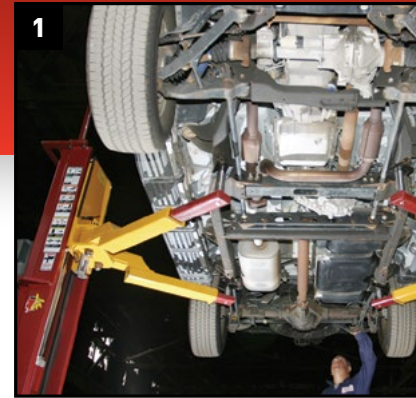

▲ Two post lifts offer **FULL under vehicle** repairs, takes up minimal bay space, while hanging free for tire, brake or any other need

MOHAWK DESIGN

- Mohawk columns are constructed of 3/4" thick forklift masts, for a **lifetime** of troublefree service (4" wide sections).
- Each Mohawk carriage rolls on (8) 5 3/4" double-sealed, self-lubricating, steel **ball bearing rollers** and NOT plastic sliders.
- Two large heavy duty cylinders make for safer, steadier lifting than single cylinder lifts or lift models with tiny cylinders.
- Easily **adjustable** overhead stainless steel hydraulic lines can be set at **any** height (or routed in floor) to accommodate all tall trucks and vans or lowered for use in low ceiling shops.
- 3 1/2" **low profile** swing arms **fit under the lowest riding sports cars**.
- 3" & 6" stackable truck adaptors are included as standard equipment.



Safety Weight Gauge
Shows vehicle weight, aids vehicle diagnosis, visually shows when lift is lowered on the locks



ADJUSTABLE HEIGHT STAINLESS STEEL hydraulic lines

- MOHAWK LIFTS HAVE:**
- No cables to wear and adjust
 - No pulleys to wear out and replace
 - No overhead cable cover
 - No rubber hoses

Mechanic shown is 6'2"

Automatic arm restraints

Large 4" cylinders

All position mechanical locks every 3" starting at 5" off the floor

30" wide base for stability

3" & 6" truck adaptors included

MOHAWK PATENTED INDUSTRY LEADING SAFETY SYSTEMS

- Mohawk Lifts feature **all position** mechanical safety locks in both columns, starting at 5", to full lifting height.
- Patented **infinite position**, internal hydraulic safeties, backed by external pressure compensated flow controls and velocity fuse valving.
- Swing arm restraints automatically engage upon lifting to secure the vehicle, and automatically disengage when the vehicle has been fully lowered.
- Lease/purchase plans available for 1-5 years.

Call Mohawk now!

- The best, and most inclusive warranty in the lift business, 25 years structural, 10 year mechanical, plus limited lifetime cylinder seal warranty. **Mohawk builds the best lifts, with the best warranty.**

OPERATION

- Hydraulic fluid is pumped between the two cylinders through the overhead (or optional in-floor) stainless steel hydraulic lines.
- Patented hydraulic synchronization eliminates the need for restrictive height overhead covers, cables, pulleys, equalizer chains or floor plates.

// TO BUY CHEAP IS TO BUY TWICE //

Bid Term: 11/16/18 - 11/15/20



Access for all leaving the wheels necessary repairs.

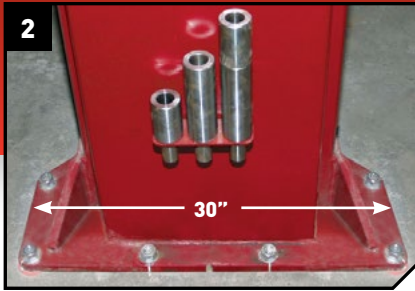

▲ Mohawk's large and stable footprint measures 30" wide and is made of 3/4" thick plate. Mohawk's large base with 8 lag bolts gives stability to the lift, while distributing the load to the shop floor.

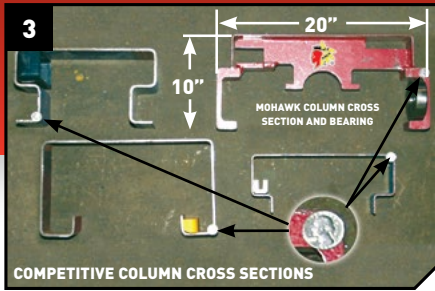

▲ Mohawk's fork lift channel & bearing (top right) VS. 3 different sheet metal columns which use plastic slides. Like your fork lifts mast, Mohawk Lifts **DON'T WEAR OUT!** Note the U.S. quarters on all four pieces (for scale).



▲ Heavy duty post design using **DUAL** cylinders with #646 leaf chain lifting, over **DUAL** bearings.



Mohawk lifts **DO NOT** use height restrictive overhead cable covers that limit lifting height.

LIFT SHOWN WITH **IN-FLOOR HYDRAULIC LINES FOR LOW CEILING OR OVERHEAD CRANES**



▲ Each carriage rolls on 8 steel ball bearing rollers for a lifetime of trouble-free service (not plastic slide blocks)

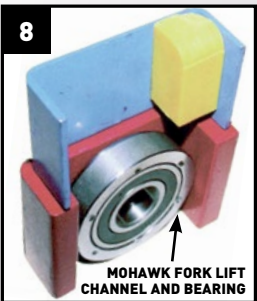

▲ **FORK LIFT CHANNEL** & bearing (bottom) vs. competitive columns & plastic slider (top)

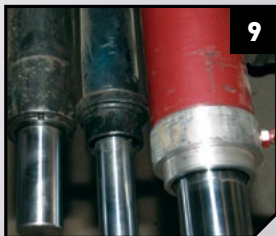

▲ **LARGE 4" CYLINDERS** equal longer seal life and lower operating pressures vs. small competitive cylinders

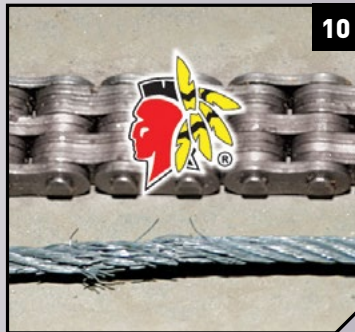

▲ **#646 HIGH STRENGTH leaf chain** compared to the competitive cables which fray



▲ **All position** mechanical locks in both columns engage the full length of travel.

- Mohawk's System I uses heavy duty #646 leaf chains and twin bearings located on each of the cylinders. Chain lifting eliminates the constant stretch, fray, maintenance and replacement costs associated with cable or screw lifts.
- Mohawk carriages roll on eight double sealed, self-lubricating, steel ball bearing rollers, for a lifetime of maintenance-free operation.
- Mohawk bearings last longer, with less friction and wear than other lifts using plastic slide blocks that need constant greasing and maintenance.

What other lift offers a 25 year structural warranty?

NJ State Approved Co-op #65MCESCCPS

TWO POST LIFT ACCESSORIES



Safety Weight Gauge
to determine vehicle weight, aid vehicle diagnosis & show lift is lowered onto locks.

Speedlane Adaptor
Slips on quickly for instant lifting without positioning swing arms yet leaves the wheels hanging free for tire and brake work.

Winner of Motor Magazine's Top 20 Tools

Bid Term: 11/16/18 - 11/15/20

MODEL SYSTEM I SPECIFICATIONS

- Capacity:**..... 10,000 lbs. (4535.92 kg)
- Lifting Speed:**..... 50 seconds (faster with lighter load)
- Motor Rating:**..... 2.0 HP/208-230V, Single-phase (3Ø optional)
- Synchronization:**..... Hydraulic fluid displacement using no chains, cables, or overhead obstructions
- Arm Pad Height:**..... 3½" (8.89 cm) min.
- Lifting Height:**..... 6' (1.83 m) under arm
- Arm Pad Height @ Full Rise:**..... 6' 3½" (1.84 m) min.
- Lift Pad Height with Adaptors:**..... 7' ½" (2.15 m)
- Overall Width:**..... 11' 10" (3.61 m) **(adjustable)**
- Width Between Posts:**..... 10' (3.05 m) **(adjustable)**
- Width Between Lifting Arms:**..... 8' 10" (2.69 m) **(adjustable)**
- Column Height:**..... 8' 7" (2.62 m)
- Overhead Hydraulic Line Height:** ... 12' (3.51 m) Standard **(adjustable)** to accommodate any height ceiling or routed in-floor)
- Weight:**..... 2500 lbs. (1088.62 kg)
- Concrete Floor Requirements:**..... 4000 psi (27579.02 kPa) mix 4½" (11.43 cm) depth
- Anchoring System: Included**..... (16) ¾"x5" (1.9x12.7 cm) bolts
- Mechanical Safety Locks:**..... **Automatic; all position** starting @ 5" (7.62 cm) off the floor
- Hydraulic Safety Systems:**..... **Automatic;** all position
- Swing Arm Restraints:**..... **Automatic** upon ascent
- Cylinders:**..... 2 (1 per column)
- Drive System:**..... #646 leaf chain routed over cylinder
- 3" Frame Adaptors (stackable):**..... 4 included as standard equipment
- 6" Frame Adaptors (stackable):**..... 4 included as standard equipment
- Steel Carriage Bearings:**..... (8) per carriage, double sealed, self-lubricating
- Floor Access Between Posts:**..... Clear and unobstructed
- Warranty:**..... **25 years structural, 10 year mechanical, plus limited lifetime cylinder seal warranty**

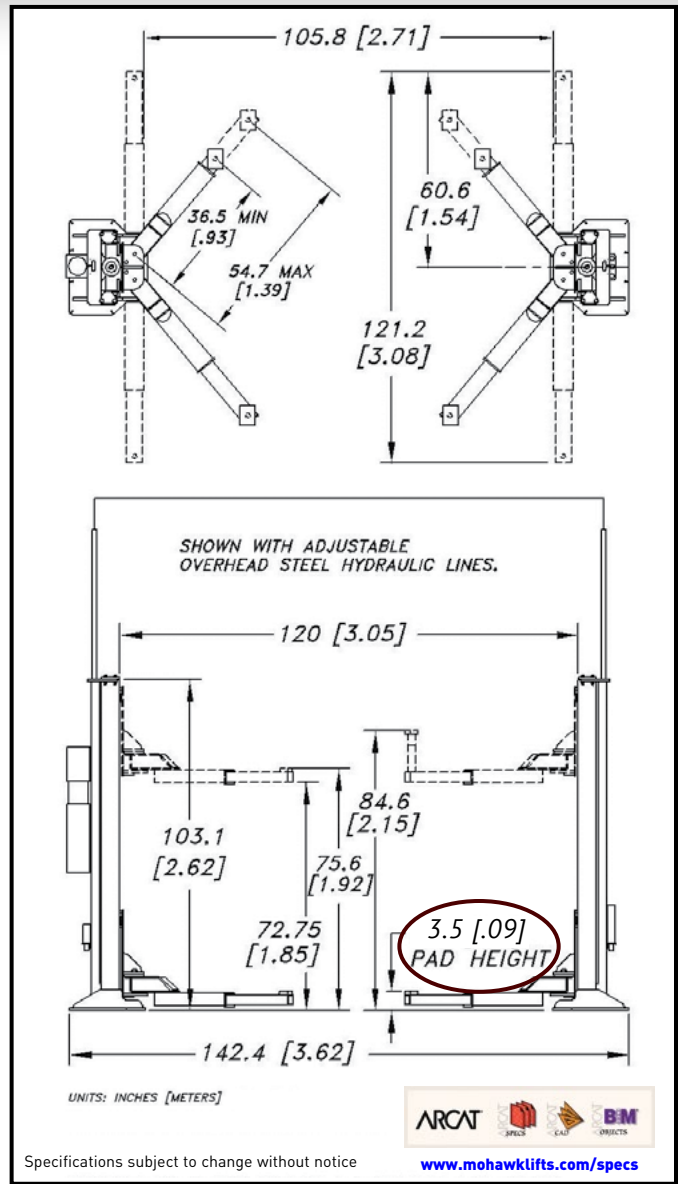

Mohawk builds the best products with the finest materials, to the highest standards. Just compare our lifts. Our staff will assist you with a fleet evaluation, design assistance and answer any technical questions you have. We invite your calls.

Mohawk lifts are manufactured in compliance with the following standards: ALI, ANSI, ASME, AISI, ASTM, ASA, NEC, AWG, NEMA.

MEETS CURRENT NATIONAL ANSI CODE FOR LIFTS.



For more detailed product information read this book at
www.mohawklifts.com/wmamam



Mohawk Resources, LTD.
 P.O. Box 110
 65 Vrooman Ave
 Amsterdam, NY 12010
 (800) 833-2006
 (518) 842-1431
 FAX: (518) 842-1289



AVAILABLE UNDER DISCOUNTED GOVERNMENT CONTRACT IN ALL 50 STATES



DISTRIBUTED BY:

www.mohawklifts.com
 NJ State Approved Co-op #65MCECCPS

Bid Term: 11/16/18 REV 11/15/20