



# Commercial Price Book and Specification Guide

Effective January 1, 2015

Rev. 2017-01



# Commercial Terms & Conditions (Applicable to all divisions of Datum Storage Solutions)

---

**Payment Terms:** Deposits are required for all 1st time orders and until credit has been established. Datum's standard terms are NET 30, and Datum does offer prompt pay discounts. All invoices and payments in U.S. dollars.

**Pricing:** All prices shown are F.O.B. Emigsville, PA 17318-0355 and are subject to change without notice. See separate contract for GSA pricing, terms and conditions.

**Minimum Order:** \$100 (net). Any order less than \$100 NET will be subject to a \$25.00 NET service charge.

**Shipping:** All orders are shipped best way, prepaid and add, unless otherwise noted. Inside delivery, liftgate, 2-man delivery and call-before delivery are available for an additional charge. Please consult factory for additional pricing information.

**Ordering Instructions:** All orders must be in writing and accompanied by a purchase order number. Quantities, part numbers, paint, and laminate colors must be clearly noted on order. All orders will be confirmed with a written acknowledgment.

**Changes to orders:** Once an order has entered the production schedule, any changes to that order will be subject to a 25% restocking fee and extended lead time.

**Design Service:** All divisions of Datum Storage Solutions offer complete layout-planning services at \$75.00 per hour.

**Standard Paint Colors:** Products are available in 8 standard paint colors, unless otherwise noted. Other colors may be subjected to an extended lead-time; please consult factory for more information. **Datum will only accept returns according to the Cancellation & Returns Policy on the following paint finishes: T15, T47 and T86.**

- Custom Paint Colors: Datum's state-of-the-art electrostatic powder coat has the capability to paint virtually any color. Minimum upcharge: \$500.00 NET. In order to ensure color correctness, a sample must be sent to the factory for any custom paint match request. Please contact the factory for more information and custom color costs.
- Custom Laminates: Minimum upcharge: \$500.00 NET. Please contact the factory for more information and custom laminate costs.

**Design Ownership:** All designs, plans, layouts, drawings, and specifications are the property of Datum Storage Solutions and may not be used, reproduced or distributed, in whole or part, without prior written consent.

**Freight Charges:** All shipments will be pre-pay and add unless otherwise specified. Freight charges will be added to the invoice or billed separately, depending on arrangements. Selection of the delivering carrier will be made by Datum Storage Solutions. All freight charges, except carrier's minimums, non-direct and intrastate, will be discounted. Datum Storage Solutions participates in various discount programs with carriers. Any remaining discount amounts not credited to the buyer are used to offset handling, processing, packaging, and related administrative expenses. Buyer has the option of selecting their own carrier, F.O.B. shipping point. If this option is selected, shipment must go freight collect or third party, and Datum Storage Solutions' responsibilities end when the order leaves our dock. All LTL/TL shipments using a third-party carrier will incur a \$35.00 handling fee per customer order. Additionally, a per-order handling charge of \$5.00 may be added for UPS and FedEx shipments. Datum Storage Solutions is not responsible for brokerage, customs, warehousing or any other fees associated with international shipments.

**Weight:** Weights shown are approximate and do not include dunnage.

**Freight Claims:** Datum takes the utmost care when packing our product to prevent shipping damage. It is your responsibility to note on the freight carrier's delivery receipt any damage incurred while in transit. All damage claims must be submitted by you with the carrier.

Concealed damage must be reported to Datum and/or the freight carrier in less than 5 days from the receipt of shipment. If concealed damage is reported in less than 5 days, the carrier and Datum will absorb two third's of the NET product cost, the balance of the cost for the replacement product will be billed to the dealer under the original purchase order number. All damage claims must be submitted by you with the carrier.

All concealed damage claims reported after the 5-day time limit become the responsibility of the dealer. All concealed damage claims must be submitted by you with the carrier.

All product that is delivered to a warehouse or an installation facility must be inspected prior to delivering to end destination. If damage is reported after the product is moved, the dealer is responsible for filing the claim with the carrier. If damage is found prior to moving the product, after being signed clear, it must be reported in less than 5 days from delivery.

**Freight Claims (continued):** Concealed damage incurred by a third-party carrier is not the responsibility of Datum Storage Solutions.

**CAUTION: When you give a delivering carrier a clear receipt for a shipment in which there is damaged merchandise or a shortage, the carrier is relieved of further responsibility. DAMAGE AND SHORTAGE CLAIMS MUST BE FILED BY YOU WITH THE DELIVERING CARRIER. Datum Storage Solutions will not accept return merchandise damaged in transit. Your claim is with the delivering carrier.**

# **Commercial Terms & Conditions, Continued**

---

**Note: Crating your product may reduce damage. Datum offers crating for a charge of \$75.00 per skid. Please contact the factory for details.**

**Cancellations & Returns:** ORDERS FOR "SPECIAL" OR "CUSTOM" ITEMS ARE NOT SUBJECT TO CHANGE OR CANCELLATION. No returned merchandise will be accepted without written consent of Datum Storage Solutions. All returned shipments are to be freight prepaid by the shipper and are subject to a handling charge of 25% plus reimbursement of all original transportation charges incurred by Datum Storage Solutions. Once production of "non-stock" items has begun, cancellation of the order is subject to Datum Storage Solutions' approval and a 25% surcharge will be assessed on all approved cancellation items. Custom colors or custom laminate panels are not returnable.

Return authorization must be requested within 30 days of invoicing and no product may be returned without a prior written return authorization. All returns must be made within 30 days of receiving the written return authorization and are subject to a 25% restocking charge (\$20.00 minimum) plus all incurred freight charges. All returns must be in original packaging and in resellable condition for a credit to be issued. Datum will not issue return authorizations on product that has been assembled by the dealer or the end user.

NO GOODS ACCEPTED FOR RETURN WITHOUT PRIOR APPROVAL. Seller must have the right to inspect any goods claimed to be defective at Buyer's place of business or require Buyer to return the goods to the Seller for inspection on Seller's premises. Transportation charges covering returned goods will be borne by Seller only if such goods are proven to be defective.

**Storage:** Datum does not have the facilities to store completed orders, therefore all orders must ship when completed. If a postponement of product shipment is requested by the Dealer after the ordered goods are released to manufacturing or at a time when Datum is ready to ship the ordered goods, Datum may transfer the ordered goods to storage at the Dealer's risk and expense. This transfer to storage will be considered delivery to the Dealer for all purposes including invoicing and payment.

**Replacements:** Replacement requests for damaged or missing parts must be submitted to Datum within 30 days of receipt of product. Damaged product must be signed for, damaged or refused, and reported within 30 days of receipt of product. Replacement requests made after 30 days of receipt of order will be sent out at dealer cost plus freight.

**Lifetime Warranty:\*** Datum Storage Solutions warrants to the original purchaser for the life of the product that it shall be free of any defect in materials or workmanship, so long as the original purchaser is the owner and possessor of the product and the product is installed by a Datum Certified Installer. *A purchase order or Datum order number will be required in order to confirm date of purchase.* **For a period of two years from the date of shipment, Datum Storage Solutions will provide all labor free of charge** at the location of the product to repair or replace any part that fails because of such defects. After two years from date of shipment, labor will no longer be provided. All replacements parts will be supplied for the life of the product so long as all requirements are met as set forth in this warranty. This warranty does not include defects to the product resulting from accident, misuse, improper installation or operation, normal wear, neglect, unauthorized repair or alteration. The purchase of this product shall constitute a purchaser's agreement that the sole remedy for any breach of warranty shall be such repair or replacement as expressly provided above. In no event shall Datum Storage Solutions be liable for any incidental or consequential damages arising out of the use or inability to use the product for any purpose whatsoever. Effective January 1, 2015.

**ANY PRODUCT NOT INSTALLED BY A DATUM CERTIFIED INSTALLER WILL RECEIVE A ONE-YEAR PARTS WARRANTY.**

Contact Datum Storage Solutions for a Datum Certified Installer in your area.

\*Lifetime Warranty excludes all tambour doors and all electrical components, which carry a two-year warranty.  
Excludes all sales outside of the contiguous 48 states, Canada and Mexico.

**TERMS AND CONDITIONS ARE APPLICABLE TO ALL DIVISIONS OF DATUM STORAGE SOLUTIONS INCLUDING:**

Datum Storage Solutions®  
ArgosSECURITY™ by Datum®  
Intellerum™ by Datum®  
Adelphia by Datum®

***All terms, pricing and product information is subject to change without notice at the discretion of Datum Storage Solutions.***



## EDGE TREATMENTS, DRAWER PULLS AND PAINT AND LAMINATE OPTIONS

### EDGE TREATMENT

Edge treatments apply to individual series. They are not available on every series. Check the list price letter code suffix to verify the edge treatment available on the series. After selecting the edge type be sure to add the suffix letter code to the model number.

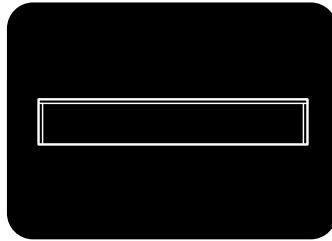

**SE** Self-Edge Matching Laminate  
Butt joint corners.

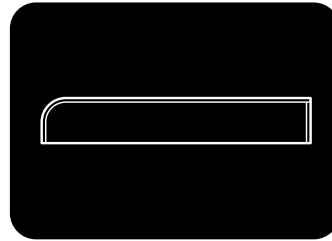

**WS** Post Formed Waterfall Matching Laminate  
Waterfall on working side only.  
Butt joint corners.

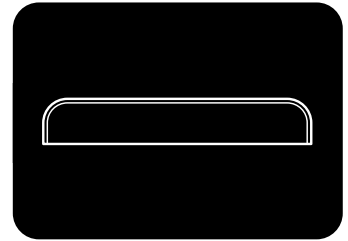

**WD** Post Formed Waterfall Matching Laminate  
Waterfall both sides.  
Butt joint corners.



**MS** 3mm (PVC) Matching Edge  
Butt joint corners.

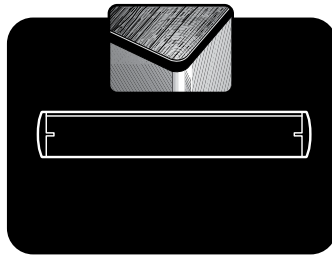

**TR** Vinyl 'T' Mold Edge  
Radius corners.  
*Color: Black only*

### DRAWER PULL TYPE

Drawer pull selection available on most series. This selection shows the availability of draw pulls on each series.

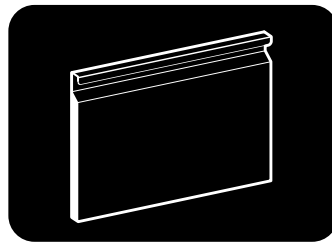

**RP** Full Width Recessed Pull  
*Available on all series except: 400, 850, 1010*

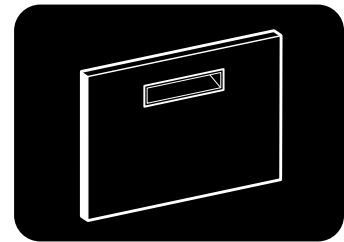

**Y** 6" Black Recessed Pull  
*Available on 1000 and 1010 series.*

### PAINT AND LAMINATE OPTIONS

Adelphia by Datum® products are available in 8 standard paint colors and 13 laminate options.

Visit [datumstorage.com](http://datumstorage.com) for a complete list.

#### STANDARD PAINTS

Black: T25  
Light Gray: T47  
Gray Mist: T86  
Medium Gray Metallic: T23  
Tan Metallic: T56  
Warm Brown: T22  
Bone White: T15  
Ivory: T48

#### STANDARD LAMINATES

Antique White: M46/L46  
Cactus Star: M85/L85  
Beige Granite: M90/L90  
Desert Dusk: M95/L95  
Finnish Oak: M15/L15  
Hardrock Maple: M10/L10  
Regal Cherry: M20/L20  
Sapelli Mahogany: M25/L25  
Doeskin: M65/L65  
Smoke Gray: M70/L70  
Oyster Gray: M64/L64  
Black: M26/L26  
Storm: M75/L75

# CREATE YOUR OWN OPTIONS WITH ADELPHIA BY DATUM®

SHOWN WITH 1100 SERIES, MOST EXAMPLES AND WORKSTATIONS WILL WORK FOR ON THE 1200 PANEL END AND 1000 SERIES ALSO.

## FREESTANDING DESK BASED WORKSTATIONS

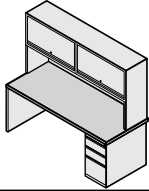
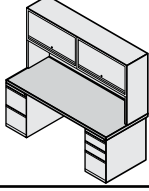
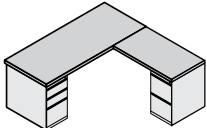
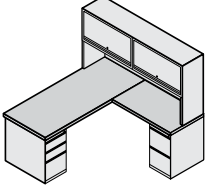
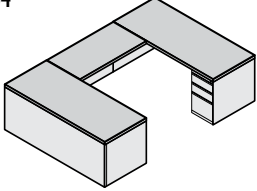
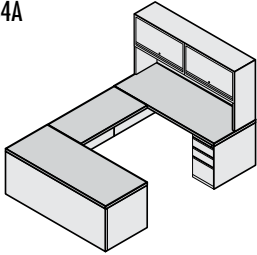
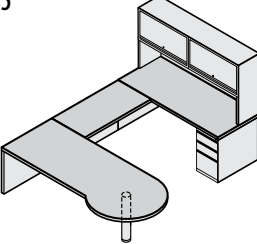
Example	Description	W	D	Model	SE Laminate Top, 3mm PVC SE, MS	Waterfall (Working Side, Both Sides) WS, WD
	Single Pedestal Desk	72"	30"	CUS-72		
	Overhead Organizer, pull up doors	72"	15"	CDTO-72		
	<b>Total</b>				<b>2693.</b>	<b>2800.</b>
	Plan View	72"	30"			
	Double Pedestal Desk*	72"	30"	CUD-72		
	Overhead Organizer, pull up doors	72"	15"	CDTO-72		
	<b>Total</b>				<b>3090.</b>	<b>3200.</b>
	Plan View	72"	30"			
	Pedestals at ends, no overhangs-special order					
	Single Pedestal Desk	72"	30"	CUS-72		
	Return	42"	24"	CU-CR42		
	<b>Total</b>				<b>2500.</b>	<b>2685.</b>
	Plan View	72"	72"			
	Single Pedestal Desk	72"	30"	CUS-72		
	Return	42"	24"	CU-CR42		
	Overhead Organizer, pull up doors	72"	15"	CDTO-72		
	<b>Total</b>				<b>3645.</b>	<b>3825.</b>
Plan View	72"	72"				
	Single Pedestal Desk	72"	30"	CUS-72		
	Bridge	48"	24"	TCR-48		
	Single Pedestal Desk	72"	30"	CUS-72		
	<b>Total</b>				<b>3625.</b>	<b>3925.</b>
Plan View	108"	72"				
	Single Pedestal Desk	72"	30"	CUS-72		
	Bridge	48"	24"	TCR-48		
	Single Pedestal Desk	72"	30"	CUS-72		
	Overhead Organizer, pull up doors	72"	15"	CDTO-72		
<b>Total</b>				<b>4760.</b>	<b>5060.</b>	
Plan View	108"	72"				
	Single Pedestal Desk	72"	30"	CUS-72		
	Bridge	48"	24"	TCR-48		
	"P" Shaped Peninsula	96"	36"	TDP-96E		
	Overhead Organizer, pull up doors	72"	15"	CDTO-72		
<b>Total</b>				<b>4685.</b>	<b>4875.</b>	
Plan View	120"	96"				
	*No Waterfall available					

## EDGE TREATMENT 1100 SERIES

"SE" SE laminate top - (add suffix "A" to model #)

"WD" Waterfall on both sides - (add suffix "C" to model #)

"WS" Waterfall on working side - (add suffix "B" to model #)

"MS" 3mm PVC edge - (add suffix "D" to model #)

**Note: All Desks are "Random Keyed" unless specified "Keyed Alike". All interior parts are painted Charcoal.**

# CREATE YOUR OWN OPTIONS WITH ADELPHIA

SHOWN WITH 1100 SERIES, MOST EXAMPLES AND WORKSTATIONS WILL WORK FOR ON THE 1200 PANEL END AND 1000 SERIES ALSO.

## FREESTANDING DESK BASED WORKSTATIONS

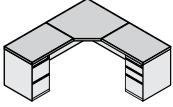
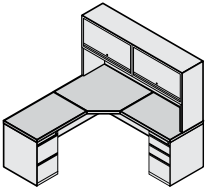
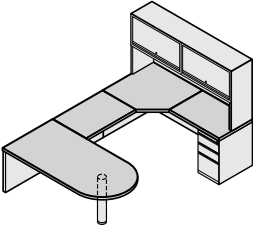
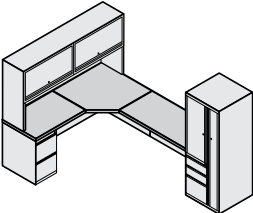
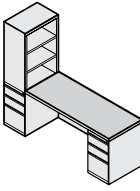
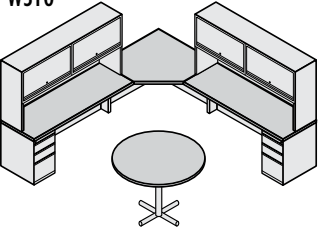
Example	Description	W	D	Model	Self Edge SE, MS	Waterfall (Working Side, Both Sides) WS, WD
WS6 	Runoff	36"	24"	CU-CR36-S		
	Corner Unit	36"	24"	CU-3624		
	Runoff	36"	24"	CU-CR36-S		
	<b>Total</b>				<b>2695.</b>	<b>2910.</b>
	Plan View	72"	72"			
WS6A 	Runoff	36"	24"	CU-CR36-S		
	Corner Unit	36"	24"	CU-3624		
	Runoff	36"	24"	CU-CR36-S		
	Overhead Organizer, pull up doors	72"	15"	CDTO-72		
	<b>Total</b>				<b>3835.</b>	<b>4050.</b>
Plan View	72"	72"				
WS7 	Runoff	36"	24"	CU-CR36-S		
	Corner Unit	36"	24"	CU-3624		
	"D" Shaped Peninsula Desk	72"	30"	TDD-72		
	Bridge	42"	24"	TCR-42		
	Overhead Organizer, pull up doors	72"	15"	CDTO-72		
	<b>Total</b>				<b>4435.</b>	<b>4665.</b>
Plan View	114"	72"				
WS8 	Runoff	36"	24"	CU-CR36-S		
	Corner Unit	36"	24"	CU-3624		
	Bridge	48"	24"	TCR-48		
	Tower	24"	24"	TWFC-6424-1F2B-R		
	Overhead Organizer, pull up doors	72"	15"	CDTO-72		
	<b>Total</b>				<b>5185.</b>	<b>5415.</b>
Plan View	72"	72"				
WS9 	Runoff	60"	24"	CU-CR60		
	Tower	24"	15"	TOS-6424-1F2B-R		
	Bracket	-	-	BRK-TWR		
	<b>Total</b>				<b>2110.</b>	<b>2180.</b>
Plan View	75"	24"				
WS10 	Runoff	72"	24"	CU-CR72		
	Corner Unit	42"	24"	CU-4224		
	Runoff	72"	24"	CU-CR72		
	Overhead Organizer, pull up doors	72"	15"	CDTO-72		
	Overhead Organizer, pull up doors	72"	15"	CDTO-72		
	Casual Table, free standing, round	48"	48"	T48R-3036-48		
	<b>Total</b>				<b>6480.</b>	<b>7800.</b>
Plan View	114"	114"				

\* Self Edge (SE)

# CREATE YOUR OWN OPTIONS WITH ADELPHIA

SHOWN WITH 1100 SERIES, MOST EXAMPLES AND WORKSTATIONS WILL WORK FOR ON THE 1200 PANEL END AND 1000 SERIES ALSO.

## FREESTANDING DESK BASED GROUPINGS

### Example

#### WSG1

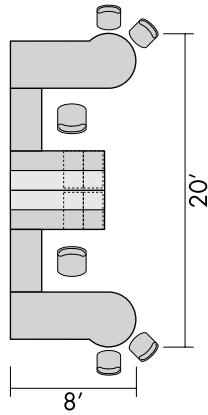
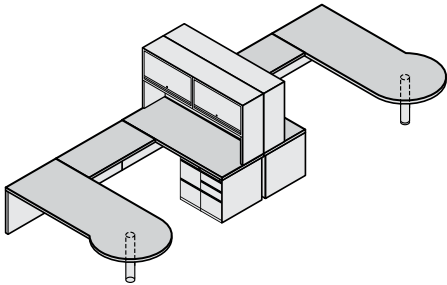

Qty.	Description	W	D	Model
2	Single Pedestal Desks (w/pedestal)	72"	30"	CUS-72
2	Bridges	48"	24"	TCR-48
2	Peninsula Desks	96"	36"	TDP-96E
2	Overhead Organizer, pull up doors	72"	15"	CDTO-72
2	Additional Pedestal, 2 File	14-5/8"	28-1/2"	PC2-28-7
2	Task Lights	48	-	TL-48
2	Tack Boards	72	-	TB72
<b>Total WSA with additional pedestals x's 2</b>		SE Laminate Top		<b>10,610.</b>

#### WSG2

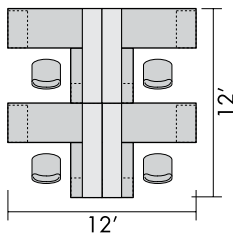
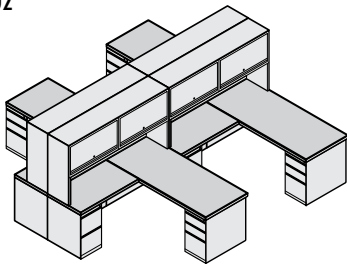

4	Single Pedestal Desk	72"	30"	CUS-72
4	Single Pedestal Return (Runoff)	42"	24"	CU-CR42
4	Overhead Organizer, pull up doors	72"	15"	CDTO-72
4	Task Light	48	-	TL-48
4	Tack Board	72	-	TB72
<b>Total WSA x's 4</b>		SE Laminate Top		<b>14,555.</b>

#### WSG3

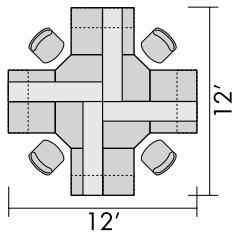
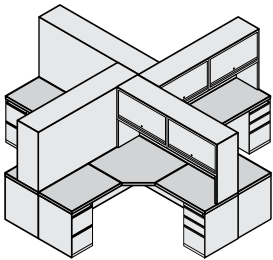

4	Single Pedestal Returns (Runoff)	36"	24"	CU-CR36
4	Single Ped. Rts. (Runoff), 2 File	36"	24"	CU-CR36
4	Corner Units	36"	24"	CU-3624
4	Overhead Organizer, pull up doors	72"	15"	CDTO-72
2	Task Light	48	-	TL-48
2	Tack Board	72	-	TB72
<b>Total WSA x's 4</b>		SE Laminate Top		<b>15,315.</b>

#### WSG4

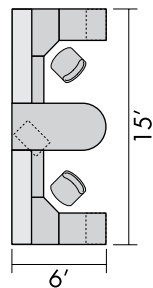
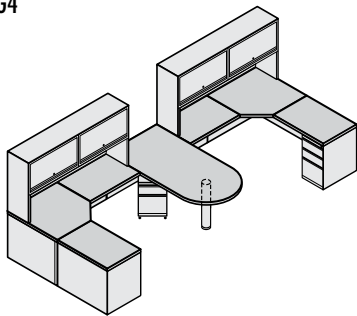

2	Single Pedestal Returns (Runoff)	36"	24"	CU-CR36
2	Corner Units	36"	24"	CU-3624
2	Bridge	36"	24"	TCR-36
2	Overhead Organizers, pull up doors	72"	15"	CDTO-72
1	"D" Shaped Table	72"	36"	TDD-72E
1	Mobile Pedestal, 2 Box, 1 File	14-5/8"	28-1/2"	PB3-28-4-P-MPK
2	Task Lights	48	-	TL-48
2	Tack Boards	72	-	TB72
<b>Total WS7 w/mobile ped., 1 "D" table x's 2</b>		SE Laminate Top		<b>8,445</b>

#### WSG5

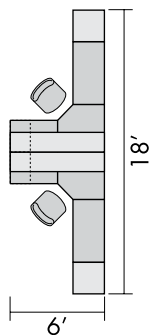
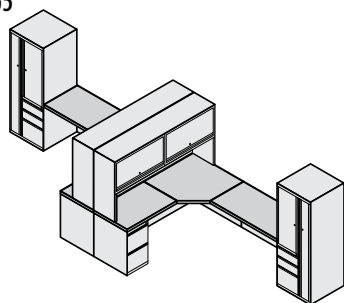

2	Bridges	42"	24"	TCR-42
2	Corner Units	36"	24"	CU-3624
2	Single Ped. Rts. (Runoff), 2 File	36"	24"	CU-CR36
2	Overhead Organizers, pull up doors	72"	15"	CDTO-72
1	Tower 64" high, 2 box, 1 file, LH	24"	24"	TWCF-6-2B1F
1	Tower 64" high, 2 box, 1 file, RH	24"	24"	TWCF-6-2B1F-R
2	Tackboards	72	-	TB72
<b>Total WS8 with R and L hand towers x's 2</b>		SE Laminate Top		<b>10,370.</b>

Additional edge treatments are available, see individual pages for details.



# CREATE YOUR OWN OPTIONS WITH ADELPHIA

SHOWN WITH 1100 SERIES, MOST EXAMPLES AND WORKSTATIONS WILL WORK FOR ON THE 1200 PANEL END AND 1000 SERIES ALSO.

## FREESTANDING DESK BASED GROUPINGS

Example

WSG6

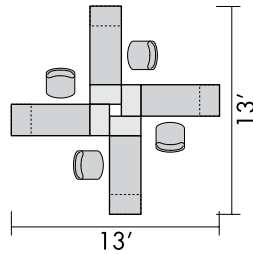
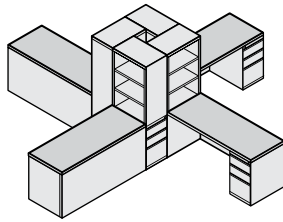

Qty.	Description	W	D	Model
4	Single Pedestal Return (Runoff)	60"	24"	CU-CR60
4	Towers, Pedestal/Side Bookcase, left	14 <sup>5</sup> / <sub>8</sub> "	24"	TPSB-6-2B1F-L

**Total WSG6 x's 4** SE Laminate Top (SE) **8,410.**

WSG7

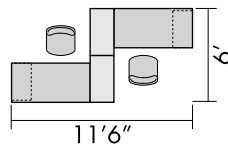
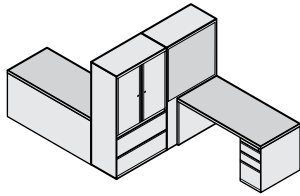

2	Single Pedestal Desk	60"	30"	CUS-60
2	Lateral/Storage Cabinet	36"	18"	LD-TWR-36-2
2	Tackboards*	32"sq.	-	*

**Total WSG7** SE Laminate Top **6,160.**

\*(tackboards additional contact factory)

WSG8

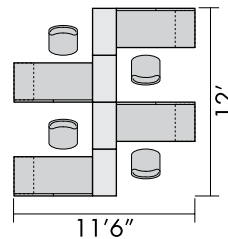
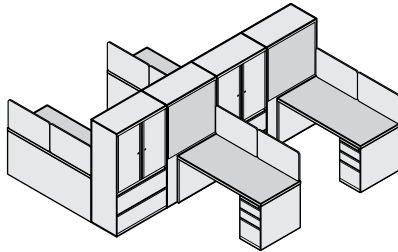

4	Single Pedestal Desks	60"	30"	CUS-60
4	Lateral/Storage Cabinets	36"	18"	LD-TWR-36-2
8	Privacy Screens*	30"	18"	*
4	Tackboards*	32"sq.	-	*

**Total WSG8 x's 2** SE Laminate Top **12,315.**

\*(tackboards and screens additional contact factory)

WSG9

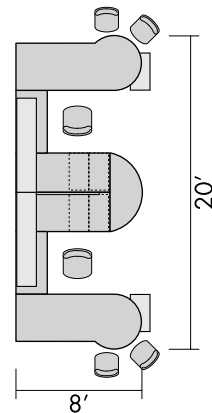
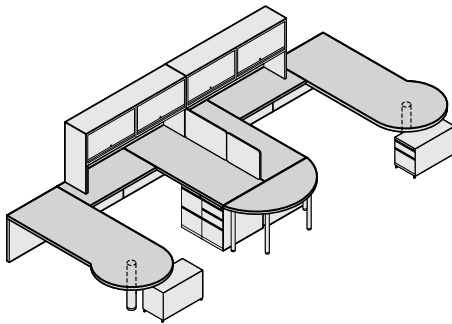

2	Single Pedestal Desks (w/pedestal)	72"	30"	CUS-72
2	Bridges	48"	24"	TCR-48
2	Peninsula Desks	96"	36"	TDP-96E
2	Overhead Organizer, pull up doors	72"	15"	CDTO-72
2	Additional Pedestals, 2 Box	14 <sup>5</sup> / <sub>8</sub> "	28 <sup>1</sup> / <sub>2</sub> "	PC2-28-7
2	Mobile Pedestals, 1 Box, 1 File	14 <sup>5</sup> / <sub>8</sub> "	28 <sup>1</sup> / <sub>2</sub> "	PB2-28(P-MPK)
1	Semi Circle Table	60"	24"	CASEMI-60
1	Privacy Screen*	30"	18"	*
1	Privacy Screen*	24"	18"	*
2	Task Lights	48	-	TL-48
2	Tack Boards	72	-	TB72

**\*Total WSG9 screens additional contact factory** SE Laminate Top **10,045.**

WSG10

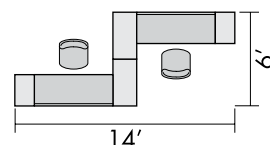
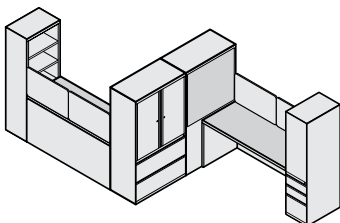

2	Shells†	60"	30"	†
2	Lateral/Storage Cabinet	36"	18"	LD-TWR-36-2
2	Towers	14 <sup>5</sup> / <sub>8</sub> "	24"	TPSB-6-2B1F
4	Privacy Screens*	30"	18"	*
2	Tackboards*	32"sq.	-	*

† Special order without one end panel

\* Available, contact factory for details

# 1100 SERIES DESKS / CRENENZA

THESE INDIVIDUAL UNITS COMBINE TO MAKE WORKSTATIONS AND GROUPINGS. SEE EXAMPLES ON PAGES 8-11.

## DOUBLE PEDESTAL

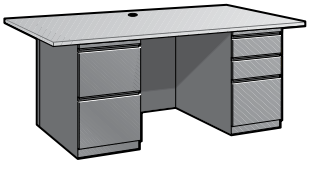
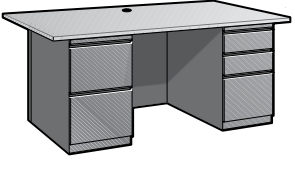
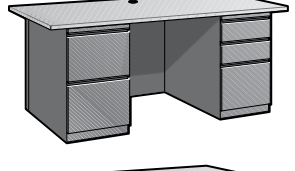
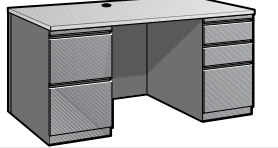
Description	H	W	D	Model	SE Laminate Top 3mm PVC Edge SE, MS	Waterfall (Working Side, Both Sides) WS, WD	Wgt.
 Desk with two pedestals and locks. No center drawer. 7-1/2" overhang on ends & 6-1/4" overhang on rear. Two drawer pedestal on left, three drawer on right. Recessed full width pulls. Wire Grommets in top and back panel.	29"	72"	36"	<b>CUD-72E</b>	<b>1955</b>	<b>2057</b>	285
 Desk with two pedestals and locks. No center drawer. 6-1/4" overhang rear & 4-1/2" on ends. Two drawer pedestal on left, three drawer on right. Recessed full width pulls. Wire Grommets in top and back panel.	29"	66"	36"	<b>CUD-66E</b>	<b>1800.</b>	<b>1904.</b>	270
 Same as above, except 4-1/2" overhang on ends.	29"	66"	30"	<b>CUD-66</b>	<b>1645.</b>	<b>1750.</b>	235
 Same as above, except no overhangs.	29"	57-1/4"	30"	<b>CUD-60</b>	<b>1553.</b>	<b>1659.</b>	225

## SINGLE PEDESTAL

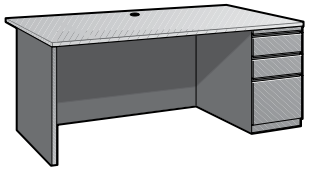
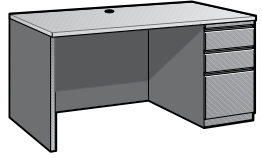
	Desks with three drawer pedestal on right or left w/lock. No center drawer. 6-1/4" overhang rear & flush ends. Recessed full width pulls. Wire Grommets in top and back panel.	29"	72"	36"	<b>CUS-72E</b>	<b>1660.</b>	<b>1765.</b>	235
		29"	66"	36"	<b>CUS-66E</b>	<b>1506.</b>	<b>1612.</b>	210
	Desks with three drawer pedestal on right or left w/lock. No center drawer. No Overhangs. Recessed full width pulls. Wire Grommets in top and back panel.	29"	72"	30"	<b>CUS-72</b>	<b>1553.</b>	<b>1659.</b>	220
		29"	66"	30"	<b>CUS-66</b>	<b>1392.</b>	<b>1499.</b>	205
		29"	57-1/4"	30"	<b>CUS-60</b>	<b>1345.</b>	<b>1451.</b>	195
		29"	48"	30"	<b>CUS-48</b>	<b>1234.</b>	<b>1335.</b>	175

 <b>Center Drawer</b> with lock. Does not lock pedestals. Pencil tray in top box drawer when no center drawer is used.	2"	23"/27"	20-1/2"	<b>CD</b>	<b>148.</b>		15
--	----	---------	---------	-----------	-------------	--	----

## CRENENZA

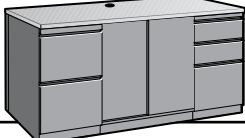
 Credenza includes two box/file and two file pedestals. 29-3/4" wide cupboard w/one adj. shelf. Recessed full width pulls. All cabinets with lock.	29"	60"	24"	<b>CUZ-60</b>	<b>1908.</b>	<b>1994.</b>	-
--	-----	-----	-----	---------------	--------------	--------------	---

## EDGE TREATMENT 1100 SERIES - Additional options/accessories refer to pages 16-19

"SE" SE laminate top - (add suffix "A" to model #)

"WD" Waterfall on both sides - (add suffix "C" to model #)

"WS" Waterfall on working side - (add suffix "B" to model #)

"MS" 3mm PVC edge - (add suffix "D" to model #)

**1100 SERIES****RUNOFF UNITS / BRIDGES / TEACHER'S DESKS**

THESE INDIVIDUAL UNITS COMBINE TO MAKE WORKSTATIONS AND GROUPINGS. SEE EXAMPLES ON PAGES 8-11.

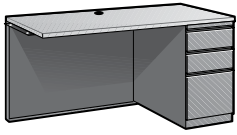
**19" DEEP**

Return with three drawer pedestal and lock. 29" desk height. Wire Grommets in top and back panel.  
\*No pedestal on CU-R36.

H	W	D	Model	SE Laminate Top 3mm PVC Edge SE, MS	Waterfall (Working Side, Both Sides) WS, WD	Wgt.
29"	72"	19-3/8"	<b>CU-R72</b>	<b>1129.</b>	<b>1200.</b>	120
29"	60"	19-3/8"	<b>CU-R60</b>	<b>1014.</b>	<b>1093.</b>	110
29"	48"	19-3/8"	<b>CU-R48</b>	<b>907.</b>	<b>987.</b>	105
29"	42"	19-3/8"	<b>CU-R42</b>	<b>862.</b>	<b>941.</b>	100
29"	36"	19-3/8"	<b>CU-R36-S</b>	<b>862.</b>	<b>941.</b>	90
29"	36"	19-3/8"	<b>CU-R36*</b>	<b>669.</b>	<b>747.</b>	50

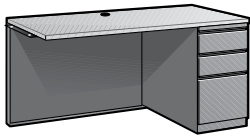
**24" DEEP**

Return with three drawer pedestal and lock. 29" desk height.  
For use with 66" or larger Single Pedestal Desk. Wire Grommets in top and back panel.  
\*No pedestal on CU-CR36.

29"	72"	24"	<b>CU-CR72</b>	<b>1160.</b>	<b>1232.</b>	130
29"	60"	24"	<b>CU-CR60</b>	<b>1077.</b>	<b>1154.</b>	120
29"	48"	24"	<b>CU-CR48</b>	<b>993.</b>	<b>1072.</b>	115
29"	42"	24"	<b>CU-CR42</b>	<b>947.</b>	<b>1024.</b>	110
29"	36"	24"	<b>CU-CR36-S</b>	<b>947.</b>	<b>1024.</b>	100
29"	36"	24"	<b>CU-CR36*</b>	<b>718.</b>	<b>795.</b>	60

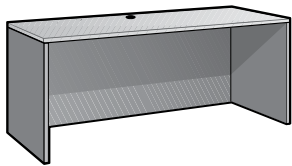
**SHELLS****NEW**

Wire Grommets in top and back panel. Includes: top, back panel & two (2) end panels.  
See page 32 and 34 for mobile or fixed pedestals.

29"	72"	30"	<b>TCS-72-30</b>	<b>1100.</b>	<b>1187</b>	-
29"	66"	30"	<b>TCS-66-30</b>	<b>1042.</b>	<b>1111.</b>	-
29"	60"	30"	<b>TCS-60-30</b>	<b>950.</b>	<b>1037.</b>	-
29"	48"	30"	<b>TCS-48-30</b>	<b>939.</b>	<b>1024.</b>	-
29"	72"	24"	<b>TCS-72-24</b>	<b>1065.</b>	<b>1152.</b>	-
29"	66"	24"	<b>TCS-66-24</b>	<b>1051.</b>	<b>1054.</b>	-
29"	60"	24"	<b>TCS-60-24</b>	<b>917.</b>	<b>1002.</b>	-
29"	48"	24"	<b>TCS-48-24</b>	<b>868.</b>	<b>939.</b>	-

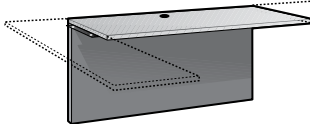
**BRIDGES DESK HEIGHT**

Attach to Corner Units, Desks, Credenzas or Peninsula-Desks. Connectors included. For use on 1100 series desks only. For 3/4 high back panel see 1200 series.

29"	48"	24"	<b>TCR-48</b>	<b>517.</b>	<b>604</b>	60
29"	42"	24"	<b>TCR-42</b>	<b>470.</b>	<b>558.</b>	55

See page 19 for keyboards

**FEATURES 1200 SERIES**

Full height pedestals.

Full height flush back panel.

Full width recessed drawer pulls.

Heavy duty construction throughout.

Heavy duty **full** extension ball bearing suspension on file & box drawers.

High side file drawer.

Interchangeable lock cores.

Pencil tray in top box drawer w/no center drawer.

Shipped fully assembled.

Box/file drawer pedestal with lock on right and left.

Leveling glides.

Wire Grommets in top and back panel, except Teacher's Desks.

Note: All Desks are "Random Keyed" unless specified "Keyed Alike".

# 1200 SERIES DESKS

THESE INDIVIDUAL UNITS COMBINE TO MAKE WORKSTATIONS AND GROUPINGS. SEE EXAMPLES ON PAGES 8-11.

## DOUBLE PEDESTAL

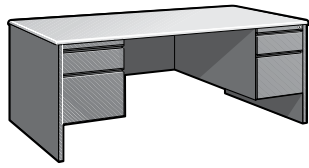

Description  
Desks with two box/file pedestals w/ locks. No center drawer. Flush back panel, full depth pedestals. Wire management see below.

H	W	D	Model	SE Laminate Top 3mm PVC Edge SE, MS	Waterfall (Working Side, Both Sides) WS, WD	Wgt.
29"	72"	36"	<b>C4D-72E</b>	<b>1314.</b>	<b>1436.</b>	265
29"	72"	30"	<b>C4D-72</b>	<b>1286.</b>	<b>1410.</b>	255
29"	66"	30"	<b>C4D-66</b>	<b>1258.</b>	<b>1383.</b>	250

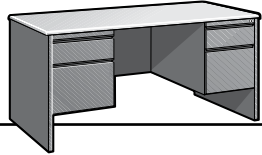

Description  
Desks with two box/file pedestals w/ locks. No center drawer. Flush back panel, full depth pedestals. Wire management see below.

29"	60"	30"	<b>C4D-60</b>	<b>1130.</b>	<b>1254.</b>	231
-----	-----	-----	---------------	--------------	--------------	-----

## SINGLE PEDESTAL

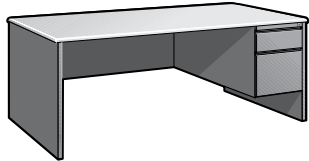

72x36 Shown

Description  
Desks with box/file pedestal & lock. No center drawer. Flush back panel, full depth pedestals. Wire management see below.

29"	72"	36"	<b>C4S-72E</b>	<b>1179.</b>	<b>1300</b>	205
-----	-----	-----	----------------	--------------	-------------	-----

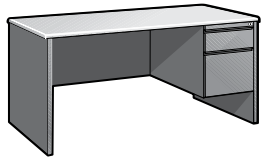

66x30 Shown

Same as above.

29"	66"	30"	<b>C4S-66</b>	<b>1086.</b>	<b>1210.</b>	195
29"	48"	30"	<b>C4S-48</b>	<b>968.</b>	<b>1092.</b>	175

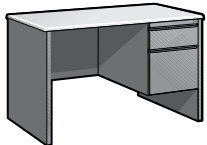

48x24 Shown

Same as above.

29"	66"	24"	<b>C4S-66-4</b>	<b>911.</b>	<b>1011.</b>	185
29"	48"	24"	<b>C4S-48-4</b>	<b>841.</b>	<b>941.</b>	165

## FEATURES 1200 SERIES

Full height end panels.  
3/4" high flush back panel.  
Full width recessed drawer pulls.  
Heavy duty construction throughout.  
Heavy duty **full** extension ball bearing suspension on file drawers.  
High side file drawer.  
Interchangeable lock cores.

Pencil tray in top box drawer w/no center drawer.  
Shipped fully assembled.  
Box/file drawer pedestal with lock on right and left.  
Leveling glides.  
Note: All Desks are "Random Keyed" unless specified "Keyed Alike".

## EDGE TREATMENT 1200 SERIES – Additional options/accessories refer to pages 16-19

"SE" SE laminate top - (add suffix "SE" to model #)  
"WS" Waterfall on working side - (add suffix "WS" to model #)  
"WD" Waterfall on both sides - (add suffix "WD" to model #)  
"MS" 3mm PVC edge - (add suffix "MS" to model #)

# 1200 SERIES RUNOFF UNITS / CREDENZAS / BRIDGES

THESE INDIVIDUAL UNITS COMBINE TO MAKE WORKSTATIONS AND GROUPINGS. SEE EXAMPLES ON PAGES 8-11.

## RUNOFF UNITS

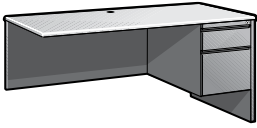
Description	H	W	D	Model	SE Laminate Top	Waterfall (Working Side, Both Sides)	Wgt.
					3mm PVC Edge	WS, WD	
					SE, MS		
 Standard box/file pedestal with lock. Grommet in top and back panel.	29"	60"	24"	<b>C4-CR60</b>	<b>772.</b>	<b>872.</b>	135
	29"	48"	24"	<b>C4-CR48</b>	<b>703.</b>	<b>801.</b>	128
	29"	42"	24"	<b>C4-CR42</b>	<b>661.</b>	<b>759.</b>	121

60x24 Shown

## CREDENZAS / DESKS

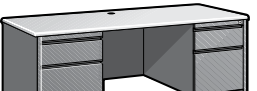
 Standard two (2) box/file pedestals with lock Grommet in top and back panel.	29"	72"	24"	<b>C4D-724</b>	<b>1130.</b>	<b>1230.</b>	195
	29"	66"	24"	<b>C4D-664</b>	<b>1108.</b>	<b>1207.</b>	185
	29"	60"	24"	<b>C4D-604</b>	<b>1090.</b>	<b>1189.</b>	175

60x24 Shown

## SHELLS

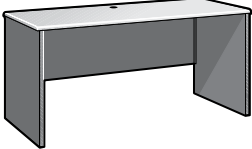
 Includes: top, 3/4 back panel & two (2) end panels. See page 23 and 24 for mobile or fixed pedestals.	29"	72"	30"	<b>S3-72-30</b>	<b>880.</b>	<b>1004.</b>	125
	29"	66"	30"	<b>S3-66-30</b>	<b>840.</b>	<b>963.</b>	115
	29"	60"	30"	<b>S3-60-30</b>	<b>801.</b>	<b>925.</b>	110
	29"	72"	24"	<b>S4-72-24</b>	<b>845.</b>	<b>969.</b>	-
	29"	66"	24"	<b>S4-66-24</b>	<b>803.</b>	<b>927.</b>	-
	29"	60"	24"	<b>S4-60-24</b>	<b>767.</b>	<b>890.</b>	-

## BRIDGES

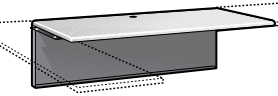
 Desk Height Bridges attach to Corner Units, Desks, connectors included. Grommet in top and back panel. For use on 1200 series desks only. For full height back panel see page 13.	29"	48"	24"	<b>TCR4-48</b>	<b>506.</b>	<b>604.</b>	60
	29"	42"	24"	<b>TCR4-42</b>	<b>464.</b>	<b>564.</b>	55

See page 19 for keyboards

## SPECIFIC OPTIONS FOR 1200 DESKS

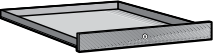
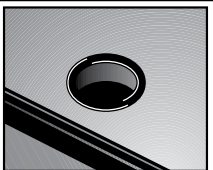
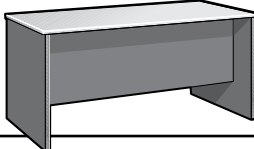
 Center Drawer with lock. Note: Does not lock pedestals.	2"	23/27"	20 <sup>1</sup> / <sub>2</sub> "	<b>C4-CD-0</b>	<b>148.</b>		10
 Wire Management Consists of (2) two grommets in top and (1) one each in end panel for pass through feed to adjoining desk. Top box drawer is short depth with wire management through rear of pedestal.				<b>C4D-WM</b>	<b>65.</b>		
 Short Depth Pedestal w/Recessed Back panel Add "RBP" to model number. Example: C4D-66-RBP.				<b>RBP</b>	<b>0.</b>		

## "D" SHAPED

## 5 SIZES / 2 DEPTHS

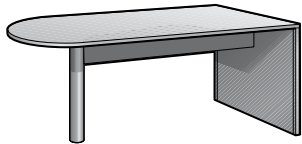

Plan View with 72W 30D

**Description**  
**"D" Shaped** Peninsula Desks are free standing & can be attached to Desks, Returns, Bridges and Credenzas. 12" high back panel.

H	W	D	Model	SE Laminate Top (SE)	Wgt.
29"	96"	36"	<b>TDD-96E</b>	<b>1257.</b>	140
29"	72"	36"	<b>TDD-72E</b>	<b>1128.</b>	120
29"	72"	30"	<b>TDD-72</b>	<b>1081.</b>	105
29"	66"	30"	<b>TDD-66</b>	<b>1048.</b>	95
29"	60"	30"	<b>TDD-60</b>	<b>1024.</b>	90

Top Dimensions (Plan View)

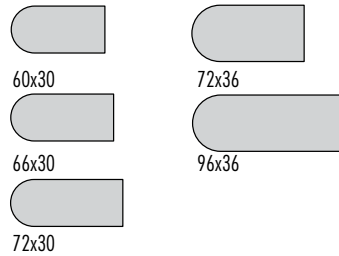
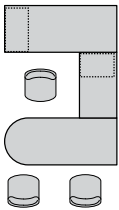

## CORNER UNIT

## 2 SIZES

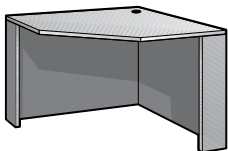

36x24 Shown

**Description**  
 Corner Unit accepts 24" deep Returns, Bridges or Credenzas.

H	W	D	Model	Self Edge (SE)	Wgt.
29"	36"	24"	<b>CU-3624</b>	<b>796.</b>	105
29"	42"	24"	<b>CU-4224</b>	<b>822.</b>	116

Ideal computer location with optional Keyboard Shelf. Shallow end panels enhance movement. Available in 29" desk height. Grommets in top and back panel.

Plan View with 42W 24D

Top Dimensions (Plan View)

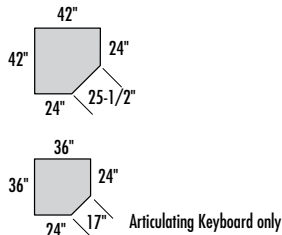
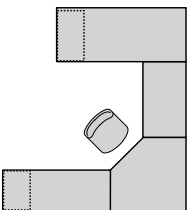

### EDGE TREATMENT

"SE" SE laminate top - (add suffix "SE" to model #)

"MS" 3mm PVC Edge - (add suffix "MS" to model #)

# ACCESSORIES WALL HUNG / OVERHEAD ORGANIZERS PRIVACY SCREENS

## WALL CABINET

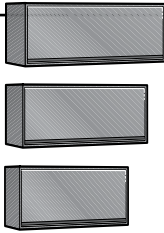
	Description	H	W	D	Model	List Price	Wgt.
	Wall-hung overhead organizer cabinet with flipper doors and lock.	16½"	42"	15"	<b>WHC-42</b>	<b>633.</b>	70
	Three (3) dividers per unit.	16½"	36"	15"	<b>WHC-36</b>	<b>616.</b>	60
	"Z" brackets included for wall mounting.	16½"	30"	15"	<b>WHC-30</b>	<b>599.</b>	50

## DESK TOP OVERHEAD ORGANIZER

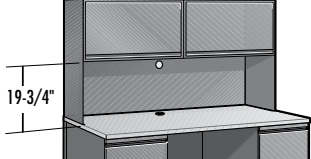
	Description	H	W	D	Model	List Price	Wgt.
	Overhead organizer cabinet with flipper doors and locks.	37"	72"	15"	<b>CDTO-72</b>	<b>1138.</b>	157
	Three (3) dividers per unit.	37"	66"	15"	<b>CDTO-66</b>	<b>1071.</b>	154
	Optional tackboard see below.	37"	60"	15"	<b>CDTO-60</b>	<b>1046.</b>	152
		37"	57¼"	15"	<b>CDTO-57</b>	<b>1046.</b>	150
		37"	48"	15"	<b>CDTO-48</b>	<b>1022.</b>	148

## DESK TOP OVERHEAD ORGANIZER / OPEN SHELF

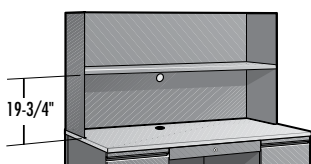
	Description	H	W	D	Model	List Price	Wgt.
	Overhead organizer shelf.	33¾"	72"	15"	<b>ODTO-72</b>	<b>563.</b>	89
	Mounts to desk top.	33¾"	66"	15"	<b>ODTO-66</b>	<b>536.</b>	80
	Optional tack board see below.	33¾"	60"	15"	<b>ODTO-60</b>	<b>525.</b>	75
		33¾"	57¼"	15"	<b>ODTO-57</b>	<b>525.</b>	73
		33¾"	48"	15"	<b>ODTO-48</b>	<b>490.</b>	70

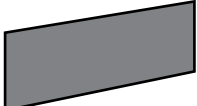

**Note: All furniture is "Random Keyed" unless specified "Keyed Alike".**

## SPECIFIC OPTIONS FOR OVERHEAD ORGANIZERS

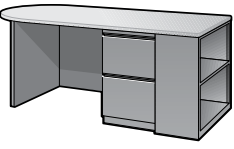
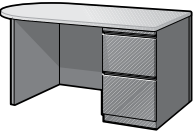

	<b>Task Light</b> -(with 9 foot cord) 48"	For 72", 66"		<b>TL-48</b>	<b>294.</b>	18
	<b>Task Light</b> -(with 9 foot cord) 36"	For 60", 57¼", 48"		<b>TL-36</b>	<b>268.</b>	15
	<b>Tackboard</b>	For 72"		<b>TB72</b>	<b>354.</b>	30
		For 66"		<b>TB66</b>	<b>316.</b>	35
		For 60"		<b>TB60</b>	<b>308.</b>	21
		For 57¼"		<b>TB57</b>	<b>308.</b>	20
		For 48"		<b>TB48</b>	<b>281.</b>	19

# TEACHERS' DESKS, PODIUMS, TRANSACTIONS COUNTERS

## TEACHERS' DESKS

Description	H	W	D	Model	Self Edge Laminate Top/"T" (SE)	3mm PVC (MS)	Wgt.
 Desk with curved overhang. Includes 48"x 30" cube desk, 12" bookcase, 72"x 30" laminated top with safety vinyl edge and radius corners. Two dr. pedestal w/lock.	29"	72"	30"	<b>TCD-72</b>	<b>1606.</b>	<b>1837.</b>	—
 Desk with curved overhang. Includes 48"x 30" cube desk, 60"x 30" laminated top with safety vinyl edge and radius corners. Two dr. pedestal w/lock.	29"	60"	30"	<b>TCD-60</b>	<b>1339.</b>	<b>1570.</b>	—
 <b>Center Drawer</b> with lock. Does not lock pedestals.	2"	23"/27"	20-1/2"	<b>CD</b>	<b>148.</b>		15

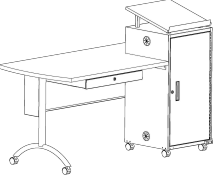
## MOBILE DESKS AND PODIUMS

Description	W	D	Model	3mm PVC (MS)	Wgt.
 <b>Mobile Teacher Desk</b> with casters and 2-drawer pedestal w/lock.	60"	24"	<b>6024-MTD-F</b>	<b>1350.</b>	140
	60"	30"	<b>6030-MTD-F</b>	<b>1400.</b>	145
	48"	24"	<b>4824-MTD-F</b>	<b>1300.</b>	130
	48"	30"	<b>4830-MTD-F</b>	<b>1350.</b>	125
 <b>Mobile Podium Desk</b> with casters and attached podium with locking storage cabinet and adjustable shelves.	60"	24"	<b>6024-POD</b>	<b>1700.</b>	150
	60"	30"	<b>6030-POD</b>	<b>1800.</b>	155
<b>Center Drawer</b> for Mobile Desks			<b>CD-POD</b>	<b>148.</b>	10
Description	W	D	Model	3mm PVC (MS)	Wgt.
 <b>Mobile Podium with Slanted Top</b> , casters, locking storage and adjustable shelves.	48"	30"	<b>ML500F</b>	<b>740.</b>	65
 <b>Mobile Podium with Flat Top</b> , casters, locking storage and adjustable shelves.	48"	30"	<b>ML500</b>	<b>740.</b>	65

## TRANSACTION COUNTER

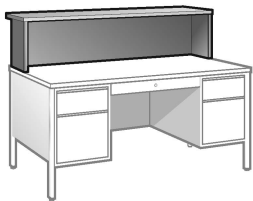
Description	H	W	D	Model	Self Edge Laminate Top/"T" (SE)	3mm PVC (MS)	Wgt.
 Laminate top with 4" overhang at rear.	14"	72"	12"	<b>TRAN-72</b>	<b>885.</b>	<b>986.</b>	—
	14"	66"	12"	<b>TRAN-66</b>	<b>855.</b>	<b>942.</b>	—
	14"	60"	12"	<b>TRAN-60</b>	<b>831.</b>	<b>899.</b>	—

## EDGE TREATMENT

"SE" SE laminate top - (add suffix "SE" to model #)

"MS" 3mm PVC edge - (add suffix "MS" to model #)



# ACCESSORIES DESKS / COMPUTER TABLES

## ADDITIONAL OPTIONS / ACCESSORIES DESK SERIES

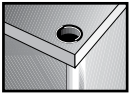
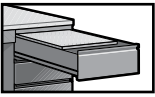
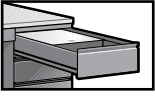
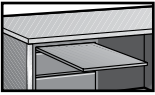
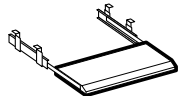
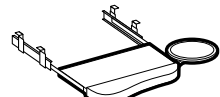
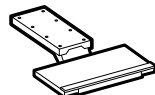
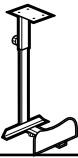
	Description	H	W	D	Model	List Price
	<b>Grommet</b> Specify location. Recommended for use with Keyboard Shelves.	-	2-1/2"	DIA.	<b>GR-1</b>	<b>25.</b>
	<b>Reference Shelf</b> Adds 19-3/4" of Extension Located behind drawer front. Drawer must be extended for access. 1000, 1100, 1200 Series only.				<b>D-RS</b> (Per Pedestal)	<b>100.</b>
	<b>In Drawer Reference Shelf</b> Plastic cover.				<b>ID-RS</b> (Per Pedestal)	<b>60.</b>
	<b>NEW Reference Shelf - Self Supporting</b> Steel construction for durability. Spring loaded. Add an extra work surface or mouse support.				<b>SL-RS</b> (Per Pedestal)	<b>139.</b>
	<b>Keyboard Shelf</b> Retracting w/ ball bearing slide Adjustable height.	Adj.	21"	10-1/2"	<b>KB-1</b>	<b>148.</b>
	<b>Keyboard Shelf w/Mouse Tray</b> (L or R hand adj.) Ball bearing Slide out position w/detent stops. Integral molded pencil tray.	Adj.	21"	10-1/2"	<b>KB-2</b>	<b>185.</b>
	<b>Keyboard Shelf</b> Articulating and retracting. Adjustable height and angle w/locking position.	Adj.	21"	10-1/2"	<b>KB-3</b>	<b>417.</b>
	<b>CPU Holder</b> Mounts to underside of top. Adjustable vertical or horizontal. Black finish only.	Adj.	Adj.	-	<b>CPU</b>	<b>142.</b>
	<b>Wire Management Trough</b>	3"	15"	2"	<b>WM-1</b>	<b>65.</b>
	<b>Leg Wire Management Clip</b> For CTO (open leg)	-	-	-	<b>LWMC</b>	<b>8.</b>
	<b>Pencil Tray - Top Box</b> Top Box Drawer Letter width only.				<b>P-TR</b>	<b>31.</b>
	<b>Box Drawer Divider (per pedestal)</b>				<b>P-DD</b>	<b>13.</b>
	<b>File Drawer Divider</b>				<b>PF-DD</b>	<b>16.</b>
	<b>Magnetic Label Holder</b>				<b>ML</b>	<b>8.</b>

When ordering add suffix to model number.

# 1000 SERIES

## DESKS

SELF EDGE TOP STANDARD/SAFETY VINYL EDGE & RADIUS CORNERS OPTIONAL.

### DOUBLE PEDESTAL

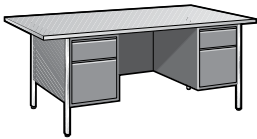
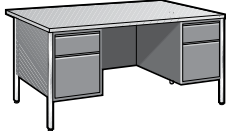
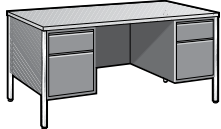
Description	H	W	D	Model	SE Laminate Top (SE)	3mm PVC Edge (MS)	Wgt.
 Desk with two box/file pedestals and locks. No center drawer. 6" overhang rear & 6" each end. Recessed pulls.	29"	72"	36"	<b>DP72E</b>	<b>1355.</b>	<b>1479.</b>	300
 Desk with two box/file pedestals and locks. No center drawer. 6" overhang rear. Recessed pulls.	29"	60"	36"	<b>DP60E</b>	<b>1242.</b>	<b>1366.</b>	290
 Desk with two box/file pedestals and locks. No center drawer. Recessed pulls.	29"	60"	30"	<b>DP60</b>	<b>1151.</b>	<b>1275.</b>	235

Three box drawer pedestal optional (one only) specify by adding suffix "-3" to model number. (Example DP60-3)

### SINGLE PEDESTAL

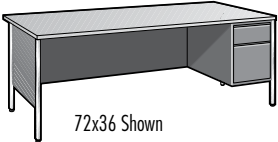
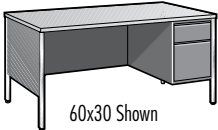
 Desk with box/file pedestal and locks. No center drawer. 6" Overhang rear. Recessed pulls. Specify left or right hand pedestal.	29"	72"	36"	<b>SP72E</b>	<b>1203.</b>	<b>1326.</b>	265
	29"	66"	36"	<b>SP66E</b>	<b>1193.</b>	<b>1317.</b>	235
 Desk with box/file pedestal and locks. No center drawer. Recessed Pulls. Specify left or right hand pedestal.	29"	72"	30"	<b>SP72</b>	<b>1130.</b>	<b>1254.</b>	240
	29"	66"	30"	<b>SP66</b>	<b>1103.</b>	<b>1227.</b>	235
	29"	60"	30"	<b>SP60</b>	<b>1000.</b>	<b>1125.</b>	210
	29"	48"	30"	<b>SP48</b>	<b>968.</b>	<b>1092.</b>	175

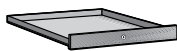

**Center Drawer** with lock.

2" 23"/27" 20-1/2" **CD**

**148.**

15

Note: Does not lock pedestals. Pencil tray in top box drawer when no center drawer is used.

### FEATURES 1000 SERIES

All double pedestal desks are standard with box/file pedestal on right and on left w/locks. Single pedestals have box/file pedestal w/lock.

Safety vinyl "T" edge with radius corners optional.

Full width recessed beveled pulls.

Heavy duty construction throughout.

Heavy duty **full** extension ball bearing suspension on file drawers.

All drawers have overlapping drawer fronts.

High side file drawers.

Leveling glides.

### EDGE TREATMENT 1000 SERIES

"SE" SE laminate top- (add suffix "SE" to model #)

"MS" 3mm PVC edge w/square corners- (add suffix "MS" to model #)

# 1000 SERIES RUNOFF UNITS / CREDENZAS

## 24" DEEP

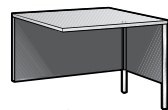

36x24 Shown

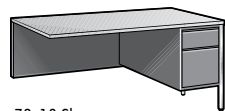

72x18 Shown

Description	H	W	D	Model	SE Laminate Top (SE)	3mm PVC Edge (MS)	Wgt.
Returns include a two (2) drawer pedestal with lock.	29"	36"	24"	<b>CR36</b>	<b>558.</b>	<b>656.</b>	50
<b>Note: 36" returns do not have pedestals, 24" deep returns can be used on 66" or 72" desks only.</b>	29"	42"	24"	<b>CR42</b>	<b>809.</b>	<b>906.</b>	108
	29"	48"	24"	<b>CR48</b>	<b>834.</b>	<b>933.</b>	116
	29"	60"	24"	<b>CR60</b>	<b>904.</b>	<b>1003.</b>	128

## CREDENZAS

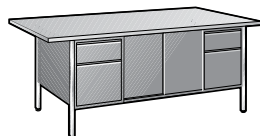

72x18 Shown

Credenza includes two box/file pedestals and one 27-3/4" wide cupboard w/one adjustable shelf. 6" overhang on each end. Recessed pulls. All units with lock.	29"	72"	18"	<b>CZ-72</b>	<b>1382.</b>	<b>1481.</b>	250
	29"	60"	18"	<b>CZ-60</b>	<b>1294.</b>	<b>1392.</b>	235

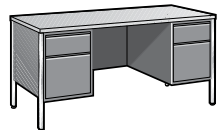

Credenza includes two box/file pedestals w/locks. Recessed pulls. Open knee space w/back panel.	29"	60"	18"	<b>CZ-64K</b>	<b>1140.</b>	<b>1239.</b>	215
---	-----	-----	-----	---------------	--------------	--------------	-----

## DESK WITH MAINTENANCE SAVER LEGS

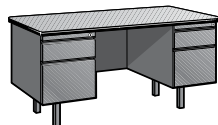

<b>Desk w/Maintenance Saver Legs</b>	29"	60"	30"	<b>DP60R-S</b>	<b>1242.</b>		-
Pedestal mounted legs in two sizes, 60 x 30 double pedestal & 48 x 30 single pedestal. Pedestals w/lock. Shown with top edge "E".	29"	48"	30"	<b>SP48R-S</b>	<b>1062.</b>		-



<b>Center Drawer with lock.</b> Note: Does not lock pedestals. Pencil tray in top box drawer when no center drawer is used.	2"	23"/27"	20-1/2"	<b>CD</b>	<b>148.</b>		15
---	----	---------	---------	-----------	-------------	--	----

## EDGE TREATMENT 1000 SERIES

"SE" SE laminate top- (add suffix "SE" to model #)

"MS" 3mm PVC edge w/square corners- (add suffix "MS" to model #)

## ADDITIONAL OPTIONS / ACCESSORIES

**Overhead Organizers**  
**Keyboard Shelves**  
**Etc.**

**Note: All Desks are "Random Keyed" unless specified "Keyed Alike".**

# 1010 SERIES

# DESKS

TOP STANDARD W/SAFETY VINYL EDGE & RADIUS CORNERS. LIMITED FINISH CHOICES SEE BELOW.

## DOUBLE PEDESTAL

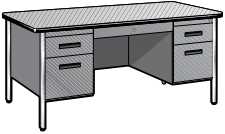
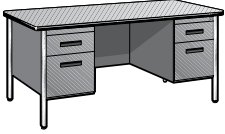
	Description	H	W	D	Model	SE Laminate Top (SE)	Wgt.
	Desk with two box/file pedestals and optional locking center drawer. Lock on right side pedestal only. Flush pulls. Center drawer does not lock pedestal.	29"	60"	30"	<b>3060DP/CD</b>	<b>998.</b>	225
	Desk with two box/file pedestals. No center drawer. Lock on right side pedestal only. Flush pulls.	29"	60"	30"	<b>3060DP</b>	<b>851.</b>	210

## SINGLE PEDESTAL

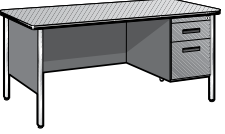
	Desk with box/file pedestal. No center drawer. Specify right or left pedestal. (add /R or /L to model number) Pedestal locks.	29"	66"	30"	<b>66SP</b>	<b>770.</b>	220
		29"	48"	30"	<b>48SP</b>	<b>661.</b>	165

## RUNOFF UNITS

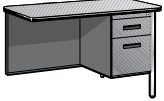
	Return with pedestal and lock. Specify right or left pedestal. (add /R or /L to model number) * Use with 66" main desk only.	29"	42"	24"	<b>4224RT*</b>	<b>551.</b>	105
--	--	-----	-----	-----	----------------	-------------	-----

## SPECIFIC OPTIONS FOR 1010 SERIES

	<b>Center Drawer</b> with lock. Can be added to any desk. Note: Does not lock pedestals.	2"	27"	20-1/2"	<b>CD</b>	<b>148.</b>	15
--	--	----	-----	---------	-----------	-------------	----

## FEATURES 1010 SERIES

All double pedestal desks are standard with box/file pedestal on right and on left. Lock in right pedestal only. Single pedestals have box/file pedestal w/lock.

Safety vinyl "T" edge with radius corners standard.

High side file drawers.

Heavy duty construction.

Flush recessed drawer pulls.

Interchangeable lock cores.

Heavy duty 3/4 extension ball bearing suspension on file & box drawers.

All drawers have overlapping drawer fronts.

Pencil tray in top box drawer when no center drawer is used.

Leveling glides.

## ADDITIONAL OPTIONS / ACCESSORIES REFER TO PAGES 16-19

Overhead Organizers  
Keyboard Shelves  
Etc.

Note: All Desks are "Random Keyed" unless specified "Keyed Alike".

# 1500 SERIES COMPUTER TABLES SAFETY VINYL EDGE WITH RADIUS CORNERS STANDARD.

## OPEN LEG

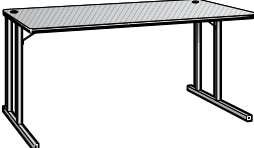
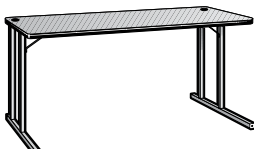

Description	H	W	D	Model	Vinyl 'T'	Wgt.
 Tables with safety vinyl edge top and radius corners. Wire management includes: top grommets, wire clips and wire trough. 30" deep.	29"	72"	30"	<b>CTO720</b>	<b>675.</b>	136
	29"	66"	30"	<b>CTO660</b>	<b>630.</b>	127
	29"	60"	30"	<b>CTO600</b>	<b>574.</b>	118
	29"	48"	30"	<b>CTO480</b>	<b>524.</b>	102
	29"	36"	30"	<b>CTO360</b>	<b>463.</b>	75
 24" deep. Same as above.	29"	72"	24"	<b>CTO724</b>	<b>616.</b>	116
	29"	66"	24"	<b>CTO664</b>	<b>577.</b>	105
	29"	60"	24"	<b>CTO604</b>	<b>529.</b>	95
	29"	48"	24"	<b>CTO484</b>	<b>486.</b>	75
	29"	36"	24"	<b>CTO364</b>	<b>435.</b>	55

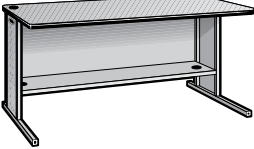
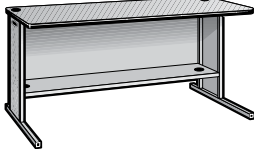
## CLOSED LEG

Description	H	W	D	Model	List Price	Wgt.
 Tables with safety vinyl edge top and radius corners. Pedestals are additional see below. Wire management includes: top, leg and shelf grommets and wire clips. 30" deep.	29"	72"	30"	<b>CTC720</b>	<b>858.</b>	156
	29"	66"	30"	<b>CTC660</b>	<b>812.</b>	147
	29"	60"	30"	<b>CTC600</b>	<b>756.</b>	138
	29"	48"	30"	<b>CTC480</b>	<b>705.</b>	112
	29"	36"	30"	<b>CTC360</b>	<b>646.</b>	85
 24" deep.	29"	72"	24"	<b>CTC724</b>	<b>797.</b>	136
	29"	66"	24"	<b>CTC664</b>	<b>757.</b>	125
	29"	60"	24"	<b>CTC604</b>	<b>711.</b>	115
	29"	48"	24"	<b>CTC484</b>	<b>668.</b>	94
	29"	36"	24"	<b>CTC364</b>	<b>616.</b>	70

**2" DIA Swivel Casters (2 locking) for Open or Close leg models (add 2-1/2" to Height) 65.**

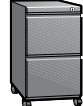
## SPECIFIC OPTIONS FOR 1500 SERIES

Description	H	W	D	Model	List Price	Wgt.
 <b>Mobile Pedestal</b> (2) box and (1) file drawer w/lock, steel top, caster base (2 locking, 2 swivel) & counter balance.	27-1/8"	14-5/8"	22-1/2"	<b>MB-PC3</b>	<b>632.</b>	90
 <b>Mobile Pedestal</b> (2) file drawer w/lock, steel top, caster base (2 locking, 2 swivel) & counter balance.	27-1/8"	14-5/8"	22-1/2"	<b>MB-PC2</b>	<b>587.</b>	80
 <b>Suspended Pedestal</b> One (1) box drawer, one (1) file drawer letter w/lock. Available on closed leg only.	19"	14-5/8"	22-1/2"	<b>PB2-22</b>	<b>354.</b>	65

## ADDITIONAL OPTIONS/ACCESSORIES REFER TO PAGES 16-19

**Overhead Organizers  
Keyboard Shelves  
Etc.**

**Note: All Desks are "Random Keyed" unless specified "Keyed Alike".**

# 1320 SERIES CASUAL TABLES

SELF EDGE TOP STANDARD/SAFETY VINYL 'T' EDGE/WOOD BULLNOSE

## TABLE TOPS - SQUARE

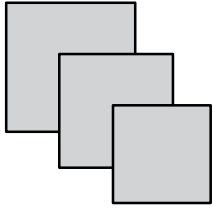

Description	W	D	Model	SE Laminate Top Vinyl T (SE, TR)	Wood Bullnose (WB)	Wgt.
Square tops only, bases below.	48"	48"	<b>T48S</b>	<b>669.</b>	<b>1673.</b>	—
	42"	42"	<b>T42S</b>	<b>558.</b>	<b>1393.</b>	—
	36"	36"	<b>T36S</b>	<b>426.</b>	<b>1060.</b>	—

## TABLE TOPS - ROUND

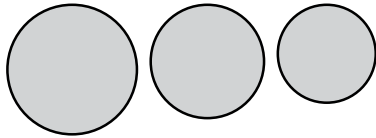

Round tops only, bases below.	W	Model	Vinyl T (TR)	Wood Bullnose (WB)	Wgt.
48" DIA	<b>T48R</b>	<b>669.</b>	<b>1673.</b>	—	
42" DIA	<b>T42R</b>	<b>558.</b>	<b>1393.</b>	—	
36" DIA	<b>T36R</b>	<b>426.</b>	<b>1060.</b>	—	

## TABLE BASES - FOR SQUARE & ROUND



Description	Round	Model	Single X Base Black	Single X Base Chrome	Wgt.
Bases are 13 gauge steel, 3" DIA with adjustable glides. Bullnose profile, single column, X-base. Specify black or chrome.	48" Round	<b>3036-48</b>	<b>384.</b>	<b>495.</b>	—
	42" Round	<b>3032-42</b>	<b>367.</b>	<b>470.</b>	—
	36" Round	<b>3026-36</b>	<b>348.</b>	<b>391.</b>	—
	Square				
	48" Square	<b>3042-48</b>	<b>464.</b>	<b>559.</b>	—
	42" Square	<b>3042-42</b>	<b>464.</b>	<b>559.</b>	—
	36" Square	<b>3038-36</b>	<b>374.</b>	<b>464.</b>	—

## EDGE TREATMENT CONFERENCE TABLE TOPS

"SE" SE laminate top- (add suffix "SE" to model #)

"TR" Vinyl 'T' molding w/radius corners- (add suffix "TR" to model #)

"WB" Wood Bullnose - (add suffix "WB" to model #)

"MS" 3 mm PVC - (add suffix "MS" to model #)



**Example 48" DIA Top/48" Base**  
Bullnose edge, chrome base.

**T48R-F/3036-48-C**

**2167.**

—



**Example 48"x 48" Top/48" Base**  
Bullnose edge, chrome base.

**T48S-F/3042-48-C**

**2231.**

—

## TABLE TOPS - RECTANGULAR

Description	W	D	Model	Self Edge/Vinyl 'T' (SE, TR)	Wood Bullnose (WB)	Wgt.
Rectangular tops only, bases below.	120"	42"	<b>T12042S</b>	<b>1300.</b>	<b>2812.</b>	-
K. D. assembly required.	96"	36"	<b>T9636S</b>	<b>728.</b>	<b>1803.</b>	-
	72"	36"	<b>T7236S</b>	<b>546.</b>	<b>1355.</b>	-

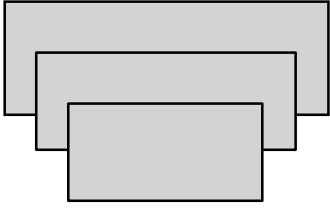

## TABLE BASES

Description	Model	Black	Chrome	Wgt.
Set of 3 double column bases for 120"x 42" tables	<b>2036-3</b>	<b>1046.</b>	<b>1147.</b>	-
Set of 2 double column bases for 96"x 36" tables	<b>2036-2</b>	<b>781.</b>	<b>836.</b>	-
Set of 2 single column bases for 72"x 36" tables	<b>2022</b>	<b>508.</b>	<b>558.</b>	-

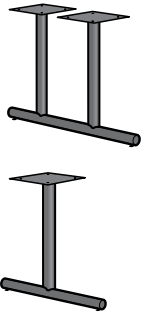

Bases are 13 gauge steel, 2" DIA with adjustable glides. Specify Black or chrome.

## EDGE TREATMENT CONFERENCE TABLE TOPS

"A" SE laminate top- (add suffix "A" to model #)

"E" Vinyl 'T' molding w/radius corners- (add suffix "E" to model #)

"F" Wood Bullnose - (add suffix "F" to model #)

Example 96"x 36" Top/2 column base **T9636S-F/2036-2-C**

**2639.**

Bullnose edge, chrome base.



# WORK GROUP / CLASSROOM SERIES

## OVAL DESKS / TABLES

### ADJUSTABLE HEIGHT

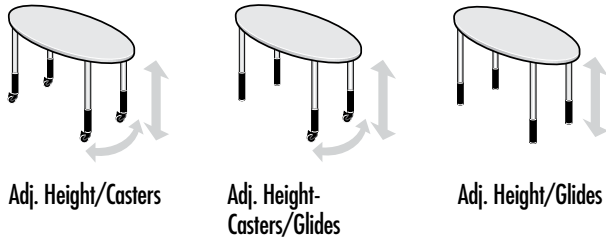

H	W	D	Model	SE Laminate Top/ Vinyl 'T' (SE, TR)	Wgt.
29"	60"	30"	CAOVA-6030	<b>765.</b>	—
29"	66"	30"	CAOVA-6630	<b>840.</b>	—
29"	72"	30"	CAOVA-7230	<b>898.</b>	—
Casters, each			AC	<b>35.</b> (each caster)	—

Adjustable height from 25-3/4" to 29-1/4".

## RECTANGULAR TABLES

### ADJUSTABLE HEIGHT

(SE, MS)

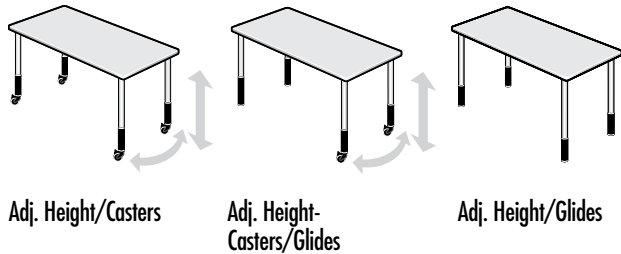

H	W	D	Model	(SE, MS)	Wgt.
29"	60"	24"	CAREC-6024	<b>780.</b>	—
29"	54"	24"	CAREC-5424	<b>728.</b>	—
Casters, each			AC	<b>35.</b> (each caster)	—

Adjustable height from 25-3/4" to 29-1/4".

## SEMI CIRCLE TABLES

### ADJUSTABLE HEIGHT

(SE, MS)



H	W	D	Model	(SE, MS)	Wgt.
29"	60"	24"	CASEMI-60	<b>730.</b>	—
29"	48"	24"	CASEMI-48	<b>695.</b>	—
Casters, each			AC	<b>35.</b> (each caster)	—

Adjustable height from 25-3/4" to 29-1/4".

## TRAPEZOID TABLES

### ADJUSTABLE HEIGHT

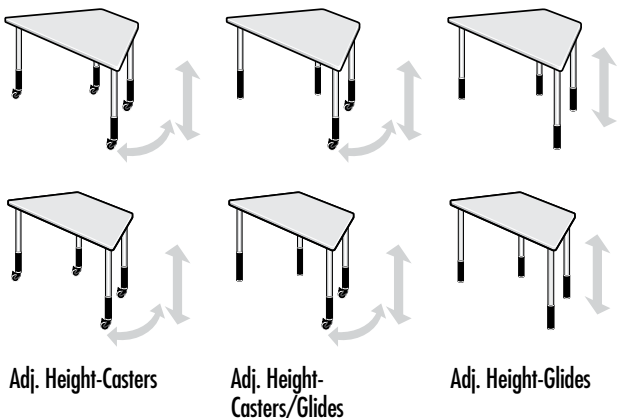

H	W	D	Model	Wgt.
29"	60"	24"	CATRA-6024	<b>773.</b>
29"	54"	24"	CATRA-5424	<b>718.</b>
Casters, each			AC	<b>35.</b> (each caster)

Adjustable height from 25-3/4" to 29-1/4".

## FEATURES

All desks/tables are available w/casters and adj. height legs, glides w/adj. height legs or a combination of both. Tops adjust from 25-3/4" to 29-1/4" to accommodate a range of body sizes or work preferences. Casters are locking and will NOT add any height to tables.

Edge Treatments: Tops are priced with Self Edge Matching Laminate (SE) and Vinyl "T" Mold Edge (TR) as well as 3mm (PVC) Matching Edge (D). Add suffix.

Tables are modular to facilitate work and study groupings, as in classroom environments. They can also be

combined with other series to make Office Workstation Groupings.



# WORK GROUP / CLASSROOM SERIES

## WORK / STUDY CLUSTERS

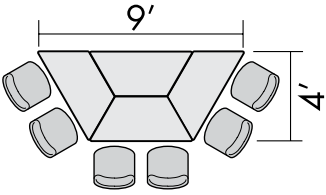
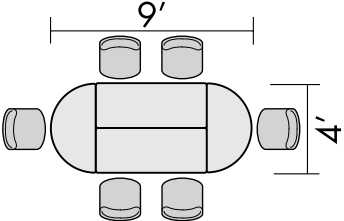
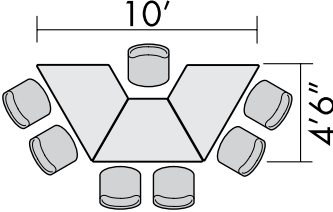
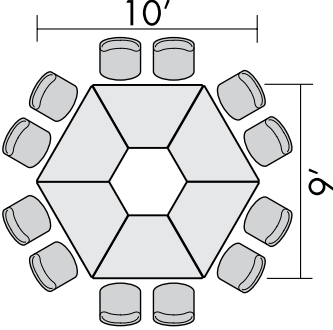
Example	Qty/Description	W	D	Model	Edge Vinyl 'T' (TR)
<b>WC1</b> 	4- Trapezoid Tables	54"	24"	<b>CATRA-5424</b>	
<b>Total</b>					<b>3390.</b>
Plan View		108"	48"		
<b>WC2</b> 	2- Semi Circle Tables 2- Rectangle Tables	48" 60"	24" 24"	<b>CASEMI-48</b> <b>CAREC-6030</b>	
<b>Total</b>					<b>3466.</b>
Plan View		108"	48"		
<b>WC3</b> 	3- Trapezoid Tables	60"	34"	<b>CATRA-6034</b>	
<b>Total</b>					<b>2658.</b>
Plan View		120"	54"		
<b>WC4</b> 	6- Trapezoid Tables	60"	34"	<b>CATRA-6034</b>	
<b>Total</b>					<b>5314.</b>
Plan View		120"	108"		

## TYPICAL CLASSROOM CONFIGURATION 800 SQUARE FEET

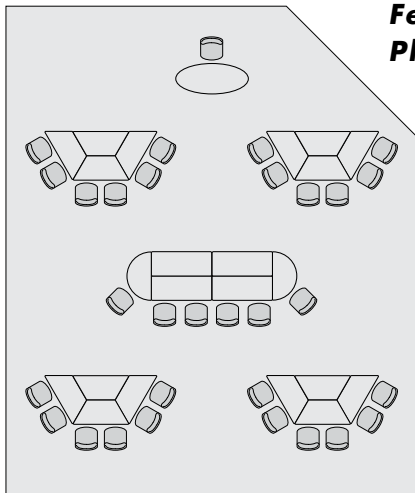



**Featured Classroom furniture for "Microsoft School of The Future" - Philadelphia School District. Example is 800 square feet.**

# 1300 SERIES TABLES

SELF EDGE TOP STANDARD/SAFETY VINYL EDGE & RADIUS CORNERS OPTIONAL.

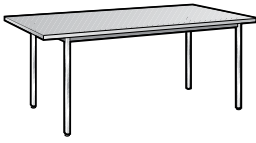
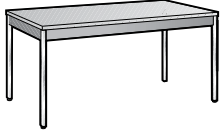
## TABLES

	Description	H	W	D	Model	Self Edge (SE)	PVC Edge (MS)	Wgt.
 <p>72x36 Top</p>	Table with apron on four sides. Overhang: 6" ends, 3" front/back	29"	72"	36"	<b>T72E</b>	<b>682.</b>	<b>753.</b>	170
	Table with apron on four sides. Overhang: 6" ends only.	29"	72"	30"	<b>T72</b>	<b>642.</b>	<b>715.</b>	135
 <p>60x30 Top</p>	Table with apron on four sides.	29"	60"	30"	<b>T60</b>	<b>545.</b>	<b>624.</b>	110
	Table with apron on four sides.	29"	48"	30"	<b>T48</b>	<b>487.</b>	<b>571.</b>	90
 <p>30x30 Top</p>	Tables with apron on four sides. Height 19"	19"	36"	36"	<b>T3636</b>	<b>483.</b>		—
		19"	36"	24"	<b>T3624</b>	<b>409.</b>		—
		19"	36"	18"	<b>T3618</b>	<b>409.</b>		—
		19"	30"	30"	<b>T3030</b>	<b>418.</b>		—
		19"	30"	24"	<b>T3024</b>	<b>392.</b>		—
		19"	30"	18"	<b>T3018</b>	<b>392.</b>		—

## EDGE TREATMENT 1300 SERIES

"SE" SE laminate top- (add suffix "SE" to model #)

"TR" Vinyl 'T' molding w/radius corners- (add suffix "TR" to model #)

"MS" 3mm PVC edge w/square corners- (add suffix "MS" to model #)

# 1310 SERIES STUDENT TABLES - ADJUSTABLE HEIGHT

SAFETY VINYL EDGE & RADIUS CORNERS STANDARD.

## STUDENT TABLES

## ADJUSTABLE HEIGHT

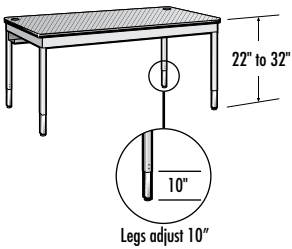
	Description	H	W	D	Model	Vinyl 'T' (TR)	Wgt.
 <p>22" to 32" Legs adjust 10"</p>	Table with two (2) grommets, wire management trough and safety vinyl edge radius corner top. Height adjusts from 22" to 32".	22-32"	72"	30"	<b>CTA720</b>	<b>732.</b>	170
		22-32"	60"	30"	<b>CTA600</b>	<b>635.</b>	134
		22-32"	48"	30"	<b>CTA480</b>	<b>577.</b>	88
		22-32"	72"	24"	<b>CTA724</b>	<b>690.</b>	163
		22-32"	60"	24"	<b>CTA604</b>	<b>590.</b>	123
		22-32"	48"	24"	<b>CTA484</b>	<b>515.</b>	78

# TOWERS

## LATERAL FILES / VERTICAL FILES / WARDROBE / OPTIONS

### 63-3/4" HIGH LATERAL / STORAGE



File Combinations	H	W	D	Model	List Price	Wgt.
3 lateral file drawers (shown)	63-3/4"	30"	18"	<b>LD-TWR-30-3</b>	<b>1635.</b>	-
3 lateral file drawers	63-3/4"	36"	18"	<b>LD-TWR-36-3</b>	<b>1771.</b>	-
3 lateral file drawers	63-3/4"	42"	18"	<b>LD-TWR-42-3</b>	<b>1924.</b>	-
2 lateral file drawers (shown)	63-3/4"	30"	18"	<b>LD-TWR-30-2</b>	<b>1569.</b>	-
2 lateral file drawers	63-3/4"	36"	18"	<b>LD-TWR-36-2</b>	<b>1675.</b>	-
2 lateral file drawers	63-3/4"	42"	18"	<b>LD-TWR-42-2</b>	<b>1771.</b>	-
Tackboard/White Board*					Contact factory	

### WARDROBE / LOCKER



Wardrobe/Locker	63-3/4"	15"	18"	<b>CAB-6415-LU*</b>	<b>535.</b>	-
Wardrobe/Locker	63-3/4"	9"	18"	<b>CAB-6409</b>	<b>504.</b>	-
Wardrobe/Locker	51-3/4"	15"	18"	<b>CAB-5215</b>	<b>484.</b>	-
Wardrobe/Locker	51-3/4"	9"	18"	<b>CAB-5209-LU*</b>	<b>465.</b>	-

\*Louvers available (no charge) add "LU" to model #

Must be bolted to wall

Note: 24" D models available, contact factory for pricing

### OPTIONS

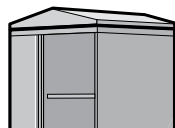

<b>Top Cap Cover</b>	4"	14-5/8"	24"	<b>CAP-2414</b>	<b>272.</b>	-
Cover restricts clutter on top of tower storage. Sizes available 24"x14-5/8", 24"x24". Not available on all lateral sizes.	4"	24"	24"	<b>CAP-2424</b>	<b>307.</b>	-

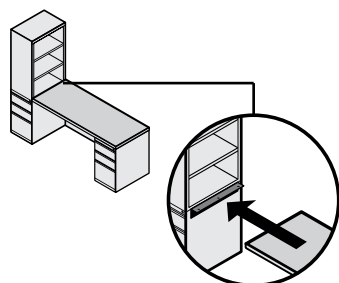

<b>Desk Attachment Option</b>	-	-	-	<b>BRK-TWR</b>	<b>52.</b>	-
-------------------------------	---	---	---	----------------	------------	---

Add this bracket to any tower then add a runoff unit or shell to the tower's side, 24" deep. Shown with CU-CR60.

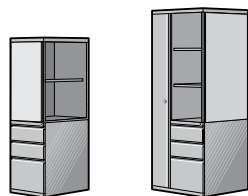

	H	W	D	Model	List Price	Wgt.
<b>Tackboards</b>	36"	14"	1/2"	<b>TB-1436</b>	<b>261.</b>	-
Front mounted or side mounted for 51-3/4" and 63-3/4" high towers. 14" wide is front size and 24" wide is side mounted size. White boards are available, contact factory for pricing.	24"	14"	1/2"	<b>TB-2414</b>	<b>244.</b>	-
	36"	24"	1/2"	<b>TB-3624</b>	<b>282.</b>	-
	24"	24"	1/2"	<b>TB-2424</b>	<b>273.</b>	-

### FEATURES

Lateral files have heavy duty ball bearing suspension w/safety interlock and hanging folder frames, with lock.

High side file drawers on vertical files.

Heavy duty full extension ball bearing suspension on vertical file drawers.

Closed and locking cupboard with adjustable shelf.

Shipped fully assembled.

Leveling glides.

Concealed hinges on cabinets and or cupboards.

## WARDROBE OPEN FRONT SHELVES



File/Box Drawer Combinations	H	W	D	Model	List Price	Wgt.
3 file drawers (shown)	63-3/4"	24"	24"	<b>TWOF-6424-3F</b>	<b>1681.</b>	-
2 file, 2 box drawers (shown)	63-3/4"	24"	24"	<b>TWOF-6424-2F2B</b>	<b>1795.</b>	-
1 file, 4 box drawers	63-3/4"	24"	24"	<b>TWOF-6424-1F4B</b>	<b>1908.</b>	-
6 box drawers	63-3/4"	24"	24"	<b>TWOF-6424-6B</b>	<b>2021.</b>	-
2 file drawers	63-3/4"	24"	24"	<b>TWOF-6424-2F</b>	<b>1601.</b>	-
1 file, 2 box drawers (shown)	63-3/4"	24"	24"	<b>TWOF-6424-1F2B</b>	<b>1715.</b>	-
4 box drawers	63-3/4"	24"	24"	<b>TWOF-6424-4B</b>	<b>1828.</b>	-

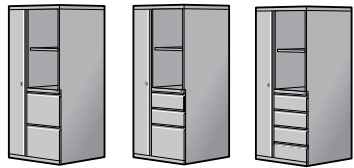

2 file drawers	51-3/4"	24"	24"	<b>TWOF-5224-2F</b>	<b>1451.</b>	-
1 file, 2 box drawers	51-3/4"	24"	24"	<b>TWOF-5224-1F2B</b>	<b>1564.</b>	-
4 box drawers	51-3/4"	24"	24"	<b>TWOF-5224-4B</b>	<b>1677.</b>	-

## WARDROBE OPEN SIDE BOOKCASE



3 file drawers (shown)	63-3/4"	24"	24"	<b>TWOS-6424-3F</b>	<b>1631.</b>	-
2 file, 2 box drawers (shown)	63-3/4"	24"	24"	<b>TWOS-6424-2F2B</b>	<b>1744.</b>	-
1 file, 4 box drawers	63-3/4"	24"	24"	<b>TWOS-6424-1F4B</b>	<b>1858.</b>	-
6 box drawers	63-3/4"	24"	24"	<b>TWOS-6424-6B</b>	<b>1971.</b>	-
2 file drawers	63-3/4"	24"	24"	<b>TWOS-6424-2F</b>	<b>1521.</b>	-
1 file, 2 box drawers (shown)	63-3/4"	24"	24"	<b>TWOS-6424-1F2B</b>	<b>1626.</b>	-
4 box drawers	63-3/4"	24"	24"	<b>TWOS-6424-4B</b>	<b>1739.</b>	-



2 file drawers	51-3/4"	24"	24"	<b>TWOS-5224-2F</b>	<b>1402.</b>	-
1 file, 2 box drawers	51-3/4"	24"	24"	<b>TWOS-5224-1F2B</b>	<b>1514.</b>	-
4 box drawers	51-3/4"	24"	24"	<b>TWOS-5224-4B</b>	<b>1628.</b>	-

## WARDROBE FRONT CUPBOARD

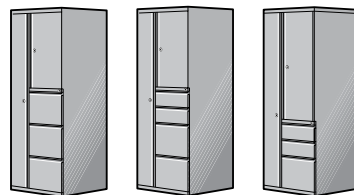

3 file drawers (shown)	63-3/4"	24"	24"	<b>TWFC-6424-33F</b>	<b>1771.</b>	-
2 file, 2 box drawers (shown)	63-3/4"	24"	24"	<b>TWFC-6424-2F2B</b>	<b>1884.</b>	-
1 file, 4 box drawers	63-3/4"	24"	24"	<b>TWFC-6424-1F4B</b>	<b>1998.</b>	-
6 box drawers	63-3/4"	24"	24"	<b>TWFC-6424-6B</b>	<b>2112.</b>	-
2 file drawers	63-3/4"	24"	24"	<b>TWFC-6424-2F</b>	<b>1671.</b>	-
1 file, 2 box drawers (shown)	63-3/4"	24"	24"	<b>TWFC-6424-1F2B</b>	<b>1784.</b>	-
4 box drawers	63-3/4"	24"	24"	<b>TWFC-6424-4B</b>	<b>1897.</b>	-



2 file drawers	51-3/4"	24"	24"	<b>TWFC-5224-2F</b>	<b>1542.</b>	-
1 file, 2 box drawers	51-3/4"	24"	24"	<b>TWFC-5224-1F2B</b>	<b>1654.</b>	-
4 box drawers	51-3/4"	24"	24"	<b>TWFC-5224-4B</b>	<b>1767.</b>	-

**Note: For Right Hand Wardrobe add suffix "R" to the model number.**

### FEATURES

Includes a 63" or 51" wardrobe closet, 9" wide.

Wardrobe closet may be either right or left hand swing/side and includes a shelf w/coat rod, locking door.

Heavy duty **full** extension ball bearing suspension on file drawers.

High side file drawers.

Cupboards have adjustable shelves.

Shipped fully assembled.

Box/file drawer pedestal with lock.

Leveling glides.

Concealed hinges on cabinets and or cupboards.

Optional desk attachment.

Optional top cap.

Optional Tackboards or White Boards.

Mobile/Caster Base

## OPEN FRONT SHELVES

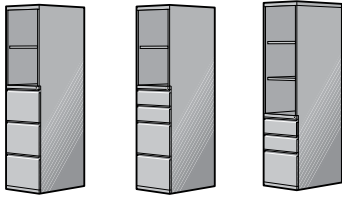

File/Box Drawer Combinations	H	W	D	Model	List Price	Wgt.
3 file drawers (shown)	63-3/4"	14-5/8"	24"	<b>TOF-6424-3F</b>	<b>1024.</b>	-
2 file, 2 box drawers (shown)	63-3/4"	14-5/8"	24"	<b>TOF-6424-2F2B</b>	<b>1096.</b>	-
1 file, 4 box drawers	63-3/4"	14-5/8"	24"	<b>TOF-6424-1F4B</b>	<b>1231.</b>	-
6 box drawers	63-3/4"	14-5/8"	24"	<b>TOF-6424-6B</b>	<b>1335.</b>	-
2 file drawers	63-3/4"	14-5/8"	24"	<b>TOF-6424-2F</b>	<b>951.</b>	-
1 file, 2 box drawers (shown)	63-3/4"	14-5/8"	24"	<b>TOF-6424-1F2B</b>	<b>1055.</b>	-
4 box drawers	63-3/4"	14-5/8"	24"	<b>TOF-6424-4B</b>	<b>1158.</b>	-



2 file drawers	51-3/4"	14-5/8"	24"	<b>TOF-5224-2F</b>	<b>880.</b>	-
1 file, 2 box drawers	51-3/4"	14-5/8"	24"	<b>TOF-5224-1F2B</b>	<b>985.</b>	-
4 box drawers	51-3/4"	14-5/8"	24"	<b>TOF-5224-4B</b>	<b>1087.</b>	-

## OPEN SIDE BOOKCASE

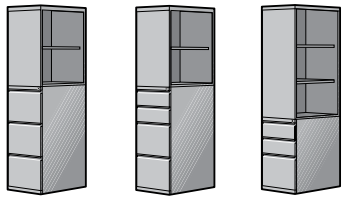

3 file drawers (shown)	63-3/4"	14-5/8"	24"	<b>TOS-6424-3F</b>	<b>979.</b>	-
2 file, 2 box drawers (shown)	63-3/4"	14-5/8"	24"	<b>TOS-6424-2F2B</b>	<b>1083.</b>	-
1 file, 4 box drawers	63-3/4"	14-5/8"	24"	<b>TOS-6424-1F4B</b>	<b>1186.</b>	-
6 box drawers	63-3/4"	14-5/8"	24"	<b>TOS-6424-6B</b>	<b>1288.</b>	-
2 file drawers	63-3/4"	14-5/8"	24"	<b>TOS-6424-2F</b>	<b>872.</b>	-
1 file, 2 box drawers (shown)	63-3/4"	14-5/8"	24"	<b>TOS-6424-1F2B</b>	<b>973.</b>	-
4 box drawers	63-3/4"	14-5/8"	24"	<b>TOS-6424-4B</b>	<b>1077.</b>	-

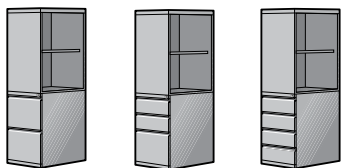

2 file drawers	51-3/4"	14-5/8"	24"	<b>TOS-5224-2F</b>	<b>836.</b>	-
1 file, 2 box drawers	51-3/4"	14-5/8"	24"	<b>TOS-5224-1F2B</b>	<b>940.</b>	-
4 box drawers	51-3/4"	14-5/8"	24"	<b>TWOS-5224-4B</b>	<b>1042.</b>	-

## FRONT CUPBOARD



3 file drawers (shown)	63-3/4"	14-5/8"	24"	<b>TFC-6424-33F</b>	<b>1107.</b>	-
2 file, 2 box drawers (shown)	63-3/4"	14-5/8"	24"	<b>TFC-6424-2F2B</b>	<b>1210.</b>	-
1 file, 4 box drawers	63-3/4"	14-5/8"	24"	<b>TFC-6424-1F4B</b>	<b>1314.</b>	-
6 box drawers	63-3/4"	14-5/8"	24"	<b>TFC-6424-6B</b>	<b>1416.</b>	-
2 file drawers	63-3/4"	14-5/8"	24"	<b>TFC-6424-2F</b>	<b>1015.</b>	-
1 file, 2 box drawers (shown)	63-3/4"	14-5/8"	24"	<b>TFC-6424-1F2B</b>	<b>1118.</b>	-
4 box drawers	63-3/4"	14-5/8"	24"	<b>TFC-6424-4B</b>	<b>1246.</b>	-



2 file drawers	51-3/4"	14-5/8"	24"	<b>TFC-5224-2F</b>	<b>964.</b>	-
1 file, 2 box drawers	51-3/4"	14-5/8"	24"	<b>TFC-5224-1F2B</b>	<b>1066.</b>	-
4 box drawers	51-3/4"	14-5/8"	24"	<b>TFC-5224-4B</b>	<b>1194.</b>	-

**Note: All furniture is "Random Keyed" unless specified "Keyed Alike".**

## FEATURES

Heavy duty **full** extension ball bearing suspension on file drawers.

High side file drawers.

Cupboards have adjustable shelves.

Shipped fully assembled.

Box/file drawer pedestal with lock.

Leveling glides.







Concealed hinges on cupboards.

Optional desk attachment.

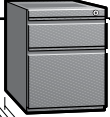

Optional top cap.

Optional Tack Boards or White Boards.

**14 - 5 / 8 " W I D E L E T T E R**

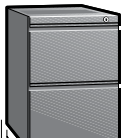

	Description	H	W	D	Model	List Price	Wgt.
 Three Depths	One (1) box drawer, one (1) file drawer, letter w/lock.	19"	14-5/8"	17-7/8"	<b>PB2-18</b>	<b>306.</b>	50
		19"	14-5/8"	22-1/2"	<b>PB2-22</b>	<b>321.</b>	60
		19"	14-5/8"	28-1/2"	<b>PB2-28</b>	<b>336.</b>	70
 Three Depths	Three (3) box drawers, letter w/lock.	19"	14-5/8"	17-7/8"	<b>PB3-18</b>	<b>342.</b>	70
		19"	14-5/8"	22-1/2"	<b>PB3-22</b>	<b>358.</b>	77
		19"	14-5/8"	28-1/2"	<b>PB3-28</b>	<b>375.</b>	85
 Three Depths	Two (2) file drawers, letter w/lock.	27-3/4"	14-5/8"	17-7/8"	<b>PC2-18-7</b>	<b>402.</b>	72
		27-3/4"	14-5/8"	22-1/2"	<b>PC2-22-7</b>	<b>420.</b>	76
		27-3/4"	14-5/8"	28-1/2"	<b>PC2-28-7</b>	<b>444.</b>	90
 Three Depths	Two (2) box drawers, one (1) file drawer, letter w/lock.	27-3/4"	14-5/8"	17-7/8"	<b>PC3-18-7</b>	<b>440.</b>	77
		27-3/4"	14-5/8"	22-1/2"	<b>PC3-22-7</b>	<b>461.</b>	83
		27-3/4"	14-5/8"	28-1/2"	<b>PC3-28-7</b>	<b>481.</b>	98
 Three Depths	Four (4) box drawers, letter w/lock.	27-3/4"	14-5/8"	17-7/8"	<b>PC4-18-7</b>	<b>480.</b>	87
		27-3/4"	14-5/8"	22-1/2"	<b>PC4-22-7</b>	<b>502.</b>	95
		27-3/4"	14-5/8"	28-1/2"	<b>PC4-28-7</b>	<b>523.</b>	100
 One Depth	Two (2) personal drawers, One (1) box drawer, One (1) file drawer, letter w/lock.	27-3/4"	14-5/8"	28-1/2"	<b>PC6-28-7</b>	<b>607.</b>	110

**17 - 5 / 8 " W I D E L E G A L**

	Description	H	W	D	Model	List Price	Wgt.
 Three Depths	Two (2) file drawers, legal w/lock.	27-3/4"	17-5/8"	17-7/8"	<b>PF2-18-7</b>	<b>487.</b>	76
		27-3/4"	17-5/8"	22-1/2"	<b>PF2-22-7</b>	<b>508.</b>	80
		27-3/4"	17-5/8"	28-1/2"	<b>PF2-28-7</b>	<b>531.</b>	94
 Three Depths	Two (2) box drawers, one (1) file drawer, legal w/lock.	27-3/4"	17-5/8"	17-7/8"	<b>PF3-18-7</b>	<b>538.</b>	87
		27-3/4"	17-5/8"	22-1/2"	<b>PF3-22-7</b>	<b>563.</b>	91
		27-3/4"	17-5/8"	28-1/2"	<b>PF3-28-7</b>	<b>587.</b>	105

Note: All furniture is "Random Keyed" unless specified "Keyed Alike".

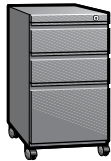
# ACCESSORIES 900 SERIES

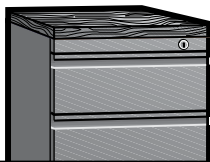
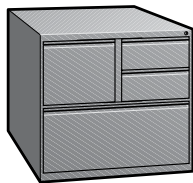
	Description	H	W	D	Model	List Price	Wgt.
	<b>Mobile Kit</b> contains steel top, caster base & counter balance. Add to price of any 900 pedestal. Add 2-1/2" to height. (27-1/8" high overall when using 24-3/4" pedestal) (30-1/8" high overall when using 27-3/4" pedestal)	-	-	-	<b>P-MPK</b>	<b>120.</b>	40
	<b>Tops / Steel</b> (Letter or Legal) Add 1/8" to height of pedestal. Factory installed only.	-	-	-	<b>P-ST</b>	<b>78.</b>	8
	<b>Tops / Laminate</b>				<b>P-DT</b>		-
	30" Deep – Per Linear Inch	1-1/4"	-	28-1/2"	Contact Factory		-
	24" Deep – Per Linear Inch	1-1/4"	-	22-1/2"	Contact Factory		-
	18" Deep – Per Linear Inch	1-1/4"	-	17-7/8"	Contact Factory		-
	<b>Pederal</b> is a combo unit containing two (2) box drawers, one (1) vertical file drawer and one (1) lateral file dwr. Full ball bearing suspension, removable core lock, full width recessed pulls and adj. glides. Counter balance.	27-3/4"	30"	18"	<b>PED30L</b>	<b>939.</b>	-
	<b>Counter Balance</b> For any pedestal.	-	-	-	<b>P-CBW</b>	<b>52.</b>	

## FEATURES 900 / 950 SERIES







- High quality steel ball bearing suspension.
- High side file drawers.
- Recessed drawer pulls.
- All drawers are interchangeable.
- Locks on all pedestals with removable core.
- Locks are "Master Keyed" and have a field removable core.
- Pedestals have 4 adjustable glides.
- Pedestals can be supplied to accept wood or laminate fronts.

## ORDERING INFORMATION

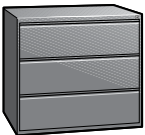
1. Model Number
2. Options above
3. Paint finish color

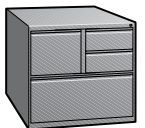
**Note:** All furniture is "Random Keyed" unless specified "Keyed Alike".

**FIXED / RECEDING**

	Description	H	W	D	Model	List Price
	(2) Fixed drawer fronts, with lock. Equipped with side-to-side frames. Counter balance included.	27-3/4"	30"	18"	<b>802-30L</b>	<b>757.</b>
		27-3/4"	36"	18"	<b>802-36L</b>	<b>836.</b>
		27-3/4"	42"	18"	<b>802-42L</b>	<b>904.</b>
	(1) Receding Door, with pull out shelf. 3 dividers & 1 pr. of side-to-side frames. (1) Fixed front dr. on bottom w/1 pr. of side-to-side frames w/lock. Counter balance included.	27-3/4"	30"	18"	<b>812-30L</b>	<b>794.</b>
		27-3/4"	36"	18"	<b>812-36L</b>	<b>874.</b>
		27-3/4"	42"	18"	<b>812-42L</b>	<b>942.</b>
	(3) Fixed drawer fronts, with lock. Equipped with side-to-side frames.	39-3/4"	30"	18"	<b>803-30L</b>	<b>991.</b>
		39-3/4"	36"	18"	<b>803-36L</b>	<b>1089.</b>
		39-3/4"	42"	18"	<b>803-42L</b>	<b>1228.</b>
	(2) Receding Doors, with pull out shelf. 3 dividers & 1 pr. of side-to-side frames. (1) Fixed front dr. on bottom w/1 pr. of side-to-side frames & lock.	39-3/4"	30"	18"	<b>813-30L</b>	<b>1065.</b>
		39-3/4"	36"	18"	<b>813-36L</b>	<b>1164.</b>
		39-3/4"	42"	18"	<b>813-42L</b>	<b>1308.</b>
	(4) Fixed drawer fronts, with lock. Equipped with side-to-side frames.	51-3/4"	30"	18"	<b>804-30L</b>	<b>1254.</b>
		51-3/4"	36"	18"	<b>804-36L</b>	<b>1386.</b>
		51-3/4"	42"	18"	<b>804-42L</b>	<b>1559.</b>
	(3) Receding Doors, with pull out shelf. 3 dividers & 1 pr. of side-to-side frames. (1) Fixed front dr. on bottom w/1 pr. of side-to-side frames & lock.	51-3/4"	30"	18"	<b>814-30L</b>	<b>1365.</b>
		51-3/4"	36"	18"	<b>814-36L</b>	<b>1498.</b>
		51-3/4"	42"	18"	<b>814-42L</b>	<b>1672.</b>
	(1) Receding door, pull out shelf over (4) Fixed drawer fronts, with lock. Equipped with side-to-side frames.	63-3/4"	30"	18"	<b>805-30L</b>	<b>1463.</b>
		63-3/4"	36"	18"	<b>805-36L</b>	<b>1638.</b>
		63-3/4"	42"	18"	<b>805-42L</b>	<b>1805.</b>
	(4) Receding Doors, with pull out shelf. 3 dividers & 1 pr. of side-to-side frames. (1) Fixed front dr. on bottom w/1 pr. of side-to-side frames & lock.	63-3/4"	30"	18"	<b>815-30L</b>	<b>1612.</b>
		63-3/4"	36"	18"	<b>815-36L</b>	<b>1786.</b>
		63-3/4"	42"	18"	<b>815-42L</b>	<b>1953.</b>

**FEDERAL COMBO UNIT**

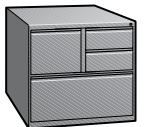
	<b>Federal</b> is a combo unit containing two (2) box drawers, one (1) vertical file drawer and one (1) lateral file dwr. Full ball bearing suspension, removable core lock, full width recessed pulls and adj. glides. Counter balance.	27-3/4"	30"	18"	<b>PED30L</b>	<b>939.</b>	-
--	--	---------	-----	-----	---------------	-------------	---

**FEATURES 800**



- Heavy duty ball bearing suspension.
  - Safety interlock to prevent more than one drawer opening at a time.
  - Full width recessed pull or bevel pull.
  - Locks with removable core are standard on all laterals.
  - Four (4) adjustable glides keep file level, assure smooth operation.
  - Roll-out drawers are furnished with hanging folder frames for side to side filing of letter or legal files.
- Note: All files are "Random Keyed" unless specified "Keyed Alike".**



# STORAGE CABINETS / ACCESSORIES

800 AND 850 SERIES

## ACCESSORIES / OPTIONS

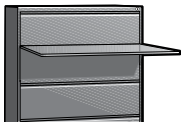
	Description	H	W	D	Model	List Price	Wgt.
	<b>Double Door Storage Closets</b>						
	Storage, w/4 Adjustable Shelves	63 <sup>3</sup> / <sub>4</sub> "	36"	18"	<b>8-6536S</b>	<b>658.</b>	120
	Storage, w/4 Adjustable Shelves*	63 <sup>3</sup> / <sub>4</sub> "	36"	24"	<b>4-6536S</b>	<b>824.</b>	-
	Wardrobe, w/Shelf & Hanger Bar	63 <sup>3</sup> / <sub>4</sub> "	36"	18"	<b>8-6536W</b>	<b>645.</b>	102
	Combo, w/3 Adj. Shelves & Hanger Bar	63 <sup>3</sup> / <sub>4</sub> "	36"	18"	<b>8-6536C</b>	<b>726.</b>	117
	Extra Shelf - Storage Cabinet	1"	36"	17"	<b>8-18S</b>	<b>56.</b>	7
	Use with Towers						
	<b>Single Door Storage Closets</b>						
	Storage, w/4 Adjustable Shelves	63 <sup>3</sup> / <sub>4</sub> "	24"	18"	<b>8-6524S</b>	<b>565.</b>	105
	Storage, w/4 Adjustable Shelves*	63 <sup>3</sup> / <sub>4</sub> "	24"	24"	<b>4-6524S</b>	<b>678.</b>	105
	Wardrobe, w/Shelf & Hanger Bar	63 <sup>3</sup> / <sub>4</sub> "	24"	18"	<b>8-6524W</b>	<b>537.</b>	90
	Extra Shelf - Storage Cabinet	1"	24"	17"	<b>8-24S</b>	<b>50.</b>	8
	Use with Towers						
	<b>Overhead Storage Cabinet</b>						
	One Adjustable Shelf, with sliding door & lock.	28"	30"	18"	<b>8-OF3028</b>	<b>644.</b>	
		28"	36"	18"	<b>8-OF3628</b>	<b>670.</b>	
		28"	42"	18"	<b>8-OF4228</b>	<b>703.</b>	
	Stacking Angles For Above				<b>8-OFSC</b>	<b>44.</b>	
	<b>Reference Shelf (800 Series only)</b>	1"	30"	10 <sup>-1</sup> / <sub>2</sub> "	<b>8-RS-30</b>	<b>122.</b>	8
	Available in 4 & 5 drawer files only.	1"	36"	10 <sup>-1</sup> / <sub>2</sub> "	<b>8-RS-36</b>	<b>135.</b>	8
	Note: Add 1" to overall height of cabinet.	1"	42"	10 <sup>-1</sup> / <sub>2</sub> "	<b>8-RS-42</b>	<b>146.</b>	10

### Bar Locks

2 per cabinet - - - **BL** Contact Factory

### Front to Rear Rails

**30" and 36" Drawers (2 pair)** - - - **8-HE-30/36** **27./per drawer**

**42" Drawers (3 pair)** - - - **8-HE-42** **41./per drawer**

### Counter Balance for Lateral File

Needed for free standing lateral files. - - - **8-CB** **74.**



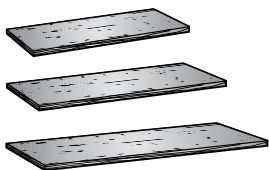

### Dividers

Set of 3 dividers can be used in drawers and shelf. - - - **8-DD** **24.**

Description	H	W	D	Model	Self Edge (SE)	Waterfall-specify side(s)/3mm PVC (WS)-(WD)-(MS)	Wgt.
<b>Self Edge Top (For 2 &amp; 3 Drawer lateral files)</b>							
Covers one 30" file	1 <sup>-1</sup> / <sub>4</sub> "	30"	18"	<b>8-LT30</b>	<b>216.</b>	<b>304.</b>	22
Covers one 36" file	1 <sup>-1</sup> / <sub>4</sub> "	36"	18"	<b>8-LT36</b>	<b>229.</b>	<b>315.</b>	27
Covers one 42" file	1 <sup>-1</sup> / <sub>4</sub> "	42"	18"	<b>8-LT42</b>	<b>264.</b>	<b>351.</b>	33
Covers <b>two</b> 36" file	1 <sup>-1</sup> / <sub>4</sub> "	72"	18"	<b>8-LT72</b>	<b>431.</b>	<b>508.</b>	56
Covers <b>two</b> 42" file	1 <sup>-1</sup> / <sub>4</sub> "	84"	18"	<b>8-LT84</b>	<b>501.</b>	<b>579.</b>	66



## VERTICAL FILES

	Description	H	W	D	Model	High Dwr. Sides (B)*	Wgt.
	2 Drawer Letter, with lock	29"	15"	28"	<b>402L</b>	<b>457.</b>	80
	2 Drawer Legal, with lock	29"	18"	28"	<b>412L</b>	<b>576.</b>	88
	3 Drawer Letter, with lock	40 <sup>7</sup> / <sub>16</sub> "	15"	28"	<b>403L</b>	<b>558.</b>	111
	3 Drawer Legal, with lock	40 <sup>7</sup> / <sub>16</sub> "	18"	28"	<b>413L</b>	<b>629.</b>	119
	4 Drawer Letter, with lock	51 <sup>7</sup> / <sub>8</sub> "	15"	28"	<b>404L</b>	<b>608.</b>	131
	4 Drawer Legal, with lock	51 <sup>7</sup> / <sub>8</sub> "	18"	28"	<b>414L</b>	<b>674.</b>	142
	5 Drawer Letter, with lock	59 <sup>1</sup> / <sub>2</sub> "	15"	28"	<b>405L</b>	<b>739.</b>	161
	5 Drawer Legal, with lock	59 <sup>1</sup> / <sub>2</sub> "	18"	28"	<b>415L</b>	<b>837.</b>	172





## ORDERING INFORMATION

Note: All models include thumbblatch, lock, full progressive cradle suspension delrin rollers.

\* When selecting low drawer sides add (A) to model number, high side add (B) to model number. Example: 404L-A for low drawer side.

**Note: All files are "Random Keyed" unless specified "Keyed Alike".**

**V E R T I C A L F I L E S**

		Description	H	W	D	Model*	High Dwr. Sides (B)*	Wgt.
	27-3/4" Optional	2 Drawer Letter, with lock	29"	15"	28"	<b>702L</b>	<b>587.</b>	93
		2 Drawer Legal, with lock	29"	18"	28"	<b>712L</b>	<b>647.</b>	98
		3 Drawer Letter, with lock	40 <sup>7/8</sup> "	15"	28"	<b>703L</b>	<b>731.</b>	132
		3 Drawer Legal, with lock	40 <sup>7/8</sup> "	18"	28"	<b>713L</b>	<b>799.</b>	137
		4 Drawer Letter, with lock	51 <sup>7/8</sup> "	15"	28"	<b>704L</b>	<b>786.</b>	171
		4 Drawer Legal, with lock	51 <sup>7/8</sup> "	18"	28"	<b>714L</b>	<b>873.</b>	176
		5 Drawer Letter, with lock	59 <sup>1/2</sup> "	15"	28"	<b>705L</b>	<b>1004.</b>	201
		5 Drawer Legal, with lock	59 <sup>1/2</sup> "	18"	28"	<b>715L</b>	<b>1086.</b>	206

Note: All models include thumbblatch, full Progressive cradle suspension, w/10 steel ball bearing rollers.

\*\*Add -RP for Recessed Pull Drawer

Note: All files are "Random Keyed" unless specified "Keyed Alike".

## 12" DEEP

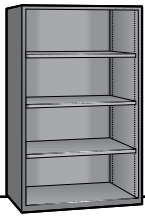

54-1/2" High Shown

Description	Shelf #	H	W	D	Model	List Price	Wgt.
12" deep double wall bookcases with adjustable shelves. Available with optional add on shelves, dividers & tops.	1	29"	36"	12"	DW229B	<b>249.</b>	45
	2	42"	36"	12"	DW242B	<b>284.</b>	55
	2	48"	36"	12"	DW248B	<b>332.</b>	60
	3	54-1/2"	36"	12"	DW254B	<b>352.</b>	70
	4	72"	36"	12"	DW272B	<b>416.</b>	93
	5	84"	36"	12"	DW284B	<b>547.</b>	117
<b>Extra Shelf for above w/clips</b>					DW12S	<b>40.</b>	12
<b>Divider for Shelf</b>					DW12D	<b>27.</b>	4

## 15" DEEP



48" High Shown

Description	Shelf #	H	W	D	Model	List Price	Wgt.
15" deep double wall bookcases with adjustable shelves. Available with optional add on shelves, dividers & tops.	1	29"	36"	15"	DW1529B	<b>284.</b>	51
	2	42"	36"	15"	DW1542B	<b>347.</b>	60
	2	48"	36"	15"	DW1548B	<b>423.</b>	65
	3	54-1/2"	36"	15"	DW1554B	<b>438.</b>	70
	4	72"	36"	15"	DW1572B	<b>578.</b>	102
	5	84"	36"	15"	DW1584B	<b>739.</b>	129
<b>Extra Shelf for above w/clips</b>					DW15S	<b>47.</b>	-
<b>Divider for Shelf</b>					DW15D	<b>29.</b>	-

## RADIUS CORNER BOOKCASE

NEW

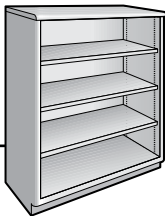

12" and 15" Deep. Special heavy duty construction. Radius front edges for safety - excellent for classroom use.

					List Price		
	1	32"	48"	12"	RSW3212	<b>500.</b>	-
	3	52"	37"	15"	RSW5215	<b>727.</b>	-
<b>Extra Shelf for above</b>					SW12S	<b>61.</b>	-
					SW15S	<b>71.</b>	-
<b>Divider for Shelf</b>					DW12D	<b>26.</b>	-
					DW15D	<b>29.</b>	-

## OPTIONS / ACCESSORIES

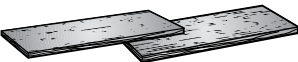

<b>Self Edge Top</b> (Specify 12" or 15")	DW-SET-1	<b>235.</b>	-
<b>Waterfall Edge Top</b> - front only (Specify 12" or 15") or 3mm PVC (Not available on Radius Corner Bookcase)	DW-SET-2	<b>279.</b>	-
<b>Adjustable glides</b>	-		Contact Factory

## WARNING

Note: 72" & 84" high units must be secured to a wall for safety.

**STORAGE**

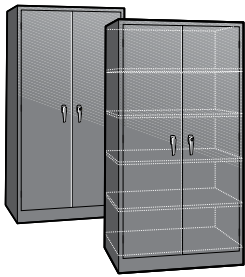

Description	H	W	D	Model	List Price	Wgt.
Storage closet with adjustable shelves. Secure 3 point locking. 4 shelves on 72" H models, 2 shelves on 42" H.	42"	36"	18"	<b>842S</b>	<b>522.</b>	-
	42"	36"	24"	<b>442S</b>	<b>608.</b>	-
	72"	36"	18"	<b>872S</b>	<b>532.</b>	130
	72"	36"	24"	<b>472S</b>	<b>721.</b>	152
	78"	36"	18"	<b>878S</b>	<b>721.</b>	134
	78"	36"	24"	<b>478S</b>	<b>814.</b>	174

**WARDROBE**

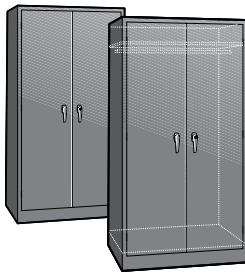

Description	H	W	D	Model	List Price	Wgt.
Wardrobe closet with hat shelf and coat rod. Secure 3 point locking.	72"	36"	18"	<b>872W</b>	<b>517.</b>	102
	72"	36"	24"	<b>472W</b>	<b>699.</b>	127
	78"	36"	18"	<b>878W</b>	<b>699.</b>	116
	78"	36"	24"	<b>478W</b>	<b>795.</b>	141

**COMBINATION**



Description	H	W	D	Model	List Price	Wgt.
Combination closet has 3 adj. shelves on 72" High and 4 adj. shelves on 78" High. All models with hat shelf and coat rod. Secure 3 point locking.	72"	36"	18"	<b>872C</b>	<b>611.</b>	115
	72"	36"	24"	<b>472C</b>	<b>814.</b>	138
	78"	36"	18"	<b>878C</b>	<b>814.</b>	125
	78"	36"	24"	<b>478C</b>	<b>996.</b>	161

**OPTIONS / ACCESSORIES**



Extra Shelf, storage cabinet	H	W	D	Model	List Price	Wgt.
Painted charcoal only	1"	36"	18"	<b>18S</b>	<b>53.</b>	9
	1"	36"	24"	<b>24S</b>	<b>60.</b>	10
Adjustable glides				-	Contact Factory	

**ORDERING INFORMATION**

**Note:** Also available is a 63<sup>3/4</sup>" size that can be used alongside lateral files. It matches the height of a five drawer lateral file.

**Note:** All storage cabinets are "Keyed Alike" - contact factory for "Random Keyed" price.

***Adelphia***  
**STEEL FURNITURE BUILT TO LAST** by DATUM®

**DORMITORY**

## STUDENT DESKS / TABLES

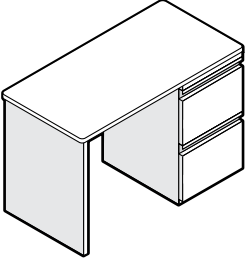
Standard Pulls		Description	W	D	H	Model	List Price	Wgt.
	Student desk with:		42"	24"	29"	<b>D-D42-2</b>	<b>710.</b>	<b>135</b>
	• File/file drawer pedestal		48"	24"	29"	<b>D-D48-2</b>	<b>735.</b>	<b>155</b>

Specify right or left hand pedestal  
See accessory page for related products.

-**"R"** Right hand pedestal (Add suffix "R" to model #)  
-**"L"** Left hand pedestal (Add suffix "L" to model #)

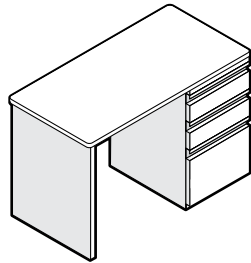

Student desk with:	42"	24"	29"	<b>D-D42-3</b>	<b>750.</b>	<b>135</b>
• Box/box/file drawer pedestal	48"	24"	29"	<b>D-D48-3</b>	<b>775.</b>	<b>155</b>

Specify right or left hand pedestal  
See accessory page for related products.

-**"R"** Right hand pedestal (Add suffix "R" to model #)  
-**"L"** Left hand pedestal (Add suffix "L" to model #)

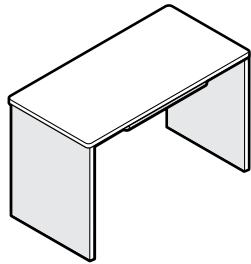

Student table desk with:	42"	24"	29"	<b>D-TD42-1</b>	<b>695.</b>	<b>100</b>
• Two widths available	48"	24"	29"	<b>D-TD48-1</b>	<b>725.</b>	<b>112</b>
• Plastic center drawer						

See accessory page for related products.

-**"R"** Right hand pedestal (Add suffix "R" to model #)  
-**"L"** Left hand pedestal (Add suffix "L" to model #)

## OPTIONS

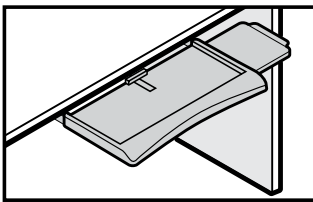

Keyboard tray with retractable platform and mouse pad extension.	21-1/2"	11"	-	<b>D-KB-1</b>	<b>85.</b>	<b>17</b>
--	---------	-----	---	---------------	------------	-----------

## FEATURES

Standard full length recessed pulls.	High side file drawer.
Full height pedestals.	Shipped fully assembled.
3/4 high flush back panel.	Leveling glides.
Heavy duty construction throughout.	Textured paint.
Heavy duty ball bearing suspension on file & box drawers.	Meets or exceeds ANSI/BIFMA X5.5-2008 standards.

## ADDITIONAL OPTIONS

Available upon request - contact factory:  
Special widths, heights and depths available contact factory.

## STUDENT DESKS / TABLES ACCESSORIES

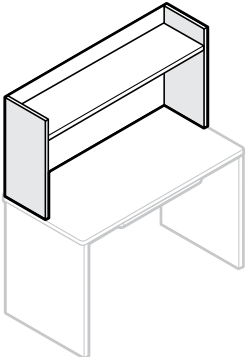
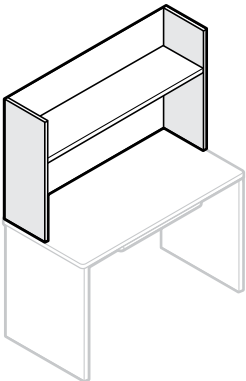
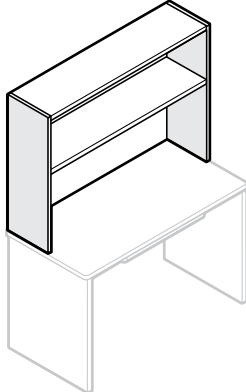
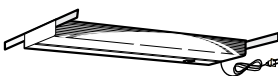
	Description	W	D	H	Model	List Price	Wgt.
	24" high Study Carrel with:	42"	12"	24"	<b>D-DTC-4224</b>	<b>465.</b>	<b>59</b>
	<ul style="list-style-type: none"> <li>• One shelf</li> <li>• Light deflector</li> <li>• Wire access hole, under shelf</li> <li>• 19" clearance under shelf</li> </ul>	48"	12"	24"	<b>D-DTC-4824</b>	<b>480.</b>	<b>70</b>
	30" high Study Carrel with:	42"	12"	30"	<b>D-DTC-4230</b>	<b>490.</b>	<b>62</b>
	<ul style="list-style-type: none"> <li>• One shelf</li> <li>• Two widths available</li> <li>• Light deflector</li> <li>• Wire access hole, under shelf</li> <li>• 19" clearance under shelf</li> </ul>	48"	12"	30"	<b>D-DTC-4830</b>	<b>520.</b>	<b>74</b>
	36" high Study Carrel with:	42"	12"	36"	<b>D-DTC-4236-2</b>	<b>615.</b>	<b>69</b>
	<ul style="list-style-type: none"> <li>• Two shelves</li> <li>• Two widths available</li> <li>• Light deflector</li> <li>• Wire access hole, under shelf</li> <li>• 19" clearance under shelf</li> </ul>	48"	12"	36"	<b>D-DTC-4836-2</b>	<b>635.</b>	<b>80</b>
	Woodgrain laminate light deflector	42"	-	-	<b>LDL</b>	<b>20.</b>	<b>3</b>
	Woodgrain laminate light deflector	48"	-	-	<b>LDL</b>	<b>20.</b>	<b>4</b>
	Woodgrain shelf	1"	12"	36"	<b>WGS-42</b>	<b>160.</b>	<b>12</b>
Woodgrain shelf	1"	12"	48"	<b>WGS-48</b>	<b>185.</b>	<b>15</b>	
	Task Light with:	20"	4"	1"	<b>TL-20</b>	<b>150.</b>	<b>5</b>
	<ul style="list-style-type: none"> <li>• 9 foot cord</li> </ul>						

## FEATURES

- Shipped fully assembled.
- Textured paint.
- Special heights and widths are available, contact factory.
- Meets or exceeds ANSI/BIFMA X5.5-2008 standards.



## CHESTS

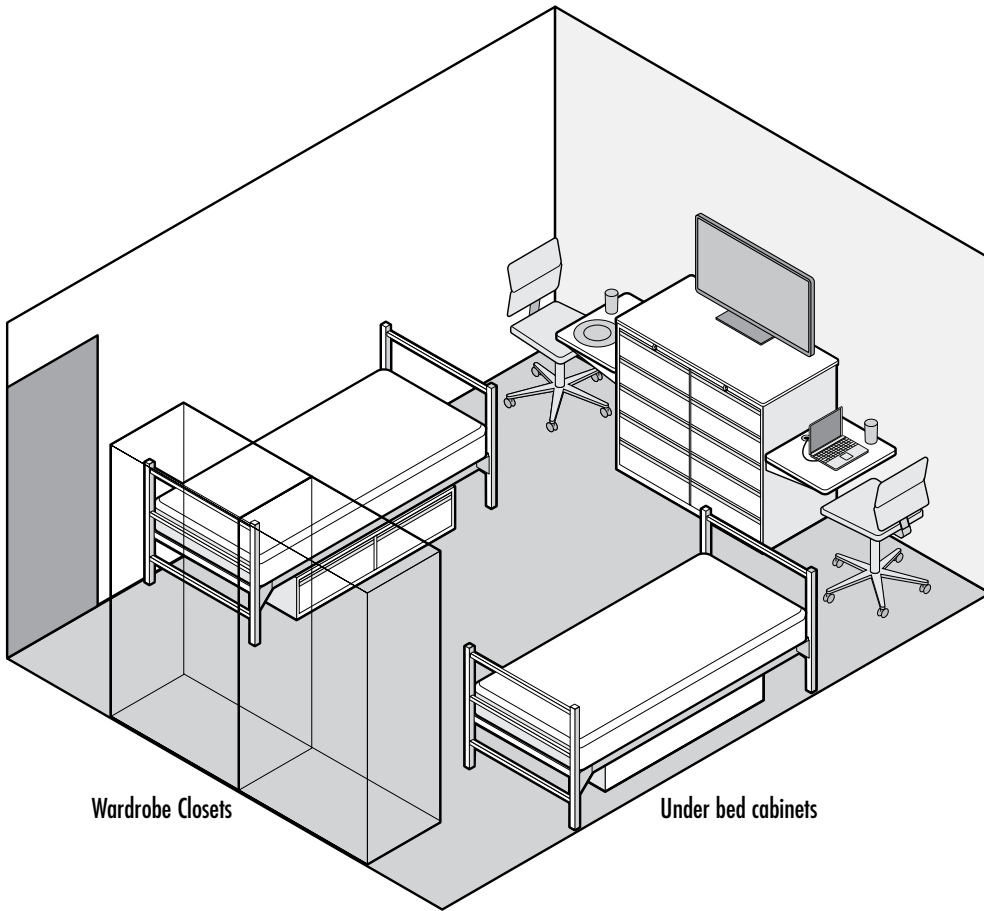

Wardrobe Closets

Under bed cabinets

Drop down work surfaces are reinforced and feature heavy duty low profile support brackets.

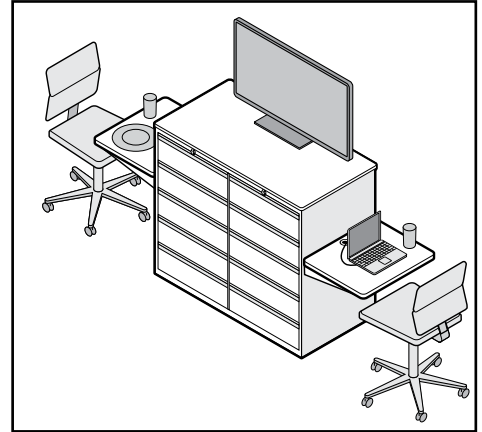

Extra storage is available.

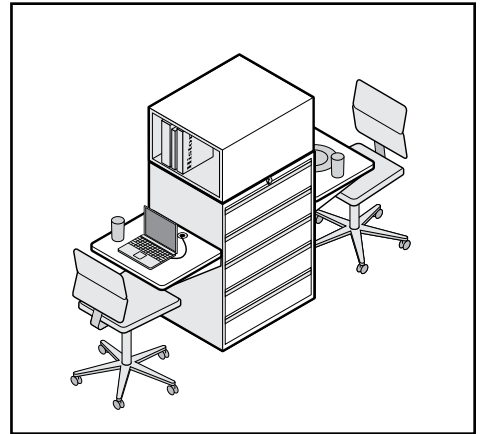

## FEATURES

Full width recessed pulls.

Heavy duty construction throughout.

Heavy duty ball bearing suspension on all drawers.

Laminate top with radius corners.

Lock(s) secure all drawers & accepts a padlock.

Chests are counterbalanced to prevent tipping.

Shipped fully assembled.

Leveling glides.

Textured paint.

Meets or exceeds ANSI/BIFMA X5.5-2008 standards.

## OPTIONS

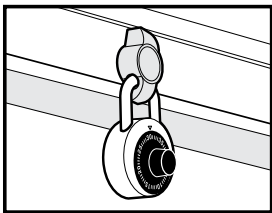

Unique locking mechanism secures all drawers and can be pad locked.

Available upon request - contact factory:

Lockable drawers with padlock hasps for single or multiple drawers.

## CHESTS SINGLE WIDTH

### Standard Pulls

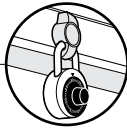
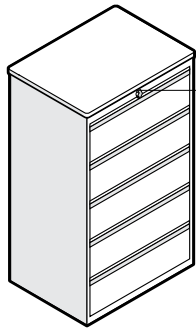

Unique optional locking mechanism

Dwr.#	W	D	H	Model	List Price	Wgt.
2	30"	22-1/2"	22-3/4"	<b>D-2DC</b>	<b>635.</b>	105
3	30"	22-1/2"	31-3/4"	<b>D-3DC</b>	<b>775.</b>	129
4	30"	22-1/2"	40-3/4"	<b>D-4DC</b>	<b>920.</b>	150
5	30"	22-1/2"	49-3/4"	<b>D-5DC</b>	<b>1,055.</b>	175

<b>Lockable dwrs. padlock hasps LO-1</b>	<b>160.</b>	-
--	-------------	---

- Two through five drawer chest, single width
- Counterbalance
- **"NT"** No Top (deduct \$50 list)

## CHESTS DOUBLE WIDTH

### Standard Pulls

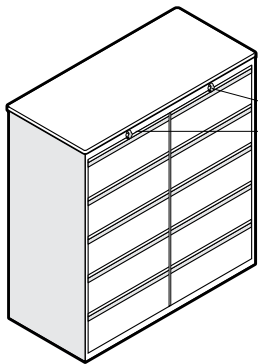

Unique optional locking mechanism

Dwr.#	W	D	H	Model	List Price	Wgt.
6	48"	22-1/2"	31-3/4"	<b>D-6DDC</b>	<b>1,305.</b>	240
8	48"	22-1/2"	40-3/4"	<b>D-8DDC</b>	<b>1,495.</b>	265
10	48"	22-1/2"	49-3/4"	<b>D-10DDC</b>	<b>1,695.</b>	320

<b>Lockable dwrs. padlock hasps LO-2</b>	<b>320.</b>	-
--	-------------	---

- Six, eight and ten drawer chest
- Three, four, and five high, side by side
- Counterbalance
- **"NT"** No Top (deduct \$60 list)

## DROP DOWN WORK SURFACE FOR CHESTS

Top #	W	D	H	Model	List Price	Wgt.
1 Top	22"	18"	3/4"	<b>D-D2418</b>	<b>370.</b>	-

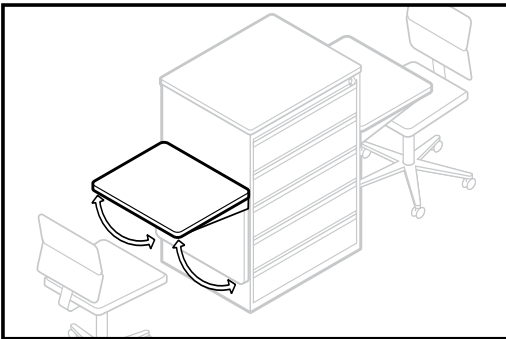

- One 18" deep work surface that can be dropped down for additional space when needed
- Can be used with single (5 dwr.) or double (10 dwr.) chests
- Cabinet reinforced to accept work surface

## DOUBLE SIDED BOOK CASE FOR CHESTS

Shelf #	W	D	H	Model	List Price	Wgt.
1 shelf	30"	22-1/2"	14"	<b>D-BB14</b>	<b>315.</b>	-

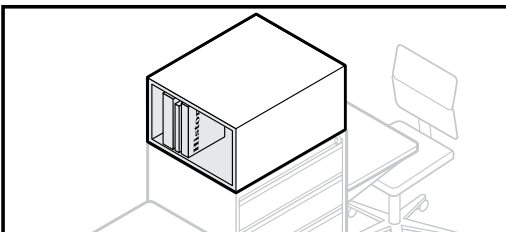

- Double sided bookcase with center wall and two (2) adjustable dividers
- Includes stacking clips

### OPTIONS

Available upon request - contact factory:

Available without laminate tops

## CHESTS SINGLE WIDTH

Laminate Accents On Pulls	Dwr.#	W	D	H	Model	List Price	Wgt.
	2	30"	22-1/2"	22-3/4"	<b>D-2DC-LA</b>	<b>665.</b>	-
	3	30"	22-1/2"	31-3/4"	<b>D-3DC-LA</b>	<b>815.</b>	-
	4	30"	22-1/2"	40-3/4"	<b>D-4DC-LA</b>	<b>970.</b>	-
	5	30"	22-1/2"	49-3/4"	<b>D-5DC-LA</b>	<b>1,125.</b>	-
<b>Lockable dwrs. padlock hasps LO-1</b>						<b>160.</b>	-

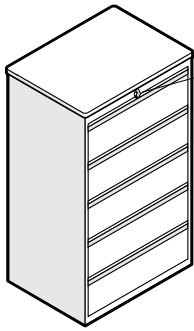

Optional Lock

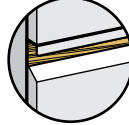

Laminate Accent

- Two through five drawer chest, single width
- Counterbalance
- "NT" No Top (deduct \$50 list)

## CHESTS DOUBLE WIDTH

Laminate Accents On Pulls	Dwr.#	W	D	H	Model	List Price	Wgt.
	6	48"	22-1/2"	31-3/4"	<b>D-6DDC-LA</b>	<b>1,385.</b>	-
	8	48"	22-1/2"	40-3/4"	<b>D-8DDC-LA</b>	<b>1,600.</b>	-
	10	48"	22-1/2"	49-3/4"	<b>D-10DDC-LA</b>	<b>1,830.</b>	-
<b>Lockable dwrs. padlock hasps LO-2</b>						<b>315.</b>	-

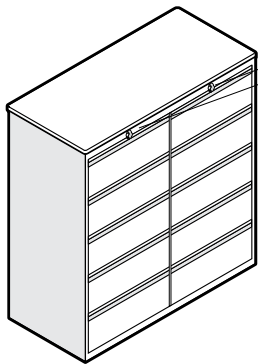

Optional Lock

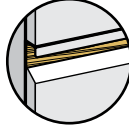

Laminate Accent

- Six, eight and ten drawer chest
- Three, four, and five high, side by side
- Counterbalance
- "NT" No Top (deduct \$60 list)

## DROP DOWN WORK SURFACE FOR CHESTS

Top #	W	D	H	Model	List Price	Wgt.
1 Top	22"	18"	3/4"	<b>D-D2418</b>	<b>370.</b>	-

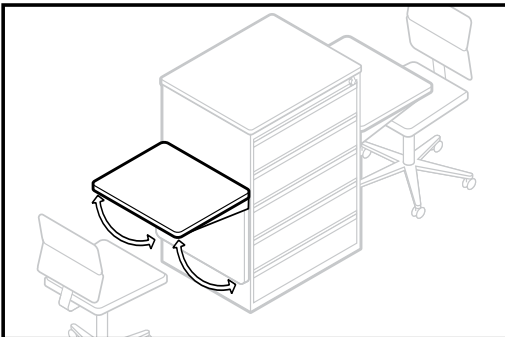

- One 18" deep work surface that can be dropped down for additional space when needed
- Can be used with single (5 dwr.) or double (10 dwr.) chests
- Cabinet reinforced to accept work surface

## DOUBLE SIDED BOOK CASE FOR CHESTS

Shelf #	W	D	H	Model	List Price	Wgt.
1 shelf	30"	22-1/2"	14"	<b>D-BB14</b>	<b>315.</b>	-

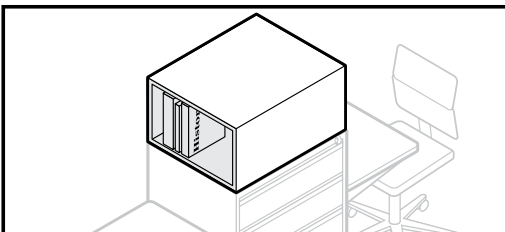

- Double sided bookcase with center wall and two (2) adjustable dividers
- Includes stacking clips

## OPTIONS

Available upon request - contact factory:

Available without laminate tops

## WALL UNIT - WARDROBE / CHEST COMBO

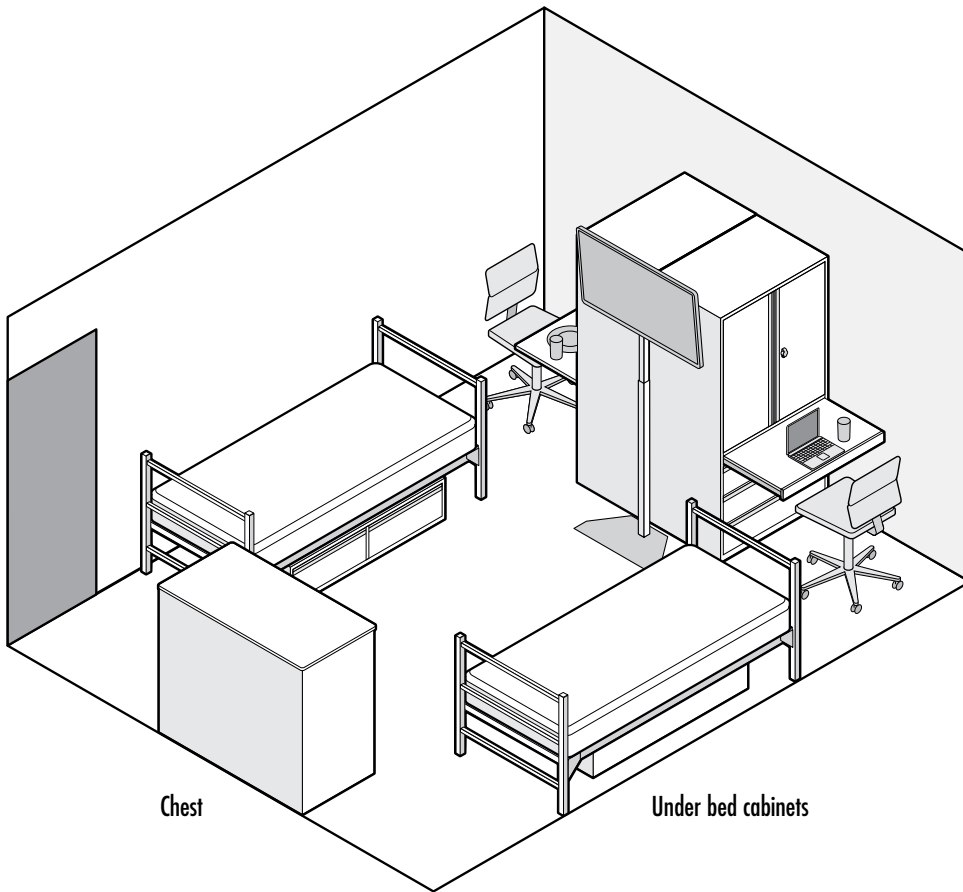

Chest

Under bed cabinets

Versatile furniture is important when space is limited.

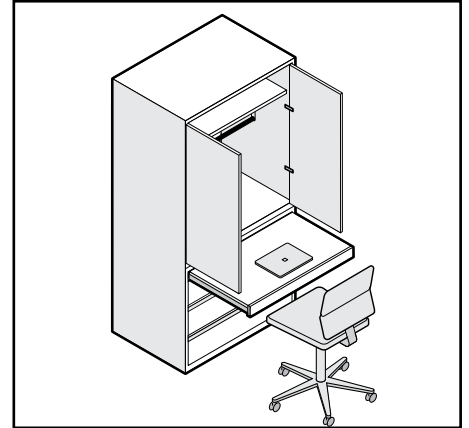

Large work surface is easily retractable. Rides on full suspension.

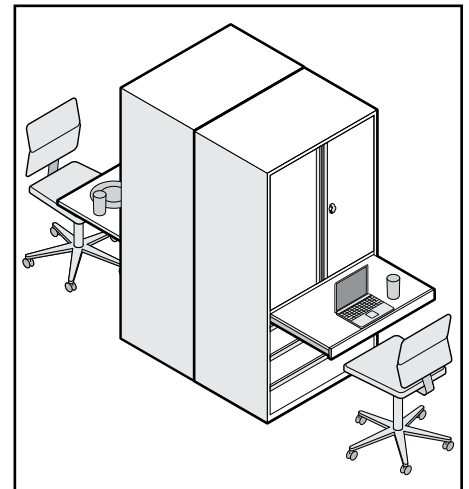

## FEATURES

Durable double wall construction.

All locks can be padlocked.

Heavy duty ball bearing suspension on all drawers.

Shipped fully assembled.

Leveling glides.

Textured paint.

Meets or exceeds ANSI/BIFMA X5.5-2008 standards.

## WARDROBE DOUBLE DOOR W/TWO DRAWERS

### Standard Pulls

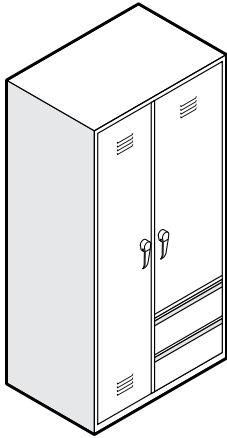

W	D	H	Model	List Price	Wgt.
36"	24"	72"	<b>D-WS-2D72</b>	<b>\$ 1,340.</b>	-
36"	24"	78"	<b>D-WS-2D78</b>	<b>1,565.</b>	-

Double door wardrobe with:

- Two drawers
- Vertical divider
- Handle has three (3) point locking system & will accept padlock
- Fixed shelf on left w/hanger bar
- Three adjustable shelves on right

Note: Fixed shelf with hanger bar can be substituted for shelves

## WALL UNIT - WARDROBE / CHEST COMBO

### Standard Pulls

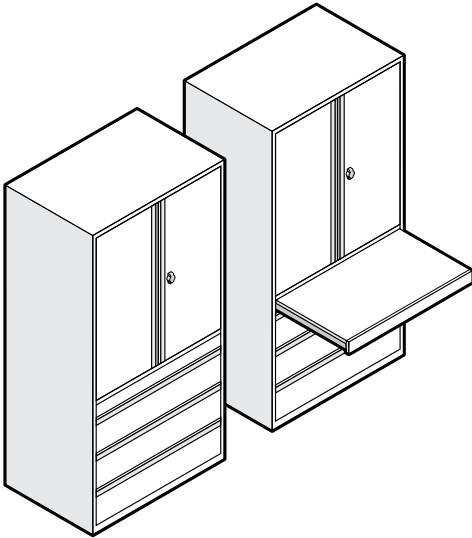

W	D	H	Model	List Price	Wgt.
36"	24"	72"	<b>D-WUWS-72</b>	<b>\$ 1,980.</b>	-
36"	24"	78"	<b>D-WUWS-78</b>	<b>1,990.</b>	-

Wardrobe/Chest with:

- One hanger bar behind two upper doors
- Three lower drawers
- Recessed pulls
- Wardrobe locks can be padlocked
- Retractable work surface on full suspension
- Other sizes available, contact factory

### FEATURES - ALL WARDROBES

Durable double wall construction.

All locks can be padlocked.

Heavy duty ball bearing suspension on all drawers.

Shipped fully assembled.

Leveling glides.

Textured paint.

Meets or exceeds ANSI/BIFMA X5.5-2008 standards.

## WARDROBE DOUBLE DOOR W/TWO DRAWERS

Laminate Accents On Pulls

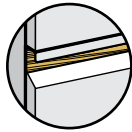
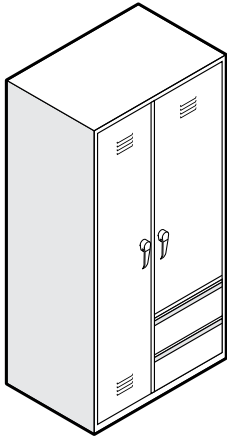

Laminate Accent

W	D	H	Model	List Price	Wgt.
36"	24"	72"	<b>D-WS-2D72-LA</b>	<b>1,355.</b>	-
36"	24"	78"	<b>D-WS-2D78-LA</b>	<b>1,580.</b>	-

Double door wardrobe with:

- Two drawers
  - Vertical divider
  - Handle has three (3) point locking system & will accept padlock
  - Fixed shelf on left w/hanger bar
  - Three adjustable shelves on right
- Note: Fixed shelf with hanger bar can be substituted for shelves

## WALL UNIT - WARDROBE / CHEST COMBO

Laminate Accents On Pulls

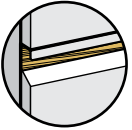
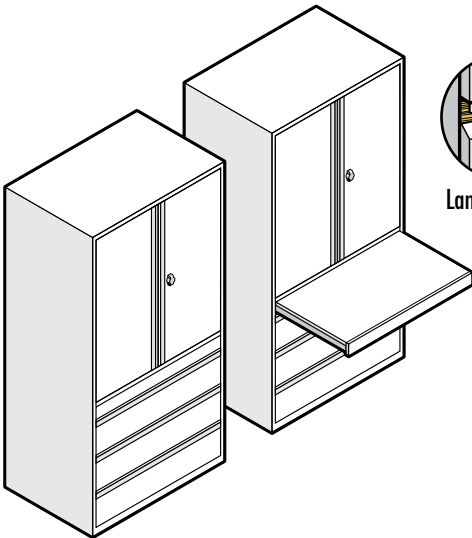

Laminate Accent

W	D	H	Model	List Price	Wgt.
36"	24"	72"	<b>D-WUWS-72-LA</b>	<b>2,035.</b>	-
36"	24"	78"	<b>D-WUWS-78-LA</b>	<b>2,050.</b>	-

Wardrobe/Chest with:

- One hanger bar behind two upper doors
- Three lower drawers
- Recessed pulls
- Wardrobe locks can be padlocked
- Retractable work surface on full suspension
- Other sizes available, contact factory

### FEATURES - ALL WARDROBES

Durable double wall construction.

All locks can be padlocked.

Heavy duty ball bearing suspension on all drawers.

Shipped fully assembled.

Leveling glides.

Textured paint.

Meets or exceeds ANSI/BIFMA X5.5-2008 standards.

## WARDROBE SINGLE DOOR

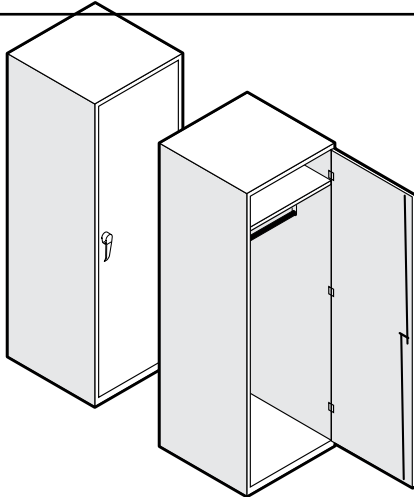

W	D	H	Model	List Price	Wgt.
24"	24"	72"	<b>D-47224W</b>	<b>\$735.</b>	87
24"	24"	78"	<b>D-47824W</b>	<b>840.</b>	99
24"	24"	78"	<b>D-2424S</b> Extra shelf	<b>50.</b>	5

Single door wardrobe with:

- One shelf
- Hanger bar

## WARDROBE DOUBLE DOOR

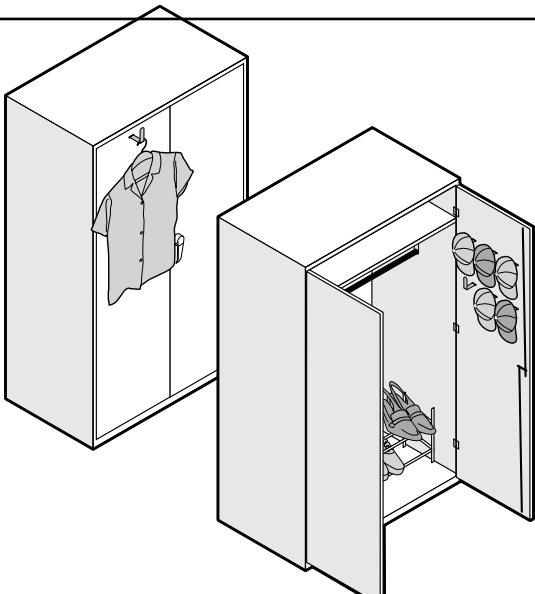

W	D	H	Model	List Price	Wgt.
36"	24"	72"	<b>D-47236W</b>	<b>\$1,045.</b>	145
36"	24"	78"	<b>D-47836W</b>	<b>1,180.</b>	159
42"	24"	72"	<b>D-47242W</b>	<b>1,220.</b>	175
42"	24"	78"	<b>D-47842W</b>	<b>1,360.</b>	189
36"	24"		<b>D-3624S</b> Extra shelf	<b>60.</b>	6
42"	24"		<b>D-4224S</b> Extra shelf	<b>70.</b>	7

Double door wardrobe with:

- One shelf
- Hanger bar
- Shown with options

## WARDROBE / STORAGE COMBO

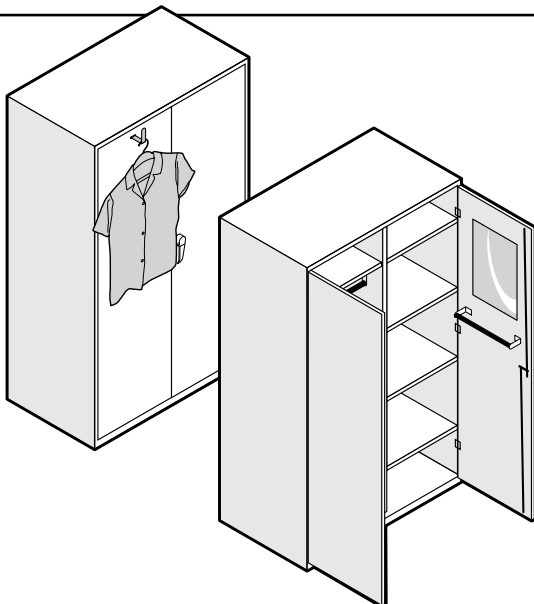

W	D	H	Model	List Price	Wgt.
36"	24"	78"	<b>D-47836C</b>	<b>\$1,150.</b>	-
42"	24"	78"	<b>D-47842C</b>	<b>1,345.</b>	-

Combo wardrobe/storage with:

- One fixed shelf and hanger bar, left side
- Four adjustable shelves, right side
- Handle has three (3) point locking system & will accept padlock
- Shown with options

### OPTIONS

Coat hook	<b>D-CH</b>	<b>30.</b>	-
Mirror	<b>D-MR</b>	<b>120.</b>	-
Towel Bar	<b>D-TB</b>	<b>50.</b>	-
Shoe Rack	<b>D-SR</b>	<b>45.</b>	-

## BEDSIDE CABINETS/NIGHTSTANDS

### Standard Pulls

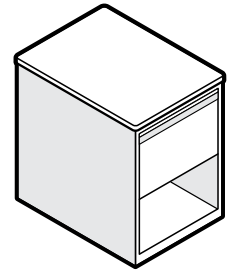

- One 7-1/2" drawer with open storage shelf below
- Laminate top with radius corners
- Counterbalance
- "NT" No Top (deduct \$40 list)

W D H Model List Price Wgt.

20" 20" 25" **D-NS1D** **475.** -

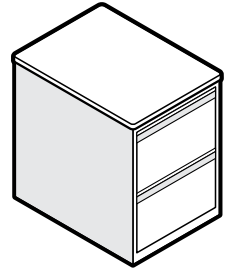

- Two 11" drawers
- Laminate top with radius corners
- Counterbalance
- "NT" No Top (deduct \$40 list)

20" 20" 25" **D-NS2D** **540.** -

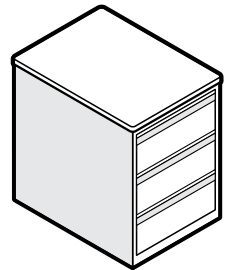

- Three 7-1/2" drawers
- Laminate top with radius corners
- Counterbalance
- "NT" No Top (deduct \$40 list)

20" 20" 25" **D-NS3D** **580.** -

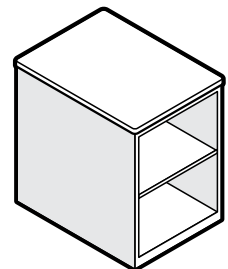

- Open storage with one (1) adjustable shelf
- Laminate top with radius corners
- Counterbalance not required
- "NT" No Top (deduct \$40 list)

20" 20" 25" **D-NSOS** **450.** -

### FEATURES

Heavy duty construction throughout.

Heavy duty ball bearing suspension on all drawers.

Cabinets with drawers are counterbalanced to prevent tipping.

Shipped fully assembled.

Leveling glides.

Textured paint.



## BEDSIDE CABINETS/NIGHTSTANDS

### Laminate Accents On Pulls

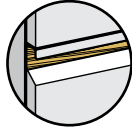
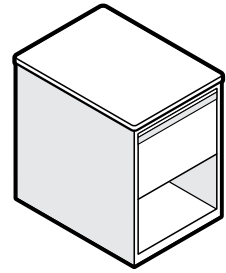

Laminate Accent

W	D	H	Model	List Price	Wgt.
20"	20"	25"	<b>D-NS1D-LA</b>	<b>505.</b>	-

- One 7-1/2" drawer with open storage shelf below
- Laminate top with radius corners
- Counterbalance
- "NT" No Top (deduct \$40 list)

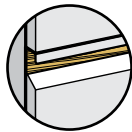
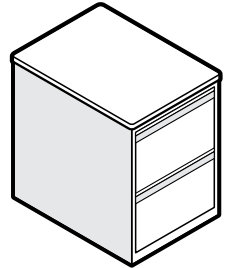

Laminate Accent

20"	20"	25"	<b>D-NS2D-LA</b>	<b>580.</b>	-
-----	-----	-----	------------------	-------------	---

- Two 11" drawers
- Laminate top with radius corners
- Counterbalance
- "NT" No Top (deduct \$40 list)

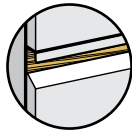
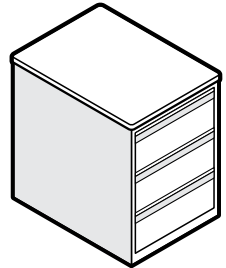

Laminate Accent

20"	20"	25"	<b>D-NS3D-LA</b>	<b>630.</b>	-
-----	-----	-----	------------------	-------------	---

- Three 7-1/2" drawers
- Laminate top with radius corners
- Counterbalance
- "NT" No Top (deduct \$40 list)

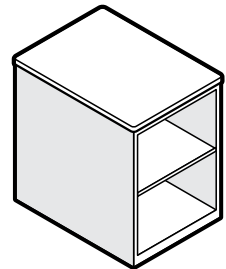

20"	20"	25"	<b>D-NSOS-LA</b>	<b>450.</b>	-
-----	-----	-----	------------------	-------------	---

- Open storage with one (1) adjustable shelf
- Laminate top with radius corners
- Counterbalance not required
- "NT" No Top (deduct \$40 list)

### FEATURES

Heavy duty construction throughout.

Heavy duty ball bearing suspension on all drawers.

Cabinets with drawers are counterbalanced to prevent tipping.

Shipped fully assembled.

Leveling glides.

Textured paint.

Meets or exceeds ANSI/BIFMA X5.5-2008 standards.

## WARDROBE CHEST INSERTS

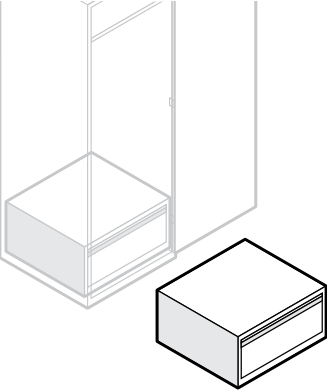
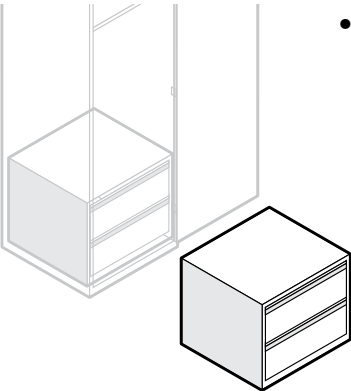
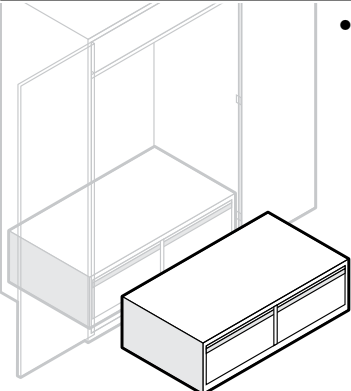
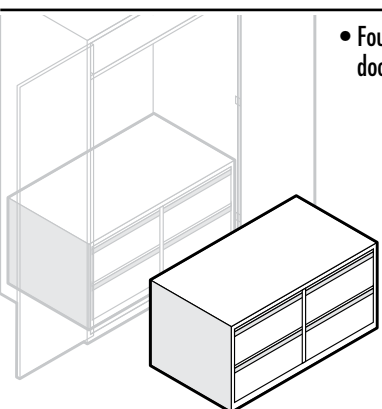
Description	W	D	H	Model	List Price	Wgt.
 <ul style="list-style-type: none"> <li>• One drawer unit for single door wardrobe.</li> </ul>	20"	20"	12"	<b>D-1D-22</b>	<b>\$305.</b>	-
 <ul style="list-style-type: none"> <li>• Two drawer unit for single door wardrobe.</li> </ul>	20"	20"	22"	<b>D-2D-22</b>	<b>\$435.</b>	-
 <ul style="list-style-type: none"> <li>• Two drawer unit for double door wardrobe.</li> </ul>	31"	20"	12"	<b>D-2D-34</b>	<b>\$595.</b>	-
	37"	20"	12"	<b>D-2D-40</b>	<b>640.</b>	-
 <ul style="list-style-type: none"> <li>• Four drawer unit for double door wardrobe.</li> </ul>	31"	20"	22"	<b>D-40-34</b>	<b>\$785.</b>	-
	37"	20"	22"	<b>D-48-40</b>	<b>820.</b>	-

### FEATURES

Full width recessed drawer pulls.

Heavy duty ball bearing suspension on all drawers.

Shipped fully assembled.

Textured paint.

Meets or exceeds ANSI/BIFMA X5.5-2008 standards.

## 12 INCH DEEP BOOKCASES

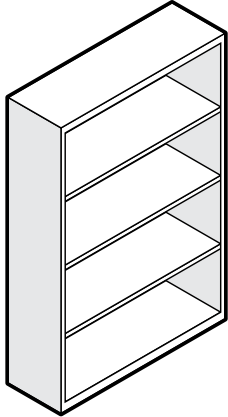

**Description**

Bookcase with:

- 12" Deep shelves
- 3 heights available
- Adjustable shelves
- Double wall sides

Options:

- Extra shelves with clips
- Divider for shelf
- Other sizes available

Shelf#	W	D	H	Model	List Price	Wgt.
1	36"	12"	29"	<b>D-B29</b>	<b>310.</b>	-
2	36"	12"	42"	<b>D-B42</b>	<b>345.</b>	-
3	36"	12"	54"	<b>D-B54</b>	<b>605.</b>	-
<b>Extra shelf with clips</b>				<b>DW12S</b>	<b>50.</b>	-
<b>Divider for shelf</b>				<b>DW12D</b>	<b>35.</b>	-

## FEATURES

Durable double wall construction.

Adjustable shelves with clips.

Extra shelves available.

Special heights available.

Dividers available.

Shipped fully assembled.

Leveling glides.

Textured paint.

Meets or exceeds ANSI/BIFMA X5.5-2008 standards.

## SINGLE BED SQUARE TUBE

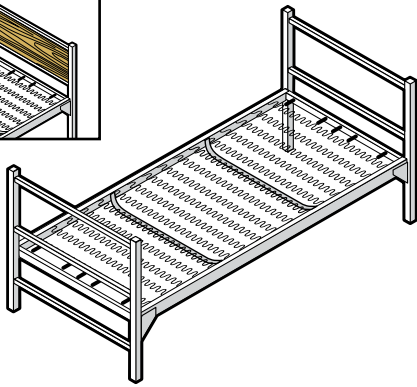
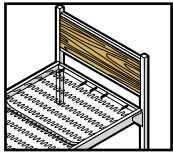

Description	W	D	H	Model	List Price	Wgt.
<ul style="list-style-type: none"> <li>Sleeping surface is heavy gauge "no sag" w/ high carbon wire links and 2 sets of helicals</li> <li>Heavy gauge reinforced frame</li> <li>Meets or exceeds ANSI/BIFMA X5.5-2008 standards</li> </ul>	80"	39"	38"	<b>MIL125SQ3980GSA-S</b>	<b>582.</b>	-
	80"	36"	38"	<b>MIL125SQ3680GSA-S</b>	<b>523.</b>	-
	75"	39"	38"	<b>MIL125SQ3975GSA-S</b>	<b>561.</b>	-
	75"	36"	38"	<b>MIL125SQ3675GSA-S</b>	<b>523.</b>	-
<b>Laminated Head Board</b>	-	-	-	<b>HBL</b>	<b>60.</b>	
<b>Laminated Foot Board</b>	-	-	-	<b>FBL</b>	<b>60.</b>	
<b>Facia Rail</b>	-	-	-	<b>FR</b>	<b>25.</b>	
<b>Adapters (set of 4) single beds to bunk beds</b>				<b>D-ADA-S</b>	<b>79.</b>	

## BUNK BED SQUARE TUBE

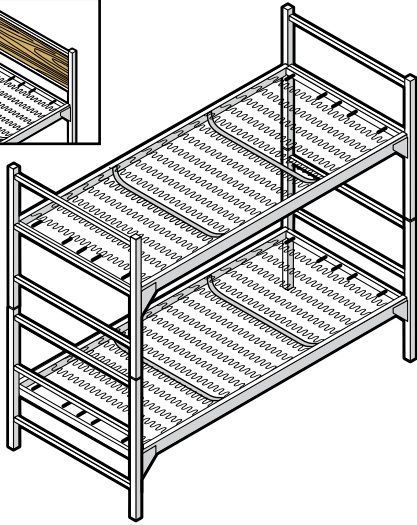
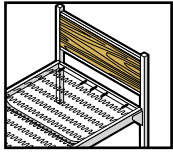

Bunk bed with: <ul style="list-style-type: none"> <li>Sleeping surface is heavy gauge "no sag" with high carbon wire links and two sets of helicals</li> <li>Heavy gauge reinforced frames</li> <li>Meets or exceeds ANSI/BIFMA X5.5-2008 standards</li> </ul>	80"	39"	63"	<b>MIL125SQ3980GSA</b>	<b>1,215.</b>	-
	80"	36"	63"	<b>MIL125SQ3680GSA</b>	<b>1,046.</b>	-
	75"	39"	63"	<b>MIL125SQ3975GSA</b>	<b>1,121.</b>	-
	75"	36"	63"	<b>MIL125SQ3675GSA</b>	<b>1,046.</b>	-
<b>Guardrail</b>	51"	-	-	<b>50-GR51</b>	<b>99.</b>	-
<b>Ladder</b>	-	-	-	<b>4-LAD</b>	<b>99.</b>	-

## MATTRESS

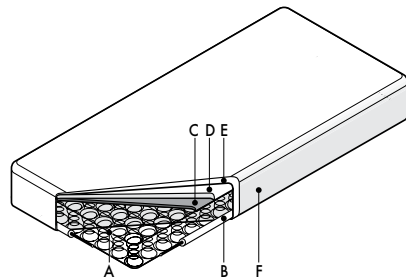

Innerspring Mattress with: <ul style="list-style-type: none"> <li>A. Spring unit is a 312 Bonnell Coil in 13 gauge with 6 gauge border. Tempered wire used in construction.</li> <li>B. Upholstery layers overlap boarder rod for added protection and comfort.</li> <li>C. Heavy, durable fiber padding evenly supports mattress.</li> </ul>	80"	39"	7"*	<b>D-3980-M</b>	<b>419.</b>	-
<ul style="list-style-type: none"> <li>D. Fire retardant foam topper, meets Cal TB #117.</li> <li>E. Fire barrier.</li> <li>F. SOFlux OX™ nylon cover</li> </ul>						
* Contact factory for additional sizes.						

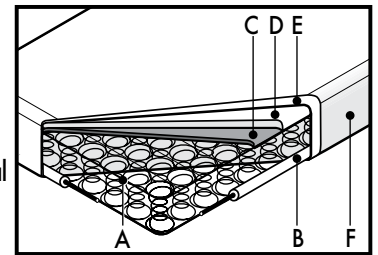

## OPTIONS UNDER BED CABINET

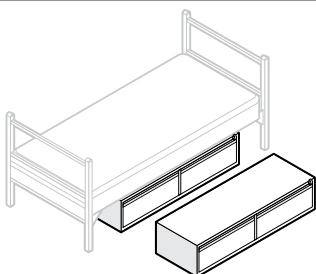

Chest with: <ul style="list-style-type: none"> <li>Full width recessed pulls</li> <li>Heavy duty ball bearing suspension on drawers</li> <li>Shipped fully assembled</li> <li>Textured paint</li> <li>Meets or exceeds ANSI/BIFMA X5.5-2008 standards</li> </ul>	52"	18"	12"	<b>D-UB2B</b>	<b>660.</b>	-
	64"	22 <sup>1</sup> / <sub>2</sub> "	9 <sup>3</sup> / <sub>4</sub> "	<b>D-UB2B-MS</b>	<b>800.</b>	-

## SINGLE BED ROUND TUBE

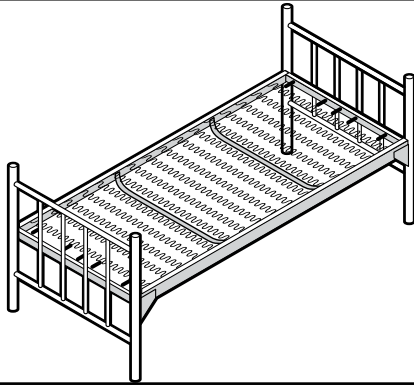

Description	W	D	H	Model	List Price
Single bed with:	80"	39"	29"	<b>MIL150RD3980GSA-S</b>	<b>595.</b>
• Sleeping surface is heavy gauge "no sag" with high carbon wire links and two sets of helicals	80"	36"	29"	<b>MIL150RD3680GSA-S</b>	<b>523.</b>
• Heavy gauge 1-1/2" round tube	75"	39"	29"	<b>MIL150RD3975GSA-S</b>	<b>561.</b>
• Meets or exceeds ANSI/BIFMA X5.5-2008 standards	75"	36"	29"	<b>MIL150RD3675GSA-S</b>	<b>523.</b>
<b>Adapters (set of 4)</b>	-	-	-	<b>D-ADA-R</b>	<b>79.</b>
Make single beds into bunk beds (set of 4)					

## BUNK BED ROUND TUBE

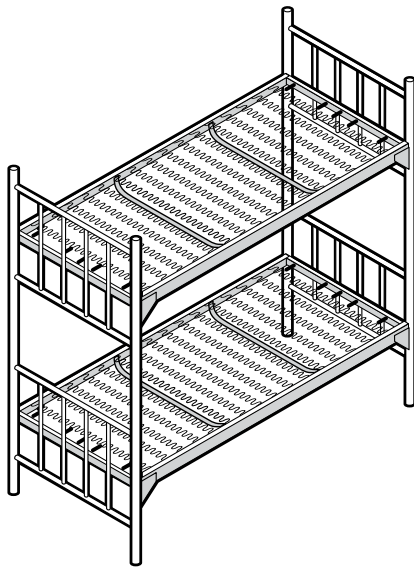

Bunk bed with:	80"	39"	68-1/2"	<b>MIL150RD3980GSA</b>	<b>1,250.</b>
• Sleeping surface is heavy gauge "no sag" with high carbon wire links and two sets of helicals	80"	36"	68-1/2"	<b>MIL150RD3680GSA</b>	<b>1,046.</b>
• Heavy gauge 1-1/2" round tube	75"	39"	68-1/2"	<b>MIL150RD3975GSA</b>	<b>1,121.</b>
• Meets or exceeds ANSI/BIFMA X5.5-2008 standards	75"	36"	68-1/2"	<b>MIL150RD3675GSA</b>	<b>1,046.</b>
<b>Guardrail</b>	51"	-	-	<b>50-GR51</b>	<b>99.</b>
<b>Ladder</b>	-	-	-	<b>4-LAD</b>	<b>99.</b>

## MATTRESS

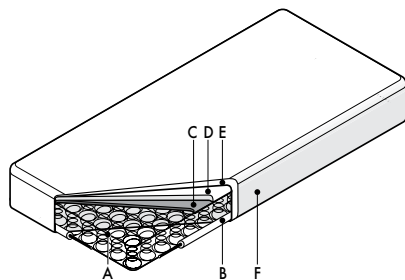

Innerspring Mattress with:

- A. Spring unit is a 312 Bonnell Coil in 13 gauge with 6 gauge border. Tempered wire used in construction.
- B. Upholstery layers overlap boarder rod for added protection and comfort.
- C. Heavy, durable fiber padding evenly supports mattress.

80" 39" 7"\* **D-3980-M** **419.**

- D. Fire retardant foam topper, meets Cal TB #117.
- E. Fire barrier.
- F. SOFlux OX™ nylon cover

\* Contact factory for additional sizes.

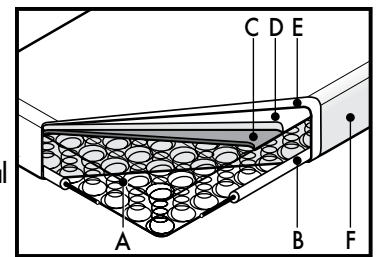

## OPTIONS UNDER BED CABINET

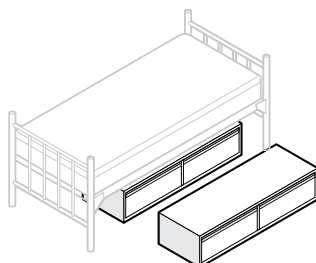

Chest with:

- Full width recessed pulls
- Heavy duty ball bearing suspension on drawers
- Shipped fully assembled
- Textured paint
- Meets or exceeds ANSI/BIFMA X5.5-2008 standards

52" 18" 12"	<b>D-UB2B</b>	<b>660.</b>	-
64" 22-1/2" 9-3/4"	<b>D-UB2B-MS</b>	<b>800.</b>	-

## SINGLE BED ADJUSTABLE HEIGHT

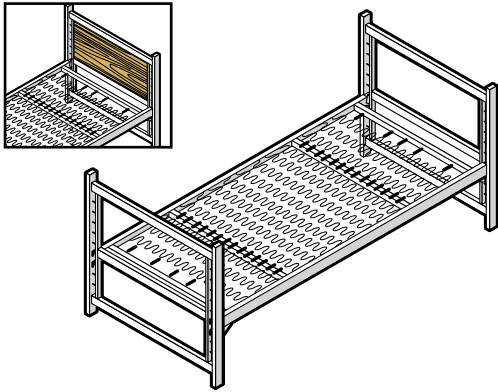

Description	W	D	H	Model	List Price	Wgt.
• Sinuous wire deck	83-3/4"	41"	35"	<b>MIL150AH3980GSA-S</b>	<b>655.</b>	-
• Heavy gauge 1-3/4" x 3/4" tubing, 16 gauge. Plastic caps.	83-3/4"	38"	35"	<b>MIL150AH3680GSA-S</b>	<b>617.</b>	-
• 7 positions on 3" increments	78-3/4"	41"	35"	<b>MIL150AH3975GSA-S</b>	<b>655.</b>	-
• Meets or exceeds ANSI/BIFMA X5.5-2008 standards	78-3/4"	38"	35"	<b>MIL150AH3675GSA-S</b>	<b>617.</b>	-
<b>Laminated Head Board</b>	-	-	-	<b>HBL</b>	<b>60.</b>	-
<b>Laminated Foot Board</b>	-	-	-	<b>FBL</b>	<b>60.</b>	-
<b>Facia Rail</b>	-	-	-	<b>FR</b>	<b>25.</b>	-
<b>Adapters (set of 4) single beds to bunk beds</b>	-	-	-	<b>D-150-AH</b>	<b>87.</b>	-

## BUNK BED ADJUSTABLE HEIGHT

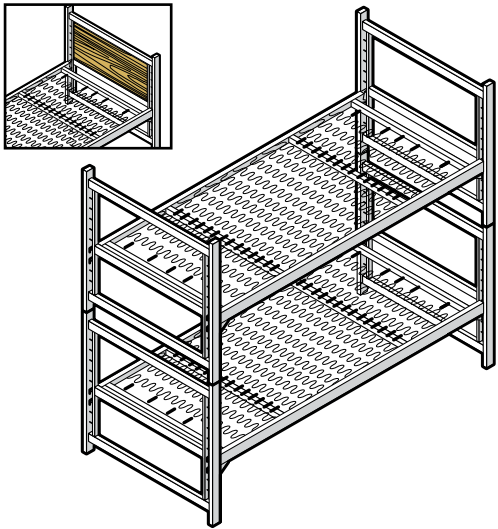

• Sinuous wire deck	83-3/4"	41"	71"	<b>MIL150AH3980GSA-B</b>	<b>1,375.</b>	-
• Heavy gauge 1-3/4" x 3/4" tubing, 16 gauge. Plastic caps.	83-3/4"	38"	71"	<b>MIL150AH3680GSA-B</b>	<b>1,151.</b>	-
• 7 positions on 3" increments	78-3/4"	41"	71"	<b>MIL150AH3975GSA-B</b>	<b>1,375.</b>	-
• Meets or exceeds ANSI/BIFMA X5.5-2008 standards	78-3/4"	38"	71"	<b>MIL150AH3675GSA-B</b>	<b>1,151.</b>	-
<b>53" Guardrail</b>	-	-	-	<b>GR-53</b>	<b>50.</b>	-
<b>Full Length Guardrail</b>	-	-	-	<b>GR-F</b>	<b>57.</b>	-
<b>Bunk Bed Ladder</b>	-	-	-	<b>LAD</b>	<b>60.</b>	-

## MATTRESS

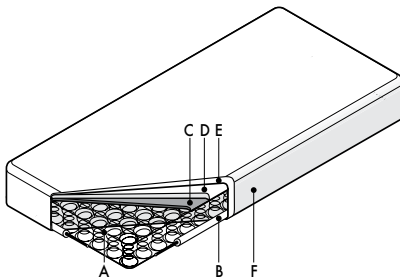

Innerspring Mattress with:	80"	39"	7"*	<b>D-3980-M</b>	<b>419.</b>	65
A. Spring unit is a 312 Bonnell Coil in 13 gauge with 6 gauge border. Tempered wire used in construction.	D. Fire retardant foam topper, meets Cal TB #117.					
B. Upholstery layers overlap boarder rod for added protection and comfort.	E. Fire barrier.					
C. Heavy, durable fiber padding evenly supports mattress.	F. SOFlux OX™ nylon cover					
* Contact factory for additional sizes.						

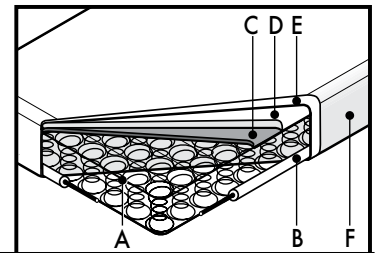

## OPTIONS UNDER BED CHEST

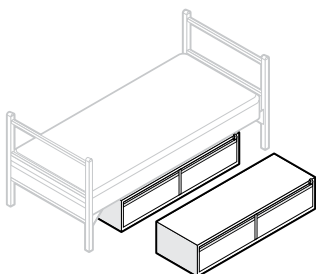

Chest with:	52"	18"	12"	<b>D-UB2B</b>	<b>660.</b>	-
• Full width recessed pulls	64"	22-1/2"	9-3/4"	<b>D-UB2B-MS</b>	<b>800.</b>	-
• Heavy duty ball bearing suspension on drawers						
• Shipped fully assembled						
• Textured paint						
• Meets or exceeds ANSI/BIFMA X5.5-2008 standards						

## SINGLE BED BOLT ON ADJUSTABLE HEIGHT

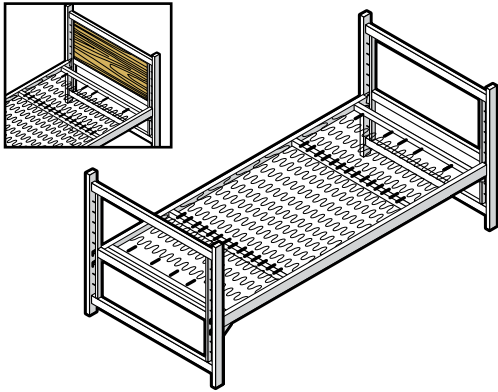

Description	W	D	H	Model	List Price	Wgt.
	83-3/4"	41"	35"	<b>MIL150AHB3980GSA-S</b>	<b>605.</b>	-
	83-3/4"	38"	35"	<b>MIL150AHB3680GSA-S</b>	<b>590.</b>	-
	78-3/4"	41"	35"	<b>MIL150AHB3975GSA-S</b>	<b>605.</b>	-
	78-3/4"	38"	35"	<b>MIL150AHB3675GSA-S</b>	<b>590.</b>	-
<b>Laminated Head Board</b>	-	-	-	<b>HBL</b>	<b>60.</b>	-
<b>Laminated Foot Board</b>	-	-	-	<b>FBL</b>	<b>60.</b>	-
<b>Facia Rail</b>	-	-	-	<b>FR</b>	<b>25.</b>	-
<b>Adapters (set of 4) single beds to bunk beds</b>	-	-	-	<b>D-150-AHB</b>	<b>87.</b>	-

## BUNK BED BOLT ON ADJUSTABLE HEIGHT

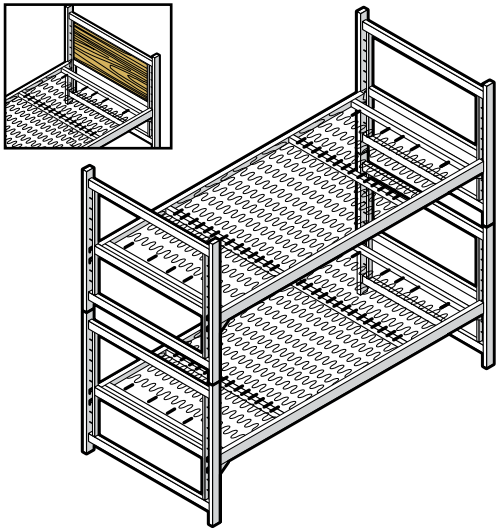

• Sinuous wire deck	83-3/4"	41"	71"	<b>MIL150AHB3980GSA-BU</b>	<b>1,225.</b>	-
• Heavy gauge 1-3/4" x 3/4" tubing, 16 gauge.	83-3/4"	38"	71"	<b>MIL150AHB3680GSA-BU</b>	<b>1,051.</b>	-
• Meets or exceeds ANSI/BIFMA X5.5-2008 standards	78-3/4"	41"	71"	<b>MIL150AHB3975GSA-BU</b>	<b>1,275.</b>	-
	78-3/4"	38"	71"	<b>MIL150AHB3675GSA-BU</b>	<b>1,051.</b>	-

<b>53" Guardrail</b>	-	-	-	<b>GR-53</b>	<b>50.</b>	-
<b>Full Length Guardrail</b>	-	-	-	<b>GR-F</b>	<b>57.</b>	-
<b>Bunk Bed Ladder</b>	-	-	-	<b>LAD</b>	<b>60.</b>	-

## MATTRESS

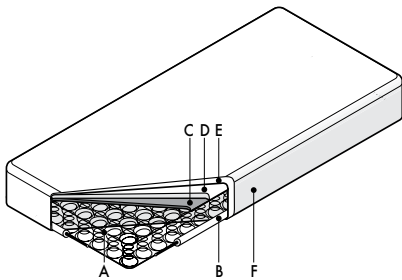

Innerspring Mattress with: A. Spring unit is a 312 Bonnell Coil in 13 gauge with 6 gauge border. Tempered wire used in construction. B. Upholstery layers overlap boarder rod for added protection and comfort. C. Heavy, durable fiber padding evenly supports mattress.	80"	39"	7"*	<b>D-3980-M</b>	<b>419.</b>	65
				D. Fire retardant foam topper, meets Cal TB #117. E. Fire barrier. F. SOFlux OX™ nylon cover		
				* Contact factory for additional sizes.		

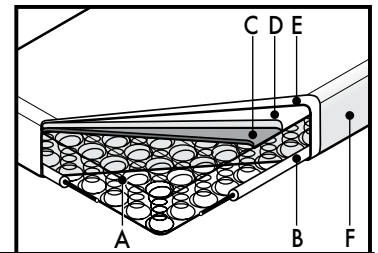

## OPTIONS UNDER BED CHEST

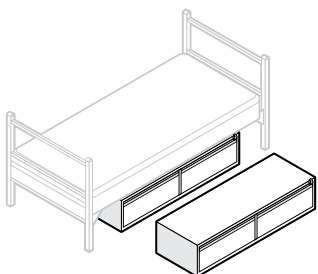

Chest with: • Full width recessed pulls • Heavy duty ball bearing suspension on drawers • Shipped fully assembled • Textured paint • Meets or exceeds ANSI/BIFMA X5.5-2008 standards	52"	18"	12"	<b>D-UB2B</b>	<b>660.</b>	-
	64"	22-1/2"	9-3/4"	<b>D-UB2B-MS</b>	<b>800.</b>	-

## SINGLE BED ADJUSTABLE HEIGHT - STEEL PAN DECK

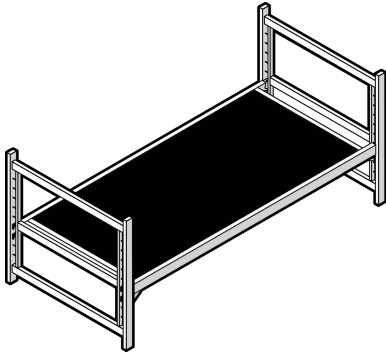

Description	W	D	H	Model	List Price	Wgt.
• Durable Steel Construction	78- <sup>3</sup> / <sub>4</sub> "	38"	35"	<b>MIL150AHP3675BED-GSA-S</b>	<b>777.</b>	-
• 5 Height Adjustments	78- <sup>3</sup> / <sub>4</sub> "	41"	35"	<b>MIL150AHP3680BED-GSA-S</b>	<b>805.</b>	-
• 16-gauge Construction	78- <sup>3</sup> / <sub>4</sub> "	38"	35"	<b>MIL150AHP3975BED-GSA-S</b>	<b>777.</b>	-
• Meets or exceeds ANSI/BIFMA X5.5-2008 standards	83- <sup>3</sup> / <sub>4</sub> "	38"	35"	<b>MIL150AHP3980BED-GSA-S</b>	<b>805.</b>	-
<b>Adapters (set of 4) single beds to bunk beds</b>				<b>MIL150AHP-D-150-AH</b>	<b>87.</b>	-

## BUNK BED ADJUSTABLE HEIGHT - STEEL PAN DECK

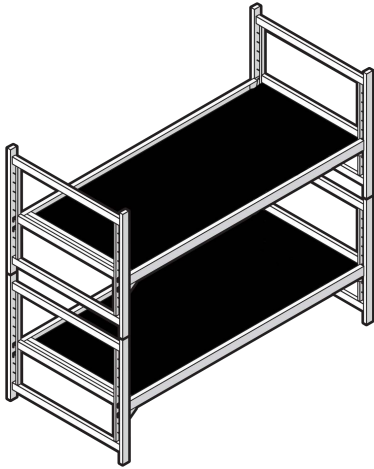

• Durable Steel Construction	83- <sup>3</sup> / <sub>4</sub> "	41"	71"	<b>MIL150AHP3675-GSA-B</b>	<b>1,299.</b>	-
• 5 Height Adjustments	83- <sup>3</sup> / <sub>4</sub> "	38"	71"	<b>MIL150AHP3975-GSA-B</b>	<b>1,299.</b>	-
• 16-gauge Construction	78- <sup>3</sup> / <sub>4</sub> "	41"	71"	<b>MIL150AHP3680-GSA-B</b>	<b>1,525.</b>	-
• Meets or exceeds ANSI/BIFMA X5.5-2008 standards	78- <sup>3</sup> / <sub>4</sub> "	41"	71"	<b>MIL150AHP3980-GSA-B</b>	<b>1,525.</b>	-
<b>53" Guardrail</b>	-	-	-	<b>GR-53</b>	<b>50.</b>	-
<b>Full Length Guardrail</b>	-	-	-	<b>GR-F</b>	<b>57.</b>	-
<b>Bunk Bed Ladder</b>	-	-	-	<b>LAD</b>	<b>60.</b>	-

## OPTIONS UNDER BED CHEST

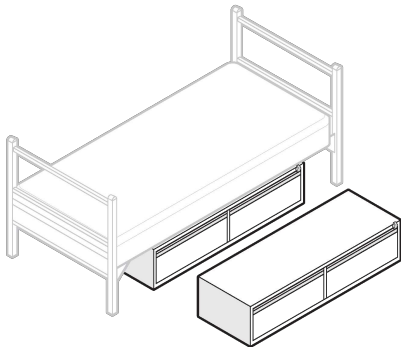

Chest with:						
• Full-width recessed pulls	52"	18"	12"	<b>D-UB2B</b>	<b>660.</b>	-
• Heavy-duty ball bearing suspension on drawers	64"	22- <sup>1</sup> / <sub>2</sub> "	9- <sup>3</sup> / <sub>4</sub> "	<b>D-UB2B-MS</b>	<b>800.</b>	-
• Shipped fully assembled						
• Textured paint						
• Meets or exceeds ANSI/BIFMA X5.5-2008 standards						





# *Adelphia*

**STEEL FURNITURE BUILT TO LAST** by DATUM®

Adelphia has been manufacturing casegoods and specialized filing components for over seven decades. Our mission is to serve a market that requires storage of any media with products that give you the best possible value and enduring quality.



89 Church Road, PO Box 355 | Emigsville, PA 17318-0355

**Toll Free** 1.800.865.8211 | **Fax** 1.801.4735 | **Email** [adelphiasales@datumstorage.com](mailto:adelphiasales@datumstorage.com)

[datumstorage.com](http://datumstorage.com)