

ABCO 2.0

Price Guide

March, 2017

For most up-to-date pricing,
please refer to our price guides
found at abcofurniture.com

ABCO 2.0 table of contents

ABCO 2.0 Tables

- New Medley.....4-16
- Smart Tables 18-27
- Z Series.....28-34

ABCO 2.0 Casegoods

- KEEL.....35-74

- COM76
- izzy+ flavors.....77-78
- Terms & Conditions.....79-80
- Warranty 81

NEW MEDLEY®

Education today requires technology, so the New Medley Series of training tables features three wire-management solutions for students and teachers. Each has its own unique method of handling cords and cables neatly and efficiently. They also provide practical functionality, quick-change mobility and height adjustability. Constructed of commercial-grade

materials, they are sturdy, stand up to heavy use, and come in a flexible range of widths, depths and configurations. Optional casters make tables easy to rearrange for changing lesson plans and group projects. Just as important, New Medley offers fixed- and adjustable-height leg options to fit multiple age groups and ADA requirements. Smart and simple,

New Medley gives students and teachers exactly what they need when they need it. And now, New Medley is outfitted in the izzy+ flavors palette of materials and colors, bringing a fresh new look to an all time favorite.

MODEL NUMBER BUILD

CCFLAA2460 Chestnut Woodline 2MM Brown Alloy Grommets – G2
 1. Model # 2. 3. 4. 5. 6.

SPECIFY

1. Model Number	2. TOP COLOR LAMINATE	3. EDGE TYPE	5. PAINT FINISH	6. OPTIONS	
1. Model Number	<p>Core Solid LBT Dover White LDM Pearl LB4 Folkstone LDQ Platinum LCB Earth LDA Citadel LCD Graphite LAS Black</p> <p>Classic Pattern LRP Grey Mesh LRC Pewter Mesh LPD Platinum Drops LWH White Drops LNT Neutral Twill LSR Sarum Twill</p> <p>Classic Wood Grain LTS Fusion Maple LSV Monticello Maple LS2 Huntington Maple LXW Wild Cherry LS4 Versailles Anigre LTW Empire Mahogany LVK Montana Walnut LT6 Hemlock</p> <p>Evolving Wood Grain LCC Smoky Brown Pear LZ7 White Ash LZ8 Weathered Ash LZ9 Natural Ash LCH Cherry Riftwood</p>	<p>Melamine (SOK only) Core Solid M01 Cloud M17 Ivory M18 Folkstone M19 Platinum M20 Earth M03 Graphite M13 Black</p> <p>Classic Pattern M14 White Nebula M15 Grey Nebula M16 Graphite Nebula</p> <p>Classic Wood Grain M06 Fusion Maple M07 Monticello Maple M08 Huntington Maple M09 Wild Cherry M10 Versailles Anigre M11 Empire Mahogany M12 Montana Walnut M21 Hemlock</p>	<p>2MM ABS Edgeband T-Mold</p> <p>4. 2MM EDGE COLOR</p> <p>Core Solid E30 White E31 Neutral White E33 Folkstone E32 Platinum E39 Earth E38 Brown E36 Citadel E35 Graphite E37 Black E34 Satin Silver</p> <p>Classic Wood Grain E41 Fusion Maple E42 Monticello Maple E43 Huntington Maple E44 Wild Cherry E45 Versailles Anigre E40 Empire Mahogany E47 Montana Walnut E46 Hemlock</p> <p>4. SMOOTH T-MOLD COLOR</p> <p>V39 Earth V36 Citadel V35 Graphite V37 Black</p>	<p>P07 White P06 Silver P09 Charcoal P10 Black P11 Alloy</p>	<p>C Casters TP Travel Pack G1 One Grommet, centered G2 Two Grommets, at each end</p>
2. Top Color					
3. Edge Type					
4. Edge Color					
5. Paint Finish					
6. Options					

CONSTRUCTION/FEATURES

- 1/4" thick high-pressure laminate top with T-mold or 2mm ABS edgeband
- Metal base (1" x 2" leg & feet) & modesty panel with powder coated paint finish
- Feet have black contour end caps and adjustable glides
- 1" x 1" metal support bar on 60", 66" & 72"
- Adjustable height models from 24" to 32"
- DU Pedestals cannot be used with New Medley

OPTIONS

- 3" casters (does not change table height) (+\$41) place a "C" after model #
- Wire management tray (WM9)
- Vertical wire management cord cover (CCFLWVM)
- Ganging kit connecting tables end to end
- Grommets: G1 – one grommet, centered (+\$22); G2 – two grommets, at each end (+\$43) (60"-72")

SPECIFY

1. Model Number
2. Top Color
3. Edge Type & Color
4. Paint Finish
5. Options

STANDARD PRODUCT

- 29" fixed or height-adjustable table with modesty panel and glides, no grommets

Fixed Height (29") Table with Modesty Panel

MODEL NUMBER	NOMINAL DIM.			TOTAL WT.	CUBIC FEET	T-MOLD LIST PRICE	2MM LIST PRICE
	D	W	H				
CCFL 20309*	20	30	29	44	2.2	\$ 447	\$ 447
CCFL 20369*	20	36	29	51	2.7	466	466
CCFL 20429*	20	42	29	58	3.2	501	501
CCFL 20489**	20	48	29	64	3.7	515	515
CCFL 20609	20	60	29	78	4.7	536	536
CCFL 20669	20	66	29	85	5.2	613	613
CCFL 20729	20	72	29	92	5.7	613	613
CCFL 24309*	24	30	29	48	2.8	448	448
CCFL 24369**	24	36	29	55	3.3	468	468
CCFL 24429**	24	42	29	62	3.8	507	507
CCFL 24489**	24	48	29	69	4.3	523	523
CCFL 24609	24	60	29	83	5.3	565	565
CCFL 24669	24	66	29	90	5.8	644	644
CCFL 24729	24	72	29	97	6.3	644	644
CCFL 30309*	30	30	29	60	3.8	484	484
CCFL 30369**	30	36	29	60	3.8	496	496
CCFL 30429**	30	42	29	67	4.3	530	530
CCFL 30489**	30	48	29	74	4.8	547	547
CCFL 30609	30	60	29	88	5.8	619	619
CCFL 30669	30	66	29	95	6.3	682	682
CCFL 30729	30	72	29	102	6.8	682	682

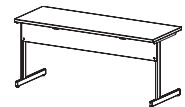

Options

OPTION CODE	DESCRIPTION	LIST PRICE
C	3" Caster (2 locking, 2 non-locking)	\$ 41
G1	One grommet, centered (any table size)	22
G2	Two grommets, one at each end (60"-72" tables)	43



*UPSable

**UPSable with travel pack + \$8 net (place a "TP" after model number and indicate UPS as preferred shipping method)

NEW MEDLEY®

Height Adjustable Table with Modesty Panel

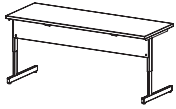

MODEL NUMBER	NOMINAL DIM.			TOTAL WT.	CUBIC FEET	T-MOLD LIST PRICE	2MM LIST PRICE
	D	W	H				
CCFLAA 2030*	20	30	24-32	44	2.3	\$ 471	\$ 471
CCFLAA 2036*	20	36	24-32	51	2.8	475	475
CCFLAA 2042**	20	42	24-32	58	3.3	534	534
CCFLAA 2048**	20	48	24-32	64	3.8	536	536
CCFLAA 2060	20	60	24-32	78	4.8	541	541
CCFLAA 2066	20	66	24-32	85	5.3	656	656
CCFLAA 2072	20	72	24-32	92	5.8	656	656
CCFLAA 2430*	24	30	24-32	48	2.8	475	475
CCFLAA 2436**	24	36	24-32	55	3.3	477	477
CCFLAA 2442**	24	42	24-32	62	3.8	547	547
CCFLAA 2448**	24	48	24-32	69	4.3	556	556
CCFLAA 2460	24	60	24-32	83	5.3	584	584
CCFLAA 2466	24	66	24-32	90	5.8	703	703
CCFLAA 2472	24	72	24-32	97	6.3	703	703
CCFLAA 3030**	30	30	24-32	60	3.8	462	462
CCFLAA 3036**	30	36	24-32	60	3.8	501	501
CCFLAA 3042**	30	42	24-32	67	4.3	573	573
CCFLAA 3048**	30	48	24-32	74	4.8	604	604
CCFLAA 3060	30	60	24-32	88	5.8	671	671
CCFLAA 3066	30	66	24-32	95	6.3	745	745
CCFLAA 3072	30	72	24-32	102	6.8	745	745

*UPSable

**UPSable with travel pack + \$8 net (place a "TP" after model number)

CONSTRUCTION/FEATURES

- 1/4" thick high-pressure laminate top with T-mold or 2mm ABS edgeband
- Metal base (1" x 2" leg & feet) & modesty panel with powder coated paint finish
- Feet have black contour end caps and adjustable glides
- 1" x 1" metal support bar on 60", 66" & 72"
- Adjustable height models from 24" to 32"
- Horizontal wire management tray with open ends. Use for optional power, data or lay-in cords see New Medley Electrical System section
- DU Pedestals cannot be used with New Medley

OPTIONS

- 3" casters (does not change table height) (+\$41) place a "C" after model #
- End caps (with grommet) for horizontal wire management tray
- Ganging kit connecting tables end to end
- Grommets: G1 – one grommet, centered (+\$22); G2 – two grommets, at each end (+\$43) (60"-72")

SPECIFY

1. Model Number
2. Top Color
3. Edge Type & Color
4. Paint Finish
5. Options

STANDARD PRODUCT

- 29" fixed or height-adjustable table with wire management tray and glides, no grommets

Fixed Height (29") Table with Wire Management Tray

MODEL NUMBER	NOMINAL DIM.			TOTAL WT.	CUBIC FEET	T-MOLD LIST PRICE	2MM LIST PRICE
	D	W	H				
CCFLW 20309*	20	30	29	44	2.2	\$ 502	\$ 502
CCFLW 20369*	20	36	29	51	2.7	527	527
CCFLW 20429*	20	42	29	58	3.2	568	568
CCFLW 20489**	20	48	29	64	3.7	583	583
CCFLW 20609	20	60	29	78	4.7	608	608
CCFLW 20669	20	66	29	85	5.2	677	677
CCFLW 20729	20	72	29	92	5.7	677	677
CCFLW 24309**	24	30	29	48	2.8	504	504
CCFLW 24369**	24	36	29	55	3.3	528	528
CCFLW 24429**	24	42	29	62	3.8	569	569
CCFLW 24489**	24	48	29	69	4.3	592	592
CCFLW 24609	24	60	29	83	5.3	642	642
CCFLW 24669	24	66	29	90	5.8	711	711
CCFLW 24729	24	72	29	97	6.3	711	711
CCFLW 30309**	30	30	29	60	3.8	523	523
CCFLW 30369**	30	36	29	60	3.8	564	564
CCFLW 30429**	30	42	29	67	4.3	602	602
CCFLW 30489**	30	48	29	74	4.8	622	622
CCFLW 30609	30	60	29	88	5.8	707	707
CCFLW 30669	30	66	29	95	6.3	756	756
CCFLW 30729	30	72	29	102	6.8	756	756

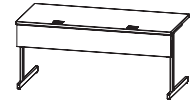

Options

OPTION CODE	DESCRIPTION	LIST PRICE
C	3" Caster (2 locking, 2 non-locking)	\$ 41
G1	One grommet, centered (any table size)	22
G2	Two grommets, one at each end (60"-72" tables)	43

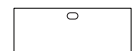

*UPSable

**UPSable with travel pack + \$8 net (place a "TP" after model number and indicate UPS as preferred shipping method)

NEW MEDLEY®

Height Adjustable Table with Wire Management Tray

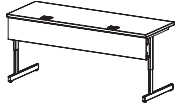

MODEL NUMBER	NOMINAL DIM.			TOTAL WT.	CUBIC FEET	T-MOLD LIST PRICE	2MM LIST PRICE
	D	W	H				
CCFLWAA 2030*	20	30	24-32	44	2.3	\$ 531	\$ 531
CCFLWAA 2036*	20	36	24-32	51	2.8	536	536
CCFLWAA 2042**	20	42	24-32	58	3.3	606	606
CCFLWAA 2048**	20	48	24-32	64	3.8	608	608
CCFLWAA 2060	20	60	24-32	78	4.8	615	615
CCFLWAA 2066	20	66	24-32	85	5.3	726	726
CCFLWAA 2072	20	72	24-32	92	5.8	726	726
CCFLWAA 2430*	24	30	24-32	48	2.8	536	536
CCFLWAA 2436**	24	36	24-32	55	3.3	540	540
CCFLWAA 2442**	24	42	24-32	62	3.8	622	622
CCFLWAA 2448**	24	48	24-32	69	4.3	630	630
CCFLWAA 2460	24	60	24-32	83	5.3	666	666
CCFLWAA 2466	24	66	24-32	90	5.8	781	781
CCFLWAA 2472	24	72	24-32	97	6.3	781	781
CCFLWAA 3030**	30	30	24-32	60	3.8	534	534
CCFLWAA 3036**	30	36	24-32	60	3.8	568	568
CCFLWAA 3042**	30	42	24-32	67	4.3	652	652
CCFLWAA 3048**	30	48	24-32	74	4.8	688	688
CCFLWAA 3060	30	60	24-32	88	5.8	767	767
CCFLWAA 3066	30	66	24-32	95	6.3	832	832
CCFLWAA 3072	30	72	24-32	102	6.8	832	832

*UPSable

**UPSable with travel pack + \$8 net (place a "TP" after model number)

CONSTRUCTION/FEATURES

- 1/4" thick high-pressure laminate top with T-mold or 2mm ABS edgeband
- Metal base (1" x 2" leg & feet) & modesty panel with powder coated paint finish
- Feet have black contour end caps and adjustable glides on foot
- 1" x 1" metal support bar on 60", 66" & 72"
- Adjustable height models from 24" to 32"
- Secure horizontal wire management box: 9" height with locking, hinged locking door, end cap (with grommet) for side to side channeling of cords. Use for optional power, data or lay-in cords see New Medley Electrical System section. Box has closed ends with grommets
- DU Pedestals cannot be used with New Medley

OPTIONS

- 3" casters (does not change table height) (+\$41) place a "C" after model #
- Ganging kit connecting tables end to end
- Vertical wire management cord cover - CCFLWMM

SPECIFY

1. Model Number
2. Top Color
3. Edge Type & Color
4. Paint Finish
5. Options

STANDARD PRODUCT

- 29" fixed or height-adjustable table with secure wire management tray and glides

Fixed Height (29") Table with Secure Wire Management Tray

MODEL NUMBER	NOMINAL DIM.			TOTAL WT.	CUBIC FEET	T-MOLD LIST PRICE	2MM LIST PRICE
	D	W	H				
CCFLFT 24309*	24	30	29	53	2.8	\$ 761	\$ 761
CCFLFT 24369**	24	36	29	61	3.3	778	778
CCFLFT 24429**	24	42	29	69	3.8	861	861
CCFLFT 24489**	24	48	29	77	4.3	870	870
CCFLFT 24609	24	60	29	92	5.3	916	916
CCFLFT 24669	24	66	29	100	5.8	1063	1063
CCFLFT 24729	24	72	29	108	6.3	1063	1063
CCFLFT 30309**	30	30	29	70	4.1	741	741
CCFLFT 30369**	30	36	29	70	4.1	789	789
CCFLFT 30429**	30	42	29	77	4.6	867	867
CCFLFT 30489**	30	48	29	85	5.1	916	916
CCFLFT 30609	30	60	29	101	6.1	992	992
CCFLFT 30669	30	66	29	108	6.6	1113	1113
CCFLFT 30729	30	72	29	116	7.1	1113	1113

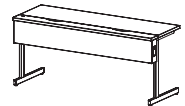

Height Adjustable Table with Secure Wire Management Tray

MODEL NUMBER	NOMINAL DIM.			TOTAL WT.	CUBIC FEET	T-MOLD LIST PRICE	2MM LIST PRICE
	D	W	H				
CCFLFTAA 2430*	24	30	24-32	50	2.8	\$ 792	\$ 792
CCFLFTAA 2436**	24	36	24-32	59	3.3	796	796
CCFLFTAA 2442**	24	42	24-32	65	3.8	886	886
CCFLFTAA 2448**	24	48	24-32	74	4.3	895	895
CCFLFTAA 2460	24	60	24-32	88	5.3	944	944
CCFLFTAA 2466	24	66	24-32	95	5.8	1098	1098
CCFLFTAA 2472	24	72	24-32	103	6.3	1098	1098
CCFLFTAA 3030**	30	30	24-32	55	3.0	763	763
CCFLFTAA 3036**	30	36	24-32	68	3.8	810	810
CCFLFTAA 3042**	30	42	24-32	74	4.3	906	906
CCFLFTAA 3048**	30	48	24-32	83	4.8	948	948
CCFLFTAA 3060	30	60	24-32	97	5.8	1041	1041
CCFLFTAA 3066	30	66	24-32	104	6.3	1147	1147
CCFLFTAA 3072	30	72	24-32	112	6.8	1147	1147

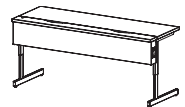

Options

OPTION CODE	DESCRIPTION	LIST PRICE
C	3" Caster (2 locking, 2 non-locking)	\$ 41

*UPSable

**UPSable with travel pack + \$8 net (place a "TP" after model number and indicate UPS as preferred shipping method)

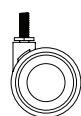

NEW MEDLEY®

Computer Centers

CONSTRUCTION/FEATURES

- 1¼" thick high-pressure laminate top with T-mold
- Metal base (1" x 2" leg & feet) & modesty panel with powder coated paint finish
- Feet have black contour end caps and adjustable glides
- Fixed 29" and height adjustable models from 24" to 32"
- Vertical wire management channel: 5¾" D x 13½" W, accepts most power strips

OPTIONS

- 3" casters (do not change workstation height) (+\$82) place a "C" after model #
- Ganging kit connecting workstations, back to back
- Accessory shelf, same construction as worksurface

SPECIFY

1. Model Number
2. Top Color
3. Edge Color
4. Paint Finish
5. Options

Fixed Height Computer Center

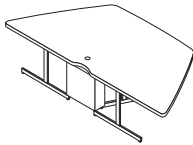

MODEL NUMBER	NOMINAL DIM.			TOTAL WT.	CUBIC FEET	T-MOLD LIST PRICE
	D	W	H			
CFLCC 9	42	96	29	186	13.3	\$ 1372

Adjustable Height Computer Center

MODEL NUMBER	NOMINAL DIM.			TOTAL WT.	CUBIC FEET	T-MOLD LIST PRICE
	D	W	H			
CFLCCAA	42	96	24-32	186	13.3	\$ 1436

Computer Center with Optional Shelf

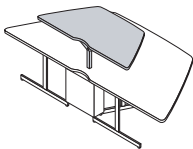

MODEL NUMBER	NOMINAL DIM.			TOTAL WT.	CUBIC FEET	T-MOLD LIST PRICE
	D	W	H			
CFLCCGANG*	GANGER KIT			3	0.5	\$ 44
CFLCCSHELF	24	56	16-22	62	5.4	613

*UPSable

**UPSable with travel pack + \$8 net (place a "TP" after model number and indicate UPS as preferred shipping method)

CONSTRUCTION/FEATURES

- 1¼" thick high-pressure laminate top with T-mold
- Metal single post base with powder coated paint finish
- Feet have black contour end caps and adjustable glides

SPECIFY

1. Model Number
2. Top Color
3. Edge Type & Color
4. Paint Finish

MODEL NUMBER	NOMINAL DIM.			TOTAL WT.	CUBIC FEET	T-MOLD LIST PRICE
	D	W	H			
CFLW 2036 9	20	36	29	44	3.5	\$ 454
CFLW 2042 9	20	42	29	55	4.2	474
CFLW 2436 9	24	36	29	47	3.5	490
CFLW 2442 9	24	42	29	62	4.2	511
CFLW 3036 9	30	36	29	47	3.5	562
CFLW 3042 9	30	42	29	62	4.2	582

For 20" Tables

CFLW 9020*	20	20		10	2.0	141
------------	----	----	--	----	-----	-----

For 24" Tables

CFLW 9024*	24	24		15	2.0	176
------------	----	----	--	----	-----	-----

For 30" Tables

CFLW 9030*	30	30		25	2.5	176
------------	----	----	--	----	-----	-----

For 24" Tables

CFLW 2424 9*	24	24	26/29	24	2.0	354
--------------	----	----	-------	----	-----	-----

For 30" Tables

CFLW 3030 9*	30	30	26/29	34	2.5	354
--------------	----	----	-------	----	-----	-----

- Woodgrain laminate direction is diagonal on CFLW corners
- 1¼" square post standard on corners and squares
- All wedges sent with (2) 18" flat plates

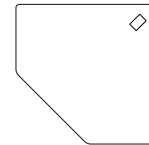

Corner



90°



Square

*UPSable

**UPSable with travel pack + \$8 net (place a "TP" after model number and indicate UPS as preferred shipping method)

NEW MEDLEY®

END CAP

CONSTRUCTION/FEATURES

- To close wire management tray on CCFLW series
- Sold in pairs

SPECIFY

1. Model Number
2. Paint Color

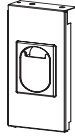

MODEL NUMBER	DESCRIPTION	TOTAL WT.	LIST PRICE
CCFLWEC	End cap w/grommet	0.5	\$ 42

NEW MEDLEY GANGER KIT

CONSTRUCTION/FEATURES

- Set of 2 use 1 front and 1 rear; black only,
- Use with CCFL, CCFLW & CCFLFT

SPECIFY

1. Model Number

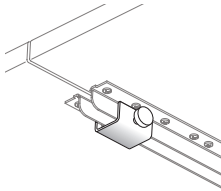

MODEL NUMBER	TOTAL WT.	LIST PRICE
CCFL GANG	0.5	\$ 66

VERTICAL WIRE MANAGEMENT CORD COVER

CONSTRUCTION/FEATURES

- Use 1 per leg
- Use with CCFL, CCFLW & CCFLFT

SPECIFY

1. Model Number
2. Paint Color

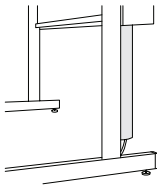

MODEL NUMBER	USAGE	TOTAL WT.	LIST PRICE
CCFLWWM-6	for adult adjustable with/without casters	0.5	\$ 32
CCFLWWM-11	for 29" fixed with casters	0.5	32
CCFLWWM-14	for 29" with glides	0.5	32

LOCKING CENTER DRAWER

CONSTRUCTION/FEATURES

- All metal construction
- UPS able (shown with *)

SPECIFY

1. Model Number
2. Paint Color

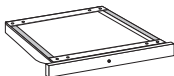

MODEL NUMBER	NOMINAL DIM.			TOTAL WT.	CUBIC FEET	LIST PRICE
	D	W	H			
CD*	18	19 ⁷ / ₈	2 ¹ / ₂	5	1.0	\$ 252

NEW MEDLEY®

BLACK PLASTIC LOCKING CENTER DRAWER

CONSTRUCTION/FEATURES

- UPSable (shown with *)

SPECIFY

1. Model Number

MODEL NUMBER	NOMINAL DIM.			TOTAL WT.	CUBIC FEET	LIST PRICE
	D	W	H			
CDP*	16 $\frac{7}{8}$	23 $\frac{1}{4}$	2	7	1.3	\$ 95

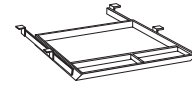

WIRE MANAGEMENT TRAY

CONSTRUCTION/FEATURES

- Available in black only
- UPSable (shown with *)

SPECIFY

1. Model Number

MODEL NUMBER	DESCRIPTION	LENGTH	TOTAL WT.	CUBIC FEET	LIST PRICE
WM9*	1 for 24"-36" width table	9"	2	.5	\$ 22
	2 for 36"-42" width table				
	3 for 48"-72" width table				

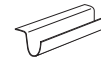

BRACKETS AND CASTERS

CONSTRUCTION/FEATURES

- UPSable (shown with *)

SPECIFY

1. Model Number

MODEL NUMBER	DESCRIPTION	TOTAL WT.	CUBIC FEET	LIST PRICE
CFLCASTER*	For New Medley only (3 inch) (4-pack, 2 locking, 2 non-locking; increases height)	2	1.0	\$ 48
CFFLATBRKT*	16" Flat Plate (galvanized)	1	0.5	21

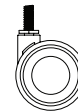

NEW MEDLEY®

Electrical System for Use with New Medley Rectangular Tables

Byrne Electrical's 4-Trac System® is a UL listed, Manufactured Wiring System. 4-Trac® features a low profile, 4-wire, 2 circuit system that provides 20 amps of power per circuit. 4-Trac® meets the requirements of UL 183 and National Electric Code Article 604. It also complies with municipal standards such as New York, Los Angeles and San Francisco. It is, however, the customer's responsibility to ensure installation of the system is in compliance with all local, regional and national codes. A licensed electrician is required to make all connections to the building power supply. This electrical system is not intended for use with any ABCO Modular Furniture Series.

GENERAL RULES FOR THE SPECIFICATION OF CIRCUITS

- Up to four computers (tower and monitor combined) per circuit
- Eight laptops per circuit
- Subtract one computer (tower and monitor combined) or laptop if adding a printer

If exceeding the above numbers in a row, Circuit II must be added. Use the same quantities for specification of Circuit II. A Hardwire Infeed must be specified when using Circuits I and II together. In addition, verify with building engineering staff two circuits of electrical power are available at infeed sight. Circuit I is standard for the Power Table Kits. To specify Circuit II, order Circuit II Power Table Kits. Power Table Kits and Table Jumpers are designed for use with many different size tables in the same row.

POWER TABLE KITS

CONSTRUCTION/FEATURES

- Power Table Kits are ordered based on table width
- Each Power Table Kit 30"-72" includes:
 - (2) Circuit I duplex receptacles, (1) duplex connecting harness and
 - (2) duplex receptacle mounting brackets.
- 24" Table Kit includes: (1) Circuit I duplex receptacle and (1) duplex receptacle mounting bracket.
- Center of the power table kit is aligned with the center of the table.
- Ex: For a 36" wide table, specify the BEPTK-136 kit.

SPECIFY

1. Model Number

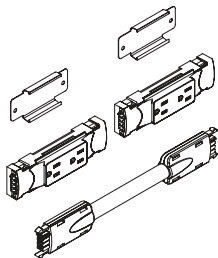

MODEL NUMBER	TABLE WIDTH	TOTAL WT.	LIST PRICE
Circuit I Power Table Kits			
BEPTK-I30	30"	.65	\$ 114
BEPTK-I36	36"	.75	149
BEPTK-I42	42"	.85	152
BEPTK-I48	48"	.95	155
BEPTK-I60	60"	1.15	163
BEPTK-I66	66"	1.25	166
BEPTK-I72	72"	1.35	170
Circuit II Power Table Kits			
BEPTK-II30	30"	.65	114
BEPTK-II36	36"	.75	149
BEPTK-II42	42"	.85	152
BEPTK-II48	48"	.95	155
BEPTK-II60	60"	1.15	163
BEPTK-II66	66"	1.25	166
BEPTK-II72	72"	1.35	170

CONSTRUCTION/FEATURES

- Required to connect power from one table to another
- 18" table jumper connects power in rows when tables are side by side
- 24" table jumper connect power in collaborative settings such as U-shaped, anytime a corner is created
- Connects any combination of Power Table Kits and table widths
- Order one less Table Jumper than number of tables being connected. Ex: For three tables, specify two jumpers

SPECIFY

1. Model Number

MODEL NUMBER	TABLE WIDTH	TOTAL WT.	LIST PRICE
BETJ18	18"	.50	\$ 49
BETJ24	24"	.50	60

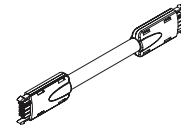

H CONNECTOR

CONSTRUCTION/FEATURES

- Splits power in multiple directions.
- Use when power source is in the center of a row of tables rather than at the end.
- 4 connection points - one power in and 3 out.

SPECIFY

1. Model Number

MODEL NUMBER	DESCRIPTION	LIST PRICE
BEHC	4 Wire "H" Connector	\$ 19
BEHCMBK	H Connector Mounting Bracket Kit	8

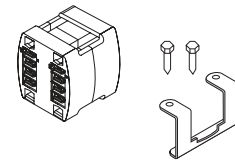

POWER INFEEDS

CONSTRUCTION/FEATURES

- Four types of power infeeds are offered:
 - Hardwire infeed – installed by a licensed electrician – UL Listed
 - 20 amp, 90 degree right angle plug infeed – UL Recognized, not UL Listed
 - 20 amp, right angle infeed – UL Recognized, not UL Listed
 - 20 amp, straight plug infeed – special wall receptacle required – UL Recognized, not UL Listed

SPECIFY

1. Model Number

MODEL NUMBER	DESCRIPTION	LENGTH	TOTAL WT.	LIST PRICE
BEHWI6*	Direct Hardwire Infeed	6 ft.	1.5	\$ 105
BE90DRAPI6**	90° Right Angle Plug Infeed	6 ft.	1.5	160
BERAPI6**	Right Angle Plug Infeed	6 ft.	1.5	155
BESPI6**	Straight Plug Infeed	6 ft.	1.5	155

- *Hardwired to building power source by licensed electrician then connect to receptacle in power system.
- **Plugs into 20 amp wall outlet only. Connect to receptacle in power system. Circuit I only. UL Recognized, not UL Listed
- **Requires 20 amp wall outlet

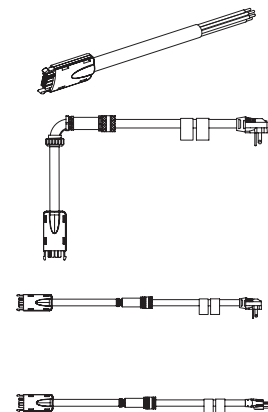

④
Plug
end view

NEW MEDLEY®

DATA BOX

CONSTRUCTION/FEATURES

- Data may be added using the Data Box Minitap with Voice Adaptor Kit.
- Includes (2) Duraloc velcro-type strips for mounting to metal and wood screws for mounting to wood.
- Accommodates two Keystone-style data jacks or couplers.

SPECIFY

1. Model Number

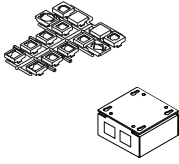

MODEL NUMBER	DESCRIPTION	TOTAL WT.	LIST PRICE
BEDB	Data Box w/Voice Adaptor Kit	0.25	\$ 80

RJ45 DATA JACKS

CONSTRUCTION/FEATURES

- Packed 1 per bag.
- Contact Customer Service for availability of other data/voice Jacks and Couplers

SPECIFY

1. Model Number

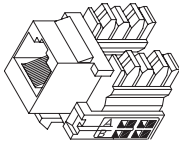

MODEL NUMBER	DESCRIPTION	TOTAL WT.	LIST PRICE
BERJ45	AMP 8-Pin, RJ45 Cat5e Data Jack	0.5	\$ 26

CLAMP-ON POWER/DATA MODULE

SPECIFY

1. Model Number

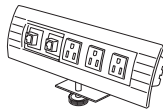

MODEL NUMBER	NOMINAL DIM.			TOTAL WT.	CUBIC FEET	LIST PRICE
	D	L	H			
CPOWER*	2½	10	3⅝	3	1.0	\$ 431

SMART TABLES® High Pressure Laminate

Smart Tables are ready to help you get the most out of your presentation rooms, teaching areas and conferencing sites. This furniture is designed to be versatile, mobile and adaptable to meet the ever-changing needs of today's world of business and learning. Choose from 3 different top shapes and optional casters

to easily reconfigure tables for many uses. Table tops feature 1¼" thick high pressure laminate top with a backer for stability, while perforated metal modesty panels offer an attractive solution. Optional wire management system channels cords horizontally and vertically while optional power/data module allows you to plug in

to power and data outlets. Choose from three distinctive base functions – free standing, tilt and folding. And now, Smart Tables are outfitted in the izzy+ flavors palette of materials and colors, bringing a fresh new look to an all time favorite.

MODEL NUMBER BUILD

SF A RT H 1860	LTW	2MM	E40	P10	G
1. Model #	2.	3.	4.	5.	6.

SPECIFY

1. Model Number
2. Top Color
3. Edge Type
4. Edge Color
5. Base and Modesty Panel Finish
6. Options

2. TOP COLOR

- Core Solid**
LBT Dover White
LDM Pearl
LB4 Folkstone
LDQ Platinum
LCB Earth
LDA Citadel
LCD Graphite
LAS Black
- Classic Pattern**
LRP Grey Mesh
LRC Pewter Mesh
LPD Platinum Drops
LWH White Drops
LNT Neutral Twill
LSR Sarum Twill
- Classic Wood Grain**
LTS Fusion Maple
LSV Monticello Maple
LS2 Huntington Maple
LXW Wild Cherry
LS4 Versailles Anigre
LTW Empire Mahogany
LVK Montana Walnut
LT6 Hemlock
- Evolving Wood Grain**
LCC Smoky Brown Pear
LZ7 White Ash
LZ8 Weathered Ash
LZ9 Natural Ash
LCH Cherry Riftwood

3. EDGE TYPE

- 2MM** ABS Edgeband
T-Mold Smooth

4. 2MM EDGE COLOR

- Core Solid**
E30 White
E31 Neural White
E32 Platinum
E33 Folkstone
E34 Satin Silver
E35 Graphite
E36 Citadel
E37 Black
E38 Brown
E39 Earth
- Classic Wood Grain**
E40 Empire Mahogany
E41 Fusion Maple
E42 Monticello Maple
E43 Huntington Maple
E44 Wild Cherry
E45 Versailles Anigre
E46 Hemlock
E47 Montana Walnut

OR

4. T-Mold EDGE COLOR

- V35** Graphite
V36 Citadel
V37 Black
V39 Earth

5. BASE FINISH (STBAC 22 available in black only)

- P06** Silver
P07 White
P09 Charcoal
P10 Black
P11 Alloy
P54 Mirror (Chrome)

6. OPTIONS

- C** Casters (see options on each page for upcharge note)
- G** Glides (std)
- W** Wire management system with grommets (see Accessories section for upcharge note)

SMART TABLES® High Pressure Laminate

CONSTRUCTION/FEATURES

- 1¼" thick high-pressure laminate top with T-mold or 2mm ABS edgeband
- 84" & 96" lengths require 3 bases & no stretcher bar
- 60" & 72" lengths use 1" x 1" metal support bar
- Use with Arch and T Bases – sold separately

OPTIONS

- Modesty panels – perforated metal
- Power/data & power/communication modules
- Wire management (see Smart Table Accessories)

SPECIFY

1. Model Number
2. Top Color
3. Edge Type
4. Edge Color
5. Base & Modesty Finish
6. Options

Rectangular Tops (for Fixed/Shared – Arch & T Base)

MODEL NUMBER	SIZE IN INCHES	BASE STYLE	TOTAL WT.	CUBIC FEET	LIST PRICE	
					T-MOLD	2MM
Rectangle						
STS RT H 1848	18 x 48	A	30	1.8	\$ 271	\$ 271
STS RT H 1860	18 x 60	A	35	2.2	281	281
STS RT H 1872	18 x 72	A	40	2.7	319	319
STS RT H 1884*	18 x 84	A	45	3.5	373	373
STS RT H 1896*	18 x 96	A	50	3.5	389	389
STS RT H 2448	24 x 48	C	35	2.3	281	281
STS RT H 2460	24 x 60	C	45	2.9	306	306
STS RT H 2472	24 x 72	C	55	3.5	328	328
STS RT H 2484*	24 x 84	C	65	4.6	416	416
STS RT H 2496*	24 x 96	C	70	4.6	432	432
STS RT H 3048	30 x 48	D	45	2.9	289	289
STS RT H 3060	30 x 60	D	55	3.6	333	333
STS RT H 3072	30 x 72	D	70	4.3	376	376
STS RT H 3084*	30 x 84	D	80	5.7	465	465
STS RT H 3096*	30 x 96	D	90	5.7	476	476

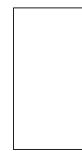

RECTANGLE

*Requires 3 bases. See base section for styles and requirements.

SMART TABLES® High-Pressure Laminate

Half Rounds (for Fixed/Shared – Arch & T Base)



HALF ROUND

MODEL NUMBER	SIZE IN INCHES	BASE STYLE	TOTAL WT.	CUBIC FEET	LIST PRICE	
					T-MOLD	2MM
STS HRD H 48	24 x 48	C	35	3.2	\$ 281	\$ 281
STS HRD H 60	30 x 60	D	55	3.6	332	332
STS HRD H 72	36 x 72	D	70	6.9	421	421

- Finished size dimensions are slightly undersized to allow a perfect fit at the end of two 24" or 30", or three 24" depth Smart Tables®

Wedge Tops (for Fixed/Shared – Arch & T Base)



90° CORNER WEDGE

MODEL NUMBER	SIZE IN INCHES	BASE STYLE	TOTAL WT.	CUBIC FEET	LIST PRICE	
					T-MOLD	2MM
STS 90 H 18*	18 x 18	NA	10	1.5	\$ 145	\$ 145
STS 90 H 24*	24 x 24	NA	25	1.5	168	168
STS 90 H 30**	30 x 30	C	35	2.5	188	188

* UPSable

** STS 90 H 30 wedge requires one STB 22, STBAC 22 or STA 22 base in the center for support

- Four gangers and attaching thumbknobs included with each corner wedge

SMART TABLES[®] High-Pressure Laminate

Fixed/Shared – Arch & T Bases

BASES

- Bases can be fixed or shared. Fixed base is secured to one top only, 2 or more required per top; shared base is secured to two tops, metal plate spans at seam of tops
- Tops sold separately - use with rectangular, half round, and wedge tops

OPTIONS

- 2" casters (does not change height, except STBAC 22) (+\$21) place a "C" after model #
- Thumbknobs, see Smart Tables Accessories

SPECIFY

1. Model Number
2. Base Finish (STBAC 22 black only)
3. Options
4. Tops Model (last 2 pages)

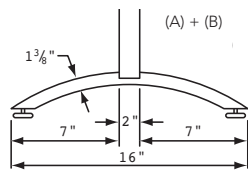
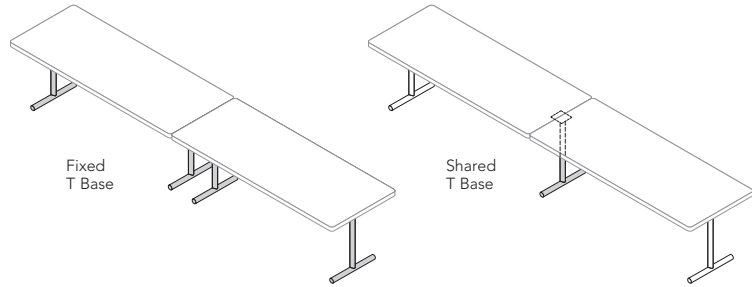

STA 16
for 18" deep tops only

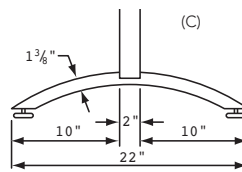

STA 22
for 24" deep tops
and 30" 90° wedge

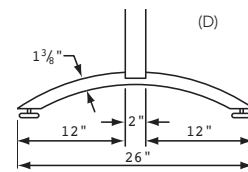

STA 26
for 30" deep tops only

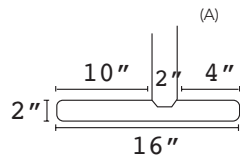

STB 16
for 18" deep tops only

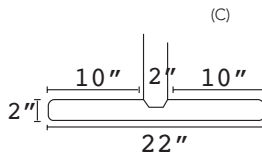

STB 22
for 24" deep tops
and 30" 90° wedge

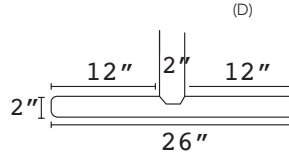

STB 26
for 30" deep tops only

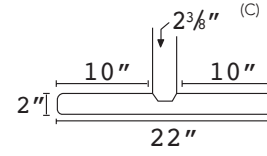

STBAC 22 (Black only)
(Adjustable Height)
for 24" deep tops
(48", 60" and 72" widths only)

MODEL NUMBER	SIZE IN INCHES	TOTAL WT.	CUBIC FEET	LIST PRICE	
				PAINT	P54 MIRROR (CHROME)
STA 16	16 x 27 3/4	10	4.0	\$ 235	NA
STA 22	22 x 27 3/4	11	4.0	254	NA
STA 26	26 x 27 3/4	12	4.6	263	NA
STB 16	16 x 27 3/4	14	4.0	180	+\$115
STB 22	22 x 27 3/4	17	4.0	193	+\$120
STB 26	26 x 27 3/4	19	4.6	197	+\$130
STBAC 22	22 x 27 3/4-39 3/4	15	2.5	476	NA

Price is per base and includes four attaching bolts (screws on STBAC 22) with each base, leveling glides included. Thumbknobs sold separately (not available on STBAC 22)

SMART TABLES® High-Pressure Laminate

CONSTRUCTION/FEATURES

- 1/4" thick high-pressure laminate top with T-mold or 2mm ABS edgeband
- 2" diameter Arch or T base metal base
- Folding tables use 1" x 1" metal support bar

OPTIONS

- 2" casters (does not change height) (+\$41) place a "C" after model #
- Power/data & power/communication modules
- Wire management (see Smart Table Accessories)
- P54 Mirror (Chrome) Base Upcharge available on T Base Models:
18" + \$345
24" + \$365
30" + \$395

SPECIFY

1. Model Number
2. Top Color
3. Edge Type
4. Edge Color
5. Base & Modesty Finish
6. Options

Rectangular Tops (with Folding Arch Base)

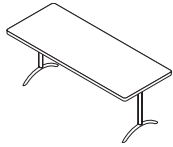

MODEL NUMBER	SIZE IN INCHES	TOTAL WT.	CUBIC FEET	LIST PRICE	
				T-MOLD	2MM
SF A RT H 1860	18 x 60	76	3.9	\$ 1146	\$ 1146
SF A RT H 1872	18 x 72	106	4.7	1185	1185
SF A RT H 1884	18 x 84	126	6.2	1233	1233
SF A RT H 1896	18 x 96	146	6.2	1272	1272
SF A RT H 2460	24 x 60	104	5.1	1216	1216
SF A RT H 2472	24 x 72	124	6.2	1240	1240
SF A RT H 2484	24 x 84	144	8.2	1329	1329
SF A RT H 2496	24 x 96	164	8.2	1404	1404
SF A RT H 3060	30 x 60	133	6.4	1313	1313
SF A RT H 3072	30 x 72	143	7.6	1367	1367
SF A RT H 3084	30 x 84	162	10.1	1382	1382
SF A RT H 3096	30 x 96	183	10.1	1477	1477

Rectangular Tops (with Folding T Base)

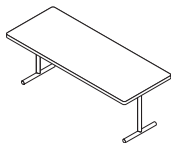

MODEL NUMBER	SIZE IN INCHES	TOTAL WT.	CUBIC FEET	LIST PRICE	
				T-MOLD	2MM
SF T RT H 1860	18 x 60	90	3.9	\$ 932	\$ 932
SF T RT H 1872	18 x 72	110	4.7	968	968
SF T RT H 1884	18 x 84	130	6.2	1010	1010
SF T RT H 1896	18 x 96	150	6.2	1043	1043
SF T RT H 2460	24 x 60	110	5.1	988	988
SF T RT H 2472	24 x 72	130	6.2	1011	1011
SF T RT H 2484	24 x 84	150	8.2	1086	1086
SF T RT H 2496	24 x 96	170	8.2	1152	1152
SF T RT H 3060	30 x 60	140	6.4	1069	1069
SF T RT H 3072	30 x 72	150	7.6	1116	1116
SF T RT H 3084	30 x 84	170	10.1	1131	1131
SF T RT H 3096	30 x 96	190	10.1	1212	1212

SMART TABLES® High-Pressure Laminate

CONSTRUCTION/FEATURES

- 1/4" thick high-pressure laminate top with T-mold or 2mm ABS edgeband
- 2" diameter Arch metal base
- 60"-96" tables use 1" x 1" metal support bar

OPTIONS

- 2" casters (does not change height) (+\$41) place a "C" after model #
- Power/data & power/communication modules
- Wire management (see Smart Table Accessories)
- P54 Mirror (Chrome) Base Upcharge available on T Base Models:
18" + \$345
24" + \$365
30" + \$395

SPECIFY

1. Model Number
2. Top Color
3. Edge Type
4. Edge Color
5. Base & Modesty Finish
6. Options

Rectangular Tops (with Tilt Arch Base)

MODEL NUMBER	SIZE IN INCHES	TOTAL WT.	CUBIC FEET	LIST PRICE	
				T-MOLD	2MM
ST A RT H 1848	18 x 48	66	3.2	\$ 1107	\$ 1107
ST A RT H 1860	18 x 60	76	3.9	1139	1139
ST A RT H 1872	18 x 72	106	4.7	1180	1180
ST A RT H 1884	18 x 84	126	6.2	1231	1231
ST A RT H 1896	18 x 96	146	6.2	1268	1268
ST A RT H 2448	24 x 48	94	4.1	1166	1166
ST A RT H 2460	24 x 60	104	5.1	1209	1209
ST A RT H 2472	24 x 72	124	6.2	1239	1239
ST A RT H 2484	24 x 84	144	8.2	1357	1357
ST A RT H 2496	24 x 96	164	8.2	1392	1392
ST A RT H 3048	30 x 48	121	5.1	1184	1184
ST A RT H 3060	30 x 60	133	6.4	1310	1310
ST A RT H 3072	30 x 72	143	7.6	1364	1364
ST A RT H 3084	30 x 84	162	10.1	1389	1389
ST A RT H 3096	30 x 96	183	10.1	1397	1397

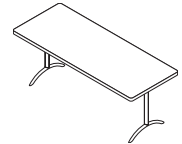

Half Round Tops (with Tilt Arch Base)

MODEL NUMBER	SIZE IN INCHES	TOTAL WT.	CUBIC FEET	LIST PRICE	
				T-MOLD	2MM
ST A HRD H 48	24 x 48	104	4.6	\$1168	\$ 1168
ST A HRD H 60	30 x 60	128	6.4	1313	1313
ST A HRD H 72	36 x 72	143	8.4	1332	1332



- Not available with modesty panel
- Finished size dimensions are slightly undersized to allow a perfect fit at the end of two 24" or 30", or three 24" depth Smart Tables®

SMART TABLES® High-Pressure Laminate

CONSTRUCTION/FEATURES

- 1¼" thick high-pressure laminate top with T-mold or 2mm ABS edgeband
- 2" diameter T base metal base

OPTIONS

- 2" casters (does not change height) (+\$41) place a "C" after model #
- Power/data & power/communication modules
- Wire management (see Smart Table Accessories)
- P54 Mirror (Chrome) Base Upcharge available on T Base Models:
18" + \$345
24" + \$365
30" + \$395

SPECIFY

1. Model Number
2. Top Color
3. Edge Type
4. Edge Color
5. Base & Modesty Finish
6. Options

Rectangular Tops (with Tilt T Base)

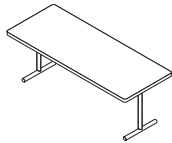

MODEL NUMBER	SIZE IN INCHES	TOTAL WT.	CUBIC FEET	T-MOLD	LIST PRICE	2MM
ST T RT H 1848	18 x 48	85	3.2	\$ 898	\$ 898	\$ 898
ST T RT H 1860	18 x 60	90	3.9	926		926
ST T RT H 1872	18 x 72	110	4.7	961		961
ST T RT H 1884	18 x 84	130	6.2	1005		1005
ST T RT H 1896	18 x 96	150	6.2	1037		1037
ST T RT H 2448	24 x 48	100	4.1	942		942
ST T RT H 2460	24 x 60	120	5.1	980		980
ST T RT H 2472	24 x 72	140	6.2	1006		1006
ST T RT H 2484	24 x 84	150	8.2	1110		1110
ST T RT H 2496	24 x 96	170	8.2	1141		1141
ST T RT H 3048	30 x 48	110	5.1	958		958
ST T RT H 3060	30 x 60	130	6.4	1066		1066
ST T RT H 3072	30 x 72	150	7.6	1115		1115
ST T RT H 3084	30 x 84	170	10.1	1134		1134
ST T RT H 3096	30 x 96	190	10.1	1141		1141

Half Round Top (with Tilt T Base)



MODEL NUMBER	SIZE IN INCHES	TOTAL WT.	CUBIC FEET	T-MOLD	LIST PRICE	2MM
ST T HRD H 48	24 x 48	110	4.6	\$ 944	\$ 944	\$ 944
ST T HRD H 60	30 x 60	135	6.4	1068		1068
ST T HRD H 72	36 x 72	150	8.4	1087		1087

- Not available with modesty panel
- Finished size dimensions are slightly undersized to allow a perfect fit at the end of two 24" or 30", or three 24" depth Smart Tables®

Accessories available for the Smart Tables includes Thumbknob Kit, Ganger Kit, Flat bracket, Table Truck, Power/Data Modules, Wire Management and Power/Communication Modules.

MODEL NUMBER BUILD

STRUCK	P06
1. Model #	2.

SPECIFY

1. Model Number
2. Paint Finish
(if applicable)

2. PAINT FINISH (IF APPLICABLE)

- P06 Silver
- P07 White
- P09 Charcoal
- P10 Black
- P11 Alloy

SMART TABLES® Accessories

THUMBKNOB KIT

CONSTRUCTION/FEATURES

- 4 thumbknobs to replace bolts for ease of re-configuration on fixed, shared or post base tables

SPECIFY

1. Model Number

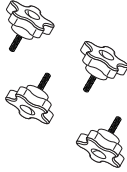

MODEL NUMBER	NOMINAL DIM.			TOTAL WT.	CUBIC FEET	LIST PRICE
	D	W	H			
THUMBKNOB*				1	0.5	\$ 15

GANGER KIT

CONSTRUCTION/FEATURES

- 2 black metal gangers & 4 thumbknobs to be used to gang fixed, shared, folding or tilt base tables

SPECIFY

1. Model Number

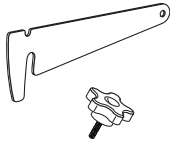

MODEL NUMBER	DIMENSIONS W X L	TOTAL WT.	CUBIC FEET	LIST PRICE

LEVEL LOCK

SPECIFY

1. Model Number

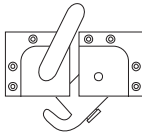

MODEL NUMBER	LIST PRICE
LLOCK	\$ 79

TABLE TRUCKS

CONSTRUCTION/FEATURES

- Stores 16 fixed or shared tops (no thumbknobs), 13 fixed or shared tops (thumbknobs) or 6 folding base tables
- UPSable (shown with *)

SPECIFY

1. Model Number
2. Paint Finish

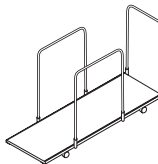

MODEL NUMBER	DIMENSIONS D X W X H	TOTAL WT.	CUBIC FEET	LIST PRICE
STRUCK 6	33 x 74 x 44	200	10.0	\$1287
48", 60" and 72" Tables				
STRUCK 8	33 x 98 x 44	275	15.0	1406
84" and 96" Tables				

*UPSable

**UPSable with travel pack + \$8 net (place a "TP" after model number and indicate UPS as preferred shipping method)

POWER/DATA MODULES

CONSTRUCTION/FEATURES

- UL approved, rating 15 AMP/125 volt, includes two RJ-45 cat5 data jacks and 6' molded plug cord set.
- POWER modules requires purchase of wire management system

SPECIFY

1. Model Number

MODEL NUMBER	EXACT DIM. D X W X H	TOTAL WT.	CUBIC FEET	LIST PRICE
POWER*	3¼ x 8¾ x 2¾	3	1.0	\$ 273
CPOWER*	2½ x 10 x 3½	3	1.0	431

* UPSable

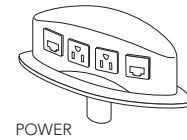

POWER

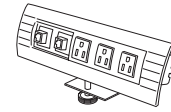

CPOWER

WIRE MANAGEMENT SYSTEMS

CONSTRUCTION/FEATURES

- Use with 24" and 30" deep rectangular, tops with arch or T bases

OPTIONS

- 48" & 60" tables, includes 2 grommets, 1 four-channel and 1 vertical wire manager (+\$90) place a "W" after model #
- 72" tables, includes 2 grommets, 2 four-channel and 1 vertical wire manager (+\$116) place a "W" after model #
- 84" & 96" tables, includes 3 grommets, 2 four-channel and 1 vertical wire manager (+\$116) place a "W" after model #

SPECIFY

1. add "W" after model #

MODEL NUMBER	GROMMETS	FOUR-CHANNEL WIRE MANAGERS	UPCHARGE TO PRICE OF TABLE
Wire Management			
48" and 60" Tables	2	1	\$ 90
72" Tables	2	2	116
84" and 96" Tables	3	2	116

MODEL NUMBER	LIST PRICE
Four-Channel Wire Managers	
WM4C*	\$ 45
Vertical Wire Managers	
WMV*	24

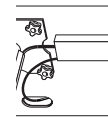

FOUR-CHANNEL WIRE MANAGER



VERTICAL WIRE MANAGER

Z SERIES®

With the Z Series, graceful aesthetics and forward-looking design are constructed from the best materials. Z Series is comprised of two tables that share the same forward base design and vertical wire management but have two distinct horizontal wire management solutions. Z2 has a fixed, pierced metal modesty. When specifying with grommet(s), a lay-in cord tray manages wires under the table to the vertical wire management in the legs. Z3 has a curved, fold-down, lockable modesty panel that covers a horizontal tray for

power and data. The optional modesty panel laminate insert adds a sleek, classy finish. The top is high-pressure laminate. Select 2MM ABS edgeband or user-side bullet nose urethane for exceptional comfort. Aluminum base has an arched cast foot, oval leg extrusion and is joined at a stylish angle. Vertical wire management is handled neatly and efficiently, with channels in the legs directing cords to floor and on to the power source. ADA height is available on both models at a fixed 32-inch height

allowing for easy wheelchair access and user comfort. Additional options include 3" casters for easy mobility, a quick and easy way to specify your grommet needs, no matter if you want just one or three.

MODEL NUMBER BUILD

Z3 2472	LDQ Platinum	U	U04 Dolphin / E32 Platinum	P06 Silver	C	ADA	LI	G2
1. Model #	2.	3.	4.	5.	6	7.	8.	9.

SPECIFY	2. TOP COLOR LAMINATE	3. EDGE TYPE	4. URETHANE EDGE COLOR for user's side only, specify 2MM edge color for remaining 3 sides	5. BASE FINISH & MODESTY PANEL COLOR	OPTIONS <i>availability varies per model</i>
1. Model Number	Core Solid LBT Dover White LDM Pearl LB4 Folkstone LDQ Platinum LCB Earth LDA Citadel LCD Graphite LAS Black	2MM 2MM ABS Edgeband (Standard) U Edgeband/Urethane* combo	U27 Oyster U25 Koala U02 Wolf U26 Kangaroo U04 Dolphin U05 Otter U22 Hippo U32 Beaver U06 Black Bear U24 Cardinal U13 Blue Heron U14 Jay U21 Parakeet U23 Oriole	P07 White P06 Silver P09 Charcoal P10 Black P11 Alloy	6. FEET STYLE G Glides (std) C 3" Casters*
2. Top Color	Classic Pattern LRP Grey Mesh LRC Pewter Mesh LPD Platinum Drops LWH White Drops LNT Neutral Twill LSR Sarum Twill				7. HEIGHT 29 29" height (std) ADA ADA compliant* height- 32" ADAC ADA compliant* height- 32" with casters
3. Edge Type	Classic Wood Grain LTS Fusion Maple LSV Monticello Maple LS2 Huntington Maple LXW Wild Cherry LS4 Versailles Anigre LTW Empire Mahogany LVK Montana Walnut LT6 Hemlock		4. 2MM EDGE COLOR Core Solid E30 White E31 Neutral White E33 Folkstone E32 Platinum E39 Earth E38 Brown E36 Citadel E35 Graphite E37 Black E34 Satin Silver		8. MODESTY PANEL INSERT LI Laminate insert* for modesty panel (defaults to top color)
4. Edge Color	Evolving Wood Grain LCC Smoky Brown Pear LZ7 White Ash LZ8 Weathered Ash LZ9 Natural Ash LCH Cherry Riftwood		Classic Wood Grain E41 Fusion Maple E42 Monticello Maple E43 Huntington Maple E44 Wild Cherry E45 Versailles Anigre E40 Empire Mahogany E47 Montana Walnut E46 Hemlock		9. GROMMETS NG No grommet (std) G1 one grommet* centered, any size, G2 two grommets* at each end, 60", 66", 72" widths G3 three grommets* at each end and center, 60", 66", 72" widths
5. Paint Color					
OPTIONS					
6. Feet Style					
7. Height					
8. Modesty Panel Insert					
9. Grommets					

* see options for upcharge

CONSTRUCTION/FEATURES

- 1 1/4" thick high-pressure laminate top
- Two edge types - 2MM ABS edgeband or Urethane/2MM combo
- 16 gauge stretcher bar on 48", 60", 66" and 72" widths
- Oval aluminum extrusion leg upright with vertical wire management
- Cast aluminum foot with adjustable glides
- Curved pierced metal modesty panel folds and locks to secure horizontal wire management
- Fixed 29" height

STANDARD PRODUCT

- 29" fixed height with 2MM edgeband and glides, no grommets, no modesty panel laminate insert

SPECIFY

1. Model Number
2. Top Color
3. Edge Type
4. Edge Color
5. Paint Color

Options:

6. Feet Style
7. Height
8. Modesty Panel Insert
9. Grommets

OPTIONS

- U Urethane Edge
- C 3" Casters
- ADA ADA compliant height- 32"
- ADAC ADA compliant height- 32" with casters
- LI Laminate insert for modesty panel
- G1, G2, G3 Grommets, choose one, two or three grommets

Z3 Rectangle Table (with Locking Curved Modesty Panel)

MODEL NUMBER	EXACT DIMENSIONS D X W	TOTAL WT.	CUBIC FEET	LIST PRICE
Z3 2036	20 x 36	62	4.2	\$ 875
Z3 2042	20 x 42	70	4.6	909
Z3 2048	20 x 48	78	4.9	943
Z3 2060	20 x 60	93	5.7	1095
Z3 2066	20 x 66	100	6.1	1147
Z3 2072	20 x 72	107	6.5	1179
Z3 2436	24 x 36	70	5.0	898
Z3 2442	24 x 42	79	5.5	937
Z3 2448	24 x 48	88	5.9	974
Z3 2460	24 x 60	103	6.8	1142
Z3 2466	24 x 66	111	7.2	1203
Z3 2472	24 x 72	119	7.7	1235
Z3 3036	30 x 36	80	6.1	936
Z3 3042	30 x 42	90	6.7	978
Z3 3048	30 x 48	100	7.2	1021
Z3 3060	30 x 60	118	8.3	1203
Z3 3066	30 x 66	128	8.9	1272
Z3 3072	30 x 72	137	9.5	1302

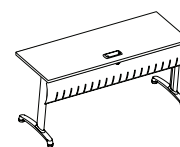

SHOWN WITH G1 GROMMET OPTION

Options

OPTION CODE	DESCRIPTION	TABLE DIMENSION		LIST PRICE
		W		
U	Urethane User Side Edge	36	\$ 236	
		42	248	
		48	259	
		60	281	
		66	293	
		72	304	
LI	Modesty Panel Insert	36	34	
		42	39	
		48	45	
		60	50	
		66	57	
		72	62	
C	3" Caster (2 locking, 2 non-locking)		46	
ADA	ADA Compliant 32" Height		57	
ADAC	ADA Compliant 32" Height with Casters		103	
G1	One grommet, centered (any table size)		36	
G2	Two grommets, one at each end (60", 66" & 72")		72	
G3	Three grommets, one at each end, one centered (60", 66" & 72")		108	

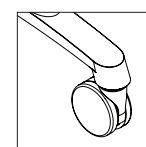
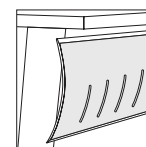
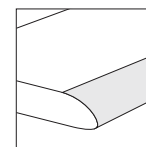

Z SERIES

CONSTRUCTION/FEATURES

- 1 1/4" thick high-pressure laminate top
- Two edge types - 2MM ABS edgeband or Urethane/2MM combo
- 16 gauge stretcher bar on 48", 60", 66" and 72" widths
- Oval aluminum extrusion leg upright with vertical wire management
- Cast aluminum foot with adjustable glides
- Flat, pierced metal modesty panel painted to match legs
- Fixed 29" height

STANDARD PRODUCT

- 29" fixed height with 2MM edgeband and glides, no grommets

SPECIFY

1. Model Number
2. Top Color
3. Edge Type
4. Edge Color
5. Paint Color

Options:

6. Feet Style
7. Height
8. Grommets

OPTIONS

- U Urethane Edge
 C 3" Casters
 ADA ADA compliant height- 32"
 ADAC ADA compliant height- 32" with casters
 G1, G2, G3 Grommets, choose one, two or three grommets and lay-in cord tray wire management

Z2 Rectangle Table (with Fixed Modesty Panel)

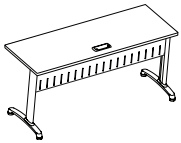

SHOWN WITH G1 GROMMET OPTION

MODEL NUMBER	EXACT DIMENSIONS D X W	TOTAL WT.	CUBIC FEET	LIST PRICE
Z2 2036	20 x 36	57	4.2	\$ 714
Z2 2042	20 x 42	64	4.6	737
Z2 2048	20 x 48	71	4.9	756
Z2 2060	20 x 60	83	5.7	890
Z2 2066	20 x 66	89	6.1	904
Z2 2072	20 x 72	95	6.5	940
Z2 2436	24 x 36	64	5.0	736
Z2 2442	24 x 42	72	5.5	763
Z2 2448	24 x 48	80	5.9	785
Z2 2460	24 x 60	94	6.8	936
Z2 2466	24 x 66	101	7.2	969
Z2 2472	24 x 72	108	7.7	985
Z2 3036	30 x 36	74	6.1	772
Z2 3042	30 x 42	84	6.7	803
Z2 3048	30 x 48	93	7.2	830
Z2 3060	30 x 60	109	8.3	994
Z2 3066	30 x 66	117	8.9	1041
Z2 3072	30 x 72	126	9.5	1058

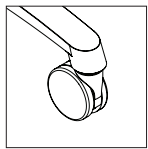
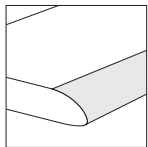

OPTION CODE	DESCRIPTION	TABLE DIMENSION W	LIST PRICE
U	Urethane User Side Edge	36	\$ 236
		42	248
		48	259
		60	281
		66	293
		72	304
C	3" Caster (2 locking, 2 non-locking)		46
ADA	ADA Compliant 32" Height		57
ADAC	ADA Compliant 32" Height with Casters		103
G1	One grommet, centered (any table size) and lay-in cord tray wire management	36	54
		42	54
		48	59
		60	59
		66	65
		72	65
G2	Two grommets, one at each end (60", 66" & 72") and lay-in cord tray wire management	60	95
		66	101
		72	101
G3	Three grommets, one at each end, one centered (60", 66" & 72") and lay-in cord tray wire management	60	131
		66	137
		72	137

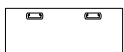

CONSTRUCTION/FEATURES

- 1 1/4" thick high-pressure laminate top
- Two edge types - 2MM ABS edgeband or Urethane/2MM combo
- Double release point for easy tilt
- Oval aluminum extrusion leg upright with vertical wire management
- Cast aluminum foot with adjustable glides
- Flat, pierced metal modesty panel painted to match legs
- Fixed 29" height

STANDARD PRODUCT

- 29" fixed height with 2MM edgeband and glides, no grommets

SPECIFY

1. Model Number
2. Top Color
3. Edge Type
4. Edge Color
5. Paint Color

Options:

6. Feet Style
7. Grommets

OPTIONS

- U Urethane Edge
 C 3" Casters
 G1, G2, G3
 Grommets, choose one, two or three grommets and lay-in cord tray wire management

Z2 Tilt Rectangle Table (with Fixed Modesty Panel)

MODEL NUMBER	EXACT DIMENSIONS D X W	TOTAL WT.	CUBIC FEET	LIST PRICE
Z2TL 2036	20 x 36	69	6.2	\$ 1055
Z2TL 2042	20 x 42	76	6.6	1080
Z2TL 2048	20 x 48	83	6.9	1105
Z2TL 2060	20 x 60	95	7.1	1238
Z2TL 2066	20 x 66	101	8.1	1313
Z2TL 2072	20 x 72	107	8.5	1335
Z2TL 2436	24 x 36	76	7.0	1079
Z2TL 2442	24 x 42	84	7.5	1107
Z2TL 2448	24 x 48	92	7.9	1133
Z2TL 2460	24 x 60	106	8.8	1285
Z2TL 2466	24 x 66	113	9.2	1364
Z2TL 2472	24 x 72	120	9.9	1391

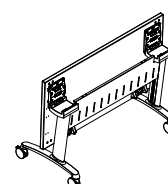

SHOWN WITH OPTIONAL CASTERS

OPTION CODE	DESCRIPTION	TABLE DIMENSION		LIST PRICE
		W		
U	Urethane User Side Edge	36		\$ 236
		42		248
		48		259
		60		281
		66		293
		72		304
C	3" Caster (2 locking, 2 non-locking)			46
G1	One grommet, centered (any table size) and lay-in cord tray wire management	36		54
		42		54
		48		59
		60		59
		66		65
G2	Two grommets, one at each end (60", 66" & 72") and lay-in cord tray wire management	60		95
		66		101
		72		101
		72		65
G3	Three grommets, one at each end, one centered (60", 66" & 72") and lay-in cord tray wire management	60		131
		66		138
		72		138

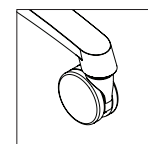
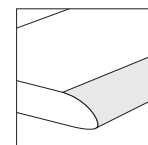

Z SERIES Electrical System

Z-Series Z3 tables are designed to manage Byrne Electric's 4-Track Power System®. No matter if you're powering tables in rows or collaborative configurations, it's easy to specify a power solution.

The 4-Track Power System can accommodate up to 26 duplex receptacles using both Circuit I and Circuit II power. Specify Circuit I power up to 13 duplex receptacles.

If more power is required, continue by specifying Circuit II power for up to an additional 13 duplex receptacles. For power connection between tables in a row, specify 18" Table Jumper, for corners, use 24" Table Jumper.

Need power to split in different directions, add an H Connection to get the power going just where you need it.

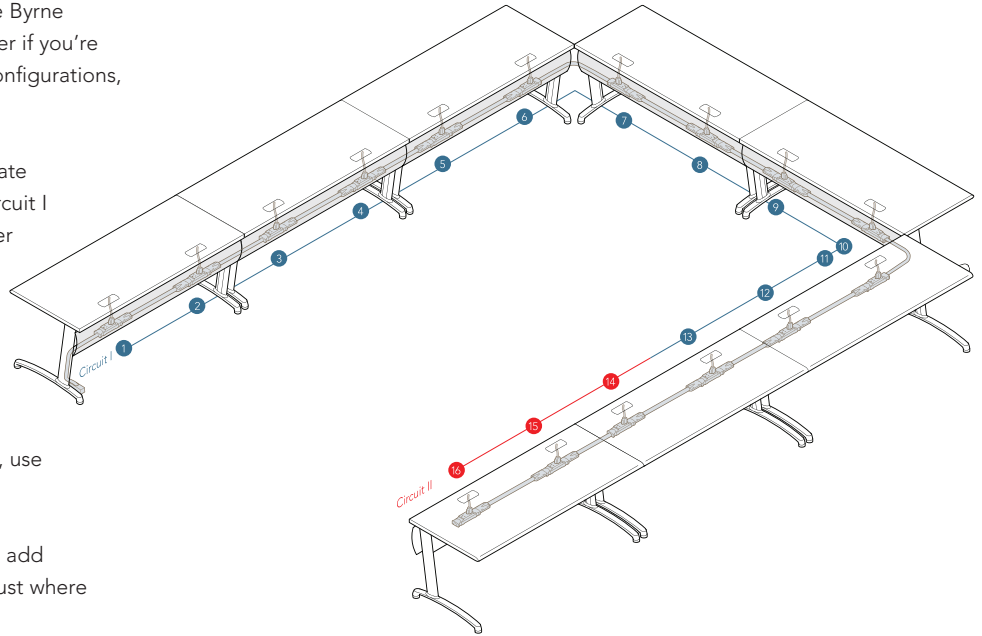

POWER TABLE KITS

CONSTRUCTION/FEATURES

- Power Table Kits are ordered based on table width
Ex: For a 36" wide table, specify the BEPTZ-136 kit
- Each Power Table Kit 36"-84" includes:
(2) duplex receptacles, (1) duplex connecting harness and
(2) duplex receptacle mounting brackets.
- Center of the power table kit is aligned with the center of the table.

SPECIFY

1. Model Number

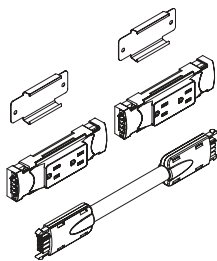

MODEL NUMBER	TABLE WIDTH	TOTAL WT.	LIST PRICE
Circuit I Power Table Kits			
BEPTKZ-I36	36"	.75	\$ 149
BEPTKZ-I42	42"	.85	152
BEPTKZ-I48	48"	.95	155
BEPTKZ-I60	60"	1.15	163
BEPTKZ-I66	66"	1.25	166
BEPTKZ-I72	72"	1.35	170
Circuit II Power Table Kits			
BEPTKZ-II36	36"	.75	\$ 149
BEPTKZ-II42	42"	.85	152
BEPTKZ-II48	48"	.95	155
BEPTKZ-II60	60"	1.15	163
BEPTKZ-II66	66"	1.25	166
BEPTKZ-II72	72"	1.35	170

Z SERIES Electrical System

TABLE JUMPER

CONSTRUCTION/FEATURES

- Required to connect power from one table to another
- 18" table jumper connects power in rows when tables are side by side
- 24" table jumper connect power in collaborative settings such as U-shaped, anytime a corner is created
- Connects any combination of Power Table Kits and table widths
- Order one less Table Jumper than number of tables being connected
Ex: For three tables, specify two jumpers

SPECIFY

1. Model Number

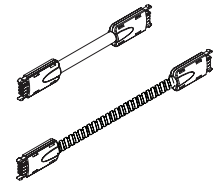

MODEL NUMBER	DESCRIPTION	LIST PRICE
BETJ18	18" Table Jumper	\$ 49
BETJ24	24" Table Jumper	60

H CONNECTOR

CONSTRUCTION/FEATURES

- Splits power in multiple directions.
- Use when power source is in the center of a row of tables rather than at the end.
- 4 connection points - one power in and 3 out.

SPECIFY

1. Model Number

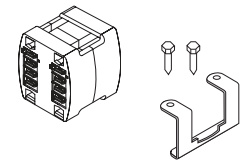

MODEL NUMBER	DESCRIPTION	LIST PRICE
BEHC	4 Wire "H" Connector	\$ 19
BEHCMBK	H Connector Mounting Bracket Kit	8

POWER INFEEDS

CONSTRUCTION/FEATURES

- Four types of power infeeds are offered:
 - Hardwire infeed – installed by a licensed electrician ñ UL Listed
 - 20 amp, 90 degree right angle plug infeed - UL Recognized, not UL Listed
 - 20 amp, right angle infeed – UL Recognized, not UL Listed
 - 20 amp, straight plug infeed – special wall receptacle required – UL Recognized, not UL Listed

SPECIFY

1. Model Number

MODEL NUMBER	DESCRIPTION	LENGTH	TOTAL WT.	LIST PRICE
BEHWI6*	Direct Hardwire Infeed	6 ft.	1.5	\$ 105
BE90DRAP16**	90° Right Angle Plug Infeed	6 ft.	1.5	160
BERAP16**	Right Angle Plug Infeed	6 ft.	1.5	155
BESPI6**	Straight Plug Infeed	6 ft.	1.5	155

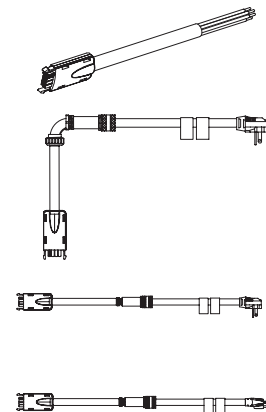

- *Hardwired to building power source by licensed electrician then connect to receptacle in power system.
**Plugs into 20 amp wall outlet only. Connect to receptacle in power system.Circuit I only. UL Recognized, not UL Listed



Z SERIES Electrical System

MINI-PORT

CONSTRUCTION/FEATURES

- Two power and two empty for optional Data Jacks.
- Includes Adaptor Kit.
- Replaces standard grommet
- 21" cord

SPECIFY

1. Model Number

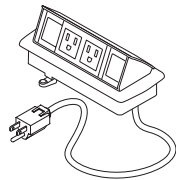

MODEL NUMBER	DESCRIPTION	TOTAL WT.	LIST PRICE
ZMINIPOINT	Pop-up Power Port	3.0	\$ 210

RJ45 DATA JACKS

CONSTRUCTION/FEATURES

- Packed 1 per bag.
- Contact Customer Service for availability of other data/voice Jacks and Couplers

SPECIFY

1. Model Number

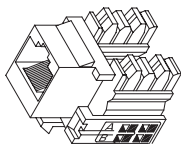

MODEL NUMBER	DESCRIPTION	TOTAL WT.	LIST PRICE
BERJ45	AMP 8-Pin, RJ45 Cat5e Data Jack	0.5	\$ 26

DATA BOX

CONSTRUCTION/FEATURES

- Data may be added using the Data Box Minitap with Voice Adaptor Kit.
- Includes (2) Duraloc velcro-type strips for mounting to metal and wood screws for mounting to wood.
- Accommodates two Keystone-style data jacks or couplers.

SPECIFY

1. Model Number

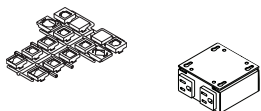

MODEL NUMBER	DESCRIPTION	TOTAL WT.	LIST PRICE
BEDB	Data Box w/Voice Adaptor Kit	0.25	\$ 80

FLOOR MOUNT BRACKET

CONSTRUCTION/FEATURES

- Set of 4 with concrete fasteners

SPECIFY

1. Model Number

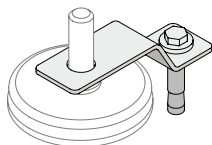

MODEL NUMBER	DESCRIPTION	TOTAL WT.	LIST PRICE
ZFMTBRKT	Floor Mounting Bracket	0.25	\$ 62

Z GANGER

CONSTRUCTION/FEATURES

- Includes spanner piece and thumb knobs
- Set of two
- Not available on Z2 Tilt

SPECIFY

1. Model Number

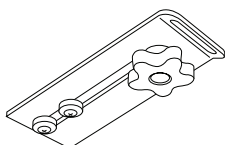

MODEL NUMBER	DESCRIPTION	LIST PRICE
ZGANGER	Table Ganger	\$ 36

KEEL is a freestanding casegoods line that offers a variety of component options for open and private applications. Its multi-tiered design provides its unique function and modern look.

Every unit starts with the keel panel and case; and when combined this is called the base cabinet. It provides the foundation and support for all attached storage, work surfaces and accessories.

The base cabinet comes in two depths; 22" depth in 48", 60", 72", 84" & 96" widths & 18" depth in 60", 72", 84" & 96" widths.

KEEL VOCABULARY

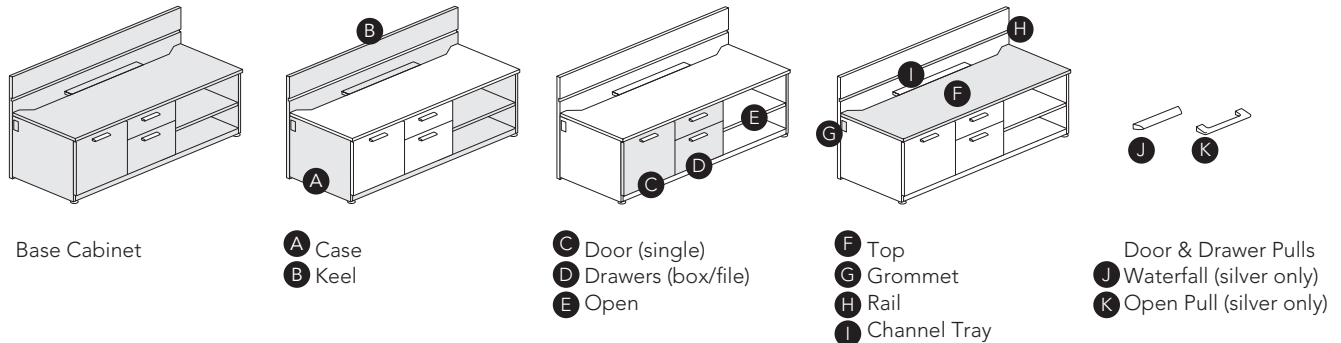

MODEL NUMBER BUILD

KBC 2248-04 M03 LCC LBT W L
 1. Model # 2. 3. 4. 5. 6.

SPECIFY

- Model Number
- Case & Keel Panel color (must be the same color)
- Drawer & Door Front color
- Top Color
- Drawer/Door Pull select Waterfall or Open
- Locking Mechanism
 K or L upcharge:
 22"D x 48"W = +\$50.00
 22"D x 60"W = +\$60.00
 22"D x 72"W = +\$70.00
 22"D x 84"W = +\$70.00
 22"D x 96"W = +\$80.00
 18"D x all W = +\$60.00

2. CASE & KEEL Melamines with coordinating edgebands

CORE SOLIDS | EDGEBAND

- M01 Cloud | White
- M17 Ivory | Neutral White
- M19 Platinum | Platinum
- M03 Graphite | Graphite
- M13 Black | Black

CLASSIC WOODGRAINS | EDGEBAND

- M06 Fusion Maple | Fusion Maple
- M08 Huntington Maple | Huntington Maple
- M11 Empire Mahogany | Empire Mahogany
- M21 Hemlock | Hemlock

3. DRAWER & DOOR

Melamines with coordinating edgebands

CORE SOLIDS | EDGEBAND

- M01 Cloud | White
- M17 Ivory | Neutral White
- M19 Platinum | Platinum
- M03 Graphite | Graphite
- M13 Black | Black

CLASSIC WOODGRAINS | EDGEBAND

- M06 Fusion Maple | Fusion Maple
- M08 Huntington Maple | Huntington Maple
- M11 Empire Mahogany | Empire Mahogany
- M21 Hemlock | Hemlock

Laminates with complimentary edgebands

EVOLVING WOODGRAINS | EDGEBAND

- LCC Smoky Brown Pear | Graphite
- LCG Millennium Oak | Earth
- LCR Oiled Walnut | Brown
- LCY Dunewood | Neutral White

4. TOPS

Laminates with coordinating edgebands

CORE SOLIDS | EDGEBAND

- LBT Dover White | White
- LDM Pearl | Neutral White
- LDQ Platinum | Platinum
- LCD Graphite | Graphite
- LAS Black | Black

CLASSIC WOODGRAINS | EDGEBAND

- LTS Fusion Maple | Fusion Maple
- LS2 Huntington Maple | Huntington Maple
- LTW Empire Mahogany | Empire Mahogany
- LT6 Hemlock | Hemlock

Laminates with complimentary edgebands

CLASSIC PATTERNS | EDGEBAND

- LRP Grey Mesh | Folkstone
- LRT Steel Mesh | Citadel
- LRZ Gilded Mesh | Platinum
- LRC Pewter Mesh | Citadel

EVOLVING WOODGRAINS | EDGEBAND

- LCC Smoky Brown Pear | Graphite
- LCG Millennium Oak | Earth
- LCR Oiled Walnut | Brown
- LCY Dunewood | Neutral White

5. PULLS

- O Open (silver only)
- W Waterfall (silver only)

6. LOCKING MECHANISM



- N No Lock (standard)
- K Locks Keyed Alike (upcharge)
- L Locks Keyed Random (upcharge)

KEEL™ base cabinet

CONSTRUCTION/FEATURES

- Top - 1" thick high pressure laminate (HPL) with 2mm edge
- Case - 5/8" thick & Keel Panel - 1" thick thermofused melamine (TFM) with 2mm edge
- Drawer or Door Fronts - 5/8" thick (HPL) or (TFM) with 2mm edge
- Wire management and 2 side grommets
- Includes 24" Channel Tray
- Drawers are Box/File, File includes hanging bars
- Single Doors that are 18" width, hinge is on left if door is left of base cabinet center, opposite for right hinged.

OPTIONS

- Metal drawer pulls
 -  (W) Waterfall (silver)
 -  (O) Open Pull (silver)
- Locking Mechanism, place an "N, K or L" after model #

SPECIFY

1. Model Number
2. Case & Keel Color
3. Door & Drawer Color
4. Top Color
5. Drawer/Door Pulls
6. Options: Locking Mechanism upcharge for K or L
48"W + \$50.00
60"W + \$60.00

22" depth | 48" width

DIMENSIONS

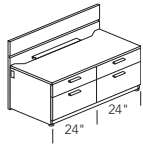

MODEL	D	W	base H	overall H	WEIGHT	CUBIC FEET	LIST PRICE
KBC 2248-01	22	48	21	34	287	20.8	\$ 2,480

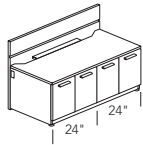

KBC 2248-02	22	48	21	34	227	20.8	2,361
-------------	----	----	----	----	-----	------	-------

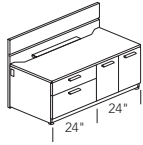

KBC 2248-03	22	48	21	34	251	20.8	2,421
-------------	----	----	----	----	-----	------	-------

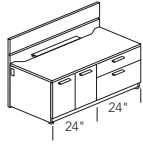

KBC 2248-04	22	48	21	34	251	20.8	2,421
-------------	----	----	----	----	-----	------	-------

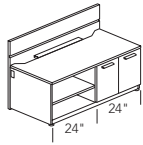

KBC 2248-05	22	48	21	34	227	20.8	2,136
-------------	----	----	----	----	-----	------	-------

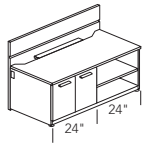

KBC 2248-06	22	48	21	34	227	20.8	2,136
-------------	----	----	----	----	-----	------	-------

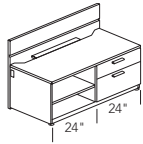

KBC 2248-07	22	48	21	34	251	20.8	2,195
-------------	----	----	----	----	-----	------	-------

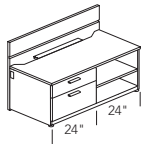

KBC 2248-08	22	48	21	34	251	20.8	2,195
-------------	----	----	----	----	-----	------	-------

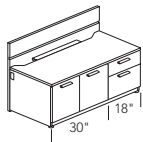

KBC 2248-09	22	48	21	34	251	20.8	2,402
-------------	----	----	----	----	-----	------	-------

KEEL™ base cabinet

MODEL	DIMENSIONS				WEIGHT	CUBIC FEET	LIST PRICE
	D	W	base H	overall H			
KBC 2248-10	22	48	21	34	251	20.8	\$ 2,163
KBC 2248-11	22	48	21	34	251	20.8	2,163
KBC 2248-12	22	48	21	34	228	20.8	2,008
KBC 2248-13	22	48	21	34	228	20.8	2,008
KBC 2248-14	22	48	21	34	253	20.8	2,237

22" depth | 48" width

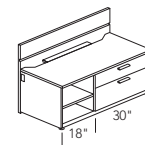
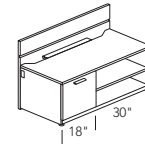
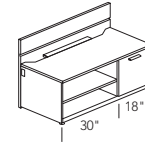
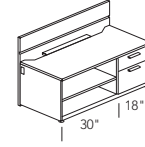
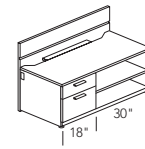

MODEL	DIMENSIONS				WEIGHT	CUBIC FEET	LIST PRICE
	D	W	base H	overall H			
KBC 2260-01	22	60	21	34	327	26.0	\$ 2,781
KBC 2260-02	22	60	21	34	275	26.0	2,548
KBC 2260-03	22	60	21	34	287	26.0	2,424
KBC 2260-04	22	60	21	34	287	26.0	2,424
KBC 2260-05	22	60	21	34	299	26.0	2,608

22" depth | 60" width

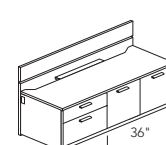
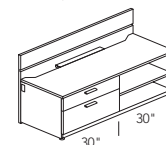
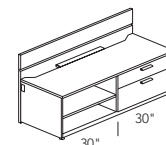
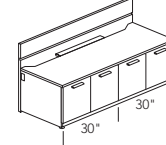
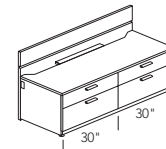



KEEL™ base cabinet

CONSTRUCTION/FEATURES

- Top - 1" thick high pressure laminate (HPL) with 2mm edge
- Case - 5/8" thick & Keel Panel - 1" thick thermofused melamine (TFM) with 2mm edge
- Drawer or Door Fronts - 5/8" thick (HPL) or (TFM) with 2mm edge
- Wire management and 2 side grommets
- Includes 24" Channel Tray
- Drawers are Box/File, File includes hanging bars
- Single Doors that are 18" width, hinge is on left if door is left of base cabinet center, opposite for right hinged.

OPTIONS

- Metal drawer pulls
 -  (W) Waterfall (silver)
 -  (O) Open Pull (silver)
- Locking Mechanism, place an "N, K or L" after model #

SPECIFY

1. Model Number
2. Case & Keel Color
3. Door & Drawer Color
4. Top Color
5. Drawer/Door Pulls
6. Options: Locking Mechanism upcharge for K or L
60"W + \$60.00
72"W + \$70.00

22" depth | 60" width

DIMENSIONS

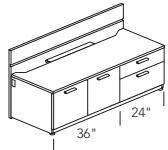

MODEL	D	W	base H	overall H	WEIGHT	CUBIC FEET	LIST PRICE
KBC 2260-06	22	60	21	34	299	26.0	\$ 2,608

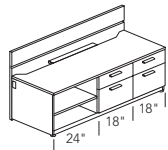

KBC 2260-07	22	60	21	34	311	26.0	2,732
-------------	----	----	----	----	-----	------	-------

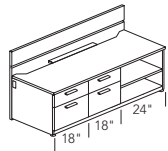

KBC 2260-08	22	60	21	34	311	26.0	2,732
-------------	----	----	----	----	-----	------	-------

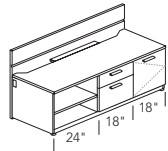

KBC 2260-09	22	60	21	34	287	26.0	2,577
-------------	----	----	----	----	-----	------	-------

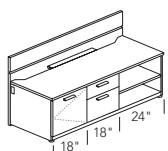

KBC 2260-10	22	60	21	34	287	26.0	2,577
-------------	----	----	----	----	-----	------	-------

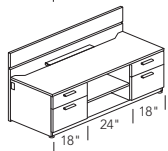

KBC 2260-11	22	60	21	34	311	26.0	2,730
-------------	----	----	----	----	-----	------	-------

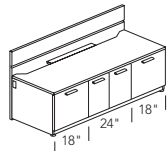

KBC 2260-12	22	60	21	34	275	26.0	2,645
-------------	----	----	----	----	-----	------	-------

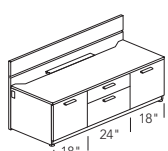

KBC 2260-13	22	60	21	34	299	26.0	2,706
-------------	----	----	----	----	-----	------	-------

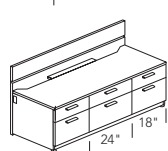

KBC 2260-14	22	60	21	34	347	26.0	2,944
-------------	----	----	----	----	-----	------	-------

KEEL™ base cabinet

22" depth | 72" width

MODEL	DIMENSIONS				WEIGHT	CUBIC FEET	LIST PRICE
	D	W	base H	overall H			
KBC 2272-01	22	72	21	34	320	31.2	\$ 2,729
KBC 2272-02	22	72	21	34	355	31.2	2,948
KBC 2272-03	22	72	21	34	355	31.2	2,948
KBC 2272-04	22	72	21	34	331	31.2	2,889
KBC 2272-05	22	72	21	34	331	31.2	2,889
KBC 2272-06	22	72	21	34	331	31.2	2,871
KBC 2272-07	22	72	21	34	295	31.2	2,871
KBC 2272-08	22	72	21	34	307	31.2	2,827
KBC 2272-09	22	72	21	34	355	31.2	2,946
KBC 2272-10	22	72	21	34	331	31.2	2,762
KBC 2272-11	22	72	21	34	331	31.2	2,762

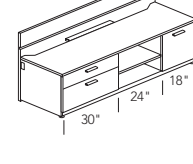
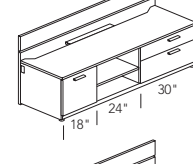
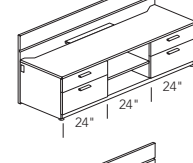
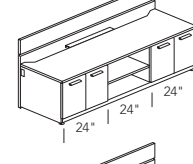
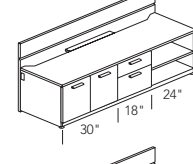
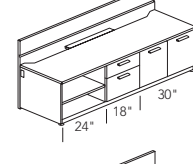
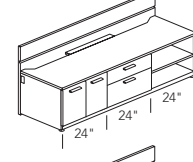
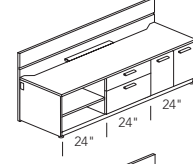
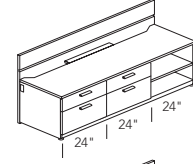
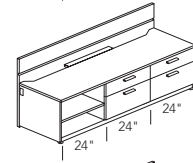
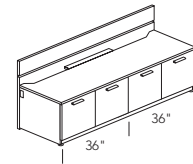



KEEL™ base cabinet

CONSTRUCTION/FEATURES

- Top - 1" thick high pressure laminate (HPL) with 2mm edge
- Case - 5/8" thick & Keel Panel - 1" thick thermofused melamine (TFM) with 2mm edge
- Drawer or Door Fronts - 5/8" thick (HPL) or (TFM) with 2mm edge
- Wire management and 2 side grommets
- Includes 24" Channel Tray
- Drawers are Box/File, File includes hanging bars
- Single Doors that are 18" width, hinge is on left if door is left of base cabinet center, opposite for right hinged.

OPTIONS

- Metal drawer pulls
 -  (W) Waterfall (silver)
 -  (O) Open Pull (silver)
- Locking Mechanism, place an "N, K or L" after model #

SPECIFY

1. Model Number
2. Case & Keel Color
3. Door & Drawer Color
4. Top Color
5. Drawer/Door Pulls
6. Options: Locking Mechanism upcharge for K or L
72"W + \$70.00
84"W + \$70.00

22" depth | 72" width

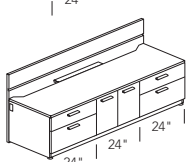
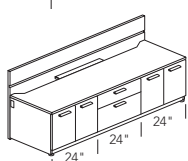
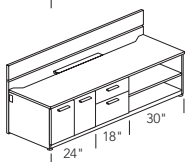
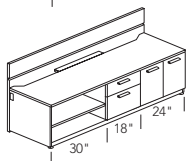
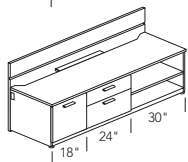
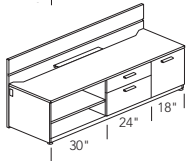
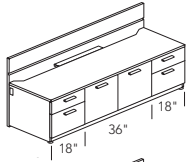

DIMENSIONS

MODEL	DIMENSIONS				WEIGHT	CUBIC FEET	LIST PRICE
	D	W	base H	overall H			
KBC 2272-12	22	72	21	34	368	31.2	\$ 3,136
KBC 2272-13	22	72	21	34	331	31.2	2,760
KBC 2272-14	22	72	21	34	331	31.2	2,760
KBC 2272-15	22	72	21	34	331	31.2	2,857
KBC 2272-16	22	72	21	34	331	31.2	2,857
KBC 2272-17	22	72	21	34	344	31.2	3,114
KBC 2272-18	22	72	21	34	368	31.2	3,308

22" depth | 84" width

MODEL	DIMENSIONS				WEIGHT	CUBIC FEET	LIST PRICE
	D	W	base H	overall H			
KBC 2284-01	22	84	21	34	403	36.4	\$ 3,334
KBC 2284-02	22	84	21	34	355	36.4	3,237
KBC 2284-03	22	84	21	34	379	36.4	3,371
KBC 2284-04	22	84	21	34	355	36.4	3,237
KBC 2284-05	22	84	21	34	403	36.4	3,326
KBC 2284-06	22	84	21	34	403	36.4	3,326
KBC 2284-07	22	84	21	34	379	36.4	3,073
KBC 2284-08	22	84	21	34	379	36.4	3,073
KBC 2284-09	22	84	21	34	367	36.4	3,169
KBC 2284-10	22	84	21	34	367	36.4	3,169
KBC 2284-11	22	84	21	34	367	36.4	3,129

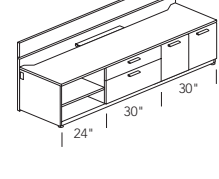
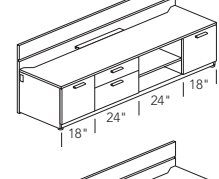
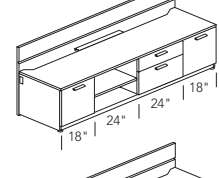
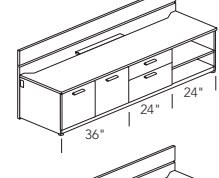
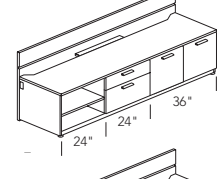
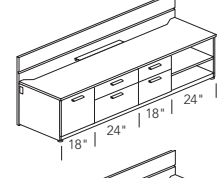
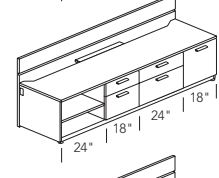
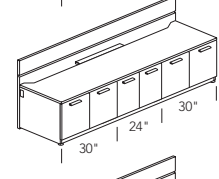
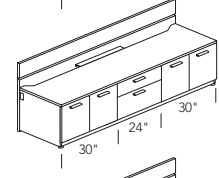
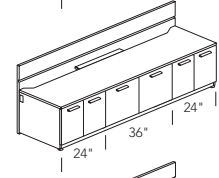
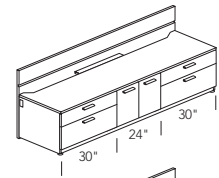



KEEL™ base cabinet

CONSTRUCTION/FEATURES

- Top - 1" thick high pressure laminate (HPL) with 2mm edge
- Case - 5/8" thick & Keel Panel - 1" thick thermofused melamine (TFM) with 2mm edge
- Drawer or Door Fronts - 5/8" thick (HPL) or (TFM) with 2mm edge
- Wire management and 2 side grommets
- Includes 24" Channel Tray
- Drawers are Box/File, File includes hanging bars
- Single Doors that are 18" width, hinge is on left if door is left of base cabinet center, opposite for right hinged.

OPTIONS

- Metal drawer pulls
 -  (W) Waterfall (silver)
 -  (O) Open Pull (silver)
- Locking Mechanism, place an "N, K or L" after model #

SPECIFY

1. Model Number
2. Case & Keel Color
3. Door & Drawer Color
4. Top Color
5. Drawer/Door Pulls
6. Options: Locking Mechanism upcharge for K or L
84"W + \$70.00
96"W + \$80.00

22" depth | 84" width

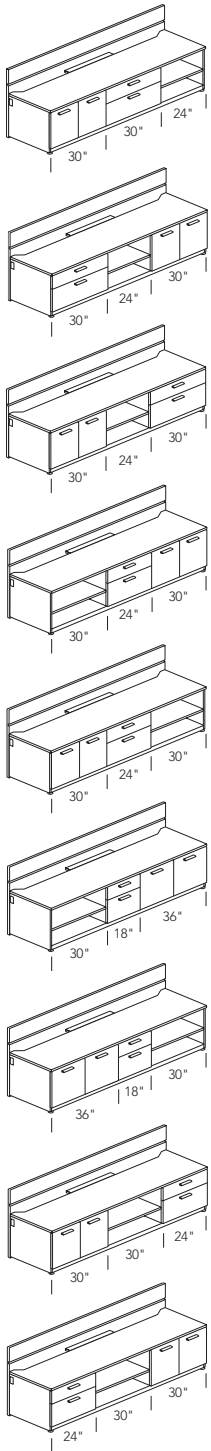

DIMENSIONS

MODEL	D	W	base H	overall H	WEIGHT	CUBIC FEET	LIST PRICE
KBC 2284-12	22	84	21	34	367	36.4	\$ 3,129
KBC 2284-13	22	84	21	34	367	36.4	3,059
KBC 2284-14	22	84	21	34	367	36.4	3,127
KBC 2284-15	22	84	21	34	367	36.4	3,058
KBC 2284-16	22	84	21	34	367	36.4	3,058
KBC 2284-17	22	84	21	34	367	36.4	3,041
KBC 2284-18	22	84	21	34	367	36.4	3,041
KBC 2284-19	22	84	21	34	367	36.4	3,057
KBC 2284-20	22	84	21	34	367	36.4	3,057

22" depth | 96" width

MODEL	DIMENSIONS				WEIGHT	CUBIC FEET	LIST PRICE
	D	W	base H	overall H			
KBC 2296-01	22	96	21	34	391	41.6	\$ 3,606
KBC 2296-02	22	96	21	34	415	41.6	3,668
KBC 2296-03	22	96	21	34	415	41.6	3,651
KBC 2296-04	22	96	21	34	415	41.6	3,651
KBC 2296-05	22	96	21	34	415	41.6	3,640
KBC 2296-06	22	96	21	34	415	41.6	3,640
KBC 2296-07	22	96	21	34	427	41.6	3,824
KBC 2296-08	22	96	21	34	427	41.6	3,824
KBC 2296-09	22	96	21	34	439	41.6	3,699
KBC 2296-10	22	96	21	34	439	41.6	3,699
KBC 2296-11	22	96	21	34	439	41.6	3,767

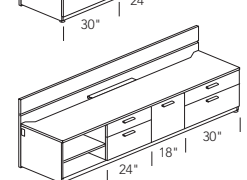
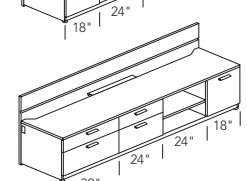
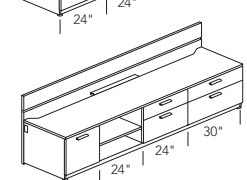
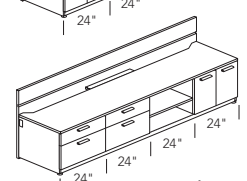
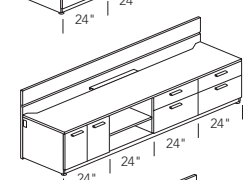
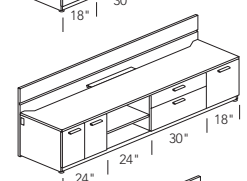
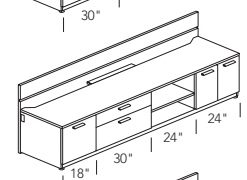
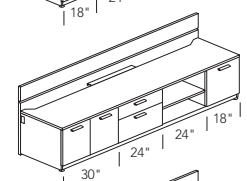
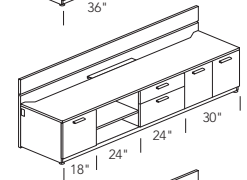
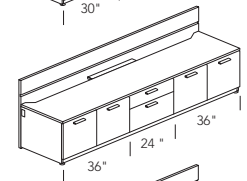
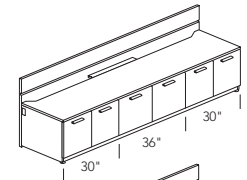

KEEL™ base cabinet

CONSTRUCTION/FEATURES

- Top - 1" thick high pressure laminate (HPL) with 2mm edge
- Case - 5/8" thick & Keel Panel - 1" thick thermofused melamine (TFM) with 2mm edge
- Drawer or Door Fronts - 5/8" thick (HPL) or (TFM) with 2mm edge
- Wire management and 2 side grommets
- Includes 24" Channel Tray
- Drawers are Box/File, File includes hanging bars
- Single Doors that are 18" width, hinge is on left if door is left of base cabinet center, opposite for right hinged.

OPTIONS

- Metal drawer pulls
 - (W) Waterfall (silver)
 - (O) Open Pull (silver)
- Locking Mechanism, place an "N, K or L" after model #

SPECIFY

1. Model Number
2. Case & Keel Color
3. Door & Drawer Color
4. Top Color
5. Drawer/Door Pulls
6. Options: Locking Mechanism upcharge for K or L
96"W + \$80.00
18"D, all W + \$60.00

22" depth | 96" width

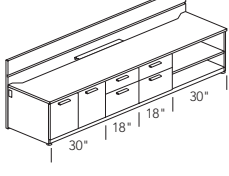
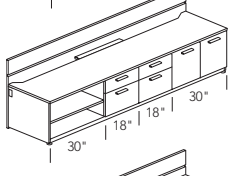
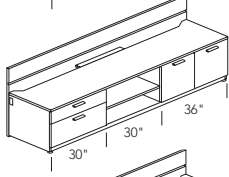
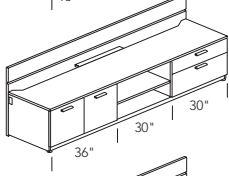
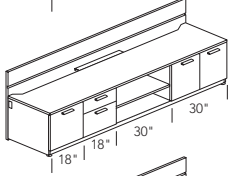
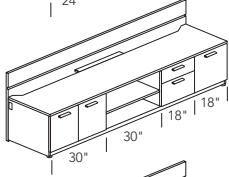
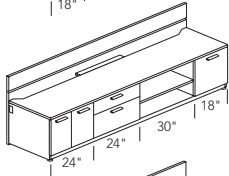
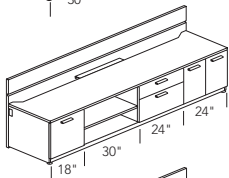
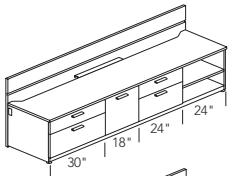

DIMENSIONS

MODEL	D	W	base H	overall H	WEIGHT	CUBIC FEET	LIST PRICE
KBC 2296-12	22	96	21	34	415	41.6	\$ 3,767
KBC 2296-13	22	96	21	34	403	41.6	3,637
KBC 2296-14	22	96	21	34	403	41.6	3,637
KBC 2296-15	22	96	21	34	403	41.6	3,614
KBC 2296-16	22	96	21	34	403	41.6	3,614
KBC 2296-17	22	96	21	34	415	41.6	3,561
KBC 2296-18	22	96	21	34	415	41.6	3,561
KBC 2296-19	22	96	21	34	427	41.6	3,778
KBC 2296-20	22	96	21	34	427	41.6	3,778

KEEL™ base cabinet

MODEL	DIMENSIONS				WEIGHT	CUBIC FEET	LIST PRICE
	D	W	base H	overall H			
KBC 2296-21	22	96	21	34	439	41.6	\$3,735
KBC 2296-22	22	96	21	34	439	41.6	3,735
KBC 2296-23	22	96	21	34	415	41.6	3,762
KBC 2296-24	22	96	21	34	403	41.6	3,607

22" depth | 96" width

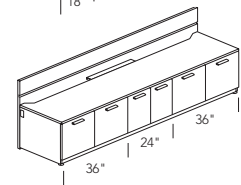
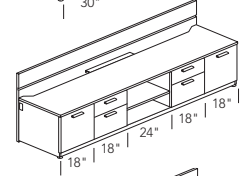
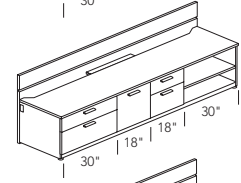
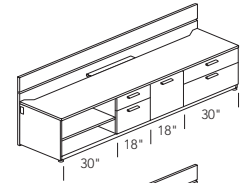

MODEL	DIMENSIONS				WEIGHT	CUBIC FEET	LIST PRICE
	D	W	base H	overall H			
KBC 1860	18	60	21	34	201	20.1	\$ 2,360
KBC 1872	18	72	21	34	245	24.1	2,536
KBC 1884	18	84	21	34	280	28.1	2,694
KBC 1896	18	96	21	34	314	32.1	2,799

18" depth

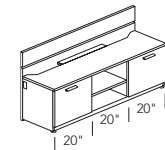

60" width

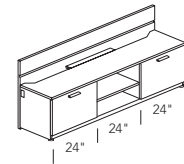

72" width

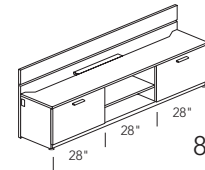

84" width

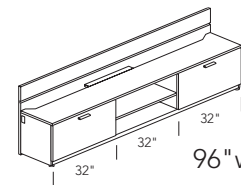

96" width

KEEL™ worksurfaces and supports

Keel Mounted Worksurfaces are supported on one end by attaching to the Keel Rail with bolts through the supplied brackets, and on the other end by a Worksurface Support. This creates an "L" off of the Keel. Supports include a Drawer Pedestal in B/B/F and F/F

configuration; a laminated Panel End; a Metal Leg/Panel and a Metal Column. A single support is needed for the Keel Mounted Worksurface and two for the Freestanding Worksurface. Worksurfaces over 72" must be supported on one end by a Metal Column or Pedestal

Support. All Elbow worksurfaces must be supported on one end by a Metal Column Support.

KEEL VOCABULARY

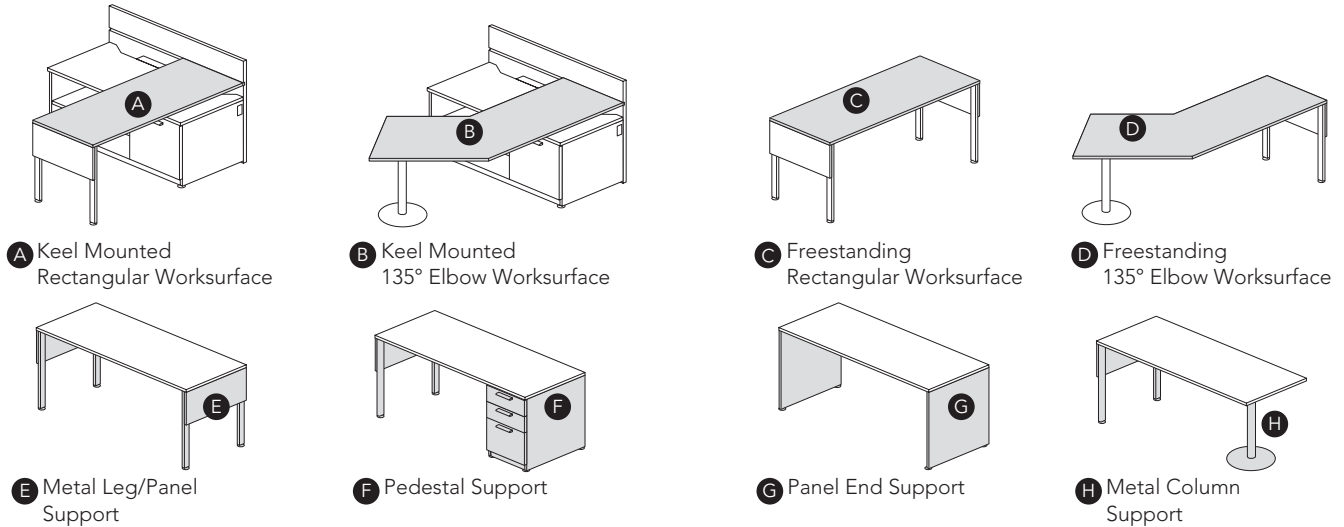

MODEL NUMBER BUILD WORKSURFACE	KRWS 2242 FS	LBT	MODEL NUMBER BUILD WORKSURFACE SUPPORT	KWSS PEDBBF24	LBT	OR	M01	M01	W
	1. Model #	2.		1. Model #	2.	3.	4.	5.	

SPECIFY WORKSURFACE

1. Model Number
2. Worksurfaces Color
Must order
1 support for Keel Mounted
2 support for Freestanding
3. Optional Horizontal Cable Manager

SPECIFY WORKSURFACE SUPPORT

1. Model Number
2. Panel End or Metal Leg/Panel Color
or
3. Pedestal Case Color
4. Pedestal Drawer Front Color
5. Drawer/Door Pull
select Waterfall or Open
O = Open (silver only)
W = Waterfall (silver only)

2. WORKSURFACES and PANEL END OR METAL LEG/PANEL

- Laminates with coordinating edgebands
- CORE SOLIDS | EDGE BAND**
- LBT Dover White | White
LDM Pearl | Neutral White
LDQ Platinum | Platinum
LCD Graphite | Graphite
LAS Black | Black
- CLASSIC WOODGRAINS | EDGE BAND**
- LTS Fusion Maple | Fusion Maple
LS2 Huntington Maple | Huntington Maple
LTW Empire Mahogany | Empire Mahogany
LT6 Hemlock | Hemlock

- Laminates with complimentary edgebands
- CLASSIC PATTERNS | EDGE BAND**
- LRP Grey Mesh | Folkstone
LRT Steel Mesh | Citadel
LRZ Gilded Mesh | Platinum
LRC Pewter Mesh | Citadel
- EVOLVING WOODGRAINS | EDGE BAND**
- LCC Smoky Brown Pear | Graphite
LCG Millennium Oak | Earth
LCR Oiled Walnut | Brown
LCY Dunewood | Neutral White

3. PEDESTAL CASE Melamines with coordinating edgebands

- CORE SOLIDS | EDGE BAND**
- M01 Cloud | White
M17 Ivory | Neutral White
M19 Platinum | Platinum
M03 Graphite | Graphite
M13 Black | Black
- CLASSIC WOODGRAINS | EDGE BAND**
- M06 Fusion Maple | Fusion Maple
M08 Huntington Maple | Huntington Maple
M11 Empire Mahogany | Empire Mahogany
M21 Hemlock | Hemlock

4. PEDESTAL DRAWER FRONT Melamines with coordinating edgebands

- CORE SOLIDS | EDGE BAND**
- M01 Cloud | White
M17 Ivory | Neutral White
M19 Platinum | Platinum
M03 Graphite | Graphite
M13 Black | Black
- CLASSIC WOODGRAINS | EDGE BAND**
- M06 Fusion Maple | Fusion Maple
M08 Huntington Maple | Huntington Maple
M11 Empire Mahogany | Empire Mahogany
M21 Hemlock | Hemlock

- Laminates with complimentary edgebands
- EVOLVING WOODGRAINS | EDGE BAND**
- LCC Smoky Brown Pear | Graphite
LCG Millennium Oak | Earth
LCR Oiled Walnut | Brown
LCY Dunewood | Neutral White

KEEL™ worksurfaces and supports

CONSTRUCTION/FEATURES

- 1" thick High Pressure Laminate(HPL) with 2mm edge
- Anti-sag support bar of 11ga. steel stock for worksurfaces 60" and up.
- Keel Mounted Worksurfaces have 2 steel attachment brackets
- Freestanding Worksurfaces require 2 supports.
- Keel Mounted Worksurface may be attached at right angle to a Freestanding with a Flat Bracket (see accessory section)
- Pedestal support has full extension, ball-bearing slides and standard locking mechanism
- Metal Leg/Panel Support panel and Panel End Support are 1" thick (HPL) with 2mm edge

OPTIONS

- Supports (order separately)
- Horizontal Cable Manager
- Metal drawer pulls

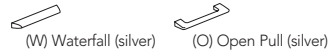

RESTRICTIONS

- Freestanding & Keel Mounted Rectangular Worksurfaces, widths of 78", 84" & 90", must use Pedestal Support or Metal Column Support
- Elbow Worksurfaces, 78", 84" & 90", must use Metal Column Support at Elbow end.
- Do not use Metal Column Support at both ends of a Freestanding Worksurface.

SPECIFY Worksurface

1. Model Number
2. Worksurfaces, Panel Support Color
3. Optional Horizontal Cable Manager

SPECIFY Worksurface Support

1. Model Number
2. Panel End or Metal Leg/Panel Color
3. Pedestal Case Color
4. Pedestal Drawer Front Color
5. Pedestal Drawer Pull

Keel Mounted Rectangular Worksurface

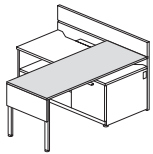

DIMENSIONS

MODEL	D	W	overall H	WEIGHT	CUBIC FEET	LIST PRICE
KRWS 2442 KM	24	42	29	52	0.6	\$ 303
KRWS 2448 KM	24	48	29	59	0.7	314
KRWS 2460 KM	24	60	29	74	0.8	440
KRWS 2466 KM	24	66	29	81	0.9	495
KRWS 2472 KM	24	72	29	88	1.0	534
KRWS 2478 KM	24	78	29	96	1.1	608
KRWS 2484 KM	24	84	29	103	1.2	621
KRWS 2490 KM	24	90	29	118	1.3	629
KRWS 3042 KM	30	42	29	65	0.7	\$ 324
KRWS 3048 KM	30	48	29	74	0.8	344
KRWS 3060 KM	30	60	29	92	1.0	471
KRWS 3066 KM	30	66	29	101	1.1	536
KRWS 3072 KM	30	72	29	111	1.3	565
KRWS 3078 FM	30	78	29	120	1.4	639
KRWS 3084 KM	30	84	29	129	1.5	650
KRWS 3090 KM	30	90	29	109	1.6	659

Freestanding Rectangular Worksurface

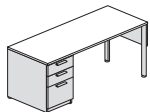

DIMENSIONS

MODEL	D	W	overall H	WEIGHT	CUBIC FEET	LIST PRICE
KRWS 2242 FS	22	42	29	43	0.5	\$ 260
KRWS 2248 FS	22	48	29	54	0.6	281
KRWS 2260 FS	22	60	29	64	0.8	406
KRWS 2266 FS	22	66	29	74	0.8	513
KRWS 2272 FS	22	72	29	78	0.9	534
KRWS 2442 FS	24	42	29	48	0.6	\$ 260
KRWS 2448 FS	24	48	29	56	0.7	284
KRWS 2460 FS	24	60	29	70	0.8	399
KRWS 2466 FS	24	66	29	78	0.9	450
KRWS 2472 FS	24	72	29	85	1.0	504
KRWS 2478 FS	24	78	29	92	1.1	555
KRWS 3042 FS	30	42	29	61	0.7	\$ 284
KRWS 3048 FS	30	48	29	70	0.8	305
KRWS 3060 FS	30	60	29	89	1.0	418
KRWS 3066 FS	30	66	29	97	1.1	492
KRWS 3072 FS	30	72	29	107	1.3	524
KRWS 3078 FS	30	78	29	116	1.4	629

KEEL™ worksurfaces and supports

MODEL	DIMENSIONS				WEIGHT	CUBIC FEET	LIST PRICE
	worksurface D	overall D	overall W	overall H			
KEW R 2478 KM	24	36	78	29	92	1.6	\$ 713
KEW R 2484 KM	24	36	84	29	103	1.8	715
KEW R 2490 KM	24	36	90	29	118	1.9	822
KEW R 3078 KM	30	42	78	29	116	1.9	756
KEW R 3084 KM	30	42	84	29	129	2.0	754
KEW R 3090 KM	30	42	90	29	139	2.2	838
KEW L 2478 KM	24	36	78	29	92	1.6	\$ 713
KEW L 2484 KM	24	36	84	29	103	1.8	715
KEW L 2490 KM	24	36	90	29	118	1.9	822
KEW L 3078 KM	30	42	78	29	116	1.9	756
KEW L 3084 KM	30	42	84	29	129	2.0	754
KEW L 3090 KM	30	42	90	29	139	2.2	838

Keel Mounted 135° Elbow Worksurface

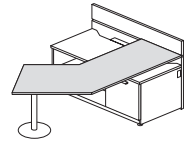

right handed

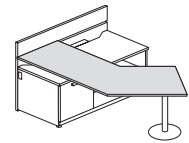

left handed

MODEL	DIMENSIONS				WEIGHT	CUBIC FEET	LIST PRICE
	worksurface D	overall D	overall W	overall H			
KEW R 2478 FS	24	36	78	29	90	1.6	\$ 659
KEW R 2484 FS	24	36	84	29	101	1.8	681
KEW R 2490 FS	24	36	90	29	116	1.9	765
KEW R 3078 FS	30	42	78	29	114	1.9	713
KEW R 3084 FS	30	42	84	29	127	2.0	713
KEW R 3090 FS	30	42	90	29	137	2.2	786
KEW L 2478 FS	24	36	78	29	90	1.6	\$ 659
KEW L 2484 FS	24	36	84	29	101	1.8	681
KEW L 2490 FS	24	36	90	29	116	1.9	765
KEW L 3078 FS	30	42	78	29	114	1.9	713
KEW L 3084 FS	30	42	84	29	127	2.0	713
KEW L 3090 FS	30	42	90	29	137	2.2	786

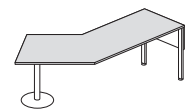

right handed

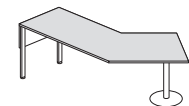

left handed

MODEL	DIMENSIONS			WEIGHT	CUBIC FEET	LIST PRICE
	D	W	overall H			
KWSS ML-PNL22	1	22	29	16	0.4	\$ 295
KWSS ML-PNL 24	1	24	29	18	0.4	291
KWSS ML-PNL 30	1	30	29	20	0.5	277
KWSS PEDBBF24	24	15	29	111	6.0	\$ 1221
KWSS PEDBBF30	30	15	29	131	7.6	1204
KWSS PEDFF24	24	15	29	108	6.0	\$ 1065
KWSS PEDFF30	30	15	29	128	7.6	1149
KWSS PNLEND22	22	1	29	20	0.4	\$ 384
KWSS PNLEND24	24	1	29	22	0.4	391
KWSS PNLEND30	30	1	29	25	0.5	397
KWSS MCOL	20 dia		29	67	2.4	\$ 839

Worksurface Supports

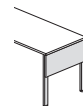

Metal Leg/Panel Support



Pedestal Support box/box/file



Pedestal Support file/file

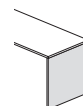

Panel End Support

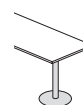

Metal Column Support

KEEL™ table desk

CONSTRUCTION/FEATURES

- Top and Sides – 1" thick high pressure laminate (HPL) with 2mm edge
- Metal legs are 1" x 2" steel tube, silver finish
- Modesty Panel, 5/8" thick (HPL), recesses 2 3/4" under top

OPTIONS

- Horizontal Cable Manager

SPECIFY

1. Model Number
2. Top, Side & Modesty Panel Color
3. Optional Horizontal Cable Manager

DIMENSIONS

Table Desk

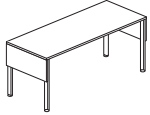

MODEL	D	W	overall H	WEIGHT	CUBIC FEET	LIST PRICE
KTD 2460	24	60	29	108	24	\$ 986
KTD 2466	24	66	29	116	27	996
KTD 2472	24	72	29	124	29	1017
KTD 3060	30	60	29	125	30	1017
KTD 3066	30	66	29	133	33	1038
KTD 3072	30	72	29	143	36	1059

Table Desk with Modesty

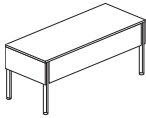

KTD 2460 MP	24	60	29	134	24	\$ 1353
KTD 2466 MP	24	66	29	144	27	1385
KTD 2472 MP	24	72	29	153	29	1406
KTD 3060 MP	30	60	29	151	30	1406
KTD 3066 MP	30	66	29	161	33	1427
KTD 3072 MP	30	72	29	173	36	1469

KEEL Hutches provide easy access overhead storage and, when used in open plan, offer visual privacy and space definition. Swing door and slide door, shared and a double high hutch, all offer great versatility while three heights and eight widths accommodate any storage

need. Hutch attaches securely to the Keel Rail ensuring a secure, no-tip attachment. A decorative, metal support is offered on all hutches to replace the laminated end panel giving a more open, airy appearance to the group.

KEEL VOCABULARY

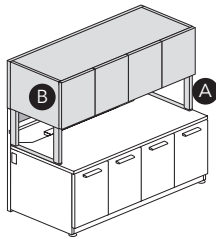

- A** Hutch with Metal Supports
- B** Case(top, sides & bottom)

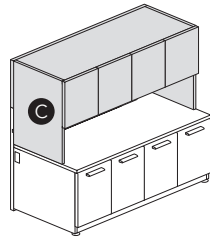

- C** Hutch with Panel Supports

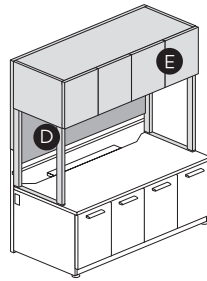

- D** Tackboard
- E** Swing Door Front

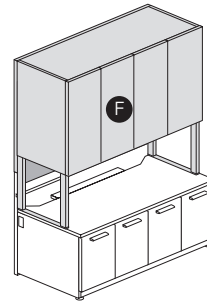

- F** Double Hutch

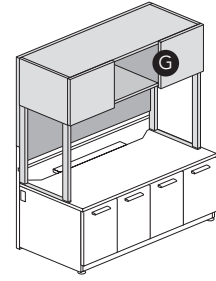

- G** Hutch with Slide Door Front

MODEL NUMBER BUILD

KHSD PS 6049 M03 LCC Sisal/Straw L
 1. Model # 2. 3. 4. 5.

SPECIFY

1. Model Number
2. Hutch Case Color
3. Hutch Door Front Color
4. Tackboard Fabric (on all Hutches but Wall Mounted). Grade 1 fabric is standard, upcharge for fabric Grades 2-4:
 Grade 2 = +\$60.00
 Grade 3 = +\$90.00
 Grade 4 = +\$150.00
 Grade 5 = +\$240.00
5. Locking Mechanism K & L upcharge: see each page for \$

2. HUTCH CASE

Melamines with coordinating edgebands

CORE SOLIDS | EDGE BAND

- M01 Cloud | White
- M17 Ivory | Neutral White
- M19 Platinum | Platinum
- M03 Graphite | Graphite
- M13 Black | Black

CLASSIC WOODGRAINS | EDGE BAND

- M06 Fusion Maple | Fusion Maple
- M08 Huntington Maple | Huntington Maple
- M11 Empire Mahogany | Empire Mahogany
- M21 Hemlock | Hemlock

3. HUTCH DOOR FRONT

Melamines with coordinating edgebands

CORE SOLIDS | EDGE BAND

- M01 Cloud | White
- M17 Ivory | Neutral White
- M19 Platinum | Platinum
- M03 Graphite | Graphite
- M13 Black | Black

CLASSIC WOODGRAINS | EDGE BAND

- M06 Fusion Maple | Fusion Maple
- M08 Huntington Maple | Huntington Maple
- M11 Empire Mahogany | Empire Mahogany
- M21 Hemlock | Hemlock

Laminates with complimentary edgebands

EVOLVING WOODGRAINS | EDGE BAND

- LCC Smoky Brown Pear | Graphite
- LCG Millennium Oak | Earth
- LCR Oiled Walnut | Brown
- LCY Dunewood | Neutral White

4. TACKBOARD FABRICS

Grade 1

CSM

Grade 2

Script: Feldspar, Flint, Nectar, Sand, Shadow, Slate, Sterling, Taupe

Pact: Azure, Calla, Dragon, Eureka, Harbour, Lime, Patina, Tanzanite

Grade 3

Blazer Lite: Angel, Aspire, Balance, Bliss, Cuddle, Dainty, Daydream, Graceful, Harmony, Hope, Pastel, Pillow, Retreat, Solace, Wish

5. LOCKING MECHANISM

- N No Lock (standard)
- K Locks Keyed Alike (upcharge)
- L Locks Keyed Random (upcharge)

KEEL™ hutches

CONSTRUCTION/FEATURES

- Case - 5/8" thick & Back - 1" thick thermofused melamine (TFM) with 2mm edge
- Door Fronts - 5/8" thick high pressure laminate (HPL) or (TFM) with 2mm edge
- Tackboard included in grade 1 fabric (grade 2-5 available)
- Available with laminated panel supports or metal supports

OPTIONS

- Locking Mechanism, place an "N, K or L" after model #
- Tackboard Fabric

SPECIFY

1. Model Number
2. Case Color
3. Door Color
4. Tackboard Fabric
5. Options: Locking Mechanism upcharge for K or L
36", 42"W = +\$42.00
48", 54"W = +\$62.00
60", 72"W = +\$83.00

Swing Door with Panel Support

DIMENSIONS

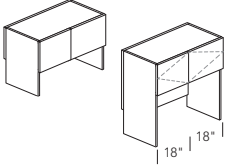
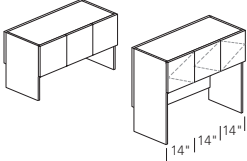
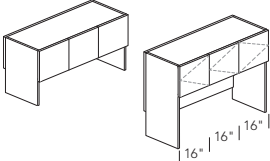
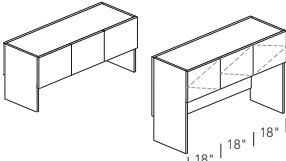
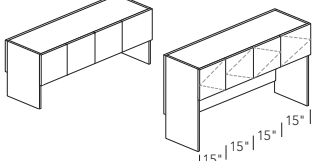
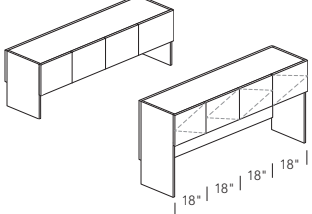
MODEL	DIMENSIONS				WEIGHT	CUBIC FEET	LIST PRICE	
	D	W	hutch H	overall H				
	KHSD PS 3649	15.25	36	28	49	90	15.6	\$ 1097
	KHSD PS 3663	15.25	36	42	63	92	20.1	1203
	KHSD PS 4249	15.25	42	28	49	105	18.2	\$ 1298
	KHSD PS 4263	15.25	42	42	63	107	23.4	1382
	KHSD PS 4849	15.25	48	28	49	120	20.8	\$ 1302
	KHSD PS 4863	15.25	48	42	63	122	26.8	1471
	KHSD PS 5449	15.25	54	28	49	137	23.4	\$ 1516
	KHSD PS 5463	15.25	54	42	63	139	30.1	1645
	KHSD PS 6049	15.25	60	28	49	150	26.1	\$ 1528
	KHSD PS 6063	15.25	60	42	63	152	33.5	1759
	KHSD PS 7249	15.25	72	28	49	181	31.3	\$ 1639
	KHSD PS 7263	15.25	72	42	63	184	40.2	1851

Swing Door with Metal Support

MODEL	DIMENSIONS				WEIGHT	CUBIC FEET	LIST PRICE
	D	W	hutch H	overall H			
KHSD MS 3649	15.25	36	28	49	90	15.6	\$ 1231
KHSD MS 3663	15.25	36	42	63	92	20.1	1363
KHSD MS 4249	15.25	42	28	49	105	18.2	\$ 1519
KHSD MS 4263	15.25	42	42	63	107	23.4	1622
KHSD MS 4849	15.25	48	28	49	120	20.8	\$ 1440
KHSD MS 4863	15.25	48	42	63	122	26.8	1634
KHSD MS 5449	15.25	54	28	49	137	23.4	\$ 1647
KHSD MS 5463	15.25	54	42	63	139	30.1	1803
KHSD MS 6049	15.25	60	28	49	150	26.1	\$ 1668
KHSD MS 6063	15.25	60	42	63	152	33.5	1926
KHSD MS 7249	15.25	72	28	49	181	31.3	\$ 1783
KHSD MS 7263	15.25	72	42	63	184	40.2	2020

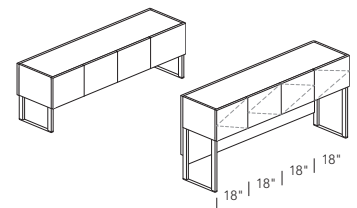
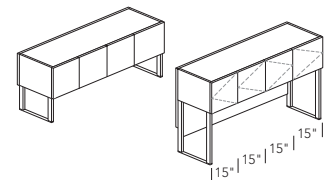
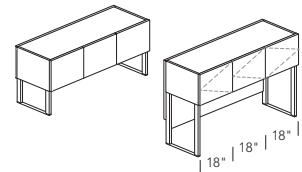
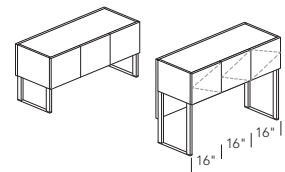
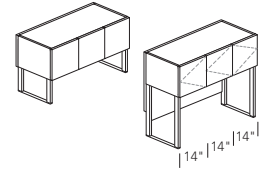
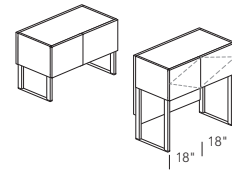

KEEL™ hutches

CONSTRUCTION/FEATURES

- Case - 5/8" thick & Back - 1" thick thermofused melamine (TFM) with 2mm edge
- Door Fronts - 5/8" thick high pressure laminate (HPL) or (TFM) with 2mm edge
- Tackboard included in grade 1 fabric (grade 2-5 available)
- Available with laminated panel supports or metal supports

OPTIONS

- Locking Mechanism, place an "N, K or L" after model #
- Tackboard Fabric

SPECIFY

1. Model Number
2. Case Color
3. Door Color
4. Tackboard Fabric
5. Options: Locking Mechanism upcharge for K or L
36", 42", 48"W = +\$32.00
54", 60", 72"W = +\$61.00

Slide Door with Panel Support

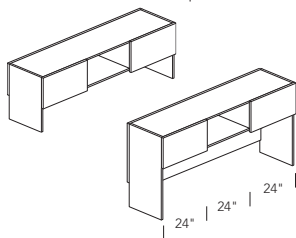
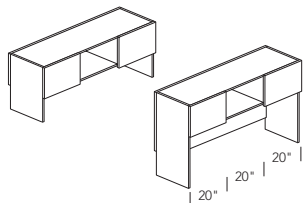
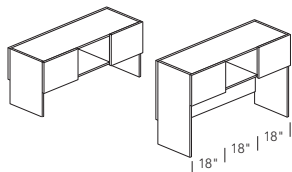
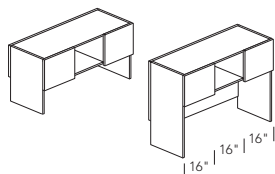
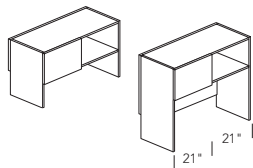
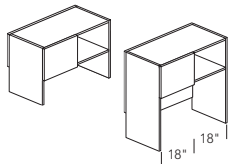

DIMENSIONS

MODEL	D	W	hutch H	overall H	WEIGHT	CUBIC FEET	LIST PRICE
KHSLD PS 3649	15.25	36	28	49	90	15.6	\$ 1298
KHSLD PS 3663	15.25	36	42	63	92	20.1	1404
KHSLD PS 4249	15.25	42	28	49	105	18.2	\$ 1499
KHSLD PS 4263	15.25	42	42	63	107	23.4	1577
KHSLD PS 4849	15.25	48	28	49	120	20.8	\$ 1371
KHSLD PS 4863	15.25	48	42	63	122	26.8	1540
KHSLD PS 5449	15.25	54	28	49	137	23.4	\$ 1906
KHSLD PS 5463	15.25	54	42	63	139	30.1	2036
KHSLD PS 6049	15.25	60	28	49	150	26.1	\$ 1793
KHSLD PS 6063	15.25	60	42	63	152	33.5	2024
KHSLD PS 7249	15.25	72	28	49	181	31.3	\$ 1896
KHSLD PS 7263	15.25	72	42	63	184	40.2	2108

Slide Door with Metal Support

MODEL	DIMENSIONS				WEIGHT	CUBIC FEET	LIST PRICE
	D	W	hutch H	overall H			
KHSLD MS 3649	15.25	36	28	49	90	15.6	\$ 1425
KHSLD MS 3663	15.25	36	42	63	92	20.1	1556
KHSLD MS 4249	15.25	42	28	49	105	18.2	\$ 1520
KHSLD MS 4263	15.25	42	42	63	107	23.4	1622
KHSLD MS 4849	15.25	48	28	49	120	20.8	\$ 1500
KHSLD MS 4863	15.25	48	42	63	122	26.8	1695
KHSLD MS 5449	15.25	54	28	49	137	23.4	\$ 1925
KHSLD MS 5463	15.25	54	42	63	139	30.1	2043
KHSLD MS 6049	15.25	60	28	49	150	26.1	\$ 1926
KHSLD MS 6063	15.25	60	42	63	152	33.5	2182
KHSLD MS 7249	15.25	72	28	49	181	31.3	\$ 2032
KHSLD MS 7263	15.25	72	42	63	184	40.2	2269

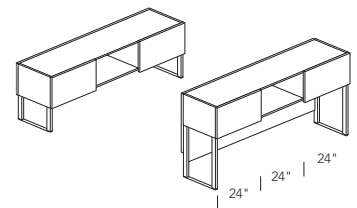
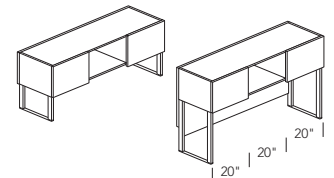
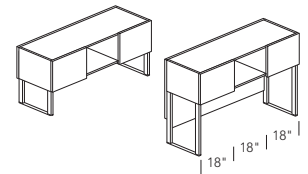
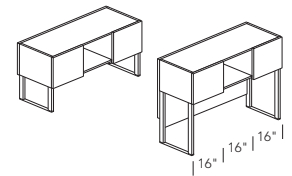
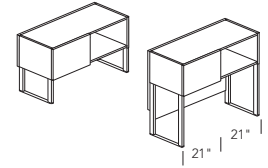
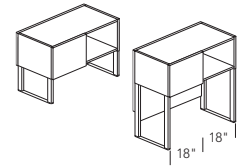

KEEL™ hutches

CONSTRUCTION/FEATURES

- Case - 5/8" thick & Back - 1" thick thermofused melamine (TFM) with 2mm edge
- Door Fronts - 5/8" thick high pressure laminate (HPL) or (TFM) with 2mm edge
- Tackboard included in grade 1 fabric (grade 2-5 available)
- Available with laminated panel supports or metal supports
- Shared Hutch: brackets seat hutch on top of double Keel Panel and attaches to Keel Rail on both sides

OPTIONS

- Locking Mechanism, place an "N, K or L" after model #
- Tackboard Fabric

SPECIFY

1. Model Number
2. Case Color
3. Door Color
4. Tackboard Fabric
5. Options: Locking Mechanism upcharge for K or L
KHD = +\$83.00
KSH = +\$83.00

Double Swing Door with Panel Support

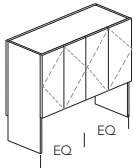

DIMENSIONS

MODEL	D	W	hutch H	overall H	WEIGHT	CUBIC FEET	LIST PRICE
KHD PS 4871	15.25	48	50	71	101	30.2	\$ 2147
KHD PS 6071	15.25	60	50	71	127	37.7	2317
KHD PS 7271	15.25	72	50	71	154	45.3	2448

Double Swing Door with Metal Support

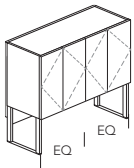

KHD MS 4871	15.25	48	50	71	101	30.2	\$ 2293
KHD MS 6071	15.25	60	50	71	127	37.7	2465
KHD MS 7271	15.25	72	50	71	154	45.3	2599

Shared Door Left

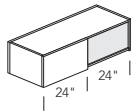
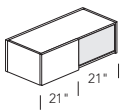
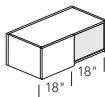

DIMENSIONS

MODEL	D	W	hutch H	overall H	WEIGHT	CUBIC FEET	LIST PRICE
KHSH 36 DL	15.25	36	15	49	84	4.8	\$ 1872
KHSH 42 DL	15.25	42	15	49	96	5.6	2023
KHSH 48 DL	15.25	48	15	49	108	6.4	1976

Shared Door Right

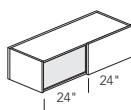
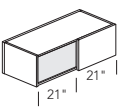
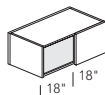

KHSH 36 DR	15.25	36	15	49	84	4.8	\$ 1872
KHSH 42 DR	15.25	42	15	49	96	5.6	2023
KHSH 48 DR	15.25	48	15	49	108	6.4	1976

CONSTRUCTION/FEATURES

- Case - 5/8" thick & Back - 1" thick thermofused melamine (TFM) with 2mm edge
- Door Fronts - 5/8" thick high pressure laminate (HPL) or (TFM) with 2mm edge
- Secured to wall using plywood cleats. Installer to determine best and safest method of attachment to wall.

OPTIONS

- Locking Mechanism, place an "N, K or L" after model #

SPECIFY

1. Model Number
2. Case Color
3. Door Color
4. Options: Locking Mechanism upcharge for K or L
 - 36" W = +\$27.00
 - 42", 48" W = +\$42.00
 - 54", 60", 72"W = +\$54.00
 - 84" W = +\$68.00
 - 96" W = +\$81.00

MODEL	DIMENSIONS				WEIGHT	CUBIC FEET	LIST PRICE
	D	W	hutch H	overall H			
KHSD WM 36	15.25	36	15	NA	72	4.8	\$ 998
KHSD WM 42	15.25	42	15	NA	78	5.6	1004
KHSD WM 48	15.25	48	15	NA	84	6.4	1189
KHSD WM 54	15.25	54	15	NA	90	7.2	1218
KHSD WM 60	15.25	60	15	NA	96	8.0	1411
KHSD WM 72	15.25	72	15	NA	108	9.6	1476
KHSD WM 84	15.25	84	15	NA	125	11.2	1680
KHSD WM 96	15.25	96	15	NA	154	12.8	1877

Swing Door Wall Mounted

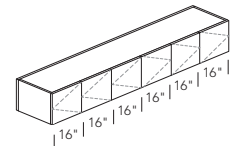
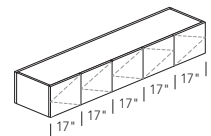
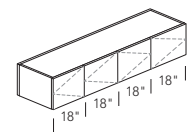
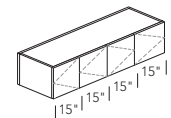
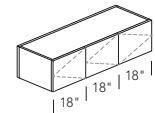
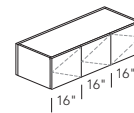
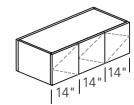
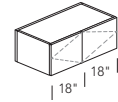

KEEL™ hutches

CONSTRUCTION/FEATURES

- Case - 5/8" thick & Back - 1" thick thermofused melamine (TFM) with 2mm edge
- Door Fronts - 5/8" thick high pressure laminate (HPL) or (TFM) with 2mm edge
- Secured to wall using plywood cleats. Installer to determine best and safest method of attachment to wall.

OPTIONS

- Locking Mechanism, place an "N, K or L" after model #

SPECIFY

1. Model Number
2. Case Color
3. Door Color
4. Options: Locking Mechanism upcharge for K or L
 36", 42", 48" W = +\$32.00
 54", 60", 72", 84", 96" W = +\$61.00

Slide Door Wall Mounted

DIMENSIONS

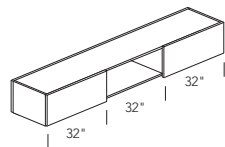
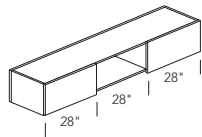
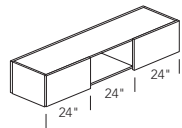
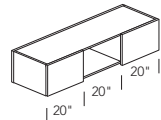
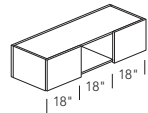
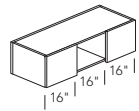
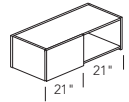
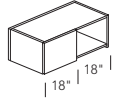

MODEL	DIMENSIONS				WEIGHT	CUBIC FEET	LIST PRICE
	D	W	hutch H	overall H			
KHSLD WM 36	15.25	36	15	NA	72	4.8	\$ 1152
KHSLD WM 42	15.25	42	15	NA	78	5.6	1184
KHSLD WM 48	15.25	48	15	NA	84	6.4	1204
KHSLD WM 54	15.25	54	15	NA	90	7.2	1552
KHSLD WM 60	15.25	60	15	NA	96	8.0	1616
KHSLD WM 72	15.25	72	15	NA	108	9.6	1674
KHSLD WM 84	15.25	84	15	NA	125	11.2	1743
KHSLD WM 96	15.25	96	15	NA	154	12.8	1802

KEEL™ cabinet & horizontal storage

KEEL Cabinets offer above surface shelf and door storage. Three heights, 49", 63" and 71" and three widths, 18", 24" and 30" are offered.

Cabinets sit on base cabinet. A cam lock in each side panel attaches cabinet to the keel rail ensuring a secure, no-tip attachment.

The Horizontal Storage gives a counter height surface with storage using three open compartments with laminated panel end or metal support.

KEEL VOCABULARY

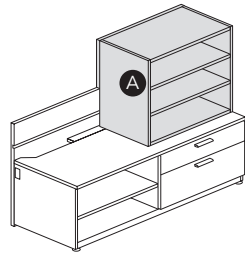

A Cabinet Bookcase

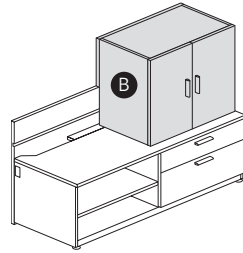

B Cabinet with Doors

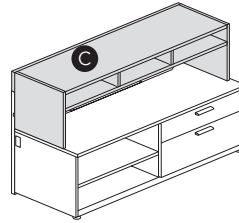

C Horizontal Storage with Panel End Support

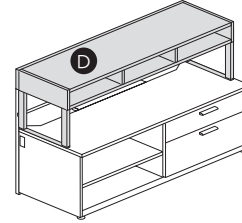

D Horizontal Storage with Metal Support

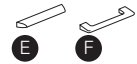

Door & Drawer Pulls
E Waterfall (silver only)
F Open Pull (silver only)

MODEL NUMBER BUILD

KCD 3049 M03 LCC O L
 1. Model # 2. 3. 4. 5.

SPECIFY

1. Model Number
2. Cabinet Case Color
3. Cabinet Door Front Color
4. Door Pull
select Waterfall or Open
5. Locking Mechanism
K & L upcharge:
18" W = +\$36.00
24", 36"W = +\$46.00
KCBC = na

2. CABINET CASE

Melamines with coordinating edgebands

CORE SOLIDS | EDGE BAND

- M01 Cloud | White
- M17 Ivory | Neutral White
- M19 Platinum | Platinum
- M03 Graphite | Graphite
- M13 Black | Black

CLASSIC WOODGRAINS | EDGE BAND

- M06 Fusion Maple | Fusion Maple
- M08 Huntington Maple | Huntington Maple
- M11 Empire Mahogany | Empire Mahogany
- M21 Hemlock | Hemlock

3. CABINET DOOR FRONT

Melamines with coordinating edgebands

CORE SOLIDS | EDGE BAND

- M01 Cloud | White
- M17 Ivory | Neutral White
- M19 Platinum | Platinum
- M03 Graphite | Graphite
- M13 Black | Black

CLASSIC WOODGRAINS | EDGE BAND

- M06 Fusion Maple | Fusion Maple
- M08 Huntington Maple | Huntington Maple
- M11 Empire Mahogany | Empire Mahogany
- M21 Hemlock | Hemlock

Laminates with complimentary edgebands

EVOLVING WOODGRAINS | EDGE BAND

- LCC Smoky Brown Pear | Graphite
- LCG Millennium Oak | Earth
- LCR Oiled Walnut | Brown
- LCY Dunewood | Neutral White

4. PULLS

- O Open (silver only)
- W Waterfall (silver only)

5. LOCKING MECHANISM



- N No Lock (standard)
- K Locks Keyed Alike (upcharge)
- L Locks Keyed Random (upcharge)

KEEL™ cabinet & horizontal storage

CONSTRUCTION/FEATURES

- Case - 5/8" thick & Back - 1" thick thermofused melamine (TFM) with 2mm edge
- Door Fronts - 5/8" thick high pressure laminate (HPL) or (TFM) with 2mm edge
- 4 3/4" interior height of pigeon holes in Horizontal Storage
- Adjustable shelves in Cabinet Bookcase and Cabinet with Doors.

OPTIONS

- Metal door pulls
 -  (W) Waterfall (silver)
 -  (O) Open Pull (silver)
- Locking Mechanism, place an "N, K or L" after model #

SPECIFY

1. Model Number
2. Case Color
3. Door Color
4. Door Pull
5. Options: Locking Mechanism upcharge for K or L
 - 18" W = +\$36.00
 - 24", 36"W = +\$46.00
 - KCBC = na

Cabinet Bookcase

DIMENSIONS

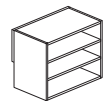

MODEL	DIMENSIONS				WEIGHT	CUBIC FEET	LIST PRICE
	D	W	cabinet H	overall H			
KCBC 1849	14.63	18	28	49	40	4.3	\$ 712
KCBC 1863	14.63	18	42	63	61	6.4	857
KCBC 1871	14.63	18	50	71	76	7.6	893
KCBC 2449	14.63	24	28	49	50	5.7	\$ 735
KCBC 2463	14.63	24	42	63	72	8.5	891
KCBC 2471	14.63	24	50	71	86	10.2	930
KCBC 3049	14.63	30	28	49	67	7.1	\$ 757
KCBC 3063	14.63	30	42	63	88	10.7	926
KCBC 3071	14.63	30	50	71	103	12.7	969

Cabinet with Doors

DIMENSIONS



right hinge



left hinge

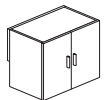

MODEL	DIMENSIONS				WEIGHT	CUBIC FEET	LIST PRICE
	D	W	cabinet H	overall H			
KCD 1849R	15.38	18	28	49	49	4.5	\$ 832
KCD 1863R	15.38	18	42	63	77	6.7	1020
KCD 1871R	15.38	18	50	71	97	8.0	1075
KCD 1849L	15.38	18	28	49	49	4.5	\$ 832
KCD 1863L	15.38	18	42	63	77	6.7	1020
KCD 1871L	15.38	18	50	71	97	8.0	1075
KCD 2449	15.38	24	28	49	65	6.0	\$ 959
KCD 2463	15.38	24	42	63	92	9.0	1181
KCD 2471	15.38	24	50	71	113	10.7	1247
KCD 3049	15.38	30	28	49	94	7.5	\$1004
KCD 3063	15.38	30	42	63	120	11.2	1248
KCD 3071	15.38	30	50	71	142	13.3	1319

KEEL™ cabinet & horizontal storage

MODEL	DIMENSIONS				WEIGHT	CUBIC FEET	LIST PRICE
	D	W	cabinet H	overall H			
KHS PS 30	14.625	30	18.5	39.5	30	4.7	\$ 734
KHS PS 36	14.625	36	18.5	39.5	43	5.6	765
KHS PS 42	14.625	42	18.5	39.5	48	6.5	839
KHS PS 48	14.625	48	18.5	39.5	52	7.5	870
KHS PS 54	14.625	54	18.5	39.5	57	8.4	902
KHS PS 60	14.625	60	18.5	39.5	63	9.3	923
KHS PS 72	14.625	72	18.5	39.5	74	11.2	965

Horizontal Storage Panel End Support

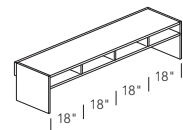
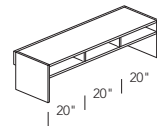
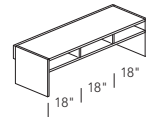
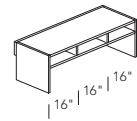
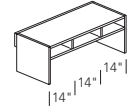
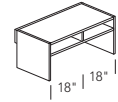
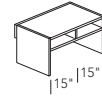

KEEL™ cabinet & horizontal storage

CONSTRUCTION/FEATURES

- Case - 5/8" thick & Back - 1" thick thermofused melamine (TFM) with 2mm edge
- 4 3/4" interior height of pigeon holes in Horizontal Storage

SPECIFY

1. Model Number
2. Case Color

Horizontal Storage Metal Support

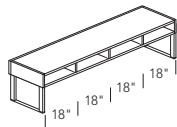
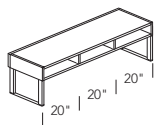
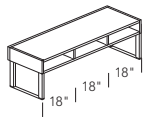
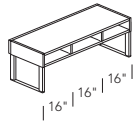
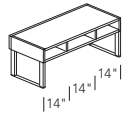
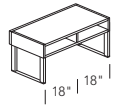
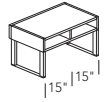

MODEL	DIMENSIONS				WEIGHT	CUBIC FEET	LIST PRICE
	D	W	cabinet H	overall H			
KHS MS 30	14.625	30	18.5	39.5	30	4.7	\$ 944
KHS MS 36	14.625	36	18.5	39.5	43	5.6	975
KHS MS 42	14.625	42	18.5	39.5	48	6.5	1049
KHS MS 48	14.625	48	18.5	39.5	52	7.5	1080
KHS MS 54	14.625	54	18.5	39.5	57	8.4	1112
KHS MS 60	14.625	60	18.5	39.5	63	9.3	1133
KHS MS 72	14.625	72	18.5	39.5	74	11.2	1175

A wide variety of freestanding storage pieces offer great versatility. Combinations of box/file drawer, cabinet w/door, bookcase and personal closet space are available in 49", 63" and 71" heights and widths of 18", 24" and 30".

Doors are hinged left or right for ease of access in groups. Cabinets may be placed at the end of a Keel or between Keels end-to-end for shared storage. Paired grommets are in each cabinet side to allow power pass-through when required.

Optional Wire Managers offered in accessories.

KEEL VOCABULARY

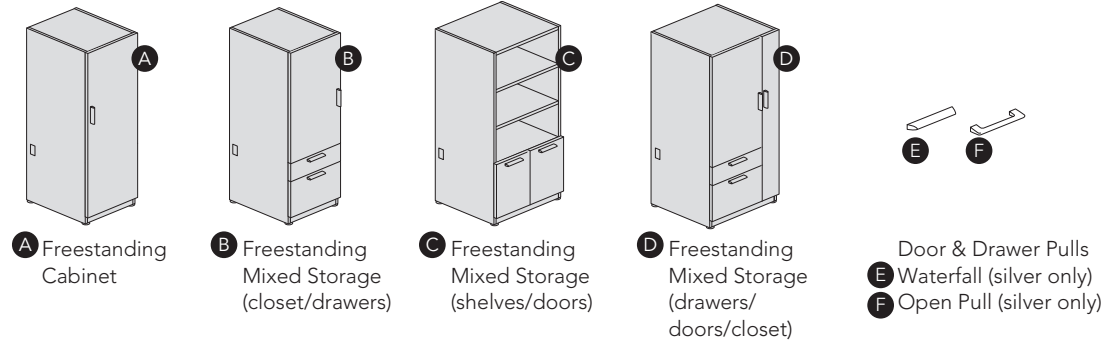

MODEL NUMBER BUILD

KFMS 3049-01 M03 LCC W L
 1. Model # 2. 3. 4. 5.

SPECIFY

1. Model Number
2. Case Color
3. Drawer/Door/
Closet Front Color
4. Drawer/Door Pull
select Waterfall or Open
5. Locking Mechanism
K & L upcharge:
 KFSC = +\$30.00
 KFMS-01 = +\$60.00
 KFMS-02 = +\$30.00
 KFMS-03 = +\$70.00
 KFMS-04 = +\$70.00
 KFMS-05 = +\$30.00

2. CASE

Melamines with coordinating edgebands

CORE SOLIDS | EDGE BAND
M01 Cloud | White
M17 Ivory | Neutral White
M19 Platinum | Platinum
M03 Graphite | Graphite
M13 Black | Black

CLASSIC WOODGRAINS | EDGE BAND

M06 Fusion Maple | Fusion Maple
M08 Huntington Maple | Huntington Maple
M11 Empire Mahogany | Empire Mahogany
M21 Hemlock | Hemlock

3. DRAWER/DOOR/CLOSET FRONT

Melamines with coordinating edgebands

CORE SOLIDS | EDGE BAND
M01 Cloud | White
M17 Ivory | Neutral White
M19 Platinum | Platinum
M03 Graphite | Graphite
M13 Black | Black

CLASSIC WOODGRAINS | EDGE BAND

M06 Fusion Maple | Fusion Maple
M08 Huntington Maple | Huntington Maple
M11 Empire Mahogany | Empire Mahogany
M21 Hemlock | Hemlock

Laminates with complimentary edgebands

EVOLVING WOODGRAINS | EDGE BAND
LCC Smoky Brown Pear | Graphite
LCG Millennium Oak | Earth
LCR Oiled Walnut | Brown
LCY Dunewood | Neutral White

4. PULLS

- O Open (silver only)
- W Waterfall (silver only)

5. LOCKING MECHANISM



- N No Lock (standard)
- K Locks Keyed Alike (upcharge)
- L Locks Keyed Random (upcharge)

KEEL™ freestanding storage

CONSTRUCTION/FEATURES

- Case - 5/8" thick & Back - 1" thick thermofused melamine (TFM) with 2mm edge
- Dividers, & shelves - 5/8" thick (TFM) with 2mm edge
- Drawer and Door Fronts - 5/8" thick high pressure laminate (HPL) or (TFM) with 2mm edge
- Drawers - 1/2" thick with full extension, ball-bearing slides and standard hanging bars for file drawer
- Closet side with hanging bar for coats
- Adjustable Glides
- Grommets in cabinet sides for power pass-through

OPTIONS

- Metal Drawer/Door Pulls
 -  (W) Waterfall (silver)
 -  (O) Open Pull (silver)
- Locking Mechanism place an "N, K or L" after model #
- Wire Managers

SPECIFY

1. Model Number
2. Case Color
3. Door Color
4. Drawer/Door Pulls
5. Options: Locking Mechanism upcharge for K or L
 - KFSC = +\$30.00
 - KFMS-01 = +\$60.00
 - KFMS-02 = +\$30.00
 - KFMS-03 = +\$70.00
 - KFMS-04 = +\$70.00
 - KFMS-05 = +\$30.00

Freestanding Cabinet

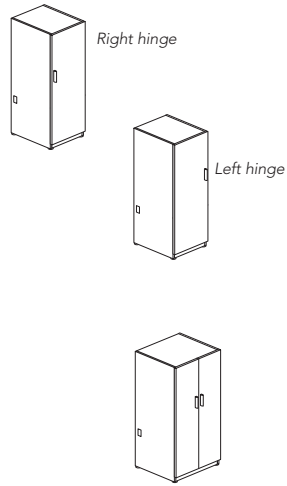

MODEL	DIMENSIONS			WEIGHT	CUBIC FEET	LIST PRICE
	D	W	H			
KFSC 1849 R	22	18	49	124	11	\$ 1252
KFSC 1863 R	22	18	63	150	14	1425
KFSC 1871 R	22	18	71	162	16	1497
KFSC 1849 L	22	18	49	124	11	\$ 1252
KFSC 1863 L KFSC	22	18	63	150	14	1425
1871 L	22	18	71	162	16	1497
KFSC 2449	22	24	49	146	15	\$ 1426
KFSC 2463	22	24	63	177	19	1623
KFSC 2471	22	24	71	193	22	1714
KFSC 3049	22	30	49	171	19	\$ 1512
KFSC 3063	22	30	63	206	24	1731
KFSC 3071	22	30	71	224	27	1823

Freestanding Mixed Storage Doors/Drawers

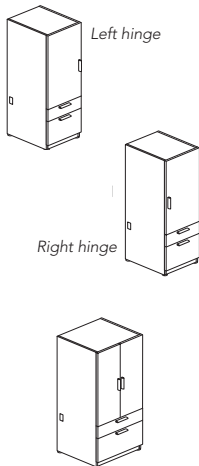

MODEL	DIMENSIONS			WEIGHT	CUBIC FEET	LIST PRICE
	D	W	H			
KFMS 1849-01 L	22	18	49	125	11	\$ 1424
KFMS 1863-01 L	22	18	63	143	14	1603
KFMS 1871-01 L	22	18	71	137	16	1662
KFMS 1849-01 R	22	18	49	125	11	\$ 1424
KFMS 1863-01 R	22	18	63	143	14	1603
KFMS 1871-01 R	22	18	71	137	16	1662
KFMS 2449-01	22	24	49	138	15	\$ 1600
KFMS 2463-01	22	24	63	168	19	1811
KFMS 2471-01	22	24	71	184	22	1887
KFMS 3049-01	22	30	49	159	19	\$ 1701
KFMS 3063-01	22	30	63	194	24	1933
KFMS 3071-01	22	30	71	213	27	2009

MODEL	DIMENSIONS			WEIGHT	CUBIC FEET	LIST PRICE
	D	W	H			
KFMS 1849-02	22	18	49	120	11	\$ 1315
KFMS 1863-02	22	18	63	138	14	1469
KFMS 1871-02	22	18	71	132	16	1524
KFMS 2449-02	22	24	49	133	15	\$ 1403
KFMS 2463-02	22	24	63	163	19	1573
KFMS 2471-02	22	24	71	179	22	1635
KFMS 3049-02	22	30	49	154	19	\$ 1492
KFMS 3063-02	22	30	63	189	24	1679
KFMS 3071-02	22	30	71	208	27	1739

Freestanding Mixed Storage Shelves/Drawers

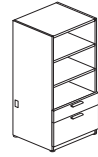

MODEL	DIMENSIONS			WEIGHT	CUBIC FEET	LIST PRICE
	D	W	H			
KFMS 2449-03	22	24	49	159	15	\$ 1691
KFMS 2463-03	22	24	63	195	19	1901
KFMS 2471-03	22	24	71	214	22	1993
KFMS 3049-03	22	30	49	182	19	\$ 1755
KFMS 3063-03	22	30	63	220	24	1978
KFMS 3071-03	22	30	71	243	27	2072

Freestanding Mixed Storage Doors/Drawers Closet Right

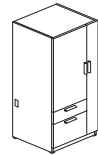

KEEL™ freestanding storage

Freestanding
Mixed Storage
Doors/Drawers
Closet Left

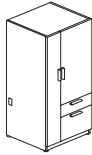

MODEL	DIMENSIONS			WEIGHT	CUBIC FEET	LIST PRICE
	D	W	H			
KFMS 2449-04	22	24	49	159	15	\$ 1691
KFMS 2463-04	22	24	63	195	19	1901
KFMS 2471-04	22	24	71	214	22	1993
KFMS 3049-04	22	30	49	182	19	\$ 1755
KFMS 3063-04	22	30	63	220	24	1978
KFMS 3071-04	22	30	71	243	27	2072

Freestanding
Mixed Storage
Shelves/Doors

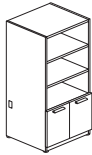

MODEL	DIMENSIONS			WEIGHT	CUBIC FEET	LIST PRICE
	D	W	H			
KFMS 2449-05	22	24	49	133	15	\$ 1361
KFMS 2463-05	22	24	63	163	19	1532
KFMS 2471-05	22	24	71	179	22	1593
KFMS 3049-05	22	30	49	154	19	\$ 1437
KFMS 3063-05	22	30	63	189	24	1625
KFMS 3071-05	22	30	71	208	27	1993

A Mobile Pedestal is offered in box/file configuration with two locking and two non-locking casters. A seating version has 3" seat pad for added comfort. A lock is standard on both versions. Drawer Pedestals in box/box/file and a file/file configurations are offered in the

Worksurface Support section and a lock is standard on both versions. Lateral files are metal case and drawers with laminate fronts with 2mm edge. Available in two widths and in two, three and four drawer heights on ball-bearing suspension with full extension.

KEEL VOCABULARY

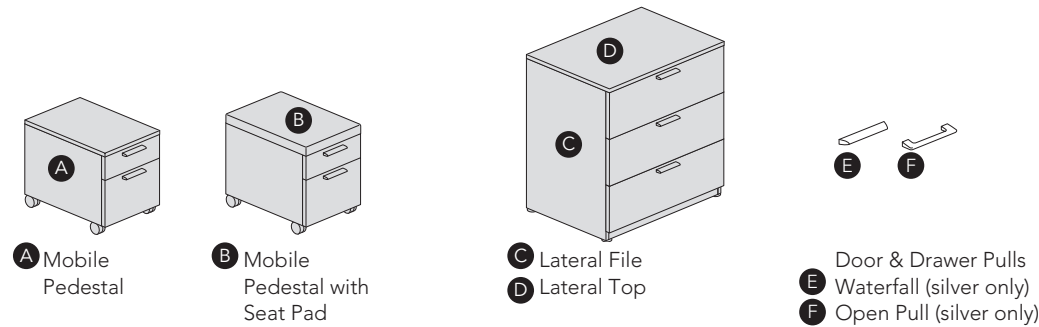

MODEL NUMBER BUILD

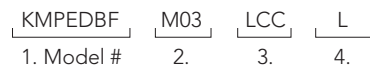

SPECIFY PEDESTAL

1. Model Number
2. Case Color
3. Drawer Color
4. Drawer Pull
select Waterfall or Open
5. Locking Mechanism
(standard)
6. Optional Seat Pad Fabric

2. PEDESTAL CASE

Melamines with coordinating edgebands

CORE SOLIDS | EDGEBAND

- M01 Cloud | White
- M17 Ivory | Neutral White
- M19 Platinum | Platinum
- M03 Graphite | Graphite
- M13 Black | Black

CLASSIC WOODGRAINS | EDGEBAND

- M06 Fusion Maple | Fusion Maple
- M08 Huntington Maple | Huntington Maple
- M11 Empire Mahogany | Empire Mahogany
- M21 Hemlock | Hemlock

4. PULLS

- O Open (silver only)
- W Waterfall (silver only)

5. LOCKING MECHANISM

- K Locks Keyed Alike
- L Locks Keyed Random

6. SEAT PAD FABRIC

Grade 3

Cover Cloth: Platinum, Oat, Sorrel, Zest, Fuchsia, Delft Indigo, Taupe, Vesper, Flame, Bouquet, Cyan, Hickory

SPECIFY LATERAL

1. Model Number
3. Drawer & Optional Top Color
4. Drawer Pull
select Waterfall or Open
5. Locking Mechanism
(standard)

3. DRAWER FRONT AND OPT LAMINATE TOP

Melamines with coordinating edgebands

CORE SOLIDS | EDGEBAND

- M01 Cloud | White
- M17 Ivory | Neutral White
- M19 Platinum | Platinum
- M03 Graphite | Graphite
- M13 Black | Black

CLASSIC WOODGRAINS | EDGEBAND

- M06 Fusion Maple | Fusion Maple
- M08 Huntington Maple | Huntington Maple
- M11 Empire Mahogany | Empire Mahogany
- M21 Hemlock | Hemlock

Laminates with complimentary edgebands

EVOLVING WOODGRAINS | EDGEBAND

- LCC Smoky Brown Pear | Graphite
- LCG Millennium Oak | Earth
- LCR Oiled Walnut | Brown
- LCY Dunewood | Neutral White

KEEL™ filing

CONSTRUCTION/FEATURES

- Case - 5/8" thick thermofused melamine (TFM) with 2mm edge,
- Drawer front - 5/8" thick high pressure laminate (HPL) or (TFM) with 2mm edge
- Drawers - 1/2" thick box with full extension, ball-bearing slides and standard hanging bars for file drawer
- Two non-locking rear and two locking front casters
- Standard Locking Mechanism

OPTIONS

- Metal Drawer Pull
 - (W) Waterfall (silver)
 - (O) Open Pull (silver)
- Locking Mechanism
place an "K or L" after model #

SPECIFY pedestal

1. Model Number
2. Case Color
3. Drawer Color
4. Options: Locking Mechanism K or L
5. Seat Pad Fabric

Mobile Pedestal



MODEL	DIMENSIONS			WEIGHT	CUBIC FEET	LIST PRICE
	D	W	H			
KMPEDBF	20	15	21	108	3.6	\$ 1019

Mobile Pedestal with Seat Pad



KMPEDBFSP	20	15	24	133	4.2	\$ 1223
-----------	----	----	----	-----	-----	---------

CONSTRUCTION/FEATURES

- Case and Drawers - metal, silver paint
- Drawer front - 5/8" thick high pressure laminate (HPL) or thermofused melamine (TFM) with 2mm edge
- Optional Top - 1" thick (HPL) or (TFM) with 2mm edge secured to case with double sided tape
- Drawers - 1/2" thick box with full extension, ball-bearing slides and standard hanging bars for letter/legal filing, side to side or front to back. Front to back legal requires accessory Filing Bar MLFFB
- Standard Locking Mechanism

OPTIONS

- Metal Drawer Pull
 - (W) Waterfall (silver)
 - (O) Open Pull (silver)
- Locking Mechanism
place an "K or L" after model #

SPECIFY

1. Model Number
2. Drawer or Optional Top Color
3. Options: Locking Mechanism K or L

Lateral File

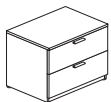

MODEL	DIMENSIONS			DRAWERS	WEIGHT	CUBIC FEET	LIST PRICE
	D	W	H				
KLF 30 2D	17.5	30	28	2	93	8.5	\$ 1158
KLF 36 2D	17.5	36	28	2	119	10.2	1268
KLF 30 3D	17.5	30	40	3	139	12.2	\$ 1541
KLF 36 3D	17.5	36	40	3	178	14.6	1656
KLF 30 4D	17.5	30	52	4	186	15.8	\$ 1907
KLF 36 4D	17.5	36	52	4	238	19.0	2060
KLF TOP 30	17.5	30	1		18	0.3	\$ 186
KLF TOP 36	17.5	36	1		21	0.4	207

Lateral File - top

Lateral File - counter balance

Lateral File - 36" file converter

KLF CB 2D	1	18	12		43	0.1	\$ 264
KLF CB 3D	1	18	12		34	0.1	226
KLF CB 4D	1	18	12		22	0.1	155
KLF FB36	1	36	12		1	0.3	\$ 21

Accessory Surface rests on the Keel Base Cabinet creating a 29" height to line up with worksurface at right angle. Modesty and Privacy/Modesty panels mount to worksurfaces as a sight buffer in a variety of widths. Additional Channel Trays are available to further cover the wire

management trough in base cabinets. Seat pad may be located anywhere on the Keel Base Cabinet Top. An array of Organizational Accessories attach to the Keel Rail freeing up worksurface space.

KEEL VOCABULARY

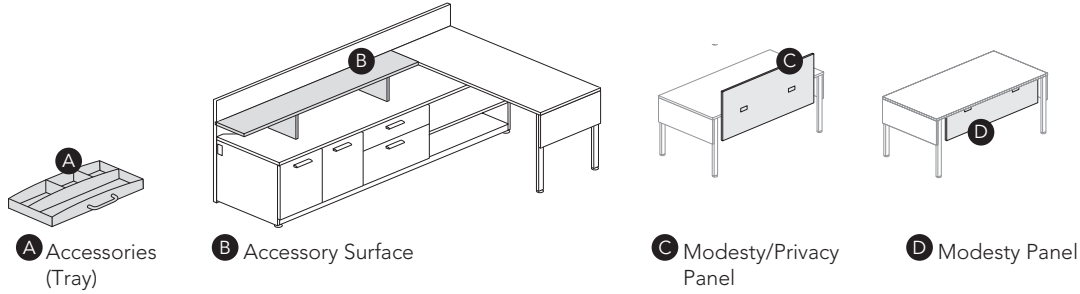

MODEL NUMBER BUILD

KAS22 LCC M03
 1. Model # 2. 3.

SPECIFY

1. Model Number
2. Accessory Top or Modesty Panel Color
3. Accessory Base Color
4. Optional Seat Pad Fabric

2. ACCESSORY SURFACE TOP & MODESTY PANEL

Laminates with coordinating edgebands

- CORE SOLIDS | EDGEBAND**
- LBT Dover White | White
 - LDM Pearl | Neutral White
 - LDQ Platinum | Platinum
 - LCD Graphite | Graphite
 - LAS Black | Black
- CLASSIC WOODGRAINS | EDGEBAND**
- LTS Fusion Maple | Fusion Maple
 - LS2 Huntington Maple | Huntington Maple
 - LTW Empire Mahogany | Empire Mahogany
 - LT6 Hemlock | Hemlock

Laminates with complimentary edgebands

- CLASSIC PATTERNS | EDGEBAND**
- LRP Grey Mesh | Folkstone
 - LRT Steel Mesh | Citadel
 - LRZ Gilded Mesh | Platinum
 - LRC Pewter Mesh | Citadel
- EVOLVING WOODGRAINS | EDGEBAND**
- LCC Smoky Brown Pear | Graphite
 - LCG Millennium Oak | Earth
 - LCR Oiled Walnut | Brown
 - LCY Dunewood | Neutral White

3. ACCESSORY SURFACE BASE

Melamines with coordinating edgebands

- CORE SOLIDS | EDGEBAND**
- M01 Cloud | White
 - M17 Ivory | Neutral White
 - M19 Platinum | Platinum
 - M03 Graphite | Graphite
 - M13 Black | Black
- CLASSIC WOODGRAINS | EDGEBAND**
- M06 Fusion Maple | Fusion Maple
 - M08 Huntington Maple | Huntington Maple
 - M11 Empire Mahogany | Empire Mahogany
 - M21 Hemlock | Hemlock

4. SEAT PAD FABRIC

Grade 3

Cover Cloth: Platinum, Oat, Sorrel, Zest, Fuchsia, Delft Indigo, Taupe, Vesper, Flame, Bouquet, Cyan, Hickory

KEEL™ accessories & power

CONSTRUCTION/FEATURES

- Plastic Wire Manager channels cords through cabinets and under worksurfaces to the Keel Wire Trough
- Organizational accessories mount to Keel Rail
- Seat Pad with non-skid backing
- Accessory Shelf Top in 1" (HPL) with 5/8" (TFM) Bases, all with 2mm edge
- Modesty and Privacy/Modesty Panel in 5/8" (HPL) with 2mm edge
- Power Data unit attaches to Keel Top through the Wire Management Gap

SPECIFY

1. Model Number
2. Accessory Top or Modesty Panel Color
3. Accessory Shelf Base Color

	MODEL	DIMENSIONS			WEIGHT	CUBIC FEET	LIST PRICE
		D	W	H			
Flat Bracket	KA FLBRK	17.25	3	0.25	3	0.01	\$ 33
Wire Manager	KA WM7	2.75	7	1	.5	0.01	\$ 16
	KA WM14	2.75	14	1	1	0.02	19
	KA WM26	2.75	26	1	2	0.04	26
Tray	KA T	8	7	1	4	0.03	\$ 149
Binder Holder	KA BH	10	5	12	6	0.35	\$ 149
Pencil Cup	KA PC	3	3	4	3	0.02	\$ 92
Paper Tray	KA PT	11	12	1	4	0.08	\$ 149
Channel Tray	KA CT	2.25	24	1	4	0.03	\$ 51
Seat Pad	KSP	18.25	22.5	3	3	0.7	\$ 233

Accessory Surface

MODEL	DIMENSIONS			WEIGHT	CUBIC FEET	LIST PRICE
	D	W	H			
KAS 22	11.5	22	8	10	1	\$ 472
KAS 28	11.5	28	8	12	1	485
KAS 34	11.5	34	8	14	2	487
KAS 40	11.5	40	8	16	2	509
KAS 46	11.5	46	8	19	2	537
KAS 52	11.5	52	8	20	3	561
KAS 58	11.5	58	8	19	3	625
KAS 64	11.5	64	8	26	3	635
KAS 70	11.5	70	8	28	4	674

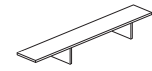

MODEL	DIMENSIONS			WEIGHT	CUBIC FEET	LIST PRICE
		W	H			
KMPPNL 30		30	23	25	0.4	\$ 477
KMPPNL 36		36	23	30	0.5	489
KMPPNL 42		42	23	35	0.6	492
KMPPNL 48		48	23	40	0.6	506
KMPPNL 54		54	23	44	0.7	792
KMPPNL 60		60	23	49	0.8	807
KMPPNL 66		66	23	55	0.9	818
KMPPNL 72		72	23	60	1.0	822
KMPPNL 78		78	23	64	1.0	839

Modesty/Privacy Panel

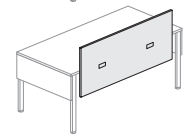

KMPNL 30		30	11	12	0.2	\$ 303
KMPNL 36		36	11	14	0.2	314
KMPNL 42		42	11	16	0.3	324
KMPNL 48		48	11	18	0.3	356
KMPNL 54		54	11	20	0.3	372
KMPNL 60		60	11	22	0.4	387
KMPNL 66		66	11	26	0.4	398
KMPNL 72		72	11	28	0.5	402
KMPNL 78		78	11	30	0.5	419

Modesty Panel



MODEL	DESCRIPTION	LENGTH	WEIGHT	CUBIC FEET	LIST PRICE
KA PDW	KEEL POWER DATA White	72	5	0.04	\$ 345
KA PDB	KEEL POWER DATA Black	72	5	0.04	440

Power Data

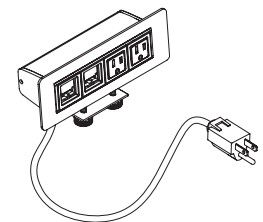

KEEL™ accessories & power

Byrne Electrical's 4-Trac System® is a UL listed, Manufactured Wiring System. 4-Trac® features a low profile, 4-wire, 2 circuit system that provides 20 amps of power per circuit. 4-Trac® meets the requirements of UL 183 and National Electric Code Article 604. It also complies with municipal standards such as New York, Los Angeles and San Francisco. It is, however, the customer's responsibility to ensure installation of the system is in compliance with all local, regional and national codes. A licensed electrician is required to make all connections to the building power supply. This electrical system is not intended for use with any other ABCO 2.0 Modular Furniture Series.

GENERAL RULES FOR THE SPECIFICATION OF CIRCUITS

- Single circuit, 20 amp capacity for one or two stations not to exceed 20 amp load
- Two circuit, hardwired 40 amp capacity for one or more stations not to exceed 40 amp load
Details in Specification Guide

CONSTRUCTION/FEATURES

- Metal conduit on connectors
- Twin duplex receptacles
- Mounting hardware
- 6" connectors
- Jumpers in 8 lengths

SPECIFY

1. Model Number

Power Kit

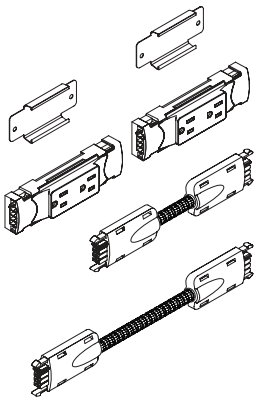

MODEL	DESCRIPTION	JUMPER L	WEIGHT	LIST PRICE
Single Circuit				
KBEPK 130		12	1.5	\$ 237
KBEPK 136		18	1.7	246
KBEPK 142		24	1.9	244
KBEPK 148		30	2.2	252
KBEPK 160		42	2.6	260
KBEPK 172		54	2.8	265
KBEPK 184		66	3.0	273
KBEPK 196		78	3.2	281
Two Circuit				
KBEPK 230		12	1.5	\$ 237
KBEPK 236		18	1.7	246
KBEPK 242		24	1.9	244
KBEPK 248		30	2.2	252
KBEPK 260		42	2.6	260
KBEPK 272		54	2.8	265
KBEPK 284		66	3.0	273
KBEPK 296		78	3.2	281

CONSTRUCTION/FEATURES

- Metal conduit on jumpers
- Required to connect Base Cabinets back to back
- Used for pass-thru power in Freestanding Cabinets

SPECIFY

1. Model Number

Jumper

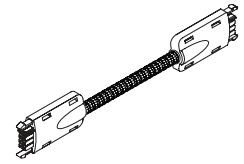

MODEL	JUMPER L	WEIGHT	LIST PRICE
KBEJ 6	6	0.3	\$ 61
KBEJ 12	12	0.4	65
KBEJ 18	18	0.5	69
KBEJ 24	24	0.7	74
KBEJ 30	30	0.8	78
KBEJ 36	36	1.0	84
KBEJ 42	42	1.3	88
KBEJ 48	48	1.4	92
KBEJ 54	54	1.6	97
KBEJ 60	60	1.8	101
KBEJ 66	66	1.9	105
KBEJ 72	72	2.0	109
KBEJ 78	78	2.3	113

CONSTRUCTION/FEATURES

- Four types of power infeeds are offered:
 - Two Circuit Hardwire infeed – installed by a licensed electrician
 - Single or Two Circuit Rotating Hardware Infeed - installed by licenced electrician
 - Single Circuit Straight Plug Infeed - requires 20 Amp Wall receptacle
 - Single Circuit Right Angle Plug Infeed - requires 20 Amp Wall receptacle

SPECIFY

1. Model Number

Power Infeeds

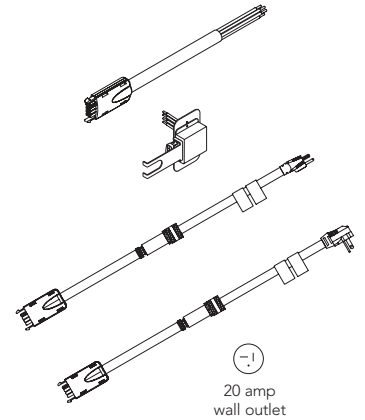

MODEL	DESCRIPTION	L	WEIGHT	LIST PRICE
KBEHW6*	Two Circuit Hardwire Infeed	72"	1.5	\$ 107
KBEHW8*	Two Circuit Hardwire Infeed	96"	1.8	128
KBERPHW*	Single or Two Circuit Rotating Hardware Infeed	72"	1.5	92
KBESP6**	Single Circuit Straight Plug Infeed	72"	1.5	174
KBERAP6**	Single Circuit Right Angle Plug Infeed	72"	1.5	174

*Hardwired to building power source by licensed electrician then connect to receptacle in power system.

**Plugs into 20 amp wall outlet only. Connect to receptacle in power system.Circuit I only. UL Recognized, not UL Listed.



CONSTRUCTION/FEATURES

- Data may be added using the Data Box Minitap with Voice Adaptor Kit.
- Includes (2) Duraloc velcro-type strips for mounting to metal and wood screws for mounting to wood.
- Accommodates two Keystone-style data jacks or couplers.

SPECIFY

1. Model Number

Data Box & RJ45 Data Jack

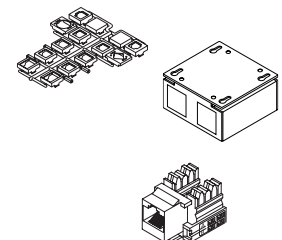

MODEL	DESCRIPTION	WEIGHT	LIST PRICE
KBEDB	Data Box with Voice Adaptor Kit	0.25	\$ 78
KBERJ45	RJ45 Data Jack, AMP 8-Pin, RJ45 Cat5e Data	0.5	24

KEEL™ general product information

DIMENSIONS

All KEEL components are manufactured in exact size dimensions. A stated 66" width is a true 66".

ASSEMBLY

Base Cabinets, Hutches, Keel Mount, Freestanding and Horizontal Storage, Mobile Pedestals and Worksurface Supports ship fully assembled. Table Desks and the attachment of Worksurface Supports require simple & quick assembly.

SHIPPING

Most KEEL product is shipped on skids for added protection in transit

EDGE

All surfaces receive 2mm, flat edge band in ABS material. Edge colors default to the Melamine or HPL Pattern selected. See chart below.

COLORS:

Melamines with coordinating edgebands

CORE SOLIDS | EDGE BAND

M01	Cloud White
M17	Ivory Neutral White
M19	Platinum Platinum
M03	Graphite Graphite
M13	Black Black

CLASSIC WOODGRAINS | EDGE BAND

M06	Fusion Maple Fusion Maple
M08	Huntington Maple Huntington Maple
M11	Empire Mahogany Empire Mahogany
M21	Hemlock Hemlock

Laminates with coordinating edgebands

CORE SOLIDS | EDGE BAND

LBT	Dover White White
LDM	Pearl Neutral White
LDQ	Platinum Platinum
LCD	Graphite Graphite
LAS	Black Black

CLASSIC WOODGRAINS | EDGE BAND

LTS	Fusion Maple Fusion Maple
LS2	Huntington Maple Huntington Maple
LTW	Empire Mahogany Empire Mahogany
LT6	Hemlock Hemlock

Laminates with complimentary edgebands

CLASSIC PATTERNS | EDGE BAND

LRP	Grey Mesh Folkstone
LRT	Steel Mesh Citadel
LRZ	Gilded Mesh Platinum
LRC	Pewter Mesh Citadel

EVOLVING WOODGRAINS | EDGE BAND

LCC	Smoky Brown Pear Graphite
LCG	Millennium Oak Earth
LCR	Oiled Walnut Brown
LCY	Dunewood Neutral White

PAINT FINISH

Powder coat finish in silver. ABCO 2.0 uses an environmentally automated powder coat paint system for all metal surfaces

LOCKS

Available on KEEL Base Cabinets, Storage Pieces and Hutches. When specified, all doors and drawers lock. Must specify: N if no lock is desired (standard); K if Keyed Alike (at upcharge); L if Keyed Randomly (at upcharge)

Locks standard on Lateral Files (central locking), Mobile and Worksurface Support Peds

PULLS

Open Pull in silver O
Waterfall Pull in silver W

TACKBOARD

Standard in Grade 1 Fabric on Keel Hutches. Upcharge for Grade 2 – 5.

Grade 1 CSM

Grade 2 **Script:** Feldspar, Flint, Nectar, Sand, Shadow, Slate, Sterling, Taupe
Pact: Azure, Calla, Dragon, Eureka, Harbour, Lime, Patina, Tanzanite

Grade 3 **Blazer Lite:** Angel, Aspire, Balance, Bliss, Cuddle, Dainty, Daydream, Graceful, Harmony, Hope, Pastel, Pillow, Retreat, Solace, Wish

Grade 4 CSM & 5

SEAT PAD

Converts space on Keel Base Cabinet top into an auxiliary seat. Non-skid backing holds pad in place.

ANSI-BIFMA CERTIFICATION

KEEL product series meets or exceeds applicable ANSI/BIFMA X5.9 – 2004 Storage Units Test and ANSI/BIFMA X5.5 – 2008 Desk/Table Products Test

LEED and INDOOR QUALITY INFORMATION

May be viewed online at www.abcofurniture.com

COM – Customers Own Material

Fabric Approval

All fabric must be evaluated and approved for use on ABCO 2.0 seating products. Please contact our Customs Department to see if the COM fabric of your choice has been tested and approved on our products.

Fabric Evaluation

Fabric not already approved must be evaluated. A 12" x 12" fabric sample must be mailed to:

ABCO 2.0 by izzy+
Customer Service
11451 Harter Drive
Middlebury, IN 46540

Backing of COM Fabrics

Latex or acrylic backing is required for all COM upholstery fabrics. If a fabric arrives at ABCO 2.0 and is not backed, a handling charge of \$26 net, plus \$3.00 net per yard will be applied to each COM order. If ABCO 2.0 is to back the COM, a minimum of 6 yards is required and the fabric must be exactly 54" wide.

Shipping COM Fabric

All shipments must note:

- Dealer/Customer Name, Order Number,
- Yardage Shipped, Fabric Application
- Direction, Exterior Fabric Face.

Ship approved seat pad fabric freight prepaid to:

izzy+ / KEEL Seat Pad
COM Department
11451 Harter Drive
Middlebury, IN 46540

Ship approved tackboard fabric freight prepaid to:

izzy+ / KEEL Tackboard
attn: COM TEST
17237 Van Wagoner Rd.
Spring Lake, MI 49456

Fabric sent COD or freight collect will not be accepted.

Manufacturing Schedule

COM/COL orders will be scheduled for manufacturing and a shipping date issued after the factory receives all COM/COL for the order. If your order requires partial or split shipment, please contact customer service.

Warranty

ABCO 2.0's ten (10), five (5), and three (3) year warranties do not cover COM/COL. COM/COL is not covered by any ABCO 2.0 warranty.

Conditions

ABCO 2.0 will inventory COM/COL for one month. COM/COL pricing may increase if material requires extra backing or labor. Any COM fabric purchased by ABCO 2.0 on behalf of a customer will be inspected at the time of production to ensure it meets ABCO 2.0's upholstery standards. ABCO 2.0 will notify customers if the fabric fails to meet those standards. ABCO 2.0 will assume that any COM fabric purchased by a customer and shipped to ABCO 2.0 has been inspected by that customer and has been approved for use. Customers indemnify and hold ABCO 2.0 harmless against all claims for damage or injury to property or persons by reason or failure of COM/COL to be merchantable, fit, or safe for use. ABCO 2.0 is not responsible for COM/COL wear, defects, or appropriateness. ABCO 2.0 is not responsible for COM's received with bow and skew issues. It's assumed that the fabric vendor has shipped ABCO 2.0 useable fabric. COM is not inspected for bow and skew upon arrival, it is determined at the point of manufacturing the product. If a COM has bow and skew issues (regardless of whether ABCO 2.0's vendor backed the fabric or it was received with backing), the customer will be contacted to have the fabric vendor issue an RA for pick up of the skewed fabric and ship replacement fabric to ABCO 2.0. At that point, the order will be unscheduled. It will be rescheduled upon receipt of replacement COM.

izzy+ flavors – Furniture Products

Tables and Storage: izzy+ flavors offers a wide selection of standard high-pressure laminates for our table surfaces. We also accept non-standard choices from domestic producers; longer lead times may apply. For other non-standard laminates please contact Customer Service. Additional upcharges and leadtime may apply. Table surfaces coordinate with our thermoplastic, upholstery and metal collections.

Laminates: izzy+ has partnered with Formica and Wilsonart to create a consistent finish in our standard palette (-58 from Formica and -60 and -38 from Wilsonart).

Note: Not all izzy+ flavor options listed below are available on KEEL. See the KEEL product sections for specific material applications

Laminates

Core Solids

LAS	Black	Formica 909-58
LBT	Dover White	Formica 7197-58
LDM	Pearl	Formica 934-58
LB4	Folkstone	Formica 927-58
LDQ	Platinum	Formica 902-58
LCB	Earth	Formica 5342-58
LDA	Citadel	Formica 1097-58
LCD	Graphite	Formica 837-58

Classic Patterns

LRC	Pewter Mesh	Wilsonart 4878-38
LRP	Grey Mesh	Wilsonart 4877-38
LPD	Platinum Drops	Formica 8825-58
LWH	White Drops	Formica 8824-58
LNT	Neutral Twill	Formica 8826-48
LSR	Sarum Twill	Formica 8827-48

Classic Wood Grains

LTS	Fusion Maple	Wilsonart 7909-60
LSV	Monticello Maple	Wilsonart 7925-60
LS2	Huntington Maple	Wilsonart 7929-60
LXW	Wild Cherry	Wilsonart 7054-60
LS4	Versailles Anigre	Wilsonart 7923-60
LTW	Empire Mahogany	Wilsonart 7122-60
LVK	Montana Walnut	Wilsonart 7110-60
LT6	Hemlock	Wilsonart 11067-60

Evolving Wood Grains/Markerboard

LCC	Smoky Brown Pear	Formica 5488-58
LZ7	White Ash	Formica 8841-58
LZ8	Weathered Ash	Formica 8842-58
LZ9	Natural Ash	Formica 8843-58
LDW	Markerboard Surface	Formica 949-90
LCH	Cherry Riftwood	Formica 6411-58

Melamines (Thermofused Melamine TFM)

Core Solids

M01	Cloud
M17	Ivory
M18	Folkstone
M19	Platinum
M20	Earth
M03	Graphite
M13	Black

Classic Patterns

M14	White Nebula
M15	Grey Nebula
M16	Graphite Nebula

Classic Wood Grains

M06	Fusion Maple
M07	Monticello Maple
M08	Huntington Maple
M09	Wild Cherry
M10	Versailles Anigre
M12	Montana Walnut
M11	Empire Mahogany
M21	Hemlock

izzy+ flavors – Furniture Products

Edges

We've made it easy to coordinate a matching or coordinating edgeband. If the name is the same, they are an exact match. If not, they are a close coordinating color.

Edgeband (2mm ABS)

Core Solids

E30	White
E31	Neutral White
E33	Folkstone
E34	Satin Silver
E32	Platinum
E39	Earth
E38	Brown
E36	Citadel
E35	Graphite
E37	Black

Classic Wood Grains

E41	Fusion Maple
E42	Monticello Maple
E43	Huntington Maple
E44	Wild Cherry
E45	Versailles Anigre
E47	Montana Walnut
E40	Empire Mahogany
E46	Hemlock

Urethanes (Z Series only)

U27	Oyster
U25	Koala
U02	Wolf
U26	Kangaroo
U04	Dolphin
U05	Otter
U22	Hippo
U32	Beaver
U06	Black Bear

T-Molds

V37	Black
V35	Graphite
V36	Citadel
V39	Earth

Frame Finishes

P06	Silver
P07	White
P09	Charcoal
P10	Black
P11	Alloy
P54	Mirror

Terms and Conditions

Eligibility

ABCO 2.0 by izzy+ furniture and seating are sold nationally through authorized dealers and distributors only. Distribution of this price guide does not in itself constitute an offer to sell.

New Accounts

New accounts may only be established with:

- Approval of an ABCO 2.0 Sales Representative
- Approval of ABCO 2.0 Sales Management
- Purchase Order for \$2,000 List Minimum Initial Order
- Completion or Receipt of a Blanket Certificate of Resale
- Completion of Credit Application
- Agreement to ABCO 2.0 Terms of Sale

Sales will be cash in advance until credit is established and will require a cashier's check, money order or bank approved company check. Clearance of cash in advance check or money order must occur prior to order being scheduled for production. ABCO 2.0 may review credit, change or cancel credit terms and/or request advance payment at anytime at its discretion.

Pricing and Terms

Prices, product specifications and packaging are subject to change without notice. Surcharges may be added during the life of this price list as deemed necessary due to unforeseen economic conditions. **This price guide supersedes any and all prior published price guides.** List prices shown apply to product only. Storage, sales tax and any installation charges are additional. All orders are shipped freight prepaid within the contiguous United States and Canada. Freight charges will be the responsibility of ABCO 2.0. FOB point is ABCO 2.0's factory. The title of goods passes to the purchaser and our responsibility ceases when the carrier accepts shipment at our manufacturing facility. Prices in effect when the order is received will apply. If the shipping date requested exceeds six (6) months from the order receipt, ABCO 2.0 may use the published list prices effective at the shipment date

Prompt Payment Terms: 1% 10 days, Net 30. Payment is due according to our invoice terms. Past due amounts will be subject to a 1.5% monthly interest charge. In the event of delinquency, the customer shall be liable for reasonable collection costs, including attorney fees. If, in the judgment of ABCO 2.0, the financial condition of the purchaser at any time during the period of the agreement does not justify the previously agreed payment terms, ABCO 2.0 may require full or partial payment in advance. ABCO 2.0 reserves the right to withhold shipment and/or production of customer's order due to customer's failure to satisfy credit requirements or pay past due invoices. Disputed accounts must be submitted in writing within 30 days of invoice date for consideration. Lack of written dispute may result in delayed orders.

Canadian Customers

All prices listed are in United States (U.S.) Dollars. Customs charges are prepaid; however the Purchaser is responsible for GST tax. Contact Customer Service for current exchange rate.

International Customers

All prices listed are in United States (U.S.) Dollars. All freight, taxes, and export fees are the purchaser's responsibility.

Ordering

Send purchase orders to:

E-mail to orders@izzyplus.com or fax to 800.831.9821.

To ensure that we can process your order as quickly as possible, please provide us the following information:

- Purchase Order Number
- Correct Model Number(s)
- Detailed Product Description(s)
- Applicable Specifications (laminates, paint, edge treatment, fabric)
- Correct Price
- Ship To Address
- Contact and Phone Number
- Any Special Instructions
- Reference to a Supplement Order with any Special Quote Information or Custom Product Documentation

Please refer to the front section of each product line for specifying instructions. Incomplete information and incorrect pricing will delay the process. Orders will not be entered into our manufacturing system until all information is provided.

Purchase Order Verification

ABCO 2.0 will automatically fax purchase order verifications within approximately 24 hours of order entry (or mail if no fax number is on file). Please check the verification thoroughly and notify ABCO 2.0 Customer Service within 24 hours of any discrepancies. ABCO 2.0 will manufacture the product as specified on the verification and cannot be responsible for errors if not notified by the customer. ABCO 2.0 is not required to accept changes to acknowledged orders. The customer will be charged for any expenses related to accepted changes, and the order may then be rescheduled at ABCO 2.0's discretion. The verification ship date reflects the estimated shipping week. This date does not constitute an essential term of agreement. Shipments may occur prior to or after the original acknowledged date. Order verification may be delayed due to credit issues.

To avoid purchase order duplication, mark confirming copies "confirming copy."

Additions to Orders

Please contact ABCO 2.0 Customer Service prior to adding to, changing or combining orders already received by ABCO 2.0, and reference the original order number to combine with the additional order for shipping or to meet prepaid freight requirements. ABCO 2.0 will not accept additions to original orders if already scheduled for production and cannot hold orders once production has begun. For more efficient handling, factory approved additions to original orders will be treated as separate orders and invoices by ABCO 2.0.

Lead-Times

Contact Customer Service for details.

Customer's Own Material (COM)

COM orders require contact with customer service department for product pricing and yardage requirements. A sample of material must be sent to ABCO 2.0 for approval prior to acceptance of order. Customer's material must ship prepaid to ABCO 2.0 with the supplier tag clearly showing the amount of material, product number, dealer's name, customer purchase order number and ABCO 2.0 order number. Customer's material is applied at customer's own risk and excluded from the ABCO 2.0 warranty. Customer is responsible for providing material that meets any state or federal codes or laws.

Freight

A small order fee of \$40 net will apply on orders less than \$800 list.

UPSable items will be shipped at standard UPS rates plus any additional handling charges. Flat fees will be reflected on the invoice as "Shipping and Handling." Shipments outside of the continental United States that qualify for prepaid freight are prepaid to port and collect from that point. Pre-determined additional expenses such as the following will be debited to the customer's account and charged on a separate invoice.

- Inside Delivery
- Upstairs Delivery
- Call Before Delivery
- Residential Fees
- Other Special Charges

Freight rates are subject to change without notice and apply to shipments in the U.S. only. Please note any special delivery needs on your purchase order. ABCO 2.0 will work with your company and the freight carrier to try and accommodate your delivery needs. ABCO 2.0 will make every effort to work with the freight carriers but cannot be responsible for delivery schedule. ABCO 2.0 can also accommodate collect shipments and third party billing at no additional charge. UPSable items are denoted by an asterisk (*). ABCO 2.0 cannot be responsible for damage to items not approved for small package delivery by UPS. Prepaid orders cannot be split shipped or shipped with different dates. Weights and cube values are approximate.

Terms and Conditions

California Shipments

ABCO 2.0 will charge California sales tax on all invoices to any dealer that requests ABCO 2.0 ship directly to the State of California, but cannot provide a valid California resale certificate.

Freight Responsibility and Claims

Carrier routing will be determined by ABCO 2.0 on all prepaid or prepaid and add orders. When the customer selects the carrier, ABCO 2.0 is not responsible for the services provided by that carrier. Customer selected carrier shipments will be shipped collect or third party based on the customer's instructions. ABCO 2.0 has made special arrangements with selected freight companies for the handling of freight damage claims. All ABCO 2.0 shipments are put on the freight line free from damage and are signed for as such by the carrier's agent. ABCO 2.0's responsibility for the product's safe delivery ceases at this point and responsibility is assumed by the carrier. As a service, ABCO 2.0 will file freight claims for F.O.B. origin, prepaid and prepaid and add shipments under the following conditions: Any shipments received with shortages must be noted "short" on the bill of lading and signed by the receiving agent as well as the carrier. Any shipments received with visible carton damage must be inspected immediately to determine if there is product damage. If there is product damage, refuse only the cartons containing damaged products. The applicable products must be noted "damaged and refused" on the bill of lading and signed by the receiving agent as well as the carrier. Notification of any claim activity that results from damage should be reported to izzy+ within 5 days of shipment receipt. This applies to both obvious and concealed damage. Replacement orders may be subject to ABCO 2.0's inspection of refused products. Freight claims for third party and/or collect shipments are the responsibility of the customer. Contact Customer Service at (800) 336-0070 if shipment is not received within 10 days of shipment.

Returns

Returned merchandise will not be accepted without written approval from ABCO 2.0 Customer Service on a Return Authorization (RA) form. Once an RA is approved, merchandise must be returned to ABCO 2.0 prepaid, in the original cartons (with proper inner packing), addressed with return labels and accompanied by a copy of the RA form. ABCO 2.0 will refuse shipments of returned goods that do not meet these criteria. A minimum 45% restocking fee will be applicable for all approved returns. If the original shipment was shipped prepaid by ABCO 2.0, freight charges will also be due for the original shipment.

ABCO WILL NOT ACCEPT RETURNS FOR THE FOLLOWING UNDER ANY CIRCUMSTANCES:

- Custom Items
- Items shipped as acknowledged on an ABCO 2.0 Order Verification
- Items that have been fully or partially assembled
- Duplicate orders due to duplicate customer purchase orders
- Items invoiced more than 60 days ago
- Items received at ABCO 2.0 45 days or more after issuance of RA

Cancellations

Orders entered and verified may not be cancelled or changed without receipt of a written cancellation request and ABCO 2.0's consent. A cancellation or change charge of 30% will be applied to orders cancelled or changed while in production (verification date to ship date). **Orders for custom items or products with custom laminate colors may not be cancelled or changed.** Please see "Returns Policy" to cancel an order that has been shipped from the factory.

Postponements

Requests for postponement of shipment beyond the scheduled and verified ship date will be subject to a 25% holding and handling charge. Under no circumstances will orders be held more than 10 days past the scheduled and acknowledged ship date.

Copyright

All material in this publication is protected under copyright.

Warranty

izzy+ stands behind our products.

izzy+ warrants that its standard contract furniture and seating products are free from defects in material and workmanship during normal use.

Normal use is defined as a maximum of eight (8) hours per day, six (6) days per week (single shift) for the lifetime of the product with the following exceptions:

Ten Years

Furniture: All storage and nonadjustable legs are warranted for ten (10) years.

Seating: Gas cylinders, controls & functional parts, and the Dotti stool frame are warranted for ten (10) years.

Five Years

Furniture: Gas lifts, exposed wood, screens, adjustable legs, adjustable mechanisms and glides for five (5) years.

Seating: Arm caps, casters, glides, backliners, and exposed wood parts (finished wood chairs and wood base caps) for five (5) years.

Three Years

Furniture: Panel and upholstery materials for three (3) years.

Seating: Upholstery materials (foam, mesh and textiles) for three (3) years.

One Year

Furniture: Glass, Resin and products sold by, but not manufactured by, ABCO and ABCO 2.0 for one (1) year.

Power: Electrical power components for one (1) year.

Multi-Shift Applications

In any multi-shift application, the warranty is reduced as follows: ten (10) year to six (6) year; five (5) year to three (3) year; three (3) year to one (1) year.

Service Parts

Service parts are warranted for one (1) year from defects from the date of replacement or for the remainder of the original product warranty (whichever is greater).

International Customer Warranty

One (1) year on parts. Freight will be paid to Port of Exit. Labor is excluded.

Customer's Own Material Warranty

izzy+ does not warrant the appearance, behavior or durability of customer furnished upholstery materials (COM/COL). The acceptance of the COM/COL by izzy+ only means that initial application of the COM/COL utilizing existing manufacturing processes was successful and does not imply that izzy+ warrants the COM/COL or its performance during use. izzy+ is not responsible for COM/COL appearance, condition, performance, durability, colorfastness or any other physical attribute of the COM/COL.

izzy+ Flavors

Since textiles vary in weave, thickness and memory, some creasing and/or gathering may occur during the upholstery application process. Due to natural variations over which we have no control, all furniture is sold subject to minor irregularities of color, surface, grain and texture. Textiles are sold subject to minor variations of color. Leather upholstery materials are of the finest quality. Because leather is a natural product, variations of texture are common and should be expected. Leather will contain natural markings such as neck wrinkles, scratches, backbone marks and stretch marks. These distinctions give leather its unique characteristics and are considered to be a part of the natural beauty of leather.

Markerboard tables with urethane edges:

Black Bear urethane must be specified with markerboard laminate table products due to cleanability. Claims of this nature void the urethane warranty.

The Fine Print

Excluded from warranty is product that has unauthorized modifications, or if the customer fails to perform normal maintenance service on the product. This includes, but is not limited to, lubrication and cleaning, minor assembly and adjustment and periodic operational checks. Natural variations occurring in wood are not considered defects; izzy+ does not warranty the colorfastness or matching of color, grain or texture, normal wear and tear, or damages resulting from shipping, storage, or installation.

This warranty does not include defects from normal wear and tear, accidents, negligence, abuse, shipment, handling, storage, or environmental conditions. Any modifications to izzy+'s products by the purchaser, purchaser's employees or agents, void this warranty. izzy+ reserves the right to reasonably determine whether a defect resulted from a factor excluded from this warranty. If a defect in material or workmanship is determined to have occurred in normal use during the warranty period, izzy+ will repair or replace the warranted product with a product of like or comparable quality. The expressed warranties contained herein are in lieu of all other warranties, expressed or implied, including any warranty of merchantability and fitness for a particular purpose, and all other warranties arising from the course of dealing or usage of trade. Any action to enforce this warranty must be brought within three (3) months from the time an alleged defect in material or workmanship first occurs.

Repair and Replacement:

Repair or replacement of any defective izzy+ contract seating product for the period of time provided, shall constitute complete fulfillment of all the liabilities of izzy+, whether the claims of the purchaser are based in contract, in tort (including negligence and/or strict liability) or otherwise, with respect to, or arising out of, the product furnished hereunder. izzy+ is not liable for any special or consequential damages under this warranty. The remedies provided above are the purchaser's sole remedies for any failure of izzy+ to comply with its obligations regarding the material and workmanship of its products. All incidental or consequential damages which may arise, including but not limited to, business losses, personal damage and third party liability are hereby expressly excluded.

Any labor charges for correcting a manufacturing problem for a product under warranty must be submitted in writing and approved by izzy+ Customer Service prior to corrective action. Labor charges will not be paid if the estimate was not submitted and approved prior to labor being completed.

ABCO 2.0