

July 3, 2011

Updated January 11, 2017

800-424-2432





---

<b>Aristotle® Classic</b>	General Information	4
---------------------------	---------------------	---

---

<b>Aristotle® Classic Pedestal Desks</b>		
	Double Pedestal Desks	6
	Bow Front Double Pedestal Desks	10
	Single Pedestal Desks-Pedestal on Left	14
	Bow Front Single Pedestal Desks-Pedestal on Left	16
	Single Pedestal Desks-Pedestal on Right	18
	Bow Front Single Pedestal Desks-Pedestal on Right	20

---

<b>Aristotle® Classic Desks</b>		
	Bow Front Desks-Straight Cutaway	22
	Bow Front Desks-Curved Cutaway	24
	P-Top Desks-Straight Cutaway	26
	P-Top Desks-Curved Cutaway	28
	D-Top Desks-Straight Cutaway	30
	D-Top Desks-Curved Cutaway	32
	D-Top Desks-Straight Cutaway	34
	D-Top Desks-Curved Cutaway	36

---

<b>Aristotle® Classic Returns</b>		
	Pedestal-Left	38
	Pedestal-Right	40
	Pedestal-Left and Pedestal-Right	40
	Flush-Left and Right, No Pedestal	44
	Aluminum Frame Profile with Modesty and End Panel Inserts	46

---

<b>Aristotle® Classic Bridge</b>		
	Bridges	48

---

<b>Aristotle® Classic Credenzas</b>		
	Single Pedestal Credenzas-Left	50
	Single Pedestal Credenzas-Right	52
	Double Pedestal Credenzas	54
	Credenza-Center Storage	58
	Credenza-Lateral Files	60
	Credenza-Storage	64

---

<b>Aristotle® Classic Reception Workstations</b>		
	Reception Desks	66
	Bow Front Reception Desks	72
	Returns	78

---

<b>Aristotle® Classic Shells</b>		
	Corner Units	84
	Desk Shells-20"	86
	Desk Shells-24"	88
	Desk Shells-30"	90
	Desk Shells-Inset Back Panel	92
	Extended Corner Desk Shells - 20" - Extended Left	94
	Extended Corner Desk Shells - 20" - Extended Right	96
	Extended Corner Desk Shells - 24" - Extended Left	98
	Extended Corner Desk Shells - 24" - Extended Right	100
	Extended Corner Desk Shells - 30" - Extended Left	102
	Extended Corner Desk Shells - 30" - Extended Right	104

---

<b>Aristotle® Classic D-Tops</b>		
	Suspended	106
	With End Panel	108

---

<b>Aristotle® Classic P-Tops</b>		
	Suspended	110
	With End Panel	112

---

<b>Aristotle® Classic Storage</b>		
	Open Overheads	114
	Closed Overheads-Open Back Below Shelf	118
	Closed Overheads	120
	Overhead - Frosted Glass Doors	132
	Overheads-Sliding Frosted Acrylic Doors	134
	Open Corner Overhead	136
	Closed Corner Overhead	138
	Gallery Reception Desks	142
	Extended Corner Reception Gallery	146

# Contents

Refer to KI Terms & Conditions document or visit [ki.com](http://ki.com).

Hanging Pedestals	154
Full Height Pedestals	156
Mobile Pedestals	158
Lateral Files-Under Desk	160
Lateral Files-Integrated	162
Lateral Files-Freestanding	164
Lower Storage Units - Under Desk	166
Lower Storage Units - Freestanding	170
24" Wide Storage Towers	176
24" Wide Storage and Wardrobe Towers	178
24" Wide Storage, Wardrobe and File Towers	180
24" Wide Storage, Wardrobe and File Towers/30" and 36" Storage Towers	182
30" and 36" Storage Towers/36" Storage and Wardrobe Towers	184
Bookcases-24" Wide	186
Bookcases-30" Wide	188
Bookcases-36" Wide	190
Bookcase Accessories	192
Quarter-Round Bookcases	194
Square Bookcases	198
<b>Aristotle® Classic Accessories</b>	
Desktop Acrylic Screen	200
Desktop Screen Support	202
Paper Management	204
Tackboards	206
Connector Tops	210
<b>Aristotle® Classic</b>	
Conference Room	212
Metal Leg Return	214
Metal Leg Tables and Desks	216
<b>Aristotle® Classic Accessories</b>	
Grommet, Wire Management Channel, Keyed Alike Kits	218
Task Lights	220
<b>Aristotle® Executive</b>	
General Information	222
<b>Aristotle® Executive Pedestal Desks</b>	
Double Pedestal Desks	224
Bow Front Double Pedestal Desks	228
Single Pedestal Desks-Pedestal on Left	232
Bow Front Single Pedestal Desks-Pedestal on Left	234
Single Pedestal Desks-Pedestal on Right	236
Bow Front Single Pedestal Desks-Pedestal on Right	238
<b>Aristotle® Executive Desks</b>	
Bow Front Desks-Straight Cutaway	240
Bow Front Desks-Curved Cutaway	242
P-Top Desks-Straight Cutaway	244
P-Top Desks-Curved Cutaway	246
D-Top Desks-Straight Cutaway	248
D-Top Desks-Curved Cutaway	250
D-Top Desks-Straight Cutaway	252
D-Top Desks-Curved Cutaway	254
<b>Aristotle® Executive Returns</b>	
Pedestal-Left	256
Pedestal-Right	260
Flush-Left and Right, No Pedestal	264
Aluminum Frame Profile with Modesty and End Panel Inserts	266
<b>Aristotle® Executive Bridge</b>	
Bridges	268
<b>Aristotle® Executive Credenzas</b>	
Single Pedestal Credenzas-Left	270
Single Pedestal Credenzas-Right	272
Double Pedestal Credenzas	274
Credenza-Center Storage	278
Credenza-Lateral Files	280
Credenza-Storage	284
Credenza-Double Storage	286
<b>Aristotle® Executive Reception Workstations</b>	
Reception Desks	288



Bow Front Reception Desks	294
Returns	300
<hr/>	
<b>Aristotle® Executive Shells</b>	
Corner Units	306
Desk Shells-20"	308
Desk Shells-24"	310
Desk Shells-30"	312
Desk Shells-Inset Back Panel	314
Extended Corner Desk Shells - 20" - Extended Left	316
Extended Corner Desk Shells - 20" - Extended Right	320
Extended Corner Desk Shells - 24" - Extended Left	324
Extended Corner Desk Shells - 24" - Extended Right	328
Extended Corner Desk Shells - 30" - Extended Left	332
Extended Corner Desk Shells - 30" - Extended Right	336
<hr/>	
<b>Aristotle® Executive D-Tops</b>	
Suspended	340
With End Panel	342
<hr/>	
<b>Aristotle® Executive P-Tops</b>	
Suspended	344
With End Panel	346
<hr/>	
<b>Aristotle® Executive Storage</b>	
Open Overheads	348
Closed Overheads-Open Back Below Shelf	352
Closed Overheads	354
Overhead - Frosted Glass Doors	360
Overheads-Sliding Frosted Acrylic Doors	362
Open Corner Overhead	364
Closed Corner Overhead	366
Gallery Reception Desks	370
Extended Corner Reception Gallery	374
Hanging Pedestals	382
Full Height Pedestals	384
Mobile Pedestals	386
Lateral Files-Under Desk	388
Lateral Files-Integrated	390
Lateral Files-Freestanding	392
Lower Storage Units - Under Desk	394
Lower Storage Units - Freestanding	398
24" Wide Storage Towers	404
24" Wide Storage and Wardrobe Towers	406
24" Wide Storage, Wardrobe and File Towers	408
24" Wide Wardrobe, File and Storage Towers	410
30" and 36" Storage Towers	412
30 and 36" Storage and Wardrobe Towers	414
Bookcases-24" Wide	416
Bookcases-30" Wide	418
Bookcases-36" Wide	420
Bookcase Accessories	422
Quarter-Round Bookcases	424
Square Bookcases	428
<hr/>	
<b>Aristotle® Executive Accessories</b>	
Desktop Acrylic Screen	430
Desktop Screen Support	432
Paper Management	434
Tackboards	436
Connector Tops	440
<hr/>	
<b>Aristotle® Executive</b>	
Conference Room	442
Metal Leg Return	444
Metal Leg Tables and Desks	446
<hr/>	
<b>Aristotle® Executive Accessories</b>	
Grommet, Wire Management Channel, Keyed Alike Kits	448
Task Lights	450
<hr/>	
<b>Index</b>	452

# Aristotle® Classic

## General Information

### General Information

The Aristotle Casegoods collection from KI creates upscale environments for intelligent workspaces without a heavy price tag. Warm wood grains offer classic appeal while solid finishes provide a more contemporary aesthetic. Both may be combined with metallic accents for truly unique style.

Aristotle is offered in both a Classic version and an Executive version. Aristotle in its Classic offering is more economical when budget is a key concern. It features 1" work surfaces and a flat grain-matched edge. For a more upscale aesthetic, Aristotle Executive features 1-1/2" work surfaces, and any of three edge band options may be featured. Aside from work surfaces, the Classic Aristotle and the Executive Aristotle lines feature similar construction and specifications and both are planned in keeping with the guidelines set forth in this document.

### Aristotle Classic Construction

All work surfaces, tops and end panels are 1" thick. Bookcases have 1" thick top and shelves. Edge banding is 2.5 mm thick and matches the laminate finish. Adjustable glides keep surfaces level. Most products are shipped pre-assembled. Products that are shipped ready-to-configure have most fittings pre-attached for quick installation.

All dimensions shown are nominal. Approximate weights and volumes relate to crated items and are indicated for shipping purposes. Glides allow for 5/8" adjustment.

### Edge detail

1" thick work surface and top  
2.5 mm flat edge banding

### Drawer construction

Pedestals feature five-sided drawer construction and full depth drawers to maximize storage capacity. Pedestals also feature a pencil tray standard in the upper drawer box. Lateral files have steel drawers.

### Drawer suspension

File drawers utilize a heavy-duty full extension ball bearing slide for smooth operation. Box drawers operate on full extension slides allowing total access to drawer.

### File drawers

Credenza, pedestal, and lateral file drawers accommodate letter and legal filing. Lateral file unit drawers are equipped to accept front-to-back filing hardware, specified separately. Lateral files have an anti-tip interlock system.

### Overheads

Overheads have a 133/4" internal height clearance and feature a full width, concealed cable pass-through 13/4" high. 36" high overheads have 171/2" clearance above desktops and are 65" high installed. 43" high overheads have 24" clearance above desk

top and are 72" high installed. Wall mount overheads include instructions and mounting hardware.

### Frosted glass door cabinets

Frosted glass doors on overheads and select storage towers have a vinyl wrapped MDF frame in silver finish with tempered, frosted glass.

### Acrylic Door Cabinets

Cabinets feature 13-3/4" internal height clearance. Full-width concealed cable pass through (1-3/4") is provided for 36" and 43" high units. Wall mount also available. Units are non-locking.

### Desktop panel screens

Desktop panels are 1/4" thick frosted acrylic to offer personal privacy while enhancing the overall design. Desktop panel supports are available separately in silver or black finish. A simple surface-mounted attachment secures the panel support to the desktop as a field installation.

### Sizes

Published width and depth dimensions are nominal. To determine actual sizes use the multiplier 0.9843. (Example: a desk listed with a nominal width of 60" is actually 60" x 0.9843 = 591/16"), and refer to the conversion chart below:

Nominal/Actual	Nominal/Actual	Nominal/Actual	Nominal/Actual
24"	23-5/8"	72"	70-7/8"
30"	29-1/2"	78"	76-3/4"
36"	35-7/16"	84"	82-11/16"
42"	41-5/16"	90"	88-9/16"
48"	47-1/4"	96"	94-1/2"
54"	53-1/8"	102"	100-3/8"
60"	59-1/16"	108"	106-1/4"
66"	64-15/16"		

### Grommets

Grommets are indicated on all product illustrations when standard and have a 23/4" diameter opening. For non-standard locations, field-installed grommet kits are available. See Accessories.

### End and Back Panels

Full height end and back panels are standard on most items. Partial height panels are available as a no charge option on most desk shells, extended corner desk shells, and corner units. The 2Q option provides 14" clearance from the floor, and the 3Q option provides 8" clearance from the floor.

### Modesty Panels

Partial modesty panels (PMP) are 14" and provide 14" of lower clearance. Full height modesty panels (FMP) extend to the floor. Partial modesty panels are standard with no upcharge. Full modesty panels are offered on limited models at an upcharge.

### Pulls

NP - No pulls. An integral pull is standard on all drawers and doors. Three pull options are available. To order, add pull code to product code and \$10 per

pull to list price. Note that overheads cannot have pulls specified.

### Laminate top and base finish

All surfaces are manufactured using high-performance thermally fused laminate, providing a durable, resilient finish. Laminates can be mixed and matched to create a two-toned look. Edge banding matches laminate finish.

Shelf finish on bookcases and overheads matches shell (vertical) finish.

### Meeting table, freestanding desk and return base metal leg finish

Matching freestanding tables provide auxiliary work surfaces. Metal legs in two styles offer strength and durability in a contemporary profile.

Metal-legged returns are attached to a primary desk with flat attachment brackets. The legs include an integrated wire management slot and an adjustable glide.

### Keying options

Locks are standard on all pedestals, credenzas, and lateral files. Locks are pre-installed in all workstation components (all multi-lock units are keyed alike). Workstations are available keyed alike at time of order. Indicate clearly which offices are to be keyed alike. See Keyed Alike Kits if additional key sets are required. The following key options are available at the end of the model strings:  
KS - Key standard  
KA - Key alike (note room numbers on order)



# Aristotle® Classic Pedestal Desks

## Double Pedestal Desks

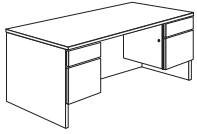
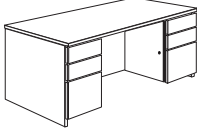
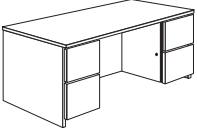
	MODEL	W x D x H	MODEL NUMBER					Approx. Packaged Weight
			Basic Model	Horizontal Surface Finish	Vertical Surface Finish	Pull Option	Lock Option	
 ARPED	<b>Double Pedestal Desk, Box/File Option A</b> • Two box/file pedestals • Full height modesty panel recessed 2-1/2" for 30" deep desks and 8-3/4" for 36" deep desks • Grommets not offered • Pedestals feature locks on inside panels • Integral pull is standard; use xxx4 for optional pulls	60 x 30 x 29"	KDP6030A.H	□□□	□□□	□□□□	□□	245.0#
		66 x 30 x 29"	KDP6630A.H	□□□	□□□	□□□□	□□	255.0#
		72 x 30 x 29"	KDP7230A.H	□□□	□□□	□□□□	□□	265.0#
		72 x 36 x 29"	KDP7236A.H	□□□	□□□	□□□□	□□	275.0#
		84 x 36 x 29"	KDP8436A.H	□□□	□□□	□□□□	□□	285.0#
 ARPED	<b>Double Pedestal Desk, Box/Box/File Option B</b> • Two box/box/file pedestals • Full height modesty panel recessed 2-1/2" for 30" deep desks and 8-3/4" for 36" deep desks • Grommets not offered • Pedestals feature locks on inside panels • Integral pull is standard; use xxx6 for optional pulls • Upper box drawers are non-locking	60 x 30 x 29"	KDP6030B.H	□□□	□□□	□□□□	□□	245.0#
		66 x 30 x 29"	KDP6630B.H	□□□	□□□	□□□□	□□	315.0#
		72 x 30 x 29"	KDP7230B.H	□□□	□□□	□□□□	□□	325.0#
		72 x 36 x 29"	KDP7236B.H	□□□	□□□	□□□□	□□	335.0#
		84 x 36 x 29"	KDP8436B.H	□□□	□□□	□□□□	□□	345.0#
 ARPED	<b>Double Pedestal Desk, File/File Option C</b> • Two file/file pedestals • Full height modesty panel recessed 2-1/2" for 30" deep desks and 8-3/4" for 36" deep desks • Grommets not offered • Pedestals feature locks on inside panels • Integral pull is standard; use xxx4 for optional pulls	60 x 30 x 29"	KDP6030C.H	□□□	□□□	□□□□	□□	305.0#
		66 x 30 x 29"	KDP6630C.H	□□□	□□□	□□□□	□□	315.0#
		72 x 30 x 29"	KDP7230C.H	□□□	□□□	□□□□	□□	325.0#
		72 x 36 x 29"	KDP7236C.H	□□□	□□□	□□□□	□□	335.0#
		84 x 36 x 29"	KDP8436C.H	□□□	□□□	□□□□	□□	345.0#
				<b>A</b>	<b>B</b>	<b>C</b>	<b>D</b>	<b>E</b>

### HOW TO ORDER

Indicate the following information on order form:

- Quantity of each item.
- Model number, including options. See "How To Build a Model Number".
- Any special service required.

Note: • The □ indicates that a choice is required.

- The absence of the □ indicates that no choice is required.
- Alpha-numeric characters in place of □ indicate that no other alternatives are available.

### HOW TO BUILD A MODEL NUMBER

- A** Select basic model.
- B** Select horizontal surface finish.  
Refer to color addendum at ki.com or KI Fabrics & Finishes binder.
- C** Select vertical surface finish.  
Refer to color addendum at ki.com or KI Fabrics & Finishes binder.
- D** Select pull option.
- |             |   |
|-------------|---|
| <b>NP</b>   | - Standard integral pull                |
| <b>BPA4</b> | - Silver bar pull (4); add \$40         |
| <b>BPA6</b> | - Silver bar pull (6); add \$60         |
| <b>KIB4</b> | - Waterfall black pull (4); add \$40    |
| <b>KIB6</b> | - Waterfall black pull (6); add \$60    |
| <b>KIS4</b> | - Waterfall silver pull (4); add \$40   |
| <b>KIS6</b> | - Waterfall silver pull (6); add \$60   |
| <b>RCP4</b> | - Rectangular silver pull (4); add \$40 |

**RCP6** - Rectangular silver pull (6); add \$60

**E** Select lock option.

**KA** - Key alike  
**KS** - Key standard





# Aristotle® Classic Pedestal Desks

Double Pedestal Desks

Delivered Pricing

\$ 1402  
1473  
1550  
1559  
1637

\$ 1737  
1813  
1842  
1897  
1954

\$ 1737  
1813  
1842  
1897  
1954

**SPECIAL SERVICES**

**Special Carton Marking**

With specially marked information N/C

**Shipping**

Shipped **assembled freight prepaid f.o.b. KI-Aristotle Brampton, Ontario L6T 5T6** factory. Freight class #85.

Specifications and prices are subject to change without prior notice.

# Aristotle® Classic Pedestal Desks

## Double Pedestal Desks

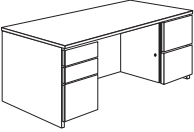
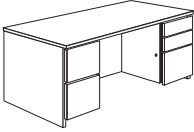
		MODEL NUMBER					Approx. Packaged Weight	
		Basic Model	Horizontal Surface Finish	Vertical Surface Finish	Pull Option	Lock Option		
MODEL	W x D x H							
 <p>ARPED</p>	<b>Double Pedestal Desk, Box/Box/File Option F</b>	60 x 30 x 29"	KDP6030F.H	<input type="checkbox"/> <input type="checkbox"/> <input type="checkbox"/>	<input type="checkbox"/> <input type="checkbox"/> <input type="checkbox"/>	<input type="checkbox"/> <input type="checkbox"/> <input type="checkbox"/> <input type="checkbox"/>	<input type="checkbox"/> <input type="checkbox"/>	305.0#
		66 x 30 x 29"	KDP6630F.H	<input type="checkbox"/> <input type="checkbox"/> <input type="checkbox"/>	<input type="checkbox"/> <input type="checkbox"/> <input type="checkbox"/>	<input type="checkbox"/> <input type="checkbox"/> <input type="checkbox"/> <input type="checkbox"/>	<input type="checkbox"/> <input type="checkbox"/>	315.0#
		72 x 30 x 29"	KDP7230F.H	<input type="checkbox"/> <input type="checkbox"/> <input type="checkbox"/>	<input type="checkbox"/> <input type="checkbox"/> <input type="checkbox"/>	<input type="checkbox"/> <input type="checkbox"/> <input type="checkbox"/> <input type="checkbox"/>	<input type="checkbox"/> <input type="checkbox"/>	325.0#
		72 x 36 x 29"	KDP7236F.H	<input type="checkbox"/> <input type="checkbox"/> <input type="checkbox"/>	<input type="checkbox"/> <input type="checkbox"/> <input type="checkbox"/>	<input type="checkbox"/> <input type="checkbox"/> <input type="checkbox"/> <input type="checkbox"/>	<input type="checkbox"/> <input type="checkbox"/>	335.0#
		84 x 36 x 29"	KDP8436F.H	<input type="checkbox"/> <input type="checkbox"/> <input type="checkbox"/>	<input type="checkbox"/> <input type="checkbox"/> <input type="checkbox"/>	<input type="checkbox"/> <input type="checkbox"/> <input type="checkbox"/> <input type="checkbox"/>	<input type="checkbox"/> <input type="checkbox"/>	345.0#
 <p>ARPED</p>	<b>Double Pedestal Desk, Locking File/File Option G</b>	60 x 30 x 29"	KDP6030G.H	<input type="checkbox"/> <input type="checkbox"/> <input type="checkbox"/>	<input type="checkbox"/> <input type="checkbox"/> <input type="checkbox"/>	<input type="checkbox"/> <input type="checkbox"/> <input type="checkbox"/> <input type="checkbox"/>	<input type="checkbox"/> <input type="checkbox"/>	305.0#
		66 x 30 x 29"	KDP6630G.H	<input type="checkbox"/> <input type="checkbox"/> <input type="checkbox"/>	<input type="checkbox"/> <input type="checkbox"/> <input type="checkbox"/>	<input type="checkbox"/> <input type="checkbox"/> <input type="checkbox"/> <input type="checkbox"/>	<input type="checkbox"/> <input type="checkbox"/>	315.0#
		72 x 30 x 29"	KDP7230G.H	<input type="checkbox"/> <input type="checkbox"/> <input type="checkbox"/>	<input type="checkbox"/> <input type="checkbox"/> <input type="checkbox"/>	<input type="checkbox"/> <input type="checkbox"/> <input type="checkbox"/> <input type="checkbox"/>	<input type="checkbox"/> <input type="checkbox"/>	325.0#
		72 x 36 x 29"	KDP7236G.H	<input type="checkbox"/> <input type="checkbox"/> <input type="checkbox"/>	<input type="checkbox"/> <input type="checkbox"/> <input type="checkbox"/>	<input type="checkbox"/> <input type="checkbox"/> <input type="checkbox"/> <input type="checkbox"/>	<input type="checkbox"/> <input type="checkbox"/>	335.0#
		84 x 36 x 29"	KDP8436G.H	<input type="checkbox"/> <input type="checkbox"/> <input type="checkbox"/>	<input type="checkbox"/> <input type="checkbox"/> <input type="checkbox"/>	<input type="checkbox"/> <input type="checkbox"/> <input type="checkbox"/> <input type="checkbox"/>	<input type="checkbox"/> <input type="checkbox"/>	345.0#
				<b>A</b>	<b>B</b>	<b>C</b>	<b>D</b>	<b>E</b>

### HOW TO ORDER

Indicate the following information on order form:

- Quantity of each item.
- Model number, including options. See "How To Build a Model Number".
- Any special service required.

Note: • The  indicates that a choice is required.

- The absence of the  indicates that no choice is required.
- Alpha-numeric characters in place of  indicate that no other alternatives are available.

### HOW TO BUILD A MODEL NUMBER

- A** Select basic model.
- B** Select horizontal surface finish.  
Refer to color addendum at [ki.com](http://ki.com) or KI Fabrics & Finishes binder.
- C** Select vertical surface finish.  
Refer to color addendum at [ki.com](http://ki.com) or KI Fabrics & Finishes binder.
- D** Select pull option.
- |             |   |
|-------------|---|
| <b>NP</b>   | - Standard integral pull                |
| <b>BPA5</b> | - Silver bar pull (5); add \$50         |
| <b>KIB5</b> | - Waterfall black pull (5); add \$50    |
| <b>KIS5</b> | - Waterfall silver pull (5); add \$50   |
| <b>RCP5</b> | - Rectangular silver pull (5); add \$50 |
- E** Select lock option.
- |           |                |
|-----------|----------------|
| <b>KA</b> | - Key alike    |
| <b>KS</b> | - Key standard |



# Aristotle® Classic Pedestal Desks

Double Pedestal Desks

Delivered Pricing

\$ 1737  
1813  
1842  
1897  
1954

\$ 1737  
1813  
1842  
1897  
1954

**SPECIAL SERVICES**

**Special Carton Marking**

With specially marked information N/C

**Shipping**

Shipped **assembled freight prepaid f.o.b. KI-Aristotle Brampton, Ontario L6T 5T6** factory. Freight class #85.

Specifications and prices are subject to change without prior notice.

# Aristotle® Classic Pedestal Desks

## Bow Front Double Pedestal Desks

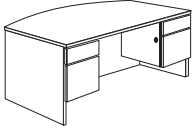
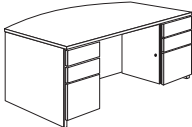
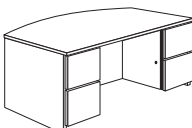
		MODEL NUMBER					Approx. Packaged Weight		
		Basic Model	Horizontal Surface Finish	Vertical Surface Finish	Pull Option	Lock Option			
 <p>ARPED</p>	<b>Bow Front Double Pedestal Desk, Box/File Option A</b> • Two box/file pedestals • Full height modesty panel recessed 8-3/4" for 36" deep desks and 14-3/4" for 42" deep desks • Grommets not offered • Pedestals feature locks on inside panels • Integral pull is standard; use xxx4 for optional pulls	66 x 36 x 29"	KBDP6636A.H	□□□	□□□	□□□□	□□	260.0#	
		72 x 42 x 29"	KBDP7242A.H	□□□	□□□	□□□□	□□	280.0#	
		84 x 42 x 29"	KBDP8442A.H	□□□	□□□	□□□□	□□	290.0#	
 <p>ARPED</p>	<b>Bow Front Double Pedestal Desk, Box/File Option B</b> • Two box/box/file pedestals • Full height modesty panel recessed 8-3/4" for 36" deep desks and 14-3/4" for 42" deep desks • Grommets not offered • Pedestals feature locks on inside panels • Integral pull is standard; use xxx6 for optional pulls • Upper box drawers are non-locking	66 x 36 x 29"	KBDP6636B.H	□□□	□□□	□□□□	□□	320.0#	
		72 x 42 x 29"	KBDP7242B.H	□□□	□□□	□□□□	□□	340.0#	
		84 x 42 x 29"	KBDP8442B.H	□□□	□□□	□□□□	□□	350.0#	
 <p>ARPED</p>	<b>Bow Front Double Pedestal Desk, File/File Option C</b> • Two file/file pedestals • Full height modesty panel recessed 8-3/4" for 36" deep desks and 14-3/4" for 42" deep desks • Grommets not offered • Pedestals feature locks on inside panels • Integral pull is standard; use xxx4 for optional pulls	66 x 36 x 29"	KBDP6636C.H	□□□	□□□	□□□□	□□	320.0#	
		72 x 42 x 29"	KBDP7242C.H	□□□	□□□	□□□□	□□	340.0#	
		84 x 42 x 29"	KBDP8442C.H	□□□	□□□	□□□□	□□	350.0#	
				<b>A</b>	<b>B</b>	<b>C</b>	<b>D</b>	<b>E</b>	

### HOW TO ORDER

Indicate the following information on order form:

- Quantity of each item.
- Model number, including options. See "How To Build a Model Number".
- Any special service required.

Note: • The □ indicates that a choice is required.

- The absence of the □ indicates that no choice is required.
- Alpha-numeric characters in place of □ indicate that no other alternatives are available.

### HOW TO BUILD A MODEL NUMBER

- A** Select basic model.
- B** Select horizontal surface finish.  
Refer to color addendum at ki.com or KI Fabrics & Finishes binder.
- C** Select vertical surface finish.  
Refer to color addendum at ki.com or KI Fabrics & Finishes binder.
- D** Select pull option.
 

<b>NP</b>	- Standard integral pull
<b>BPA4</b>	- Silver bar pull (4); add \$40
<b>BPA6</b>	- Silver bar pull (6); add \$60
<b>KIB4</b>	- Waterfall black pull (4); add \$40
<b>KIB6</b>	- Waterfall black pull (6); add \$60
<b>KIS4</b>	- Waterfall silver pull (4); add \$40
<b>KIS6</b>	- Waterfall silver pull (6); add \$60
<b>RCP4</b>	- Rectangular silver pull (4); add \$40

**RCP6** - Rectangular silver pull (6); add \$60

- E** Select lock option.
 

<b>KA</b>	- Key alike
<b>KS</b>	- Key standard



# Aristotle® Classic Pedestal Desks

Bow Front Double Pedestal Desks

Delivered Pricing

\$ 1904  
1912  
1967

\$ 2233  
2252  
2282

\$ 2233  
2252  
2282

**SPECIAL SERVICES**

**Special Carton Marking**

With specially marked information N/C

**Shipping**

Shipped **assembled freight prepaid f.o.b. KI-Aristotle Brampton, Ontario L6T 5T6** factory. Freight class #85.

Specifications and prices are subject to change without prior notice.

# Aristotle® Classic Pedestal Desks

Bow Front Double Pedestal Desks

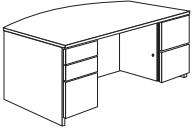
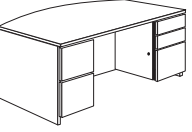
		MODEL NUMBER					Approx. Packaged Weight	
		Basic Model	Horizontal Surface Finish	Vertical Surface Finish	Pull Option	Lock Option		
 <p>ARPED</p>	<b>Bow Front Double Pedestal Desk, Box/Box/File Option F</b> <ul style="list-style-type: none"> <li>Box/box/file pedestal on left, upper drawer non-locking</li> <li>Locking file/file pedestal on right</li> <li>Full height modesty panel recessed 8-3/4" for 36" deep desks and 14-3/4" for 42" deep desks</li> <li>Grommets not offered</li> <li>Pedestals feature locks on inside panels</li> <li>Integral pull is standard; use xxx5 for optional pulls</li> </ul>	66 x 36 x 29"	KBDP6636F.H	<input type="checkbox"/> <input type="checkbox"/> <input type="checkbox"/>	<input type="checkbox"/> <input type="checkbox"/> <input type="checkbox"/>	<input type="checkbox"/> <input type="checkbox"/> <input type="checkbox"/> <input type="checkbox"/>	<input type="checkbox"/> <input type="checkbox"/>	320.0#
		72 x 42 x 29"	KBDP7242F.H	<input type="checkbox"/> <input type="checkbox"/> <input type="checkbox"/>	<input type="checkbox"/> <input type="checkbox"/> <input type="checkbox"/>	<input type="checkbox"/> <input type="checkbox"/> <input type="checkbox"/> <input type="checkbox"/>	<input type="checkbox"/> <input type="checkbox"/>	340.0#
		84 x 42 x 29"	KBDP8442F.H	<input type="checkbox"/> <input type="checkbox"/> <input type="checkbox"/>	<input type="checkbox"/> <input type="checkbox"/> <input type="checkbox"/>	<input type="checkbox"/> <input type="checkbox"/> <input type="checkbox"/> <input type="checkbox"/>	<input type="checkbox"/> <input type="checkbox"/>	350.0#
 <p>ARPED</p>	<b>Bow Front Double Pedestal Desk, Locking File/File Option G</b> <ul style="list-style-type: none"> <li>Locking file/file pedestal on left</li> <li>Box/box/file pedestal on right, upper drawer non-locking</li> <li>Full height modesty panel recessed 8-3/4" for 36" deep desks and 14-3/4" for 42" deep desks</li> <li>Grommets not offered</li> <li>Pedestals feature locks on inside panels</li> <li>Integral pull is standard; use xxx5 for optional pulls</li> </ul>	66 x 36 x 29"	KBDP6636G.H	<input type="checkbox"/> <input type="checkbox"/> <input type="checkbox"/>	<input type="checkbox"/> <input type="checkbox"/> <input type="checkbox"/>	<input type="checkbox"/> <input type="checkbox"/> <input type="checkbox"/> <input type="checkbox"/>	<input type="checkbox"/> <input type="checkbox"/>	320.0#
		72 x 42 x 29"	KBDP7242G.H	<input type="checkbox"/> <input type="checkbox"/> <input type="checkbox"/>	<input type="checkbox"/> <input type="checkbox"/> <input type="checkbox"/>	<input type="checkbox"/> <input type="checkbox"/> <input type="checkbox"/> <input type="checkbox"/>	<input type="checkbox"/> <input type="checkbox"/>	340.0#
		84 x 42 x 29"	KBDP8442G.H	<input type="checkbox"/> <input type="checkbox"/> <input type="checkbox"/>	<input type="checkbox"/> <input type="checkbox"/> <input type="checkbox"/>	<input type="checkbox"/> <input type="checkbox"/> <input type="checkbox"/> <input type="checkbox"/>	<input type="checkbox"/> <input type="checkbox"/>	350.0#
				<b>A</b>	<b>B</b>	<b>C</b>	<b>D</b>	<b>E</b>

## HOW TO ORDER

Indicate the following information on order form:

- Quantity of each item.
- Model number, including options. See "How To Build a Model Number".
- Any special service required.

Note: • The  indicates that a choice is required.

- The absence of the  indicates that no choice is required.
- Alpha-numeric characters in place of  indicate that no other alternatives are available.

## HOW TO BUILD A MODEL NUMBER

- A** Select basic model.
- B** Select horizontal surface finish.  
Refer to color addendum at [ki.com](http://ki.com) or KI Fabrics & Finishes binder.
- C** Select vertical surface finish.  
Refer to color addendum at [ki.com](http://ki.com) or KI Fabrics & Finishes binder.
- D** Select pull option.
- |             |   |
|-------------|---|
| <b>NP</b>   | - Standard integral pull                |
| <b>BPA5</b> | - Silver bar pull (5); add \$50         |
| <b>KIB5</b> | - Waterfall black pull (5); add \$50    |
| <b>KIS5</b> | - Waterfall silver pull (5); add \$50   |
| <b>RCP5</b> | - Rectangular silver pull (5); add \$50 |
- E** Select lock option.
- |           |                |
|-----------|----------------|
| <b>KA</b> | - Key alike    |
| <b>KS</b> | - Key standard |



# Aristotle® Classic Pedestal Desks

Bow Front Double Pedestal Desks

Delivered  
Pricing

\$ 2233  
2252  
2282

\$ 2233  
2252  
2282

### SPECIAL SERVICES

#### Special Carton Marking

With specially marked information    N/C

#### Shipping

Shipped **assembled freight prepaid f.o.b. KI-Aristotle Brampton, Ontario L6T 5T6** factory. Freight class #85.

Specifications and prices are subject to change without prior notice.

# Aristotle® Classic Pedestal Desks

Single Pedestal Desks-Pedestal on Left

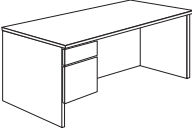
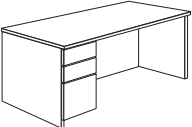
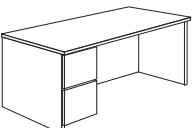
	MODEL	W x D x H	MODEL NUMBER						Approx. Packaged Weight
			Basic Model	Horizontal Surface Finish	Vertical Surface Finish	End Panel	Pull Option	Lock Option	
 <p>ARSPD</p>	<b>Single Pedestal Desk-Left, Box/File Option A</b> • Box/file pedestal on left • Full height modesty panel recessed 2-1/2" for 30" deep desks and 8-3/4" for 36" deep desks • Grommets not offered • Pedestals feature locks on inside panels • Integral pull is standard; use xxx2 for optional pulls	48 x 30 x 29"	KSPL4830A.H	<input type="checkbox"/> <input type="checkbox"/> <input type="checkbox"/>	<input type="checkbox"/> <input type="checkbox"/> <input type="checkbox"/>	<input type="checkbox"/> <input type="checkbox"/> <input type="checkbox"/> <input type="checkbox"/>	<input type="checkbox"/> <input type="checkbox"/> <input type="checkbox"/> <input type="checkbox"/>	<input type="checkbox"/> <input type="checkbox"/>	170.0#
		54 x 30 x 29"	KSPL5430A.H	<input type="checkbox"/> <input type="checkbox"/> <input type="checkbox"/>	<input type="checkbox"/> <input type="checkbox"/> <input type="checkbox"/>	<input type="checkbox"/> <input type="checkbox"/> <input type="checkbox"/> <input type="checkbox"/>	<input type="checkbox"/> <input type="checkbox"/> <input type="checkbox"/> <input type="checkbox"/>	<input type="checkbox"/> <input type="checkbox"/>	180.0#
		60 x 30 x 29"	KSPL6030A.H	<input type="checkbox"/> <input type="checkbox"/> <input type="checkbox"/>	<input type="checkbox"/> <input type="checkbox"/> <input type="checkbox"/>	<input type="checkbox"/> <input type="checkbox"/> <input type="checkbox"/> <input type="checkbox"/>	<input type="checkbox"/> <input type="checkbox"/> <input type="checkbox"/> <input type="checkbox"/>	<input type="checkbox"/> <input type="checkbox"/>	190.0#
		66 x 30 x 29"	KSPL6630A.H	<input type="checkbox"/> <input type="checkbox"/> <input type="checkbox"/>	<input type="checkbox"/> <input type="checkbox"/> <input type="checkbox"/>	<input type="checkbox"/> <input type="checkbox"/> <input type="checkbox"/> <input type="checkbox"/>	<input type="checkbox"/> <input type="checkbox"/> <input type="checkbox"/> <input type="checkbox"/>	<input type="checkbox"/> <input type="checkbox"/>	200.0#
		72 x 30 x 29"	KSPL7230A.H	<input type="checkbox"/> <input type="checkbox"/> <input type="checkbox"/>	<input type="checkbox"/> <input type="checkbox"/> <input type="checkbox"/>	<input type="checkbox"/> <input type="checkbox"/> <input type="checkbox"/> <input type="checkbox"/>	<input type="checkbox"/> <input type="checkbox"/> <input type="checkbox"/> <input type="checkbox"/>	<input type="checkbox"/> <input type="checkbox"/>	210.0#
		72 x 36 x 29"	KSPL7236A.H	<input type="checkbox"/> <input type="checkbox"/> <input type="checkbox"/>	<input type="checkbox"/> <input type="checkbox"/> <input type="checkbox"/>	<input type="checkbox"/> <input type="checkbox"/> <input type="checkbox"/> <input type="checkbox"/>	<input type="checkbox"/> <input type="checkbox"/> <input type="checkbox"/> <input type="checkbox"/>	<input type="checkbox"/> <input type="checkbox"/>	220.0#
		84 x 36 x 29"	KSPL8436A.H	<input type="checkbox"/> <input type="checkbox"/> <input type="checkbox"/>	<input type="checkbox"/> <input type="checkbox"/> <input type="checkbox"/>	<input type="checkbox"/> <input type="checkbox"/> <input type="checkbox"/> <input type="checkbox"/>	<input type="checkbox"/> <input type="checkbox"/> <input type="checkbox"/> <input type="checkbox"/>	<input type="checkbox"/> <input type="checkbox"/>	230.0#
 <p>ARSPD</p>	<b>Single Pedestal Desk-Left, Box/Box/File Option B</b> • Box/box/file pedestal on left • Full height modesty panel recessed 2-1/2" for 30" deep desks and 8-3/4" for 36" deep desks • Grommets not offered • Pedestals feature locks on inside panels • Integral pull is standard; use xxx3 for optional pulls • Upper box drawer is non-locking	48 x 30 x 29"	KSPL4830B.H	<input type="checkbox"/> <input type="checkbox"/> <input type="checkbox"/>	<input type="checkbox"/> <input type="checkbox"/> <input type="checkbox"/>	<input type="checkbox"/> <input type="checkbox"/> <input type="checkbox"/> <input type="checkbox"/>	<input type="checkbox"/> <input type="checkbox"/> <input type="checkbox"/> <input type="checkbox"/>	<input type="checkbox"/> <input type="checkbox"/>	200.0#
		54 x 30 x 29"	KSPL5430B.H	<input type="checkbox"/> <input type="checkbox"/> <input type="checkbox"/>	<input type="checkbox"/> <input type="checkbox"/> <input type="checkbox"/>	<input type="checkbox"/> <input type="checkbox"/> <input type="checkbox"/> <input type="checkbox"/>	<input type="checkbox"/> <input type="checkbox"/> <input type="checkbox"/> <input type="checkbox"/>	<input type="checkbox"/> <input type="checkbox"/>	210.0#
		60 x 30 x 29"	KSPL6030B.H	<input type="checkbox"/> <input type="checkbox"/> <input type="checkbox"/>	<input type="checkbox"/> <input type="checkbox"/> <input type="checkbox"/>	<input type="checkbox"/> <input type="checkbox"/> <input type="checkbox"/> <input type="checkbox"/>	<input type="checkbox"/> <input type="checkbox"/> <input type="checkbox"/> <input type="checkbox"/>	<input type="checkbox"/> <input type="checkbox"/>	220.0#
		66 x 30 x 29"	KSPL6630B.H	<input type="checkbox"/> <input type="checkbox"/> <input type="checkbox"/>	<input type="checkbox"/> <input type="checkbox"/> <input type="checkbox"/>	<input type="checkbox"/> <input type="checkbox"/> <input type="checkbox"/> <input type="checkbox"/>	<input type="checkbox"/> <input type="checkbox"/> <input type="checkbox"/> <input type="checkbox"/>	<input type="checkbox"/> <input type="checkbox"/>	230.0#
		72 x 30 x 29"	KSPL7230B.H	<input type="checkbox"/> <input type="checkbox"/> <input type="checkbox"/>	<input type="checkbox"/> <input type="checkbox"/> <input type="checkbox"/>	<input type="checkbox"/> <input type="checkbox"/> <input type="checkbox"/> <input type="checkbox"/>	<input type="checkbox"/> <input type="checkbox"/> <input type="checkbox"/> <input type="checkbox"/>	<input type="checkbox"/> <input type="checkbox"/>	240.0#
		72 x 36 x 29"	KSPL7236B.H	<input type="checkbox"/> <input type="checkbox"/> <input type="checkbox"/>	<input type="checkbox"/> <input type="checkbox"/> <input type="checkbox"/>	<input type="checkbox"/> <input type="checkbox"/> <input type="checkbox"/> <input type="checkbox"/>	<input type="checkbox"/> <input type="checkbox"/> <input type="checkbox"/> <input type="checkbox"/>	<input type="checkbox"/> <input type="checkbox"/>	250.0#
		84 x 36 x 29"	KSPL8436B.H	<input type="checkbox"/> <input type="checkbox"/> <input type="checkbox"/>	<input type="checkbox"/> <input type="checkbox"/> <input type="checkbox"/>	<input type="checkbox"/> <input type="checkbox"/> <input type="checkbox"/> <input type="checkbox"/>	<input type="checkbox"/> <input type="checkbox"/> <input type="checkbox"/> <input type="checkbox"/>	<input type="checkbox"/> <input type="checkbox"/>	260.0#
 <p>ARSPD</p>	<b>Single Pedestal Desk-Left, File/File Option C</b> • File/file pedestal on left • Full height modesty panel recessed 2-1/2" for 30" deep desks and 8-3/4" for 36" deep desks • Grommets not offered • Pedestals feature locks on inside panels • Integral pull is standard; use xxx2 for optional pulls	48 x 30 x 29"	KSPL4830C.H	<input type="checkbox"/> <input type="checkbox"/> <input type="checkbox"/>	<input type="checkbox"/> <input type="checkbox"/> <input type="checkbox"/>	<input type="checkbox"/> <input type="checkbox"/> <input type="checkbox"/> <input type="checkbox"/>	<input type="checkbox"/> <input type="checkbox"/> <input type="checkbox"/> <input type="checkbox"/>	<input type="checkbox"/> <input type="checkbox"/>	200.0#
		54 x 30 x 29"	KSPL5430C.H	<input type="checkbox"/> <input type="checkbox"/> <input type="checkbox"/>	<input type="checkbox"/> <input type="checkbox"/> <input type="checkbox"/>	<input type="checkbox"/> <input type="checkbox"/> <input type="checkbox"/> <input type="checkbox"/>	<input type="checkbox"/> <input type="checkbox"/> <input type="checkbox"/> <input type="checkbox"/>	<input type="checkbox"/> <input type="checkbox"/>	210.0#
		60 x 30 x 29"	KSPL6030C.H	<input type="checkbox"/> <input type="checkbox"/> <input type="checkbox"/>	<input type="checkbox"/> <input type="checkbox"/> <input type="checkbox"/>	<input type="checkbox"/> <input type="checkbox"/> <input type="checkbox"/> <input type="checkbox"/>	<input type="checkbox"/> <input type="checkbox"/> <input type="checkbox"/> <input type="checkbox"/>	<input type="checkbox"/> <input type="checkbox"/>	220.0#
		66 x 30 x 29"	KSPL6630C.H	<input type="checkbox"/> <input type="checkbox"/> <input type="checkbox"/>	<input type="checkbox"/> <input type="checkbox"/> <input type="checkbox"/>	<input type="checkbox"/> <input type="checkbox"/> <input type="checkbox"/> <input type="checkbox"/>	<input type="checkbox"/> <input type="checkbox"/> <input type="checkbox"/> <input type="checkbox"/>	<input type="checkbox"/> <input type="checkbox"/>	230.0#
		72 x 30 x 29"	KSPL7230C.H	<input type="checkbox"/> <input type="checkbox"/> <input type="checkbox"/>	<input type="checkbox"/> <input type="checkbox"/> <input type="checkbox"/>	<input type="checkbox"/> <input type="checkbox"/> <input type="checkbox"/> <input type="checkbox"/>	<input type="checkbox"/> <input type="checkbox"/> <input type="checkbox"/> <input type="checkbox"/>	<input type="checkbox"/> <input type="checkbox"/>	240.0#
		72 x 36 x 29"	KSPL7236C.H	<input type="checkbox"/> <input type="checkbox"/> <input type="checkbox"/>	<input type="checkbox"/> <input type="checkbox"/> <input type="checkbox"/>	<input type="checkbox"/> <input type="checkbox"/> <input type="checkbox"/> <input type="checkbox"/>	<input type="checkbox"/> <input type="checkbox"/> <input type="checkbox"/> <input type="checkbox"/>	<input type="checkbox"/> <input type="checkbox"/>	250.0#
		84 x 36 x 29"	KSPL8436C.H	<input type="checkbox"/> <input type="checkbox"/> <input type="checkbox"/>	<input type="checkbox"/> <input type="checkbox"/> <input type="checkbox"/>	<input type="checkbox"/> <input type="checkbox"/> <input type="checkbox"/> <input type="checkbox"/>	<input type="checkbox"/> <input type="checkbox"/> <input type="checkbox"/> <input type="checkbox"/>	<input type="checkbox"/> <input type="checkbox"/>	260.0#

A

B

C

D

E

F

## HOW TO ORDER

Indicate the following information on order form:

- Quantity of each item.
- Model number, including options. See "How To Build a Model Number".
- Any special service required.

Note: • The  indicates that a choice is required.

- The absence of the  indicates that no choice is required.
- Alpha-numeric characters in place of  indicate that no other alternatives are available.

## HOW TO BUILD A MODEL NUMBER

**A** Select basic model.

**B** Select horizontal surface finish.  
Refer to color addendum at ki.com or KI Fabrics & Finishes binder.

**C** Select vertical surface finish.  
Refer to color addendum at ki.com or KI Fabrics & Finishes binder.

**D** Select end panel option.  
**CGR** - Recessed end panel right side  
**FULL** - Full end panel both sides

**E** Select pull option.  
**NP** - Standard integral pull  
**BPA2** - Silver bar pull (2); add \$20  
**BPA3** - Silver bar pull (3); add \$30  
**KIB2** - Waterfall black pull (2); add \$20  
**KIB3** - Waterfall black pull (3); add \$30  
**KIS2** - Waterfall silver pull (2); add \$20

**KIS3** - Waterfall silver pull (3); add \$30

**RCP2** - Rectangular silver pull (2); add \$20

**RCP3** - Rectangular silver pull (3); add \$30

**F** Select lock option.

**KA** - Key alike

**KS** - Key standard





# Aristotle® Classic Pedestal Desks

Single Pedestal Desks-Pedestal on Left

## Delivered Pricing

\$ 1044  
1083  
1137  
1212  
1295  
1340  
1367

\$ 1212  
1239  
1304  
1383  
1449  
1508  
1508

\$ 1212  
1239  
1304  
1383  
1449  
1508  
1508

### SPECIAL SERVICES

#### Special Carton Marking

With specially marked information N/C



#### Shipping

Shipped **assembled freight prepaid f.o.b. KI-Aristotle Brampton, Ontario L6T 5T6** factory. Freight class #85.

Specifications and prices are subject to change without prior notice.

# Aristotle® Classic Pedestal Desks

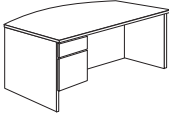
Bow Front Single Pedestal Desks-Pedestal on Left

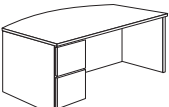
	MODEL	W x D x H	MODEL NUMBER					Approx. Packaged Weight
			Basic Model	Horizontal Surface Finish	Vertical Surface Finish	Pull Option	Lock Option	
 <p>ARPED</p>	<b>Bow Front Single Pedestal Desk-Left, Box/File Option A</b> • Box/file pedestal on left • Full height modesty panel recessed 8-3/4" for 36" deep desks and 14-3/4" for 42" deep desks • Grommets not offered • Pedestals feature locks on inside panels • Integral pull is standard; use xxx2 for optional pulls	66 x 36 x 29"	KBSPL6636A.H	<input type="checkbox"/> <input type="checkbox"/> <input type="checkbox"/>	<input type="checkbox"/> <input type="checkbox"/> <input type="checkbox"/>	<input type="checkbox"/> <input type="checkbox"/> <input type="checkbox"/> <input type="checkbox"/>	<input type="checkbox"/> <input type="checkbox"/>	205.0#
		72 x 42 x 29"	KBSPL7242A.H	<input type="checkbox"/> <input type="checkbox"/> <input type="checkbox"/>	<input type="checkbox"/> <input type="checkbox"/> <input type="checkbox"/>	<input type="checkbox"/> <input type="checkbox"/> <input type="checkbox"/> <input type="checkbox"/>	<input type="checkbox"/> <input type="checkbox"/>	225.0#
		84 x 42 x 29"	KBSPL8442A.H	<input type="checkbox"/> <input type="checkbox"/> <input type="checkbox"/>	<input type="checkbox"/> <input type="checkbox"/> <input type="checkbox"/>	<input type="checkbox"/> <input type="checkbox"/> <input type="checkbox"/> <input type="checkbox"/>	<input type="checkbox"/> <input type="checkbox"/>	235.0#
 <p>ARPED</p>	<b>Bow Front Single Pedestal Desk-Left, Box/Box/File Option B</b> • Box/box/file pedestal on left • Full height modesty panel recessed 8-3/4" for 36" deep desks and 14-3/4" for 42" deep desks • Grommets not offered • Pedestals feature locks on inside panels • Integral pull is standard; use xxx3 for optional pulls • Upper box drawer is non-locking	66 x 36 x 29"	KBSPL6636B.H	<input type="checkbox"/> <input type="checkbox"/> <input type="checkbox"/>	<input type="checkbox"/> <input type="checkbox"/> <input type="checkbox"/>	<input type="checkbox"/> <input type="checkbox"/> <input type="checkbox"/> <input type="checkbox"/>	<input type="checkbox"/> <input type="checkbox"/>	235.0#
		72 x 42 x 29"	KBSPL7242B.H	<input type="checkbox"/> <input type="checkbox"/> <input type="checkbox"/>	<input type="checkbox"/> <input type="checkbox"/> <input type="checkbox"/>	<input type="checkbox"/> <input type="checkbox"/> <input type="checkbox"/> <input type="checkbox"/>	<input type="checkbox"/> <input type="checkbox"/>	255.0#
		84 x 42 x 29"	KBSPL8442B.H	<input type="checkbox"/> <input type="checkbox"/> <input type="checkbox"/>	<input type="checkbox"/> <input type="checkbox"/> <input type="checkbox"/>	<input type="checkbox"/> <input type="checkbox"/> <input type="checkbox"/> <input type="checkbox"/>	<input type="checkbox"/> <input type="checkbox"/>	265.0#
 <p>ARPED</p>	<b>Bow Front Single Pedestal Desk-Left, File/File Option C</b> • File/file pedestal on left • Full height modesty panel recessed 8-3/4" for 36" deep desks and 14-3/4" for 42" deep desks • Grommets not offered • Pedestals feature locks on inside panels • Integral pull is standard; use xxx2 for optional pulls	66 x 36 x 29"	KBSPL6636C.H	<input type="checkbox"/> <input type="checkbox"/> <input type="checkbox"/>	<input type="checkbox"/> <input type="checkbox"/> <input type="checkbox"/>	<input type="checkbox"/> <input type="checkbox"/> <input type="checkbox"/> <input type="checkbox"/>	<input type="checkbox"/> <input type="checkbox"/>	235.0#
		72 x 42 x 29"	KBSPL7242C.H	<input type="checkbox"/> <input type="checkbox"/> <input type="checkbox"/>	<input type="checkbox"/> <input type="checkbox"/> <input type="checkbox"/>	<input type="checkbox"/> <input type="checkbox"/> <input type="checkbox"/> <input type="checkbox"/>	<input type="checkbox"/> <input type="checkbox"/>	255.0#
		84 x 42 x 29"	KBSPL8442C.H	<input type="checkbox"/> <input type="checkbox"/> <input type="checkbox"/>	<input type="checkbox"/> <input type="checkbox"/> <input type="checkbox"/>	<input type="checkbox"/> <input type="checkbox"/> <input type="checkbox"/> <input type="checkbox"/>	<input type="checkbox"/> <input type="checkbox"/>	265.0#

**A**      **B**      **C**      **D**      **E**

## HOW TO ORDER

Indicate the following information on order form:

- Quantity of each item.
- Model number, including options. See "How To Build a Model Number".
- Any special service required.

Note: • The  indicates that a choice is required.

- The absence of the  indicates that no choice is required.
- Alpha-numeric characters in place of  indicate that no other alternatives are available.

## HOW TO BUILD A MODEL NUMBER

- A** Select basic model.
- B** Select horizontal surface finish.  
Refer to color addendum at ki.com or KI Fabrics & Finishes binder.
- C** Select vertical surface finish.  
Refer to color addendum at ki.com or KI Fabrics & Finishes binder.
- D** Select pull option.
 

<b>NP</b>	- Standard integral pull
<b>BPA2</b>	- Silver bar pull (2); add \$20
<b>BPA3</b>	- Silver bar pull (3); add \$30
<b>KIB2</b>	- Waterfall black pull (2); add \$20
<b>KIB3</b>	- Waterfall black pull (3); add \$30
<b>KIS2</b>	- Waterfall silver pull (2); add \$20
<b>KIS3</b>	- Waterfall silver pull (3); add \$30
<b>RCP2</b>	- Rectangular silver pull (2); add \$20

**RCP3** - Rectangular silver pull (3); add \$30

- E** Select lock option.
 

<b>KA</b>	- Key alike
<b>KS</b>	- Key standard



# Aristotle® Classic Pedestal Desks

Bow Front Single Pedestal Desks-Pedestal on Left

Delivered Pricing

\$ 1561  
1610  
1657

\$ 1725  
1778  
1830

\$ 1725  
1778  
1830

**SPECIAL SERVICES**

**Special Carton Marking**

With specially marked information N/C

**Shipping**

Shipped **assembled freight prepaid f.o.b. KI-Aristotle Brampton, Ontario L6T 5T6** factory. Freight class #85.

Specifications and prices are subject to change without prior notice.

# Aristotle® Classic Pedestal Desks

Single Pedestal Desks-Pedestal on Right

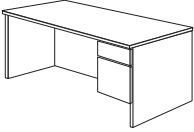
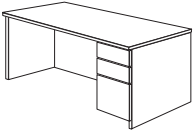
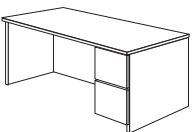
	MODEL	W x D x H	MODEL NUMBER						Approx. Packaged Weight
			Basic Model	Horizontal Surface Finish	Vertical Surface Finish	End Panel	Pull Option	Lock Option	
 <p>ARSPD</p>	<b>Single Pedestal Desk-Right, Box/File Option A</b> • Box/file pedestal on right • Full height modesty panel recessed 2-1/2" for 30" deep desks and 8-3/4" for 36" deep desks • Grommets not offered • Pedestals feature locks on inside panels • Integral pull is standard; use xxx2 for optional pulls	48 x 30 x 29"	KSPR4830A.H	□□□	□□□	□□□□	□□□□	□□	170.0#
		54 x 30 x 29"	KSPR5430A.H	□□□	□□□	□□□□	□□□□	□□	180.0#
		60 x 30 x 29"	KSPR6030A.H	□□□	□□□	□□□□	□□□□	□□	190.0#
		66 x 30 x 29"	KSPR6630A.H	□□□	□□□	□□□□	□□□□	□□	200.0#
		72 x 30 x 29"	KSPR7230A.H	□□□	□□□	□□□□	□□□□	□□	210.0#
		72 x 36 x 29"	KSPR7236A.H	□□□	□□□	□□□□	□□□□	□□	220.0#
		84 x 36 x 29"	KSPR8436A.H	□□□	□□□	□□□□	□□□□	□□	230.0#
 <p>ARSPD</p>	<b>Single Pedestal Desk-Right, Box/Box/File Option B</b> • Box/box/file pedestal on right • Full height modesty panel recessed 2-1/2" for 30" deep desks and 8-3/4" for 36" deep desks • Grommets not offered • Pedestals feature locks on inside panels • Integral pull is standard; use xxx3 for optional pulls • Upper box drawer is non-locking	48 x 30 x 29"	KSPR4830B.H	□□□	□□□	□□□□	□□□□	□□	200.0#
		54 x 30 x 29"	KSPR5430B.H	□□□	□□□	□□□□	□□□□	□□	210.0#
		60 x 30 x 29"	KSPR6030B.H	□□□	□□□	□□□□	□□□□	□□	220.0#
		66 x 30 x 29"	KSPR6630B.H	□□□	□□□	□□□□	□□□□	□□	230.0#
		72 x 30 x 29"	KSPR7230B.H	□□□	□□□	□□□□	□□□□	□□	240.0#
		72 x 36 x 29"	KSPR7236B.H	□□□	□□□	□□□□	□□□□	□□	250.0#
		84 x 36 x 29"	KSPR8436B.H	□□□	□□□	□□□□	□□□□	□□	260.0#
 <p>ARSPD</p>	<b>Single Pedestal Desk-Right, File/File Option C</b> • File/file pedestal on right • Full height modesty panel recessed 2-1/2" for 30" deep desks and 8-3/4" for 36" deep desks • Grommets not offered • Pedestals feature locks on inside panels • Integral pull is standard; use xxx2 for optional pulls	48 x 30 x 29"	KSPR4830C.H	□□□	□□□	□□□□	□□□□	□□	200.0#
		54 x 30 x 29"	KSPR5430C.H	□□□	□□□	□□□□	□□□□	□□	210.0#
		60 x 30 x 29"	KSPR6030C.H	□□□	□□□	□□□□	□□□□	□□	220.0#
		66 x 30 x 29"	KSPR6630C.H	□□□	□□□	□□□□	□□□□	□□	230.0#
		72 x 30 x 29"	KSPR7230C.H	□□□	□□□	□□□□	□□□□	□□	240.0#
		72 x 36 x 29"	KSPR7236C.H	□□□	□□□	□□□□	□□□□	□□	250.0#
		84 x 36 x 29"	KSPR8436C.H	□□□	□□□	□□□□	□□□□	□□	260.0#

**A**      **B**      **C**      **D**      **E**      **F**

## HOW TO ORDER

Indicate the following information on order form:

- Quantity of each item.
- Model number, including options. See "How To Build a Model Number".
- Any special service required.

Note: • The □ indicates that a choice is required.

- The absence of the □ indicates that no choice is required.
- Alpha-numeric characters in place of □ indicate that no other alternatives are available.

## HOW TO BUILD A MODEL NUMBER

- A** Select basic model.
- B** Select horizontal surface finish.  
Refer to color addendum at ki.com or KI Fabrics & Finishes binder.
- C** Select vertical surface finish.  
Refer to color addendum at ki.com or KI Fabrics & Finishes binder.
- D** Select end panel option.  

<b>CGL</b>	- Recessed end panel left side
<b>FULL</b>	- Full end panel both sides
- E** Select pull option.  

<b>NP</b>	- Standard integral pull
<b>BPA2</b>	- Silver bar pull (2); add \$20
<b>BPA3</b>	- Silver bar pull (3); add \$30
<b>KIB2</b>	- Waterfall black pull (2); add \$20
<b>KIB3</b>	- Waterfall black pull (3); add \$30
<b>KIS2</b>	- Waterfall silver pull (2); add \$20

- |             |   |
|-------------|---|
| <b>KIS3</b> | - Waterfall silver pull (3); add \$30   |
| <b>RCP2</b> | - Rectangular silver pull (2); add \$20 |
| <b>RCP3</b> | - Rectangular silver pull (3); add \$30 |
- F** Select lock option.  

<b>KA</b>	- Key alike
<b>KS</b>	- Key standard



# Aristotle® Classic Pedestal Desks

Single Pedestal Desks-Pedestal on Right

Delivered Pricing

\$ 1044  
1083  
1137  
1212  
1295  
1340  
1367

\$ 1212  
1239  
1304  
1383  
1449  
1508  
1508

\$ 1212  
1239  
1304  
1383  
1449  
1509  
1508

**SPECIAL SERVICES**

**Special Carton Marking**

With specially marked information N/C

**Shipping**

Shipped **assembled freight prepaid f.o.b. KI-Aristotle Brampton, Ontario L6T 5T6** factory. Freight class #85.

Specifications and prices are subject to change without prior notice.

# Aristotle® Classic Pedestal Desks

Bow Front Single Pedestal Desks-Pedestal on Right

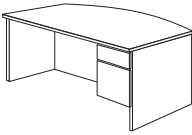
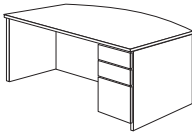
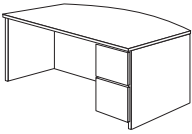
		MODEL NUMBER					Approx. Packaged Weight	
		Basic Model	Horizontal Surface Finish	Vertical Surface Finish	Pull Option	Lock Option		
 <p>ARPED</p>	<b>Bow Front Single Pedestal Desk-Right, Box/File Option A</b> • Box/file pedestal on right • Full height modesty panel recessed 8-3/4" for 36" deep desks and 14-3/4" for 42" deep desks • Grommets not offered • Pedestals feature locks on inside panels • Integral pull is standard; use xxx2 for optional pulls	66 x 36 x 29"	KBSPR6636A.H	<input type="checkbox"/> <input type="checkbox"/> <input type="checkbox"/>	<input type="checkbox"/> <input type="checkbox"/> <input type="checkbox"/>	<input type="checkbox"/> <input type="checkbox"/> <input type="checkbox"/> <input type="checkbox"/>	<input type="checkbox"/> <input type="checkbox"/>	205.0#
		72 x 42 x 29"	KBSPR7242A.H	<input type="checkbox"/> <input type="checkbox"/> <input type="checkbox"/>	<input type="checkbox"/> <input type="checkbox"/> <input type="checkbox"/>	<input type="checkbox"/> <input type="checkbox"/> <input type="checkbox"/> <input type="checkbox"/>	<input type="checkbox"/> <input type="checkbox"/>	225.0#
		84 x 42 x 29"	KBSPR8442A.H	<input type="checkbox"/> <input type="checkbox"/> <input type="checkbox"/>	<input type="checkbox"/> <input type="checkbox"/> <input type="checkbox"/>	<input type="checkbox"/> <input type="checkbox"/> <input type="checkbox"/> <input type="checkbox"/>	<input type="checkbox"/> <input type="checkbox"/>	235.0#
 <p>ARPED</p>	<b>Bow Front Single Pedestal Desk-Right, Box/Box/File Option B</b> • Box/box/file pedestal on right • Full height modesty panel recessed 8-3/4" for 36" deep desks and 14-3/4" for 42" deep desks • Grommets not offered • Pedestals feature locks on inside panels • Integral pull is standard; use xxx3 for optional pulls • Upper box drawer is non-locking	66 x 36 x 29"	KBSPR6636B.H	<input type="checkbox"/> <input type="checkbox"/> <input type="checkbox"/>	<input type="checkbox"/> <input type="checkbox"/> <input type="checkbox"/>	<input type="checkbox"/> <input type="checkbox"/> <input type="checkbox"/> <input type="checkbox"/>	<input type="checkbox"/> <input type="checkbox"/>	235.0#
		72 x 42 x 29"	KBSPR7242B.H	<input type="checkbox"/> <input type="checkbox"/> <input type="checkbox"/>	<input type="checkbox"/> <input type="checkbox"/> <input type="checkbox"/>	<input type="checkbox"/> <input type="checkbox"/> <input type="checkbox"/> <input type="checkbox"/>	<input type="checkbox"/> <input type="checkbox"/>	255.0#
		84 x 42 x 29"	KBSPR8442B.H	<input type="checkbox"/> <input type="checkbox"/> <input type="checkbox"/>	<input type="checkbox"/> <input type="checkbox"/> <input type="checkbox"/>	<input type="checkbox"/> <input type="checkbox"/> <input type="checkbox"/> <input type="checkbox"/>	<input type="checkbox"/> <input type="checkbox"/>	265.0#
 <p>ARPED</p>	<b>Bow Front Single Pedestal Desk-Right, File/File Option C</b> • File/file pedestal on right • Full height modesty panel recessed 8-3/4" for 36" deep desks and 14-3/4" for 42" deep desks • Grommets not offered • Pedestals feature locks on inside panels • Integral pull is standard; use xxx2 for optional pulls	66 x 36 x 29"	KBSPR6636C.H	<input type="checkbox"/> <input type="checkbox"/> <input type="checkbox"/>	<input type="checkbox"/> <input type="checkbox"/> <input type="checkbox"/>	<input type="checkbox"/> <input type="checkbox"/> <input type="checkbox"/> <input type="checkbox"/>	<input type="checkbox"/> <input type="checkbox"/>	235.0#
		72 x 42 x 29"	KBSPR7242C.H	<input type="checkbox"/> <input type="checkbox"/> <input type="checkbox"/>	<input type="checkbox"/> <input type="checkbox"/> <input type="checkbox"/>	<input type="checkbox"/> <input type="checkbox"/> <input type="checkbox"/> <input type="checkbox"/>	<input type="checkbox"/> <input type="checkbox"/>	255.0#
		84 x 42 x 29"	KBSPR8442C.H	<input type="checkbox"/> <input type="checkbox"/> <input type="checkbox"/>	<input type="checkbox"/> <input type="checkbox"/> <input type="checkbox"/>	<input type="checkbox"/> <input type="checkbox"/> <input type="checkbox"/> <input type="checkbox"/>	<input type="checkbox"/> <input type="checkbox"/>	265.0#

**A**      **B**      **C**      **D**      **E**

## HOW TO ORDER

Indicate the following information on order form:

- Quantity of each item.
- Model number, including options. See "How To Build a Model Number".
- Any special service required.

Note: • The  indicates that a choice is required.

- The absence of the  indicates that no choice is required.
- Alpha-numeric characters in place of  indicate that no other alternatives are available.

## HOW TO BUILD A MODEL NUMBER

- A** Select basic model.
- B** Select horizontal surface finish.  
Refer to color addendum at ki.com or KI Fabrics & Finishes binder.
- C** Select vertical surface finish.  
Refer to color addendum at ki.com or KI Fabrics & Finishes binder.
- D** Select pull option.
 

<b>NP</b>	- Standard integral pull
<b>BPA2</b>	- Silver bar pull (2); add \$20
<b>BPA3</b>	- Silver bar pull (3); add \$30
<b>KIB2</b>	- Waterfall black pull (2); add \$20
<b>KIB3</b>	- Waterfall black pull (3); add \$30
<b>KIS2</b>	- Waterfall silver pull (2); add \$20
<b>KIS3</b>	- Waterfall silver pull (3); add \$30
<b>RCP2</b>	- Rectangular silver pull (2); add \$20

**RCP3** - Rectangular silver pull (3); add \$30

- E** Select lock option.
 

<b>KA</b>	- Key alike
<b>KS</b>	- Key standard



# Aristotle® Classic Pedestal Desks

Bow Front Single Pedestal Desks-Pedestal on Right

Delivered  
Pricing

\$ 1561  
1610  
1657

\$ 1725  
1778  
1830

\$ 1725  
1778  
1830

**SPECIAL SERVICES**

**Special Carton Marking**

With specially marked information N/C

**Shipping**

Shipped **assembled freight prepaid f.o.b. KI-Aristotle Brampton, Ontario L6T 5T6** factory. Freight class #85.

Specifications and prices are subject to change without prior notice.







# Aristotle® Classic Desks

Bow Front Desks-Straight Cutaway

Delivered Pricing

\$ 1410
1410
1410
1458
1458
1458
1501
1501
1501

\$ 1410
1410
1410
1458
1458
1458
1501
1501
1501

**SPECIAL SERVICES**

**Special Carton Marking**

With specially marked information N/C

**Shipping**

Shipped k.d. freight prepaid f.o.b.  
KI-Aristotle Brampton, Ontario L6T 5T6  
factory. Freight class #85.

Specifications and prices are subject to  
change without prior notice.

# Aristotle® Classic Desks

Bow Front Desks-Curved Cutaway

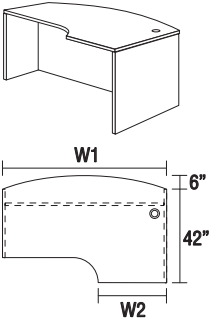
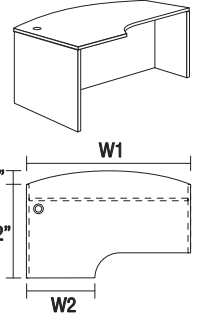
MODEL	W1 x W2 x D x H	MODEL NUMBER			Approx. Packaged Weight
		Basic Model	Horizontal Surface Finish	Vertical Surface Finish	
 <p><b>Bow Front Desk-Extended Left, Curved Cutaway</b></p> <ul style="list-style-type: none"> <li>• Curved cutaway</li> <li>• Bow front extends 6" on visitor side</li> <li>• Full height modesty panel is inset 14-1/4"</li> <li>• Accommodates full height or mobile pedestal, specified separately</li> <li>• Grommet included</li> </ul>	66 x 20 x 48 x 29"	KECDC6620L.H	<input type="checkbox"/> <input type="checkbox"/> <input type="checkbox"/>	<input type="checkbox"/> <input type="checkbox"/> <input type="checkbox"/>	165.0#
	66 x 24 x 48 x 29"	KECDC6624L.H	<input type="checkbox"/> <input type="checkbox"/> <input type="checkbox"/>	<input type="checkbox"/> <input type="checkbox"/> <input type="checkbox"/>	165.0#
	66 x 30 x 48 x 29"	KECDC6630L.H	<input type="checkbox"/> <input type="checkbox"/> <input type="checkbox"/>	<input type="checkbox"/> <input type="checkbox"/> <input type="checkbox"/>	165.0#
	72 x 20 x 48 x 29"	KECDC7220L.H	<input type="checkbox"/> <input type="checkbox"/> <input type="checkbox"/>	<input type="checkbox"/> <input type="checkbox"/> <input type="checkbox"/>	175.0#
	72 x 24 x 48 x 29"	KECDC7224L.H	<input type="checkbox"/> <input type="checkbox"/> <input type="checkbox"/>	<input type="checkbox"/> <input type="checkbox"/> <input type="checkbox"/>	175.0#
	72 x 30 x 48 x 29"	KECDC7230L.H	<input type="checkbox"/> <input type="checkbox"/> <input type="checkbox"/>	<input type="checkbox"/> <input type="checkbox"/> <input type="checkbox"/>	175.0#
	78 x 20 x 48 x 29"	KECDC7820L.H	<input type="checkbox"/> <input type="checkbox"/> <input type="checkbox"/>	<input type="checkbox"/> <input type="checkbox"/> <input type="checkbox"/>	186.0#
	78 x 24 x 48 x 29"	KECDC7824L.H	<input type="checkbox"/> <input type="checkbox"/> <input type="checkbox"/>	<input type="checkbox"/> <input type="checkbox"/> <input type="checkbox"/>	186.0#
	78 x 30 x 48 x 29"	KECDC7830L.H	<input type="checkbox"/> <input type="checkbox"/> <input type="checkbox"/>	<input type="checkbox"/> <input type="checkbox"/> <input type="checkbox"/>	186.0#
ARPED					
 <p><b>Bow Front Desk-Extended Right, Curved Cutaway</b></p> <ul style="list-style-type: none"> <li>• Curved cutaway</li> <li>• Bow front extends 6" on visitor side</li> <li>• Full height modesty panel is inset 14-1/4"</li> <li>• Accommodates full height or mobile pedestal, specified separately</li> <li>• Grommet included</li> </ul>	66 x 20 x 48 x 29"	KECDC6620R.H	<input type="checkbox"/> <input type="checkbox"/> <input type="checkbox"/>	<input type="checkbox"/> <input type="checkbox"/> <input type="checkbox"/>	165.0#
	66 x 24 x 48 x 29"	KECDC6624R.H	<input type="checkbox"/> <input type="checkbox"/> <input type="checkbox"/>	<input type="checkbox"/> <input type="checkbox"/> <input type="checkbox"/>	165.0#
	66 x 30 x 48 x 29"	KECDC6630R.H	<input type="checkbox"/> <input type="checkbox"/> <input type="checkbox"/>	<input type="checkbox"/> <input type="checkbox"/> <input type="checkbox"/>	165.0#
	72 x 20 x 48 x 29"	KECDC7220R.H	<input type="checkbox"/> <input type="checkbox"/> <input type="checkbox"/>	<input type="checkbox"/> <input type="checkbox"/> <input type="checkbox"/>	175.0#
	72 x 24 x 48 x 29"	KECDC7224R.H	<input type="checkbox"/> <input type="checkbox"/> <input type="checkbox"/>	<input type="checkbox"/> <input type="checkbox"/> <input type="checkbox"/>	175.0#
	72 x 30 x 48 x 29"	KECDC7230R.H	<input type="checkbox"/> <input type="checkbox"/> <input type="checkbox"/>	<input type="checkbox"/> <input type="checkbox"/> <input type="checkbox"/>	175.0#
	78 x 20 x 48 x 29"	KECDC7820R.H	<input type="checkbox"/> <input type="checkbox"/> <input type="checkbox"/>	<input type="checkbox"/> <input type="checkbox"/> <input type="checkbox"/>	186.0#
	78 x 24 x 48 x 29"	KECDC7824R.H	<input type="checkbox"/> <input type="checkbox"/> <input type="checkbox"/>	<input type="checkbox"/> <input type="checkbox"/> <input type="checkbox"/>	186.0#
	78 x 30 x 48 x 29"	KECDC7830R.H	<input type="checkbox"/> <input type="checkbox"/> <input type="checkbox"/>	<input type="checkbox"/> <input type="checkbox"/> <input type="checkbox"/>	186.0#
ARPED					

**A**      **B**      **C**

## HOW TO ORDER

Indicate the following information on order form:

1. Quantity of each item.
2. Model number, including options. See "How To Build a Model Number".
3. Any special service required.

Note: • The  indicates that a choice is required.

- The absence of the  indicates that no choice is required.
- Alpha-numeric characters in place of  indicate that no other alternatives are available.

## HOW TO BUILD A MODEL NUMBER

- A** Select basic model.
- B** Select horizontal surface finish.  
Refer to color addendum at [ki.com](http://ki.com) or KI Fabrics & Finishes binder.
- C** Select vertical surface finish.  
Refer to color addendum at [ki.com](http://ki.com) or KI Fabrics & Finishes binder.



# Aristotle® Classic Desks

Bow Front Desks-Curved Cutaway

Delivered Pricing

\$ 1410  
1410  
1410  
1458  
1458  
1458  
1501  
1501  
1501

\$ 1410  
1410  
1410  
1458  
1458  
1458  
1501  
1501  
1501

**SPECIAL SERVICES**

**Special Carton Marking**

With specially marked information N/C

**Shipping**

Shipped k.d. freight prepaid f.o.b.  
KI-Aristotle Brampton, Ontario L6T 5T6  
factory. Freight class #85.

Specifications and prices are subject to  
change without prior notice.

# Aristotle® Classic Desks

P-Top Desks-Straight Cutaway

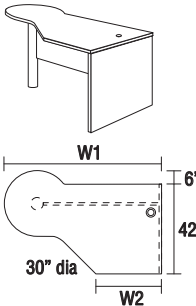
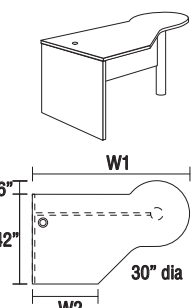
MODEL	W1 x W2 x D x H	MODEL NUMBER	MODEL NUMBER					Approx. Packaged Weight
			Basic Model	Horizontal Surface Finish	Vertical Surface Finish	Leg Finish	Modesty Panel	
 <p><b>P-Top Desk-Extended Left, Straight Cutaway</b></p> <ul style="list-style-type: none"> <li>• Straight cutaway</li> <li>• Modesty panel is 14" standard; full modesty panel available with upcharge</li> <li>• 6" diameter post leg</li> <li>• Grommet included</li> </ul>	66 x 20 x 48 x 29"	KPTCS6620L.H	<input type="checkbox"/> <input type="checkbox"/> <input type="checkbox"/>	<input type="checkbox"/> <input type="checkbox"/> <input type="checkbox"/>	<input type="checkbox"/> <input type="checkbox"/>	<input type="checkbox"/> <input type="checkbox"/> <input type="checkbox"/>	123.0#	
	66 x 24 x 48 x 29"	KPTCS6624L.H	<input type="checkbox"/> <input type="checkbox"/> <input type="checkbox"/>	<input type="checkbox"/> <input type="checkbox"/> <input type="checkbox"/>	<input type="checkbox"/> <input type="checkbox"/>	<input type="checkbox"/> <input type="checkbox"/> <input type="checkbox"/>	123.0#	
	66 x 30 x 48 x 29"	KPTCS6630L.H	<input type="checkbox"/> <input type="checkbox"/> <input type="checkbox"/>	<input type="checkbox"/> <input type="checkbox"/> <input type="checkbox"/>	<input type="checkbox"/> <input type="checkbox"/>	<input type="checkbox"/> <input type="checkbox"/> <input type="checkbox"/>	123.0#	
	72 x 20 x 48 x 29"	KPTCS7220L.H	<input type="checkbox"/> <input type="checkbox"/> <input type="checkbox"/>	<input type="checkbox"/> <input type="checkbox"/> <input type="checkbox"/>	<input type="checkbox"/> <input type="checkbox"/>	<input type="checkbox"/> <input type="checkbox"/> <input type="checkbox"/>	130.0#	
	72 x 24 x 48 x 29"	KPTCS7224L.H	<input type="checkbox"/> <input type="checkbox"/> <input type="checkbox"/>	<input type="checkbox"/> <input type="checkbox"/> <input type="checkbox"/>	<input type="checkbox"/> <input type="checkbox"/>	<input type="checkbox"/> <input type="checkbox"/> <input type="checkbox"/>	130.0#	
	72 x 30 x 48 x 29"	KPTCS7230L.H	<input type="checkbox"/> <input type="checkbox"/> <input type="checkbox"/>	<input type="checkbox"/> <input type="checkbox"/> <input type="checkbox"/>	<input type="checkbox"/> <input type="checkbox"/>	<input type="checkbox"/> <input type="checkbox"/> <input type="checkbox"/>	130.0#	
	78 x 30 x 48 x 29"	KPTCS7820L.H	<input type="checkbox"/> <input type="checkbox"/> <input type="checkbox"/>	<input type="checkbox"/> <input type="checkbox"/> <input type="checkbox"/>	<input type="checkbox"/> <input type="checkbox"/>	<input type="checkbox"/> <input type="checkbox"/> <input type="checkbox"/>	138.0#	
	78 x 24 x 48 x 29"	KPTCS7824L.H	<input type="checkbox"/> <input type="checkbox"/> <input type="checkbox"/>	<input type="checkbox"/> <input type="checkbox"/> <input type="checkbox"/>	<input type="checkbox"/> <input type="checkbox"/>	<input type="checkbox"/> <input type="checkbox"/> <input type="checkbox"/>	138.0#	
	78 x 30 x 48 x 29"	KPTCS7830L.H	<input type="checkbox"/> <input type="checkbox"/> <input type="checkbox"/>	<input type="checkbox"/> <input type="checkbox"/> <input type="checkbox"/>	<input type="checkbox"/> <input type="checkbox"/>	<input type="checkbox"/> <input type="checkbox"/> <input type="checkbox"/>	138.0#	
	ARSPD							
 <p><b>P-Top Desk-Extended Right, Straight Cutaway</b></p> <ul style="list-style-type: none"> <li>• Straight cutaway</li> <li>• Modesty panel is 14" standard; full modesty panel available with upcharge</li> <li>• 6" diameter post leg</li> <li>• Grommet included</li> </ul>	66 x 20 x 48 x 29"	KPTCS6620R.H	<input type="checkbox"/> <input type="checkbox"/> <input type="checkbox"/>	<input type="checkbox"/> <input type="checkbox"/> <input type="checkbox"/>	<input type="checkbox"/> <input type="checkbox"/>	<input type="checkbox"/> <input type="checkbox"/> <input type="checkbox"/>	123.0#	
	66 x 24 x 48 x 29"	KPTCS6624R.H	<input type="checkbox"/> <input type="checkbox"/> <input type="checkbox"/>	<input type="checkbox"/> <input type="checkbox"/> <input type="checkbox"/>	<input type="checkbox"/> <input type="checkbox"/>	<input type="checkbox"/> <input type="checkbox"/> <input type="checkbox"/>	123.0#	
	66 x 30 x 48 x 29"	KPTCS6630R.H	<input type="checkbox"/> <input type="checkbox"/> <input type="checkbox"/>	<input type="checkbox"/> <input type="checkbox"/> <input type="checkbox"/>	<input type="checkbox"/> <input type="checkbox"/>	<input type="checkbox"/> <input type="checkbox"/> <input type="checkbox"/>	123.0#	
	72 x 20 x 48 x 29"	KPTCS7220R.H	<input type="checkbox"/> <input type="checkbox"/> <input type="checkbox"/>	<input type="checkbox"/> <input type="checkbox"/> <input type="checkbox"/>	<input type="checkbox"/> <input type="checkbox"/>	<input type="checkbox"/> <input type="checkbox"/> <input type="checkbox"/>	130.0#	
	72 x 24 x 48 x 29"	KPTCS7224R.H	<input type="checkbox"/> <input type="checkbox"/> <input type="checkbox"/>	<input type="checkbox"/> <input type="checkbox"/> <input type="checkbox"/>	<input type="checkbox"/> <input type="checkbox"/>	<input type="checkbox"/> <input type="checkbox"/> <input type="checkbox"/>	130.0#	
	72 x 30 x 48 x 29"	KPTCS7230R.H	<input type="checkbox"/> <input type="checkbox"/> <input type="checkbox"/>	<input type="checkbox"/> <input type="checkbox"/> <input type="checkbox"/>	<input type="checkbox"/> <input type="checkbox"/>	<input type="checkbox"/> <input type="checkbox"/> <input type="checkbox"/>	130.0#	
	78 x 20 x 48 x 29"	KPTCS7820R.H	<input type="checkbox"/> <input type="checkbox"/> <input type="checkbox"/>	<input type="checkbox"/> <input type="checkbox"/> <input type="checkbox"/>	<input type="checkbox"/> <input type="checkbox"/>	<input type="checkbox"/> <input type="checkbox"/> <input type="checkbox"/>	138.0#	
	78 x 24 x 48 x 29"	KPTCS7824R.H	<input type="checkbox"/> <input type="checkbox"/> <input type="checkbox"/>	<input type="checkbox"/> <input type="checkbox"/> <input type="checkbox"/>	<input type="checkbox"/> <input type="checkbox"/>	<input type="checkbox"/> <input type="checkbox"/> <input type="checkbox"/>	138.0#	
	78 x 30 x 48 x 29"	KPTCS7830R.H	<input type="checkbox"/> <input type="checkbox"/> <input type="checkbox"/>	<input type="checkbox"/> <input type="checkbox"/> <input type="checkbox"/>	<input type="checkbox"/> <input type="checkbox"/>	<input type="checkbox"/> <input type="checkbox"/> <input type="checkbox"/>	138.0#	
	ARSPD							

**A**      **B**      **C**      **D**      **E**

## HOW TO ORDER

Indicate the following information on order form:

1. Quantity of each item.
2. Model number, including options. See "How To Build a Model Number".
3. Any special service required.

Note: • The  indicates that a choice is required.

- The absence of the  indicates that no choice is required.
- Alpha-numeric characters in place of  indicate that no other alternatives are available.

## HOW TO BUILD A MODEL NUMBER

- A** Select basic model.
- B** Select horizontal surface finish.  
Refer to color addendum at ki.com or KI Fabrics & Finishes binder.
- C** Select vertical surface finish.  
Refer to color addendum at ki.com or KI Fabrics & Finishes binder.
- D** Select leg finish.  
Refer to color addendum at ki.com or KI Fabrics & Finishes binder.
- E** Select modesty panel.  
  - PMP** - 14" partial modesty panel (standard)
  - FMP** - Full height modesty panel; add \$70



Delivered Pricing

\$ 1569
1569
1569
1614
1614
1614
1662
1662
1662

\$ 1569
1569
1569
1614
1614
1614
1662
1662
1662

**SPECIAL SERVICES**

**Special Carton Marking**

With specially marked information N/C

**Shipping**

Shipped k.d. freight prepaid f.o.b.  
KI-Aristotle Brampton, Ontario L6T 5T6  
factory. Freight class #85.

Specifications and prices are subject to  
change without prior notice.

# Aristotle® Classic Desks

P-Top Desks-Curved Cutaway

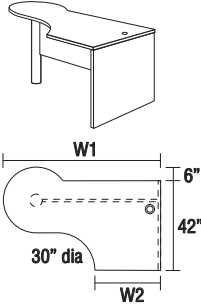
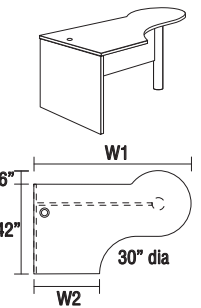
MODEL	W1 x W2 x D x H	MODEL NUMBER	MODEL NUMBER					Approx. Packaged Weight
			Basic Model	Horizontal Surface Finish	Vertical Surface Finish	Leg Finish	Modesty Panel	
 <p><b>P-Top Desk-Extended Left, Curved Cutaway</b></p> <ul style="list-style-type: none"> <li>• Curved cutaway</li> <li>• Modesty panel is 14" standard; full modesty panel available with upcharge</li> <li>• 6" diameter post leg</li> <li>• Grommet included</li> </ul>	66 x 20 x 48 x 29"	KPTCC6620L.H	<input type="checkbox"/>	<input type="checkbox"/>	<input type="checkbox"/>	<input type="checkbox"/>	123.0#	
	66 x 24 x 48 x 29"	KPTCC6624L.H	<input type="checkbox"/>	<input type="checkbox"/>	<input type="checkbox"/>	<input type="checkbox"/>	123.0#	
	66 x 30 x 48 x 29"	KPTCC6630L.H	<input type="checkbox"/>	<input type="checkbox"/>	<input type="checkbox"/>	<input type="checkbox"/>	123.0#	
	72 x 20 x 48 x 29"	KPTCC7220L.H	<input type="checkbox"/>	<input type="checkbox"/>	<input type="checkbox"/>	<input type="checkbox"/>	130.0#	
	72 x 24 x 48 x 29"	KPTCC7224L.H	<input type="checkbox"/>	<input type="checkbox"/>	<input type="checkbox"/>	<input type="checkbox"/>	130.0#	
	72 x 30 x 48 x 29"	KPTCC7230L.H	<input type="checkbox"/>	<input type="checkbox"/>	<input type="checkbox"/>	<input type="checkbox"/>	130.0#	
	78 x 20 x 48 x 29"	KPTCC7820L.H	<input type="checkbox"/>	<input type="checkbox"/>	<input type="checkbox"/>	<input type="checkbox"/>	138.0#	
	78 x 24 x 48 x 29"	KPTCC7824L.H	<input type="checkbox"/>	<input type="checkbox"/>	<input type="checkbox"/>	<input type="checkbox"/>	138.0#	
	78 x 30 x 48 x 29"	KPTCC7830L.H	<input type="checkbox"/>	<input type="checkbox"/>	<input type="checkbox"/>	<input type="checkbox"/>	138.0#	
	ARSPD							
 <p><b>P-Top Desk-Extended Right, Curved Cutaway</b></p> <ul style="list-style-type: none"> <li>• Curved cutaway</li> <li>• Modesty panel is 14" standard; full modesty panel available with upcharge</li> <li>• 6" diameter post leg</li> <li>• Grommet included</li> </ul>	66 x 20 x 48 x 29"	KPTCC6620R.H	<input type="checkbox"/>	<input type="checkbox"/>	<input type="checkbox"/>	<input type="checkbox"/>	123.0#	
	66 x 24 x 48 x 29"	KPTCC6624R.H	<input type="checkbox"/>	<input type="checkbox"/>	<input type="checkbox"/>	<input type="checkbox"/>	123.0#	
	66 x 30 x 48 x 29"	KPTCC6630R.H	<input type="checkbox"/>	<input type="checkbox"/>	<input type="checkbox"/>	<input type="checkbox"/>	123.0#	
	72 x 20 x 48 x 29"	KPTCC7220R.H	<input type="checkbox"/>	<input type="checkbox"/>	<input type="checkbox"/>	<input type="checkbox"/>	130.0#	
	72 x 24 x 48 x 29"	KPTCC7224R.H	<input type="checkbox"/>	<input type="checkbox"/>	<input type="checkbox"/>	<input type="checkbox"/>	130.0#	
	72 x 30 x 48 x 29"	KPTCC7230R.H	<input type="checkbox"/>	<input type="checkbox"/>	<input type="checkbox"/>	<input type="checkbox"/>	130.0#	
	78 x 20 x 48 x 29"	KPTCC7820R.H	<input type="checkbox"/>	<input type="checkbox"/>	<input type="checkbox"/>	<input type="checkbox"/>	138.0#	
	78 x 24 x 48 x 29"	KPTCC7824R.H	<input type="checkbox"/>	<input type="checkbox"/>	<input type="checkbox"/>	<input type="checkbox"/>	138.0#	
	78 x 30 x 48 x 29"	KPTCC7830R.H	<input type="checkbox"/>	<input type="checkbox"/>	<input type="checkbox"/>	<input type="checkbox"/>	138.0#	
	ARSPD							

**A**      **B**      **C**      **D**      **E**

## HOW TO ORDER

Indicate the following information on order form:

1. Quantity of each item.
2. Model number, including options. See "How To Build a Model Number".
3. Any special service required.

Note: • The  indicates that a choice is required.

- The absence of the  indicates that no choice is required.
- Alpha-numeric characters in place of  indicate that no other alternatives are available.

## HOW TO BUILD A MODEL NUMBER

- A** Select basic model.
- B** Select horizontal surface finish.  
Refer to color addendum at ki.com or KI Fabrics & Finishes binder.
- C** Select vertical surface finish.  
Refer to color addendum at ki.com or KI Fabrics & Finishes binder.
- D** Select leg finish.  
Refer to color addendum at ki.com or KI Fabrics & Finishes binder.
- E** Select modesty panel.  
  - PMP** - 14" partial modesty panel (standard)
  - FMP** - Full height modesty panel; add \$70



# Aristotle® Classic Desks

P-Top Desks-Curved Cutaway

Delivered Pricing

\$ 1569
1569
1569
1614
1614
1614
1662
1662
1662

\$ 1569
1569
1569
1614
1614
1614
1662
1662
1662

**SPECIAL SERVICES**

**Special Carton Marking**

With specially marked information N/C

**Shipping**

Shipped k.d. freight prepaid f.o.b.  
KI-Aristotle Brampton, Ontario L6T 5T6  
factory. Freight class #85.

Specifications and prices are subject to  
change without prior notice.

# Aristotle® Classic Desks

D-Top Desks-Straight Cutaway

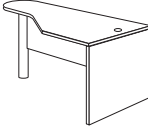
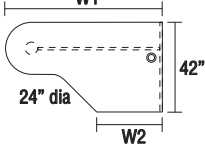
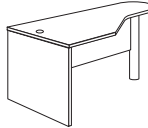
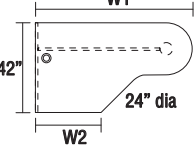
MODEL	W1 x W2 x D x H	MODEL NUMBER	MODEL NUMBER					Approx. Packaged Weight
			Basic Model	Horizontal Surface Finish	Vertical Surface Finish	Leg Finish	Modesty Panel	
 <p><b>D-Top Desk-24" Extended Left, Straight Cutaway</b></p> <ul style="list-style-type: none"> <li>• Straight cutaway</li> <li>• Modesty panel is 14" standard; full modesty panel available with upcharge</li> <li>• 6" diameter post leg</li> <li>• Grommet included</li> </ul>  <p>W1 42" 24" dia W2</p>	66 x 20 x 42 x 29"	KDTCS662420L.H	<input type="checkbox"/>	<input type="checkbox"/>	<input type="checkbox"/>	<input type="checkbox"/>	123.0#	
	66 x 24 x 42 x 29"	KDTCS662424L.H	<input type="checkbox"/>	<input type="checkbox"/>	<input type="checkbox"/>	<input type="checkbox"/>	123.0#	
	66 x 30 x 42 x 29"	KDTCS662430L.H	<input type="checkbox"/>	<input type="checkbox"/>	<input type="checkbox"/>	<input type="checkbox"/>	123.0#	
	72 x 20 x 42 x 29"	KDTCS722420L.H	<input type="checkbox"/>	<input type="checkbox"/>	<input type="checkbox"/>	<input type="checkbox"/>	130.0#	
	72 x 24 x 42 x 29"	KDTCS722424L.H	<input type="checkbox"/>	<input type="checkbox"/>	<input type="checkbox"/>	<input type="checkbox"/>	130.0#	
	72 x 30 x 42 x 29"	KDTCS722430L.H	<input type="checkbox"/>	<input type="checkbox"/>	<input type="checkbox"/>	<input type="checkbox"/>	130.0#	
	78 x 20 x 42 x 29"	KDTCS782420L.H	<input type="checkbox"/>	<input type="checkbox"/>	<input type="checkbox"/>	<input type="checkbox"/>	138.0#	
	78 x 24 x 42 x 29"	KDTCS782424L.H	<input type="checkbox"/>	<input type="checkbox"/>	<input type="checkbox"/>	<input type="checkbox"/>	138.0#	
	78 x 30 x 42 x 29"	KDTCS782430L.H	<input type="checkbox"/>	<input type="checkbox"/>	<input type="checkbox"/>	<input type="checkbox"/>	138.0#	
	ARSPD							
 <p><b>D-Top Desk-24" Extended Right, Straight Cutaway</b></p> <ul style="list-style-type: none"> <li>• Straight cutaway</li> <li>• Modesty panel is 14" standard; full modesty panel available with upcharge</li> <li>• 6" diameter post leg</li> <li>• Grommet included</li> </ul>  <p>W1 42" 24" dia W2</p>	66 x 20 x 42 x 29"	KDTCS662420R.H	<input type="checkbox"/>	<input type="checkbox"/>	<input type="checkbox"/>	<input type="checkbox"/>	123.0#	
	66 x 24 x 42 x 29"	KDTCS662424R.H	<input type="checkbox"/>	<input type="checkbox"/>	<input type="checkbox"/>	<input type="checkbox"/>	123.0#	
	66 x 30 x 42 x 29"	KDTCS662430R.H	<input type="checkbox"/>	<input type="checkbox"/>	<input type="checkbox"/>	<input type="checkbox"/>	123.0#	
	72 x 20 x 42 x 29"	KDTCS722420R.H	<input type="checkbox"/>	<input type="checkbox"/>	<input type="checkbox"/>	<input type="checkbox"/>	130.0#	
	72 x 24 x 42 x 29"	KDTCS722424R.H	<input type="checkbox"/>	<input type="checkbox"/>	<input type="checkbox"/>	<input type="checkbox"/>	130.0#	
	72 x 30 x 42 x 29"	KDTCS722430R.H	<input type="checkbox"/>	<input type="checkbox"/>	<input type="checkbox"/>	<input type="checkbox"/>	130.0#	
	78 x 20 x 42 x 29"	KDTCS782420R.H	<input type="checkbox"/>	<input type="checkbox"/>	<input type="checkbox"/>	<input type="checkbox"/>	138.0#	
	78 x 24 x 42 x 29"	KDTCS782424R.H	<input type="checkbox"/>	<input type="checkbox"/>	<input type="checkbox"/>	<input type="checkbox"/>	138.0#	
	78 x 30 x 42 x 29"	KDTCS782430R.H	<input type="checkbox"/>	<input type="checkbox"/>	<input type="checkbox"/>	<input type="checkbox"/>	138.0#	
	ARSPD							
			<b>A</b>	<b>B</b>	<b>C</b>	<b>D</b>	<b>E</b>	

## HOW TO ORDER

Indicate the following information on order form:

1. Quantity of each item.
2. Model number, including options. See "How To Build a Model Number".
3. Any special service required.

Note: • The  indicates that a choice is required.

- The absence of the  indicates that no choice is required.
- Alpha-numeric characters in place of  indicate that no other alternatives are available.

## HOW TO BUILD A MODEL NUMBER

- A** Select basic model.
- B** Select horizontal surface finish.  
Refer to color addendum at ki.com or KI Fabrics & Finishes binder.
- C** Select vertical surface finish.  
Refer to color addendum at ki.com or KI Fabrics & Finishes binder.
- D** Select leg finish.  
Refer to color addendum at ki.com or KI Fabrics & Finishes binder.
- E** Select modesty panel.  
  - PMP** - 14" partial modesty panel (standard)
  - FMP** - Full height modesty panel; add \$70





Delivered Pricing

\$ 1411
1411
1411
1458
1458
1458
1502
1502
1502

\$ 1411
1411
1411
1458
1458
1458
1502
1502
1502

**SPECIAL SERVICES**

**Special Carton Marking**

With specially marked information N/C

**Shipping**

Shipped k.d. freight prepaid f.o.b.  
KI-Aristotle Brampton, Ontario L6T 5T6  
factory. Freight class #85.

Specifications and prices are subject to  
change without prior notice.

# Aristotle® Classic Desks

D-Top Desks-Curved Cutaway

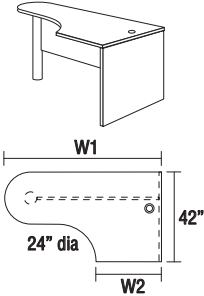
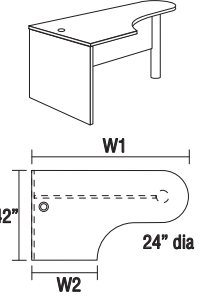
MODEL	W1 x W2 x D x H	MODEL NUMBER	Basic Model	Horizontal Surface Finish	Vertical Surface Finish	Leg Finish	Modesty Panel	Approx. Packaged Weight
 <p><b>D-Top Desk-24" Extended Left, Curved Cutaway</b></p> <ul style="list-style-type: none"> <li>• Curved cutaway</li> <li>• Modesty panel is 14" standard; full modesty panel available with upcharge</li> <li>• 6" diameter post leg</li> <li>• Grommet included</li> </ul>	66 x 20 x 42 x 29"	KDTCC662420L.H	<input type="checkbox"/>	<input type="checkbox"/>	<input type="checkbox"/>	<input type="checkbox"/>	<input type="checkbox"/>	123.0#
	66 x 24 x 42 x 29"	KDTCC662424L.H	<input type="checkbox"/>	<input type="checkbox"/>	<input type="checkbox"/>	<input type="checkbox"/>	<input type="checkbox"/>	123.0#
	66 x 30 x 42 x 29"	KDTCC662430L.H	<input type="checkbox"/>	<input type="checkbox"/>	<input type="checkbox"/>	<input type="checkbox"/>	<input type="checkbox"/>	123.0#
	72 x 20 x 42 x 29"	KDTCC722420L.H	<input type="checkbox"/>	<input type="checkbox"/>	<input type="checkbox"/>	<input type="checkbox"/>	<input type="checkbox"/>	130.0#
	72 x 24 x 42 x 29"	KDTCC722424L.H	<input type="checkbox"/>	<input type="checkbox"/>	<input type="checkbox"/>	<input type="checkbox"/>	<input type="checkbox"/>	130.0#
	72 x 30 x 42 x 29"	KDTCC722430L.H	<input type="checkbox"/>	<input type="checkbox"/>	<input type="checkbox"/>	<input type="checkbox"/>	<input type="checkbox"/>	130.0#
	78 x 20 x 42 x 29"	KDTCC782420L.H	<input type="checkbox"/>	<input type="checkbox"/>	<input type="checkbox"/>	<input type="checkbox"/>	<input type="checkbox"/>	138.0#
	78 x 24 x 42 x 29"	KDTCC782424L.H	<input type="checkbox"/>	<input type="checkbox"/>	<input type="checkbox"/>	<input type="checkbox"/>	<input type="checkbox"/>	138.0#
	78 x 30 x 42 x 29"	KDTCC782430L.H	<input type="checkbox"/>	<input type="checkbox"/>	<input type="checkbox"/>	<input type="checkbox"/>	<input type="checkbox"/>	138.0#
	ARSPD							
 <p><b>D-Top Desk-24" Extended Right, Curved Cutaway</b></p> <ul style="list-style-type: none"> <li>• Curved cutaway</li> <li>• Modesty panel is 14" standard; full modesty panel available with upcharge</li> <li>• 6" diameter post leg</li> <li>• Grommet included</li> </ul>	66 x 20 x 42 x 29"	KDTCC662420R.H	<input type="checkbox"/>	<input type="checkbox"/>	<input type="checkbox"/>	<input type="checkbox"/>	<input type="checkbox"/>	123.0#
	66 x 24 x 42 x 29"	KDTCC662424R.H	<input type="checkbox"/>	<input type="checkbox"/>	<input type="checkbox"/>	<input type="checkbox"/>	<input type="checkbox"/>	123.0#
	66 x 30 x 42 x 29"	KDTCC662430R.H	<input type="checkbox"/>	<input type="checkbox"/>	<input type="checkbox"/>	<input type="checkbox"/>	<input type="checkbox"/>	123.0#
	72 x 20 x 42 x 29"	KDTCC722420R.H	<input type="checkbox"/>	<input type="checkbox"/>	<input type="checkbox"/>	<input type="checkbox"/>	<input type="checkbox"/>	130.0#
	72 x 24 x 42 x 29"	KDTCC722424R.H	<input type="checkbox"/>	<input type="checkbox"/>	<input type="checkbox"/>	<input type="checkbox"/>	<input type="checkbox"/>	130.0#
	72 x 30 x 42 x 29"	KDTCC722430R.H	<input type="checkbox"/>	<input type="checkbox"/>	<input type="checkbox"/>	<input type="checkbox"/>	<input type="checkbox"/>	130.0#
	78 x 20 x 42 x 29"	KDTCC782420R.H	<input type="checkbox"/>	<input type="checkbox"/>	<input type="checkbox"/>	<input type="checkbox"/>	<input type="checkbox"/>	138.0#
	78 x 24 x 42 x 29"	KDTCC782424R.H	<input type="checkbox"/>	<input type="checkbox"/>	<input type="checkbox"/>	<input type="checkbox"/>	<input type="checkbox"/>	138.0#
	78 x 30 x 42 x 29"	KDTCC782430R.H	<input type="checkbox"/>	<input type="checkbox"/>	<input type="checkbox"/>	<input type="checkbox"/>	<input type="checkbox"/>	138.0#
	ARSPD							

**A**      **B**      **C**      **D**      **E**

## HOW TO ORDER

Indicate the following information on order form:

1. Quantity of each item.
2. Model number, including options. See "How To Build a Model Number".
3. Any special service required.

Note: • The  indicates that a choice is required.

- The absence of the  indicates that no choice is required.
- Alpha-numeric characters in place of  indicate that no other alternatives are available.

## HOW TO BUILD A MODEL NUMBER

- A** Select basic model.
- B** Select horizontal surface finish.  
Refer to color addendum at ki.com or KI Fabrics & Finishes binder.
- C** Select vertical surface finish.  
Refer to color addendum at ki.com or KI Fabrics & Finishes binder.
- D** Select leg finish.  
Refer to color addendum at ki.com or KI Fabrics & Finishes binder.
- E** Select modesty panel.  
  - PMP** - 14" partial modesty panel (standard)
  - FMP** - Full height modesty panel; add \$70



# Aristotle® Classic Desks

D-Top Desks-Curved Cutaway

Delivered Pricing

\$ 1411
1411
1411
1458
1458
1458
1502
1502
1502

\$ 1411
1411
1411
1458
1458
1458
1502
1502
1502

**SPECIAL SERVICES**

**Special Carton Marking**

With specially marked information N/C

**Shipping**

Shipped k.d. freight prepaid f.o.b.  
KI-Aristotle Brampton, Ontario L6T 5T6  
factory. Freight class #85.

Specifications and prices are subject to  
change without prior notice.

# Aristotle® Classic Desks

D-Top Desks-Straight Cutaway

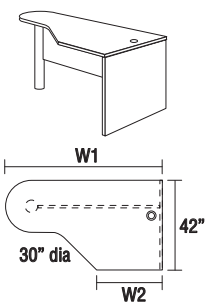
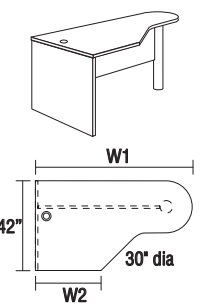
MODEL	W1 x W2 x D x H	MODEL NUMBER	Approx. Packaged Weight				
			Basic Model	Horizontal Surface Finish	Vertical Surface Finish	Leg Finish	Modesty Panel
 <p><b>D-Top Desk-30" Extended Left, Straight Cutaway</b></p> <ul style="list-style-type: none"> <li>• Straight cutaway</li> <li>• Modesty panel is 14" standard; full modesty panel available with upcharge</li> <li>• 6" diameter post leg</li> <li>• Grommet included</li> </ul>	66 x 20 x 42 x 29"	KDTCS663020L.H	<input type="checkbox"/>	<input type="checkbox"/>	<input type="checkbox"/>	<input type="checkbox"/>	125.0#
	66 x 24 x 42 x 29"	KDTCS663024L.H	<input type="checkbox"/>	<input type="checkbox"/>	<input type="checkbox"/>	<input type="checkbox"/>	125.0#
	66 x 30 x 42 x 29"	KDTCS663030L.H	<input type="checkbox"/>	<input type="checkbox"/>	<input type="checkbox"/>	<input type="checkbox"/>	125.0#
	72 x 20 x 42 x 29"	KDTCS723020L.H	<input type="checkbox"/>	<input type="checkbox"/>	<input type="checkbox"/>	<input type="checkbox"/>	132.0#
	72 x 24 x 42 x 29"	KDTCS723024L.H	<input type="checkbox"/>	<input type="checkbox"/>	<input type="checkbox"/>	<input type="checkbox"/>	132.0#
	72 x 30 x 42 x 29"	KDTCS723030L.H	<input type="checkbox"/>	<input type="checkbox"/>	<input type="checkbox"/>	<input type="checkbox"/>	132.0#
	78 x 20 x 42 x 29"	KDTCS783020L.H	<input type="checkbox"/>	<input type="checkbox"/>	<input type="checkbox"/>	<input type="checkbox"/>	140.0#
	78 x 24 x 42 x 29"	KDTCS783024L.H	<input type="checkbox"/>	<input type="checkbox"/>	<input type="checkbox"/>	<input type="checkbox"/>	140.0#
	78 x 30 x 42 x 29"	KDTCS783030L.H	<input type="checkbox"/>	<input type="checkbox"/>	<input type="checkbox"/>	<input type="checkbox"/>	140.0#
	ARSPD						
 <p><b>D-Top Desk-30" Extended Right, Straight Cutaway</b></p> <ul style="list-style-type: none"> <li>• Straight cutaway</li> <li>• Modesty panel is 14" standard; full modesty panel available with upcharge</li> <li>• 6" diameter post leg</li> <li>• Grommet included</li> </ul>	66 x 20 x 42 x 29"	KDTCS663020R.H	<input type="checkbox"/>	<input type="checkbox"/>	<input type="checkbox"/>	<input type="checkbox"/>	125.0#
	66 x 24 x 42 x 29"	KDTCS663024R.H	<input type="checkbox"/>	<input type="checkbox"/>	<input type="checkbox"/>	<input type="checkbox"/>	125.0#
	66 x 30 x 42 x 29"	KDTCS663030R.H	<input type="checkbox"/>	<input type="checkbox"/>	<input type="checkbox"/>	<input type="checkbox"/>	125.0#
	72 x 20 x 42 x 29"	KDTCS723020R.H	<input type="checkbox"/>	<input type="checkbox"/>	<input type="checkbox"/>	<input type="checkbox"/>	132.0#
	72 x 24 x 42 x 29"	KDTCS723024R.H	<input type="checkbox"/>	<input type="checkbox"/>	<input type="checkbox"/>	<input type="checkbox"/>	132.0#
	72 x 30 x 42 x 29"	KDTCS723030R.H	<input type="checkbox"/>	<input type="checkbox"/>	<input type="checkbox"/>	<input type="checkbox"/>	132.0#
	78 x 20 x 42 x 29"	KDTCS783020R.H	<input type="checkbox"/>	<input type="checkbox"/>	<input type="checkbox"/>	<input type="checkbox"/>	140.0#
	78 x 24 x 42 x 29"	KDTCS783024R.H	<input type="checkbox"/>	<input type="checkbox"/>	<input type="checkbox"/>	<input type="checkbox"/>	140.0#
	78 x 30 x 42 x 29"	KDTCS783030R.H	<input type="checkbox"/>	<input type="checkbox"/>	<input type="checkbox"/>	<input type="checkbox"/>	140.0#
	ARSPD						
			<b>A</b>	<b>B</b>	<b>C</b>	<b>D</b>	<b>E</b>

## HOW TO ORDER

Indicate the following information on order form:

1. Quantity of each item.
2. Model number, including options. See "How To Build a Model Number".
3. Any special service required.

Note: • The  indicates that a choice is required.

- The absence of the  indicates that no choice is required.
- Alpha-numeric characters in place of  indicate that no other alternatives are available.

## HOW TO BUILD A MODEL NUMBER

- A** Select basic model.
- B** Select horizontal surface finish.  
Refer to color addendum at ki.com or KI Fabrics & Finishes binder.
- C** Select vertical surface finish.  
Refer to color addendum at ki.com or KI Fabrics & Finishes binder.
- D** Select leg finish.  
Refer to color addendum at ki.com or KI Fabrics & Finishes binder.
- E** Select modesty panel.  
  - PMP** - 14" partial modesty panel (standard)
  - FMP** - Full height modesty panel; add \$70



# Aristotle® Classic Desks

D-Top Desks-Straight Cutaway

Delivered Pricing

\$ 1411
1411
1411
1458
1458
1458
1502
1502
1502

\$ 1411
1411
1411
1458
1458
1458
1502
1502
1502

**SPECIAL SERVICES**

**Special Carton Marking**

With specially marked information N/C

**Shipping**

Shipped k.d. freight prepaid f.o.b.  
KI-Aristotle Brampton, Ontario L6T 5T6  
factory. Freight class #85.

Specifications and prices are subject to  
change without prior notice.

# Aristotle® Classic Desks

## D-Top Desks-Curved Cutaway

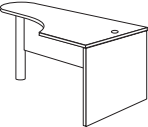
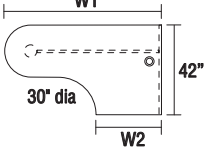
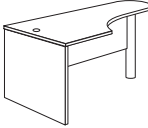
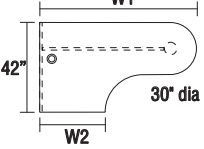
	MODEL	W1 x W2 x D x H	MODEL NUMBER					Approx. Packaged Weight
			Basic Model	Horizontal Surface Finish	Vertical Surface Finish	Leg Finish	Modesty Panel	
  W1 30" dia 42" W2	<b>D-Top Desk-30" Extended Left, Curved Cutaway</b> <ul style="list-style-type: none"> <li>• Curved cutaway</li> <li>• Modesty panel is 14" standard; full modesty panel available with upcharge</li> <li>• 6" diameter post leg</li> <li>• Grommet included</li> </ul>	66 x 20 x 42 x 29"	KDTCC663020L.H	<input type="checkbox"/> <input type="checkbox"/> <input type="checkbox"/>	<input type="checkbox"/> <input type="checkbox"/> <input type="checkbox"/>	<input type="checkbox"/> <input type="checkbox"/>	<input type="checkbox"/> <input type="checkbox"/> <input type="checkbox"/>	125.0#
		66 x 24 x 42 x 29"	KDTCC663024L.H	<input type="checkbox"/> <input type="checkbox"/> <input type="checkbox"/>	<input type="checkbox"/> <input type="checkbox"/> <input type="checkbox"/>	<input type="checkbox"/> <input type="checkbox"/>	<input type="checkbox"/> <input type="checkbox"/> <input type="checkbox"/>	125.0#
		66 x 30 x 42 x 29"	KDTCC663030L.H	<input type="checkbox"/> <input type="checkbox"/> <input type="checkbox"/>	<input type="checkbox"/> <input type="checkbox"/> <input type="checkbox"/>	<input type="checkbox"/> <input type="checkbox"/>	<input type="checkbox"/> <input type="checkbox"/> <input type="checkbox"/>	125.0#
		72 x 20 x 42 x 29"	KDTCC723020L.H	<input type="checkbox"/> <input type="checkbox"/> <input type="checkbox"/>	<input type="checkbox"/> <input type="checkbox"/> <input type="checkbox"/>	<input type="checkbox"/> <input type="checkbox"/>	<input type="checkbox"/> <input type="checkbox"/> <input type="checkbox"/>	132.0#
		72 x 24 x 42 x 29"	KDTCC723024L.H	<input type="checkbox"/> <input type="checkbox"/> <input type="checkbox"/>	<input type="checkbox"/> <input type="checkbox"/> <input type="checkbox"/>	<input type="checkbox"/> <input type="checkbox"/>	<input type="checkbox"/> <input type="checkbox"/> <input type="checkbox"/>	132.0#
		72 x 30 x 42 x 29"	KDTCC723030L.H	<input type="checkbox"/> <input type="checkbox"/> <input type="checkbox"/>	<input type="checkbox"/> <input type="checkbox"/> <input type="checkbox"/>	<input type="checkbox"/> <input type="checkbox"/>	<input type="checkbox"/> <input type="checkbox"/> <input type="checkbox"/>	132.0#
		78 x 20 x 42 x 29"	KDTCC783020L.H	<input type="checkbox"/> <input type="checkbox"/> <input type="checkbox"/>	<input type="checkbox"/> <input type="checkbox"/> <input type="checkbox"/>	<input type="checkbox"/> <input type="checkbox"/>	<input type="checkbox"/> <input type="checkbox"/> <input type="checkbox"/>	140.0#
		78 x 24 x 42 x 29"	KDTCC783024L.H	<input type="checkbox"/> <input type="checkbox"/> <input type="checkbox"/>	<input type="checkbox"/> <input type="checkbox"/> <input type="checkbox"/>	<input type="checkbox"/> <input type="checkbox"/>	<input type="checkbox"/> <input type="checkbox"/> <input type="checkbox"/>	140.0#
		78 x 30 x 42 x 29"	KDTCC783030L.H	<input type="checkbox"/> <input type="checkbox"/> <input type="checkbox"/>	<input type="checkbox"/> <input type="checkbox"/> <input type="checkbox"/>	<input type="checkbox"/> <input type="checkbox"/>	<input type="checkbox"/> <input type="checkbox"/> <input type="checkbox"/>	140.0#
		ARSPD						
  W1 42" 30" dia W2	<b>D-Top Desk-30" Extended Right, Curved Cutaway</b> <ul style="list-style-type: none"> <li>• Curved cutaway</li> <li>• Modesty panel is 14" standard; full modesty panel available with upcharge</li> <li>• 6" diameter post leg</li> <li>• Grommet included</li> </ul>	66 x 20 x 42 x 29"	KDTCC663020R.H	<input type="checkbox"/> <input type="checkbox"/> <input type="checkbox"/>	<input type="checkbox"/> <input type="checkbox"/> <input type="checkbox"/>	<input type="checkbox"/> <input type="checkbox"/>	<input type="checkbox"/> <input type="checkbox"/> <input type="checkbox"/>	125.0#
		66 x 24 x 42 x 29"	KDTCC663024R.H	<input type="checkbox"/> <input type="checkbox"/> <input type="checkbox"/>	<input type="checkbox"/> <input type="checkbox"/> <input type="checkbox"/>	<input type="checkbox"/> <input type="checkbox"/>	<input type="checkbox"/> <input type="checkbox"/> <input type="checkbox"/>	125.0#
		66 x 30 x 42 x 29"	KDTCC663030R.H	<input type="checkbox"/> <input type="checkbox"/> <input type="checkbox"/>	<input type="checkbox"/> <input type="checkbox"/> <input type="checkbox"/>	<input type="checkbox"/> <input type="checkbox"/>	<input type="checkbox"/> <input type="checkbox"/> <input type="checkbox"/>	125.0#
		72 x 20 x 42 x 29"	KDTCC723020R.H	<input type="checkbox"/> <input type="checkbox"/> <input type="checkbox"/>	<input type="checkbox"/> <input type="checkbox"/> <input type="checkbox"/>	<input type="checkbox"/> <input type="checkbox"/>	<input type="checkbox"/> <input type="checkbox"/> <input type="checkbox"/>	132.0#
		72 x 24 x 42 x 29"	KDTCC723024R.H	<input type="checkbox"/> <input type="checkbox"/> <input type="checkbox"/>	<input type="checkbox"/> <input type="checkbox"/> <input type="checkbox"/>	<input type="checkbox"/> <input type="checkbox"/>	<input type="checkbox"/> <input type="checkbox"/> <input type="checkbox"/>	132.0#
		72 x 30 x 42 x 29"	KDTCC723030R.H	<input type="checkbox"/> <input type="checkbox"/> <input type="checkbox"/>	<input type="checkbox"/> <input type="checkbox"/> <input type="checkbox"/>	<input type="checkbox"/> <input type="checkbox"/>	<input type="checkbox"/> <input type="checkbox"/> <input type="checkbox"/>	132.0#
		78 x 20 x 42 x 29"	KDTCC783020R.H	<input type="checkbox"/> <input type="checkbox"/> <input type="checkbox"/>	<input type="checkbox"/> <input type="checkbox"/> <input type="checkbox"/>	<input type="checkbox"/> <input type="checkbox"/>	<input type="checkbox"/> <input type="checkbox"/> <input type="checkbox"/>	140.0#
		78 x 24 x 42 x 29"	KDTCC783024R.H	<input type="checkbox"/> <input type="checkbox"/> <input type="checkbox"/>	<input type="checkbox"/> <input type="checkbox"/> <input type="checkbox"/>	<input type="checkbox"/> <input type="checkbox"/>	<input type="checkbox"/> <input type="checkbox"/> <input type="checkbox"/>	140.0#
		78 x 30 x 42 x 29"	KDTCC783030R.H	<input type="checkbox"/> <input type="checkbox"/> <input type="checkbox"/>	<input type="checkbox"/> <input type="checkbox"/> <input type="checkbox"/>	<input type="checkbox"/> <input type="checkbox"/>	<input type="checkbox"/> <input type="checkbox"/> <input type="checkbox"/>	140.0#
		ARSPD						
			<b>A</b>	<b>B</b>	<b>C</b>	<b>D</b>	<b>E</b>	

### HOW TO ORDER

Indicate the following information on order form:

1. Quantity of each item.
2. Model number, including options. See "How To Build a Model Number".
3. Any special service required.

Note: • The  indicates that a choice is required.

- The absence of the  indicates that no choice is required.
- Alpha-numeric characters in place of  indicate that no other alternatives are available.

### HOW TO BUILD A MODEL NUMBER

- A** Select basic model.
- B** Select horizontal surface finish.  
Refer to color addendum at [ki.com](http://ki.com) or KI Fabrics & Finishes binder.
- C** Select vertical surface finish.  
Refer to color addendum at [ki.com](http://ki.com) or KI Fabrics & Finishes binder.
- D** Select leg finish.  
Refer to color addendum at [ki.com](http://ki.com) or KI Fabrics & Finishes binder.
- E** Select modesty panel.  
**PMP** - 14" partial modesty panel (standard)  
**FMP** - Full height modesty panel; add \$70



# Aristotle® Classic Desks

D-Top Desks-Curved Cutaway

Delivered Pricing

\$ 1411
1411
1411
1458
1458
1458
1502
1502
1502

\$ 1411
1411
1411
1458
1458
1458
1502
1502
1502

**SPECIAL SERVICES**

**Special Carton Marking**

With specially marked information N/C



**Shipping**

Shipped k.d. freight prepaid f.o.b.  
KI-Aristotle Brampton, Ontario L6T 5T6  
factory. Freight class #85.

Specifications and prices are subject to  
change without prior notice.

# Aristotle® Classic Returns

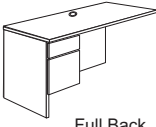
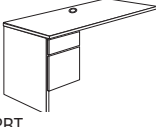
Pedestal-Left

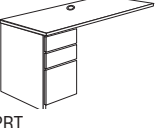
MODEL	W x D x H	MODEL NUMBER						Approx. Packaged Weight	
		Basic Model	Horizontal Surface Finish	Vertical Surface Finish	Pull Option	Lock Option	Back Panel		
 <p>Full Back</p>  <p>ARPRT</p>	<b>Pedestal Return-Left, Box/File Option A</b>	30 x 20 x 29"	KRL3020A.H	<input type="checkbox"/> <input type="checkbox"/> <input type="checkbox"/>	<input type="checkbox"/> <input type="checkbox"/> <input type="checkbox"/>	<input type="checkbox"/> <input type="checkbox"/> <input type="checkbox"/> <input type="checkbox"/>	<input type="checkbox"/> <input type="checkbox"/>	<input type="checkbox"/> <input type="checkbox"/>	98.0#
	<ul style="list-style-type: none"> <li>Box/file locking pedestal with full extension slides</li> <li>Full height back panels over 48" wide feature horizontal wood grain pattern</li> <li>Integral pull is standard; use xxx2 for optional pulls</li> <li>Grommet location center rear</li> <li>Pedestals feature locks on inside panels</li> </ul>	36 x 20 x 29"	KRL3620A.H	<input type="checkbox"/> <input type="checkbox"/> <input type="checkbox"/>	<input type="checkbox"/> <input type="checkbox"/> <input type="checkbox"/>	<input type="checkbox"/> <input type="checkbox"/> <input type="checkbox"/> <input type="checkbox"/>	<input type="checkbox"/> <input type="checkbox"/>	<input type="checkbox"/> <input type="checkbox"/>	105.0#
		42 x 20 x 29"	KRL4220A.H	<input type="checkbox"/> <input type="checkbox"/> <input type="checkbox"/>	<input type="checkbox"/> <input type="checkbox"/> <input type="checkbox"/>	<input type="checkbox"/> <input type="checkbox"/> <input type="checkbox"/> <input type="checkbox"/>	<input type="checkbox"/> <input type="checkbox"/>	<input type="checkbox"/> <input type="checkbox"/>	113.0#
		48 x 20 x 29"	KRL4820A.H	<input type="checkbox"/> <input type="checkbox"/> <input type="checkbox"/>	<input type="checkbox"/> <input type="checkbox"/> <input type="checkbox"/>	<input type="checkbox"/> <input type="checkbox"/> <input type="checkbox"/> <input type="checkbox"/>	<input type="checkbox"/> <input type="checkbox"/>	<input type="checkbox"/> <input type="checkbox"/>	120.0#
		54 x 20 x 29"	KRL5420A.H	<input type="checkbox"/> <input type="checkbox"/> <input type="checkbox"/>	<input type="checkbox"/> <input type="checkbox"/> <input type="checkbox"/>	<input type="checkbox"/> <input type="checkbox"/> <input type="checkbox"/> <input type="checkbox"/>	<input type="checkbox"/> <input type="checkbox"/>	<input type="checkbox"/> <input type="checkbox"/>	128.0#
		60 x 20 x 29"	KRL6020A.H	<input type="checkbox"/> <input type="checkbox"/> <input type="checkbox"/>	<input type="checkbox"/> <input type="checkbox"/> <input type="checkbox"/>	<input type="checkbox"/> <input type="checkbox"/> <input type="checkbox"/> <input type="checkbox"/>	<input type="checkbox"/> <input type="checkbox"/>	<input type="checkbox"/> <input type="checkbox"/>	135.0#
		30 x 24 x 29"	KRL3024A.H	<input type="checkbox"/> <input type="checkbox"/> <input type="checkbox"/>	<input type="checkbox"/> <input type="checkbox"/> <input type="checkbox"/>	<input type="checkbox"/> <input type="checkbox"/> <input type="checkbox"/> <input type="checkbox"/>	<input type="checkbox"/> <input type="checkbox"/>	<input type="checkbox"/> <input type="checkbox"/>	103.0#
		36 x 24 x 29"	KRL3624A.H	<input type="checkbox"/> <input type="checkbox"/> <input type="checkbox"/>	<input type="checkbox"/> <input type="checkbox"/> <input type="checkbox"/>	<input type="checkbox"/> <input type="checkbox"/> <input type="checkbox"/> <input type="checkbox"/>	<input type="checkbox"/> <input type="checkbox"/>	<input type="checkbox"/> <input type="checkbox"/>	110.0#
		42 x 24 x 29"	KRL4224A.H	<input type="checkbox"/> <input type="checkbox"/> <input type="checkbox"/>	<input type="checkbox"/> <input type="checkbox"/> <input type="checkbox"/>	<input type="checkbox"/> <input type="checkbox"/> <input type="checkbox"/> <input type="checkbox"/>	<input type="checkbox"/> <input type="checkbox"/>	<input type="checkbox"/> <input type="checkbox"/>	118.0#
		48 x 24 x 29"	KRL4824A.H	<input type="checkbox"/> <input type="checkbox"/> <input type="checkbox"/>	<input type="checkbox"/> <input type="checkbox"/> <input type="checkbox"/>	<input type="checkbox"/> <input type="checkbox"/> <input type="checkbox"/> <input type="checkbox"/>	<input type="checkbox"/> <input type="checkbox"/>	<input type="checkbox"/> <input type="checkbox"/>	125.0#
 <p>Full Back</p>  <p>ARPRT</p>	<b>Pedestal Return-Left, Box/Box/File Option B</b>	30 x 20 x 29"	KRL3020B.H	<input type="checkbox"/> <input type="checkbox"/> <input type="checkbox"/>	<input type="checkbox"/> <input type="checkbox"/> <input type="checkbox"/>	<input type="checkbox"/> <input type="checkbox"/> <input type="checkbox"/> <input type="checkbox"/>	<input type="checkbox"/> <input type="checkbox"/>	<input type="checkbox"/> <input type="checkbox"/>	128.0#
	<ul style="list-style-type: none"> <li>Box/box/file locking pedestal with full extension slides</li> <li>Upper box drawer is non-locking</li> <li>Full height back panels over 48" wide feature horizontal wood grain pattern</li> <li>Integral pull is standard; use xxx3 for optional pulls</li> <li>Grommet location center rear</li> <li>Pedestals feature locks on inside panels</li> </ul>	36 x 20 x 29"	KRL3620B.H	<input type="checkbox"/> <input type="checkbox"/> <input type="checkbox"/>	<input type="checkbox"/> <input type="checkbox"/> <input type="checkbox"/>	<input type="checkbox"/> <input type="checkbox"/> <input type="checkbox"/> <input type="checkbox"/>	<input type="checkbox"/> <input type="checkbox"/>	<input type="checkbox"/> <input type="checkbox"/>	135.0#
		42 x 20 x 29"	KRL4220B.H	<input type="checkbox"/> <input type="checkbox"/> <input type="checkbox"/>	<input type="checkbox"/> <input type="checkbox"/> <input type="checkbox"/>	<input type="checkbox"/> <input type="checkbox"/> <input type="checkbox"/> <input type="checkbox"/>	<input type="checkbox"/> <input type="checkbox"/>	<input type="checkbox"/> <input type="checkbox"/>	143.0#
		48 x 20 x 29"	KRL4820B.H	<input type="checkbox"/> <input type="checkbox"/> <input type="checkbox"/>	<input type="checkbox"/> <input type="checkbox"/> <input type="checkbox"/>	<input type="checkbox"/> <input type="checkbox"/> <input type="checkbox"/> <input type="checkbox"/>	<input type="checkbox"/> <input type="checkbox"/>	<input type="checkbox"/> <input type="checkbox"/>	150.0#
		54 x 20 x 29"	KRL5420B.H	<input type="checkbox"/> <input type="checkbox"/> <input type="checkbox"/>	<input type="checkbox"/> <input type="checkbox"/> <input type="checkbox"/>	<input type="checkbox"/> <input type="checkbox"/> <input type="checkbox"/> <input type="checkbox"/>	<input type="checkbox"/> <input type="checkbox"/>	<input type="checkbox"/> <input type="checkbox"/>	158.0#
		60 x 20 x 29"	KRL6020B.H	<input type="checkbox"/> <input type="checkbox"/> <input type="checkbox"/>	<input type="checkbox"/> <input type="checkbox"/> <input type="checkbox"/>	<input type="checkbox"/> <input type="checkbox"/> <input type="checkbox"/> <input type="checkbox"/>	<input type="checkbox"/> <input type="checkbox"/>	<input type="checkbox"/> <input type="checkbox"/>	165.0#
		30 x 24 x 29"	KRL3024B.H	<input type="checkbox"/> <input type="checkbox"/> <input type="checkbox"/>	<input type="checkbox"/> <input type="checkbox"/> <input type="checkbox"/>	<input type="checkbox"/> <input type="checkbox"/> <input type="checkbox"/> <input type="checkbox"/>	<input type="checkbox"/> <input type="checkbox"/>	<input type="checkbox"/> <input type="checkbox"/>	133.0#
		36 x 24 x 29"	KRL3624B.H	<input type="checkbox"/> <input type="checkbox"/> <input type="checkbox"/>	<input type="checkbox"/> <input type="checkbox"/> <input type="checkbox"/>	<input type="checkbox"/> <input type="checkbox"/> <input type="checkbox"/> <input type="checkbox"/>	<input type="checkbox"/> <input type="checkbox"/>	<input type="checkbox"/> <input type="checkbox"/>	140.0#
		42 x 24 x 29"	KRL4224B.H	<input type="checkbox"/> <input type="checkbox"/> <input type="checkbox"/>	<input type="checkbox"/> <input type="checkbox"/> <input type="checkbox"/>	<input type="checkbox"/> <input type="checkbox"/> <input type="checkbox"/> <input type="checkbox"/>	<input type="checkbox"/> <input type="checkbox"/>	<input type="checkbox"/> <input type="checkbox"/>	148.0#
		48 x 24 x 29"	KRL4824B.H	<input type="checkbox"/> <input type="checkbox"/> <input type="checkbox"/>	<input type="checkbox"/> <input type="checkbox"/> <input type="checkbox"/>	<input type="checkbox"/> <input type="checkbox"/> <input type="checkbox"/> <input type="checkbox"/>	<input type="checkbox"/> <input type="checkbox"/>	<input type="checkbox"/> <input type="checkbox"/>	155.0#
	54 x 24 x 29"	KRL5424B.H	<input type="checkbox"/> <input type="checkbox"/> <input type="checkbox"/>	<input type="checkbox"/> <input type="checkbox"/> <input type="checkbox"/>	<input type="checkbox"/> <input type="checkbox"/> <input type="checkbox"/> <input type="checkbox"/>	<input type="checkbox"/> <input type="checkbox"/>	<input type="checkbox"/> <input type="checkbox"/>	163.0#	
	60 x 24 x 29"	KRL6024B.H	<input type="checkbox"/> <input type="checkbox"/> <input type="checkbox"/>	<input type="checkbox"/> <input type="checkbox"/> <input type="checkbox"/>	<input type="checkbox"/> <input type="checkbox"/> <input type="checkbox"/> <input type="checkbox"/>	<input type="checkbox"/> <input type="checkbox"/>	<input type="checkbox"/> <input type="checkbox"/>	170.0#	

**A**      **B**      **C**      **D**      **E**      **F**

## HOW TO ORDER

Indicate the following information on order form:

- Quantity of each item.
- Model number, including options. See "How To Build a Model Number".
- Any special service required.

Note: • The  indicates that a choice is required.

- The absence of the  indicates that no choice is required.
- Alpha-numeric characters in place of  indicate that no other alternatives are available.

## HOW TO BUILD A MODEL NUMBER

**A** Select basic model.

**B** Select horizontal surface finish.  
Refer to color addendum at ki.com or KI Fabrics & Finishes binder.

**C** Select vertical surface finish.  
Refer to color addendum at ki.com or KI Fabrics & Finishes binder.

**D** Select pull option.

<b>NP</b>	- Standard integral pull
<b>BPA2</b>	- Silver bar pull (2); add \$20
<b>BPA3</b>	- Silver bar pull (3); add \$30
<b>KIB2</b>	- Waterfall black pull (2); add \$20
<b>KIB3</b>	- Waterfall black pull (3); add \$30
<b>KIS2</b>	- Waterfall silver pull (2); add \$20
<b>KIS3</b>	- Waterfall silver pull (3); add \$30
<b>RCP2</b>	- Rectangular silver pull (2); add \$20

**RCP3** - Rectangular silver pull (3); add \$30

**E** Select lock option.

<b>KA</b>	- Key alike
<b>KS</b>	- Key standard

**F** Select back panel option.

<b>FB</b>	- Full Back
<b>OB</b>	- Open Back





Delivered Pricing

- \$ 792
- 834
- 878
- 927
- 974
- 1020
- 835
- 881
- 927
- 968
- 1018
- 1065
- \$ 943
- 977
- 1044
- 1095
- 1132
- 1165
- 980
- 1027
- 1095
- 1137
- 1166
- 1200

**SPECIAL SERVICES**

**Special Carton Marking**

With specially marked information N/C



**Shipping**

Shipped **assembled freight prepaid f.o.b. KI-Aristotle Brampton, Ontario L6T 5T6** factory. Freight class #85.

Specifications and prices are subject to change without prior notice.

# Aristotle® Classic Returns

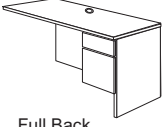
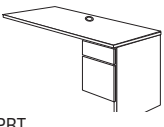
## Pedestal-Right

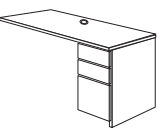
MODEL	W x D x H	Basic Model	MODEL NUMBER						Approx. Packaged Weight
			Horizontal Surface Finish	Vertical Surface Finish	Pull Option	Lock Option	Back Panel		
 <p>Full Back</p>  <p>Open Back</p> <p>ARRPT</p>	<b>Pedestal Return-Right, Box/File Option A</b>	30 x 20 x 29"	KRR3020A.H	<input type="checkbox"/> <input type="checkbox"/> <input type="checkbox"/>	<input type="checkbox"/> <input type="checkbox"/> <input type="checkbox"/>	<input type="checkbox"/> <input type="checkbox"/> <input type="checkbox"/> <input type="checkbox"/>	<input type="checkbox"/> <input type="checkbox"/>	<input type="checkbox"/> <input type="checkbox"/>	98.0#
	36 x 20 x 29"	KRR3620A.H	<input type="checkbox"/> <input type="checkbox"/> <input type="checkbox"/>	<input type="checkbox"/> <input type="checkbox"/> <input type="checkbox"/>	<input type="checkbox"/> <input type="checkbox"/> <input type="checkbox"/> <input type="checkbox"/>	<input type="checkbox"/> <input type="checkbox"/>	<input type="checkbox"/> <input type="checkbox"/>	105.0#	
	42 x 20 x 29"	KRR4220A.H	<input type="checkbox"/> <input type="checkbox"/> <input type="checkbox"/>	<input type="checkbox"/> <input type="checkbox"/> <input type="checkbox"/>	<input type="checkbox"/> <input type="checkbox"/> <input type="checkbox"/> <input type="checkbox"/>	<input type="checkbox"/> <input type="checkbox"/>	<input type="checkbox"/> <input type="checkbox"/>	113.0#	
	48 x 20 x 29"	KRR4820A.H	<input type="checkbox"/> <input type="checkbox"/> <input type="checkbox"/>	<input type="checkbox"/> <input type="checkbox"/> <input type="checkbox"/>	<input type="checkbox"/> <input type="checkbox"/> <input type="checkbox"/> <input type="checkbox"/>	<input type="checkbox"/> <input type="checkbox"/>	<input type="checkbox"/> <input type="checkbox"/>	120.0#	
	54 x 20 x 29"	KRR5420A.H	<input type="checkbox"/> <input type="checkbox"/> <input type="checkbox"/>	<input type="checkbox"/> <input type="checkbox"/> <input type="checkbox"/>	<input type="checkbox"/> <input type="checkbox"/> <input type="checkbox"/> <input type="checkbox"/>	<input type="checkbox"/> <input type="checkbox"/>	<input type="checkbox"/> <input type="checkbox"/>	128.0#	
	60 x 20 x 29"	KRR6020A.H	<input type="checkbox"/> <input type="checkbox"/> <input type="checkbox"/>	<input type="checkbox"/> <input type="checkbox"/> <input type="checkbox"/>	<input type="checkbox"/> <input type="checkbox"/> <input type="checkbox"/> <input type="checkbox"/>	<input type="checkbox"/> <input type="checkbox"/>	<input type="checkbox"/> <input type="checkbox"/>	135.0#	
	30 x 24 x 29"	KRR3024A.H	<input type="checkbox"/> <input type="checkbox"/> <input type="checkbox"/>	<input type="checkbox"/> <input type="checkbox"/> <input type="checkbox"/>	<input type="checkbox"/> <input type="checkbox"/> <input type="checkbox"/> <input type="checkbox"/>	<input type="checkbox"/> <input type="checkbox"/>	<input type="checkbox"/> <input type="checkbox"/>	103.0#	
	36 x 24 x 29"	KRR3624A.H	<input type="checkbox"/> <input type="checkbox"/> <input type="checkbox"/>	<input type="checkbox"/> <input type="checkbox"/> <input type="checkbox"/>	<input type="checkbox"/> <input type="checkbox"/> <input type="checkbox"/> <input type="checkbox"/>	<input type="checkbox"/> <input type="checkbox"/>	<input type="checkbox"/> <input type="checkbox"/>	110.0#	
	42 x 24 x 29"	KRR4224A.H	<input type="checkbox"/> <input type="checkbox"/> <input type="checkbox"/>	<input type="checkbox"/> <input type="checkbox"/> <input type="checkbox"/>	<input type="checkbox"/> <input type="checkbox"/> <input type="checkbox"/> <input type="checkbox"/>	<input type="checkbox"/> <input type="checkbox"/>	<input type="checkbox"/> <input type="checkbox"/>	118.0#	
	48 x 24 x 29"	KRR4824A.H	<input type="checkbox"/> <input type="checkbox"/> <input type="checkbox"/>	<input type="checkbox"/> <input type="checkbox"/> <input type="checkbox"/>	<input type="checkbox"/> <input type="checkbox"/> <input type="checkbox"/> <input type="checkbox"/>	<input type="checkbox"/> <input type="checkbox"/>	<input type="checkbox"/> <input type="checkbox"/>	125.0#	
54 x 24 x 29"	KRR5424A.H	<input type="checkbox"/> <input type="checkbox"/> <input type="checkbox"/>	<input type="checkbox"/> <input type="checkbox"/> <input type="checkbox"/>	<input type="checkbox"/> <input type="checkbox"/> <input type="checkbox"/> <input type="checkbox"/>	<input type="checkbox"/> <input type="checkbox"/>	<input type="checkbox"/> <input type="checkbox"/>	133.0#		
60 x 24 x 29"	KRR6024A.H	<input type="checkbox"/> <input type="checkbox"/> <input type="checkbox"/>	<input type="checkbox"/> <input type="checkbox"/> <input type="checkbox"/>	<input type="checkbox"/> <input type="checkbox"/> <input type="checkbox"/> <input type="checkbox"/>	<input type="checkbox"/> <input type="checkbox"/>	<input type="checkbox"/> <input type="checkbox"/>	140.0#		
 <p>Full Back</p>  <p>Open Back</p> <p>ARRPT</p>	<b>Pedestal Return-Right, Box/Box/File Option B</b>	30 x 20 x 29"	KRR3020B.H	<input type="checkbox"/> <input type="checkbox"/> <input type="checkbox"/>	<input type="checkbox"/> <input type="checkbox"/> <input type="checkbox"/>	<input type="checkbox"/> <input type="checkbox"/> <input type="checkbox"/> <input type="checkbox"/>	<input type="checkbox"/> <input type="checkbox"/>	<input type="checkbox"/> <input type="checkbox"/>	128.0#
	36 x 20 x 29"	KRR3620B.H	<input type="checkbox"/> <input type="checkbox"/> <input type="checkbox"/>	<input type="checkbox"/> <input type="checkbox"/> <input type="checkbox"/>	<input type="checkbox"/> <input type="checkbox"/> <input type="checkbox"/> <input type="checkbox"/>	<input type="checkbox"/> <input type="checkbox"/>	<input type="checkbox"/> <input type="checkbox"/>	135.0#	
	42 x 20 x 29"	KRR4220B.H	<input type="checkbox"/> <input type="checkbox"/> <input type="checkbox"/>	<input type="checkbox"/> <input type="checkbox"/> <input type="checkbox"/>	<input type="checkbox"/> <input type="checkbox"/> <input type="checkbox"/> <input type="checkbox"/>	<input type="checkbox"/> <input type="checkbox"/>	<input type="checkbox"/> <input type="checkbox"/>	143.0#	
	48 x 20 x 29"	KRR4820B.H	<input type="checkbox"/> <input type="checkbox"/> <input type="checkbox"/>	<input type="checkbox"/> <input type="checkbox"/> <input type="checkbox"/>	<input type="checkbox"/> <input type="checkbox"/> <input type="checkbox"/> <input type="checkbox"/>	<input type="checkbox"/> <input type="checkbox"/>	<input type="checkbox"/> <input type="checkbox"/>	150.0#	
	54 x 20 x 29"	KRR5420B.H	<input type="checkbox"/> <input type="checkbox"/> <input type="checkbox"/>	<input type="checkbox"/> <input type="checkbox"/> <input type="checkbox"/>	<input type="checkbox"/> <input type="checkbox"/> <input type="checkbox"/> <input type="checkbox"/>	<input type="checkbox"/> <input type="checkbox"/>	<input type="checkbox"/> <input type="checkbox"/>	158.0#	
	60 x 20 x 29"	KRR6020B.H	<input type="checkbox"/> <input type="checkbox"/> <input type="checkbox"/>	<input type="checkbox"/> <input type="checkbox"/> <input type="checkbox"/>	<input type="checkbox"/> <input type="checkbox"/> <input type="checkbox"/> <input type="checkbox"/>	<input type="checkbox"/> <input type="checkbox"/>	<input type="checkbox"/> <input type="checkbox"/>	165.0#	
	30 x 24 x 29"	KRR3024B.H	<input type="checkbox"/> <input type="checkbox"/> <input type="checkbox"/>	<input type="checkbox"/> <input type="checkbox"/> <input type="checkbox"/>	<input type="checkbox"/> <input type="checkbox"/> <input type="checkbox"/> <input type="checkbox"/>	<input type="checkbox"/> <input type="checkbox"/>	<input type="checkbox"/> <input type="checkbox"/>	133.0#	
	36 x 24 x 29"	KRR3624B.H	<input type="checkbox"/> <input type="checkbox"/> <input type="checkbox"/>	<input type="checkbox"/> <input type="checkbox"/> <input type="checkbox"/>	<input type="checkbox"/> <input type="checkbox"/> <input type="checkbox"/> <input type="checkbox"/>	<input type="checkbox"/> <input type="checkbox"/>	<input type="checkbox"/> <input type="checkbox"/>	140.0#	
	42 x 24 x 29"	KRR4224B.H	<input type="checkbox"/> <input type="checkbox"/> <input type="checkbox"/>	<input type="checkbox"/> <input type="checkbox"/> <input type="checkbox"/>	<input type="checkbox"/> <input type="checkbox"/> <input type="checkbox"/> <input type="checkbox"/>	<input type="checkbox"/> <input type="checkbox"/>	<input type="checkbox"/> <input type="checkbox"/>	148.0#	
	48 x 24 x 29"	KRR4824B.H	<input type="checkbox"/> <input type="checkbox"/> <input type="checkbox"/>	<input type="checkbox"/> <input type="checkbox"/> <input type="checkbox"/>	<input type="checkbox"/> <input type="checkbox"/> <input type="checkbox"/> <input type="checkbox"/>	<input type="checkbox"/> <input type="checkbox"/>	<input type="checkbox"/> <input type="checkbox"/>	155.0#	
54 x 24 x 29"	KRR5424B.H	<input type="checkbox"/> <input type="checkbox"/> <input type="checkbox"/>	<input type="checkbox"/> <input type="checkbox"/> <input type="checkbox"/>	<input type="checkbox"/> <input type="checkbox"/> <input type="checkbox"/> <input type="checkbox"/>	<input type="checkbox"/> <input type="checkbox"/>	<input type="checkbox"/> <input type="checkbox"/>	163.0#		
60 x 24 x 29"	KRR6024B.H	<input type="checkbox"/> <input type="checkbox"/> <input type="checkbox"/>	<input type="checkbox"/> <input type="checkbox"/> <input type="checkbox"/>	<input type="checkbox"/> <input type="checkbox"/> <input type="checkbox"/> <input type="checkbox"/>	<input type="checkbox"/> <input type="checkbox"/>	<input type="checkbox"/> <input type="checkbox"/>	170.0#		

**A**      **B**      **C**      **D**      **E**      **F**

### HOW TO ORDER

Indicate the following information on order form:

- Quantity of each item.
- Model number, including options. See "How To Build a Model Number".
- Any special service required.

Note: • The  indicates that a choice is required.

- The absence of the  indicates that no choice is required.
- Alpha-numeric characters in place of  indicate that no other alternatives are available.

### HOW TO BUILD A MODEL NUMBER

- A** Select basic model.
- B** Select horizontal surface finish.  
Refer to color addendum at ki.com or KI Fabrics & Finishes binder.
- C** Select vertical surface finish.  
Refer to color addendum at ki.com or KI Fabrics & Finishes binder.
- D** Select pull option.
- |             |   |
|-------------|---|
| <b>NP</b>   | - Standard integral pull                |
| <b>BPA2</b> | - Silver bar pull (2); add \$20         |
| <b>BPA3</b> | - Silver bar pull (3); add \$30         |
| <b>KIB2</b> | - Waterfall black pull (2); add \$20    |
| <b>KIB3</b> | - Waterfall black pull (3); add \$30    |
| <b>KIS2</b> | - Waterfall silver pull (2); add \$20   |
| <b>KIS3</b> | - Waterfall silver pull (3); add \$30   |
| <b>RCP2</b> | - Rectangular silver pull (2); add \$20 |

**RCP3** - Rectangular silver pull (3); add \$30

- E** Select lock option.
- |           |                |
|-----------|----------------|
| <b>KA</b> | - Key alike    |
| <b>KS</b> | - Key standard |

- F** Select back panel option.
- |           |             |
|-----------|-------------|
| <b>FB</b> | - Full Back |
| <b>OB</b> | - Open Back |



Aristotle® Classic Returns  
Pedestal-Right

Delivered Pricing

- \$ 792
- 834
- 878
- 927
- 974
- 1020
- 835
- 881
- 927
- 968
- 1018
- 1065
- \$ 943
- 977
- 1044
- 1095
- 1132
- 1165
- 980
- 1027
- 1095
- 1137
- 1166
- 1200

**SPECIAL SERVICES**

**Special Carton Marking**

With specially marked information N/C

**Shipping**

Shipped **assembled freight prepaid f.o.b. KI-Aristotle Brampton, Ontario L6T 5T6** factory. Freight class #85.

Specifications and prices are subject to change without prior notice.

# Aristotle® Classic Returns

Pedestal-Left and Pedestal-Right

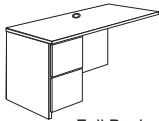
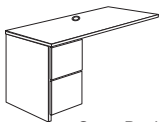
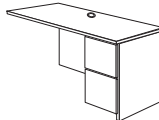
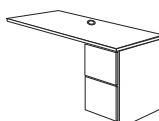
	MODEL	W x D x H	MODEL NUMBER						Approx. Packaged Weight
			Basic Model	Horizontal Surface Finish	Vertical Surface Finish	Pull Option	Lock Option	Back Panel	
 <p>Full Back</p>  <p>Open Back</p> <p>ARRPT</p>	<b>Pedestal Return-Left, File/File Option C</b> <ul style="list-style-type: none"> <li>File/file locking pedestal with full extension slides</li> <li>Full height back panels over 48" wide feature horizontal wood grain pattern</li> <li>Integral pull is standard; use xxx2 for optional pulls</li> <li>Grommet location center rear</li> <li>Pedestals feature locks on inside panels</li> </ul>	30 x 20 x 29"	KRL3020C.H	<input type="checkbox"/> <input type="checkbox"/> <input type="checkbox"/> <input type="checkbox"/>	<input type="checkbox"/> <input type="checkbox"/> <input type="checkbox"/> <input type="checkbox"/>	<input type="checkbox"/> <input type="checkbox"/> <input type="checkbox"/> <input type="checkbox"/>	<input type="checkbox"/> <input type="checkbox"/>	<input type="checkbox"/> <input type="checkbox"/>	128.0#
		36 x 20 x 29"	KRL3620C.H	<input type="checkbox"/> <input type="checkbox"/> <input type="checkbox"/> <input type="checkbox"/>	<input type="checkbox"/> <input type="checkbox"/> <input type="checkbox"/> <input type="checkbox"/>	<input type="checkbox"/> <input type="checkbox"/> <input type="checkbox"/> <input type="checkbox"/>	<input type="checkbox"/> <input type="checkbox"/>	<input type="checkbox"/> <input type="checkbox"/>	135.0#
		42 x 20 x 29"	KRL4220C.H	<input type="checkbox"/> <input type="checkbox"/> <input type="checkbox"/> <input type="checkbox"/>	<input type="checkbox"/> <input type="checkbox"/> <input type="checkbox"/> <input type="checkbox"/>	<input type="checkbox"/> <input type="checkbox"/> <input type="checkbox"/> <input type="checkbox"/>	<input type="checkbox"/> <input type="checkbox"/>	<input type="checkbox"/> <input type="checkbox"/>	143.0#
		48 x 20 x 29"	KRL4820C.H	<input type="checkbox"/> <input type="checkbox"/> <input type="checkbox"/> <input type="checkbox"/>	<input type="checkbox"/> <input type="checkbox"/> <input type="checkbox"/> <input type="checkbox"/>	<input type="checkbox"/> <input type="checkbox"/> <input type="checkbox"/> <input type="checkbox"/>	<input type="checkbox"/> <input type="checkbox"/>	<input type="checkbox"/> <input type="checkbox"/>	150.0#
		54 x 20 x 29"	KRL5420C.H	<input type="checkbox"/> <input type="checkbox"/> <input type="checkbox"/> <input type="checkbox"/>	<input type="checkbox"/> <input type="checkbox"/> <input type="checkbox"/> <input type="checkbox"/>	<input type="checkbox"/> <input type="checkbox"/> <input type="checkbox"/> <input type="checkbox"/>	<input type="checkbox"/> <input type="checkbox"/>	<input type="checkbox"/> <input type="checkbox"/>	158.0#
		60 x 20 x 29"	KRL6020C.H	<input type="checkbox"/> <input type="checkbox"/> <input type="checkbox"/> <input type="checkbox"/>	<input type="checkbox"/> <input type="checkbox"/> <input type="checkbox"/> <input type="checkbox"/>	<input type="checkbox"/> <input type="checkbox"/> <input type="checkbox"/> <input type="checkbox"/>	<input type="checkbox"/> <input type="checkbox"/>	<input type="checkbox"/> <input type="checkbox"/>	165.0#
		30 x 24 x 29"	KRL3024C.H	<input type="checkbox"/> <input type="checkbox"/> <input type="checkbox"/> <input type="checkbox"/>	<input type="checkbox"/> <input type="checkbox"/> <input type="checkbox"/> <input type="checkbox"/>	<input type="checkbox"/> <input type="checkbox"/> <input type="checkbox"/> <input type="checkbox"/>	<input type="checkbox"/> <input type="checkbox"/>	<input type="checkbox"/> <input type="checkbox"/>	133.0#
		36 x 24 x 29"	KRL3624C.H	<input type="checkbox"/> <input type="checkbox"/> <input type="checkbox"/> <input type="checkbox"/>	<input type="checkbox"/> <input type="checkbox"/> <input type="checkbox"/> <input type="checkbox"/>	<input type="checkbox"/> <input type="checkbox"/> <input type="checkbox"/> <input type="checkbox"/>	<input type="checkbox"/> <input type="checkbox"/>	<input type="checkbox"/> <input type="checkbox"/>	140.0#
		42 x 24 x 29"	KRL4224C.H	<input type="checkbox"/> <input type="checkbox"/> <input type="checkbox"/> <input type="checkbox"/>	<input type="checkbox"/> <input type="checkbox"/> <input type="checkbox"/> <input type="checkbox"/>	<input type="checkbox"/> <input type="checkbox"/> <input type="checkbox"/> <input type="checkbox"/>	<input type="checkbox"/> <input type="checkbox"/>	<input type="checkbox"/> <input type="checkbox"/>	148.0#
		48 x 24 x 29"	KRL4824C.H	<input type="checkbox"/> <input type="checkbox"/> <input type="checkbox"/> <input type="checkbox"/>	<input type="checkbox"/> <input type="checkbox"/> <input type="checkbox"/> <input type="checkbox"/>	<input type="checkbox"/> <input type="checkbox"/> <input type="checkbox"/> <input type="checkbox"/>	<input type="checkbox"/> <input type="checkbox"/>	<input type="checkbox"/> <input type="checkbox"/>	155.0#
		54 x 24 x 29"	KRL5424C.H	<input type="checkbox"/> <input type="checkbox"/> <input type="checkbox"/> <input type="checkbox"/>	<input type="checkbox"/> <input type="checkbox"/> <input type="checkbox"/> <input type="checkbox"/>	<input type="checkbox"/> <input type="checkbox"/> <input type="checkbox"/> <input type="checkbox"/>	<input type="checkbox"/> <input type="checkbox"/>	<input type="checkbox"/> <input type="checkbox"/>	163.0#
		60 x 24 x 29"	KRL6024C.H	<input type="checkbox"/> <input type="checkbox"/> <input type="checkbox"/> <input type="checkbox"/>	<input type="checkbox"/> <input type="checkbox"/> <input type="checkbox"/> <input type="checkbox"/>	<input type="checkbox"/> <input type="checkbox"/> <input type="checkbox"/> <input type="checkbox"/>	<input type="checkbox"/> <input type="checkbox"/>	<input type="checkbox"/> <input type="checkbox"/>	170.0#
 <p>Full Back</p>  <p>Open Back</p> <p>ARRPT</p>	<b>Pedestal Return-Right, File/File Option C</b> <ul style="list-style-type: none"> <li>File/file locking pedestal with full extension slides</li> <li>Full height back panels over 48" wide feature horizontal wood grain pattern</li> <li>Integral pull is standard; use xxx2 for optional pulls</li> <li>Grommet location center rear</li> <li>Pedestals feature locks on inside panels</li> </ul>	30 x 20 x 29"	KRR3020C.H	<input type="checkbox"/> <input type="checkbox"/> <input type="checkbox"/> <input type="checkbox"/>	<input type="checkbox"/> <input type="checkbox"/> <input type="checkbox"/> <input type="checkbox"/>	<input type="checkbox"/> <input type="checkbox"/> <input type="checkbox"/> <input type="checkbox"/>	<input type="checkbox"/> <input type="checkbox"/>	<input type="checkbox"/> <input type="checkbox"/>	128.0#
		36 x 20 x 29"	KRR3620C.H	<input type="checkbox"/> <input type="checkbox"/> <input type="checkbox"/> <input type="checkbox"/>	<input type="checkbox"/> <input type="checkbox"/> <input type="checkbox"/> <input type="checkbox"/>	<input type="checkbox"/> <input type="checkbox"/> <input type="checkbox"/> <input type="checkbox"/>	<input type="checkbox"/> <input type="checkbox"/>	<input type="checkbox"/> <input type="checkbox"/>	135.0#
		42 x 20 x 29"	KRR4220C.H	<input type="checkbox"/> <input type="checkbox"/> <input type="checkbox"/> <input type="checkbox"/>	<input type="checkbox"/> <input type="checkbox"/> <input type="checkbox"/> <input type="checkbox"/>	<input type="checkbox"/> <input type="checkbox"/> <input type="checkbox"/> <input type="checkbox"/>	<input type="checkbox"/> <input type="checkbox"/>	<input type="checkbox"/> <input type="checkbox"/>	143.0#
		48 x 20 x 29"	KRR4820C.H	<input type="checkbox"/> <input type="checkbox"/> <input type="checkbox"/> <input type="checkbox"/>	<input type="checkbox"/> <input type="checkbox"/> <input type="checkbox"/> <input type="checkbox"/>	<input type="checkbox"/> <input type="checkbox"/> <input type="checkbox"/> <input type="checkbox"/>	<input type="checkbox"/> <input type="checkbox"/>	<input type="checkbox"/> <input type="checkbox"/>	150.0#
		54 x 20 x 29"	KRR5420C.H	<input type="checkbox"/> <input type="checkbox"/> <input type="checkbox"/> <input type="checkbox"/>	<input type="checkbox"/> <input type="checkbox"/> <input type="checkbox"/> <input type="checkbox"/>	<input type="checkbox"/> <input type="checkbox"/> <input type="checkbox"/> <input type="checkbox"/>	<input type="checkbox"/> <input type="checkbox"/>	<input type="checkbox"/> <input type="checkbox"/>	158.0#
		60 x 20 x 29"	KRR6020C.H	<input type="checkbox"/> <input type="checkbox"/> <input type="checkbox"/> <input type="checkbox"/>	<input type="checkbox"/> <input type="checkbox"/> <input type="checkbox"/> <input type="checkbox"/>	<input type="checkbox"/> <input type="checkbox"/> <input type="checkbox"/> <input type="checkbox"/>	<input type="checkbox"/> <input type="checkbox"/>	<input type="checkbox"/> <input type="checkbox"/>	165.0#
		30 x 24 x 29"	KRR3024C.H	<input type="checkbox"/> <input type="checkbox"/> <input type="checkbox"/> <input type="checkbox"/>	<input type="checkbox"/> <input type="checkbox"/> <input type="checkbox"/> <input type="checkbox"/>	<input type="checkbox"/> <input type="checkbox"/> <input type="checkbox"/> <input type="checkbox"/>	<input type="checkbox"/> <input type="checkbox"/>	<input type="checkbox"/> <input type="checkbox"/>	133.0#
		36 x 24 x 29"	KRR3624C.H	<input type="checkbox"/> <input type="checkbox"/> <input type="checkbox"/> <input type="checkbox"/>	<input type="checkbox"/> <input type="checkbox"/> <input type="checkbox"/> <input type="checkbox"/>	<input type="checkbox"/> <input type="checkbox"/> <input type="checkbox"/> <input type="checkbox"/>	<input type="checkbox"/> <input type="checkbox"/>	<input type="checkbox"/> <input type="checkbox"/>	140.0#
		42 x 24 x 29"	KRR4224C.H	<input type="checkbox"/> <input type="checkbox"/> <input type="checkbox"/> <input type="checkbox"/>	<input type="checkbox"/> <input type="checkbox"/> <input type="checkbox"/> <input type="checkbox"/>	<input type="checkbox"/> <input type="checkbox"/> <input type="checkbox"/> <input type="checkbox"/>	<input type="checkbox"/> <input type="checkbox"/>	<input type="checkbox"/> <input type="checkbox"/>	148.0#
		48 x 24 x 29"	KRR4824C.H	<input type="checkbox"/> <input type="checkbox"/> <input type="checkbox"/> <input type="checkbox"/>	<input type="checkbox"/> <input type="checkbox"/> <input type="checkbox"/> <input type="checkbox"/>	<input type="checkbox"/> <input type="checkbox"/> <input type="checkbox"/> <input type="checkbox"/>	<input type="checkbox"/> <input type="checkbox"/>	<input type="checkbox"/> <input type="checkbox"/>	155.0#
		54 x 24 x 29"	KRR5424C.H	<input type="checkbox"/> <input type="checkbox"/> <input type="checkbox"/> <input type="checkbox"/>	<input type="checkbox"/> <input type="checkbox"/> <input type="checkbox"/> <input type="checkbox"/>	<input type="checkbox"/> <input type="checkbox"/> <input type="checkbox"/> <input type="checkbox"/>	<input type="checkbox"/> <input type="checkbox"/>	<input type="checkbox"/> <input type="checkbox"/>	163.0#
		60 x 24 x 29"	KRR6024C.H	<input type="checkbox"/> <input type="checkbox"/> <input type="checkbox"/> <input type="checkbox"/>	<input type="checkbox"/> <input type="checkbox"/> <input type="checkbox"/> <input type="checkbox"/>	<input type="checkbox"/> <input type="checkbox"/> <input type="checkbox"/> <input type="checkbox"/>	<input type="checkbox"/> <input type="checkbox"/>	<input type="checkbox"/> <input type="checkbox"/>	170.0#

A

B

C

D

E

F

## HOW TO ORDER

Indicate the following information on order form:

- Quantity of each item.
- Model number, including options. See "How To Build a Model Number".
- Any special service required.

Note: • The  indicates that a choice is required.

- The absence of the  indicates that no choice is required.
- Alpha-numeric characters in place of  indicate that no other alternatives are available.

## HOW TO BUILD A MODEL NUMBER

**A** Select basic model.

**B** Select horizontal surface finish.  
Refer to color addendum at ki.com or KI Fabrics & Finishes binder.

**C** Select vertical surface finish.  
Refer to color addendum at ki.com or KI Fabrics & Finishes binder.

**D** Select pull option.

<b>NP</b>	- Standard integral pull
<b>BPA2</b>	- Silver bar pull (2); add \$20
<b>KIB2</b>	- Waterfall black pull (2); add \$20
<b>KIS2</b>	- Waterfall silver pull (2); add \$20
<b>RCP2</b>	- Rectangular silver pull (2); add \$20

**E** Select lock option.

<b>KA</b>	- Key alike
<b>KS</b>	- Key standard

**F** Select back panel option.

<b>FB</b>	- Full Back
<b>OB</b>	- Open Back



# Aristotle® Classic Returns

Pedestal-Left and Pedestal-Right

Delivered Pricing

\$ 943  
 977  
 1044  
 1095  
 1132  
 1165  
 980  
 1027  
 1095  
 1137  
 1166  
 1200

\$ 943  
 977  
 1044  
 1095  
 1132  
 1165  
 980  
 1027  
 1095  
 1137  
 1166  
 1200

**SPECIAL SERVICES**

**Special Carton Marking**

With specially marked information N/C

**Shipping**

Shipped **assembled freight prepaid f.o.b. KI-Aristotle Brampton, Ontario L6T 5T6** factory. Freight class #85.

Specifications and prices are subject to change without prior notice.

# Aristotle® Classic Returns

Flush-Left and Right, No Pedestal

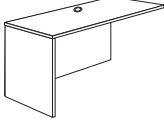
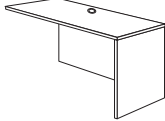
	MODEL	W x D x H	MODEL NUMBER			Approx. Packaged Weight
			Basic Model	Horizontal Surface Finish	Vertical Surface Finish	
 <p>ARPRT</p>	<b>Flush Return-Left, No Pedestal</b> <ul style="list-style-type: none"> <li>• Full height back panels over 48" wide feature horizontal wood grain pattern</li> <li>• Grommet location center rear</li> </ul>	30 x 20 x 29"	KFRL3020.H	<input type="checkbox"/>	<input type="checkbox"/>	68.0#
		36 x 20 x 29"	KFRL3620.H	<input type="checkbox"/>	<input type="checkbox"/>	70.0#
		42 x 20 x 29"	KFRL4220.H	<input type="checkbox"/>	<input type="checkbox"/>	73.0#
		48 x 20 x 29"	KFRL4820.H	<input type="checkbox"/>	<input type="checkbox"/>	75.0#
		54 x 20 x 29"	KFRL5420.H	<input type="checkbox"/>	<input type="checkbox"/>	78.0#
		60 x 20 x 29"	KFRL6020.H	<input type="checkbox"/>	<input type="checkbox"/>	80.0#
		30 x 24 x 29"	KFRL3024.H	<input type="checkbox"/>	<input type="checkbox"/>	68.0#
		36 x 24 x 29"	KFRL3624.H	<input type="checkbox"/>	<input type="checkbox"/>	70.0#
		42 x 24 x 29"	KFRL4224.H	<input type="checkbox"/>	<input type="checkbox"/>	73.0#
		48 x 24 x 29"	KFRL4824.H	<input type="checkbox"/>	<input type="checkbox"/>	75.0#
		54 x 24 x 29"	KFRL5424.H	<input type="checkbox"/>	<input type="checkbox"/>	78.0#
		60 x 24 x 29"	KFRL6024.H	<input type="checkbox"/>	<input type="checkbox"/>	80.0#
 <p>ARPRT</p>	<b>Flush Return-Right, No Pedestal</b> <ul style="list-style-type: none"> <li>• Back panels over 48" wide feature horizontal wood grain pattern</li> <li>• Grommet location center rear</li> </ul>	30 x 20 x 29"	KFRR3020.H	<input type="checkbox"/>	<input type="checkbox"/>	68.0#
		36 x 20 x 29"	KFRR3620.H	<input type="checkbox"/>	<input type="checkbox"/>	70.0#
		42 x 20 x 29"	KFRR4220.H	<input type="checkbox"/>	<input type="checkbox"/>	73.0#
		48 x 20 x 29"	KFRR4820.H	<input type="checkbox"/>	<input type="checkbox"/>	75.0#
		54 x 20 x 29"	KFRR5420.H	<input type="checkbox"/>	<input type="checkbox"/>	78.0#
		60 x 20 x 29"	KFRR6020.H	<input type="checkbox"/>	<input type="checkbox"/>	80.0#
		30 x 24 x 29"	KFRR3024.H	<input type="checkbox"/>	<input type="checkbox"/>	68.0#
		36 x 24 x 29"	KFRR3624.H	<input type="checkbox"/>	<input type="checkbox"/>	70.0#
		42 x 24 x 29"	KFRR4224.H	<input type="checkbox"/>	<input type="checkbox"/>	73.0#
		48 x 24 x 29"	KFRR4824.H	<input type="checkbox"/>	<input type="checkbox"/>	75.0#
		54 x 24 x 29"	KFRR5424.H	<input type="checkbox"/>	<input type="checkbox"/>	78.0#
		60 x 24 x 29"	KFRR6024.H	<input type="checkbox"/>	<input type="checkbox"/>	80.0#

A

B

C

## HOW TO ORDER

Indicate the following information on order form:

1. Quantity of each item.
2. Model number, including options. See "How To Build a Model Number".
3. Any special service required.

Note: • The  indicates that a choice is required.

- The absence of the  indicates that no choice is required.
- Alpha-numeric characters in place of  indicate that no other alternatives are available.

## HOW TO BUILD A MODEL NUMBER

- A** Select basic model.
- B** Select horizontal surface finish.  
Refer to color addendum at [ki.com](http://ki.com) or KI Fabrics & Finishes binder.
- C** Select vertical surface finish.  
Refer to color addendum at [ki.com](http://ki.com) or KI Fabrics & Finishes binder.



# Aristotle® Classic Returns

Flush-Left and Right, No Pedestal

Delivered Pricing

\$ 485  
515  
542  
573  
600  
631  
510  
544  
576  
606  
637  
667

\$ 485  
515  
542  
573  
600  
631  
510  
544  
576  
606  
637  
667

**SPECIAL SERVICES**

**Special Carton Marking**

With specially marked information N/C

**Shipping**

Shipped k.d. freight prepaid f.o.b.  
KI-Aristotle Brampton, Ontario L6T 5T6  
factory. Freight class #85.

Specifications and prices are subject to  
change without prior notice.

# Aristotle® Classic Returns

Aluminum Frame Profile with Modesty and End Panel Inserts

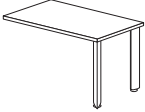
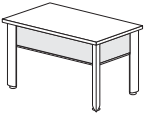
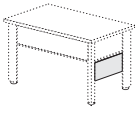
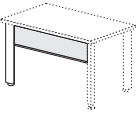
	MODEL	W x D x H	MODEL NUMBER		Approx. Packaged Weight
			Basic Model	Horizontal Surface Finish	
 ARPRT	<b>Return-Aluminum Frame Profile</b>	42 x 24 x 29"	KRAL4224.H	<input type="checkbox"/> <input type="checkbox"/> <input type="checkbox"/>	33.0#
	• Standard return does not feature grommet	48 x 24 x 29"	KRAL4824.H	<input type="checkbox"/> <input type="checkbox"/> <input type="checkbox"/>	36.0#
	• Two support legs, wave profile	54 x 24 x 29"	KRAL5424.H	<input type="checkbox"/> <input type="checkbox"/> <input type="checkbox"/>	40.0#
	• Optional acrylic end panel specified separately	60 x 24 x 29"	KRAL6024.H	<input type="checkbox"/> <input type="checkbox"/> <input type="checkbox"/>	43.0#
	• Aluminum leg features clear, anodized finish	42 x 30 x 29"	KRAL4230.H	<input type="checkbox"/> <input type="checkbox"/> <input type="checkbox"/>	39.0#
	• Leg provides vertical wire management	48 x 30 x 29"	KRAL4830.H	<input type="checkbox"/> <input type="checkbox"/> <input type="checkbox"/>	43.0#
		54 x 30 x 29"	KRAL5430.H	<input type="checkbox"/> <input type="checkbox"/> <input type="checkbox"/>	47.0#
	60 x 30 x 29"	KRAL6030.H	<input type="checkbox"/> <input type="checkbox"/> <input type="checkbox"/>	52.0#	
 ARPRT	<b>Return-Aluminum Frame Profile w/End and Modesty Panels</b>	42 x 24 x 29"	KRAL4224EM.H	<input type="checkbox"/> <input type="checkbox"/> <input type="checkbox"/>	33.0#
	• Standard return does not feature grommet	48 x 24 x 29"	KRAL4824EM.H	<input type="checkbox"/> <input type="checkbox"/> <input type="checkbox"/>	36.0#
	• Three support legs, wave profile	54 x 24 x 29"	KRAL5424EM.H	<input type="checkbox"/> <input type="checkbox"/> <input type="checkbox"/>	40.0#
	• Features one acrylic end panel and one acrylic modesty panel	60 x 24 x 29"	KRAL6024EM.H	<input type="checkbox"/> <input type="checkbox"/> <input type="checkbox"/>	43.0#
	• Aluminum leg features clear, anodized finish	42 x 30 x 29"	KRAL4230EM.H	<input type="checkbox"/> <input type="checkbox"/> <input type="checkbox"/>	39.0#
	• Legs provide vertical wire management	48 x 30 x 29"	KRAL4830EM.H	<input type="checkbox"/> <input type="checkbox"/> <input type="checkbox"/>	43.0#
		54 x 30 x 29"	KRAL5430EM.H	<input type="checkbox"/> <input type="checkbox"/> <input type="checkbox"/>	47.0#
	60 x 30 x 29"	KRAL6030EM.H	<input type="checkbox"/> <input type="checkbox"/> <input type="checkbox"/>	52.0#	
 HRDPT	<b>Add-On Acrylic End Panel</b>	16 x 1/4 x 10"	KAEP24		1.0#
	• For optional addition to KRAL returns	22 x 1/4 x 10"	KAEP30		1.0#
	• Field retrofittable				
 HRDPT	<b>Add-On Acrylic Modesty Panel</b>	34 x 1/4 x 10"	KAMPL42		3.0#
	• For optional addition to KRAL returns	40 x 1/4 x 10"	KAMPL48		4.0#
	• Field retrofittable	46 x 1/4 x 10"	KAMPL54		4.0#
	• Includes support leg	52 x 1/4 x 10"	KAMPL60		5.0#
	• Not to be used with KRALEM.H end panels				
• Acrylic features frosted neutral finish					
• Aluminum leg features clear, anodized finish					

A

B

## HOW TO ORDER

Indicate the following information on order form:

- Quantity of each item.
- Model number, including options. See "How To Build a Model Number".
- Any special service required.

Note: • The  indicates that a choice is required.

- The absence of the  indicates that no choice is required.
- Alpha-numeric characters in place of  indicate that no other alternatives are available.

## HOW TO BUILD A MODEL NUMBER

- A** Select basic model.
- B** Select horizontal surface finish.  
Refer to color addendum at [ki.com](http://ki.com) or KI Fabrics & Finishes binder.





# Aristotle® Classic Returns

Aluminum Frame Profile with Modesty and End Panel Inserts

Delivered Pricing

\$ 759  
766  
806  
825  
844  
852  
859  
983

\$ 1301  
1327  
1385  
1422  
1405  
1428  
1460  
1602

\$ 115  
134

\$ 416  
434  
455  
475

### SPECIAL SERVICES

#### Special Carton Marking

With specially marked information N/C

#### Shipping

Shipped k.d. freight prepaid f.o.b.  
KI-Aristotle Brampton, Ontario L6T 5T6  
factory. Freight class #85.

Specifications and prices are subject to  
change without prior notice.

# Aristotle® Classic Bridge

## Bridges

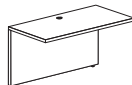
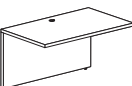
	MODEL	W x D x H	MODEL NUMBER				Approx. Packaged Weight
			Basic Model	Horizontal Surface Finish	Vertical Surface Finish	Back Panel Height	
 ARPRT	<b>Bridge - 20"</b> • Back panels over 48" wide feature horizontal wood grain pattern • Grommet location center rear • Full height back panel standard; 1/2 and 3/4 height back panel available	30 x 20 x 29"	KBR3020.H	□□□	□□□	□□□□	60.0#
		36 x 20 x 29"	KBR3620.H	□□□	□□□	□□□□	62.0#
		42 x 20 x 29"	KBR4220.H	□□□	□□□	□□□□	65.0#
		48 x 20 x 29"	KBR4820.H	□□□	□□□	□□□□	67.0#
		54 x 20 x 29"	KBR5420.H	□□□	□□□	□□□□	70.0#
		60 x 20 x 29"	KBR6020.H	□□□	□□□	□□□□	72.0#
 ARPRT	<b>Bridge - 24"</b> • Back panels over 48" wide feature horizontal wood grain pattern • Grommet location center rear • Full height back panel standard; 1/2 and 3/4 height back panel available	30 x 24 x 29"	KBR3024.H	□□□	□□□	□□□□	60.0#
		36 x 24 x 29"	KBR3624.H	□□□	□□□	□□□□	62.0#
		42 x 24 x 29"	KBR4224.H	□□□	□□□	□□□□	65.0#
		48 x 24 x 29"	KBR4824.H	□□□	□□□	□□□□	67.0#
		54 x 24 x 29"	KBR5424.H	□□□	□□□	□□□□	70.0#
		60 x 24 x 29"	KBR6024.H	□□□	□□□	□□□□	72.0#

A

B

C

D

### HOW TO ORDER

Indicate the following information on order form:

- Quantity of each item.
- Model number, including options. See "How To Build a Model Number".
- Any special service required.

Note: • The □ indicates that a choice is required.

- The absence of the □ indicates that no choice is required.
- Alpha-numeric characters in place of □ indicate that no other alternatives are available.

### HOW TO BUILD A MODEL NUMBER

- A** Select basic model.
- B** Select horizontal surface finish.  
Refer to color addendum at [ki.com](http://ki.com) or KI Fabrics & Finishes binder.
- C** Select vertical surface finish.  
Refer to color addendum at [ki.com](http://ki.com) or KI Fabrics & Finishes binder.
- D** Select back panel height.
- |             |                          |
|-------------|--------------------------|
| <b>FULL</b> | - Full height (standard) |
| <b>2Q</b>   | - 1/2 height back panel  |
| <b>3Q</b>   | - 3/4 height back panel  |



Delivered  
Pricing

\$ 317
363
404
455
505
557
\$ 352
397
472
546
539
592

**SPECIAL SERVICES**

**Special Carton Marking**

With specially marked information N/C

**Shipping**

Shipped k.d. freight prepaid f.o.b.  
KI-Aristotle Brampton, Ontario L6T 5T6  
factory. Freight class #85.

Specifications and prices are subject to  
change without prior notice.

# Aristotle® Classic Credenzas

Single Pedestal Credenzas-Left

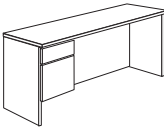
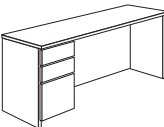
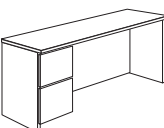
	MODEL	W x D x H	MODEL NUMBER						Approx. Packaged Weight
			Basic Model	Horizontal Surface Finish	Vertical Surface Finish	Pull Option	Lock Option	End Panel	
 ARCRD	<b>Single Pedestal Credenza-Left, Box/File Option A</b> <ul style="list-style-type: none"> <li>Box/file locking pedestal features full extension slides</li> <li>Full height back panel features horizontal wood grain pattern</li> <li>Integral pull is standard; use xxx2 for optional pulls</li> <li>Standard with no grommet</li> <li>Pedestals feature locks on inside panels</li> </ul>	60 x 20 x 29"	KCPL6020A.H	□□□	□□□	□□□□	□□	□□□□	160.0#
		66 x 20 x 29"	KCPL6620A.H	□□□	□□□	□□□□	□□	□□□□	165.0#
		72 x 20 x 29"	KCPL7220A.H	□□□	□□□	□□□□	□□	□□□□	175.0#
		60 x 24 x 29"	KCPL6024A.H	□□□	□□□	□□□□	□□	□□□□	165.0#
		66 x 24 x 29"	KCPL6624A.H	□□□	□□□	□□□□	□□	□□□□	170.0#
		72 x 24 x 29"	KCPL7224A.H	□□□	□□□	□□□□	□□	□□□□	180.0#
 ARCRD	<b>Single Pedestal Credenza-Left, Box/Box/File Option B</b> <ul style="list-style-type: none"> <li>Box/box/file locking pedestal features full extension slides</li> <li>Upper box drawer is non-locking</li> <li>Full height back panel features horizontal wood grain pattern</li> <li>Integral pull is standard; use xxx3 for optional pulls</li> <li>Standard with no grommet</li> <li>Pedestals feature locks on inside panels</li> </ul>	60 x 20 x 29"	KCPL6020B.H	□□□	□□□	□□□□	□□	□□□□	190.0#
		66 x 20 x 29"	KCPL6620B.H	□□□	□□□	□□□□	□□	□□□□	195.0#
		72 x 20 x 29"	KCPL7220B.H	□□□	□□□	□□□□	□□	□□□□	205.0#
		60 x 24 x 29"	KCPL6024B.H	□□□	□□□	□□□□	□□	□□□□	195.0#
		66 x 24 x 29"	KCPL6624B.H	□□□	□□□	□□□□	□□	□□□□	200.0#
		72 x 24 x 29"	KCPL7224B.H	□□□	□□□	□□□□	□□	□□□□	210.0#
 ARCRD	<b>Single Pedestal Credenza-Left, File/File Option C</b> <ul style="list-style-type: none"> <li>File/file locking pedestal features full extension slides</li> <li>Full height back panel features horizontal wood grain pattern</li> <li>Integral pull is standard; use xxx2 for optional pulls</li> <li>Standard with no grommet</li> <li>Pedestals feature locks on inside panels</li> </ul>	60 x 20 x 29"	KCPL6020C.H	□□□	□□□	□□□□	□□	□□□□	190.0#
		66 x 20 x 29"	KCPL6620C.H	□□□	□□□	□□□□	□□	□□□□	195.0#
		72 x 20 x 29"	KCPL7220C.H	□□□	□□□	□□□□	□□	□□□□	205.0#
		60 x 24 x 29"	KCPL6024C.H	□□□	□□□	□□□□	□□	□□□□	195.0#
		66 x 24 x 29"	KCPL6624C.H	□□□	□□□	□□□□	□□	□□□□	200.0#
		72 x 24 x 29"	KCPL7224C.H	□□□	□□□	□□□□	□□	□□□□	210.0#
			<b>A</b>	<b>B</b>	<b>C</b>	<b>D</b>	<b>E</b>	<b>F</b>	

## HOW TO ORDER

Indicate the following information on order form:

- Quantity of each item.
- Model number, including options. See "How To Build a Model Number".
- Any special service required.

Note: • The □ indicates that a choice is required.

- The absence of the □ indicates that no choice is required.
- Alpha-numeric characters in place of □ indicate that no other alternatives are available.

## HOW TO BUILD A MODEL NUMBER

**A** Select basic model.

**B** Select horizontal surface finish.  
Refer to color addendum at ki.com or KI Fabrics & Finishes binder.

**C** Select vertical surface finish.  
Refer to color addendum at ki.com or KI Fabrics & Finishes binder.

**D** Select pull option.

<b>NP</b>	- Standard integral pull
<b>BPA2</b>	- Silver bar pull (2); add \$20
<b>BPA3</b>	- Silver bar pull (3); add \$30
<b>KIB2</b>	- Waterfall black pull (2); add \$20
<b>KIB3</b>	- Waterfall black pull (3); add \$30
<b>KIS2</b>	- Waterfall silver pull (2); add \$20
<b>KIS3</b>	- Waterfall silver pull (3); add \$30
<b>RCP2</b>	- Rectangular silver pull (2); add \$20

**RCP3** - Rectangular silver pull (3); add \$30

**E** Select lock option.

<b>KA</b>	- Key alike
<b>KS</b>	- Key standard

**F** Select end panel.

<b>CGR</b>	- Recessed end panel right side
<b>FULL</b>	- Full end panel both sides



Aristotle® Classic Credenzas  
Single Pedestal Credenzas-Left

Delivered Pricing

\$ 1075  
1095  
1114  
1143  
1164  
1212

\$ 1244  
1262  
1281  
1314  
1332  
1383

\$ 1244  
1262  
1281  
1314  
1332  
1383

**SPECIAL SERVICES**

**Special Carton Marking**

With specially marked information N/C

**Shipping**

Shipped assembled freight prepaid f.o.b. KI-Aristotle Brampton, Ontario L6T 5T6 factory. Freight class #85.

Specifications and prices are subject to change without prior notice.

# Aristotle® Classic Credenzas

Single Pedestal Credenzas-Right

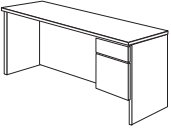
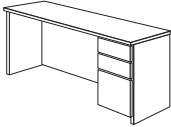
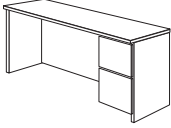
		MODEL NUMBER						Approx. Packaged Weight	
		Basic Model	Horizontal Surface Finish	Vertical Surface Finish	Pull Option	Lock Option	End Panel		
MODEL	W x D x H								
 <p>ARCRD</p>	<b>Single Pedestal Credenza-Right, Box/File Option A</b> <ul style="list-style-type: none"> <li>Box/file locking pedestal features full extension slides</li> <li>Full height back panel features horizontal wood grain pattern</li> <li>Integral pull is standard; use xxx2 for optional pulls</li> <li>Standard with no grommet</li> <li>Pedestals feature locks on inside panels</li> </ul>	60 x 20 x 29"	KCPR6020A.H	□□□	□□□	□□□□	□□	□□□□	160.0#
		66 x 20 x 29"	KCPR6620A.H	□□□	□□□	□□□□	□□	□□□□	165.0#
		72 x 20 x 29"	KCPR7220A.H	□□□	□□□	□□□□	□□	□□□□	175.0#
		60 x 24 x 29"	KCPR6024A.H	□□□	□□□	□□□□	□□	□□□□	165.0#
		66 x 24 x 29"	KCPR6624A.H	□□□	□□□	□□□□	□□	□□□□	170.0#
		72 x 24 x 29"	KCPR7224A.H	□□□	□□□	□□□□	□□	□□□□	180.0#
 <p>ARCRD</p>	<b>Single Pedestal Credenza-Right, Box/Box/File Option B</b> <ul style="list-style-type: none"> <li>Box/box/file locking pedestal features full extension slides</li> <li>Upper box drawer is non-locking</li> <li>Full height back panel features horizontal wood grain pattern</li> <li>Integral pull is standard; use xxx3 for optional pulls</li> <li>Standard with no grommet</li> <li>Pedestals feature locks on inside panels</li> </ul>	60 x 20 x 29"	KCPR6020B.H	□□□	□□□	□□□□	□□	□□□□	190.0#
		66 x 20 x 29"	KCPR6620B.H	□□□	□□□	□□□□	□□	□□□□	195.0#
		72 x 20 x 29"	KCPR7220B.H	□□□	□□□	□□□□	□□	□□□□	205.0#
		60 x 24 x 29"	KCPR6024B.H	□□□	□□□	□□□□	□□	□□□□	195.0#
		66 x 24 x 29"	KCPR6624B.H	□□□	□□□	□□□□	□□	□□□□	200.0#
		72 x 24 x 29"	KCPR7224B.H	□□□	□□□	□□□□	□□	□□□□	210.0#
 <p>ARCRD</p>	<b>Single Pedestal Credenza-Right, File/File Option C</b> <ul style="list-style-type: none"> <li>File/file locking pedestal features full extension slides</li> <li>Full height back panel features horizontal wood grain pattern</li> <li>Integral pull is standard; use xxx2 for optional pulls</li> <li>Standard with no grommet</li> <li>Pedestals feature locks on inside panels</li> </ul>	60 x 20 x 29"	KCPR6020C.H	□□□	□□□	□□□□	□□	□□□□	190.0#
		66 x 20 x 29"	KCPR6620C.H	□□□	□□□	□□□□	□□	□□□□	195.0#
		72 x 20 x 29"	KCPR7220C.H	□□□	□□□	□□□□	□□	□□□□	205.0#
		60 x 24 x 29"	KCPR6024C.H	□□□	□□□	□□□□	□□	□□□□	195.0#
		66 x 24 x 29"	KCPR6624C.H	□□□	□□□	□□□□	□□	□□□□	200.0#
		72 x 24 x 29"	KCPR7224C.H	□□□	□□□	□□□□	□□	□□□□	210.0#
				<b>A</b>	<b>B</b>	<b>C</b>	<b>D</b>	<b>E</b>	<b>F</b>

## HOW TO ORDER

Indicate the following information on order form:

- Quantity of each item.
- Model number, including options. See "How To Build a Model Number".
- Any special service required.

Note: • The □ indicates that a choice is required.

- The absence of the □ indicates that no choice is required.
- Alpha-numeric characters in place of □ indicate that no other alternatives are available.

## HOW TO BUILD A MODEL NUMBER

**A** Select basic model.

**B** Select horizontal surface finish.  
Refer to color addendum at ki.com or KI Fabrics & Finishes binder.

**C** Select vertical surface finish.  
Refer to color addendum at ki.com or KI Fabrics & Finishes binder.

**D** Select pull option.

<b>NP</b>	- Standard integral pull
<b>BPA2</b>	- Silver bar pull (2); add \$20
<b>BPA3</b>	- Silver bar pull (3); add \$30
<b>KIB2</b>	- Waterfall black pull (2); add \$20
<b>KIB3</b>	- Waterfall black pull (3); add \$30
<b>KIS2</b>	- Waterfall silver pull (2); add \$20
<b>KIS3</b>	- Waterfall silver pull (3); add \$30
<b>RCP2</b>	- Rectangular silver pull (2); add \$20

**RCP3** - Rectangular silver pull (3); add \$30

**E** Select lock option.

<b>KA</b>	- Key alike
<b>KS</b>	- Key standard

**F** Select end panel.

<b>CGL</b>	- Recessed end panel left side
<b>FULL</b>	- Full end panel both sides



Aristotle® Classic Credenzas  
Single Pedestal Credenzas-Right

Delivered Pricing

\$ 1075  
1095  
1114  
1143  
1164  
1212

\$ 1244  
1262  
1281  
1314  
1332  
1383

\$ 1244  
1262  
1281  
1314  
1332  
1383

**SPECIAL SERVICES**

**Special Carton Marking**

With specially marked information N/C

**Shipping**

Shipped assembled freight prepaid f.o.b. KI-Aristotle Brampton, Ontario L6T 5T6 factory. Freight class #85.

Specifications and prices are subject to change without prior notice.

# Aristotle® Classic Credenzas

Double Pedestal Credenzas

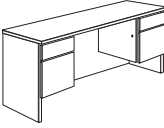
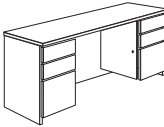
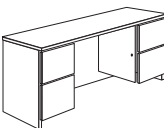
	MODEL	W x D x H	MODEL NUMBER					Approx. Packaged Weight
			Basic Model	Horizontal Surface Finish	Vertical Surface Finish	Pull Option	Lock Option	
 ARCRD	<b>Double Pedestal Credenzas, Box/File Option A</b> <ul style="list-style-type: none"> <li>Box/file locking pedestals feature full extension slides</li> <li>Full height back panel features horizontal wood grain pattern</li> <li>Integral pull is standard; use xxx4 for optional pulls</li> <li>Standard with no grommet</li> <li>Pedestals feature locks on inside panels</li> </ul>	60 x 20 x 29"	KCDP6020A.H	□□□	□□□	□□□□	□□	215.0#
		66 x 20 x 29"	KCDP6620A.H	□□□	□□□	□□□□	□□	220.0#
		72 x 20 x 29"	KCDP7220A.H	□□□	□□□	□□□□	□□	230.0#
		60 x 24 x 29"	KCDP6024A.H	□□□	□□□	□□□□	□□	220.0#
		66 x 24 x 29"	KCDP6624A.H	□□□	□□□	□□□□	□□	225.0#
		72 x 24 x 29"	KCDP7224A.H	□□□	□□□	□□□□	□□	235.0#
 ARCRD	<b>Double Pedestal Credenzas, Box/Box/File Option B</b> <ul style="list-style-type: none"> <li>Box/box/file locking pedestals feature full extension slides</li> <li>Upper box drawer is non-locking</li> <li>Full height back panel features horizontal wood grain pattern</li> <li>Integral pull is standard; use xxx6 for optional pulls</li> <li>Standard with no grommet</li> <li>Pedestals feature locks on inside panels</li> </ul>	60 x 20 x 29"	KCDP6020B.H	□□□	□□□	□□□□	□□	275.0#
		66 x 20 x 29"	KCDP6620B.H	□□□	□□□	□□□□	□□	280.0#
		72 x 20 x 29"	KCDP7220B.H	□□□	□□□	□□□□	□□	290.0#
		60 x 24 x 29"	KCDP6024B.H	□□□	□□□	□□□□	□□	280.0#
		66 x 24 x 29"	KCDP6624B.H	□□□	□□□	□□□□	□□	285.0#
		72 x 24 x 29"	KCDP7224B.H	□□□	□□□	□□□□	□□	295.0#
 ARCRD	<b>Double Pedestal Credenzas, File/File Option C</b> <ul style="list-style-type: none"> <li>File/file locking pedestals feature full extension slides</li> <li>Full height back panel features horizontal wood grain pattern</li> <li>Integral pull is standard; use xxx4 for optional pulls</li> <li>Standard with no grommet</li> <li>Pedestals feature locks on inside panels</li> </ul>	60 x 20 x 29"	KCDP6020C.H	□□□	□□□	□□□□	□□	275.0#
		66 x 20 x 29"	KCDP6620C.H	□□□	□□□	□□□□	□□	280.0#
		72 x 20 x 29"	KCDP7220C.H	□□□	□□□	□□□□	□□	290.0#
		60 x 24 x 29"	KCDP6024C.H	□□□	□□□	□□□□	□□	280.0#
		66 x 24 x 29"	KCDP6624C.H	□□□	□□□	□□□□	□□	285.0#
		72 x 24 x 29"	KCDP7224C.H	□□□	□□□	□□□□	□□	295.0#
			<b>A</b>	<b>B</b>	<b>C</b>	<b>D</b>	<b>E</b>	

## HOW TO ORDER

Indicate the following information on order form:

- Quantity of each item.
- Model number, including options. See "How To Build a Model Number".
- Any special service required.

Note: • The □ indicates that a choice is required.

- The absence of the □ indicates that no choice is required.
- Alpha-numeric characters in place of □ indicate that no other alternatives are available.

## HOW TO BUILD A MODEL NUMBER

- A** Select basic model.
- B** Select horizontal surface finish.  
Refer to color addendum at ki.com or KI Fabrics & Finishes binder.
- C** Select vertical surface finish.  
Refer to color addendum at ki.com or KI Fabrics & Finishes binder.
- D** Select pull option.
- |             |   |
|-------------|---|
| <b>NP</b>   | - Standard integral pull                |
| <b>BPA4</b> | - Silver bar pull (4); add \$40         |
| <b>BPA6</b> | - Silver bar pull (6); add \$60         |
| <b>KIB4</b> | - Waterfall black pull (4); add \$40    |
| <b>KIB6</b> | - Waterfall black pull (6); add \$60    |
| <b>KIS4</b> | - Waterfall silver pull (4); add \$40   |
| <b>KIS6</b> | - Waterfall silver pull (6); add \$60   |
| <b>RCP4</b> | - Rectangular silver pull (4); add \$40 |

**RCP6** - Rectangular silver pull (6); add \$60

**E** Select lock option.

**KA** - Key alike  
**KS** - Key standard





# Aristotle® Classic Credenzas

Double Pedestal Credenzas

Delivered Pricing

\$ 1365  
1383  
1402  
1465  
1483  
1525

\$ 1701  
1720  
1737  
1806  
1820  
1862

\$ 1701  
1720  
1737  
1806  
1820  
1862

**SPECIAL SERVICES**

**Special Carton Marking**

With specially marked information N/C

**Shipping**

Shipped **assembled freight prepaid f.o.b. KI-Aristotle Brampton, Ontario L6T 5T6** factory. Freight class #85.

Specifications and prices are subject to change without prior notice.

# Aristotle® Classic Credenzas

Double Pedestal Credenzas

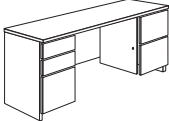
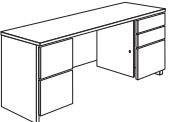
			MODEL NUMBER					Approx. Packaged Weight
MODEL	W x D x H	Basic Model	Horizontal Surface Finish	Vertical Surface Finish	Pull Option	Lock Option		
 <p>ARCRD</p>	<b>Double Pedestal Credenzas, Box/Box/File Option F</b>	60 x 20 x 29"	KCDP6020F.H	<input type="checkbox"/> <input type="checkbox"/> <input type="checkbox"/>	<input type="checkbox"/> <input type="checkbox"/> <input type="checkbox"/>	<input type="checkbox"/> <input type="checkbox"/> <input type="checkbox"/> <input type="checkbox"/>	<input type="checkbox"/> <input type="checkbox"/>	275.0#
		66 x 20 x 29"	KCDP6620F.H	<input type="checkbox"/> <input type="checkbox"/> <input type="checkbox"/>	<input type="checkbox"/> <input type="checkbox"/> <input type="checkbox"/>	<input type="checkbox"/> <input type="checkbox"/> <input type="checkbox"/> <input type="checkbox"/>	<input type="checkbox"/> <input type="checkbox"/>	280.0#
		72 x 20 x 29"	KCDP7220F.H	<input type="checkbox"/> <input type="checkbox"/> <input type="checkbox"/>	<input type="checkbox"/> <input type="checkbox"/> <input type="checkbox"/>	<input type="checkbox"/> <input type="checkbox"/> <input type="checkbox"/> <input type="checkbox"/>	<input type="checkbox"/> <input type="checkbox"/>	290.0#
		60 x 24 x 29"	KCDP6024F.H	<input type="checkbox"/> <input type="checkbox"/> <input type="checkbox"/>	<input type="checkbox"/> <input type="checkbox"/> <input type="checkbox"/>	<input type="checkbox"/> <input type="checkbox"/> <input type="checkbox"/> <input type="checkbox"/>	<input type="checkbox"/> <input type="checkbox"/>	280.0#
		66 x 24 x 29"	KCDP6624F.H	<input type="checkbox"/> <input type="checkbox"/> <input type="checkbox"/>	<input type="checkbox"/> <input type="checkbox"/> <input type="checkbox"/>	<input type="checkbox"/> <input type="checkbox"/> <input type="checkbox"/> <input type="checkbox"/>	<input type="checkbox"/> <input type="checkbox"/>	285.0#
		72 x 24 x 29"	KCDP7224F.H	<input type="checkbox"/> <input type="checkbox"/> <input type="checkbox"/>	<input type="checkbox"/> <input type="checkbox"/> <input type="checkbox"/>	<input type="checkbox"/> <input type="checkbox"/> <input type="checkbox"/> <input type="checkbox"/>	<input type="checkbox"/> <input type="checkbox"/>	295.0#
 <p>ARCRD</p>	<b>Double Pedestal Credenzas, Box/File Option G</b>	60 x 20 x 29"	KCDP6020G.H	<input type="checkbox"/> <input type="checkbox"/> <input type="checkbox"/>	<input type="checkbox"/> <input type="checkbox"/> <input type="checkbox"/>	<input type="checkbox"/> <input type="checkbox"/> <input type="checkbox"/> <input type="checkbox"/>	<input type="checkbox"/> <input type="checkbox"/>	275.0#
		66 x 20 x 29"	KCDP6620G.H	<input type="checkbox"/> <input type="checkbox"/> <input type="checkbox"/>	<input type="checkbox"/> <input type="checkbox"/> <input type="checkbox"/>	<input type="checkbox"/> <input type="checkbox"/> <input type="checkbox"/> <input type="checkbox"/>	<input type="checkbox"/> <input type="checkbox"/>	280.0#
		72 x 20 x 29"	KCDP7220G.H	<input type="checkbox"/> <input type="checkbox"/> <input type="checkbox"/>	<input type="checkbox"/> <input type="checkbox"/> <input type="checkbox"/>	<input type="checkbox"/> <input type="checkbox"/> <input type="checkbox"/> <input type="checkbox"/>	<input type="checkbox"/> <input type="checkbox"/>	290.0#
		60 x 24 x 29"	KCDP6024G.H	<input type="checkbox"/> <input type="checkbox"/> <input type="checkbox"/>	<input type="checkbox"/> <input type="checkbox"/> <input type="checkbox"/>	<input type="checkbox"/> <input type="checkbox"/> <input type="checkbox"/> <input type="checkbox"/>	<input type="checkbox"/> <input type="checkbox"/>	280.0#
		66 x 24 x 29"	KCDP6624G.H	<input type="checkbox"/> <input type="checkbox"/> <input type="checkbox"/>	<input type="checkbox"/> <input type="checkbox"/> <input type="checkbox"/>	<input type="checkbox"/> <input type="checkbox"/> <input type="checkbox"/> <input type="checkbox"/>	<input type="checkbox"/> <input type="checkbox"/>	285.0#
		72 x 24 x 29"	KCDP7224G.H	<input type="checkbox"/> <input type="checkbox"/> <input type="checkbox"/>	<input type="checkbox"/> <input type="checkbox"/> <input type="checkbox"/>	<input type="checkbox"/> <input type="checkbox"/> <input type="checkbox"/> <input type="checkbox"/>	<input type="checkbox"/> <input type="checkbox"/>	295.0#
			<b>A</b>	<b>B</b>	<b>C</b>	<b>D</b>	<b>E</b>	

## HOW TO ORDER

Indicate the following information on order form:

- Quantity of each item.
- Model number, including options. See "How To Build a Model Number".
- Any special service required.

Note: • The  indicates that a choice is required.

- The absence of the  indicates that no choice is required.
- Alpha-numeric characters in place of  indicate that no other alternatives are available.

## HOW TO BUILD A MODEL NUMBER

- A** Select basic model.
- B** Select horizontal surface finish.  
Refer to color addendum at [ki.com](http://ki.com) or KI Fabrics & Finishes binder.
- C** Select vertical surface finish.  
Refer to color addendum at [ki.com](http://ki.com) or KI Fabrics & Finishes binder.
- D** Select pull option.
- |             |   |
|-------------|---|
| <b>NP</b>   | - Standard integral pull                |
| <b>BPA5</b> | - Silver bar pull (5); add \$50         |
| <b>KIB5</b> | - Waterfall black pull (5); add \$50    |
| <b>KIS5</b> | - Waterfall silver pull (5); add \$50   |
| <b>RCP5</b> | - Rectangular silver pull (5); add \$50 |
- E** Select lock option.
- |           |                |
|-----------|----------------|
| <b>KA</b> | - Key alike    |
| <b>KS</b> | - Key standard |



# Aristotle® Classic Credenzas

Double Pedestal Credenzas

Delivered Pricing

\$ 1701  
1720  
1737  
1806  
1820  
1862

\$ 1701  
1720  
1737  
1806  
1820  
1862

**SPECIAL SERVICES**

**Special Carton Marking**

With specially marked information N/C

**Shipping**

Shipped **assembled freight prepaid f.o.b. KI-Aristotle Brampton, Ontario L6T 5T6** factory. Freight class #85.

Specifications and prices are subject to change without prior notice.

# Aristotle® Classic Credenzas

Credenza-Center Storage

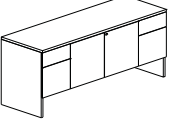
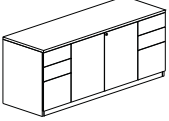
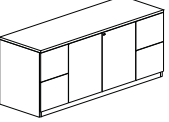
	MODEL	W x D x H	MODEL NUMBER					Approx. Packaged Weight
			Basic Model	Horizontal Surface Finish	Vertical Surface Finish	Pull Option	Lock Option	
 <p>ARCRD</p>	<b>Credenza-Center Storage and Double Box/File Pedestal</b> <ul style="list-style-type: none"> <li>Box/file locking pedestals feature full extension slides</li> <li>Center storage cabinet</li> <li>Full height back panel features horizontal wood grain pattern</li> <li>Integral pull is standard; use xxx6 for optional pulls</li> <li>Standard with no grommet</li> </ul>	60 x 20 x 29"	KCZ6020A.H	□□□	□□□	□□□□	□□	210.0#
		66 x 20 x 29"	KCZ6620A.H	□□□	□□□	□□□□	□□	220.0#
		72 x 20 x 29"	KCZ7220A.H	□□□	□□□	□□□□	□□	230.0#
		60 x 24 x 29"	KCZ6024A.H	□□□	□□□	□□□□	□□	230.0#
		66 x 24 x 29"	KCZ6624A.H	□□□	□□□	□□□□	□□	240.0#
		72 x 24 x 29"	KCZ7224A.H	□□□	□□□	□□□□	□□	250.0#
 <p>ARCRD</p>	<b>Credenza-Center Storage and Double Box/Box/File Pedestal</b> <ul style="list-style-type: none"> <li>Box/box/file locking pedestals feature full extension slides</li> <li>Upper box drawers do not lock</li> <li>Center storage cabinet</li> <li>Full height back panel features horizontal wood grain pattern</li> <li>Integral pull is standard; use xxx8 for optional pulls</li> <li>Standard with no grommet</li> </ul>	60 x 20 x 29"	KCZ6020B.H	□□□	□□□	□□□□	□□	270.0#
		66 x 20 x 29"	KCZ6620B.H	□□□	□□□	□□□□	□□	280.0#
		72 x 20 x 29"	KCZ7220B.H	□□□	□□□	□□□□	□□	290.0#
		60 x 24 x 29"	KCZ6024B.H	□□□	□□□	□□□□	□□	290.0#
		66 x 24 x 29"	KCZ6624B.H	□□□	□□□	□□□□	□□	300.0#
		72 x 24 x 29"	KCZ7224B.H	□□□	□□□	□□□□	□□	310.0#
 <p>ARCRD</p>	<b>Credenza-Center Storage and Double File/File Pedestal</b> <ul style="list-style-type: none"> <li>File/file locking pedestals feature full extension slides</li> <li>Center storage cabinet</li> <li>Full height back panel features horizontal wood grain pattern</li> <li>Integral pull is standard; use xxx6 for optional pulls</li> <li>Standard with no grommet</li> </ul>	60 x 20 x 29"	KCZ6020C.H	□□□	□□□	□□□□	□□	270.0#
		66 x 20 x 29"	KCZ6620C.H	□□□	□□□	□□□□	□□	280.0#
		72 x 20 x 29"	KCZ7220C.H	□□□	□□□	□□□□	□□	290.0#
		60 x 24 x 29"	KCZ6024C.H	□□□	□□□	□□□□	□□	290.0#
		66 x 24 x 29"	KCZ6624C.H	□□□	□□□	□□□□	□□	300.0#
		72 x 24 x 29"	KCZ7224C.H	□□□	□□□	□□□□	□□	310.0#

A

B

C

D

E

## HOW TO ORDER

Indicate the following information on order form:

- Quantity of each item.
- Model number, including options. See "How To Build a Model Number".
- Any special service required.

Note: • The  indicates that a choice is required.

- The absence of the  indicates that no choice is required.
- Alpha-numeric characters in place of  indicate that no other alternatives are available.

## HOW TO BUILD A MODEL NUMBER

**A** Select basic model.

**B** Select horizontal surface finish.  
Refer to color addendum at ki.com or KI Fabrics & Finishes binder.

**C** Select vertical surface finish.  
Refer to color addendum at ki.com or KI Fabrics & Finishes binder.

**D** Select pull option.

<b>NP</b>	- Standard integral pull
<b>BPA6</b>	- Silver bar pull (6); add \$60
<b>BPA8</b>	- Silver bar pull (8); add \$80
<b>KIB6</b>	- Waterfall black pull (6); add \$60
<b>KIB8</b>	- Waterfall black pull (8); add \$80
<b>KIS6</b>	- Waterfall silver pull (6); add \$60
<b>KIS8</b>	- Waterfall silver pull (8); add \$80
<b>RCP6</b>	- Rectangular silver pull (6); add \$60

**RCP8** - Rectangular silver pull (8); add \$80

**E** Select lock option.

<b>KA</b>	- Key alike
<b>KS</b>	- Key standard



# Aristotle® Classic Credenzas

Credenza-Center Storage

Delivered Pricing

\$ 1645  
1669  
1694  
1720  
1794  
1855

\$ 1932  
1956  
1985  
2012  
2084  
2143

\$ 1932  
1956  
1985  
2012  
2084  
2143

**SPECIAL SERVICES**

**Special Carton Marking**

With specially marked information N/C

**Shipping**

Shipped **assembled freight prepaid f.o.b. KI-Aristotle Brampton, Ontario L6T 5T6** factory. Freight class #85.

Specifications and prices are subject to change without prior notice.

# Aristotle® Classic Credenzas

Credenza-Lateral Files

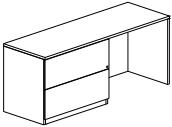
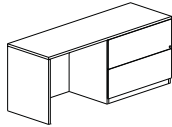
	MODEL	W x D x H	MODEL NUMBER						Approx. Packaged Weight
			Basic Model	Horizontal Surface Finish	Vertical Surface Finish	Pull Option	Lock Option	End Panel	
 <p>ARCRD</p>	<b>Credenza-Lateral File-Left</b>	60 x 20 x 29"	KCFL6020.H	□□□	□□□	□□□□	□□	□□□□	160.0#
	• 36" wide lateral file features 12" drawers	66 x 20 x 29"	KCFL6620.H	□□□	□□□	□□□□	□□	□□□□	170.0#
	• Drawers accommodate letter and legal filing	72 x 20 x 29"	KCFL7220.H	□□□	□□□	□□□□	□□	□□□□	180.0#
	• Full height back panel features horizontal wood grain pattern	60 x 24 x 29"	KCFL6024.H	□□□	□□□	□□□□	□□	□□□□	180.0#
	• All drawers and doors standard locking and keyed alike	66 x 24 x 29"	KCFL6624.H	□□□	□□□	□□□□	□□	□□□□	190.0#
	• Optional front to back filing hardware specified separately	72 x 24 x 29"	KCFL7224.H	□□□	□□□	□□□□	□□	□□□□	200.0#
	• Integral pull is standard; use xxx2 for optional pulls								
• Standard with no grommet									
 <p>ARCRD</p>	<b>Credenza-Lateral File-Right</b>	60 x 20 x 29"	KCFR6020.H	□□□	□□□	□□□□	□□	□□□□	160.0#
	• 36" wide lateral file features 12" drawers	66 x 20 x 29"	KCFR6620.H	□□□	□□□	□□□□	□□	□□□□	170.0#
	• Drawers accommodate letter and legal filing	72 x 20 x 29"	KCFR7220.H	□□□	□□□	□□□□	□□	□□□□	180.0#
	• Full height back panel features horizontal wood grain pattern	60 x 24 x 29"	KCFR6024.H	□□□	□□□	□□□□	□□	□□□□	180.0#
	• All drawers and doors standard locking and keyed alike	66 x 24 x 29"	KCFR6624.H	□□□	□□□	□□□□	□□	□□□□	190.0#
	• Optional front to back filing hardware specified separately	72 x 24 x 29"	KCFR7224.H	□□□	□□□	□□□□	□□	□□□□	200.0#
	• Integral pull is standard; use xxx2 for optional pulls								
• Standard with no grommet									
				<b>A</b>	<b>B</b>	<b>C</b>	<b>D</b>	<b>E</b>	<b>F</b>

## HOW TO ORDER

Indicate the following information on order form:

- Quantity of each item.
- Model number, including options. See "How To Build a Model Number".
- Any special service required.

Note: • The □ indicates that a choice is required.

- The absence of the □ indicates that no choice is required.
- Alpha-numeric characters in place of □ indicate that no other alternatives are available.

## HOW TO BUILD A MODEL NUMBER

**A** Select basic model.

**B** Select horizontal surface finish.  
Refer to color addendum at ki.com or KI Fabrics & Finishes binder.

**C** Select vertical surface finish.  
Refer to color addendum at ki.com or KI Fabrics & Finishes binder.

**D** Select pull option.

<b>NP</b>	- Standard integral pull
<b>BPA2</b>	- Silver bar pull (2); add \$20
<b>KIB2</b>	- Waterfall black pull (2); add \$20
<b>KIS2</b>	- Waterfall silver pull (2); add \$20
<b>RCP2</b>	- Rectangular silver pull (2); add \$20

**E** Select lock option.

<b>KA</b>	- Key alike
<b>KS</b>	- Key standard

**F** Select end panel.

**CGR** - Recessed end panel right side

**CGL** - Recessed end panel left side

**FULL** - Full end panel both sides



# Aristotle® Classic Credenzas

Credenza-Lateral Files

Delivered Pricing

\$ 1525  
1552  
1582  
1600  
1632  
1714

\$ 1525  
1552  
1582  
1600  
1632  
1714

**SPECIAL SERVICES**

**Special Carton Marking**

With specially marked information N/C

**Shipping**

Shipped **assembled freight prepaid f.o.b. KI-Aristotle Brampton, Ontario L6T 5T6** factory. Freight class #85.

Specifications and prices are subject to change without prior notice.

# Aristotle® Classic Credenzas

Credenza-Lateral Files

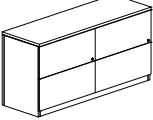
	MODEL	W x D x H	MODEL NUMBER					Approx. Packaged Weight	
			Basic Model	Horizontal Surface Finish	Vertical Surface Finish	Pull Option	Lock Option		
 <p>ARCRD</p>	<b>Credenza-Double Lateral File</b>	60 x 20 x 29"	KCFF6020.H	<input type="checkbox"/> <input type="checkbox"/> <input type="checkbox"/>	<input type="checkbox"/> <input type="checkbox"/> <input type="checkbox"/>	<input type="checkbox"/> <input type="checkbox"/> <input type="checkbox"/> <input type="checkbox"/>	<input type="checkbox"/> <input type="checkbox"/>	240.0#	
	<ul style="list-style-type: none"> <li>• 30" wide lateral drawers on 60" model</li> </ul>	72 x 20 x 29"	KCFF7220.H	<input type="checkbox"/> <input type="checkbox"/> <input type="checkbox"/>	<input type="checkbox"/> <input type="checkbox"/> <input type="checkbox"/>	<input type="checkbox"/> <input type="checkbox"/> <input type="checkbox"/> <input type="checkbox"/>	<input type="checkbox"/> <input type="checkbox"/>	260.0#	
	<ul style="list-style-type: none"> <li>• 36" wide lateral drawers on 72" model</li> </ul>	60 x 24 x 29"	KCFF6024.H	<input type="checkbox"/> <input type="checkbox"/> <input type="checkbox"/>	<input type="checkbox"/> <input type="checkbox"/> <input type="checkbox"/>	<input type="checkbox"/> <input type="checkbox"/> <input type="checkbox"/> <input type="checkbox"/>	<input type="checkbox"/> <input type="checkbox"/>	260.0#	
	<ul style="list-style-type: none"> <li>• Drawers accommodate letter and legal filing</li> </ul>	72 x 24 x 29"	KCFF7224.H	<input type="checkbox"/> <input type="checkbox"/> <input type="checkbox"/>	<input type="checkbox"/> <input type="checkbox"/> <input type="checkbox"/>	<input type="checkbox"/> <input type="checkbox"/> <input type="checkbox"/> <input type="checkbox"/>	<input type="checkbox"/> <input type="checkbox"/>	280.0#	
	<ul style="list-style-type: none"> <li>• Full height back panel features horizontal wood grain pattern</li> <li>• All drawers and doors standard locking and keyed alike</li> <li>• Optional front to back filing hardware specified separately</li> <li>• Integral pull is standard; use xxx4 for optional pulls</li> <li>• Standard with no grommet</li> </ul>								
				<b>A</b>	<b>B</b>	<b>C</b>	<b>D</b>	<b>E</b>	

## HOW TO ORDER

Indicate the following information on order form:

1. Quantity of each item.
2. Model number, including options. See "How To Build a Model Number".
3. Any special service required.

Note: • The  indicates that a choice is required.

- The absence of the  indicates that no choice is required.
- Alpha-numeric characters in place of  indicate that no other alternatives are available.

## HOW TO BUILD A MODEL NUMBER

- A** Select basic model.
- B** Select horizontal surface finish.  
Refer to color addendum at [ki.com](http://ki.com) or KI Fabrics & Finishes binder.
- C** Select vertical surface finish.  
Refer to color addendum at [ki.com](http://ki.com) or KI Fabrics & Finishes binder.
- D** Select pull option.
- |             |   |
|-------------|---|
| <b>NP</b>   | - Standard integral pull                |
| <b>BPA4</b> | - Silver bar pull (4); add \$40         |
| <b>KIB4</b> | - Waterfall black pull (4); add \$40    |
| <b>KIS4</b> | - Waterfall silver pull (4); add \$40   |
| <b>RCP4</b> | - Rectangular silver pull (4); add \$40 |
- E** Select lock option.
- |           |                |
|-----------|----------------|
| <b>KA</b> | - Key alike    |
| <b>KS</b> | - Key standard |





# Aristotle® Classic Credenzas

Credenza-Lateral Files

Delivered  
Pricing

\$ 2131  
2247  
2360  
2442

**SPECIAL SERVICES**

**Special Carton Marking**

With specially marked information N/C

**Shipping**

Shipped **assembled freight prepaid f.o.b. KI-Aristotle Brampton, Ontario L6T 5T6** factory. Freight class #85.

Specifications and prices are subject to change without prior notice.

# Aristotle® Classic Credenzas

Credenza-Storage

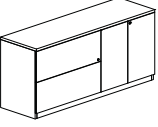
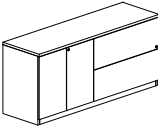
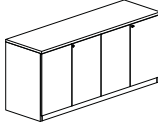
	MODEL	W x D x H	MODEL NUMBER					Approx. Packaged Weight
			Basic Model	Horizontal Surface Finish	Vertical Surface Finish	Pull Option	Lock Option	
 <p>ARCRD</p>	<b>Credenza-Lateral File-Left and Storage-Right</b> <ul style="list-style-type: none"> <li>• 36" wide lateral file features 12" drawers</li> <li>• Drawers accommodate letter and legal filing</li> <li>• Full height back panel features horizontal wood grain pattern</li> <li>• All drawers and doors standard locking and keyed alike</li> <li>• One adjustable shelf in storage cabinet</li> <li>• Optional front to back filing hardware specified separately</li> <li>• Integral pull is standard; use xxx4 for optional pulls</li> <li>• Standard with no grommet</li> </ul>	66 x 20 x 29"	KCFS6620.H	<input type="checkbox"/> <input type="checkbox"/> <input type="checkbox"/>	<input type="checkbox"/> <input type="checkbox"/> <input type="checkbox"/>	<input type="checkbox"/> <input type="checkbox"/> <input type="checkbox"/> <input type="checkbox"/>	<input type="checkbox"/> <input type="checkbox"/>	240.0#
		72 x 20 x 29"	KCFS7220.H	<input type="checkbox"/> <input type="checkbox"/> <input type="checkbox"/>	<input type="checkbox"/> <input type="checkbox"/> <input type="checkbox"/>	<input type="checkbox"/> <input type="checkbox"/> <input type="checkbox"/> <input type="checkbox"/>	<input type="checkbox"/> <input type="checkbox"/>	250.0#
		66 x 24 x 29"	KCFS6624.H	<input type="checkbox"/> <input type="checkbox"/> <input type="checkbox"/>	<input type="checkbox"/> <input type="checkbox"/> <input type="checkbox"/>	<input type="checkbox"/> <input type="checkbox"/> <input type="checkbox"/> <input type="checkbox"/>	<input type="checkbox"/> <input type="checkbox"/>	260.0#
		72 x 24 x 29"	KCFS7224.H	<input type="checkbox"/> <input type="checkbox"/> <input type="checkbox"/>	<input type="checkbox"/> <input type="checkbox"/> <input type="checkbox"/>	<input type="checkbox"/> <input type="checkbox"/> <input type="checkbox"/> <input type="checkbox"/>	<input type="checkbox"/> <input type="checkbox"/>	270.0#
 <p>ARCRD</p>	<b>Credenza-Storage-Left and Lateral File-Right</b> <ul style="list-style-type: none"> <li>• 36" wide lateral file features 12" drawers</li> <li>• Drawers accommodate letter and legal filing</li> <li>• Full height back panel features horizontal wood grain pattern</li> <li>• All drawers and doors standard locking and keyed alike</li> <li>• One adjustable shelf in storage cabinet</li> <li>• Optional front to back filing hardware specified separately</li> <li>• Integral pull is standard; use xxx4 for optional pulls</li> <li>• Standard with no grommet</li> </ul>	66 x 20 x 29"	KCSF6620.H	<input type="checkbox"/> <input type="checkbox"/> <input type="checkbox"/>	<input type="checkbox"/> <input type="checkbox"/> <input type="checkbox"/>	<input type="checkbox"/> <input type="checkbox"/> <input type="checkbox"/> <input type="checkbox"/>	<input type="checkbox"/> <input type="checkbox"/>	240.0#
		72 x 20 x 29"	KCSF7220.H	<input type="checkbox"/> <input type="checkbox"/> <input type="checkbox"/>	<input type="checkbox"/> <input type="checkbox"/> <input type="checkbox"/>	<input type="checkbox"/> <input type="checkbox"/> <input type="checkbox"/> <input type="checkbox"/>	<input type="checkbox"/> <input type="checkbox"/>	250.0#
		66 x 24 x 29"	KCSF6624.H	<input type="checkbox"/> <input type="checkbox"/> <input type="checkbox"/>	<input type="checkbox"/> <input type="checkbox"/> <input type="checkbox"/>	<input type="checkbox"/> <input type="checkbox"/> <input type="checkbox"/> <input type="checkbox"/>	<input type="checkbox"/> <input type="checkbox"/>	260.0#
		72 x 24 x 29"	KCSF7224.H	<input type="checkbox"/> <input type="checkbox"/> <input type="checkbox"/>	<input type="checkbox"/> <input type="checkbox"/> <input type="checkbox"/>	<input type="checkbox"/> <input type="checkbox"/> <input type="checkbox"/> <input type="checkbox"/>	<input type="checkbox"/> <input type="checkbox"/>	270.0#
 <p>ARCRD</p>	<b>Credenza-Double Storage</b> <ul style="list-style-type: none"> <li>• One adjustable shelf in storage cabinet</li> <li>• Integral pull is standard; use xxx4 for optional pulls</li> <li>• Standard with no grommet</li> <li>• Full height back panel features horizontal wood grain pattern</li> </ul>	66 x 20 x 29"	KCSS6620.H	<input type="checkbox"/> <input type="checkbox"/> <input type="checkbox"/>	<input type="checkbox"/> <input type="checkbox"/> <input type="checkbox"/>	<input type="checkbox"/> <input type="checkbox"/> <input type="checkbox"/> <input type="checkbox"/>	<input type="checkbox"/> <input type="checkbox"/>	230.0#
		72 x 20 x 29"	KCSS7220.H	<input type="checkbox"/> <input type="checkbox"/> <input type="checkbox"/>	<input type="checkbox"/> <input type="checkbox"/> <input type="checkbox"/>	<input type="checkbox"/> <input type="checkbox"/> <input type="checkbox"/> <input type="checkbox"/>	<input type="checkbox"/> <input type="checkbox"/>	240.0#
		66 x 24 x 29"	KCSS6624.H	<input type="checkbox"/> <input type="checkbox"/> <input type="checkbox"/>	<input type="checkbox"/> <input type="checkbox"/> <input type="checkbox"/>	<input type="checkbox"/> <input type="checkbox"/> <input type="checkbox"/> <input type="checkbox"/>	<input type="checkbox"/> <input type="checkbox"/>	250.0#
		72 x 24 x 29"	KCSS7224.H	<input type="checkbox"/> <input type="checkbox"/> <input type="checkbox"/>	<input type="checkbox"/> <input type="checkbox"/> <input type="checkbox"/>	<input type="checkbox"/> <input type="checkbox"/> <input type="checkbox"/> <input type="checkbox"/>	<input type="checkbox"/> <input type="checkbox"/>	260.0#

A

B

C

D

E

## HOW TO ORDER

Indicate the following information on order form:

1. Quantity of each item.
2. Model number, including options. See "How To Build a Model Number".
3. Any special service required.

Note: • The  indicates that a choice is required.

- The absence of the  indicates that no choice is required.
- Alpha-numeric characters in place of  indicate that no other alternatives are available.

## HOW TO BUILD A MODEL NUMBER

- A** Select basic model.
- B** Select horizontal surface finish.  
Refer to color addendum at ki.com or KI Fabrics & Finishes binder.
- C** Select vertical surface finish.  
Refer to color addendum at ki.com or KI Fabrics & Finishes binder.
- D** Select pull option.
- |             |   |
|-------------|---|
| <b>NP</b>   | - Standard integral pull                |
| <b>BPA4</b> | - Silver bar pull (4); add \$40         |
| <b>KIB4</b> | - Waterfall black pull (4); add \$40    |
| <b>KIS4</b> | - Waterfall silver pull (4); add \$40   |
| <b>RCP4</b> | - Rectangular silver pull (4); add \$40 |
- E** Select lock option.
- |           |                |
|-----------|----------------|
| <b>KA</b> | - Key alike    |
| <b>KS</b> | - Key standard |



# Aristotle® Classic Credenzas

Credenza-Storage

Delivered Pricing

\$ 1807  
1896  
1976  
2060

\$ 1807  
1896  
1976  
2060

\$ 1471  
1508  
1588  
1616

**SPECIAL SERVICES**

**Special Carton Marking**

With specially marked information N/C

**Shipping**

Shipped **assembled freight prepaid f.o.b. KI-Aristotle Brampton, Ontario L6T 5T6** factory. Freight class #85.

Specifications and prices are subject to change without prior notice.

# Aristotle® Classic Reception Workstations

## Reception Desks

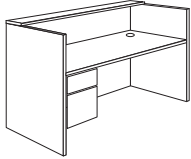
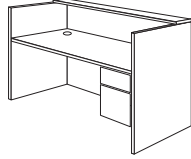
		MODEL NUMBER					Approx. Packaged Weight	
		Basic Model	Horizontal Surface Finish	Vertical Surface Finish	Pull Option	Lock Option		
MODEL	W x D x H							
 ARGRD	<b>Reception Desk-Left, Box/File Pedestal Option A</b>	66 x 30 x 44"	KGDL6630A.H	<input type="checkbox"/> <input type="checkbox"/> <input type="checkbox"/>	<input type="checkbox"/> <input type="checkbox"/> <input type="checkbox"/>	<input type="checkbox"/> <input type="checkbox"/> <input type="checkbox"/> <input type="checkbox"/>	<input type="checkbox"/> <input type="checkbox"/>	250.0#
	<ul style="list-style-type: none"> <li>Box/file locking pedestal with full extension slides</li> <li>30" desk features full height back panel and 2 rear corner grommets</li> <li>Full height back panel features horizontal wood grain pattern</li> <li>12" deep transaction top</li> <li>14" clearance above desktop</li> <li>Integral pull is standard; use xxx2 for optional pulls</li> <li>Pedestals feature locks on inside panels</li> </ul>	72 x 30 x 44"	KGDL7230A.H	<input type="checkbox"/> <input type="checkbox"/> <input type="checkbox"/>	<input type="checkbox"/> <input type="checkbox"/> <input type="checkbox"/>	<input type="checkbox"/> <input type="checkbox"/> <input type="checkbox"/> <input type="checkbox"/>	<input type="checkbox"/> <input type="checkbox"/>	260.0#
 ARGRD	<b>Reception Desk-Right, Box/File Pedestal Option A</b>	66 x 30 x 44"	KGDR6630A.H	<input type="checkbox"/> <input type="checkbox"/> <input type="checkbox"/>	<input type="checkbox"/> <input type="checkbox"/> <input type="checkbox"/>	<input type="checkbox"/> <input type="checkbox"/> <input type="checkbox"/> <input type="checkbox"/>	<input type="checkbox"/> <input type="checkbox"/>	250.0#
	<ul style="list-style-type: none"> <li>Box/file locking pedestal with full extension slides</li> <li>30" desk features full height back panel and 2 rear corner grommets</li> <li>Full height back panel features horizontal wood grain pattern</li> <li>12" deep transaction top</li> <li>14" clearance above desktop</li> <li>Integral pull is standard; use xxx2 for optional pulls</li> <li>Pedestals feature locks on inside panels</li> </ul>	72 x 30 x 44"	KGDR7230A.H	<input type="checkbox"/> <input type="checkbox"/> <input type="checkbox"/>	<input type="checkbox"/> <input type="checkbox"/> <input type="checkbox"/>	<input type="checkbox"/> <input type="checkbox"/> <input type="checkbox"/> <input type="checkbox"/>	<input type="checkbox"/> <input type="checkbox"/>	260.0#
				<b>A</b>	<b>B</b>	<b>C</b>	<b>D</b>	<b>E</b>

### HOW TO ORDER

Indicate the following information on order form:

- Quantity of each item.
- Model number, including options. See "How To Build a Model Number".
- Any special service required.

Note: • The  indicates that a choice is required.

- The absence of the  indicates that no choice is required.
- Alpha-numeric characters in place of  indicate that no other alternatives are available.

### HOW TO BUILD A MODEL NUMBER

- A** Select basic model.
- B** Select horizontal surface finish.  
Refer to color addendum at ki.com or KI Fabrics & Finishes binder.
- C** Select vertical surface finish.  
Refer to color addendum at ki.com or KI Fabrics & Finishes binder.
- D** Select pull option.
- |             |   |
|-------------|---|
| <b>NP</b>   | - Standard integral pull                |
| <b>BPA2</b> | - Silver bar pull (2); add \$20         |
| <b>KIB2</b> | - Waterfall black pull (2); add \$20    |
| <b>KIS2</b> | - Waterfall silver pull (2); add \$20   |
| <b>RCP2</b> | - Rectangular silver pull (2); add \$20 |
- E** Select lock option.
- |           |                |
|-----------|----------------|
| <b>KA</b> | - Key alike    |
| <b>KS</b> | - Key standard |



# Aristotle® Classic Reception Workstations

Reception Desks

Delivered  
Pricing

\$ 1598

1762

\$ 1598

1762

**SPECIAL SERVICES**

**Special Carton Marking**

With specially marked information    N/C

**Shipping**

Shipped **assembled freight prepaid f.o.b. KI-Aristotle Brampton, Ontario L6T 5T6** factory. Freight class #85.

Specifications and prices are subject to change without prior notice.

# Aristotle® Classic Reception Workstations

## Reception Desks

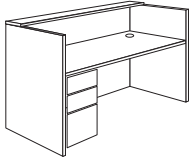
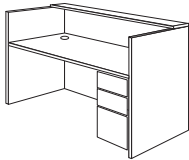
		MODEL NUMBER					Approx. Packaged Weight	
		Basic Model	Horizontal Surface Finish	Vertical Surface Finish	Pull Option	Lock Option		
MODEL	W x D x H							
 <p>ARGRD</p>	<b>Reception Desk-Left, Box/Box/File Pedestal Option B</b>	66 x 30 x 44"	KGDL6630B.H	<input type="checkbox"/> <input type="checkbox"/> <input type="checkbox"/>	<input type="checkbox"/> <input type="checkbox"/> <input type="checkbox"/>	<input type="checkbox"/> <input type="checkbox"/> <input type="checkbox"/> <input type="checkbox"/>	<input type="checkbox"/> <input type="checkbox"/>	280.0#
	<ul style="list-style-type: none"> <li>Box/box/file pedestal with full extension slides (upper box drawer does not lock)</li> <li>30" desk features full height back panel and 2 rear corner grommets</li> <li>Full height back panel features horizontal wood grain pattern</li> <li>12" deep transaction top</li> <li>14" clearance above desktop</li> <li>Integral pull is standard; use xxx3 for optional pulls</li> <li>Pedestals feature locks on inside panels</li> </ul>	72 x 30 x 44"	KGDL7230B.H	<input type="checkbox"/> <input type="checkbox"/> <input type="checkbox"/>	<input type="checkbox"/> <input type="checkbox"/> <input type="checkbox"/>	<input type="checkbox"/> <input type="checkbox"/> <input type="checkbox"/> <input type="checkbox"/>	<input type="checkbox"/> <input type="checkbox"/>	290.0#
 <p>ARGRD</p>	<b>Reception Desk-Right, Box/Box/File Pedestal Option B</b>	66 x 30 x 44"	KGDR6630B.H	<input type="checkbox"/> <input type="checkbox"/> <input type="checkbox"/>	<input type="checkbox"/> <input type="checkbox"/> <input type="checkbox"/>	<input type="checkbox"/> <input type="checkbox"/> <input type="checkbox"/> <input type="checkbox"/>	<input type="checkbox"/> <input type="checkbox"/>	280.0#
	<ul style="list-style-type: none"> <li>Box/box/file pedestal with full extension slides (upper box drawer does not lock)</li> <li>30" desk features full height back panel and 2 rear corner grommets</li> <li>Full height back panel features horizontal wood grain pattern</li> <li>12" deep transaction top</li> <li>14" clearance above desktop</li> <li>Integral pull is standard; use xxx3 for optional pulls</li> <li>Pedestals feature locks on inside panels</li> </ul>	72 x 30 x 44"	KGDR7230B.H	<input type="checkbox"/> <input type="checkbox"/> <input type="checkbox"/>	<input type="checkbox"/> <input type="checkbox"/> <input type="checkbox"/>	<input type="checkbox"/> <input type="checkbox"/> <input type="checkbox"/> <input type="checkbox"/>	<input type="checkbox"/> <input type="checkbox"/>	290.0#
				<b>A</b>	<b>B</b>	<b>C</b>	<b>D</b>	<b>E</b>

### HOW TO ORDER

Indicate the following information on order form:

- Quantity of each item.
- Model number, including options. See "How To Build a Model Number".
- Any special service required.

Note: • The  indicates that a choice is required.

- The absence of the  indicates that no choice is required.
- Alpha-numeric characters in place of  indicate that no other alternatives are available.

### HOW TO BUILD A MODEL NUMBER

- A** Select basic model.
- B** Select horizontal surface finish.  
Refer to color addendum at ki.com or KI Fabrics & Finishes binder.
- C** Select vertical surface finish.  
Refer to color addendum at ki.com or KI Fabrics & Finishes binder.
- D** Select pull option.
- |             |   |
|-------------|---|
| <b>NP</b>   | - Standard integral pull                |
| <b>BPA3</b> | - Silver bar pull (3); add \$30         |
| <b>KIB3</b> | - Waterfall black pull (3); add \$30    |
| <b>KIS3</b> | - Waterfall silver pull (3); add \$30   |
| <b>RCP3</b> | - Rectangular silver pull (3); add \$30 |
- E** Select lock option.
- |           |                |
|-----------|----------------|
| <b>KA</b> | - Key alike    |
| <b>KS</b> | - Key standard |



# Aristotle® Classic Reception Workstations

Reception Desks

Delivered  
Pricing

\$ 1737  
1900

\$ 1737  
1900

**SPECIAL SERVICES**

**Special Carton Marking**

With specially marked information    N/C

**Shipping**

Shipped **assembled freight prepaid f.o.b. KI-Aristotle Brampton, Ontario L6T 5T6** factory. Freight class #85.

Specifications and prices are subject to change without prior notice.

# Aristotle® Classic Reception Workstations

## Reception Desks

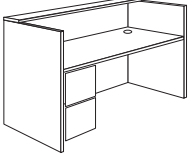
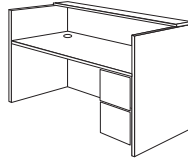
	MODEL	W x D x H	MODEL NUMBER					Approx. Packaged Weight
			Basic Model	Horizontal Surface Finish	Vertical Surface Finish	Pull Option	Lock Option	
 ARGRD	<b>Reception Desk-Left, File/File Pedestal Option C</b> <ul style="list-style-type: none"> <li>File/file pedestal with full extension slides</li> <li>30" desk features full height back panel and 2 rear corner grommets</li> <li>Full height back panel features horizontal wood grain pattern</li> <li>12" deep transaction top</li> <li>14" clearance above desktop</li> <li>Integral pull is standard; use xxx2 for optional pulls</li> <li>Pedestals feature locks on inside panels</li> </ul>	66 x 30 x 44"	KGDL6630C.H	<input type="checkbox"/> <input type="checkbox"/> <input type="checkbox"/>	<input type="checkbox"/> <input type="checkbox"/> <input type="checkbox"/>	<input type="checkbox"/> <input type="checkbox"/> <input type="checkbox"/> <input type="checkbox"/>	<input type="checkbox"/> <input type="checkbox"/>	280.0#
		72 x 30 x 44"	KGDL7230C.H	<input type="checkbox"/> <input type="checkbox"/> <input type="checkbox"/>	<input type="checkbox"/> <input type="checkbox"/> <input type="checkbox"/>	<input type="checkbox"/> <input type="checkbox"/> <input type="checkbox"/> <input type="checkbox"/>	<input type="checkbox"/> <input type="checkbox"/>	290.0#
 ARGRD	<b>Reception Desk-Right, File/File Pedestal Option C</b> <ul style="list-style-type: none"> <li>File/file pedestal with full extension slides</li> <li>30" desk features full height back panel and 2 rear corner grommets</li> <li>Full height back panel features horizontal wood grain pattern</li> <li>12" deep transaction top</li> <li>14" clearance above desktop</li> <li>Integral pull is standard; use xxx2 for optional pulls</li> <li>Pedestals feature locks on inside panels</li> </ul>	66 x 30 x 44"	KGDR6630C.H	<input type="checkbox"/> <input type="checkbox"/> <input type="checkbox"/>	<input type="checkbox"/> <input type="checkbox"/> <input type="checkbox"/>	<input type="checkbox"/> <input type="checkbox"/> <input type="checkbox"/> <input type="checkbox"/>	<input type="checkbox"/> <input type="checkbox"/>	280.0#
		72 x 30 x 44"	KGDR7230C.H	<input type="checkbox"/> <input type="checkbox"/> <input type="checkbox"/>	<input type="checkbox"/> <input type="checkbox"/> <input type="checkbox"/>	<input type="checkbox"/> <input type="checkbox"/> <input type="checkbox"/> <input type="checkbox"/>	<input type="checkbox"/> <input type="checkbox"/>	290.0#
				<b>A</b>	<b>B</b>	<b>C</b>	<b>D</b>	<b>E</b>

### HOW TO ORDER

Indicate the following information on order form:

- Quantity of each item.
- Model number, including options. See "How To Build a Model Number".
- Any special service required.

Note: • The  indicates that a choice is required.

- The absence of the  indicates that no choice is required.
- Alpha-numeric characters in place of  indicate that no other alternatives are available.

### HOW TO BUILD A MODEL NUMBER

- A** Select basic model.
- B** Select horizontal surface finish.  
Refer to color addendum at ki.com or KI Fabrics & Finishes binder.
- C** Select vertical surface finish.  
Refer to color addendum at ki.com or KI Fabrics & Finishes binder.
- D** Select pull option.
- |             |   |
|-------------|---|
| <b>NP</b>   | - Standard integral pull                |
| <b>BPA2</b> | - Silver bar pull (2); add \$20         |
| <b>KIB2</b> | - Waterfall black pull (2); add \$20    |
| <b>KIS2</b> | - Waterfall silver pull (2); add \$20   |
| <b>RCP2</b> | - Rectangular silver pull (2); add \$20 |
- E** Select lock option.
- |           |                |
|-----------|----------------|
| <b>KA</b> | - Key alike    |
| <b>KS</b> | - Key standard |





# Aristotle® Classic Reception Workstations

Reception Desks

Delivered  
Pricing

\$ 1737

1900

\$ 1737

1900

### SPECIAL SERVICES

#### Special Carton Marking

With specially marked information N/C

#### Shipping

Shipped **assembled freight prepaid f.o.b. KI-Aristotle Brampton, Ontario L6T 5T6** factory. Freight class #85.

Specifications and prices are subject to change without prior notice.

# Aristotle® Classic Reception Workstations

## Bow Front Reception Desks

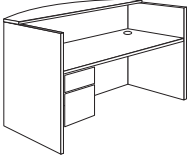
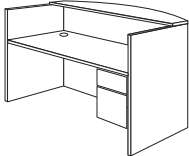
	MODEL	W x D x H	MODEL NUMBER					Approx. Packaged Weight
			Basic Model	Horizontal Surface Finish	Vertical Surface Finish	Pull Option	Lock Option	
 ARGRD	<b>Bow Front Reception Desk-Left, Box/File Option A</b> <ul style="list-style-type: none"> <li>Bow Front transaction counter is 18" deep with 6" overhang</li> <li>Box/file locking pedestal with full extension slides</li> <li>30" desk features full height back panel and 2 rear corner grommets</li> <li>Full height back panel features horizontal wood grain pattern</li> <li>12" deep transaction top</li> <li>14" clearance above desktop</li> <li>Integral pull is standard; use xxx2 for optional pulls</li> <li>Pedestals feature locks on inside panels</li> </ul>	66 x 36 x 44"	KGDBL6636A.H	<input type="checkbox"/> <input type="checkbox"/> <input type="checkbox"/>	<input type="checkbox"/> <input type="checkbox"/> <input type="checkbox"/>	<input type="checkbox"/> <input type="checkbox"/> <input type="checkbox"/> <input type="checkbox"/>	<input type="checkbox"/> <input type="checkbox"/>	260.0#
		72 x 36 x 44"	KGDBL7236A.H	<input type="checkbox"/> <input type="checkbox"/> <input type="checkbox"/>	<input type="checkbox"/> <input type="checkbox"/> <input type="checkbox"/>	<input type="checkbox"/> <input type="checkbox"/> <input type="checkbox"/> <input type="checkbox"/>	<input type="checkbox"/> <input type="checkbox"/>	270.0#
 ARGRD	<b>Bow Front Reception Desk-Right, Box/File Option A</b> <ul style="list-style-type: none"> <li>Bow Front transaction counter is 18" deep with 6" overhang</li> <li>Box/file locking pedestal with full extension slides</li> <li>30" desk features full height back panel and 2 rear corner grommets</li> <li>Full height back panel features horizontal wood grain pattern</li> <li>12" deep transaction top</li> <li>14" clearance above desktop</li> <li>Integral pull is standard; use xxx2 for optional pulls</li> <li>Pedestals feature locks on inside panels</li> </ul>	66 x 36 x 44"	KGDBR6636A.H	<input type="checkbox"/> <input type="checkbox"/> <input type="checkbox"/>	<input type="checkbox"/> <input type="checkbox"/> <input type="checkbox"/>	<input type="checkbox"/> <input type="checkbox"/> <input type="checkbox"/> <input type="checkbox"/>	<input type="checkbox"/> <input type="checkbox"/>	260.0#
		72 x 36 x 44"	KGDBR7236A.H	<input type="checkbox"/> <input type="checkbox"/> <input type="checkbox"/>	<input type="checkbox"/> <input type="checkbox"/> <input type="checkbox"/>	<input type="checkbox"/> <input type="checkbox"/> <input type="checkbox"/> <input type="checkbox"/>	<input type="checkbox"/> <input type="checkbox"/>	270.0#
				<b>A</b>	<b>B</b>	<b>C</b>	<b>D</b>	<b>E</b>

### HOW TO ORDER

Indicate the following information on order form:

- Quantity of each item.
- Model number, including options. See "How To Build a Model Number".
- Any special service required.

Note: • The  indicates that a choice is required.

- The absence of the  indicates that no choice is required.
- Alpha-numeric characters in place of  indicate that no other alternatives are available.

### HOW TO BUILD A MODEL NUMBER

- A** Select basic model.
- B** Select horizontal surface finish.  
Refer to color addendum at ki.com or KI Fabrics & Finishes binder.
- C** Select vertical surface finish.  
Refer to color addendum at ki.com or KI Fabrics & Finishes binder.
- D** Select pull option.
- |             |   |
|-------------|---|
| <b>NP</b>   | - Standard integral pull                |
| <b>BPA2</b> | - Silver bar pull (2); add \$20         |
| <b>KIB2</b> | - Waterfall black pull (2); add \$20    |
| <b>KIS2</b> | - Waterfall silver pull (2); add \$20   |
| <b>RCP2</b> | - Rectangular silver pull (2); add \$20 |
- E** Select lock option.
- |           |                |
|-----------|----------------|
| <b>KA</b> | - Key alike    |
| <b>KS</b> | - Key standard |



# Aristotle® Classic Reception Workstations

Bow Front Reception Desks

Delivered  
Pricing

\$ 1669

1832

\$ 1669

1832

**SPECIAL SERVICES**

**Special Carton Marking**

With specially marked information    N/C

**Shipping**

Shipped **assembled freight prepaid f.o.b. KI-Aristotle Brampton, Ontario L6T 5T6** factory. Freight class #85.

Specifications and prices are subject to change without prior notice.

# Aristotle® Classic Reception Workstations

## Bow Front Reception Desks

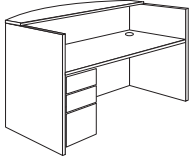
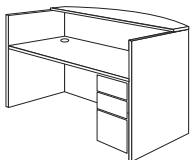
	MODEL	W x D x H	MODEL NUMBER					Approx. Packaged Weight
			Basic Model	Horizontal Surface Finish	Vertical Surface Finish	Pull Option	Lock Option	
 ARGRD	<b>Bow Front Reception Desk-Left, Box/Box/File Option B</b> <ul style="list-style-type: none"> <li>Bow Front transaction counter is 18" deep with 6" overhang</li> <li>Box/box/file pedestal with full extension slides (upper box drawer does not lock)</li> <li>30" desk features full height back panel and 2 rear corner grommets</li> <li>Full height back panel features horizontal wood grain pattern</li> <li>12" deep transaction top</li> <li>14" clearance above desktop</li> <li>Integral pull is standard; use xxx3 for optional pulls</li> <li>Pedestals feature locks on inside panels</li> </ul>	66 x 36 x 44"	KGDBL6636B.H	<input type="checkbox"/> <input type="checkbox"/>	<input type="checkbox"/> <input type="checkbox"/>	<input type="checkbox"/> <input type="checkbox"/> <input type="checkbox"/> <input type="checkbox"/>	<input type="checkbox"/> <input type="checkbox"/>	290.0#
		72 x 36 x 44"	KGDBL7236B.H	<input type="checkbox"/> <input type="checkbox"/>	<input type="checkbox"/> <input type="checkbox"/>	<input type="checkbox"/> <input type="checkbox"/> <input type="checkbox"/> <input type="checkbox"/>	<input type="checkbox"/> <input type="checkbox"/>	300.0#
 ARGRD	<b>Bow Front Reception Desk-Right, Box/Box/File Option B</b> <ul style="list-style-type: none"> <li>Bow Front transaction counter is 18" deep with 6" overhang</li> <li>Box/box/file pedestal with full extension slides (upper box drawer does not lock)</li> <li>30" desk features full height back panel and 2 rear corner grommets</li> <li>Full height back panel features horizontal wood grain pattern</li> <li>12" deep transaction top</li> <li>14" clearance above desktop</li> <li>Integral pull is standard; use xxx3 for optional pulls</li> <li>Pedestals feature locks on inside panels</li> </ul>	66 x 36 x 44"	KGDBR6636B.H	<input type="checkbox"/> <input type="checkbox"/>	<input type="checkbox"/> <input type="checkbox"/>	<input type="checkbox"/> <input type="checkbox"/> <input type="checkbox"/> <input type="checkbox"/>	<input type="checkbox"/> <input type="checkbox"/>	290.0#
		72 x 36 x 44"	KGDBR7236B.H	<input type="checkbox"/> <input type="checkbox"/>	<input type="checkbox"/> <input type="checkbox"/>	<input type="checkbox"/> <input type="checkbox"/> <input type="checkbox"/> <input type="checkbox"/>	<input type="checkbox"/> <input type="checkbox"/>	300.0#
			<b>A</b>	<b>B</b>	<b>C</b>	<b>D</b>	<b>E</b>	

### HOW TO ORDER

Indicate the following information on order form:

- Quantity of each item.
- Model number, including options. See "How To Build a Model Number".
- Any special service required.

Note: • The  indicates that a choice is required.

- The absence of the  indicates that no choice is required.
- Alpha-numeric characters in place of  indicate that no other alternatives are available.

### HOW TO BUILD A MODEL NUMBER

- A** Select basic model.
- B** Select horizontal surface finish.  
Refer to color addendum at ki.com or KI Fabrics & Finishes binder.
- C** Select vertical surface finish.  
Refer to color addendum at ki.com or KI Fabrics & Finishes binder.
- D** Select pull option.
- |             |   |
|-------------|---|
| <b>NP</b>   | - Standard integral pull                |
| <b>BPA3</b> | - Silver bar pull (3); add \$30         |
| <b>KIB3</b> | - Waterfall black pull (3); add \$30    |
| <b>KIS3</b> | - Waterfall silver pull (3); add \$30   |
| <b>RCP3</b> | - Rectangular silver pull (3); add \$30 |
- E** Select lock option.
- |           |                |
|-----------|----------------|
| <b>KA</b> | - Key alike    |
| <b>KS</b> | - Key standard |



# Aristotle® Classic Reception Workstations

Bow Front Reception Desks

Delivered  
Pricing

\$ 1808

1970

\$ 1808

1970

**SPECIAL SERVICES**

**Special Carton Marking**

With specially marked information    N/C

**Shipping**

Shipped **assembled freight prepaid f.o.b. KI-Aristotle Brampton, Ontario L6T 5T6** factory. Freight class #85.

Specifications and prices are subject to change without prior notice.

# Aristotle® Classic Reception Workstations

## Bow Front Reception Desks

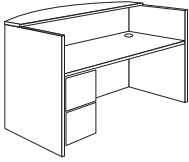
		MODEL NUMBER					Approx. Packaged Weight	
		Basic Model	Horizontal Surface Finish	Vertical Surface Finish	Pull Option	Lock Option		
 <p>ARGRD</p>	<b>Bow Front Reception Desk-Left, File/File Option C</b> • Bow Front transaction counter is 18" deep with 6" overhang • File/file pedestal with full extension slides • 30" desk features full height back panel and 2 rear corner grommets • Full height back panel features horizontal wood grain pattern • 14" clearance above desktop • Integral pull is standard; use xxx2 for optional pulls • Pedestals feature locks on inside panels	66 x 36 x 44" 72 x 36 x 44"	KGDBL6636C.H KGDBL7236C.H	<input type="checkbox"/> <input type="checkbox"/> <input type="checkbox"/> <input type="checkbox"/> <input type="checkbox"/> <input type="checkbox"/>	<input type="checkbox"/> <input type="checkbox"/> <input type="checkbox"/> <input type="checkbox"/> <input type="checkbox"/> <input type="checkbox"/>	<input type="checkbox"/> <input type="checkbox"/> <input type="checkbox"/> <input type="checkbox"/> <input type="checkbox"/> <input type="checkbox"/> <input type="checkbox"/> <input type="checkbox"/>	<input type="checkbox"/> <input type="checkbox"/> <input type="checkbox"/> <input type="checkbox"/>	290.0# 300.0#
	<b>Bow Front Reception Desk-Right, File/File Option C</b> • Bow Front transaction counter is 18" deep with 6" overhang • File/file pedestal with full extension slides • 30" desk features full height back panel and 2 rear corner grommets • Full height back panel features horizontal wood grain pattern • 12" deep transaction top • 14" clearance above desktop • Integral pull is standard; use xxx2 for optional pulls • Pedestals feature locks on inside panels	66 x 36 x 44" 72 x 36 x 44"	KGDBR6636C.H KGDBR7236C.H	<input type="checkbox"/> <input type="checkbox"/> <input type="checkbox"/> <input type="checkbox"/> <input type="checkbox"/> <input type="checkbox"/>	<input type="checkbox"/> <input type="checkbox"/> <input type="checkbox"/> <input type="checkbox"/> <input type="checkbox"/> <input type="checkbox"/>	<input type="checkbox"/> <input type="checkbox"/> <input type="checkbox"/> <input type="checkbox"/> <input type="checkbox"/> <input type="checkbox"/> <input type="checkbox"/> <input type="checkbox"/>	<input type="checkbox"/> <input type="checkbox"/> <input type="checkbox"/> <input type="checkbox"/>	290.0# 300.0#
				<b>A</b>	<b>B</b>	<b>C</b>	<b>D</b>	<b>E</b>

### HOW TO ORDER

Indicate the following information on order form:

- Quantity of each item.
- Model number, including options. See "How To Build a Model Number".
- Any special service required.

Note: • The  indicates that a choice is required.

- The absence of the  indicates that no choice is required.
- Alpha-numeric characters in place of  indicate that no other alternatives are available.

### HOW TO BUILD A MODEL NUMBER

- A** Select basic model.
- B** Select horizontal surface finish.  
Refer to color addendum at ki.com or KI Fabrics & Finishes binder.
- C** Select vertical surface finish.  
Refer to color addendum at ki.com or KI Fabrics & Finishes binder.
- D** Select pull option.
 

<b>NP</b>	- Standard integral pull
<b>BPA2</b>	- Silver bar pull (2); add \$20
<b>KIB2</b>	- Waterfall black pull (2); add \$20
<b>KIS2</b>	- Waterfall silver pull (2); add \$20
<b>RCP2</b>	- Rectangular silver pull (2); add \$20
- E** Select lock option.
 

<b>KA</b>	- Key alike
<b>KS</b>	- Key standard



# Aristotle® Classic Reception Workstations

Bow Front Reception Desks

Delivered  
Pricing

\$ 1808

1970

\$ 1808

1970

**SPECIAL SERVICES**

**Special Carton Marking**

With specially marked information N/C

**Shipping**

Shipped **assembled freight prepaid f.o.b. KI-Aristotle Brampton, Ontario L6T 5T6** factory. Freight class #85.

Specifications and prices are subject to change without prior notice.

# Aristotle® Classic Reception Workstations

Returns

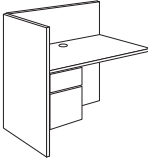
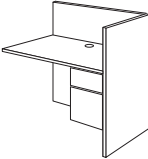
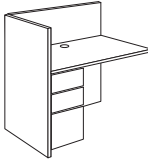
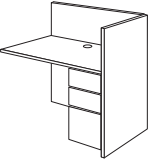
	MODEL	W x D x H	MODEL NUMBER					Approx. Packaged Weight
			Basic Model	Horizontal Surface Finish	Vertical Surface Finish	Pull Option	Lock Option	
	<b>Reception Return-Left, Box/File Pedestal Option A</b> • Box/file locking pedestal with full extension slides • 24" deep return features 1 rear center grommet • Integral pull is standard; use xxx2 for optional pulls • Pedestals feature locks on inside panels	42 x 24 x 43"	KGRL4224A.H	□□□	□□□	□□□□	□□	130.0#
		48 x 24 x 43"	KGRL4824A.H	□□□	□□□	□□□□	□□	135.0#
ARGRD								
	<b>Reception Return-Right, Box/File Pedestal Option A</b> • Box/file locking pedestal with full extension slides • 24" deep return features 1 rear center grommet • Integral pull is standard; use xxx2 for optional pulls • Pedestals feature locks on inside panels	42 x 24 x 43"	KGRR4224A.H	□□□	□□□	□□□□	□□	130.0#
		48 x 24 x 43"	KGRR4824A.H	□□□	□□□	□□□□	□□	135.0#
ARGRD								
	<b>Reception Return-Left, Box/Box/File Pedestal Option B</b> • Box/box/file pedestal with full extension slides (upper box drawer does not lock) • 24" deep return features 1 rear center grommet • Integral pull is standard; use xxx3 for optional pulls • Pedestals feature locks on inside panels	42 x 24 x 43"	KGRL4224B.H	□□□	□□□	□□□□	□□	160.0#
		48 x 24 x 43"	KGRL4824B.H	□□□	□□□	□□□□	□□	165.0#
ARGRD								
	<b>Reception Return-Right, Box/Box/File Pedestal Option B</b> • Box/box/file pedestal with full extension slides (upper box drawer does not lock) • 24" deep return features 1 rear center grommet • Integral pull is standard; use xxx3 for optional pulls • Pedestals feature locks on inside panels	42 x 24 x 43"	KGRR4224B.H	□□□	□□□	□□□□	□□	160.0#
		48 x 24 x 43"	KGRR4824B.H	□□□	□□□	□□□□	□□	165.0#
ARGRD								

A

B

C

D

E

## HOW TO ORDER

Indicate the following information on order form:

- Quantity of each item.
- Model number, including options. See "How To Build a Model Number".
- Any special service required.

Note: • The  indicates that a choice is required.

- The absence of the  indicates that no choice is required.
- Alpha-numeric characters in place of  indicate that no other alternatives are available.

## HOW TO BUILD A MODEL NUMBER

- A** Select basic model.
- B** Select horizontal surface finish.  
Refer to color addendum at ki.com or KI Fabrics & Finishes binder.
- C** Select vertical surface finish.  
Refer to color addendum at ki.com or KI Fabrics & Finishes binder.
- D** Select pull option.
- |             |   |
|-------------|---|
| <b>NP</b>   | - Standard integral pull                |
| <b>BPA2</b> | - Silver bar pull (2); add \$20         |
| <b>BPA3</b> | - Silver bar pull (3); add \$30         |
| <b>KIB2</b> | - Waterfall black pull (2); add \$20    |
| <b>KIB3</b> | - Waterfall black pull (3); add \$30    |
| <b>KIS2</b> | - Waterfall silver pull (2); add \$20   |
| <b>KIS3</b> | - Waterfall silver pull (3); add \$30   |
| <b>RCP2</b> | - Rectangular silver pull (2); add \$20 |

**RCP3** - Rectangular silver pull (3); add \$30

- E** Select lock option.
- |           |                |
|-----------|----------------|
| <b>KA</b> | - Key alike    |
| <b>KS</b> | - Key standard |





# Aristotle® Classic Reception Workstations

Returns

Delivered  
Pricing

\$ 1069  
1103

\$ 1069  
1103

\$ 1240  
1275

\$ 1240  
1275

**SPECIAL SERVICES**

**Special Carton Marking**

With specially marked information    N/C



**Shipping**

Shipped **assembled freight prepaid f.o.b. KI-Aristotle Brampton, Ontario L6T 5T6** factory. Freight class #85.

Specifications and prices are subject to change without prior notice.

# Aristotle® Classic Reception Workstations

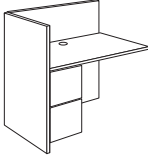
Returns

	MODEL	W x D x H	MODEL NUMBER					Approx. Packaged Weight
			Basic Model	Horizontal Surface Finish	Vertical Surface Finish	Pull Option	Lock Option	
	<b>Reception Return-Left, File/File Pedestal Option C</b> • Box/file locking pedestal with full extension slides • 24" deep return features 1 rear center grommet • Integral pull is standard; use xxx2 for optional pulls • Pedestals feature locks on inside panels	42 x 24 x 43"	KGRL4224C.H	<input type="checkbox"/> <input type="checkbox"/> <input type="checkbox"/>	<input type="checkbox"/> <input type="checkbox"/> <input type="checkbox"/>	<input type="checkbox"/> <input type="checkbox"/> <input type="checkbox"/> <input type="checkbox"/>	<input type="checkbox"/> <input type="checkbox"/>	160.0#
		48 x 24 x 43"	KGRL4824C.H	<input type="checkbox"/> <input type="checkbox"/> <input type="checkbox"/>	<input type="checkbox"/> <input type="checkbox"/> <input type="checkbox"/>	<input type="checkbox"/> <input type="checkbox"/> <input type="checkbox"/> <input type="checkbox"/>	<input type="checkbox"/> <input type="checkbox"/>	165.0#
ARGRD								
	<b>Reception Return-Right, Pedestal Option C</b> • Box/file locking pedestal with full extension slides • 24" deep return features 1 rear center grommet • Integral pull is standard; use xxx2 for optional pulls • Pedestals feature locks on inside panels	42 x 24 x 43"	KGRR4224C.H	<input type="checkbox"/> <input type="checkbox"/> <input type="checkbox"/>	<input type="checkbox"/> <input type="checkbox"/> <input type="checkbox"/>	<input type="checkbox"/> <input type="checkbox"/> <input type="checkbox"/> <input type="checkbox"/>	<input type="checkbox"/> <input type="checkbox"/>	160.0#
		48 x 24 x 43"	KGRR4824C.H	<input type="checkbox"/> <input type="checkbox"/> <input type="checkbox"/>	<input type="checkbox"/> <input type="checkbox"/> <input type="checkbox"/>	<input type="checkbox"/> <input type="checkbox"/> <input type="checkbox"/> <input type="checkbox"/>	<input type="checkbox"/> <input type="checkbox"/>	165.0#
ARGRD								
				<b>A</b>	<b>B</b>	<b>C</b>	<b>D</b>	<b>E</b>

## HOW TO ORDER

Indicate the following information on order form:

- Quantity of each item.
- Model number, including options. See "How To Build a Model Number".
- Any special service required.

Note: • The  indicates that a choice is required.

- The absence of the  indicates that no choice is required.
- Alpha-numeric characters in place of  indicate that no other alternatives are available.

## HOW TO BUILD A MODEL NUMBER

- A** Select basic model.
- B** Select horizontal surface finish.  
Refer to color addendum at ki.com or KI Fabrics & Finishes binder.
- C** Select vertical surface finish.  
Refer to color addendum at ki.com or KI Fabrics & Finishes binder.
- D** Select pull option.
 

<b>NP</b>	- Standard integral pull
<b>BPA2</b>	- Silver bar pull (2); add \$20
<b>KIB2</b>	- Waterfall black pull (2); add \$20
<b>KIS2</b>	- Waterfall silver pull (2); add \$20
<b>RCP2</b>	- Rectangular silver pull (2); add \$20
- E** Select lock option.
 

<b>KA</b>	- Key alike
<b>KS</b>	- Key standard



# Aristotle® Classic Reception Workstations

Returns

Delivered  
Pricing

\$ 1240

1275

\$ 1240

1275

### SPECIAL SERVICES

#### Special Carton Marking

With specially marked information    N/C

#### Shipping

Shipped **assembled freight prepaid f.o.b. KI-Aristotle Brampton, Ontario L6T 5T6** factory. Freight class #85.

Specifications and prices are subject to change without prior notice.

# Aristotle® Classic Reception Workstations

Returns

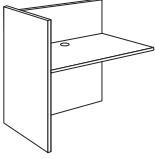
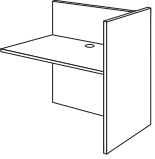
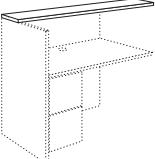
	MODEL	W x D x H	MODEL NUMBER			Approx. Packaged Weight
			Basic Model	Horizontal Surface Finish	Vertical Surface Finish	
	<b>Reception Return-Left, No Pedestal</b> • 24" deep return features 1 rear center grommet	42 x 24 x 43"	KGRL4224.H	<input type="checkbox"/> <input type="checkbox"/> <input type="checkbox"/>	<input type="checkbox"/> <input type="checkbox"/> <input type="checkbox"/>	85.0#
		48 x 24 x 43"	KGRL4824.H	<input type="checkbox"/> <input type="checkbox"/> <input type="checkbox"/>	<input type="checkbox"/> <input type="checkbox"/> <input type="checkbox"/>	90.0#
ARGRD						
	<b>Reception Return-Right, No Pedestal</b> • 24" deep return features 1 rear center grommet	42 x 24 x 43"	KGRR4224.H	<input type="checkbox"/> <input type="checkbox"/> <input type="checkbox"/>	<input type="checkbox"/> <input type="checkbox"/> <input type="checkbox"/>	85.0#
		48 x 24 x 43"	KGRR4824.H	<input type="checkbox"/> <input type="checkbox"/> <input type="checkbox"/>	<input type="checkbox"/> <input type="checkbox"/> <input type="checkbox"/>	90.0#
ARGRD						
	<b>Reception Return Transaction Top</b> • Field installed • Replacement top only	60 x 12 x 1"	KGRTT42.H	<input type="checkbox"/> <input type="checkbox"/> <input type="checkbox"/>		15.0#
		66 x 12 x 1"	KGRTT48.H	<input type="checkbox"/> <input type="checkbox"/> <input type="checkbox"/>		17.0#
ARGRD						
			<b>A</b>	<b>B</b>	<b>C</b>	

## HOW TO ORDER

Indicate the following information on order form:

- Quantity of each item.
- Model number, including options. See "How To Build a Model Number".
- Any special service required.

Note: • The  indicates that a choice is required.

- The absence of the  indicates that no choice is required.
- Alpha-numeric characters in place of  indicate that no other alternatives are available.

## HOW TO BUILD A MODEL NUMBER

- A** Select basic model.
- B** Select horizontal surface finish.  
Refer to color addendum at [ki.com](http://ki.com) or KI Fabrics & Finishes binder.
- C** Select vertical surface finish.  
Refer to color addendum at [ki.com](http://ki.com) or KI Fabrics & Finishes binder.



# Aristotle® Classic Reception Workstations

Returns

Delivered  
Pricing

\$ 511

541

\$ 511

541

\$ 164

174

**SPECIAL SERVICES**

**Special Carton Marking**

With specially marked information N/C

**Shipping**

Shipped k.d. freight prepaid f.o.b.  
KI-Aristotle Brampton, Ontario L6T 5T6  
factory. Freight class #85.

Specifications and prices are subject to  
change without prior notice.

# Aristotle® Classic Shells

Corner Units

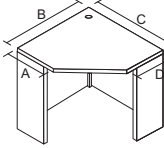
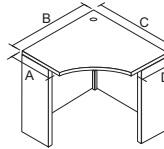
MODEL	Opening	A x B x C x D	Basic Model	MODEL NUMBER					
				Horizontal Surface Finish	Vertical Surface Finish	Leg Finish	Back Panel Height	Grommets	
 <p><b>Straight Corner</b></p> <ul style="list-style-type: none"> <li>• Corner post in black or silver</li> <li>• Left and right recessed end panels standard</li> <li>• One optional grommet center rear</li> <li>• 29" Height</li> </ul>	25"	18 x 36 x 36 x 18"	KCC361818.H	□□□	□□□	□□	□□□□	□□□	
	21"	20 x 36 x 36 x 20"	KCC362020.H	□□□	□□□	□□	□□□□	□□□	
	17"	24 x 36 x 36 x 24"	KCC362424.H	□□□	□□□	□□	□□□□	□□□	
	25"	24 x 42 x 42 x 24"	KCC422424.H	□□□	□□□	□□	□□□□	□□□	
	17"	30 x 42 x 42 x 30"	KCC423030.H	□□□	□□□	□□	□□□□	□□□	
	22"	24 x 42 x 42 x 30"	KCC422430.H	□□□	□□□	□□	□□□□	□□□	
	22"	30 x 42 x 42 x 24"	KCC423024.H	□□□	□□□	□□	□□□□	□□□	
	30"	24 x 48 x 48 x 30"	KCC482430.H	□□□	□□□	□□	□□□□	□□□	
	30"	30 x 48 x 48 x 24"	KCC483024.H	□□□	□□□	□□	□□□□	□□□	
	34"	24 x 48 x 48 x 24"	KCC482424.H	□□□	□□□	□□	□□□□	□□□	
25"	30 x 48 x 48 x 30"	KCC483030.H	□□□	□□□	□□	□□□□	□□□		
 <p><b>Curvilinear Corner</b></p> <ul style="list-style-type: none"> <li>• Corner post in black or silver</li> <li>• Left and right recessed end panels standard</li> <li>• One optional grommet center rear</li> <li>• 29" Height</li> </ul>		18 x 36 x 36 x 18"	KCV361818.H	□□□	□□□	□□	□□□□	□□□	
		20 x 36 x 36 x 20"	KCV362020.H	□□□	□□□	□□	□□□□	□□□	
		24 x 36 x 36 x 24"	KCV362424.H	□□□	□□□	□□	□□□□	□□□	
		24 x 42 x 42 x 24"	KCV422424.H	□□□	□□□	□□	□□□□	□□□	
		30 x 42 x 42 x 30"	KCV423030.H	□□□	□□□	□□	□□□□	□□□	
		24 x 48 x 48 x 24"	KCV482424.H	□□□	□□□	□□	□□□□	□□□	
		30 x 48 x 48 x 30"	KCV483030.H	□□□	□□□	□□	□□□□	□□□	

**A**      **B**      **C**      **D**      **E**      **F**

## HOW TO ORDER

Indicate the following information on order form:

1. Quantity of each item.
2. Model number, including options. See "How To Build a Model Number".
3. Any special service required.

Note: • The □ indicates that a choice is required.

- The absence of the □ indicates that no choice is required.
- Alpha-numeric characters in place of □ indicate that no other alternatives are available.

## HOW TO BUILD A MODEL NUMBER

- A** Select basic model.
- B** Select horizontal surface finish.  
Refer to color addendum at ki.com or KI Fabrics & Finishes binder.
- C** Select vertical surface finish.  
Refer to color addendum at ki.com or KI Fabrics & Finishes binder.
- D** Select corner leg finish  
Refer to color addendum at ki.com or KI Fabrics & Finishes binder.
- E** Select back panel height.
 

<b>FULL</b>	- Full height (standard)
<b>2Q</b>	- 1/2 height back panel
<b>2QL</b>	- 1/2 height back panel, left
<b>2QR</b>	- 1/2 height back panel, right
<b>3Q</b>	- 3/4 height back panel
<b>3QL</b>	- 3/4 height back panel, left
<b>3QR</b>	- 3/4 height back panel, right

**F** Select grommets.

- |            |              |
|------------|--------------|
| <b>NGR</b> | - No grommet |
| <b>G</b>   | - Grommet    |
- Grommets are factory installed.



Aristotle® Classic Shells  
Corner Units

Approx.  
Packaged  
Weight

Delivered  
Pricing

85.0#	\$ 791
85.0#	791
85.0#	791
105.0#	942
105.0#	942
105.0#	942
105.0#	942
125.0#	1063
125.0#	1063
125.0#	1063
85.0#	\$ 791
85.0#	791
85.0#	791
105.0#	942
105.0#	942
125.0#	1063
125.0#	1063

**SPECIAL SERVICES**

**Special Carton Marking**

With specially marked information N/C

**Shipping**

Shipped k.d. freight prepaid f.o.b.  
KI-Aristotle Brampton, Ontario L6T 5T6  
factory. Freight class #85.

Specifications and prices are subject to  
change without prior notice.

# Aristotle® Classic Shells

Desk Shells-20"

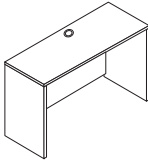
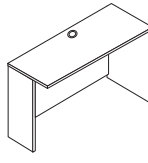
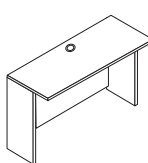
	MODEL	W x D x H	MODEL NUMBER					Approx. Packaged Weight
			Basic Model	Horizontal Surface Finish	Vertical Surface Finish	Back Panel Height	Grommets	
 ARSPD	<b>Desk Shells-20" Option A - Two Full End Panels</b>	24 x 20 x 29"	KDA2420.H	□□□	□□□	□□□□	□□□	63.0#
		30 x 20 x 29"	KDA3020.H	□□□	□□□	□□□□	□□□	68.0#
	• Back panel features horizontal grain pattern	36 x 20 x 29"	KDA3620.H	□□□	□□□	□□□□	□□□	72.0#
	• Recessed center support panel included with desk shells 78" or wider	42 x 20 x 29"	KDA4220.H	□□□	□□□	□□□□	□□□	77.0#
	• Optional desk shelf, specified separately	48 x 20 x 29"	KDA4820.H	□□□	□□□	□□□□	□□□	86.0#
	• Optional 1/2 and 3/4 height back panels options listed below	54 x 20 x 29"	KDA5420.H	□□□	□□□	□□□□	□□□	91.0#
	• One optional grommet center rear	60 x 20 x 29"	KDA6020.H	□□□	□□□	□□□□	□□□	100.0#
		66 x 20 x 29"	KDA6620.H	□□□	□□□	□□□□	□□□	105.0#
		72 x 20 x 29"	KDA7220.H	□□□	□□□	□□□□	□□□	109.0#
		78 x 20 x 29"	KDA7820.H	□□□	□□□	□□□□	□□□	114.0#
	84 x 20 x 29"	KDA8420.H	□□□	□□□	□□□□	□□□	118.0#	
	96 x 20 x 29"	KDA9620.H	□□□	□□□	□□□□	□□□	122.0#	
 ARSPD	<b>Desk Shells-20" Option B - One Recessed and One Full End Panel</b>	24 x 20 x 29"	KDB2420.H	□□□	□□□	□□□□	□□□	58.0#
		36 x 20 x 29"	KDB3620.H	□□□	□□□	□□□□	□□□	67.0#
	• Back panel features horizontal grain pattern	30 x 20 x 29"	KDB3020.H	□□□	□□□	□□□□	□□□	63.0#
	• Recessed center support panel included with desk shells 78" or wider	42 x 20 x 29"	KDB4220.H	□□□	□□□	□□□□	□□□	72.0#
	• Optional desk shelf, specified separately	48 x 20 x 29"	KDB4820.H	□□□	□□□	□□□□	□□□	81.0#
	• Optional 1/2 and 3/4 height back panels options listed below	54 x 20 x 29"	KDB5420.H	□□□	□□□	□□□□	□□□	86.0#
	• One optional grommet center rear	60 x 20 x 29"	KDB6020.H	□□□	□□□	□□□□	□□□	95.0#
		66 x 20 x 29"	KDB6620.H	□□□	□□□	□□□□	□□□	100.0#
		72 x 20 x 29"	KDB7220.H	□□□	□□□	□□□□	□□□	104.0#
		78 x 20 x 29"	KDB7820.H	□□□	□□□	□□□□	□□□	109.0#
	84 x 20 x 29"	KDB8420.H	□□□	□□□	□□□□	□□□	113.0#	
	96 x 20 x 29"	KDB9620.H	□□□	□□□	□□□□	□□□	117.0#	
 ARSPD	<b>Desk Shells-20" Option C - Two Recessed End Panels</b>	24 x 20 x 29"	KDC2420.H	□□□	□□□	□□□□	□□□	58.0#
		30 x 20 x 29"	KDC3020.H	□□□	□□□	□□□□	□□□	63.0#
	• Back panel features horizontal grain pattern	36 x 20 x 29"	KDC3620.H	□□□	□□□	□□□□	□□□	67.0#
	• Recessed center support panel included with desk shells 78" or wider	42 x 20 x 29"	KDC4220.H	□□□	□□□	□□□□	□□□	72.0#
	• Optional desk shelf, specified separately	48 x 20 x 29"	KDC4820.H	□□□	□□□	□□□□	□□□	81.0#
	• Optional 1/2 and 3/4 height back panels options listed below	54 x 20 x 29"	KDC5420.H	□□□	□□□	□□□□	□□□	86.0#
	• One optional grommet center rear	60 x 20 x 29"	KDC6020.H	□□□	□□□	□□□□	□□□	95.0#
		66 x 20 x 29"	KDC6620.H	□□□	□□□	□□□□	□□□	100.0#
		72 x 20 x 29"	KDC7220.H	□□□	□□□	□□□□	□□□	104.0#
		78 x 20 x 29"	KDC7820.H	□□□	□□□	□□□□	□□□	109.0#
	84 x 20 x 29"	KDC8420.H	□□□	□□□	□□□□	□□□	113.0#	
	96 x 20 x 29"	KDC9620.H	□□□	□□□	□□□□	□□□	117.0#	

A

B

C

D

E

## HOW TO ORDER

Indicate the following information on order form:

- Quantity of each item.
- Model number, including options. See "How To Build a Model Number".
- Any special service required.

Note: • The □ indicates that a choice is required.

- The absence of the □ indicates that no choice is required.
- Alpha-numeric characters in place of □ indicate that no other alternatives are available.

## HOW TO BUILD A MODEL NUMBER

- A** Select basic model.
- B** Select horizontal surface finish.  
Refer to color addendum at [ki.com](http://ki.com) or KI Fabrics & Finishes binder.
- C** Select vertical surface finish.  
Refer to color addendum at [ki.com](http://ki.com) or KI Fabrics & Finishes binder.
- D** Select back panel height.
- |      |                          |
|------|--------------------------|
| FULL | - Full height (standard) |
| 2Q   | - 1/2 height back panel  |
| 3Q   | - 3/4 height back panel  |
- E** Select grommet.
- |     |              |
|-----|--------------|
| NGR | - No grommet |
| G   | - Grommet    |
- Grommets are factory installed.





# Aristotle® Classic Shells

Desk Shells-20"

Delivered Pricing

\$ 555
569
580
609
633
647
663
699
743
825
895
1048
\$ 555
580
569
609
633
647
663
699
743
825
895
1048
\$ 555
569
580
609
633
647
663
699
743
825
895
1048

**SPECIAL SERVICES**

**Special Carton Marking**

With specially marked information N/C

**Shipping**

Shipped k.d. freight prepaid f.o.b.  
KI-Aristotle Brampton, Ontario L6T 5T6  
factory. Freight class #85.

Specifications and prices are subject to  
change without prior notice.

# Aristotle® Classic Shells

Desk Shells-24"

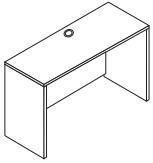
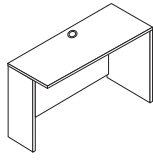
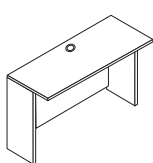
	MODEL	W x D x H	MODEL NUMBER					Approx. Packaged Weight
			Basic Model	Horizontal Surface Finish	Vertical Surface Finish	Back Panel Height	Grommets	
 <p>ARSPD</p>	<b>Desk Shells-24" Option A - Two Full End Panels</b>	24 x 24 x 29"	KDA2424.H	□□□	□□□	□□□□	□□□	70.0#
		30 x 24 x 29"	KDA3024.H	□□□	□□□	□□□□	□□□	75.0#
	• Back panel features horizontal grain pattern	36 x 24 x 29"	KDA3624.H	□□□	□□□	□□□□	□□□	80.0#
	• Recessed center support panel included with desk shells 78" or wider	48 x 24 x 29"	KDA4824.H	□□□	□□□	□□□□	□□□	95.0#
	• Optional desk shelf, specified separately	54 x 24 x 29"	KDA5424.H	□□□	□□□	□□□□	□□□	100.0#
	• Optional 1/2 and 3/4 height back panels options listed below	60 x 24 x 29"	KDA6024.H	□□□	□□□	□□□□	□□□	110.0#
	• One optional grommet center rear	66 x 24 x 29"	KDA6624.H	□□□	□□□	□□□□	□□□	115.0#
		72 x 24 x 29"	KDA7224.H	□□□	□□□	□□□□	□□□	120.0#
		42 x 24 x 29"	KDA4224.H	□□□	□□□	□□□□	□□□	85.0#
		78 x 24 x 29"	KDA7824.H	□□□	□□□	□□□□	□□□	125.0#
	84 x 24 x 29"	KDA8424.H	□□□	□□□	□□□□	□□□	130.0#	
	96 x 24 x 29"	KDA9624.H	□□□	□□□	□□□□	□□□	135.0#	
 <p>ARSPD</p>	<b>Desk Shells-24" Option B - One Recessed and One Full End Panel</b>	24 x 24 x 29"	KDB2424.H	□□□	□□□	□□□□	□□□	65.0#
		30 x 24 x 29"	KDB3024.H	□□□	□□□	□□□□	□□□	70.0#
	• Back panel features horizontal grain pattern	36 x 24 x 29"	KDB3624.H	□□□	□□□	□□□□	□□□	75.0#
	• Recessed center support panel included with desk shells 78" or wider	42 x 24 x 29"	KDB4224.H	□□□	□□□	□□□□	□□□	80.0#
	• Optional desk shelf, specified separately	48 x 24 x 29"	KDB4824.H	□□□	□□□	□□□□	□□□	90.0#
	• Optional 1/2 and 3/4 height back panels options listed below	54 x 24 x 29"	KDB5424.H	□□□	□□□	□□□□	□□□	95.0#
	• One optional grommet center rear	60 x 24 x 29"	KDB6024.H	□□□	□□□	□□□□	□□□	105.0#
		66 x 24 x 29"	KDB6624.H	□□□	□□□	□□□□	□□□	110.0#
		72 x 24 x 29"	KDB7224.H	□□□	□□□	□□□□	□□□	115.0#
		78 x 24 x 29"	KDB7824.H	□□□	□□□	□□□□	□□□	120.0#
	84 x 24 x 29"	KDB8424.H	□□□	□□□	□□□□	□□□	125.0#	
	96 x 24 x 29"	KDB9624.H	□□□	□□□	□□□□	□□□	130.0#	
 <p>ARSPD</p>	<b>Desk Shells-24" Option C - Two Recessed End Panels</b>	24 x 24 x 29"	KDC2424.H	□□□	□□□	□□□□	□□□	65.0#
		30 x 24 x 29"	KDC3024.H	□□□	□□□	□□□□	□□□	70.0#
	• Back panel features horizontal grain pattern	36 x 24 x 29"	KDC3624.H	□□□	□□□	□□□□	□□□	75.0#
	• Recessed center support panel included with desk shells 78" or wider	42 x 24 x 29"	KDC4224.H	□□□	□□□	□□□□	□□□	80.0#
	• Optional desk shelf, specified separately	48 x 24 x 29"	KDC4824.H	□□□	□□□	□□□□	□□□	90.0#
	• Optional 1/2 and 3/4 height back panels options listed below	54 x 24 x 29"	KDC5424.H	□□□	□□□	□□□□	□□□	95.0#
	• One optional grommet center rear	60 x 24 x 29"	KDC6024.H	□□□	□□□	□□□□	□□□	105.0#
		66 x 24 x 29"	KDC6624.H	□□□	□□□	□□□□	□□□	110.0#
		72 x 24 x 29"	KDC7224.H	□□□	□□□	□□□□	□□□	115.0#
		78 x 24 x 29"	KDC7824.H	□□□	□□□	□□□□	□□□	120.0#
	84 x 24 x 29"	KDC8424.H	□□□	□□□	□□□□	□□□	125.0#	
	96 x 24 x 29"	KDC9624.H	□□□	□□□	□□□□	□□□	130.0#	

**A**      **B**      **C**      **D**      **E**

## HOW TO ORDER

Indicate the following information on order form:

- Quantity of each item.
- Model number, including options. See "How To Build a Model Number".
- Any special service required.

Note: • The □ indicates that a choice is required.

- The absence of the □ indicates that no choice is required.
- Alpha-numeric characters in place of □ indicate that no other alternatives are available.

## HOW TO BUILD A MODEL NUMBER

- A** Select basic model.
- B** Select horizontal surface finish.  
Refer to color addendum at ki.com or KI Fabrics & Finishes binder.
- C** Select vertical surface finish.  
Refer to color addendum at ki.com or KI Fabrics & Finishes binder.
- D** Select back panel height.
 

<b>FULL</b>	- Full height (standard)
<b>2Q</b>	- 1/2 height back panel
<b>3Q</b>	- 3/4 height back panel
- E** Select grommet.
 

<b>NGR</b>	- No grommet
<b>G</b>	- Grommet

Grommets are factory installed.



# Aristotle® Classic Shells

Desk Shells-24"

Delivered Pricing

\$ 569  
590  
614  
657  
683  
699  
734  
777  
633  
872  
942  
1095

\$ 569  
590  
614  
633  
657  
683  
699  
734  
777  
872  
942  
1095

\$ 569  
590  
614  
633  
657  
683  
699  
734  
777  
872  
942  
1095

**SPECIAL SERVICES**

**Special Carton Marking**

With specially marked information N/C

**Shipping**

Shipped k.d. freight prepaid f.o.b.  
KI-Aristotle Brampton, Ontario L6T 5T6  
factory. Freight class #85.

Specifications and prices are subject to  
change without prior notice.

# Aristotle® Classic Shells

Desk Shells-30"

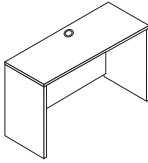
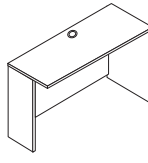
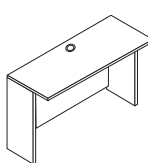
	MODEL	W x D x H	MODEL NUMBER					Approx. Packaged Weight
			Basic Model	Horizontal Surface Finish	Vertical Surface Finish	Back Panel Height	Grommets	
 <p>ARSPD</p>	<b>Desk Shells-30" Option A - Two Full End Panels</b>	24 x 30 x 29"	KDA2430.H	□□□	□□□	□□□□	□□□	80.0#
		30 x 30 x 29"	KDA3030.H	□□□	□□□	□□□□	□□□	87.0#
	• Back panel features horizontal grain pattern	36 x 30 x 29"	KDA3630.H	□□□	□□□	□□□□	□□□	95.0#
	• Recessed center support panel included with desk shells 78" or wider	42 x 30 x 29"	KDA4230.H	□□□	□□□	□□□□	□□□	102.0#
	• Optional desk shelf, specified separately	48 x 30 x 29"	KDA4830.H	□□□	□□□	□□□□	□□□	110.0#
	• Optional 1/2 and 3/4 height back panels options listed below	54 x 30 x 29"	KDA5430.H	□□□	□□□	□□□□	□□□	117.0#
	• One optional grommet center rear	60 x 30 x 29"	KDA6030.H	□□□	□□□	□□□□	□□□	125.0#
		66 x 30 x 29"	KDA6630.H	□□□	□□□	□□□□	□□□	132.0#
		72 x 30 x 29"	KDA7230.H	□□□	□□□	□□□□	□□□	140.0#
		78 x 30 x 29"	KDA7830.H	□□□	□□□	□□□□	□□□	150.0#
	84 x 30 x 29"	KDA8430.H	□□□	□□□	□□□□	□□□	157.0#	
	96 x 30 x 29"	KDA9630.H	□□□	□□□	□□□□	□□□	164.0#	
 <p>ARSPD</p>	<b>Desk Shells-30" Option B - One Recessed and One Full End Panel</b>	24 x 30 x 29"	KDB2430.H	□□□	□□□	□□□□	□□□	75.0#
		30 x 30 x 29"	KDB3030.H	□□□	□□□	□□□□	□□□	82.0#
	• Back panel features horizontal grain pattern	36 x 30 x 29"	KDB3630.H	□□□	□□□	□□□□	□□□	90.0#
	• Recessed center support panel included with desk shells 78" or wider	42 x 30 x 29"	KDB4230.H	□□□	□□□	□□□□	□□□	97.0#
	• Optional desk shelf, specified separately	48 x 30 x 29"	KDB4830.H	□□□	□□□	□□□□	□□□	105.0#
	• Optional 1/2 and 3/4 height back panels options listed below	54 x 30 x 29"	KDB5430.H	□□□	□□□	□□□□	□□□	112.0#
	• One optional grommet center rear	60 x 30 x 29"	KDB6030.H	□□□	□□□	□□□□	□□□	120.0#
		66 x 30 x 29"	KDB6630.H	□□□	□□□	□□□□	□□□	127.0#
		72 x 30 x 29"	KDB7230.H	□□□	□□□	□□□□	□□□	135.0#
		78 x 30 x 29"	KDB7830.H	□□□	□□□	□□□□	□□□	145.0#
	84 x 30 x 29"	KDB8430.H	□□□	□□□	□□□□	□□□	152.0#	
	96 x 30 x 29"	KDB9630.H	□□□	□□□	□□□□	□□□	159.0#	
 <p>ARSPD</p>	<b>Desk Shells-30" Option C - Two Recessed End Panels</b>	24 x 30 x 29"	KDC2430.H	□□□	□□□	□□□□	□□□	75.0#
		30 x 30 x 29"	KDC3030.H	□□□	□□□	□□□□	□□□	82.0#
	• Back panel features horizontal grain pattern	36 x 30 x 29"	KDC3630.H	□□□	□□□	□□□□	□□□	90.0#
	• Recessed center support panel included with desk shells 78" or wider	42 x 30 x 29"	KDC4230.H	□□□	□□□	□□□□	□□□	97.0#
	• Optional desk shelf, specified separately	48 x 30 x 29"	KDC4830.H	□□□	□□□	□□□□	□□□	105.0#
	• Optional 1/2 and 3/4 height back panels options listed below	54 x 30 x 29"	KDC5430.H	□□□	□□□	□□□□	□□□	112.0#
	• One optional grommet center rear	60 x 30 x 29"	KDC6030.H	□□□	□□□	□□□□	□□□	120.0#
		66 x 30 x 29"	KDC6630.H	□□□	□□□	□□□□	□□□	127.0#
		72 x 30 x 29"	KDC7230.H	□□□	□□□	□□□□	□□□	135.0#
		78 x 30 x 29"	KDC7830.H	□□□	□□□	□□□□	□□□	145.0#
	84 x 30 x 29"	KDC8430.H	□□□	□□□	□□□□	□□□	152.0#	
	96 x 30 x 29"	KDC9630.H	□□□	□□□	□□□□	□□□	159.0#	

**A**      **B**      **C**      **D**      **E**

## HOW TO ORDER

Indicate the following information on order form:

- Quantity of each item.
- Model number, including options. See "How To Build a Model Number".
- Any special service required.

Note: • The □ indicates that a choice is required.

- The absence of the □ indicates that no choice is required.
- Alpha-numeric characters in place of □ indicate that no other alternatives are available.

## HOW TO BUILD A MODEL NUMBER

- A** Select basic model.
- B** Select horizontal surface finish.  
Refer to color addendum at ki.com or KI Fabrics & Finishes binder.
- C** Select vertical surface finish.  
Refer to color addendum at ki.com or KI Fabrics & Finishes binder.
- D** Select back panel height.
 

<b>FULL</b>	- Full height (standard)
<b>2Q</b>	- 1/2 height back panel
<b>3Q</b>	- 3/4 height back panel
- E** Select grommet.
 

<b>NGR</b>	- No grommet
<b>G</b>	- Grommet

Grommets are factory installed.



# Aristotle® Classic Shells

Desk Shells-30"

Delivered Pricing

\$ 603  
 627  
 651  
 693  
 715  
 743  
 734  
 816  
 859  
 955  
 1049  
 1200

\$ 603  
 627  
 651  
 693  
 715  
 743  
 734  
 816  
 859  
 955  
 1049  
 1200

\$ 603  
 627  
 651  
 693  
 715  
 743  
 734  
 816  
 859  
 955  
 1049  
 1200

**SPECIAL SERVICES**

**Special Carton Marking**

With specially marked information N/C

**Shipping**

Shipped k.d. freight prepaid f.o.b.  
**KI-Aristotle Brampton, Ontario L6T 5T6**  
 factory. Freight class #85.

Specifications and prices are subject to  
 change without prior notice.

# Aristotle® Classic Shells

Desk Shells-Inset Back Panel

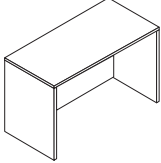
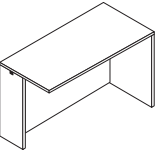
	MODEL	W x D x H	MODEL NUMBER			Approx. Packaged Weight
			Basic Model	Horizontal Surface Finish	Vertical Surface Finish	
 <p>ARDSI</p>	<b>Desk Shells-Inset Back Panel Option A - Two Full End Panels</b> <ul style="list-style-type: none"> <li>• Full height back panel is inset 6" on 30" deep desks and 12" on 36" deep desks</li> <li>• Back panel features horizontal wood grain</li> <li>• Recessed center support panel included with desk shells 78" or wider</li> <li>• Standard without grommets</li> <li>• Notch option enables an inline transition from a larger depth worksurface to a 6" shorter depth</li> </ul>	24 x 30 x 29"	KDAI2430.H	<input type="checkbox"/> <input type="checkbox"/> <input type="checkbox"/> <input type="checkbox"/>	<input type="checkbox"/> <input type="checkbox"/> <input type="checkbox"/> <input type="checkbox"/>	80.0#
		30 x 30 x 29"	KDAI3030.H	<input type="checkbox"/> <input type="checkbox"/> <input type="checkbox"/> <input type="checkbox"/>	<input type="checkbox"/> <input type="checkbox"/> <input type="checkbox"/> <input type="checkbox"/>	87.0#
		36 x 30 x 29"	KDAI3630.H	<input type="checkbox"/> <input type="checkbox"/> <input type="checkbox"/> <input type="checkbox"/>	<input type="checkbox"/> <input type="checkbox"/> <input type="checkbox"/> <input type="checkbox"/>	95.0#
		42 x 30 x 29"	KDAI4230.H	<input type="checkbox"/> <input type="checkbox"/> <input type="checkbox"/> <input type="checkbox"/>	<input type="checkbox"/> <input type="checkbox"/> <input type="checkbox"/> <input type="checkbox"/>	102.0#
		48 x 30 x 29"	KDAI4830.H	<input type="checkbox"/> <input type="checkbox"/> <input type="checkbox"/> <input type="checkbox"/>	<input type="checkbox"/> <input type="checkbox"/> <input type="checkbox"/> <input type="checkbox"/>	110.0#
		54 x 30 x 29"	KDAI5430.H	<input type="checkbox"/> <input type="checkbox"/> <input type="checkbox"/> <input type="checkbox"/>	<input type="checkbox"/> <input type="checkbox"/> <input type="checkbox"/> <input type="checkbox"/>	117.0#
		60 x 30 x 29"	KDAI6030.H	<input type="checkbox"/> <input type="checkbox"/> <input type="checkbox"/> <input type="checkbox"/>	<input type="checkbox"/> <input type="checkbox"/> <input type="checkbox"/> <input type="checkbox"/>	125.0#
		66 x 30 x 29"	KDAI6630.H	<input type="checkbox"/> <input type="checkbox"/> <input type="checkbox"/> <input type="checkbox"/>	<input type="checkbox"/> <input type="checkbox"/> <input type="checkbox"/> <input type="checkbox"/>	132.0#
		72 x 30 x 29"	KDAI7230.H	<input type="checkbox"/> <input type="checkbox"/> <input type="checkbox"/> <input type="checkbox"/>	<input type="checkbox"/> <input type="checkbox"/> <input type="checkbox"/> <input type="checkbox"/>	140.0#
		78 x 30 x 29"	KDAI7830.H	<input type="checkbox"/> <input type="checkbox"/> <input type="checkbox"/> <input type="checkbox"/>	<input type="checkbox"/> <input type="checkbox"/> <input type="checkbox"/> <input type="checkbox"/>	150.0#
		84 x 30 x 29"	KDAI8430.H	<input type="checkbox"/> <input type="checkbox"/> <input type="checkbox"/> <input type="checkbox"/>	<input type="checkbox"/> <input type="checkbox"/> <input type="checkbox"/> <input type="checkbox"/>	157.0#
		96 x 30 x 29"	KDAI9630.H	<input type="checkbox"/> <input type="checkbox"/> <input type="checkbox"/> <input type="checkbox"/>	<input type="checkbox"/> <input type="checkbox"/> <input type="checkbox"/> <input type="checkbox"/>	164.0#
		60 x 36 x 29"	KDAI6036.H	<input type="checkbox"/> <input type="checkbox"/> <input type="checkbox"/> <input type="checkbox"/>	<input type="checkbox"/> <input type="checkbox"/> <input type="checkbox"/> <input type="checkbox"/>	135.0#
		66 x 36 x 29"	KDAI6636.H	<input type="checkbox"/> <input type="checkbox"/> <input type="checkbox"/> <input type="checkbox"/>	<input type="checkbox"/> <input type="checkbox"/> <input type="checkbox"/> <input type="checkbox"/>	142.0#
72 x 36 x 29"	KDAI7236.H	<input type="checkbox"/> <input type="checkbox"/> <input type="checkbox"/> <input type="checkbox"/>	<input type="checkbox"/> <input type="checkbox"/> <input type="checkbox"/> <input type="checkbox"/>	150.0#		
 <p>ARDSI</p>	<b>Desk Shells-Inset Back Panel Option B - One Recessed and One Full End Panel (interchangeable)</b> <ul style="list-style-type: none"> <li>• Full height back panel is inset 6" on 30" deep desks and 12" on 36" deep desks</li> <li>• Back panel features horizontal wood grain</li> <li>• Recessed center support panel included with desk shells 78" or wider</li> <li>• Standard without grommets</li> <li>• Notch option enables an inline transition from a larger depth worksurface to a 6" shorter depth</li> </ul>	24 x 30 x 29"	KDBI2430.H	<input type="checkbox"/> <input type="checkbox"/> <input type="checkbox"/> <input type="checkbox"/>	<input type="checkbox"/> <input type="checkbox"/> <input type="checkbox"/> <input type="checkbox"/>	75.0#
		30 x 30 x 29"	KDBI3030.H	<input type="checkbox"/> <input type="checkbox"/> <input type="checkbox"/> <input type="checkbox"/>	<input type="checkbox"/> <input type="checkbox"/> <input type="checkbox"/> <input type="checkbox"/>	82.0#
		36 x 30 x 29"	KDBI3630.H	<input type="checkbox"/> <input type="checkbox"/> <input type="checkbox"/> <input type="checkbox"/>	<input type="checkbox"/> <input type="checkbox"/> <input type="checkbox"/> <input type="checkbox"/>	90.0#
		42 x 30 x 29"	KDBI4230.H	<input type="checkbox"/> <input type="checkbox"/> <input type="checkbox"/> <input type="checkbox"/>	<input type="checkbox"/> <input type="checkbox"/> <input type="checkbox"/> <input type="checkbox"/>	97.0#
		48 x 30 x 29"	KDBI4830.H	<input type="checkbox"/> <input type="checkbox"/> <input type="checkbox"/> <input type="checkbox"/>	<input type="checkbox"/> <input type="checkbox"/> <input type="checkbox"/> <input type="checkbox"/>	105.0#
		54 x 30 x 29"	KDBI5430.H	<input type="checkbox"/> <input type="checkbox"/> <input type="checkbox"/> <input type="checkbox"/>	<input type="checkbox"/> <input type="checkbox"/> <input type="checkbox"/> <input type="checkbox"/>	112.0#
		60 x 30 x 29"	KDBI6030.H	<input type="checkbox"/> <input type="checkbox"/> <input type="checkbox"/> <input type="checkbox"/>	<input type="checkbox"/> <input type="checkbox"/> <input type="checkbox"/> <input type="checkbox"/>	120.0#
		66 x 30 x 29"	KDBI6630.H	<input type="checkbox"/> <input type="checkbox"/> <input type="checkbox"/> <input type="checkbox"/>	<input type="checkbox"/> <input type="checkbox"/> <input type="checkbox"/> <input type="checkbox"/>	127.0#
		72 x 30 x 29"	KDBI7230.H	<input type="checkbox"/> <input type="checkbox"/> <input type="checkbox"/> <input type="checkbox"/>	<input type="checkbox"/> <input type="checkbox"/> <input type="checkbox"/> <input type="checkbox"/>	135.0#
		78 x 30 x 29"	KDBI7830.H	<input type="checkbox"/> <input type="checkbox"/> <input type="checkbox"/> <input type="checkbox"/>	<input type="checkbox"/> <input type="checkbox"/> <input type="checkbox"/> <input type="checkbox"/>	145.0#
		84 x 30 x 29"	KDBI8430.H	<input type="checkbox"/> <input type="checkbox"/> <input type="checkbox"/> <input type="checkbox"/>	<input type="checkbox"/> <input type="checkbox"/> <input type="checkbox"/> <input type="checkbox"/>	152.0#
		96 x 30 x 29"	KDBI9630.H	<input type="checkbox"/> <input type="checkbox"/> <input type="checkbox"/> <input type="checkbox"/>	<input type="checkbox"/> <input type="checkbox"/> <input type="checkbox"/> <input type="checkbox"/>	159.0#
		60 x 36 x 29"	KDBI6036.H	<input type="checkbox"/> <input type="checkbox"/> <input type="checkbox"/> <input type="checkbox"/>	<input type="checkbox"/> <input type="checkbox"/> <input type="checkbox"/> <input type="checkbox"/>	130.0#
		66 x 36 x 29"	KDBI6636.H	<input type="checkbox"/> <input type="checkbox"/> <input type="checkbox"/> <input type="checkbox"/>	<input type="checkbox"/> <input type="checkbox"/> <input type="checkbox"/> <input type="checkbox"/>	137.0#
72 x 36 x 29"	KDBI7236.H	<input type="checkbox"/> <input type="checkbox"/> <input type="checkbox"/> <input type="checkbox"/>	<input type="checkbox"/> <input type="checkbox"/> <input type="checkbox"/> <input type="checkbox"/>	145.0#		

A

B

C

## HOW TO ORDER

Indicate the following information on order form:

1. Quantity of each item.
2. Model number, including options. See "How To Build a Model Number".
3. Any special service required.

Note: • The  indicates that a choice is required.

- The absence of the  indicates that no choice is required.
- Alpha-numeric characters in place of  indicate that no other alternatives are available.

## HOW TO BUILD A MODEL NUMBER

- A** Select basic model.
- B** Select horizontal surface finish.  
Refer to color addendum at [ki.com](http://ki.com) or KI Fabrics & Finishes binder.
- C** Select vertical surface finish.  
Refer to color addendum at [ki.com](http://ki.com) or KI Fabrics & Finishes binder.



Delivered Pricing

\$ 603  
627  
651  
693  
715  
743  
734  
816  
859  
955  
1049  
1200  
871  
896  
921

\$ 603  
627  
651  
693  
715  
743  
734  
816  
859  
955  
1049  
1200  
871  
896  
921

**SPECIAL SERVICES**

**Special Carton Marking**

With specially marked information N/C

**Shipping**

Shipped k.d. freight prepaid f.o.b.  
KI-Aristotle Brampton, Ontario L6T 5T6  
factory. Freight class #85.

Specifications and prices are subject to  
change without prior notice.

# Aristotle® Classic Shells

Extended Corner Desk Shells - 20" - Extended Left

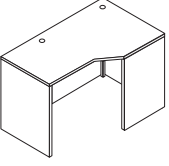
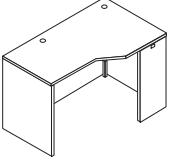
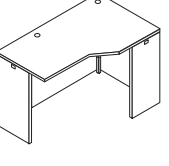
MODEL	W x D x H	MODEL NUMBER						
		Basic Model	Horizontal Surface Finish	Vertical Surface Finish	Leg Finish	Back Panel Height	Cutaway	Grommets
 <p><b>Extended-Left Option A-Two Full End Panels</b></p> <ul style="list-style-type: none"> <li>• Corner post in black or silver</li> <li>• Back panel features horizontal grain pattern</li> <li>• Cutaway may be straight or curved</li> <li>• 20" desks do not accommodate pedestals</li> </ul>	60 x 36 x 29"	KCDLA6020.H	□□□	□□□	□□	□□□□	□□	□□□
	66 x 36 x 29"	KCDLA6620.H	□□□	□□□	□□	□□□□	□□	□□□
	72 x 36 x 29"	KCDLA7220.H	□□□	□□□	□□	□□□□	□□	□□□
ARSPD								
 <p><b>Extended-Left, Option B - One Full/One Recessed End Panel, Interchangeable</b></p> <ul style="list-style-type: none"> <li>• Corner post in black or silver</li> <li>• Back panel features horizontal grain pattern</li> <li>• Cutaway may be straight or curved</li> <li>• 20" desks do not accommodate pedestals</li> </ul>	60 x 36 x 29"	KCDLB6020.H	□□□	□□□	□□	□□□□	□□	□□□
	66 x 36 x 29"	KCDLB6620.H	□□□	□□□	□□	□□□□	□□	□□□
	72 x 36 x 29"	KCDLB7220.H	□□□	□□□	□□	□□□□	□□	□□□
ARSPD								
 <p><b>Extended-Left Option C-Two Recessed End Panels</b></p> <ul style="list-style-type: none"> <li>• Corner post in black or silver</li> <li>• Back panel features horizontal grain pattern</li> <li>• Cutaway may be straight or curved</li> <li>• 20" desks do not accommodate pedestals</li> </ul>	60 x 36 x 29"	KCDLC6020.H	□□□	□□□	□□	□□□□	□□	□□□
	66 x 36 x 29"	KCDLC6620.H	□□□	□□□	□□	□□□□	□□	□□□
	72 x 36 x 29"	KCDLC7220.H	□□□	□□□	□□	□□□□	□□	□□□
ARSPD								

**A**      **B**      **C**      **D**      **E**      **F**      **G**

## HOW TO ORDER

Indicate the following information on order form:

1. Quantity of each item.
2. Model number, including options. See "How To Build a Model Number".
3. Any special service required.

Note: • The □ indicates that a choice is required.

- The absence of the □ indicates that no choice is required.
- Alpha-numeric characters in place of □ indicate that no other alternatives are available.

## HOW TO BUILD A MODEL NUMBER

- A** Select basic model.
- B** Select horizontal surface finish. Refer to color addendum at ki.com or KI Fabrics & Finishes binder.
- C** Select vertical surface finish. Refer to color addendum at ki.com or KI Fabrics & Finishes binder.
- D** Select corner leg finish. Refer to color addendum at ki.com or KI Fabrics & Finishes binder.
- E** Select back panel height.
 

FULL	- Full height (standard)
2Q	- 1/2 height back panel
2QL	- 1/2 height back panel, left
2QR	- 1/2 height back panel, right
3Q	- 3/4 height back panel
3QL	- 3/4 height back panel, left
3QR	- 3/4 height back panel, right

**F** Select cutaway option.

- |    |                    |
|----|--------------------|
| ST | - Straight cutaway |
| CV | - Curved cutaway   |

**G** Select grommet.

- |     |              |
|-----|--------------|
| NGR | - No grommet |
| G   | - Grommet    |





# Aristotle® Classic Shells

Extended Corner Desk Shells - 20" - Extended Left

Approx. Packaged Weight	Delivered Pricing
115.0#	\$ 971
125.0#	1077
135.0#	1164

115.0#	\$ 971
125.0#	1077
135.0#	1164

115.0#	\$ 971
125.0#	1077
135.0#	1164

**SPECIAL SERVICES**

**Special Carton Marking**

With specially marked information N/C

**Shipping**

Shipped k.d. freight prepaid f.o.b. KI-Aristotle Brampton, Ontario L6T 5T6 factory. Freight class #85.

Specifications and prices are subject to change without prior notice.

# Aristotle® Classic Shells

Extended Corner Desk Shells - 20" - Extended Right

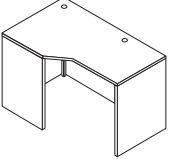
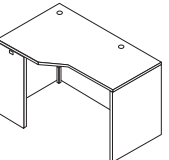
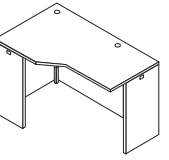
MODEL	W x D x H	MODEL NUMBER						
		Basic Model	Horizontal Surface Finish	Vertical Surface Finish	Leg Finish	Back Panel Height	Cutaway	Grommets
 <p><b>Extended-Right Option A-Two Full End Panels</b></p> <ul style="list-style-type: none"> <li>• Corner post in black or silver</li> <li>• Back panel features horizontal grain pattern</li> <li>• Cutaway may be straight or curved</li> <li>• 20" desks do not accommodate pedestals</li> </ul>	60 x 36 x 29"	KCDRA6020.H	<input type="checkbox"/> <input type="checkbox"/> <input type="checkbox"/>	<input type="checkbox"/> <input type="checkbox"/> <input type="checkbox"/>	<input type="checkbox"/> <input type="checkbox"/>	<input type="checkbox"/> <input type="checkbox"/> <input type="checkbox"/> <input type="checkbox"/>	<input type="checkbox"/> <input type="checkbox"/>	<input type="checkbox"/> <input type="checkbox"/>
	66 x 36 x 29"	KCDRA6620.H	<input type="checkbox"/> <input type="checkbox"/> <input type="checkbox"/>	<input type="checkbox"/> <input type="checkbox"/> <input type="checkbox"/>	<input type="checkbox"/> <input type="checkbox"/>	<input type="checkbox"/> <input type="checkbox"/> <input type="checkbox"/> <input type="checkbox"/>	<input type="checkbox"/> <input type="checkbox"/>	<input type="checkbox"/> <input type="checkbox"/>
	72 x 36 x 29"	KCDRA7220.H	<input type="checkbox"/> <input type="checkbox"/> <input type="checkbox"/>	<input type="checkbox"/> <input type="checkbox"/> <input type="checkbox"/>	<input type="checkbox"/> <input type="checkbox"/>	<input type="checkbox"/> <input type="checkbox"/> <input type="checkbox"/> <input type="checkbox"/>	<input type="checkbox"/> <input type="checkbox"/>	<input type="checkbox"/> <input type="checkbox"/>
ARSPD								
 <p><b>Extended-Right Option B-One Full/One Recessed End Panel, Interchangeable</b></p> <ul style="list-style-type: none"> <li>• Corner post in black or silver</li> <li>• Back panel features horizontal grain pattern</li> <li>• Cutaway may be straight or curved</li> <li>• 20" desks do not accommodate pedestals</li> </ul>	60 x 36 x 29"	KCDRB6020.H	<input type="checkbox"/> <input type="checkbox"/> <input type="checkbox"/>	<input type="checkbox"/> <input type="checkbox"/> <input type="checkbox"/>	<input type="checkbox"/> <input type="checkbox"/>	<input type="checkbox"/> <input type="checkbox"/> <input type="checkbox"/> <input type="checkbox"/>	<input type="checkbox"/> <input type="checkbox"/>	<input type="checkbox"/> <input type="checkbox"/>
	66 x 36 x 29"	KCDRB6620.H	<input type="checkbox"/> <input type="checkbox"/> <input type="checkbox"/>	<input type="checkbox"/> <input type="checkbox"/> <input type="checkbox"/>	<input type="checkbox"/> <input type="checkbox"/>	<input type="checkbox"/> <input type="checkbox"/> <input type="checkbox"/> <input type="checkbox"/>	<input type="checkbox"/> <input type="checkbox"/>	<input type="checkbox"/> <input type="checkbox"/>
	72 x 36 x 29"	KCDRB7220.H	<input type="checkbox"/> <input type="checkbox"/> <input type="checkbox"/> <input type="checkbox"/>	<input type="checkbox"/> <input type="checkbox"/> <input type="checkbox"/>	<input type="checkbox"/> <input type="checkbox"/>	<input type="checkbox"/> <input type="checkbox"/> <input type="checkbox"/> <input type="checkbox"/>	<input type="checkbox"/> <input type="checkbox"/>	<input type="checkbox"/> <input type="checkbox"/>
ARSPD								
 <p><b>Extended-Right Option C-Two Recessed End Panels</b></p> <ul style="list-style-type: none"> <li>• Corner post in black or silver</li> <li>• Back panel features horizontal grain pattern</li> <li>• Cutaway may be straight or curved</li> <li>• 20" desks do not accommodate pedestals</li> </ul>	60 x 36 x 29"	KCDRC6020.H	<input type="checkbox"/> <input type="checkbox"/> <input type="checkbox"/>	<input type="checkbox"/> <input type="checkbox"/> <input type="checkbox"/>	<input type="checkbox"/> <input type="checkbox"/>	<input type="checkbox"/> <input type="checkbox"/> <input type="checkbox"/> <input type="checkbox"/>	<input type="checkbox"/> <input type="checkbox"/>	<input type="checkbox"/> <input type="checkbox"/>
	66 x 36 x 29"	KCDRC6620.H	<input type="checkbox"/> <input type="checkbox"/> <input type="checkbox"/>	<input type="checkbox"/> <input type="checkbox"/> <input type="checkbox"/>	<input type="checkbox"/> <input type="checkbox"/>	<input type="checkbox"/> <input type="checkbox"/> <input type="checkbox"/> <input type="checkbox"/>	<input type="checkbox"/> <input type="checkbox"/>	<input type="checkbox"/> <input type="checkbox"/>
	72 x 36 x 29"	KCDRC7220.H	<input type="checkbox"/> <input type="checkbox"/> <input type="checkbox"/>	<input type="checkbox"/> <input type="checkbox"/> <input type="checkbox"/>	<input type="checkbox"/> <input type="checkbox"/>	<input type="checkbox"/> <input type="checkbox"/> <input type="checkbox"/> <input type="checkbox"/>	<input type="checkbox"/> <input type="checkbox"/>	<input type="checkbox"/> <input type="checkbox"/>
ARSPD								

**A**      **B**      **C**      **D**      **E**      **F**      **G**

## HOW TO ORDER

Indicate the following information on order form:

1. Quantity of each item.
2. Model number, including options. See "How To Build a Model Number".
3. Any special service required.

Note: • The  indicates that a choice is required.

- The absence of the  indicates that no choice is required.
- Alpha-numeric characters in place of  indicate that no other alternatives are available.

## HOW TO BUILD A MODEL NUMBER

- A** Select basic model.
- B** Select horizontal surface finish.  
Refer to color addendum at ki.com or KI Fabrics & Finishes binder.
- C** Select vertical surface finish.  
Refer to color addendum at ki.com or KI Fabrics & Finishes binder.
- D** Select corner leg finish  
Refer to color addendum at ki.com or KI Fabrics & Finishes binder.
- E** Select back panel height.
 

FULL	- Full height (standard)
2Q	- 1/2 height back panel
2QL	- 1/2 height back panel, left
2QR	- 1/2 height back panel, right
3Q	- 3/4 height back panel
3QL	- 3/4 height back panel, left
3QR	- 3/4 height back panel, right

**F** Select cutaway option.

- |    |                    |
|----|--------------------|
| ST | - Straight cutaway |
| CV | - Curved cutaway   |

**G** Select grommet.

- |     |              |
|-----|--------------|
| NGR | - No grommet |
| G   | - Grommet    |



# Aristotle® Classic Shells

Extended Corner Desk Shells - 20" - Extended Right

Approx. Packaged Weight	Delivered Pricing
115.0#	\$ 971
125.0#	1077
135.0#	1164

115.0#	\$ 971
125.0#	1077
135.0#	1164

115.0#	\$ 971
125.0#	1077
135.0#	1164

**SPECIAL SERVICES**

**Special Carton Marking**

With specially marked information N/C

**Shipping**

Shipped k.d. freight prepaid f.o.b. KI-Aristotle Brampton, Ontario L6T 5T6 factory. Freight class #85.

Specifications and prices are subject to change without prior notice.

# Aristotle® Classic Shells

Extended Corner Desk Shells - 24" - Extended Left

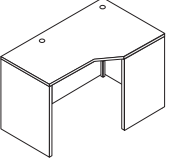
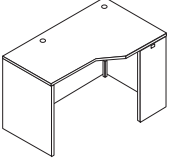
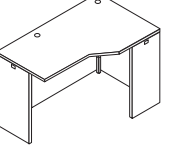
MODEL		W x D x H	MODEL NUMBER						
			Basic Model	Horizontal Surface Finish	Vertical Surface Finish	Leg Finish	Back Panel Height	Cutaway	Grommets
	<b>Extended-Left Option A-Two Full End Panels</b> • Corner post in black or silver • Back panel features horizontal grain pattern • Cutaway may be straight or curved • 20" desks do not accommodate pedestals	60 x 36 x 29"	KCDLA6024.H	□□□	□□□	□□	□□□□	□□	□□□
		66 x 36 x 29"	KCDLA6624.H	□□□	□□□	□□	□□□□	□□	□□□
		72 x 36 x 29"	KCDLA7224.H	□□□	□□□	□□	□□□□	□□	□□□
ARSPD									
	<b>Extended-Left, Option B - One Full/One Recessed End Panel, Interchangeable</b> • Corner post in black or silver • Back panel features horizontal grain pattern • Cutaway may be straight or curved • 20" desks do not accommodate pedestals	60 x 36 x 29"	KCDLB6024.H	□□□	□□□	□□	□□□□	□□	□□□
		66 x 36 x 29"	KCDLB6624.H	□□□	□□□	□□	□□□□	□□	□□□
		72 x 36 x 29"	KCDLB7224.H	□□□	□□□	□□	□□□□	□□	□□□
ARSPD									
	<b>Extended-Left Option C-Two Recessed End Panels</b> • Corner post in black or silver • Back panel features horizontal grain pattern • Cutaway may be straight or curved • 20" desks do not accommodate pedestals	60 x 36 x 29"	KCDLC6024.H	□□□	□□□	□□	□□□□	□□	□□□
		66 x 36 x 29"	KCDLC6624.H	□□□	□□□	□□	□□□□	□□	□□□
		72 x 36 x 29"	KCDLC7224.H	□□□	□□□	□□	□□□□	□□	□□□
ARSPD									
			<b>A</b>	<b>B</b>	<b>C</b>	<b>D</b>	<b>E</b>	<b>F</b>	<b>G</b>

## HOW TO ORDER

Indicate the following information on order form:

- Quantity of each item.
- Model number, including options. See "How To Build a Model Number".
- Any special service required.

Note: • The  indicates that a choice is required.

- The absence of the  indicates that no choice is required.
- Alpha-numeric characters in place of  indicate that no other alternatives are available.

## HOW TO BUILD A MODEL NUMBER

- A** Select basic model.
- B** Select horizontal surface finish.  
Refer to color addendum at ki.com or KI Fabrics & Finishes binder.
- C** Select vertical surface finish.  
Refer to color addendum at ki.com or KI Fabrics & Finishes binder.
- D** Select corner leg finish  
Refer to color addendum at ki.com or KI Fabrics & Finishes binder.
- E** Select back panel height.
 

<b>FULL</b>	- Full height (standard)
<b>2Q</b>	- 1/2 height back panel
<b>2QL</b>	- 1/2 height back panel, left
<b>2QR</b>	- 1/2 height back panel, right
<b>3Q</b>	- 3/4 height back panel
<b>3QL</b>	- 3/4 height back panel, left
<b>3QR</b>	- 3/4 height back panel, right

- F** Select cutaway option.
 

<b>ST</b>	- Straight cutaway
<b>CV</b>	- Curved cutaway
- G** Select grommet.
 

<b>NGR</b>	- No grommet
<b>G</b>	- Grommet



# Aristotle® Classic Shells

Extended Corner Desk Shells - 24" - Extended Left

Approx. Packaged Weight	Delivered Pricing
115.0#	\$ 983
125.0#	1077
135.0#	1164

115.0#	\$ 983
125.0#	1077
135.0#	1164

115.0#	\$ 983
125.0#	1077
135.0#	1164

### SPECIAL SERVICES

#### Special Carton Marking

With specially marked information N/C

#### Shipping

Shipped k.d. freight prepaid f.o.b. KI-Aristotle Brampton, Ontario L6T 5T6 factory. Freight class #85.

Specifications and prices are subject to change without prior notice.

# Aristotle® Classic Shells

Extended Corner Desk Shells - 24" - Extended Right

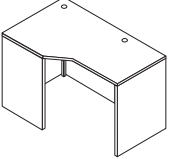
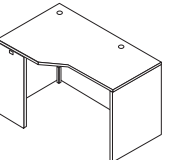
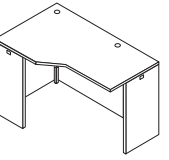
MODEL	W x D x H	MODEL NUMBER						
		Basic Model	Horizontal Surface Finish	Vertical Surface Finish	Leg Finish	Back Panel Height	Cutaway	Grommets
 <p><b>Extended-Right Option A-Two Full End Panels</b></p> <ul style="list-style-type: none"> <li>• Corner post in black or silver</li> <li>• Back panel features horizontal grain pattern</li> <li>• Cutaway may be straight or curved</li> <li>• 20" desks do not accommodate pedestals</li> </ul>	60 x 36 x 29"	KCDRA6024.H	<input type="checkbox"/> <input type="checkbox"/> <input type="checkbox"/>	<input type="checkbox"/> <input type="checkbox"/> <input type="checkbox"/>	<input type="checkbox"/> <input type="checkbox"/>	<input type="checkbox"/> <input type="checkbox"/> <input type="checkbox"/> <input type="checkbox"/>	<input type="checkbox"/> <input type="checkbox"/>	<input type="checkbox"/> <input type="checkbox"/> <input type="checkbox"/>
	66 x 36 x 29"	KCDRA6624.H	<input type="checkbox"/> <input type="checkbox"/> <input type="checkbox"/>	<input type="checkbox"/> <input type="checkbox"/> <input type="checkbox"/>	<input type="checkbox"/> <input type="checkbox"/>	<input type="checkbox"/> <input type="checkbox"/> <input type="checkbox"/> <input type="checkbox"/>	<input type="checkbox"/> <input type="checkbox"/>	<input type="checkbox"/> <input type="checkbox"/> <input type="checkbox"/>
	72 x 36 x 29"	KCDRA7224.H	<input type="checkbox"/> <input type="checkbox"/> <input type="checkbox"/>	<input type="checkbox"/> <input type="checkbox"/> <input type="checkbox"/>	<input type="checkbox"/> <input type="checkbox"/>	<input type="checkbox"/> <input type="checkbox"/> <input type="checkbox"/> <input type="checkbox"/>	<input type="checkbox"/> <input type="checkbox"/>	<input type="checkbox"/> <input type="checkbox"/> <input type="checkbox"/>
ARSPD								
 <p><b>Extended-Right Option B-One Full/One Recessed End Panel, Interchangeable</b></p> <ul style="list-style-type: none"> <li>• Corner post in black or silver</li> <li>• Back panel features horizontal grain pattern</li> <li>• Cutaway may be straight or curved</li> <li>• 20" desks do not accommodate pedestals</li> </ul>	60 x 36 x 29"	KCDRB6024.H	<input type="checkbox"/> <input type="checkbox"/> <input type="checkbox"/>	<input type="checkbox"/> <input type="checkbox"/> <input type="checkbox"/>	<input type="checkbox"/> <input type="checkbox"/>	<input type="checkbox"/> <input type="checkbox"/> <input type="checkbox"/> <input type="checkbox"/>	<input type="checkbox"/> <input type="checkbox"/>	<input type="checkbox"/> <input type="checkbox"/> <input type="checkbox"/>
	66 x 36 x 29"	KCDRB6624.H	<input type="checkbox"/> <input type="checkbox"/> <input type="checkbox"/>	<input type="checkbox"/> <input type="checkbox"/> <input type="checkbox"/>	<input type="checkbox"/> <input type="checkbox"/>	<input type="checkbox"/> <input type="checkbox"/> <input type="checkbox"/> <input type="checkbox"/>	<input type="checkbox"/> <input type="checkbox"/>	<input type="checkbox"/> <input type="checkbox"/> <input type="checkbox"/>
	72 x 36 x 29"	KCDRB7224.H	<input type="checkbox"/> <input type="checkbox"/> <input type="checkbox"/>	<input type="checkbox"/> <input type="checkbox"/> <input type="checkbox"/>	<input type="checkbox"/> <input type="checkbox"/>	<input type="checkbox"/> <input type="checkbox"/> <input type="checkbox"/> <input type="checkbox"/>	<input type="checkbox"/> <input type="checkbox"/>	<input type="checkbox"/> <input type="checkbox"/> <input type="checkbox"/>
ARSPD								
 <p><b>Extended-Right Option C-Two Recessed End Panels</b></p> <ul style="list-style-type: none"> <li>• Corner post in black or silver</li> <li>• Back panel features horizontal grain pattern</li> <li>• Cutaway may be straight or curved</li> <li>• 20" desks do not accommodate pedestals</li> </ul>	60 x 36 x 29"	KCDRC6024.H	<input type="checkbox"/> <input type="checkbox"/> <input type="checkbox"/>	<input type="checkbox"/> <input type="checkbox"/> <input type="checkbox"/>	<input type="checkbox"/> <input type="checkbox"/>	<input type="checkbox"/> <input type="checkbox"/> <input type="checkbox"/> <input type="checkbox"/>	<input type="checkbox"/> <input type="checkbox"/>	<input type="checkbox"/> <input type="checkbox"/> <input type="checkbox"/>
	66 x 36 x 29"	KCDRC6624.H	<input type="checkbox"/> <input type="checkbox"/> <input type="checkbox"/>	<input type="checkbox"/> <input type="checkbox"/> <input type="checkbox"/>	<input type="checkbox"/> <input type="checkbox"/>	<input type="checkbox"/> <input type="checkbox"/> <input type="checkbox"/> <input type="checkbox"/>	<input type="checkbox"/> <input type="checkbox"/>	<input type="checkbox"/> <input type="checkbox"/> <input type="checkbox"/>
	72 x 36 x 29"	KCDRC7224.H	<input type="checkbox"/> <input type="checkbox"/> <input type="checkbox"/>	<input type="checkbox"/> <input type="checkbox"/> <input type="checkbox"/>	<input type="checkbox"/> <input type="checkbox"/>	<input type="checkbox"/> <input type="checkbox"/> <input type="checkbox"/> <input type="checkbox"/>	<input type="checkbox"/> <input type="checkbox"/>	<input type="checkbox"/> <input type="checkbox"/> <input type="checkbox"/>
ARSPD								

**A**      **B**      **C**      **D**      **E**      **F**      **G**

## HOW TO ORDER

Indicate the following information on order form:

1. Quantity of each item.
2. Model number, including options. See "How To Build a Model Number".
3. Any special service required.

Note: • The  indicates that a choice is required.

- The absence of the  indicates that no choice is required.
- Alpha-numeric characters in place of  indicate that no other alternatives are available.

## HOW TO BUILD A MODEL NUMBER

- A** Select basic model.
- B** Select horizontal surface finish.  
Refer to color addendum at ki.com or KI Fabrics & Finishes binder.
- C** Select vertical surface finish.  
Refer to color addendum at ki.com or KI Fabrics & Finishes binder.
- D** Select corner leg finish  
Refer to color addendum at ki.com or KI Fabrics & Finishes binder.
- E** Select back panel height.
 

<b>FULL</b>	- Full height (standard)
<b>2Q</b>	- 1/2 height back panel
<b>2QL</b>	- 1/2 height back panel, left
<b>2QR</b>	- 1/2 height back panel, right
<b>3Q</b>	- 3/4 height back panel
<b>3QL</b>	- 3/4 height back panel, left
<b>3QR</b>	- 3/4 height back panel, right

**F** Select cutaway option.

- |           |                    |
|-----------|--------------------|
| <b>ST</b> | - Straight cutaway |
| <b>CV</b> | - Curved cutaway   |

**G** Select grommet.

- |            |              |
|------------|--------------|
| <b>NGR</b> | - No grommet |
| <b>G</b>   | - Grommet    |



# Aristotle® Classic Shells

Extended Corner Desk Shells - 24" - Extended Right

Approx. Packaged Weight	Delivered Pricing
115.0#	\$ 983
125.0#	1077
135.0#	1164

115.0#	\$ 983
125.0#	1077
135.0#	1164

115.0#	\$ 983
125.0#	1077
135.0#	1164

## SPECIAL SERVICES

### Special Carton Marking

With specially marked information N/C

### Shipping

Shipped k.d. freight prepaid f.o.b.  
KI-Aristotle Brampton, Ontario L6T 5T6  
factory. Freight class #85.

Specifications and prices are subject to  
change without prior notice.

# Aristotle® Classic Shells

Extended Corner Desk Shells - 30" - Extended Left

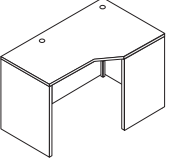
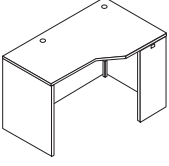
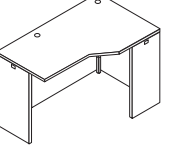
MODEL	W x D x H	MODEL NUMBER						
		Basic Model	Horizontal Surface Finish	Vertical Surface Finish	Leg Finish	Back Panel Height	Cutaway	Grommets
 <p><b>Extended-Left Option A - Two Full End Panels</b></p> <ul style="list-style-type: none"> <li>• Corner post in black or silver</li> <li>• Back panel features horizontal grain pattern</li> <li>• Cutaway may be straight or curved</li> <li>• 20" desks do not accommodate pedestals</li> </ul>	60 x 36 x 29"	KCDLA6030.H	□□□	□□□	□□	□□□□	□□	□□□
	66 x 36 x 29"	KCDLA6630.H	□□□	□□□	□□	□□□□	□□	□□□
	72 x 36 x 29"	KCDLA7230.H	□□□	□□□	□□	□□□□	□□	□□□
ARSPD								
 <p><b>Extended-Left, Option B - One Full/One Recessed End Panel, Interchangeable</b></p> <ul style="list-style-type: none"> <li>• Corner post in black or silver</li> <li>• Back panel features horizontal grain pattern</li> <li>• Cutaway may be straight or curved</li> <li>• 20" desks do not accommodate pedestals</li> </ul>	60 x 36 x 29"	KCDLB6030.H	□□□	□□□	□□	□□□□	□□	□□□
	66 x 36 x 29"	KCDLB6630.H	□□□	□□□	□□	□□□□	□□	□□□
	72 x 36 x 29"	KCDLB7230.H	□□□	□□□	□□	□□□□	□□	□□□
ARSPD								
 <p><b>Extended-Left Option C - Two Recessed End Panels</b></p> <ul style="list-style-type: none"> <li>• Corner post in black or silver</li> <li>• Back panel features horizontal grain pattern</li> <li>• Cutaway may be straight or curved</li> <li>• 20" desks do not accommodate pedestals</li> </ul>	60 x 36 x 29"	KCDLC6030.H	□□□	□□□	□□	□□□□	□□	□□□
	66 x 36 x 29"	KCDLC6630.H	□□□	□□□	□□	□□□□	□□	□□□
	72 x 36 x 29"	KCDLC7230.H	□□□	□□□	□□	□□□□	□□	□□□
ARSPD								

**A**      **B**      **C**      **D**      **E**      **F**      **G**

## HOW TO ORDER

Indicate the following information on order form:

1. Quantity of each item.
2. Model number, including options. See "How To Build a Model Number".
3. Any special service required.

Note: • The □ indicates that a choice is required.

- The absence of the □ indicates that no choice is required.
- Alpha-numeric characters in place of □ indicate that no other alternatives are available.

## HOW TO BUILD A MODEL NUMBER

- A** Select basic model.
- B** Select horizontal surface finish. Refer to color addendum at ki.com or KI Fabrics & Finishes binder.
- C** Select vertical surface finish. Refer to color addendum at ki.com or KI Fabrics & Finishes binder.
- D** Select corner leg finish. Refer to color addendum at ki.com or KI Fabrics & Finishes binder.
- E** Select back panel height.
 

<b>FULL</b>	- Full height (standard)
<b>2Q</b>	- 1/2 height back panel
<b>2QL</b>	- 1/2 height back panel, left
<b>2QR</b>	- 1/2 height back panel, right
<b>3Q</b>	- 3/4 height back panel
<b>3QL</b>	- 3/4 height back panel, left
<b>3QR</b>	- 3/4 height back panel, right

**F** Select cutaway option.

- |           |                    |
|-----------|--------------------|
| <b>ST</b> | - Straight cutaway |
| <b>CV</b> | - Curved cutaway   |

**G** Select grommet.

- |            |              |
|------------|--------------|
| <b>NGR</b> | - No grommet |
| <b>G</b>   | - Grommet    |





# Aristotle® Classic Shells

Extended Corner Desk Shells - 30" - Extended Left

Approx. Packaged Weight	Delivered Pricing
115.0#	\$ 993
125.0#	1077
135.0#	1164

115.0#	\$ 993
125.0#	1077
135.0#	1164

115.0#	\$ 993
125.0#	1077
135.0#	1164

### SPECIAL SERVICES

#### Special Carton Marking

With specially marked information N/C

#### Shipping

Shipped k.d. freight prepaid f.o.b. KI-Aristotle Brampton, Ontario L6T 5T6 factory. Freight class #85.

Specifications and prices are subject to change without prior notice.

# Aristotle® Classic Shells

Extended Corner Desk Shells - 30" - Extended Right

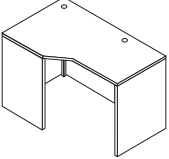
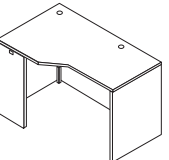
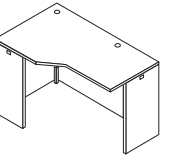
MODEL	W x D x H	MODEL NUMBER						
		Basic Model	Horizontal Surface Finish	Vertical Surface Finish	Leg Finish	Back Panel Height	Cutaway	Grommets
 <p><b>Extended-Right Option A-Two Full End Panels</b></p> <ul style="list-style-type: none"> <li>• Corner post in black or silver</li> <li>• Back panel features horizontal grain pattern</li> <li>• Cutaway may be straight or curved</li> <li>• 20" desks do not accommodate pedestals</li> </ul>	60 x 36 x 29"	KCDRA6030.H	<input type="checkbox"/> <input type="checkbox"/> <input type="checkbox"/>	<input type="checkbox"/> <input type="checkbox"/> <input type="checkbox"/>	<input type="checkbox"/> <input type="checkbox"/>	<input type="checkbox"/> <input type="checkbox"/> <input type="checkbox"/> <input type="checkbox"/>	<input type="checkbox"/> <input type="checkbox"/>	<input type="checkbox"/> <input type="checkbox"/>
	66 x 36 x 29"	KCDRA6630.H	<input type="checkbox"/> <input type="checkbox"/> <input type="checkbox"/>	<input type="checkbox"/> <input type="checkbox"/> <input type="checkbox"/>	<input type="checkbox"/> <input type="checkbox"/>	<input type="checkbox"/> <input type="checkbox"/> <input type="checkbox"/> <input type="checkbox"/>	<input type="checkbox"/> <input type="checkbox"/>	<input type="checkbox"/> <input type="checkbox"/>
	72 x 36 x 29"	KCDRA7230.H	<input type="checkbox"/> <input type="checkbox"/> <input type="checkbox"/>	<input type="checkbox"/> <input type="checkbox"/> <input type="checkbox"/>	<input type="checkbox"/> <input type="checkbox"/>	<input type="checkbox"/> <input type="checkbox"/> <input type="checkbox"/> <input type="checkbox"/>	<input type="checkbox"/> <input type="checkbox"/>	<input type="checkbox"/> <input type="checkbox"/>
ARSPD								
 <p><b>Extended-Right Option B-One Full/One Recessed End Panel, Interchangeable</b></p> <ul style="list-style-type: none"> <li>• Corner post in black or silver</li> <li>• Back panel features horizontal grain pattern</li> <li>• Cutaway may be straight or curved</li> <li>• 20" desks do not accommodate pedestals</li> </ul>	60 x 36 x 29"	KCDRB6030.H	<input type="checkbox"/> <input type="checkbox"/> <input type="checkbox"/>	<input type="checkbox"/> <input type="checkbox"/> <input type="checkbox"/>	<input type="checkbox"/> <input type="checkbox"/>	<input type="checkbox"/> <input type="checkbox"/> <input type="checkbox"/> <input type="checkbox"/>	<input type="checkbox"/> <input type="checkbox"/>	<input type="checkbox"/> <input type="checkbox"/>
	66 x 36 x 29"	KCDRB6630.H	<input type="checkbox"/> <input type="checkbox"/> <input type="checkbox"/>	<input type="checkbox"/> <input type="checkbox"/> <input type="checkbox"/>	<input type="checkbox"/> <input type="checkbox"/>	<input type="checkbox"/> <input type="checkbox"/> <input type="checkbox"/> <input type="checkbox"/>	<input type="checkbox"/> <input type="checkbox"/>	<input type="checkbox"/> <input type="checkbox"/>
	72 x 36 x 29"	KCDRB7230.H	<input type="checkbox"/> <input type="checkbox"/> <input type="checkbox"/>	<input type="checkbox"/> <input type="checkbox"/> <input type="checkbox"/>	<input type="checkbox"/> <input type="checkbox"/>	<input type="checkbox"/> <input type="checkbox"/> <input type="checkbox"/> <input type="checkbox"/>	<input type="checkbox"/> <input type="checkbox"/>	<input type="checkbox"/> <input type="checkbox"/>
ARSPD								
 <p><b>Extended-Right Option C-Two Recessed End Panels</b></p> <ul style="list-style-type: none"> <li>• Corner post in black or silver</li> <li>• Back panel features horizontal grain pattern</li> <li>• Cutaway may be straight or curved</li> <li>• 20" desks do not accommodate pedestals</li> </ul>	60 x 36 x 29"	KCDRC6030.H	<input type="checkbox"/> <input type="checkbox"/> <input type="checkbox"/>	<input type="checkbox"/> <input type="checkbox"/> <input type="checkbox"/>	<input type="checkbox"/> <input type="checkbox"/>	<input type="checkbox"/> <input type="checkbox"/> <input type="checkbox"/> <input type="checkbox"/>	<input type="checkbox"/> <input type="checkbox"/>	<input type="checkbox"/> <input type="checkbox"/>
	66 x 36 x 29"	KCDRC6630.H	<input type="checkbox"/> <input type="checkbox"/> <input type="checkbox"/>	<input type="checkbox"/> <input type="checkbox"/> <input type="checkbox"/>	<input type="checkbox"/> <input type="checkbox"/>	<input type="checkbox"/> <input type="checkbox"/> <input type="checkbox"/> <input type="checkbox"/>	<input type="checkbox"/> <input type="checkbox"/>	<input type="checkbox"/> <input type="checkbox"/>
	72 x 36 x 29"	KCDRC7230.H	<input type="checkbox"/> <input type="checkbox"/> <input type="checkbox"/>	<input type="checkbox"/> <input type="checkbox"/> <input type="checkbox"/>	<input type="checkbox"/> <input type="checkbox"/>	<input type="checkbox"/> <input type="checkbox"/> <input type="checkbox"/> <input type="checkbox"/>	<input type="checkbox"/> <input type="checkbox"/>	<input type="checkbox"/> <input type="checkbox"/>
ARSPD								

**A**      **B**      **C**      **D**      **E**      **F**      **G**

## HOW TO ORDER

Indicate the following information on order form:

1. Quantity of each item.
2. Model number, including options. See "How To Build a Model Number".
3. Any special service required.

Note: • The  indicates that a choice is required.

- The absence of the  indicates that no choice is required.
- Alpha-numeric characters in place of  indicate that no other alternatives are available.

## HOW TO BUILD A MODEL NUMBER

- A** Select basic model.
- B** Select horizontal surface finish.  
Refer to color addendum at ki.com or KI Fabrics & Finishes binder.
- C** Select vertical surface finish.  
Refer to color addendum at ki.com or KI Fabrics & Finishes binder.
- D** Select corner leg finish  
Refer to color addendum at ki.com or KI Fabrics & Finishes binder.
- E** Select back panel height.
 

<b>FULL</b>	- Full height (standard)
<b>2Q</b>	- 1/2 height back panel
<b>2QL</b>	- 1/2 height back panel, left
<b>2QR</b>	- 1/2 height back panel, right
<b>3Q</b>	- 3/4 height back panel
<b>3QL</b>	- 3/4 height back panel, left
<b>3QR</b>	- 3/4 height back panel, right

**F** Select cutaway option.

- |           |                    |
|-----------|--------------------|
| <b>ST</b> | - Straight cutaway |
| <b>CV</b> | - Curved cutaway   |

**G** Select grommet.

- |            |              |
|------------|--------------|
| <b>NGR</b> | - No grommet |
| <b>G</b>   | - Grommet    |



# Aristotle® Classic Shells

Extended Corner Desk Shells - 30" - Extended Right

Approx. Packaged Weight	Delivered Pricing
115.0#	\$ 993
125.0#	1077
135.0#	1164

115.0#	\$ 993
125.0#	1077
135.0#	1164

115.0#	\$ 993
125.0#	1077
135.0#	1164

## SPECIAL SERVICES

### Special Carton Marking

With specially marked information N/C

### Shipping

Shipped k.d. freight prepaid f.o.b.  
KI-Aristotle Brampton, Ontario L6T 5T6  
factory. Freight class #85.

Specifications and prices are subject to  
change without prior notice.

# Aristotle® Classic D-Tops

Suspended

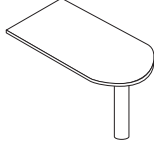
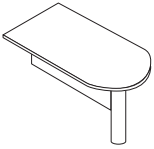
	MODEL	W x D x H	MODEL NUMBER					Approx. Packaged Weight	
			Basic Model	Horizontal Surface Finish	Vertical Surface Finish	Post Leg Finish	Modesty Panel		
 <p>ARDPT</p>	<b>Suspended D-Top</b> • 6" diameter post leg in black or silver • No grommet option • Suspended D-tops must be attached to adjacent furniture for proper stability	36 x 24 x 29"	KDS3624.H	□□□			□□		60.0#
		42 x 24 x 29"	KDS4224.H	□□□			□□		65.0#
		48 x 24 x 29"	KDS4824.H	□□□			□□		70.0#
		54 x 24 x 29"	KDS5424.H	□□□			□□		75.0#
		60 x 24 x 29"	KDS6024.H	□□□			□□		80.0#
		66 x 24 x 29"	KDS6624.H	□□□			□□		85.0#
		48 x 30 x 29"	KDS4830.H	□□□			□□		80.0#
		54 x 30 x 29"	KDS5430.H	□□□			□□		85.0#
		60 x 30 x 29"	KDS6030.H	□□□			□□		90.0#
		66 x 30 x 29"	KDS6630.H	□□□			□□		93.0#
		72 x 30 x 29"	KDS7230.H	□□□			□□		95.0#
		66 x 36 x 29"	KDS6636.H	□□□			□□		95.0#
		72 x 36 x 29"	KDS7236.H	□□□			□□		100.0#
		 <p>ARDPT</p>	<b>Suspended D-Top with Centered Modesty Panel</b> • Includes half end panel, attached on site for placement on approach or user side • 6" diameter post leg in black or silver • No grommet option • Suspended D-tops must be attached to adjacent furniture for proper stability	36 x 24 x 29"	KDSM3624.H	□□□	□□□	□□	□□□
42 x 24 x 29"	KDSM4224.H			□□□	□□□	□□	□□□	80.0#	
48 x 24 x 29"	KDSM4824.H			□□□	□□□	□□	□□□	85.0#	
54 x 24 x 29"	KDSM5424.H			□□□	□□□	□□	□□□	90.0#	
60 x 24 x 29"	KDSM6024.H			□□□	□□□	□□	□□□	95.0#	
66 x 24 x 29"	KDSM6624.H			□□□	□□□	□□	□□□	100.0#	
48 x 30 x 29"	KDSM4830.H			□□□	□□□	□□	□□□	95.0#	
54 x 30 x 29"	KDSM5430.H			□□□	□□□	□□	□□□	100.0#	
60 x 30 x 29"	KDSM6030.H			□□□	□□□	□□	□□□	105.0#	
66 x 30 x 29"	KDSM6630.H			□□□	□□□	□□	□□□	108.0#	
72 x 30 x 29"	KDSM7230.H			□□□	□□□	□□	□□□	110.0#	
66 x 36 x 29"	KDSM6636.H			□□□	□□□	□□	□□□	110.0#	
72 x 36 x 29"	KDSM7236.H			□□□	□□□	□□	□□□	115.0#	
					<b>A</b>	<b>B</b>	<b>C</b>	<b>D</b>	<b>E</b>

## HOW TO ORDER

Indicate the following information on order form:

- Quantity of each item.
- Model number, including options. See "How To Build a Model Number".
- Any special service required.

Note: • The □ indicates that a choice is required.

- The absence of the □ indicates that no choice is required.
- Alpha-numeric characters in place of □ indicate that no other alternatives are available.

## HOW TO BUILD A MODEL NUMBER

- A** Select basic model.
- B** Select horizontal surface finish.  
Refer to color addendum at ki.com or KI Fabrics & Finishes binder.
- C** Select vertical surface finish.  
Refer to color addendum at ki.com or KI Fabrics & Finishes binder.
- D** Select post leg finish.  
Refer to color addendum at ki.com or KI Fabrics & Finishes binder.
- E** Select modesty panel.  
**PMP** - 14" partial modesty panel (standard)  
**FMP** - Full height modesty panel; add \$70



# Aristotle® Classic D-Tops

Suspended

Delivered  
Pricing

\$ 571
584
595
606
613
633
610
627
651
677
729
748
757
\$ 615
631
642
653
661
681
658
672
698
722
778
796
805

## SPECIAL SERVICES

### Special Carton Marking

With specially marked information N/C

### Shipping

Shipped k.d. freight prepaid f.o.b.  
KI-Aristotle Brampton, Ontario L6T 5T6  
factory. Freight class #85.

Specifications and prices are subject to  
change without prior notice.

# Aristotle® Classic D-Tops

With End Panel

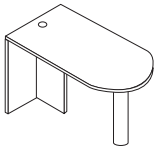
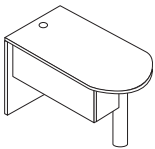
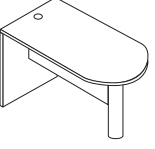
	MODEL	W x D x H	MODEL NUMBER					Approx. Packaged Weight
			Basic Model	Horizontal Surface Finish	Vertical Surface Finish	Post Leg Finish	Modesty Panel	
 <p>ARDPT</p>	<b>D-Top with End Panel</b> • Features side panel for additional support • 6" diameter post leg in black or silver • Center grommet opposite post leg • D-Tops must be attached to adjacent furniture for proper stability • Attachment method is worksurface to worksurface, and cannot be obstructed by an end panel	48 x 24 x 29"	KDF4824.H	<input type="checkbox"/> <input type="checkbox"/> <input type="checkbox"/>	<input type="checkbox"/> <input type="checkbox"/> <input type="checkbox"/>	<input type="checkbox"/> <input type="checkbox"/>		85.0#
		54 x 24 x 29"	KDF5424.H	<input type="checkbox"/> <input type="checkbox"/> <input type="checkbox"/>	<input type="checkbox"/> <input type="checkbox"/> <input type="checkbox"/>	<input type="checkbox"/> <input type="checkbox"/>		95.0#
		60 x 24 x 29"	KDF6024.H	<input type="checkbox"/> <input type="checkbox"/> <input type="checkbox"/>	<input type="checkbox"/> <input type="checkbox"/> <input type="checkbox"/>	<input type="checkbox"/> <input type="checkbox"/>		105.0#
		66 x 24 x 29"	KDF6624.H	<input type="checkbox"/> <input type="checkbox"/> <input type="checkbox"/>	<input type="checkbox"/> <input type="checkbox"/> <input type="checkbox"/>	<input type="checkbox"/> <input type="checkbox"/>		115.0#
		48 x 30 x 29"	KDF4830.H	<input type="checkbox"/> <input type="checkbox"/> <input type="checkbox"/>	<input type="checkbox"/> <input type="checkbox"/> <input type="checkbox"/>	<input type="checkbox"/> <input type="checkbox"/>		110.0#
		54 x 30 x 29"	KDF5430.H	<input type="checkbox"/> <input type="checkbox"/> <input type="checkbox"/>	<input type="checkbox"/> <input type="checkbox"/> <input type="checkbox"/>	<input type="checkbox"/> <input type="checkbox"/>		115.0#
		60 x 30 x 29"	KDF6030.H	<input type="checkbox"/> <input type="checkbox"/> <input type="checkbox"/>	<input type="checkbox"/> <input type="checkbox"/> <input type="checkbox"/>	<input type="checkbox"/> <input type="checkbox"/>		120.0#
		66 x 30 x 29"	KDF6630.H	<input type="checkbox"/> <input type="checkbox"/> <input type="checkbox"/>	<input type="checkbox"/> <input type="checkbox"/> <input type="checkbox"/>	<input type="checkbox"/> <input type="checkbox"/>		125.0#
		72 x 30 x 29"	KDF7230.H	<input type="checkbox"/> <input type="checkbox"/> <input type="checkbox"/>	<input type="checkbox"/> <input type="checkbox"/> <input type="checkbox"/>	<input type="checkbox"/> <input type="checkbox"/>		130.0#
		66 x 36 x 29"	KDF6636.H	<input type="checkbox"/> <input type="checkbox"/> <input type="checkbox"/>	<input type="checkbox"/> <input type="checkbox"/> <input type="checkbox"/>	<input type="checkbox"/> <input type="checkbox"/>		130.0#
		72 x 36 x 29"	KDF7236.H	<input type="checkbox"/> <input type="checkbox"/> <input type="checkbox"/>	<input type="checkbox"/> <input type="checkbox"/> <input type="checkbox"/>	<input type="checkbox"/> <input type="checkbox"/>		135.0#
 <p>ARDPT</p>	<b>D-Top with End Panel and Offset Modesty Panel</b> • Features side panel for additional support • 6" diameter post leg in black or silver • Center grommet opposite post leg • D-Tops must be attached to adjacent furniture for proper stability • Attachment method is worksurface to worksurface, and cannot be obstructed by an end panel • Modesty panel is reversible	60 x 30 x 29"	KDM6030.H	<input type="checkbox"/> <input type="checkbox"/> <input type="checkbox"/>	<input type="checkbox"/> <input type="checkbox"/> <input type="checkbox"/>	<input type="checkbox"/> <input type="checkbox"/>	<input type="checkbox"/> <input type="checkbox"/> <input type="checkbox"/>	125.0#
		66 x 30 x 29"	KDM6630.H	<input type="checkbox"/> <input type="checkbox"/> <input type="checkbox"/>	<input type="checkbox"/> <input type="checkbox"/> <input type="checkbox"/>	<input type="checkbox"/> <input type="checkbox"/>	<input type="checkbox"/> <input type="checkbox"/> <input type="checkbox"/>	130.0#
		72 x 30 x 29"	KDM7230.H	<input type="checkbox"/> <input type="checkbox"/> <input type="checkbox"/>	<input type="checkbox"/> <input type="checkbox"/> <input type="checkbox"/>	<input type="checkbox"/> <input type="checkbox"/>	<input type="checkbox"/> <input type="checkbox"/> <input type="checkbox"/>	135.0#
		72 x 36 x 29"	KDM7236.H	<input type="checkbox"/> <input type="checkbox"/> <input type="checkbox"/>	<input type="checkbox"/> <input type="checkbox"/> <input type="checkbox"/>	<input type="checkbox"/> <input type="checkbox"/>	<input type="checkbox"/> <input type="checkbox"/> <input type="checkbox"/>	135.0#
 <p>ARDPT</p>	<b>D-Top with End Panel and Centered Modesty Panel</b> • Features side panel for additional support • 6" diameter post leg in black or silver • Center grommet opposite post leg • D-Tops must be attached to adjacent furniture for proper stability • Attachment method is worksurface to worksurface, and cannot be obstructed by an end panel	48 x 24 x 29"	KDCM4824.H	<input type="checkbox"/> <input type="checkbox"/> <input type="checkbox"/>	<input type="checkbox"/> <input type="checkbox"/> <input type="checkbox"/>	<input type="checkbox"/> <input type="checkbox"/>	<input type="checkbox"/> <input type="checkbox"/> <input type="checkbox"/>	85.0#
		54 x 24 x 29"	KDCM5424.H	<input type="checkbox"/> <input type="checkbox"/> <input type="checkbox"/>	<input type="checkbox"/> <input type="checkbox"/> <input type="checkbox"/>	<input type="checkbox"/> <input type="checkbox"/>	<input type="checkbox"/> <input type="checkbox"/> <input type="checkbox"/>	95.0#
		60 x 24 x 29"	KDCM6024.H	<input type="checkbox"/> <input type="checkbox"/> <input type="checkbox"/>	<input type="checkbox"/> <input type="checkbox"/> <input type="checkbox"/>	<input type="checkbox"/> <input type="checkbox"/>	<input type="checkbox"/> <input type="checkbox"/> <input type="checkbox"/>	105.0#
		66 x 24 x 29"	KDCM6624.H	<input type="checkbox"/> <input type="checkbox"/> <input type="checkbox"/>	<input type="checkbox"/> <input type="checkbox"/> <input type="checkbox"/>	<input type="checkbox"/> <input type="checkbox"/>	<input type="checkbox"/> <input type="checkbox"/> <input type="checkbox"/>	115.0#
		48 x 30 x 29"	KDCM4830.H	<input type="checkbox"/> <input type="checkbox"/> <input type="checkbox"/>	<input type="checkbox"/> <input type="checkbox"/> <input type="checkbox"/>	<input type="checkbox"/> <input type="checkbox"/>	<input type="checkbox"/> <input type="checkbox"/> <input type="checkbox"/>	110.0#
		54 x 30 x 29"	KDCM5430.H	<input type="checkbox"/> <input type="checkbox"/> <input type="checkbox"/>	<input type="checkbox"/> <input type="checkbox"/> <input type="checkbox"/>	<input type="checkbox"/> <input type="checkbox"/>	<input type="checkbox"/> <input type="checkbox"/> <input type="checkbox"/>	115.0#
		60 x 30 x 29"	KDCM6030.H	<input type="checkbox"/> <input type="checkbox"/> <input type="checkbox"/>	<input type="checkbox"/> <input type="checkbox"/> <input type="checkbox"/>	<input type="checkbox"/> <input type="checkbox"/>	<input type="checkbox"/> <input type="checkbox"/> <input type="checkbox"/>	120.0#
		66 x 30 x 29"	KDCM6630.H	<input type="checkbox"/> <input type="checkbox"/> <input type="checkbox"/>	<input type="checkbox"/> <input type="checkbox"/> <input type="checkbox"/>	<input type="checkbox"/> <input type="checkbox"/>	<input type="checkbox"/> <input type="checkbox"/> <input type="checkbox"/>	125.0#
		72 x 30 x 29"	KDCM7230.H	<input type="checkbox"/> <input type="checkbox"/> <input type="checkbox"/>	<input type="checkbox"/> <input type="checkbox"/> <input type="checkbox"/>	<input type="checkbox"/> <input type="checkbox"/>	<input type="checkbox"/> <input type="checkbox"/> <input type="checkbox"/>	130.0#
		66 x 36 x 29"	KDCM6636.H	<input type="checkbox"/> <input type="checkbox"/> <input type="checkbox"/>	<input type="checkbox"/> <input type="checkbox"/> <input type="checkbox"/>	<input type="checkbox"/> <input type="checkbox"/>	<input type="checkbox"/> <input type="checkbox"/> <input type="checkbox"/>	130.0#
		72 x 36 x 29"	KDCM7236.H	<input type="checkbox"/> <input type="checkbox"/> <input type="checkbox"/>	<input type="checkbox"/> <input type="checkbox"/> <input type="checkbox"/>	<input type="checkbox"/> <input type="checkbox"/> <input type="checkbox"/>		135.0#

**A**      **B**      **C**      **D**      **E**

## HOW TO ORDER

Indicate the following information on order form:

- Quantity of each item.
- Model number, including options. See "How To Build a Model Number".
- Any special service required.

Note: • The  indicates that a choice is required.

- The absence of the  indicates that no choice is required.
- Alpha-numeric characters in place of  indicate that no other alternatives are available.

## HOW TO BUILD A MODEL NUMBER

- A** Select basic model.
- B** Select horizontal surface finish.  
Refer to color addendum at ki.com or KI Fabrics & Finishes binder.
- C** Select vertical surface finish.  
Refer to color addendum at ki.com or KI Fabrics & Finishes binder.
- D** Select post leg finish.  
Refer to color addendum at ki.com or KI Fabrics & Finishes binder.
- E** Select modesty panel height.  
**PMP** - 14" partial modesty panel (standard)  
**FMP** - Full height modesty panel; add \$70



# Aristotle® Classic D-Tops

With End Panel

Delivered Pricing

\$ 699  
713  
723  
737  
767  
786  
763  
829  
884  
914  
923

---

\$ 862  
884  
905  
815

---

\$ 746  
766  
788  
815  
797  
713  
867  
885  
902  
938  
974

**SPECIAL SERVICES**

**Special Carton Marking**

With specially marked information N/C

**Shipping**

Shipped **k.d. freight prepaid f.o.b. KI-Aristotle Brampton, Ontario L6T 5T6** factory. Freight class #85.

Specifications and prices are subject to change without prior notice.

# Aristotle® Classic P-Tops

Suspended

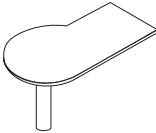
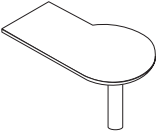
	MODEL	W x D x H	MODEL NUMBER			Approx. Packaged Weight
			Basic Model	Horizontal Surface Finish	Post Leg Finish	
 ARDPT	<b>Suspended P-Top, Left</b> <ul style="list-style-type: none"> <li>• 6" diameter post leg in black or silver</li> <li>• No grommet option</li> <li>• Suspended P-Tops must be attached to adjacent furniture for proper stability</li> </ul>	60 x 36 x 29"	KPLS6036.H	<input type="checkbox"/> <input type="checkbox"/> <input type="checkbox"/>	<input type="checkbox"/> <input type="checkbox"/>	85.0#
		66 x 36 x 29"	KPLS6636.H	<input type="checkbox"/> <input type="checkbox"/> <input type="checkbox"/>	<input type="checkbox"/> <input type="checkbox"/>	90.0#
		72 x 36 x 29"	KPLS7236.H	<input type="checkbox"/> <input type="checkbox"/> <input type="checkbox"/>	<input type="checkbox"/> <input type="checkbox"/>	95.0#
		60 x 42 x 29"	KPLS6042.H	<input type="checkbox"/> <input type="checkbox"/> <input type="checkbox"/>	<input type="checkbox"/> <input type="checkbox"/>	88.0#
		66 x 42 x 29"	KPLS6642.H	<input type="checkbox"/> <input type="checkbox"/> <input type="checkbox"/>	<input type="checkbox"/> <input type="checkbox"/>	93.0#
		72 x 42 x 29"	KPLS7242.H	<input type="checkbox"/> <input type="checkbox"/> <input type="checkbox"/>	<input type="checkbox"/> <input type="checkbox"/>	98.0#
 ARDPT	<b>Suspended P-Top, Right</b> <ul style="list-style-type: none"> <li>• 6" diameter post leg in black or silver</li> <li>• No grommet option</li> <li>• Suspended P-Tops must be attached to adjacent furniture for proper stability</li> </ul>	60 x 36 x 29"	KPRS6036.H	<input type="checkbox"/> <input type="checkbox"/> <input type="checkbox"/>	<input type="checkbox"/> <input type="checkbox"/>	85.0#
		66 x 36 x 29"	KPRS6636.H	<input type="checkbox"/> <input type="checkbox"/> <input type="checkbox"/>	<input type="checkbox"/> <input type="checkbox"/>	90.0#
		72 x 36 x 29"	KPRS7236.H	<input type="checkbox"/> <input type="checkbox"/> <input type="checkbox"/>	<input type="checkbox"/> <input type="checkbox"/>	95.0#
		60 x 42 x 29"	KPRS6042.H	<input type="checkbox"/> <input type="checkbox"/> <input type="checkbox"/>	<input type="checkbox"/> <input type="checkbox"/>	88.0#
		66 x 42 x 29"	KPRS6642.H	<input type="checkbox"/> <input type="checkbox"/> <input type="checkbox"/>	<input type="checkbox"/> <input type="checkbox"/>	93.0#
		72 x 42 x 29"	KPRS7242.H	<input type="checkbox"/> <input type="checkbox"/> <input type="checkbox"/>	<input type="checkbox"/> <input type="checkbox"/>	98.0#
			<b>A</b>	<b>B</b>	<b>C</b>	

## HOW TO ORDER

Indicate the following information on order form:

1. Quantity of each item.
2. Model number, including options. See "How To Build a Model Number".
3. Any special service required.

Note: • The  indicates that a choice is required.

- The absence of the  indicates that no choice is required.
- Alpha-numeric characters in place of  indicate that no other alternatives are available.

## HOW TO BUILD A MODEL NUMBER

- A** Select basic model.
- B** Select horizontal surface finish.  
Refer to color addendum at [ki.com](http://ki.com) or KI Fabrics & Finishes binder.
- C** Select post leg finish.  
Refer to color addendum at [ki.com](http://ki.com) or KI Fabrics & Finishes binder.





# Aristotle® Classic P-Tops

Suspended

Delivered  
Pricing

\$ 845  
871  
933  
857  
883  
946

\$ 845  
871  
933  
857  
883  
946

**SPECIAL SERVICES**

**Special Carton Marking**

With specially marked information N/C

**Shipping**

Shipped **k.d. freight prepaid f.o.b.**  
**KI-Aristotle Brampton, Ontario L6T 5T6**  
factory. Freight class #85.

Specifications and prices are subject to  
change without prior notice.

# Aristotle® Classic P-Tops

With End Panel

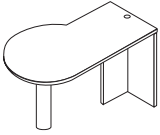
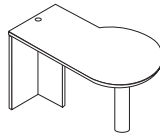
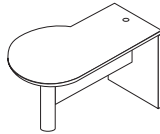
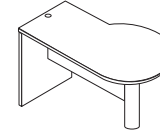
	MODEL	W x D x H	MODEL NUMBER					Approx. Packaged Weight
			Basic Model	Horizontal Surface Finish	Vertical Surface Finish	Post Leg Finish	Modesty Panel	
 <p>ARDPT</p>	<b>P-Top with End Panel, Left</b> • Features side panel for additional support • 6" diameter post leg in black or silver • Center grommet opposite post leg • P-Tops must be attached to adjacent furniture for proper stability • Attachment method is worksurface to worksurface, and cannot be obstructed by an end panel	60 x 36 x 29"	KPLF6036.H	<input type="checkbox"/> <input type="checkbox"/> <input type="checkbox"/>	<input type="checkbox"/> <input type="checkbox"/> <input type="checkbox"/>	<input type="checkbox"/> <input type="checkbox"/> <input type="checkbox"/>		115.0#
		66 x 36 x 29"	KPLF6636.H	<input type="checkbox"/> <input type="checkbox"/> <input type="checkbox"/>	<input type="checkbox"/> <input type="checkbox"/> <input type="checkbox"/>	<input type="checkbox"/> <input type="checkbox"/> <input type="checkbox"/>		125.0#
		72 x 36 x 29"	KPLF7236.H	<input type="checkbox"/> <input type="checkbox"/> <input type="checkbox"/>	<input type="checkbox"/> <input type="checkbox"/> <input type="checkbox"/>	<input type="checkbox"/> <input type="checkbox"/> <input type="checkbox"/>		130.0#
		60 x 42 x 29"	KPLF6042.H	<input type="checkbox"/> <input type="checkbox"/> <input type="checkbox"/>	<input type="checkbox"/> <input type="checkbox"/> <input type="checkbox"/>	<input type="checkbox"/> <input type="checkbox"/> <input type="checkbox"/>		120.0#
		66 x 42 x 29"	KPLF6642.H	<input type="checkbox"/> <input type="checkbox"/> <input type="checkbox"/>	<input type="checkbox"/> <input type="checkbox"/> <input type="checkbox"/>	<input type="checkbox"/> <input type="checkbox"/> <input type="checkbox"/>		130.0#
		72 x 42 x 29"	KPLF7242.H	<input type="checkbox"/> <input type="checkbox"/> <input type="checkbox"/>	<input type="checkbox"/> <input type="checkbox"/> <input type="checkbox"/>	<input type="checkbox"/> <input type="checkbox"/> <input type="checkbox"/>		135.0#
 <p>ARDPT</p>	<b>P-Top with End Panel, Right</b> • Features side panel for additional support • 6" diameter post leg in black or silver • Center grommet opposite post leg • P-Tops must be attached to adjacent furniture for proper stability • Attachment method is worksurface to worksurface, and cannot be obstructed by an end panel	60 x 36 x 29"	KPRF6036.H	<input type="checkbox"/> <input type="checkbox"/> <input type="checkbox"/>	<input type="checkbox"/> <input type="checkbox"/> <input type="checkbox"/>	<input type="checkbox"/> <input type="checkbox"/> <input type="checkbox"/>		115.0#
		66 x 36 x 29"	KPRF6636.H	<input type="checkbox"/> <input type="checkbox"/> <input type="checkbox"/>	<input type="checkbox"/> <input type="checkbox"/> <input type="checkbox"/>	<input type="checkbox"/> <input type="checkbox"/> <input type="checkbox"/>		125.0#
		72 x 36 x 29"	KPRF7236.H	<input type="checkbox"/> <input type="checkbox"/> <input type="checkbox"/>	<input type="checkbox"/> <input type="checkbox"/> <input type="checkbox"/>	<input type="checkbox"/> <input type="checkbox"/> <input type="checkbox"/>		130.0#
		60 x 42 x 29"	KPRF6042.H	<input type="checkbox"/> <input type="checkbox"/> <input type="checkbox"/>	<input type="checkbox"/> <input type="checkbox"/> <input type="checkbox"/>	<input type="checkbox"/> <input type="checkbox"/> <input type="checkbox"/>		120.0#
		66 x 42 x 29"	KPRF6642.H	<input type="checkbox"/> <input type="checkbox"/> <input type="checkbox"/>	<input type="checkbox"/> <input type="checkbox"/> <input type="checkbox"/>	<input type="checkbox"/> <input type="checkbox"/> <input type="checkbox"/>		130.0#
		72 x 42 x 29"	KPRF7242.H	<input type="checkbox"/> <input type="checkbox"/> <input type="checkbox"/>	<input type="checkbox"/> <input type="checkbox"/> <input type="checkbox"/>	<input type="checkbox"/> <input type="checkbox"/> <input type="checkbox"/>		135.0#
 <p>ARDPT</p>	<b>P-Top with End Panel, Left with Centered Modesty Panel</b> • Features side panel for additional support • 6" diameter post leg in black or silver • Center grommet opposite post leg • P-Tops must be attached to adjacent furniture for proper stability • Attachment method is worksurface to worksurface, and cannot be obstructed by an end panel	60 x 36 x 29"	KPLM6036.H	<input type="checkbox"/> <input type="checkbox"/> <input type="checkbox"/>	<input type="checkbox"/> <input type="checkbox"/> <input type="checkbox"/>	<input type="checkbox"/> <input type="checkbox"/> <input type="checkbox"/>	<input type="checkbox"/> <input type="checkbox"/> <input type="checkbox"/>	115.0#
		66 x 36 x 29"	KPLM6636.H	<input type="checkbox"/> <input type="checkbox"/> <input type="checkbox"/>	<input type="checkbox"/> <input type="checkbox"/> <input type="checkbox"/>	<input type="checkbox"/> <input type="checkbox"/> <input type="checkbox"/>	<input type="checkbox"/> <input type="checkbox"/> <input type="checkbox"/>	125.0#
		72 x 36 x 29"	KPLM7236.H	<input type="checkbox"/> <input type="checkbox"/> <input type="checkbox"/>	<input type="checkbox"/> <input type="checkbox"/> <input type="checkbox"/>	<input type="checkbox"/> <input type="checkbox"/> <input type="checkbox"/>	<input type="checkbox"/> <input type="checkbox"/> <input type="checkbox"/>	130.0#
		60 x 42 x 29"	KPLM6042.H	<input type="checkbox"/> <input type="checkbox"/> <input type="checkbox"/>	<input type="checkbox"/> <input type="checkbox"/> <input type="checkbox"/>	<input type="checkbox"/> <input type="checkbox"/> <input type="checkbox"/>	<input type="checkbox"/> <input type="checkbox"/> <input type="checkbox"/>	120.0#
		66 x 42 x 29"	KPLM6642.H	<input type="checkbox"/> <input type="checkbox"/> <input type="checkbox"/>	<input type="checkbox"/> <input type="checkbox"/> <input type="checkbox"/>	<input type="checkbox"/> <input type="checkbox"/> <input type="checkbox"/>	<input type="checkbox"/> <input type="checkbox"/> <input type="checkbox"/>	130.0#
		72 x 42 x 29"	KPLM7242.H	<input type="checkbox"/> <input type="checkbox"/> <input type="checkbox"/>	<input type="checkbox"/> <input type="checkbox"/> <input type="checkbox"/>	<input type="checkbox"/> <input type="checkbox"/> <input type="checkbox"/>	<input type="checkbox"/> <input type="checkbox"/> <input type="checkbox"/>	135.0#
 <p>ARDPT</p>	<b>P-Top with End Panel, Right with Centered Modesty Panel</b> • Features side panel for additional support • 6" diameter post leg in black or silver • Center grommet opposite post leg • P-Tops must be attached to adjacent furniture for proper stability • Attachment method is worksurface to worksurface, and cannot be obstructed by an end panel	60 x 36 x 29"	KPRM6036.H	<input type="checkbox"/> <input type="checkbox"/> <input type="checkbox"/>	<input type="checkbox"/> <input type="checkbox"/> <input type="checkbox"/>	<input type="checkbox"/> <input type="checkbox"/> <input type="checkbox"/>	<input type="checkbox"/> <input type="checkbox"/> <input type="checkbox"/>	115.0#
		66 x 36 x 29"	KPRM6636.H	<input type="checkbox"/> <input type="checkbox"/> <input type="checkbox"/>	<input type="checkbox"/> <input type="checkbox"/> <input type="checkbox"/>	<input type="checkbox"/> <input type="checkbox"/> <input type="checkbox"/>	<input type="checkbox"/> <input type="checkbox"/> <input type="checkbox"/>	125.0#
		72 x 36 x 29"	KPRM7236.H	<input type="checkbox"/> <input type="checkbox"/> <input type="checkbox"/>	<input type="checkbox"/> <input type="checkbox"/> <input type="checkbox"/>	<input type="checkbox"/> <input type="checkbox"/> <input type="checkbox"/>	<input type="checkbox"/> <input type="checkbox"/> <input type="checkbox"/>	130.0#
		60 x 42 x 29"	KPRM6042.H	<input type="checkbox"/> <input type="checkbox"/> <input type="checkbox"/>	<input type="checkbox"/> <input type="checkbox"/> <input type="checkbox"/>	<input type="checkbox"/> <input type="checkbox"/> <input type="checkbox"/>	<input type="checkbox"/> <input type="checkbox"/> <input type="checkbox"/>	120.0#
		66 x 42 x 29"	KPRM6642.H	<input type="checkbox"/> <input type="checkbox"/> <input type="checkbox"/>	<input type="checkbox"/> <input type="checkbox"/> <input type="checkbox"/>	<input type="checkbox"/> <input type="checkbox"/> <input type="checkbox"/>	<input type="checkbox"/> <input type="checkbox"/> <input type="checkbox"/>	130.0#
		72 x 42 x 29"	KPRM7242.H	<input type="checkbox"/> <input type="checkbox"/> <input type="checkbox"/>	<input type="checkbox"/> <input type="checkbox"/> <input type="checkbox"/>	<input type="checkbox"/> <input type="checkbox"/> <input type="checkbox"/>	<input type="checkbox"/> <input type="checkbox"/> <input type="checkbox"/>	135.0#

A
B
C
D
E

## HOW TO ORDER

Indicate the following information on order form:

- Quantity of each item.
- Model number, including options. See "How To Build a Model Number".
- Any special service required.

Note: • The  indicates that a choice is required.

- The absence of the  indicates that no choice is required.
- Alpha-numeric characters in place of  indicate that no other alternatives are available.

## HOW TO BUILD A MODEL NUMBER

- A** Select basic model.
- B** Select horizontal surface finish.  
Refer to color addendum at [ki.com](http://ki.com) or KI Fabrics & Finishes binder.
- C** Select vertical surface finish.  
Refer to color addendum at [ki.com](http://ki.com) or KI Fabrics & Finishes binder.
- D** Select post leg finish.  
Refer to color addendum at [ki.com](http://ki.com) or KI Fabrics & Finishes binder.
- E** Select modesty panel height.  
**PMP** - 14" partial modesty panel (standard)  
**FMP** - Full height modesty panel; add \$70



# Aristotle® Classic P-Tops

With End Panel

Delivered Pricing

\$ 1019  
1048  
1074  
1036  
1065  
1094

\$ 1019  
1048  
1074  
1036  
1065  
1094

\$ 1076  
1105  
1134  
1096  
1124  
1153

\$ 1076  
1105  
1134  
1096  
1124  
1153

**SPECIAL SERVICES**

**Special Carton Marking**

With specially marked information N/C

**Shipping**

Shipped k.d. freight prepaid f.o.b.  
KI-Aristotle Brampton, Ontario L6T 5T6  
factory. Freight class #85.

Specifications and prices are subject to  
change without prior notice.

# Aristotle® Classic Storage

## Open Overheads

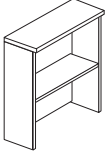
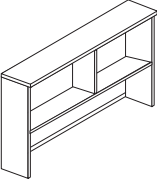
	MODEL	Features	W x D x H	MODEL NUMBER				Approx. Packaged Weight
				Basic Model	Cutaway Gable Option	Horizontal Surface Finish	Vertical Surface Finish	
 <p>AROVD</p>	<b>Open Overhead, 36" High</b> <ul style="list-style-type: none"> <li>• 17-1/2" clearance above desktop and 65" installed height</li> <li>• 13-3/4" internal height clearance</li> <li>• Full-width concealed cable pass through 1-3/4" high</li> <li>• Tackboards and papers sorters specified separately</li> <li>• Cutaway gable option should only be specified in side-to-side overhead applications, as standalone units are not stable with cutaway gables</li> </ul>	Without center divider	24 x 16 x 36"	KOS2436.H	<input type="checkbox"/> <input type="checkbox"/> <input type="checkbox"/>	<input type="checkbox"/> <input type="checkbox"/> <input type="checkbox"/>	<input type="checkbox"/> <input type="checkbox"/> <input type="checkbox"/>	60.0#
		Without center divider	30 x 16 x 36"	KOS3036.H	<input type="checkbox"/> <input type="checkbox"/> <input type="checkbox"/>	<input type="checkbox"/> <input type="checkbox"/> <input type="checkbox"/>	<input type="checkbox"/> <input type="checkbox"/> <input type="checkbox"/>	70.0#
		Without center divider	36 x 16 x 36"	KOS3636.H	<input type="checkbox"/> <input type="checkbox"/> <input type="checkbox"/>	<input type="checkbox"/> <input type="checkbox"/> <input type="checkbox"/>	<input type="checkbox"/> <input type="checkbox"/> <input type="checkbox"/>	80.0#
		Without center divider	42 x 16 x 36"	KOS4236.H	<input type="checkbox"/> <input type="checkbox"/> <input type="checkbox"/>	<input type="checkbox"/> <input type="checkbox"/> <input type="checkbox"/>	<input type="checkbox"/> <input type="checkbox"/> <input type="checkbox"/>	90.0#
 <p>AROVD</p>	<b>Open Overhead, 36" High</b> <ul style="list-style-type: none"> <li>• 17-1/2" clearance above desktop and 65" installed height</li> <li>• 13-3/4" internal height clearance</li> <li>• Full-width concealed cable pass through 1-3/4" high</li> <li>• Tackboards and papers sorters specified separately</li> <li>• Cutaway gable option should only be specified in side-to-side overhead applications, as standalone units are not stable with cutaway gables</li> </ul>	With center divider	48 x 16 x 36"	KOS4836.H	<input type="checkbox"/> <input type="checkbox"/> <input type="checkbox"/>	<input type="checkbox"/> <input type="checkbox"/> <input type="checkbox"/>	<input type="checkbox"/> <input type="checkbox"/> <input type="checkbox"/>	100.0#
		With center divider	54 x 16 x 36"	KOS5436.H	<input type="checkbox"/> <input type="checkbox"/> <input type="checkbox"/>	<input type="checkbox"/> <input type="checkbox"/> <input type="checkbox"/>	<input type="checkbox"/> <input type="checkbox"/> <input type="checkbox"/>	110.0#
		With center divider	60 x 16 x 36"	KOS6036.H	<input type="checkbox"/> <input type="checkbox"/> <input type="checkbox"/>	<input type="checkbox"/> <input type="checkbox"/> <input type="checkbox"/>	<input type="checkbox"/> <input type="checkbox"/> <input type="checkbox"/>	120.0#
		With center divider	66 x 16 x 36"	KOS6636.H	<input type="checkbox"/> <input type="checkbox"/> <input type="checkbox"/>	<input type="checkbox"/> <input type="checkbox"/> <input type="checkbox"/>	<input type="checkbox"/> <input type="checkbox"/> <input type="checkbox"/>	130.0#
		With center divider	72 x 16 x 36"	KOS7236.H	<input type="checkbox"/> <input type="checkbox"/> <input type="checkbox"/>	<input type="checkbox"/> <input type="checkbox"/> <input type="checkbox"/>	<input type="checkbox"/> <input type="checkbox"/> <input type="checkbox"/>	140.0#
		With center divider	78 x 16 x 36"	KOS7836.H	<input type="checkbox"/> <input type="checkbox"/> <input type="checkbox"/>	<input type="checkbox"/> <input type="checkbox"/> <input type="checkbox"/>	<input type="checkbox"/> <input type="checkbox"/> <input type="checkbox"/>	150.0#

**A**      **B**      **C**      **D**

### HOW TO ORDER

Indicate the following information on order form:

1. Quantity of each item.
2. Model number, including options. See "How To Build a Model Number".
3. Any special service required.

- Note:
- The  indicates that a choice is required.
  - The absence of the  indicates that no choice is required.
  - Alpha-numeric characters in place of  indicate that no other alternatives are available.

### HOW TO BUILD A MODEL NUMBER

- A** Select basic model.
- B** Select cutaway gable option.
  - CGN** - No Cutaway gable (standard)
  - CGL** - Cutaway gable left; add \$70
  - CGR** - Cutaway gable right; add \$70
  - CLR** - Cutaway gable left and right; add \$141
- C** Select horizontal surface finish. Refer to color addendum at ki.com or KI Fabrics & Finishes binder.
- D** Select vertical surface finish. Refer to color addendum at ki.com or KI Fabrics & Finishes binder.



# Aristotle® Classic Storage

Open Overheads

Delivered Pricing

\$ 478  
538  
590  
614

\$ 692  
728  
791  
843  
900  
961

**SPECIAL SERVICES**

**Special Carton Marking**

With specially marked information N/C

**Shipping**

Shipped **assembled freight prepaid f.o.b. KI-Aristotle Brampton, Ontario L6T 5T6** factory. Freight class #85.

Specifications and prices are subject to change without prior notice.

# Aristotle® Classic Storage

## Open Overheads

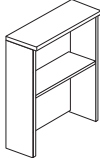
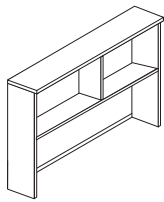
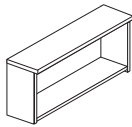
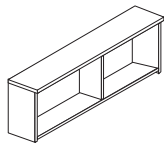
	MODEL	Features	W x D x H	MODEL NUMBER			
				Basic Model	Cutaway Gable Option	Horizontal Surface Finish	Vertical Surface Finish
 <p>AROVD</p>	<b>Open Overhead, 43" High</b> <ul style="list-style-type: none"> <li>• 24" clearance above desktop and 72" installed height</li> <li>• 13-3/4" internal height clearance</li> <li>• Full-width concealed cable pass through 1-3/4" high</li> <li>• Tackboards and papers sorters specified separately</li> <li>• Cutaway gable option should only be specified in side-to-side overhead applications, as standalone units are not stable with cutaway gables</li> </ul>	Without center divider	24 x 16 x 43"	KOS2443.H	<input type="checkbox"/> <input type="checkbox"/> <input type="checkbox"/>	<input type="checkbox"/> <input type="checkbox"/> <input type="checkbox"/>	<input type="checkbox"/> <input type="checkbox"/> <input type="checkbox"/>
		Without center divider	30 x 16 x 43"	KOS3043.H	<input type="checkbox"/> <input type="checkbox"/> <input type="checkbox"/>	<input type="checkbox"/> <input type="checkbox"/> <input type="checkbox"/>	<input type="checkbox"/> <input type="checkbox"/> <input type="checkbox"/>
		Without center divider	36 x 16 x 43"	KOS3643.H	<input type="checkbox"/> <input type="checkbox"/> <input type="checkbox"/>	<input type="checkbox"/> <input type="checkbox"/> <input type="checkbox"/>	<input type="checkbox"/> <input type="checkbox"/> <input type="checkbox"/>
		Without center divider	42 x 16 x 43"	KOS4243.H	<input type="checkbox"/> <input type="checkbox"/> <input type="checkbox"/>	<input type="checkbox"/> <input type="checkbox"/> <input type="checkbox"/>	<input type="checkbox"/> <input type="checkbox"/> <input type="checkbox"/>
 <p>AROVD</p>	<b>Open Overhead, 43" High</b> <ul style="list-style-type: none"> <li>• 24" clearance above desktop and 72" installed height</li> <li>• 13-3/4" internal height clearance</li> <li>• Full-width concealed cable pass through 1-3/4" high</li> <li>• Tackboards and papers sorters specified separately</li> <li>• Cutaway gable option should only be specified in side-to-side overhead applications, as standalone units are not stable with cutaway gables</li> </ul>	With center divider	48 x 16 x 43"	KOS4843.H	<input type="checkbox"/> <input type="checkbox"/> <input type="checkbox"/>	<input type="checkbox"/> <input type="checkbox"/> <input type="checkbox"/>	<input type="checkbox"/> <input type="checkbox"/> <input type="checkbox"/>
		With center divider	54 x 16 x 43"	KOS5443.H	<input type="checkbox"/> <input type="checkbox"/> <input type="checkbox"/>	<input type="checkbox"/> <input type="checkbox"/> <input type="checkbox"/>	<input type="checkbox"/> <input type="checkbox"/> <input type="checkbox"/>
		With center divider	60 x 16 x 43"	KOS6043.H	<input type="checkbox"/> <input type="checkbox"/> <input type="checkbox"/>	<input type="checkbox"/> <input type="checkbox"/> <input type="checkbox"/>	<input type="checkbox"/> <input type="checkbox"/> <input type="checkbox"/>
		With center divider	66 x 16 x 43"	KOS6643.H	<input type="checkbox"/> <input type="checkbox"/> <input type="checkbox"/>	<input type="checkbox"/> <input type="checkbox"/> <input type="checkbox"/>	<input type="checkbox"/> <input type="checkbox"/> <input type="checkbox"/>
		With center divider	72 x 16 x 43"	KOS7243.H	<input type="checkbox"/> <input type="checkbox"/> <input type="checkbox"/>	<input type="checkbox"/> <input type="checkbox"/> <input type="checkbox"/>	<input type="checkbox"/> <input type="checkbox"/> <input type="checkbox"/>
		With center divider	78 x 16 x 43"	KOS7843.H	<input type="checkbox"/> <input type="checkbox"/> <input type="checkbox"/>	<input type="checkbox"/> <input type="checkbox"/> <input type="checkbox"/>	<input type="checkbox"/> <input type="checkbox"/> <input type="checkbox"/>
 <p>AROVD</p>	<b>Open Overhead-Wall Mount</b> <ul style="list-style-type: none"> <li>• 13-3/4" internal height clearance</li> <li>• Attachment hardware included</li> </ul>	Without center divider	24 x 17 x 18"	KWMOS24.H		<input type="checkbox"/> <input type="checkbox"/> <input type="checkbox"/>	<input type="checkbox"/> <input type="checkbox"/> <input type="checkbox"/>
		Without center divider	30 x 17 x 18"	KWMOS30.H		<input type="checkbox"/> <input type="checkbox"/> <input type="checkbox"/>	<input type="checkbox"/> <input type="checkbox"/> <input type="checkbox"/>
		Without center divider	36 x 17 x 18"	KWMOS36.H		<input type="checkbox"/> <input type="checkbox"/> <input type="checkbox"/>	<input type="checkbox"/> <input type="checkbox"/> <input type="checkbox"/>
		Without center divider	42 x 17 x 18"	KWMOS42.H		<input type="checkbox"/> <input type="checkbox"/> <input type="checkbox"/>	<input type="checkbox"/> <input type="checkbox"/> <input type="checkbox"/>
 <p>AROVD</p>	<b>Open Overhead-Wall Mount</b> <ul style="list-style-type: none"> <li>• 13-3/4" internal height clearance</li> <li>• Attachment hardware included</li> </ul>	With center divider	48 x 17 x 18"	KWMOS48.H		<input type="checkbox"/> <input type="checkbox"/> <input type="checkbox"/>	<input type="checkbox"/> <input type="checkbox"/> <input type="checkbox"/>
		With center divider	54 x 17 x 18"	KWMOS54.H		<input type="checkbox"/> <input type="checkbox"/> <input type="checkbox"/>	<input type="checkbox"/> <input type="checkbox"/> <input type="checkbox"/>
		With center divider	60 x 17 x 18"	KWMOS60.H		<input type="checkbox"/> <input type="checkbox"/> <input type="checkbox"/>	<input type="checkbox"/> <input type="checkbox"/> <input type="checkbox"/>
		With center divider	66 x 17 x 18"	KWMOS66.H		<input type="checkbox"/> <input type="checkbox"/> <input type="checkbox"/>	<input type="checkbox"/> <input type="checkbox"/> <input type="checkbox"/>
		With center divider	72 x 17 x 18"	KWMOS72.H		<input type="checkbox"/> <input type="checkbox"/> <input type="checkbox"/>	<input type="checkbox"/> <input type="checkbox"/> <input type="checkbox"/>
	With center divider	78 x 17 x 18"	KWMOS78.H		<input type="checkbox"/> <input type="checkbox"/> <input type="checkbox"/>	<input type="checkbox"/> <input type="checkbox"/> <input type="checkbox"/>	

**A**      **B**      **C**      **D**

### HOW TO ORDER

Indicate the following information on order form:

1. Quantity of each item.
2. Model number, including options. See "How To Build a Model Number".
3. Any special service required.

Note:

- The  indicates that a choice is required.
- The absence of the  indicates that no choice is required.
- Alpha-numeric characters in place of  indicate that no other alternatives are available.

### HOW TO BUILD A MODEL NUMBER

- A** Select basic model.
- B** Select cutaway gable option.
  - CGN** - No Cutaway gable (standard)
  - CGL** - Cutaway gable left; add \$70
  - CGR** - Cutaway gable right; add \$70
  - CLR** - Cutaway gable left and right; add \$141
- C** Select horizontal surface finish. Refer to color addendum at [ki.com](http://ki.com) or KI Fabrics & Finishes binder.
- D** Select vertical surface finish. Refer to color addendum at [ki.com](http://ki.com) or KI Fabrics & Finishes binder.



# Aristotle® Classic Storage

Open Overheads

Approx. Packaged Weight	Delivered Pricing
60.0#	\$ 625
70.0#	685
80.0#	740
90.0#	762

100.0#	\$ 837
110.0#	877
120.0#	939
130.0#	989
140.0#	1049
150.0#	1107

42.0#	\$ 481
51.0#	538
59.0#	590
68.0#	614

76.0#	\$ 692
85.0#	766
93.0#	791
102.0#	843
110.0#	900
119.0#	953

## SPECIAL SERVICES

### Special Carton Marking

With specially marked information N/C

### Shipping

Shipped **assembled freight prepaid f.o.b.**  
**KI-Aristotle Brampton, Ontario L6T 5T6**  
 factory. Freight class #85.

Specifications and prices are subject to  
 change without prior notice.

# Aristotle® Classic Storage

Closed Overheads-Open Back Below Shelf

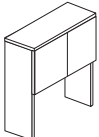
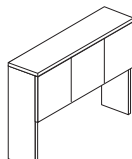
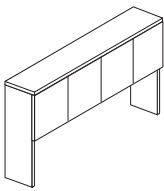
	MODEL	W x D x H	MODEL NUMBER			Approx. Packaged Weight
			Basic Model	Horizontal Surface Finish	Vertical Surface Finish	
 <p>AROVD</p>	<b>Closed Overhead, 36" High-Open Back Below Shelf</b> <ul style="list-style-type: none"> <li>• 17-1/2" clearance above desktop and 65" installed height</li> <li>• 13-3/4" internal height clearance</li> <li>• Full-width concealed cable pass through 1-3/4" high</li> <li>• Pulls cannot be specified</li> </ul>	24 x 16 x 36"	KOD02436.H	<input type="checkbox"/> <input type="checkbox"/> <input type="checkbox"/>	<input type="checkbox"/> <input type="checkbox"/> <input type="checkbox"/>	60.0#
		30 x 16 x 36"	KOD03036.H	<input type="checkbox"/> <input type="checkbox"/> <input type="checkbox"/>	<input type="checkbox"/> <input type="checkbox"/> <input type="checkbox"/>	70.0#
		36 x 16 x 36"	KOD03636.H	<input type="checkbox"/> <input type="checkbox"/> <input type="checkbox"/>	<input type="checkbox"/> <input type="checkbox"/> <input type="checkbox"/>	80.0#
		42 x 16 x 36"	KOD04236.H	<input type="checkbox"/> <input type="checkbox"/> <input type="checkbox"/>	<input type="checkbox"/> <input type="checkbox"/> <input type="checkbox"/>	90.0#
 <p>AROVD</p>	<b>Closed Overhead, 36" High-Open Back Below Shelf</b> <ul style="list-style-type: none"> <li>• 17-1/2" clearance above desktop and 65" installed height</li> <li>• 13-3/4" internal height clearance</li> <li>• Full-width concealed cable pass through 1-3/4" high</li> <li>• 48" and wider units feature center divider</li> <li>• Pulls cannot be specified</li> </ul>	48 x 16 x 36"	KOD04836.H	<input type="checkbox"/> <input type="checkbox"/> <input type="checkbox"/>	<input type="checkbox"/> <input type="checkbox"/> <input type="checkbox"/>	100.0#
 <p>AROVD</p>	<b>Closed Overhead, 36" High-Open Back Below Shelf</b> <ul style="list-style-type: none"> <li>• 17-1/2" clearance above desktop and 65" installed height</li> <li>• 13-3/4" internal height clearance</li> <li>• Full-width concealed cable pass through 1-3/4" high</li> <li>• 48" and wider units feature center divider</li> <li>• Pulls cannot be specified</li> </ul>	54 x 16 x 36"	KOD05436.H	<input type="checkbox"/> <input type="checkbox"/> <input type="checkbox"/>	<input type="checkbox"/> <input type="checkbox"/> <input type="checkbox"/>	110.0#
		60 x 16 x 36"	KOD06036.H	<input type="checkbox"/> <input type="checkbox"/> <input type="checkbox"/>	<input type="checkbox"/> <input type="checkbox"/> <input type="checkbox"/>	120.0#
		66 x 16 x 36"	KOD06636.H	<input type="checkbox"/> <input type="checkbox"/> <input type="checkbox"/>	<input type="checkbox"/> <input type="checkbox"/> <input type="checkbox"/>	130.0#
		72 x 16 x 36"	KOD07236.H	<input type="checkbox"/> <input type="checkbox"/> <input type="checkbox"/>	<input type="checkbox"/> <input type="checkbox"/> <input type="checkbox"/>	140.0#
		78 x 16 x 36"	KOD07836.H	<input type="checkbox"/> <input type="checkbox"/> <input type="checkbox"/>	<input type="checkbox"/> <input type="checkbox"/> <input type="checkbox"/>	150.0#

**A**      **B**      **C**

### HOW TO ORDER

Indicate the following information on order form:

1. Quantity of each item.
2. Model number, including options. See "How To Build a Model Number".
3. Any special service required.

Note: • The  indicates that a choice is required.

- The absence of the  indicates that no choice is required.
- Alpha-numeric characters in place of  indicate that no other alternatives are available.

### HOW TO BUILD A MODEL NUMBER

- A** Select basic model.
- B** Select horizontal surface finish. Refer to color addendum at [ki.com](http://ki.com) or KI Fabrics & Finishes binder.
- C** Select vertical surface finish. Refer to color addendum at [ki.com](http://ki.com) or KI Fabrics & Finishes binder.





# Aristotle® Classic Storage

Closed Overheads-Open Back Below Shelf

Delivered  
Pricing

\$ 652  
691  
737  
805

\$ 890

\$ 976  
1038  
1099  
1155  
1215

**SPECIAL SERVICES**

**Special Carton Marking**

With specially marked information    N/C

**Shipping**

Shipped **assembled freight prepaid f.o.b. KI-Aristotle Brampton, Ontario L6T 5T6** factory. Freight class #85.

Specifications and prices are subject to change without prior notice.

# Aristotle® Classic Storage

Closed Overheads

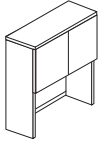

AROVD

**MODEL**

**Features**

**W x D x H**

- Closed Overhead, 36" High**
- 17-1/2" clearance above desktop and 65" installed height
  - 13-3/4" internal height clearance
  - Full-width concealed cable pass through 1-3/4" high
  - Pulls cannot be specified
  - Cutaway gable option should only be specified in side-to-side overhead applications, as standalone units are not stable with cutaway gables

2 doors	24 x 16 x 36"	KOD2436.H
2 doors	30 x 16 x 36"	KOD3036.H
2 doors	36 x 16 x 36"	KOD3636.H
2 doors	42 x 16 x 36"	KOD4236.H

**MODEL NUMBER**

Basic Model	Cutaway Gable Option	Lock Option	Key Option	Horizontal Surface Finish	Vertical Surface Finish
KOD2436.H	<input type="checkbox"/> <input type="checkbox"/> <input type="checkbox"/>	<input type="checkbox"/>	<input type="checkbox"/>	<input type="checkbox"/> <input type="checkbox"/> <input type="checkbox"/>	<input type="checkbox"/> <input type="checkbox"/>
KOD3036.H	<input type="checkbox"/> <input type="checkbox"/> <input type="checkbox"/>	<input type="checkbox"/>	<input type="checkbox"/>	<input type="checkbox"/> <input type="checkbox"/> <input type="checkbox"/>	<input type="checkbox"/> <input type="checkbox"/>
KOD3636.H	<input type="checkbox"/> <input type="checkbox"/> <input type="checkbox"/>	<input type="checkbox"/>	<input type="checkbox"/>	<input type="checkbox"/> <input type="checkbox"/> <input type="checkbox"/>	<input type="checkbox"/> <input type="checkbox"/>
KOD4236.H	<input type="checkbox"/> <input type="checkbox"/> <input type="checkbox"/>	<input type="checkbox"/>	<input type="checkbox"/>	<input type="checkbox"/> <input type="checkbox"/> <input type="checkbox"/>	<input type="checkbox"/> <input type="checkbox"/>

**A**      **B**      **C**      **D**      **E**      **F**

**HOW TO ORDER**

Indicate the following information on order form:

1. Quantity of each item.
2. Model number, including options. See "How To Build a Model Number".
3. Any special service required.

- Note:
- The  indicates that a choice is required.
  - The absence of the  indicates that no choice is required.
  - Alpha-numeric characters in place of  indicate that no other alternatives are available.

**HOW TO BUILD A MODEL NUMBER**

Fabrics & Finishes binder.

- A** Select basic model.
- B** Select cutaway gable option.
  - CGN** - No Cutaway gable (standard)
  - CGL** - Cutaway gable left; add \$70
  - CGR** - Cutaway gable right; add \$70
  - CLR** - Cutaway gable left and right; add \$141
- C** Select locking option.
  - NL** - No lock (standard)
  - L** - With lock; add \$64
- D** Select key option.
  - KA** - Key alike
  - KS** - Key standard
- E** Select horizontal surface finish. Refer to color addendum at ki.com or KI Fabrics & Finishes binder.
- F** Select vertical surface finish. Refer to color addendum at ki.com or KI



# Aristotle® Classic Storage

Closed Overheads

Approx. Packaged Weight	Delivered Pricing
70.0#	\$ 693
80.0#	750
95.0#	801
105.0#	878

## SPECIAL SERVICES

### Special Carton Marking

With specially marked information N/C

### Shipping

Shipped **assembled freight prepaid f.o.b.**  
**KI-Aristotle Brampton, Ontario L6T 5T6**  
 factory. Freight class #85.

Specifications and prices are subject to  
 change without prior notice.

# Aristotle® Classic Storage

Closed Overheads

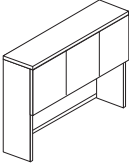
				MODEL NUMBER					
MODEL	Features	W x D x H	Basic Model	Cutaway Gable Option	Lock Option	Key Option	Horizontal Surface Finish	Vertical Surface Finish	
 <p>AROVD</p>	<b>Closed Overhead, 36" High</b> • 17-1/2" clearance above desktop and 65" installed height • 13-3/4" internal height clearance • Full-width concealed cable pass through 1-3/4" high • 48" and wider units feature center divider • Pulls cannot be specified • Cutaway gable option should only be specified in side-to-side overhead applications, as standalone units are not stable with cutaway gables	3 doors 48 x 16 x 36"	KOD4836.H	<input type="checkbox"/> <input type="checkbox"/> <input type="checkbox"/>	<input type="checkbox"/>	<input type="checkbox"/> <input type="checkbox"/> <input type="checkbox"/> <input type="checkbox"/>	<input type="checkbox"/> <input type="checkbox"/>	<input type="checkbox"/> <input type="checkbox"/>	
		4 doors 54 x 16 x 36"	KOD5436.H	<input type="checkbox"/> <input type="checkbox"/> <input type="checkbox"/>	<input type="checkbox"/>	<input type="checkbox"/>	<input type="checkbox"/> <input type="checkbox"/> <input type="checkbox"/> <input type="checkbox"/>	<input type="checkbox"/> <input type="checkbox"/>	<input type="checkbox"/> <input type="checkbox"/>
		4 doors 60 x 16 x 36"	KOD6036.H	<input type="checkbox"/> <input type="checkbox"/> <input type="checkbox"/>	<input type="checkbox"/>	<input type="checkbox"/>	<input type="checkbox"/> <input type="checkbox"/> <input type="checkbox"/> <input type="checkbox"/>	<input type="checkbox"/> <input type="checkbox"/>	<input type="checkbox"/> <input type="checkbox"/>
		4 doors 66 x 16 x 36"	KOD6636.H	<input type="checkbox"/> <input type="checkbox"/> <input type="checkbox"/>	<input type="checkbox"/>	<input type="checkbox"/>	<input type="checkbox"/> <input type="checkbox"/> <input type="checkbox"/> <input type="checkbox"/>	<input type="checkbox"/> <input type="checkbox"/>	<input type="checkbox"/> <input type="checkbox"/>
		4 doors 72 x 16 x 36"	KOD7236.H	<input type="checkbox"/> <input type="checkbox"/> <input type="checkbox"/>	<input type="checkbox"/>	<input type="checkbox"/>	<input type="checkbox"/> <input type="checkbox"/> <input type="checkbox"/> <input type="checkbox"/>	<input type="checkbox"/> <input type="checkbox"/>	<input type="checkbox"/> <input type="checkbox"/>
		4 doors 78 x 16 x 36"	KOD7836.H	<input type="checkbox"/> <input type="checkbox"/> <input type="checkbox"/>	<input type="checkbox"/>	<input type="checkbox"/>	<input type="checkbox"/> <input type="checkbox"/> <input type="checkbox"/> <input type="checkbox"/>	<input type="checkbox"/> <input type="checkbox"/>	<input type="checkbox"/> <input type="checkbox"/>

**A**      **B**      **C**      **D**      **E**      **F**

### HOW TO ORDER

Indicate the following information on order form:

- Quantity of each item.
- Model number, including options. See "How To Build a Model Number".
- Any special service required.

Note: • The  indicates that a choice is required.  
 • The absence of the  indicates that no choice is required.  
 • Alpha-numeric characters in place of  indicate that no other alternatives are available.

### HOW TO BUILD A MODEL NUMBER

Fabrics & Finishes binder.

- A** Select basic model.
- B** Select cutaway gable option.
  - CGN** - No Cutaway gable (standard)
  - CGL** - Cutaway gable left; add \$70
  - CGR** - Cutaway gable right; add \$70
  - CLR** - Cutaway gable left and right; add \$141
- C** Select locking option.
  - NL** - No lock (standard)
  - L** - With lock; add \$141
- D** Select key option.
  - KA** - Key alike
  - KS** - Key standard
- E** Select horizontal surface finish.  
 Refer to color addendum at ki.com or KI Fabrics & Finishes binder.
- F** Select vertical surface finish.  
 Refer to color addendum at ki.com or KI



# Aristotle® Classic Storage

Closed Overheads

Approx. Packaged Weight	Delivered Pricing
120.0#	\$ 968

130.0#	\$ 1056
145.0#	1129
155.0#	1198
170.0#	1252
180.0#	1311

**SPECIAL SERVICES**

**Special Carton Marking**

With specially marked information N/C

**Shipping**

Shipped **assembled freight prepaid f.o.b. KI-Aristotle Brampton, Ontario L6T 5T6** factory. Freight class #85.

Specifications and prices are subject to change without prior notice.

# Aristotle® Classic Storage

Closed Overheads

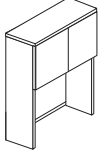

AROVD

MODEL	Features	W x D x H	MODEL NUMBER					
			Basic Model	Cutaway Gable Option	Lock Option	Key Option	Horizontal Surface Finish	Vertical Surface Finish
<b>Closed Overhead, 43" High</b> • 24" clearance above desktop and 72" installed height • 13-3/4" internal height clearance • Full-width concealed cable pass through 1-3/4" high • Pulls cannot be specified • Cutaway gable option should only be specified in side-to-side overhead applications, as standalone units are not stable with cutaway gables	2 doors	24 x 16 x 43"	KOD2443.H	<input type="checkbox"/> <input type="checkbox"/> <input type="checkbox"/>	<input type="checkbox"/> <input type="checkbox"/>	<input type="checkbox"/> <input type="checkbox"/>	<input type="checkbox"/> <input type="checkbox"/> <input type="checkbox"/>	<input type="checkbox"/> <input type="checkbox"/> <input type="checkbox"/>
	2 doors	30 x 16 x 43"	KOD3043.H	<input type="checkbox"/> <input type="checkbox"/> <input type="checkbox"/>	<input type="checkbox"/> <input type="checkbox"/>	<input type="checkbox"/> <input type="checkbox"/>	<input type="checkbox"/> <input type="checkbox"/> <input type="checkbox"/>	<input type="checkbox"/> <input type="checkbox"/> <input type="checkbox"/>
	2 doors	36 x 16 x 43"	KOD3643.H	<input type="checkbox"/> <input type="checkbox"/> <input type="checkbox"/>	<input type="checkbox"/> <input type="checkbox"/>	<input type="checkbox"/> <input type="checkbox"/>	<input type="checkbox"/> <input type="checkbox"/> <input type="checkbox"/>	<input type="checkbox"/> <input type="checkbox"/> <input type="checkbox"/>
	2 doors	42 x 16 x 43"	KOD4243.H	<input type="checkbox"/> <input type="checkbox"/> <input type="checkbox"/>	<input type="checkbox"/> <input type="checkbox"/>	<input type="checkbox"/> <input type="checkbox"/>	<input type="checkbox"/> <input type="checkbox"/> <input type="checkbox"/>	<input type="checkbox"/> <input type="checkbox"/> <input type="checkbox"/>

**A**      **B**      **C**      **D**      **E**      **F**

## HOW TO ORDER

Indicate the following information on order form:

- Quantity of each item.
- Model number, including options. See "How To Build a Model Number".
- Any special service required.

Note: • The  indicates that a choice is required.  
 • The absence of the  indicates that no choice is required.  
 • Alpha-numeric characters in place of  indicate that no other alternatives are available.

## HOW TO BUILD A MODEL NUMBER

Fabrics & Finishes binder.

- A** Select basic model.
- B** Select cutaway gable option.
  - CGN** - No Cutaway gable (standard)
  - CGL** - Cutaway gable left; add \$70
  - CGR** - Cutaway gable right; add \$70
  - CLR** - Cutaway gable left and right; add \$141
- C** Select locking option.
  - NL** - No lock (standard)
  - L** - With lock; add \$64
- D** Select key option.
  - KA** - Key alike
  - KS** - Key standard
- E** Select horizontal surface finish.  
 Refer to color addendum at ki.com or KI Fabrics & Finishes binder.
- F** Select vertical surface finish.  
 Refer to color addendum at ki.com or KI



# Aristotle® Classic Storage

Closed Overheads

Approx. Packaged Weight	Delivered Pricing
80.0#	\$ 857
90.0#	916
105.0#	964
115.0#	1042

## SPECIAL SERVICES

### Special Carton Marking

With specially marked information N/C

### Shipping

Shipped **assembled freight prepaid f.o.b.**  
**KI-Aristotle Brampton, Ontario L6T 5T6**  
 factory. Freight class #85.

Specifications and prices are subject to  
 change without prior notice.

# Aristotle® Classic Storage

## Closed Overheads

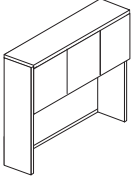
				MODEL NUMBER					
MODEL	Features	W x D x H	Basic Model	Cutaway Gable Option	Lock Option	Key Option	Horizontal Surface Finish	Vertical Surface Finish	
 <p>AROVD</p>	<b>Closed Overhead, 43" High</b> • 24" clearance above desktop and 72" installed height • 13-3/4" internal height clearance • Full-width concealed cable pass through 1-3/4" high • 48" and wider units feature center divider • Pulls cannot be specified • Cutaway gable option should only be specified in side-to-side overhead applications, as standalone units are not stable with cutaway gables	3 doors 48 x 16 x 43"	KOD4843.H	<input type="checkbox"/> <input type="checkbox"/> <input type="checkbox"/>	<input type="checkbox"/>	<input type="checkbox"/>	<input type="checkbox"/> <input type="checkbox"/> <input type="checkbox"/>	<input type="checkbox"/> <input type="checkbox"/> <input type="checkbox"/>	
		4 doors 54 x 16 x 43"	KOD5443.H	<input type="checkbox"/> <input type="checkbox"/> <input type="checkbox"/>	<input type="checkbox"/>	<input type="checkbox"/>	<input type="checkbox"/> <input type="checkbox"/> <input type="checkbox"/>	<input type="checkbox"/> <input type="checkbox"/> <input type="checkbox"/>	
		4 doors 60 x 16 x 43"	KOD6043.H	<input type="checkbox"/> <input type="checkbox"/> <input type="checkbox"/>	<input type="checkbox"/>	<input type="checkbox"/>	<input type="checkbox"/> <input type="checkbox"/> <input type="checkbox"/>	<input type="checkbox"/> <input type="checkbox"/> <input type="checkbox"/>	
		4 doors 66 x 16 x 43"	KOD6643.H	<input type="checkbox"/> <input type="checkbox"/> <input type="checkbox"/>	<input type="checkbox"/>	<input type="checkbox"/>	<input type="checkbox"/> <input type="checkbox"/> <input type="checkbox"/>	<input type="checkbox"/> <input type="checkbox"/> <input type="checkbox"/>	
		4 doors 72 x 16 x 43"	KOD7243.H	<input type="checkbox"/> <input type="checkbox"/> <input type="checkbox"/>	<input type="checkbox"/>	<input type="checkbox"/>	<input type="checkbox"/> <input type="checkbox"/> <input type="checkbox"/>	<input type="checkbox"/> <input type="checkbox"/> <input type="checkbox"/>	
		4 doors 78 x 16 x 43"	KOD7843.H	<input type="checkbox"/> <input type="checkbox"/> <input type="checkbox"/>	<input type="checkbox"/>	<input type="checkbox"/>	<input type="checkbox"/> <input type="checkbox"/> <input type="checkbox"/>	<input type="checkbox"/> <input type="checkbox"/> <input type="checkbox"/>	

**A**      **B**      **C**      **D**      **E**      **F**

### HOW TO ORDER

Indicate the following information on order form:

- Quantity of each item.
- Model number, including options. See "How To Build a Model Number".
- Any special service required.

Note: • The  indicates that a choice is required.  
 • The absence of the  indicates that no choice is required.  
 • Alpha-numeric characters in place of  indicate that no other alternatives are available.

### HOW TO BUILD A MODEL NUMBER

Fabrics & Finishes binder.

- A** Select basic model.
- B** Select cutaway gable option.
  - CGN** - No Cutaway gable (standard)
  - CGL** - Cutaway gable left; add \$70
  - CGR** - Cutaway gable right; add \$70
  - CLR** - Cutaway gable left and right; add \$141
- C** Select locking option.
  - NL** - No lock (standard)
  - L** - With lock; add \$141
- D** Select key option.
  - KA** - Key alike
  - KS** - Key standard
- E** Select horizontal surface finish.  
 Refer to color addendum at ki.com or KI Fabrics & Finishes binder.
- F** Select vertical surface finish.  
 Refer to color addendum at ki.com or KI





# Aristotle® Classic Storage

Closed Overheads

Approx. Packaged Weight	Delivered Pricing
130.0#	\$ 1133

140.0#	\$ 1218
155.0#	1295
165.0#	1363
180.0#	1418
190.0#	1476

**SPECIAL SERVICES**

**Special Carton Marking**

With specially marked information    N/C

**Shipping**

Shipped **assembled freight prepaid f.o.b. KI-Aristotle Brampton, Ontario L6T 5T6** factory. Freight class #85.

Specifications and prices are subject to change without prior notice.

# Aristotle® Classic Storage

Closed Overheads

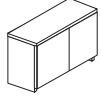

AROVD

MODEL	Features	W x D x H	MODEL NUMBER					Approx. Packaged Weight
			Basic Model	Lock Option	Key Option	Horizontal Surface Finish	Vertical Surface Finish	
<b>Closed Overhead-Wall Mount</b> <ul style="list-style-type: none"> <li>• 13-3/4" internal height clearance</li> <li>• Attachment hardware included</li> <li>• 24-42" wide models feature two doors</li> <li>• 48" models feature three doors</li> <li>• 54" and wider models feature four doors</li> </ul>	2 doors	24 x 17 x 18"	KWVOD24.H	<input type="checkbox"/>	<input type="checkbox"/>	<input type="checkbox"/>	<input type="checkbox"/>	52.0#
	2 doors	30 x 17 x 18"	KWVOD30.H	<input type="checkbox"/>	<input type="checkbox"/>	<input type="checkbox"/>	<input type="checkbox"/>	61.0#
	2 doors	36 x 17 x 18"	KWVOD36.H	<input type="checkbox"/>	<input type="checkbox"/>	<input type="checkbox"/>	<input type="checkbox"/>	72.0#
	2 doors	42 x 17 x 18"	KWVOD42.H	<input type="checkbox"/>	<input type="checkbox"/>	<input type="checkbox"/>	<input type="checkbox"/>	83.0#
				<b>A</b>	<b>B</b>	<b>C</b>	<b>D</b>	<b>E</b>

## HOW TO ORDER

Indicate the following information on order form:

1. Quantity of each item.
2. Model number, including options. See "How To Build a Model Number".
3. Any special service required.

Note: • The  indicates that a choice is required.

- The absence of the  indicates that no choice is required.
- Alpha-numeric characters in place of  indicate that no other alternatives are available.

## HOW TO BUILD A MODEL NUMBER

- A** Select basic model.
- B** Select locking option.
- |    |                       |
|----|-----------------------|
| NL | - No lock (standard)  |
| L  | - With lock; add \$64 |
- C** Select key option.
- |    |                |
|----|----------------|
| KA | - Key alike    |
| KS | - Key standard |
- D** Select horizontal surface finish.  
Refer to color addendum at ki.com or KI Fabrics & Finishes binder.
- E** Select vertical surface finish.  
Refer to color addendum at ki.com or KI Fabrics & Finishes binder.



# Aristotle® Classic Storage

Closed Overheads

Delivered  
Pricing

\$ 694

750

801

878

### SPECIAL SERVICES

#### Special Carton Marking

With specially marked information N/C

#### Shipping

Shipped **assembled freight prepaid f.o.b. KI-Aristotle Brampton, Ontario L6T 5T6** factory. Freight class #85.

Specifications and prices are subject to change without prior notice.

# Aristotle® Classic Storage

Closed Overheads

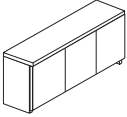
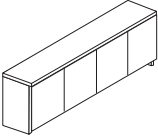
	MODEL	Features	W x D x H	MODEL NUMBER					Approx. Packaged Weight
				Basic Model	Lock Option	Key Option	Horizontal Surface Finish	Vertical Surface Finish	
 <p>AROVD</p>	<b>Closed Overhead-Wall Mount</b> • 13-3/4" internal height clearance • Attachment hardware included • 24-42" wide models feature two doors • 48" models feature three doors • 54" and wider models feature four doors	3 doors	48 x 17 x 18"	KWMOD48.H	<input type="checkbox"/>	<input type="checkbox"/>	<input type="checkbox"/>	<input type="checkbox"/>	96.0#
 <p>AROVD</p>	<b>Closed Overhead-Wall Mount</b> • 13-3/4" internal height clearance • Attachment hardware included • 24-42" wide models feature two doors • 48" models feature three doors • 54" and wider models feature four doors	4 doors	54 x 17 x 18"	KWMOD54.H	<input type="checkbox"/>	<input type="checkbox"/>	<input type="checkbox"/>	<input type="checkbox"/>	107.0#
		4 doors	60 x 17 x 18"	KWMOD60.H	<input type="checkbox"/>	<input type="checkbox"/>	<input type="checkbox"/>	<input type="checkbox"/>	118.0#
		4 doors	66 x 17 x 18"	KWMOD66.H	<input type="checkbox"/>	<input type="checkbox"/>	<input type="checkbox"/>	<input type="checkbox"/>	129.0#
		4 doors	72 x 17 x 18"	KWMOD72.H	<input type="checkbox"/>	<input type="checkbox"/>	<input type="checkbox"/>	<input type="checkbox"/>	140.0#
		4 doors	78 x 17 x 18"	KWMOD78.H	<input type="checkbox"/>	<input type="checkbox"/>	<input type="checkbox"/>	<input type="checkbox"/>	151.0#
				<b>A</b>	<b>B</b>	<b>C</b>	<b>D</b>	<b>E</b>	

## HOW TO ORDER

Indicate the following information on order form:

- Quantity of each item.
- Model number, including options. See "How To Build a Model Number".
- Any special service required.

Note: • The  indicates that a choice is required.

- The absence of the  indicates that no choice is required.
- Alpha-numeric characters in place of  indicate that no other alternatives are available.

## HOW TO BUILD A MODEL NUMBER

**A** Select basic model.

**B** Select locking option.

NL - No lock (standard)  
L - With lock; add \$141

**C** Select key option.

KA - Key alike  
KS - Key standard

**D** Select horizontal surface finish.

Refer to color addendum at [ki.com](http://ki.com) or KI Fabrics & Finishes binder.

**E** Select vertical surface finish.

Refer to color addendum at [ki.com](http://ki.com) or KI Fabrics & Finishes binder.



# Aristotle® Classic Storage

Closed Overheads

Delivered  
Pricing

\$ 968

\$ 989

1129

1198

1252

1319

## SPECIAL SERVICES

### Special Carton Marking

With specially marked information N/C

### Shipping

Shipped **assembled freight prepaid f.o.b.**  
**KI-Aristotle Brampton, Ontario L6T 5T6**  
factory. Freight class #85.

Specifications and prices are subject to  
change without prior notice.

# Aristotle® Classic Storage

Overhead - Frosted Glass Doors

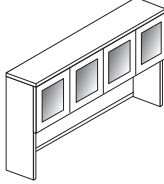
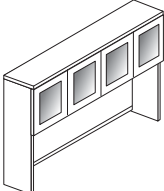
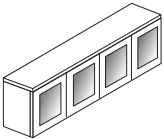
	MODEL	W x D x H	MODEL NUMBER				Approx. Packaged Weight
			Basic Model	Cutaway Gable Option	Horizontal Surface Finish	Vertical Surface Finish	
 <p>AROVD</p>	<b>Overhead-36" High, Frosted Glass Doors</b> <ul style="list-style-type: none"> <li>• 17-1/2" clearance above desktop and 36" high</li> <li>• 13-3/4" internal height clearance</li> <li>• Full-width concealed cable pass through 1-3/4" high</li> <li>• Closed overheads standard without pulls, non-locking; pulls and locks cannot be specified</li> <li>• Door frame features silver finish</li> <li>• Pulls and locks cannot be specified</li> <li>• Tackboards and paper sorters specified separately</li> <li>• Cutaway gable option should only be specified in side-to-side overhead applications, as standalone units are not stable with cutaway gables</li> </ul>	60 x 16 x 36"	KOF6036.H.AL	<input type="checkbox"/> <input type="checkbox"/> <input type="checkbox"/>	<input type="checkbox"/> <input type="checkbox"/> <input type="checkbox"/>	<input type="checkbox"/> <input type="checkbox"/> <input type="checkbox"/>	145.0#
		66 x 16 x 36"	KOF6636.H.AL	<input type="checkbox"/> <input type="checkbox"/> <input type="checkbox"/>	<input type="checkbox"/> <input type="checkbox"/> <input type="checkbox"/>	<input type="checkbox"/> <input type="checkbox"/> <input type="checkbox"/>	165.0#
		72 x 16 x 36"	KOF7236.H.AL	<input type="checkbox"/> <input type="checkbox"/> <input type="checkbox"/>	<input type="checkbox"/> <input type="checkbox"/> <input type="checkbox"/>	<input type="checkbox"/> <input type="checkbox"/> <input type="checkbox"/>	170.0#
 <p>AROVD</p>	<b>Overhead-43" High, Frosted Glass Doors</b> <ul style="list-style-type: none"> <li>• 24-1/2" clearance above desktop and 43" high</li> <li>• 13-3/4" internal height clearance</li> <li>• Full-width concealed cable pass through 1-3/4" high</li> <li>• Closed overheads standard without pulls, non-locking; pulls and locks cannot be specified</li> <li>• Tackboards and paper sorters specified separately</li> <li>• Cutaway gable option should only be specified in side-to-side overhead applications, as standalone units are not stable with cutaway gables</li> </ul>	60 x 16 x 43"	KOF6043.H.AL	<input type="checkbox"/> <input type="checkbox"/> <input type="checkbox"/>	<input type="checkbox"/> <input type="checkbox"/> <input type="checkbox"/>	<input type="checkbox"/> <input type="checkbox"/> <input type="checkbox"/>	155.0#
		66 x 16 x 43"	KOF6643.H.AL	<input type="checkbox"/> <input type="checkbox"/> <input type="checkbox"/>	<input type="checkbox"/> <input type="checkbox"/> <input type="checkbox"/>	<input type="checkbox"/> <input type="checkbox"/> <input type="checkbox"/>	165.0#
		72 x 16 x 43"	KOF7243.H.AL	<input type="checkbox"/> <input type="checkbox"/> <input type="checkbox"/>	<input type="checkbox"/> <input type="checkbox"/> <input type="checkbox"/>	<input type="checkbox"/> <input type="checkbox"/> <input type="checkbox"/>	180.0#
 <p>AROVD</p>	<b>Overhead-Wall Mount, Frosted Glass Doors</b> <ul style="list-style-type: none"> <li>• 13-3/4" internal height clearance</li> <li>• Full-width concealed cable pass through 1-3/4" high</li> <li>• Closed overheads standard without pulls, non-locking; pulls and locks cannot be specified</li> <li>• Attachment hardware included</li> <li>• Paper sorter insert not available</li> </ul>	60 x 17 x 18"	KWMOF60.H.AL		<input type="checkbox"/> <input type="checkbox"/> <input type="checkbox"/>	<input type="checkbox"/> <input type="checkbox"/> <input type="checkbox"/>	118.0#
		66 x 17 x 18"	KWMOF66.H.AL		<input type="checkbox"/> <input type="checkbox"/> <input type="checkbox"/>	<input type="checkbox"/> <input type="checkbox"/> <input type="checkbox"/>	128.0#
		72 x 17 x 18"	KWMOF72.H.AL		<input type="checkbox"/> <input type="checkbox"/> <input type="checkbox"/>	<input type="checkbox"/> <input type="checkbox"/> <input type="checkbox"/>	140.0#

A                      B                      C                      D

## HOW TO ORDER

Indicate the following information on order form:

1. Quantity of each item.
2. Model number, including options. See "How To Build a Model Number".
3. Any special service required.

- Note:
- The  indicates that a choice is required.
  - The absence of the  indicates that no choice is required.
  - Alpha-numeric characters in place of  indicate that no other alternatives are available.

## HOW TO BUILD A MODEL NUMBER

- A** Select basic model.
- B** Select cutaway gable option.
- |            |   |
|------------|---|
| <b>CGN</b> | - No Cutaway gable (standard)             |
| <b>CGL</b> | - Cutaway gable left; add \$70            |
| <b>CGR</b> | - Cutaway gable right; add \$70           |
| <b>CLR</b> | - Cutaway gable left and right; add \$141 |
- C** Select horizontal surface finish.  
Refer to color addendum at ki.com or KI Fabrics & Finishes binder.
- D** Select vertical surface finish.  
Refer to color addendum at ki.com or KI Fabrics & Finishes binder.



# Aristotle® Classic Storage

Overhead - Frosted Glass Doors

Delivered Pricing

\$ 1818  
1880  
1942

\$ 2006  
2069  
2129

\$ 1818  
1880  
1942

**SPECIAL SERVICES**

**Special Carton Marking**

With specially marked information N/C

**Shipping**

Shipped **assembled freight prepaid f.o.b. KI-Aristotle Brampton, Ontario L6T 5T6** factory. Freight class #85.

Specifications and prices are subject to change without prior notice.

# Aristotle® Classic Storage

Overheads—Sliding Frosted Acrylic Doors

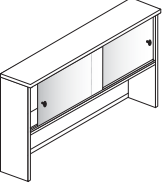
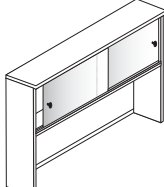
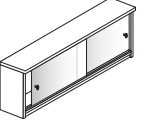
	MODEL	W x D x H	MODEL NUMBER				Approx. Packaged Weight
			Basic Model	Cutaway Gable Option	Horizontal Surface Finish	Vertical Surface Finish	
 <p>AROVD</p>	<b>Overhead-36" High, Sliding Frosted Acrylic Doors</b> <ul style="list-style-type: none"> <li>• 17-1/2" clearance above desktop and 36" high</li> <li>• 13-3/4" internal height clearance</li> <li>• Full-width concealed cable pass through 1-3/4" high</li> <li>• Lock option not available</li> <li>• Aluminum knob pulls standard</li> <li>• Cutaway gable option should only be specified in side-to-side overhead applications, as standalone units are not stable with cutaway gables</li> </ul>	42 x 16 x 36"	KOSD4236.H	<input type="checkbox"/> <input type="checkbox"/> <input type="checkbox"/>	<input type="checkbox"/> <input type="checkbox"/> <input type="checkbox"/>	<input type="checkbox"/> <input type="checkbox"/> <input type="checkbox"/>	120.0#
		48 x 16 x 36"	KOSD4836.H	<input type="checkbox"/> <input type="checkbox"/> <input type="checkbox"/>	<input type="checkbox"/> <input type="checkbox"/> <input type="checkbox"/>	<input type="checkbox"/> <input type="checkbox"/> <input type="checkbox"/>	135.0#
		54 x 16 x 36"	KOSD5436.H	<input type="checkbox"/> <input type="checkbox"/> <input type="checkbox"/>	<input type="checkbox"/> <input type="checkbox"/> <input type="checkbox"/>	<input type="checkbox"/> <input type="checkbox"/> <input type="checkbox"/>	145.0#
		60 x 16 x 36"	KOSD6036.H	<input type="checkbox"/> <input type="checkbox"/> <input type="checkbox"/>	<input type="checkbox"/> <input type="checkbox"/> <input type="checkbox"/>	<input type="checkbox"/> <input type="checkbox"/> <input type="checkbox"/>	160.0#
		66 x 16 x 36"	KOSD6636.H	<input type="checkbox"/> <input type="checkbox"/> <input type="checkbox"/>	<input type="checkbox"/> <input type="checkbox"/> <input type="checkbox"/>	<input type="checkbox"/> <input type="checkbox"/> <input type="checkbox"/>	175.0#
		72 x 16 x 36"	KOSD7236.H	<input type="checkbox"/> <input type="checkbox"/> <input type="checkbox"/>	<input type="checkbox"/> <input type="checkbox"/> <input type="checkbox"/>	<input type="checkbox"/> <input type="checkbox"/> <input type="checkbox"/>	190.0#
		78 x 16 x 36"	KOSD7836.H	<input type="checkbox"/> <input type="checkbox"/> <input type="checkbox"/>	<input type="checkbox"/> <input type="checkbox"/> <input type="checkbox"/>	<input type="checkbox"/> <input type="checkbox"/> <input type="checkbox"/>	195.0#
 <p>AROVD</p>	<b>Overhead-43" High, Sliding Frosted Acrylic Doors</b> <ul style="list-style-type: none"> <li>• 24-1/2" clearance above desktop and 43" high</li> <li>• 13-3/4" internal height clearance</li> <li>• Full-width concealed cable pass through 1-3/4" high</li> <li>• Lock option not available</li> <li>• Aluminum knob pulls standard</li> <li>• Cutaway gable option should only be specified in side-to-side overhead applications, as standalone units are not stable with cutaway gables</li> </ul>	42 x 16 x 43"	KOSD4243.H	<input type="checkbox"/> <input type="checkbox"/> <input type="checkbox"/>	<input type="checkbox"/> <input type="checkbox"/> <input type="checkbox"/>	<input type="checkbox"/> <input type="checkbox"/> <input type="checkbox"/>	130.0#
		48 x 16 x 43"	KOSD4843.H	<input type="checkbox"/> <input type="checkbox"/> <input type="checkbox"/>	<input type="checkbox"/> <input type="checkbox"/> <input type="checkbox"/>	<input type="checkbox"/> <input type="checkbox"/> <input type="checkbox"/>	145.0#
		54 x 16 x 43"	KOSD5443.H	<input type="checkbox"/> <input type="checkbox"/> <input type="checkbox"/>	<input type="checkbox"/> <input type="checkbox"/> <input type="checkbox"/>	<input type="checkbox"/> <input type="checkbox"/> <input type="checkbox"/>	155.0#
		60 x 16 x 43"	KOSD6043.H	<input type="checkbox"/> <input type="checkbox"/> <input type="checkbox"/>	<input type="checkbox"/> <input type="checkbox"/> <input type="checkbox"/>	<input type="checkbox"/> <input type="checkbox"/> <input type="checkbox"/>	170.0#
		66 x 16 x 43"	KOSD6643.H	<input type="checkbox"/> <input type="checkbox"/> <input type="checkbox"/>	<input type="checkbox"/> <input type="checkbox"/> <input type="checkbox"/>	<input type="checkbox"/> <input type="checkbox"/> <input type="checkbox"/>	185.0#
		72 x 16 x 43"	KOSD7243.H	<input type="checkbox"/> <input type="checkbox"/> <input type="checkbox"/>	<input type="checkbox"/> <input type="checkbox"/> <input type="checkbox"/>	<input type="checkbox"/> <input type="checkbox"/> <input type="checkbox"/>	195.0#
		78 x 16 x 43"	KOSD7843.H	<input type="checkbox"/> <input type="checkbox"/> <input type="checkbox"/>	<input type="checkbox"/> <input type="checkbox"/> <input type="checkbox"/>	<input type="checkbox"/> <input type="checkbox"/> <input type="checkbox"/>	205.0#
 <p>AROVD</p>	<b>Overhead-Wall Mount, Sliding Frosted Acrylic Doors</b> <ul style="list-style-type: none"> <li>• 13-3/4" internal height clearance</li> <li>• Full-width concealed cable pass through 1-3/4" high</li> <li>• Lock option not available</li> <li>• Aluminum knob pulls standard</li> <li>• Attachment hardware included</li> </ul>	42 x 17 x 18"	KWMOSD42.H		<input type="checkbox"/> <input type="checkbox"/> <input type="checkbox"/>	<input type="checkbox"/> <input type="checkbox"/> <input type="checkbox"/>	93.0#
		48 x 17 x 18"	KWMOSD48.H		<input type="checkbox"/> <input type="checkbox"/> <input type="checkbox"/>	<input type="checkbox"/> <input type="checkbox"/> <input type="checkbox"/>	111.0#
		54 x 17 x 18"	KWMOSD54.H		<input type="checkbox"/> <input type="checkbox"/> <input type="checkbox"/>	<input type="checkbox"/> <input type="checkbox"/> <input type="checkbox"/>	122.0#
		60 x 17 x 18"	KWMOSD60.H		<input type="checkbox"/> <input type="checkbox"/> <input type="checkbox"/>	<input type="checkbox"/> <input type="checkbox"/> <input type="checkbox"/>	133.0#
		66 x 17 x 18"	KWMOSD66.H		<input type="checkbox"/> <input type="checkbox"/> <input type="checkbox"/>	<input type="checkbox"/> <input type="checkbox"/> <input type="checkbox"/>	144.0#
		72 x 17 x 18"	KWMOSD72.H		<input type="checkbox"/> <input type="checkbox"/> <input type="checkbox"/>	<input type="checkbox"/> <input type="checkbox"/> <input type="checkbox"/>	155.0#
		78 x 17 x 18"	KWMOSD78.H		<input type="checkbox"/> <input type="checkbox"/> <input type="checkbox"/>	<input type="checkbox"/> <input type="checkbox"/> <input type="checkbox"/>	166.0#

A

B

C

D

## HOW TO ORDER

Indicate the following information on order form:

1. Quantity of each item.
2. Model number, including options. See "How To Build a Model Number".
3. Any special service required.

Note: • The  indicates that a choice is required.

- The absence of the  indicates that no choice is required.
- Alpha-numeric characters in place of  indicate that no other alternatives are available.

## HOW TO BUILD A MODEL NUMBER

**A** Select basic model.

**B** Select cutaway gable option.

**CGN** - No Cutaway gable (standard)

**CGL** - Cutaway gable left; add \$70

**CGR** - Cutaway gable right; add \$70

**CLR** - Cutaway gable left and right; add \$141

**C** Select horizontal surface finish.

Refer to color addendum at [ki.com](http://ki.com) or KI Fabrics & Finishes binder.

**D** Select vertical surface finish.

Refer to color addendum at [ki.com](http://ki.com) or KI Fabrics & Finishes binder.





# Aristotle® Classic Storage

Overheads-Sliding Frosted Acrylic Doors

## Delivered Pricing

\$ 914  
977  
1064  
1145  
1183  
1225  
1284

\$ 1090  
1154  
1240  
1321  
1360  
1402  
1461

\$ 914  
977  
1064  
1145  
1183  
1225  
1284

### SPECIAL SERVICES

#### Special Carton Marking

With specially marked information N/C

#### Shipping

Shipped **assembled freight prepaid f.o.b. KI-Aristotle Brampton, Ontario L6T 5T6** factory. Freight class #85.

Specifications and prices are subject to change without prior notice.

# Aristotle® Classic Storage

Open Corner Overhead

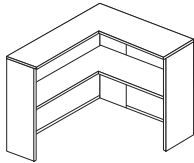
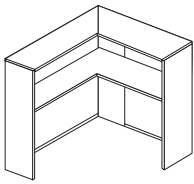
	MODEL	W x D x H	MODEL NUMBER				Approx. Packaged Weight
			Basic Model	Cutaway Gable Option	Horizontal Surface Finish	Vertical Surface Finish	
 <p>AROVD</p>	<b>Open Corner Overhead, 36" High</b>	36 x 16 x 36"	KOCS3636.H	<input type="checkbox"/> <input type="checkbox"/> <input type="checkbox"/>	<input type="checkbox"/> <input type="checkbox"/> <input type="checkbox"/>	<input type="checkbox"/> <input type="checkbox"/> <input type="checkbox"/>	140.0#
	• 17-1/2" clearance above desktop and 65" installed height	42 x 16 x 36"	KOCS4236.H	<input type="checkbox"/> <input type="checkbox"/> <input type="checkbox"/>	<input type="checkbox"/> <input type="checkbox"/> <input type="checkbox"/>	<input type="checkbox"/> <input type="checkbox"/> <input type="checkbox"/>	150.0#
	• 13-3/4" internal height clearance	48 x 16 x 36"	KOCS4836.H	<input type="checkbox"/> <input type="checkbox"/> <input type="checkbox"/>	<input type="checkbox"/> <input type="checkbox"/> <input type="checkbox"/>	<input type="checkbox"/> <input type="checkbox"/> <input type="checkbox"/>	160.0#
	• Full-width concealed cable pass through 1-3/4" high						
	• Ships assembled in two cartons						
	• Cutaway gable option should only be specified in side-to-side overhead applications, as standalone units are not stable with cutaway gables						
 <p>AROVD</p>	<b>Open Corner Overhead, 43" High</b>	36 x 16 x 43"	KOCS3643.H	<input type="checkbox"/> <input type="checkbox"/> <input type="checkbox"/>	<input type="checkbox"/> <input type="checkbox"/> <input type="checkbox"/>	<input type="checkbox"/> <input type="checkbox"/> <input type="checkbox"/>	160.0#
	• 24" clearance above desktop and 72" installed height	42 x 16 x 43"	KOCS4243.H	<input type="checkbox"/> <input type="checkbox"/> <input type="checkbox"/>	<input type="checkbox"/> <input type="checkbox"/> <input type="checkbox"/>	<input type="checkbox"/> <input type="checkbox"/> <input type="checkbox"/>	170.0#
	• 13-3/4" internal height clearance	48 x 16 x 43"	KOCS4843.H	<input type="checkbox"/> <input type="checkbox"/> <input type="checkbox"/>	<input type="checkbox"/> <input type="checkbox"/> <input type="checkbox"/>	<input type="checkbox"/> <input type="checkbox"/> <input type="checkbox"/>	180.0#
	• Full-width concealed cable pass through 1-3/4" high						
	• Ships assembled in two cartons						
	• Cutaway gable option should only be specified in side-to-side overhead applications, as standalone units are not stable with cutaway gables						
				<b>A</b>	<b>B</b>	<b>C</b>	<b>D</b>

## HOW TO ORDER

Indicate the following information on order form:

- Quantity of each item.
- Model number, including options. See "How To Build a Model Number".
- Any special service required.

Note: • The  indicates that a choice is required.

- The absence of the  indicates that no choice is required.
- Alpha-numeric characters in place of  indicate that no other alternatives are available.

## HOW TO BUILD A MODEL NUMBER

**A** Select basic model.

**B** Select cutaway gable option.

**CGN** - No Cutaway gable (standard)

**CGL** - Cutaway gable left; add \$70

**CGR** - Cutaway gable right; add \$70

**CLR** - Cutaway gable left and right; add \$141

**C** Select horizontal surface finish.

Refer to color addendum at [ki.com](http://ki.com) or KI Fabrics & Finishes binder.

**D** Select vertical surface finish.

Refer to color addendum at [ki.com](http://ki.com) or KI Fabrics & Finishes binder.



# Aristotle® Classic Storage

Open Corner Overhead

Delivered  
Pricing

\$ 1075

1128

1276

\$ 1317

1344

1422

### SPECIAL SERVICES

#### Special Carton Marking

With specially marked information    N/C

#### Shipping

Shipped **assembled freight prepaid f.o.b. KI-Aristotle Brampton, Ontario L6T 5T6** factory. Freight class #85.

Specifications and prices are subject to change without prior notice.

# Aristotle® Classic Storage

Closed Corner Overhead

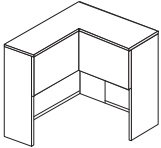
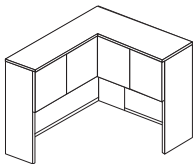
MODEL	Features	W x D x H	MODEL NUMBER				Approx. Packaged Weight
			Basic Model	Cutaway Gable Option	Horizontal Surface Finish	Vertical Surface Finish	
 <p>AROVD</p> <p><b>Closed Corner Overhead, 36" High</b></p> <ul style="list-style-type: none"> <li>• 17-1/2" clearance above desktop and 65" installed height</li> <li>• 13-3/4" internal height clearance</li> <li>• Full-width concealed cable pass through 1-3/4" high</li> <li>• Corner overheads with doors are non-locking only, standard with no pulls</li> <li>• Lock option not available</li> <li>• Tackboards and paper sorter specified separately</li> <li>• Ships assembled in two cartons</li> <li>• Cutaway gable option should only be specified in side-to-side overhead applications, as standalone units are not stable with cutaway gables</li> </ul>	2 doors	36 x 16 x 36"	KOCD3636.H	<input type="checkbox"/> <input type="checkbox"/> <input type="checkbox"/>	<input type="checkbox"/> <input type="checkbox"/> <input type="checkbox"/>	<input type="checkbox"/> <input type="checkbox"/> <input type="checkbox"/>	165.0#
	4 doors	42 x 16 x 36"	KOCD4236.H	<input type="checkbox"/> <input type="checkbox"/> <input type="checkbox"/>	<input type="checkbox"/> <input type="checkbox"/> <input type="checkbox"/>	<input type="checkbox"/> <input type="checkbox"/> <input type="checkbox"/>	175.0#
	4 doors	48 x 16 x 36"	KOCD4836.H	<input type="checkbox"/> <input type="checkbox"/> <input type="checkbox"/>	<input type="checkbox"/> <input type="checkbox"/> <input type="checkbox"/>	<input type="checkbox"/> <input type="checkbox"/> <input type="checkbox"/>	190.0#
 <p>AROVD</p> <p><b>Closed Corner Overhead, 36" High</b></p> <ul style="list-style-type: none"> <li>• 17-1/2" clearance above desktop and 65" installed height</li> <li>• 13-3/4" internal height clearance</li> <li>• Full-width concealed cable pass through 1-3/4" high</li> <li>• Corner overheads with doors are non-locking only, standard with no pulls</li> <li>• Lock option not available</li> <li>• Tackboards and paper sorter specified separately</li> <li>• Ships assembled in two cartons</li> <li>• Cutaway gable option should only be specified in side-to-side overhead applications, as standalone units are not stable with cutaway gables</li> </ul>							

**A**      **B**      **C**      **D**

## HOW TO ORDER

Indicate the following information on order form:

1. Quantity of each item.
2. Model number, including options. See "How To Build a Model Number".
3. Any special service required.

Note: • The  indicates that a choice is required.  
 • The absence of the  indicates that no choice is required.  
 • Alpha-numeric characters in place of  indicate that no other alternatives are available.

## HOW TO BUILD A MODEL NUMBER

- A** Select basic model.
- B** Select cutaway gable option.
  - CGN** - No Cutaway gable (standard)
  - CGL** - Cutaway gable left; add \$70
  - CGR** - Cutaway gable right; add \$70
  - CLR** - Cutaway gable left and right; add \$141
- C** Select horizontal surface finish. Refer to color addendum at [ki.com](http://ki.com) or KI Fabrics & Finishes binder.
- D** Select vertical surface finish. Refer to color addendum at [ki.com](http://ki.com) or KI Fabrics & Finishes binder.



# Aristotle® Classic Storage

## Closed Corner Overhead

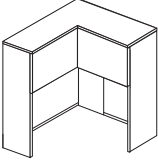
	MODEL	Features	W x D x H	MODEL NUMBER				Approx. Packaged Weight
				Basic Model	Cutaway Gable Option	Horizontal Surface Finish	Vertical Surface Finish	
 <p>AROVD</p>	<b>Closed Corner Overhead, 43" High</b> <ul style="list-style-type: none"> <li>• 24" clearance above desktop and 72" installed height</li> <li>• 13-3/4" internal height clearance</li> <li>• Full-width concealed cable pass through 1-3/4" high</li> <li>• Corner overheads with doors are non-locking only, standard with no pulls</li> <li>• Lock option not available</li> <li>• Tackboards and paper sorter specified separately</li> <li>• Ships assembled in two cartons</li> <li>• Cutaway gable option should only be specified in side-to-side overhead applications, as standalone units are not stable with cutaway gables</li> </ul>	2 doors	36 x 16 x 43"	KOCD3643.H	<input type="checkbox"/> <input type="checkbox"/> <input type="checkbox"/>	<input type="checkbox"/> <input type="checkbox"/> <input type="checkbox"/>	<input type="checkbox"/> <input type="checkbox"/> <input type="checkbox"/>	185.0#
		4 doors	42 x 16 x 43"	KOCD4243.H	<input type="checkbox"/> <input type="checkbox"/> <input type="checkbox"/>	<input type="checkbox"/> <input type="checkbox"/> <input type="checkbox"/>	<input type="checkbox"/> <input type="checkbox"/> <input type="checkbox"/>	195.0#
		4 doors	48 x 16 x 43"	KOCD4843.H	<input type="checkbox"/> <input type="checkbox"/> <input type="checkbox"/>	<input type="checkbox"/> <input type="checkbox"/> <input type="checkbox"/>	<input type="checkbox"/> <input type="checkbox"/> <input type="checkbox"/>	210.0#

**A**      **B**      **C**      **D**

### HOW TO ORDER

Indicate the following information on order form:

1. Quantity of each item.
2. Model number, including options. See "How To Build a Model Number".
3. Any special service required.

Note: • The  indicates that a choice is required.  
 • The absence of the  indicates that no choice is required.  
 • Alpha-numeric characters in place of  indicate that no other alternatives are available.

### HOW TO BUILD A MODEL NUMBER

- A** Select basic model.
- B** Select cutaway gable option.
  - CGN** - No Cutaway gable (standard)
  - CGL** - Cutaway gable left; add \$70
  - CGR** - Cutaway gable right; add \$70
  - CLR** - Cutaway gable left and right; add \$141
- C** Select horizontal surface finish. Refer to color addendum at ki.com or KI Fabrics & Finishes binder.
- D** Select vertical surface finish. Refer to color addendum at ki.com or KI Fabrics & Finishes binder.



# Aristotle® Classic Storage

Closed Corner Overhead

Delivered  
Pricing

\$ 1586

\$ 1707

1838

### SPECIAL SERVICES

#### Special Carton Marking

With specially marked information N/C

#### Shipping

Shipped **assembled freight prepaid f.o.b. KI-Aristotle Brampton, Ontario L6T 5T6** factory. Freight class #85.

Specifications and prices are subject to change without prior notice.

# Aristotle® Classic Storage

## Gallery Reception Desks

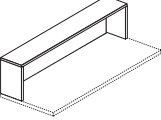
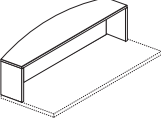
	MODEL	W x D x H	MODEL NUMBER			Approx. Packaged Weight
			Basic Model	Horizontal Surface Finish	Vertical Surface Finish	
 <p>ARGRD</p>	<b>Reception Gallery</b> <ul style="list-style-type: none"> <li>Transaction top is 12" deep</li> <li>Installed height is 44"</li> <li>Clearance above desk top is 14"</li> <li>Desk specified separately</li> </ul>	24 x 12 x 15"	KOSG24.H	<input type="checkbox"/> <input type="checkbox"/> <input type="checkbox"/> <input type="checkbox"/>	<input type="checkbox"/> <input type="checkbox"/> <input type="checkbox"/> <input type="checkbox"/>	30.0#
		30 x 12 x 15"	KOSG30.H	<input type="checkbox"/> <input type="checkbox"/> <input type="checkbox"/> <input type="checkbox"/>	<input type="checkbox"/> <input type="checkbox"/> <input type="checkbox"/> <input type="checkbox"/>	35.0#
		36 x 12 x 15"	KOSG36.H	<input type="checkbox"/> <input type="checkbox"/> <input type="checkbox"/> <input type="checkbox"/>	<input type="checkbox"/> <input type="checkbox"/> <input type="checkbox"/> <input type="checkbox"/>	40.0#
		42 x 12 x 15"	KOSG42.H	<input type="checkbox"/> <input type="checkbox"/> <input type="checkbox"/> <input type="checkbox"/>	<input type="checkbox"/> <input type="checkbox"/> <input type="checkbox"/> <input type="checkbox"/>	45.0#
		48 x 12 x 15"	KOSG48.H	<input type="checkbox"/> <input type="checkbox"/> <input type="checkbox"/> <input type="checkbox"/>	<input type="checkbox"/> <input type="checkbox"/> <input type="checkbox"/> <input type="checkbox"/>	50.0#
		54 x 12 x 15"	KOSG54.H	<input type="checkbox"/> <input type="checkbox"/> <input type="checkbox"/> <input type="checkbox"/>	<input type="checkbox"/> <input type="checkbox"/> <input type="checkbox"/> <input type="checkbox"/>	55.0#
		60 x 12 x 15"	KOSG60.H	<input type="checkbox"/> <input type="checkbox"/> <input type="checkbox"/> <input type="checkbox"/>	<input type="checkbox"/> <input type="checkbox"/> <input type="checkbox"/> <input type="checkbox"/>	60.0#
		66 x 12 x 15"	KOSG66.H	<input type="checkbox"/> <input type="checkbox"/> <input type="checkbox"/> <input type="checkbox"/>	<input type="checkbox"/> <input type="checkbox"/> <input type="checkbox"/> <input type="checkbox"/>	65.0#
		72 x 12 x 15"	KOSG72.H	<input type="checkbox"/> <input type="checkbox"/> <input type="checkbox"/> <input type="checkbox"/>	<input type="checkbox"/> <input type="checkbox"/> <input type="checkbox"/> <input type="checkbox"/>	70.0#
		78 x 12 x 15"	KOSG78.H	<input type="checkbox"/> <input type="checkbox"/> <input type="checkbox"/> <input type="checkbox"/>	<input type="checkbox"/> <input type="checkbox"/> <input type="checkbox"/> <input type="checkbox"/>	75.0#
		84 x 12 x 15"	KOSG84.H	<input type="checkbox"/> <input type="checkbox"/> <input type="checkbox"/> <input type="checkbox"/>	<input type="checkbox"/> <input type="checkbox"/> <input type="checkbox"/> <input type="checkbox"/>	80.0#
		96 x 12 x 15"	KOSG96.H	<input type="checkbox"/> <input type="checkbox"/> <input type="checkbox"/> <input type="checkbox"/>	<input type="checkbox"/> <input type="checkbox"/> <input type="checkbox"/> <input type="checkbox"/>	90.0#
 <p>ARGRD</p>	<b>Bow Front Reception Gallery</b> <ul style="list-style-type: none"> <li>Transaction top is 18" deep with 6" overhang</li> <li>Installed height is 44"</li> <li>Clearance above desk top is 14"</li> <li>Desk specified separately</li> </ul>	24 x 18 x 15"	KBOSG24.H	<input type="checkbox"/> <input type="checkbox"/> <input type="checkbox"/> <input type="checkbox"/>	<input type="checkbox"/> <input type="checkbox"/> <input type="checkbox"/> <input type="checkbox"/>	35.0#
		30 x 18 x 15"	KBOSG30.H	<input type="checkbox"/> <input type="checkbox"/> <input type="checkbox"/> <input type="checkbox"/>	<input type="checkbox"/> <input type="checkbox"/> <input type="checkbox"/> <input type="checkbox"/>	40.0#
		36 x 18 x 15"	KBOSG36.H	<input type="checkbox"/> <input type="checkbox"/> <input type="checkbox"/> <input type="checkbox"/>	<input type="checkbox"/> <input type="checkbox"/> <input type="checkbox"/> <input type="checkbox"/>	45.0#
		42 x 18 x 15"	KBOSG42.H	<input type="checkbox"/> <input type="checkbox"/> <input type="checkbox"/> <input type="checkbox"/>	<input type="checkbox"/> <input type="checkbox"/> <input type="checkbox"/> <input type="checkbox"/>	50.0#
		48 x 18 x 15"	KBOSG48.H	<input type="checkbox"/> <input type="checkbox"/> <input type="checkbox"/> <input type="checkbox"/>	<input type="checkbox"/> <input type="checkbox"/> <input type="checkbox"/> <input type="checkbox"/>	55.0#
		54 x 18 x 15"	KBOSG54.H	<input type="checkbox"/> <input type="checkbox"/> <input type="checkbox"/> <input type="checkbox"/>	<input type="checkbox"/> <input type="checkbox"/> <input type="checkbox"/> <input type="checkbox"/>	60.0#
		60 x 18 x 15"	KBOSG60.H	<input type="checkbox"/> <input type="checkbox"/> <input type="checkbox"/> <input type="checkbox"/>	<input type="checkbox"/> <input type="checkbox"/> <input type="checkbox"/> <input type="checkbox"/>	65.0#
		66 x 18 x 15"	KBOSG66.H	<input type="checkbox"/> <input type="checkbox"/> <input type="checkbox"/> <input type="checkbox"/>	<input type="checkbox"/> <input type="checkbox"/> <input type="checkbox"/> <input type="checkbox"/>	70.0#
		72 x 18 x 15"	KBOSG72.H	<input type="checkbox"/> <input type="checkbox"/> <input type="checkbox"/> <input type="checkbox"/>	<input type="checkbox"/> <input type="checkbox"/> <input type="checkbox"/> <input type="checkbox"/>	75.0#
		78 x 18 x 15"	KBOSG78.H	<input type="checkbox"/> <input type="checkbox"/> <input type="checkbox"/> <input type="checkbox"/>	<input type="checkbox"/> <input type="checkbox"/> <input type="checkbox"/> <input type="checkbox"/>	80.0#
		84 x 18 x 15"	KBOSG84.H	<input type="checkbox"/> <input type="checkbox"/> <input type="checkbox"/> <input type="checkbox"/>	<input type="checkbox"/> <input type="checkbox"/> <input type="checkbox"/> <input type="checkbox"/>	85.0#
		96 x 18 x 15"	KBOSG96.H	<input type="checkbox"/> <input type="checkbox"/> <input type="checkbox"/> <input type="checkbox"/>	<input type="checkbox"/> <input type="checkbox"/> <input type="checkbox"/> <input type="checkbox"/>	95.0#

A

B

C

### HOW TO ORDER

Indicate the following information on order form:

- Quantity of each item.
- Model number, including options. See "How To Build a Model Number".
- Any special service required.

Note: • The  indicates that a choice is required.

- The absence of the  indicates that no choice is required.
- Alpha-numeric characters in place of  indicate that no other alternatives are available.

### HOW TO BUILD A MODEL NUMBER

- A** Select basic model.
- B** Select horizontal surface finish.  
Refer to color addendum at [ki.com](http://ki.com) or KI Fabrics & Finishes binder.
- C** Select vertical surface finish.  
Refer to color addendum at [ki.com](http://ki.com) or KI Fabrics & Finishes binder.





Delivered Pricing

\$ 364
374
412
432
448
495
518
531
621
665
677
714
\$ 412
423
460
480
495
544
565
581
668
713
724
762

**SPECIAL SERVICES**

**Special Carton Marking**

With specially marked information N/C

**Shipping**

Shipped k.d. freight prepaid f.o.b.  
KI-Aristotle Brampton, Ontario L6T 5T6  
factory. Freight class #85.

Specifications and prices are subject to  
change without prior notice.

# Aristotle® Classic Storage

## Gallery Reception Desks

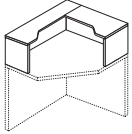
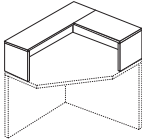
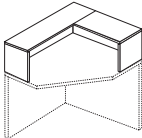
MODEL	W x D x H	MODEL NUMBER			Approx. Packaged Weight
		Basic Model	Horizontal Surface Finish	Vertical Surface Finish	
 <p><b>Corner Reception Gallery - 36"x36"</b></p> <ul style="list-style-type: none"> <li>• Transaction top is 9" deep with 12" corners</li> <li>• Installed height is 44"</li> <li>• Clearance above desk top is 14"</li> <li>• Desk specified separately</li> </ul>	36 x 36 x 15"	KOSGC36.H	<input type="checkbox"/> <input type="checkbox"/> <input type="checkbox"/>	<input type="checkbox"/> <input type="checkbox"/> <input type="checkbox"/>	45.0#
ARGRD					
 <p><b>Corner Reception Gallery - 42"x42"</b></p> <ul style="list-style-type: none"> <li>• Transaction top is 9" deep with 12" corners</li> <li>• Installed height is 44"</li> <li>• Clearance above desk top is 14"</li> <li>• Desk specified separately</li> </ul>	42 x 42 x 15"	KOSGC42.H	<input type="checkbox"/> <input type="checkbox"/> <input type="checkbox"/>	<input type="checkbox"/> <input type="checkbox"/> <input type="checkbox"/>	55.0#
ARGRD					
 <p><b>Corner Reception Gallery - 48"x48"</b></p> <ul style="list-style-type: none"> <li>• Transaction top is 9" deep with 12" corners</li> <li>• Installed height is 44"</li> <li>• Clearance above desk top is 14"</li> <li>• Desk specified separately</li> </ul>	48 x 48 x 15"	KOSGC48.H	<input type="checkbox"/> <input type="checkbox"/> <input type="checkbox"/>	<input type="checkbox"/> <input type="checkbox"/> <input type="checkbox"/>	65.0#
ARGRD					

**A**      **B**      **C**

### HOW TO ORDER

Indicate the following information on order form:

1. Quantity of each item.
2. Model number, including options. See "How To Build a Model Number".
3. Any special service required.

Note: • The  indicates that a choice is required.

- The absence of the  indicates that no choice is required.
- Alpha-numeric characters in place of  indicate that no other alternatives are available.

### HOW TO BUILD A MODEL NUMBER

- A** Select basic model.
- B** Select horizontal surface finish.  
Refer to color addendum at [ki.com](http://ki.com) or KI Fabrics & Finishes binder.
- C** Select vertical surface finish.  
Refer to color addendum at [ki.com](http://ki.com) or KI Fabrics & Finishes binder.



# Aristotle® Classic Storage

Gallery Reception Desks

Delivered  
Pricing  
\$ 751

\$ 783

\$ 817

### SPECIAL SERVICES

#### Special Carton Marking

With specially marked information N/C

#### Shipping

Shipped k.d. freight prepaid f.o.b.  
KI-Aristotle Brampton, Ontario L6T 5T6  
factory. Freight class #85.

Specifications and prices are subject to  
change without prior notice.

# Aristotle® Classic Storage

## Extended Corner Reception Gallery

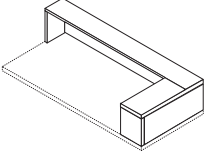
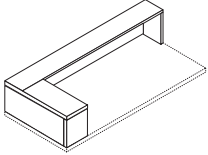
MODEL	W x D x H	MODEL NUMBER			Approx. Packaged Weight
		Basic Model	Horizontal Surface Finish	Vertical Surface Finish	
 <p><b>Extended Corner Reception Gallery-24", Left</b></p> <ul style="list-style-type: none"> <li>• Transaction top is 9" deep with 12" corners</li> <li>• Installed height is 44"</li> <li>• Clearance above desk top is 14"</li> <li>• Desk specified separately</li> </ul>	60 x 24 x 15"	KOSGCL6024.H	<input type="checkbox"/> <input type="checkbox"/> <input type="checkbox"/>	<input type="checkbox"/> <input type="checkbox"/> <input type="checkbox"/>	70.0#
	66 x 24 x 15"	KOSGCL6624.H	<input type="checkbox"/> <input type="checkbox"/> <input type="checkbox"/>	<input type="checkbox"/> <input type="checkbox"/> <input type="checkbox"/>	75.0#
	72 x 24 x 15"	KOSGCL7224.H	<input type="checkbox"/> <input type="checkbox"/> <input type="checkbox"/>	<input type="checkbox"/> <input type="checkbox"/> <input type="checkbox"/>	80.0#
	84 x 24 x 15"	KOSGCL8424.H	<input type="checkbox"/> <input type="checkbox"/> <input type="checkbox"/>	<input type="checkbox"/> <input type="checkbox"/> <input type="checkbox"/>	90.0#
	96 x 24 x 15"	KOSGCL9624.H	<input type="checkbox"/> <input type="checkbox"/> <input type="checkbox"/>	<input type="checkbox"/> <input type="checkbox"/> <input type="checkbox"/>	100.0#
ARGRD					
 <p><b>Extended Corner Reception Gallery-24", Right</b></p> <ul style="list-style-type: none"> <li>• Transaction top is 9" deep with 12" corners</li> <li>• Installed height is 44"</li> <li>• Clearance above desk top is 14"</li> <li>• Desk specified separately</li> </ul>	60 x 24 x 15"	KOSGCR6024.H	<input type="checkbox"/> <input type="checkbox"/> <input type="checkbox"/>	<input type="checkbox"/> <input type="checkbox"/> <input type="checkbox"/>	70.0#
	66 x 24 x 15"	KOSGCR6624.H	<input type="checkbox"/> <input type="checkbox"/> <input type="checkbox"/>	<input type="checkbox"/> <input type="checkbox"/> <input type="checkbox"/>	75.0#
	72 x 24 x 15"	KOSGCR7224.H	<input type="checkbox"/> <input type="checkbox"/> <input type="checkbox"/>	<input type="checkbox"/> <input type="checkbox"/> <input type="checkbox"/>	80.0#
	84 x 24 x 15"	KOSGCR8424.H	<input type="checkbox"/> <input type="checkbox"/> <input type="checkbox"/>	<input type="checkbox"/> <input type="checkbox"/> <input type="checkbox"/>	90.0#
	96 x 24 x 15"	KOSGCR9624.H	<input type="checkbox"/> <input type="checkbox"/> <input type="checkbox"/>	<input type="checkbox"/> <input type="checkbox"/> <input type="checkbox"/>	100.0#
ARGRD					

**A**

**B**

**C**

### HOW TO ORDER

Indicate the following information on order form:

1. Quantity of each item.
2. Model number, including options. See "How To Build a Model Number".
3. Any special service required.

Note: • The  indicates that a choice is required.

- The absence of the  indicates that no choice is required.
- Alpha-numeric characters in place of  indicate that no other alternatives are available.

### HOW TO BUILD A MODEL NUMBER

- A** Select basic model.
- B** Select horizontal surface finish. Refer to color addendum at [ki.com](http://ki.com) or KI Fabrics & Finishes binder.
- C** Select vertical surface finish. Refer to color addendum at [ki.com](http://ki.com) or KI Fabrics & Finishes binder.



# Aristotle® Classic Storage

Extended Corner Reception Gallery

Delivered  
Pricing

\$ 740

745

751

773

791

\$ 740

745

751

773

791

## SPECIAL SERVICES

### Special Carton Marking

With specially marked information N/C

### Shipping

Shipped **k.d. freight prepaid f.o.b.**  
**KI-Aristotle Brampton, Ontario L6T 5T6**  
factory. Freight class #85.

Specifications and prices are subject to  
change without prior notice.

# Aristotle® Classic Storage

## Extended Corner Reception Gallery

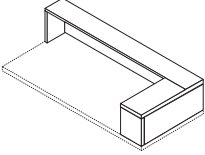
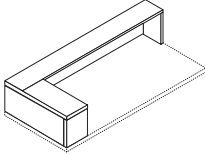
MODEL	W x D x H	MODEL NUMBER			Approx. Packaged Weight
		Basic Model	Horizontal Surface Finish	Vertical Surface Finish	
 <p><b>Extended Corner Reception Gallery-30", Left</b></p> <ul style="list-style-type: none"> <li>• Transaction top is 9" deep with 12" corners</li> <li>• Installed height is 44"</li> <li>• Clearance above desk top is 14"</li> <li>• Desk specified separately</li> </ul>	60 x 30 x 15"	KOSGCL6030.H	<input type="checkbox"/> <input type="checkbox"/> <input type="checkbox"/>	<input type="checkbox"/> <input type="checkbox"/> <input type="checkbox"/>	75.0#
	66 x 30 x 15"	KOSGCL6630.H	<input type="checkbox"/> <input type="checkbox"/> <input type="checkbox"/>	<input type="checkbox"/> <input type="checkbox"/> <input type="checkbox"/>	80.0#
	72 x 30 x 15"	KOSGCL7230.H	<input type="checkbox"/> <input type="checkbox"/> <input type="checkbox"/>	<input type="checkbox"/> <input type="checkbox"/> <input type="checkbox"/>	85.0#
	84 x 30 x 15"	KOSGCL8430.H	<input type="checkbox"/> <input type="checkbox"/> <input type="checkbox"/>	<input type="checkbox"/> <input type="checkbox"/> <input type="checkbox"/>	95.0#
	96 x 30 x 15"	KOSGCL9630.H	<input type="checkbox"/> <input type="checkbox"/> <input type="checkbox"/>	<input type="checkbox"/> <input type="checkbox"/> <input type="checkbox"/>	105.0#
ARGRD					
 <p><b>Extended Corner Reception Gallery-30", Right</b></p> <ul style="list-style-type: none"> <li>• Transaction top is 9" deep with 12" corners</li> <li>• Installed height is 44"</li> <li>• Clearance above desk top is 14"</li> <li>• Desk specified separately</li> </ul>	60 x 30 x 15"	KOSGCR6030.H	<input type="checkbox"/> <input type="checkbox"/> <input type="checkbox"/>	<input type="checkbox"/> <input type="checkbox"/> <input type="checkbox"/>	75.0#
	66 x 30 x 15"	KOSGCR6630.H	<input type="checkbox"/> <input type="checkbox"/> <input type="checkbox"/>	<input type="checkbox"/> <input type="checkbox"/> <input type="checkbox"/>	80.0#
	72 x 30 x 15"	KOSGCR7230.H	<input type="checkbox"/> <input type="checkbox"/> <input type="checkbox"/>	<input type="checkbox"/> <input type="checkbox"/> <input type="checkbox"/>	85.0#
	84 x 30 x 15"	KOSGCR8430.H	<input type="checkbox"/> <input type="checkbox"/> <input type="checkbox"/>	<input type="checkbox"/> <input type="checkbox"/> <input type="checkbox"/>	95.0#
	96 x 30 x 15"	KOSGCR9630.H	<input type="checkbox"/> <input type="checkbox"/> <input type="checkbox"/>	<input type="checkbox"/> <input type="checkbox"/> <input type="checkbox"/>	105.0#
ARGRD					
			<b>A</b>	<b>B</b>	<b>C</b>

### HOW TO ORDER

Indicate the following information on order form:

1. Quantity of each item.
2. Model number, including options. See "How To Build a Model Number".
3. Any special service required.

Note: • The  indicates that a choice is required.

- The absence of the  indicates that no choice is required.
- Alpha-numeric characters in place of  indicate that no other alternatives are available.

### HOW TO BUILD A MODEL NUMBER

- A** Select basic model.
- B** Select horizontal surface finish.  
Refer to color addendum at [ki.com](http://ki.com) or KI Fabrics & Finishes binder.
- C** Select vertical surface finish.  
Refer to color addendum at [ki.com](http://ki.com) or KI Fabrics & Finishes binder.



# Aristotle® Classic Storage

Extended Corner Reception Gallery

Delivered Pricing

\$ 751  
759  
773  
791  
811

\$ 751  
759  
773  
791  
811

**SPECIAL SERVICES**

**Special Carton Marking**

With specially marked information N/C

**Shipping**

Shipped k.d. freight prepaid f.o.b.  
KI-Aristotle Brampton, Ontario L6T 5T6  
factory. Freight class #85.

Specifications and prices are subject to  
change without prior notice.

# Aristotle® Classic Storage

## Extended Corner Reception Gallery

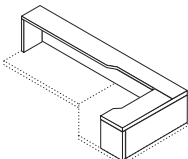
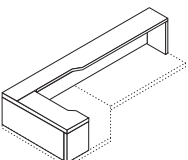
MODEL	W x D x H	MODEL NUMBER			Approx. Packaged Weight
		Basic Model	Horizontal Surface Finish	Vertical Surface Finish	
 <p><b>Extended Corner Reception Gallery-36", Left</b></p> <ul style="list-style-type: none"> <li>• Transaction top is 9" deep with 12" corners</li> <li>• Installed height is 44"</li> <li>• Clearance above desk top is 14"</li> <li>• Desk specified separately</li> </ul>	60 x 36 x 15"	KOSGCL6036.H	<input type="checkbox"/> <input type="checkbox"/> <input type="checkbox"/>	<input type="checkbox"/> <input type="checkbox"/> <input type="checkbox"/>	80.0#
	66 x 36 x 15"	KOSGCL6636.H	<input type="checkbox"/> <input type="checkbox"/> <input type="checkbox"/>	<input type="checkbox"/> <input type="checkbox"/> <input type="checkbox"/>	85.0#
	72 x 36 x 15"	KOSGCL7236.H	<input type="checkbox"/> <input type="checkbox"/> <input type="checkbox"/>	<input type="checkbox"/> <input type="checkbox"/> <input type="checkbox"/>	90.0#
	84 x 36 x 15"	KOSGCL8436.H	<input type="checkbox"/> <input type="checkbox"/> <input type="checkbox"/>	<input type="checkbox"/> <input type="checkbox"/> <input type="checkbox"/>	100.0#
	96 x 36 x 15"	KOSGCL9636.H	<input type="checkbox"/> <input type="checkbox"/> <input type="checkbox"/>	<input type="checkbox"/> <input type="checkbox"/> <input type="checkbox"/>	110.0#
	ARGRD				
 <p><b>Extended Corner Reception Gallery-36", Right</b></p> <ul style="list-style-type: none"> <li>• Transaction top is 9" deep with 12" corners</li> <li>• Installed height is 44"</li> <li>• Clearance above desk top is 14"</li> <li>• Desk specified separately</li> </ul>	60 x 36 x 15"	KOSGCR6036.H	<input type="checkbox"/> <input type="checkbox"/> <input type="checkbox"/>	<input type="checkbox"/> <input type="checkbox"/> <input type="checkbox"/>	80.0#
	66 x 36 x 15"	KOSGCR6636.H	<input type="checkbox"/> <input type="checkbox"/> <input type="checkbox"/>	<input type="checkbox"/> <input type="checkbox"/> <input type="checkbox"/>	85.0#
	72 x 36 x 15"	KOSGCR7236.H	<input type="checkbox"/> <input type="checkbox"/> <input type="checkbox"/>	<input type="checkbox"/> <input type="checkbox"/> <input type="checkbox"/>	90.0#
	84 x 36 x 15"	KOSGCR8436.H	<input type="checkbox"/> <input type="checkbox"/> <input type="checkbox"/>	<input type="checkbox"/> <input type="checkbox"/> <input type="checkbox"/>	100.0#
	96 x 36 x 15"	KOSGCR9636.H	<input type="checkbox"/> <input type="checkbox"/> <input type="checkbox"/>	<input type="checkbox"/> <input type="checkbox"/> <input type="checkbox"/>	110.0#
	ARGRD				

**A**      **B**      **C**

### HOW TO ORDER

Indicate the following information on order form:

1. Quantity of each item.
2. Model number, including options. See "How To Build a Model Number".
3. Any special service required.

Note: • The  indicates that a choice is required.

- The absence of the  indicates that no choice is required.
- Alpha-numeric characters in place of  indicate that no other alternatives are available.

### HOW TO BUILD A MODEL NUMBER

- A** Select basic model.
- B** Select horizontal surface finish. Refer to color addendum at [ki.com](http://ki.com) or KI Fabrics & Finishes binder.
- C** Select vertical surface finish. Refer to color addendum at [ki.com](http://ki.com) or KI Fabrics & Finishes binder.





# Aristotle® Classic Storage

Extended Corner Reception Gallery

Delivered  
Pricing

\$ 773  
782  
791  
811  
828

\$ 773  
782  
791  
811  
828

### SPECIAL SERVICES

#### Special Carton Marking

With specially marked information N/C

#### Shipping

Shipped k.d. freight prepaid f.o.b.  
KI-Aristotle Brampton, Ontario L6T 5T6  
factory. Freight class #85.

Specifications and prices are subject to  
change without prior notice.

# Aristotle® Classic Storage

## Extended Corner Reception Gallery

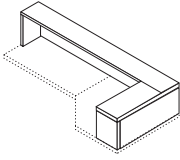
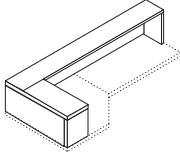
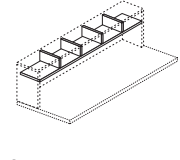
	MODEL	W x D x H	MODEL NUMBER			Approx. Packaged Weight
			Basic Model	Horizontal Surface Finish	Vertical Surface Finish	
	<b>Extended Corner Reception Gallery-42\", Left</b> <ul style="list-style-type: none"> <li>Transaction top is 9\" deep with 12\" corners</li> <li>Installed height is 44\"</li> <li>Clearance above desk top is 14\"</li> <li>Desk specified separately</li> </ul>	66 x 42 x 15\"	KOSGCL6642.H	<input type="checkbox"/> <input type="checkbox"/> <input type="checkbox"/>	<input type="checkbox"/> <input type="checkbox"/> <input type="checkbox"/>	90.0#
		72 x 42 x 15\"	KOSGCL7242.H	<input type="checkbox"/> <input type="checkbox"/> <input type="checkbox"/>	<input type="checkbox"/> <input type="checkbox"/> <input type="checkbox"/>	95.0#
		84 x 42 x 15\"	KOSGCL8442.H	<input type="checkbox"/> <input type="checkbox"/> <input type="checkbox"/>	<input type="checkbox"/> <input type="checkbox"/> <input type="checkbox"/>	105.0#
		96 x 42 x 15\"	KOSGCL9642.H	<input type="checkbox"/> <input type="checkbox"/> <input type="checkbox"/>	<input type="checkbox"/> <input type="checkbox"/> <input type="checkbox"/>	115.0#
ARGRD						
	<b>Extended Corner Reception Gallery-42\", Right</b> <ul style="list-style-type: none"> <li>Transaction top is 9\" deep with 12\" corners</li> <li>Installed height is 44\"</li> <li>Clearance above desk top is 14\"</li> <li>Desk specified separately</li> </ul>	66 x 42 x 15\"	KOSGCR6642.H	<input type="checkbox"/> <input type="checkbox"/> <input type="checkbox"/>	<input type="checkbox"/> <input type="checkbox"/> <input type="checkbox"/>	90.0#
		72 x 42 x 15\"	KOSGCR7242.H	<input type="checkbox"/> <input type="checkbox"/> <input type="checkbox"/>	<input type="checkbox"/> <input type="checkbox"/> <input type="checkbox"/>	95.0#
		84 x 42 x 15\"	KOSGCR8442.H	<input type="checkbox"/> <input type="checkbox"/> <input type="checkbox"/>	<input type="checkbox"/> <input type="checkbox"/> <input type="checkbox"/>	105.0#
		96 x 42 x 15\"	KOSGCR9642.H	<input type="checkbox"/> <input type="checkbox"/> <input type="checkbox"/>	<input type="checkbox"/> <input type="checkbox"/> <input type="checkbox"/>	115.0#
ARGRD						
	<b>Reception Gallery Paper Sorter Insert</b> <ul style="list-style-type: none"> <li>Field installed</li> <li>Not compatible with corner galleries</li> <li>Not compatible with tackboards</li> <li>3-1/4\" clearance in cubbies</li> <li>Reception gallery specified separately</li> </ul>	22 x 11 x 4-1/2\"	KGPS24.H	<input type="checkbox"/> <input type="checkbox"/> <input type="checkbox"/>	<input type="checkbox"/> <input type="checkbox"/> <input type="checkbox"/>	14.0#
		28 x 11 x 4-1/2\"	KGPS30.H	<input type="checkbox"/> <input type="checkbox"/> <input type="checkbox"/>	<input type="checkbox"/> <input type="checkbox"/> <input type="checkbox"/>	17.0#
		34 x 11 x 4-1/2\"	KGPS36.H	<input type="checkbox"/> <input type="checkbox"/> <input type="checkbox"/>	<input type="checkbox"/> <input type="checkbox"/> <input type="checkbox"/>	20.0#
		40 x 11 x 4-1/2\"	KGPS42.H	<input type="checkbox"/> <input type="checkbox"/> <input type="checkbox"/>	<input type="checkbox"/> <input type="checkbox"/> <input type="checkbox"/>	23.0#
		46 x 11 x 4-1/2\"	KGPS48.H	<input type="checkbox"/> <input type="checkbox"/> <input type="checkbox"/>	<input type="checkbox"/> <input type="checkbox"/> <input type="checkbox"/>	26.0#
		52 x 11 x 4-1/2\"	KGPS54.H	<input type="checkbox"/> <input type="checkbox"/> <input type="checkbox"/>	<input type="checkbox"/> <input type="checkbox"/> <input type="checkbox"/>	29.0#
		58 x 11 x 4-1/2\"	KGPS60.H	<input type="checkbox"/> <input type="checkbox"/> <input type="checkbox"/>	<input type="checkbox"/> <input type="checkbox"/> <input type="checkbox"/>	32.0#
		64 x 11 x 4-1/2\"	KGPS66.H	<input type="checkbox"/> <input type="checkbox"/> <input type="checkbox"/>	<input type="checkbox"/> <input type="checkbox"/> <input type="checkbox"/>	35.0#
		70 x 11 x 4-1/2\"	KGPS72.H	<input type="checkbox"/> <input type="checkbox"/> <input type="checkbox"/>	<input type="checkbox"/> <input type="checkbox"/> <input type="checkbox"/>	38.0#
76 x 11 x 4-1/2\"	KGPS78.H	<input type="checkbox"/> <input type="checkbox"/> <input type="checkbox"/>	<input type="checkbox"/> <input type="checkbox"/> <input type="checkbox"/>	41.0#		

A

B

C

### HOW TO ORDER

Indicate the following information on order form:

- Quantity of each item.
- Model number, including options. See "How To Build a Model Number".
- Any special service required.

Note: • The  indicates that a choice is required.

- The absence of the  indicates that no choice is required.
- Alpha-numeric characters in place of  indicate that no other alternatives are available.

### HOW TO BUILD A MODEL NUMBER

- A** Select basic model.
- B** Select horizontal surface finish.  
Refer to color addendum at [ki.com](http://ki.com) or KI Fabrics & Finishes binder.
- C** Select vertical surface finish.  
Refer to color addendum at [ki.com](http://ki.com) or KI Fabrics & Finishes binder.



# Aristotle® Classic Storage

Extended Corner Reception Gallery

## Delivered Pricing

\$ 799  
811  
828  
849

\$ 799  
811  
828  
849

\$ 368  
392  
415  
438  
464  
487  
511  
535  
560  
587

### SPECIAL SERVICES

#### Special Carton Marking

With specially marked information N/C

#### Shipping

Shipped **k.d. freight prepaid f.o.b.**  
**KI-Aristotle Brampton, Ontario L6T 5T6**  
factory. Freight class #85.

Specifications and prices are subject to  
change without prior notice.

# Aristotle® Classic Storage

## Hanging Pedestals

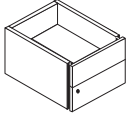
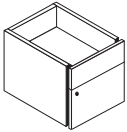
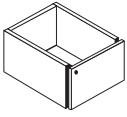
	MODEL	W x D x H	MODEL NUMBER				Approx. Packaged Weight
			Basic Model	Vertical Surface Finish	Pull Option	Key Option	
 <p>ARHPD</p>	<b>Hanging Pedestal-Box/Box</b> <ul style="list-style-type: none"> <li>Standard with all drawers locking</li> <li>Pencil tray standard in upper box drawer</li> <li>Integral pull is standard; use xxx2 for optional pulls</li> </ul>	15-1/2 x 19 x 14"	KH2B.H	□□□	□□□□	□□	40.0#
 <p>ARHPD</p>	<b>Hanging Pedestal-Box/File</b> <ul style="list-style-type: none"> <li>Standard with both drawers locking</li> <li>File drawer accommodates letter/legal filing</li> <li>Pencil tray standard in box drawer</li> <li>Integral pull is standard; use xxx2 for optional pulls</li> </ul>	15-1/2 x 19 x 19"	KHBF.H	□□□	□□□□	□□	55.0#
 <p>ARHPD</p>	<b>Hanging Pedestal-File</b> <ul style="list-style-type: none"> <li>Standard with all drawers locking</li> <li>File drawer accommodates letter/legal filing</li> <li>Integral pull is standard; use xxx1 for optional pulls</li> </ul>	15-1/2 x 19 x 14"	KHF.H	□□□	□□□□	□□	45.0#

**A**   **B**   **C**   **D**

### HOW TO ORDER

Indicate the following information on order form:

- Quantity of each item.
- Model number, including options. See "How To Build a Model Number".
- Any special service required.

Note:

- The □ indicates that a choice is required.
- The absence of the □ indicates that no choice is required.
- Alpha-numeric characters in place of □ indicate that no other alternatives are available.

### HOW TO BUILD A MODEL NUMBER

- A** Select basic model.
- B** Select vertical surface finish.  
Refer to color addendum at ki.com or KI Fabrics & Finishes binder.
- C** Select pull option.
 

<b>NP</b>	- Standard integral pull
<b>BPA</b>	- Silver bar pull (1); add \$10
<b>BPA2</b>	- Silver bar pull (2); add \$20
<b>KIB</b>	- Waterfall black pull (1); add \$10
<b>KIB2</b>	- Waterfall black pull (2); add \$20
<b>KIS</b>	- Waterfall silver pull (1); add \$10
<b>KIS2</b>	- Waterfall silver pull (2); add \$20
<b>RCP</b>	- Rectangular silver pull (1); add \$10
<b>RCP2</b>	- Rectangular silver pull (2); add \$20

**D** Select key option.

- |           |                |
|-----------|----------------|
| <b>KA</b> | - Key alike    |
| <b>KS</b> | - Key standard |



# Aristotle® Classic Storage

Hanging Pedestals

Delivered  
Pricing  
\$ 545

\$ 633

\$ 520

**SPECIAL SERVICES**

**Special Carton Marking**

With specially marked information N/C

**Shipping**

Shipped **assembled freight prepaid f.o.b. KI-Aristotle Brampton, Ontario L6T 5T6** factory. Freight class #85.

Specifications and prices are subject to change without prior notice.

# Aristotle® Classic Storage

## Full Height Pedestals

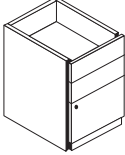
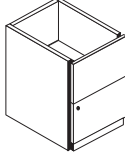
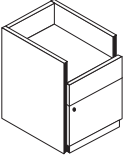
	MODEL	W x D x H	MODEL NUMBER				Approx. Packaged Weight
			Basic Model	Vertical Surface Finish	Pull Option	Key Option	
 <p><b>Full Height Pedestal-Box/Box/File</b></p> <ul style="list-style-type: none"> <li>• Standard with all drawers locking</li> <li>• Pencil tray standard in upper box drawer</li> <li>• File drawer accommodates letter/legal filing</li> <li>• Integral pull is standard; use xxx3 for optional pulls</li> </ul>	15-1/2 x 19 x 28"	KF2BF.H	<input type="checkbox"/> <input type="checkbox"/> <input type="checkbox"/>	<input type="checkbox"/> <input type="checkbox"/> <input type="checkbox"/> <input type="checkbox"/>	<input type="checkbox"/> <input type="checkbox"/>	85.0#	
ARHPD							
 <p><b>Full Height Pedestal-File/File</b></p> <ul style="list-style-type: none"> <li>• Standard with all drawers locking</li> <li>• File drawer accommodates letter/legal filing</li> <li>• Integral pull is standard; use xxx2 for optional pulls</li> </ul>	15-1/2 x 19 x 28"	KF2F.H	<input type="checkbox"/> <input type="checkbox"/> <input type="checkbox"/>	<input type="checkbox"/> <input type="checkbox"/> <input type="checkbox"/> <input type="checkbox"/>	<input type="checkbox"/> <input type="checkbox"/>	85.0#	
ARHPD							
 <p><b>Full Height Pedestal-Shelf/Box/File</b></p> <ul style="list-style-type: none"> <li>• Standard with both drawers locking</li> <li>• Pencil tray standard in box drawer</li> <li>• File drawer accommodates letter/legal filing</li> <li>• Integral pull is standard; use xxx2 for optional pulls</li> </ul>	15-1/2 x 19 x 28"	KFSBF.H	<input type="checkbox"/> <input type="checkbox"/> <input type="checkbox"/>	<input type="checkbox"/> <input type="checkbox"/> <input type="checkbox"/> <input type="checkbox"/>	<input type="checkbox"/> <input type="checkbox"/>	80.0#	
ARHPD							

**A**   **B**   **C**   **D**

### HOW TO ORDER

Indicate the following information on order form:

1. Quantity of each item.
2. Model number, including options. See "How To Build a Model Number".
3. Any special service required.

Note:

- The  indicates that a choice is required.
- The absence of the  indicates that no choice is required.
- Alpha-numeric characters in place of  indicate that no other alternatives are available.

### HOW TO BUILD A MODEL NUMBER

- A** Select basic model.
- B** Select vertical surface finish.  
Refer to color addendum at ki.com or KI Fabrics & Finishes binder.
- C** Select pull option.
 

<b>NP</b>	- Standard integral pull
<b>BPA2</b>	- Silver bar pull (2); add \$20
<b>BPA3</b>	- Silver bar pull (3); add \$30
<b>KIB2</b>	- Waterfall black pull (2); add \$20
<b>KIB3</b>	- Waterfall black pull (3); add \$30
<b>KIS2</b>	- Waterfall silver pull (2); add \$20
<b>KIS3</b>	- Waterfall silver pull (3); add \$30
<b>RCP2</b>	- Rectangular silver pull (2); add \$20
<b>RCP3</b>	- Rectangular silver pull (3); add \$30

### **D** Select key option.

- |           |                |
|-----------|----------------|
| <b>KA</b> | - Key alike    |
| <b>KS</b> | - Key standard |



# Aristotle® Classic Storage

Full Height Pedestals

Delivered  
Pricing  
\$ 829

\$ 829

\$ 829

### SPECIAL SERVICES

#### Special Carton Marking

With specially marked information N/C



#### Shipping

Shipped **assembled freight prepaid f.o.b. KI-Aristotle Brampton, Ontario L6T 5T6** factory. Freight class #85.

Specifications and prices are subject to change without prior notice.

# Aristotle® Classic Storage

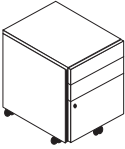
Mobile Pedestals

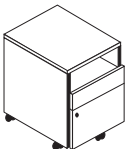
MODEL	W x D x H	MODEL NUMBER					Approx. Packaged Weight
		Basic Model	Horizontal Surface Finish	Vertical Surface Finish	Pull Option	Key Option	
 <p>ARHPD</p> <p><b>Mobile Pedestal-Box/File</b></p> <ul style="list-style-type: none"> <li>• 5/8" thick top</li> <li>• Standard with both drawers locking</li> <li>• File drawer accommodates letter/legal filing</li> <li>• Pencil tray standard in box drawer</li> <li>• Integral pull is standard; use xxx2 for optional pulls</li> <li>• 5 wheel anti-tip feature standard</li> </ul>	15-1/2 x 19 x 21-1/2"	KMBFH	<input type="checkbox"/> <input type="checkbox"/> <input type="checkbox"/>	<input type="checkbox"/> <input type="checkbox"/> <input type="checkbox"/>	<input type="checkbox"/> <input type="checkbox"/> <input type="checkbox"/> <input type="checkbox"/> <input type="checkbox"/>	<input type="checkbox"/> <input type="checkbox"/>	80.0#
 <p>ARHPD</p> <p><b>Mobile Pedestal-Box/Box/File</b></p> <ul style="list-style-type: none"> <li>• 5/8" thick top</li> <li>• Standard with all drawers locking</li> <li>• File drawer accommodates letter/legal filing</li> <li>• Pencil tray standard in upper box drawer</li> <li>• Integral pull is standard; use xxx3 for optional pulls</li> <li>• 5 wheel anti-tip feature standard</li> </ul>	15-1/2 x 19 x 27-3/4"	KM2BFH	<input type="checkbox"/> <input type="checkbox"/> <input type="checkbox"/>	<input type="checkbox"/> <input type="checkbox"/> <input type="checkbox"/>	<input type="checkbox"/> <input type="checkbox"/> <input type="checkbox"/> <input type="checkbox"/> <input type="checkbox"/>	<input type="checkbox"/> <input type="checkbox"/>	95.0#
 <p>ARHPD</p> <p><b>Full Height Pedestal-File/File</b></p> <ul style="list-style-type: none"> <li>• 5/8" thick top</li> <li>• Standard with all drawers locking</li> <li>• File drawer accommodates letter/legal filing</li> <li>• Integral pull is standard; use xxx2 for optional pulls</li> <li>• 5 wheel anti-tip feature standard</li> </ul>	15-1/2 x 19 x 27-3/4"	KM2FH	<input type="checkbox"/> <input type="checkbox"/> <input type="checkbox"/>	<input type="checkbox"/> <input type="checkbox"/> <input type="checkbox"/>	<input type="checkbox"/> <input type="checkbox"/> <input type="checkbox"/> <input type="checkbox"/> <input type="checkbox"/>	<input type="checkbox"/> <input type="checkbox"/>	95.0#
 <p>ARHPD</p> <p><b>Mobile Pedestal-Shelf/Box/File</b></p> <ul style="list-style-type: none"> <li>• 5/8" thick top</li> <li>• Standard with both drawers locking</li> <li>• File drawer accommodates letter/legal filing</li> <li>• Pencil tray standard in box drawer</li> <li>• Integral pull is standard; use xxx2 for optional pulls</li> <li>• 5 wheel anti-tip feature standard</li> </ul>	15-1/2 x 19 x 27-3/4"	KMSBFH	<input type="checkbox"/> <input type="checkbox"/> <input type="checkbox"/>	<input type="checkbox"/> <input type="checkbox"/> <input type="checkbox"/>	<input type="checkbox"/> <input type="checkbox"/> <input type="checkbox"/> <input type="checkbox"/> <input type="checkbox"/>	<input type="checkbox"/> <input type="checkbox"/>	95.0#

**A**      **B**      **C**      **D**      **E**

## HOW TO ORDER

Indicate the following information on order form:

1. Quantity of each item.
2. Model number, including options. See "How To Build a Model Number".
3. Any special service required.

Note: • The  indicates that a choice is required.

- The absence of the  indicates that no choice is required.
- Alpha-numeric characters in place of  indicate that no other alternatives are available.

## HOW TO BUILD A MODEL NUMBER

- A** Select basic model.
- B** Select horizontal surface finish.  
Refer to color addendum at ki.com or KI Fabrics & Finishes binder.
- C** Select vertical surface finish.  
Refer to color addendum at ki.com or KI Fabrics & Finishes binder.
- D** Select pull option.
 

<b>NP</b>	- Standard integral pull
<b>BPA2</b>	- Silver bar pull (2); add \$20
<b>BPA3</b>	- Silver bar pull (3); add \$30
<b>KIB2</b>	- Waterfall black pull (2); add \$20
<b>KIB3</b>	- Waterfall black pull (3); add \$30
<b>KIS2</b>	- Waterfall silver pull (2); add \$20
<b>KIS3</b>	- Waterfall silver pull (3); add \$30
<b>RCP2</b>	- Rectangular silver pull (2); add \$20

**RCP3** - Rectangular silver pull (3); add \$30

- E** Select key option.
 

<b>KA</b>	- Key alike
<b>KS</b>	- Key standard





# Aristotle® Classic Storage

Mobile Pedestals

Delivered  
Pricing  
\$ 829

\$ 923

\$ 923

\$ 923

### SPECIAL SERVICES

#### Special Carton Marking

With specially marked information N/C

#### Shipping

Shipped **assembled freight prepaid f.o.b. KI-Aristotle Brampton, Ontario L6T 5T6** factory. Freight class #85.

Specifications and prices are subject to change without prior notice.





# Aristotle® Classic Storage

Lateral Files-Under Desk

Delivered  
Pricing

\$ 1239

1274

**SPECIAL SERVICES**

**Special Carton Marking**

With specially marked information    N/C

**Shipping**

Shipped **assembled freight prepaid f.o.b. KI-Aristotle Brampton, Ontario L6T 5T6** factory. Freight class #85.

Specifications and prices are subject to change without prior notice.

# Aristotle® Classic Storage

Lateral Files-Integrated

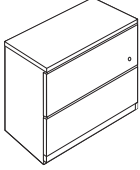
	MODEL	W x D x H	MODEL NUMBER					Approx. Packaged Weight
			Basic Model	Horizontal Surface Finish	Vertical Surface Finish	Pull Option	Key Option	
 <p>ARHPD</p>	<b>Lateral File-Two Drawer Integrated</b>	30 x 20 x 29"	KLF23020.H	<input type="checkbox"/> <input type="checkbox"/> <input type="checkbox"/>	<input type="checkbox"/> <input type="checkbox"/> <input type="checkbox"/>	<input type="checkbox"/> <input type="checkbox"/> <input type="checkbox"/> <input type="checkbox"/>	<input type="checkbox"/> <input type="checkbox"/>	105.0#
	<ul style="list-style-type: none"> <li>Matches depth and height of adjacent items</li> </ul>	30 x 24 x 29"	KLF23024.H	<input type="checkbox"/> <input type="checkbox"/> <input type="checkbox"/>	<input type="checkbox"/> <input type="checkbox"/> <input type="checkbox"/>	<input type="checkbox"/> <input type="checkbox"/> <input type="checkbox"/> <input type="checkbox"/>	<input type="checkbox"/> <input type="checkbox"/>	115.0#
	<ul style="list-style-type: none"> <li>Vertical grain standard on fronts</li> </ul>	36 x 20 x 29"	KLF23620.H	<input type="checkbox"/> <input type="checkbox"/> <input type="checkbox"/>	<input type="checkbox"/> <input type="checkbox"/> <input type="checkbox"/>	<input type="checkbox"/> <input type="checkbox"/> <input type="checkbox"/> <input type="checkbox"/>	<input type="checkbox"/> <input type="checkbox"/>	130.0#
	<ul style="list-style-type: none"> <li>Accommodates letter and legal filing</li> </ul>	36 x 24 x 29"	KLF23624.H	<input type="checkbox"/> <input type="checkbox"/> <input type="checkbox"/>	<input type="checkbox"/> <input type="checkbox"/> <input type="checkbox"/>	<input type="checkbox"/> <input type="checkbox"/> <input type="checkbox"/> <input type="checkbox"/>	<input type="checkbox"/> <input type="checkbox"/>	140.0#
	<ul style="list-style-type: none"> <li>Steel drawers with heavy duty full extension ball bearing slides</li> </ul>							
	<ul style="list-style-type: none"> <li>Integral pull is standard; use xxx2 for optional pulls</li> </ul>							
	<ul style="list-style-type: none"> <li>Locking</li> </ul>							
	<ul style="list-style-type: none"> <li>Units feature bottom toe kick</li> </ul>							
	<ul style="list-style-type: none"> <li>Intended for use within office, and complementary to adjacent storage pieces</li> </ul>							
				<b>A</b>	<b>B</b>	<b>C</b>	<b>D</b>	<b>E</b>

## HOW TO ORDER

Indicate the following information on order form:

- Quantity of each item.
- Model number, including options. See "How To Build a Model Number".
- Any special service required.

Note: • The  indicates that a choice is required.

- The absence of the  indicates that no choice is required.
- Alpha-numeric characters in place of  indicate that no other alternatives are available.

## HOW TO BUILD A MODEL NUMBER

- A** Select basic model.
- B** Select horizontal surface finish.  
Refer to color addendum at ki.com or KI Fabrics & Finishes binder.
- C** Select vertical surface finish.  
Refer to color addendum at ki.com or KI Fabrics & Finishes binder.
- D** Select pull option.
 

<b>NP</b>	- Standard integral pull
<b>BPA2</b>	- Silver bar pull (2); add \$20
<b>KIB2</b>	- Waterfall black pull (2); add \$20
<b>KIS2</b>	- Waterfall silver pull (2); add \$20
<b>RCP2</b>	- Rectangular silver pull (2); add \$20
- E** Select key option.
 

<b>KA</b>	- Key alike
<b>KS</b>	- Key standard



# Aristotle® Classic Storage

Lateral Files-Integrated

Delivered  
Pricing

\$ 1317  
1350  
1367  
1488

## SPECIAL SERVICES

### Special Carton Marking

With specially marked information N/C

### Shipping

Shipped **assembled freight prepaid f.o.b.**  
**KI-Aristotle Brampton, Ontario L6T 5T6**  
factory. Freight class #85.

Specifications and prices are subject to  
change without prior notice.

# Aristotle® Classic Storage

Lateral Files-Freestanding

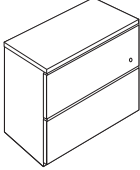
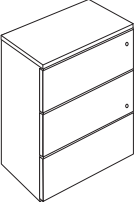
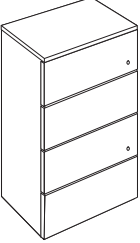
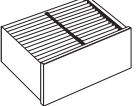
MODEL	W x D x H	MODEL NUMBER					Approx. Packaged Weight	
		Basic Model	Horizontal Surface Finish	Vertical Surface Finish	Pull Option	Key Option		
 <p>ARHPD</p>	<b>Lateral File-Two Drawer Freestanding</b> • Anti-tip interlock mechanism • Horizontal grain standard on fronts • Accommodates letter and legal filing • Steel drawers with heavy duty full extension ball bearing slides • Integral pull is standard; use xxx2 for optional pulls • Locking • Intended for freestanding/archival storage applications • No toe kick	30 x 20 x 30"	KSLF23020.H	<input type="checkbox"/> <input type="checkbox"/>	<input type="checkbox"/> <input type="checkbox"/>	<input type="checkbox"/> <input type="checkbox"/> <input type="checkbox"/> <input type="checkbox"/>	<input type="checkbox"/> <input type="checkbox"/>	105.0#
	36 x 20 x 30"	KSLF23620.H	<input type="checkbox"/> <input type="checkbox"/>	<input type="checkbox"/> <input type="checkbox"/>	<input type="checkbox"/> <input type="checkbox"/> <input type="checkbox"/> <input type="checkbox"/>	<input type="checkbox"/> <input type="checkbox"/>	130.0#	
 <p>ARHPD</p>	<b>Lateral File-Three Drawer Freestanding</b> • Anti-tip interlock mechanism • Horizontal grain standard on fronts • Accommodates letter and legal filing • Steel drawers with heavy duty full extension ball bearing slides • Integral pull is standard; use xxx3 for optional pulls • 2 locks, keyed alike • Intended for freestanding/archival storage applications • No toe kick	30 x 20 x 44"	KSLF33020.H	<input type="checkbox"/> <input type="checkbox"/>	<input type="checkbox"/> <input type="checkbox"/>	<input type="checkbox"/> <input type="checkbox"/> <input type="checkbox"/> <input type="checkbox"/>	<input type="checkbox"/> <input type="checkbox"/>	175.0#
	36 x 20 x 44"	KSLF33620.H	<input type="checkbox"/> <input type="checkbox"/>	<input type="checkbox"/> <input type="checkbox"/>	<input type="checkbox"/> <input type="checkbox"/> <input type="checkbox"/> <input type="checkbox"/>	<input type="checkbox"/> <input type="checkbox"/>	200.0#	
 <p>ARHPD</p>	<b>Lateral File-Four Drawer Freestanding</b> • Anti-tip interlock mechanism • Horizontal grain standard on fronts • Accommodates letter and legal filing • Steel drawers with heavy duty full extension ball bearing slides • Integral pull is standard; use xxx4 for optional pulls • 2 locks, keyed alike • Intended for freestanding/archival storage applications • No toe kick	30 x 20 x 58"	KSLF43020.H	<input type="checkbox"/> <input type="checkbox"/>	<input type="checkbox"/> <input type="checkbox"/>	<input type="checkbox"/> <input type="checkbox"/> <input type="checkbox"/> <input type="checkbox"/>	<input type="checkbox"/> <input type="checkbox"/>	220.0#
	36 x 20 x 58"	KSLF43620.H	<input type="checkbox"/> <input type="checkbox"/>	<input type="checkbox"/> <input type="checkbox"/>	<input type="checkbox"/> <input type="checkbox"/> <input type="checkbox"/> <input type="checkbox"/>	<input type="checkbox"/> <input type="checkbox"/>	260.0#	
 <p>HRDPT</p>	<b>Front-to-Back Filing Hardware</b> • Set of four bars accommodates one drawer • Specify one set per drawer as required		KFTBF					1.0#

## HOW TO ORDER

Indicate the following information on order form:

- Quantity of each item.
- Model number, including options. See "How To Build a Model Number".
- Any special service required.

Note: • The  indicates that a choice is required.

- The absence of the  indicates that no choice is required.
- Alpha-numeric characters in place of  indicate that no other alternatives are available.

## HOW TO BUILD A MODEL NUMBER

- A** Select basic model.
- B** Select horizontal surface finish.  
Refer to color addendum at ki.com or KI Fabrics & Finishes binder.
- C** Select vertical surface finish.  
Refer to color addendum at ki.com or KI Fabrics & Finishes binder.
- D** Select pull option.
 

<b>NP</b>	- Standard integral pull
<b>BPA3</b>	- Silver bar pull (3); add \$30
<b>BPA4</b>	- Silver bar pull (4); add \$40
<b>KIB3</b>	- Waterfall black pull (3); add \$30
<b>KIB4</b>	- Waterfall black pull (4); add \$40
<b>KIS3</b>	- Waterfall silver pull (3); add \$30
<b>KIS4</b>	- Waterfall silver pull (4); add \$40
<b>RCP3</b>	- Rectangular silver pull (3); add \$30

**RCP4** - Rectangular silver pull (4); add \$40

- E** Select key option.
 

<b>KA</b>	- Key alike
<b>KS</b>	- Key standard



# Aristotle® Classic Storage

Lateral Files-Freestanding

Delivered  
Pricing

\$ 1317

1367

\$ 1833

1897

\$ 2242

2321

\$ 6

### SPECIAL SERVICES

#### Special Carton Marking

With specially marked information N/C

#### Shipping

Shipped **assembled freight prepaid f.o.b. KI-Aristotle Brampton, Ontario L6T 5T6** factory. Freight class #85.

Specifications and prices are subject to change without prior notice.

# Aristotle® Classic Storage

Lower Storage Units - Under Desk

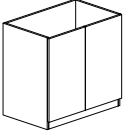
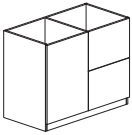
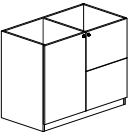
	MODEL	W x D x H	MODEL NUMBER				Approx. Packaged Weight
			Basic Model	Vertical Surface Finish	Pull Option	Key Option	
 ARHPD	<b>Storage Cabinet-Under Desk, Nonlocking</b> • Fits below 20", 24" or 30" desk shell • Includes one 33-3/8" wide adjustable shelf • Non-locking • Integral pull is standard; use xxx2 for optional pulls • Cabinet fronts are not grain-matched	30 x 19 x 28"	KSCT30.H	<input type="checkbox"/> <input type="checkbox"/> <input type="checkbox"/>	<input type="checkbox"/> <input type="checkbox"/> <input type="checkbox"/> <input type="checkbox"/>		80.0#
		36 x 19 x 28"	KSCT36.H	<input type="checkbox"/> <input type="checkbox"/> <input type="checkbox"/>	<input type="checkbox"/> <input type="checkbox"/> <input type="checkbox"/> <input type="checkbox"/>		90.0#
 ARHPD	<b>Storage and File Cabinet-Under Desk, Nonlocking</b> • Fits below 20", 24" or 30" desk shell • Includes one 33-3/8" wide adjustable shelf • Two files drawers on right • Non-locking • Integral pull is standard; use xxx3 for optional pulls	36 x 19 x 28"	KBSCT.H	<input type="checkbox"/> <input type="checkbox"/> <input type="checkbox"/>	<input type="checkbox"/> <input type="checkbox"/> <input type="checkbox"/> <input type="checkbox"/>		110.0#
 ARHPD	<b>Storage and File Cabinet-Under Desk, Locking</b> • Fits below 20", 24" or 30" desk shell • Includes one 33-3/8" wide adjustable shelf • Two files drawers on right • Locking, two locks keyed alike • Integral pull is standard; use xxx3 for optional pulls	36 x 19 x 28"	KBSCTL.H	<input type="checkbox"/> <input type="checkbox"/> <input type="checkbox"/>	<input type="checkbox"/> <input type="checkbox"/> <input type="checkbox"/> <input type="checkbox"/>	<input type="checkbox"/> <input type="checkbox"/>	110.0#

**A**      **B**      **C**      **D**

### HOW TO ORDER

Indicate the following information on order form:

- Quantity of each item.
- Model number, including options. See "How To Build a Model Number".
- Any special service required.

Note: • The  indicates that a choice is required.  
 • The absence of the  indicates that no choice is required.  
 • Alpha-numeric characters in place of  indicate that no other alternatives are available.

### HOW TO BUILD A MODEL NUMBER

- A** Select basic model.
- B** Select vertical surface finish.  
Refer to color addendum at ki.com or KI Fabrics & Finishes binder.
- C** Select pull option.
 

<b>NP</b>	- Standard integral pull
<b>BPA2</b>	- Silver bar pull (2); add \$20
<b>BPA3</b>	- Silver bar pull (3); add \$30
<b>KIB2</b>	- Waterfall black pull (2); add \$20
<b>KIB3</b>	- Waterfall black pull (3); add \$30
<b>KIS2</b>	- Waterfall silver pull (2); add \$20
<b>KIS3</b>	- Waterfall silver pull (3); add \$30
<b>RCP2</b>	- Rectangular silver pull (2); add \$20
<b>RCP3</b>	- Rectangular silver pull (3); add \$30

### **D** Select key option.

- |           |                |
|-----------|----------------|
| <b>KA</b> | - Key alike    |
| <b>KS</b> | - Key standard |





# Aristotle® Classic Storage

Lower Storage Units - Under Desk

Delivered Pricing

\$ 561

592

\$ 921

\$ 1037

### SPECIAL SERVICES

#### Special Carton Marking

With specially marked information    N/C

#### Shipping

Shipped **assembled freight prepaid f.o.b. KI-Aristotle Brampton, Ontario L6T 5T6** factory. Freight class #85.

Specifications and prices are subject to change without prior notice.

# Aristotle® Classic Storage

Lower Storage Units - Under Desk

MODEL	W x D x H	MODEL NUMBER				Approx. Packaged Weight		
		Basic Model	Vertical Surface Finish	Pull Option	Key Option			
<p>ARHPD</p>	<b>Multi-File Storage Cabinet-Under Desk</b> • Fits below 20", 24" or 30" desk shell • Two box drawers upper left • 12-1/2" wide closed storage upper right • Lower locking lateral file drawer • Integral pull is standard; use xxx4 for optional pulls • Cabinet fronts are not grain-matched	30 x 19 x 28"	KMFSBT30.H	□□□	□□□□	□□	105.0#	
<p>ARHPD</p>	<b>Multi-File Storage Cabinet-Under Desk</b> • Fits below 20", 24" or 30" desk shell • File drawer upper left • 12-1/2" wide closed storage upper right • Lower locking lateral file drawer • Integral pull is standard; use xxx3 for optional pulls • Cabinet fronts are not grain-matched	30 x 19 x 28"	KMFSFT30.H	□□□	□□□□	□□	105.0#	
				<b>A</b>	<b>B</b>	<b>C</b>	<b>D</b>	

## HOW TO ORDER

Indicate the following information on order form:

- Quantity of each item.
- Model number, including options. See "How To Build a Model Number".
- Any special service required.

Note:

- The □ indicates that a choice is required.
- The absence of the □ indicates that no choice is required.
- Alpha-numeric characters in place of □ indicate that no other alternatives are available.

## HOW TO BUILD A MODEL NUMBER

- A** Select basic model.
- B** Select vertical surface finish.  
Refer to color addendum at ki.com or KI Fabrics & Finishes binder.
- C** Select pull option.
 

<b>NP</b>	- Standard integral pull
<b>BPA3</b>	- Silver bar pull (3); add \$30
<b>BPA4</b>	- Silver bar pull (4); add \$40
<b>KIB3</b>	- Waterfall black pull (3); add \$30
<b>KIB4</b>	- Waterfall black pull (4); add \$40
<b>KIS3</b>	- Waterfall silver pull (3); add \$30
<b>KIS4</b>	- Waterfall silver pull (4); add \$40
<b>RCP3</b>	- Rectangular silver pull (3); add \$30
<b>RCP4</b>	- Rectangular silver pull (4); add \$40

## D Select key option.

- |           |                |
|-----------|----------------|
| <b>KA</b> | - Key alike    |
| <b>KS</b> | - Key standard |



# Aristotle® Classic Storage

Lower Storage Units - Under Desk

Delivered  
Pricing  
\$ 1212

\$ 1212

**SPECIAL SERVICES**

**Special Carton Marking**

With specially marked information    N/C

**Shipping**

Shipped **assembled freight prepaid f.o.b. KI-Aristotle Brampton, Ontario L6T 5T6** factory. Freight class #85.

Specifications and prices are subject to change without prior notice.

# Aristotle® Classic Storage

Lower Storage Units - Freestanding

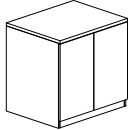
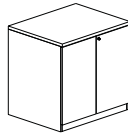
	MODEL	W x D x H	MODEL NUMBER					Approx. Packaged Weight
			Basic Model	Horizontal Surface Finish	Vertical Surface Finish	Pull Option	Key Option	
 ARHPD	<b>Storage Cabinet-Freestanding, Nonlocking</b> <ul style="list-style-type: none"> <li>Includes one 33-3/8" wide adjustable shelf</li> <li>Non-locking</li> <li>Integral pull is standard; use xxx2 for optional pulls</li> <li>Cabinet fronts are not grain-matched</li> </ul>	30 x 20 x 29"	KSC3020.H	<input type="checkbox"/> <input type="checkbox"/> <input type="checkbox"/>	<input type="checkbox"/> <input type="checkbox"/> <input type="checkbox"/>	<input type="checkbox"/> <input type="checkbox"/> <input type="checkbox"/> <input type="checkbox"/>		85.0#
		30 x 24 x 29"	KSC3024.H	<input type="checkbox"/> <input type="checkbox"/> <input type="checkbox"/>	<input type="checkbox"/> <input type="checkbox"/> <input type="checkbox"/>	<input type="checkbox"/> <input type="checkbox"/> <input type="checkbox"/> <input type="checkbox"/>		95.0#
		36 x 20 x 29"	KSC3620.H	<input type="checkbox"/> <input type="checkbox"/> <input type="checkbox"/>	<input type="checkbox"/> <input type="checkbox"/> <input type="checkbox"/>	<input type="checkbox"/> <input type="checkbox"/> <input type="checkbox"/> <input type="checkbox"/>		100.0#
		36 x 24 x 29"	KSC3624.H	<input type="checkbox"/> <input type="checkbox"/> <input type="checkbox"/>	<input type="checkbox"/> <input type="checkbox"/> <input type="checkbox"/>	<input type="checkbox"/> <input type="checkbox"/> <input type="checkbox"/> <input type="checkbox"/>		110.0#
 ARHPD	<b>Storage Cabinet-Freestanding, Locking</b> <ul style="list-style-type: none"> <li>Includes one 33-3/8" wide adjustable shelf</li> <li>Locking</li> <li>Integral pull is standard; use xxx2 for optional pulls</li> </ul>	30 x 20 x 29"	KSCL3020.H	<input type="checkbox"/> <input type="checkbox"/> <input type="checkbox"/>	<input type="checkbox"/> <input type="checkbox"/> <input type="checkbox"/>	<input type="checkbox"/> <input type="checkbox"/> <input type="checkbox"/> <input type="checkbox"/>	<input type="checkbox"/> <input type="checkbox"/>	85.0#
		30 x 24 x 29"	KSCL3024.H	<input type="checkbox"/> <input type="checkbox"/> <input type="checkbox"/>	<input type="checkbox"/> <input type="checkbox"/> <input type="checkbox"/>	<input type="checkbox"/> <input type="checkbox"/> <input type="checkbox"/> <input type="checkbox"/>	<input type="checkbox"/> <input type="checkbox"/>	95.0#
		36 x 20 x 29"	KSCL3620.H	<input type="checkbox"/> <input type="checkbox"/> <input type="checkbox"/>	<input type="checkbox"/> <input type="checkbox"/> <input type="checkbox"/>	<input type="checkbox"/> <input type="checkbox"/> <input type="checkbox"/> <input type="checkbox"/>	<input type="checkbox"/> <input type="checkbox"/>	100.0#
		36 x 24 x 29"	KSCL3624.H	<input type="checkbox"/> <input type="checkbox"/> <input type="checkbox"/>	<input type="checkbox"/> <input type="checkbox"/> <input type="checkbox"/>	<input type="checkbox"/> <input type="checkbox"/> <input type="checkbox"/> <input type="checkbox"/>	<input type="checkbox"/> <input type="checkbox"/>	110.0#
				<b>A</b>	<b>B</b>	<b>C</b>	<b>D</b>	<b>E</b>

## HOW TO ORDER

Indicate the following information on order form:

- Quantity of each item.
- Model number, including options. See "How To Build a Model Number".
- Any special service required.

Note: • The  indicates that a choice is required.

- The absence of the  indicates that no choice is required.
- Alpha-numeric characters in place of  indicate that no other alternatives are available.

## HOW TO BUILD A MODEL NUMBER

- A** Select basic model.
- B** Select horizontal surface finish.  
Refer to color addendum at [ki.com](http://ki.com) or KI Fabrics & Finishes binder.
- C** Select vertical surface finish.  
Refer to color addendum at [ki.com](http://ki.com) or KI Fabrics & Finishes binder.
- D** Select pull option.
- |             |   |
|-------------|---|
| <b>NP</b>   | - Standard integral pull                |
| <b>BPA2</b> | - Silver bar pull (2); add \$20         |
| <b>KIB2</b> | - Waterfall black pull (2); add \$20    |
| <b>KIS2</b> | - Waterfall silver pull (2); add \$20   |
| <b>RCP2</b> | - Rectangular silver pull (2); add \$20 |
- E** Select key option.
- |           |                |
|-----------|----------------|
| <b>KA</b> | - Key alike    |
| <b>KS</b> | - Key standard |



# Aristotle® Classic Storage

Lower Storage Units - Freestanding

Delivered  
Pricing

\$ 731  
757  
780  
804

\$ 826  
849  
885  
920

## SPECIAL SERVICES

### Special Carton Marking

With specially marked information N/C

### Shipping

Shipped **assembled freight prepaid f.o.b.**  
**KI-Aristotle Brampton, Ontario L6T 5T6**  
factory. Freight class #85.

Specifications and prices are subject to  
change without prior notice.

# Aristotle® Classic Storage

Lower Storage Units - Freestanding

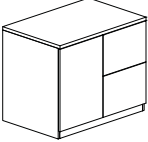
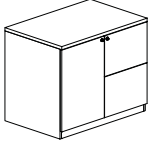
	MODEL	W x D x H	MODEL NUMBER					Approx. Packaged Weight
			Basic Model	Horizontal Surface Finish	Vertical Surface Finish	Pull Option	Key Option	
 ARHPD	<b>Storage and File Cabinet-Freestanding, Nonlocking</b> <ul style="list-style-type: none"> <li>• Left storage 18-1/2" wide</li> <li>• Two files drawers on right</li> <li>• Non-locking</li> <li>• Integral pull is standard; use xxx3 for optional pulls</li> </ul>	36 x 20 x 29"	KBSC3620.H	<input type="checkbox"/> <input type="checkbox"/>	<input type="checkbox"/> <input type="checkbox"/>	<input type="checkbox"/> <input type="checkbox"/> <input type="checkbox"/> <input type="checkbox"/>	<input type="checkbox"/>	115.0#
		36 x 24 x 29"	KBSC3624.H	<input type="checkbox"/> <input type="checkbox"/>	<input type="checkbox"/> <input type="checkbox"/>	<input type="checkbox"/> <input type="checkbox"/> <input type="checkbox"/> <input type="checkbox"/>	<input type="checkbox"/>	125.0#
 ARHPD	<b>Storage and File Cabinet-Freestanding, Locking</b> <ul style="list-style-type: none"> <li>• Left storage 18-1/2" wide</li> <li>• Two files drawers on right</li> <li>• Locking, two locks keyed alike</li> <li>• Integral pull is standard; use xxx3 for optional pulls</li> </ul>	36 x 20 x 29"	KBSC3620.H	<input type="checkbox"/> <input type="checkbox"/>	<input type="checkbox"/> <input type="checkbox"/>	<input type="checkbox"/> <input type="checkbox"/> <input type="checkbox"/> <input type="checkbox"/>	<input type="checkbox"/> <input type="checkbox"/>	115.0#
		36 x 24 x 29"	KBSC3624.H	<input type="checkbox"/> <input type="checkbox"/>	<input type="checkbox"/> <input type="checkbox"/>	<input type="checkbox"/> <input type="checkbox"/> <input type="checkbox"/> <input type="checkbox"/>	<input type="checkbox"/> <input type="checkbox"/>	125.0#
				<b>A</b>	<b>B</b>	<b>C</b>	<b>D</b>	<b>E</b>

## HOW TO ORDER

Indicate the following information on order form:

1. Quantity of each item.
2. Model number, including options. See "How To Build a Model Number".
3. Any special service required.

Note: • The  indicates that a choice is required.

- The absence of the  indicates that no choice is required.
- Alpha-numeric characters in place of  indicate that no other alternatives are available.

## HOW TO BUILD A MODEL NUMBER

- A** Select basic model.
- B** Select horizontal surface finish.  
Refer to color addendum at [ki.com](http://ki.com) or KI Fabrics & Finishes binder.
- C** Select vertical surface finish.  
Refer to color addendum at [ki.com](http://ki.com) or KI Fabrics & Finishes binder.
- D** Select pull option.
- |             |   |
|-------------|---|
| <b>NP</b>   | - Standard integral pull                |
| <b>BPA3</b> | - Silver bar pull (3); add \$30         |
| <b>KIB3</b> | - Waterfall black pull (3); add \$30    |
| <b>KIS3</b> | - Waterfall silver pull (3); add \$30   |
| <b>RCP3</b> | - Rectangular silver pull (3); add \$30 |
- E** Select key option.
- |           |                |
|-----------|----------------|
| <b>KA</b> | - Key alike    |
| <b>KS</b> | - Key standard |



# Aristotle® Classic Storage

Lower Storage Units - Freestanding

Delivered  
Pricing

\$ 1059

1076

\$ 1213

1223

**SPECIAL SERVICES**

**Special Carton Marking**

With specially marked information    N/C

**Shipping**

Shipped **assembled freight prepaid f.o.b. KI-Aristotle Brampton, Ontario L6T 5T6** factory. Freight class #85.

Specifications and prices are subject to change without prior notice.

# Aristotle® Classic Storage

Lower Storage Units - Freestanding

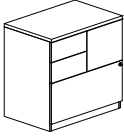
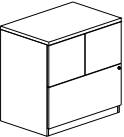
MODEL	W x D x H	MODEL NUMBER					Approx. Packaged Weight
		Basic Model	Horizontal Surface Finish	Vertical Surface Finish	Pull Option	Key Option	
 <p><b>Multi-File Storage Cabinet-Freestanding</b></p> <ul style="list-style-type: none"> <li>Two box drawers upper left</li> <li>12-1/2" wide closed storage upper right</li> <li>Lower locking lateral file drawer</li> <li>Integral pull is standard; use xxx4 for optional pulls</li> <li>Cabinet fronts are not grain-matched</li> </ul>	30 x 20 x 29"	KMFSB3020.H	□□□	□□□	□□□□	□□	105.0#
	30 x 24 x 29"	KMFSB3024.H	□□□	□□□	□□□□	□□	105.0#
 <p><b>Multi-File Storage Cabinet-Freestanding</b></p> <ul style="list-style-type: none"> <li>File drawer upper left</li> <li>12-1/2" wide closed storage upper right</li> <li>Lower locking lateral file drawer</li> <li>Integral pull is standard; use xxx3 for optional pulls</li> <li>Cabinet fronts are not grain-matched</li> </ul>	30 x 20 x 29"	KMFSF3020.H	□□□	□□□	□□□□	□□	105.0#
	30 x 24 x 29"	KMFSF3024.H	□□□	□□□	□□□□	□□	105.0#

**A**      **B**      **C**      **D**      **E**

## HOW TO ORDER

Indicate the following information on order form:

- Quantity of each item.
- Model number, including options. See "How To Build a Model Number".
- Any special service required.

Note: • The □ indicates that a choice is required.

- The absence of the □ indicates that no choice is required.
- Alpha-numeric characters in place of □ indicate that no other alternatives are available.

## HOW TO BUILD A MODEL NUMBER

- A** Select basic model.
- B** Select horizontal surface finish. Refer to color addendum at ki.com or KI Fabrics & Finishes binder.
- C** Select vertical surface finish. Refer to color addendum at ki.com or KI Fabrics & Finishes binder.

- D** Select pull option.
  - NP** - Standard integral pull
  - BPA3** - Silver bar pull (3); add \$30
  - BPA4** - Silver bar pull (4); add \$40
  - KIB3** - Waterfall black pull (3); add \$30
  - KIB4** - Waterfall black pull (4); add \$40
  - KIS3** - Waterfall silver pull (3); add \$30
  - KIS4** - Waterfall silver pull (4); add \$40
  - RCP3** - Rectangular silver pull (3); add \$30

**RCP4** - Rectangular silver pull (4); add \$40

- E** Select key option.
  - KA** - Key alike
  - KS** - Key standard





# Aristotle® Classic Storage

Lower Storage Units - Freestanding

Delivered  
Pricing

\$ 1293

1328

\$ 1293

1328

**SPECIAL SERVICES**

**Special Carton Marking**

With specially marked information    N/C

**Shipping**

Shipped **assembled freight prepaid f.o.b. KI-Aristotle Brampton, Ontario L6T 5T6** factory. Freight class #85.

Specifications and prices are subject to change without prior notice.

# Aristotle® Classic Storage

## 24" Wide Storage Towers

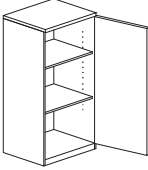
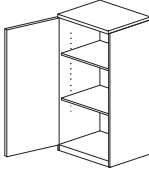
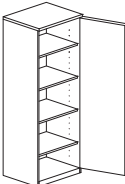
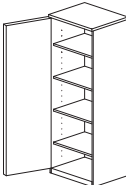
		MODEL NUMBER							Approx. Packaged Weight
		MODEL	W x D x H	Basic Model	Horizontal Surface Finish	Vertical Surface Finish	Pull Option	Lock Option	
	<b>Storage Tower-48" and 54" High, Right-Hinged Door</b> • Right-hinged door • 2 full-width adjustable shelves, 21-1/2" wide • Integral pull is standard; use xxx1 for optional pulls	24 x 20 x 48"	KST242048R.H	□□□	□□□	□□□□	□□	□□	160.0#
		24 x 24 x 48"	KST242448R.H	□□□	□□□	□□□□	□□	□□	165.0#
		24 x 20 x 54"	KST242054R.H	□□□	□□□	□□□□	□□	□□	170.0#
		24 x 24 x 54"	KST242454R.H	□□□	□□□	□□□□	□□	□□	180.0#
ARHPD									
	<b>Storage Tower-48" and 54" High, Left-Hinged Door</b> • Left-hinged door • 2 full-width adjustable shelves, 21-1/2" wide • Integral pull is standard; use xxx1 for optional pulls	24 x 20 x 48"	KST242048L.H	□□□	□□□	□□□□	□□	□□	160.0#
		24 x 24 x 48"	KST242448L.H	□□□	□□□	□□□□	□□	□□	165.0#
		24 x 20 x 54"	KST242054L.H	□□□	□□□	□□□□	□□	□□	170.0#
		24 x 24 x 54"	KST242454L.H	□□□	□□□	□□□□	□□	□□	180.0#
ARHPD									
	<b>Storage Tower-65" and 72" High, Right-Hinged Door</b> • Right-hinged door • 4 full-width adjustable shelves, 21-1/2" wide • Integral pull is standard; use xxx1 for optional pulls	24 x 20 x 65"	KST242065R.H	□□□	□□□	□□□□	□□	□□	175.0#
		24 x 24 x 65"	KST242465R.H	□□□	□□□	□□□□	□□	□□	180.0#
		24 x 20 x 72"	KST242072R.H	□□□	□□□	□□□□	□□	□□	180.0#
		24 x 24 x 72"	KST242472R.H	□□□	□□□	□□□□	□□	□□	190.0#
ARHPD									
	<b>Storage Tower-65" and 72" High, Left-Hinged Door</b> • Left-hinged door • 4 full-width adjustable shelves, 21-1/2" wide • Integral pull is standard; use xxx1 for optional pulls	24 x 20 x 65"	KST242065L.H	□□□	□□□	□□□□	□□	□□	175.0#
		24 x 24 x 65"	KST242465L.H	□□□	□□□	□□□□	□□	□□	180.0#
		24 x 20 x 72"	KST242072L.H	□□□	□□□	□□□□	□□	□□	180.0#
		24 x 24 x 72"	KST242472L.H	□□□	□□□	□□□□	□□	□□	190.0#
ARHPD									

**A**      **B**      **C**      **D**      **E**      **F**

### HOW TO ORDER

Indicate the following information on order form:

- Quantity of each item.
- Model number, including options. See "How To Build a Model Number".
- Any special service required.

Note: • The  indicates that a choice is required.

- The absence of the  indicates that no choice is required.
- Alpha-numeric characters in place of  indicate that no other alternatives are available.

### HOW TO BUILD A MODEL NUMBER

**A** Select basic model.

**B** Select horizontal surface finish.  
Refer to color addendum at ki.com or KI Fabrics & Finishes binder.

**C** Select vertical surface finish.  
Refer to color addendum at ki.com or KI Fabrics & Finishes binder.

**D** Select pull option.

<b>NP</b>	- Standard integral pull
<b>BPA</b>	- Silver bar pull (1); add \$10
<b>KIB</b>	- Waterfall black pull (1); add \$10
<b>KIS</b>	- Waterfall silver pull (1); add \$10
<b>RCP</b>	- Rectangular silver pull (1); add \$10

**E** Select lock option.

<b>NL</b>	- No lock (standard)
<b>L</b>	- With lock; add \$64

**F** Select key option.

<b>KA</b>	- Key alike
<b>KS</b>	- Key standard



# Aristotle® Classic Storage

24" Wide Storage Towers

Delivered Pricing

\$ 942  
1014  
1019  
1076

\$ 942  
1014  
1019  
1076

\$ 1103  
1275  
1154  
1317

\$ 1103  
1275  
1154  
1317

**SPECIAL SERVICES**

**Special Carton Marking**

With specially marked information N/C

**Shipping**

Shipped **assembled freight prepaid f.o.b. KI-Aristotle Brampton, Ontario L6T 5T6** factory. Freight class #85.

Specifications and prices are subject to change without prior notice.

# Aristotle® Classic Storage

24" Wide Storage and Wardrobe Towers

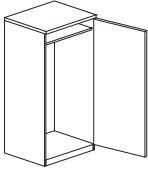
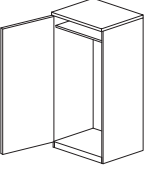
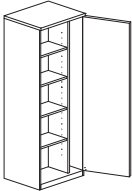
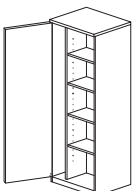
MODEL	W x D x H	MODEL NUMBER						Approx. Packaged Weight
		Basic Model	Horizontal Surface Finish	Vertical Surface Finish	Pull Option	Lock Option	Key Option	
 <p><b>Wardrobe Tower-48" and 54" High, Right-Hinged Door</b></p> <ul style="list-style-type: none"> <li>Right-hinged door</li> <li>Full-width coat hanger bar, 21-1/2" wide</li> <li>Integral pull is standard; use xxx1 for optional pulls</li> </ul>	24 x 20 x 48"	KWT242048R.H	□□□	□□□	□□□□	□□	□□	150.0#
	24 x 24 x 48"	KWT242448R.H	□□□	□□□	□□□□	□□	□□	155.0#
	24 x 20 x 54"	KWT242054R.H	□□□	□□□	□□□□	□□	□□	160.0#
	24 x 24 x 54"	KWT242454R.H	□□□	□□□	□□□□	□□	□□	170.0#
ARHPD								
 <p><b>Wardrobe Tower-48" and 54" High, Left-Hinged Door</b></p> <ul style="list-style-type: none"> <li>Left-hinged door</li> <li>Full-width coat hanger bar, 21-1/2" wide</li> <li>Integral pull is standard; use xxx1 for optional pulls</li> </ul>	24 x 20 x 48"	KWT242048L.H	□□□	□□□	□□□□	□□	□□	150.0#
	24 x 24 x 48"	KWT242448L.H	□□□	□□□	□□□□	□□	□□	155.0#
	24 x 20 x 54"	KWT242054L.H	□□□	□□□	□□□□	□□	□□	160.0#
	24 x 24 x 54"	KWT242454L.H	□□□	□□□	□□□□	□□	□□	170.0#
ARHPD								
 <p><b>Storage and Wardrobe Tower-65" and 72" High, Right-Hinged Door</b></p> <ul style="list-style-type: none"> <li>Right-hinged door</li> <li>4 adjustable shelves, 14-1/4" wide</li> <li>Coat hanger bar, 6-3/8" wide</li> <li>Integral pull is standard; use xxx1 for optional pulls</li> </ul>	24 x 20 x 65"	KSW242065R.H	□□□	□□□	□□□□	□□	□□	175.0#
	24 x 24 x 65"	KSW242465R.H	□□□	□□□	□□□□	□□	□□	180.0#
	24 x 20 x 72"	KSW242072R.H	□□□	□□□	□□□□	□□	□□	180.0#
	24 x 24 x 72"	KSW242472R.H	□□□	□□□	□□□□	□□	□□	190.0#
ARHPD								
 <p><b>Storage and Wardrobe Tower-65" and 72" High, Left-Hinged Door</b></p> <ul style="list-style-type: none"> <li>Left-hinged door</li> <li>4 adjustable shelves, 14-1/4" wide</li> <li>Coat hanger bar, 6-3/8" wide</li> <li>Integral pull is standard; use xxx1 for optional pulls</li> </ul>	24 x 20 x 65"	KSW242065L.H	□□□	□□□	□□□□	□□	□□	175.0#
	24 x 24 x 65"	KSW242465L.H	□□□	□□□	□□□□	□□	□□	180.0#
	24 x 20 x 72"	KSW242072L.H	□□□	□□□	□□□□	□□	□□	180.0#
	24 x 24 x 72"	KSW242472L.H	□□□	□□□	□□□□	□□	□□	190.0#
ARHPD								

**A**      **B**      **C**      **D**      **E**      **F**

## HOW TO ORDER

Indicate the following information on order form:

- Quantity of each item.
- Model number, including options. See "How To Build a Model Number".
- Any special service required.

Note: • The □ indicates that a choice is required.

- The absence of the □ indicates that no choice is required.
- Alpha-numeric characters in place of □ indicate that no other alternatives are available.

## HOW TO BUILD A MODEL NUMBER

**A** Select basic model.

**B** Select horizontal surface finish.  
Refer to color addendum at ki.com or KI Fabrics & Finishes binder.

**C** Select vertical surface finish.  
Refer to color addendum at ki.com or KI Fabrics & Finishes binder.

**D** Select pull option.

<b>NP</b>	- Standard integral pull
<b>BPA</b>	- Silver bar pull (1); add \$10
<b>KIB</b>	- Waterfall black pull (1); add \$10
<b>KIS</b>	- Waterfall silver pull (1); add \$10
<b>RCP</b>	- Rectangular silver pull (1); add \$10

**E** Select lock option.

<b>NL</b>	- No lock (standard)
<b>L</b>	- With lock; add \$64

**F** Select key option.

<b>KA</b>	- Key alike
<b>KS</b>	- Key standard



# Aristotle® Classic Storage

24" Wide Storage and Wardrobe Towers

Delivered Pricing

\$ 942  
1014  
1019  
1076

\$ 942  
1014  
1019  
1076

\$ 1103  
1275  
1154  
1317

\$ 1103  
1275  
1154  
1317

**SPECIAL SERVICES**

**Special Carton Marking**

With specially marked information N/C

**Shipping**

Shipped **assembled freight prepaid f.o.b. KI-Aristotle Brampton, Ontario L6T 5T6** factory. Freight class #85.

Specifications and prices are subject to change without prior notice.

# Aristotle® Classic Storage

24" Wide Storage, Wardrobe and File Towers

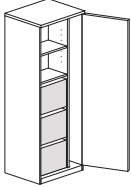
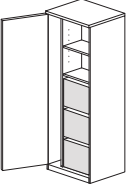
MODEL	W x D x H	MODEL NUMBER						Approx. Packaged Weight
		Basic Model	Horizontal Surface Finish	Vertical Surface Finish	Pull Option	Lock Option	Key Option	
 <p><b>Storage, Wardrobe and File Tower-65" and 72" High, Right-Hinged Door</b></p> <ul style="list-style-type: none"> <li>• Right-hinged, full-width door</li> <li>• 3 letter/legal file drawers</li> <li>• 1 adjustable shelf, 14-1/4" wide</li> <li>• Coat hanger bar, 6-3/8" wide</li> <li>• Integral pull is standard; use xxx1 for optional pulls</li> </ul>	24 x 20 x 65"	KSWF242065R.H	<input type="checkbox"/> <input type="checkbox"/> <input type="checkbox"/>	<input type="checkbox"/> <input type="checkbox"/> <input type="checkbox"/>	<input type="checkbox"/> <input type="checkbox"/> <input type="checkbox"/> <input type="checkbox"/>	<input type="checkbox"/> <input type="checkbox"/>	<input type="checkbox"/> <input type="checkbox"/>	190.0#
	24 x 24 x 65"	KSWF242465R.H	<input type="checkbox"/> <input type="checkbox"/> <input type="checkbox"/>	<input type="checkbox"/> <input type="checkbox"/> <input type="checkbox"/>	<input type="checkbox"/> <input type="checkbox"/> <input type="checkbox"/> <input type="checkbox"/>	<input type="checkbox"/> <input type="checkbox"/>	<input type="checkbox"/> <input type="checkbox"/>	195.0#
	24 x 20 x 72"	KSWF242072R.H	<input type="checkbox"/> <input type="checkbox"/> <input type="checkbox"/>	<input type="checkbox"/> <input type="checkbox"/> <input type="checkbox"/>	<input type="checkbox"/> <input type="checkbox"/> <input type="checkbox"/> <input type="checkbox"/>	<input type="checkbox"/> <input type="checkbox"/>	<input type="checkbox"/> <input type="checkbox"/>	195.0#
	24 x 24 x 72"	KSWF242472R.H	<input type="checkbox"/> <input type="checkbox"/> <input type="checkbox"/>	<input type="checkbox"/> <input type="checkbox"/> <input type="checkbox"/>	<input type="checkbox"/> <input type="checkbox"/> <input type="checkbox"/> <input type="checkbox"/>	<input type="checkbox"/> <input type="checkbox"/>	<input type="checkbox"/> <input type="checkbox"/>	205.0#
 <p><b>Storage, Wardrobe and File Tower-65" and 72" High, Left-Hinged</b></p> <ul style="list-style-type: none"> <li>• Left-hinged, full-width door</li> <li>• 3 letter/legal file drawers</li> <li>• 1 adjustable shelf, 14-1/4" wide</li> <li>• Coat hanger bar, 6-3/8" wide</li> <li>• Integral pull is standard; use xxx1 for optional pulls</li> </ul>	24 x 20 x 65"	KSWF242065L.H	<input type="checkbox"/> <input type="checkbox"/> <input type="checkbox"/>	<input type="checkbox"/> <input type="checkbox"/> <input type="checkbox"/>	<input type="checkbox"/> <input type="checkbox"/> <input type="checkbox"/> <input type="checkbox"/>	<input type="checkbox"/> <input type="checkbox"/>	<input type="checkbox"/> <input type="checkbox"/>	190.0#
	24 x 24 x 65"	KSWF242465L.H	<input type="checkbox"/> <input type="checkbox"/> <input type="checkbox"/>	<input type="checkbox"/> <input type="checkbox"/> <input type="checkbox"/>	<input type="checkbox"/> <input type="checkbox"/> <input type="checkbox"/> <input type="checkbox"/>	<input type="checkbox"/> <input type="checkbox"/>	<input type="checkbox"/> <input type="checkbox"/>	195.0#
	24 x 20 x 72"	KSWF242072L.H	<input type="checkbox"/> <input type="checkbox"/> <input type="checkbox"/>	<input type="checkbox"/> <input type="checkbox"/> <input type="checkbox"/>	<input type="checkbox"/> <input type="checkbox"/> <input type="checkbox"/> <input type="checkbox"/>	<input type="checkbox"/> <input type="checkbox"/>	<input type="checkbox"/> <input type="checkbox"/>	195.0#
	24 x 24 x 72"	KSWF242472L.H	<input type="checkbox"/> <input type="checkbox"/> <input type="checkbox"/>	<input type="checkbox"/> <input type="checkbox"/> <input type="checkbox"/>	<input type="checkbox"/> <input type="checkbox"/> <input type="checkbox"/> <input type="checkbox"/>	<input type="checkbox"/> <input type="checkbox"/>	<input type="checkbox"/> <input type="checkbox"/>	205.0#

**A**      **B**      **C**      **D**      **E**      **F**

### HOW TO ORDER

Indicate the following information on order form:

1. Quantity of each item.
2. Model number, including options. See "How To Build a Model Number".
3. Any special service required.

Note: • The  indicates that a choice is required.

- The absence of the  indicates that no choice is required.
- Alpha-numeric characters in place of  indicate that no other alternatives are available.

### HOW TO BUILD A MODEL NUMBER

- A** Select basic model.
- B** Select horizontal surface finish. Refer to color addendum at ki.com or KI Fabrics & Finishes binder.
- C** Select vertical surface finish. Refer to color addendum at ki.com or KI Fabrics & Finishes binder.
- D** Select pull option.
 

<b>NP</b>	- Standard integral pull
<b>BPA</b>	- Silver bar pull (1); add \$10
<b>KIB</b>	- Waterfall black pull (1); add \$10
<b>KIS</b>	- Waterfall silver pull (1); add \$10
<b>RCP</b>	- Rectangular silver pull (1); add \$10
- E** Select lock option.
 

<b>NL</b>	- No lock (standard)
<b>L</b>	- With lock; add \$64

**F** Select key option.

- |           |                |
|-----------|----------------|
| <b>KA</b> | - Key alike    |
| <b>KS</b> | - Key standard |



# Aristotle® Classic Storage

24" Wide Storage, Wardrobe and File Towers

Delivered  
Pricing

\$ 1623  
1874  
1694  
1937

\$ 1623  
1874  
1694  
1937

### SPECIAL SERVICES

#### Special Carton Marking

With specially marked information N/C

#### Shipping

Shipped **assembled freight prepaid f.o.b. KI-Aristotle Brampton, Ontario L6T 5T6** factory. Freight class #85.

Specifications and prices are subject to change without prior notice.

# Aristotle® Classic Storage

24" Wide Storage, Wardrobe and File Towers/30" and 36" Storage Towers

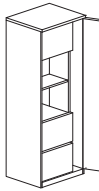
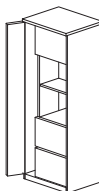
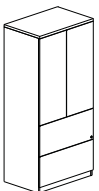
		MODEL NUMBER						Approx. Packaged Weight
MODEL	W x D x H	Basic Model	Horizontal Surface Finish	Vertical Surface Finish	Pull Option	Lock Option	Key Option	
 <p><b>Wardrobe, File and Storage Tower-65" and 72" High, Right-Hinged Door</b></p> <ul style="list-style-type: none"> <li>Right-hinged door</li> <li>Upper closed/middle open storage</li> <li>2 lower letter/legal file drawers, locking, option of "NL=No lock" not available</li> <li>Coat hanger bar, 6-3/8" wide</li> <li>Door available non-locking only</li> <li>Integral pull is standard; use xxx4 for optional pulls</li> </ul>	24 x 20 x 65"	KWFS242065R.H	□□□	□□□	□□□□	L	□□	175.0#
	24 x 24 x 65"	KWFS242465R.H	□□□	□□□	□□□□	L	□□	180.0#
	24 x 20 x 72"	KWFS242072R.H	□□□	□□□	□□□□	L	□□	180.0#
	24 x 24 x 72"	KWFS242472R.H	□□□	□□□	□□□□	L	□□	190.0#
ARHPD								
 <p><b>Wardrobe, File and Storage Tower-65" and 72" High, Left-Hinged Door</b></p> <ul style="list-style-type: none"> <li>Left-hinged door</li> <li>Upper closed/middle open storage</li> <li>2 lower letter/legal file drawers, locking, option of "NL=No lock" not available</li> <li>Coat hanger bar, 6-3/8" wide</li> <li>Door available non-locking only</li> <li>Integral pull is standard; use xxx4 for optional pulls</li> </ul>	24 x 20 x 65"	KWFS242065L.H	□□□	□□□	□□□□	L	□□	175.0#
	24 x 24 x 65"	KWFS242465L.H	□□□	□□□	□□□□	L	□□	180.0#
	24 x 20 x 72"	KWFS242072L.H	□□□	□□□	□□□□	L	□□	180.0#
	24 x 24 x 72"	KWFS242472L.H	□□□	□□□	□□□□	L	□□	190.0#
ARHPD								
 <p><b>Storage Tower with Lateral Files-Standard Doors</b></p> <ul style="list-style-type: none"> <li>Locking lateral files</li> <li>2 adjustable full width shelves in cabinet</li> <li>Non-locking upper doors</li> <li>Integral pull is standard; use xxx4 for optional pulls</li> </ul>	30 x 20 x 65"	KFS302065.H	□□□	□□□	□□□□		□□	185.0#
	30 x 24 x 65"	KFS302465.H	□□□	□□□	□□□□		□□	210.0#
	30 x 20 x 72"	KFS302072.H	□□□	□□□	□□□□		□□	205.0#
	30 x 24 x 72"	KFS302472.H	□□□	□□□	□□□□		□□	230.0#
	36 x 20 x 65"	KFS362065.H	□□□	□□□	□□□□		□□	215.0#
	36 x 24 x 65"	KFS362465.H	□□□	□□□	□□□□		□□	240.0#
	36 x 20 x 72"	KFS362072.H	□□□	□□□	□□□□		□□	235.0#
	36 x 24 x 72"	KFS362472.H	□□□	□□□	□□□□		□□	260.0#
ARHPD								
			<b>A</b>	<b>B</b>	<b>C</b>	<b>D</b>	<b>E</b>	<b>F</b>

## HOW TO ORDER

Indicate the following information on order form:

- Quantity of each item.
- Model number, including options. See "How To Build a Model Number".
- Any special service required.

Note: • The □ indicates that a choice is required.

- The absence of the □ indicates that no choice is required.
- Alpha-numeric characters in place of □ indicate that no other alternatives are available.

## HOW TO BUILD A MODEL NUMBER

- A** Select basic model.
- B** Select horizontal surface finish. Refer to color addendum at ki.com or KI Fabrics & Finishes binder.
- C** Select vertical surface finish. Refer to color addendum at ki.com or KI Fabrics & Finishes binder.
- D** Select pull option.
 

<b>NP</b>	- Standard integral pull
<b>BPA4</b>	- Silver bar pull (4); add \$40
<b>KIB4</b>	- Waterfall black pull (4); add \$40
<b>KIS4</b>	- Waterfall silver pull (4); add \$40
<b>RCP4</b>	- Rectangular silver pull (4); add \$40
- E** Select lock option.
 

<b>L</b>	- With lock
----------	-------------

**F** Select key option.

- |           |                |
|-----------|----------------|
| <b>KA</b> | - Key alike    |
| <b>KS</b> | - Key standard |





# Aristotle® Classic Storage

24" Wide Storage, Wardrobe and File Towers/30" and 36" Storage Towers

## Delivered Pricing

\$ 1623  
1874  
1694  
1937

\$ 1623  
1874  
1694  
1937

\$ 1682  
2009  
1777  
2100  
1921  
2250  
2013  
2342

### SPECIAL SERVICES

#### Special Carton Marking

With specially marked information N/C

#### Shipping

Shipped **assembled freight prepaid f.o.b. KI-Aristotle Brampton, Ontario L6T 5T6** factory. Freight class #85.

Specifications and prices are subject to change without prior notice.

# Aristotle® Classic Storage

36" Storage and Wardrobe Towers

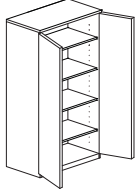
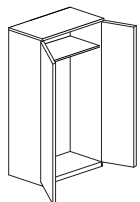
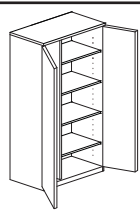
MODEL		W x D x H	MODEL NUMBER						Approx. Packaged Weight
			Basic Model	Horizontal Surface Finish	Vertical Surface Finish	Pull Option	Lock Option	Key Option	
	<b>Storage Tower with Lateral Files-Frosted Glass Doors</b> • Locking lateral files • 2 adjustable shelves in cabinet • Knob finish matches pull finish (frosted doors are standard with knobs) • Non-locking glass doors • Integral pull is standard; use xxx2 for optional pulls	30 x 20 x 65"	KFFS302065.H.AL	□□□	□□□	□□□□		□□	185.0#
		30 x 24 x 65"	KFFS302465.H.AL	□□□	□□□	□□□□		□□	210.0#
		30 x 20 x 72"	KFFS302072.H.AL	□□□	□□□	□□□□		□□	205.0#
		30 x 24 x 72"	KFFS302472.H.AL	□□□	□□□	□□□□		□□	230.0#
		36 x 20 x 65"	KFFS362065.H.AL	□□□	□□□	□□□□		□□	215.0#
		36 x 24 x 65"	KFFS362465.H.AL	□□□	□□□	□□□□		□□	240.0#
		36 x 20 x 72"	KFFS362072.H.AL	□□□	□□□	□□□□		□□	235.0#
ARHPD		36 x 24 x 72"	KFFS362472.H.AL	□□□	□□□	□□□□		□□	260.0#
	<b>Storage Tower</b> • 4 adjustable full width shelves in cabinet • Integral pull is standard; use xxx2 for optional pulls	36 x 20 x 65"	KST362065.H	□□□	□□□	□□□□	□□	□□	200.0#
		36 x 24 x 65"	KST362465.H	□□□	□□□	□□□□	□□	□□	220.0#
		36 x 20 x 72"	KST362072.H	□□□	□□□	□□□□	□□	□□	215.0#
		36 x 24 x 72"	KST362472.H	□□□	□□□	□□□□	□□	□□	240.0#
ARHPD									
	<b>Wardrobe Tower</b> • Full-width wardrobe • Hat shelf • Full -width coat hanger bar • Integral pull is standard; use xxx2 for optional pulls	36 x 20 x 65"	KWT362065.H	□□□	□□□	□□□□	□□	□□	165.0#
		36 x 24 x 65"	KWT362465.H	□□□	□□□	□□□□	□□	□□	175.0#
		36 x 20 x 72"	KWT362072.H	□□□	□□□	□□□□	□□	□□	170.0#
		36 x 24 x 72"	KWT362472.H	□□□	□□□	□□□□	□□	□□	185.0#
ARHPD									
	<b>Storage and Wardrobe Tower</b> • 4 adjustable shelves in cabinet, 26" wide • Coat hanger bar, 6-3/8" wide • Integral pull is standard; use xxx2 for optional pulls	36 x 20 x 65"	KSW362065.H	□□□	□□□	□□□□	□□	□□	200.0#
		36 x 24 x 65"	KSW362465.H	□□□	□□□	□□□□	□□	□□	220.0#
		36 x 20 x 72"	KSW362072.H	□□□	□□□	□□□□	□□	□□	215.0#
		36 x 24 x 72"	KSW362472.H	□□□	□□□	□□□□	□□	□□	240.0#
ARHPD									

**A**      **B**      **C**      **D**      **E**      **F**

## HOW TO ORDER

Indicate the following information on order form:

- Quantity of each item.
- Model number, including options. See "How To Build a Model Number".
- Any special service required.

Note: • The □ indicates that a choice is required.

- The absence of the □ indicates that no choice is required.
- Alpha-numeric characters in place of □ indicate that no other alternatives are available.

## HOW TO BUILD A MODEL NUMBER

**A** Select basic model.

**B** Select horizontal surface finish.  
Refer to color addendum at ki.com or KI Fabrics & Finishes binder.

**C** Select vertical surface finish.  
Refer to color addendum at ki.com or KI Fabrics & Finishes binder.

**D** Select pull option.

<b>NP</b>	- Standard integral pull
<b>BPA2</b>	- Silver bar pull (2); add \$20
<b>KIB2</b>	- Waterfall black pull (2); add \$20
<b>KIS2</b>	- Waterfall silver pull (2); add \$20
<b>RCP2</b>	- Rectangular silver pull (2); add \$20

**E** Select lock option.

<b>NL</b>	- No lock (standard)
<b>L</b>	- With lock; add \$64

**F** Select key option.

<b>KA</b>	- Key alike
<b>KS</b>	- Key standard



# Aristotle® Classic Storage

36" Storage and Wardrobe Towers

Delivered Pricing

\$ 2150  
2273  
2229  
2360  
2290  
2419  
2388  
2516

\$ 1559  
1702  
1643  
1797

\$ 1559  
1702  
1643  
1797

\$ 1559  
1702  
1643  
1797

**SPECIAL SERVICES**

**Special Carton Marking**

With specially marked information N/C

**Shipping**

Shipped **assembled freight prepaid f.o.b. KI-Aristotle Brampton, Ontario L6T 5T6** factory. Freight class #85.

Specifications and prices are subject to change without prior notice.

# Aristotle® Classic Storage

Bookcases-24" Wide

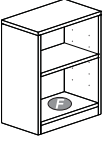
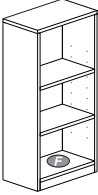
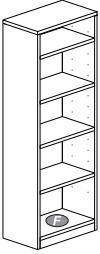
	MODEL	W x D x H	MODEL NUMBER			Approx. Packaged Weight
			Basic Model	Horizontal Surface Finish	Vertical Surface Finish	
 <p>ARHPD</p>	<b>Bookcase 24" Wide-One Adjustable Shelf, One Fixed Shelf</b> • Shelf finish matches shell (vertical surface finish)	24 x 14 x 29"	KBC2429.H	<input type="checkbox"/> <input type="checkbox"/> <input type="checkbox"/>	<input type="checkbox"/> <input type="checkbox"/> <input type="checkbox"/>	50.0#
 <p>ARHPD</p>	<b>Bookcase 24" Wide-Two Adjustable Shelves, One Fixed Shelf</b> • Shelf finish matches shell (vertical surface finish)	24 x 14 x 48"	KBC2448.H	<input type="checkbox"/> <input type="checkbox"/> <input type="checkbox"/>	<input type="checkbox"/> <input type="checkbox"/> <input type="checkbox"/>	65.0#
 <p>ARHPD</p>	<b>Bookcase 24" Wide-Four Adjustable Shelves, One Fixed Shelf</b> • Shelf finish matches shell (vertical surface finish)	24 x 14 x 65"	KBC2465.H	<input type="checkbox"/> <input type="checkbox"/> <input type="checkbox"/>	<input type="checkbox"/> <input type="checkbox"/> <input type="checkbox"/>	90.0#
		24 x 14 x 72"	KBC2472.H	<input type="checkbox"/> <input type="checkbox"/> <input type="checkbox"/>	<input type="checkbox"/> <input type="checkbox"/> <input type="checkbox"/>	105.0#

**A**      **B**      **C**

## HOW TO ORDER

Indicate the following information on order form:

- Quantity of each item.
- Model number, including options. See "How To Build a Model Number".
- Any special service required.

Note: • The  indicates that a choice is required.

- The absence of the  indicates that no choice is required.
- Alpha-numeric characters in place of  indicate that no other alternatives are available.

## HOW TO BUILD A MODEL NUMBER

- A** Select basic model.
- B** Select horizontal surface finish.  
Refer to color addendum at [ki.com](http://ki.com) or KI Fabrics & Finishes binder.
- C** Select vertical surface finish.  
Refer to color addendum at [ki.com](http://ki.com) or KI Fabrics & Finishes binder.



# Aristotle® Classic Storage

Bookcases-24" Wide

Delivered  
Pricing  
\$ 567

\$ 611

\$ 709  
771

**SPECIAL SERVICES**

**Special Carton Marking**

With specially marked information N/C

**Shipping**

Shipped **assembled freight prepaid f.o.b. KI-Aristotle Brampton, Ontario L6T 5T6** factory. Freight class #85.

Specifications and prices are subject to change without prior notice.

# Aristotle® Classic Storage

Bookcases-30" Wide

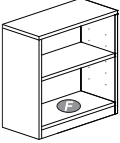
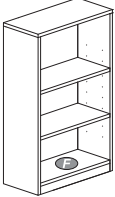
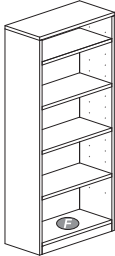
	MODEL	W x D x H	MODEL NUMBER			Approx. Packaged Weight
			Basic Model	Horizontal Surface Finish	Vertical Surface Finish	
 <p>ARHPD</p>	<b>Bookcase 30" Wide-One Adjustable Shelf, One Fixed Shelf</b> • Shelf finish matches shell (vertical surface finish)	30 x 14 x 29"	KBC3029.H	<input type="checkbox"/> <input type="checkbox"/> <input type="checkbox"/>	<input type="checkbox"/> <input type="checkbox"/> <input type="checkbox"/>	55.0#
 <p>ARHPD</p>	<b>Bookcase 30" Wide-Two Adjustable Shelves, One Fixed Shelf</b> • Shelf finish matches shell (vertical surface finish)	30 x 14 x 48"	KBC3048.H	<input type="checkbox"/> <input type="checkbox"/> <input type="checkbox"/>	<input type="checkbox"/> <input type="checkbox"/> <input type="checkbox"/>	75.0#
 <p>ARHPD</p>	<b>Bookcase 30" Wide-Four Adjustable Shelves, One Fixed Shelf</b> • Shelf finish matches shell (vertical surface finish)	30 x 14 x 65"	KBC3065.H	<input type="checkbox"/> <input type="checkbox"/> <input type="checkbox"/>	<input type="checkbox"/> <input type="checkbox"/> <input type="checkbox"/>	105.0#
			30 x 14 x 72"	KBC3072.H	<input type="checkbox"/> <input type="checkbox"/> <input type="checkbox"/>	<input type="checkbox"/> <input type="checkbox"/> <input type="checkbox"/>

**A**      **B**      **C**

## HOW TO ORDER

Indicate the following information on order form:

- Quantity of each item.
- Model number, including options. See "How To Build a Model Number".
- Any special service required.

Note: • The  indicates that a choice is required.

- The absence of the  indicates that no choice is required.
- Alpha-numeric characters in place of  indicate that no other alternatives are available.

## HOW TO BUILD A MODEL NUMBER

- A** Select basic model.
- B** Select horizontal surface finish.  
Refer to color addendum at [ki.com](http://ki.com) or KI Fabrics & Finishes binder.
- C** Select vertical surface finish.  
Refer to color addendum at [ki.com](http://ki.com) or KI Fabrics & Finishes binder.



# Aristotle® Classic Storage

Bookcases-30" Wide

Delivered  
Pricing  
\$ 612

\$ 661

\$ 766  
834

**SPECIAL SERVICES**

**Special Carton Marking**

With specially marked information N/C

**Shipping**

Shipped **assembled freight prepaid f.o.b. KI-Aristotle Brampton, Ontario L6T 5T6** factory. Freight class #85.

Specifications and prices are subject to change without prior notice.

# Aristotle® Classic Storage

Bookcases-36" Wide

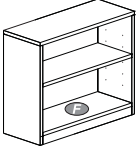
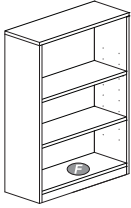
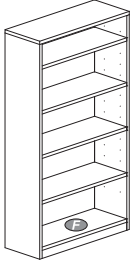
	MODEL	W x D x H	MODEL NUMBER			Approx. Packaged Weight
			Basic Model	Horizontal Surface Finish	Vertical Surface Finish	
	<b>Bookcase 36" Wide-One Adjustable Shelf, One Fixed Shelf</b> • Shelf finish matches shell (vertical surface finish)	36 x 14 x 29"	KBC3629.H	<input type="checkbox"/> <input type="checkbox"/> <input type="checkbox"/>	<input type="checkbox"/> <input type="checkbox"/> <input type="checkbox"/>	60.0#
ARHPD						
	<b>Bookcase 36" Wide-Two Adjustable Shelves, One Fixed Shelf</b> • Shelf finish matches shell (vertical surface finish)	36 x 14 x 48"	KBC3648.H	<input type="checkbox"/> <input type="checkbox"/> <input type="checkbox"/>	<input type="checkbox"/> <input type="checkbox"/> <input type="checkbox"/>	85.0#
ARHPD						
	<b>Bookcase 36" Wide-Four Adjustable Shelves, One Fixed Shelf</b> • Shelf finish matches shell (vertical surface finish)	36 x 14 x 65"	KBC3665.H	<input type="checkbox"/> <input type="checkbox"/> <input type="checkbox"/>	<input type="checkbox"/> <input type="checkbox"/> <input type="checkbox"/>	120.0#
		36 x 14 x 72"	KBC3672.H	<input type="checkbox"/> <input type="checkbox"/> <input type="checkbox"/>	<input type="checkbox"/> <input type="checkbox"/> <input type="checkbox"/>	135.0#
ARHPD						

**A**      **B**      **C**

## HOW TO ORDER

Indicate the following information on order form:

- Quantity of each item.
- Model number, including options. See "How To Build a Model Number".
- Any special service required.

Note: • The  indicates that a choice is required.

- The absence of the  indicates that no choice is required.
- Alpha-numeric characters in place of  indicate that no other alternatives are available.

## HOW TO BUILD A MODEL NUMBER

- A** Select basic model.
- B** Select horizontal surface finish. Refer to color addendum at [ki.com](http://ki.com) or KI Fabrics & Finishes binder.
- C** Select vertical surface finish. Refer to color addendum at [ki.com](http://ki.com) or KI Fabrics & Finishes binder.





# Aristotle® Classic Storage

Bookcases-36" Wide

Delivered  
Pricing

\$ 681

\$ 734

\$ 850

927

**SPECIAL SERVICES**

**Special Carton Marking**

With specially marked information N/C



**Shipping**

Shipped **assembled freight prepaid f.o.b. KI-Aristotle Brampton, Ontario L6T 5T6** factory. Freight class #85.

Specifications and prices are subject to change without prior notice.

# Aristotle® Classic Storage

Bookcase Accessories

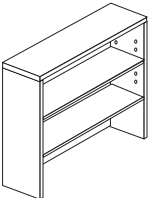
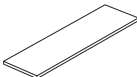
	MODEL	W x D x H	MODEL NUMBER			Approx. Packaged Weight
			Basic Model	Horizontal Surface Finish	Vertical Surface Finish	
	<b>Extra Shelf for 24" Wide Bookcase</b> • Includes 2 wire shelf supports	22 x 13 x 1"	KES24.H	<input type="checkbox"/> <input type="checkbox"/> <input type="checkbox"/>		4.0#
ARHPD						
	<b>Extra Shelf for 30" Wide Bookcase</b> • Includes 2 wire shelf supports	28 x 13 x 1"	KES30.H	<input type="checkbox"/> <input type="checkbox"/> <input type="checkbox"/>		5.0#
ARHPD						
	<b>Extra Shelf for 36" Wide Bookcase</b> • Includes 2 wire shelf supports	34 x 13 x 1"	KES36.H	<input type="checkbox"/> <input type="checkbox"/> <input type="checkbox"/>		6.0#
ARHPD						
	<b>Desk Top Stack-On Bookcase</b> • For use on top of lateral files and storage cabinets • 12" clearance above desktop • 36" high feature one adjustable shelf; 43" feature two adjustable shelves • Shelf finish matches shell (vertical surface finish)	30 x 16 x 36"	KXCB3036.H	<input type="checkbox"/> <input type="checkbox"/> <input type="checkbox"/> <input type="checkbox"/>	<input type="checkbox"/> <input type="checkbox"/> <input type="checkbox"/> <input type="checkbox"/>	70.0#
		30 x 16 x 43"	KXCB3043.H	<input type="checkbox"/> <input type="checkbox"/> <input type="checkbox"/> <input type="checkbox"/>	<input type="checkbox"/> <input type="checkbox"/> <input type="checkbox"/> <input type="checkbox"/>	80.0#
		36 x 16 x 36"	KXCB3636.H	<input type="checkbox"/> <input type="checkbox"/> <input type="checkbox"/> <input type="checkbox"/>	<input type="checkbox"/> <input type="checkbox"/> <input type="checkbox"/> <input type="checkbox"/>	80.0#
		36 x 16 x 43"	KXCB3643.H	<input type="checkbox"/> <input type="checkbox"/> <input type="checkbox"/> <input type="checkbox"/>	<input type="checkbox"/> <input type="checkbox"/> <input type="checkbox"/> <input type="checkbox"/>	90.0#
ARHPD						
	<b>Extra Desk Top Shelves</b> • Extra shelf for 30" wide desk top bookcase • Extra shelf for 36" wide desktop bookcase	28 x 13 x 1"	KXES30.H	<input type="checkbox"/> <input type="checkbox"/> <input type="checkbox"/>		5.0#
		34 x 13 x 1"	KXES36.H	<input type="checkbox"/> <input type="checkbox"/> <input type="checkbox"/>		6.0#
ARHPD						
			<b>A</b>	<b>B</b>	<b>C</b>	

## HOW TO ORDER

Indicate the following information on order form:

- Quantity of each item.
- Model number, including options. See "How To Build a Model Number".
- Any special service required.

Note: • The  indicates that a choice is required.

- The absence of the  indicates that no choice is required.
- Alpha-numeric characters in place of  indicate that no other alternatives are available.

## HOW TO BUILD A MODEL NUMBER

- A** Select basic model.
- B** Select horizontal surface finish.  
Refer to color addendum at ki.com or KI Fabrics & Finishes binder.
- C** Select vertical surface finish.  
Refer to color addendum at ki.com or KI Fabrics & Finishes binder.



Delivered  
Pricing

\$ 111

\$ 111

\$ 111

\$ 655

701

701

771

\$ 111

111

**SPECIAL SERVICES**

**Special Carton Marking**

With specially marked information N/C

**Shipping**

Shipped **assembled freight prepaid f.o.b.**  
**KI-Aristotle Brampton, Ontario L6T 5T6**  
factory. Freight class #85.

Specifications and prices are subject to  
change without prior notice.

# Aristotle® Classic Storage

Quarter-Round Bookcases

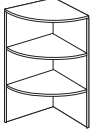
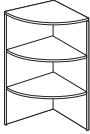
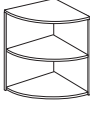
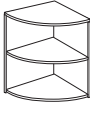
	MODEL	W x D x H	MODEL NUMBER			Approx. Packaged Weight
			Basic Model	Horizontal Surface Finish	Vertical Surface Finish	
 ARHPD	<b>Quarter-Round Bookcase-Desk Top Stack-On Section, Right</b> • Orientation determines grain direction, to match adjacent units • 16" is intended for desk top use, with no bottom shelf • Two fixed shelves • Shelf finish matches shell (vertical surface finish)	16 x 16 x 36"	KQRB1636R.H	<input type="checkbox"/> <input type="checkbox"/> <input type="checkbox"/>	<input type="checkbox"/> <input type="checkbox"/> <input type="checkbox"/>	65.0#
		16 x 16 x 43"	KQRB1643R.H	<input type="checkbox"/> <input type="checkbox"/> <input type="checkbox"/>	<input type="checkbox"/> <input type="checkbox"/> <input type="checkbox"/>	70.0#
 ARHPD	<b>Quarter-Round Bookcase-Desk Top Stack-On Section, Left</b> • Orientation determines grain direction, to match adjacent units • 16" is intended for desk top use, with no bottom shelf • Two fixed shelves • Shelf finish matches shell (vertical surface finish)	16 x 16 x 36"	KQRB1636L.H	<input type="checkbox"/> <input type="checkbox"/> <input type="checkbox"/>	<input type="checkbox"/> <input type="checkbox"/> <input type="checkbox"/>	65.0#
		16 x 16 x 43"	KQRB1643L.H	<input type="checkbox"/> <input type="checkbox"/> <input type="checkbox"/>	<input type="checkbox"/> <input type="checkbox"/> <input type="checkbox"/>	70.0#
 ARHPD	<b>Quarter-Round Bookcase-Desk/Credenza, Right</b> • Orientation determines grain direction, to match adjacent units • 29" flush with adjacent worksurface height • Two fixed shelves • Shelf finish matches shell (vertical surface finish)	20 x 20 x 29"	KQRB2029R.H	<input type="checkbox"/> <input type="checkbox"/> <input type="checkbox"/>	<input type="checkbox"/> <input type="checkbox"/> <input type="checkbox"/>	65.0#
		24 x 24 x 29"	KQRB2429R.H	<input type="checkbox"/> <input type="checkbox"/> <input type="checkbox"/>	<input type="checkbox"/> <input type="checkbox"/> <input type="checkbox"/>	70.0#
 ARHPD	<b>Quarter-Round Bookcase-Desk/Credenza, Left</b> • Orientation determines grain direction, to match adjacent units • 29" flush with adjacent worksurface height • Two fixed shelves • Shelf finish matches shell (vertical surface finish)	20 x 20 x 29"	KQRB2029L.H	<input type="checkbox"/> <input type="checkbox"/> <input type="checkbox"/>	<input type="checkbox"/> <input type="checkbox"/> <input type="checkbox"/>	65.0#
		24 x 24 x 29"	KQRB2429L.H	<input type="checkbox"/> <input type="checkbox"/> <input type="checkbox"/>	<input type="checkbox"/> <input type="checkbox"/> <input type="checkbox"/>	70.0#

**A**

**B**

**C**

## HOW TO ORDER

Indicate the following information on order form:

- Quantity of each item.
- Model number, including options. See "How To Build a Model Number".
- Any special service required.

Note: • The  indicates that a choice is required.

- The absence of the  indicates that no choice is required.
- Alpha-numeric characters in place of  indicate that no other alternatives are available.

## HOW TO BUILD A MODEL NUMBER

- A** Select basic model.
- B** Select horizontal surface finish.  
Refer to color addendum at [ki.com](http://ki.com) or KI Fabrics & Finishes binder.
- C** Select vertical surface finish.  
Refer to color addendum at [ki.com](http://ki.com) or KI Fabrics & Finishes binder.



# Aristotle® Classic Storage

Quarter-Round Bookcases

Delivered  
Pricing

\$ 444

525

\$ 444

525

\$ 468

511

\$ 468

511

### SPECIAL SERVICES

#### Special Carton Marking

With specially marked information    N/C

#### Shipping

Shipped **assembled freight prepaid f.o.b.**  
**KI-Aristotle Brampton, Ontario L6T 5T6**  
factory. Freight class #85.

Specifications and prices are subject to  
change without prior notice.

# Aristotle® Classic Storage

Quarter-Round Bookcases

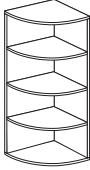
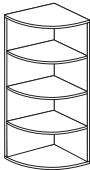
MODEL	W x D x H	MODEL NUMBER			Approx. Packaged Weight	
		Basic Model	Horizontal Surface Finish	Vertical Surface Finish		
 <p>ARHPD</p>	<b>Quarter-Round Bookcase-Overhead, Right</b> • Orientation determines grain direction, to match adjacent units • 16" matches depth and height of installed overhead • Four fixed shelves • Shelf finish matches shell (vertical surface finish)	16 x 16 x 65" 16 x 16 x 72"	KQRB1665R.H KQRB1672R.H	<input type="checkbox"/> <input type="checkbox"/> <input type="checkbox"/> <input type="checkbox"/> <input type="checkbox"/> <input type="checkbox"/>	<input type="checkbox"/> <input type="checkbox"/> <input type="checkbox"/> <input type="checkbox"/> <input type="checkbox"/> <input type="checkbox"/>	90.0# 95.0#
	<b>Quarter-Round Bookcase-Overhead, Left</b> • Orientation determines grain direction, to match adjacent units • 16" matches depth and height of installed overhead • Four fixed shelves • Shelf finish matches shell (vertical surface finish)	16 x 16 x 65" 16 x 16 x 72"	KQRB1665L.H KQRB1672L.H	<input type="checkbox"/> <input type="checkbox"/> <input type="checkbox"/> <input type="checkbox"/> <input type="checkbox"/> <input type="checkbox"/>	<input type="checkbox"/> <input type="checkbox"/> <input type="checkbox"/> <input type="checkbox"/> <input type="checkbox"/> <input type="checkbox"/>	90.0# 95.0#
 <p>ARHPD</p>	<b>Quarter-Round Bookcase-Tower, Right</b> • Orientation determines grain direction, to match adjacent units • 20" and 24" matches depth and height of towers • Four fixed shelves • Shelf finish matches shell (vertical surface finish)	20 x 20 x 65" 20 x 20 x 72" 24 x 24 x 65" 24 x 24 x 72"	KQRB2065R.H KQRB2072R.H KQRB2465R.H KQRB2472R.H	<input type="checkbox"/> <input type="checkbox"/> <input type="checkbox"/> <input type="checkbox"/> <input type="checkbox"/> <input type="checkbox"/> <input type="checkbox"/> <input type="checkbox"/> <input type="checkbox"/> <input type="checkbox"/> <input type="checkbox"/> <input type="checkbox"/>	<input type="checkbox"/> <input type="checkbox"/> <input type="checkbox"/> <input type="checkbox"/> <input type="checkbox"/> <input type="checkbox"/> <input type="checkbox"/> <input type="checkbox"/> <input type="checkbox"/> <input type="checkbox"/> <input type="checkbox"/> <input type="checkbox"/>	100.0# 110.0# 105.0# 115.0#
	<b>Quarter-Round Bookcase-Tower, Left</b> • Orientation determines grain direction, to match adjacent units • 20" and 24" matches depth and height of towers • Four fixed shelves • Shelf finish matches shell (vertical surface finish)	20 x 20 x 65" 20 x 20 x 72" 24 x 24 x 65" 24 x 24 x 72"	KQRB2065L.H KQRB2072L.H KQRB2465L.H KQRB2472L.H	<input type="checkbox"/> <input type="checkbox"/> <input type="checkbox"/> <input type="checkbox"/> <input type="checkbox"/> <input type="checkbox"/> <input type="checkbox"/> <input type="checkbox"/> <input type="checkbox"/> <input type="checkbox"/> <input type="checkbox"/> <input type="checkbox"/>	<input type="checkbox"/> <input type="checkbox"/> <input type="checkbox"/> <input type="checkbox"/> <input type="checkbox"/> <input type="checkbox"/> <input type="checkbox"/> <input type="checkbox"/> <input type="checkbox"/> <input type="checkbox"/> <input type="checkbox"/> <input type="checkbox"/>	100.0# 110.0# 105.0# 115.0#

**A**      **B**      **C**

### HOW TO ORDER

Indicate the following information on order form:

- Quantity of each item.
- Model number, including options. See "How To Build a Model Number".
- Any special service required.

Note: • The  indicates that a choice is required.

- The absence of the  indicates that no choice is required.
- Alpha-numeric characters in place of  indicate that no other alternatives are available.

### HOW TO BUILD A MODEL NUMBER

- A** Select basic model.
- B** Select horizontal surface finish. Refer to color addendum at [ki.com](http://ki.com) or KI Fabrics & Finishes binder.
- C** Select vertical surface finish. Refer to color addendum at [ki.com](http://ki.com) or KI Fabrics & Finishes binder.



# Aristotle® Classic Storage

Quarter-Round Bookcases

Delivered  
Pricing

\$ 600

639

\$ 600

639

\$ 672

724

823

867

\$ 672

724

823

867

### SPECIAL SERVICES

#### Special Carton Marking

With specially marked information    N/C

#### Shipping

Shipped **assembled freight prepaid f.o.b.**  
**KI-Aristotle Brampton, Ontario L6T 5T6**  
factory. Freight class #85.

Specifications and prices are subject to  
change without prior notice.

# Aristotle® Classic Storage

## Square Bookcases

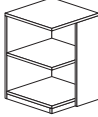
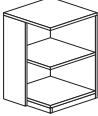
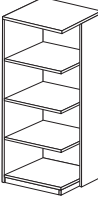
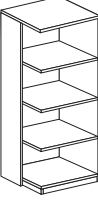
	MODEL	W x D x H	MODEL NUMBER			Approx. Packaged Weight
			Basic Model	Horizontal Surface Finish	Vertical Surface Finish	
 ARHPD	<b>Corner-Square Bookcase-Desk/Credenza, Right</b> <ul style="list-style-type: none"> <li>• Orientation determines grain direction, to match adjacent units</li> <li>• 29" flush with adjacent worksurface height</li> <li>• Two fixed shelves</li> <li>• Shelf finish matches shell (vertical surface finish)</li> </ul>	20 x 20 x 29"	KCSB2029R.H	<input type="checkbox"/> <input type="checkbox"/>	<input type="checkbox"/> <input type="checkbox"/>	60.0#
		24 x 24 x 29"	KCSB2429R.H	<input type="checkbox"/> <input type="checkbox"/>	<input type="checkbox"/> <input type="checkbox"/>	65.0#
 ARHPD	<b>Corner-Square Bookcase-Desk/Credenza, Left</b> <ul style="list-style-type: none"> <li>• Orientation determines grain direction, to match adjacent units</li> <li>• 29" flush with adjacent worksurface height</li> <li>• Two fixed shelves</li> <li>• Shelf finish matches shell (vertical surface finish)</li> </ul>	20 x 20 x 29"	KCSB2029L.H	<input type="checkbox"/> <input type="checkbox"/>	<input type="checkbox"/> <input type="checkbox"/>	60.0#
		24 x 24 x 29"	KCSB2429L.H	<input type="checkbox"/> <input type="checkbox"/>	<input type="checkbox"/> <input type="checkbox"/>	65.0#
 ARHPD	<b>Corner-Square Bookcase--Tower, Right</b> <ul style="list-style-type: none"> <li>• Orientation determines grain direction, to match adjacent units</li> <li>• 20" and 24" matches depth and height of towers</li> <li>• Four fixed shelves</li> <li>• Shelf finish matches shell (vertical surface finish)</li> </ul>	20 x 20 x 65"	KCSB2065R.H	<input type="checkbox"/> <input type="checkbox"/>	<input type="checkbox"/> <input type="checkbox"/>	110.0#
		24 x 24 x 65"	KCSB2465R.H	<input type="checkbox"/> <input type="checkbox"/>	<input type="checkbox"/> <input type="checkbox"/>	115.0#
		20 x 20 x 72"	KCSB2072R.H	<input type="checkbox"/> <input type="checkbox"/>	<input type="checkbox"/> <input type="checkbox"/>	120.0#
		24 x 24 x 72"	KCSB2472R.H	<input type="checkbox"/> <input type="checkbox"/>	<input type="checkbox"/> <input type="checkbox"/>	125.0#
 ARHPD	<b>Corner-Square Bookcase--Tower, Left</b> <ul style="list-style-type: none"> <li>• Orientation determines grain direction, to match adjacent units</li> <li>• 20" and 24" matches depth and height of towers</li> <li>• Four fixed shelves</li> <li>• Shelf finish matches shell (vertical surface finish)</li> </ul>	20 x 20 x 65"	KCSB2065L.H	<input type="checkbox"/> <input type="checkbox"/>	<input type="checkbox"/> <input type="checkbox"/>	110.0#
		24 x 24 x 65"	KCSB2465L.H	<input type="checkbox"/> <input type="checkbox"/>	<input type="checkbox"/> <input type="checkbox"/>	115.0#
		20 x 20 x 72"	KCSB2072L.H	<input type="checkbox"/> <input type="checkbox"/>	<input type="checkbox"/> <input type="checkbox"/>	120.0#
		24 x 24 x 72"	KCSB2472L.H	<input type="checkbox"/> <input type="checkbox"/>	<input type="checkbox"/> <input type="checkbox"/>	125.0#

**A**      **B**      **C**

### HOW TO ORDER

Indicate the following information on order form:

1. Quantity of each item.
2. Model number, including options. See "How To Build a Model Number".
3. Any special service required.

Note: • The  indicates that a choice is required.

- The absence of the  indicates that no choice is required.
- Alpha-numeric characters in place of  indicate that no other alternatives are available.

### HOW TO BUILD A MODEL NUMBER

- A** Select basic model.
- B** Select horizontal surface finish. Refer to color addendum at [ki.com](http://ki.com) or KI Fabrics & Finishes binder.
- C** Select vertical surface finish. Refer to color addendum at [ki.com](http://ki.com) or KI Fabrics & Finishes binder.





# Aristotle® Classic Storage

Square Bookcases

Delivered  
Pricing

\$ 489

579

\$ 489

579

\$ 743

904

800

953

\$ 743

904

800

953

### SPECIAL SERVICES

#### Special Carton Marking

With specially marked information    N/C

#### Shipping

Shipped **assembled freight prepaid f.o.b.**  
**KI-Aristotle Brampton, Ontario L6T 5T6**  
factory. Freight class #85.

Specifications and prices are subject to  
change without prior notice.

# Aristotle® Classic Accessories

## Desktop Acrylic Screen

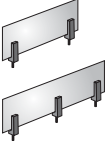
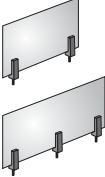
	MODEL	W x D x H	MODEL NUMBER		Approx. Packaged Weight
			Basic Model		
 ARFDT	<b>Desktop Acrylic Screen - 12" H</b> <ul style="list-style-type: none"> <li>• 24-54" wide require 2 desk top screen supports, specified separately</li> <li>• 60-72" wide require 3 desk top screen supports, specified separately</li> <li>• 1/4" frosted acrylic</li> <li>• Surface mounted attachment</li> <li>• Field installed</li> </ul>	21 x 1/4 x 12"	KDTP2412		2.0#
		27 x 1/4 x 12"	KDTP3012		3.0#
		33 x 1/4 x 12"	KDTP3612		4.0#
		39 x 1/4 x 12"	KDTP4212		5.0#
		45 x 1/4 x 12"	KDTP4812		6.0#
		51 x 1/4 x 12"	KDTP5412		7.0#
		57 x 1/4 x 12"	KDTP6012		8.0#
		63 x 1/4 x 12"	KDTP6612		9.0#
		69 x 1/4 x 12"	KDTP7212		10.0#
 ARFDT	<b>Desktop Acrylic Screen - 18" H</b> <ul style="list-style-type: none"> <li>• 24-54" wide require 2 desk top screen supports, specified separately</li> <li>• 60-72" wide require 3 desk top screen supports, specified separately</li> <li>• 1/4" frosted acrylic</li> <li>• Surface mounted attachment</li> <li>• Field installed</li> </ul>	21 x 1/4 x 18"	KDTP2418		3.0#
		27 x 1/4 x 18"	KDTP3018		5.0#
		33 x 1/4 x 18"	KDTP3618		6.0#
		39 x 1/4 x 18"	KDTP4218		8.0#
		45 x 1/4 x 18"	KDTP4818		9.0#
		51 x 1/4 x 18"	KDTP5418		11.0#
		57 x 1/4 x 18"	KDTP6018		12.0#
		63 x 1/4 x 18"	KDTP6618		14.0#
		69 x 1/4 x 18"	KDTP7218		15.0#

**A**

### HOW TO ORDER

Indicate the following information on order form:

1. Quantity of each item.
2. Model number, including options. See "How To Build a Model Number".
3. Any special service required.

Note: • The  indicates that a choice is required.

- The absence of the  indicates that no choice is required.
- Alpha-numeric characters in place of  indicate that no other alternatives are available.

### HOW TO BUILD A MODEL NUMBER

- A** Select basic model.



# Aristotle® Classic Accessories

Desktop Acrylic Screen

## Delivered Pricing

\$ 115
133
151
194
194
249
249
249
284
\$ 192
226
226
293
293
359
359
425
432

### SPECIAL SERVICES

#### Special Carton Marking

With specially marked information N/C



#### Shipping

Shipped **assembled freight prepaid f.o.b. KI-Aristotle Brampton, Ontario L6T 5T6** factory. Freight class #85.

Specifications and prices are subject to change without prior notice.

# Aristotle® Classic Accessories

## Desktop Screen Support

	MODEL	W x D x H	MODEL NUMBER	
			Basic Model	Approx. Packaged Weight
 ARFDT	<b>Desktop Screen Support-6" High, Aluminum Finish</b>	1-1/2 x 1-1/2 x 6"	KDTPSA	1.0#
 ARFDT	<b>Desktop Screen Support-6" High, Black Finish</b>	1-1/2 x 1-1/2 x 6"	KDTPSB	1.0#
 ARFDT	<b>Desktop Screen Support-6" High, Charcoal Finish</b>	1-1/2 x 1-1/2 x 6"	KDTPSC	1.0#

**A**

### HOW TO ORDER

Indicate the following information on order form:

1. Quantity of each item.
2. Model number, including options. See "How To Build a Model Number".
3. Any special service required.

- Note:
- The  indicates that a choice is required.
  - The absence of the  indicates that no choice is required.
  - Alpha-numeric characters in place of  indicate that no other alternatives are available.

### HOW TO BUILD A MODEL NUMBER

- A** Select basic model.



Delivered  
Pricing  
\$ 42

\$ 42

\$ 42

**SPECIAL SERVICES**

**Special Carton Marking**

With specially marked information N/C



**Shipping**

Shipped **assembled freight prepaid f.o.b. KI-Aristotle Brampton, Ontario L6T 5T6** factory. Freight class #85.

Specifications and prices are subject to change without prior notice.

# Aristotle® Classic Accessories

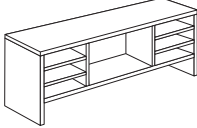
Paper Management

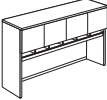
MODEL	W x D x H	MODEL NUMBER			Approx. Packaged Weight	
		Basic Model	Horizontal Surface Finish	Vertical Surface Finish		
	Stack-On Organizer Hutch	60 x 16 x 22"	KSOH6022.H	<input type="checkbox"/> <input type="checkbox"/> <input type="checkbox"/>	<input type="checkbox"/> <input type="checkbox"/> <input type="checkbox"/>	105.0#
		66 x 16 x 22"	KSOH6622.H	<input type="checkbox"/> <input type="checkbox"/> <input type="checkbox"/>	<input type="checkbox"/> <input type="checkbox"/> <input type="checkbox"/>	112.0#
		72 x 16 x 22"	KSOH7222.H	<input type="checkbox"/> <input type="checkbox"/> <input type="checkbox"/>	<input type="checkbox"/> <input type="checkbox"/> <input type="checkbox"/>	120.0#
		78 x 16 x 22"	KSOH7822.H	<input type="checkbox"/> <input type="checkbox"/> <input type="checkbox"/>	<input type="checkbox"/> <input type="checkbox"/> <input type="checkbox"/>	129.0#
AROVD						
	Paper Organizer	17 x 13-1/2 x 17-1/4"	KPOHD1713.H	<input type="checkbox"/> <input type="checkbox"/> <input type="checkbox"/>	<input type="checkbox"/> <input type="checkbox"/> <input type="checkbox"/>	30.0#
	• Horizontal dividers					
AROVD						
	Paper Organizer	17 x 13-1/2 x 17-1/4"	KPOHVD1713.H	<input type="checkbox"/> <input type="checkbox"/> <input type="checkbox"/>	<input type="checkbox"/> <input type="checkbox"/> <input type="checkbox"/>	31.0#
	• Horizontal and vertical dividers					
AROVD						
	Overhead Paper Sorter Insert	22 x 13-1/2 x 5-1/4"	KOPS24.H		<input type="checkbox"/> <input type="checkbox"/> <input type="checkbox"/>	14.0#
	• Paper sorters are not compatible with the cutaway gable option, which offers insufficient clearance for the sorter	28 x 13-1/2 x 5-1/4"	KOPS30.H		<input type="checkbox"/> <input type="checkbox"/> <input type="checkbox"/>	17.0#
	• Not for use with 17" tackboards and 36" stanchions as there is insufficient clearance	34 x 13-1/2 x 5-1/4"	KOPS36.H		<input type="checkbox"/> <input type="checkbox"/> <input type="checkbox"/>	20.0#
	• Field installed (mount optional tackboard first)	40 x 13-1/2 x 5-1/4"	KOPS42.H		<input type="checkbox"/> <input type="checkbox"/> <input type="checkbox"/>	23.0#
	• Not available for corner overheads and wall mount overheads	46 x 13-1/2 x 5-1/4"	KOPS48.H		<input type="checkbox"/> <input type="checkbox"/> <input type="checkbox"/>	26.0#
	• Vertical surface finish is laminate finish for entire insert	52 x 13-1/2 x 5-1/4"	KOPS54.H		<input type="checkbox"/> <input type="checkbox"/> <input type="checkbox"/>	29.0#
		58 x 13-1/2 x 5-1/4"	KOPS60.H		<input type="checkbox"/> <input type="checkbox"/> <input type="checkbox"/>	32.0#
		64 x 13-1/2 x 5-1/4"	KOPS66.H		<input type="checkbox"/> <input type="checkbox"/> <input type="checkbox"/>	35.0#
	70 x 13-1/2 x 5-1/4"	KOPS72.H		<input type="checkbox"/> <input type="checkbox"/> <input type="checkbox"/>	38.0#	
	76 x 13-1/2 x 5-1/4"	KOPS78.H		<input type="checkbox"/> <input type="checkbox"/> <input type="checkbox"/>	41.0#	

A

B

C

## HOW TO ORDER

Indicate the following information on order form:

- Quantity of each item.
- Model number, including options. See "How To Build a Model Number".
- Any special service required.

Note: • The  indicates that a choice is required.

- The absence of the  indicates that no choice is required.
- Alpha-numeric characters in place of  indicate that no other alternatives are available.

## HOW TO BUILD A MODEL NUMBER

- A** Select basic model.
- B** Select horizontal surface finish.  
Refer to color addendum at ki.com or KI Fabrics & Finishes binder.
- C** Select vertical surface finish.  
Refer to color addendum at ki.com or KI Fabrics & Finishes binder.



# Aristotle® Classic Accessories

Paper Management

Delivered  
Pricing

\$ 611

637

661

690

\$ 234

\$ 234

\$ 353

379

404

431

456

478

508

535

560

584

### SPECIAL SERVICES

#### Special Carton Marking

With specially marked information N/C

#### Shipping

Shipped **assembled freight prepaid f.o.b.**  
**KI-Aristotle Brampton, Ontario L6T 5T6**  
factory. Freight class #85.

Specifications and prices are subject to  
change without prior notice.

# Aristotle® Classic Accessories

## Tackboards

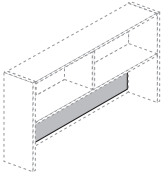
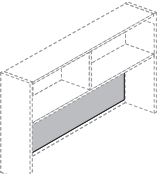
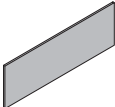
	MODEL	W x D x H	MODEL NUMBER		Approx. Packaged Weight
			Basic Model	Fabric Color	
 ARTAC	<b>Tackboard for 36" High Overhead</b> • Tackboards are attached to a horizontal load bar (supplied) with removable mounting brackets	30 x 3/4 x 17"	KTK30	<input type="checkbox"/> <input type="checkbox"/> <input type="checkbox"/> <input type="checkbox"/>	3.0#
		36 x 3/4 x 17"	KTK36	<input type="checkbox"/> <input type="checkbox"/> <input type="checkbox"/> <input type="checkbox"/>	4.0#
		42 x 3/4 x 17"	KTK42	<input type="checkbox"/> <input type="checkbox"/> <input type="checkbox"/> <input type="checkbox"/>	5.0#
		48 x 3/4 x 17"	KTK48	<input type="checkbox"/> <input type="checkbox"/> <input type="checkbox"/> <input type="checkbox"/>	6.0#
		54 x 3/4 x 17"	KTK54	<input type="checkbox"/> <input type="checkbox"/> <input type="checkbox"/> <input type="checkbox"/>	6.0#
		60 x 3/4 x 17"	KTK60	<input type="checkbox"/> <input type="checkbox"/> <input type="checkbox"/> <input type="checkbox"/>	8.0#
		66 x 3/4 x 17"	KTK66	<input type="checkbox"/> <input type="checkbox"/> <input type="checkbox"/> <input type="checkbox"/>	9.0#
		72 x 3/4 x 17"	KTK72	<input type="checkbox"/> <input type="checkbox"/> <input type="checkbox"/> <input type="checkbox"/>	10.0#
		78 x 3/4 x 17"	KTK78	<input type="checkbox"/> <input type="checkbox"/> <input type="checkbox"/> <input type="checkbox"/>	10.0#
		 ARTAC	<b>Tackboard for 43" High Overhead</b> • Tackboards are attached to a horizontal load bar (supplied) with removable mounting brackets	30 x 3/4 x 24"	KTK3024
36 x 3/4 x 24"	KTK3624			<input type="checkbox"/> <input type="checkbox"/> <input type="checkbox"/> <input type="checkbox"/>	4.0#
42 x 3/4 x 24"	KTK4224			<input type="checkbox"/> <input type="checkbox"/> <input type="checkbox"/> <input type="checkbox"/>	5.0#
48 x 3/4 x 24"	KTK4824			<input type="checkbox"/> <input type="checkbox"/> <input type="checkbox"/> <input type="checkbox"/>	6.0#
54 x 3/4 x 24"	KTK5424			<input type="checkbox"/> <input type="checkbox"/> <input type="checkbox"/> <input type="checkbox"/>	6.0#
60 x 3/4 x 24"	KTK6024			<input type="checkbox"/> <input type="checkbox"/> <input type="checkbox"/> <input type="checkbox"/>	8.0#
66 x 3/4 x 24"	KTK6624			<input type="checkbox"/> <input type="checkbox"/> <input type="checkbox"/> <input type="checkbox"/>	9.0#
72 x 3/4 x 24"	KTK7224			<input type="checkbox"/> <input type="checkbox"/> <input type="checkbox"/> <input type="checkbox"/>	10.0#
78 x 3/4 x 24"	KTK7824			<input type="checkbox"/> <input type="checkbox"/> <input type="checkbox"/> <input type="checkbox"/>	10.0#
 ARTAC	<b>Wall-Mount Tackboards</b> • Tackboards are attached to a horizontal load bar (supplied) with removable mounting brackets			30 x 3/4 x 17"	KWMTK30
		36 x 3/4 x 17"	KWMTK36	<input type="checkbox"/> <input type="checkbox"/> <input type="checkbox"/> <input type="checkbox"/>	4.0#
		42 x 3/4 x 17"	KWMTK42	<input type="checkbox"/> <input type="checkbox"/> <input type="checkbox"/> <input type="checkbox"/>	5.0#
		48 x 3/4 x 17"	KWMTK48	<input type="checkbox"/> <input type="checkbox"/> <input type="checkbox"/> <input type="checkbox"/>	6.0#
		54 x 3/4 x 17"	KWMTK54	<input type="checkbox"/> <input type="checkbox"/> <input type="checkbox"/> <input type="checkbox"/>	6.0#
		60 x 3/4 x 17"	KWMTK60	<input type="checkbox"/> <input type="checkbox"/> <input type="checkbox"/> <input type="checkbox"/>	8.0#
		66 x 3/4 x 17"	KWMTK66	<input type="checkbox"/> <input type="checkbox"/> <input type="checkbox"/> <input type="checkbox"/>	9.0#
		72 x 3/4 x 17"	KWMTK72	<input type="checkbox"/> <input type="checkbox"/> <input type="checkbox"/> <input type="checkbox"/>	10.0#
		78 x 3/4 x 17"	KWMTK78	<input type="checkbox"/> <input type="checkbox"/> <input type="checkbox"/> <input type="checkbox"/>	10.0#
		30 x 3/4 x 24"	KWMTK3024	<input type="checkbox"/> <input type="checkbox"/> <input type="checkbox"/> <input type="checkbox"/>	3.0#
		36 x 3/4 x 24"	KWMTK3624	<input type="checkbox"/> <input type="checkbox"/> <input type="checkbox"/> <input type="checkbox"/>	4.0#
		42 x 3/4 x 24"	KWMTK4224	<input type="checkbox"/> <input type="checkbox"/> <input type="checkbox"/> <input type="checkbox"/>	5.0#
		48 x 3/4 x 24"	KWMTK4824	<input type="checkbox"/> <input type="checkbox"/> <input type="checkbox"/> <input type="checkbox"/>	6.0#
		54 x 3/4 x 24"	KWMTK5424	<input type="checkbox"/> <input type="checkbox"/> <input type="checkbox"/> <input type="checkbox"/>	6.0#
		60 x 3/4 x 24"	KWMTK6024	<input type="checkbox"/> <input type="checkbox"/> <input type="checkbox"/> <input type="checkbox"/>	8.0#
		66 x 3/4 x 24"	KWMTK6624	<input type="checkbox"/> <input type="checkbox"/> <input type="checkbox"/> <input type="checkbox"/>	9.0#
		72 x 3/4 x 24"	KWMTK7224	<input type="checkbox"/> <input type="checkbox"/> <input type="checkbox"/> <input type="checkbox"/>	10.0#
		78 x 3/4 x 24"	KWMTK7824	<input type="checkbox"/> <input type="checkbox"/> <input type="checkbox"/> <input type="checkbox"/>	10.0#

A

B

### HOW TO ORDER

Indicate the following information on order form:

- Quantity of each item.
- Model number, including options. See "How To Build a Model Number".
- Any special service required.

Note: • The  indicates that a choice is required.

- The absence of the  indicates that no choice is required.
- Alpha-numeric characters in place of  indicate that no other alternatives are available.

### HOW TO BUILD A MODEL NUMBER

**A** Select basic model.

**B** Select fabric color.

Refer to color addendum at [ki.com](http://ki.com) or in KI Fabrics & Finishes binder.





# Aristotle® Classic Accessories

Tackboards

Delivered Pricing Fabric Grade 1 & C.O.M.	Delivered Pricing Fabric Grade 2	Delivered Pricing Fabric Grade 3 & Pallas Vertical Fabric Grade PV	Delivered Pricing Pallas Vertical Fabric Grade PV1	Delivered Pricing Pallas Vertical Fabric Grade PV2
\$ 134	\$ 140	\$ 142	\$ 151	\$ 164
151	161	161	170	181
167	173	174	184	201
181	191	192	204	219
196	207	211	227	242
232	240	242	259	280
237	250	251	268	286
245	256	258	276	295
247	262	267	286	306
\$ 181	\$ 193	\$ 197	\$ 210	\$ 225
206	218	222	239	255
227	240	245	262	280
246	262	267	285	305
267	283	288	309	331
314	334	340	364	389
321	341	348	372	398
333	353	361	385	412
343	364	371	397	424
\$ 139	\$ 148	\$ 148	\$ 161	\$ 170
158	165	165	174	190
172	179	180	194	208
187	198	198	211	226
207	219	224	240	256
234	245	247	261	282
239	251	252	270	289
248	259	260	278	298
250	266	271	289	310
188	200	204	218	234
215	228	233	248	266
234	247	252	270	289
255	271	276	296	316
275	291	298	318	341
317	336	343	367	392
324	344	351	375	402
338	357	365	390	418
350	371	378	405	434

## SPECIAL SERVICES

### Special Carton Marking

With specially marked information N/C

### Shipping

Shipped k.d. freight prepaid f.o.b. Manitowoc, Wisconsin 54220 factory. Freight class #70.

Specifications and prices are subject to change without prior notice.

# Aristotle® Classic Accessories

## Tackboards

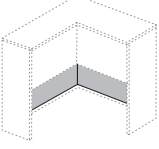
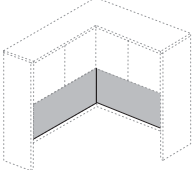
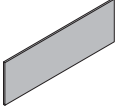
	MODEL	W x D x H	MODEL NUMBER		Approx. Packaged Weight
			Basic Model	Fabric Color	
 <p>ARTAC</p>	<b>Tackboard for Corner Symmetrical 36" High Overhead</b> • Tackboards are attached to a horizontal load bar (supplied) with removable mounting brackets	33 x 32-1/2 x 3/4 x 17"	KTKC3636	<input type="checkbox"/> <input type="checkbox"/> <input type="checkbox"/> <input type="checkbox"/>	4.0#
		39 x 38-1/2 x 3/4 x 17"	KTKC4242	<input type="checkbox"/> <input type="checkbox"/> <input type="checkbox"/> <input type="checkbox"/>	5.0#
		45 x 44-1/2 x 3/4 x 17"	KTKC4848	<input type="checkbox"/> <input type="checkbox"/> <input type="checkbox"/> <input type="checkbox"/>	6.0#
 <p>ARTAC</p>	<b>Tackboard for Corner Symmetrical 43" High Overhead</b> • Tackboards are attached to a horizontal load bar (supplied) with removable mounting brackets	33 x 32-1/2 x 3/4 x 24"	KTKC363624	<input type="checkbox"/> <input type="checkbox"/> <input type="checkbox"/> <input type="checkbox"/>	4.0#
		39 x 38-1/2 x 3/4 x 24"	KTKC424224	<input type="checkbox"/> <input type="checkbox"/> <input type="checkbox"/> <input type="checkbox"/>	5.0#
		45 x 44-1/2 x 3/4 x 24"	KTKC484824	<input type="checkbox"/> <input type="checkbox"/> <input type="checkbox"/> <input type="checkbox"/>	6.0#
 <p>ARTAC</p>	<b>Tackboard for Gallery Reception Desk</b> • Tackboards are attached to a horizontal load bar (supplied) with removable mounting brackets	66 x 3/4 x 13"	KTKG66	<input type="checkbox"/> <input type="checkbox"/> <input type="checkbox"/> <input type="checkbox"/>	9.0#
		72 x 3/4 x 13"	KTKG72	<input type="checkbox"/> <input type="checkbox"/> <input type="checkbox"/> <input type="checkbox"/>	10.0#

A

B

### HOW TO ORDER

Indicate the following information on order form:

- Quantity of each item.
- Model number, including options. See "How To Build a Model Number".
- Any special service required.

Note: • The  indicates that a choice is required.

- The absence of the  indicates that no choice is required.
- Alpha-numeric characters in place of  indicate that no other alternatives are available.

### HOW TO BUILD A MODEL NUMBER

**A** Select basic model.

**B** Select fabric color.  
Refer to color addendum at [ki.com](http://ki.com) or in KI Fabrics & Finishes binder.



# Aristotle® Classic Accessories

Tackboards

Delivered Pricing Fabric Grade 1 & C.O.M.	Delivered Pricing Fabric Grade 2	Delivered Pricing Fabric Grade 3 & Pallas Vertical Fabric Grade PV	Delivered Pricing Pallas Vertical Fabric Grade PV1	Delivered Pricing Pallas Vertical Fabric Grade PV2
\$ 302	\$ 317	\$ 318	\$ 340	\$ 365
333	347	348	372	400
365	379	381	408	439
\$ 410	\$ 434	\$ 443	\$ 474	\$ 507
453	480	489	524	560
496	525	537	574	614
\$ 218	\$ 227	\$ 229	\$ 245	\$ 261
225	235	236	251	272

**SPECIAL SERVICES**

**Special Carton Marking**

With specially marked information N/C



**Shipping**

Shipped k.d. freight prepaid f.o.b. Manitowoc, Wisconsin 54220 factory. Freight class #70.

Specifications and prices are subject to change without prior notice.

# Aristotle® Classic Accessories

## Connector Tops

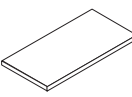
	MODEL	W x D x H	MODEL NUMBER		Approx. Packaged Weight
			Basic Model	Horizontal Surface Finish	
 ARFDT	<b>Desk Extension Table</b> • Woodgrain runs 45 degrees from straight edges • 30x30" metal X base standard	24 x 28 x 29"	KECT2424.H	<input type="checkbox"/> <input type="checkbox"/> <input type="checkbox"/>	40.0#
		30 x 35 x 29"	KECT3030.H	<input type="checkbox"/> <input type="checkbox"/> <input type="checkbox"/>	48.0#
 ARFDT	<b>Half-Round Connector Top</b> • 3" black post leg standard • Woodgrain runs parallel to surface width	48 x 24 x 29"	KHRCT2424.H	<input type="checkbox"/> <input type="checkbox"/> <input type="checkbox"/>	40.0#
		54 x 27 x 29"	KHRCT2430.H	<input type="checkbox"/> <input type="checkbox"/> <input type="checkbox"/>	45.0#
		60 x 30 x 29"	KHRCT3030.H	<input type="checkbox"/> <input type="checkbox"/> <input type="checkbox"/>	50.0#
 ARFDT	<b>Quarter-Round Connector Top</b> • Woodgrain runs parallel to one edge and 90 degrees to other	24 x 24 x 29"	KQRCT2424.H	<input type="checkbox"/> <input type="checkbox"/> <input type="checkbox"/>	20.0#
		24 x 30 x 29"	KQRCT2430.H	<input type="checkbox"/> <input type="checkbox"/> <input type="checkbox"/>	25.0#
		30 x 24 x 29"	KQRCT3024.H	<input type="checkbox"/> <input type="checkbox"/> <input type="checkbox"/>	25.0#
		30 x 30 x 29"	KQRCT3030.H	<input type="checkbox"/> <input type="checkbox"/> <input type="checkbox"/>	30.0#
 ARFDT	<b>Connector Top</b> • Woodgrain runs parallel to surface width	24 x 24"	KBCT2424.H	<input type="checkbox"/> <input type="checkbox"/> <input type="checkbox"/>	15.0#
		24 x 30"	KBCT2430.H	<input type="checkbox"/> <input type="checkbox"/> <input type="checkbox"/>	20.0#
		30 x 24"	KBCT3024.H	<input type="checkbox"/> <input type="checkbox"/> <input type="checkbox"/>	20.0#
		30 x 30"	KBCT3030.H	<input type="checkbox"/> <input type="checkbox"/> <input type="checkbox"/>	25.0#
		36 x 24"	KBCT3624.H	<input type="checkbox"/> <input type="checkbox"/> <input type="checkbox"/>	25.0#
		36 x 30"	KBCT3630.H	<input type="checkbox"/> <input type="checkbox"/> <input type="checkbox"/>	30.0#
		42 x 24"	KBCT4224.H	<input type="checkbox"/> <input type="checkbox"/> <input type="checkbox"/>	30.0#
42 x 30"	KBCT4230.H	<input type="checkbox"/> <input type="checkbox"/> <input type="checkbox"/>	35.0#		

A

B

### HOW TO ORDER

Indicate the following information on order form:

1. Quantity of each item.
2. Model number, including options. See "How To Build a Model Number".
3. Any special service required.

Note: • The  indicates that a choice is required.

- The absence of the  indicates that no choice is required.
- Alpha-numeric characters in place of  indicate that no other alternatives are available.

### HOW TO BUILD A MODEL NUMBER

- A** Select basic model.
- B** Select horizontal surface finish.  
Refer to color addendum at [ki.com](http://ki.com) or KI Fabrics & Finishes binder.



# Aristotle® Classic Accessories

Connector Tops

Delivered  
Pricing

\$ 724

753

\$ 468

542

624

\$ 309

403

403

455

\$ 267

278

278

293

293

309

309

320

## SPECIAL SERVICES

### Special Carton Marking

With specially marked information N/C

### Shipping

Shipped k.d. freight prepaid f.o.b.  
KI-Aristotle Brampton, Ontario L6T 5T6  
factory. Freight class #85.

Specifications and prices are subject to  
change without prior notice.





# Aristotle® Classic

## Slimline Metal Leg Set

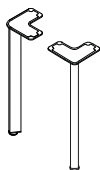
	MODEL	H	MODEL NUMBER		Approx. Packaged Weight	
			Basic Model	Leg Finish		
 <p>HRDPT</p>	<b>Slimline Metal Leg Set</b> <ul style="list-style-type: none"> <li>• Black (BL) or Starlight Silver (SX)</li> <li>• Set of two metal legs</li> <li>• Specify one set of two legs for use with returns: specify two sets of two legs for use with table and desk worksurfaces</li> <li>• Metal legs feature integrated wire management slot and adjustable glide</li> </ul>	28"	ARISLEGSET	<input type="checkbox"/> <input type="checkbox"/>	10.0#	

**A** **B**

### HOW TO ORDER

Indicate the following information on order form:

1. Quantity of each item.
2. Model number, including options. See "How To Build a Model Number".
3. Any special service required.

- Note:
- The  indicates that a choice is required.
  - The absence of the  indicates that no choice is required.
  - Alpha-numeric characters in place of  indicate that no other alternatives are available.

### HOW TO BUILD A MODEL NUMBER

- A** Select basic model.
- B** Select leg finish. Refer to color addendum at [ki.com](http://ki.com) or KI Fabrics & Finishes binder.





# Aristotle® Classic

Slimline Metal Leg Set

Delivered  
Pricing  
\$ 200

**SPECIAL SERVICES**

**Special Carton Marking**

With specially marked information N/C

**Shipping**

Shipped **k.d. freight prepaid f.o.b. Bonduel, Wisconsin 54107** factory. Freight class #85.

Specifications and prices are subject to change without prior notice.

# Aristotle® Classic

Table/Desk Worksurfaces

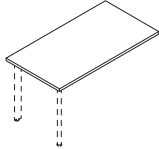
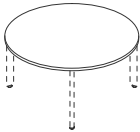
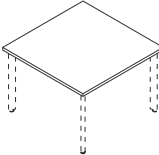
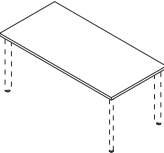
	MODEL	W x D	MODEL NUMBER		Approx. Packaged Weight
			Basic Model	Horizontal Surface Finish	
 ARACT	<b>Return Worksurface</b> <ul style="list-style-type: none"> <li>• Worksurface only</li> <li>• Does not accept modesty panel or end panel inserts, and is not retrofittable to accept the inserts at a later time</li> <li>• Specify slimline legs separately; requires one set of two legs</li> </ul>	24 x 42"	KRWL42242LTO	<input type="checkbox"/> <input type="checkbox"/> <input type="checkbox"/>	25.0#
		24 x 48"	KRWL48242LTO	<input type="checkbox"/> <input type="checkbox"/> <input type="checkbox"/>	35.0#
		24 x 60"	KRWL60242LTO	<input type="checkbox"/> <input type="checkbox"/> <input type="checkbox"/>	50.0#
 ARACT	<b>Meeting Table Round Worksurface</b> <ul style="list-style-type: none"> <li>• Worksurface only</li> <li>• 1" thick top</li> <li>• 30" and 36" tops accommodate 3 people, 42" accommodates 4 people, 48" accommodates 5 people</li> <li>• Specify slimline legs separately; requires 2 sets of legs, 4 legs total</li> </ul>	30" dia	KRD304LTO	<input type="checkbox"/> <input type="checkbox"/> <input type="checkbox"/>	40.0#
		36" dia	KRD364LTO	<input type="checkbox"/> <input type="checkbox"/> <input type="checkbox"/>	50.0#
		42" dia	KRD424LTO	<input type="checkbox"/> <input type="checkbox"/> <input type="checkbox"/>	60.0#
		48" dia	KRD484LTO	<input type="checkbox"/> <input type="checkbox"/> <input type="checkbox"/>	70.0#
 ARACT	<b>Meeting Table Square Worksurface</b> <ul style="list-style-type: none"> <li>• Worksurface only</li> <li>• 1" thick top</li> <li>• Worksurface accommodates 4 people</li> <li>• Specify slimline legs separately; requires 2 sets of legs, 4 legs total</li> </ul>	30 x 30"	KSQ304LTO	<input type="checkbox"/> <input type="checkbox"/> <input type="checkbox"/>	40.0#
		36 x 36"	KSQ364LTO	<input type="checkbox"/> <input type="checkbox"/> <input type="checkbox"/>	50.0#
		42 x 42"	KSQ424LTO	<input type="checkbox"/> <input type="checkbox"/> <input type="checkbox"/>	60.0#
		48 x 48"	KSQ484LTO	<input type="checkbox"/> <input type="checkbox"/> <input type="checkbox"/>	70.0#
 ARACT	<b>Meeting Table Rectangular Worksurface</b> <ul style="list-style-type: none"> <li>• Worksurface only</li> <li>• 1" thick top</li> <li>• Specify slimline legs separately; requires 2 sets of legs, 4 legs total</li> </ul>	42 x 18"	KWSR42184LTO	<input type="checkbox"/> <input type="checkbox"/> <input type="checkbox"/>	21.0#
		48 x 24"	KWSR48244LTO	<input type="checkbox"/> <input type="checkbox"/> <input type="checkbox"/>	28.0#
		60 x 24"	KWSR60244LTO	<input type="checkbox"/> <input type="checkbox"/> <input type="checkbox"/>	35.0#
		60 x 30"	KWSR60304LTO	<input type="checkbox"/> <input type="checkbox"/> <input type="checkbox"/>	44.0#
		72 x 30"	KWSR72304LTO	<input type="checkbox"/> <input type="checkbox"/> <input type="checkbox"/>	53.0#

**A**

**B**

## HOW TO ORDER

Indicate the following information on order form:

1. Quantity of each item.
2. Model number, including options. See "How To Build a Model Number".
3. Any special service required.

Note: • The  indicates that a choice is required.

- The absence of the  indicates that no choice is required.
- Alpha-numeric characters in place of  indicate that no other alternatives are available.

## HOW TO BUILD A MODEL NUMBER

- A** Select basic model.
- B** Select horizontal surface finish. Refer to color addendum at [ki.com](http://ki.com) or KI Fabrics & Finishes binder.

 Delivered  
 Pricing

 \$ 414  
 421  
 491

 \$ 564  
 595  
 696  
 753

 \$ 527  
 557  
 660  
 715

 \$ 490  
 495  
 559  
 621  
 662

**SPECIAL SERVICES**
**Special Carton Marking**

With specially marked information N/C



**Shipping**

 Shipped k.d. freight prepaid f.o.b.  
 KI-Aristotle Brampton, Ontario L6T 5T6  
 factory. Freight class #85.

 Specifications and prices are subject to  
 change without prior notice.

# Aristotle® Classic Accessories

Grommet, Wire Management Channel, Keyed Alike Kits

			MODEL NUMBER	
	MODEL	Features W x D	Basic Model	Approx. Packaged Weight
 HRDPT	<b>Grommet</b> • 2-3/4" diameter • Field installed • Requires 2-3/4" diameter hole • Black finish	2-3/4 x 2-3/4"	KGR	1.0#
 HRDPT	<b>Wire Management Channel</b> • Attaches to back panel • Field installed • 12" J-channel • Conceals wires beneath desktop	12"	KWMC	1.0#
HRDPT	<b>Keyed Alike Kits</b> • Provides single key workstation access • Field installed • Units can be quickly and easily re-keyed using a lock core removal key (included with kit) • Determine correct number of keyed alike locks required per office by referring to product illustrations (Note: some units have multiple locks)	1 lock	KKAK.1	1.0#
		2 locks	KKAK.2	1.0#
		3 locks	KKAK.3	1.0#
		4 locks	KKAK.4	1.0#
		5 locks	KKAK.5	1.0#
		6 locks	KKAK.6	1.0#

**A**

## HOW TO ORDER

Indicate the following information on order form:

- Quantity of each item.
- Model number, including options. See "How To Build a Model Number".
- Any special service required.

- Note:
- The  indicates that a choice is required.
  - The absence of the  indicates that no choice is required.
  - Alpha-numeric characters in place of  indicate that no other alternatives are available.

## HOW TO BUILD A MODEL NUMBER

- A** Select basic model.



# Aristotle® Classic Accessories

Grommet, Wire Management Channel, Keyed Alike Kits

Delivered  
Pricing

\$ 4

\$ 4

\$ 11

29

41

55

70

83

## SPECIAL SERVICES

### Special Carton Marking

With specially marked information N/C

### Shipping

Shipped k.d. freight prepaid f.o.b.  
KI-Aristotle Brampton, Ontario L6T 5T6  
factory. Freight class #85.

Specifications and prices are subject to  
change without prior notice.

# Aristotle® Classic Accessories

## Task Lights

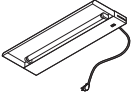
MODEL	W x D	MODEL NUMBER		Approx. Packaged Weight
		Basic Model		
 <p><b>Universal Overhead Task Lights</b></p> <ul style="list-style-type: none"> <li>Task lights mount under overhead cabinets</li> </ul>	24"	TLT5.24		3.9#
	36"	TLT5.36		5.3#
	48"	TLT5.48		6.7#

HRDPT



### HOW TO ORDER

Indicate the following information on order form:

- Quantity of each item.
- Model number, including options. See "How To Build a Model Number".
- Any special service required.

Note: • The  indicates that a choice is required.

- The absence of the  indicates that no choice is required.
- Alpha-numeric characters in place of  indicate that no other alternatives are available.

### HOW TO BUILD A MODEL NUMBER

- A** Select basic model.



# Aristotle® Classic Accessories

Task Lights

Delivered  
Pricing

\$ 76  
83  
91

## SPECIAL SERVICES

### Special Carton Marking

With specially marked information N/C

### Shipping

Shipped k.d. freight prepaid f.o.b. Manitowoc, Wisconsin 54220 factory. Freight class #70.

Specifications and prices are subject to change without prior notice.

# Aristotle® Classic

Conference Room Furniture

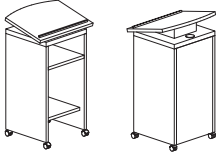
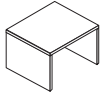
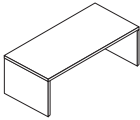
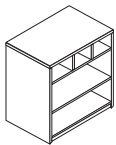
	MODEL	W x D x H	MODEL NUMBER			Approx. Packaged Weight
			Basic Model	Horizontal Surface Finish	Vertical Surface Finish	
	<b>Lectern</b> • Features two interior shelves • Grommet included • Locking casters • Ships assembled	18 x 18 x 44"	KLT1818.H	<input type="checkbox"/> <input type="checkbox"/> <input type="checkbox"/>	<input type="checkbox"/> <input type="checkbox"/> <input type="checkbox"/>	85.0#
		ARACC				
	<b>End table</b> • Full width center support • Ships K.D.	24 x 24 x 18"	KET2424.H	<input type="checkbox"/> <input type="checkbox"/> <input type="checkbox"/>	<input type="checkbox"/> <input type="checkbox"/> <input type="checkbox"/>	40.0#
		ARACC	30 x 30 x 18"	KET3030.H	<input type="checkbox"/> <input type="checkbox"/> <input type="checkbox"/>	<input type="checkbox"/> <input type="checkbox"/> <input type="checkbox"/>
	<b>Coffee Table</b> • Full width center support • Ships K.D.	42 x 20 x 16"	KCT4220.H	<input type="checkbox"/> <input type="checkbox"/> <input type="checkbox"/>	<input type="checkbox"/> <input type="checkbox"/> <input type="checkbox"/>	50.0#
		ARACC	48 x 24 x 16"	KCT4824.H	<input type="checkbox"/> <input type="checkbox"/> <input type="checkbox"/>	<input type="checkbox"/> <input type="checkbox"/> <input type="checkbox"/>
	<b>Printer Table</b> • Three 8-1/2 x 2-3/4" high paper sorter cubbies • One pullout shelf with paper access • 12" upper and 8" lower shelf clearance • Rear cable management grommets • Ships assembled	30 x 24 x 29"	KPT3024.H	<input type="checkbox"/> <input type="checkbox"/> <input type="checkbox"/>	<input type="checkbox"/> <input type="checkbox"/> <input type="checkbox"/>	100.0#
		ARACC	36 x 24 x 29"	KPT3624.H	<input type="checkbox"/> <input type="checkbox"/> <input type="checkbox"/>	<input type="checkbox"/> <input type="checkbox"/> <input type="checkbox"/>
			<b>A</b>	<b>B</b>	<b>C</b>	

## HOW TO ORDER

Indicate the following information on order form:

- Quantity of each item.
- Model number, including options. See "How To Build a Model Number".
- Any special service required.

Note: • The  indicates that a choice is required.

- The absence of the  indicates that no choice is required.
- Alpha-numeric characters in place of  indicate that no other alternatives are available.

## HOW TO BUILD A MODEL NUMBER

- A** Select basic model.
- B** Select horizontal surface finish.  
Refer to color addendum at [ki.com](http://ki.com) or KI Fabrics & Finishes binder.
- C** Select vertical surface finish.  
Refer to color addendum at [ki.com](http://ki.com) or KI Fabrics & Finishes binder.





Delivered  
Pricing

\$ 630

\$ 314

343

\$ 345

375

\$ 576

653

**SPECIAL SERVICES**

**Special Carton Marking**

With specially marked information N/C

**Shipping**

Unless noted, Shipped **assembled freight prepaid f.o.b. KI-Aristotle Brampton, Ontario L6T 5T6** factory. Freight class #85.

Specifications and prices are subject to change without prior notice.

# Aristotle® Classic

Conference Room Furniture

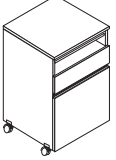
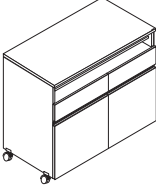
MODEL	W x D x H	MODEL NUMBER				Approx. Packaged Weight
		Basic Model	Horizontal Surface Finish	Vertical Surface Finish	Pull Option	
 <p><b>Single Service Cart</b></p> <ul style="list-style-type: none"> <li>• Integral pull is standard; use xxx2 for optional pulls</li> <li>• Upper pull-out shelf</li> <li>• One box drawer</li> <li>• Storage cabinet features adjustable shelf</li> <li>• Non-locking</li> <li>• Ships assembled</li> </ul>	19 x 21 x 36"	KSS1921.H	<input type="checkbox"/> <input type="checkbox"/> <input type="checkbox"/>	<input type="checkbox"/> <input type="checkbox"/> <input type="checkbox"/>	<input type="checkbox"/> <input type="checkbox"/> <input type="checkbox"/> <input type="checkbox"/>	85.0#
	ARACC					
 <p><b>Double Service Cart</b></p> <ul style="list-style-type: none"> <li>• Integral pull is standard; use xxx4 for optional pulls</li> <li>• Upper pull-out shelf</li> <li>• Two box drawers</li> <li>• Adjustable storage cabinet shelves</li> <li>• Non-locking</li> <li>• Ships assembled</li> </ul>	32 x 21 x 36"	KSS3221.H	<input type="checkbox"/> <input type="checkbox"/> <input type="checkbox"/>	<input type="checkbox"/> <input type="checkbox"/> <input type="checkbox"/>	<input type="checkbox"/> <input type="checkbox"/> <input type="checkbox"/> <input type="checkbox"/>	120.0#
	ARACC					

**A**      **B**      **C**      **D**

### HOW TO ORDER

Indicate the following information on order form:

1. Quantity of each item.
2. Model number, including options. See "How To Build a Model Number".
3. Any special service required.

Note: • The  indicates that a choice is required.

- The absence of the  indicates that no choice is required.
- Alpha-numeric characters in place of  indicate that no other alternatives are available.

### HOW TO BUILD A MODEL NUMBER

- A** Select basic model.
- B** Select horizontal surface finish.  
Refer to color addendum at ki.com or KI Fabrics & Finishes binder.
- C** Select vertical surface finish.  
Refer to color addendum at ki.com or KI Fabrics & Finishes binder.
- D** Select pull option.
 

<b>NP</b>	- Standard integral pull
<b>BPA2</b>	- Silver bar pull (2); add \$20
<b>BPA4</b>	- Silver bar pull (4); add \$40
<b>KIB2</b>	- Waterfall black pull (2); add \$20
<b>KIB4</b>	- Waterfall black pull (4); add \$40
<b>KIS2</b>	- Waterfall silver pull (2); add \$20
<b>KIS4</b>	- Waterfall silver pull (4); add \$40
<b>RCP2</b>	- Rectangular silver pull (2); add \$20

**RCP4** - Rectangular silver pull (4); add \$40



Delivered  
Pricing

\$ 804

\$ 1344

**SPECIAL SERVICES**

**Special Carton Marking**

With specially marked information N/C

**Shipping**

Shipped **assembled freight prepaid f.o.b. KI-Aristotle Brampton, Ontario L6T 5T6** factory. Freight class #85.

Specifications and prices are subject to change without prior notice.

# Aristotle® Classic

Conference Room Furniture

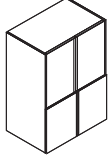
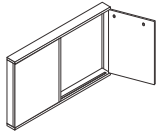
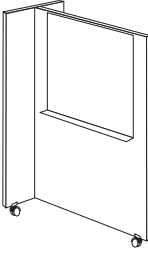
	MODEL	W x D x H	MODEL NUMBER				Approx. Packaged Weight
			Basic Model	Horizontal Surface Finish	Vertical Surface Finish	Pull Option	
 <p>ARACC</p>	<b>Audiovisual Cabinet</b> • Integral pull is standard; use xxx4 for optional pulls • Upper doors retract inside cabinet • Pull-out turntable for TV-29" high • Upper VCR shelf-5" high • Lower box drawer for media storage • Lower right section with two adjustable shelves • Cable management grommets in back • Non-locking • Ships assembled	36 x 25 x 65"	KAV3625.H	<input type="checkbox"/> <input type="checkbox"/> <input type="checkbox"/>	<input type="checkbox"/> <input type="checkbox"/> <input type="checkbox"/>	<input type="checkbox"/> <input type="checkbox"/> <input type="checkbox"/> <input type="checkbox"/>	260.0#
 <p>ARACC</p>	<b>Marker Board</b> • Integral pull is standard; use xxx2 for optional pulls • Whiteboard for dry-erase markers • Ledge for eraser and marker storage • Left door-tackable corkboard • Right door-flipchart pegs (on 17-1/2" centers) • Two-piece cleat wall-mount system • Ships assembled	50 x 5 x 40"	KMB5040.H	<input type="checkbox"/> <input type="checkbox"/> <input type="checkbox"/>	<input type="checkbox"/> <input type="checkbox"/> <input type="checkbox"/>	<input type="checkbox"/> <input type="checkbox"/> <input type="checkbox"/> <input type="checkbox"/>	140.0#
 <p>ARACC</p>	<b>Mobile White Board Divider</b> • Marker tray standard • 36 x 36" markerboard • Ships K.D.	48 x 28 x 72"	KMWD4872.H		<input type="checkbox"/> <input type="checkbox"/> <input type="checkbox"/>		120.0#
			<b>A</b>	<b>B</b>	<b>C</b>	<b>D</b>	

### HOW TO ORDER

Indicate the following information on order form:

- Quantity of each item.
- Model number, including options. See "How To Build a Model Number".
- Any special service required.

Note: • The  indicates that a choice is required.

- The absence of the  indicates that no choice is required.
- Alpha-numeric characters in place of  indicate that no other alternatives are available.

### HOW TO BUILD A MODEL NUMBER

- A** Select basic model.
- B** Select horizontal surface finish.  
Refer to color addendum at ki.com or KI Fabrics & Finishes binder.
- C** Select vertical surface finish.  
Refer to color addendum at ki.com or KI Fabrics & Finishes binder.
- D** Select pull option.
 

<b>NP</b>	- Standard integral pull
<b>BPA2</b>	- Silver bar pull (2); add \$20
<b>BPA4</b>	- Silver bar pull (4); add \$40
<b>KIB2</b>	- Waterfall black pull (2); add \$20
<b>KIB4</b>	- Waterfall black pull (4); add \$40
<b>KIS2</b>	- Waterfall silver pull (2); add \$20
<b>KIS4</b>	- Waterfall silver pull (4); add \$40
<b>RCP2</b>	- Rectangular silver pull (2); add \$20

**RCP4** - Rectangular silver pull (4); add \$40



Delivered  
Pricing  
\$ 2958

\$ 1347

\$ 1011

**SPECIAL SERVICES**

**Special Carton Marking**

With specially marked information N/C

**Shipping**

Unless noted, Shipped **assembled freight prepaid f.o.b. KI-Aristotle Brampton, Ontario L6T 5T6** factory. Freight class #85.

Specifications and prices are subject to change without prior notice.

# Aristotle® Executive

## General Information

### General Information

The Aristotle Casegoods collection from KI creates upscale environments for intelligent workspaces without a heavy price tag. Warm wood grains offer classic appeal while solid finishes provide a more contemporary aesthetic. Both may be combined with metallic accents for truly unique style.

Aristotle is offered in both a Classic version and an Executive version. Aristotle in its Classic offering is more economical when budget is a key concern. It features 1" work surfaces and a flat grain-matched edge. For a more upscale aesthetic, Aristotle Executive features 1-1/2" work surfaces, and any of three edge band options may be featured. Aside from work surfaces, the Classic Aristotle and the Executive Aristotle lines feature similar construction and specifications and both are planned in keeping with the guidelines set forth in this document.

### Aristotle Executive Construction

All work surfaces, tops and end panels are 1-1/2" thick. Bookcases have 1-1/2" thick top and shelves. Edge banding is 2.5 mm thick and matches the laminate finish. Adjustable glides keep surfaces level. Most products are shipped pre-assembled. Products that are shipped ready-to-configure have most fittings pre-attached for quick installation. All dimensions shown are nominal. Approximate weights and volumes relate to crated items and are indicated for shipping purposes. Glides allow for 5/8" adjustment.

### Drawer construction

Pedestals feature five-sided drawer construction and full depth drawers to maximize storage capacity. Pedestals also feature a pencil tray standard in the upper drawer box. Lateral files have steel drawers.

### Drawer suspension

File drawers utilize a heavy-duty full extension ball bearing slide for smooth operation. Box drawers operate on full extension slides allowing total access to drawer.

### File drawers

Credenza, pedestal, and lateral file drawers accommodate letter and legal filing. Lateral file unit drawers are equipped to accept front-to-back filing hardware, specified separately. Lateral files have an anti-tip interlock system.

### Overheads

Overheads have a 13-3/4" internal height clearance and feature a full width, concealed cable pass-through 1-3/4" high. 36" high overheads have 17-1/2" clearance above desktops and are 65" high installed. 43" high overheads have 24" clearance above desk top and are 72" high installed. Wall mount overheads include instructions and mounting hardware.

### Frosted glass door cabinets

Frosted glass doors on overheads and select storage towers have a vinyl wrapped MDF frame in silver finish with tempered, frosted glass.

### Acrylic Door Cabinets

Cabinets feature 13-3/4" internal height clearance. Full-width concealed cable pass through (1-3/4") is provided for 36" and 43" high units. Wall mount also available. Units are non-locking.

### Desktop panel screens

Desktop panels are 1/4" thick frosted acrylic to offer personal privacy while enhancing the overall design. Desktop panel supports are available separately in silver or black finish. A simple surface-mounted attachment secures the panel support to the desktop as a field installation.

### Sizes

Published width and depth dimensions are nominal. To determine actual sizes use the multiplier 0.9843. (Example: a desk listed with a nominal width of 60" is actually 60" x 0.9843 = 59-1/16"), and refer to the conversion chart below:

Nominal/Actual	Nominal/Actual	Nominal/Actual	Nominal/Actual
24"	23-5/8"	72"	70-7/8"
30"	29-1/2"	78"	76-3/4"
36"	35-7/16"	84"	82-11/16"
42"	41-5/16"	90"	88-9/16"
48"	47-1/4"	96"	94-1/2"
54"	53-1/8"	102"	100-3/8"
60"	59-1/16"	108"	106-1/4"
66"	64-15/16"		

### Grommets

Grommets are indicated on all product illustrations when standard and have a 2-3/4" diameter opening. For non-standard locations, field-installed grommet kits are available. See Accessories.

### End and Back Panels

Full height end and back panels are standard on most items. Partial height panels are available as a no charge option on most desk shells, extended corner desk shells, and corner units. The 2Q option provides 14" clearance from the floor, and the 3Q option provides 8" clearance from the floor.

### Modesty Panels

Partial modesty panels (PMP) are 14" and provide 14" of lower clearance. Full height modesty panels (FMP) extend to the floor. Partial modesty panels are standard with no upcharge. Full modesty panels are offered on limited models at an upcharge.

### Pulls

Surface-mounted handles are standard where shown. Note that overheads do not feature pulls.

### Laminate top and base finish

All surfaces are manufactured using high-performance thermally fused laminate, providing a durable, resilient finish.

Laminates can be mixed and matched to create a two-toned look. Edge banding matches laminate finish.

Shelf finish on bookcases and overheads matches shell (vertical) finish.

### Meeting table, freestanding desk and return base metal leg finish

Matching freestanding tables provide auxiliary work surfaces. Metal legs in two styles offer strength and durability in a contemporary profile. Metal-legged returns are attached to a primary desk with flat attachment brackets. The legs include an integrated wire management slot and an adjustable glide.

### Keying options

Locks are standard on all pedestals, credenzas, and lateral files.

Locks are pre-installed in all workstation components (all multi-lock units are keyed alike).

Workstations are available keyed alike at time of order. Indicate clearly which offices are to be keyed alike. See Keyed Alike Kits if additional key sets are required.

The following key options are available at the end of the model strings:

KS - Key standard

KA - Key alike (note room numbers on order)

### Power Station

Each power station features three grounded outlets, two jacks (RJ45/RJ11) and a 10-ft power cord. Hole diameter is 4-1/4".



**Edge detail**

1-1/2" thick worksurface and top  
2.5 mm flat edge banding

**Pulls**

Surface-mounted handles are standard  
where shown.  
Note that overheads do not feature pulls.

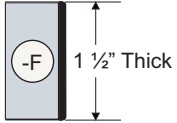

Flat edge

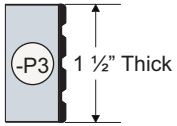

Profiled edge

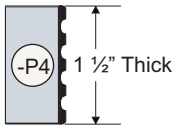

Profiled edge

---

# Aristotle® Executive Pedestal Desks

Double Pedestal Desks

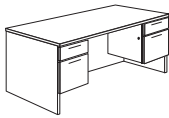
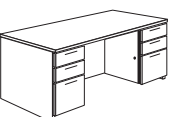
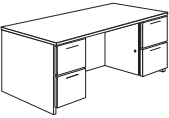
			MODEL NUMBER						Approx. Packaged Weight
MODEL	W x D x H	Basic Model	Edge Style	Horizontal Surface Finish	Vertical Surface Finish	Pull Option	Lock Option		
 <p>AEPED</p>	<b>Double Pedestal Desk, Box/File Option A</b>	60 x 30 x 29-1/2"	KDP6030A.E	<input type="checkbox"/>	<input type="checkbox"/>	<input type="checkbox"/>	<input type="checkbox"/>	<input type="checkbox"/>	270.0#
	• 1-1/2" top with choice of three edge styles	66 x 30 x 29-1/2"	KDP6630A.E	<input type="checkbox"/>	<input type="checkbox"/>	<input type="checkbox"/>	<input type="checkbox"/>	<input type="checkbox"/>	280.0#
	• Two box/file pedestals	72 x 30 x 29-1/2"	KDP7230A.E	<input type="checkbox"/>	<input type="checkbox"/>	<input type="checkbox"/>	<input type="checkbox"/>	<input type="checkbox"/>	290.0#
	• Full height modesty panel recessed	72 x 36 x 29-1/2"	KDP7236A.E	<input type="checkbox"/>	<input type="checkbox"/>	<input type="checkbox"/>	<input type="checkbox"/>	<input type="checkbox"/>	305.0#
	• 2-1/2" for 30" deep desks and 8-3/4" for 36" deep desks	84 x 36 x 29-1/2"	KDP8436A.E	<input type="checkbox"/>	<input type="checkbox"/>	<input type="checkbox"/>	<input type="checkbox"/>	<input type="checkbox"/>	325.0#
	• Grommets not offered								
 <p>AEPED</p>	<b>Double Pedestal Desk, Box/Box/File Option B</b>	60 x 30 x 29-1/2"	KDP6030B.E	<input type="checkbox"/>	<input type="checkbox"/>	<input type="checkbox"/>	<input type="checkbox"/>	<input type="checkbox"/>	330.0#
	• 1-1/2" top with choice of three edge styles	66 x 30 x 29-1/2"	KDP6630B.E	<input type="checkbox"/>	<input type="checkbox"/>	<input type="checkbox"/>	<input type="checkbox"/>	<input type="checkbox"/>	340.0#
	• Two box/box/file pedestals	72 x 30 x 29-1/2"	KDP7230B.E	<input type="checkbox"/>	<input type="checkbox"/>	<input type="checkbox"/>	<input type="checkbox"/>	<input type="checkbox"/>	350.0#
	• Full height modesty panel recessed	72 x 36 x 29-1/2"	KDP7236B.E	<input type="checkbox"/>	<input type="checkbox"/>	<input type="checkbox"/>	<input type="checkbox"/>	<input type="checkbox"/>	360.0#
	• 2-1/2" for 30" deep desks and 8-3/4" for 36" deep desks	84 x 36 x 29-1/2"	KDP8436B.E	<input type="checkbox"/>	<input type="checkbox"/>	<input type="checkbox"/>	<input type="checkbox"/>	<input type="checkbox"/>	385.0#
	• Grommets not offered								
 <p>AEPED</p>	<b>Double Pedestal Desk, File/File Option C</b>	60 x 30 x 29-1/2"	KDP6030C.E	<input type="checkbox"/>	<input type="checkbox"/>	<input type="checkbox"/>	<input type="checkbox"/>	<input type="checkbox"/>	330.0#
	• 1-1/2" top with choice of three edge styles	66 x 30 x 29-1/2"	KDP6630C.E	<input type="checkbox"/>	<input type="checkbox"/>	<input type="checkbox"/>	<input type="checkbox"/>	<input type="checkbox"/>	340.0#
	• Two file/file pedestals	72 x 30 x 29-1/2"	KDP7230C.E	<input type="checkbox"/>	<input type="checkbox"/>	<input type="checkbox"/>	<input type="checkbox"/>	<input type="checkbox"/>	350.0#
	• Full height modesty panel recessed	72 x 36 x 29-1/2"	KDP7236C.E	<input type="checkbox"/>	<input type="checkbox"/>	<input type="checkbox"/>	<input type="checkbox"/>	<input type="checkbox"/>	360.0#
	• 2-1/2" for 30" deep desks and 8-3/4" for 36" deep desks	84 x 36 x 29-1/2"	KDP8436C.E	<input type="checkbox"/>	<input type="checkbox"/>	<input type="checkbox"/>	<input type="checkbox"/>	<input type="checkbox"/>	385.0#
	• Grommets not offered								

**A**   **B**   **C**   **D**   **E**   **F**

## HOW TO ORDER

Indicate the following information on order form:

- Quantity of each item.
- Model number, including options. See "How To Build a Model Number".
- Any special service required.

Note: • The  indicates that a choice is required.

- The absence of the  indicates that no choice is required.
- Alpha-numeric characters in place of  indicate that no other alternatives are available.

## HOW TO BUILD A MODEL NUMBER

**A** Select basic model.

**B** Select edge style.

- F** - Flat edge
- P3** - Three wave profile edge
- P4** - Four wave profile edge

**C** Select horizontal surface finish.

Refer to color addendum at ki.com or KI Fabrics & Finishes binder.

**D** Select vertical surface finish.

Refer to color addendum at ki.com or KI Fabrics & Finishes binder.

**E** Select pull option.

- BPA4** - Silver bar pull (4)
- BPA6** - Silver bar pull (6)
- KIB4** - Waterfall black pull (4)
- KIB6** - Waterfall black pull (6)
- KIS4** - Waterfall silver pull (4)
- KIS6** - Waterfall silver pull (6)

**RCP4** - Rectangular silver pull (4)

**RCP6** - Rectangular silver pull (6)

**F** Select lock option.

- KA** - Key alike
- KS** - Key standard





# Aristotle® Executive Pedestal Desks

Double Pedestal Desks

Delivered Pricing

\$ 1611  
1694  
1781  
1793  
1882

\$ 1996  
2084  
2117  
2182  
2248

\$ 1996  
2084  
2117  
2182  
2248

**SPECIAL SERVICES**

**Special Carton Marking**

With specially marked information N/C

**Shipping**

Shipped **assembled freight prepaid f.o.b. KI-Aristotle Brampton, Ontario L6T 5T6** factory. Freight class #85.

Specifications and prices are subject to change without prior notice.

# Aristotle® Executive Pedestal Desks

## Double Pedestal Desks

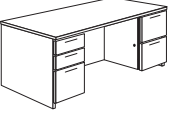
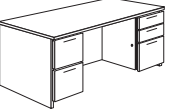
			MODEL NUMBER						Approx. Packaged Weight
MODEL	W x D x H	Basic Model	Edge Style	Horizontal Surface Finish	Vertical Surface Finish	Pull Option	Lock Option		
 <p>AEPED</p>	<b>Double Pedestal Desk, Box/Box/File Option F</b>	60 x 30 x 29-1/2"	KDP6030FE	<input type="checkbox"/>	<input type="checkbox"/>	<input type="checkbox"/>	<input type="checkbox"/>	<input type="checkbox"/>	330.0#
		66 x 30 x 29-1/2"	KDP6630FE	<input type="checkbox"/>	<input type="checkbox"/>	<input type="checkbox"/>	<input type="checkbox"/>	<input type="checkbox"/>	340.0#
		72 x 30 x 29-1/2"	KDP7230FE	<input type="checkbox"/>	<input type="checkbox"/>	<input type="checkbox"/>	<input type="checkbox"/>	<input type="checkbox"/>	350.0#
		72 x 36 x 29-1/2"	KDP7236FE	<input type="checkbox"/>	<input type="checkbox"/>	<input type="checkbox"/>	<input type="checkbox"/>	<input type="checkbox"/>	360.0#
		84 x 36 x 29-1/2"	KDP8436FE	<input type="checkbox"/>	<input type="checkbox"/>	<input type="checkbox"/>	<input type="checkbox"/>	<input type="checkbox"/>	385.0#
 <p>AEPED</p>	<b>Double Pedestal Desk, Locking File/File Option G</b>	60 x 30 x 29-1/2"	KDP6030G.E	<input type="checkbox"/>	<input type="checkbox"/>	<input type="checkbox"/>	<input type="checkbox"/>	<input type="checkbox"/>	330.0#
		66 x 30 x 29-1/2"	KDP6630G.E	<input type="checkbox"/>	<input type="checkbox"/>	<input type="checkbox"/>	<input type="checkbox"/>	<input type="checkbox"/>	340.0#
		72 x 30 x 29-1/2"	KDP7230G.E	<input type="checkbox"/>	<input type="checkbox"/>	<input type="checkbox"/>	<input type="checkbox"/>	<input type="checkbox"/>	350.0#
		72 x 36 x 29-1/2"	KDP7236G.E	<input type="checkbox"/>	<input type="checkbox"/>	<input type="checkbox"/>	<input type="checkbox"/>	<input type="checkbox"/>	360.0#
		84 x 36 x 29-1/2"	KDP8436G.E	<input type="checkbox"/>	<input type="checkbox"/>	<input type="checkbox"/>	<input type="checkbox"/>	<input type="checkbox"/>	385.0#
			<b>A</b>	<b>B</b>	<b>C</b>	<b>D</b>	<b>E</b>	<b>F</b>	

### HOW TO ORDER

Indicate the following information on order form:

- Quantity of each item.
- Model number, including options. See "How To Build a Model Number".
- Any special service required.

Note:

- The  indicates that a choice is required.
- The absence of the  indicates that no choice is required.
- Alpha-numeric characters in place of  indicate that no other alternatives are available.

### HOW TO BUILD A MODEL NUMBER

- A** Select basic model.
- B** Select edge style.
- |           |                           |
|-----------|---------------------------|
| <b>F</b>  | - Flat edge               |
| <b>P3</b> | - Three wave profile edge |
| <b>P4</b> | - Four wave profile edge  |
- C** Select horizontal surface finish.  
Refer to color addendum at ki.com or KI Fabrics & Finishes binder.
- D** Select vertical surface finish.  
Refer to color addendum at ki.com or KI Fabrics & Finishes binder.
- E** Select pull option.
- |             |                               |
|-------------|-------------------------------|
| <b>BPA5</b> | - Silver bar pull (5)         |
| <b>KIB5</b> | - Waterfall black pull (5)    |
| <b>KIS5</b> | - Waterfall silver pull (5)   |
| <b>RCP5</b> | - Rectangular silver pull (5) |
- F** Select lock option.
- |           |                |
|-----------|----------------|
| <b>KA</b> | - Key alike    |
| <b>KS</b> | - Key standard |



# Aristotle® Executive Pedestal Desks

Double Pedestal Desks

Delivered Pricing

\$ 1996  
2084  
2117  
2182  
2248

\$ 1996  
2084  
2117  
2182  
2248

**SPECIAL SERVICES**

**Special Carton Marking**

With specially marked information N/C

**Shipping**

Shipped **assembled freight prepaid f.o.b. KI-Aristotle Brampton, Ontario L6T 5T6** factory. Freight class #85.

Specifications and prices are subject to change without prior notice.

# Aristotle® Executive Pedestal Desks

## Bow Front Double Pedestal Desks

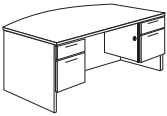
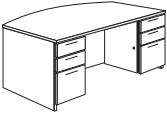
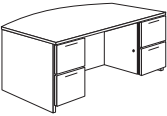
		MODEL NUMBER							Approx. Packaged Weight
MODEL	W x D x H	Basic Model	Edge Style	Horizontal Surface Finish	Vertical Surface Finish	Pull Option	Lock Option		
 <p>AEPED</p>	<b>Bow Front Double Pedestal Desk, Box/File Option A</b>	66 x 36 x 29-1/2"	KBDP6636A.E	<input type="checkbox"/>	<input type="checkbox"/>	<input type="checkbox"/>	<input type="checkbox"/>	<input type="checkbox"/>	295.0#
		72 x 42 x 29-1/2"	KBDP7242A.E	<input type="checkbox"/>	<input type="checkbox"/>	<input type="checkbox"/>	<input type="checkbox"/>	<input type="checkbox"/>	320.0#
		84 x 42 x 29-1/2"	KBDP8442A.E	<input type="checkbox"/>	<input type="checkbox"/>	<input type="checkbox"/>	<input type="checkbox"/>	<input type="checkbox"/>	335.0#
		<ul style="list-style-type: none"> <li>• 1-1/2" top with choice of three edge styles</li> <li>• Two box/file pedestals</li> <li>• Full height modesty panel recessed 8-3/4" for 36" deep desks and 14-3/4" for 42" deep desks</li> <li>• Grommets not offered</li> <li>• Pedestals feature locks on inside panels</li> <li>• 84" desks have center support panel</li> </ul>							
 <p>AEPED</p>	<b>Bow Front Double Pedestal Desk, Box/File Option B</b>	66 x 36 x 29-1/2"	KBDP6636B.E	<input type="checkbox"/>	<input type="checkbox"/>	<input type="checkbox"/>	<input type="checkbox"/>	<input type="checkbox"/>	355.0#
		72 x 42 x 29-1/2"	KBDP7242B.E	<input type="checkbox"/>	<input type="checkbox"/>	<input type="checkbox"/>	<input type="checkbox"/>	<input type="checkbox"/>	380.0#
		84 x 42 x 29-1/2"	KBDP8442B.E	<input type="checkbox"/>	<input type="checkbox"/>	<input type="checkbox"/>	<input type="checkbox"/>	<input type="checkbox"/>	395.0#
		<ul style="list-style-type: none"> <li>• 1-1/2" top with choice of three edge styles</li> <li>• Two box/box/file pedestals</li> <li>• Full height modesty panel recessed 8-3/4" for 36" deep desks and 14-3/4" for 42" deep desks</li> <li>• Grommets not offered</li> <li>• Pedestals feature locks on inside panels</li> <li>• Upper box drawers are non-locking</li> <li>• 84" desks have center support panel</li> </ul>							
 <p>AEPED</p>	<b>Bow Front Double Pedestal Desk, File/File Option C</b>	66 x 36 x 29-1/2"	KBDP6636C.E	<input type="checkbox"/>	<input type="checkbox"/>	<input type="checkbox"/>	<input type="checkbox"/>	<input type="checkbox"/>	355.0#
		72 x 42 x 29-1/2"	KBDP7242C.E	<input type="checkbox"/>	<input type="checkbox"/>	<input type="checkbox"/>	<input type="checkbox"/>	<input type="checkbox"/>	380.0#
		84 x 42 x 29-1/2"	KBDP8442C.E	<input type="checkbox"/>	<input type="checkbox"/>	<input type="checkbox"/>	<input type="checkbox"/>	<input type="checkbox"/>	395.0#
		<ul style="list-style-type: none"> <li>• 1-1/2" top with choice of three edge styles</li> <li>• Two file/file pedestals</li> <li>• Full height modesty panel recessed 8-3/4" for 36" deep desks and 14-3/4" for 42" deep desks</li> <li>• Grommets not offered</li> <li>• Pedestals feature locks on inside panels</li> <li>• 84" desks have center support panel</li> </ul>							

**A**      **B**      **C**      **D**      **E**      **F**

### HOW TO ORDER

Indicate the following information on order form:

- Quantity of each item.
- Model number, including options. See "How To Build a Model Number".
- Any special service required.

Note:

- The  indicates that a choice is required.
- The absence of the  indicates that no choice is required.
- Alpha-numeric characters in place of  indicate that no other alternatives are available.

### HOW TO BUILD A MODEL NUMBER

- A** Select basic model.
 

<b>F</b>	- Flat edge
<b>P3</b>	- Three wave profile edge
<b>P4</b>	- Four wave profile edge
- B** Select edge style.
 

<b>F</b>	- Flat edge
<b>P3</b>	- Three wave profile edge
<b>P4</b>	- Four wave profile edge
- C** Select horizontal surface finish. Refer to color addendum at ki.com or KI Fabrics & Finishes binder.
- D** Select vertical surface finish. Refer to color addendum at ki.com or KI Fabrics & Finishes binder.
- E** Select pull option.
 

<b>BPA4</b>	- Silver bar pull (4)
<b>BPA6</b>	- Silver bar pull (6)
<b>KIB4</b>	- Waterfall black pull (4)
<b>KIB6</b>	- Waterfall black pull (6)
<b>KIS4</b>	- Waterfall silver pull (4)
<b>KIS6</b>	- Waterfall silver pull (6)

- RCP4** - Rectangular silver pull (4)
- RCP6** - Rectangular silver pull (6)
- F** Select lock option.
 

<b>KA</b>	- Key alike
<b>KS</b>	- Key standard



# Aristotle® Executive Pedestal Desks

Bow Front Double Pedestal Desks

Delivered Pricing

\$ 2095  
2103  
2165

\$ 2456  
2476  
2511

\$ 2456  
2476  
2511

**SPECIAL SERVICES**

**Special Carton Marking**

With specially marked information N/C

**Shipping**

Shipped **assembled freight prepaid f.o.b. KI-Aristotle Brampton, Ontario L6T 5T6** factory. Freight class #85.

Specifications and prices are subject to change without prior notice.

# Aristotle® Executive Pedestal Desks

Bow Front Double Pedestal Desks

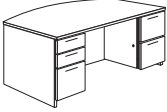
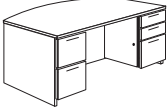
	MODEL	W x D x H	MODEL NUMBER						Approx. Packaged Weight
			Basic Model	Edge Style	Horizontal Surface Finish	Vertical Surface Finish	Pull Option	Lock Option	
 <p>AEPED</p>	<b>Bow Front Double Pedestal Desk, Box/Box/File Option F</b> <ul style="list-style-type: none"> <li>1-1/2" top with choice of three edge styles</li> <li>Box/box/file pedestal on left, upper drawer non-locking</li> <li>Locking file/file pedestal on right</li> <li>Full height modesty panel recessed 8-3/4" for 36" deep desks and 14-3/4" for 42" deep desks</li> <li>Grommets not offered</li> <li>Pedestals feature locks on inside panels</li> <li>84" desks have center support panel</li> </ul>	66 x 36 x 29-1/2"	KBDP6636F.E	<input type="checkbox"/>	<input type="checkbox"/>	<input type="checkbox"/>	<input type="checkbox"/>	<input type="checkbox"/>	355.0#
		72 x 42 x 29-1/2"	KBDP7242F.E	<input type="checkbox"/>	<input type="checkbox"/>	<input type="checkbox"/>	<input type="checkbox"/>	<input type="checkbox"/>	380.0#
		84 x 42 x 29-1/2"	KBDP8442F.E	<input type="checkbox"/>	<input type="checkbox"/>	<input type="checkbox"/>	<input type="checkbox"/>	<input type="checkbox"/>	395.0#
 <p>AEPED</p>	<b>Bow Front Double Pedestal Desk, Locking File/File Option G</b> <ul style="list-style-type: none"> <li>1-1/2" top with choice of three edge styles</li> <li>Locking file/file pedestal on left</li> <li>Box/box/file pedestal on right, upper drawer non-locking</li> <li>Full height modesty panel recessed 8-3/4" for 36" deep desks and 14-3/4" for 42" deep desks</li> <li>Grommets not offered</li> <li>Pedestals feature locks on inside panels</li> <li>84" desks have center support panel</li> </ul>	66 x 36 x 29-1/2"	KBDP6636G.E	<input type="checkbox"/>	<input type="checkbox"/>	<input type="checkbox"/>	<input type="checkbox"/>	<input type="checkbox"/>	355.0#
		72 x 42 x 29-1/2"	KBDP7242G.E	<input type="checkbox"/>	<input type="checkbox"/>	<input type="checkbox"/>	<input type="checkbox"/>	<input type="checkbox"/>	380.0#
		84 x 42 x 29-1/2"	KBDP8442G.E	<input type="checkbox"/>	<input type="checkbox"/>	<input type="checkbox"/>	<input type="checkbox"/>	<input type="checkbox"/>	395.0#
			<b>A</b>	<b>B</b>	<b>C</b>	<b>D</b>	<b>E</b>	<b>F</b>	

## HOW TO ORDER

Indicate the following information on order form:

- Quantity of each item.
- Model number, including options. See "How To Build a Model Number".
- Any special service required.

Note:

- The  indicates that a choice is required.
- The absence of the  indicates that no choice is required.
- Alpha-numeric characters in place of  indicate that no other alternatives are available.

## HOW TO BUILD A MODEL NUMBER

- A** Select basic model.
- B** Select edge style.
 

<b>F</b>	- Flat edge
<b>P3</b>	- Three wave profile edge
<b>P4</b>	- Four wave profile edge
- C** Select horizontal surface finish.  
Refer to color addendum at ki.com or KI Fabrics & Finishes binder.
- D** Select vertical surface finish.  
Refer to color addendum at ki.com or KI Fabrics & Finishes binder.
- E** Select pull option.
 

<b>BPA5</b>	- Silver bar pull (5)
<b>KIB5</b>	- Waterfall black pull (5)
<b>KIS5</b>	- Waterfall silver pull (5)
<b>RCP5</b>	- Rectangular silver pull (5)
- F** Select lock option.
 

<b>KA</b>	- Key alike
<b>KS</b>	- Key standard



# Aristotle® Executive Pedestal Desks

Bow Front Double Pedestal Desks

Delivered  
Pricing

\$ 2456  
2476  
2511

\$ 2456  
2476  
2511

**SPECIAL SERVICES**

**Special Carton Marking**

With specially marked information N/C

**Shipping**

Shipped **assembled freight prepaid f.o.b. KI-Aristotle Brampton, Ontario L6T 5T6** factory. Freight class #85.

Specifications and prices are subject to change without prior notice.

# Aristotle® Executive Pedestal Desks

Single Pedestal Desks-Pedestal on Left

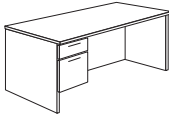
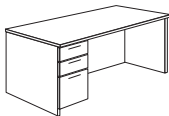
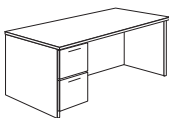
			MODEL NUMBER						
MODEL	W x D x H	Basic Model	Edge Style	Horizontal Surface Finish	Vertical Surface Finish	End Panel	Pull Option	Lock Option	
 <p>AESPD</p>	<b>Single Pedestal Desk-Left, Box/File Option A</b>	48 x 30 x 29-1/2"	KSPL4830A.E	<input type="checkbox"/>	<input type="checkbox"/>	<input type="checkbox"/>	<input type="checkbox"/>	<input type="checkbox"/>	
	• 1-1/2" top with choice of three edge styles	54 x 30 x 29-1/2"	KSPL5430A.E	<input type="checkbox"/>	<input type="checkbox"/>	<input type="checkbox"/>	<input type="checkbox"/>	<input type="checkbox"/>	
	• Box/file pedestal on left	60 x 30 x 29-1/2"	KSPL6030A.E	<input type="checkbox"/>	<input type="checkbox"/>	<input type="checkbox"/>	<input type="checkbox"/>	<input type="checkbox"/>	
	• Full height modesty panel recessed	66 x 30 x 29-1/2"	KSPL6630A.E	<input type="checkbox"/>	<input type="checkbox"/>	<input type="checkbox"/>	<input type="checkbox"/>	<input type="checkbox"/>	
	• 2-1/2" for 30" deep desks and 8-3/4" for 36" deep desks	72 x 30 x 29-1/2"	KSPL7230A.E	<input type="checkbox"/>	<input type="checkbox"/>	<input type="checkbox"/>	<input type="checkbox"/>	<input type="checkbox"/>	
	• Grommets not offered	72 x 36 x 29-1/2"	KSPL7236A.E	<input type="checkbox"/>	<input type="checkbox"/>	<input type="checkbox"/>	<input type="checkbox"/>	<input type="checkbox"/>	
	• Pedestals feature locks on inside panels	84 x 36 x 29-1/2"	KSPL8436A.E	<input type="checkbox"/>	<input type="checkbox"/>	<input type="checkbox"/>	<input type="checkbox"/>	<input type="checkbox"/>	
• 84" desks have center support panel									
 <p>AESPD</p>	<b>Single Pedestal Desk-Left, Box/Box/File Option B</b>	48 x 30 x 29-1/2"	KSPL4830B.E	<input type="checkbox"/>	<input type="checkbox"/>	<input type="checkbox"/>	<input type="checkbox"/>	<input type="checkbox"/>	
	• 1-1/2" top with choice of three edge styles	54 x 30 x 29-1/2"	KSPL5430B.E	<input type="checkbox"/>	<input type="checkbox"/>	<input type="checkbox"/>	<input type="checkbox"/>	<input type="checkbox"/>	
	• Box/box/file pedestal on left	60 x 30 x 29-1/2"	KSPL6030B.E	<input type="checkbox"/>	<input type="checkbox"/>	<input type="checkbox"/>	<input type="checkbox"/>	<input type="checkbox"/>	
	• Full height modesty panel recessed	66 x 30 x 29-1/2"	KSPL6630B.E	<input type="checkbox"/>	<input type="checkbox"/>	<input type="checkbox"/>	<input type="checkbox"/>	<input type="checkbox"/>	
	• 2-1/2" for 30" deep desks and 8-3/4" for 36" deep desks	72 x 30 x 29-1/2"	KSPL7230B.E	<input type="checkbox"/>	<input type="checkbox"/>	<input type="checkbox"/>	<input type="checkbox"/>	<input type="checkbox"/>	
	• Grommets not offered	72 x 36 x 29-1/2"	KSPL7236B.E	<input type="checkbox"/>	<input type="checkbox"/>	<input type="checkbox"/>	<input type="checkbox"/>	<input type="checkbox"/>	
	• Pedestals feature locks on inside panels	84 x 36 x 29-1/2"	KSPL8436B.E	<input type="checkbox"/>	<input type="checkbox"/>	<input type="checkbox"/>	<input type="checkbox"/>	<input type="checkbox"/>	
• Upper box drawer is non-locking									
• 84" desks have center support panel									
 <p>AESPD</p>	<b>Single Pedestal Desk-Left, File/File Option C</b>	48 x 30 x 29-1/2"	KSPL4830C.E	<input type="checkbox"/>	<input type="checkbox"/>	<input type="checkbox"/>	<input type="checkbox"/>	<input type="checkbox"/>	
	• 1-1/2" top with choice of three edge styles	54 x 30 x 29-1/2"	KSPL5430C.E	<input type="checkbox"/>	<input type="checkbox"/>	<input type="checkbox"/>	<input type="checkbox"/>	<input type="checkbox"/>	
	• File/file pedestal on left	60 x 30 x 29-1/2"	KSPL6030C.E	<input type="checkbox"/>	<input type="checkbox"/>	<input type="checkbox"/>	<input type="checkbox"/>	<input type="checkbox"/>	
	• Full height modesty panel recessed	66 x 30 x 29-1/2"	KSPL6630C.E	<input type="checkbox"/>	<input type="checkbox"/>	<input type="checkbox"/>	<input type="checkbox"/>	<input type="checkbox"/>	
	• 2-1/2" for 30" deep desks and 8-3/4" for 36" deep desks	72 x 30 x 29-1/2"	KSPL7230C.E	<input type="checkbox"/>	<input type="checkbox"/>	<input type="checkbox"/>	<input type="checkbox"/>	<input type="checkbox"/>	
	• Grommets not offered	72 x 36 x 29-1/2"	KSPL7236C.E	<input type="checkbox"/>	<input type="checkbox"/>	<input type="checkbox"/>	<input type="checkbox"/>	<input type="checkbox"/>	
	• Pedestals feature locks on inside panels	84 x 36 x 29-1/2"	KSPL8436C.E	<input type="checkbox"/>	<input type="checkbox"/>	<input type="checkbox"/>	<input type="checkbox"/>	<input type="checkbox"/>	
• 84" desks have center support panel									

**A**      **B**      **C**      **D**      **E**      **F**      **G**

## HOW TO ORDER

Indicate the following information on order form:

- Quantity of each item.
- Model number, including options. See "How To Build a Model Number".
- Any special service required.

Note: • The  indicates that a choice is required.

- The absence of the  indicates that no choice is required.
- Alpha-numeric characters in place of  indicate that no other alternatives are available.

## HOW TO BUILD A MODEL NUMBER

**A** Select basic model.

**B** Select edge style.

- F** - Flat edge
- P3** - Three wave profile edge
- P4** - Four wave profile edge

**C** Select horizontal surface finish.

Refer to color addendum at ki.com or KI Fabrics & Finishes binder.

**D** Select vertical surface finish.

Refer to color addendum at ki.com or KI Fabrics & Finishes binder.

**E** Select end panel option.

- CGR** - Recessed end panel right side
- FULL** - Full end panel both sides

**F** Select pull option.

- BPA2** - Silver bar pull (2)
- BPA3** - Silver bar pull (3)
- KIB2** - Waterfall black pull (2)

**KIB3** - Waterfall black pull (3)

**KIS2** - Waterfall silver pull (2)

**KIS3** - Waterfall silver pull (3)

**RCP2** - Rectangular silver pull (2)

**RCP3** - Rectangular silver pull (3)

**G** Select lock option.

**KA** - Key alike

**KS** - Key standard





# Aristotle® Executive Pedestal Desks

Single Pedestal Desks-Pedestal on Left

Approx.  
Packaged  
Weight

Delivered  
Pricing

190.0#	\$ 1200
200.0#	1244
215.0#	1307
225.0#	1395
240.0#	1489
250.0#	1541
265.0#	1572

220.0#	\$ 1395
230.0#	1423
245.0#	1500
255.0#	1590
270.0#	1667
280.0#	1733
295.0#	1788

220.0#	\$ 1395
230.0#	1423
245.0#	1500
255.0#	1590
270.0#	1667
280.0#	1733
295.0#	1788

**SPECIAL SERVICES**

**Special Carton Marking**

With specially marked information N/C

**Shipping**

Shipped **assembled freight prepaid f.o.b. KI-Aristotle Brampton, Ontario L6T 5T6** factory. Freight class #85.

Specifications and prices are subject to change without prior notice.

# Aristotle® Executive Pedestal Desks

Bow Front Single Pedestal Desks-Pedestal on Left

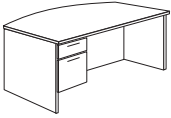
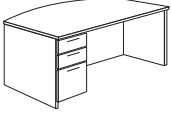
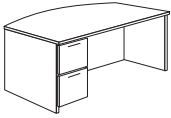
			MODEL NUMBER						Approx. Packaged Weight
MODEL	W x D x H	Basic Model	Edge Style	Horizontal Surface Finish	Vertical Surface Finish	Pull Option	Lock Option		
 <p>AEPED</p>	<b>Bow Front Single Pedestal Desk-Left, Box/File Option A</b>	66 x 36 x 29-1/2"	KBSPL6636A.E	<input type="checkbox"/>	<input type="checkbox"/>	<input type="checkbox"/>	<input type="checkbox"/>	<input type="checkbox"/>	240.0#
		72 x 42 x 29-1/2"	KBSPL7242A.E	<input type="checkbox"/>	<input type="checkbox"/>	<input type="checkbox"/>	<input type="checkbox"/>	<input type="checkbox"/>	265.0#
		84 x 42 x 29-1/2"	KBSPL8442A.E	<input type="checkbox"/>	<input type="checkbox"/>	<input type="checkbox"/>	<input type="checkbox"/>	<input type="checkbox"/>	280.0#
 <p>AEPED</p>	<b>Bow Front Single Pedestal Desk-Left, Box/Box/File Option B</b>	66 x 36 x 29-1/2"	KBSPL6636B.E	<input type="checkbox"/>	<input type="checkbox"/>	<input type="checkbox"/>	<input type="checkbox"/>	<input type="checkbox"/>	270.0#
		72 x 42 x 29-1/2"	KBSPL7242B.E	<input type="checkbox"/>	<input type="checkbox"/>	<input type="checkbox"/>	<input type="checkbox"/>	<input type="checkbox"/>	295.0#
		84 x 42 x 29-1/2"	KBSPL8442B.E	<input type="checkbox"/>	<input type="checkbox"/>	<input type="checkbox"/>	<input type="checkbox"/>	<input type="checkbox"/>	310.0#
 <p>AEPED</p>	<b>Bow Front Single Pedestal Desk-Left, File/File Option C</b>	66 x 36 x 29-1/2"	KBSPL6636C.E	<input type="checkbox"/>	<input type="checkbox"/>	<input type="checkbox"/>	<input type="checkbox"/>	<input type="checkbox"/>	270.0#
		72 x 42 x 29-1/2"	KBSPL7242C.E	<input type="checkbox"/>	<input type="checkbox"/>	<input type="checkbox"/>	<input type="checkbox"/>	<input type="checkbox"/>	295.0#
		84 x 42 x 29-1/2"	KBSPL8442C.E	<input type="checkbox"/>	<input type="checkbox"/>	<input type="checkbox"/>	<input type="checkbox"/>	<input type="checkbox"/>	310.0#

**A**      **B**      **C**      **D**      **E**      **F**

## HOW TO ORDER

Indicate the following information on order form:

- Quantity of each item.
- Model number, including options. See "How To Build a Model Number".
- Any special service required.

Note:

- The  indicates that a choice is required.
- The absence of the  indicates that no choice is required.
- Alpha-numeric characters in place of  indicate that no other alternatives are available.

## HOW TO BUILD A MODEL NUMBER

- A** Select basic model.
- B** Select edge style.
  - F** - Flat edge
  - P3** - Three wave profile edge
  - P4** - Four wave profile edge
- C** Select horizontal surface finish. Refer to color addendum at ki.com or KI Fabrics & Finishes binder.
- D** Select vertical surface finish. Refer to color addendum at ki.com or KI Fabrics & Finishes binder.
- E** Select pull option.
  - BPA2** - Silver bar pull (2)
  - BPA3** - Silver bar pull (3)
  - KIB2** - Waterfall black pull (2)
  - KIB3** - Waterfall black pull (3)
  - KIS2** - Waterfall silver pull (2)
  - KIS3** - Waterfall silver pull (3)

- RCP2** - Rectangular silver pull (2)
- RCP3** - Rectangular silver pull (3)
- F** Select lock option.
  - KA** - Key alike
  - KS** - Key standard



# Aristotle® Executive Pedestal Desks

Bow Front Single Pedestal Desks-Pedestal on Left

Delivered Pricing

\$ 1719  
1771  
1823

\$ 1897  
1955  
2014

\$ 1897  
1955  
2014

**SPECIAL SERVICES**

**Special Carton Marking**

With specially marked information N/C



**Shipping**

Shipped **assembled freight prepaid f.o.b. KI-Aristotle Brampton, Ontario L6T 5T6** factory. Freight class #85.

Specifications and prices are subject to change without prior notice.

# Aristotle® Executive Pedestal Desks

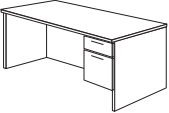
Single Pedestal Desks-Pedestal on Right

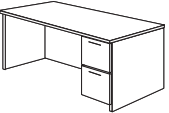
			MODEL NUMBER						
MODEL	W x D x H	Basic Model	Edge Style	Horizontal Surface Finish	Vertical Surface Finish	End Panel	Pull Option	Lock Option	
 <p>AESPD</p>	<b>Single Pedestal Desk-Right, Box/File Option A</b>	48 x 30 x 29-1/2"	KSPR4830A.E	<input type="checkbox"/>	<input type="checkbox"/>	<input type="checkbox"/>	<input type="checkbox"/>	<input type="checkbox"/>	
	• 1-1/2" top with choice of three edge styles	54 x 30 x 29-1/2"	KSPR5430A.E	<input type="checkbox"/>	<input type="checkbox"/>	<input type="checkbox"/>	<input type="checkbox"/>	<input type="checkbox"/>	
	• Box/file pedestal on right	60 x 30 x 29-1/2"	KSPR6030A.E	<input type="checkbox"/>	<input type="checkbox"/>	<input type="checkbox"/>	<input type="checkbox"/>	<input type="checkbox"/>	
	• Full height modesty panel recessed	66 x 30 x 29-1/2"	KSPR6630A.E	<input type="checkbox"/>	<input type="checkbox"/>	<input type="checkbox"/>	<input type="checkbox"/>	<input type="checkbox"/>	
	• 2-1/2" for 30" deep desks and 8-3/4" for 36" deep desks	72 x 30 x 29-1/2"	KSPR7230A.E	<input type="checkbox"/>	<input type="checkbox"/>	<input type="checkbox"/>	<input type="checkbox"/>	<input type="checkbox"/>	
	• Grommets not offered	72 x 36 x 29-1/2"	KSPR7236A.E	<input type="checkbox"/>	<input type="checkbox"/>	<input type="checkbox"/>	<input type="checkbox"/>	<input type="checkbox"/>	
	• Pedestals feature locks on inside panels	84 x 36 x 29-1/2"	KSPR8436A.E	<input type="checkbox"/>	<input type="checkbox"/>	<input type="checkbox"/>	<input type="checkbox"/>	<input type="checkbox"/>	
• 84" desks have center support panel									
 <p>AESPD</p>	<b>Single Pedestal Desk-Right, Box/Box/File Option B</b>	48 x 30 x 29-1/2"	KSPR4830B.E	<input type="checkbox"/>	<input type="checkbox"/>	<input type="checkbox"/>	<input type="checkbox"/>	<input type="checkbox"/>	
	• 1-1/2" top with choice of three edge styles	54 x 30 x 29-1/2"	KSPR5430B.E	<input type="checkbox"/>	<input type="checkbox"/>	<input type="checkbox"/>	<input type="checkbox"/>	<input type="checkbox"/>	
	• Box/box/file pedestal on right	60 x 30 x 29-1/2"	KSPR6030B.E	<input type="checkbox"/>	<input type="checkbox"/>	<input type="checkbox"/>	<input type="checkbox"/>	<input type="checkbox"/>	
	• Full height modesty panel recessed	66 x 30 x 29-1/2"	KSPR6630B.E	<input type="checkbox"/>	<input type="checkbox"/>	<input type="checkbox"/>	<input type="checkbox"/>	<input type="checkbox"/>	
	• 2-1/2" for 30" deep desks and 8-3/4" for 36" deep desks	72 x 30 x 29-1/2"	KSPR7230B.E	<input type="checkbox"/>	<input type="checkbox"/>	<input type="checkbox"/>	<input type="checkbox"/>	<input type="checkbox"/>	
	• Grommets not offered	72 x 36 x 29-1/2"	KSPR7236B.E	<input type="checkbox"/>	<input type="checkbox"/>	<input type="checkbox"/>	<input type="checkbox"/>	<input type="checkbox"/>	
	• Pedestals feature locks on inside panels	84 x 36 x 29-1/2"	KSPR8436B.E	<input type="checkbox"/>	<input type="checkbox"/>	<input type="checkbox"/>	<input type="checkbox"/>	<input type="checkbox"/>	
• Upper box drawer is non-locking									
• 84" desks have center support panel									
 <p>AESPD</p>	<b>Single Pedestal Desk-Right, File/File Option C</b>	48 x 30 x 29-1/2"	KSPR4830C.E	<input type="checkbox"/>	<input type="checkbox"/>	<input type="checkbox"/>	<input type="checkbox"/>	<input type="checkbox"/>	
	• 1-1/2" top with choice of three edge styles	54 x 30 x 29-1/2"	KSPR5430C.E	<input type="checkbox"/>	<input type="checkbox"/>	<input type="checkbox"/>	<input type="checkbox"/>	<input type="checkbox"/>	
	• File/file pedestal on right	60 x 30 x 29-1/2"	KSPR6030C.E	<input type="checkbox"/>	<input type="checkbox"/>	<input type="checkbox"/>	<input type="checkbox"/>	<input type="checkbox"/>	
	• Full height modesty panel recessed	66 x 30 x 29-1/2"	KSPR6630C.E	<input type="checkbox"/>	<input type="checkbox"/>	<input type="checkbox"/>	<input type="checkbox"/>	<input type="checkbox"/>	
	• 2-1/2" for 30" deep desks and 8-3/4" for 36" deep desks	72 x 30 x 29-1/2"	KSPR7230C.E	<input type="checkbox"/>	<input type="checkbox"/>	<input type="checkbox"/>	<input type="checkbox"/>	<input type="checkbox"/>	
	• Grommets not offered	72 x 36 x 29-1/2"	KSPR7236C.E	<input type="checkbox"/>	<input type="checkbox"/>	<input type="checkbox"/>	<input type="checkbox"/>	<input type="checkbox"/>	
	• Pedestals feature locks on inside panels	84 x 36 x 29-1/2"	KSPR8436C.E	<input type="checkbox"/>	<input type="checkbox"/>	<input type="checkbox"/>	<input type="checkbox"/>	<input type="checkbox"/>	
• 84" desks have center support panel									

**A**      **B**      **C**      **D**      **E**      **F**      **G**

## HOW TO ORDER

Indicate the following information on order form:

- Quantity of each item.
- Model number, including options. See "How To Build a Model Number".
- Any special service required.

Note: • The  indicates that a choice is required.

- The absence of the  indicates that no choice is required.
- Alpha-numeric characters in place of  indicate that no other alternatives are available.

## HOW TO BUILD A MODEL NUMBER

**A** Select basic model.

**B** Select edge style.

- F** - Flat edge
- P3** - Three wave profile edge
- P4** - Four wave profile edge

**C** Select horizontal surface finish.

Refer to color addendum at ki.com or KI Fabrics & Finishes binder.

**D** Select vertical surface finish.

Refer to color addendum at ki.com or KI Fabrics & Finishes binder.

**E** Select end panel option.

- CGL** - Recessed end panel left side
- FULL** - Full end panel both sides

**F** Select pull option.

- BPA2** - Silver bar pull (2)
- BPA3** - Silver bar pull (3)
- KIB2** - Waterfall black pull (2)

**KIB3** - Waterfall black pull (3)

**KIS2** - Waterfall silver pull (2)

**KIS3** - Waterfall silver pull (3)

**RCP2** - Rectangular silver pull (2)

**RCP3** - Rectangular silver pull (3)

**G** Select lock option.

**KA** - Key alike

**KS** - Key standard



# Aristotle® Executive Pedestal Desks

Single Pedestal Desks-Pedestal on Right

Approx.  
Packaged  
Weight

Delivered  
Pricing

190.0#	\$ 1200
200.0#	1244
215.0#	1307
225.0#	1395
240.0#	1489
250.0#	1541
265.0#	1572

220.0#	\$ 1395
230.0#	1423
245.0#	1500
255.0#	1590
270.0#	1667
280.0#	1733
295.0#	1788

220.0#	\$ 1395
230.0#	1423
245.0#	1500
255.0#	1590
270.0#	1667
280.0#	1733
295.0#	1788

**SPECIAL SERVICES**

**Special Carton Marking**

With specially marked information N/C

**Shipping**

Shipped **assembled freight prepaid f.o.b. KI-Aristotle Brampton, Ontario L6T 5T6** factory. Freight class #85.

Specifications and prices are subject to change without prior notice.

# Aristotle® Executive Pedestal Desks

Bow Front Single Pedestal Desks-Pedestal on Right

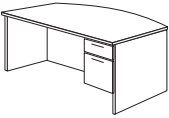
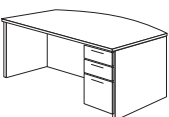
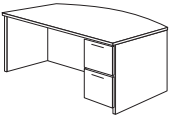
			MODEL NUMBER						Approx. Packaged Weight
MODEL	W x D x H	Basic Model	Edge Style	Horizontal Surface Finish	Vertical Surface Finish	Pull Option	Lock Option		
 <p>AEPED</p>	<b>Bow Front Single Pedestal Desk-Right, Box/File Option A</b> • 1-1/2" top with choice of three edge styles • Box/file pedestal on right • Full height modesty panel recessed 8-3/4" for 36" deep desks and 14-3/4" for 42" deep desks • Grommets not offered • Pedestals feature locks on inside panels • 84" desks have center support panel	66 x 36 x 29-1/2"	KBSPR6636A.E	<input type="checkbox"/>	<input type="checkbox"/>	<input type="checkbox"/>	<input type="checkbox"/>	<input type="checkbox"/>	240.0#
		72 x 42 x 29-1/2"	KBSPR7242A.E	<input type="checkbox"/>	<input type="checkbox"/>	<input type="checkbox"/>	<input type="checkbox"/>	<input type="checkbox"/>	265.0#
		84 x 42 x 29-1/2"	KBSPR8442A.E	<input type="checkbox"/>	<input type="checkbox"/>	<input type="checkbox"/>	<input type="checkbox"/>	<input type="checkbox"/>	280.0#
 <p>AEPED</p>	<b>Bow Front Single Pedestal Desk-Right, Box/Box/File Option B</b> • 1-1/2" top with choice of three edge styles • Box/box/file pedestal on right • Full height modesty panel recessed 8-3/4" for 36" deep desks and 14-3/4" for 42" deep desks • Grommets not offered • Pedestals feature locks on inside panels • Upper box drawer is non-locking • 84" desks have center support panel	66 x 36 x 29-1/2"	KBSPR6636B.E	<input type="checkbox"/>	<input type="checkbox"/>	<input type="checkbox"/>	<input type="checkbox"/>	<input type="checkbox"/>	270.0#
		72 x 42 x 29-1/2"	KBSPR7242B.E	<input type="checkbox"/>	<input type="checkbox"/>	<input type="checkbox"/>	<input type="checkbox"/>	<input type="checkbox"/>	295.0#
		84 x 42 x 29-1/2"	KBSPR8442B.E	<input type="checkbox"/>	<input type="checkbox"/>	<input type="checkbox"/>	<input type="checkbox"/>	<input type="checkbox"/>	310.0#
 <p>AEPED</p>	<b>Bow Front Single Pedestal Desk-Right, File/File Option C</b> • 1-1/2" top with choice of three edge styles • File/file pedestal on right • Full height modesty panel recessed 8-3/4" for 36" deep desks and 14-3/4" for 42" deep desks • Grommets not offered • Pedestals feature locks on inside panels • 84" desks have center support panel	66 x 36 x 29-1/2"	KBSPR6636C.E	<input type="checkbox"/>	<input type="checkbox"/>	<input type="checkbox"/>	<input type="checkbox"/>	<input type="checkbox"/>	270.0#
		72 x 42 x 29-1/2"	KBSPR7242C.E	<input type="checkbox"/>	<input type="checkbox"/>	<input type="checkbox"/>	<input type="checkbox"/>	<input type="checkbox"/>	295.0#
		84 x 42 x 29-1/2"	KBSPR8442C.E	<input type="checkbox"/>	<input type="checkbox"/>	<input type="checkbox"/>	<input type="checkbox"/>	<input type="checkbox"/>	310.0#

**A**      **B**      **C**      **D**      **E**      **F**

## HOW TO ORDER

Indicate the following information on order form:

- Quantity of each item.
- Model number, including options. See "How To Build a Model Number".
- Any special service required.

Note: • The  indicates that a choice is required.  
 • The absence of the  indicates that no choice is required.  
 • Alpha-numeric characters in place of  indicate that no other alternatives are available.

## HOW TO BUILD A MODEL NUMBER

- A** Select basic model.
- B** Select edge style.
 

<b>F</b>	- Flat edge
<b>P3</b>	- Three wave profile edge
<b>P4</b>	- Four wave profile edge
- C** Select horizontal surface finish.  
Refer to color addendum at ki.com or KI Fabrics & Finishes binder.
- D** Select vertical surface finish.  
Refer to color addendum at ki.com or KI Fabrics & Finishes binder.
- E** Select pull option.
 

<b>BPA2</b>	- Silver bar pull (2)
<b>BPA3</b>	- Silver bar pull (3)
<b>KIB2</b>	- Waterfall black pull (2)
<b>KIB3</b>	- Waterfall black pull (3)
<b>KIS2</b>	- Waterfall silver pull (2)
<b>KIS3</b>	- Waterfall silver pull (3)

- RCP2** - Rectangular silver pull (2)
- RCP3** - Rectangular silver pull (3)
- F** Select lock option.
 

<b>KA</b>	- Key alike
<b>KS</b>	- Key standard



# Aristotle® Executive Pedestal Desks

Bow Front Single Pedestal Desks-Pedestal on Right

Delivered  
Pricing

\$ 1719  
1771  
1823

\$ 1897  
1955  
2014

\$ 1897  
1955  
2014

**SPECIAL SERVICES**

**Special Carton Marking**

With specially marked information N/C

**Shipping**

Shipped **assembled freight prepaid f.o.b. KI-Aristotle Brampton, Ontario L6T 5T6** factory. Freight class #85.

Specifications and prices are subject to change without prior notice.

# Aristotle® Executive Desks

Bow Front Desks-Straight Cutaway

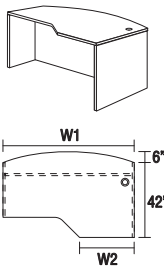
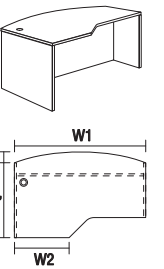
MODEL	W1 x W2 x D x H	MODEL NUMBER				Approx. Packaged Weight
		Basic Model	Edge Style	Horizontal Surface Finish	Vertical Surface Finish	
 <p><b>Bow Front Desk-Extended Left, Straight Cutaway</b></p> <ul style="list-style-type: none"> <li>• 1-1/2" top with choice of three edge styles</li> <li>• Straight cutaway</li> <li>• Bow front extends 6" on visitor side</li> <li>• Full height modesty panel is inset 14-1/4"</li> <li>• Accommodates full height or mobile pedestal, specified separately</li> <li>• Grommet included</li> </ul>	66 x 20 x 48 x 29-1/2"	KECDS6620L.E	<input type="checkbox"/>	<input type="checkbox"/>	<input type="checkbox"/>	200.0#
	66 x 24 x 48 x 29-1/2"	KECDS6624L.E	<input type="checkbox"/>	<input type="checkbox"/>	<input type="checkbox"/>	200.0#
	66 x 30 x 48 x 29-1/2"	KECDS6630L.E	<input type="checkbox"/>	<input type="checkbox"/>	<input type="checkbox"/>	200.0#
	72 x 20 x 48 x 29-1/2"	KECDS7220L.E	<input type="checkbox"/>	<input type="checkbox"/>	<input type="checkbox"/>	215.0#
	72 x 24 x 48 x 29-1/2"	KECDS7224L.E	<input type="checkbox"/>	<input type="checkbox"/>	<input type="checkbox"/>	215.0#
	72 x 30 x 48 x 29-1/2"	KECDS7230L.E	<input type="checkbox"/>	<input type="checkbox"/>	<input type="checkbox"/>	215.0#
	78 x 20 x 48 x 29-1/2"	KECDS7820L.E	<input type="checkbox"/>	<input type="checkbox"/>	<input type="checkbox"/>	231.0#
	78 x 24 x 48 x 29-1/2"	KECDS7824L.E	<input type="checkbox"/>	<input type="checkbox"/>	<input type="checkbox"/>	231.0#
	78 x 30 x 48 x 29-1/2"	KECDS7830L.E	<input type="checkbox"/>	<input type="checkbox"/>	<input type="checkbox"/>	231.0#
AEPED						
 <p><b>Bow Front Desk-Extended Right, Straight Cutaway</b></p> <ul style="list-style-type: none"> <li>• 1-1/2" top with choice of three edge styles</li> <li>• Straight cutaway</li> <li>• Bow front extends 6" on visitor side</li> <li>• Full height modesty panel is inset 14-1/4"</li> <li>• Accommodates full height or mobile pedestal, specified separately</li> <li>• Grommet included</li> </ul>	66 x 20 x 48 x 29-1/2"	KECDS6620R.E	<input type="checkbox"/>	<input type="checkbox"/>	<input type="checkbox"/>	200.0#
	66 x 24 x 48 x 29-1/2"	KECDS6624R.E	<input type="checkbox"/>	<input type="checkbox"/>	<input type="checkbox"/>	200.0#
	66 x 30 x 48 x 29-1/2"	KECDS6630R.E	<input type="checkbox"/>	<input type="checkbox"/>	<input type="checkbox"/>	200.0#
	72 x 20 x 48 x 29-1/2"	KECDS7220R.E	<input type="checkbox"/>	<input type="checkbox"/>	<input type="checkbox"/>	215.0#
	72 x 24 x 48 x 29-1/2"	KECDS7224R.E	<input type="checkbox"/>	<input type="checkbox"/>	<input type="checkbox"/>	215.0#
	72 x 30 x 48 x 29-1/2"	KECDS7230R.E	<input type="checkbox"/>	<input type="checkbox"/>	<input type="checkbox"/>	215.0#
	78 x 20 x 48 x 29-1/2"	KECDS7820R.E	<input type="checkbox"/>	<input type="checkbox"/>	<input type="checkbox"/>	231.0#
	78 x 24 x 48 x 29-1/2"	KECDS7824R.E	<input type="checkbox"/>	<input type="checkbox"/>	<input type="checkbox"/>	231.0#
	78 x 30 x 48 x 29-1/2"	KECDS7830R.E	<input type="checkbox"/>	<input type="checkbox"/>	<input type="checkbox"/>	231.0#
AEPED						

**A      B      C      D**

## HOW TO ORDER

Indicate the following information on order form:

1. Quantity of each item.
2. Model number, including options. See "How To Build a Model Number".
3. Any special service required.

Note:

- The  indicates that a choice is required.
- The absence of the  indicates that no choice is required.
- Alpha-numeric characters in place of  indicate that no other alternatives are available.

## HOW TO BUILD A MODEL NUMBER

- A** Select basic model.
- B** Select edge style.
 

<b>F</b>	- Flat edge
<b>P3</b>	- Three wave profile edge
<b>P4</b>	- Four wave profile edge
- C** Select horizontal surface finish.  
Refer to color addendum at [ki.com](http://ki.com) or KI Fabrics & Finishes binder.
- D** Select vertical surface finish.  
Refer to color addendum at [ki.com](http://ki.com) or KI Fabrics & Finishes binder.





# Aristotle® Executive Desks

Bow Front Desks-Straight Cutaway

## Delivered Pricing

\$ 1621  
1621  
1621  
1676  
1676  
1676  
1726  
1726  
1726

\$ 1621  
1621  
1621  
1676  
1676  
1676  
1726  
1726  
1726

### SPECIAL SERVICES

#### Special Carton Marking

With specially marked information N/C

#### Shipping

Shipped k.d. freight prepaid f.o.b.  
KI-Aristotle Brampton, Ontario L6T 5T6  
factory. Freight class #85.

Specifications and prices are subject to  
change without prior notice.

# Aristotle® Executive Desks

Bow Front Desks-Curved Cutaway

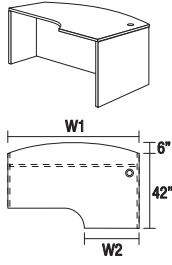
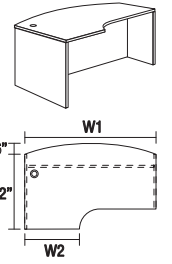
MODEL	W1 x W2 x D x H	MODEL NUMBER				Approx. Packaged Weight
		Basic Model	Edge Style	Horizontal Surface Finish	Vertical Surface Finish	
 <p><b>Bow Front Desk-Extended Left, Curved Cutaway</b></p> <ul style="list-style-type: none"> <li>• 1-1/2" top with choice of three edge styles</li> <li>• Curved cutaway</li> <li>• Bow front extends 6" on visitor side</li> <li>• Full height modesty panel is inset 14-1/4"</li> <li>• Accommodates full height or mobile pedestal, specified separately</li> <li>• Grommet included</li> </ul>	66 x 20 x 48 x 29-1/2"	KECDC6620L.E	<input type="checkbox"/>	<input type="checkbox"/>	<input type="checkbox"/>	200.0#
	66 x 24 x 48 x 29-1/2"	KECDC6624L.E	<input type="checkbox"/>	<input type="checkbox"/>	<input type="checkbox"/>	200.0#
	66 x 30 x 48 x 29-1/2"	KECDC6630L.E	<input type="checkbox"/>	<input type="checkbox"/>	<input type="checkbox"/>	200.0#
	72 x 20 x 48 x 29-1/2"	KECDC7220L.E	<input type="checkbox"/>	<input type="checkbox"/>	<input type="checkbox"/>	215.0#
	72 x 24 x 48 x 29-1/2"	KECDC7224L.E	<input type="checkbox"/>	<input type="checkbox"/>	<input type="checkbox"/>	215.0#
	72 x 30 x 48 x 29-1/2"	KECDC7230L.E	<input type="checkbox"/>	<input type="checkbox"/>	<input type="checkbox"/>	215.0#
	78 x 20 x 48 x 29-1/2"	KECDC7820L.E	<input type="checkbox"/>	<input type="checkbox"/>	<input type="checkbox"/>	231.0#
	78 x 24 x 48 x 29-1/2"	KECDC7824L.E	<input type="checkbox"/>	<input type="checkbox"/>	<input type="checkbox"/>	231.0#
	78 x 30 x 48 x 29-1/2"	KECDC7830L.E	<input type="checkbox"/>	<input type="checkbox"/>	<input type="checkbox"/>	231.0#
	AEPED					
 <p><b>Bow Front Desk-Extended Right, Curved Cutaway</b></p> <ul style="list-style-type: none"> <li>• 1-1/2" top with choice of three edge styles</li> <li>• Curved cutaway</li> <li>• Bow front extends 6" on visitor side</li> <li>• Full height modesty panel is inset 14-1/4"</li> <li>• Accommodates full height or mobile pedestal, specified separately</li> <li>• Grommet included</li> </ul>	66 x 20 x 48 x 29-1/2"	KECDC6620R.E	<input type="checkbox"/>	<input type="checkbox"/>	<input type="checkbox"/>	200.0#
	66 x 24 x 48 x 29-1/2"	KECDC6624R.E	<input type="checkbox"/>	<input type="checkbox"/>	<input type="checkbox"/>	200.0#
	66 x 30 x 48 x 29-1/2"	KECDC6630R.E	<input type="checkbox"/>	<input type="checkbox"/>	<input type="checkbox"/>	200.0#
	72 x 20 x 48 x 29-1/2"	KECDC7220R.E	<input type="checkbox"/>	<input type="checkbox"/>	<input type="checkbox"/>	215.0#
	72 x 24 x 48 x 29-1/2"	KECDC7224R.E	<input type="checkbox"/>	<input type="checkbox"/>	<input type="checkbox"/>	215.0#
	72 x 30 x 48 x 29-1/2"	KECDC7230R.E	<input type="checkbox"/>	<input type="checkbox"/>	<input type="checkbox"/>	215.0#
	78 x 20 x 48 x 29-1/2"	KECDC7820R.E	<input type="checkbox"/>	<input type="checkbox"/>	<input type="checkbox"/>	231.0#
	78 x 24 x 48 x 29-1/2"	KECDC7824R.E	<input type="checkbox"/>	<input type="checkbox"/>	<input type="checkbox"/>	231.0#
	78 x 30 x 48 x 29-1/2"	KECDC7830R.E	<input type="checkbox"/>	<input type="checkbox"/>	<input type="checkbox"/>	231.0#
	AEPED					

**A      B      C      D**

## HOW TO ORDER

Indicate the following information on order form:

1. Quantity of each item.
2. Model number, including options. See "How To Build a Model Number".
3. Any special service required.

Note:

- The  indicates that a choice is required.
- The absence of the  indicates that no choice is required.
- Alpha-numeric characters in place of  indicate that no other alternatives are available.

## HOW TO BUILD A MODEL NUMBER

- A** Select basic model.
- B** Select edge style.
 

<b>F</b>	- Flat edge
<b>P3</b>	- Three wave profile edge
<b>P4</b>	- Four wave profile edge
- C** Select horizontal surface finish.  
Refer to color addendum at [ki.com](http://ki.com) or KI Fabrics & Finishes binder.
- D** Select vertical surface finish.  
Refer to color addendum at [ki.com](http://ki.com) or KI Fabrics & Finishes binder.



# Aristotle® Executive Desks

Bow Front Desks-Curved Cutaway

Delivered Pricing

\$ 1621
1621
1621
1676
1676
1676
1726
1726
1726

\$ 1621
1621
1621
1676
1676
1676
1726
1726
1726

**SPECIAL SERVICES**

**Special Carton Marking**

With specially marked information N/C

**Shipping**

Shipped k.d. freight prepaid f.o.b.  
KI-Aristotle Brampton, Ontario L6T 5T6  
factory. Freight class #85.

Specifications and prices are subject to  
change without prior notice.

# Aristotle® Executive Desks

P-Top Desks-Straight Cutaway

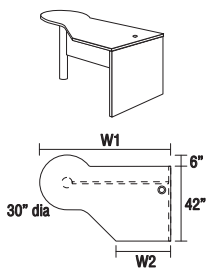
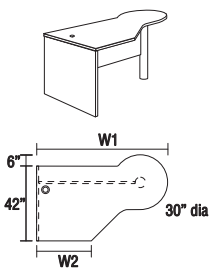
		MODEL NUMBER					
MODEL	W1 x W2 x D x H	Basic Model	Edge Style	Horizontal Surface Finish	Vertical Surface Finish	Leg Finish	Modesty Panel
 <p><b>P-Top Desk-Extended Left, Straight Cutaway</b></p> <ul style="list-style-type: none"> <li>• 1-1/2" top with choice of three edge styles</li> <li>• Straight cutaway</li> <li>• Modesty panel is 14" standard; full modesty panel available with upcharge</li> <li>• 6" diameter post leg</li> <li>• Grommet included</li> </ul>	66 x 20 x 48 x 29-1/2"	KPTCS6620L.E	<input type="checkbox"/>	<input type="checkbox"/>	<input type="checkbox"/>	<input type="checkbox"/>	<input type="checkbox"/>
	66 x 24 x 48 x 29-1/2"	KPTCS6624L.E	<input type="checkbox"/>	<input type="checkbox"/>	<input type="checkbox"/>	<input type="checkbox"/>	<input type="checkbox"/>
	66 x 30 x 48 x 29-1/2"	KPTCS6630L.E	<input type="checkbox"/>	<input type="checkbox"/>	<input type="checkbox"/>	<input type="checkbox"/>	<input type="checkbox"/>
	72 x 20 x 48 x 29-1/2"	KPTCS7220L.E	<input type="checkbox"/>	<input type="checkbox"/>	<input type="checkbox"/>	<input type="checkbox"/>	<input type="checkbox"/>
	72 x 24 x 48 x 29-1/2"	KPTCS7224L.E	<input type="checkbox"/>	<input type="checkbox"/>	<input type="checkbox"/>	<input type="checkbox"/>	<input type="checkbox"/>
	72 x 30 x 48 x 29-1/2"	KPTCS7230L.E	<input type="checkbox"/>	<input type="checkbox"/>	<input type="checkbox"/>	<input type="checkbox"/>	<input type="checkbox"/>
	78 x 20 x 48 x 29-1/2"	KPTCS7820L.E	<input type="checkbox"/>	<input type="checkbox"/>	<input type="checkbox"/>	<input type="checkbox"/>	<input type="checkbox"/>
	78 x 24 x 48 x 29-1/2"	KPTCS7824L.E	<input type="checkbox"/>	<input type="checkbox"/>	<input type="checkbox"/>	<input type="checkbox"/>	<input type="checkbox"/>
	78 x 30 x 48 x 29-1/2"	KPTCS7830L.E	<input type="checkbox"/>	<input type="checkbox"/>	<input type="checkbox"/>	<input type="checkbox"/>	<input type="checkbox"/>
AESPD							
 <p><b>P-Top Desk-Extended Right, Straight Cutaway</b></p> <ul style="list-style-type: none"> <li>• 1-1/2" top with choice of three edge styles</li> <li>• Straight cutaway</li> <li>• Modesty panel is 14" standard; full modesty panel available with upcharge</li> <li>• 6" diameter post leg</li> <li>• Grommet included</li> </ul>	66 x 20 x 48 x 29-1/2"	KPTCS6620R.E	<input type="checkbox"/>	<input type="checkbox"/>	<input type="checkbox"/>	<input type="checkbox"/>	<input type="checkbox"/>
	66 x 24 x 48 x 29-1/2"	KPTCS6624R.E	<input type="checkbox"/>	<input type="checkbox"/>	<input type="checkbox"/>	<input type="checkbox"/>	<input type="checkbox"/>
	66 x 30 x 48 x 29-1/2"	KPTCS6630R.E	<input type="checkbox"/>	<input type="checkbox"/>	<input type="checkbox"/>	<input type="checkbox"/>	<input type="checkbox"/>
	72 x 20 x 48 x 29-1/2"	KPTCS7220R.E	<input type="checkbox"/>	<input type="checkbox"/>	<input type="checkbox"/>	<input type="checkbox"/>	<input type="checkbox"/>
	72 x 24 x 48 x 29-1/2"	KPTCS7224R.E	<input type="checkbox"/>	<input type="checkbox"/>	<input type="checkbox"/>	<input type="checkbox"/>	<input type="checkbox"/>
	72 x 30 x 48 x 29-1/2"	KPTCS7230R.E	<input type="checkbox"/>	<input type="checkbox"/>	<input type="checkbox"/>	<input type="checkbox"/>	<input type="checkbox"/>
	78 x 20 x 48 x 29-1/2"	KPTCS7820R.E	<input type="checkbox"/>	<input type="checkbox"/>	<input type="checkbox"/>	<input type="checkbox"/>	<input type="checkbox"/>
	78 x 24 x 48 x 29-1/2"	KPTCS7824R.E	<input type="checkbox"/>	<input type="checkbox"/>	<input type="checkbox"/>	<input type="checkbox"/>	<input type="checkbox"/>
	78 x 30 x 48 x 29-1/2"	KPTCS7830R.E	<input type="checkbox"/>	<input type="checkbox"/>	<input type="checkbox"/>	<input type="checkbox"/>	<input type="checkbox"/>
AESPD							

**A**   **B**   **C**   **D**   **E**   **F**

## HOW TO ORDER

Indicate the following information on order form:

1. Quantity of each item.
2. Model number, including options. See "How To Build a Model Number".
3. Any special service required.

Note:

- The  indicates that a choice is required.
- The absence of the  indicates that no choice is required.
- Alpha-numeric characters in place of  indicate that no other alternatives are available.

## HOW TO BUILD A MODEL NUMBER

- A** Select basic model.
- B** Select edge style.
 

<b>F</b>	- Flat edge
<b>P3</b>	- Three wave profile edge
<b>P4</b>	- Four wave profile edge
- C** Select horizontal surface finish.  
Refer to color addendum at ki.com or KI Fabrics & Finishes binder.
- D** Select vertical surface finish.  
Refer to color addendum at ki.com or KI Fabrics & Finishes binder.
- E** Select leg finish.  
Refer to color addendum at ki.com or KI Fabrics & Finishes binder.
- F** Select modesty panel.
 

<b>PMP</b>	- 14" partial modesty panel (standard)
<b>FMP</b>	- Full height modesty panel; add \$70



# Aristotle® Executive Desks

P-Top Desks-Straight Cutaway

Approx.  
Packaged  
Weight

Delivered  
Pricing

158.0#	\$ 1806
158.0#	1806
158.0#	1806
170.0#	1854
170.0#	1854
170.0#	1854
183.0#	1911
183.0#	1911
183.0#	1911

158.0#	\$ 1806
158.0#	1806
158.0#	1806
170.0#	1854
170.0#	1854
170.0#	1854
183.0#	1911
183.0#	1911
183.0#	1911

### SPECIAL SERVICES

#### Special Carton Marking

With specially marked information N/C

#### Shipping

Shipped k.d. freight prepaid f.o.b.  
KI-Aristotle Brampton, Ontario L6T 5T6  
factory. Freight class #85.

Specifications and prices are subject to  
change without prior notice.

# Aristotle® Executive Desks

P-Top Desks-Curved Cutaway

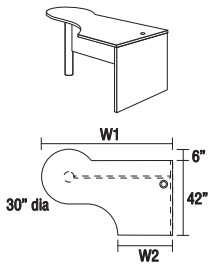
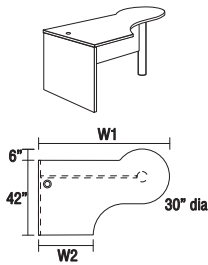
MODEL		W1 x W2 x D x H		MODEL NUMBER												
				Basic Model	Edge Style	Horizontal Surface Finish	Vertical Surface Finish	Leg Finish	Modesty Panel							
 <p><b>P-Top Desk-Extended Left, Curved Cutaway</b></p> <ul style="list-style-type: none"> <li>• 1-1/2" top with choice of three edge styles</li> <li>• Curved cutaway</li> <li>• Modesty panel is 14" standard; full modesty panel available with upcharge</li> <li>• 6" diameter post leg</li> <li>• Grommet included</li> </ul>	66 x 20 x 48 x 29-1/2"	66 x 24 x 48 x 29-1/2"	66 x 30 x 48 x 29-1/2"	72 x 20 x 48 x 29-1/2"	72 x 24 x 48 x 29-1/2"	72 x 30 x 48 x 29-1/2"	78 x 20 x 48 x 29-1/2"	78 x 24 x 48 x 29-1/2"	78 x 30 x 48 x 29-1/2"	KPTCC6620L.E	<input type="checkbox"/>	<input type="checkbox"/>	<input type="checkbox"/>	<input type="checkbox"/>	<input type="checkbox"/>	<input type="checkbox"/>
										KPTCC6624L.E	<input type="checkbox"/>	<input type="checkbox"/>	<input type="checkbox"/>	<input type="checkbox"/>	<input type="checkbox"/>	<input type="checkbox"/>
										KPTCC6630L.E	<input type="checkbox"/>	<input type="checkbox"/>	<input type="checkbox"/>	<input type="checkbox"/>	<input type="checkbox"/>	<input type="checkbox"/>
										KPTCC7220L.E	<input type="checkbox"/>	<input type="checkbox"/>	<input type="checkbox"/>	<input type="checkbox"/>	<input type="checkbox"/>	<input type="checkbox"/>
										KPTCC7224L.E	<input type="checkbox"/>	<input type="checkbox"/>	<input type="checkbox"/>	<input type="checkbox"/>	<input type="checkbox"/>	<input type="checkbox"/>
										KPTCC7230L.E	<input type="checkbox"/>	<input type="checkbox"/>	<input type="checkbox"/>	<input type="checkbox"/>	<input type="checkbox"/>	<input type="checkbox"/>
										KPTCC7820L.E	<input type="checkbox"/>	<input type="checkbox"/>	<input type="checkbox"/>	<input type="checkbox"/>	<input type="checkbox"/>	<input type="checkbox"/>
										KPTCC7824L.E	<input type="checkbox"/>	<input type="checkbox"/>	<input type="checkbox"/>	<input type="checkbox"/>	<input type="checkbox"/>	<input type="checkbox"/>
										KPTCC7830L.E	<input type="checkbox"/>	<input type="checkbox"/>	<input type="checkbox"/>	<input type="checkbox"/>	<input type="checkbox"/>	<input type="checkbox"/>
	AESPD															
 <p><b>P-Top Desk-Extended Right, Curved Cutaway</b></p> <ul style="list-style-type: none"> <li>• 1-1/2" top with choice of three edge styles</li> <li>• Curved cutaway</li> <li>• Modesty panel is 14" standard; full modesty panel available with upcharge</li> <li>• 6" diameter post leg</li> <li>• Grommet included</li> </ul>	66 x 20 x 48 x 29-1/2"	66 x 24 x 48 x 29-1/2"	66 x 30 x 48 x 29-1/2"	72 x 20 x 48 x 29-1/2"	72 x 24 x 48 x 29-1/2"	72 x 30 x 48 x 29-1/2"	78 x 20 x 48 x 29-1/2"	78 x 24 x 48 x 29-1/2"	78 x 30 x 48 x 29-1/2"	KPTCC6620R.E	<input type="checkbox"/>	<input type="checkbox"/>	<input type="checkbox"/>	<input type="checkbox"/>	<input type="checkbox"/>	<input type="checkbox"/>
										KPTCC6624R.E	<input type="checkbox"/>	<input type="checkbox"/>	<input type="checkbox"/>	<input type="checkbox"/>	<input type="checkbox"/>	<input type="checkbox"/>
										KPTCC6630R.E	<input type="checkbox"/>	<input type="checkbox"/>	<input type="checkbox"/>	<input type="checkbox"/>	<input type="checkbox"/>	<input type="checkbox"/>
										KPTCC7220R.E	<input type="checkbox"/>	<input type="checkbox"/>	<input type="checkbox"/>	<input type="checkbox"/>	<input type="checkbox"/>	<input type="checkbox"/>
										KPTCC7224R.E	<input type="checkbox"/>	<input type="checkbox"/>	<input type="checkbox"/>	<input type="checkbox"/>	<input type="checkbox"/>	<input type="checkbox"/>
										KPTCC7230R.E	<input type="checkbox"/>	<input type="checkbox"/>	<input type="checkbox"/>	<input type="checkbox"/>	<input type="checkbox"/>	<input type="checkbox"/>
										KPTCC7820R.E	<input type="checkbox"/>	<input type="checkbox"/>	<input type="checkbox"/>	<input type="checkbox"/>	<input type="checkbox"/>	<input type="checkbox"/>
										KPTCC7824R.E	<input type="checkbox"/>	<input type="checkbox"/>	<input type="checkbox"/>	<input type="checkbox"/>	<input type="checkbox"/>	<input type="checkbox"/>
										KPTCC7830R.E	<input type="checkbox"/>	<input type="checkbox"/>	<input type="checkbox"/>	<input type="checkbox"/>	<input type="checkbox"/>	<input type="checkbox"/>
	AESPD															

**A**   **B**   **C**   **D**   **E**   **F**

## HOW TO ORDER

Indicate the following information on order form:

1. Quantity of each item.
2. Model number, including options. See "How To Build a Model Number".
3. Any special service required.

Note: • The  indicates that a choice is required.  
 • The absence of the  indicates that no choice is required.  
 • Alpha-numeric characters in place of  indicate that no other alternatives are available.

## HOW TO BUILD A MODEL NUMBER

- A** Select basic model.
- B** Select edge style.
 

<b>F</b>	- Flat edge
<b>P3</b>	- Three wave profile edge
<b>P4</b>	- Four wave profile edge
- C** Select horizontal surface finish.  
Refer to color addendum at ki.com or KI Fabrics & Finishes binder.
- D** Select vertical surface finish.  
Refer to color addendum at ki.com or KI Fabrics & Finishes binder.
- E** Select leg finish.  
Refer to color addendum at ki.com or KI Fabrics & Finishes binder.
- F** Select modesty panel.
 

<b>PMP</b>	- 14" partial modesty panel (standard)
<b>FMP</b>	- Full height modesty panel; add \$70



Approx.  
Packaged  
Weight

Delivered  
Pricing

158.0#	\$ 1806
158.0#	1806
158.0#	1806
170.0#	1854
170.0#	1854
170.0#	1854
183.0#	1911
183.0#	1911
183.0#	1911

158.0#	\$ 1806
158.0#	1806
158.0#	1806
170.0#	1854
170.0#	1854
170.0#	1854
183.0#	1911
183.0#	1911
183.0#	1911

**SPECIAL SERVICES**

**Special Carton Marking**

With specially marked information N/C

**Shipping**

Shipped k.d. freight prepaid f.o.b.  
KI-Aristotle Brampton, Ontario L6T 5T6  
factory. Freight class #85.

Specifications and prices are subject to  
change without prior notice.

# Aristotle® Executive Desks

D-Top Desks-Straight Cutaway

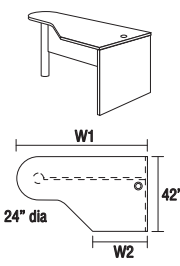
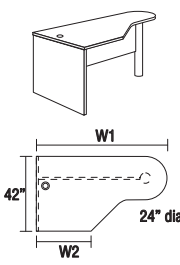
MODEL		W1 x W2 x D x H	MODEL NUMBER					
			Basic Model	Edge Style	Horizontal Surface Finish	Vertical Surface Finish	Leg Finish	Modesty Panel
 <p><b>D-Top Desk-24" Extended Left, Straight Cutaway</b></p> <ul style="list-style-type: none"> <li>• 1-1/2" top with choice of three edge styles</li> <li>• Straight cutaway</li> <li>• Modesty panel is 14" standard; full modesty panel available with upcharge</li> <li>• 6" diameter post leg</li> <li>• Grommet included</li> </ul>	66 x 20 x 42 x 29-1/2"	KDTCS662420L.E	<input type="checkbox"/>	<input type="checkbox"/>	<input type="checkbox"/>	<input type="checkbox"/>	<input type="checkbox"/>	
	66 x 24 x 42 x 29-1/2"	KDTCS662424L.E	<input type="checkbox"/>	<input type="checkbox"/>	<input type="checkbox"/>	<input type="checkbox"/>	<input type="checkbox"/>	
	66 x 30 x 42 x 29-1/2"	KDTCS662430L.E	<input type="checkbox"/>	<input type="checkbox"/>	<input type="checkbox"/>	<input type="checkbox"/>	<input type="checkbox"/>	
	72 x 20 x 42 x 29-1/2"	KDTCS722420L.E	<input type="checkbox"/>	<input type="checkbox"/>	<input type="checkbox"/>	<input type="checkbox"/>	<input type="checkbox"/>	
	72 x 24 x 42 x 29-1/2"	KDTCS722424L.E	<input type="checkbox"/>	<input type="checkbox"/>	<input type="checkbox"/>	<input type="checkbox"/>	<input type="checkbox"/>	
	72 x 30 x 42 x 29-1/2"	KDTCS722430L.E	<input type="checkbox"/>	<input type="checkbox"/>	<input type="checkbox"/>	<input type="checkbox"/>	<input type="checkbox"/>	
	78 x 20 x 42 x 29-1/2"	KDTCS782420L.E	<input type="checkbox"/>	<input type="checkbox"/>	<input type="checkbox"/>	<input type="checkbox"/>	<input type="checkbox"/>	
	78 x 24 x 42 x 29-1/2"	KDTCS782424L.E	<input type="checkbox"/>	<input type="checkbox"/>	<input type="checkbox"/>	<input type="checkbox"/>	<input type="checkbox"/>	
	78 x 30 x 42 x 29-1/2"	KDTCS782430L.E	<input type="checkbox"/>	<input type="checkbox"/>	<input type="checkbox"/>	<input type="checkbox"/>	<input type="checkbox"/>	
AESP								
 <p><b>D-Top Desk-24" Extended Right, Straight Cutaway</b></p> <ul style="list-style-type: none"> <li>• 1-1/2" top with choice of three edge styles</li> <li>• Straight cutaway</li> <li>• Modesty panel is 14" standard; full modesty panel available with upcharge</li> <li>• 6" diameter post leg</li> <li>• Grommet included</li> </ul>	66 x 20 x 42 x 29-1/2"	KDTCS662420R.E	<input type="checkbox"/>	<input type="checkbox"/>	<input type="checkbox"/>	<input type="checkbox"/>	<input type="checkbox"/>	
	66 x 24 x 42 x 29-1/2"	KDTCS662424R.E	<input type="checkbox"/>	<input type="checkbox"/>	<input type="checkbox"/>	<input type="checkbox"/>	<input type="checkbox"/>	
	66 x 30 x 42 x 29-1/2"	KDTCS662430R.E	<input type="checkbox"/>	<input type="checkbox"/>	<input type="checkbox"/>	<input type="checkbox"/>	<input type="checkbox"/>	
	72 x 20 x 42 x 29-1/2"	KDTCS722420R.E	<input type="checkbox"/>	<input type="checkbox"/>	<input type="checkbox"/>	<input type="checkbox"/>	<input type="checkbox"/>	
	72 x 24 x 42 x 29-1/2"	KDTCS722424R.E	<input type="checkbox"/>	<input type="checkbox"/>	<input type="checkbox"/>	<input type="checkbox"/>	<input type="checkbox"/>	
	72 x 30 x 42 x 29-1/2"	KDTCS722430R.E	<input type="checkbox"/>	<input type="checkbox"/>	<input type="checkbox"/>	<input type="checkbox"/>	<input type="checkbox"/>	
	78 x 20 x 42 x 29-1/2"	KDTCS782420R.E	<input type="checkbox"/>	<input type="checkbox"/>	<input type="checkbox"/>	<input type="checkbox"/>	<input type="checkbox"/>	
	78 x 24 x 42 x 29-1/2"	KDTCS782424R.E	<input type="checkbox"/>	<input type="checkbox"/>	<input type="checkbox"/>	<input type="checkbox"/>	<input type="checkbox"/>	
	78 x 30 x 42 x 29-1/2"	KDTCS782430R.E	<input type="checkbox"/>	<input type="checkbox"/>	<input type="checkbox"/>	<input type="checkbox"/>	<input type="checkbox"/>	
AESP								

**A B C D E F**

## HOW TO ORDER

Indicate the following information on order form:

1. Quantity of each item.
2. Model number, including options. See "How To Build a Model Number".
3. Any special service required.

Note: • The  indicates that a choice is required.  
 • The absence of the  indicates that no choice is required.  
 • Alpha-numeric characters in place of  indicate that no other alternatives are available.

## HOW TO BUILD A MODEL NUMBER

- A** Select basic model.
- B** Select edge style.
 

<b>F</b>	- Flat edge
<b>P3</b>	- Three wave profile edge
<b>P4</b>	- Four wave profile edge
- C** Select horizontal surface finish.  
Refer to color addendum at ki.com or KI Fabrics & Finishes binder.
- D** Select vertical surface finish.  
Refer to color addendum at ki.com or KI Fabrics & Finishes binder.
- E** Select leg finish.  
Refer to color addendum at ki.com or KI Fabrics & Finishes binder.
- F** Select modesty panel.
 

<b>PMP</b>	- 14" partial modesty panel (standard)
<b>FMP</b>	- Full height modesty panel; add \$70





Aristotle® Executive Desks  
D-Top Desks-Straight Cutaway

Approx.  
Packaged  
Weight

Delivered  
Pricing

158.0#	\$ 1621
158.0#	1621
158.0#	1621
170.0#	1677
170.0#	1677
170.0#	1677
183.0#	1727
183.0#	1727
183.0#	1727

158.0#	\$ 1621
158.0#	1621
158.0#	1621
170.0#	1677
170.0#	1677
170.0#	1677
183.0#	1727
183.0#	1727
183.0#	1727

**SPECIAL SERVICES**

**Special Carton Marking**

With specially marked information N/C



**Shipping**

Shipped k.d. freight prepaid f.o.b.  
KI-Aristotle Brampton, Ontario L6T 5T6  
factory. Freight class #85.

Specifications and prices are subject to  
change without prior notice.

# Aristotle® Executive Desks

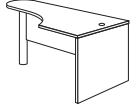
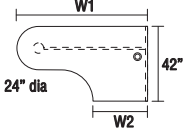
D-Top Desks-Curved Cutaway

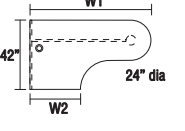
MODEL	W1 x W2 x D x H	MODEL NUMBER					
		Basic Model	Edge Style	Horizontal Surface Finish	Vertical Surface Finish	Leg Finish	Modesty Panel
 <p><b>D-Top Desk-24" Extended Left, Curved Cutaway</b></p> <ul style="list-style-type: none"> <li>• 1-1/2" top with choice of three edge styles</li> <li>• Curved cutaway</li> <li>• Modesty panel is 14" standard; full modesty panel available with upcharge</li> <li>• 6" diameter post leg</li> <li>• Grommet included</li> </ul> 	66 x 20 x 42 x 29-1/2"	KDTCC662420L.E	<input type="checkbox"/>	<input type="checkbox"/>	<input type="checkbox"/>	<input type="checkbox"/>	<input type="checkbox"/>
	66 x 24 x 42 x 29-1/2"	KDTCC662424L.E	<input type="checkbox"/>	<input type="checkbox"/>	<input type="checkbox"/>	<input type="checkbox"/>	<input type="checkbox"/>
	66 x 30 x 42 x 29-1/2"	KDTCC662430L.E	<input type="checkbox"/>	<input type="checkbox"/>	<input type="checkbox"/>	<input type="checkbox"/>	<input type="checkbox"/>
	72 x 20 x 42 x 29-1/2"	KDTCC722420L.E	<input type="checkbox"/>	<input type="checkbox"/>	<input type="checkbox"/>	<input type="checkbox"/>	<input type="checkbox"/>
	72 x 24 x 42 x 29-1/2"	KDTCC722424L.E	<input type="checkbox"/>	<input type="checkbox"/>	<input type="checkbox"/>	<input type="checkbox"/>	<input type="checkbox"/>
	72 x 30 x 42 x 29-1/2"	KDTCC722430L.E	<input type="checkbox"/>	<input type="checkbox"/>	<input type="checkbox"/>	<input type="checkbox"/>	<input type="checkbox"/>
	78 x 20 x 42 x 29-1/2"	KDTCC782420L.E	<input type="checkbox"/>	<input type="checkbox"/>	<input type="checkbox"/>	<input type="checkbox"/>	<input type="checkbox"/>
	78 x 24 x 42 x 29-1/2"	KDTCC782424L.E	<input type="checkbox"/>	<input type="checkbox"/>	<input type="checkbox"/>	<input type="checkbox"/>	<input type="checkbox"/>
	78 x 30 x 42 x 29-1/2"	KDTCC782430L.E	<input type="checkbox"/>	<input type="checkbox"/>	<input type="checkbox"/>	<input type="checkbox"/>	<input type="checkbox"/>
AESPD							
 <p><b>D-Top Desk-24" Extended Right, Curved Cutaway</b></p> <ul style="list-style-type: none"> <li>• 1-1/2" top with choice of three edge styles</li> <li>• Curved cutaway</li> <li>• Modesty panel is 14" standard; full modesty panel available with upcharge</li> <li>• 6" diameter post leg</li> <li>• Grommet included</li> </ul> 	66 x 20 x 42 x 29-1/2"	KDTCC662420R.E	<input type="checkbox"/>	<input type="checkbox"/>	<input type="checkbox"/>	<input type="checkbox"/>	<input type="checkbox"/>
	66 x 24 x 42 x 29-1/2"	KDTCC662424R.E	<input type="checkbox"/>	<input type="checkbox"/>	<input type="checkbox"/>	<input type="checkbox"/>	<input type="checkbox"/>
	66 x 30 x 42 x 29-1/2"	KDTCC662430R.E	<input type="checkbox"/>	<input type="checkbox"/>	<input type="checkbox"/>	<input type="checkbox"/>	<input type="checkbox"/>
	72 x 20 x 42 x 29-1/2"	KDTCC722420R.E	<input type="checkbox"/>	<input type="checkbox"/>	<input type="checkbox"/>	<input type="checkbox"/>	<input type="checkbox"/>
	72 x 24 x 42 x 29-1/2"	KDTCC722424R.E	<input type="checkbox"/>	<input type="checkbox"/>	<input type="checkbox"/>	<input type="checkbox"/>	<input type="checkbox"/>
	72 x 30 x 42 x 29-1/2"	KDTCC722430R.E	<input type="checkbox"/>	<input type="checkbox"/>	<input type="checkbox"/>	<input type="checkbox"/>	<input type="checkbox"/>
	78 x 20 x 42 x 29-1/2"	KDTCC782420R.E	<input type="checkbox"/>	<input type="checkbox"/>	<input type="checkbox"/>	<input type="checkbox"/>	<input type="checkbox"/>
	78 x 24 x 42 x 29-1/2"	KDTCC782424R.E	<input type="checkbox"/>	<input type="checkbox"/>	<input type="checkbox"/>	<input type="checkbox"/>	<input type="checkbox"/>
	78 x 30 x 42 x 29-1/2"	KDTCC782430R.E	<input type="checkbox"/>	<input type="checkbox"/>	<input type="checkbox"/>	<input type="checkbox"/>	<input type="checkbox"/>
AESPD							

**A**      **B**      **C**      **D**      **E**      **F**

## HOW TO ORDER

Indicate the following information on order form:

1. Quantity of each item.
2. Model number, including options. See "How To Build a Model Number".
3. Any special service required.

Note:

- The  indicates that a choice is required.
- The absence of the  indicates that no choice is required.
- Alpha-numeric characters in place of  indicate that no other alternatives are available.

## HOW TO BUILD A MODEL NUMBER

- A** Select basic model.
- B** Select edge style.
 

<b>F</b>	- Flat edge
<b>P3</b>	- Three wave profile edge
<b>P4</b>	- Four wave profile edge
- C** Select horizontal surface finish.  
Refer to color addendum at ki.com or KI Fabrics & Finishes binder.
- D** Select vertical surface finish.  
Refer to color addendum at ki.com or KI Fabrics & Finishes binder.
- E** Select leg finish.  
Refer to color addendum at ki.com or KI Fabrics & Finishes binder.
- F** Select modesty panel.
 

<b>PMP</b>	- 14" partial modesty panel (standard)
<b>FMP</b>	- Full height modesty panel; add \$70



Aristotle® Executive Desks  
D-Top Desks-Curved Cutaway

Approx.  
Packaged  
Weight

Delivered  
Pricing

158.0#	\$ 1621
158.0#	1621
158.0#	1621
170.0#	1677
170.0#	1677
170.0#	1677
183.0#	1727
183.0#	1727
183.0#	1727

158.0#	\$ 1621
158.0#	1621
158.0#	1621
170.0#	1677
170.0#	1677
170.0#	1677
183.0#	1727
183.0#	1727
183.0#	1727

**SPECIAL SERVICES**

**Special Carton Marking**

With specially marked information N/C

**Shipping**

Shipped k.d. freight prepaid f.o.b.  
KI-Aristotle Brampton, Ontario L6T 5T6  
factory. Freight class #85.

Specifications and prices are subject to  
change without prior notice.

# Aristotle® Executive Desks

D-Top Desks-Straight Cutaway

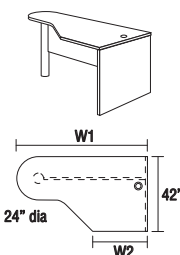
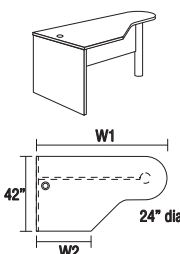
MODEL	W1 x W2 x D x H	MODEL NUMBER					
		Basic Model	Edge Style	Horizontal Surface Finish	Vertical Surface Finish	Leg Finish	Modesty Panel
 <p><b>D-Top Desk-30" Extended Left, Straight Cutaway</b></p> <ul style="list-style-type: none"> <li>• 1-1/2" top with choice of three edge styles</li> <li>• Straight cutaway</li> <li>• Modesty panel is 14" standard; full modesty panel available with upcharge</li> <li>• 6" diameter post leg</li> <li>• Grommet included</li> </ul>	66 x 20 x 42 x 29-1/2"	KDTCS663020L.E	<input type="checkbox"/>	<input type="checkbox"/>	<input type="checkbox"/>	<input type="checkbox"/>	<input type="checkbox"/>
	66 x 24 x 42 x 29-1/2"	KDTCS663024L.E	<input type="checkbox"/>	<input type="checkbox"/>	<input type="checkbox"/>	<input type="checkbox"/>	<input type="checkbox"/>
	66 x 30 x 42 x 29-1/2"	KDTCS663030L.E	<input type="checkbox"/>	<input type="checkbox"/>	<input type="checkbox"/>	<input type="checkbox"/>	<input type="checkbox"/>
	72 x 20 x 42 x 29-1/2"	KDTCS723020L.E	<input type="checkbox"/>	<input type="checkbox"/>	<input type="checkbox"/>	<input type="checkbox"/>	<input type="checkbox"/>
	72 x 24 x 42 x 29-1/2"	KDTCS723024L.E	<input type="checkbox"/>	<input type="checkbox"/>	<input type="checkbox"/>	<input type="checkbox"/>	<input type="checkbox"/>
	72 x 30 x 42 x 29-1/2"	KDTCS723030L.E	<input type="checkbox"/>	<input type="checkbox"/>	<input type="checkbox"/>	<input type="checkbox"/>	<input type="checkbox"/>
	78 x 20 x 42 x 29-1/2"	KDTCS783020L.E	<input type="checkbox"/>	<input type="checkbox"/>	<input type="checkbox"/>	<input type="checkbox"/>	<input type="checkbox"/>
	78 x 24 x 42 x 29-1/2"	KDTCS783024L.E	<input type="checkbox"/>	<input type="checkbox"/>	<input type="checkbox"/>	<input type="checkbox"/>	<input type="checkbox"/>
	78 x 30 x 42 x 29-1/2"	KDTCS783030L.E	<input type="checkbox"/>	<input type="checkbox"/>	<input type="checkbox"/>	<input type="checkbox"/>	<input type="checkbox"/>
	AESP						
 <p><b>D-Top Desk-30" Extended Right, Straight Cutaway</b></p> <ul style="list-style-type: none"> <li>• 1-1/2" top with choice of three edge styles</li> <li>• Straight cutaway</li> <li>• Modesty panel is 14" standard; full modesty panel available with upcharge</li> <li>• 6" diameter post leg</li> <li>• Grommet included</li> </ul>	66 x 20 x 42 x 29-1/2"	KDTCS663020R.E	<input type="checkbox"/>	<input type="checkbox"/>	<input type="checkbox"/>	<input type="checkbox"/>	<input type="checkbox"/>
	66 x 24 x 42 x 29-1/2"	KDTCS663024R.E	<input type="checkbox"/>	<input type="checkbox"/>	<input type="checkbox"/>	<input type="checkbox"/>	<input type="checkbox"/>
	66 x 30 x 42 x 29-1/2"	KDTCS663030R.E	<input type="checkbox"/>	<input type="checkbox"/>	<input type="checkbox"/>	<input type="checkbox"/>	<input type="checkbox"/>
	72 x 20 x 42 x 29-1/2"	KDTCS723020R.E	<input type="checkbox"/>	<input type="checkbox"/>	<input type="checkbox"/>	<input type="checkbox"/>	<input type="checkbox"/>
	72 x 24 x 42 x 29-1/2"	KDTCS723024R.E	<input type="checkbox"/>	<input type="checkbox"/>	<input type="checkbox"/>	<input type="checkbox"/>	<input type="checkbox"/>
	72 x 30 x 42 x 29-1/2"	KDTCS723030R.E	<input type="checkbox"/>	<input type="checkbox"/>	<input type="checkbox"/>	<input type="checkbox"/>	<input type="checkbox"/>
	78 x 20 x 42 x 29-1/2"	KDTCS783020R.E	<input type="checkbox"/>	<input type="checkbox"/>	<input type="checkbox"/>	<input type="checkbox"/>	<input type="checkbox"/>
	78 x 24 x 42 x 29-1/2"	KDTCS783024R.E	<input type="checkbox"/>	<input type="checkbox"/>	<input type="checkbox"/>	<input type="checkbox"/>	<input type="checkbox"/>
	78 x 30 x 42 x 29-1/2"	KDTCS783030R.E	<input type="checkbox"/>	<input type="checkbox"/>	<input type="checkbox"/>	<input type="checkbox"/>	<input type="checkbox"/>
	AESP						

**A**      **B**      **C**      **D**      **E**      **F**

## HOW TO ORDER

Indicate the following information on order form:

1. Quantity of each item.
2. Model number, including options. See "How To Build a Model Number".
3. Any special service required.

Note: • The  indicates that a choice is required.  
 • The absence of the  indicates that no choice is required.  
 • Alpha-numeric characters in place of  indicate that no other alternatives are available.

## HOW TO BUILD A MODEL NUMBER

- A** Select basic model.
- B** Select edge style.
 

<b>F</b>	- Flat edge
<b>P3</b>	- Three wave profile edge
<b>P4</b>	- Four wave profile edge
- C** Select horizontal surface finish.  
Refer to color addendum at ki.com or KI Fabrics & Finishes binder.
- D** Select vertical surface finish.  
Refer to color addendum at ki.com or KI Fabrics & Finishes binder.
- E** Select leg finish.  
Refer to color addendum at ki.com or KI Fabrics & Finishes binder.
- F** Select modesty panel.
 

<b>PMP</b>	- 14" partial modesty panel (standard)
<b>FMP</b>	- Full height modesty panel; add \$70



Aristotle® Executive Desks  
D-Top Desks-Straight Cutaway

Approx.  
Packaged  
Weight

Delivered  
Pricing

158.0#	\$ 1621
158.0#	1621
158.0#	1621
170.0#	1677
170.0#	1677
170.0#	1677
183.0#	1727
183.0#	1727
183.0#	1727

158.0#	\$ 1621
158.0#	1621
158.0#	1621
170.0#	1677
170.0#	1677
170.0#	1677
183.0#	1727
183.0#	1727
183.0#	1727

**SPECIAL SERVICES**

**Special Carton Marking**

With specially marked information N/C



**Shipping**

Shipped k.d. freight prepaid f.o.b.  
KI-Aristotle Brampton, Ontario L6T 5T6  
factory. Freight class #85.

Specifications and prices are subject to  
change without prior notice.

# Aristotle® Executive Desks

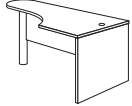
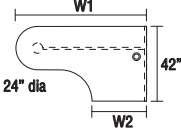
D-Top Desks-Curved Cutaway

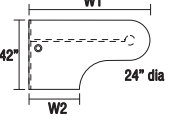
MODEL	W1 x W2 x D x H	MODEL NUMBER					
		Basic Model	Edge Style	Horizontal Surface Finish	Vertical Surface Finish	Leg Finish	Modesty Panel
 <p><b>D-Top Desk-30" Extended Left, Curved Cutaway</b></p> <ul style="list-style-type: none"> <li>• 1-1/2" top with choice of three edge styles</li> <li>• Curved cutaway</li> <li>• Modesty panel is 14" standard; full modesty panel available with upcharge</li> <li>• 6" diameter post leg</li> <li>• Grommet included</li> </ul> 	66 x 20 x 42 x 29-1/2"	KDTCC663020L.E	<input type="checkbox"/>	<input type="checkbox"/>	<input type="checkbox"/>	<input type="checkbox"/>	<input type="checkbox"/>
	66 x 24 x 42 x 29-1/2"	KDTCC663024L.E	<input type="checkbox"/>	<input type="checkbox"/>	<input type="checkbox"/>	<input type="checkbox"/>	<input type="checkbox"/>
	66 x 30 x 42 x 29-1/2"	KDTCC663030L.E	<input type="checkbox"/>	<input type="checkbox"/>	<input type="checkbox"/>	<input type="checkbox"/>	<input type="checkbox"/>
	72 x 20 x 42 x 29-1/2"	KDTCC723020L.E	<input type="checkbox"/>	<input type="checkbox"/>	<input type="checkbox"/>	<input type="checkbox"/>	<input type="checkbox"/>
	72 x 24 x 42 x 29-1/2"	KDTCC723024L.E	<input type="checkbox"/>	<input type="checkbox"/>	<input type="checkbox"/>	<input type="checkbox"/>	<input type="checkbox"/>
	72 x 30 x 42 x 29-1/2"	KDTCC723030L.E	<input type="checkbox"/>	<input type="checkbox"/>	<input type="checkbox"/>	<input type="checkbox"/>	<input type="checkbox"/>
	78 x 20 x 42 x 29-1/2"	KDTCC783020L.E	<input type="checkbox"/>	<input type="checkbox"/>	<input type="checkbox"/>	<input type="checkbox"/>	<input type="checkbox"/>
	78 x 24 x 42 x 29-1/2"	KDTCC783024L.E	<input type="checkbox"/>	<input type="checkbox"/>	<input type="checkbox"/>	<input type="checkbox"/>	<input type="checkbox"/>
	78 x 30 x 42 x 29-1/2"	KDTCC783030L.E	<input type="checkbox"/>	<input type="checkbox"/>	<input type="checkbox"/>	<input type="checkbox"/>	<input type="checkbox"/>
AESPD							
 <p><b>D-Top Desk-30" Extended Right, Curved Cutaway</b></p> <ul style="list-style-type: none"> <li>• 1-1/2" top with choice of three edge styles</li> <li>• Curved cutaway</li> <li>• Modesty panel is 14" standard; full modesty panel available with upcharge</li> <li>• 6" diameter post leg</li> <li>• Grommet included</li> </ul> 	66 x 20 x 42 x 29-1/2"	KDTCC663020R.E	<input type="checkbox"/>	<input type="checkbox"/>	<input type="checkbox"/>	<input type="checkbox"/>	<input type="checkbox"/>
	66 x 24 x 42 x 29-1/2"	KDTCC663024R.E	<input type="checkbox"/>	<input type="checkbox"/>	<input type="checkbox"/>	<input type="checkbox"/>	<input type="checkbox"/>
	66 x 30 x 42 x 29-1/2"	KDTCC663030R.E	<input type="checkbox"/>	<input type="checkbox"/>	<input type="checkbox"/>	<input type="checkbox"/>	<input type="checkbox"/>
	72 x 20 x 42 x 29-1/2"	KDTCC723020R.E	<input type="checkbox"/>	<input type="checkbox"/>	<input type="checkbox"/>	<input type="checkbox"/>	<input type="checkbox"/>
	72 x 24 x 42 x 29-1/2"	KDTCC723024R.E	<input type="checkbox"/>	<input type="checkbox"/>	<input type="checkbox"/>	<input type="checkbox"/>	<input type="checkbox"/>
	72 x 30 x 42 x 29-1/2"	KDTCC723030R.E	<input type="checkbox"/>	<input type="checkbox"/>	<input type="checkbox"/>	<input type="checkbox"/>	<input type="checkbox"/>
	78 x 20 x 42 x 29-1/2"	KDTCC783020R.E	<input type="checkbox"/>	<input type="checkbox"/>	<input type="checkbox"/>	<input type="checkbox"/>	<input type="checkbox"/>
	78 x 24 x 42 x 29-1/2"	KDTCC783024R.E	<input type="checkbox"/>	<input type="checkbox"/>	<input type="checkbox"/>	<input type="checkbox"/>	<input type="checkbox"/>
	78 x 30 x 42 x 29-1/2"	KDTCC783030R.E	<input type="checkbox"/>	<input type="checkbox"/>	<input type="checkbox"/>	<input type="checkbox"/>	<input type="checkbox"/>
AESPD							

**A**      **B**      **C**      **D**      **E**      **F**

## HOW TO ORDER

Indicate the following information on order form:

1. Quantity of each item.
2. Model number, including options. See "How To Build a Model Number".
3. Any special service required.

Note:

- The  indicates that a choice is required.
- The absence of the  indicates that no choice is required.
- Alpha-numeric characters in place of  indicate that no other alternatives are available.

## HOW TO BUILD A MODEL NUMBER

- A** Select basic model.
- B** Select edge style.
 

<b>F</b>	- Flat edge
<b>P3</b>	- Three wave profile edge
<b>P4</b>	- Four wave profile edge
- C** Select horizontal surface finish.  
Refer to color addendum at ki.com or KI Fabrics & Finishes binder.
- D** Select vertical surface finish.  
Refer to color addendum at ki.com or KI Fabrics & Finishes binder.
- E** Select leg finish.  
Refer to color addendum at ki.com or KI Fabrics & Finishes binder.
- F** Select modesty panel.
 

<b>PMP</b>	- 14" partial modesty panel (standard)
<b>FMP</b>	- Full height modesty panel; add \$70



Aristotle® Executive Desks  
D-Top Desks-Curved Cutaway

Approx.  
Packaged  
Weight

Delivered  
Pricing

158.0#	\$ 1621
158.0#	1621
158.0#	1621
170.0#	1677
170.0#	1677
170.0#	1677
183.0#	1727
183.0#	1727
183.0#	1727

158.0#	\$ 1621
158.0#	1621
158.0#	1621
170.0#	1677
170.0#	1677
170.0#	1677
183.0#	1727
183.0#	1727
183.0#	1727

**SPECIAL SERVICES**

**Special Carton Marking**

With specially marked information N/C



**Shipping**

Shipped k.d. freight prepaid f.o.b.  
KI-Aristotle Brampton, Ontario L6T 5T6  
factory. Freight class #85.

Specifications and prices are subject to  
change without prior notice.

# Aristotle® Executive Returns

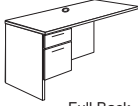
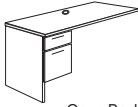
Pedestal-Left

		MODEL NUMBER							
MODEL	W x D x H	Basic Model	Edge Style	Horizontal Surface Finish	Vertical Surface Finish	Pull Option	Lock Option	Back Panel	
 Full Back  Open Back AEPRT	<b>Pedestal Return-Left, Box/File Option A</b> • 1-1/2" top with choice of three edge styles • Box/file locking pedestal with full extension slides • Full height back panels over 48" wide feature horizontal wood grain pattern • Grommet location center rear • Pedestals feature locks on inside panels	30 x 20 x 29-1/2"	KRL3020A.E	<input type="checkbox"/>	<input type="checkbox"/>	<input type="checkbox"/>	<input type="checkbox"/>	<input type="checkbox"/>	
	36 x 20 x 29-1/2"	KRL3620A.E	<input type="checkbox"/>	<input type="checkbox"/>	<input type="checkbox"/>	<input type="checkbox"/>	<input type="checkbox"/>	<input type="checkbox"/>	
	42 x 20 x 29-1/2"	KRL4220A.E	<input type="checkbox"/>	<input type="checkbox"/>	<input type="checkbox"/>	<input type="checkbox"/>	<input type="checkbox"/>	<input type="checkbox"/>	
	48 x 20 x 29-1/2"	KRL4820A.E	<input type="checkbox"/>	<input type="checkbox"/>	<input type="checkbox"/>	<input type="checkbox"/>	<input type="checkbox"/>	<input type="checkbox"/>	
	54 x 20 x 29-1/2"	KRL5420A.E	<input type="checkbox"/>	<input type="checkbox"/>	<input type="checkbox"/>	<input type="checkbox"/>	<input type="checkbox"/>	<input type="checkbox"/>	
	60 x 20 x 29-1/2"	KRL6020A.E	<input type="checkbox"/>	<input type="checkbox"/>	<input type="checkbox"/>	<input type="checkbox"/>	<input type="checkbox"/>	<input type="checkbox"/>	
	30 x 24 x 29-1/2"	KRL3024A.E	<input type="checkbox"/>	<input type="checkbox"/>	<input type="checkbox"/>	<input type="checkbox"/>	<input type="checkbox"/>	<input type="checkbox"/>	
	36 x 24 x 29-1/2"	KRL3624A.E	<input type="checkbox"/>	<input type="checkbox"/>	<input type="checkbox"/>	<input type="checkbox"/>	<input type="checkbox"/>	<input type="checkbox"/>	
	42 x 24 x 29-1/2"	KRL4224A.E	<input type="checkbox"/>	<input type="checkbox"/>	<input type="checkbox"/>	<input type="checkbox"/>	<input type="checkbox"/>	<input type="checkbox"/>	
	48 x 24 x 29-1/2"	KRL4824A.E	<input type="checkbox"/>	<input type="checkbox"/>	<input type="checkbox"/>	<input type="checkbox"/>	<input type="checkbox"/>	<input type="checkbox"/>	
54 x 24 x 29-1/2"	KRL5424A.E	<input type="checkbox"/>	<input type="checkbox"/>	<input type="checkbox"/>	<input type="checkbox"/>	<input type="checkbox"/>	<input type="checkbox"/>		
60 x 24 x 29-1/2"	KRL6024A.E	<input type="checkbox"/>	<input type="checkbox"/>	<input type="checkbox"/>	<input type="checkbox"/>	<input type="checkbox"/>	<input type="checkbox"/>		
 Full Back  Open Back AEPRT	<b>Pedestal Return-Left, Box/Box/File Option B</b> • 1-1/2" top with choice of three edge styles • Box/box/file locking pedestal with full extension slides • Upper box drawer is non-locking • Full height back panels over 48" wide feature horizontal wood grain pattern • Grommet location center rear • Pedestals feature locks on inside panels	30 x 20 x 29-1/2"	KRL3020B.E	<input type="checkbox"/>	<input type="checkbox"/>	<input type="checkbox"/>	<input type="checkbox"/>	<input type="checkbox"/>	
	36 x 20 x 29-1/2"	KRL3620B.E	<input type="checkbox"/>	<input type="checkbox"/>	<input type="checkbox"/>	<input type="checkbox"/>	<input type="checkbox"/>	<input type="checkbox"/>	
	42 x 20 x 29-1/2"	KRL4220B.E	<input type="checkbox"/>	<input type="checkbox"/>	<input type="checkbox"/>	<input type="checkbox"/>	<input type="checkbox"/>	<input type="checkbox"/>	
	48 x 20 x 29-1/2"	KRL4820B.E	<input type="checkbox"/>	<input type="checkbox"/>	<input type="checkbox"/>	<input type="checkbox"/>	<input type="checkbox"/>	<input type="checkbox"/>	
	54 x 20 x 29-1/2"	KRL5420B.E	<input type="checkbox"/>	<input type="checkbox"/>	<input type="checkbox"/>	<input type="checkbox"/>	<input type="checkbox"/>	<input type="checkbox"/>	
	60 x 20 x 29-1/2"	KRL6020B.E	<input type="checkbox"/>	<input type="checkbox"/>	<input type="checkbox"/>	<input type="checkbox"/>	<input type="checkbox"/>	<input type="checkbox"/>	
	30 x 24 x 29-1/2"	KRL3024B.E	<input type="checkbox"/>	<input type="checkbox"/>	<input type="checkbox"/>	<input type="checkbox"/>	<input type="checkbox"/>	<input type="checkbox"/>	
	36 x 24 x 29-1/2"	KRL3624B.E	<input type="checkbox"/>	<input type="checkbox"/>	<input type="checkbox"/>	<input type="checkbox"/>	<input type="checkbox"/>	<input type="checkbox"/>	
	42 x 24 x 29-1/2"	KRL4224B.E	<input type="checkbox"/>	<input type="checkbox"/>	<input type="checkbox"/>	<input type="checkbox"/>	<input type="checkbox"/>	<input type="checkbox"/>	
	48 x 24 x 29-1/2"	KRL4824B.E	<input type="checkbox"/>	<input type="checkbox"/>	<input type="checkbox"/>	<input type="checkbox"/>	<input type="checkbox"/>	<input type="checkbox"/>	
54 x 24 x 29-1/2"	KRL5424B.E	<input type="checkbox"/>	<input type="checkbox"/>	<input type="checkbox"/>	<input type="checkbox"/>	<input type="checkbox"/>	<input type="checkbox"/>		
60 x 24 x 29-1/2"	KRL6024B.E	<input type="checkbox"/>	<input type="checkbox"/>	<input type="checkbox"/>	<input type="checkbox"/>	<input type="checkbox"/>	<input type="checkbox"/>		

**A**   **B**   **C**   **D**   **E**   **F**   **G**

## HOW TO ORDER

Indicate the following information on order form:

- Quantity of each item.
- Model number, including options. See "How To Build a Model Number".
- Any special service required.

Note: • The  indicates that a choice is required.  
 • The absence of the  indicates that no choice is required.  
 • Alpha-numeric characters in place of  indicate that no other alternatives are available.

## HOW TO BUILD A MODEL NUMBER

**A** Select basic model.

**B** Select edge style.

- F** - Flat edge
- P3** - Three wave profile edge
- P4** - Four wave profile edge

**C** Select horizontal surface finish.

Refer to color addendum at ki.com or KI Fabrics & Finishes binder.

**D** Select vertical surface finish.

Refer to color addendum at ki.com or KI Fabrics & Finishes binder.

**E** Select pull option.

- BPA2** - Silver bar pull (2)
- BPA3** - Silver bar pull (3)
- KIB2** - Waterfall black pull (2)
- KIB3** - Waterfall black pull (3)
- KIS2** - Waterfall silver pull (2)
- KIS3** - Waterfall silver pull (3)

**RCP2** - Rectangular silver pull (2)

**RCP3** - Rectangular silver pull (3)

**F** Select lock option.

- KA** - Key alike
- KS** - Key standard

**G** Select back panel option.

- FB** - Full Back (standard)
- OB** - Open Back





Approx. Packaged Weight	Delivered Pricing
108.0#	\$ 856
115.0#	899
123.0#	948
130.0#	1002
138.0#	1051
145.0#	1100
113.0#	902
120.0#	951
128.0#	1002
135.0#	1045
143.0#	1099
150.0#	1148
138.0#	\$ 1019
145.0#	1057
153.0#	1127
160.0#	1182
168.0#	1223
175.0#	1259
143.0#	1059
140.0#	1107
158.0#	1181
165.0#	1229
173.0#	1259
180.0#	1296

#### SPECIAL SERVICES

##### Special Carton Marking

With specially marked information N/C

##### Shipping

Shipped **assembled freight prepaid f.o.b. KI-Aristotle Brampton, Ontario L6T 5T6** factory. Freight class #85.

Specifications and prices are subject to change without prior notice.

# Aristotle® Executive Returns

Pedestal-Left

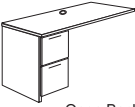
MODEL	W x D x H	MODEL NUMBER							
		Basic Model	Edge Style	Horizontal Surface Finish	Vertical Surface Finish	Pull Option	Lock Option	Back Panel	
 Full Back   Open Back  AEPRT	<b>Pedestal Return-Left, File/File Option C</b> • 1-1/2" top with choice of three edge styles • File/file locking pedestal with full extension slides • Full height back panels over 48" wide feature horizontal wood grain pattern • Grommet location center rear • Pedestals feature locks on inside panels	30 x 20 x 29-1/2"	KRL3020C.E	<input type="checkbox"/>	<input type="checkbox"/>	<input type="checkbox"/>	<input type="checkbox"/>	<input type="checkbox"/>	<input type="checkbox"/>
	36 x 20 x 29-1/2"	KRL3620C.E	<input type="checkbox"/>	<input type="checkbox"/>	<input type="checkbox"/>	<input type="checkbox"/>	<input type="checkbox"/>	<input type="checkbox"/>	
	42 x 20 x 29-1/2"	KRL4220C.E	<input type="checkbox"/>	<input type="checkbox"/>	<input type="checkbox"/>	<input type="checkbox"/>	<input type="checkbox"/>	<input type="checkbox"/>	
	48 x 20 x 29-1/2"	KRL4820C.E	<input type="checkbox"/>	<input type="checkbox"/>	<input type="checkbox"/>	<input type="checkbox"/>	<input type="checkbox"/>	<input type="checkbox"/>	
	54 x 20 x 29-1/2"	KRL5420C.E	<input type="checkbox"/>	<input type="checkbox"/>	<input type="checkbox"/>	<input type="checkbox"/>	<input type="checkbox"/>	<input type="checkbox"/>	
	60 x 20 x 29-1/2"	KRL6020C.E	<input type="checkbox"/>	<input type="checkbox"/>	<input type="checkbox"/>	<input type="checkbox"/>	<input type="checkbox"/>	<input type="checkbox"/>	
	30 x 24 x 29-1/2"	KRL3024C.E	<input type="checkbox"/>	<input type="checkbox"/>	<input type="checkbox"/>	<input type="checkbox"/>	<input type="checkbox"/>	<input type="checkbox"/>	
	36 x 24 x 29-1/2"	KRL3624C.E	<input type="checkbox"/>	<input type="checkbox"/>	<input type="checkbox"/>	<input type="checkbox"/>	<input type="checkbox"/>	<input type="checkbox"/>	
	42 x 24 x 29-1/2"	KRL4224C.E	<input type="checkbox"/>	<input type="checkbox"/>	<input type="checkbox"/>	<input type="checkbox"/>	<input type="checkbox"/>	<input type="checkbox"/>	
	48 x 24 x 29-1/2"	KRL4824C.E	<input type="checkbox"/>	<input type="checkbox"/>	<input type="checkbox"/>	<input type="checkbox"/>	<input type="checkbox"/>	<input type="checkbox"/>	
	54 x 24 x 29-1/2"	KRL5424C.E	<input type="checkbox"/>	<input type="checkbox"/>	<input type="checkbox"/>	<input type="checkbox"/>	<input type="checkbox"/>	<input type="checkbox"/>	
	60 x 24 x 29-1/2"	KRL6024C.E	<input type="checkbox"/>	<input type="checkbox"/>	<input type="checkbox"/>	<input type="checkbox"/>	<input type="checkbox"/>	<input type="checkbox"/>	

**A**   **B**   **C**   **D**   **E**   **F**   **G**

## HOW TO ORDER

Indicate the following information on order form:

- Quantity of each item.
- Model number, including options. See "How To Build a Model Number".
- Any special service required.

Note: • The  indicates that a choice is required.  
 • The absence of the  indicates that no choice is required.  
 • Alpha-numeric characters in place of  indicate that no other alternatives are available.

## HOW TO BUILD A MODEL NUMBER

- A** Select basic model.
 

FB	- Full Back (standard)
OB	- Open Back
- B** Select edge style.
 

F	- Flat edge
P3	- Three wave profile edge
P4	- Four wave profile edge
- C** Select horizontal surface finish.  
 Refer to color addendum at ki.com or KI Fabrics & Finishes binder.
- D** Select vertical surface finish.  
 Refer to color addendum at ki.com or KI Fabrics & Finishes binder.
- E** Select pull option.
 

BPA2	- Silver bar pull (2)
KIB2	- Waterfall black pull (2)
KIS2	- Waterfall silver pull (2)
RCP2	- Rectangular silver pull (2)
- F** Select lock option.
 

KA	- Key alike
KS	- Key standard
- G** Select back panel option.
 

FB	- Full Back (standard)
OB	- Open Back



Approx. Packaged Weight	Delivered Pricing
138.0#	\$ 1019
145.0#	1057
153.0#	1127
160.0#	1182
168.0#	1223
175.0#	1259
133.0#	1059
150.0#	1107
158.0#	1181
165.0#	1229
173.0#	1259
180.0#	1296

## SPECIAL SERVICES

### Special Carton Marking

With specially marked information N/C





### Shipping

Shipped **assembled freight prepaid f.o.b.**  
**KI-Aristotle Brampton, Ontario L6T 5T6**  
 factory. Freight class #85.

Specifications and prices are subject to  
 change without prior notice.

# Aristotle® Executive Returns

## Pedestal-Right

		MODEL NUMBER							
MODEL	W x D x H	Basic Model	Edge Style	Horizontal Surface Finish	Vertical Surface Finish	Pull Option	Lock Option	Back Panel	
 <p>Full Back</p>  <p>Open Back</p> <p>AEPRT</p>	<b>Pedestal Return-Right, Box/File Option A</b>	30 x 20 x 29-1/2"	KRR3020A.E	<input type="checkbox"/>	<input type="checkbox"/>	<input type="checkbox"/>	<input type="checkbox"/>	<input type="checkbox"/>	
		30 x 24 x 29-1/2"	KRR3024A.E	<input type="checkbox"/>	<input type="checkbox"/>	<input type="checkbox"/>	<input type="checkbox"/>	<input type="checkbox"/>	
	<ul style="list-style-type: none"> <li>1-1/2" top with choice of three edge styles</li> </ul>	36 x 20 x 29-1/2"	KRR3620A.E	<input type="checkbox"/>	<input type="checkbox"/>	<input type="checkbox"/>	<input type="checkbox"/>	<input type="checkbox"/>	
	<ul style="list-style-type: none"> <li>Box/file locking pedestal with full extension slides</li> </ul>	36 x 24 x 29-1/2"	KRR3624A.E	<input type="checkbox"/>	<input type="checkbox"/>	<input type="checkbox"/>	<input type="checkbox"/>	<input type="checkbox"/>	
	<ul style="list-style-type: none"> <li>Full height back panels over 48" wide feature horizontal wood grain pattern</li> </ul>	42 x 20 x 29-1/2"	KRR4220A.E	<input type="checkbox"/>	<input type="checkbox"/>	<input type="checkbox"/>	<input type="checkbox"/>	<input type="checkbox"/>	
	<ul style="list-style-type: none"> <li>Grommet location center rear</li> </ul>	42 x 24 x 29-1/2"	KRR4224A.E	<input type="checkbox"/>	<input type="checkbox"/>	<input type="checkbox"/>	<input type="checkbox"/>	<input type="checkbox"/>	
	<ul style="list-style-type: none"> <li>Pedestals feature locks on inside panels</li> </ul>	48 x 20 x 29-1/2"	KRR4820A.E	<input type="checkbox"/>	<input type="checkbox"/>	<input type="checkbox"/>	<input type="checkbox"/>	<input type="checkbox"/>	
		48 x 24 x 29-1/2"	KRR4824A.E	<input type="checkbox"/>	<input type="checkbox"/>	<input type="checkbox"/>	<input type="checkbox"/>	<input type="checkbox"/>	
		54 x 20 x 29-1/2"	KRR5420A.E	<input type="checkbox"/>	<input type="checkbox"/>	<input type="checkbox"/>	<input type="checkbox"/>	<input type="checkbox"/>	
		54 x 24 x 29-1/2"	KRR5424A.E	<input type="checkbox"/>	<input type="checkbox"/>	<input type="checkbox"/>	<input type="checkbox"/>	<input type="checkbox"/>	
	60 x 20 x 29-1/2"	KRR6020A.E	<input type="checkbox"/>	<input type="checkbox"/>	<input type="checkbox"/>	<input type="checkbox"/>	<input type="checkbox"/>		
	60 x 24 x 29-1/2"	KRR6024A.E	<input type="checkbox"/>	<input type="checkbox"/>	<input type="checkbox"/>	<input type="checkbox"/>	<input type="checkbox"/>		
 <p>Full Back</p>  <p>Open Back</p> <p>AEPRT</p>	<b>Pedestal Return-Right, Box/Box/File Option B</b>	30 x 20 x 29-1/2"	KRR3020B.E	<input type="checkbox"/>	<input type="checkbox"/>	<input type="checkbox"/>	<input type="checkbox"/>	<input type="checkbox"/>	
		36 x 20 x 29-1/2"	KRR3620B.E	<input type="checkbox"/>	<input type="checkbox"/>	<input type="checkbox"/>	<input type="checkbox"/>	<input type="checkbox"/>	
	<ul style="list-style-type: none"> <li>1-1/2" top with choice of three edge styles</li> </ul>	42 x 20 x 29-1/2"	KRR4220B.E	<input type="checkbox"/>	<input type="checkbox"/>	<input type="checkbox"/>	<input type="checkbox"/>	<input type="checkbox"/>	
	<ul style="list-style-type: none"> <li>Box/box/file locking pedestal with full extension slides</li> </ul>	48 x 20 x 29-1/2"	KRR4820B.E	<input type="checkbox"/>	<input type="checkbox"/>	<input type="checkbox"/>	<input type="checkbox"/>	<input type="checkbox"/>	
	<ul style="list-style-type: none"> <li>Upper box drawer is non-locking</li> </ul>	54 x 20 x 29-1/2"	KRR5420B.E	<input type="checkbox"/>	<input type="checkbox"/>	<input type="checkbox"/>	<input type="checkbox"/>	<input type="checkbox"/>	
	<ul style="list-style-type: none"> <li>Full height back panels over 48" wide feature horizontal wood grain pattern</li> </ul>	60 x 20 x 29-1/2"	KRR6020B.E	<input type="checkbox"/>	<input type="checkbox"/>	<input type="checkbox"/>	<input type="checkbox"/>	<input type="checkbox"/>	
	<ul style="list-style-type: none"> <li>Grommet location center rear</li> </ul>	30 x 24 x 29-1/2"	KRR3024B.E	<input type="checkbox"/>	<input type="checkbox"/>	<input type="checkbox"/>	<input type="checkbox"/>	<input type="checkbox"/>	
	<ul style="list-style-type: none"> <li>Pedestals feature locks on inside panels</li> </ul>	36 x 24 x 29-1/2"	KRR3624B.E	<input type="checkbox"/>	<input type="checkbox"/>	<input type="checkbox"/>	<input type="checkbox"/>	<input type="checkbox"/>	
		42 x 24 x 29-1/2"	KRR4224B.E	<input type="checkbox"/>	<input type="checkbox"/>	<input type="checkbox"/>	<input type="checkbox"/>	<input type="checkbox"/>	
		48 x 24 x 29-1/2"	KRR4824B.E	<input type="checkbox"/>	<input type="checkbox"/>	<input type="checkbox"/>	<input type="checkbox"/>	<input type="checkbox"/>	
	54 x 24 x 29-1/2"	KRR5424B.E	<input type="checkbox"/>	<input type="checkbox"/>	<input type="checkbox"/>	<input type="checkbox"/>	<input type="checkbox"/>		
	60 x 24 x 29-1/2"	KRR6024B.E	<input type="checkbox"/>	<input type="checkbox"/>	<input type="checkbox"/>	<input type="checkbox"/>	<input type="checkbox"/>		

**A**   **B**   **C**   **D**   **E**   **F**   **G**

### HOW TO ORDER

Indicate the following information on order form:

- Quantity of each item.
- Model number, including options. See "How To Build a Model Number".
- Any special service required.

Note:

- The  indicates that a choice is required.
- The absence of the  indicates that no choice is required.
- Alpha-numeric characters in place of  indicate that no other alternatives are available.

### HOW TO BUILD A MODEL NUMBER

**A** Select basic model.

**B** Select edge style.

- F** - Flat edge
- P3** - Three wave profile edge
- P4** - Four wave profile edge

**C** Select horizontal surface finish.

Refer to color addendum at ki.com or KI Fabrics & Finishes binder.

**D** Select vertical surface finish.

Refer to color addendum at ki.com or KI Fabrics & Finishes binder.

**E** Select pull option.

- BPA2** - Silver bar pull (2)
- BPA3** - Silver bar pull (3)
- KIB2** - Waterfall black pull (2)
- KIB3** - Waterfall black pull (3)
- KIS2** - Waterfall silver pull (2)
- KIS3** - Waterfall silver pull (3)

**RCP2** - Rectangular silver pull (2)

**RCP3** - Rectangular silver pull (3)

**F** Select lock option.

- KA** - Key alike
- KS** - Key standard

**G** Select back panel option.

- FB** - Full Back (standard)
- OB** - Open Back



Approx. Packaged Weight	Delivered Pricing
108.0#	\$ 856
113.0#	902
115.0#	899
120.0#	951
123.0#	948
128.0#	1002
130.0#	1002
135.0#	1045
138.0#	1051
143.0#	1099
145.0#	1100
150.0#	1148
138.0#	\$ 1019
145.0#	1057
153.0#	1127
160.0#	1182
168.0#	1223
175.0#	1259
143.0#	1059
140.0#	1107
158.0#	1181
165.0#	1229
173.0#	1259
180.0#	1296

## SPECIAL SERVICES

### Special Carton Marking

With specially marked information N/C

### Shipping

Shipped **assembled freight prepaid f.o.b. KI-Aristotle Brampton, Ontario L6T 5T6** factory. Freight class #85.

Specifications and prices are subject to change without prior notice.

# Aristotle® Executive Returns

## Pedestal-Right

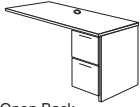
MODEL	W x D x H	MODEL NUMBER							
		Basic Model	Edge Style	Horizontal Surface Finish	Vertical Surface Finish	Pull Option	Lock Option	Back Panel	
 Full Back   Open Back  AEPRT	<b>Pedestal Return-Right, File/File Option C</b> • 1-1/2" top with choice of three edge styles • File/file locking pedestal with full extension slides • Full height back panels over 48" wide feature horizontal wood grain pattern • Grommet location center rear • Pedestals feature locks on inside panels	30 x 20 x 29-1/2"	KRR3020C.E	<input type="checkbox"/>	<input type="checkbox"/>	<input type="checkbox"/>	<input type="checkbox"/>	<input type="checkbox"/>	<input type="checkbox"/>
	36 x 20 x 29-1/2"	KRR3620C.E	<input type="checkbox"/>	<input type="checkbox"/>	<input type="checkbox"/>	<input type="checkbox"/>	<input type="checkbox"/>	<input type="checkbox"/>	
	42 x 20 x 29-1/2"	KRR4220C.E	<input type="checkbox"/>	<input type="checkbox"/>	<input type="checkbox"/>	<input type="checkbox"/>	<input type="checkbox"/>	<input type="checkbox"/>	
	48 x 20 x 29-1/2"	KRR4820C.E	<input type="checkbox"/>	<input type="checkbox"/>	<input type="checkbox"/>	<input type="checkbox"/>	<input type="checkbox"/>	<input type="checkbox"/>	
	54 x 20 x 29-1/2"	KRR5420C.E	<input type="checkbox"/>	<input type="checkbox"/>	<input type="checkbox"/>	<input type="checkbox"/>	<input type="checkbox"/>	<input type="checkbox"/>	
	60 x 20 x 29-1/2"	KRR6020C.E	<input type="checkbox"/>	<input type="checkbox"/>	<input type="checkbox"/>	<input type="checkbox"/>	<input type="checkbox"/>	<input type="checkbox"/>	
	30 x 24 x 29-1/2"	KRR3024C.E	<input type="checkbox"/>	<input type="checkbox"/>	<input type="checkbox"/>	<input type="checkbox"/>	<input type="checkbox"/>	<input type="checkbox"/>	
	36 x 24 x 29-1/2"	KRR3624C.E	<input type="checkbox"/>	<input type="checkbox"/>	<input type="checkbox"/>	<input type="checkbox"/>	<input type="checkbox"/>	<input type="checkbox"/>	
	42 x 24 x 29-1/2"	KRR4224C.E	<input type="checkbox"/>	<input type="checkbox"/>	<input type="checkbox"/>	<input type="checkbox"/>	<input type="checkbox"/>	<input type="checkbox"/>	
	48 x 24 x 29-1/2"	KRR4824C.E	<input type="checkbox"/>	<input type="checkbox"/>	<input type="checkbox"/>	<input type="checkbox"/>	<input type="checkbox"/>	<input type="checkbox"/>	
	54 x 24 x 29-1/2"	KRR5424C.E	<input type="checkbox"/>	<input type="checkbox"/>	<input type="checkbox"/>	<input type="checkbox"/>	<input type="checkbox"/>	<input type="checkbox"/>	
	60 x 24 x 29-1/2"	KRR6024C.E	<input type="checkbox"/>	<input type="checkbox"/>	<input type="checkbox"/>	<input type="checkbox"/>	<input type="checkbox"/>	<input type="checkbox"/>	

**A**   **B**   **C**   **D**   **E**   **F**   **G**

### HOW TO ORDER

Indicate the following information on order form:

- Quantity of each item.
- Model number, including options. See "How To Build a Model Number".
- Any special service required.

Note: • The  indicates that a choice is required.  
 • The absence of the  indicates that no choice is required.  
 • Alpha-numeric characters in place of  indicate that no other alternatives are available.

### HOW TO BUILD A MODEL NUMBER

- A** Select basic model.
 

F	- Flat edge
P3	- Three wave profile edge
P4	- Four wave profile edge
- B** Select edge style.
 

F	- Flat edge
P3	- Three wave profile edge
P4	- Four wave profile edge
- C** Select horizontal surface finish.  
Refer to color addendum at ki.com or KI Fabrics & Finishes binder.
- D** Select vertical surface finish.  
Refer to color addendum at ki.com or KI Fabrics & Finishes binder.
- E** Select pull option.
 

BPA2	- Silver bar pull (2)
KIB2	- Waterfall black pull (2)
KIS2	- Waterfall silver pull (2)
RCP2	- Rectangular silver pull (2)
- F** Select lock option.
 

KA	- Key alike
KS	- Key standard
- G** Select back panel option.
 

FB	- Full Back (standard)
OB	- Open Back



Approx. Packaged Weight	Delivered Pricing
138.0#	\$ 1019
145.0#	1057
153.0#	1127
160.0#	1182
168.0#	1223
175.0#	1259
133.0#	1059
150.0#	1107
158.0#	1181
165.0#	1229
173.0#	1259
180.0#	1296

## SPECIAL SERVICES

### Special Carton Marking

With specially marked information N/C

### Shipping

Shipped **assembled freight prepaid f.o.b. KI-Aristotle Brampton, Ontario L6T 5T6** factory. Freight class #85.

Specifications and prices are subject to change without prior notice.

# Aristotle® Executive Returns

Flush-Left and Right, No Pedestal

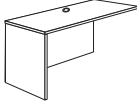
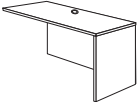
	MODEL	W x D x H	MODEL NUMBER				Approx. Packaged Weight
			Basic Model	Edge Style	Horizontal Surface Finish	Vertical Surface Finish	
 <p>AEPRT</p>	<b>Flush Return-Left, No Pedestal</b> <ul style="list-style-type: none"> <li>• 1-1/2" top with choice of three edge styles</li> <li>• Full height back panels over 48" wide feature horizontal wood grain pattern</li> <li>• Grommet location center rear</li> </ul>	30 x 20 x 29-1/2"	KFRL3020.E	<input type="checkbox"/>	<input type="checkbox"/>	<input type="checkbox"/>	78.0#
		36 x 20 x 29-1/2"	KFRL3620.E	<input type="checkbox"/>	<input type="checkbox"/>	<input type="checkbox"/>	80.0#
		42 x 20 x 29-1/2"	KFRL4220.E	<input type="checkbox"/>	<input type="checkbox"/>	<input type="checkbox"/>	83.0#
		48 x 20 x 29-1/2"	KFRL4820.E	<input type="checkbox"/>	<input type="checkbox"/>	<input type="checkbox"/>	85.0#
		54 x 20 x 29-1/2"	KFRL5420.E	<input type="checkbox"/>	<input type="checkbox"/>	<input type="checkbox"/>	88.0#
		60 x 20 x 29-1/2"	KFRL6020.E	<input type="checkbox"/>	<input type="checkbox"/>	<input type="checkbox"/>	90.0#
		30 x 24 x 29-1/2"	KFRL3024.E	<input type="checkbox"/>	<input type="checkbox"/>	<input type="checkbox"/>	78.0#
		36 x 24 x 29-1/2"	KFRL3624.E	<input type="checkbox"/>	<input type="checkbox"/>	<input type="checkbox"/>	80.0#
		42 x 24 x 29-1/2"	KFRL4224.E	<input type="checkbox"/>	<input type="checkbox"/>	<input type="checkbox"/>	83.0#
		48 x 24 x 29-1/2"	KFRL4824.E	<input type="checkbox"/>	<input type="checkbox"/>	<input type="checkbox"/>	85.0#
		54 x 24 x 29-1/2"	KFRL5424.E	<input type="checkbox"/>	<input type="checkbox"/>	<input type="checkbox"/>	88.0#
		60 x 24 x 29-1/2"	KFRL6024.E	<input type="checkbox"/>	<input type="checkbox"/>	<input type="checkbox"/>	90.0#
 <p>AEPRT</p>	<b>Flush Return-Right, No Pedestal</b> <ul style="list-style-type: none"> <li>• 1-1/2" top with choice of three edge styles</li> <li>• Back panels over 48" wide feature horizontal wood grain pattern</li> <li>• Grommet location center rear</li> </ul>	30 x 20 x 29-1/2"	KFRR3020.E	<input type="checkbox"/>	<input type="checkbox"/>	<input type="checkbox"/>	78.0#
		36 x 20 x 29-1/2"	KFRR3620.E	<input type="checkbox"/>	<input type="checkbox"/>	<input type="checkbox"/>	80.0#
		42 x 20 x 29-1/2"	KFRR4220.E	<input type="checkbox"/>	<input type="checkbox"/>	<input type="checkbox"/>	83.0#
		48 x 20 x 29-1/2"	KFRR4820.E	<input type="checkbox"/>	<input type="checkbox"/>	<input type="checkbox"/>	85.0#
		54 x 20 x 29-1/2"	KFRR5420.E	<input type="checkbox"/>	<input type="checkbox"/>	<input type="checkbox"/>	88.0#
		60 x 20 x 29-1/2"	KFRR6020.E	<input type="checkbox"/>	<input type="checkbox"/>	<input type="checkbox"/>	90.0#
		30 x 24 x 29-1/2"	KFRR3024.E	<input type="checkbox"/>	<input type="checkbox"/>	<input type="checkbox"/>	78.0#
		36 x 24 x 29-1/2"	KFRR3624.E	<input type="checkbox"/>	<input type="checkbox"/>	<input type="checkbox"/>	80.0#
		42 x 24 x 29-1/2"	KFRR4224.E	<input type="checkbox"/>	<input type="checkbox"/>	<input type="checkbox"/>	83.0#
		48 x 24 x 29-1/2"	KFRR4824.E	<input type="checkbox"/>	<input type="checkbox"/>	<input type="checkbox"/>	85.0#
		54 x 24 x 29-1/2"	KFRR5424.E	<input type="checkbox"/>	<input type="checkbox"/>	<input type="checkbox"/>	88.0#
		60 x 24 x 29-1/2"	KFRR6024.E	<input type="checkbox"/>	<input type="checkbox"/>	<input type="checkbox"/>	90.0#

**A**   **B**   **C**   **D**

## HOW TO ORDER

Indicate the following information on order form:

1. Quantity of each item.
2. Model number, including options. See "How To Build a Model Number".
3. Any special service required.

Note: • The  indicates that a choice is required.

- The absence of the  indicates that no choice is required.
- Alpha-numeric characters in place of  indicate that no other alternatives are available.

## HOW TO BUILD A MODEL NUMBER

**A** Select basic model.

**B** Select edge style.

<b>F</b>	- Flat edge
<b>P3</b>	- Three wave profile edge
<b>P4</b>	- Four wave profile edge

**C** Select horizontal surface finish.

Refer to color addendum at [ki.com](http://ki.com) or KI Fabrics & Finishes binder.

**D** Select vertical surface finish.

Refer to color addendum at [ki.com](http://ki.com) or KI Fabrics & Finishes binder.





# Aristotle® Executive Returns

Flush-Left and Right, No Pedestal

Delivered Pricing

\$ 557
590
624
658
691
724
586
626
662
697
733
769

\$ 557
590
624
658
691
724
586
626
662
697
733
769

### SPECIAL SERVICES

#### Special Carton Marking

With specially marked information N/C

#### Shipping

Shipped k.d. freight prepaid f.o.b.  
KI-Aristotle Brampton, Ontario L6T 5T6  
factory. Freight class #85.

Specifications and prices are subject to  
change without prior notice.

# Aristotle® Executive Returns

Aluminum Frame Profile with Modesty and End Panel Inserts

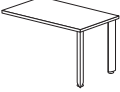
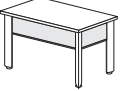
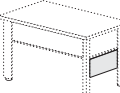
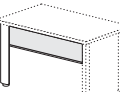
	MODEL	W x D x H	MODEL NUMBER			Approx. Packaged Weight
			Basic Model	Edge Style	Horizontal Surface Finish	
 AEPRT	<b>Return-Aluminum Frame Profile</b>	42 x 24 x 29-1/2"	KRAL4224.E	<input type="checkbox"/>	<input type="checkbox"/>	45.0#
	<ul style="list-style-type: none"> <li>1-1/2" top with choice of three edge styles</li> <li>Standard return does not feature grommet</li> <li>Two support legs, wave profile</li> <li>Optional acrylic end panel specified separately</li> <li>Aluminum leg features clear, anodized finish</li> <li>Leg provides vertical wire management</li> </ul>	48 x 24 x 29-1/2"	KRAL4824.E	<input type="checkbox"/>	<input type="checkbox"/>	50.0#
		54 x 24 x 29-1/2"	KRAL5424.E	<input type="checkbox"/>	<input type="checkbox"/>	55.0#
		60 x 24 x 29-1/2"	KRAL6024.E	<input type="checkbox"/>	<input type="checkbox"/>	61.0#
		42 x 30 x 29-1/2"	KRAL4230.E	<input type="checkbox"/>	<input type="checkbox"/>	54.0#
		48 x 30 x 29-1/2"	KRAL4830.E	<input type="checkbox"/>	<input type="checkbox"/>	61.0#
		54 x 30 x 29-1/2"	KRAL5430.E	<input type="checkbox"/>	<input type="checkbox"/>	67.0#
		60 x 30 x 29-1/2"	KRAL6030.E	<input type="checkbox"/>	<input type="checkbox"/>	74.0#
 AEPRT	<b>Return-Aluminum Frame Profile w/End and Modesty Panels</b>	42 x 24 x 29-1/2"	KRAL4224EM.E	<input type="checkbox"/>	<input type="checkbox"/>	55.0#
	<ul style="list-style-type: none"> <li>1-1/2" top with choice of three edge styles</li> <li>Standard return does not feature grommet</li> <li>Three support legs, wave profile</li> <li>Features one acrylic end panel and one acrylic modesty panel</li> <li>Aluminum leg features clear, anodized finish</li> <li>Legs provide vertical wire management</li> </ul>	48 x 24 x 29-1/2"	KRAL4824EM.E	<input type="checkbox"/>	<input type="checkbox"/>	61.0#
		54 x 24 x 29-1/2"	KRAL5424EM.E	<input type="checkbox"/>	<input type="checkbox"/>	67.0#
		60 x 24 x 29-1/2"	KRAL6024EM.E	<input type="checkbox"/>	<input type="checkbox"/>	74.0#
		42 x 30 x 29-1/2"	KRAL4230EM.E	<input type="checkbox"/>	<input type="checkbox"/>	65.0#
		48 x 30 x 29-1/2"	KRAL4830EM.E	<input type="checkbox"/>	<input type="checkbox"/>	73.0#
		54 x 30 x 29-1/2"	KRAL5430EM.E	<input type="checkbox"/>	<input type="checkbox"/>	80.0#
		60 x 30 x 29-1/2"	KRAL6030EM.E	<input type="checkbox"/>	<input type="checkbox"/>	88.0#
 HRDPT	<b>Add-On Acrylic End Panel</b>	16 x 1/4 x 10"	KAEP24			1.0#
	<ul style="list-style-type: none"> <li>For optional addition to KRAL returns</li> <li>Field retrofittable</li> <li>May be used to extend KRALEM.H end panels</li> <li>Acrylic features frosted neutral finish</li> <li>Aluminum leg features clear, anodized finish</li> </ul>	22 x 1/4 x 10"	KAEP30			1.0#
 HRDPT	<b>Add-On Acrylic Modesty Panel</b>	34 x 1/4 x 10"	KAMPL42			3.0#
	<ul style="list-style-type: none"> <li>For optional addition to KRAL returns</li> <li>Field retrofittable</li> <li>Includes support leg</li> <li>Not to be used with KRALEM.H end panels</li> <li>Acrylic features frosted neutral finish</li> <li>Aluminum leg features clear, anodized finish</li> </ul>	40 x 1/4 x 10"	KAMPL48			4.0#
		46 x 1/4 x 10"	KAMPL54			4.0#
		52 x 1/4 x 10"	KAMPL60			5.0#

**A**      **B**      **C**

## HOW TO ORDER

Indicate the following information on order form:

- Quantity of each item.
- Model number, including options. See "How To Build a Model Number".
- Any special service required.

Note: • The  indicates that a choice is required.  
 • The absence of the  indicates that no choice is required.  
 • Alpha-numeric characters in place of  indicate that no other alternatives are available.

## HOW TO BUILD A MODEL NUMBER

**A** Select basic model.

**B** Select edge style.

<b>F</b>	- Flat edge
<b>P3</b>	- Three wave profile edge
<b>P4</b>	- Four wave profile edge

**C** Select horizontal surface finish.

Refer to color addendum at [ki.com](http://ki.com) or KI Fabrics & Finishes binder.



# Aristotle® Executive Returns

Aluminum Frame Profile with Modesty and End Panel Inserts

Delivered Pricing

\$ 874  
882  
927  
949  
970  
980  
988  
1130

\$ 1497  
1523  
1592  
1637  
1615  
1641  
1678  
1842

\$ 115  
134

\$ 416  
434  
455  
475

### SPECIAL SERVICES

#### Special Carton Marking

With specially marked information N/C

#### Shipping

Shipped k.d. freight prepaid f.o.b.  
KI-Aristotle Brampton, Ontario L6T 5T6  
factory. Freight class #85.

Specifications and prices are subject to  
change without prior notice.

# Aristotle® Executive Bridge

## Bridges

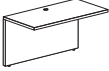
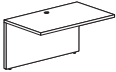
			MODEL NUMBER					Approx. Packaged Weight
MODEL	W x D x H	Basic Model	Edge Style	Horizontal Surface Finish	Vertical Surface Finish	Back Panel Height		
 AEPRT	<b>Bridge - 20"</b> • 1-1/2" top with choice of three edge styles • Back panels over 48" wide feature horizontal wood grain pattern • Grommet location center rear • Full height back panel standard; 1/2 and 3/4 height back panel available	30 x 20 x 29-1/2"	KBR3020.E	<input type="checkbox"/>	<input type="checkbox"/>	<input type="checkbox"/>	<input type="checkbox"/>	70.0#
		36 x 20 x 29-1/2"	KBR3620.E	<input type="checkbox"/>	<input type="checkbox"/>	<input type="checkbox"/>	<input type="checkbox"/>	72.0#
		42 x 20 x 29-1/2"	KBR4220.E	<input type="checkbox"/>	<input type="checkbox"/>	<input type="checkbox"/>	<input type="checkbox"/>	75.0#
		48 x 20 x 29-1/2"	KBR4820.E	<input type="checkbox"/>	<input type="checkbox"/>	<input type="checkbox"/>	<input type="checkbox"/>	77.0#
		54 x 20 x 29-1/2"	KBR5420.E	<input type="checkbox"/>	<input type="checkbox"/>	<input type="checkbox"/>	<input type="checkbox"/>	80.0#
		60 x 20 x 29-1/2"	KBR6020.E	<input type="checkbox"/>	<input type="checkbox"/>	<input type="checkbox"/>	<input type="checkbox"/>	82.0#
 AEPRT	<b>Bridge - 24"</b> • 1-1/2" top with choice of three edge styles • Back panels over 48" wide feature horizontal wood grain pattern • Grommet location center rear • Full height back panel standard; 1/2 and 3/4 height back panel available	30 x 24 x 29-1/2"	KBR3024.E	<input type="checkbox"/>	<input type="checkbox"/>	<input type="checkbox"/>	<input type="checkbox"/>	70.0#
		36 x 24 x 29-1/2"	KBR3624.E	<input type="checkbox"/>	<input type="checkbox"/>	<input type="checkbox"/>	<input type="checkbox"/>	72.0#
		42 x 24 x 29-1/2"	KBR4224.E	<input type="checkbox"/>	<input type="checkbox"/>	<input type="checkbox"/>	<input type="checkbox"/>	75.0#
		48 x 24 x 29-1/2"	KBR4824.E	<input type="checkbox"/>	<input type="checkbox"/>	<input type="checkbox"/>	<input type="checkbox"/>	77.0#
		54 x 24 x 29-1/2"	KBR5424.E	<input type="checkbox"/>	<input type="checkbox"/>	<input type="checkbox"/>	<input type="checkbox"/>	80.0#
		60 x 24 x 29-1/2"	KBR6024.E	<input type="checkbox"/>	<input type="checkbox"/>	<input type="checkbox"/>	<input type="checkbox"/>	82.0#
			<b>A</b>	<b>B</b>	<b>C</b>	<b>D</b>	<b>E</b>	

### HOW TO ORDER

Indicate the following information on order form:

- Quantity of each item.
- Model number, including options. See "How To Build a Model Number".
- Any special service required.

Note: • The  indicates that a choice is required.  
 • The absence of the  indicates that no choice is required.  
 • Alpha-numeric characters in place of  indicate that no other alternatives are available.

### HOW TO BUILD A MODEL NUMBER

- A** Select basic model.
- B** Select edge style.
- |           |                           |
|-----------|---------------------------|
| <b>F</b>  | - Flat edge               |
| <b>P3</b> | - Three wave profile edge |
| <b>P4</b> | - Four wave profile edge  |
- C** Select horizontal surface finish.  
Refer to color addendum at ki.com or KI Fabrics & Finishes binder.
- D** Select vertical surface finish.  
Refer to color addendum at ki.com or KI Fabrics & Finishes binder.
- E** Select back panel height.
- |             |                          |
|-------------|--------------------------|
| <b>FULL</b> | - Full height (standard) |
| <b>2Q</b>   | - 1/2 height back panel  |
| <b>3Q</b>   | - 3/4 height back panel  |



Delivered  
Pricing

\$ 381
435
486
546
607
668

\$ 423
478
567
657
672
711

**SPECIAL SERVICES**

**Special Carton Marking**

With specially marked information N/C

**Shipping**

Shipped k.d. freight prepaid f.o.b.  
KI-Aristotle Brampton, Ontario L6T 5T6  
factory. Freight class #85.

Specifications and prices are subject to  
change without prior notice.

# Aristotle® Executive Credenzas

Single Pedestal Credenzas-Left

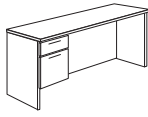
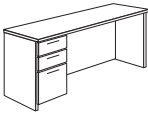
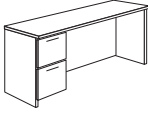
			MODEL NUMBER						
MODEL	W x D x H	Basic Model	Edge Style	Horizontal Surface Finish	Vertical Surface Finish	Pull Option	Lock Option	End Panel	
 <p>AECRD</p>	<b>Single Pedestal Credenza-Left, Box/File Option A</b>	60 x 20 x 29-1/2"	KCPL6020A.E	<input type="checkbox"/>	<input type="checkbox"/>	<input type="checkbox"/>	<input type="checkbox"/>	<input type="checkbox"/>	
	• 1-1/2" top with choice of three edge styles	66 x 20 x 29-1/2"	KCPL6620A.E	<input type="checkbox"/>	<input type="checkbox"/>	<input type="checkbox"/>	<input type="checkbox"/>	<input type="checkbox"/>	
	• Box/file locking pedestal features full extension slides	72 x 20 x 29-1/2"	KCPL7220A.E	<input type="checkbox"/>	<input type="checkbox"/>	<input type="checkbox"/>	<input type="checkbox"/>	<input type="checkbox"/>	
	• Full height back panel features horizontal wood grain pattern	60 x 24 x 29-1/2"	KCPL6024A.E	<input type="checkbox"/>	<input type="checkbox"/>	<input type="checkbox"/>	<input type="checkbox"/>	<input type="checkbox"/>	
	• Standard with no grommet	66 x 24 x 29-1/2"	KCPL6624A.E	<input type="checkbox"/>	<input type="checkbox"/>	<input type="checkbox"/>	<input type="checkbox"/>	<input type="checkbox"/>	
	• Pedestals feature locks on inside panels	72 x 24 x 29-1/2"	KCPL7224A.E	<input type="checkbox"/>	<input type="checkbox"/>	<input type="checkbox"/>	<input type="checkbox"/>	<input type="checkbox"/>	
 <p>AECRD</p>	<b>Single Pedestal Credenza-Left, Box/Box/File Option B</b>	60 x 20 x 29-1/2"	KCPL6020B.E	<input type="checkbox"/>	<input type="checkbox"/>	<input type="checkbox"/>	<input type="checkbox"/>	<input type="checkbox"/>	
	• 1-1/2" top with choice of three edge styles	66 x 20 x 29-1/2"	KCPL6620B.E	<input type="checkbox"/>	<input type="checkbox"/>	<input type="checkbox"/>	<input type="checkbox"/>	<input type="checkbox"/>	
	• Box/box/file locking pedestal features full extension slides	72 x 20 x 29-1/2"	KCPL7220B.E	<input type="checkbox"/>	<input type="checkbox"/>	<input type="checkbox"/>	<input type="checkbox"/>	<input type="checkbox"/>	
	• Upper box drawer is non-locking	60 x 24 x 29-1/2"	KCPL6024B.E	<input type="checkbox"/>	<input type="checkbox"/>	<input type="checkbox"/>	<input type="checkbox"/>	<input type="checkbox"/>	
	• Full height back panel features horizontal wood grain pattern	66 x 24 x 29-1/2"	KCPL6624B.E	<input type="checkbox"/>	<input type="checkbox"/>	<input type="checkbox"/>	<input type="checkbox"/>	<input type="checkbox"/>	
	• Standard with no grommet	72 x 24 x 29-1/2"	KCPL7224B.E	<input type="checkbox"/>	<input type="checkbox"/>	<input type="checkbox"/>	<input type="checkbox"/>	<input type="checkbox"/>	
	• Pedestals feature locks on inside panels								
 <p>AECRD</p>	<b>Single Pedestal Credenza-Left, File/File Option C</b>	60 x 20 x 29-1/2"	KCPL6020C.E	<input type="checkbox"/>	<input type="checkbox"/>	<input type="checkbox"/>	<input type="checkbox"/>	<input type="checkbox"/>	
	• 1-1/2" top with choice of three edge styles	66 x 20 x 29-1/2"	KCPL6620C.E	<input type="checkbox"/>	<input type="checkbox"/>	<input type="checkbox"/>	<input type="checkbox"/>	<input type="checkbox"/>	
	• File/file locking pedestal features full extension slides	72 x 20 x 29-1/2"	KCPL7220C.E	<input type="checkbox"/>	<input type="checkbox"/>	<input type="checkbox"/>	<input type="checkbox"/>	<input type="checkbox"/>	
	• Full height back panel features horizontal wood grain pattern	60 x 24 x 29-1/2"	KCPL6024C.E	<input type="checkbox"/>	<input type="checkbox"/>	<input type="checkbox"/>	<input type="checkbox"/>	<input type="checkbox"/>	
	• Standard with no grommet	66 x 24 x 29-1/2"	KCPL6624C.E	<input type="checkbox"/>	<input type="checkbox"/>	<input type="checkbox"/>	<input type="checkbox"/>	<input type="checkbox"/>	
	• Pedestals feature locks on inside panels	72 x 24 x 29-1/2"	KCPL7224C.E	<input type="checkbox"/>	<input type="checkbox"/>	<input type="checkbox"/>	<input type="checkbox"/>	<input type="checkbox"/>	

**A**   **B**   **C**   **D**   **E**   **F**   **G**

## HOW TO ORDER

Indicate the following information on order form:

- Quantity of each item.
- Model number, including options. See "How To Build a Model Number".
- Any special service required.

Note: • The  indicates that a choice is required.  
 • The absence of the  indicates that no choice is required.  
 • Alpha-numeric characters in place of  indicate that no other alternatives are available.

## HOW TO BUILD A MODEL NUMBER

**A** Select basic model.

**B** Select edge style.

- F** - Flat edge
- P3** - Three wave profile edge
- P4** - Four wave profile edge

**C** Select horizontal surface finish.

Refer to color addendum at ki.com or KI Fabrics & Finishes binder.

**D** Select vertical surface finish.

Refer to color addendum at ki.com or KI Fabrics & Finishes binder.

**E** Select pull option.

- BPA2** - Silver bar pull (2)
- BPA3** - Silver bar pull (3)
- KIB2** - Waterfall black pull (2)
- KIB3** - Waterfall black pull (3)
- KIS2** - Waterfall silver pull (2)
- KIS3** - Waterfall silver pull (3)

**RCP2** - Rectangular silver pull (2)

**RCP3** - Rectangular silver pull (3)

**F** Select lock option.

- KA** - Key alike
- KS** - Key standard

**G** Select end panel.

- CGR** - Recessed end panel right side
- FULL** - Full end panel both sides



# Aristotle® Executive Credenzas

Single Pedestal Credenzas-Left

Approx.  
Packaged  
Weight

Delivered  
Pricing

160.0#	\$ 1205
165.0#	1228
175.0#	1246
165.0#	1280
170.0#	1303
180.0#	1359

190.0#	\$ 1393
195.0#	1413
205.0#	1436
195.0#	1472
200.0#	1490
210.0#	1550

190.0#	\$ 1393
195.0#	1413
205.0#	1436
195.0#	1472
200.0#	1490
210.0#	1550

**SPECIAL SERVICES**

**Special Carton Marking**

With specially marked information N/C

**Shipping**

Shipped **assembled freight prepaid f.o.b. KI-Aristotle Brampton, Ontario L6T 5T6** factory. Freight class #85.

Specifications and prices are subject to change without prior notice.

# Aristotle® Executive Credenzas

Single Pedestal Credenzas-Right

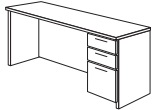
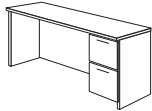
			MODEL NUMBER						
MODEL	W x D x H	Basic Model	Edge Style	Horizontal Surface Finish	Vertical Surface Finish	Pull Option	Lock Option	End Panel	
 <p>AECDR</p>	<b>Single Pedestal Credenza-Right, Box/File Option A</b>	60 x 20 x 29-1/2"	KCPR6020A.E	<input type="checkbox"/>	<input type="checkbox"/>	<input type="checkbox"/>	<input type="checkbox"/>	<input type="checkbox"/>	
	• 1-1/2" top with choice of three edge styles	66 x 20 x 29-1/2"	KCPR6620A.E	<input type="checkbox"/>	<input type="checkbox"/>	<input type="checkbox"/>	<input type="checkbox"/>	<input type="checkbox"/>	
	• Box/file locking pedestal features full extension slides	72 x 20 x 29-1/2"	KCPR7220A.E	<input type="checkbox"/>	<input type="checkbox"/>	<input type="checkbox"/>	<input type="checkbox"/>	<input type="checkbox"/>	
	• Full height back panel features horizontal wood grain pattern	60 x 24 x 29-1/2"	KCPR6024A.E	<input type="checkbox"/>	<input type="checkbox"/>	<input type="checkbox"/>	<input type="checkbox"/>	<input type="checkbox"/>	
	• Standard with no grommet	66 x 24 x 29-1/2"	KCPR6624A.E	<input type="checkbox"/>	<input type="checkbox"/>	<input type="checkbox"/>	<input type="checkbox"/>	<input type="checkbox"/>	
	• Pedestals feature locks on inside panels	72 x 24 x 29-1/2"	KCPR7224A.E	<input type="checkbox"/>	<input type="checkbox"/>	<input type="checkbox"/>	<input type="checkbox"/>	<input type="checkbox"/>	
 <p>AECDR</p>	<b>Single Pedestal Credenza-Right, Box/Box/File Option B</b>	60 x 20 x 29-1/2"	KCPR6020B.E	<input type="checkbox"/>	<input type="checkbox"/>	<input type="checkbox"/>	<input type="checkbox"/>	<input type="checkbox"/>	
	• 1-1/2" top with choice of three edge styles	66 x 20 x 29-1/2"	KCPR6620B.E	<input type="checkbox"/>	<input type="checkbox"/>	<input type="checkbox"/>	<input type="checkbox"/>	<input type="checkbox"/>	
	• Box/box/file locking pedestal features full extension slides	72 x 20 x 29-1/2"	KCPR7220B.E	<input type="checkbox"/>	<input type="checkbox"/>	<input type="checkbox"/>	<input type="checkbox"/>	<input type="checkbox"/>	
	• Upper box drawer is non-locking	60 x 24 x 29-1/2"	KCPR6024B.E	<input type="checkbox"/>	<input type="checkbox"/>	<input type="checkbox"/>	<input type="checkbox"/>	<input type="checkbox"/>	
	• Full height back panel features horizontal wood grain pattern	66 x 24 x 29-1/2"	KCPR6624B.E	<input type="checkbox"/>	<input type="checkbox"/>	<input type="checkbox"/>	<input type="checkbox"/>	<input type="checkbox"/>	
	• Standard with no grommet	72 x 24 x 29-1/2"	KCPR7224B.E	<input type="checkbox"/>	<input type="checkbox"/>	<input type="checkbox"/>	<input type="checkbox"/>	<input type="checkbox"/>	
 <p>AECDR</p>	<b>Single Pedestal Credenza-Right, File/File Option C</b>	60 x 20 x 29-1/2"	KCPR6020C.E	<input type="checkbox"/>	<input type="checkbox"/>	<input type="checkbox"/>	<input type="checkbox"/>	<input type="checkbox"/>	
	• 1-1/2" top with choice of three edge styles	66 x 20 x 29-1/2"	KCPR6620C.E	<input type="checkbox"/>	<input type="checkbox"/>	<input type="checkbox"/>	<input type="checkbox"/>	<input type="checkbox"/>	
	• File/file locking pedestal features full extension slides	72 x 20 x 29-1/2"	KCPR7220C.E	<input type="checkbox"/>	<input type="checkbox"/>	<input type="checkbox"/>	<input type="checkbox"/>	<input type="checkbox"/>	
	• Full height back panel features horizontal wood grain pattern	60 x 24 x 29-1/2"	KCPR6024C.E	<input type="checkbox"/>	<input type="checkbox"/>	<input type="checkbox"/>	<input type="checkbox"/>	<input type="checkbox"/>	
	• Standard with no grommet	66 x 24 x 29-1/2"	KCPR6624C.E	<input type="checkbox"/>	<input type="checkbox"/>	<input type="checkbox"/>	<input type="checkbox"/>	<input type="checkbox"/>	
	• Pedestals feature locks on inside panels	72 x 24 x 29-1/2"	KCPR7224C.E	<input type="checkbox"/>	<input type="checkbox"/>	<input type="checkbox"/>	<input type="checkbox"/>	<input type="checkbox"/>	
			<b>A</b>	<b>B</b>	<b>C</b>	<b>D</b>	<b>E</b>	<b>F</b>	<b>G</b>

## HOW TO ORDER

Indicate the following information on order form:

- Quantity of each item.
- Model number, including options. See "How To Build a Model Number".
- Any special service required.

Note: • The  indicates that a choice is required.  
 • The absence of the  indicates that no choice is required.  
 • Alpha-numeric characters in place of  indicate that no other alternatives are available.

## HOW TO BUILD A MODEL NUMBER

**A** Select basic model.

**B** Select edge style.

- F** - Flat edge
- P3** - Three wave profile edge
- P4** - Four wave profile edge

**C** Select horizontal surface finish.

Refer to color addendum at ki.com or KI Fabrics & Finishes binder.

**D** Select vertical surface finish.

Refer to color addendum at ki.com or KI Fabrics & Finishes binder.

**E** Select pull option.

- BPA2** - Silver bar pull (2)
- BPA3** - Silver bar pull (3)
- KIB2** - Waterfall black pull (2)
- KIB3** - Waterfall black pull (3)
- KIS2** - Waterfall silver pull (2)
- KIS3** - Waterfall silver pull (3)

**RCP2** - Rectangular silver pull (2)

**RCP3** - Rectangular silver pull (3)

**F** Select lock option.

- KA** - Key alike
- KS** - Key standard

**G** Select end panel.

- CGL** - Recessed end panel left side
- FULL** - Full end panel both sides





# Aristotle® Executive Credenzas

Single Pedestal Credenzas-Right

Approx.  
Packaged  
Weight

Delivered  
Pricing

165.0#	\$ 1205
185.0#	1228
195.0#	1246
170.0#	1280
190.0#	1303
200.0#	1359

205.0#	\$ 1393
215.0#	1413
225.0#	1436
210.0#	1472
220.0#	1490
230.0#	1550

205.0#	\$ 1393
215.0#	1413
225.0#	1436
210.0#	1472
220.0#	1490
230.0#	1550

**SPECIAL SERVICES**

**Special Carton Marking**

With specially marked information N/C



**Shipping**

Shipped **assembled freight prepaid f.o.b. KI-Aristotle Brampton, Ontario L6T 5T6** factory. Freight class #85.

Specifications and prices are subject to change without prior notice.

# Aristotle® Executive Credenzas

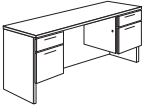
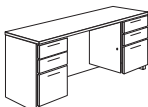
Double Pedestal Credenzas

	MODEL	W x D x H	MODEL NUMBER						Approx. Packaged Weight
			Basic Model	Edge Style	Horizontal Surface Finish	Vertical Surface Finish	Pull Option	Lock Option	
	<b>Double Pedestal Credenzas, Box/File Option A</b> • 1-1/2" top with choice of three edge styles • Box/file locking pedestals feature full extension slides • Full height back panel features horizontal wood grain pattern • Standard with no grommet • Pedestals feature locks on inside panels	60 x 20 x 29-1/2"	KCDP6020A.E	□□	□□□	□□□	□□□□	□□	230.0#
		66 x 20 x 29-1/2"	KCDP6620A.E	□□	□□□	□□□	□□□□	□□	240.0#
		72 x 20 x 29-1/2"	KCDP7220A.E	□□	□□□	□□□	□□□□	□□	250.0#
		60 x 24 x 29-1/2"	KCDP6024A.E	□□	□□□	□□□	□□□□	□□	235.0#
		66 x 24 x 29-1/2"	KCDP6624A.E	□□	□□□	□□□	□□□□	□□	245.0#
		72 x 24 x 29-1/2"	KCDP7224A.E	□□	□□□	□□□	□□□□	□□	255.0#
AECRD									
	<b>Double Pedestal Credenzas, Box/Box/File Option B</b> • 1-1/2" top with choice of three edge styles • Box/box/file locking pedestals feature full extension slides • Upper box drawer is non-locking • Full height back panel features horizontal wood grain pattern • Standard with no grommet • Pedestals feature locks on inside panels	60 x 20 x 29-1/2"	KCDP6020B.E	□□	□□□	□□□	□□□□	□□	290.0#
		66 x 20 x 29-1/2"	KCDP6620B.E	□□	□□□	□□□	□□□□	□□	300.0#
		72 x 20 x 29-1/2"	KCDP7220B.E	□□	□□□	□□□	□□□□	□□	310.0#
		60 x 24 x 29-1/2"	KCDP6024B.E	□□	□□□	□□□	□□□□	□□	295.0#
		66 x 24 x 29-1/2"	KCDP6624B.E	□□	□□□	□□□	□□□□	□□	305.0#
		72 x 24 x 29-1/2"	KCDP7224B.E	□□	□□□	□□□	□□□□	□□	315.0#
AECRD									
	<b>Double Pedestal Credenzas, File/File Option C</b> • 1-1/2" top with choice of three edge styles • File/file locking pedestals feature full extension slides • Full height back panel features horizontal wood grain pattern • Standard with no grommet • Pedestals feature locks on inside panels	60 x 20 x 29-1/2"	KCDP6020C.E	□□	□□□	□□□	□□□□	□□	290.0#
		66 x 20 x 29-1/2"	KCDP6620C.E	□□	□□□	□□□	□□□□	□□	300.0#
		72 x 20 x 29-1/2"	KCDP7220C.E	□□	□□□	□□□	□□□□	□□	310.0#
		60 x 24 x 29-1/2"	KCDP6024C.E	□□	□□□	□□□	□□□□	□□	295.0#
		66 x 24 x 29-1/2"	KCDP6624C.E	□□	□□□	□□□	□□□□	□□	305.0#
		72 x 24 x 29-1/2"	KCDP7224C.E	□□	□□□	□□□	□□□□	□□	315.0#
AECRD									

**A**      **B**      **C**      **D**      **E**      **F**

## HOW TO ORDER

Indicate the following information on order form:

- Quantity of each item.
- Model number, including options. See "How To Build a Model Number".
- Any special service required.

Note: • The □ indicates that a choice is required.  
 • The absence of the □ indicates that no choice is required.  
 • Alpha-numeric characters in place of □ indicate that no other alternatives are available.

## HOW TO BUILD A MODEL NUMBER

- A** Select basic model.
- B** Select edge style.
- |    |                           |
|----|---------------------------|
| F  | - Flat edge               |
| P3 | - Three wave profile edge |
| P4 | - Four wave profile edge  |
- C** Select horizontal surface finish.  
 Refer to color addendum at ki.com or KI Fabrics & Finishes binder.
- D** Select vertical surface finish.  
 Refer to color addendum at ki.com or KI Fabrics & Finishes binder.
- E** Select pull option.
- |      |                               |
|------|-------------------------------|
| BPA4 | - Silver bar pull (4)         |
| BPA6 | - Silver bar pull (6)         |
| KIB4 | - Waterfall black pull (4)    |
| KIB6 | - Waterfall black pull (6)    |
| KIS4 | - Waterfall silver pull (4)   |
| KIS6 | - Waterfall silver pull (6)   |
| RCP4 | - Rectangular silver pull (4) |

**RCP6** - Rectangular silver pull (6)

- F** Select lock option.
- |    |                |
|----|----------------|
| KA | - Key alike    |
| KS | - Key standard |



# Aristotle® Executive Credenzas

Double Pedestal Credenzas

Delivered Pricing

\$ 1568  
1590  
1611  
1685  
1709  
1755

\$ 1956  
1979  
1997  
2053  
2094  
2106

\$ 1956  
1979  
1997  
2053  
2094  
2106

**SPECIAL SERVICES**

**Special Carton Marking**

With specially marked information N/C

**Shipping**

Shipped **assembled freight prepaid f.o.b. KI-Aristotle Brampton, Ontario L6T 5T6** factory. Freight class #85.

Specifications and prices are subject to change without prior notice.

# Aristotle® Executive Credenzas

Double Pedestal Credenzas

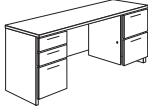
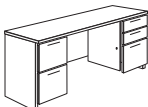
			MODEL NUMBER						Approx. Packaged Weight
MODEL	W x D x H	Basic Model	Edge Style	Horizontal Surface Finish	Vertical Surface Finish	Pull Option	Lock Option		
 <p>AECRD</p>	<b>Double Pedestal Credenzas, Box/Box/File Option F</b>	60 x 20 x 29-1/2"	KCDP6020F.E	<input type="checkbox"/>	<input type="checkbox"/>	<input type="checkbox"/>	<input type="checkbox"/>	<input type="checkbox"/>	290.0#
		66 x 20 x 29-1/2"	KCDP6620F.E	<input type="checkbox"/>	<input type="checkbox"/>	<input type="checkbox"/>	<input type="checkbox"/>	<input type="checkbox"/>	300.0#
		72 x 20 x 29-1/2"	KCDP7220F.E	<input type="checkbox"/>	<input type="checkbox"/>	<input type="checkbox"/>	<input type="checkbox"/>	<input type="checkbox"/>	310.0#
		60 x 24 x 29-1/2"	KCDP6024F.E	<input type="checkbox"/>	<input type="checkbox"/>	<input type="checkbox"/>	<input type="checkbox"/>	<input type="checkbox"/>	295.0#
		66 x 24 x 29-1/2"	KCDP6624F.E	<input type="checkbox"/>	<input type="checkbox"/>	<input type="checkbox"/>	<input type="checkbox"/>	<input type="checkbox"/>	305.0#
		72 x 24 x 29-1/2"	KCDP7224F.E	<input type="checkbox"/>	<input type="checkbox"/>	<input type="checkbox"/>	<input type="checkbox"/>	<input type="checkbox"/>	315.0#
 <p>AECRD</p>	<b>Double Pedestal Credenzas, Box/File Option G</b>	60 x 20 x 29-1/2"	KCDP6020G.E	<input type="checkbox"/>	<input type="checkbox"/>	<input type="checkbox"/>	<input type="checkbox"/>	<input type="checkbox"/>	290.0#
		66 x 20 x 29-1/2"	KCDP6620G.E	<input type="checkbox"/>	<input type="checkbox"/>	<input type="checkbox"/>	<input type="checkbox"/>	<input type="checkbox"/>	300.0#
		72 x 20 x 29-1/2"	KCDP7220G.E	<input type="checkbox"/>	<input type="checkbox"/>	<input type="checkbox"/>	<input type="checkbox"/>	<input type="checkbox"/>	310.0#
		60 x 24 x 29-1/2"	KCDP6024G.E	<input type="checkbox"/>	<input type="checkbox"/>	<input type="checkbox"/>	<input type="checkbox"/>	<input type="checkbox"/>	295.0#
		66 x 24 x 29-1/2"	KCDP6624G.E	<input type="checkbox"/>	<input type="checkbox"/>	<input type="checkbox"/>	<input type="checkbox"/>	<input type="checkbox"/>	305.0#
		72 x 24 x 29-1/2"	KCDP7224G.E	<input type="checkbox"/>	<input type="checkbox"/>	<input type="checkbox"/>	<input type="checkbox"/>	<input type="checkbox"/>	315.0#
			<b>A</b>	<b>B</b>	<b>C</b>	<b>D</b>	<b>E</b>	<b>F</b>	

## HOW TO ORDER

Indicate the following information on order form:

- Quantity of each item.
- Model number, including options. See "How To Build a Model Number".
- Any special service required.

Note:

- The  indicates that a choice is required.
- The absence of the  indicates that no choice is required.
- Alpha-numeric characters in place of  indicate that no other alternatives are available.

## HOW TO BUILD A MODEL NUMBER

- A** Select basic model.
- B** Select edge style.
 

<b>F</b>	- Flat edge
<b>P3</b>	- Three wave profile edge
<b>P4</b>	- Four wave profile edge
- C** Select horizontal surface finish.  
Refer to color addendum at ki.com or KI Fabrics & Finishes binder.
- D** Select vertical surface finish.  
Refer to color addendum at ki.com or KI Fabrics & Finishes binder.
- E** Select pull option.
 

<b>BPA5</b>	- Silver bar pull (5)
<b>KIB5</b>	- Waterfall black pull (5)
<b>KIS5</b>	- Waterfall silver pull (5)
<b>RCP5</b>	- Rectangular silver pull (5)
- F** Select lock option.
 

<b>KA</b>	- Key alike
<b>KS</b>	- Key standard



# Aristotle® Executive Credenzas

Double Pedestal Credenzas

Delivered Pricing

\$ 1956  
1979  
1997  
2053  
2094  
2106

\$ 1956  
1979  
1997  
2053  
2094  
2106

**SPECIAL SERVICES**

**Special Carton Marking**

With specially marked information N/C

**Shipping**

Shipped **assembled freight prepaid f.o.b. KI-Aristotle Brampton, Ontario L6T 5T6** factory. Freight class #85.

Specifications and prices are subject to change without prior notice.

# Aristotle® Executive Credenzas

Credenza-Center Storage

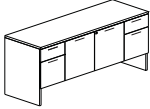
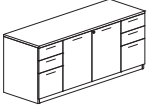
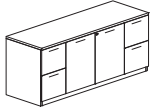
			MODEL NUMBER						Approx. Packaged Weight
MODEL	W x D x H	Basic Model	Edge Style	Horizontal Surface Finish	Vertical Surface Finish	Pull Option	Lock Option		
 <p>AECRD</p>	<b>Credenza-Center Storage and Double Box/File Pedestal</b>	60 x 20 x 29-1/2"	KCZ6020A.E	<input type="checkbox"/>	<input type="checkbox"/>	<input type="checkbox"/>	<input type="checkbox"/>	<input type="checkbox"/>	245.0#
		66 x 20 x 29-1/2"	KCZ6620A.E	<input type="checkbox"/>	<input type="checkbox"/>	<input type="checkbox"/>	<input type="checkbox"/>	<input type="checkbox"/>	255.0#
		72 x 20 x 29-1/2"	KCZ7220A.E	<input type="checkbox"/>	<input type="checkbox"/>	<input type="checkbox"/>	<input type="checkbox"/>	<input type="checkbox"/>	270.0#
		60 x 24 x 29-1/2"	KCZ6024A.E	<input type="checkbox"/>	<input type="checkbox"/>	<input type="checkbox"/>	<input type="checkbox"/>	<input type="checkbox"/>	250.0#
		66 x 24 x 29-1/2"	KCZ6624A.E	<input type="checkbox"/>	<input type="checkbox"/>	<input type="checkbox"/>	<input type="checkbox"/>	<input type="checkbox"/>	260.0#
		72 x 24 x 29-1/2"	KCZ7224A.E	<input type="checkbox"/>	<input type="checkbox"/>	<input type="checkbox"/>	<input type="checkbox"/>	<input type="checkbox"/>	275.0#
 <p>AECRD</p>	<b>Credenza-Center Storage and Double Box/File Pedestal</b>	60 x 20 x 29-1/2"	KCZ6020B.E	<input type="checkbox"/>	<input type="checkbox"/>	<input type="checkbox"/>	<input type="checkbox"/>	<input type="checkbox"/>	305.0#
		66 x 20 x 29-1/2"	KCZ6620B.E	<input type="checkbox"/>	<input type="checkbox"/>	<input type="checkbox"/>	<input type="checkbox"/>	<input type="checkbox"/>	315.0#
		72 x 20 x 29-1/2"	KCZ7220B.E	<input type="checkbox"/>	<input type="checkbox"/>	<input type="checkbox"/>	<input type="checkbox"/>	<input type="checkbox"/>	330.0#
		60 x 24 x 29-1/2"	KCZ6024B.E	<input type="checkbox"/>	<input type="checkbox"/>	<input type="checkbox"/>	<input type="checkbox"/>	<input type="checkbox"/>	310.0#
		66 x 24 x 29-1/2"	KCZ6624B.E	<input type="checkbox"/>	<input type="checkbox"/>	<input type="checkbox"/>	<input type="checkbox"/>	<input type="checkbox"/>	320.0#
		72 x 24 x 29-1/2"	KCZ7224B.E	<input type="checkbox"/>	<input type="checkbox"/>	<input type="checkbox"/>	<input type="checkbox"/>	<input type="checkbox"/>	335.0#
 <p>AECRD</p>	<b>Credenza-Center Storage and Double File/File Pedestal</b>	60 x 20 x 29-1/2"	KCZ6020C.E	<input type="checkbox"/>	<input type="checkbox"/>	<input type="checkbox"/>	<input type="checkbox"/>	<input type="checkbox"/>	305.0#
		66 x 20 x 29-1/2"	KCZ6620C.E	<input type="checkbox"/>	<input type="checkbox"/>	<input type="checkbox"/>	<input type="checkbox"/>	<input type="checkbox"/>	315.0#
		72 x 20 x 29-1/2"	KCZ7220C.E	<input type="checkbox"/>	<input type="checkbox"/>	<input type="checkbox"/>	<input type="checkbox"/>	<input type="checkbox"/>	330.0#
		60 x 24 x 29-1/2"	KCZ6024C.E	<input type="checkbox"/>	<input type="checkbox"/>	<input type="checkbox"/>	<input type="checkbox"/>	<input type="checkbox"/>	310.0#
		66 x 24 x 29-1/2"	KCZ6624C.E	<input type="checkbox"/>	<input type="checkbox"/>	<input type="checkbox"/>	<input type="checkbox"/>	<input type="checkbox"/>	320.0#
		72 x 24 x 29-1/2"	KCZ7224C.E	<input type="checkbox"/>	<input type="checkbox"/>	<input type="checkbox"/>	<input type="checkbox"/>	<input type="checkbox"/>	335.0#
			<b>A</b>	<b>B</b>	<b>C</b>	<b>D</b>	<b>E</b>	<b>F</b>	

## HOW TO ORDER

Indicate the following information on order form:

- Quantity of each item.
- Model number, including options. See "How To Build a Model Number".
- Any special service required.

Note:

- The  indicates that a choice is required.
- The absence of the  indicates that no choice is required.
- Alpha-numeric characters in place of  indicate that no other alternatives are available.

## HOW TO BUILD A MODEL NUMBER

**A** Select basic model.

**B** Select edge style.

- F** - Flat edge
- P3** - Three wave profile edge
- P4** - Four wave profile edge

**C** Select horizontal surface finish.

Refer to color addendum at ki.com or KI Fabrics & Finishes binder.

**D** Select vertical surface finish.

Refer to color addendum at ki.com or KI Fabrics & Finishes binder.

**E** Select pull option.

- BPA6** - Silver bar pull (6)
- BPA8** - Silver bar pull (8)
- KIB6** - Waterfall black pull (6)
- KIB8** - Waterfall black pull (8)
- KIS6** - Waterfall silver pull (6)
- KIS8** - Waterfall silver pull (8)

**RCP6** - Rectangular silver pull (6)

**RCP8** - Rectangular silver pull (8)

**F** Select lock option.

- KA** - Key alike
- KS** - Key standard



# Aristotle® Executive Credenzas

Credenza-Center Storage

Delivered Pricing

\$ 1893  
1918  
1950  
1979  
2064  
2133

\$ 2221  
2251  
2281  
2313  
2396  
2466

\$ 2221  
2251  
2281  
2313  
2396  
2466

**SPECIAL SERVICES**

**Special Carton Marking**

With specially marked information    N/C

**Shipping**

Shipped **assembled freight prepaid f.o.b. KI-Aristotle Brampton, Ontario L6T 5T6** factory. Freight class #85.

Specifications and prices are subject to change without prior notice.

# Aristotle® Executive Credenzas

Credenza-Lateral Files

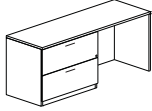
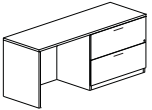
			MODEL NUMBER							
MODEL	W x D x H	Basic Model	Edge Style	Horizontal Surface Finish	Vertical Surface Finish	Pull Option	Lock Option	End Panel		
 <p>AECRD</p> <p><b>Credenza-Lateral File-Left</b></p> <ul style="list-style-type: none"> <li>• 1-1/2" top with choice of 3 edge styles</li> <li>• 36" wide lateral file features 12" drawers</li> <li>• Drawers accommodate letter and legal filing</li> <li>• Full height back panel features horizontal wood grain pattern</li> <li>• All drawers and doors standard locking and keyed alike</li> <li>• Optional front to back filing hardware specified separately</li> <li>• Standard with no grommet</li> </ul>	60 x 20 x 29-1/2"	KCFL6020.E	<input type="checkbox"/>	<input type="checkbox"/>	<input type="checkbox"/>	<input type="checkbox"/>	<input type="checkbox"/>	<input type="checkbox"/>		
	66 x 20 x 29-1/2"	KCFL6620.E	<input type="checkbox"/>	<input type="checkbox"/>	<input type="checkbox"/>	<input type="checkbox"/>	<input type="checkbox"/>	<input type="checkbox"/>		
	72 x 20 x 29-1/2"	KCFL7220.E	<input type="checkbox"/>	<input type="checkbox"/>	<input type="checkbox"/>	<input type="checkbox"/>	<input type="checkbox"/>	<input type="checkbox"/>		
	60 x 24 x 29-1/2"	KCFL6024.E	<input type="checkbox"/>	<input type="checkbox"/>	<input type="checkbox"/>	<input type="checkbox"/>	<input type="checkbox"/>	<input type="checkbox"/>		
	66 x 24 x 29-1/2"	KCFL6624.E	<input type="checkbox"/>	<input type="checkbox"/>	<input type="checkbox"/>	<input type="checkbox"/>	<input type="checkbox"/>	<input type="checkbox"/>		
	72 x 24 x 29-1/2"	KCFL7224.E	<input type="checkbox"/>	<input type="checkbox"/>	<input type="checkbox"/>	<input type="checkbox"/>	<input type="checkbox"/>	<input type="checkbox"/>		
 <p>AECRD</p> <p><b>Credenza-Lateral File-Right</b></p> <ul style="list-style-type: none"> <li>• 1-1/2" top with choice of 3 edge styles</li> <li>• 36" wide lateral file features 12" drawers</li> <li>• Drawers accommodate letter and legal filing</li> <li>• Full height back panel features horizontal wood grain pattern</li> <li>• All drawers and doors standard locking and keyed alike</li> <li>• Optional front to back filing hardware specified separately</li> <li>• Standard with no grommet</li> </ul>	60 x 20 x 29-1/2"	KCFR6020.E	<input type="checkbox"/>	<input type="checkbox"/>	<input type="checkbox"/>	<input type="checkbox"/>	<input type="checkbox"/>	<input type="checkbox"/>		
	66 x 20 x 29-1/2"	KCFR6620.E	<input type="checkbox"/>	<input type="checkbox"/>	<input type="checkbox"/>	<input type="checkbox"/>	<input type="checkbox"/>	<input type="checkbox"/>		
	72 x 20 x 29-1/2"	KCFR7220.E	<input type="checkbox"/>	<input type="checkbox"/>	<input type="checkbox"/>	<input type="checkbox"/>	<input type="checkbox"/>	<input type="checkbox"/>		
	60 x 24 x 29-1/2"	KCFR6024.E	<input type="checkbox"/>	<input type="checkbox"/>	<input type="checkbox"/>	<input type="checkbox"/>	<input type="checkbox"/>	<input type="checkbox"/>		
	66 x 24 x 29-1/2"	KCFR6624.E	<input type="checkbox"/>	<input type="checkbox"/>	<input type="checkbox"/>	<input type="checkbox"/>	<input type="checkbox"/>	<input type="checkbox"/>		
	72 x 24 x 29-1/2"	KCFR7224.E	<input type="checkbox"/>	<input type="checkbox"/>	<input type="checkbox"/>	<input type="checkbox"/>	<input type="checkbox"/>	<input type="checkbox"/>		
			<b>A</b>	<b>B</b>	<b>C</b>	<b>D</b>	<b>E</b>	<b>F</b>	<b>G</b>	

## HOW TO ORDER

Indicate the following information on order form:

1. Quantity of each item.
2. Model number, including options. See "How To Build a Model Number".
3. Any special service required.

Note: • The  indicates that a choice is required.

- The absence of the  indicates that no choice is required.
- Alpha-numeric characters in place of  indicate that no other alternatives are available.

## HOW TO BUILD A MODEL NUMBER

**A** Select basic model.

**B** Select edge style.

- F** - Flat edge  
**P3** - Three wave profile edge  
**P4** - Four wave profile edge

**C** Select horizontal surface finish.

Refer to color addendum at ki.com or KI Fabrics & Finishes binder.

**D** Select vertical surface finish.

Refer to color addendum at ki.com or KI Fabrics & Finishes binder.

**E** Select pull option.

- BPA2** - Silver bar pull (2)  
**KIB2** - Waterfall black pull (2)  
**KIS2** - Waterfall silver pull (2)  
**RCP2** - Rectangular silver pull (2)

**F** Select lock option.

- KA** - Key alike  
**KS** - Key standard

**G** Select end panel.

**CGR** - Recessed end panel right side

**CGL** - Recessed end panel left side

**FULL** - Full end panel both sides





# Aristotle® Executive Credenzas

Credenza-Lateral Files

Approx. Packaged Weight	Delivered Pricing
195.0#	\$ 1755
205.0#	1784
220.0#	1819
200.0#	1840
210.0#	1876
225.0#	1970

## SPECIAL SERVICES

### Special Carton Marking

With specially marked information N/C

### Shipping

Shipped **assembled freight prepaid f.o.b. KI-Aristotle Brampton, Ontario L6T 5T6** factory. Freight class #85.

Specifications and prices are subject to change without prior notice.





# Aristotle® Executive Credenzas

Credenza-Lateral Files

Delivered  
Pricing

\$ 2450  
2583  
2713  
2808

**SPECIAL SERVICES**

**Special Carton Marking**

With specially marked information    N/C

**Shipping**

Shipped **assembled freight prepaid f.o.b. KI-Aristotle Brampton, Ontario L6T 5T6** factory. Freight class #85.

Specifications and prices are subject to change without prior notice.

# Aristotle® Executive Credenzas

Credenza-Storage

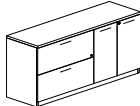
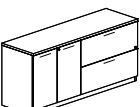
		MODEL NUMBER						Approx. Packaged Weight
MODEL	W x D x H	Basic Model	Edge Style	Horizontal Surface Finish	Vertical Surface Finish	Pull Option	Lock Option	
 <p>AECDR</p> <p><b>Credenza-Lateral File-Left and Storage-Right</b></p> <ul style="list-style-type: none"> <li>• 1-1/2" top with choice of 3 edge styles</li> <li>• 36" wide lateral file features 12" drawers</li> <li>• Drawers accommodate letter and legal filing</li> <li>• Full height back panel features horizontal wood grain pattern</li> <li>• All drawers and doors standard locking and keyed alike</li> <li>• One adjustable shelf in storage cabinet</li> <li>• Optional front to back filing hardware specified separately</li> <li>• Standard with no grommet</li> </ul>	66 x 20 x 29-1/2"	KCFS6620.E	<input type="checkbox"/>	<input type="checkbox"/>	<input type="checkbox"/>	<input type="checkbox"/>	<input type="checkbox"/>	275.0#
	72 x 20 x 29-1/2"	KCFS7220.E	<input type="checkbox"/>	<input type="checkbox"/>	<input type="checkbox"/>	<input type="checkbox"/>	<input type="checkbox"/>	290.0#
	66 x 24 x 29-1/2"	KCFS6624.E	<input type="checkbox"/>	<input type="checkbox"/>	<input type="checkbox"/>	<input type="checkbox"/>	<input type="checkbox"/>	280.0#
	72 x 24 x 29-1/2"	KCFS7224.E	<input type="checkbox"/>	<input type="checkbox"/>	<input type="checkbox"/>	<input type="checkbox"/>	<input type="checkbox"/>	295.0#
 <p>AECDR</p> <p><b>Credenza-Storage-Left and Lateral File-Right</b></p> <ul style="list-style-type: none"> <li>• 1-1/2" top with choice of 3 edge styles</li> <li>• 36" wide lateral file features 12" drawers</li> <li>• Drawers accommodate letter and legal filing</li> <li>• Full height back panel features horizontal wood grain pattern</li> <li>• All drawers and doors standard locking and keyed alike</li> <li>• One adjustable shelf in storage cabinet</li> <li>• Optional front to back filing hardware specified separately</li> <li>• Standard with no grommet</li> </ul>	66 x 20 x 29-1/2"	KCSF6620.E	<input type="checkbox"/>	<input type="checkbox"/>	<input type="checkbox"/>	<input type="checkbox"/>	<input type="checkbox"/>	240.0#
	72 x 20 x 29-1/2"	KCSF7220.E	<input type="checkbox"/>	<input type="checkbox"/>	<input type="checkbox"/>	<input type="checkbox"/>	<input type="checkbox"/>	250.0#
	66 x 24 x 29-1/2"	KCSF6624.E	<input type="checkbox"/>	<input type="checkbox"/>	<input type="checkbox"/>	<input type="checkbox"/>	<input type="checkbox"/>	260.0#
	72 x 24 x 29-1/2"	KCSF7224.E	<input type="checkbox"/>	<input type="checkbox"/>	<input type="checkbox"/>	<input type="checkbox"/>	<input type="checkbox"/>	270.0#
			<b>A</b>	<b>B</b>	<b>C</b>	<b>D</b>	<b>E</b>	<b>F</b>

## HOW TO ORDER

Indicate the following information on order form:

1. Quantity of each item.
2. Model number, including options. See "How To Build a Model Number".
3. Any special service required.

Note:

- The  indicates that a choice is required.
- The absence of the  indicates that no choice is required.
- Alpha-numeric characters in place of  indicate that no other alternatives are available.

## HOW TO BUILD A MODEL NUMBER

- A** Select basic model.
- B** Select edge style.
 

<b>F</b>	- Flat edge
<b>P3</b>	- Three wave profile edge
<b>P4</b>	- Four wave profile edge
- C** Select horizontal surface finish. Refer to color addendum at ki.com or KI Fabrics & Finishes binder.
- D** Select vertical surface finish. Refer to color addendum at ki.com or KI Fabrics & Finishes binder.
- E** Select pull option.
 

<b>BPA4</b>	- Silver bar pull (4)
<b>KIB4</b>	- Waterfall black pull (4)
<b>KIS4</b>	- Waterfall silver pull (4)
<b>RCP4</b>	- Rectangular silver pull (4)
- F** Select lock option.
 

<b>KA</b>	- Key alike
<b>KS</b>	- Key standard



# Aristotle® Executive Credenzas

Credenza-Storage

Delivered Pricing

\$ 2078  
2179  
2271  
2370

\$ 2078  
2179  
2271  
2370

**SPECIAL SERVICES**

**Special Carton Marking**

With specially marked information N/C

**Shipping**

Shipped **assembled freight prepaid f.o.b. KI-Aristotle Brampton, Ontario L6T 5T6** factory. Freight class #85.

Specifications and prices are subject to change without prior notice.

# Aristotle® Executive Credenzas

Credenza-Double Storage

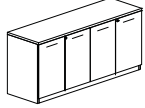

AECRD

MODEL	W x D x H	MODEL NUMBER						Approx. Packaged Weight
		Basic Model	Edge Style	Horizontal Surface Finish	Vertical Surface Finish	Pull Option	Lock Option	
<b>Credenza-Double Storage</b> <ul style="list-style-type: none"> <li>• 1-1/2" top with choice of 3 edge styles</li> <li>• One adjustable shelf in storage cabinet</li> <li>• Standard with no grommet</li> <li>• Full height back panel features horizontal wood grain pattern</li> </ul>	66 x 20 x 29-1/2"	KCSS6620.E	<input type="checkbox"/> <input type="checkbox"/>	<input type="checkbox"/> <input type="checkbox"/>	<input type="checkbox"/> <input type="checkbox"/>	<input type="checkbox"/> <input type="checkbox"/> <input type="checkbox"/> <input type="checkbox"/>	<input type="checkbox"/> <input type="checkbox"/>	265.0#
	72 x 20 x 29-1/2"	KCSS7220.E	<input type="checkbox"/> <input type="checkbox"/>	<input type="checkbox"/> <input type="checkbox"/>	<input type="checkbox"/> <input type="checkbox"/>	<input type="checkbox"/> <input type="checkbox"/> <input type="checkbox"/> <input type="checkbox"/>	<input type="checkbox"/> <input type="checkbox"/>	270.0#
	66 x 24 x 29-1/2"	KCSS6624.E	<input type="checkbox"/> <input type="checkbox"/>	<input type="checkbox"/> <input type="checkbox"/>	<input type="checkbox"/> <input type="checkbox"/>	<input type="checkbox"/> <input type="checkbox"/> <input type="checkbox"/> <input type="checkbox"/>	<input type="checkbox"/> <input type="checkbox"/>	280.0#
	72 x 24 x 29-1/2"	KCSS7224.E	<input type="checkbox"/> <input type="checkbox"/>	<input type="checkbox"/> <input type="checkbox"/>	<input type="checkbox"/> <input type="checkbox"/>	<input type="checkbox"/> <input type="checkbox"/> <input type="checkbox"/> <input type="checkbox"/>	<input type="checkbox"/> <input type="checkbox"/>	285.0#
			<b>A</b>	<b>B</b>	<b>C</b>	<b>D</b>	<b>E</b>	<b>F</b>

## HOW TO ORDER

Indicate the following information on order form:

1. Quantity of each item.
2. Model number, including options. See "How To Build a Model Number".
3. Any special service required.

Note: • The  indicates that a choice is required.  
 • The absence of the  indicates that no choice is required.  
 • Alpha-numeric characters in place of  indicate that no other alternatives are available.

## HOW TO BUILD A MODEL NUMBER

- A** Select basic model.
- B** Select edge style.
- |           |                           |
|-----------|---------------------------|
| <b>F</b>  | - Flat edge               |
| <b>P3</b> | - Three wave profile edge |
| <b>P4</b> | - Four wave profile edge  |
- C** Select horizontal surface finish.  
Refer to color addendum at ki.com or KI Fabrics & Finishes binder.
- D** Select vertical surface finish.  
Refer to color addendum at ki.com or KI Fabrics & Finishes binder.
- E** Select pull option.
- |             |                               |
|-------------|-------------------------------|
| <b>BPA4</b> | - Silver bar pull (4)         |
| <b>KIB4</b> | - Waterfall black pull (4)    |
| <b>KIS4</b> | - Waterfall silver pull (4)   |
| <b>RCP4</b> | - Rectangular silver pull (4) |
- F** Select lock option.
- |           |                |
|-----------|----------------|
| <b>KA</b> | - Key alike    |
| <b>KS</b> | - Key standard |



# Aristotle® Executive Credenzas

Credenza-Double Storage

Delivered  
Pricing

\$ 1691  
1733  
1827  
1858

**SPECIAL SERVICES**

**Special Carton Marking**

With specially marked information    N/C



**Shipping**

Shipped **assembled freight prepaid f.o.b. KI-Aristotle Brampton, Ontario L6T 5T6** factory. Freight class #85.

Specifications and prices are subject to change without prior notice.

# Aristotle® Executive Reception Workstations

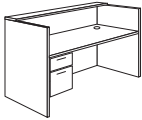
Reception Desks

		MODEL NUMBER						Approx. Packaged Weight	
MODEL	W x D x H	Basic Model	Edge Style	Horizontal Surface Finish	Vertical Surface Finish	Pull Option	Lock Option		
 <p>AEGRD</p>	<b>Reception Desk-Left, Box/File Pedestal Option A</b>	66 x 30 x 45"	KGDL6630A.E	<input type="checkbox"/>	<input type="checkbox"/>	<input type="checkbox"/>	<input type="checkbox"/>	280.0#	
		72 x 30 x 45"	KGDL7230A.E	<input type="checkbox"/>	<input type="checkbox"/>	<input type="checkbox"/>	<input type="checkbox"/>	295.0#	
		<ul style="list-style-type: none"> <li>• 1-1/2" top with choice of three edge styles</li> <li>• Box/file locking pedestal with full extension slides</li> <li>• 30" desk features full height back panel and 2 rear corner grommets</li> <li>• Full height back panel features horizontal wood grain pattern</li> <li>• 12" deep transaction top</li> <li>• 14" clearance above desktop</li> <li>• Pedestals feature locks on inside panels</li> </ul>							
 <p>AEGRD</p>	<b>Reception Desk-Right, Box/File Pedestal Option A</b>	66 x 30 x 45"	KGDR6630A.E	<input type="checkbox"/>	<input type="checkbox"/>	<input type="checkbox"/>	<input type="checkbox"/>	280.0#	
		72 x 30 x 45"	KGDR7230A.E	<input type="checkbox"/>	<input type="checkbox"/>	<input type="checkbox"/>	<input type="checkbox"/>	295.0#	
		<ul style="list-style-type: none"> <li>• 1-1/2" top with choice of three edge styles</li> <li>• Box/file locking pedestal with full extension slides</li> <li>• 30" desk features full height back panel and 2 rear corner grommets</li> <li>• Full height back panel features horizontal wood grain pattern</li> <li>• 12" deep transaction top</li> <li>• 14" clearance above desktop</li> <li>• Pedestals feature locks on inside panels</li> </ul>							
				<b>A</b>	<b>B</b>	<b>C</b>	<b>D</b>	<b>E</b>	<b>F</b>

## HOW TO ORDER

Indicate the following information on order form:

1. Quantity of each item.
2. Model number, including options. See "How To Build a Model Number".
3. Any special service required.

Note:

- The  indicates that a choice is required.
- The absence of the  indicates that no choice is required.
- Alpha-numeric characters in place of  indicate that no other alternatives are available.

## HOW TO BUILD A MODEL NUMBER

- A** Select basic model.
- B** Select edge style.
 

<b>F</b>	- Flat edge
<b>P3</b>	- Three wave profile edge
<b>P4</b>	- Four wave profile edge
- C** Select horizontal surface finish. Refer to color addendum at ki.com or KI Fabrics & Finishes binder.
- D** Select vertical surface finish. Refer to color addendum at ki.com or KI Fabrics & Finishes binder.
- E** Select pull option.
 

<b>BPA2</b>	- Silver bar pull (2)
<b>KIB2</b>	- Waterfall black pull (2)
<b>KIS2</b>	- Waterfall silver pull (2)
<b>RCP2</b>	- Rectangular silver pull (2)
- F** Select lock option.
 

<b>KA</b>	- Key alike
<b>KS</b>	- Key standard





# Aristotle® Executive Reception Workstations

Reception Desks

Delivered  
Pricing

\$ 1789

1971

\$ 1789

1971

**SPECIAL SERVICES**

**Special Carton Marking**

With specially marked information N/C



**Shipping**

Shipped **assembled freight prepaid f.o.b. KI-Aristotle Brampton, Ontario L6T 5T6** factory. Freight class #85.

Specifications and prices are subject to change without prior notice.

# Aristotle® Executive Reception Workstations

Reception Desks

		MODEL NUMBER						Approx. Packaged Weight	
		Basic Model	Edge Style	Horizontal Surface Finish	Vertical Surface Finish	Pull Option	Lock Option		
 <p>AEGRD</p>	<b>Reception Desk-Left, Box/Box/File Pedestal Option B</b> • 1-1/2" top with choice of three edge styles • Box/box/file pedestal with full extension slides (upper box drawer does not lock) • 30" desk features full height back panel and 2 rear corner grommets • Full height back panel features horizontal wood grain pattern • 12" deep transaction top • 14" clearance above desktop • Pedestals feature locks on inside panels	66 x 30 x 45"	KGDL6630B.E	<input type="checkbox"/>	<input type="checkbox"/>	<input type="checkbox"/>	<input type="checkbox"/>	<input type="checkbox"/>	310.0#
		72 x 30 x 45"	KGDL7230B.E	<input type="checkbox"/>	<input type="checkbox"/>	<input type="checkbox"/>	<input type="checkbox"/>	<input type="checkbox"/>	325.0#
 <p>AEGRD</p>	<b>Reception Desk-Right, Box/Box/File Pedestal Option B</b> • 1-1/2" top with choice of three edge styles • Box/box/file pedestal with full extension slides (upper box drawer does not lock) • 30" desk features full height back panel and 2 rear corner grommets • Full height back panel features horizontal wood grain pattern • 12" deep transaction top • 14" clearance above desktop • Pedestals feature locks on inside panels	66 x 30 x 45"	KGDR6630B.E	<input type="checkbox"/>	<input type="checkbox"/>	<input type="checkbox"/>	<input type="checkbox"/>	<input type="checkbox"/>	310.0#
		72 x 30 x 45"	KGDR7230B.E	<input type="checkbox"/>	<input type="checkbox"/>	<input type="checkbox"/>	<input type="checkbox"/>	<input type="checkbox"/>	325.0#
				<b>A</b>	<b>B</b>	<b>C</b>	<b>D</b>	<b>E</b>	<b>F</b>

## HOW TO ORDER

Indicate the following information on order form:

- Quantity of each item.
- Model number, including options. See "How To Build a Model Number".
- Any special service required.

Note: • The  indicates that a choice is required.  
 • The absence of the  indicates that no choice is required.  
 • Alpha-numeric characters in place of  indicate that no other alternatives are available.

## HOW TO BUILD A MODEL NUMBER

- A** Select basic model.
- B** Select edge style.
 

<b>F</b>	- Flat edge
<b>P3</b>	- Three wave profile edge
<b>P4</b>	- Four wave profile edge
- C** Select horizontal surface finish.  
Refer to color addendum at ki.com or KI Fabrics & Finishes binder.
- D** Select vertical surface finish.  
Refer to color addendum at ki.com or KI Fabrics & Finishes binder.
- E** Select pull option.
 

<b>BPA3</b>	- Silver bar pull (3)
<b>KIB3</b>	- Waterfall black pull (3)
<b>KIS3</b>	- Waterfall silver pull (3)
<b>RCP3</b>	- Rectangular silver pull (3)
- F** Select lock option.
 

<b>KA</b>	- Key alike
<b>KS</b>	- Key standard



# Aristotle® Executive Reception Workstations

Reception Desks

Delivered  
Pricing

\$ 1946  
2127

\$ 1946  
2127

**SPECIAL SERVICES**

**Special Carton Marking**

With specially marked information N/C

**Shipping**

Shipped **assembled freight prepaid f.o.b. KI-Aristotle Brampton, Ontario L6T 5T6** factory. Freight class #85.

Specifications and prices are subject to change without prior notice.

# Aristotle® Executive Reception Workstations

Reception Desks

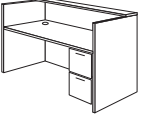
		MODEL NUMBER						Approx. Packaged Weight	
MODEL	W x D x H	Basic Model	Edge Style	Horizontal Surface Finish	Vertical Surface Finish	Pull Option	Lock Option		
 <p>AEGRD</p>	<b>Reception Desk-Left, File/File Pedestal Option C</b>	66 x 30 x 45"	KGDL6630C.E	<input type="checkbox"/>	<input type="checkbox"/>	<input type="checkbox"/>	<input type="checkbox"/>	310.0#	
		72 x 30 x 45"	KGDL7230C.E	<input type="checkbox"/>	<input type="checkbox"/>	<input type="checkbox"/>	<input type="checkbox"/>	325.0#	
	<ul style="list-style-type: none"> <li>• 1-1/2" top with choice of three edge styles</li> <li>• File/file pedestal with full extension slides</li> <li>• 30" desk features full height back panel and 2 rear corner grommets</li> <li>• Full height back panel features horizontal wood grain pattern</li> <li>• 12" deep transaction top</li> <li>• 14" clearance above desktop</li> <li>• Pedestals feature locks on inside panels</li> </ul>								
 <p>AEGRD</p>	<b>Reception Desk-Right, File/File Pedestal Option C</b>	66 x 30 x 45"	KGDR6630C.E	<input type="checkbox"/>	<input type="checkbox"/>	<input type="checkbox"/>	<input type="checkbox"/>	310.0#	
		72 x 30 x 45"	KGDR7230C.E	<input type="checkbox"/>	<input type="checkbox"/>	<input type="checkbox"/>	<input type="checkbox"/>	325.0#	
	<ul style="list-style-type: none"> <li>• 1-1/2" top with choice of three edge styles</li> <li>• File/file pedestal with full extension slides</li> <li>• 30" desk features full height back panel and 2 rear corner grommets</li> <li>• Full height back panel features horizontal wood grain pattern</li> <li>• 12" deep transaction top</li> <li>• 14" clearance above desktop</li> <li>• Pedestals feature locks on inside panels</li> </ul>								
				<b>A</b>	<b>B</b>	<b>C</b>	<b>D</b>	<b>E</b>	<b>F</b>

## HOW TO ORDER

Indicate the following information on order form:

1. Quantity of each item.
2. Model number, including options. See "How To Build a Model Number".
3. Any special service required.

Note:

- The  indicates that a choice is required.
- The absence of the  indicates that no choice is required.
- Alpha-numeric characters in place of  indicate that no other alternatives are available.

## HOW TO BUILD A MODEL NUMBER

- A** Select basic model.
- B** Select edge style.
 

<b>F</b>	- Flat edge
<b>P3</b>	- Three wave profile edge
<b>P4</b>	- Four wave profile edge
- C** Select horizontal surface finish.  
Refer to color addendum at ki.com or KI Fabrics & Finishes binder.
- D** Select vertical surface finish.  
Refer to color addendum at ki.com or KI Fabrics & Finishes binder.
- E** Select pull option.
 

<b>BPA2</b>	- Silver bar pull (2)
<b>KIB2</b>	- Waterfall black pull (2)
<b>KIS2</b>	- Waterfall silver pull (2)
<b>RCP2</b>	- Rectangular silver pull (2)
- F** Select lock option.
 

<b>KA</b>	- Key alike
<b>KS</b>	- Key standard



# Aristotle® Executive Reception Workstations

Reception Desks

Delivered  
Pricing

\$ 1946  
2127

\$ 1946  
2127

**SPECIAL SERVICES**

**Special Carton Marking**

With specially marked information N/C



**Shipping**

Shipped **assembled freight prepaid f.o.b. KI-Aristotle Brampton, Ontario L6T 5T6** factory. Freight class #85.

Specifications and prices are subject to change without prior notice.

# Aristotle® Executive Reception Workstations

## Bow Front Reception Desks

		MODEL NUMBER						Approx. Packaged Weight	
MODEL	W x D x H	Basic Model	Edge Style	Horizontal Surface Finish	Vertical Surface Finish	Pull Option	Lock Option		
 <p>AEGRD</p>	<b>Bow Front Reception Desk-Left, Box/File Option A</b>	66 x 36 x 45"	KGDBL6636A.E	<input type="checkbox"/>	<input type="checkbox"/>	<input type="checkbox"/>	<input type="checkbox"/>	290.0#	
	<ul style="list-style-type: none"> <li>• 1-1/2" top with choice of three edge styles</li> <li>• Bow Front transaction counter is 18" deep with 6" overhang</li> <li>• Box/file locking pedestal with full extension slides</li> <li>• 30" desk features full height back panel and 2 rear corner grommets</li> <li>• Full height back panel features horizontal wood grain pattern</li> <li>• 12" deep transaction top</li> <li>• 14" clearance above desktop</li> <li>• Pedestals feature locks on inside panels</li> </ul>	72 x 36 x 45"	KGDBL7236A.E	<input type="checkbox"/>	<input type="checkbox"/>	<input type="checkbox"/>	<input type="checkbox"/>	305.0#	
 <p>AEGRD</p>	<b>Bow Front Reception Desk-Right, Box/File Option A</b>	66 x 36 x 45"	KGDBR6636A.E	<input type="checkbox"/>	<input type="checkbox"/>	<input type="checkbox"/>	<input type="checkbox"/>	290.0#	
	<ul style="list-style-type: none"> <li>• 1-1/2" top with choice of three edge styles</li> <li>• Bow Front transaction counter is 18" deep with 6" overhang</li> <li>• Box/file locking pedestal with full extension slides</li> <li>• 30" desk features full height back panel and 2 rear corner grommets</li> <li>• Full height back panel features horizontal wood grain pattern</li> <li>• 12" deep transaction top</li> <li>• 14" clearance above desktop</li> <li>• Pedestals feature locks on inside panels</li> </ul>	72 x 36 x 45"	KGDBR7236A.E	<input type="checkbox"/>	<input type="checkbox"/>	<input type="checkbox"/>	<input type="checkbox"/>	305.0#	
				<b>A</b>	<b>B</b>	<b>C</b>	<b>D</b>	<b>E</b>	<b>F</b>

### HOW TO ORDER

Indicate the following information on order form:

1. Quantity of each item.
2. Model number, including options. See "How To Build a Model Number".
3. Any special service required.

Note:

- The  indicates that a choice is required.
- The absence of the  indicates that no choice is required.
- Alpha-numeric characters in place of  indicate that no other alternatives are available.

### HOW TO BUILD A MODEL NUMBER

- A** Select basic model.
- B** Select edge style.
 

<b>F</b>	- Flat edge
<b>P3</b>	- Three wave profile edge
<b>P4</b>	- Four wave profile edge
- C** Select horizontal surface finish.  
Refer to color addendum at ki.com or KI Fabrics & Finishes binder.
- D** Select vertical surface finish.  
Refer to color addendum at ki.com or KI Fabrics & Finishes binder.
- E** Select pull option.
 

<b>BPA2</b>	- Silver bar pull (2)
<b>KIB2</b>	- Waterfall black pull (2)
<b>KIS2</b>	- Waterfall silver pull (2)
<b>RCP2</b>	- Rectangular silver pull (2)
- F** Select lock option.
 

<b>KA</b>	- Key alike
<b>KS</b>	- Key standard



# Aristotle® Executive Reception Workstations

Bow Front Reception Desks

Delivered  
Pricing

\$ 1869  
2064

\$ 1869  
2064

**SPECIAL SERVICES**

**Special Carton Marking**

With specially marked information    N/C



**Shipping**

Shipped **assembled freight prepaid f.o.b. KI-Aristotle Brampton, Ontario L6T 5T6** factory. Freight class #85.

Specifications and prices are subject to change without prior notice.

# Aristotle® Executive Reception Workstations

## Bow Front Reception Desks

		MODEL NUMBER						Approx. Packaged Weight	
MODEL	W x D x H	Basic Model	Edge Style	Horizontal Surface Finish	Vertical Surface Finish	Pull Option	Lock Option		
 <p>AEGRD</p>	<b>Bow Front Reception Desk-Left, Box/Box/File Option B</b>	66 x 36 x 45"	KGDBL6636B.E	<input type="checkbox"/>	<input type="checkbox"/>	<input type="checkbox"/>	<input type="checkbox"/>	320.0#	
	<ul style="list-style-type: none"> <li>1-1/2" top with choice of three edge styles</li> <li>Bow Front transaction counter is 18" deep with 6" overhang</li> <li>Box/box/file pedestal with full extension slides (upper box drawer does not lock)</li> <li>30" desk features full height back panel and 2 rear corner grommets</li> <li>Full height back panel features horizontal wood grain pattern</li> <li>12" deep transaction top</li> <li>14" clearance above desktop</li> <li>Pedestals feature locks on inside panels</li> </ul>	72 x 36 x 45"	KGDBL7236B.E	<input type="checkbox"/>	<input type="checkbox"/>	<input type="checkbox"/>	<input type="checkbox"/>	335.0#	
 <p>AEGRD</p>	<b>Bow Front Reception Desk-Right, Box/Box/File Option B</b>	66 x 36 x 45"	KGDBR6636B.E	<input type="checkbox"/>	<input type="checkbox"/>	<input type="checkbox"/>	<input type="checkbox"/>	320.0#	
	<ul style="list-style-type: none"> <li>1-1/2" top with choice of three edge styles</li> <li>Bow Front transaction counter is 18" deep with 6" overhang</li> <li>Box/box/file pedestal with full extension slides (upper box drawer does not lock)</li> <li>30" desk features full height back panel and 2 rear corner grommets</li> <li>Full height back panel features horizontal wood grain pattern</li> <li>12" deep transaction top</li> <li>14" clearance above desktop</li> <li>Pedestals feature locks on inside panels</li> </ul>	72 x 36 x 45"	KGDBR7236B.E	<input type="checkbox"/>	<input type="checkbox"/>	<input type="checkbox"/>	<input type="checkbox"/>	335.0#	
				<b>A</b>	<b>B</b>	<b>C</b>	<b>D</b>	<b>E</b>	<b>F</b>

### HOW TO ORDER

Indicate the following information on order form:

- Quantity of each item.
- Model number, including options. See "How To Build a Model Number".
- Any special service required.

Note:

- The  indicates that a choice is required.
- The absence of the  indicates that no choice is required.
- Alpha-numeric characters in place of  indicate that no other alternatives are available.

### HOW TO BUILD A MODEL NUMBER

- A** Select basic model.
- B** Select edge style.
 

<b>F</b>	- Flat edge
<b>P3</b>	- Three wave profile edge
<b>P4</b>	- Four wave profile edge
- C** Select horizontal surface finish. Refer to color addendum at ki.com or KI Fabrics & Finishes binder.
- D** Select vertical surface finish. Refer to color addendum at ki.com or KI Fabrics & Finishes binder.
- E** Select pull option.
 

<b>BPA3</b>	- Silver bar pull (3)
<b>KIB3</b>	- Waterfall black pull (3)
<b>KIS3</b>	- Waterfall silver pull (3)
<b>RCP3</b>	- Rectangular silver pull (3)
- F** Select lock option.
 

<b>KA</b>	- Key alike
<b>KS</b>	- Key standard





# Aristotle® Executive Reception Workstations

Bow Front Reception Desks

Delivered  
Pricing

\$ 2024  
2208

\$ 2024  
2208

**SPECIAL SERVICES**

**Special Carton Marking**

With specially marked information N/C



**Shipping**

Shipped **assembled freight prepaid f.o.b. KI-Aristotle Brampton, Ontario L6T 5T6** factory. Freight class #85.

Specifications and prices are subject to change without prior notice.

# Aristotle® Executive Reception Workstations

## Bow Front Reception Desks

		MODEL NUMBER						Approx. Packaged Weight	
MODEL	W x D x H	Basic Model	Edge Style	Horizontal Surface Finish	Vertical Surface Finish	Pull Option	Lock Option		
 <p>AEGRD</p>	<b>Bow Front Reception Desk-Left, File/File Option C</b>	66 x 36 x 45"	KGDBL6636C.E	<input type="checkbox"/>	<input type="checkbox"/>	<input type="checkbox"/>	<input type="checkbox"/>	320.0#	
	<ul style="list-style-type: none"> <li>• 1-1/2" top with choice of three edge styles</li> <li>• Bow Front transaction counter is 18" deep with 6" overhang</li> <li>• File/file pedestal with full extension slides</li> <li>• 30" desk features full height back panel and 2 rear corner grommets</li> <li>• Full height back panel features horizontal wood grain pattern</li> <li>• 14" clearance above desktop</li> <li>• Pedestals feature locks on inside panels</li> </ul>	72 x 36 x 45"	KGDBL7236C.E	<input type="checkbox"/>	<input type="checkbox"/>	<input type="checkbox"/>	<input type="checkbox"/>	335.0#	
 <p>AEGRD</p>	<b>Bow Front Reception Desk-Right, File/File Option C</b>	66 x 36 x 45"	KGDBR6636C.E	<input type="checkbox"/>	<input type="checkbox"/>	<input type="checkbox"/>	<input type="checkbox"/>	320.0#	
	<ul style="list-style-type: none"> <li>• 1-1/2" top with choice of three edge styles</li> <li>• Bow Front transaction counter is 18" deep with 6" overhang</li> <li>• File/file pedestal with full extension slides</li> <li>• 30" desk features full height back panel and 2 rear corner grommets</li> <li>• Full height back panel features horizontal wood grain pattern</li> <li>• 12" deep transaction top</li> <li>• 14" clearance above desktop</li> <li>• Pedestals feature locks on inside panels</li> </ul>	72 x 36 x 45"	KGDBR7236C.E	<input type="checkbox"/>	<input type="checkbox"/>	<input type="checkbox"/>	<input type="checkbox"/>	335.0#	
				<b>A</b>	<b>B</b>	<b>C</b>	<b>D</b>	<b>E</b>	<b>F</b>

### HOW TO ORDER

Indicate the following information on order form:

1. Quantity of each item.
2. Model number, including options. See "How To Build a Model Number".
3. Any special service required.

Note:

- The  indicates that a choice is required.
- The absence of the  indicates that no choice is required.
- Alpha-numeric characters in place of  indicate that no other alternatives are available.

### HOW TO BUILD A MODEL NUMBER

- A** Select basic model.
- B** Select edge style.
 

<b>F</b>	- Flat edge
<b>P3</b>	- Three wave profile edge
<b>P4</b>	- Four wave profile edge
- C** Select horizontal surface finish. Refer to color addendum at ki.com or KI Fabrics & Finishes binder.
- D** Select vertical surface finish. Refer to color addendum at ki.com or KI Fabrics & Finishes binder.
- E** Select pull option.
 

<b>BPA2</b>	- Silver bar pull (2)
<b>KIB2</b>	- Waterfall black pull (2)
<b>KIS2</b>	- Waterfall silver pull (2)
<b>RCP2</b>	- Rectangular silver pull (2)
- F** Select lock option.
 

<b>KA</b>	- Key alike
<b>KS</b>	- Key standard



# Aristotle® Executive Reception Workstations

Bow Front Reception Desks

Delivered  
Pricing

\$ 2024

2208

\$ 2024

2208

**SPECIAL SERVICES**

**Special Carton Marking**

With specially marked information N/C



**Shipping**

Shipped **assembled freight prepaid f.o.b. KI-Aristotle Brampton, Ontario L6T 5T6** factory. Freight class #85.

Specifications and prices are subject to change without prior notice.

# Aristotle® Executive Reception Workstations

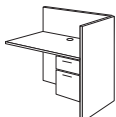
Returns

		MODEL NUMBER						Approx. Packaged Weight	
		Basic Model	Edge Style	Horizontal Surface Finish	Vertical Surface Finish	Pull Option	Lock Option		
 <p>AEGRD</p>	<b>Reception Return-Left, Box/File Pedestal Option A</b> • 1-1/2" top with choice of three edge styles • Box/file locking pedestal with full extension slides • 24" deep return features 1 rear center grommet • Pedestals feature locks on inside panels	42 x 24 x 43-1/2"	KGRL4224A.E	<input type="checkbox"/>	<input type="checkbox"/>	<input type="checkbox"/>	<input type="checkbox"/>	<input type="checkbox"/>	140.0#
		48 x 24 x 43-1/2"	KGRL4824A.E	<input type="checkbox"/>	<input type="checkbox"/>	<input type="checkbox"/>	<input type="checkbox"/>	<input type="checkbox"/>	145.0#
 <p>AEGRD</p>	<b>Reception Return-Right, Box/File Pedestal Option A</b> • 1-1/2" top with choice of three edge styles • Box/file locking pedestal with full extension slides • 24" deep return features 1 rear center grommet • Pedestals feature locks on inside panels	42 x 24 x 43-1/2"	KGRR4224A.E	<input type="checkbox"/>	<input type="checkbox"/>	<input type="checkbox"/>	<input type="checkbox"/>	<input type="checkbox"/>	140.0#
		48 x 24 x 43-1/2"	KGRR4824A.E	<input type="checkbox"/>	<input type="checkbox"/>	<input type="checkbox"/>	<input type="checkbox"/>	<input type="checkbox"/>	145.0#
 <p>AEGRD</p>	<b>Reception Return-Left, Box/Box/File Pedestal Option B</b> • 1-1/2" top with choice of three edge styles • Box/box/file pedestal with full extension slides (upper box drawer does not lock) • 24" deep return features 1 rear center grommet • Pedestals feature locks on inside panels	42 x 24 x 43-1/2"	KGRL4224B.E	<input type="checkbox"/>	<input type="checkbox"/>	<input type="checkbox"/>	<input type="checkbox"/>	<input type="checkbox"/>	170.0#
		48 x 24 x 43-1/2"	KGRL4824B.E	<input type="checkbox"/>	<input type="checkbox"/>	<input type="checkbox"/>	<input type="checkbox"/>	<input type="checkbox"/>	175.0#
 <p>AEGRD</p>	<b>Reception Return-Right, Box/Box/File Pedestal Option B</b> • 1-1/2" top with choice of three edge styles • Box/box/file pedestal with full extension slides (upper box drawer does not lock) • 24" deep return features 1 rear center grommet • Pedestals feature locks on inside panels	42 x 24 x 43-1/2"	KGRR4224B.E	<input type="checkbox"/>	<input type="checkbox"/>	<input type="checkbox"/>	<input type="checkbox"/>	<input type="checkbox"/>	170.0#
		48 x 24 x 43-1/2"	KGRR4824B.E	<input type="checkbox"/>	<input type="checkbox"/>	<input type="checkbox"/>	<input type="checkbox"/>	<input type="checkbox"/>	175.0#

**A**      **B**      **C**      **D**      **E**      **F**

## HOW TO ORDER

Indicate the following information on order form:

- Quantity of each item.
- Model number, including options. See "How To Build a Model Number".
- Any special service required.

Note: • The  indicates that a choice is required.  
 • The absence of the  indicates that no choice is required.  
 • Alpha-numeric characters in place of  indicate that no other alternatives are available.

## HOW TO BUILD A MODEL NUMBER

- A** Select basic model.
 

KA	- Key alike
KS	- Key standard
- B** Select edge style.
 

F	- Flat edge
P3	- Three wave profile edge
P4	- Four wave profile edge
- C** Select horizontal surface finish.  
Refer to color addendum at ki.com or KI Fabrics & Finishes binder.
- D** Select vertical surface finish.  
Refer to color addendum at ki.com or KI Fabrics & Finishes binder.
- E** Select pull option.
 

BPA2	- Silver bar pull (2)
BPA3	- Silver bar pull (3)
KIB2	- Waterfall black pull (2)
KIB3	- Waterfall black pull (3)
KIS2	- Waterfall silver pull (2)
KIS3	- Waterfall silver pull (3)
RCP2	- Rectangular silver pull (2)
RCP3	- Rectangular silver pull (3)
- F** Select lock option.
 

KA	- Key alike
KS	- Key standard



# Aristotle® Executive Reception Workstations

Returns

Delivered  
Pricing

\$ 1155

1193

\$ 1155

1193

\$ 1339

1376

\$ 1339

1376

**SPECIAL SERVICES**

**Special Carton Marking**

With specially marked information N/C

**Shipping**

Shipped **assembled freight prepaid f.o.b. KI-Aristotle Brampton, Ontario L6T 5T6** factory. Freight class #85.

Specifications and prices are subject to change without prior notice.

# Aristotle® Executive Reception Workstations

Returns

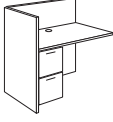
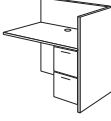
		MODEL NUMBER							Approx. Packaged Weight
			Basic Model	Edge Style	Horizontal Surface Finish	Vertical Surface Finish	Pull Option	Lock Option	
MODEL	W x D x H								
 <p>AEGRD</p>	<b>Reception Return-Left, File/File Pedestal Option C</b>	42 x 24 x 43-1/2"	KGRL4224C.E	<input type="checkbox"/>	<input type="checkbox"/>	<input type="checkbox"/>	<input type="checkbox"/>	<input type="checkbox"/>	170.0#
		48 x 24 x 43-1/2"	KGRL4824C.E	<input type="checkbox"/>	<input type="checkbox"/>	<input type="checkbox"/>	<input type="checkbox"/>	<input type="checkbox"/>	175.0#
		<ul style="list-style-type: none"> <li>• 1-1/2" top with choice of three edge styles</li> <li>• Box/file locking pedestal with full extension slides</li> <li>• 24" deep return features 1 rear center grommet</li> <li>• Pedestals feature locks on inside panels</li> </ul>							
 <p>AEGRD</p>	<b>Reception Return-Right, Pedestal Option C</b>	42 x 24 x 43-1/2"	KGRR4224C.E	<input type="checkbox"/>	<input type="checkbox"/>	<input type="checkbox"/>	<input type="checkbox"/>	<input type="checkbox"/>	170.0#
		48 x 24 x 43-1/2"	KGRR4824C.E	<input type="checkbox"/>	<input type="checkbox"/>	<input type="checkbox"/>	<input type="checkbox"/>	<input type="checkbox"/>	175.0#
		<ul style="list-style-type: none"> <li>• 1-1/2" top with choice of three edge styles</li> <li>• Box/file locking pedestal with full extension slides</li> <li>• 24" deep return features 1 rear center grommet</li> <li>• Pedestals feature locks on inside panels</li> </ul>							

A
B
C
D
E
F

## HOW TO ORDER

Indicate the following information on order form:

1. Quantity of each item.
2. Model number, including options. See "How To Build a Model Number".
3. Any special service required.

Note:

- The  indicates that a choice is required.
- The absence of the  indicates that no choice is required.
- Alpha-numeric characters in place of  indicate that no other alternatives are available.

## HOW TO BUILD A MODEL NUMBER

- A** Select basic model.
- B** Select edge style.
 

F	- Flat edge
P3	- Three wave profile edge
P4	- Four wave profile edge
- C** Select horizontal surface finish. Refer to color addendum at ki.com or KI Fabrics & Finishes binder.
- D** Select vertical surface finish. Refer to color addendum at ki.com or KI Fabrics & Finishes binder.
- E** Select pull option.
 

BPA2	- Silver bar pull (2)
KIB2	- Waterfall black pull (2)
KIS2	- Waterfall silver pull (2)
RCP2	- Rectangular silver pull (2)
- F** Select lock option.
 

KA	- Key alike
KS	- Key standard



# Aristotle® Executive Reception Workstations

Returns

Delivered  
Pricing

\$ 1339

1376

\$ 1339

1376

**SPECIAL SERVICES**

**Special Carton Marking**

With specially marked information    N/C

**Shipping**

Shipped **assembled freight prepaid f.o.b. KI-Aristotle Brampton, Ontario L6T 5T6** factory. Freight class #85.

Specifications and prices are subject to change without prior notice.

# Aristotle® Executive Reception Workstations

Returns

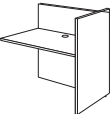
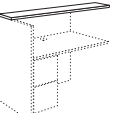
	MODEL	W x D x H	MODEL NUMBER				Approx. Packaged Weight
			Basic Model	Edge Style	Horizontal Surface Finish	Vertical Surface Finish	
	<b>Reception Return-Left, No Pedestal</b> • 1-1/2" top with choice of three edge styles • 24" deep return features 1 rear center grommet	42 x 24 x 43-1/2"	KGRL4224.E	<input type="checkbox"/>	<input type="checkbox"/>	<input type="checkbox"/>	95.0#
		48 x 24 x 43-1/2"	KGRL4824.E	<input type="checkbox"/>	<input type="checkbox"/>	<input type="checkbox"/>	105.0#
AEGRD							
	<b>Reception Return-Right, No Pedestal</b> • 1-1/2" top with choice of three edge styles • 24" deep return features 1 rear center grommet	42 x 24 x 43-1/2"	KGRR4224.E	<input type="checkbox"/>	<input type="checkbox"/>	<input type="checkbox"/>	95.0#
		48 x 24 x 43-1/2"	KGRR4824.E	<input type="checkbox"/>	<input type="checkbox"/>	<input type="checkbox"/>	105.0#
AEGRD							
	<b>Reception Return Transaction Top</b> • 1-1/2" top with choice of three edge styles • Field installed • Replacement top only	60 x 12 x 1"	KGRTT42.E	<input type="checkbox"/>	<input type="checkbox"/>		22.0#
		66 x 12 x 1"	KGRTT48.E	<input type="checkbox"/>	<input type="checkbox"/>		25.0#
AEGRD							

**A**   **B**   **C**   **D**

## HOW TO ORDER

Indicate the following information on order form:

- Quantity of each item.
- Model number, including options. See "How To Build a Model Number".
- Any special service required.

Note: • The  indicates that a choice is required.  
 • The absence of the  indicates that no choice is required.  
 • Alpha-numeric characters in place of  indicate that no other alternatives are available.

## HOW TO BUILD A MODEL NUMBER

- A** Select basic model.
- B** Select edge style.
 

<b>F</b>	- Flat edge
<b>P3</b>	- Three wave profile edge
<b>P4</b>	- Four wave profile edge
- C** Select horizontal surface finish.  
 Refer to color addendum at [ki.com](http://ki.com) or KI Fabrics & Finishes binder.
- D** Select vertical surface finish.  
 Refer to color addendum at [ki.com](http://ki.com) or KI Fabrics & Finishes binder.





# Aristotle® Executive Reception Workstations

Returns

Delivered  
Pricing

\$ 573

606

\$ 573

606

\$ 192

206

**SPECIAL SERVICES**

**Special Carton Marking**

With specially marked information N/C

**Shipping**

Shipped k.d. freight prepaid f.o.b.  
KI-Aristotle Brampton, Ontario L6T 5T6  
factory. Freight class #85.

Specifications and prices are subject to  
change without prior notice.

# Aristotle® Executive Shells

## Corner Units

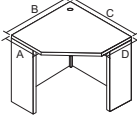
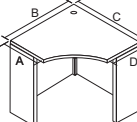
	Opening	A x B x C x D	MODEL NUMBER							Approx. Packaged Weight
			Basic Model	Edge Style	Horizontal Surface Finish	Vertical Surface Finish	Leg Finish	Back Panel Height	Grommets	
 <p>AESPD</p> <p><b>Straight Corner</b></p> <ul style="list-style-type: none"> <li>• 1-1/2" top with choice of three edge styles</li> <li>• Corner post in black or silver</li> <li>• Left and right recessed end panels standard</li> <li>• One optional grommet center rear</li> <li>• 29-1/2" Height</li> </ul>	25"	18 x 36 x 36 x 18"	KCC361818.E	□□	□□□	□□□	□□	□□□□	□□□	85.0#
	21"	20 x 36 x 36 x 20"	KCC362020.E	□□	□□□	□□□	□□	□□□□	□□□	85.0#
	17"	24 x 36 x 36 x 24"	KCC362424.E	□□	□□□	□□□	□□	□□□□	□□□	85.0#
	25"	24 x 42 x 42 x 24"	KCC422424.E	□□	□□□	□□□	□□	□□□□	□□□	105.0#
	17"	30 x 42 x 42 x 30"	KCC423030.E	□□	□□□	□□□	□□	□□□□	□□□	105.0#
	22"	24 x 42 x 42 x 30"	KCC422430.E	□□	□□□	□□□	□□	□□□□	□□□	105.0#
	22"	30 x 42 x 42 x 24"	KCC423024.E	□□	□□□	□□□	□□	□□□□	□□□	105.0#
	30"	24 x 48 x 48 x 30"	KCC482430.E	□□	□□□	□□□	□□	□□□□	□□□	125.0#
	30"	30 x 48 x 48 x 24"	KCC483024.E	□□	□□□	□□□	□□	□□□□	□□□	125.0#
	34"	24 x 48 x 48 x 24"	KCC482424.E	□□	□□□	□□□	□□	□□□□	□□□	125.0#
25"	30 x 48 x 48 x 30"	KCC483030.E	□□	□□□	□□□	□□	□□□□	□□□	125.0#	
 <p>AESPD</p> <p><b>Curvilinear Corner</b></p> <ul style="list-style-type: none"> <li>• 1-1/2" top with choice of three edge styles</li> <li>• Corner post in black or silver</li> <li>• Left and right recessed end panels standard</li> <li>• One optional grommet center rear</li> <li>• 29-1/2" Height</li> </ul>		18 x 36 x 36 x 18"	KCV361818.E	□□	□□□	□□□	□□	□□□□	□□□	85.0#
		20 x 36 x 36 x 20"	KCV362020.E	□□	□□□	□□□	□□	□□□□	□□□	85.0#
		24 x 36 x 36 x 24"	KCV362424.E	□□	□□□	□□□	□□	□□□□	□□□	85.0#
		24 x 42 x 42 x 24"	KCV422424.E	□□	□□□	□□□	□□	□□□□	□□□	105.0#
		30 x 42 x 42 x 30"	KCV423030.E	□□	□□□	□□□	□□	□□□□	□□□	105.0#
		24 x 48 x 48 x 24"	KCV482424.E	□□	□□□	□□□	□□	□□□□	□□□	125.0#
		30 x 48 x 48 x 30"	KCV483030.E	□□	□□□	□□□	□□	□□□□	□□□	125.0#

**A**   **B**   **C**   **D**   **E**   **F**   **G**

### HOW TO ORDER

Indicate the following information on order form:

1. Quantity of each item.
2. Model number, including options. See "How To Build a Model Number".
3. Any special service required.

Note:

- The □ indicates that a choice is required.
- The absence of the □ indicates that no choice is required.
- Alpha-numeric characters in place of □ indicate that no other alternatives are available.

### HOW TO BUILD A MODEL NUMBER

- A** Select basic model.
- B** Select edge style.
  - F** - Flat edge
  - P3** - Three wave profile edge
  - P4** - Four wave profile edge
- C** Select horizontal surface finish. Refer to color addendum at ki.com or KI Fabrics & Finishes binder.
- D** Select vertical surface finish. Refer to color addendum at ki.com or KI Fabrics & Finishes binder.
- E** Select corner leg finish. Refer to color addendum at ki.com or KI Fabrics & Finishes binder.
- F** Select back panel height.
  - FULL** - Full height (standard)
  - 2Q** - 1/2 height back panel
  - 2QL** - 1/2 height back panel, right

- 2QR** - 1/2 height back panel, left
- 3Q** - 3/4 height back panel
- 3QL** - 3/4 height back panel, left
- 3QR** - 3/4 height back panel, right

- G** Select grommets.
  - NGR** - No grommet
  - G** - Grommet
 Grommets are factory installed.



Delivered  
Pricing

\$ 912
912
912
1085
1085
1085
1085
1223
1223
1223

\$ 912
912
912
1085
1085
1223
1223

**SPECIAL SERVICES**

**Special Carton Marking**

With specially marked information N/C

**Shipping**

Shipped k.d. freight prepaid f.o.b.  
KI-Aristotle Brampton, Ontario L6T 5T6  
factory. Freight class #85.

Specifications and prices are subject to  
change without prior notice.

# Aristotle® Executive Shells

Desk Shells-20"

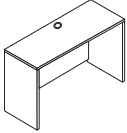
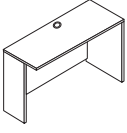
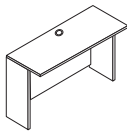
	MODEL	W x D x H	MODEL NUMBER						Approx. Packaged Weight
			Basic Model	Edge Style	Horizontal Surface Finish	Vertical Surface Finish	Back Panel Height	Grommets	
 <p>AESPD</p>	<b>Desk Shells-20" Option A - Two Full End Panels</b> • 1-1/2" top with choice of three edge styles • Back panel features horizontal grain pattern • Recessed center support panel included with desk shells 78" or wider • Optional desk shelf, specified separately • Optional 1/2 and 3/4 height back panels options listed below • One optional grommet center rear	24 x 20 x 29-1/2"	KDA2420.E	<input type="checkbox"/>	<input type="checkbox"/>	<input type="checkbox"/>	<input type="checkbox"/>	<input type="checkbox"/>	73.0#
		30 x 20 x 29-1/2"	KDA3020.E	<input type="checkbox"/>	<input type="checkbox"/>	<input type="checkbox"/>	<input type="checkbox"/>	<input type="checkbox"/>	78.0#
		36 x 20 x 29-1/2"	KDA3620.E	<input type="checkbox"/>	<input type="checkbox"/>	<input type="checkbox"/>	<input type="checkbox"/>	<input type="checkbox"/>	82.0#
		42 x 20 x 29-1/2"	KDA4220.E	<input type="checkbox"/>	<input type="checkbox"/>	<input type="checkbox"/>	<input type="checkbox"/>	<input type="checkbox"/>	87.0#
		48 x 20 x 29-1/2"	KDA4820.E	<input type="checkbox"/>	<input type="checkbox"/>	<input type="checkbox"/>	<input type="checkbox"/>	<input type="checkbox"/>	96.0#
		54 x 20 x 29-1/2"	KDA5420.E	<input type="checkbox"/>	<input type="checkbox"/>	<input type="checkbox"/>	<input type="checkbox"/>	<input type="checkbox"/>	106.0#
		60 x 20 x 29-1/2"	KDA6020.E	<input type="checkbox"/>	<input type="checkbox"/>	<input type="checkbox"/>	<input type="checkbox"/>	<input type="checkbox"/>	115.0#
		66 x 20 x 29-1/2"	KDA6620.E	<input type="checkbox"/>	<input type="checkbox"/>	<input type="checkbox"/>	<input type="checkbox"/>	<input type="checkbox"/>	120.0#
		72 x 20 x 29-1/2"	KDA7220.E	<input type="checkbox"/>	<input type="checkbox"/>	<input type="checkbox"/>	<input type="checkbox"/>	<input type="checkbox"/>	129.0#
		78 x 20 x 29-1/2"	KDA7820.E	<input type="checkbox"/>	<input type="checkbox"/>	<input type="checkbox"/>	<input type="checkbox"/>	<input type="checkbox"/>	133.0#
84 x 20 x 29-1/2"	KDA8420.E	<input type="checkbox"/>	<input type="checkbox"/>	<input type="checkbox"/>	<input type="checkbox"/>	<input type="checkbox"/>	138.0#		
96 x 20 x 29-1/2"	KDA9620.E	<input type="checkbox"/>	<input type="checkbox"/>	<input type="checkbox"/>	<input type="checkbox"/>	<input type="checkbox"/>	142.0#		
 <p>AESPD</p>	<b>Desk Shells-20" Option B - One Recessed and One Full End Panel</b> • 1-1/2" top with choice of three edge styles • Back panel features horizontal grain pattern • Recessed center support panel included with desk shells 78" or wider • Optional desk shelf, specified separately • Optional 1/2 and 3/4 height back panels options listed below • One optional grommet center rear • Non-handed end panels are interchangeable	24 x 20 x 29-1/2"	KDB2420.E	<input type="checkbox"/>	<input type="checkbox"/>	<input type="checkbox"/>	<input type="checkbox"/>	<input type="checkbox"/>	68.0#
		30 x 20 x 29-1/2"	KDB3020.E	<input type="checkbox"/>	<input type="checkbox"/>	<input type="checkbox"/>	<input type="checkbox"/>	<input type="checkbox"/>	73.0#
		36 x 20 x 29-1/2"	KDB3620.E	<input type="checkbox"/>	<input type="checkbox"/>	<input type="checkbox"/>	<input type="checkbox"/>	<input type="checkbox"/>	77.0#
		42 x 20 x 29-1/2"	KDB4220.E	<input type="checkbox"/>	<input type="checkbox"/>	<input type="checkbox"/>	<input type="checkbox"/>	<input type="checkbox"/>	82.0#
		48 x 20 x 29-1/2"	KDB4820.E	<input type="checkbox"/>	<input type="checkbox"/>	<input type="checkbox"/>	<input type="checkbox"/>	<input type="checkbox"/>	91.0#
		54 x 20 x 29-1/2"	KDB5420.E	<input type="checkbox"/>	<input type="checkbox"/>	<input type="checkbox"/>	<input type="checkbox"/>	<input type="checkbox"/>	101.0#
		60 x 20 x 29-1/2"	KDB6020.E	<input type="checkbox"/>	<input type="checkbox"/>	<input type="checkbox"/>	<input type="checkbox"/>	<input type="checkbox"/>	110.0#
		66 x 20 x 29-1/2"	KDB6620.E	<input type="checkbox"/>	<input type="checkbox"/>	<input type="checkbox"/>	<input type="checkbox"/>	<input type="checkbox"/>	115.0#
		72 x 20 x 29-1/2"	KDB7220.E	<input type="checkbox"/>	<input type="checkbox"/>	<input type="checkbox"/>	<input type="checkbox"/>	<input type="checkbox"/>	124.0#
		78 x 20 x 29-1/2"	KDB7820.E	<input type="checkbox"/>	<input type="checkbox"/>	<input type="checkbox"/>	<input type="checkbox"/>	<input type="checkbox"/>	128.0#
84 x 20 x 29-1/2"	KDB8420.E	<input type="checkbox"/>	<input type="checkbox"/>	<input type="checkbox"/>	<input type="checkbox"/>	<input type="checkbox"/>	133.0#		
96 x 20 x 29-1/2"	KDB9620.E	<input type="checkbox"/>	<input type="checkbox"/>	<input type="checkbox"/>	<input type="checkbox"/>	<input type="checkbox"/>	137.0#		
 <p>AESPD</p>	<b>Desk Shells-20" Option C - Two Recessed End Panels</b> • 1-1/2" top with choice of three edge styles • Back panel features horizontal grain pattern • Recessed center support panel included with desk shells 78" or wider • Optional desk shelf, specified separately • Optional 1/2 and 3/4 height back panels options listed below • One optional grommet center rear	24 x 20 x 29-1/2"	KDC2420.E	<input type="checkbox"/>	<input type="checkbox"/>	<input type="checkbox"/>	<input type="checkbox"/>	<input type="checkbox"/>	68.0#
		30 x 20 x 29-1/2"	KDC3020.E	<input type="checkbox"/>	<input type="checkbox"/>	<input type="checkbox"/>	<input type="checkbox"/>	<input type="checkbox"/>	73.0#
		36 x 20 x 29-1/2"	KDC3620.E	<input type="checkbox"/>	<input type="checkbox"/>	<input type="checkbox"/>	<input type="checkbox"/>	<input type="checkbox"/>	77.0#
		42 x 20 x 29-1/2"	KDC4220.E	<input type="checkbox"/>	<input type="checkbox"/>	<input type="checkbox"/>	<input type="checkbox"/>	<input type="checkbox"/>	82.0#
		48 x 20 x 29-1/2"	KDC4820.E	<input type="checkbox"/>	<input type="checkbox"/>	<input type="checkbox"/>	<input type="checkbox"/>	<input type="checkbox"/>	91.0#
		54 x 20 x 29-1/2"	KDC5420.E	<input type="checkbox"/>	<input type="checkbox"/>	<input type="checkbox"/>	<input type="checkbox"/>	<input type="checkbox"/>	101.0#
		60 x 20 x 29-1/2"	KDC6020.E	<input type="checkbox"/>	<input type="checkbox"/>	<input type="checkbox"/>	<input type="checkbox"/>	<input type="checkbox"/>	110.0#
		66 x 20 x 29-1/2"	KDC6620.E	<input type="checkbox"/>	<input type="checkbox"/>	<input type="checkbox"/>	<input type="checkbox"/>	<input type="checkbox"/>	115.0#
		72 x 20 x 29-1/2"	KDC7220.E	<input type="checkbox"/>	<input type="checkbox"/>	<input type="checkbox"/>	<input type="checkbox"/>	<input type="checkbox"/>	124.0#
		78 x 20 x 29-1/2"	KDC7820.E	<input type="checkbox"/>	<input type="checkbox"/>	<input type="checkbox"/>	<input type="checkbox"/>	<input type="checkbox"/>	128.0#
84 x 20 x 29-1/2"	KDC8420.E	<input type="checkbox"/>	<input type="checkbox"/>	<input type="checkbox"/>	<input type="checkbox"/>	<input type="checkbox"/>	133.0#		
96 x 20 x 29-1/2"	KDC9620.E	<input type="checkbox"/>	<input type="checkbox"/>	<input type="checkbox"/>	<input type="checkbox"/>	<input type="checkbox"/>	137.0#		

## HOW TO ORDER

Indicate the following information on order form:

- Quantity of each item.
- Model number, including options. See "How To Build a Model Number".
- Any special service required.

Note: • The  indicates that a choice is required.  
 • The absence of the  indicates that no choice is required.  
 • Alpha-numeric characters in place of  indicate that no other alternatives are available.

## HOW TO BUILD A MODEL NUMBER

- A** Select basic model.
- B** Select edge style.
- |    |                           |
|----|---------------------------|
| F  | - Flat edge               |
| P3 | - Three wave profile edge |
| P4 | - Four wave profile edge  |
- C** Select horizontal surface finish.  
 Refer to color addendum at ki.com or KI Fabrics & Finishes binder.
- D** Select vertical surface finish.  
 Refer to color addendum at ki.com or KI Fabrics & Finishes binder.
- E** Select back panel height.
- |      |                          |
|------|--------------------------|
| FULL | - Full height (standard) |
| 2Q   | - 1/2 height back panel  |
| 3Q   | - 3/4 height back panel  |
- F** Select grommet.
- |     |              |
|-----|--------------|
| NGR | - No grommet |
| G   | - Grommet    |
- Grommets are factory installed.



# Aristotle® Executive Shells

Desk Shells-20"

Delivered Pricing

\$ 623  
 636  
 650  
 682  
 710  
 723  
 744  
 783  
 830  
 924  
 1003  
 1173

\$ 623  
 636  
 650  
 682  
 710  
 723  
 744  
 783  
 830  
 924  
 1003  
 1173

\$ 623  
 636  
 650  
 682  
 710  
 723  
 744  
 783  
 830  
 924  
 1003  
 1173

**SPECIAL SERVICES**

**Special Carton Marking**

With specially marked information N/C

**Shipping**

Shipped k.d. freight prepaid f.o.b.  
**KI-Aristotle Brampton, Ontario L6T 5T6**  
 factory. Freight class #85.

Specifications and prices are subject to change without prior notice.

# Aristotle® Executive Shells

Desk Shells-24"

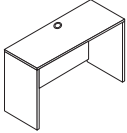
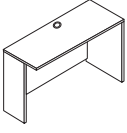
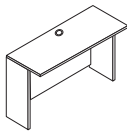
	MODEL	W x D x H	MODEL NUMBER						Approx. Packaged Weight
			Basic Model	Edge Style	Horizontal Surface Finish	Vertical Surface Finish	Back Panel Height	Grommets	
 <p>AESPD</p>	<b>Desk Shells-24" Option A - Two Full End Panels</b>	24 x 24 x 29-1/2"	KDA2424.E	<input type="checkbox"/>	<input type="checkbox"/>	<input type="checkbox"/>	<input type="checkbox"/>	<input type="checkbox"/>	80.0#
		30 x 24 x 29-1/2"	KDA3024.E	<input type="checkbox"/>	<input type="checkbox"/>	<input type="checkbox"/>	<input type="checkbox"/>	<input type="checkbox"/>	85.0#
	• 1-1/2" top with choice of three edge styles	36 x 24 x 29-1/2"	KDA3624.E	<input type="checkbox"/>	<input type="checkbox"/>	<input type="checkbox"/>	<input type="checkbox"/>	<input type="checkbox"/>	90.0#
	• Back panel features horizontal grain pattern	42 x 24 x 29-1/2"	KDA4224.E	<input type="checkbox"/>	<input type="checkbox"/>	<input type="checkbox"/>	<input type="checkbox"/>	<input type="checkbox"/>	95.0#
		48 x 24 x 29-1/2"	KDA4824.E	<input type="checkbox"/>	<input type="checkbox"/>	<input type="checkbox"/>	<input type="checkbox"/>	<input type="checkbox"/>	105.0#
	• Recessed center support panel included with desk shells 78" or wider	54 x 24 x 29-1/2"	KDA5424.E	<input type="checkbox"/>	<input type="checkbox"/>	<input type="checkbox"/>	<input type="checkbox"/>	<input type="checkbox"/>	115.0#
	• Optional desk shelf, specified separately	60 x 24 x 29-1/2"	KDA6024.E	<input type="checkbox"/>	<input type="checkbox"/>	<input type="checkbox"/>	<input type="checkbox"/>	<input type="checkbox"/>	125.0#
	• Optional 1/2 and 3/4 height back panels options listed below	66 x 24 x 29-1/2"	KDA6624.E	<input type="checkbox"/>	<input type="checkbox"/>	<input type="checkbox"/>	<input type="checkbox"/>	<input type="checkbox"/>	130.0#
		72 x 24 x 29-1/2"	KDA7224.E	<input type="checkbox"/>	<input type="checkbox"/>	<input type="checkbox"/>	<input type="checkbox"/>	<input type="checkbox"/>	140.0#
	• One optional grommet center rear	78 x 24 x 29-1/2"	KDA7824.E	<input type="checkbox"/>	<input type="checkbox"/>	<input type="checkbox"/>	<input type="checkbox"/>	<input type="checkbox"/>	145.0#
	84 x 24 x 29-1/2"	KDA8424.E	<input type="checkbox"/>	<input type="checkbox"/>	<input type="checkbox"/>	<input type="checkbox"/>	<input type="checkbox"/>	150.0#	
	96 x 24 x 29-1/2"	KDA9624.E	<input type="checkbox"/>	<input type="checkbox"/>	<input type="checkbox"/>	<input type="checkbox"/>	<input type="checkbox"/>	155.0#	
 <p>AESPD</p>	<b>Desk Shells-24" Option B - One Recessed and One Full End Panel</b>	24 x 24 x 29-1/2"	KDB2424.E	<input type="checkbox"/>	<input type="checkbox"/>	<input type="checkbox"/>	<input type="checkbox"/>	<input type="checkbox"/>	75.0#
		30 x 24 x 29-1/2"	KDB3024.E	<input type="checkbox"/>	<input type="checkbox"/>	<input type="checkbox"/>	<input type="checkbox"/>	<input type="checkbox"/>	80.0#
	• 1-1/2" top with choice of three edge styles	36 x 24 x 29-1/2"	KDB3624.E	<input type="checkbox"/>	<input type="checkbox"/>	<input type="checkbox"/>	<input type="checkbox"/>	<input type="checkbox"/>	85.0#
	• Back panel features horizontal grain pattern	42 x 24 x 29-1/2"	KDB4224.E	<input type="checkbox"/>	<input type="checkbox"/>	<input type="checkbox"/>	<input type="checkbox"/>	<input type="checkbox"/>	90.0#
		48 x 24 x 29-1/2"	KDB4824.E	<input type="checkbox"/>	<input type="checkbox"/>	<input type="checkbox"/>	<input type="checkbox"/>	<input type="checkbox"/>	100.0#
	• Recessed center support panel included with desk shells 78" or wider	54 x 24 x 29-1/2"	KDB5424.E	<input type="checkbox"/>	<input type="checkbox"/>	<input type="checkbox"/>	<input type="checkbox"/>	<input type="checkbox"/>	110.0#
	• Optional desk shelf, specified separately	60 x 24 x 29-1/2"	KDB6024.E	<input type="checkbox"/>	<input type="checkbox"/>	<input type="checkbox"/>	<input type="checkbox"/>	<input type="checkbox"/>	120.0#
	• Optional 1/2 and 3/4 height back panels options listed below	66 x 24 x 29-1/2"	KDB6624.E	<input type="checkbox"/>	<input type="checkbox"/>	<input type="checkbox"/>	<input type="checkbox"/>	<input type="checkbox"/>	125.0#
		72 x 24 x 29-1/2"	KDB7224.E	<input type="checkbox"/>	<input type="checkbox"/>	<input type="checkbox"/>	<input type="checkbox"/>	<input type="checkbox"/>	135.0#
	• One optional grommet center rear	78 x 24 x 29-1/2"	KDB7824.E	<input type="checkbox"/>	<input type="checkbox"/>	<input type="checkbox"/>	<input type="checkbox"/>	<input type="checkbox"/>	140.0#
• Non-handed end panels are interchangeable	84 x 24 x 29-1/2"	KDB8424.E	<input type="checkbox"/>	<input type="checkbox"/>	<input type="checkbox"/>	<input type="checkbox"/>	<input type="checkbox"/>	145.0#	
	96 x 24 x 29-1/2"	KDB9624.E	<input type="checkbox"/>	<input type="checkbox"/>	<input type="checkbox"/>	<input type="checkbox"/>	<input type="checkbox"/>	150.0#	
 <p>AESPD</p>	<b>Desk Shells-24" Option C - Two Recessed End Panels</b>	24 x 24 x 29-1/2"	KDC2424.E	<input type="checkbox"/>	<input type="checkbox"/>	<input type="checkbox"/>	<input type="checkbox"/>	<input type="checkbox"/>	75.0#
		30 x 24 x 29-1/2"	KDC3024.E	<input type="checkbox"/>	<input type="checkbox"/>	<input type="checkbox"/>	<input type="checkbox"/>	<input type="checkbox"/>	80.0#
	• 1-1/2" top with choice of three edge styles	36 x 24 x 29-1/2"	KDC3624.E	<input type="checkbox"/>	<input type="checkbox"/>	<input type="checkbox"/>	<input type="checkbox"/>	<input type="checkbox"/>	85.0#
	• Back panel features horizontal grain pattern	42 x 24 x 29-1/2"	KDC4224.E	<input type="checkbox"/>	<input type="checkbox"/>	<input type="checkbox"/>	<input type="checkbox"/>	<input type="checkbox"/>	90.0#
		48 x 24 x 29-1/2"	KDC4824.E	<input type="checkbox"/>	<input type="checkbox"/>	<input type="checkbox"/>	<input type="checkbox"/>	<input type="checkbox"/>	100.0#
	• Recessed center support panel included with desk shells 78" or wider	54 x 24 x 29-1/2"	KDC5424.E	<input type="checkbox"/>	<input type="checkbox"/>	<input type="checkbox"/>	<input type="checkbox"/>	<input type="checkbox"/>	110.0#
	• Optional desk shelf, specified separately	60 x 24 x 29-1/2"	KDC6024.E	<input type="checkbox"/>	<input type="checkbox"/>	<input type="checkbox"/>	<input type="checkbox"/>	<input type="checkbox"/>	120.0#
	• Optional 1/2 and 3/4 height back panels options listed below	66 x 24 x 29-1/2"	KDC6624.E	<input type="checkbox"/>	<input type="checkbox"/>	<input type="checkbox"/>	<input type="checkbox"/>	<input type="checkbox"/>	125.0#
		72 x 24 x 29-1/2"	KDC7224.E	<input type="checkbox"/>	<input type="checkbox"/>	<input type="checkbox"/>	<input type="checkbox"/>	<input type="checkbox"/>	135.0#
	• One optional grommet center rear	78 x 24 x 29-1/2"	KDC7824.E	<input type="checkbox"/>	<input type="checkbox"/>	<input type="checkbox"/>	<input type="checkbox"/>	<input type="checkbox"/>	140.0#
	84 x 24 x 29-1/2"	KDC8424.E	<input type="checkbox"/>	<input type="checkbox"/>	<input type="checkbox"/>	<input type="checkbox"/>	<input type="checkbox"/>	145.0#	
	96 x 24 x 29-1/2"	KDC9624.E	<input type="checkbox"/>	<input type="checkbox"/>	<input type="checkbox"/>	<input type="checkbox"/>	<input type="checkbox"/>	150.0#	

## HOW TO ORDER

Indicate the following information on order form:

- Quantity of each item.
- Model number, including options. See "How To Build a Model Number".
- Any special service required.

Note:

- The  indicates that a choice is required.
- The absence of the  indicates that no choice is required.
- Alpha-numeric characters in place of  indicate that no other alternatives are available.

## HOW TO BUILD A MODEL NUMBER

- A** Select basic model.
- B** Select edge style.
- |    |                           |
|----|---------------------------|
| F  | - Flat edge               |
| P3 | - Three wave profile edge |
| P4 | - Four wave profile edge  |
- C** Select horizontal surface finish.  
Refer to color addendum at [ki.com](http://ki.com) or KI Fabrics & Finishes binder.
- D** Select vertical surface finish.  
Refer to color addendum at [ki.com](http://ki.com) or KI Fabrics & Finishes binder.
- E** Select back panel height.
- |      |                          |
|------|--------------------------|
| FULL | - Full height (standard) |
| 2Q   | - 1/2 height back panel  |
| 3Q   | - 3/4 height back panel  |
- F** Select grommet.
- |     |              |
|-----|--------------|
| NGR | - No grommet |
| G   | - Grommet    |
- Grommets are factory installed.



Aristotle® Executive Shells  
Desk Shells-24"

Delivered Pricing

\$ 636  
661  
690  
735  
765  
783  
821  
870  
940  
977  
1057  
1228

\$ 636  
661  
690  
735  
765  
783  
821  
870  
940  
977  
1057  
1228

\$ 636  
661  
690  
735  
765  
783  
821  
870  
940  
977  
1057  
1228

**SPECIAL SERVICES**

**Special Carton Marking**

With specially marked information N/C

**Shipping**

Shipped k.d. freight prepaid f.o.b.  
KI-Aristotle Brampton, Ontario L6T 5T6  
factory. Freight class #85.

Specifications and prices are subject to  
change without prior notice.

# Aristotle® Executive Shells

Desk Shells-30"

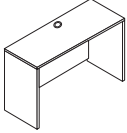
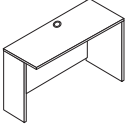
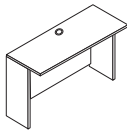
	MODEL	W x D x H	MODEL NUMBER						Approx. Packaged Weight
			Basic Model	Edge Style	Horizontal Surface Finish	Vertical Surface Finish	Back Panel Height	Grommets	
 <p>AESPD</p>	<b>Desk Shells-30" Option A - Two Full End Panels</b> • 1-1/2" top with choice of three edge styles • Back panel features horizontal grain pattern • Recessed center support panel included with desk shells 78" or wider • Optional desk shelf, specified separately • Optional 1/2 and 3/4 height back panels options listed below • One optional grommet center rear	24 x 30 x 29-1/2"	KDA2430.E	<input type="checkbox"/>	<input type="checkbox"/>	<input type="checkbox"/>	<input type="checkbox"/>	<input type="checkbox"/>	90.0#
		30 x 30 x 29-1/2"	KDA3030.E	<input type="checkbox"/>	<input type="checkbox"/>	<input type="checkbox"/>	<input type="checkbox"/>	<input type="checkbox"/>	100.0#
		36 x 30 x 29-1/2"	KDA3630.E	<input type="checkbox"/>	<input type="checkbox"/>	<input type="checkbox"/>	<input type="checkbox"/>	<input type="checkbox"/>	110.0#
		42 x 30 x 29-1/2"	KDA4230.E	<input type="checkbox"/>	<input type="checkbox"/>	<input type="checkbox"/>	<input type="checkbox"/>	<input type="checkbox"/>	120.0#
		48 x 30 x 29-1/2"	KDA4830.E	<input type="checkbox"/>	<input type="checkbox"/>	<input type="checkbox"/>	<input type="checkbox"/>	<input type="checkbox"/>	130.0#
		54 x 30 x 29-1/2"	KDA5430.E	<input type="checkbox"/>	<input type="checkbox"/>	<input type="checkbox"/>	<input type="checkbox"/>	<input type="checkbox"/>	140.0#
		60 x 30 x 29-1/2"	KDA6030.E	<input type="checkbox"/>	<input type="checkbox"/>	<input type="checkbox"/>	<input type="checkbox"/>	<input type="checkbox"/>	150.0#
		66 x 30 x 29-1/2"	KDA6630.E	<input type="checkbox"/>	<input type="checkbox"/>	<input type="checkbox"/>	<input type="checkbox"/>	<input type="checkbox"/>	160.0#
		72 x 30 x 29-1/2"	KDA7230.E	<input type="checkbox"/>	<input type="checkbox"/>	<input type="checkbox"/>	<input type="checkbox"/>	<input type="checkbox"/>	170.0#
		78 x 30 x 29-1/2"	KDA7830.E	<input type="checkbox"/>	<input type="checkbox"/>	<input type="checkbox"/>	<input type="checkbox"/>	<input type="checkbox"/>	180.0#
84 x 30 x 29-1/2"	KDA8430.E	<input type="checkbox"/>	<input type="checkbox"/>	<input type="checkbox"/>	<input type="checkbox"/>	<input type="checkbox"/>	190.0#		
96 x 30 x 29-1/2"	KDA9630.E	<input type="checkbox"/>	<input type="checkbox"/>	<input type="checkbox"/>	<input type="checkbox"/>	<input type="checkbox"/>	200.0#		
 <p>AESPD</p>	<b>Desk Shells-30" Option B - One Recessed and One Full End Panel</b> • 1-1/2" top with choice of three edge styles • Back panel features horizontal grain pattern • Recessed center support panel included with desk shells 78" or wider • Optional desk shelf, specified separately • Optional 1/2 and 3/4 height back panels options listed below • One optional grommet center rear • Non-handed end panels are interchangeable	24 x 30 x 29-1/2"	KDB2430.E	<input type="checkbox"/>	<input type="checkbox"/>	<input type="checkbox"/>	<input type="checkbox"/>	<input type="checkbox"/>	85.0#
		30 x 30 x 29-1/2"	KDB3030.E	<input type="checkbox"/>	<input type="checkbox"/>	<input type="checkbox"/>	<input type="checkbox"/>	<input type="checkbox"/>	95.0#
		36 x 30 x 29-1/2"	KDB3630.E	<input type="checkbox"/>	<input type="checkbox"/>	<input type="checkbox"/>	<input type="checkbox"/>	<input type="checkbox"/>	105.0#
		42 x 30 x 29-1/2"	KDB4230.E	<input type="checkbox"/>	<input type="checkbox"/>	<input type="checkbox"/>	<input type="checkbox"/>	<input type="checkbox"/>	115.0#
		48 x 30 x 29-1/2"	KDB4830.E	<input type="checkbox"/>	<input type="checkbox"/>	<input type="checkbox"/>	<input type="checkbox"/>	<input type="checkbox"/>	125.0#
		54 x 30 x 29-1/2"	KDB5430.E	<input type="checkbox"/>	<input type="checkbox"/>	<input type="checkbox"/>	<input type="checkbox"/>	<input type="checkbox"/>	135.0#
		60 x 30 x 29-1/2"	KDB6030.E	<input type="checkbox"/>	<input type="checkbox"/>	<input type="checkbox"/>	<input type="checkbox"/>	<input type="checkbox"/>	145.0#
		66 x 30 x 29-1/2"	KDB6630.E	<input type="checkbox"/>	<input type="checkbox"/>	<input type="checkbox"/>	<input type="checkbox"/>	<input type="checkbox"/>	155.0#
		72 x 30 x 29-1/2"	KDB7230.E	<input type="checkbox"/>	<input type="checkbox"/>	<input type="checkbox"/>	<input type="checkbox"/>	<input type="checkbox"/>	165.0#
		78 x 30 x 29-1/2"	KDB7830.E	<input type="checkbox"/>	<input type="checkbox"/>	<input type="checkbox"/>	<input type="checkbox"/>	<input type="checkbox"/>	175.0#
84 x 30 x 29-1/2"	KDB8430.E	<input type="checkbox"/>	<input type="checkbox"/>	<input type="checkbox"/>	<input type="checkbox"/>	<input type="checkbox"/>	185.0#		
96 x 30 x 29-1/2"	KDB9630.E	<input type="checkbox"/>	<input type="checkbox"/>	<input type="checkbox"/>	<input type="checkbox"/>	<input type="checkbox"/>	195.0#		
 <p>AESPD</p>	<b>Desk Shells-30" Option C - Two Recessed End Panels</b> • 1-1/2" top with choice of three edge styles • Back panel features horizontal grain pattern • Recessed center support panel included with desk shells 78" or wider • Optional desk shelf, specified separately • Optional 1/2 and 3/4 height back panels options listed below • One optional grommet center rear	24 x 30 x 29-1/2"	KDC2430.E	<input type="checkbox"/>	<input type="checkbox"/>	<input type="checkbox"/>	<input type="checkbox"/>	<input type="checkbox"/>	85.0#
		30 x 30 x 29-1/2"	KDC3030.E	<input type="checkbox"/>	<input type="checkbox"/>	<input type="checkbox"/>	<input type="checkbox"/>	<input type="checkbox"/>	95.0#
		36 x 30 x 29-1/2"	KDC3630.E	<input type="checkbox"/>	<input type="checkbox"/>	<input type="checkbox"/>	<input type="checkbox"/>	<input type="checkbox"/>	105.0#
		42 x 30 x 29-1/2"	KDC4230.E	<input type="checkbox"/>	<input type="checkbox"/>	<input type="checkbox"/>	<input type="checkbox"/>	<input type="checkbox"/>	115.0#
		48 x 30 x 29-1/2"	KDC4830.E	<input type="checkbox"/>	<input type="checkbox"/>	<input type="checkbox"/>	<input type="checkbox"/>	<input type="checkbox"/>	125.0#
		54 x 30 x 29-1/2"	KDC5430.E	<input type="checkbox"/>	<input type="checkbox"/>	<input type="checkbox"/>	<input type="checkbox"/>	<input type="checkbox"/>	135.0#
		60 x 30 x 29-1/2"	KDC6030.E	<input type="checkbox"/>	<input type="checkbox"/>	<input type="checkbox"/>	<input type="checkbox"/>	<input type="checkbox"/>	145.0#
		66 x 30 x 29-1/2"	KDC6630.E	<input type="checkbox"/>	<input type="checkbox"/>	<input type="checkbox"/>	<input type="checkbox"/>	<input type="checkbox"/>	155.0#
		72 x 30 x 29-1/2"	KDC7230.E	<input type="checkbox"/>	<input type="checkbox"/>	<input type="checkbox"/>	<input type="checkbox"/>	<input type="checkbox"/>	165.0#
		78 x 30 x 29-1/2"	KDC7830.E	<input type="checkbox"/>	<input type="checkbox"/>	<input type="checkbox"/>	<input type="checkbox"/>	<input type="checkbox"/>	175.0#
84 x 30 x 29-1/2"	KDC8430.E	<input type="checkbox"/>	<input type="checkbox"/>	<input type="checkbox"/>	<input type="checkbox"/>	<input type="checkbox"/>	185.0#		
96 x 30 x 29-1/2"	KDC9630.E	<input type="checkbox"/>	<input type="checkbox"/>	<input type="checkbox"/>	<input type="checkbox"/>	<input type="checkbox"/>	195.0#		

## HOW TO ORDER

Indicate the following information on order form:

- Quantity of each item.
- Model number, including options. See "How To Build a Model Number".
- Any special service required.

Note: • The  indicates that a choice is required.  
 • The absence of the  indicates that no choice is required.  
 • Alpha-numeric characters in place of  indicate that no other alternatives are available.

## HOW TO BUILD A MODEL NUMBER

- A** Select basic model.
- B** Select edge style.
 

F	- Flat edge
P3	- Three wave profile edge
P4	- Four wave profile edge
- C** Select horizontal surface finish.  
Refer to color addendum at [ki.com](http://ki.com) or KI Fabrics & Finishes binder.
- D** Select vertical surface finish.  
Refer to color addendum at [ki.com](http://ki.com) or KI Fabrics & Finishes binder.
- E** Select back panel height.
 

FULL	- Full height (standard)
2Q	- 1/2 height back panel
3Q	- 3/4 height back panel
- F** Select grommet.
 

NGR	- No grommet
G	- Grommet

Grommets are factory installed.





Aristotle® Executive Shells  
Desk Shells-30"

Delivered Pricing

- \$ 674
  - 701
  - 728
  - 775
  - 801
  - 830
  - 821
  - 916
  - 962
  - 1068
  - 1174
  - 1230
- 
- \$ 674
  - 701
  - 728
  - 775
  - 801
  - 830
  - 821
  - 916
  - 962
  - 1068
  - 1174
  - 1230
- 
- \$ 674
  - 701
  - 728
  - 775
  - 801
  - 830
  - 821
  - 916
  - 962
  - 1068
  - 1174
  - 1230

**SPECIAL SERVICES**

**Special Carton Marking**

With specially marked information N/C

**Shipping**

Shipped k.d. freight prepaid f.o.b.  
KI-Aristotle Brampton, Ontario L6T 5T6  
factory. Freight class #85.

Specifications and prices are subject to  
change without prior notice.

# Aristotle® Executive Shells

Desk Shells-Inset Back Panel

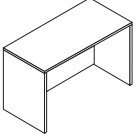
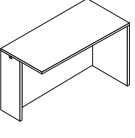
	MODEL	W x D x H	MODEL NUMBER				Approx. Packaged Weight
			Basic Model	Edge Style	Horizontal Surface Finish	Vertical Surface Finish	
 <p>AECSI</p>	<b>Desk Shells-Inset Back Panel Option A - Two Full End Panels</b> • 1-1/2" top with choice of three edge styles • Full height back panel is inset 6" on 30" deep desks and 12" on 36" deep desks • Back panel features horizontal wood grain • Recessed center support panel included with desk shells 78" or wider • Standard without grommets • Notch option enables an inline transition from a larger depth worksurface to a 6" shorter depth	24 x 30 x 29-1/2"	KDAI2430.E	<input type="checkbox"/>	<input type="checkbox"/>	<input type="checkbox"/>	90.0#
		30 x 30 x 29-1/2"	KDAI3030.E	<input type="checkbox"/>	<input type="checkbox"/>	<input type="checkbox"/>	100.0#
		36 x 30 x 29-1/2"	KDAI3630.E	<input type="checkbox"/>	<input type="checkbox"/>	<input type="checkbox"/>	110.0#
		42 x 30 x 29-1/2"	KDAI4230.E	<input type="checkbox"/>	<input type="checkbox"/>	<input type="checkbox"/>	120.0#
		48 x 30 x 29-1/2"	KDAI4830.E	<input type="checkbox"/>	<input type="checkbox"/>	<input type="checkbox"/>	130.0#
		54 x 30 x 29-1/2"	KDAI5430.E	<input type="checkbox"/>	<input type="checkbox"/>	<input type="checkbox"/>	140.0#
		60 x 30 x 29-1/2"	KDAI6030.E	<input type="checkbox"/>	<input type="checkbox"/>	<input type="checkbox"/>	150.0#
		66 x 30 x 29-1/2"	KDAI6630.E	<input type="checkbox"/>	<input type="checkbox"/>	<input type="checkbox"/>	160.0#
		72 x 30 x 29-1/2"	KDAI7230.E	<input type="checkbox"/>	<input type="checkbox"/>	<input type="checkbox"/>	170.0#
		78 x 30 x 29-1/2"	KDAI7830.E	<input type="checkbox"/>	<input type="checkbox"/>	<input type="checkbox"/>	180.0#
		84 x 30 x 29-1/2"	KDAI8430.E	<input type="checkbox"/>	<input type="checkbox"/>	<input type="checkbox"/>	190.0#
		96 x 30 x 29-1/2"	KDAI9630.E	<input type="checkbox"/>	<input type="checkbox"/>	<input type="checkbox"/>	200.0#
		60 x 36 x 29-1/2"	KDAI6036.E	<input type="checkbox"/>	<input type="checkbox"/>	<input type="checkbox"/>	160.0#
		66 x 36 x 29-1/2"	KDAI6636.E	<input type="checkbox"/>	<input type="checkbox"/>	<input type="checkbox"/>	170.0#
72 x 36 x 29-1/2"	KDAI7236.E	<input type="checkbox"/>	<input type="checkbox"/>	<input type="checkbox"/>	180.0#		
 <p>AECSI</p>	<b>Desk Shells-Inset Back Panel Option B - One Recessed and One Full End Panel (interchangeable)</b> • 1-1/2" top with choice of three edge styles • Full height back panel is inset 6" on 30" deep desks and 12" on 36" deep desks • Back panel features horizontal wood grain • Recessed center support panel included with desk shells 78" or wider • Standard without grommets • Notch option enables an inline transition from a larger depth worksurface to a 6" shorter depth	24 x 30 x 29-1/2"	KDBI2430.E	<input type="checkbox"/>	<input type="checkbox"/>	<input type="checkbox"/>	90.0#
		30 x 30 x 29-1/2"	KDBI3030.E	<input type="checkbox"/>	<input type="checkbox"/>	<input type="checkbox"/>	100.0#
		36 x 30 x 29-1/2"	KDBI3630.E	<input type="checkbox"/>	<input type="checkbox"/>	<input type="checkbox"/>	110.0#
		42 x 30 x 29-1/2"	KDBI4230.E	<input type="checkbox"/>	<input type="checkbox"/>	<input type="checkbox"/>	120.0#
		48 x 30 x 29-1/2"	KDBI4830.E	<input type="checkbox"/>	<input type="checkbox"/>	<input type="checkbox"/>	130.0#
		54 x 30 x 29-1/2"	KDBI5430.E	<input type="checkbox"/>	<input type="checkbox"/>	<input type="checkbox"/>	140.0#
		60 x 30 x 29-1/2"	KDBI6030.E	<input type="checkbox"/>	<input type="checkbox"/>	<input type="checkbox"/>	150.0#
		66 x 30 x 29-1/2"	KDBI6630.E	<input type="checkbox"/>	<input type="checkbox"/>	<input type="checkbox"/>	160.0#
		72 x 30 x 29-1/2"	KDBI7230.E	<input type="checkbox"/>	<input type="checkbox"/>	<input type="checkbox"/>	170.0#
		78 x 30 x 29-1/2"	KDBI7830.E	<input type="checkbox"/>	<input type="checkbox"/>	<input type="checkbox"/>	180.0#
		84 x 30 x 29-1/2"	KDBI8430.E	<input type="checkbox"/>	<input type="checkbox"/>	<input type="checkbox"/>	190.0#
		96 x 30 x 29-1/2"	KDBI9630.E	<input type="checkbox"/>	<input type="checkbox"/>	<input type="checkbox"/>	200.0#
		60 x 36 x 29-1/2"	KDBI6036.E	<input type="checkbox"/>	<input type="checkbox"/>	<input type="checkbox"/>	160.0#
		66 x 36 x 29-1/2"	KDBI6636.E	<input type="checkbox"/>	<input type="checkbox"/>	<input type="checkbox"/>	170.0#
72 x 36 x 29-1/2"	KDBI7236.E	<input type="checkbox"/>	<input type="checkbox"/>	<input type="checkbox"/>	180.0#		

**A**      **B**      **C**      **D**

## HOW TO ORDER

Indicate the following information on order form:

- Quantity of each item.
- Model number, including options. See "How To Build a Model Number".
- Any special service required.

Note: • The  indicates that a choice is required.  
 • The absence of the  indicates that no choice is required.  
 • Alpha-numeric characters in place of  indicate that no other alternatives are available.

## HOW TO BUILD A MODEL NUMBER

- A** Select basic model.
- B** Select edge style.
 

<b>F</b>	- Flat edge
<b>P3</b>	- Three wave profile edge
<b>P4</b>	- Four wave profile edge
- C** Select horizontal surface finish.  
Refer to color addendum at ki.com or KI Fabrics & Finishes binder.
- D** Select vertical surface finish.  
Refer to color addendum at ki.com or KI Fabrics & Finishes binder.



# Aristotle® Executive Shells

Desk Shells-Inset Back Panel

Delivered Pricing

\$ 674  
 701  
 728  
 775  
 801  
 830  
 821  
 916  
 962  
 1068  
 1174  
 1230  
 976  
 1004  
 1031

\$ 674  
 701  
 728  
 775  
 801  
 830  
 821  
 916  
 962  
 1068  
 1174  
 1230  
 976  
 1004  
 1031

**SPECIAL SERVICES**

**Special Carton Marking**

With specially marked information N/C

**Shipping**

Shipped k.d. freight prepaid f.o.b.  
**KI-Aristotle Brampton, Ontario L6T 5T6**  
 factory. Freight class #85.

Specifications and prices are subject to change without prior notice.

# Aristotle® Executive Shells

Extended Corner Desk Shells - 20" - Extended Left

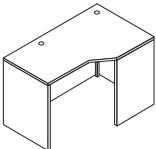
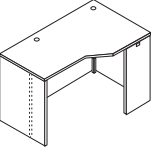
	W x D x H	MODEL NUMBER								Approx. Packaged Weight
		Basic Model	Edge Style	Horizontal Surface Finish	Vertical Surface Finish	Leg Finish	Back Panel Height	Cutaway	Grommets	
 <p>AESPD <b>Extended-Left Option A - Two Full End Panels</b></p> <ul style="list-style-type: none"> <li>• 1-1/2" top with choice of three edge styles</li> <li>• Corner post in black or silver</li> <li>• Back panel features horizontal grain pattern</li> <li>• Cutaway may be straight or curved</li> <li>• 20" desks do not accommodate pedestals</li> </ul>	60 x 20 x 29-1/2"	KCDLA6020.E	<input type="checkbox"/>	<input type="checkbox"/>	<input type="checkbox"/>	<input type="checkbox"/>	<input type="checkbox"/>	<input type="checkbox"/>	<input type="checkbox"/>	145.0#
	66 x 20 x 29-1/2"	KCDLA6620.E	<input type="checkbox"/>	<input type="checkbox"/>	<input type="checkbox"/>	<input type="checkbox"/>	<input type="checkbox"/>	<input type="checkbox"/>	<input type="checkbox"/>	155.0#
	72 x 20 x 29-1/2"	KCDLA7220.E	<input type="checkbox"/>	<input type="checkbox"/>	<input type="checkbox"/>	<input type="checkbox"/>	<input type="checkbox"/>	<input type="checkbox"/>	<input type="checkbox"/>	170.0#
 <p>AESPD <b>Extended-Left, Option B - One Full/One Recessed End Panel, Interchangeable</b></p> <ul style="list-style-type: none"> <li>• 1-1/2" top with choice of three edge styles</li> <li>• Corner post in black or silver</li> <li>• Back panel features horizontal grain pattern</li> <li>• Cutaway may be straight or curved</li> <li>• 20" desks do not accommodate pedestals</li> </ul>	60 x 20 x 29-1/2"	KCDLB6020.E	<input type="checkbox"/>	<input type="checkbox"/>	<input type="checkbox"/>	<input type="checkbox"/>	<input type="checkbox"/>	<input type="checkbox"/>	145.0#	
	66 x 20 x 29-1/2"	KCDLB6620.E	<input type="checkbox"/>	<input type="checkbox"/>	<input type="checkbox"/>	<input type="checkbox"/>	<input type="checkbox"/>	<input type="checkbox"/>	<input type="checkbox"/>	155.0#
	72 x 20 x 29-1/2"	KCDLB7220.E	<input type="checkbox"/>	<input type="checkbox"/>	<input type="checkbox"/>	<input type="checkbox"/>	<input type="checkbox"/>	<input type="checkbox"/>	<input type="checkbox"/>	170.0#

**A B C D E F G H**

## HOW TO ORDER

Indicate the following information on order form:

- Quantity of each item.
- Model number, including options. See "How To Build a Model Number".
- Any special service required.

Note:

- The  indicates that a choice is required.
- The absence of the  indicates that no choice is required.
- Alpha-numeric characters in place of  indicate that no other alternatives are available.

## HOW TO BUILD A MODEL NUMBER

- A** Select basic model.
- B** Select edge style.
  - F - Flat edge
  - P3 - Three wave profile edge
  - P4 - Four wave profile edge
- C** Select horizontal surface finish. Refer to color addendum at ki.com or KI Fabrics & Finishes binder.
- D** Select vertical surface finish. Refer to color addendum at ki.com or KI Fabrics & Finishes binder.
- E** Select corner leg finish. Refer to color addendum at ki.com or KI Fabrics & Finishes binder.
- F** Select back panel height.
  - FULL - Full height (standard)
  - 2Q - 1/2 height back panel
  - 2QL - 1/2 height back panel, right

- 2QR - 1/2 height back panel, left
- 3Q - 3/4 height back panel
- 3QL - 3/4 height back panel, left
- 3QR - 3/4 height back panel, right
- G** Select cutaway option.
  - ST - Straight cutaway
  - CV - Curved cutaway
- H** Select grommet.
  - NGR - No grommet
  - G - Grommet



# Aristotle® Executive Shells

Extended Corner Desk Shells - 20" - Extended Left

Delivered  
Pricing

\$ 1089  
1207  
1303

\$ 1089  
1207  
1303

**SPECIAL SERVICES**

**Special Carton Marking**

With specially marked information    N/C

**Shipping**

Shipped **k.d. freight prepaid f.o.b.**  
**KI-Aristotle Brampton, Ontario L6T 5T6**  
factory. Freight class #85.

Specifications and prices are subject to  
change without prior notice.





# Aristotle® Executive Shells

Extended Corner Desk Shells - 20" - Extended Left

Delivered  
Pricing

\$ 1089

1207

1303

**SPECIAL SERVICES**

**Special Carton Marking**

With specially marked information N/C

**Shipping**

Shipped k.d. freight prepaid f.o.b.  
KI-Aristotle Brampton, Ontario L6T 5T6  
factory. Freight class #85.

Specifications and prices are subject to  
change without prior notice.

# Aristotle® Executive Shells

Extended Corner Desk Shells - 20" - Extended Right

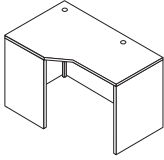
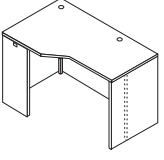
	W x D x H	MODEL NUMBER								Approx. Packaged Weight	
		Basic Model	Edge Style	Horizontal Surface Finish	Vertical Surface Finish	Leg Finish	Back Panel Height	Cutaway	Grommets		
 <p>AESPD <b>Extended-Right Option A-Two Full End Panels</b></p> <ul style="list-style-type: none"> <li>• 1-1/2" top with choice of three edge styles</li> <li>• Corner post in black or silver</li> <li>• Back panel features horizontal grain pattern</li> <li>• Cutaway may be straight or curved</li> <li>• 20" desks do not accommodate pedestals</li> </ul>	60 x 20 x 29-1/2"	KCDRA6020.E	<input type="checkbox"/>	<input type="checkbox"/>	<input type="checkbox"/>	<input type="checkbox"/>	<input type="checkbox"/>	<input type="checkbox"/>	<input type="checkbox"/>	115.0#	
	66 x 20 x 29-1/2"	KCDRA6620.E	<input type="checkbox"/>	<input type="checkbox"/>	<input type="checkbox"/>	<input type="checkbox"/>	<input type="checkbox"/>	<input type="checkbox"/>	<input type="checkbox"/>	125.0#	
	72 x 20 x 29-1/2"	KCDRA7220.E	<input type="checkbox"/>	<input type="checkbox"/>	<input type="checkbox"/>	<input type="checkbox"/>	<input type="checkbox"/>	<input type="checkbox"/>	<input type="checkbox"/>	135.0#	
 <p>AESPD <b>Extended-Right Option B-One Full/One Recessed End Panel, Interchangeable</b></p> <ul style="list-style-type: none"> <li>• 1-1/2" top with choice of three edge styles</li> <li>• Corner post in black or silver</li> <li>• Back panel features horizontal grain pattern</li> <li>• Cutaway may be straight or curved</li> <li>• 20" desks do not accommodate pedestals</li> </ul>	60 x 20 x 29-1/2"	KCDRB6020.E	<input type="checkbox"/>	<input type="checkbox"/>	<input type="checkbox"/>	<input type="checkbox"/>	<input type="checkbox"/>	<input type="checkbox"/>	<input type="checkbox"/>	115.0#	
	66 x 20 x 29-1/2"	KCDRB6620.E	<input type="checkbox"/>	<input type="checkbox"/>	<input type="checkbox"/>	<input type="checkbox"/>	<input type="checkbox"/>	<input type="checkbox"/>	<input type="checkbox"/>	125.0#	
	72 x 20 x 29-1/2"	KCDRB7220.E	<input type="checkbox"/>	<input type="checkbox"/>	<input type="checkbox"/>	<input type="checkbox"/>	<input type="checkbox"/>	<input type="checkbox"/>	<input type="checkbox"/>	135.0#	
			<b>A</b>	<b>B</b>	<b>C</b>	<b>D</b>	<b>E</b>	<b>F</b>	<b>G</b>	<b>H</b>	

## HOW TO ORDER

Indicate the following information on order form:

- Quantity of each item.
- Model number, including options. See "How To Build a Model Number".
- Any special service required.

Note:

- The  indicates that a choice is required.
- The absence of the  indicates that no choice is required.
- Alpha-numeric characters in place of  indicate that no other alternatives are available.

## HOW TO BUILD A MODEL NUMBER

- A** Select basic model.
- B** Select edge style.
 

F	- Flat edge
P3	- Three wave profile edge
P4	- Four wave profile edge
- C** Select horizontal surface finish.  
Refer to color addendum at ki.com or KI Fabrics & Finishes binder.
- D** Select vertical surface finish.  
Refer to color addendum at ki.com or KI Fabrics & Finishes binder.
- E** Select corner leg finish  
Refer to color addendum at ki.com or KI Fabrics & Finishes binder.
- F** Select back panel height.
 

FULL	- Full height (standard)
2Q	- 1/2 height back panel
2QL	- 1/2 height back panel, right

- |     |                                |
|-----|--------------------------------|
| 2QR | - 1/2 height back panel, left  |
| 3Q  | - 3/4 height back panel        |
| 3QL | - 3/4 height back panel, left  |
| 3QR | - 3/4 height back panel, right |
- G** Select cutaway option.
 

ST	- Straight cutaway
CV	- Curved cutaway
  - H** Select grommet.
 

NGR	- No grommet
G	- Grommet





# Aristotle® Executive Shells

Extended Corner Desk Shells - 20" - Extended Right

Delivered  
Pricing

\$ 1089  
1207  
1303

\$ 1089  
1207  
1303

**SPECIAL SERVICES**

**Special Carton Marking**

With specially marked information    N/C

**Shipping**

Shipped **k.d. freight prepaid f.o.b.**  
**KI-Aristotle Brampton, Ontario L6T 5T6**  
factory. Freight class #85.

Specifications and prices are subject to  
change without prior notice.





# Aristotle® Executive Shells

Extended Corner Desk Shells - 20" - Extended Right

Delivered  
Pricing

\$ 1089

1207

1303

### SPECIAL SERVICES

#### Special Carton Marking

With specially marked information N/C

#### Shipping

Shipped **k.d. freight prepaid f.o.b.**  
**KI-Aristotle Brampton, Ontario L6T 5T6**  
factory. Freight class #85.

Specifications and prices are subject to  
change without prior notice.

# Aristotle® Executive Shells

Extended Corner Desk Shells - 24" - Extended Left

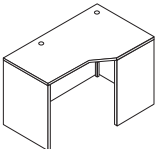
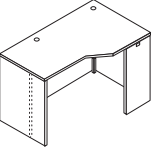
	W x D x H	MODEL NUMBER								Approx. Packaged Weight
		Basic Model	Edge Style	Horizontal Surface Finish	Vertical Surface Finish	Leg Finish	Back Panel Height	Cutaway	Grommets	
 <p>AESPD <b>Extended-Left Option A - Two Full End Panels</b></p> <ul style="list-style-type: none"> <li>• 1-1/2" top with choice of three edge styles</li> <li>• Corner post in black or silver</li> <li>• Back panel features horizontal grain pattern</li> <li>• Cutaway may be straight or curved</li> <li>• 20" desks do not accommodate pedestals</li> </ul>	60 x 24 x 29-1/2"	KCDLA6024.E	<input type="checkbox"/>	<input type="checkbox"/>	<input type="checkbox"/>	<input type="checkbox"/>	<input type="checkbox"/>	<input type="checkbox"/>	<input type="checkbox"/>	145.0#
	66 x 24 x 29-1/2"	KCDLA6624.E	<input type="checkbox"/>	<input type="checkbox"/>	<input type="checkbox"/>	<input type="checkbox"/>	<input type="checkbox"/>	<input type="checkbox"/>	<input type="checkbox"/>	155.0#
	72 x 24 x 29-1/2"	KCDLA7224.E	<input type="checkbox"/>	<input type="checkbox"/>	<input type="checkbox"/>	<input type="checkbox"/>	<input type="checkbox"/>	<input type="checkbox"/>	<input type="checkbox"/>	170.0#
 <p>AESPD <b>Extended-Left, Option B - One Full/One Recessed End Panel, Interchangeable</b></p> <ul style="list-style-type: none"> <li>• 1-1/2" top with choice of three edge styles</li> <li>• Corner post in black or silver</li> <li>• Back panel features horizontal grain pattern</li> <li>• Cutaway may be straight or curved</li> <li>• 20" desks do not accommodate pedestals</li> </ul>	60 x 24 x 29-1/2"	KCDLB6024.E	<input type="checkbox"/>	<input type="checkbox"/>	<input type="checkbox"/>	<input type="checkbox"/>	<input type="checkbox"/>	<input type="checkbox"/>	145.0#	
	66 x 24 x 29-1/2"	KCDLB6624.E	<input type="checkbox"/>	<input type="checkbox"/>	<input type="checkbox"/>	<input type="checkbox"/>	<input type="checkbox"/>	<input type="checkbox"/>	<input type="checkbox"/>	155.0#
	72 x 24 x 29-1/2"	KCDLB7224.E	<input type="checkbox"/>	<input type="checkbox"/>	<input type="checkbox"/>	<input type="checkbox"/>	<input type="checkbox"/>	<input type="checkbox"/>	<input type="checkbox"/>	170.0#
			<b>A</b>	<b>B</b>	<b>C</b>	<b>D</b>	<b>E</b>	<b>F</b>	<b>G</b>	<b>H</b>

## HOW TO ORDER

Indicate the following information on order form:

- Quantity of each item.
- Model number, including options. See "How To Build a Model Number".
- Any special service required.

Note:

- The  indicates that a choice is required.
- The absence of the  indicates that no choice is required.
- Alpha-numeric characters in place of  indicate that no other alternatives are available.

## HOW TO BUILD A MODEL NUMBER

- A** Select basic model.
- B** Select edge style.
  - F - Flat edge
  - P3 - Three wave profile edge
  - P4 - Four wave profile edge
- C** Select horizontal surface finish. Refer to color addendum at ki.com or KI Fabrics & Finishes binder.
- D** Select vertical surface finish. Refer to color addendum at ki.com or KI Fabrics & Finishes binder.
- E** Select corner leg finish. Refer to color addendum at ki.com or KI Fabrics & Finishes binder.
- F** Select back panel height.
  - FULL - Full height (standard)
  - 2Q - 1/2 height back panel
  - 2QL - 1/2 height back panel, right

- 2QR - 1/2 height back panel, left
- 3Q - 3/4 height back panel
- 3QL - 3/4 height back panel, left
- 3QR - 3/4 height back panel, right
- G** Select cutaway option.
  - ST - Straight cutaway
  - CV - Curved cutaway
- H** Select grommet.
  - NGR - No grommet
  - G - Grommet



# Aristotle® Executive Shells

Extended Corner Desk Shells - 24" - Extended Left

Delivered Pricing

\$ 1100  
1207  
1303

\$ 1100  
1207  
1303

**SPECIAL SERVICES**

**Special Carton Marking**

With specially marked information N/C

**Shipping**

Shipped k.d. freight prepaid f.o.b.  
KI-Aristotle Brampton, Ontario L6T 5T6  
factory. Freight class #85.

Specifications and prices are subject to  
change without prior notice.





# Aristotle® Executive Shells

Extended Corner Desk Shells - 24" - Extended Left

Delivered  
Pricing

\$ 1100  
1207  
1303

**SPECIAL SERVICES**

**Special Carton Marking**

With specially marked information N/C

**Shipping**

Shipped k.d. freight prepaid f.o.b.  
KI-Aristotle Brampton, Ontario L6T 5T6  
factory. Freight class #85.

Specifications and prices are subject to  
change without prior notice.

# Aristotle® Executive Shells

Extended Corner Desk Shells - 24" - Extended Right

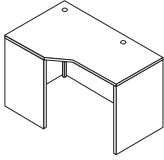
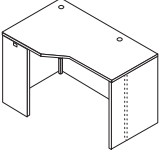
W x D x H	MODEL NUMBER								Approx. Packaged Weight	
	Basic Model	Edge Style	Horizontal Surface Finish	Vertical Surface Finish	Leg Finish	Back Panel Height	Cutaway	Grommets		
 <p>AESPD <b>Extended-Right Option A-Two Full End Panels</b></p> <ul style="list-style-type: none"> <li>• 1-1/2" top with choice of three edge styles</li> <li>• Corner post in black or silver</li> <li>• Back panel features horizontal grain pattern</li> <li>• Cutaway may be straight or curved</li> <li>• 20" desks do not accommodate pedestals</li> </ul>	60 x 24 x 29-1/2"	KCDRA6024.E	<input type="checkbox"/>	<input type="checkbox"/>	<input type="checkbox"/>	<input type="checkbox"/>	<input type="checkbox"/>	<input type="checkbox"/>	115.0#	
	66 x 24 x 29-1/2"	KCDRA6624.E	<input type="checkbox"/>	<input type="checkbox"/>	<input type="checkbox"/>	<input type="checkbox"/>	<input type="checkbox"/>	<input type="checkbox"/>	125.0#	
	72 x 24 x 29-1/2"	KCDRA7224.E	<input type="checkbox"/>	<input type="checkbox"/>	<input type="checkbox"/>	<input type="checkbox"/>	<input type="checkbox"/>	<input type="checkbox"/>	135.0#	
 <p>AESPD <b>Extended-Right Option B-One Full/One Recessed End Panel, Interchangeable</b></p> <ul style="list-style-type: none"> <li>• 1-1/2" top with choice of three edge styles</li> <li>• Corner post in black or silver</li> <li>• Back panel features horizontal grain pattern</li> <li>• Cutaway may be straight or curved</li> <li>• 20" desks do not accommodate pedestals</li> </ul>	60 x 24 x 29-1/2"	KCDRB6024.E	<input type="checkbox"/>	<input type="checkbox"/>	<input type="checkbox"/>	<input type="checkbox"/>	<input type="checkbox"/>	<input type="checkbox"/>	115.0#	
	72 x 24 x 29-1/2"	KCDRB7224.E	<input type="checkbox"/>	<input type="checkbox"/>	<input type="checkbox"/>	<input type="checkbox"/>	<input type="checkbox"/>	<input type="checkbox"/>	<input type="checkbox"/>	135.0#
	66 x 24 x 29-1/2"	KCDRB6624.E	<input type="checkbox"/>	<input type="checkbox"/>	<input type="checkbox"/>	<input type="checkbox"/>	<input type="checkbox"/>	<input type="checkbox"/>	<input type="checkbox"/>	125.0#

**A B C D E F G H**

## HOW TO ORDER

Indicate the following information on order form:

- Quantity of each item.
- Model number, including options. See "How To Build a Model Number".
- Any special service required.

Note:

- The  indicates that a choice is required.
- The absence of the  indicates that no choice is required.
- Alpha-numeric characters in place of  indicate that no other alternatives are available.

## HOW TO BUILD A MODEL NUMBER

- A** Select basic model.
- B** Select edge style.
  - F** - Flat edge
  - P3** - Three wave profile edge
  - P4** - Four wave profile edge
- C** Select horizontal surface finish. Refer to color addendum at ki.com or KI Fabrics & Finishes binder.
- D** Select vertical surface finish. Refer to color addendum at ki.com or KI Fabrics & Finishes binder.
- E** Select corner leg finish. Refer to color addendum at ki.com or KI Fabrics & Finishes binder.
- F** Select back panel height.
  - FULL** - Full height (standard)
  - 2Q** - 1/2 height back panel
  - 2QL** - 1/2 height back panel, right

- 2QR** - 1/2 height back panel, left
- 3Q** - 3/4 height back panel
- 3QL** - 3/4 height back panel, left
- 3QR** - 3/4 height back panel, right
- G** Select cutaway option.
  - ST** - Straight cutaway
  - CV** - Curved cutaway
- H** Select grommet.
  - NGR** - No grommet
  - G** - Grommet





# Aristotle® Executive Shells

Extended Corner Desk Shells - 24" - Extended Right

Delivered  
Pricing

\$ 1100  
1207  
1303

\$ 1100  
1207  
1303

**SPECIAL SERVICES**

**Special Carton Marking**

With specially marked information    N/C

**Shipping**

Shipped **k.d. freight prepaid f.o.b.**  
**KI-Aristotle Brampton, Ontario L6T 5T6**  
factory. Freight class #85.

Specifications and prices are subject to  
change without prior notice.





# Aristotle® Executive Shells

Extended Corner Desk Shells - 24" - Extended Right

Delivered  
Pricing

\$ 1100

1207

1303

**SPECIAL SERVICES**

**Special Carton Marking**

With specially marked information N/C

**Shipping**

Shipped **k.d. freight prepaid f.o.b. KI-Aristotle Brampton, Ontario L6T 5T6** factory. Freight class #85.

Specifications and prices are subject to change without prior notice.

# Aristotle® Executive Shells

Extended Corner Desk Shells - 30" - Extended Left

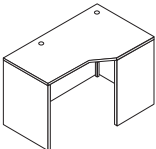
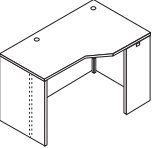
	W x D x H	MODEL NUMBER								Approx. Packaged Weight
		Basic Model	Edge Style	Horizontal Surface Finish	Vertical Surface Finish	Leg Finish	Back Panel Height	Cutaway	Grommets	
 <p>AESPD <b>Extended-Left Option A - Two Full End Panels</b></p> <ul style="list-style-type: none"> <li>• 1-1/2" top with choice of three edge styles</li> <li>• Corner post in black or silver</li> <li>• Back panel features horizontal grain pattern</li> <li>• Cutaway may be straight or curved</li> <li>• 20" desks do not accommodate pedestals</li> </ul>	60 x 30 x 29-1/2"	KCDLA6030.E	<input type="checkbox"/>	<input type="checkbox"/>	<input type="checkbox"/>	<input type="checkbox"/>	<input type="checkbox"/>	<input type="checkbox"/>	<input type="checkbox"/>	145.0#
	66 x 30 x 29-1/2"	KCDLA6630.E	<input type="checkbox"/>	<input type="checkbox"/>	<input type="checkbox"/>	<input type="checkbox"/>	<input type="checkbox"/>	<input type="checkbox"/>	<input type="checkbox"/>	155.0#
	72 x 30 x 29-1/2"	KCDLA7230.E	<input type="checkbox"/>	<input type="checkbox"/>	<input type="checkbox"/>	<input type="checkbox"/>	<input type="checkbox"/>	<input type="checkbox"/>	<input type="checkbox"/>	170.0#
 <p>AESPD <b>Extended-Left, Option B - One Full/One Recessed End Panel, Interchangeable</b></p> <ul style="list-style-type: none"> <li>• 1-1/2" top with choice of three edge styles</li> <li>• Corner post in black or silver</li> <li>• Back panel features horizontal grain pattern</li> <li>• Cutaway may be straight or curved</li> <li>• 20" desks do not accommodate pedestals</li> </ul>	60 x 30 x 29-1/2"	KCDLB6030.E	<input type="checkbox"/>	<input type="checkbox"/>	<input type="checkbox"/>	<input type="checkbox"/>	<input type="checkbox"/>	<input type="checkbox"/>	145.0#	
	66 x 30 x 29-1/2"	KCDLB6630.E	<input type="checkbox"/>	<input type="checkbox"/>	<input type="checkbox"/>	<input type="checkbox"/>	<input type="checkbox"/>	<input type="checkbox"/>	<input type="checkbox"/>	155.0#
	72 x 30 x 29-1/2"	KCDLB7230.E	<input type="checkbox"/>	<input type="checkbox"/>	<input type="checkbox"/>	<input type="checkbox"/>	<input type="checkbox"/>	<input type="checkbox"/>	<input type="checkbox"/>	170.0#
			<b>A</b>	<b>B</b>	<b>C</b>	<b>D</b>	<b>E</b>	<b>F</b>	<b>G</b>	<b>H</b>

## HOW TO ORDER

Indicate the following information on order form:

- Quantity of each item.
- Model number, including options. See "How To Build a Model Number".
- Any special service required.

Note: • The  indicates that a choice is required.  
• The absence of the  indicates that no choice is required.  
• Alpha-numeric characters in place of  indicate that no other alternatives are available.

## HOW TO BUILD A MODEL NUMBER

**A** Select basic model.

**B** Select edge style.

- F** - Flat edge  
**P3** - Three wave profile edge  
**P4** - Four wave profile edge

**C** Select horizontal surface finish.

Refer to color addendum at ki.com or KI Fabrics & Finishes binder.

**D** Select vertical surface finish.

Refer to color addendum at ki.com or KI Fabrics & Finishes binder.

**E** Select corner leg finish

Refer to color addendum at ki.com or KI Fabrics & Finishes binder.

**F** Select back panel height.

- FULL** - Full height (standard)  
**2Q** - 1/2 height back panel  
**2QL** - 1/2 height back panel, right

**2QR** - 1/2 height back panel, left

**3Q** - 3/4 height back panel

**3QL** - 3/4 height back panel, left

**3QR** - 3/4 height back panel, right

**G** Select cutaway option.

- ST** - Straight cutaway  
**CV** - Curved cutaway

**H** Select grommet.

- NGR** - No grommet  
**G** - Grommet



# Aristotle® Executive Shells

Extended Corner Desk Shells - 30" - Extended Left

Delivered Pricing

\$ 1114  
1207  
1303

\$ 1114  
1207  
1303

**SPECIAL SERVICES**

**Special Carton Marking**

With specially marked information N/C

**Shipping**

Shipped k.d. freight prepaid f.o.b.  
KI-Aristotle Brampton, Ontario L6T 5T6  
factory. Freight class #85.

Specifications and prices are subject to  
change without prior notice.





# Aristotle® Executive Shells

Extended Corner Desk Shells - 30" - Extended Left

Delivered  
Pricing

\$ 1114  
1207  
1303

**SPECIAL SERVICES**

**Special Carton Marking**

With specially marked information    N/C

**Shipping**

Shipped **k.d. freight prepaid f.o.b.**  
**KI-Aristotle Brampton, Ontario L6T 5T6**  
factory. Freight class #85.

Specifications and prices are subject to  
change without prior notice.

# Aristotle® Executive Shells

Extended Corner Desk Shells - 30" - Extended Right

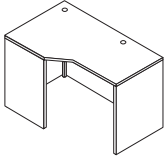
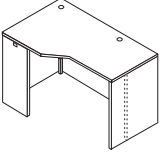
	W x D x H	MODEL NUMBER								Approx. Packaged Weight
		Basic Model	Edge Style	Horizontal Surface Finish	Vertical Surface Finish	Leg Finish	Back Panel Height	Cutaway	Grommets	
 <p>AESPD <b>Extended-Right Option A-Two Full End Panels</b></p> <ul style="list-style-type: none"> <li>• 1-1/2" top with choice of three edge styles</li> <li>• Corner post in black or silver</li> <li>• Back panel features horizontal grain pattern</li> <li>• Cutaway may be straight or curved</li> <li>• 20" desks do not accommodate pedestals</li> </ul>	60 x 30 x 29-1/2"	KCDRA6030.E	<input type="checkbox"/>	<input type="checkbox"/>	<input type="checkbox"/>	<input type="checkbox"/>	<input type="checkbox"/>	<input type="checkbox"/>	<input type="checkbox"/>	115.0#
	66 x 30 x 29-1/2"	KCDRA6630.E	<input type="checkbox"/>	<input type="checkbox"/>	<input type="checkbox"/>	<input type="checkbox"/>	<input type="checkbox"/>	<input type="checkbox"/>	<input type="checkbox"/>	125.0#
	72 x 30 x 29-1/2"	KCDRA7230.E	<input type="checkbox"/>	<input type="checkbox"/>	<input type="checkbox"/>	<input type="checkbox"/>	<input type="checkbox"/>	<input type="checkbox"/>	<input type="checkbox"/>	135.0#
 <p>AESPD <b>Extended-Right Option B-One Full/One Recessed End Panel, Interchangeable</b></p> <ul style="list-style-type: none"> <li>• 1-1/2" top with choice of three edge styles</li> <li>• Corner post in black or silver</li> <li>• Back panel features horizontal grain pattern</li> <li>• Cutaway may be straight or curved</li> <li>• 20" desks do not accommodate pedestals</li> </ul>	60 x 30 x 29-1/2"	KCDRB6030.E	<input type="checkbox"/>	<input type="checkbox"/>	<input type="checkbox"/>	<input type="checkbox"/>	<input type="checkbox"/>	<input type="checkbox"/>	<input type="checkbox"/>	115.0#
	66 x 30 x 29-1/2"	KCDRB6630.E	<input type="checkbox"/>	<input type="checkbox"/>	<input type="checkbox"/>	<input type="checkbox"/>	<input type="checkbox"/>	<input type="checkbox"/>	<input type="checkbox"/>	125.0#
	72 x 30 x 29-1/2"	KCDRB7230.E	<input type="checkbox"/>	<input type="checkbox"/>	<input type="checkbox"/>	<input type="checkbox"/>	<input type="checkbox"/>	<input type="checkbox"/>	<input type="checkbox"/>	135.0#
			<b>A</b>	<b>B</b>	<b>C</b>	<b>D</b>	<b>E</b>	<b>F</b>	<b>G</b>	<b>H</b>

## HOW TO ORDER

Indicate the following information on order form:

- Quantity of each item.
- Model number, including options. See "How To Build a Model Number".
- Any special service required.

Note:

- The  indicates that a choice is required.
- The absence of the  indicates that no choice is required.
- Alpha-numeric characters in place of  indicate that no other alternatives are available.

## HOW TO BUILD A MODEL NUMBER

- A** Select basic model.
- B** Select edge style.
 

F	- Flat edge
P3	- Three wave profile edge
P4	- Four wave profile edge
- C** Select horizontal surface finish.  
Refer to color addendum at ki.com or KI Fabrics & Finishes binder.
- D** Select vertical surface finish.  
Refer to color addendum at ki.com or KI Fabrics & Finishes binder.
- E** Select corner leg finish  
Refer to color addendum at ki.com or KI Fabrics & Finishes binder.
- F** Select back panel height.
 

FULL	- Full height (standard)
2Q	- 1/2 height back panel
2QL	- 1/2 height back panel, right

- |     |                                |
|-----|--------------------------------|
| 2QR | - 1/2 height back panel, left  |
| 3Q  | - 3/4 height back panel        |
| 3QL | - 3/4 height back panel, left  |
| 3QR | - 3/4 height back panel, right |
- G** Select cutaway option.
 

ST	- Straight cutaway
CV	- Curved cutaway
  - H** Select grommet.
 

NGR	- No grommet
G	- Grommet





# Aristotle® Executive Shells

Extended Corner Desk Shells - 30" - Extended Right

Delivered  
Pricing

\$ 1114  
1207  
1303

\$ 1114  
1207  
1303

**SPECIAL SERVICES**

**Special Carton Marking**

With specially marked information    N/C

**Shipping**

Shipped **k.d. freight prepaid f.o.b.**  
**KI-Aristotle Brampton, Ontario L6T 5T6**  
factory. Freight class #85.

Specifications and prices are subject to  
change without prior notice.





# Aristotle® Executive Shells

Extended Corner Desk Shells - 30" - Extended Right

Delivered  
Pricing

\$ 1114

1207

1303

### SPECIAL SERVICES

#### Special Carton Marking

With specially marked information N/C

#### Shipping

Shipped **k.d. freight prepaid f.o.b.**  
**KI-Aristotle Brampton, Ontario L6T 5T6**  
factory. Freight class #85.

Specifications and prices are subject to  
change without prior notice.

# Aristotle® Executive D-Tops

Suspended

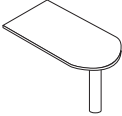
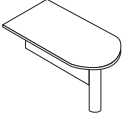
	MODEL	W x D x H	MODEL NUMBER						Approx. Packaged Weight		
			Basic Model	Edge Style	Horizontal Surface Finish	Vertical Surface Finish	Post Leg Finish	Modesty Panel			
 AEDPT	<b>Suspended D-Top</b> • 1-1/2" top with choice of three edge styles • 6" diameter post leg in black or silver • No grommet option • Suspended D-tops must be attached to adjacent furniture for proper stability	36 x 24 x 29-1/2"	KDS3624.E	<input type="checkbox"/>	<input type="checkbox"/>			<input type="checkbox"/>		75.0#	
		42 x 24 x 29-1/2"	KDS4224.E	<input type="checkbox"/>	<input type="checkbox"/>			<input type="checkbox"/>		80.0#	
		48 x 24 x 29-1/2"	KDS4824.E	<input type="checkbox"/>	<input type="checkbox"/>			<input type="checkbox"/>		85.0#	
		54 x 24 x 29-1/2"	KDS5424.E	<input type="checkbox"/>	<input type="checkbox"/>			<input type="checkbox"/>		90.0#	
		60 x 24 x 29-1/2"	KDS6024.E	<input type="checkbox"/>	<input type="checkbox"/>			<input type="checkbox"/>		95.0#	
		66 x 24 x 29-1/2"	KDS6624.E	<input type="checkbox"/>	<input type="checkbox"/>			<input type="checkbox"/>		105.0#	
		48 x 30 x 29-1/2"	KDS4830.E	<input type="checkbox"/>	<input type="checkbox"/>			<input type="checkbox"/>		108.0#	
		54 x 30 x 29-1/2"	KDS5430.E	<input type="checkbox"/>	<input type="checkbox"/>			<input type="checkbox"/>		112.0#	
		60 x 30 x 29-1/2"	KDS6030.E	<input type="checkbox"/>	<input type="checkbox"/>			<input type="checkbox"/>		115.0#	
		66 x 30 x 29-1/2"	KDS6630.E	<input type="checkbox"/>	<input type="checkbox"/>			<input type="checkbox"/>		118.0#	
		72 x 30 x 29-1/2"	KDS7230.E	<input type="checkbox"/>	<input type="checkbox"/>			<input type="checkbox"/>		125.0#	
		66 x 36 x 29-1/2"	KDS6636.E	<input type="checkbox"/>	<input type="checkbox"/>			<input type="checkbox"/>		130.0#	
		72 x 36 x 29-1/2"	KDS7236.E	<input type="checkbox"/>	<input type="checkbox"/>			<input type="checkbox"/>		135.0#	
 AEDPT	<b>Suspended D-Top with Centered Modesty Panel</b> • 1-1/2" top with choice of three edge styles • Includes half end panel, attached on site for placement on approach or user side • 6" diameter post leg in black or silver • No grommet option • Suspended D-tops must be attached to adjacent furniture for proper stability	36 x 24 x 29-1/2"	KDSM3624.E	<input type="checkbox"/>	<input type="checkbox"/>	<input type="checkbox"/>	<input type="checkbox"/>	<input type="checkbox"/>	<input type="checkbox"/>	90.0#	
		42 x 24 x 29-1/2"	KDSM4224.E	<input type="checkbox"/>	<input type="checkbox"/>	<input type="checkbox"/>	<input type="checkbox"/>	<input type="checkbox"/>	<input type="checkbox"/>	<input type="checkbox"/>	95.0#
		48 x 24 x 29-1/2"	KDSM4824.E	<input type="checkbox"/>	<input type="checkbox"/>	<input type="checkbox"/>	<input type="checkbox"/>	<input type="checkbox"/>	<input type="checkbox"/>	<input type="checkbox"/>	100.0#
		54 x 24 x 29-1/2"	KDSM5424.E	<input type="checkbox"/>	<input type="checkbox"/>	<input type="checkbox"/>	<input type="checkbox"/>	<input type="checkbox"/>	<input type="checkbox"/>	<input type="checkbox"/>	105.0#
		60 x 24 x 29-1/2"	KDSM6024.E	<input type="checkbox"/>	<input type="checkbox"/>	<input type="checkbox"/>	<input type="checkbox"/>	<input type="checkbox"/>	<input type="checkbox"/>	<input type="checkbox"/>	110.0#
		66 x 24 x 29-1/2"	KDSM6624.E	<input type="checkbox"/>	<input type="checkbox"/>	<input type="checkbox"/>	<input type="checkbox"/>	<input type="checkbox"/>	<input type="checkbox"/>	<input type="checkbox"/>	120.0#
		48 x 30 x 29-1/2"	KDSM4830.E	<input type="checkbox"/>	<input type="checkbox"/>	<input type="checkbox"/>	<input type="checkbox"/>	<input type="checkbox"/>	<input type="checkbox"/>	<input type="checkbox"/>	123.0#
		54 x 30 x 29-1/2"	KDSM5430.E	<input type="checkbox"/>	<input type="checkbox"/>	<input type="checkbox"/>	<input type="checkbox"/>	<input type="checkbox"/>	<input type="checkbox"/>	<input type="checkbox"/>	127.0#
		60 x 30 x 29-1/2"	KDSM6030.E	<input type="checkbox"/>	<input type="checkbox"/>	<input type="checkbox"/>	<input type="checkbox"/>	<input type="checkbox"/>	<input type="checkbox"/>	<input type="checkbox"/>	130.0#
		66 x 30 x 29-1/2"	KDSM6630.E	<input type="checkbox"/>	<input type="checkbox"/>	<input type="checkbox"/>	<input type="checkbox"/>	<input type="checkbox"/>	<input type="checkbox"/>	<input type="checkbox"/>	133.0#
		72 x 30 x 29-1/2"	KDSM7230.E	<input type="checkbox"/>	<input type="checkbox"/>	<input type="checkbox"/>	<input type="checkbox"/>	<input type="checkbox"/>	<input type="checkbox"/>	<input type="checkbox"/>	140.0#
		66 x 36 x 29-1/2"	KDSM6636.E	<input type="checkbox"/>	<input type="checkbox"/>	<input type="checkbox"/>	<input type="checkbox"/>	<input type="checkbox"/>	<input type="checkbox"/>	<input type="checkbox"/>	145.0#
		72 x 36 x 29-1/2"	KDSM7236.E	<input type="checkbox"/>	<input type="checkbox"/>	<input type="checkbox"/>	<input type="checkbox"/>	<input type="checkbox"/>	<input type="checkbox"/>	<input type="checkbox"/>	150.0#

A

B

C

D

E

F

## HOW TO ORDER

Indicate the following information on order form:

- Quantity of each item.
- Model number, including options. See "How To Build a Model Number".
- Any special service required.

Note: • The  indicates that a choice is required.  
 • The absence of the  indicates that no choice is required.  
 • Alpha-numeric characters in place of  indicate that no other alternatives are available.

## HOW TO BUILD A MODEL NUMBER

**A** Select basic model.

**B** Select edge style.

<b>F</b>	- Flat edge
<b>P3</b>	- Three wave profile edge
<b>P4</b>	- Four wave profile edge

**C** Select horizontal surface finish.

Refer to color addendum at ki.com or KI Fabrics & Finishes binder.

**D** Select vertical surface finish.

Refer to color addendum at ki.com or KI Fabrics & Finishes binder.

**E** Select post leg finish.

Refer to color addendum at ki.com or KI Fabrics & Finishes binder.

**F** Select modesty panel.

<b>PMP</b>	- 14" partial modesty panel (standard)
<b>FMP</b>	- Full height modesty panel; add \$70



# Aristotle® Executive D-Tops

Suspended

Delivered  
Pricing

\$ 826
847
862
878
889
919
885
907
943
982
1060
1085
1099
\$ 893
916
931
948
959
986
955
975
1012
1049
1127
1153
1167

## SPECIAL SERVICES

### Special Carton Marking

With specially marked information N/C

### Shipping

Shipped k.d. freight prepaid f.o.b.  
KI-Aristotle Brampton, Ontario L6T 5T6  
factory. Freight class #85.

Specifications and prices are subject to  
change without prior notice.

# Aristotle® Executive D-Tops

With End Panel

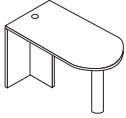
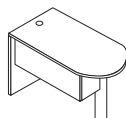
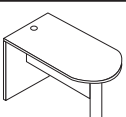
	MODEL	W x D x H	MODEL NUMBER						Approx. Packaged Weight	
			Basic Model	Edge Style	Horizontal Surface Finish	Vertical Surface Finish	Post Leg Finish	Modesty Panel		
 <p>AEDPT</p>	<b>D-Top with End Panel</b> • 1-1/2" top with choice of three edge styles • Features side panel for additional support • 6" diameter post leg in black or silver • Center grommet opposite post leg • D-tops must be attached to adjacent furniture for proper stability • Attachment method is worksurface to worksurface, and cannot be obstructed by an end panel	48 x 24 x 29-1/2"	KDF4824.E	<input type="checkbox"/>	<input type="checkbox"/>	<input type="checkbox"/>	<input type="checkbox"/>	<input type="checkbox"/>	100.0#	
		54 x 24 x 29-1/2"	KDF5424.E	<input type="checkbox"/>	<input type="checkbox"/>	<input type="checkbox"/>	<input type="checkbox"/>	<input type="checkbox"/>	110.0#	
		60 x 24 x 29-1/2"	KDF6024.E	<input type="checkbox"/>	<input type="checkbox"/>	<input type="checkbox"/>	<input type="checkbox"/>	<input type="checkbox"/>	120.0#	
		66 x 24 x 29-1/2"	KDF6624.E	<input type="checkbox"/>	<input type="checkbox"/>	<input type="checkbox"/>	<input type="checkbox"/>	<input type="checkbox"/>	135.0#	
		48 x 30 x 29-1/2"	KDF4830.E	<input type="checkbox"/>	<input type="checkbox"/>	<input type="checkbox"/>	<input type="checkbox"/>	<input type="checkbox"/>	120.0#	
		54 x 30 x 29-1/2"	KDF5430.E	<input type="checkbox"/>	<input type="checkbox"/>	<input type="checkbox"/>	<input type="checkbox"/>	<input type="checkbox"/>	130.0#	
		60 x 30 x 29-1/2"	KDF6030.E	<input type="checkbox"/>	<input type="checkbox"/>	<input type="checkbox"/>	<input type="checkbox"/>	<input type="checkbox"/>	140.0#	
		66 x 30 x 29-1/2"	KDF6630.E	<input type="checkbox"/>	<input type="checkbox"/>	<input type="checkbox"/>	<input type="checkbox"/>	<input type="checkbox"/>	150.0#	
		72 x 30 x 29-1/2"	KDF7230.E	<input type="checkbox"/>	<input type="checkbox"/>	<input type="checkbox"/>	<input type="checkbox"/>	<input type="checkbox"/>	160.0#	
		66 x 24 x 29-1/2"	KDF6636.E	<input type="checkbox"/>	<input type="checkbox"/>	<input type="checkbox"/>	<input type="checkbox"/>	<input type="checkbox"/>	165.0#	
		72 x 36 x 29-1/2"	KDF7236.E	<input type="checkbox"/>	<input type="checkbox"/>	<input type="checkbox"/>	<input type="checkbox"/>	<input type="checkbox"/>	170.0#	
 <p>AEDPT</p>	<b>D-Top with End Panel and Offset Modesty Panel</b> • 1-1/2" top with choice of three edge styles • Features side panel for additional support • 6" diameter post leg in black or silver • Center grommet opposite post leg • D-tops must be attached to adjacent furniture for proper stability • Modesty panel is reversible • Attachment method is worksurface to worksurface, and cannot be obstructed by an end panel	60 x 30 x 29-1/2"	KDM6030.E	<input type="checkbox"/>	<input type="checkbox"/>	<input type="checkbox"/>	<input type="checkbox"/>	<input type="checkbox"/>	155.0#	
		66 x 30 x 29-1/2"	KDM6630.E	<input type="checkbox"/>	<input type="checkbox"/>	<input type="checkbox"/>	<input type="checkbox"/>	<input type="checkbox"/>	<input type="checkbox"/>	165.0#
		72 x 30 x 29-1/2"	KDM7230.E	<input type="checkbox"/>	<input type="checkbox"/>	<input type="checkbox"/>	<input type="checkbox"/>	<input type="checkbox"/>	<input type="checkbox"/>	175.0#
		72 x 36 x 29-1/2"	KDM7236.E	<input type="checkbox"/>	<input type="checkbox"/>	<input type="checkbox"/>	<input type="checkbox"/>	<input type="checkbox"/>	<input type="checkbox"/>	185.0#
 <p>AEDPT</p>	<b>D-Top with End Panel and Centered Modesty Panel</b> • 1-1/2" top with choice of three edge styles • Features side panel for additional support • 6" diameter post leg in black or silver • Center grommet opposite post leg • D-tops must be attached to adjacent furniture for proper stability • Attachment method is worksurface to worksurface, and cannot be obstructed by an end panel	48 x 24 x 29-1/2"	KDCM4824.E	<input type="checkbox"/>	<input type="checkbox"/>	<input type="checkbox"/>	<input type="checkbox"/>	<input type="checkbox"/>	100.0#	
		54 x 24 x 29-1/2"	KDCM5424.E	<input type="checkbox"/>	<input type="checkbox"/>	<input type="checkbox"/>	<input type="checkbox"/>	<input type="checkbox"/>	<input type="checkbox"/>	110.0#
		60 x 24 x 29-1/2"	KDCM6024.E	<input type="checkbox"/>	<input type="checkbox"/>	<input type="checkbox"/>	<input type="checkbox"/>	<input type="checkbox"/>	<input type="checkbox"/>	120.0#
		66 x 24 x 29-1/2"	KDCM6624.E	<input type="checkbox"/>	<input type="checkbox"/>	<input type="checkbox"/>	<input type="checkbox"/>	<input type="checkbox"/>	<input type="checkbox"/>	135.0#
		48 x 30 x 29-1/2"	KDCM4830.E	<input type="checkbox"/>	<input type="checkbox"/>	<input type="checkbox"/>	<input type="checkbox"/>	<input type="checkbox"/>	<input type="checkbox"/>	135.0#
		54 x 30 x 29-1/2"	KDCM5430.E	<input type="checkbox"/>	<input type="checkbox"/>	<input type="checkbox"/>	<input type="checkbox"/>	<input type="checkbox"/>	<input type="checkbox"/>	145.0#
		60 x 30 x 29-1/2"	KDCM6030.E	<input type="checkbox"/>	<input type="checkbox"/>	<input type="checkbox"/>	<input type="checkbox"/>	<input type="checkbox"/>	<input type="checkbox"/>	155.0#
		66 x 30 x 29-1/2"	KDCM6630.E	<input type="checkbox"/>	<input type="checkbox"/>	<input type="checkbox"/>	<input type="checkbox"/>	<input type="checkbox"/>	<input type="checkbox"/>	165.0#
		72 x 30 x 29-1/2"	KDCM7230.E	<input type="checkbox"/>	<input type="checkbox"/>	<input type="checkbox"/>	<input type="checkbox"/>	<input type="checkbox"/>	<input type="checkbox"/>	175.0#
		60 x 36 x 29-1/2"	KDCM6636.E	<input type="checkbox"/>	<input type="checkbox"/>	<input type="checkbox"/>	<input type="checkbox"/>	<input type="checkbox"/>	<input type="checkbox"/>	165.0#
		72 x 36 x 29-1/2"	KDCM7236.E	<input type="checkbox"/>	<input type="checkbox"/>	<input type="checkbox"/>	<input type="checkbox"/>	<input type="checkbox"/>	185.0#	

**A**   **B**   **C**   **D**   **E**   **F**

## HOW TO ORDER

Indicate the following information on order form:

- Quantity of each item.
- Model number, including options. See "How To Build a Model Number".
- Any special service required.

Note: • The  indicates that a choice is required.  
 • The absence of the  indicates that no choice is required.  
 • Alpha-numeric characters in place of  indicate that no other alternatives are available.

## HOW TO BUILD A MODEL NUMBER

- A** Select basic model.
- B** Select edge style.  
**F** - Flat edge  
**P3** - Three wave profile edge  
**P4** - Four wave profile edge
- C** Select horizontal surface finish.  
 Refer to color addendum at ki.com or KI Fabrics & Finishes binder.
- D** Select vertical surface finish.  
 Refer to color addendum at ki.com or KI Fabrics & Finishes binder.
- E** Select post leg finish.  
 Refer to color addendum at ki.com or KI Fabrics & Finishes binder.
- F** Select modesty panel height.  
**PMP** - 14" partial modesty panel (standard)  
**FMP** - Full height modesty panel; add \$70



# Aristotle<sup>®</sup> Executive D-Tops

With End Panel

Delivered Pricing

\$ 911
926
941
957
998
1021
992
1077
1148
1187
1200
\$ 1122
1148
1178
1143

\$ 969
995
1025
1061
1034
1040
1126
1151
1173
1218
1266

**SPECIAL SERVICES**

**Special Carton Marking**

With specially marked information N/C

**Shipping**

Shipped k.d. freight prepaid f.o.b.  
KI-Aristotle Brampton, Ontario L6T 5T6  
factory. Freight class #85.

Specifications and prices are subject to  
change without prior notice.

# Aristotle® Executive P-Tops

Suspended

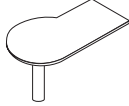
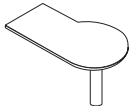
	MODEL	W x D x H	MODEL NUMBER				Approx. Packaged Weight
			Basic Model	Edge Style	Horizontal Surface Finish	Post Leg Finish	
 AEDPT	<b>Suspended P-Top, Left</b> <ul style="list-style-type: none"> <li>1-1/2" top with choice of three edge styles</li> <li>6" diameter post leg in black or silver</li> <li>No grommet option</li> <li>Suspended P-tops must be attached to adjacent furniture for proper stability</li> </ul>	60 x 36 x 29-1/2"	KPLS6036.E	<input type="checkbox"/>	<input type="checkbox"/>	<input type="checkbox"/>	120.0#
		66 x 36 x 29-1/2"	KPLS6636.E	<input type="checkbox"/>	<input type="checkbox"/>	<input type="checkbox"/>	130.0#
		72 x 36 x 29-1/2"	KPLS7236.E	<input type="checkbox"/>	<input type="checkbox"/>	<input type="checkbox"/>	135.0#
		60 x 42 x 29-1/2"	KPLS6042.E	<input type="checkbox"/>	<input type="checkbox"/>	<input type="checkbox"/>	123.0#
		66 x 42 x 29-1/2"	KPLS6642.E	<input type="checkbox"/>	<input type="checkbox"/>	<input type="checkbox"/>	133.0#
		72 x 42 x 29-1/2"	KPLS7242.E	<input type="checkbox"/>	<input type="checkbox"/>	<input type="checkbox"/>	138.0#
 AEDPT	<b>Suspended P-Top, Right</b> <ul style="list-style-type: none"> <li>1-1/2" top with choice of three edge styles</li> <li>6" diameter post leg in black or silver</li> <li>No grommet option</li> <li>Suspended P-tops must be attached to adjacent furniture for proper stability</li> </ul>	60 x 36 x 29-1/2"	KPRS6036.E	<input type="checkbox"/>	<input type="checkbox"/>	<input type="checkbox"/>	120.0#
		66 x 36 x 29-1/2"	KPRS6636.E	<input type="checkbox"/>	<input type="checkbox"/>	<input type="checkbox"/>	130.0#
		72 x 36 x 29-1/2"	KPRS7236.E	<input type="checkbox"/>	<input type="checkbox"/>	<input type="checkbox"/>	135.0#
		60 x 42 x 29-1/2"	KPRS6042.E	<input type="checkbox"/>	<input type="checkbox"/>	<input type="checkbox"/>	123.0#
		66 x 42 x 29-1/2"	KPRS6642.E	<input type="checkbox"/>	<input type="checkbox"/>	<input type="checkbox"/>	133.0#
		72 x 42 x 29-1/2"	KPRS7242.E	<input type="checkbox"/>	<input type="checkbox"/>	<input type="checkbox"/>	138.0#

A

B

C

D

## HOW TO ORDER

Indicate the following information on order form:

- Quantity of each item.
- Model number, including options. See "How To Build a Model Number".
- Any special service required.

Note:

- The  indicates that a choice is required.
- The absence of the  indicates that no choice is required.
- Alpha-numeric characters in place of  indicate that no other alternatives are available.

## HOW TO BUILD A MODEL NUMBER

- A** Select basic model.
- B** Select edge style.
- |           |                           |
|-----------|---------------------------|
| <b>F</b>  | - Flat edge               |
| <b>P3</b> | - Three wave profile edge |
| <b>P4</b> | - Four wave profile edge  |
- C** Select horizontal surface finish.  
Refer to color addendum at ki.com or KI Fabrics & Finishes binder.
- D** Select post leg finish.  
Refer to color addendum at ki.com or KI Fabrics & Finishes binder.





# Aristotle® Executive P-Tops

Suspended

Delivered Pricing

\$ 1098

1133

1213

1115

1152

1231

\$ 1098

1133

1213

1115

1152

1231

**SPECIAL SERVICES**

**Special Carton Marking**

With specially marked information N/C

**Shipping**

Shipped k.d. freight prepaid f.o.b.  
KI-Aristotle Brampton, Ontario L6T 5T6  
factory. Freight class #85.

Specifications and prices are subject to  
change without prior notice.

# Aristotle® Executive P-Tops

With End Panel

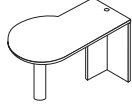
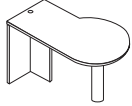
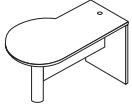
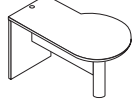
	MODEL	W x D x H	MODEL NUMBER						Approx. Packaged Weight
			Basic Model	Edge Style	Horizontal Surface Finish	Vertical Surface Finish	Post Leg Finish	Modesty Panel	
 AEDPT	<b>P-Top with End Panel, Left</b> • 1-1/2" top/choice of three edge styles • Has side panel for additional support • 6" diameter post leg in black or silver • Center grommet opposite post leg • P-tops must be attached to adjacent furniture for proper stability • Attachment method is worksurface to worksurface, and cannot be obstructed by an end panel	60 x 36 x 29-1/2"	KPLF6036.E	<input type="checkbox"/>	<input type="checkbox"/>	<input type="checkbox"/>	<input type="checkbox"/>	<input type="checkbox"/>	150.0#
		66 x 36 x 29-1/2"	KPLF6636.E	<input type="checkbox"/>	<input type="checkbox"/>	<input type="checkbox"/>	<input type="checkbox"/>	<input type="checkbox"/>	165.0#
		72 x 36 x 29-1/2"	KPLF7236.E	<input type="checkbox"/>	<input type="checkbox"/>	<input type="checkbox"/>	<input type="checkbox"/>	<input type="checkbox"/>	170.0#
		60 x 42 x 29-1/2"	KPLF6042.E	<input type="checkbox"/>	<input type="checkbox"/>	<input type="checkbox"/>	<input type="checkbox"/>	<input type="checkbox"/>	155.0#
		66 x 42 x 29-1/2"	KPLF6642.E	<input type="checkbox"/>	<input type="checkbox"/>	<input type="checkbox"/>	<input type="checkbox"/>	<input type="checkbox"/>	170.0#
		72 x 42 x 29-1/2"	KPLF7242.E	<input type="checkbox"/>	<input type="checkbox"/>	<input type="checkbox"/>	<input type="checkbox"/>	<input type="checkbox"/>	175.0#
 AEDPT	<b>P-Top with End Panel, Right</b> • 1-1/2" top/choice of three edge styles • Has side panel for additional support • 6" diameter post leg in black or silver • Center grommet opposite post leg • P-tops must be attached to adjacent furniture for proper stability • Attachment method is worksurface to worksurface, and cannot be obstructed by an end panel	60 x 36 x 29-1/2"	KPRF6036.E	<input type="checkbox"/>	<input type="checkbox"/>	<input type="checkbox"/>	<input type="checkbox"/>	<input type="checkbox"/>	150.0#
		66 x 36 x 29-1/2"	KPRF6636.E	<input type="checkbox"/>	<input type="checkbox"/>	<input type="checkbox"/>	<input type="checkbox"/>	<input type="checkbox"/>	165.0#
		72 x 36 x 29-1/2"	KPRF7236.E	<input type="checkbox"/>	<input type="checkbox"/>	<input type="checkbox"/>	<input type="checkbox"/>	<input type="checkbox"/>	170.0#
		60 x 42 x 29-1/2"	KPRF6042.E	<input type="checkbox"/>	<input type="checkbox"/>	<input type="checkbox"/>	<input type="checkbox"/>	<input type="checkbox"/>	155.0#
		66 x 42 x 29-1/2"	KPRF6642.E	<input type="checkbox"/>	<input type="checkbox"/>	<input type="checkbox"/>	<input type="checkbox"/>	<input type="checkbox"/>	170.0#
		72 x 42 x 29-1/2"	KPRF7242.E	<input type="checkbox"/>	<input type="checkbox"/>	<input type="checkbox"/>	<input type="checkbox"/>	<input type="checkbox"/>	175.0#
 AEDPT	<b>P-Top with End Panel and Centered Modesty Panel, Left</b> • 1-1/2" top/choice of three edge styles • Has side panel for additional support • 6" diameter post leg in black or silver • Center grommet opposite post leg • P-tops must be attached to adjacent furniture for proper stability • Attachment method is worksurface to worksurface, and cannot be obstructed by an end panel	60 x 36 x 29-1/2"	KPLM6036.E	<input type="checkbox"/>	<input type="checkbox"/>	<input type="checkbox"/>	<input type="checkbox"/>	<input type="checkbox"/>	165.0#
		66 x 36 x 29-1/2"	KPLM6636.E	<input type="checkbox"/>	<input type="checkbox"/>	<input type="checkbox"/>	<input type="checkbox"/>	<input type="checkbox"/>	180.0#
		72 x 36 x 29-1/2"	KPLM7236.E	<input type="checkbox"/>	<input type="checkbox"/>	<input type="checkbox"/>	<input type="checkbox"/>	<input type="checkbox"/>	185.0#
		60 x 42 x 29-1/2"	KPLM6042.E	<input type="checkbox"/>	<input type="checkbox"/>	<input type="checkbox"/>	<input type="checkbox"/>	<input type="checkbox"/>	170.0#
		66 x 42 x 29-1/2"	KPLM6642.E	<input type="checkbox"/>	<input type="checkbox"/>	<input type="checkbox"/>	<input type="checkbox"/>	<input type="checkbox"/>	185.0#
		72 x 42 x 29-1/2"	KPLM7242.E	<input type="checkbox"/>	<input type="checkbox"/>	<input type="checkbox"/>	<input type="checkbox"/>	<input type="checkbox"/>	190.0#
 AEDPT	<b>P-Top with End Panel and Centered Modesty Panel, Right</b> • 1-1/2" top/choice of three edge styles • Has side panel for additional support • 6" diameter post leg in black or silver • Center grommet opposite post leg • P-tops must be attached to adjacent furniture for proper stability • Attachment method is worksurface to worksurface, and cannot be obstructed by an end panel	60 x 36 x 29-1/2"	KPRM6036.E	<input type="checkbox"/>	<input type="checkbox"/>	<input type="checkbox"/>	<input type="checkbox"/>	<input type="checkbox"/>	165.0#
		66 x 36 x 29-1/2"	KPRM6636.E	<input type="checkbox"/>	<input type="checkbox"/>	<input type="checkbox"/>	<input type="checkbox"/>	<input type="checkbox"/>	180.0#
		72 x 36 x 29-1/2"	KPRM7236.E	<input type="checkbox"/>	<input type="checkbox"/>	<input type="checkbox"/>	<input type="checkbox"/>	<input type="checkbox"/>	185.0#
		60 x 42 x 29-1/2"	KPRM6042.E	<input type="checkbox"/>	<input type="checkbox"/>	<input type="checkbox"/>	<input type="checkbox"/>	<input type="checkbox"/>	170.0#
		66 x 42 x 29-1/2"	KPRM6642.E	<input type="checkbox"/>	<input type="checkbox"/>	<input type="checkbox"/>	<input type="checkbox"/>	<input type="checkbox"/>	185.0#
		72 x 42 x 29-1/2"	KPRM7242.E	<input type="checkbox"/>	<input type="checkbox"/>	<input type="checkbox"/>	<input type="checkbox"/>	<input type="checkbox"/>	190.0#

A

B

C

D

E

F

## HOW TO ORDER

Indicate the following information on order form:

- Quantity of each item.
- Model number, including options. See "How To Build a Model Number".
- Any special service required.

Note: • The  indicates that a choice is required.  
 • The absence of the  indicates that no choice is required.  
 • Alpha-numeric characters in place of  indicate that no other alternatives are available.

## HOW TO BUILD A MODEL NUMBER

**A** Select basic model.

**B** Select edge style.

<b>F</b>	- Flat edge
<b>P3</b>	- Three wave profile edge
<b>P4</b>	- Four wave profile edge

**C** Select horizontal surface finish.

Refer to color addendum at [ki.com](http://ki.com) or KI Fabrics & Finishes binder.

**D** Select vertical surface finish.

Refer to color addendum at [ki.com](http://ki.com) or KI Fabrics & Finishes binder.

**E** Select post leg finish.

Refer to color addendum at [ki.com](http://ki.com) or KI Fabrics & Finishes binder.

**F** Select modesty panel height.

<b>PMP</b>	- 14" partial modesty panel (standard)
<b>FMP</b>	- Full height modesty panel; add \$70



# Aristotle® Executive P-Tops

With End Panel

Delivered Pricing

\$ 1324  
1361  
1399  
1348  
1384  
1420

\$ 1324  
1361  
1399  
1348  
1384  
1420

\$ 1402  
1439  
1474  
1423  
1461  
1499

\$ 1402  
1439  
1474  
1423  
1461  
1499

**SPECIAL SERVICES**

**Special Carton Marking**

With specially marked information N/C

**Shipping**

Shipped k.d. freight prepaid f.o.b.  
KI-Aristotle Brampton, Ontario L6T 5T6  
factory. Freight class #85.

Specifications and prices are subject to  
change without prior notice.

# Aristotle® Executive Storage

## Open Overheads

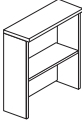
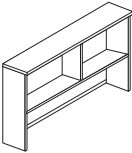
				MODEL NUMBER				
MODEL	Features	W x D x H	Basic Model	Edge Style	Cutaway Gable Option	Horizontal Surface Finish	Vertical Surface Finish	
 <p>AEQVD</p>	<p><b>Open Overhead, 36" High</b></p> <ul style="list-style-type: none"> <li>1-1/2" top with choice of three edge styles</li> <li>17-1/2" clearance above desktop and 65" installed height</li> <li>13-3/4" internal height clearance</li> <li>Full-width concealed cable pass through 1-3/4" high</li> <li>Tackboards and papers sorters specified separately</li> <li>Cutaway gable option should only be specified in side-to-side overhead applications, as standalone units are not stable with cutaway gables</li> </ul>	Without center divider	24 x 16 x 36"	KOS2436.E	<input type="checkbox"/>	<input type="checkbox"/>	<input type="checkbox"/>	<input type="checkbox"/>
		Without center divider	30 x 16 x 36"	KOS3036.E	<input type="checkbox"/>	<input type="checkbox"/>	<input type="checkbox"/>	<input type="checkbox"/>
		Without center divider	36 x 16 x 36"	KOS3636.E	<input type="checkbox"/>	<input type="checkbox"/>	<input type="checkbox"/>	<input type="checkbox"/>
		Without center divider	42 x 16 x 36"	KOS4236.E	<input type="checkbox"/>	<input type="checkbox"/>	<input type="checkbox"/>	<input type="checkbox"/>
 <p>AEQVD</p>	<p><b>Open Overhead, 36" High</b></p> <ul style="list-style-type: none"> <li>1-1/2" top with choice of three edge styles</li> <li>17-1/2" clearance above desktop and 65" installed height</li> <li>13-3/4" internal height clearance</li> <li>Full-width concealed cable pass through 1-3/4" high</li> <li>Tackboards and papers sorters specified separately</li> <li>Cutaway gable option should only be specified in side-to-side overhead applications, as standalone units are not stable with cutaway gables</li> </ul>	With center divider	48 x 16 x 36"	KOS4836.E	<input type="checkbox"/>	<input type="checkbox"/>	<input type="checkbox"/>	<input type="checkbox"/>
		With center divider	54 x 16 x 36"	KOS5436.E	<input type="checkbox"/>	<input type="checkbox"/>	<input type="checkbox"/>	<input type="checkbox"/>
		With center divider	60 x 16 x 36"	KOS6036.E	<input type="checkbox"/>	<input type="checkbox"/>	<input type="checkbox"/>	<input type="checkbox"/>
		With center divider	66 x 16 x 36"	KOS6636.E	<input type="checkbox"/>	<input type="checkbox"/>	<input type="checkbox"/>	<input type="checkbox"/>
		With center divider	72 x 16 x 36"	KOS7236.E	<input type="checkbox"/>	<input type="checkbox"/>	<input type="checkbox"/>	<input type="checkbox"/>
		With center divider	78 x 16 x 36"	KOS7836.E	<input type="checkbox"/>	<input type="checkbox"/>	<input type="checkbox"/>	<input type="checkbox"/>
			<b>A</b>	<b>B</b>	<b>C</b>	<b>D</b>	<b>E</b>	

### HOW TO ORDER

Indicate the following information on order form:

- Quantity of each item.
- Model number, including options. See "How To Build a Model Number".
- Any special service required.

Note:

- The  indicates that a choice is required.
- The absence of the  indicates that no choice is required.
- Alpha-numeric characters in place of  indicate that no other alternatives are available.

### HOW TO BUILD A MODEL NUMBER

- A** Select basic model.
- B** Select edge style.
 

<b>F</b>	- Flat edge
<b>P3</b>	- Three wave profile edge
<b>P4</b>	- Four wave profile edge
- C** Select cutaway gable option.
 

<b>CGN</b>	- No Cutaway gable (standard)
<b>CGL</b>	- Cutaway gable left; add \$70
<b>CGR</b>	- Cutaway gable right; add \$70
<b>CLR</b>	- Cutaway gable left and right; add \$141
- D** Select horizontal surface finish. Refer to color addendum at ki.com or KI Fabrics & Finishes binder.
- E** Select vertical surface finish. Refer to color addendum at ki.com or KI Fabrics & Finishes binder.



# Aristotle® Executive Storage

Open Overheads

Approx. Packaged Weight	Delivered Pricing
65.0#	\$ 547
75.0#	617
90.0#	680
100.0#	708

110.0#	\$ 796
120.0#	839
130.0#	912
140.0#	969
150.0#	1035
160.0#	1104

## SPECIAL SERVICES

### Special Carton Marking

With specially marked information N/C

### Shipping

Shipped **assembled freight prepaid f.o.b. KI-Aristotle Brampton, Ontario L6T 5T6** factory. Freight class #85.

Specifications and prices are subject to change without prior notice.

# Aristotle® Executive Storage

## Open Overheads

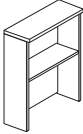
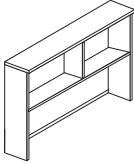
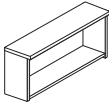
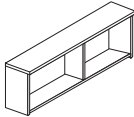
	MODEL	Features	W x D x H	MODEL NUMBER				
				Basic Model	Edge Style	Cutaway Gable Option	Horizontal Surface Finish	Vertical Surface Finish
 <p>AEOVD</p>	<b>Open Overhead, 43" High</b> <ul style="list-style-type: none"> <li>• 1-1/2" top with choice of three edge styles</li> <li>• 24" clearance above desktop and 72" installed height</li> <li>• 13-3/4" internal height clearance</li> <li>• Full-width concealed cable pass through 1-3/4" high</li> <li>• Tackboards and papers sorters specified separately</li> <li>• Cutaway gable option should only be specified in side-to-side overhead applications, as standalone units are not stable with cutaway gables</li> </ul>	Without center divider	24 x 16 x 43"	KOS2443.E	<input type="checkbox"/>	<input type="checkbox"/>	<input type="checkbox"/>	<input type="checkbox"/>
		Without center divider	30 x 16 x 43"	KOS3043.E	<input type="checkbox"/>	<input type="checkbox"/>	<input type="checkbox"/>	<input type="checkbox"/>
		Without center divider	36 x 16 x 43"	KOS3643.E	<input type="checkbox"/>	<input type="checkbox"/>	<input type="checkbox"/>	<input type="checkbox"/>
		Without center divider	42 x 16 x 43"	KOS4243.E	<input type="checkbox"/>	<input type="checkbox"/>	<input type="checkbox"/>	<input type="checkbox"/>
 <p>AEOVD</p>	<b>Open Overhead, 43" High</b> <ul style="list-style-type: none"> <li>• 1-1/2" top with choice of three edge styles</li> <li>• 24" clearance above desktop and 72" installed height</li> <li>• 13-3/4" internal height clearance</li> <li>• Full-width concealed cable pass through 1-3/4" high</li> <li>• Tackboards and papers sorters specified separately</li> <li>• Cutaway gable option should only be specified in side-to-side overhead applications, as standalone units are not stable with cutaway gables</li> </ul>	With center divider	48 x 16 x 43"	KOS4843.E	<input type="checkbox"/>	<input type="checkbox"/>	<input type="checkbox"/>	<input type="checkbox"/>
		With center divider	54 x 16 x 43"	KOS5443.E	<input type="checkbox"/>	<input type="checkbox"/>	<input type="checkbox"/>	<input type="checkbox"/>
		With center divider	60 x 16 x 43"	KOS6043.E	<input type="checkbox"/>	<input type="checkbox"/>	<input type="checkbox"/>	<input type="checkbox"/>
		With center divider	66 x 16 x 43"	KOS6643.E	<input type="checkbox"/>	<input type="checkbox"/>	<input type="checkbox"/>	<input type="checkbox"/>
		With center divider	72 x 16 x 43"	KOS7243.E	<input type="checkbox"/>	<input type="checkbox"/>	<input type="checkbox"/>	<input type="checkbox"/>
		With center divider	78 x 16 x 43"	KOS7843.E	<input type="checkbox"/>	<input type="checkbox"/>	<input type="checkbox"/>	<input type="checkbox"/>
 <p>AEOVD</p>	<b>Open Overhead-Wall Mount</b> <ul style="list-style-type: none"> <li>• 1-1/2" top with choice of three edge styles</li> <li>• 13-3/4" internal height clearance</li> <li>• Attachment hardware included</li> </ul>	Without center divider	24 x 17 x 18"	KWMS024.E	<input type="checkbox"/>		<input type="checkbox"/>	<input type="checkbox"/>
		Without center divider	30 x 17 x 18"	KWMS030.E	<input type="checkbox"/>		<input type="checkbox"/>	<input type="checkbox"/>
		Without center divider	36 x 17 x 18"	KWMS036.E	<input type="checkbox"/>		<input type="checkbox"/>	<input type="checkbox"/>
		Without center divider	42 x 17 x 18"	KWMS042.E	<input type="checkbox"/>		<input type="checkbox"/>	<input type="checkbox"/>
 <p>AEOVD</p>	<b>Open Overhead-Wall Mount</b> <ul style="list-style-type: none"> <li>• 1-1/2" top with choice of three edge styles</li> <li>• 13-3/4" internal height clearance</li> <li>• Attachment hardware included</li> </ul>	With center divider	48 x 17 x 18"	KWMS048.E	<input type="checkbox"/>		<input type="checkbox"/>	<input type="checkbox"/>
		With center divider	54 x 17 x 18"	KWMS054.E	<input type="checkbox"/>		<input type="checkbox"/>	<input type="checkbox"/>
		With center divider	60 x 17 x 18"	KWMS060.E	<input type="checkbox"/>		<input type="checkbox"/>	<input type="checkbox"/>
		With center divider	66 x 17 x 18"	KWMS066.E	<input type="checkbox"/>		<input type="checkbox"/>	<input type="checkbox"/>
		With center divider	72 x 17 x 18"	KWMS072.E	<input type="checkbox"/>		<input type="checkbox"/>	<input type="checkbox"/>
		With center divider	78 x 17 x 18"	KWMS078.E	<input type="checkbox"/>		<input type="checkbox"/>	<input type="checkbox"/>

**A**   **B**   **C**   **D**   **E**

### HOW TO ORDER

Indicate the following information on order form:

1. Quantity of each item.
2. Model number, including options. See "How To Build a Model Number".
3. Any special service required.

Note: • The  indicates that a choice is required.  
 • The absence of the  indicates that no choice is required.  
 • Alpha-numeric characters in place of  indicate that no other alternatives are available.

### HOW TO BUILD A MODEL NUMBER

- A** Select basic model.
- B** Select edge style.
 

<b>F</b>	- Flat edge
<b>P3</b>	- Three wave profile edge
<b>P4</b>	- Four wave profile edge
- C** Select cutaway gable option.
 

<b>CGN</b>	- No Cutaway gable (standard)
<b>CGL</b>	- Cutaway gable left; add \$70
<b>CGR</b>	- Cutaway gable right; add \$70
<b>CLR</b>	- Cutaway gable left and right; add \$141
- D** Select horizontal surface finish.  
 Refer to color addendum at ki.com or KI Fabrics & Finishes binder.
- E** Select vertical surface finish.  
 Refer to color addendum at ki.com or KI Fabrics & Finishes binder.



# Aristotle® Executive Storage

Open Overheads

Approx. Packaged Weight	Delivered Pricing
75.0#	\$ 717
85.0#	788
100.0#	849
110.0#	877

120.0#	\$ 963
130.0#	1009
140.0#	1079
150.0#	1138
160.0#	1205
170.0#	1275

47.0#	\$ 551
56.0#	617
65.0#	680
73.0#	708

86.0#	\$ 796
95.0#	882
103.0#	912
112.0#	969
120.0#	1036
129.0#	1096

**SPECIAL SERVICES**

**Special Carton Marking**

With specially marked information N/C

**Shipping**

Shipped **assembled freight prepaid f.o.b. KI-Aristotle Brampton, Ontario L6T 5T6** factory. Freight class #85.

Specifications and prices are subject to change without prior notice.

# Aristotle® Executive Storage

Closed Overheads-Open Back Below Shelf

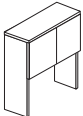
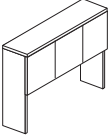
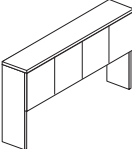
	MODEL	W x D x H	MODEL NUMBER				Approx. Packaged Weight
			Basic Model	Edge Style	Horizontal Surface Finish	Vertical Surface Finish	
 <p>AEOVD</p>	<b>Closed Overhead, 36" High-Open Back Below Shelf</b> • 1-1/2" top with choice of three edge styles • 17-1/2" clearance above desktop and 65" installed height • 13-3/4" internal height clearance • Full-width concealed cable pass through 1-3/4" high • Pulls cannot be specified	24 x 16 x 36"	KOD02436.E	<input type="checkbox"/>	<input type="checkbox"/>	<input type="checkbox"/>	60.0#
		30 x 16 x 36"	KOD03036.E	<input type="checkbox"/>	<input type="checkbox"/>	<input type="checkbox"/>	70.0#
		36 x 16 x 36"	KOD03636.E	<input type="checkbox"/>	<input type="checkbox"/>	<input type="checkbox"/>	80.0#
		42 x 16 x 36"	KOD04236.E	<input type="checkbox"/>	<input type="checkbox"/>	<input type="checkbox"/>	90.0#
 <p>AEOVD</p>	<b>Closed Overhead, 36" High-Open Back Below Shelf</b> • 1-1/2" top with choice of three edge styles • 17-1/2" clearance above desktop and 65" installed height • 13-3/4" internal height clearance • Full-width concealed cable pass through 1-3/4" high • 48" and wider units feature center divider • Pulls cannot be specified	48 x 16 x 36"	KOD04836.E	<input type="checkbox"/>	<input type="checkbox"/>	<input type="checkbox"/>	100.0#
 <p>AEOVD</p>	<b>Closed Overhead, 36" High-Open Back Below Shelf</b> • 1-1/2" top with choice of three edge styles • 17-1/2" clearance above desktop and 65" installed height • 13-3/4" internal height clearance • Full-width concealed cable pass through 1-3/4" high • 48" and wider units feature center divider • Pulls cannot be specified	54 x 16 x 36"	KOD05436.E	<input type="checkbox"/>	<input type="checkbox"/>	<input type="checkbox"/>	110.0#
		60 x 16 x 36"	KOD06036.E	<input type="checkbox"/>	<input type="checkbox"/>	<input type="checkbox"/>	120.0#
		66 x 16 x 36"	KOD06636.E	<input type="checkbox"/>	<input type="checkbox"/>	<input type="checkbox"/>	130.0#
		72 x 16 x 36"	KOD07236.E	<input type="checkbox"/>	<input type="checkbox"/>	<input type="checkbox"/>	140.0#
		78 x 16 x 36"	KOD07836.E	<input type="checkbox"/>	<input type="checkbox"/>	<input type="checkbox"/>	150.0#

**A**      **B**      **C**      **D**

## HOW TO ORDER

Indicate the following information on order form:

- Quantity of each item.
- Model number, including options. See "How To Build a Model Number".
- Any special service required.

Note: • The  indicates that a choice is required.  
 • The absence of the  indicates that no choice is required.  
 • Alpha-numeric characters in place of  indicate that no other alternatives are available.

## HOW TO BUILD A MODEL NUMBER

- A** Select basic model.
- B** Select edge style.
 

<b>F</b>	- Flat edge
<b>P3</b>	- Three wave profile edge
<b>P4</b>	- Four wave profile edge
- C** Select horizontal surface finish.  
Refer to color addendum at ki.com or KI Fabrics & Finishes binder.
- D** Select vertical surface finish.  
Refer to color addendum at ki.com or KI Fabrics & Finishes binder.





# Aristotle® Executive Storage

Closed Overheads-Open Back Below Shelf

Delivered  
Pricing

\$ 750  
794  
847  
926

\$ 1025

\$ 1123  
1195  
1265  
1329  
1401

### SPECIAL SERVICES

#### Special Carton Marking

With specially marked information    N/C



#### Shipping

Shipped **assembled freight prepaid f.o.b. KI-Aristotle Brampton, Ontario L6T 5T6** factory. Freight class #85.

Specifications and prices are subject to change without prior notice.

# Aristotle® Executive Storage

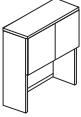
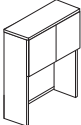
Closed Overheads

				MODEL NUMBER						
MODEL	Features	W x D x H	Basic Model	Edge Style	Cutaway Gable Option	Lock Option	Key Option	Horizontal Surface Finish	Vertical Surface Finish	
 <p>AEOVD</p>	<b>Closed Overhead, 36" High</b>	2 doors	24 x 16 x 36"	KOD2436.E	<input type="checkbox"/>	<input type="checkbox"/>	<input type="checkbox"/>	<input type="checkbox"/>	<input type="checkbox"/>	
	• 17-1/2" clearance above desktop and 65" installed height	2 doors	30 x 16 x 36"	KOD3036.E	<input type="checkbox"/>	<input type="checkbox"/>	<input type="checkbox"/>	<input type="checkbox"/>	<input type="checkbox"/>	
	• 13-3/4" internal height clearance	2 doors	36 x 16 x 36"	KOD3636.E	<input type="checkbox"/>	<input type="checkbox"/>	<input type="checkbox"/>	<input type="checkbox"/>	<input type="checkbox"/>	
	• Full-width concealed cable pass through 1-3/4" high	2 doors	42 x 16 x 36"	KOD4236.E	<input type="checkbox"/>	<input type="checkbox"/>	<input type="checkbox"/>	<input type="checkbox"/>	<input type="checkbox"/>	
	• Pulls cannot be specified									
• Cutaway gable option should only be specified in side-to-side overhead applications, as standalone units are not stable with cutaway gables										
 <p>AEOVD</p>	<b>Closed Overhead, 43" High</b>	2 doors	24 x 16 x 43"	KOD2443.E	<input type="checkbox"/>	<input type="checkbox"/>	<input type="checkbox"/>	<input type="checkbox"/>	<input type="checkbox"/>	
	• 1-1/2" top with choice of three edge styles	2 doors	30 x 16 x 43"	KOD3043.E	<input type="checkbox"/>	<input type="checkbox"/>	<input type="checkbox"/>	<input type="checkbox"/>	<input type="checkbox"/>	
	• 24" clearance above desktop and 72" installed height	2 doors	36 x 16 x 43"	KOD3643.E	<input type="checkbox"/>	<input type="checkbox"/>	<input type="checkbox"/>	<input type="checkbox"/>	<input type="checkbox"/>	
	• 13-3/4" internal height clearance	2 doors	42 x 16 x 43"	KOD4243.E	<input type="checkbox"/>	<input type="checkbox"/>	<input type="checkbox"/>	<input type="checkbox"/>	<input type="checkbox"/>	
	• Full-width concealed cable pass through 1-3/4" high									
• Pulls cannot be specified										
• Cutaway gable option should only be specified in side-to-side overhead applications, as standalone units are not stable with cutaway gables										
 <p>AEOVD</p>	<b>Closed Overhead-Wall Mount</b>	2 doors	24 x 17 x 18"	KWMOD24.E	<input type="checkbox"/>		<input type="checkbox"/>	<input type="checkbox"/>	<input type="checkbox"/>	
	• 1-1/2" top with choice of three edge styles	2 doors	30 x 17 x 18"	KWMOD30.E	<input type="checkbox"/>		<input type="checkbox"/>	<input type="checkbox"/>	<input type="checkbox"/>	
	• 13-3/4" internal height clearance	2 doors	36 x 17 x 18"	KWMOD36.E	<input type="checkbox"/>		<input type="checkbox"/>	<input type="checkbox"/>	<input type="checkbox"/>	
	• Attachment hardware included	2 doors	42 x 17 x 18"	KWMOD42.E	<input type="checkbox"/>		<input type="checkbox"/>	<input type="checkbox"/>	<input type="checkbox"/>	
	• 24-42" wide models feature two doors									
• 48" models feature three doors										
• 54" and wider models feature four doors										

**A** **B** **C** **D** **E** **F** **G**

## HOW TO ORDER

Indicate the following information on order form:

- Quantity of each item.
- Model number, including options. See "How To Build a Model Number".
- Any special service required.

Note:

- The  indicates that a choice is required.
- The absence of the  indicates that no choice is required.
- Alpha-numeric characters in place of  indicate that no other alternatives are available.

## HOW TO BUILD A MODEL NUMBER

**A** Select basic model.

**B** Select edge style.

- F** - Flat edge
- P3** - Three wave profile edge
- P4** - Four wave profile edge

**C** Select cutaway gable option.

- CGN** - No Cutaway gable (standard)
- CGL** - Cutaway gable left; add \$70
- CGR** - Cutaway gable right; add \$70
- CLR** - Cutaway gable left and right; add \$141

**D** Select locking option.

- NL** - No lock (standard)
- L** - With lock; add \$64

**E** Select key option.

- KA** - Key alike
- KS** - Key standard

**F** Select horizontal surface finish. Refer to color addendum at [ki.com](http://ki.com) or KI Fabrics & Finishes binder.

**G** Select vertical surface finish. Refer to color addendum at [ki.com](http://ki.com) or KI Fabrics & Finishes binder.



# Aristotle® Executive Storage

Closed Overheads

Approx. Packaged Weight	Delivered Pricing
75.0#	\$ 797
85.0#	862
105.0#	921
115.0#	1010

85.0#	\$ 985
95.0#	1052
115.0#	1107
125.0#	1200

57.0#	\$ 798
66.0#	862
77.0#	921
88.0#	1010

**SPECIAL SERVICES**

**Special Carton Marking**

With specially marked information N/C

**Shipping**

Shipped **assembled freight prepaid f.o.b. KI-Aristotle Brampton, Ontario L6T 5T6** factory. Freight class #85.

Specifications and prices are subject to change without prior notice.

# Aristotle® Executive Storage

Closed Overheads

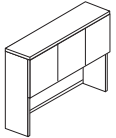
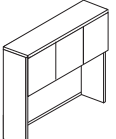
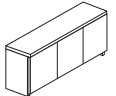
				MODEL NUMBER							
MODEL	Features	W x D x H	Basic Model	Edge Style	Cutaway Gable Option	Lock Option	Key Option	Horizontal Surface Finish	Vertical Surface Finish		
 <p>AEOVD</p>	<b>Closed Overhead, 36" High</b> <ul style="list-style-type: none"> <li>1-1/2" top with choice of three edge styles</li> <li>17-1/2" clearance above desktop and 65" installed height</li> <li>13-3/4" internal height clearance</li> <li>Full-width concealed cable pass through 1-3/4" high</li> <li>48" and wider units feature center divider</li> <li>Pulls cannot be specified</li> <li>Cutaway gable option should only be specified in side-to-side overhead applications, as standalone units are not stable with cutaway gables</li> </ul>	48 x 16 x 36"	KOD4836.E	<input type="checkbox"/>	<input type="checkbox"/>	<input type="checkbox"/>	<input type="checkbox"/>	<input type="checkbox"/>	<input type="checkbox"/>		
 <p>AEOVD</p>	<b>Closed Overhead, 43" High</b> <ul style="list-style-type: none"> <li>1-1/2" top with choice of three edge styles</li> <li>24" clearance above desktop and 72" installed height</li> <li>13-3/4" internal height clearance</li> <li>Full-width concealed cable pass through 1-3/4" high</li> <li>48" and wider units feature center divider</li> <li>Pulls cannot be specified</li> <li>Cutaway gable option should only be specified in side-to-side overhead applications, as standalone units are not stable with cutaway gables</li> </ul>	48 x 16 x 43"	KOD4843.E	<input type="checkbox"/>	<input type="checkbox"/>	<input type="checkbox"/>	<input type="checkbox"/>	<input type="checkbox"/>	<input type="checkbox"/>		
 <p>AEOVD</p>	<b>Closed Overhead-Wall Mount</b> <ul style="list-style-type: none"> <li>1-1/2" top with choice of three edge styles</li> <li>13-3/4" internal height clearance</li> <li>Attachment hardware included</li> <li>24-42" wide models feature two doors</li> <li>48" models feature three doors</li> <li>54" and wider models feature four doors</li> </ul>	48 x 17 x 18"	KWMOD48.E	<input type="checkbox"/>		<input type="checkbox"/>	<input type="checkbox"/>	<input type="checkbox"/>	<input type="checkbox"/>		

**A**   **B**   **C**   **D**   **E**   **F**   **G**

## HOW TO ORDER

Indicate the following information on order form:

- Quantity of each item.
- Model number, including options. See "How To Build a Model Number".
- Any special service required.

Note:

- The  indicates that a choice is required.
- The absence of the  indicates that no choice is required.
- Alpha-numeric characters in place of  indicate that no other alternatives are available.

## HOW TO BUILD A MODEL NUMBER

**A** Select basic model.

**B** Select edge style.

- F** - Flat edge
- P3** - Three wave profile edge
- P4** - Four wave profile edge

**C** Select cutaway gable option.

- CGN** - No Cutaway gable (standard)
- CGL** - Cutaway gable left; add \$70
- CGR** - Cutaway gable right; add \$70
- CLR** - Cutaway gable left and right; add \$141

**D** Select locking option.

- NL** - No lock (standard)
- L** - With lock; add \$141

**E** Select key option.

- KA** - Key alike
- KS** - Key standard

**F** Select horizontal surface finish. Refer to color addendum at [ki.com](http://ki.com) or KI Fabrics & Finishes binder.

**G** Select vertical surface finish. Refer to color addendum at [ki.com](http://ki.com) or KI Fabrics & Finishes binder.



# Aristotle® Executive Storage

Closed Overheads

Approx. Packaged Weight	Delivered Pricing
130.0#	\$ 1114

140.0#	\$ 1302
--------	---------

106.0#	\$ 1114
--------	---------

### SPECIAL SERVICES

#### Special Carton Marking

With specially marked information N/C

#### Shipping

Shipped **assembled freight prepaid f.o.b. KI-Aristotle Brampton, Ontario L6T 5T6** factory. Freight class #85.

Specifications and prices are subject to change without prior notice.

# Aristotle® Executive Storage

Closed Overheads

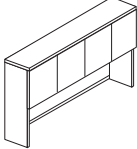
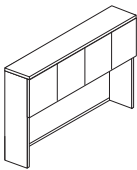
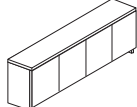
				MODEL NUMBER						
MODEL	Features	W x D x H	Basic Model	Edge Style	Cutaway Gable Option	Lock Option	Key Option	Horizontal Surface Finish	Vertical Surface Finish	
 <p>AEOVD</p> <p><b>Closed Overhead, 36" High</b></p> <ul style="list-style-type: none"> <li>1-1/2" top with choice of three edge styles</li> <li>17-1/2" clearance above desktop and 65" installed height</li> <li>13-3/4" internal height clearance</li> <li>Full-width concealed cable pass through 1-3/4" high</li> <li>48" and wider units feature center divider</li> <li>Pulls cannot be specified</li> <li>Cutaway gable option should only be specified in side-to-side overhead applications, as standalone units are not stable with cutaway gables</li> </ul>	4 doors	54 x 16 x 36"	KOD5436.E	<input type="checkbox"/>	<input type="checkbox"/>	<input type="checkbox"/>	<input type="checkbox"/>	<input type="checkbox"/>	<input type="checkbox"/>	
	4 doors	60 x 16 x 36"	KOD6036.E	<input type="checkbox"/>	<input type="checkbox"/>	<input type="checkbox"/>	<input type="checkbox"/>	<input type="checkbox"/>	<input type="checkbox"/>	
	4 doors	66 x 16 x 36"	KOD6636.E	<input type="checkbox"/>	<input type="checkbox"/>	<input type="checkbox"/>	<input type="checkbox"/>	<input type="checkbox"/>	<input type="checkbox"/>	
	4 doors	72 x 16 x 36"	KOD7236.E	<input type="checkbox"/>	<input type="checkbox"/>	<input type="checkbox"/>	<input type="checkbox"/>	<input type="checkbox"/>	<input type="checkbox"/>	
	4 doors	78 x 16 x 36"	KOD7836.E	<input type="checkbox"/>	<input type="checkbox"/>	<input type="checkbox"/>	<input type="checkbox"/>	<input type="checkbox"/>	<input type="checkbox"/>	
 <p>AEOVD</p> <p><b>Closed Overhead, 43" High</b></p> <ul style="list-style-type: none"> <li>1-1/2" top with choice of three edge styles</li> <li>24" clearance above desktop and 72" installed height</li> <li>13-3/4" internal height clearance</li> <li>Full-width concealed cable pass through 1-3/4" high</li> <li>48" and wider units feature center divider</li> <li>Pulls cannot be specified</li> <li>Cutaway gable option should only be specified in side-to-side overhead applications, as standalone units are not stable with cutaway gables</li> </ul>	4 doors	54 x 16 x 43"	KOD5443.E	<input type="checkbox"/>	<input type="checkbox"/>	<input type="checkbox"/>	<input type="checkbox"/>	<input type="checkbox"/>		
	4 doors	60 x 16 x 43"	KOD6043.E	<input type="checkbox"/>	<input type="checkbox"/>	<input type="checkbox"/>	<input type="checkbox"/>	<input type="checkbox"/>	<input type="checkbox"/>	
	4 doors	66 x 16 x 43"	KOD6643.E	<input type="checkbox"/>	<input type="checkbox"/>	<input type="checkbox"/>	<input type="checkbox"/>	<input type="checkbox"/>	<input type="checkbox"/>	
	4 doors	72 x 16 x 43"	KOD7243.E	<input type="checkbox"/>	<input type="checkbox"/>	<input type="checkbox"/>	<input type="checkbox"/>	<input type="checkbox"/>	<input type="checkbox"/>	
	4 doors	78 x 16 x 43"	KOD7843.E	<input type="checkbox"/>	<input type="checkbox"/>	<input type="checkbox"/>	<input type="checkbox"/>	<input type="checkbox"/>	<input type="checkbox"/>	
 <p>AEOVD</p> <p><b>Closed Overhead-Wall Mount</b></p> <ul style="list-style-type: none"> <li>1-1/2" top with choice of three edge styles</li> <li>Attachment hardware included</li> <li>24-42" wide models feature two doors</li> <li>48" models feature three doors</li> <li>54" and wider models feature four doors</li> </ul>	4 doors	54 x 17 x 18"	KWMOD54.E	<input type="checkbox"/>		<input type="checkbox"/>	<input type="checkbox"/>	<input type="checkbox"/>		
	4 doors	60 x 17 x 18"	KWMOD60.E	<input type="checkbox"/>		<input type="checkbox"/>	<input type="checkbox"/>	<input type="checkbox"/>		
	4 doors	66 x 17 x 18"	KWMOD66.E	<input type="checkbox"/>		<input type="checkbox"/>	<input type="checkbox"/>	<input type="checkbox"/>		
	4 doors	72 x 17 x 18"	KWMOD72.E	<input type="checkbox"/>		<input type="checkbox"/>	<input type="checkbox"/>	<input type="checkbox"/>		
	4 doors	78 x 17 x 18"	KWMOD78.E	<input type="checkbox"/>		<input type="checkbox"/>	<input type="checkbox"/>	<input type="checkbox"/>		

**A**   **B**   **C**   **D**   **E**   **F**   **G**

## HOW TO ORDER

Indicate the following information on order form:

- Quantity of each item.
- Model number, including options. See "How To Build a Model Number".
- Any special service required.

Note:

- The  indicates that a choice is required.
- The absence of the  indicates that no choice is required.
- Alpha-numeric characters in place of  indicate that no other alternatives are available.

## HOW TO BUILD A MODEL NUMBER

- A** Select basic model.
- B** Select edge style.
  - F - Flat edge
  - P3 - Three wave profile edge
  - P4 - Four wave profile edge
- C** Select cutaway gable option.
  - CGN - No Cutaway gable (standard)
  - CGL - Cutaway gable left; add \$70
  - CGR - Cutaway gable right; add \$70
  - CLR - Cutaway gable left and right; add \$141
- D** Select locking option.
  - NL - No lock (standard)
  - L - With lock; add \$141
- E** Select key option.
  - KA - Key alike
  - KS - Key standard
- F** Select horizontal surface finish. Refer to color addendum at [ki.com](http://ki.com) or KI Fabrics & Finishes binder.
- G** Select vertical surface finish. Refer to color addendum at [ki.com](http://ki.com) or KI Fabrics & Finishes binder.



# Aristotle® Executive Storage

Closed Overheads

Approx. Packaged Weight	Delivered Pricing
140.0#	\$ 1211
155.0#	1298
170.0#	1377
185.0#	1443
190.0#	1509

150.0#	\$ 1404
165.0#	1489
180.0#	1566
190.0#	1633
200.0#	1697

117.0#	\$ 1138
128.0#	1299
139.0#	1377
150.0#	1443
161.0#	1518

**SPECIAL SERVICES**

**Special Carton Marking**

With specially marked information N/C

**Shipping**

Shipped **assembled freight prepaid f.o.b. KI-Aristotle Brampton, Ontario L6T 5T6** factory. Freight class #85.

Specifications and prices are subject to change without prior notice.

# Aristotle® Executive Storage

Overhead - Frosted Glass Doors

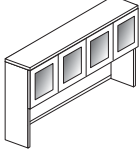
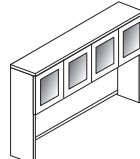
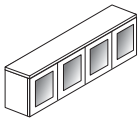
	MODEL	W x D x H	MODEL NUMBER					Approx. Packaged Weight
			Basic Model	Edge Style	Cutaway Gable Option	Horizontal Surface Finish	Vertical Surface Finish	
 <p>AEOVD</p>	<b>Overhead-36" High, Frosted Glass Doors</b> <ul style="list-style-type: none"> <li>1-1/2" top/choice of three edge styles</li> <li>17-1/2" clearance above desktop/36" high</li> <li>13-3/4" internal height clearance</li> <li>Full-width concealed cable pass through 1-3/4" high</li> <li>Closed overheads standard without pulls, non-locking; pulls and locks cannot be specified</li> <li>Door frame features silver finish</li> <li>Tackboards and paper sorters specified separately</li> <li>Cutaway gable option should only be specified in side-to-side overhead applications, as standalone units are not stable with cutaway gables</li> </ul>	60 x 16 x 36"	KOF6036.E.AL	<input type="checkbox"/>	<input type="checkbox"/>	<input type="checkbox"/>	<input type="checkbox"/>	160.0#
		66 x 16 x 36"	KOF6636.E.AL	<input type="checkbox"/>	<input type="checkbox"/>	<input type="checkbox"/>	<input type="checkbox"/>	170.0#
		72 x 16 x 36"	KOF7236.E.AL	<input type="checkbox"/>	<input type="checkbox"/>	<input type="checkbox"/>	<input type="checkbox"/>	185.0#
 <p>AEOVD</p>	<b>Overhead-43" High, Frosted Glass Doors</b> <ul style="list-style-type: none"> <li>1-1/2" top/choice of three edge styles</li> <li>24" clearance above desktop/43" high</li> <li>13-3/4" internal height clearance</li> <li>Full-width concealed cable pass through 1-3/4" high</li> <li>Closed overheads standard without pulls, non-locking; pulls and locks cannot be specified</li> <li>Tackboards and paper sorters specified separately</li> <li>Cutaway gable option should only be specified in side-to-side overhead applications, as standalone units are not stable with cutaway gables</li> </ul>	60 x 16 x 43"	KOF6043.E.AL	<input type="checkbox"/>	<input type="checkbox"/>	<input type="checkbox"/>	<input type="checkbox"/>	170.0#
		66 x 16 x 43"	KOF6643.E.AL	<input type="checkbox"/>	<input type="checkbox"/>	<input type="checkbox"/>	<input type="checkbox"/>	180.0#
		72 x 16 x 43"	KOF7243.E.AL	<input type="checkbox"/>	<input type="checkbox"/>	<input type="checkbox"/>	<input type="checkbox"/>	190.0#
 <p>AEOVD</p>	<b>Overhead-Wall Mount, Frosted Glass Doors</b> <ul style="list-style-type: none"> <li>1-1/2" top/choice of three edge styles</li> <li>13-3/4" internal height clearance</li> <li>Full-width concealed cable pass through 1-3/4" high</li> <li>Closed overheads std without pulls, non-locking; pulls/locks cannot be specified</li> <li>Attachment hardware included</li> <li>Paper sorter insert not available</li> </ul>	60 x 17 x 18"	KWMOF60.E.AL	<input type="checkbox"/>		<input type="checkbox"/>	<input type="checkbox"/>	133.0#
		66 x 17 x 18"	KWMOF66.E.AL	<input type="checkbox"/>		<input type="checkbox"/>	<input type="checkbox"/>	144.0#
		72 x 17 x 18"	KWMOF72.E.AL	<input type="checkbox"/>		<input type="checkbox"/>	<input type="checkbox"/>	155.0#

**A**      **B**      **C**      **D**      **E**

## HOW TO ORDER

Indicate the following information on order form:

- Quantity of each item.
- Model number, including options. See "How To Build a Model Number".
- Any special service required.

Note:

- The  indicates that a choice is required.
- The absence of the  indicates that no choice is required.
- Alpha-numeric characters in place of  indicate that no other alternatives are available.

## HOW TO BUILD A MODEL NUMBER

- A** Select basic model.
- B** Select edge style.
 

<b>F</b>	- Flat edge
<b>P3</b>	- Three wave profile edge
<b>P4</b>	- Four wave profile edge
- C** Select cutaway gable option.
 

<b>CGN</b>	- No Cutaway gable (standard)
<b>CGL</b>	- Cutaway gable left; add \$70
<b>CGR</b>	- Cutaway gable right; add \$70
<b>CLR</b>	- Cutaway gable left and right; add \$141
- D** Select horizontal surface finish. Refer to color addendum at [ki.com](http://ki.com) or KI Fabrics & Finishes binder.
- E** Select vertical surface finish. Refer to color addendum at [ki.com](http://ki.com) or KI Fabrics & Finishes binder.





# Aristotle® Executive Storage

Overhead - Frosted Glass Doors

Delivered Pricing

\$ 1945  
2012  
2078

\$ 2147  
2215  
2277

\$ 1945  
2012  
2078

**SPECIAL SERVICES**

**Special Carton Marking**

With specially marked information N/C

**Shipping**

Shipped **assembled freight prepaid f.o.b. KI-Aristotle Brampton, Ontario L6T 5T6** factory. Freight class #85.

Specifications and prices are subject to change without prior notice.

# Aristotle® Executive Storage

Overheads—Sliding Frosted Acrylic Doors

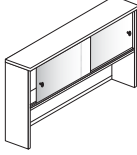
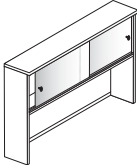
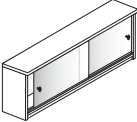
	MODEL	W x D x H	MODEL NUMBER					Approx. Packaged Weight
			Basic Model	Edge Style	Cutaway Gable Option	Horizontal Surface Finish	Vertical Surface Finish	
 <p>AEOVD</p>	<b>Overhead-36" High, Sliding Frosted Acrylic Doors</b> <ul style="list-style-type: none"> <li>1-1/2" top with choice of three edge styles</li> <li>17-1/2" clearance above desktop and 36" high</li> <li>13-3/4" internal height clearance</li> <li>Full-width concealed cable pass through 1-3/4" high</li> <li>Lock option not available</li> <li>Aluminum knob pulls standard</li> <li>Cutaway gable option should only be specified in side-to-side overhead applications, as standalone units are not stable with cutaway gables</li> </ul>	42 x 16 x 36"	KOSD4236.E	<input type="checkbox"/>	<input type="checkbox"/>	<input type="checkbox"/>	<input type="checkbox"/>	130.0#
		48 x 16 x 36"	KOSD4836.E	<input type="checkbox"/>	<input type="checkbox"/>	<input type="checkbox"/>	<input type="checkbox"/>	145.0#
		54 x 16 x 36"	KOSD5436.E	<input type="checkbox"/>	<input type="checkbox"/>	<input type="checkbox"/>	<input type="checkbox"/>	155.0#
		60 x 16 x 36"	KOSD6036.E	<input type="checkbox"/>	<input type="checkbox"/>	<input type="checkbox"/>	<input type="checkbox"/>	170.0#
		66 x 16 x 36"	KOSD6636.E	<input type="checkbox"/>	<input type="checkbox"/>	<input type="checkbox"/>	<input type="checkbox"/>	185.0#
		72 x 16 x 36"	KOSD7236.E	<input type="checkbox"/>	<input type="checkbox"/>	<input type="checkbox"/>	<input type="checkbox"/>	200.0#
		78 x 16 x 36"	KOSD7836.E	<input type="checkbox"/>	<input type="checkbox"/>	<input type="checkbox"/>	<input type="checkbox"/>	205.0#
 <p>AEOVD</p>	<b>Overhead-43" High, Sliding Frosted Acrylic Doors</b> <ul style="list-style-type: none"> <li>1-1/2" top with choice of three edge styles</li> <li>24-1/2" clearance above desktop and 43" high</li> <li>13-3/4" internal height clearance</li> <li>Full-width concealed cable pass through 1-3/4" high</li> <li>Lock option not available</li> <li>Aluminum knob pulls standard</li> <li>Cutaway gable option should only be specified in side-to-side overhead applications, as standalone units are not stable with cutaway gables</li> </ul>	42 x 16 x 43"	KOSD4243.E	<input type="checkbox"/>	<input type="checkbox"/>	<input type="checkbox"/>	<input type="checkbox"/>	140.0#
		48 x 16 x 43"	KOSD4843.E	<input type="checkbox"/>	<input type="checkbox"/>	<input type="checkbox"/>	<input type="checkbox"/>	155.0#
		54 x 16 x 43"	KOSD5443.E	<input type="checkbox"/>	<input type="checkbox"/>	<input type="checkbox"/>	<input type="checkbox"/>	165.0#
		60 x 16 x 43"	KOSD6043.E	<input type="checkbox"/>	<input type="checkbox"/>	<input type="checkbox"/>	<input type="checkbox"/>	180.0#
		66 x 16 x 43"	KOSD6643.E	<input type="checkbox"/>	<input type="checkbox"/>	<input type="checkbox"/>	<input type="checkbox"/>	195.0#
		72 x 16 x 43"	KOSD7243.E	<input type="checkbox"/>	<input type="checkbox"/>	<input type="checkbox"/>	<input type="checkbox"/>	205.0#
		78 x 16 x 43"	KOSD7843.E	<input type="checkbox"/>	<input type="checkbox"/>	<input type="checkbox"/>	<input type="checkbox"/>	215.0#
 <p>AEOVD</p>	<b>Overhead-Wall Mount, Sliding Frosted Acrylic Doors</b> <ul style="list-style-type: none"> <li>1-1/2" top with choice of three edge styles</li> <li>13-3/4" internal height clearance</li> <li>Full-width concealed cable pass through 1-3/4" high</li> <li>Lock option not available</li> <li>Aluminum knob pulls standard</li> <li>Attachment hardware included</li> </ul>	42 x 17 x 18"	KWMOSD42.E	<input type="checkbox"/>		<input type="checkbox"/>	<input type="checkbox"/>	103.0#
		48 x 17 x 18"	KWMOSD48.E	<input type="checkbox"/>		<input type="checkbox"/>	<input type="checkbox"/>	121.0#
		54 x 17 x 18"	KWMOSD54.E	<input type="checkbox"/>		<input type="checkbox"/>	<input type="checkbox"/>	132.0#
		60 x 17 x 18"	KWMOSD60.E	<input type="checkbox"/>		<input type="checkbox"/>	<input type="checkbox"/>	143.0#
		66 x 17 x 18"	KWMOSD66.E	<input type="checkbox"/>		<input type="checkbox"/>	<input type="checkbox"/>	154.0#
		72 x 17 x 18"	KWMOSD72.E	<input type="checkbox"/>		<input type="checkbox"/>	<input type="checkbox"/>	165.0#
		78 x 17 x 18"	KWMOSD78.E	<input type="checkbox"/>		<input type="checkbox"/>	<input type="checkbox"/>	176.0#

A

B

C

D

E

## HOW TO ORDER

Indicate the following information on order form:

- Quantity of each item.
- Model number, including options. See "How To Build a Model Number".
- Any special service required.

Note: • The  indicates that a choice is required.

- The absence of the  indicates that no choice is required.
- Alpha-numeric characters in place of  indicate that no other alternatives are available.

## HOW TO BUILD A MODEL NUMBER

**A** Select basic model.

**B** Select edge style.

F	- Flat edge
P3	- Three wave profile edge
P4	- Four wave profile edge

**C** Select cutaway gable option.

CGN	- No Cutaway gable (standard)
CGL	- Cutaway gable left; add \$70
CGR	- Cutaway gable right; add \$70
CLR	- Cutaway gable left and right; add \$141

**D** Select horizontal surface finish.

Refer to color addendum at [ki.com](http://ki.com) or KI Fabrics & Finishes binder.

**E** Select vertical surface finish.

Refer to color addendum at [ki.com](http://ki.com) or KI Fabrics & Finishes binder.



# Aristotle® Executive Storage

Overheads-Sliding Frosted Acrylic Doors

Delivered Pricing

\$ 1022  
1095  
1192  
1284  
1327  
1371  
1439

\$ 1218  
1293  
1388  
1480  
1522  
1568  
1636

\$ 1022  
1095  
1192  
1284  
1327  
1371  
1439

**SPECIAL SERVICES**

**Special Carton Marking**

With specially marked information    N/C

**Shipping**

Shipped **assembled freight prepaid f.o.b. KI-Aristotle Brampton, Ontario L6T 5T6** factory. Freight class #85.

Specifications and prices are subject to change without prior notice.





# Aristotle® Executive Storage

Open Corner Overhead

Delivered  
Pricing

\$ 1237  
1298  
1467

\$ 1515  
1547  
1637

**SPECIAL SERVICES**

**Special Carton Marking**

With specially marked information N/C

**Shipping**

Shipped **assembled freight prepaid f.o.b. KI-Aristotle Brampton, Ontario L6T 5T6** factory. Freight class #85.

Specifications and prices are subject to change without prior notice.

# Aristotle® Executive Storage

Closed Corner Overhead

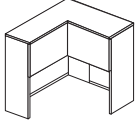
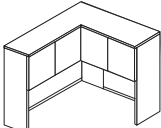
	MODEL	Features	W x D x H	MODEL NUMBER					Approx. Packaged Weight	
				Basic Model	Edge Style	Cutaway Gable Option	Horizontal Surface Finish	Vertical Surface Finish		
 <p>AEOVD</p>	<b>Closed Corner Overhead, 36" High</b> <ul style="list-style-type: none"> <li>1-1/2" top with choice of three edge styles</li> <li>17-1/2" clearance above desktop and 65" installed height</li> <li>13-3/4" internal height clearance</li> <li>Full-width concealed cable pass through 1-3/4" high</li> <li>Corner overheads with doors are non-locking only, standard with no pulls</li> <li>Lock option not available</li> <li>Tackboards and paper sorter specified separately</li> <li>Ships assembled in two cartons</li> <li>Cutaway gable option should only be specified in side-to-side overhead applications, as standalone units are not stable with cutaway gables</li> </ul>	2 doors	36 x 16 x 36"	KOCD3636.E	<input type="checkbox"/>	<input type="checkbox"/>	<input type="checkbox"/>	<input type="checkbox"/>	175.0#	
 <p>AEOVD</p>	<b>Closed Corner Overhead, 36" High</b> <ul style="list-style-type: none"> <li>1-1/2" top with choice of three edge styles</li> <li>17-1/2" clearance above desktop and 65" installed height</li> <li>13-3/4" internal height clearance</li> <li>Full-width concealed cable pass through 1-3/4" high</li> <li>Corner overheads with doors are non-locking only, standard with no pulls</li> <li>Lock option not available</li> <li>Tackboards and paper sorter specified separately</li> <li>Ships assembled in two cartons</li> <li>Cutaway gable option should only be specified in side-to-side overhead applications, as standalone units are not stable with cutaway gables</li> </ul>	4 doors	42 x 16 x 36"	KOCD4236.E	<input type="checkbox"/>	<input type="checkbox"/>	<input type="checkbox"/>	<input type="checkbox"/>	190.0#	
		4 doors	48 x 16 x 36"	KOCD4836.E	<input type="checkbox"/>	<input type="checkbox"/>	<input type="checkbox"/>	<input type="checkbox"/>	210.0#	

**A**   **B**   **C**   **D**   **E**

## HOW TO ORDER

Indicate the following information on order form:

- Quantity of each item.
- Model number, including options. See "How To Build a Model Number".
- Any special service required.

Note: • The  indicates that a choice is required.

- The absence of the  indicates that no choice is required.
- Alpha-numeric characters in place of  indicate that no other alternatives are available.

## HOW TO BUILD A MODEL NUMBER

**A** Select basic model.

**B** Select edge style.

<b>F</b>	- Flat edge
<b>P3</b>	- Three wave profile edge
<b>P4</b>	- Four wave profile edge

**C** Select cutaway gable option.

<b>CGN</b>	- No Cutaway gable (standard)
<b>CGL</b>	- Cutaway gable left; add \$70
<b>CGR</b>	- Cutaway gable right; add \$70
<b>CLR</b>	- Cutaway gable left and right; add \$141

**D** Select horizontal surface finish.

Refer to color addendum at [ki.com](http://ki.com) or KI Fabrics & Finishes binder.

**E** Select vertical surface finish.

Refer to color addendum at [ki.com](http://ki.com) or KI Fabrics & Finishes binder.



# Aristotle® Executive Storage

Closed Corner Overhead

Delivered  
Pricing  
\$ 1639

\$ 1793  
1997

**SPECIAL SERVICES**

**Special Carton Marking**

With specially marked information N/C

**Shipping**

Shipped **assembled freight prepaid f.o.b. KI-Aristotle Brampton, Ontario L6T 5T6** factory. Freight class #85.

Specifications and prices are subject to change without prior notice.

# Aristotle® Executive Storage

Closed Corner Overhead

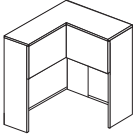
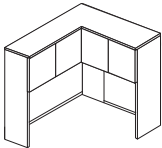
MODEL	Features	W x D x H	MODEL NUMBER					Approx. Packaged Weight	
			Basic Model	Edge Style	Cutaway Gable Option	Horizontal Surface Finish	Vertical Surface Finish		
 <p>AEOVD</p> <p><b>Closed Corner Overhead, 43" High</b></p> <ul style="list-style-type: none"> <li>• 1-1/2" top with choice of three edge styles</li> <li>• 24" clearance above desktop and 72" installed height</li> <li>• 13-3/4" internal height clearance</li> <li>• Full-width concealed cable pass through 1-3/4" high</li> <li>• Corner overheads with doors are non-locking only, standard with no pulls</li> <li>• Lock option not available</li> <li>• Tackboards and paper sorter specified separately</li> <li>• Ships assembled in two cartons</li> <li>• Cutaway gable option should only be specified in side-to-side overhead applications, as standalone units are not stable with cutaway gables</li> </ul>	2 doors	36 x 16 x 43"	KOCD3643.E	<input type="checkbox"/>	<input type="checkbox"/>	<input type="checkbox"/>	<input type="checkbox"/>	<input type="checkbox"/>	195.0#
 <p>AEOVD</p> <p><b>Closed Corner Overhead, 43" High</b></p> <ul style="list-style-type: none"> <li>• 1-1/2" top with choice of three edge styles</li> <li>• 24" clearance above desktop and 72" installed height</li> <li>• 13-3/4" internal height clearance</li> <li>• Full-width concealed cable pass through 1-3/4" high</li> <li>• Corner overheads with doors are non-locking only, standard with no pulls</li> <li>• Lock option not available</li> <li>• Tackboards and paper sorter specified separately</li> <li>• Ships assembled in two cartons</li> <li>• Cutaway gable option should only be specified in side-to-side overhead applications, as standalone units are not stable with cutaway gables</li> </ul>	4 doors	42 x 16 x 43"	KOCD4243.E	<input type="checkbox"/>	<input type="checkbox"/>	<input type="checkbox"/>	<input type="checkbox"/>	<input type="checkbox"/>	205.0#
	4 doors	48 x 16 x 43"	KOCD4843.E	<input type="checkbox"/>	<input type="checkbox"/>	<input type="checkbox"/>	<input type="checkbox"/>	<input type="checkbox"/>	230.0#

**A**      **B**      **C**      **D**      **E**

## HOW TO ORDER

Indicate the following information on order form:

1. Quantity of each item.
2. Model number, including options. See "How To Build a Model Number".
3. Any special service required.

Note:

- The  indicates that a choice is required.
- The absence of the  indicates that no choice is required.
- Alpha-numeric characters in place of  indicate that no other alternatives are available.

## HOW TO BUILD A MODEL NUMBER

- A** Select basic model.
- B** Select edge style.
 

<b>F</b>	- Flat edge
<b>P3</b>	- Three wave profile edge
<b>P4</b>	- Four wave profile edge
- C** Select cutaway gable option.
 

<b>CGN</b>	- No Cutaway gable (standard)
<b>CGL</b>	- Cutaway gable left; add \$70
<b>CGR</b>	- Cutaway gable right; add \$70
<b>CLR</b>	- Cutaway gable left and right; add \$141
- D** Select horizontal surface finish. Refer to color addendum at [ki.com](http://ki.com) or KI Fabrics & Finishes binder.
- E** Select vertical surface finish. Refer to color addendum at [ki.com](http://ki.com) or KI Fabrics & Finishes binder.





# Aristotle® Executive Storage

Closed Corner Overhead

Delivered  
Pricing  
\$ 1824

\$ 1963  
2114

**SPECIAL SERVICES**

**Special Carton Marking**

With specially marked information N/C

**Shipping**

Shipped **assembled freight prepaid f.o.b. KI-Aristotle Brampton, Ontario L6T 5T6** factory. Freight class #85.

Specifications and prices are subject to change without prior notice.

# Aristotle® Executive Storage

## Gallery Reception Desks

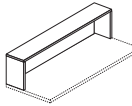
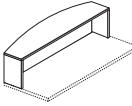
	MODEL	W x D x H	MODEL NUMBER				Approx. Packaged Weight
			Basic Model	Edge Style	Horizontal Surface Finish	Vertical Surface Finish	
 <p>AEGRD</p>	<b>Reception Gallery</b> <ul style="list-style-type: none"> <li>• 1-1/2" top with choice of three edge styles</li> <li>• Transaction top is 12" deep</li> <li>• Installed height is 45"</li> <li>• Clearance above desk top is 14"</li> <li>• Desk specified separately</li> </ul>	24 x 12 x 15-1/2"	KOSG24.E	<input type="checkbox"/>	<input type="checkbox"/>	<input type="checkbox"/>	30.0#
		30 x 12 x 15-1/2"	KOSG30.E	<input type="checkbox"/>	<input type="checkbox"/>	<input type="checkbox"/>	35.0#
		36 x 12 x 15-1/2"	KOSG36.E	<input type="checkbox"/>	<input type="checkbox"/>	<input type="checkbox"/>	40.0#
		42 x 12 x 15-1/2"	KOSG42.E	<input type="checkbox"/>	<input type="checkbox"/>	<input type="checkbox"/>	45.0#
		48 x 12 x 15-1/2"	KOSG48.E	<input type="checkbox"/>	<input type="checkbox"/>	<input type="checkbox"/>	50.0#
		54 x 12 x 15-1/2"	KOSG54.E	<input type="checkbox"/>	<input type="checkbox"/>	<input type="checkbox"/>	55.0#
		60 x 12 x 15-1/2"	KOSG60.E	<input type="checkbox"/>	<input type="checkbox"/>	<input type="checkbox"/>	60.0#
		66 x 12 x 15-1/2"	KOSG66.E	<input type="checkbox"/>	<input type="checkbox"/>	<input type="checkbox"/>	65.0#
		72 x 12 x 15-1/2"	KOSG72.E	<input type="checkbox"/>	<input type="checkbox"/>	<input type="checkbox"/>	70.0#
		78 x 12 x 15-1/2"	KOSG78.E	<input type="checkbox"/>	<input type="checkbox"/>	<input type="checkbox"/>	75.0#
		84 x 12 x 15-1/2"	KOSG84.E	<input type="checkbox"/>	<input type="checkbox"/>	<input type="checkbox"/>	80.0#
96 x 12 x 15-1/2"	KOSG96.E	<input type="checkbox"/>	<input type="checkbox"/>	<input type="checkbox"/>	90.0#		
 <p>AEGRD</p>	<b>Bow Front Reception Gallery</b> <ul style="list-style-type: none"> <li>• 1-1/2" top with choice of three edge styles</li> <li>• Transaction top is 18" deep with 6" overhang</li> <li>• Installed height is 45"</li> <li>• Clearance above desk top is 14"</li> <li>• Desk specified separately</li> </ul>	24 x 18 x 15-1/2"	KBOSG24.E	<input type="checkbox"/>	<input type="checkbox"/>	<input type="checkbox"/>	40.0#
		30 x 18 x 15-1/2"	KBOSG30.E	<input type="checkbox"/>	<input type="checkbox"/>	<input type="checkbox"/>	45.0#
		36 x 18 x 15-1/2"	KBOSG36.E	<input type="checkbox"/>	<input type="checkbox"/>	<input type="checkbox"/>	55.0#
		42 x 18 x 15-1/2"	KBOSG42.E	<input type="checkbox"/>	<input type="checkbox"/>	<input type="checkbox"/>	60.0#
		48 x 18 x 15-1/2"	KBOSG48.E	<input type="checkbox"/>	<input type="checkbox"/>	<input type="checkbox"/>	65.0#
		54 x 18 x 15-1/2"	KBOSG54.E	<input type="checkbox"/>	<input type="checkbox"/>	<input type="checkbox"/>	70.0#
		60 x 18 x 15-1/2"	KBOSG60.E	<input type="checkbox"/>	<input type="checkbox"/>	<input type="checkbox"/>	80.0#
		66 x 18 x 15-1/2"	KBOSG66.E	<input type="checkbox"/>	<input type="checkbox"/>	<input type="checkbox"/>	85.0#
		72 x 18 x 15-1/2"	KBOSG72.E	<input type="checkbox"/>	<input type="checkbox"/>	<input type="checkbox"/>	90.0#
		78 x 18 x 15-1/2"	KBOSG78.E	<input type="checkbox"/>	<input type="checkbox"/>	<input type="checkbox"/>	95.0#
		84 x 18 x 15-1/2"	KBOSG84.E	<input type="checkbox"/>	<input type="checkbox"/>	<input type="checkbox"/>	105.0#
96 x 18 x 15-1/2"	KBOSG96.E	<input type="checkbox"/>	<input type="checkbox"/>	<input type="checkbox"/>	115.0#		

A

B

C

D

### HOW TO ORDER

Indicate the following information on order form:

1. Quantity of each item.
2. Model number, including options. See "How To Build a Model Number".
3. Any special service required.

Note:

- The  indicates that a choice is required.
- The absence of the  indicates that no choice is required.
- Alpha-numeric characters in place of  indicate that no other alternatives are available.

### HOW TO BUILD A MODEL NUMBER

- A** Select basic model.
- B** Select edge style.
- |    |                           |
|----|---------------------------|
| F  | - Flat edge               |
| P3 | - Three wave profile edge |
| P4 | - Four wave profile edge  |
- C** Select horizontal surface finish.  
Refer to color addendum at ki.com or KI Fabrics & Finishes binder.
- D** Select vertical surface finish.  
Refer to color addendum at ki.com or KI Fabrics & Finishes binder.



Delivered Pricing

\$ 454
468
516
540
559
621
646
664
777
832
847
893
\$ 516
528
576
599
621
691
708
726
836
891
906
953

**SPECIAL SERVICES**

**Special Carton Marking**

With specially marked information N/C

**Shipping**

Shipped k.d. freight prepaid f.o.b.  
KI-Aristotle Brampton, Ontario L6T 5T6  
factory. Freight class #85.

Specifications and prices are subject to  
change without prior notice.

# Aristotle® Executive Storage

## Gallery Reception Desks

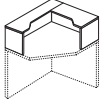
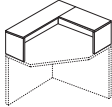
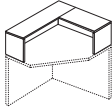
	MODEL	W x D x H	MODEL NUMBER				Approx. Packaged Weight
			Basic Model	Edge Style	Horizontal Surface Finish	Vertical Surface Finish	
 AEGRD	<b>Corner Reception Gallery - 36"x36"</b> <ul style="list-style-type: none"> <li>• 1-1/2" top with choice of three edge styles</li> <li>• Transaction top is 9" deep with 12" corners</li> <li>• Installed height is 45"</li> <li>• Clearance above desk top is 14"</li> <li>• Desk specified separately</li> </ul>	36 x 36 x 15-1/2"	KOSGC36.E	<input type="checkbox"/> <input type="checkbox"/>	<input type="checkbox"/> <input type="checkbox"/> <input type="checkbox"/>	<input type="checkbox"/> <input type="checkbox"/> <input type="checkbox"/>	45.0#
 AEGRD	<b>Corner Reception Gallery - 42"x42"</b> <ul style="list-style-type: none"> <li>• 1-1/2" top with choice of three edge styles</li> <li>• Transaction top is 9" deep with 12" corners</li> <li>• Installed height is 45"</li> <li>• Clearance above desk top is 14"</li> <li>• Desk specified separately</li> </ul>	42 x 42 x 15-1/2"	KOSGC42.E	<input type="checkbox"/> <input type="checkbox"/>	<input type="checkbox"/> <input type="checkbox"/> <input type="checkbox"/>	<input type="checkbox"/> <input type="checkbox"/> <input type="checkbox"/>	55.0#
 AEGRD	<b>Corner Reception Gallery - 48"x48"</b> <ul style="list-style-type: none"> <li>• 1-1/2" top with choice of three edge styles</li> <li>• Transaction top is 9" deep with 12" corners</li> <li>• Installed height is 45"</li> <li>• Clearance above desk top is 14"</li> <li>• Desk specified separately</li> </ul>	48 x 48 x 15-1/2"	KOSGC48.E	<input type="checkbox"/> <input type="checkbox"/>	<input type="checkbox"/> <input type="checkbox"/> <input type="checkbox"/>	<input type="checkbox"/> <input type="checkbox"/> <input type="checkbox"/>	65.0#
				<b>A</b>	<b>B</b>	<b>C</b>	<b>D</b>

### HOW TO ORDER

Indicate the following information on order form:

1. Quantity of each item.
2. Model number, including options. See "How To Build a Model Number".
3. Any special service required.

Note:

- The  indicates that a choice is required.
- The absence of the  indicates that no choice is required.
- Alpha-numeric characters in place of  indicate that no other alternatives are available.

### HOW TO BUILD A MODEL NUMBER

- A** Select basic model.
- B** Select edge style.
- |           |                           |
|-----------|---------------------------|
| <b>F</b>  | - Flat edge               |
| <b>P3</b> | - Three wave profile edge |
| <b>P4</b> | - Four wave profile edge  |
- C** Select horizontal surface finish.  
Refer to color addendum at ki.com or KI Fabrics & Finishes binder.
- D** Select vertical surface finish.  
Refer to color addendum at ki.com or KI Fabrics & Finishes binder.



# Aristotle® Executive Storage

Gallery Reception Desks

Delivered  
Pricing  
\$ 939

\$ 980

\$ 1022

**SPECIAL SERVICES**

**Special Carton Marking**

With specially marked information N/C

**Shipping**

Shipped k.d. freight prepaid f.o.b.  
KI-Aristotle Brampton, Ontario L6T 5T6  
factory. Freight class #85.

Specifications and prices are subject to  
change without prior notice.

# Aristotle® Executive Storage

Extended Corner Reception Gallery

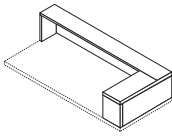
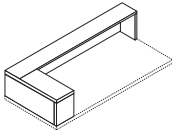
	MODEL	W x D x H	MODEL NUMBER				Approx. Packaged Weight
			Basic Model	Edge Style	Horizontal Surface Finish	Vertical Surface Finish	
 <p>AEGRD</p>	<b>Extended Corner Reception Gallery-24", Left</b> <ul style="list-style-type: none"> <li>1-1/2" top with choice of three edge styles</li> <li>Transaction top is 9" deep with 12" corners</li> <li>Installed height is 45"</li> <li>Clearance above desk top is 14"</li> <li>Desk specified separately</li> </ul>	60 x 24 x 15-1/2"	KOSGCL6024.E	<input type="checkbox"/>	<input type="checkbox"/>	<input type="checkbox"/>	80.0#
		66 x 24 x 15-1/2"	KOSGCL6624.E	<input type="checkbox"/>	<input type="checkbox"/>	<input type="checkbox"/>	85.0#
		72 x 24 x 15-1/2"	KOSGCL7224.E	<input type="checkbox"/>	<input type="checkbox"/>	<input type="checkbox"/>	95.0#
		84 x 24 x 15-1/2"	KOSGCL8424.E	<input type="checkbox"/>	<input type="checkbox"/>	<input type="checkbox"/>	105.0#
		96 x 24 x 15-1/2"	KOSGCL9624.E	<input type="checkbox"/>	<input type="checkbox"/>	<input type="checkbox"/>	115.0#
 <p>AEGRD</p>	<b>Extended Corner Reception Gallery-24", Right</b> <ul style="list-style-type: none"> <li>1-1/2" top with choice of three edge styles</li> <li>Transaction top is 9" deep with 12" corners</li> <li>Installed height is 45"</li> <li>Clearance above desk top is 14"</li> <li>Desk specified separately</li> </ul>	60 x 24 x 15-1/2"	KOSGCR6024.E	<input type="checkbox"/>	<input type="checkbox"/>	<input type="checkbox"/>	80.0#
		66 x 24 x 15-1/2"	KOSGCR6624.E	<input type="checkbox"/>	<input type="checkbox"/>	<input type="checkbox"/>	85.0#
		84 x 24 x 15-1/2"	KOSGCR8424.E	<input type="checkbox"/>	<input type="checkbox"/>	<input type="checkbox"/>	105.0#
		96 x 24 x 15-1/2"	KOSGCR9624.E	<input type="checkbox"/>	<input type="checkbox"/>	<input type="checkbox"/>	115.0#
		72 x 24 x 15-1/2"	KOSGCR7224.E	<input type="checkbox"/>	<input type="checkbox"/>	<input type="checkbox"/>	95.0#

**A**      **B**      **C**      **D**

## HOW TO ORDER

Indicate the following information on order form:

- Quantity of each item.
- Model number, including options. See "How To Build a Model Number".
- Any special service required.

Note:

- The  indicates that a choice is required.
- The absence of the  indicates that no choice is required.
- Alpha-numeric characters in place of  indicate that no other alternatives are available.

## HOW TO BUILD A MODEL NUMBER

- A** Select basic model.
- B** Select edge style.
 

<b>F</b>	- Flat edge
<b>P3</b>	- Three wave profile edge
<b>P4</b>	- Four wave profile edge
- C** Select horizontal surface finish. Refer to color addendum at [ki.com](http://ki.com) or KI Fabrics & Finishes binder.
- D** Select vertical surface finish. Refer to color addendum at [ki.com](http://ki.com) or KI Fabrics & Finishes binder.



Delivered Pricing

\$ 923  
930  
939  
967  
989

\$ 923  
930  
939  
967  
989

**SPECIAL SERVICES**

**Special Carton Marking**

With specially marked information N/C

**Shipping**

Shipped k.d. freight prepaid f.o.b.  
KI-Aristotle Brampton, Ontario L6T 5T6  
factory. Freight class #85.

Specifications and prices are subject to  
change without prior notice.

# Aristotle® Executive Storage

Extended Corner Reception Gallery

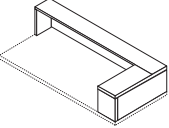
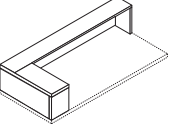
	MODEL	W x D x H	MODEL NUMBER				Approx. Packaged Weight
			Basic Model	Edge Style	Horizontal Surface Finish	Vertical Surface Finish	
 AEGRD	<b>Extended Corner Reception Gallery-30", Left</b> <ul style="list-style-type: none"> <li>1-1/2" top with choice of three edge styles</li> <li>Transaction top is 9" deep with 12" corners</li> <li>Installed height is 45"</li> <li>Clearance above desk top is 14"</li> <li>Desk specified separately</li> </ul>	60 x 30 x 15-1/2"	KOSGCL6030.E	<input type="checkbox"/>	<input type="checkbox"/>	<input type="checkbox"/>	85.0#
		66 x 30 x 15-1/2"	KOSGCL6630.E	<input type="checkbox"/>	<input type="checkbox"/>	<input type="checkbox"/>	90.0#
		72 x 30 x 15-1/2"	KOSGCL7230.E	<input type="checkbox"/>	<input type="checkbox"/>	<input type="checkbox"/>	100.0#
		84 x 30 x 15-1/2"	KOSGCL8430.E	<input type="checkbox"/>	<input type="checkbox"/>	<input type="checkbox"/>	110.0#
		96 x 30 x 15-1/2"	KOSGCL9630.E	<input type="checkbox"/>	<input type="checkbox"/>	<input type="checkbox"/>	120.0#
 AEGRD	<b>Extended Corner Reception Gallery-30", Right</b> <ul style="list-style-type: none"> <li>1-1/2" top with choice of three edge styles</li> <li>Transaction top is 9" deep with 12" corners</li> <li>Installed height is 45"</li> <li>Clearance above desk top is 14"</li> <li>Desk specified separately</li> </ul>	60 x 30 x 15-1/2"	KOSGCR6030.E	<input type="checkbox"/>	<input type="checkbox"/>	<input type="checkbox"/>	85.0#
		66 x 30 x 15-1/2"	KOSGCR6630.E	<input type="checkbox"/>	<input type="checkbox"/>	<input type="checkbox"/>	90.0#
		72 x 30 x 15-1/2"	KOSGCR7230.E	<input type="checkbox"/>	<input type="checkbox"/>	<input type="checkbox"/>	100.0#
		84 x 30 x 15-1/2"	KOSGCR8430.E	<input type="checkbox"/>	<input type="checkbox"/>	<input type="checkbox"/>	110.0#
		96 x 30 x 15-1/2"	KOSGCR9630.E	<input type="checkbox"/>	<input type="checkbox"/>	<input type="checkbox"/>	120.0#
			<b>A</b>	<b>B</b>	<b>C</b>	<b>D</b>	

## HOW TO ORDER

Indicate the following information on order form:

- Quantity of each item.
- Model number, including options. See "How To Build a Model Number".
- Any special service required.

Note:

- The  indicates that a choice is required.
- The absence of the  indicates that no choice is required.
- Alpha-numeric characters in place of  indicate that no other alternatives are available.

## HOW TO BUILD A MODEL NUMBER

- A** Select basic model.
- B** Select edge style.
- |           |                           |
|-----------|---------------------------|
| <b>F</b>  | - Flat edge               |
| <b>P3</b> | - Three wave profile edge |
| <b>P4</b> | - Four wave profile edge  |
- C** Select horizontal surface finish.  
Refer to color addendum at ki.com or KI Fabrics & Finishes binder.
- D** Select vertical surface finish.  
Refer to color addendum at ki.com or KI Fabrics & Finishes binder.





Delivered  
Pricing

\$ 939  
951  
967  
989  
1015

\$ 939  
951  
967  
989  
1015

**SPECIAL SERVICES**

**Special Carton Marking**

With specially marked information N/C

**Shipping**

Shipped k.d. freight prepaid f.o.b.  
KI-Aristotle Brampton, Ontario L6T 5T6  
factory. Freight class #85.

Specifications and prices are subject to  
change without prior notice.

# Aristotle® Executive Storage

Extended Corner Reception Gallery

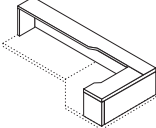
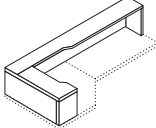
	MODEL	W x D x H	MODEL NUMBER				Approx. Packaged Weight
			Basic Model	Edge Style	Horizontal Surface Finish	Vertical Surface Finish	
 <p>AEGRD</p>	<b>Extended Corner Reception Gallery-36\", Left</b> <ul style="list-style-type: none"> <li>1-1/2\" top with choice of three edge styles</li> <li>Transaction top is 9\" deep with 12\" corners</li> <li>Installed height is 45\"</li> <li>Clearance above desk top is 14\"</li> <li>Desk specified separately</li> </ul>	60 x 36 x 15-1/2\"	KOSGCL6036.E	<input type="checkbox"/>	<input type="checkbox"/>	<input type="checkbox"/>	90.0#
		66 x 36 x 15-1/2\"	KOSGCL6636.E	<input type="checkbox"/>	<input type="checkbox"/>	<input type="checkbox"/>	95.0#
		72 x 36 x 15-1/2\"	KOSGCL7236.E	<input type="checkbox"/>	<input type="checkbox"/>	<input type="checkbox"/>	105.0#
		84 x 36 x 15-1/2\"	KOSGCL8436.E	<input type="checkbox"/>	<input type="checkbox"/>	<input type="checkbox"/>	115.0#
		96 x 36 x 15-1/2\"	KOSGCL9636.E	<input type="checkbox"/>	<input type="checkbox"/>	<input type="checkbox"/>	125.0#
 <p>AEGRD</p>	<b>Extended Corner Reception Gallery-36\", Right</b> <ul style="list-style-type: none"> <li>1-1/2\" top with choice of three edge styles</li> <li>Transaction top is 9\" deep with 12\" corners</li> <li>Installed height is 45\"</li> <li>Clearance above desk top is 14\"</li> <li>Desk specified separately</li> </ul>	60 x 36 x 15-1/2\"	KOSGCR6036.E	<input type="checkbox"/>	<input type="checkbox"/>	<input type="checkbox"/>	90.0#
		66 x 36 x 15-1/2\"	KOSGCR6636.E	<input type="checkbox"/>	<input type="checkbox"/>	<input type="checkbox"/>	95.0#
		72 x 36 x 15-1/2\"	KOSGCR7236.E	<input type="checkbox"/>	<input type="checkbox"/>	<input type="checkbox"/>	105.0#
		84 x 36 x 15-1/2\"	KOSGCR8436.E	<input type="checkbox"/>	<input type="checkbox"/>	<input type="checkbox"/>	115.0#
		96 x 36 x 15-1/2\"	KOSGCR9636.E	<input type="checkbox"/>	<input type="checkbox"/>	<input type="checkbox"/>	125.0#
				<b>A</b>	<b>B</b>	<b>C</b>	<b>D</b>

## HOW TO ORDER

Indicate the following information on order form:

- Quantity of each item.
- Model number, including options. See "How To Build a Model Number".
- Any special service required.

Note:

- The  indicates that a choice is required.
- The absence of the  indicates that no choice is required.
- Alpha-numeric characters in place of  indicate that no other alternatives are available.

## HOW TO BUILD A MODEL NUMBER

- A** Select basic model.
- B** Select edge style.
- |    |                           |
|----|---------------------------|
| F  | - Flat edge               |
| P3 | - Three wave profile edge |
| P4 | - Four wave profile edge  |
- C** Select horizontal surface finish.  
Refer to color addendum at ki.com or KI Fabrics & Finishes binder.
- D** Select vertical surface finish.  
Refer to color addendum at ki.com or KI Fabrics & Finishes binder.



Delivered  
Pricing

\$ 967  
979  
989  
1015  
1035

\$ 967  
979  
989  
1015  
1035

**SPECIAL SERVICES**

**Special Carton Marking**

With specially marked information N/C

**Shipping**

Shipped k.d. freight prepaid f.o.b.  
KI-Aristotle Brampton, Ontario L6T 5T6  
factory. Freight class #85.

Specifications and prices are subject to  
change without prior notice.

# Aristotle® Executive Storage

Extended Corner Reception Gallery

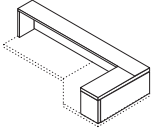
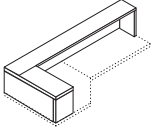
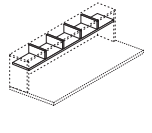
	MODEL	W x D x H	MODEL NUMBER				Approx. Packaged Weight
			Basic Model	Edge Style	Horizontal Surface Finish	Vertical Surface Finish	
 AEGRD	<b>Extended Corner Reception Gallery-42", Left</b> <ul style="list-style-type: none"> <li>1-1/2" top with choice of three edge styles</li> <li>Transaction top is 9" deep with 12" corners</li> <li>Installed height is 45"</li> <li>Clearance above desk top is 14"</li> <li>Desk specified separately</li> </ul>	66 x 42 x 15-1/2"	KOSGCL6642.E	<input type="checkbox"/>	<input type="checkbox"/>	<input type="checkbox"/>	100.0#
		72 x 42 x 15-1/2"	KOSGCL7242.E	<input type="checkbox"/>	<input type="checkbox"/>	<input type="checkbox"/>	110.0#
		84 x 42 x 15-1/2"	KOSGCL8442.E	<input type="checkbox"/>	<input type="checkbox"/>	<input type="checkbox"/>	120.0#
		96 x 42 x 15-1/2"	KOSGCL9642.E	<input type="checkbox"/>	<input type="checkbox"/>	<input type="checkbox"/>	130.0#
 AEGRD	<b>Extended Corner Reception Gallery-42", Right</b> <ul style="list-style-type: none"> <li>1-1/2" top with choice of three edge styles</li> <li>Transaction top is 9" deep with 12" corners</li> <li>Installed height is 45"</li> <li>Clearance above desk top is 14"</li> <li>Desk specified separately</li> </ul>	66 x 42 x 15-1/2"	KOSGCR6642.E	<input type="checkbox"/>	<input type="checkbox"/>	<input type="checkbox"/>	100.0#
		72 x 42 x 15-1/2"	KOSGCR7242.E	<input type="checkbox"/>	<input type="checkbox"/>	<input type="checkbox"/>	110.0#
		84 x 42 x 15-1/2"	KOSGCR8442.E	<input type="checkbox"/>	<input type="checkbox"/>	<input type="checkbox"/>	120.0#
		96 x 42 x 15-1/2"	KOSGCR9642.E	<input type="checkbox"/>	<input type="checkbox"/>	<input type="checkbox"/>	130.0#
 AROV D	<b>Reception Gallery Paper Sorter Insert</b> <ul style="list-style-type: none"> <li>Field installed</li> <li>Not compatible with corner galleries</li> <li>Not compatible with tackboards</li> <li>3-1/4" clearance in cubbies</li> <li>Reception gallery specified separately</li> </ul>	22 x 11 x 4-1/2"	KGPS24.H		<input type="checkbox"/>	<input type="checkbox"/>	14.0#
		28 x 11 x 4-1/2"	KGPS30.H		<input type="checkbox"/>	<input type="checkbox"/>	17.0#
		34 x 11 x 4-1/2"	KGPS36.H		<input type="checkbox"/>	<input type="checkbox"/>	20.0#
		40 x 11 x 4-1/2"	KGPS42.H		<input type="checkbox"/>	<input type="checkbox"/>	23.0#
		46 x 11 x 4-1/2"	KGPS48.H		<input type="checkbox"/>	<input type="checkbox"/>	26.0#
		52 x 11 x 4-1/2"	KGPS54.H		<input type="checkbox"/>	<input type="checkbox"/>	29.0#
		58 x 11 x 4-1/2"	KGPS60.H		<input type="checkbox"/>	<input type="checkbox"/>	32.0#
		64 x 11 x 4-1/2"	KGPS66.H		<input type="checkbox"/>	<input type="checkbox"/>	35.0#
		70 x 11 x 4-1/2"	KGPS72.H		<input type="checkbox"/>	<input type="checkbox"/>	38.0#
76 x 11 x 4-1/2"	KGPS78.H		<input type="checkbox"/>	<input type="checkbox"/>	41.0#		

**A**      **B**      **C**      **D**

## HOW TO ORDER

Indicate the following information on order form:

- Quantity of each item.
- Model number, including options. See "How To Build a Model Number".
- Any special service required.

Note:

- The  indicates that a choice is required.
- The absence of the  indicates that no choice is required.
- Alpha-numeric characters in place of  indicate that no other alternatives are available.

## HOW TO BUILD A MODEL NUMBER

- A** Select basic model.
- B** Select edge style.
- |           |                           |
|-----------|---------------------------|
| <b>F</b>  | - Flat edge               |
| <b>P3</b> | - Three wave profile edge |
| <b>P4</b> | - Four wave profile edge  |
- C** Select horizontal surface finish.  
Refer to color addendum at ki.com or KI Fabrics & Finishes binder.
- D** Select vertical surface finish.  
Refer to color addendum at ki.com or KI Fabrics & Finishes binder.



Delivered Pricing

\$ 998  
1014  
1035  
1062

\$ 998  
1014  
1035  
1062

\$ 368  
392  
415  
438  
464  
487  
511  
535  
560  
587

**SPECIAL SERVICES**

**Special Carton Marking**

With specially marked information N/C

**Shipping**

Shipped k.d. freight prepaid f.o.b.  
KI-Aristotle Brampton, Ontario L6T 5T6  
factory. Freight class #85.

Specifications and prices are subject to  
change without prior notice.

# Aristotle® Executive Storage

## Hanging Pedestals

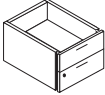
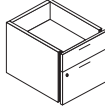
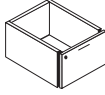
	MODEL	W x D x H	MODEL NUMBER				Approx. Packaged Weight
			Basic Model	Vertical Surface Finish	Pull Option	Key Option	
 AEHPD	<b>Hanging Pedestal-Box/Box</b> • Standard with all drawers locking • Pencil tray standard in upper box drawer	15-1/2 x 19 x 14"	KH2B.E	<input type="checkbox"/> <input type="checkbox"/>	<input type="checkbox"/> <input type="checkbox"/> <input type="checkbox"/> <input type="checkbox"/>	<input type="checkbox"/> <input type="checkbox"/>	40.0#
 AEHPD	<b>Hanging Pedestal-Box/File</b> • Standard with both drawers locking • File drawer accommodates letter/legal filing • Pencil tray standard in box drawer	15-1/2 x 19 x 19"	KHBF.E	<input type="checkbox"/> <input type="checkbox"/>	<input type="checkbox"/> <input type="checkbox"/> <input type="checkbox"/> <input type="checkbox"/>	<input type="checkbox"/> <input type="checkbox"/>	55.0#
 AEHPD	<b>Hanging Pedestal-File</b> • Standard with all drawers locking • File drawer accommodates letter/legal filing	15-1/2 x 19 x 14"	KHFE	<input type="checkbox"/> <input type="checkbox"/>	<input type="checkbox"/> <input type="checkbox"/> <input type="checkbox"/> <input type="checkbox"/>	<input type="checkbox"/> <input type="checkbox"/>	45.0#
			<b>A</b>	<b>B</b>	<b>C</b>	<b>D</b>	

### HOW TO ORDER

Indicate the following information on order form:

- Quantity of each item.
- Model number, including options. See "How To Build a Model Number".
- Any special service required.

Note: • The  indicates that a choice is required.

- The absence of the  indicates that no choice is required.
- Alpha-numeric characters in place of  indicate that no other alternatives are available.

### HOW TO BUILD A MODEL NUMBER

**A** Select basic model.

**B** Select vertical surface finish.  
Refer to color addendum at ki.com or KI Fabrics & Finishes binder.

**C** Select pull option.

<b>BPA</b>	- Silver bar pull (1)
<b>BPA2</b>	- Silver bar pull (2)
<b>KIB</b>	- Waterfall black pull (1)
<b>KIB2</b>	- Waterfall black pull (2)
<b>KIS</b>	- Waterfall silver pull (1)
<b>KIS2</b>	- Waterfall silver pull (2)
<b>RCP</b>	- Rectangular silver pull (1)
<b>RCP2</b>	- Rectangular silver pull (2)

**D** Select key option.

<b>KA</b>	- Key alike
<b>KS</b>	- Key standard



# Aristotle® Executive Storage

Hanging Pedestals

Delivered  
Pricing

\$ 575

\$ 662

\$ 537

**SPECIAL SERVICES**

**Special Carton Marking**

With specially marked information N/C

**Shipping**

Shipped **assembled freight prepaid f.o.b. KI-Aristotle Brampton, Ontario L6T 5T6** factory. Freight class #85.

Specifications and prices are subject to change without prior notice.

# Aristotle® Executive Storage

Full Height Pedestals

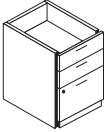
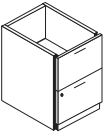
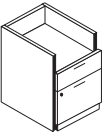
	MODEL	W x D x H	MODEL NUMBER				Approx. Packaged Weight
			Basic Model	Vertical Surface Finish	Pull Option	Key Option	
 AEHPD	<b>Full Height Pedestal-Box/Box/File</b> <ul style="list-style-type: none"> <li>Standard with all drawers locking</li> <li>Pencil tray standard in upper box drawer</li> <li>File drawer accommodates letter/legal filing</li> </ul>	15-1/2 x 19 x 28"	KF2BF.E	<input type="checkbox"/> <input type="checkbox"/> <input type="checkbox"/>	<input type="checkbox"/> <input type="checkbox"/> <input type="checkbox"/> <input type="checkbox"/>	<input type="checkbox"/> <input type="checkbox"/>	85.0#
 AEHPD	<b>Full Height Pedestal-File/File</b> <ul style="list-style-type: none"> <li>Standard with all drawers locking</li> <li>File drawer accommodates letter/legal filing</li> </ul>	15-1/2 x 19 x 28"	KF2F.E	<input type="checkbox"/> <input type="checkbox"/> <input type="checkbox"/>	<input type="checkbox"/> <input type="checkbox"/> <input type="checkbox"/> <input type="checkbox"/>	<input type="checkbox"/> <input type="checkbox"/>	85.0#
 AEHPD	<b>Full Height Pedestal-Shelf/Box/File</b> <ul style="list-style-type: none"> <li>Standard with both drawers locking</li> <li>Pencil tray standard in box drawer</li> <li>File drawer accommodates letter/legal filing</li> </ul>	15-1/2 x 19 x 28"	KFSBF.E	<input type="checkbox"/> <input type="checkbox"/> <input type="checkbox"/>	<input type="checkbox"/> <input type="checkbox"/> <input type="checkbox"/> <input type="checkbox"/>	<input type="checkbox"/> <input type="checkbox"/>	80.0#

**A**   **B**   **C**   **D**

## HOW TO ORDER

Indicate the following information on order form:

- Quantity of each item.
- Model number, including options. See "How To Build a Model Number".
- Any special service required.

Note: • The  indicates that a choice is required.

- The absence of the  indicates that no choice is required.
- Alpha-numeric characters in place of  indicate that no other alternatives are available.

## HOW TO BUILD A MODEL NUMBER

- A** Select basic model.
- B** Select vertical surface finish.  
Refer to color addendum at ki.com or KI Fabrics & Finishes binder.
- C** Select pull option.
- |             |                               |
|-------------|-------------------------------|
| <b>BPA2</b> | - Silver bar pull (2)         |
| <b>BPA3</b> | - Silver bar pull (3)         |
| <b>KIB2</b> | - Waterfall black pull (2)    |
| <b>KIB3</b> | - Waterfall black pull (3)    |
| <b>KIS2</b> | - Waterfall silver pull (2)   |
| <b>KIS3</b> | - Waterfall silver pull (3)   |
| <b>RCP2</b> | - Rectangular silver pull (2) |
| <b>RCP3</b> | - Rectangular silver pull (3) |
- D** Select key option.
- |           |                |
|-----------|----------------|
| <b>KA</b> | - Key alike    |
| <b>KS</b> | - Key standard |





# Aristotle® Executive Storage

Full Height Pedestals

Delivered  
Pricing

\$ 870

\$ 870

\$ 870

**SPECIAL SERVICES**

**Special Carton Marking**

With specially marked information N/C





**Shipping**

Shipped **assembled freight prepaid f.o.b. KI-Aristotle Brampton, Ontario L6T 5T6** factory. Freight class #85.

Specifications and prices are subject to change without prior notice.

# Aristotle® Executive Storage

Mobile Pedestals

	MODEL	W x D x H	MODEL NUMBER					Approx. Packaged Weight
			Basic Model	Horizontal Surface Finish	Vertical Surface Finish	Pull Option	Key Option	
 AEHPD	<b>Mobile Pedestal-Box/File</b> <ul style="list-style-type: none"> <li>• 5/8" thick top</li> <li>• Standard with both drawers locking</li> <li>• File drawer accommodates letter/legal filing</li> <li>• Pencil tray standard in box drawer</li> <li>• 5 wheel anti-tip feature standard</li> </ul>	15-1/2 x 19 x 21-1/2"	KMBFE	<input type="checkbox"/> <input type="checkbox"/> <input type="checkbox"/>	<input type="checkbox"/> <input type="checkbox"/> <input type="checkbox"/>	<input type="checkbox"/> <input type="checkbox"/> <input type="checkbox"/> <input type="checkbox"/>	<input type="checkbox"/> <input type="checkbox"/>	80.0#
 AEHPD	<b>Mobile Pedestal-Box/Box/File</b> <ul style="list-style-type: none"> <li>• 5/8" thick top</li> <li>• Standard with all drawers locking</li> <li>• File drawer accommodates letter/legal filing</li> <li>• Pencil tray standard in upper box drawer</li> <li>• 5 wheel anti-tip feature standard</li> </ul>	15-1/2 x 19 x 27-3/4"	KM2BFE	<input type="checkbox"/> <input type="checkbox"/> <input type="checkbox"/>	<input type="checkbox"/> <input type="checkbox"/> <input type="checkbox"/>	<input type="checkbox"/> <input type="checkbox"/> <input type="checkbox"/> <input type="checkbox"/>	<input type="checkbox"/> <input type="checkbox"/>	95.0#
 AEHPD	<b>Full Height Pedestal-File/File</b> <ul style="list-style-type: none"> <li>• 5/8" thick top</li> <li>• Standard with all drawers locking</li> <li>• File drawer accommodates letter/legal filing</li> <li>• 5 wheel anti-tip feature standard</li> </ul>	15-1/2 x 19 x 27-3/4"	KM2FE	<input type="checkbox"/> <input type="checkbox"/> <input type="checkbox"/>	<input type="checkbox"/> <input type="checkbox"/> <input type="checkbox"/>	<input type="checkbox"/> <input type="checkbox"/> <input type="checkbox"/> <input type="checkbox"/>	<input type="checkbox"/> <input type="checkbox"/>	95.0#
 AEHPD	<b>Mobile Pedestal-Shelf/Box/File</b> <ul style="list-style-type: none"> <li>• 5/8" thick top</li> <li>• Standard with both drawers locking</li> <li>• File drawer accommodates letter/legal filing</li> <li>• Pencil tray standard in box drawer</li> <li>• 5 wheel anti-tip feature standard</li> </ul>	15-1/2 x 19 x 27-3/4"	KMSBFE	<input type="checkbox"/> <input type="checkbox"/> <input type="checkbox"/>	<input type="checkbox"/> <input type="checkbox"/> <input type="checkbox"/>	<input type="checkbox"/> <input type="checkbox"/> <input type="checkbox"/> <input type="checkbox"/>	<input type="checkbox"/> <input type="checkbox"/>	95.0#
				<b>A</b>	<b>B</b>	<b>C</b>	<b>D</b>	<b>E</b>

## HOW TO ORDER

Indicate the following information on order form:

1. Quantity of each item.
2. Model number, including options. See "How To Build a Model Number".
3. Any special service required.

Note: • The  indicates that a choice is required.

- The absence of the  indicates that no choice is required.
- Alpha-numeric characters in place of  indicate that no other alternatives are available.

## HOW TO BUILD A MODEL NUMBER

- A** Select basic model.
- B** Select horizontal surface finish.  
Refer to color addendum at [ki.com](http://ki.com) or KI Fabrics & Finishes binder.
- C** Select vertical surface finish.  
Refer to color addendum at [ki.com](http://ki.com) or KI Fabrics & Finishes binder.
- D** Select pull option.
- |             |                               |
|-------------|-------------------------------|
| <b>BPA2</b> | - Silver bar pull (2)         |
| <b>BPA3</b> | - Silver bar pull (3)         |
| <b>KIB2</b> | - Waterfall black pull (2)    |
| <b>KIB3</b> | - Waterfall black pull (3)    |
| <b>KIS2</b> | - Waterfall silver pull (2)   |
| <b>KIS3</b> | - Waterfall silver pull (3)   |
| <b>RCP2</b> | - Rectangular silver pull (2) |
| <b>RCP3</b> | - Rectangular silver pull (3) |
- E** Select key option.
- |           |                |
|-----------|----------------|
| <b>KA</b> | - Key alike    |
| <b>KS</b> | - Key standard |



Delivered  
Pricing  
\$ 870

\$ 963

\$ 963

\$ 963

**SPECIAL SERVICES**

**Special Carton Marking**

With specially marked information N/C

**Shipping**

Shipped **assembled freight prepaid f.o.b. KI-Aristotle Brampton, Ontario L6T 5T6** factory. Freight class #85.

Specifications and prices are subject to change without prior notice.





# Aristotle® Executive Storage

Lateral Files-Under Desk

Delivered  
Pricing

\$ 1268  
1302

## SPECIAL SERVICES

### Special Carton Marking

With specially marked information N/C

### Shipping

Shipped **assembled freight prepaid f.o.b.**  
**KI-Aristotle Brampton, Ontario L6T 5T6**  
factory. Freight class #85.

Specifications and prices are subject to  
change without prior notice.





# Aristotle® Executive Storage

Lateral Files-Integrated

Delivered  
Pricing

\$ 1386  
1419  
1437  
1556

## SPECIAL SERVICES

### Special Carton Marking

With specially marked information N/C

### Shipping

Shipped **assembled freight prepaid f.o.b.**  
**KI-Aristotle Brampton, Ontario L6T 5T6**  
factory. Freight class #85.

Specifications and prices are subject to  
change without prior notice.

# Aristotle® Executive Storage

Lateral Files-Freestanding

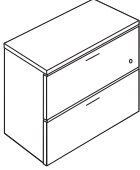
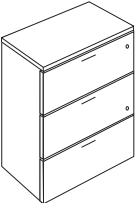
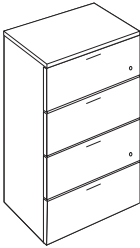
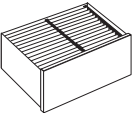
	MODEL	W x D x H	MODEL NUMBER					Approx. Packaged Weight	
			Basic Model	Edge Style	Horizontal Surface Finish	Vertical Surface Finish	Pull Option		Key Option
 AEHPD	<b>Lateral File-Two Drawer Freestanding</b> • 1-1/2" top with choice of three edge styles • Anti-tip interlock mechanism • Horizontal grain standard on fronts • Accommodates letter and legal filing • Steel drawers with heavy duty full extension ball bearing slides • Locking • Intended for freestanding/archival storage applications • No toe kick	30 x 20 x 30-1/2"	KSLF23020.E	<input type="checkbox"/>	<input type="checkbox"/>	<input type="checkbox"/>	<input type="checkbox"/>	<input type="checkbox"/>	105.0#
		36 x 20 x 30-1/2"	KSLF23620.E	<input type="checkbox"/>	<input type="checkbox"/>	<input type="checkbox"/>	<input type="checkbox"/>	<input type="checkbox"/>	<input type="checkbox"/>
 AEHPD	<b>Lateral File-Three Drawer Freestanding</b> • 1-1/2" top with choice of three edge styles • Anti-tip interlock mechanism • Horizontal grain standard on fronts • Accommodates letter and legal filing • Steel drawers with heavy duty full extension ball bearing slides • 2 locks, keyed alike • Intended for freestanding/archival storage applications • No toe kick	30 x 20 x 44-1/2"	KSLF33020.E	<input type="checkbox"/>	<input type="checkbox"/>	<input type="checkbox"/>	<input type="checkbox"/>	<input type="checkbox"/>	175.0#
		36 x 20 x 44-1/2"	KSLF33620.E	<input type="checkbox"/>	<input type="checkbox"/>	<input type="checkbox"/>	<input type="checkbox"/>	<input type="checkbox"/>	<input type="checkbox"/>
 AEHPD	<b>Lateral File-Four Drawer Freestanding</b> • 1-1/2" top with choice of three edge styles • Anti-tip interlock mechanism • Horizontal grain standard on fronts • Accommodates letter and legal filing • Steel drawers with heavy duty full extension ball bearing slides • 2 locks, keyed alike • Intended for freestanding/archival storage applications • No toe kick	30 x 20 x 58-1/2"	KSLF43020.E	<input type="checkbox"/>	<input type="checkbox"/>	<input type="checkbox"/>	<input type="checkbox"/>	<input type="checkbox"/>	220.0#
		36 x 20 x 58-1/2"	KSLF43620.E	<input type="checkbox"/>	<input type="checkbox"/>	<input type="checkbox"/>	<input type="checkbox"/>	<input type="checkbox"/>	<input type="checkbox"/>
 HRDPT	<b>Front-to-Back Filing Hardware</b> • Set of four bars accommodates one drawer • Specify one set per drawer as required		KFTBF						1.0#

## HOW TO ORDER

Indicate the following information on order form:

- Quantity of each item.
- Model number, including options. See "How To Build a Model Number".
- Any special service required.

Note: • The  indicates that a choice is required.

- The absence of the  indicates that no choice is required.
- Alpha-numeric characters in place of  indicate that no other alternatives are available.

## HOW TO BUILD A MODEL NUMBER

**A** Select basic model.

**B** Select edge style.

- |    |                           |
|----|---------------------------|
| F  | - Flat edge               |
| P3 | - Three wave profile edge |
| P4 | - Four wave profile edge  |

**C** Select horizontal surface finish.

Refer to color addendum at ki.com or KI Fabrics & Finishes binder.

**D** Select vertical surface finish.

Refer to color addendum at ki.com or KI Fabrics & Finishes binder.

**E** Select pull option.

- |      |                             |
|------|-----------------------------|
| BPA3 | - Silver bar pull (3)       |
| BPA4 | - Silver bar pull (4)       |
| KIB3 | - Waterfall black pull (3)  |
| KIB4 | - Waterfall black pull (4)  |
| KIS3 | - Waterfall silver pull (3) |
| KIS4 | - Waterfall silver pull (4) |

**RCP3** - Rectangular silver pull (3)

**RCP4** - Rectangular silver pull (4)

**F** Select key option.

- |    |                |
|----|----------------|
| KA | - Key alike    |
| KS | - Key standard |





# Aristotle® Executive Storage

Lateral Files-Freestanding

Delivered  
Pricing

\$ 1386

1437

\$ 1913

1979

\$ 2335

2413

\$ 6

**SPECIAL SERVICES**

**Special Carton Marking**

With specially marked information N/C

**Shipping**

Shipped **assembled freight prepaid f.o.b. KI-Aristotle Brampton, Ontario L6T 5T6** factory. Freight class #85.

Specifications and prices are subject to change without prior notice.

# Aristotle® Executive Storage

Lower Storage Units - Under Desk

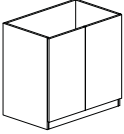
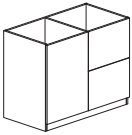
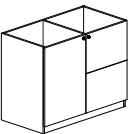
	MODEL	W x D x H	MODEL NUMBER				Approx. Packaged Weight
			Basic Model	Vertical Surface Finish	Pull Option	Key Option	
	<b>Storage Cabinet-Under Desk, Nonlocking</b> • Fits below 20", 24" or 30" desk shell • Includes one 33-3/8" wide adjustable shelf • Non-locking • Cabinet fronts are not grain-matched	30 x 19 x 28"	KSCT30.H	<input type="checkbox"/> <input type="checkbox"/> <input type="checkbox"/>	<input type="checkbox"/> <input type="checkbox"/> <input type="checkbox"/> <input type="checkbox"/>		80.0#
		36 x 19 x 28"	KSCT36.H	<input type="checkbox"/> <input type="checkbox"/> <input type="checkbox"/>	<input type="checkbox"/> <input type="checkbox"/> <input type="checkbox"/> <input type="checkbox"/>		90.0#
ARHPD							
	<b>Storage and File Cabinet-Under Desk, Nonlocking</b> • Fits below 20", 24" or 30" desk shell • Includes one 33-3/8" wide adjustable shelf • Two files drawers on right • Non-locking	36 x 19 x 28"	KBSCT.H	<input type="checkbox"/> <input type="checkbox"/> <input type="checkbox"/>	<input type="checkbox"/> <input type="checkbox"/> <input type="checkbox"/> <input type="checkbox"/>		110.0#
ARHPD							
	<b>Storage and File Cabinet-Under Desk, Locking</b> • Fits below 20", 24" or 30" desk shell • Includes one 33-3/8" wide adjustable shelf • Two files drawers on right • Locking, two locks keyed alike	36 x 19 x 28"	KBSCTL.H	<input type="checkbox"/> <input type="checkbox"/> <input type="checkbox"/>	<input type="checkbox"/> <input type="checkbox"/> <input type="checkbox"/> <input type="checkbox"/>	<input type="checkbox"/> <input type="checkbox"/>	110.0#
ARHPD							
			<b>A</b>	<b>B</b>	<b>C</b>	<b>D</b>	

## HOW TO ORDER

Indicate the following information on order form:

- Quantity of each item.
- Model number, including options. See "How To Build a Model Number".
- Any special service required.

Note:

- The  indicates that a choice is required.
- The absence of the  indicates that no choice is required.
- Alpha-numeric characters in place of  indicate that no other alternatives are available.

## HOW TO BUILD A MODEL NUMBER

**A** Select basic model.

**B** Select vertical surface finish.  
Refer to color addendum at ki.com or KI Fabrics & Finishes binder.

**C** Select pull option.

<b>NP</b>	- Standard integral pull
<b>BPA2</b>	- Silver bar pull (2); add \$20
<b>BPA3</b>	- Silver bar pull (3); add \$30
<b>KIB2</b>	- Waterfall black pull (2); add \$20
<b>KIB3</b>	- Waterfall black pull (3); add \$30
<b>KIS2</b>	- Waterfall silver pull (2); add \$20
<b>KIS3</b>	- Waterfall silver pull (3); add \$30
<b>RCP2</b>	- Rectangular silver pull (2); add \$20
<b>RCP3</b>	- Rectangular silver pull (3); add \$30

**D** Select key option.

<b>KA</b>	- Key alike
<b>KS</b>	- Key standard



# Aristotle® Executive Storage

Lower Storage Units - Under Desk

Delivered  
Pricing

\$ 561

592

\$ 921

\$ 1037

## SPECIAL SERVICES

### Special Carton Marking

With specially marked information N/C

### Shipping

Shipped **assembled freight prepaid f.o.b.**  
**KI-Aristotle Brampton, Ontario L6T 5T6**  
factory. Freight class #85.

Specifications and prices are subject to  
change without prior notice.

# Aristotle® Executive Storage

Lower Storage Units - Under Desk

MODEL	W x D x H	MODEL NUMBER				Approx. Packaged Weight	
		Basic Model	Vertical Surface Finish	Pull Option	Key Option		
<p><b>Multi-File Storage Cabinet-Under Desk</b></p> <ul style="list-style-type: none"> <li>• Fits below 20", 24" or 30" desk shell</li> <li>• Two box drawers upper left</li> <li>• 12-1/2" wide closed storage upper right</li> <li>• Lower locking lateral file drawer</li> <li>• Cabinet fronts are not grain-matched</li> </ul>	30 x 19 x 28"	KMFSBT30.H	□□□	□□□□	□□	105.0#	
							ARHPD
							ARHPD
							ARHPD
<p><b>Multi-File Storage Cabinet-Under Desk</b></p> <ul style="list-style-type: none"> <li>• Fits below 20", 24" or 30" desk shell</li> <li>• File drawer upper left</li> <li>• 12-1/2" wide closed storage upper right</li> <li>• Lower locking lateral file drawer</li> <li>• Cabinet fronts are not grain-matched</li> </ul>	30 x 19 x 28"	KMFSFT30.H	□□□	□□□□	□□	105.0#	
							ARHPD
							ARHPD
							ARHPD

**A**      **B**      **C**      **D**

## HOW TO ORDER

Indicate the following information on order form:

1. Quantity of each item.
2. Model number, including options. See "How To Build a Model Number".
3. Any special service required.

Note:

- The □ indicates that a choice is required.
- The absence of the □ indicates that no choice is required.
- Alpha-numeric characters in place of □ indicate that no other alternatives are available.

## HOW TO BUILD A MODEL NUMBER

- A** Select basic model.
- B** Select vertical surface finish.  
Refer to color addendum at ki.com or KI Fabrics & Finishes binder.
- C** Select pull option.
 

<b>NP</b>	- Standard integral pull
<b>BPA3</b>	- Silver bar pull (3); add \$30
<b>BPA4</b>	- Silver bar pull (4); add \$40
<b>KIB3</b>	- Waterfall black pull (3); add \$30
<b>KIB4</b>	- Waterfall black pull (4); add \$40
<b>KIS3</b>	- Waterfall silver pull (3); add \$30
<b>KIS4</b>	- Waterfall silver pull (4); add \$40
<b>RCP3</b>	- Rectangular silver pull (3); add \$30
<b>RCP4</b>	- Rectangular silver pull (4); add \$40

**D** Select key option.

- |           |                |
|-----------|----------------|
| <b>KA</b> | - Key alike    |
| <b>KS</b> | - Key standard |



# Aristotle® Executive Storage

Lower Storage Units - Under Desk

Delivered  
Pricing

\$ 1212

\$ 1212

## SPECIAL SERVICES

### Special Carton Marking

With specially marked information N/C

### Shipping

Shipped **assembled freight prepaid f.o.b. KI-Aristotle Brampton, Ontario L6T 5T6** factory. Freight class #85.

Specifications and prices are subject to change without prior notice.

# Aristotle® Executive Storage

Lower Storage Units - Freestanding

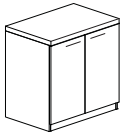
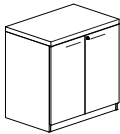
	MODEL	W x D x H	MODEL NUMBER						Approx. Packaged Weight
			Basic Model	Edge Style	Horizontal Surface Finish	Vertical Surface Finish	Pull Option	Key Option	
 <p>AEHPD</p>	<b>Storage Cabinet-Freestanding, Nonlocking</b> • 1-1/2" top with choice of three edge styles • Includes one 33-3/8" wide adjustable shelf • Non-locking • Cabinet fronts are not grain-matched	30 x 20 x 29-1/2"	KSC3020.E	<input type="checkbox"/>	<input type="checkbox"/>	<input type="checkbox"/>	<input type="checkbox"/>	<input type="checkbox"/>	95.0#
		30 x 24 x 29-1/2"	KSC3024.E	<input type="checkbox"/>	<input type="checkbox"/>	<input type="checkbox"/>	<input type="checkbox"/>	<input type="checkbox"/>	105.0#
		36 x 20 x 29-1/2"	KSC3620.E	<input type="checkbox"/>	<input type="checkbox"/>	<input type="checkbox"/>	<input type="checkbox"/>	<input type="checkbox"/>	110.0#
		36 x 24 x 29-1/2"	KSC3624.E	<input type="checkbox"/>	<input type="checkbox"/>	<input type="checkbox"/>	<input type="checkbox"/>	<input type="checkbox"/>	120.0#
 <p>AEHPD</p>	<b>Storage Cabinet-Freestanding, Locking</b> • 1-1/2" top with choice of three edge styles • Includes one 33-3/8" wide adjustable shelf • Locking	30 x 20 x 29-1/2"	KSCL3020.E	<input type="checkbox"/>	<input type="checkbox"/>	<input type="checkbox"/>	<input type="checkbox"/>	<input type="checkbox"/>	95.0#
		30 x 24 x 29-1/2"	KSCL3024.E	<input type="checkbox"/>	<input type="checkbox"/>	<input type="checkbox"/>	<input type="checkbox"/>	<input type="checkbox"/>	105.0#
		36 x 20 x 29-1/2"	KSCL3620.E	<input type="checkbox"/>	<input type="checkbox"/>	<input type="checkbox"/>	<input type="checkbox"/>	<input type="checkbox"/>	110.0#
		36 x 24 x 29-1/2"	KSCL3624.E	<input type="checkbox"/>	<input type="checkbox"/>	<input type="checkbox"/>	<input type="checkbox"/>	<input type="checkbox"/>	120.0#
				<b>A</b>	<b>B</b>	<b>C</b>	<b>D</b>	<b>E</b>	<b>F</b>

## HOW TO ORDER

Indicate the following information on order form:

- Quantity of each item.
- Model number, including options. See "How To Build a Model Number".
- Any special service required.

Note: • The  indicates that a choice is required.

- The absence of the  indicates that no choice is required.
- Alpha-numeric characters in place of  indicate that no other alternatives are available.

## HOW TO BUILD A MODEL NUMBER

**A** Select basic model.

**B** Select edge style.

- |           |                           |
|-----------|---------------------------|
| <b>F</b>  | - Flat edge               |
| <b>P3</b> | - Three wave profile edge |
| <b>P4</b> | - Four wave profile edge  |

**C** Select horizontal surface finish.

Refer to color addendum at ki.com or KI Fabrics & Finishes binder.

**D** Select vertical surface finish.

Refer to color addendum at ki.com or KI Fabrics & Finishes binder.

**E** Select pull option.

- |             |                               |
|-------------|-------------------------------|
| <b>BPA2</b> | - Silver bar pull (2)         |
| <b>KIB2</b> | - Waterfall black pull (2)    |
| <b>KIS2</b> | - Waterfall silver pull (2)   |
| <b>RCP2</b> | - Rectangular silver pull (2) |

**F** Select key option.

- |           |                |
|-----------|----------------|
| <b>KA</b> | - Key alike    |
| <b>KS</b> | - Key standard |



# Aristotle® Executive Storage

Lower Storage Units - Freestanding

## Delivered Pricing

\$ 759  
787  
809  
833

\$ 855  
878  
915  
949

### SPECIAL SERVICES

#### Special Carton Marking

With specially marked information N/C

#### Shipping

Shipped **assembled freight prepaid f.o.b. KI-Aristotle Brampton, Ontario L6T 5T6** factory. Freight class #85.

Specifications and prices are subject to change without prior notice.

# Aristotle® Executive Storage

Lower Storage Units - Freestanding

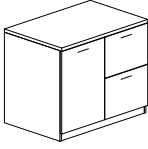
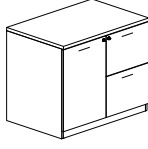
	MODEL	W x D x H	MODEL NUMBER					Approx. Packaged Weight	
			Basic Model	Edge Style	Horizontal Surface Finish	Vertical Surface Finish	Pull Option		Key Option
	<b>Storage and File Cabinet-Freestanding, Nonlocking</b> <ul style="list-style-type: none"> <li>1-1/2" top with choice of three edge styles</li> <li>Left storage 18-1/2" wide</li> <li>Two files drawers on right</li> <li>Non-locking</li> </ul>	36 x 20 x 29-1/2"	KBSC3620.E	<input type="checkbox"/>	<input type="checkbox"/>	<input type="checkbox"/>	<input type="checkbox"/>	125.0#	
		36 x 24 x 29-1/2"	KBSC3624.E	<input type="checkbox"/>	<input type="checkbox"/>	<input type="checkbox"/>	<input type="checkbox"/>	135.0#	
AEHPD									
	<b>Storage and File Cabinet-Freestanding, Locking</b> <ul style="list-style-type: none"> <li>1-1/2" top with choice of three edge styles</li> <li>Left storage 18-1/2" wide</li> <li>Two files drawers on right</li> <li>Locking, two locks keyed alike</li> </ul>	36 x 20 x 29-1/2"	KBSC3620.E	<input type="checkbox"/>	<input type="checkbox"/>	<input type="checkbox"/>	<input type="checkbox"/>	125.0#	
		36 x 24 x 29-1/2"	KBSC3624.E	<input type="checkbox"/>	<input type="checkbox"/>	<input type="checkbox"/>	<input type="checkbox"/>	135.0#	
AEHPD									
				<b>A</b>	<b>B</b>	<b>C</b>	<b>D</b>	<b>E</b>	<b>F</b>

## HOW TO ORDER

Indicate the following information on order form:

- Quantity of each item.
- Model number, including options. See "How To Build a Model Number".
- Any special service required.

Note:

- The  indicates that a choice is required.
- The absence of the  indicates that no choice is required.
- Alpha-numeric characters in place of  indicate that no other alternatives are available.

## HOW TO BUILD A MODEL NUMBER

- A** Select basic model.
- B** Select edge style.
- |    |                           |
|----|---------------------------|
| F  | - Flat edge               |
| P3 | - Three wave profile edge |
| P4 | - Four wave profile edge  |
- C** Select horizontal surface finish.  
Refer to color addendum at ki.com or KI Fabrics & Finishes binder.
- D** Select vertical surface finish.  
Refer to color addendum at ki.com or KI Fabrics & Finishes binder.
- E** Select pull option.
- |      |                               |
|------|-------------------------------|
| BPA3 | - Silver bar pull (3)         |
| KIB3 | - Waterfall black pull (3)    |
| KIS3 | - Waterfall silver pull (3)   |
| RCP3 | - Rectangular silver pull (3) |
- F** Select key option.
- |    |                |
|----|----------------|
| KA | - Key alike    |
| KS | - Key standard |





# Aristotle® Executive Storage

Lower Storage Units - Freestanding

Delivered  
Pricing

\$ 1127  
1146

\$ 1284  
1292

## SPECIAL SERVICES

### Special Carton Marking

With specially marked information N/C

### Shipping

Shipped **assembled freight prepaid f.o.b.**  
**KI-Aristotle Brampton, Ontario L6T 5T6**  
factory. Freight class #85.

Specifications and prices are subject to  
change without prior notice.

# Aristotle® Executive Storage

Lower Storage Units - Freestanding

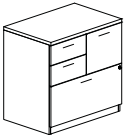
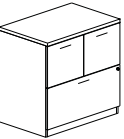
	MODEL	W x D x H	MODEL NUMBER						Approx. Packaged Weight
			Basic Model	Edge Style	Horizontal Surface Finish	Vertical Surface Finish	Pull Option	Key Option	
 <p>AEHPD</p>	<b>Multi-File Storage Cabinet-Freestanding</b> • 1-1/2" top with choice of three edge styles • Two box drawers upper left • 12-1/2" wide closed storage upper right • Lower locking lateral file drawer • Cabinet fronts are not grain-matched	30 x 20 x 29-1/2"	KMFSB3020.E	<input type="checkbox"/>	<input type="checkbox"/>	<input type="checkbox"/>	<input type="checkbox"/>	<input type="checkbox"/>	105.0#
		30 x 24 x 29-1/2"	KMFSB3024.E	<input type="checkbox"/>	<input type="checkbox"/>	<input type="checkbox"/>	<input type="checkbox"/>	<input type="checkbox"/>	105.0#
 <p>AEHPD</p>	<b>Multi-File Storage Cabinet-Freestanding</b> • 1-1/2" top with choice of three edge styles • File drawer upper left • 12-1/2" wide closed storage upper right • Lower locking lateral file drawer • Cabinet fronts are not grain-matched	30 x 20 x 29-1/2"	KMFSF3020.E	<input type="checkbox"/>	<input type="checkbox"/>	<input type="checkbox"/>	<input type="checkbox"/>	<input type="checkbox"/>	105.0#
		30 x 24 x 29-1/2"	KMFSF3024.E	<input type="checkbox"/>	<input type="checkbox"/>	<input type="checkbox"/>	<input type="checkbox"/>	<input type="checkbox"/>	105.0#
			<b>A</b>	<b>B</b>	<b>C</b>	<b>D</b>	<b>E</b>	<b>F</b>	

## HOW TO ORDER

Indicate the following information on order form:

- Quantity of each item.
- Model number, including options. See "How To Build a Model Number".
- Any special service required.

Note:

- The  indicates that a choice is required.
- The absence of the  indicates that no choice is required.
- Alpha-numeric characters in place of  indicate that no other alternatives are available.

## HOW TO BUILD A MODEL NUMBER

- A** Select basic model.
- B** Select edge style.
 

<b>F</b>	- Flat edge
<b>P3</b>	- Three wave profile edge
<b>P4</b>	- Four wave profile edge
- C** Select horizontal surface finish.  
Refer to color addendum at ki.com or KI Fabrics & Finishes binder.
- D** Select vertical surface finish.  
Refer to color addendum at ki.com or KI Fabrics & Finishes binder.
- E** Select pull option.
 

<b>BPA3</b>	- Silver bar pull (3)
<b>BPA4</b>	- Silver bar pull (4)
<b>KIB3</b>	- Waterfall black pull (3)
<b>KIB4</b>	- Waterfall black pull (4)
<b>KIS3</b>	- Waterfall silver pull (3)
<b>KIS4</b>	- Waterfall silver pull (4)
<b>RCP3</b>	- Rectangular silver pull (3)

**RCP4** - Rectangular silver pull (4)

- F** Select key option.
 

<b>KA</b>	- Key alike
<b>KS</b>	- Key standard



# Aristotle® Executive Storage

Lower Storage Units - Freestanding

Delivered  
Pricing

\$ 1384

1418

\$ 1384

1418

## SPECIAL SERVICES

### Special Carton Marking

With specially marked information N/C

### Shipping

Shipped **assembled freight prepaid f.o.b. KI-Aristotle Brampton, Ontario L6T 5T6** factory. Freight class #85.

Specifications and prices are subject to change without prior notice.

# Aristotle® Executive Storage

## 24" Wide Storage Towers

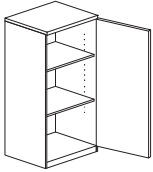
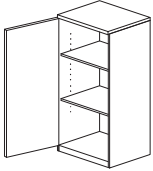
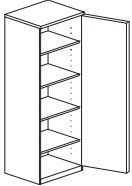
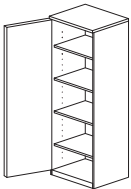
	MODEL	W x D x H	MODEL NUMBER					
			Basic Model	Edge Style	Horizontal Surface Finish	Vertical Surface Finish	Pull Option	Lock Option
 <p><b>Storage Tower-48" and 54" High, Right-Hinged Door</b></p> <ul style="list-style-type: none"> <li>1-1/2" top with choice of three edge styles</li> <li>Right-hinged door</li> <li>2 full-width adjustable shelves, 21-1/2" wide</li> </ul>	24 x 20 x 48-1/2"	KST242048R.E	<input type="checkbox"/>	<input type="checkbox"/>	<input type="checkbox"/>	<input type="checkbox"/>	<input type="checkbox"/>	<input type="checkbox"/>
	24 x 24 x 48-1/2"	KST242448R.E	<input type="checkbox"/>	<input type="checkbox"/>	<input type="checkbox"/>	<input type="checkbox"/>	<input type="checkbox"/>	<input type="checkbox"/>
	24 x 20 x 54-1/2"	KST242054R.E	<input type="checkbox"/>	<input type="checkbox"/>	<input type="checkbox"/>	<input type="checkbox"/>	<input type="checkbox"/>	<input type="checkbox"/>
	24 x 24 x 54-1/2"	KST242454R.E	<input type="checkbox"/>	<input type="checkbox"/>	<input type="checkbox"/>	<input type="checkbox"/>	<input type="checkbox"/>	<input type="checkbox"/>
AEHPD								
 <p><b>Storage Tower-48" and 54" High, Left-Hinged Door</b></p> <ul style="list-style-type: none"> <li>1-1/2" top with choice of three edge styles</li> <li>Left-hinged door</li> <li>2 full-width adjustable shelves, 21-1/2" wide</li> </ul>	24 x 20 x 48-1/2"	KST242048L.E	<input type="checkbox"/>	<input type="checkbox"/>	<input type="checkbox"/>	<input type="checkbox"/>	<input type="checkbox"/>	<input type="checkbox"/>
	24 x 24 x 48-1/2"	KST242448L.E	<input type="checkbox"/>	<input type="checkbox"/>	<input type="checkbox"/>	<input type="checkbox"/>	<input type="checkbox"/>	<input type="checkbox"/>
	24 x 20 x 54-1/2"	KST242054L.E	<input type="checkbox"/>	<input type="checkbox"/>	<input type="checkbox"/>	<input type="checkbox"/>	<input type="checkbox"/>	<input type="checkbox"/>
	24 x 24 x 54-1/2"	KST242454L.E	<input type="checkbox"/>	<input type="checkbox"/>	<input type="checkbox"/>	<input type="checkbox"/>	<input type="checkbox"/>	<input type="checkbox"/>
AEHPD								
 <p><b>Storage Tower-65" and 72" High, Right-Hinged Door</b></p> <ul style="list-style-type: none"> <li>1-1/2" top with choice of three edge styles</li> <li>Right-hinged door</li> <li>4 full-width adjustable shelves, 21-1/2" wide</li> </ul>	24 x 24 x 65-1/2"	KST242465R.E	<input type="checkbox"/>	<input type="checkbox"/>	<input type="checkbox"/>	<input type="checkbox"/>	<input type="checkbox"/>	<input type="checkbox"/>
	24 x 20 x 65-1/2"	KST242065R.E	<input type="checkbox"/>	<input type="checkbox"/>	<input type="checkbox"/>	<input type="checkbox"/>	<input type="checkbox"/>	<input type="checkbox"/>
	24 x 20 x 72-1/2"	KST242072R.E	<input type="checkbox"/>	<input type="checkbox"/>	<input type="checkbox"/>	<input type="checkbox"/>	<input type="checkbox"/>	<input type="checkbox"/>
	24 x 24 x 72-1/2"	KST242472R.E	<input type="checkbox"/>	<input type="checkbox"/>	<input type="checkbox"/>	<input type="checkbox"/>	<input type="checkbox"/>	<input type="checkbox"/>
AEHPD								
 <p><b>Storage Tower-65" and 72" High, Left-Hinged Door</b></p> <ul style="list-style-type: none"> <li>1-1/2" top with choice of three edge styles</li> <li>Left-hinged door</li> <li>4 full-width adjustable shelves, 21-1/2" wide</li> </ul>	24 x 20 x 65-1/2"	KST242065L.E	<input type="checkbox"/>	<input type="checkbox"/>	<input type="checkbox"/>	<input type="checkbox"/>	<input type="checkbox"/>	<input type="checkbox"/>
	24 x 24 x 65-1/2"	KST242465L.E	<input type="checkbox"/>	<input type="checkbox"/>	<input type="checkbox"/>	<input type="checkbox"/>	<input type="checkbox"/>	<input type="checkbox"/>
	24 x 20 x 72-1/2"	KST242072L.E	<input type="checkbox"/>	<input type="checkbox"/>	<input type="checkbox"/>	<input type="checkbox"/>	<input type="checkbox"/>	<input type="checkbox"/>
	24 x 24 x 72-1/2"	KST242472L.E	<input type="checkbox"/>	<input type="checkbox"/>	<input type="checkbox"/>	<input type="checkbox"/>	<input type="checkbox"/>	<input type="checkbox"/>
AEHPD								

**A**   **B**   **C**   **D**   **E**   **F**   **G**

### HOW TO ORDER

Indicate the following information on order form:

- Quantity of each item.
- Model number, including options. See "How To Build a Model Number".
- Any special service required.

Note: • The  indicates that a choice is required.

- The absence of the  indicates that no choice is required.
- Alpha-numeric characters in place of  indicate that no other alternatives are available.

### HOW TO BUILD A MODEL NUMBER

**A** Select basic model.

**B** Select edge style.

- F** - Flat edge  
**P3** - Three wave profile edge  
**P4** - Four wave profile edge

**C** Select horizontal surface finish.

Refer to color addendum at [ki.com](http://ki.com) or KI Fabrics & Finishes binder.

**D** Select vertical surface finish.

Refer to color addendum at [ki.com](http://ki.com) or KI Fabrics & Finishes binder.

**E** Select pull option.

- BPA** - Silver bar pull (1)  
**KIB** - Waterfall black pull (1)  
**KIS** - Waterfall silver pull (1)  
**RCP** - Rectangular silver pull (1)

**F** Select lock option.

- NL** - No lock (standard)  
**L** - With lock; add \$64

**G** Select key option.

- KA** - Key alike  
**KS** - Key standard



# Aristotle® Executive Storage

24" Wide Storage Towers

Approx. Packaged Weight	Delivered Pricing
170.0#	\$ 1036
175.0#	1115
180.0#	1121
190.0#	1186

170.0#	\$ 1036
175.0#	1115
180.0#	1121
190.0#	1186

190.0#	\$ 1404
185.0#	1213
190.0#	1269
200.0#	1449

185.0#	\$ 1213
190.0#	1404
190.0#	1269
200.0#	1449

## SPECIAL SERVICES

### Special Carton Marking

With specially marked information N/C

### Shipping

Shipped **assembled freight prepaid f.o.b.**  
**KI-Aristotle Brampton, Ontario L6T 5T6**  
 factory. Freight class #85.

Specifications and prices are subject to  
 change without prior notice.

# Aristotle® Executive Storage

24" Wide Storage and Wardrobe Towers

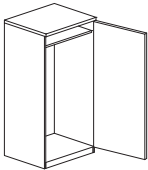
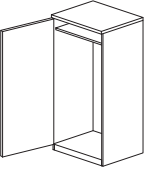
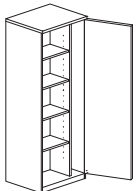
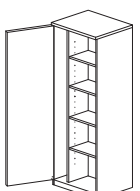
MODEL	W x D x H	MODEL NUMBER						
		Basic Model	Edge Style	Horizontal Surface Finish	Vertical Surface Finish	Pull Option	Lock Option	Key Option
 <p><b>Wardrobe Tower-48" and 54" High, Right-Hinged Door</b></p> <ul style="list-style-type: none"> <li>1-1/2" top with choice of three edge styles</li> <li>Right-hinged door</li> <li>Full-width coat hanger bar, 21-1/2" wide</li> </ul>	24 x 20 x 48-1/2"	KWT242048R.E	<input type="checkbox"/>	<input type="checkbox"/>	<input type="checkbox"/>	<input type="checkbox"/>	<input type="checkbox"/>	<input type="checkbox"/>
	24 x 24 x 48-1/2"	KWT242448R.E	<input type="checkbox"/>	<input type="checkbox"/>	<input type="checkbox"/>	<input type="checkbox"/>	<input type="checkbox"/>	<input type="checkbox"/>
	24 x 20 x 54-1/2"	KWT242054R.E	<input type="checkbox"/>	<input type="checkbox"/>	<input type="checkbox"/>	<input type="checkbox"/>	<input type="checkbox"/>	<input type="checkbox"/>
	24 x 24 x 54-1/2"	KWT242454R.E	<input type="checkbox"/>	<input type="checkbox"/>	<input type="checkbox"/>	<input type="checkbox"/>	<input type="checkbox"/>	<input type="checkbox"/>
AEHPD								
 <p><b>Wardrobe Tower-48" and 54" High, Left-Hinged Door</b></p> <ul style="list-style-type: none"> <li>1-1/2" top with choice of three edge styles</li> <li>Left-hinged door</li> <li>Full-width coat hanger bar, 21-1/2" wide</li> </ul>	24 x 20 x 48-1/2"	KWT242048L.E	<input type="checkbox"/>	<input type="checkbox"/>	<input type="checkbox"/>	<input type="checkbox"/>	<input type="checkbox"/>	<input type="checkbox"/>
	24 x 24 x 48-1/2"	KWT242448L.E	<input type="checkbox"/>	<input type="checkbox"/>	<input type="checkbox"/>	<input type="checkbox"/>	<input type="checkbox"/>	<input type="checkbox"/>
	24 x 20 x 54-1/2"	KWT242054L.E	<input type="checkbox"/>	<input type="checkbox"/>	<input type="checkbox"/>	<input type="checkbox"/>	<input type="checkbox"/>	<input type="checkbox"/>
	24 x 24 x 54-1/2"	KWT242454L.E	<input type="checkbox"/>	<input type="checkbox"/>	<input type="checkbox"/>	<input type="checkbox"/>	<input type="checkbox"/>	<input type="checkbox"/>
AEHPD								
 <p><b>Storage and Wardrobe Tower-65" and 72" High, Right-Hinged Door</b></p> <ul style="list-style-type: none"> <li>1-1/2" top with choice of three edge styles</li> <li>Right-hinged door</li> <li>4 adjustable shelves, 14-1/4" wide</li> <li>Coat hanger bar, 6-3/8" wide</li> </ul>	24 x 20 x 65-1/2"	KSW242065R.E	<input type="checkbox"/>	<input type="checkbox"/>	<input type="checkbox"/>	<input type="checkbox"/>	<input type="checkbox"/>	<input type="checkbox"/>
	24 x 24 x 65-1/2"	KSW242465R.E	<input type="checkbox"/>	<input type="checkbox"/>	<input type="checkbox"/>	<input type="checkbox"/>	<input type="checkbox"/>	<input type="checkbox"/>
	24 x 20 x 72-1/2"	KSW242072R.E	<input type="checkbox"/>	<input type="checkbox"/>	<input type="checkbox"/>	<input type="checkbox"/>	<input type="checkbox"/>	<input type="checkbox"/>
	24 x 24 x 72-1/2"	KSW242472R.E	<input type="checkbox"/>	<input type="checkbox"/>	<input type="checkbox"/>	<input type="checkbox"/>	<input type="checkbox"/>	<input type="checkbox"/>
AEHPD								
 <p><b>Storage and Wardrobe Tower-65" and 72" High, Left-Hinged Door</b></p> <ul style="list-style-type: none"> <li>1-1/2" top with choice of three edge styles</li> <li>Left-hinged door</li> <li>4 adjustable shelves, 14-1/4" wide</li> <li>Coat hanger bar, 6-3/8" wide</li> </ul>	24 x 20 x 65-1/2"	KSW242065L.E	<input type="checkbox"/>	<input type="checkbox"/>	<input type="checkbox"/>	<input type="checkbox"/>	<input type="checkbox"/>	<input type="checkbox"/>
	24 x 24 x 65-1/2"	KSW242465L.E	<input type="checkbox"/>	<input type="checkbox"/>	<input type="checkbox"/>	<input type="checkbox"/>	<input type="checkbox"/>	<input type="checkbox"/>
	24 x 20 x 72-1/2"	KSW242072L.E	<input type="checkbox"/>	<input type="checkbox"/>	<input type="checkbox"/>	<input type="checkbox"/>	<input type="checkbox"/>	<input type="checkbox"/>
	24 x 24 x 72-1/2"	KSW242472L.E	<input type="checkbox"/>	<input type="checkbox"/>	<input type="checkbox"/>	<input type="checkbox"/>	<input type="checkbox"/>	<input type="checkbox"/>
AEHPD								

**A** **B** **C** **D** **E** **F** **G**

## HOW TO ORDER

Indicate the following information on order form:

- Quantity of each item.
- Model number, including options. See "How To Build a Model Number".
- Any special service required.

Note: • The  indicates that a choice is required.

- The absence of the  indicates that no choice is required.
- Alpha-numeric characters in place of  indicate that no other alternatives are available.

## HOW TO BUILD A MODEL NUMBER

**A** Select basic model.

**B** Select edge style.

- F** - Flat edge
- P3** - Three wave profile edge
- P4** - Four wave profile edge

**C** Select horizontal surface finish.

Refer to color addendum at ki.com or KI Fabrics & Finishes binder.

**D** Select vertical surface finish.

Refer to color addendum at ki.com or KI Fabrics & Finishes binder.

**E** Select pull option.

- BPA** - Silver bar pull (1)
- KIB** - Waterfall black pull (1)
- KIS** - Waterfall silver pull (1)
- RCP** - Rectangular silver pull (1)

**F** Select lock option.

- NL** - No lock (standard)
- L** - With lock; add \$64

**G** Select key option.

- KA** - Key alike
- KS** - Key standard



# Aristotle® Executive Storage

24" Wide Storage and Wardrobe Towers

Approx. Packaged Weight	Delivered Pricing
150.0#	\$ 1036
155.0#	1115
160.0#	1121
170.0#	1186

150.0#	\$ 1036
155.0#	1115
160.0#	1121
170.0#	1186

175.0#	\$ 1213
180.0#	1404
180.0#	1269
190.0#	1449

175.0#	\$ 1213
180.0#	1404
180.0#	1269
190.0#	1449

## SPECIAL SERVICES

### Special Carton Marking

With specially marked information N/C

### Shipping

Shipped **assembled freight prepaid f.o.b.**  
**KI-Aristotle Brampton, Ontario L6T 5T6**  
factory. Freight class #85.

Specifications and prices are subject to  
change without prior notice.

# Aristotle® Executive Storage

24" Wide Storage, Wardrobe and File Towers

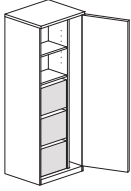
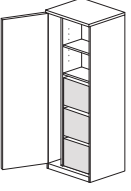
MODEL	W x D x H	MODEL NUMBER							
		Basic Model	Edge Style	Horizontal Surface Finish	Vertical Surface Finish	Pull Option	Lock Option	Key Option	
 <p><b>Storage, Wardrobe and File Tower-65" and 72" High, Right-Hinged Door</b></p> <ul style="list-style-type: none"> <li>• 1-1/2" top with choice of 3 edge styles</li> <li>• Right-hinged door</li> <li>• 3 letter/legal file drawers</li> <li>• 1 adjustable shelf, 14-1/4" wide</li> <li>• Coat hanger bar, 6-3/8" wide</li> <li>• Full-width door</li> </ul>	24 x 20 x 65-1/2"	KSWF242065R.E	<input type="checkbox"/>	<input type="checkbox"/>	<input type="checkbox"/>	<input type="checkbox"/>	<input type="checkbox"/>	<input type="checkbox"/>	
	24 x 24 x 65-1/2"	KSWF242465R.E	<input type="checkbox"/>	<input type="checkbox"/>	<input type="checkbox"/>	<input type="checkbox"/>	<input type="checkbox"/>	<input type="checkbox"/>	
	24 x 20 x 72-1/2"	KSWF242072R.E	<input type="checkbox"/>	<input type="checkbox"/>	<input type="checkbox"/>	<input type="checkbox"/>	<input type="checkbox"/>	<input type="checkbox"/>	
	24 x 24 x 72-1/2"	KSWF242472R.E	<input type="checkbox"/>	<input type="checkbox"/>	<input type="checkbox"/>	<input type="checkbox"/>	<input type="checkbox"/>	<input type="checkbox"/>	
AEHPD									
 <p><b>Storage, Wardrobe and File Tower-65" and 72" High, Left-Hinged</b></p> <ul style="list-style-type: none"> <li>• 1-1/2" top with choice of 3 edge styles</li> <li>• Left-hinged door</li> <li>• 3 letter/legal file drawers</li> <li>• 1 adjustable shelf, 14-1/4" wide</li> <li>• Coat hanger bar, 6-3/8" wide</li> <li>• Full-width door</li> </ul>	24 x 20 x 65-1/2"	KSWF242065L.E	<input type="checkbox"/>	<input type="checkbox"/>	<input type="checkbox"/>	<input type="checkbox"/>	<input type="checkbox"/>	<input type="checkbox"/>	
	24 x 24 x 65-1/2"	KSWF242465L.E	<input type="checkbox"/>	<input type="checkbox"/>	<input type="checkbox"/>	<input type="checkbox"/>	<input type="checkbox"/>	<input type="checkbox"/>	
	24 x 20 x 72-1/2"	KSWF242072L.E	<input type="checkbox"/>	<input type="checkbox"/>	<input type="checkbox"/>	<input type="checkbox"/>	<input type="checkbox"/>	<input type="checkbox"/>	
	24 x 24 x 72-1/2"	KSWF242472L.E	<input type="checkbox"/>	<input type="checkbox"/>	<input type="checkbox"/>	<input type="checkbox"/>	<input type="checkbox"/>	<input type="checkbox"/>	
AEHPD									
			<b>A</b>	<b>B</b>	<b>C</b>	<b>D</b>	<b>E</b>	<b>F</b>	<b>G</b>

## HOW TO ORDER

Indicate the following information on order form:

1. Quantity of each item.
2. Model number, including options. See "How To Build a Model Number".
3. Any special service required.

Note:

- The  indicates that a choice is required.
- The absence of the  indicates that no choice is required.
- Alpha-numeric characters in place of  indicate that no other alternatives are available.

## HOW TO BUILD A MODEL NUMBER

**A** Select basic model.

**B** Select edge style.

- F** - Flat edge
- P3** - Three wave profile edge
- P4** - Four wave profile edge

**C** Select horizontal surface finish.

Refer to color addendum at [ki.com](http://ki.com) or KI Fabrics & Finishes binder.

**D** Select vertical surface finish.

Refer to color addendum at [ki.com](http://ki.com) or KI Fabrics & Finishes binder.

**E** Select pull option.

- BPA** - Silver bar pull (1)
- KIB** - Waterfall black pull (1)
- KIS** - Waterfall silver pull (1)
- RCP** - Rectangular silver pull (1)

**F** Select lock option.

- NL** - No lock (standard)
- L** - With lock; add \$64

**G** Select key option.

- KA** - Key alike
- KS** - Key standard





# Aristotle® Executive Storage

24" Wide Storage, Wardrobe and File Towers

Approx. Packaged Weight	Delivered Pricing
190.0#	\$ 1785
195.0#	2059
195.0#	1864
205.0#	2130

190.0#	\$ 1785
195.0#	2059
195.0#	1864
205.0#	2130

## SPECIAL SERVICES

### Special Carton Marking

With specially marked information N/C

### Shipping

Shipped **assembled freight prepaid f.o.b. KI-Aristotle Brampton, Ontario L6T 5T6** factory. Freight class #85.

Specifications and prices are subject to change without prior notice.

# Aristotle® Executive Storage

24" Wide Wardrobe, File and Storage Towers

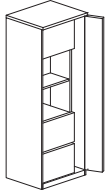
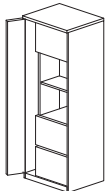
		MODEL NUMBER							
MODEL	W x D x H	Basic Model	Edge Style	Horizontal Surface Finish	Vertical Surface Finish	Pull Option	Lock Option	Key Option	
 <p>AEHPD</p>	<b>Wardrobe, File and Storage Tower-65" and 72" High, Right-Hinged Door</b> <ul style="list-style-type: none"> <li>1-1/2" top with choice of 3 edge styles</li> <li>Right-hinged door</li> <li>Upper closed storage</li> <li>Middle open storage</li> <li>2 lower letter/legal file drawers, locking, option of "NL=No lock" not available</li> <li>Coat hanger bar, 6-3/8" wide</li> <li>Wardrobe door available non-locking only</li> </ul>	24 x 20 x 65-1/2"	KWFS242065R.E	<input type="checkbox"/>	<input type="checkbox"/>	<input type="checkbox"/>	<input type="checkbox"/>	L	<input type="checkbox"/>
	24 x 24 x 65-1/2"	KWFS242465R.E	<input type="checkbox"/>	<input type="checkbox"/>	<input type="checkbox"/>	<input type="checkbox"/>	L	<input type="checkbox"/>	
	24 x 20 x 72-1/2"	KWFS242072R.E	<input type="checkbox"/>	<input type="checkbox"/>	<input type="checkbox"/>	<input type="checkbox"/>	L	<input type="checkbox"/>	
	24 x 24 x 72-1/2"	KWFS242472R.E	<input type="checkbox"/>	<input type="checkbox"/>	<input type="checkbox"/>	<input type="checkbox"/>	L	<input type="checkbox"/>	
 <p>AEHPD</p>	<b>Wardrobe, File and Storage Tower-65" and 72" High, Left-Hinged Door</b> <ul style="list-style-type: none"> <li>1-1/2" top with choice of 3 edge styles</li> <li>Left-hinged door</li> <li>Upper closed storage</li> <li>Middle open storage</li> <li>2 lower letter/legal file drawers, locking, option of "NL=No lock" not available</li> <li>Coat hanger bar, 6-3/8" wide</li> <li>Wardrobe door available non-locking only</li> </ul>	24 x 20 x 65-1/2"	KWFS242065L.E	<input type="checkbox"/>	<input type="checkbox"/>	<input type="checkbox"/>	<input type="checkbox"/>	L	<input type="checkbox"/>
	24 x 24 x 65-1/2"	KWFS242465L.E	<input type="checkbox"/>	<input type="checkbox"/>	<input type="checkbox"/>	<input type="checkbox"/>	L	<input type="checkbox"/>	
	24 x 20 x 72-1/2"	KWFS242072L.E	<input type="checkbox"/>	<input type="checkbox"/>	<input type="checkbox"/>	<input type="checkbox"/>	L	<input type="checkbox"/>	
	24 x 24 x 72-1/2"	KWFS242472L.E	<input type="checkbox"/>	<input type="checkbox"/>	<input type="checkbox"/>	<input type="checkbox"/>	L	<input type="checkbox"/>	

**A**      **B**      **C**      **D**      **E**      **F**      **G**

## HOW TO ORDER

Indicate the following information on order form:

- Quantity of each item.
- Model number, including options. See "How To Build a Model Number".
- Any special service required.

Note:

- The  indicates that a choice is required.
- The absence of the  indicates that no choice is required.
- Alpha-numeric characters in place of  indicate that no other alternatives are available.

## HOW TO BUILD A MODEL NUMBER

**A** Select basic model.

**B** Select edge style.

- F** - Flat edge
- P3** - Three wave profile edge
- P4** - Four wave profile edge

**C** Select horizontal surface finish.

Refer to color addendum at ki.com or KI Fabrics & Finishes binder.

**D** Select vertical surface finish.

Refer to color addendum at ki.com or KI Fabrics & Finishes binder.

**E** Select pull option.

- BPA4** - Silver bar pull (4)
- KIB4** - Waterfall black pull (4)
- KIS4** - Waterfall silver pull (4)
- RCP4** - Rectangular silver pull (4)

**F** Select lock option.

- L** - With lock

**G** Select key option.

- KA** - Key alike
- KS** - Key standard



# Aristotle® Executive Storage

24" Wide Wardrobe, File and Storage Towers

Approx. Packaged Weight	Delivered Pricing
185.0#	\$ 1785
190.0#	2059
190.0#	1864
200.0#	2130

185.0#	\$ 1785
190.0#	2059
190.0#	1864
200.0#	2130

## SPECIAL SERVICES

### Special Carton Marking

With specially marked information N/C

### Shipping

Shipped **assembled freight prepaid f.o.b. KI-Aristotle Brampton, Ontario L6T 5T6** factory. Freight class #85.

Specifications and prices are subject to change without prior notice.

# Aristotle® Executive Storage

30" and 36" Storage Towers

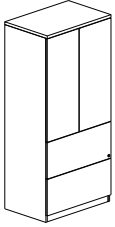
MODEL	W x D x H	MODEL NUMBER						Approx. Packaged Weight
		Basic Model	Edge Style	Horizontal Surface Finish	Vertical Surface Finish	Pull Option	Key Option	
 <p><b>Storage Tower with Lateral Files-Standard Doors</b></p> <ul style="list-style-type: none"> <li>• 1-1/2" top with choice of three edge styles</li> <li>• Locking lateral files</li> <li>• 2 adjustable full width shelves in cabinet</li> <li>• Non-locking upper doors</li> </ul>	30 x 20 x 65-1/2"	KFS302065.E	<input type="checkbox"/>	<input type="checkbox"/>	<input type="checkbox"/>	<input type="checkbox"/>	<input type="checkbox"/>	195.0#
	30 x 24 x 65-1/2"	KFS302465.E	<input type="checkbox"/>	<input type="checkbox"/>	<input type="checkbox"/>	<input type="checkbox"/>	<input type="checkbox"/>	220.0#
	30 x 20 x 72-1/2"	KFS302072.E	<input type="checkbox"/>	<input type="checkbox"/>	<input type="checkbox"/>	<input type="checkbox"/>	<input type="checkbox"/>	215.0#
	30 x 24 x 72-1/2"	KFS302472.E	<input type="checkbox"/>	<input type="checkbox"/>	<input type="checkbox"/>	<input type="checkbox"/>	<input type="checkbox"/>	240.0#
	36 x 20 x 65-1/2"	KFS362065.E	<input type="checkbox"/>	<input type="checkbox"/>	<input type="checkbox"/>	<input type="checkbox"/>	<input type="checkbox"/>	225.0#
	36 x 24 x 65-1/2"	KFS362465.E	<input type="checkbox"/>	<input type="checkbox"/>	<input type="checkbox"/>	<input type="checkbox"/>	<input type="checkbox"/>	250.0#
	36 x 20 x 72-1/2"	KFS362072.E	<input type="checkbox"/>	<input type="checkbox"/>	<input type="checkbox"/>	<input type="checkbox"/>	<input type="checkbox"/>	245.0#
	36 x 24 x 72-1/2"	KFS362472.E	<input type="checkbox"/>	<input type="checkbox"/>	<input type="checkbox"/>	<input type="checkbox"/>	<input type="checkbox"/>	270.0#

AEHPD

**A**      **B**      **C**      **D**      **E**      **F**

## HOW TO ORDER

Indicate the following information on order form:

1. Quantity of each item.
2. Model number, including options. See "How To Build a Model Number".
3. Any special service required.

Note: • The  indicates that a choice is required.  
 • The absence of the  indicates that no choice is required.  
 • Alpha-numeric characters in place of  indicate that no other alternatives are available.

## HOW TO BUILD A MODEL NUMBER

**KS** - Key standard

- A** Select basic model.
- B** Select edge style.
- |           |                           |
|-----------|---------------------------|
| <b>F</b>  | - Flat edge               |
| <b>P3</b> | - Three wave profile edge |
| <b>P4</b> | - Four wave profile edge  |
- C** Select horizontal surface finish.  
Refer to color addendum at ki.com or KI Fabrics & Finishes binder.
- D** Select vertical surface finish.  
Refer to color addendum at ki.com or KI Fabrics & Finishes binder.
- E** Select pull option.
- |             |                               |
|-------------|-------------------------------|
| <b>BPA4</b> | - Silver bar pull (4)         |
| <b>KIB4</b> | - Waterfall black pull (4)    |
| <b>KIS4</b> | - Waterfall silver pull (4)   |
| <b>RCP4</b> | - Rectangular silver pull (4) |
- F** Select key option.
- |           |             |
|-----------|-------------|
| <b>KA</b> | - Key alike |
|-----------|-------------|



# Aristotle® Executive Storage

30" and 36" Storage Towers

## Delivered Pricing

\$ 1766  
2109  
1865  
2205  
2016  
2361  
2114  
2459

### SPECIAL SERVICES

#### Special Carton Marking

With specially marked information N/C

#### Shipping

Shipped **assembled freight prepaid f.o.b. KI-Aristotle Brampton, Ontario L6T 5T6** factory. Freight class #85.

Specifications and prices are subject to change without prior notice.

# Aristotle® Executive Storage

30 and 36" Storage and Wardrobe Towers

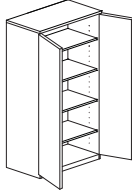
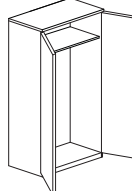
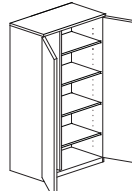
MODEL	W x D x H	MODEL NUMBER							
		Basic Model	Edge Style	Horizontal Surface Finish	Vertical Surface Finish	Pull Option	Lock Option	Key Option	
 <p><b>Storage Tower with Lateral Files-Frosted Glass Doors</b></p> <ul style="list-style-type: none"> <li>1-1/2" top with choice of three edge styles</li> <li>Locking lateral files</li> <li>2 adjustable shelves in cabinet</li> <li>Knob finish matches pull finish</li> <li>Non-locking glass doors</li> </ul>	30 x 20 x 65-1/2"	KFFS302065.E.AL	<input type="checkbox"/>	<input type="checkbox"/>	<input type="checkbox"/>	<input type="checkbox"/>	<input type="checkbox"/>	<input type="checkbox"/>	
	30 x 24 x 65-1/2"	KFFS302465.E.AL	<input type="checkbox"/>	<input type="checkbox"/>	<input type="checkbox"/>	<input type="checkbox"/>	<input type="checkbox"/>	<input type="checkbox"/>	
	30 x 20 x 72-1/2"	KFFS302072.E.AL	<input type="checkbox"/>	<input type="checkbox"/>	<input type="checkbox"/>	<input type="checkbox"/>	<input type="checkbox"/>	<input type="checkbox"/>	
	30 x 24 x 72-1/2"	KFFS302472.E.AL	<input type="checkbox"/>	<input type="checkbox"/>	<input type="checkbox"/>	<input type="checkbox"/>	<input type="checkbox"/>	<input type="checkbox"/>	
	36 x 20 x 65-1/2"	KFFS362065.E.AL	<input type="checkbox"/>	<input type="checkbox"/>	<input type="checkbox"/>	<input type="checkbox"/>	<input type="checkbox"/>	<input type="checkbox"/>	
	36 x 24 x 65-1/2"	KFFS362465.E.AL	<input type="checkbox"/>	<input type="checkbox"/>	<input type="checkbox"/>	<input type="checkbox"/>	<input type="checkbox"/>	<input type="checkbox"/>	
	36 x 20 x 72-1/2"	KFFS362072.E.AL	<input type="checkbox"/>	<input type="checkbox"/>	<input type="checkbox"/>	<input type="checkbox"/>	<input type="checkbox"/>	<input type="checkbox"/>	
AEHPD	36 x 24 x 72-1/2"	KFFS362472.E.AL	<input type="checkbox"/>	<input type="checkbox"/>	<input type="checkbox"/>	<input type="checkbox"/>	<input type="checkbox"/>	<input type="checkbox"/>	
 <p><b>Storage Tower</b></p> <ul style="list-style-type: none"> <li>1-1/2" top with choice of three edge styles</li> <li>4 adjustable full width shelves in cabinet</li> </ul>	36 x 20 x 65-1/2"	KST362065.E	<input type="checkbox"/>	<input type="checkbox"/>	<input type="checkbox"/>	<input type="checkbox"/>	<input type="checkbox"/>	<input type="checkbox"/>	
	36 x 24 x 65-1/2"	KST362465.E	<input type="checkbox"/>	<input type="checkbox"/>	<input type="checkbox"/>	<input type="checkbox"/>	<input type="checkbox"/>	<input type="checkbox"/>	
	36 x 20 x 72-1/2"	KST362072.E	<input type="checkbox"/>	<input type="checkbox"/>	<input type="checkbox"/>	<input type="checkbox"/>	<input type="checkbox"/>	<input type="checkbox"/>	
	36 x 24 x 72-1/2"	KST362472.E	<input type="checkbox"/>	<input type="checkbox"/>	<input type="checkbox"/>	<input type="checkbox"/>	<input type="checkbox"/>	<input type="checkbox"/>	
	AEHPD								
 <p><b>Wardrobe Tower</b></p> <ul style="list-style-type: none"> <li>1-1/2" top with choice of three edge styles</li> <li>Full-width wardrobe</li> <li>Hat shelf</li> <li>Full-width coat hanger bar</li> </ul>	36 x 20 x 65-1/2"	KWT362065.E	<input type="checkbox"/>	<input type="checkbox"/>	<input type="checkbox"/>	<input type="checkbox"/>	<input type="checkbox"/>	<input type="checkbox"/>	
	36 x 24 x 65-1/2"	KWT362465.E	<input type="checkbox"/>	<input type="checkbox"/>	<input type="checkbox"/>	<input type="checkbox"/>	<input type="checkbox"/>	<input type="checkbox"/>	
	36 x 20 x 72-1/2"	KWT362072.E	<input type="checkbox"/>	<input type="checkbox"/>	<input type="checkbox"/>	<input type="checkbox"/>	<input type="checkbox"/>	<input type="checkbox"/>	
	36 x 24 x 72-1/2"	KWT362472.E	<input type="checkbox"/>	<input type="checkbox"/>	<input type="checkbox"/>	<input type="checkbox"/>	<input type="checkbox"/>	<input type="checkbox"/>	
	AEHPD								
 <p><b>Storage and Wardrobe Tower</b></p> <ul style="list-style-type: none"> <li>1-1/2" top with choice of three edge styles</li> <li>4 adjustable shelves in cabinet, 26" wide</li> <li>Coat hanger bar, 6-3/8" wide</li> </ul>	36 x 20 x 65-1/2"	KSW362065.E	<input type="checkbox"/>	<input type="checkbox"/>	<input type="checkbox"/>	<input type="checkbox"/>	<input type="checkbox"/>	<input type="checkbox"/>	
	36 x 24 x 65-1/2"	KSW362465.E	<input type="checkbox"/>	<input type="checkbox"/>	<input type="checkbox"/>	<input type="checkbox"/>	<input type="checkbox"/>	<input type="checkbox"/>	
	36 x 20 x 72-1/2"	KSW362072.E	<input type="checkbox"/>	<input type="checkbox"/>	<input type="checkbox"/>	<input type="checkbox"/>	<input type="checkbox"/>	<input type="checkbox"/>	
	36 x 24 x 72-1/2"	KSW362472.E	<input type="checkbox"/>	<input type="checkbox"/>	<input type="checkbox"/>	<input type="checkbox"/>	<input type="checkbox"/>	<input type="checkbox"/>	
	AEHPD								

**A** **B** **C** **D** **E** **F** **G**

## HOW TO ORDER

Indicate the following information on order form:

- Quantity of each item.
- Model number, including options. See "How To Build a Model Number".
- Any special service required.

Note: • The  indicates that a choice is required.

- The absence of the  indicates that no choice is required.
- Alpha-numeric characters in place of  indicate that no other alternatives are available.

## HOW TO BUILD A MODEL NUMBER

- A** Select basic model.
- B** Select edge style.
  - F - Flat edge
  - P3 - Three wave profile edge
  - P4 - Four wave profile edge
- C** Select horizontal surface finish. Refer to color addendum at ki.com or KI Fabrics & Finishes binder.
- D** Select vertical surface finish. Refer to color addendum at ki.com or KI Fabrics & Finishes binder.
- E** Select pull option.
  - BPA2 - Silver bar pull (2)
  - KIB2 - Waterfall black pull (2)
  - KIS2 - Waterfall silver pull (2)
  - RCP2 - Rectangular silver pull (2)
- F** Select lock option.
  - NL - No lock (standard)

L - With lock; add \$64

- G** Select key option.
  - KA - Key alike
  - KS - Key standard



# Aristotle® Executive Storage

36" Storage and Wardrobe Towers

Approx. Packaged Weight	Delivered Pricing
195.0#	\$ 2257
220.0#	2389
215.0#	2341
240.0#	2477
225.0#	2403
250.0#	2540
245.0#	2505
270.0#	2643
210.0#	\$ 1716
230.0#	1873
225.0#	1809
250.0#	1979
175.0#	\$ 1716
185.0#	1873
180.0#	1809
195.0#	1979
210.0#	\$ 1716
230.0#	1873
225.0#	1809
250.0#	1979

## SPECIAL SERVICES

### Special Carton Marking

With specially marked information N/C

### Shipping

Shipped **assembled freight prepaid f.o.b. KI-Aristotle Brampton, Ontario L6T 5T6** factory. Freight class #85.

Specifications and prices are subject to change without prior notice.

# Aristotle® Executive Storage

Bookcases-24" Wide

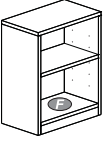
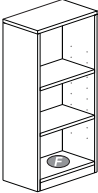
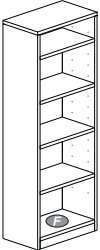
	MODEL	W x D x H	MODEL NUMBER				Approx. Packaged Weight
			Basic Model	Edge Style	Horizontal Surface Finish	Vertical Surface Finish	
 AEHPD	<b>Bookcase 24" Wide-One Adjustable Shelf, One Fixed Shelf</b> <ul style="list-style-type: none"> <li>• 1-1/2" top with choice of three edge styles</li> <li>• Shelf finish matches shell (vertical surface finish)</li> </ul>	24 x 14 x 29-1/2"	KBC2429.E	<input type="checkbox"/>	<input type="checkbox"/>	<input type="checkbox"/>	55.0#
 AEHPD	<b>Bookcase 24" Wide-Two Adjustable Shelves, One Fixed Shelf</b> <ul style="list-style-type: none"> <li>• 1-1/2" top with choice of three edge styles</li> <li>• Shelf finish matches shell (vertical surface finish)</li> </ul>	24 x 14 x 48-1/2"	KBC2448.E	<input type="checkbox"/>	<input type="checkbox"/>	<input type="checkbox"/>	70.0#
 AEHPD	<b>Bookcase 24" Wide-Four Adjustable Shelves, One Fixed Shelf</b> <ul style="list-style-type: none"> <li>• 1-1/2" top with choice of three edge styles</li> <li>• Shelf finish matches shell (vertical surface finish)</li> </ul>	24 x 14 x 65-1/2"	KBC2465.E	<input type="checkbox"/>	<input type="checkbox"/>	<input type="checkbox"/>	95.0#
		24 x 14 x 72-1/2"	KBC2472.E	<input type="checkbox"/>	<input type="checkbox"/>	<input type="checkbox"/>	110.0#
			<b>A</b>	<b>B</b>	<b>C</b>	<b>D</b>	

## HOW TO ORDER

Indicate the following information on order form:

1. Quantity of each item.
2. Model number, including options. See "How To Build a Model Number".
3. Any special service required.

Note: • The  indicates that a choice is required.  
 • The absence of the  indicates that no choice is required.  
 • Alpha-numeric characters in place of  indicate that no other alternatives are available.

## HOW TO BUILD A MODEL NUMBER

- A** Select basic model.
- B** Select edge style.
- |           |                           |
|-----------|---------------------------|
| <b>F</b>  | - Flat edge               |
| <b>P3</b> | - Three wave profile edge |
| <b>P4</b> | - Four wave profile edge  |
- C** Select horizontal surface finish.  
Refer to color addendum at ki.com or KI Fabrics & Finishes binder.
- D** Select vertical surface finish.  
Refer to color addendum at ki.com or KI Fabrics & Finishes binder.





# Aristotle® Executive Storage

Bookcases-24" Wide

Delivered  
Pricing

\$ 624

\$ 672

\$ 779

849

**SPECIAL SERVICES**

**Special Carton Marking**

With specially marked information N/C

**Shipping**

Shipped **assembled freight prepaid f.o.b. KI-Aristotle Brampton, Ontario L6T 5T6** factory. Freight class #85.

Specifications and prices are subject to change without prior notice.

# Aristotle® Executive Storage

Bookcases-30" Wide

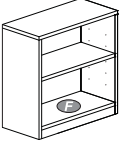
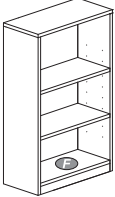
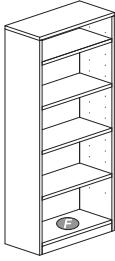
	MODEL	W x D x H	MODEL NUMBER				Approx. Packaged Weight
			Basic Model	Edge Style	Horizontal Surface Finish	Vertical Surface Finish	
	<b>Bookcase 30" Wide-One Adjustable Shelf, One Fixed Shelf</b> • 1-1/2" top with choice of three edge styles • Shelf finish matches shell (vertical surface finish)	30 x 14 x 29-1/2"	KBC3029.E	<input type="checkbox"/>	<input type="checkbox"/>	<input type="checkbox"/>	60.0#
AEHPD							
	<b>Bookcase 30" Wide-Two Adjustable Shelves, One Fixed Shelf</b> • 1-1/2" top with choice of three edge styles • Shelf finish matches shell (vertical surface finish)	30 x 14 x 48-1/2"	KBC3048.E	<input type="checkbox"/>	<input type="checkbox"/>	<input type="checkbox"/>	80.0#
AEHPD							
	<b>Bookcase 30" Wide-Four Adjustable Shelves, One Fixed Shelf</b> • 1-1/2" top with choice of three edge styles • Shelf finish matches shell (vertical surface finish)	30 x 14 x 65-1/2"	KBC3065.E	<input type="checkbox"/>	<input type="checkbox"/>	<input type="checkbox"/>	110.0#
		30 x 14 x 72-1/2"	KBC3072.E	<input type="checkbox"/>	<input type="checkbox"/>	<input type="checkbox"/>	125.0#
AEHPD							
				<b>A</b>	<b>B</b>	<b>C</b>	<b>D</b>

## HOW TO ORDER

Indicate the following information on order form:

- Quantity of each item.
- Model number, including options. See "How To Build a Model Number".
- Any special service required.

Note: • The  indicates that a choice is required.  
 • The absence of the  indicates that no choice is required.  
 • Alpha-numeric characters in place of  indicate that no other alternatives are available.

## HOW TO BUILD A MODEL NUMBER

- A** Select basic model.
- B** Select edge style.
- |           |                           |
|-----------|---------------------------|
| <b>F</b>  | - Flat edge               |
| <b>P3</b> | - Three wave profile edge |
| <b>P4</b> | - Four wave profile edge  |
- C** Select horizontal surface finish.  
 Refer to color addendum at ki.com or KI Fabrics & Finishes binder.
- D** Select vertical surface finish.  
 Refer to color addendum at ki.com or KI Fabrics & Finishes binder.



# Aristotle® Executive Storage

Bookcases-30" Wide

Delivered  
Pricing

\$ 673

\$ 726

\$ 843

918

## SPECIAL SERVICES

### Special Carton Marking

With specially marked information N/C

### Shipping

Shipped **assembled freight prepaid f.o.b.**  
**KI-Aristotle Brampton, Ontario L6T 5T6**  
factory. Freight class #85.

Specifications and prices are subject to  
change without prior notice.

# Aristotle® Executive Storage

Bookcases-36" Wide

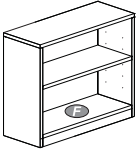
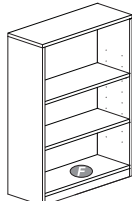
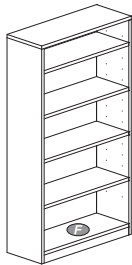
	MODEL	W x D x H	MODEL NUMBER				Approx. Packaged Weight
			Basic Model	Edge Style	Horizontal Surface Finish	Vertical Surface Finish	
	<b>Bookcase 36" Wide-One Adjustable Shelf, One Fixed Shelf</b> • 1-1/2" top with choice of three edge styles • Shelf finish matches shell (vertical surface finish)	36 x 14 x 29-1/2"	KBC3629.E	<input type="checkbox"/>	<input type="checkbox"/>	<input type="checkbox"/>	65.0#
AEHPD							
	<b>Bookcase 36" Wide-Two Adjustable Shelves, One Fixed Shelf</b> • 1-1/2" top with choice of three edge styles • Shelf finish matches shell (vertical surface finish)	36 x 14 x 48-1/2"	KBC3648.E	<input type="checkbox"/>	<input type="checkbox"/>	<input type="checkbox"/>	90.0#
AEHPD							
	<b>Bookcase 36" Wide-Four Adjustable Shelves, One Fixed Shelf</b> • 1-1/2" top with choice of three edge styles • Shelf finish matches shell (vertical surface finish)	36 x 14 x 65-1/2"	KBC3665.E	<input type="checkbox"/>	<input type="checkbox"/>	<input type="checkbox"/>	125.0#
		36 x 14 x 72-1/2"	KBC3672.E	<input type="checkbox"/>	<input type="checkbox"/>	<input type="checkbox"/>	140.0#
AEHPD							
				<b>A</b>	<b>B</b>	<b>C</b>	<b>D</b>

## HOW TO ORDER

Indicate the following information on order form:

- Quantity of each item.
- Model number, including options. See "How To Build a Model Number".
- Any special service required.

Note: • The  indicates that a choice is required.  
 • The absence of the  indicates that no choice is required.  
 • Alpha-numeric characters in place of  indicate that no other alternatives are available.

## HOW TO BUILD A MODEL NUMBER

- A** Select basic model.
- B** Select edge style.
- |    |                           |
|----|---------------------------|
| F  | - Flat edge               |
| P3 | - Three wave profile edge |
| P4 | - Four wave profile edge  |
- C** Select horizontal surface finish.  
 Refer to color addendum at ki.com or KI Fabrics & Finishes binder.
- D** Select vertical surface finish.  
 Refer to color addendum at ki.com or KI Fabrics & Finishes binder.



# Aristotle® Executive Storage

Bookcases-36" Wide

Delivered  
Pricing

\$ 749

\$ 808

\$ 933

1020

## SPECIAL SERVICES

### Special Carton Marking

With specially marked information N/C



### Shipping

Shipped **assembled freight prepaid f.o.b.**  
**KI-Aristotle Brampton, Ontario L6T 5T6**  
factory. Freight class #85.

Specifications and prices are subject to  
change without prior notice.

# Aristotle® Executive Storage

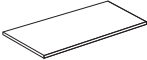
Bookcases

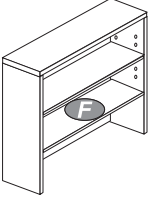
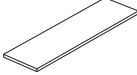
	MODEL	W x D x H	MODEL NUMBER				Approx. Packaged Weight
			Basic Model	Edge Style	Horizontal Surface Finish	Vertical Surface Finish	
	<b>Extra Shelf for 24" Wide Bookcase</b> • Includes 2 wire shelf supports	22 x 13 x 1"	KES24.H		□□□		4.0#
ARHPD							
	<b>Extra Shelf for 30" Wide Bookcase</b> • Includes 2 wire shelf supports	28 x 13 x 1"	KES30.H		□□□		5.0#
ARHPD							
	<b>Extra Shelf for 36" Wide Bookcase</b> • Includes 2 wire shelf supports	34 x 13 x 1"	KES36.H		□□□		6.0#
ARHPD							
	<b>Desk Top Stack-On Bookcase</b> • For use on top of lateral files and storage cabinets • 12" clearance above desktop • 36" high feature one adjustable shelf; 43" feature two adjustable shelves • Shelf finish matches shell (vertical surface finish)	30 x 16 x 36"	KXCB3036.E	□□	□□□	□□□□	70.0#
		30 x 16 x 43"	KXCB3043.E	□□	□□□	□□□□	80.0#
		36 x 16 x 36"	KXCB3636.E	□□	□□□	□□□□	80.0#
		36 x 16 x 43"	KXCB3643.E	□□	□□□	□□□□	90.0#
AEHPD							
	<b>Extra Desk Top Shelves</b> • Extra shelf for 30" wide desk top bookcase • Extra shelf for 36" wide desktop bookcase	28 x 13 x 1"	KXES30.H		□□□		5.0#
		34 x 13 x 1"	KXES36.H		□□□		6.0#
ARHPD							
			<b>A</b>	<b>B</b>	<b>C</b>	<b>D</b>	

## HOW TO ORDER

Indicate the following information on order form:

- Quantity of each item.
- Model number, including options. See "How To Build a Model Number".
- Any special service required.

Note: • The □ indicates that a choice is required.  
• The absence of the □ indicates that no choice is required.  
• Alpha-numeric characters in place of □ indicate that no other alternatives are available.

## HOW TO BUILD A MODEL NUMBER

- A** Select basic model.
- B** Select edge style.
- |    |                           |
|----|---------------------------|
| F  | - Flat edge               |
| P3 | - Three wave profile edge |
| P4 | - Four wave profile edge  |
- C** Select horizontal surface finish.  
Refer to color addendum at [ki.com](http://ki.com) or KI Fabrics & Finishes binder.
- D** Select vertical surface finish.  
Refer to color addendum at [ki.com](http://ki.com) or KI Fabrics & Finishes binder.



Delivered  
Pricing

\$ 111

\$ 111

\$ 111

\$ 718

771

771

848

\$ 111

111

## SPECIAL SERVICES

### Special Carton Marking

With specially marked information N/C

### Shipping

Shipped **assembled freight prepaid f.o.b.**  
**KI-Aristotle Brampton, Ontario L6T 5T6**  
factory. Freight class #85.

Specifications and prices are subject to  
change without prior notice.

# Aristotle® Executive Storage

Quarter-Round Bookcases

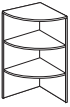
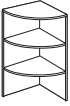
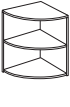
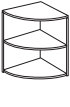
	MODEL	W x D x H	MODEL NUMBER				Approx. Packaged Weight
			Basic Model	Edge Style	Horizontal Surface Finish	Vertical Surface Finish	
 AEHPD	<b>Quarter-Round Bookcase-Desk Top Stack-On Section, Right</b> • 1-1/2" top with choice of three edge styles • Orientation determines grain direction, to match adjacent units • 16" is intended for desk top use, with no bottom shelf • Two fixed shelves • Shelf finish matches shell (vertical surface finish)	16 x 16 x 36"	KQRB1636R.E	<input type="checkbox"/>	<input type="checkbox"/>	<input type="checkbox"/>	70.0#
		16 x 16 x 43"	KQRB1643R.E	<input type="checkbox"/>	<input type="checkbox"/>	<input type="checkbox"/>	75.0#
 AEHPD	<b>Quarter-Round Bookcase-Desk Top Stack-On Section, Left</b> • 1-1/2" top with choice of three edge styles • Orientation determines grain direction, to match adjacent units • 16" is intended for desk top use, with no bottom shelf • Two fixed shelves • Shelf finish matches shell (vertical surface finish)	16 x 16 x 36"	KQRB1636L.E	<input type="checkbox"/>	<input type="checkbox"/>	<input type="checkbox"/>	70.0#
		16 x 16 x 43"	KQRB1643L.E	<input type="checkbox"/>	<input type="checkbox"/>	<input type="checkbox"/>	75.0#
 AEHPD	<b>Quarter-Round Bookcase-Desk/Credenza, Right</b> • 1-1/2" top with choice of three edge styles • Orientation determines grain direction, to match adjacent units • 29" flush with adjacent worksurface height • Two fixed shelves • Shelf finish matches shell (vertical surface finish)	20 x 20 x 29"	KQRB2029R.E	<input type="checkbox"/>	<input type="checkbox"/>	<input type="checkbox"/>	70.0#
		24 x 24 x 29"	KQRB2429R.E	<input type="checkbox"/>	<input type="checkbox"/>	<input type="checkbox"/>	75.0#
 AEHPD	<b>Quarter-Round Bookcase-Desk/Credenza, Left</b> • 1-1/2" top with choice of three edge styles • Orientation determines grain direction, to match adjacent units • 29" flush with adjacent worksurface height • Two fixed shelves • Shelf finish matches shell (vertical surface finish)	20 x 20 x 29"	KQRB2029L.E	<input type="checkbox"/>	<input type="checkbox"/>	<input type="checkbox"/>	70.0#
		24 x 24 x 29"	KQRB2429L.E	<input type="checkbox"/>	<input type="checkbox"/>	<input type="checkbox"/>	75.0#

A

B

C

D

## HOW TO ORDER

Indicate the following information on order form:

- Quantity of each item.
- Model number, including options. See "How To Build a Model Number".
- Any special service required.

Note: • The  indicates that a choice is required.

- The absence of the  indicates that no choice is required.
- Alpha-numeric characters in place of  indicate that no other alternatives are available.

## HOW TO BUILD A MODEL NUMBER

**A** Select basic model.

**B** Select edge style.

F	- Flat edge
P3	- Three wave profile edge
P4	- Four wave profile edge

**C** Select horizontal surface finish.

Refer to color addendum at ki.com or KI Fabrics & Finishes binder.

**D** Select vertical surface finish.

Refer to color addendum at ki.com or KI Fabrics & Finishes binder.





# Aristotle® Executive Storage

Quarter-Round Bookcases

Delivered  
Pricing

\$ 488

578

\$ 488

578

\$ 516

563

\$ 516

563

## SPECIAL SERVICES

### Special Carton Marking

With specially marked information N/C

### Shipping

Shipped **assembled freight prepaid f.o.b.**  
**KI-Aristotle Brampton, Ontario L6T 5T6**  
factory. Freight class #85.

Specifications and prices are subject to  
change without prior notice.

# Aristotle® Executive Storage

## Quarter-Round Bookcases

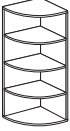
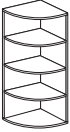
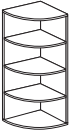
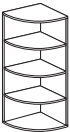
	MODEL	W x D x H	MODEL NUMBER				Approx. Packaged Weight
			Basic Model	Edge Style	Horizontal Surface Finish	Vertical Surface Finish	
 AEHPD	<b>Quarter-Round Bookcase-Overhead, Right</b> <ul style="list-style-type: none"> <li>1-1/2" top with choice of three edge styles</li> <li>Orientation determines grain direction, to match adjacent units</li> <li>16" matches depth and height of installed overhead</li> <li>Four fixed shelves</li> <li>Shelf finish matches shell (vertical surface finish)</li> </ul>	16 x 16 x 65"	KQRB1665R.E	<input type="checkbox"/>	<input type="checkbox"/>	<input type="checkbox"/>	95.0#
		16 x 16 x 72"	KQRB1672R.E	<input type="checkbox"/>	<input type="checkbox"/>	<input type="checkbox"/>	100.0#
 AEHPD	<b>Quarter-Round Bookcase-Overhead, Left</b> <ul style="list-style-type: none"> <li>1-1/2" top with choice of three edge styles</li> <li>Orientation determines grain direction, to match adjacent units</li> <li>16" matches depth and height of installed overhead</li> <li>Four fixed shelves</li> <li>Shelf finish matches shell (vertical surface finish)</li> </ul>	16 x 16 x 65"	KQRB1665L.E	<input type="checkbox"/>	<input type="checkbox"/>	<input type="checkbox"/>	95.0#
		16 x 16 x 72"	KQRB1672L.E	<input type="checkbox"/>	<input type="checkbox"/>	<input type="checkbox"/>	100.0#
 AEHPD	<b>Quarter-Round Bookcase-Tower, Right</b> <ul style="list-style-type: none"> <li>1-1/2" top with choice of three edge styles</li> <li>Orientation determines grain direction, to match adjacent units</li> <li>20" and 24" matches depth and height of towers</li> <li>Four fixed shelves</li> <li>Shelf finish matches shell (vertical surface finish)</li> </ul>	20 x 20 x 65"	KQRB2065R.E	<input type="checkbox"/>	<input type="checkbox"/>	<input type="checkbox"/>	105.0#
		24 x 24 x 65"	KQRB2465R.E	<input type="checkbox"/>	<input type="checkbox"/>	<input type="checkbox"/>	110.0#
		20 x 20 x 72"	KQRB2072R.E	<input type="checkbox"/>	<input type="checkbox"/>	<input type="checkbox"/>	115.0#
		24 x 24 x 72"	KQRB2472R.E	<input type="checkbox"/>	<input type="checkbox"/>	<input type="checkbox"/>	120.0#
 AEHPD	<b>Quarter-Round Bookcase-Tower, Left</b> <ul style="list-style-type: none"> <li>1-1/2" top with choice of three edge styles</li> <li>Orientation determines grain direction, to match adjacent units</li> <li>20" and 24" matches depth and height of towers</li> <li>Four fixed shelves</li> <li>Shelf finish matches shell (vertical surface finish)</li> </ul>	20 x 20 x 65"	KQRB2065L.E	<input type="checkbox"/>	<input type="checkbox"/>	<input type="checkbox"/>	105.0#
		24 x 24 x 65"	KQRB2465L.E	<input type="checkbox"/>	<input type="checkbox"/>	<input type="checkbox"/>	110.0#
		20 x 20 x 72"	KQRB2072L.E	<input type="checkbox"/>	<input type="checkbox"/>	<input type="checkbox"/>	115.0#
		24 x 24 x 72"	KQRB2472L.E	<input type="checkbox"/>	<input type="checkbox"/>	<input type="checkbox"/>	120.0#

A

B

C

D

### HOW TO ORDER

Indicate the following information on order form:

- Quantity of each item.
- Model number, including options. See "How To Build a Model Number".
- Any special service required.

Note: • The  indicates that a choice is required.

- The absence of the  indicates that no choice is required.
- Alpha-numeric characters in place of  indicate that no other alternatives are available.

### HOW TO BUILD A MODEL NUMBER

**A** Select basic model.

**B** Select edge style.

<b>F</b>	- Flat edge
<b>P3</b>	- Three wave profile edge
<b>P4</b>	- Four wave profile edge

**C** Select horizontal surface finish.

Refer to color addendum at [ki.com](http://ki.com) or KI Fabrics & Finishes binder.

**D** Select vertical surface finish.

Refer to color addendum at [ki.com](http://ki.com) or KI Fabrics & Finishes binder.



# Aristotle® Executive Storage

Quarter-Round Bookcases

Delivered  
Pricing

\$ 660

702

\$ 660

702

\$ 741

904

799

953

\$ 741

904

799

953

## SPECIAL SERVICES

### Special Carton Marking

With specially marked information N/C

### Shipping

Shipped **assembled freight prepaid f.o.b.**  
**KI-Aristotle Brampton, Ontario L6T 5T6**  
factory. Freight class #85.

Specifications and prices are subject to  
change without prior notice.

# Aristotle® Executive Storage

## Square Bookcases

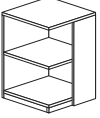
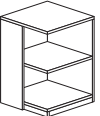
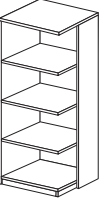
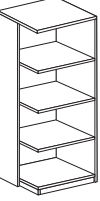
	MODEL	W x D x H	MODEL NUMBER				Approx. Packaged Weight
			Basic Model	Edge Style	Horizontal Surface Finish	Vertical Surface Finish	
 AEHPD	<b>Corner-Square Bookcase-Desk/Credenza, Right</b> <ul style="list-style-type: none"> <li>• 1-1/2" top with choice of three edge styles</li> <li>• Orientation determines grain direction, to match adjacent units</li> <li>• 29" flush with adjacent worksurface height</li> <li>• Two fixed shelves</li> <li>• Shelf finish matches shell (vertical surface finish)</li> </ul>	20 x 20 x 29"	KCSB2029R.E	<input type="checkbox"/>	<input type="checkbox"/>	<input type="checkbox"/>	65.0#
		24 x 24 x 29"	KCSB2429R.E	<input type="checkbox"/>	<input type="checkbox"/>	<input type="checkbox"/>	70.0#
 AEHPD	<b>Corner-Square Bookcase-Desk/Credenza, Left</b> <ul style="list-style-type: none"> <li>• 1-1/2" top with choice of three edge styles</li> <li>• Orientation determines grain direction, to match adjacent units</li> <li>• 29" flush with adjacent worksurface height</li> <li>• Two fixed shelves</li> <li>• Shelf finish matches shell (vertical surface finish)</li> </ul>	20 x 20 x 29"	KCSB2029L.E	<input type="checkbox"/>	<input type="checkbox"/>	<input type="checkbox"/>	65.0#
		24 x 24 x 29"	KCSB2429L.E	<input type="checkbox"/>	<input type="checkbox"/>	<input type="checkbox"/>	70.0#
 AEHPD	<b>Corner-Square Bookcase--Tower, Right</b> <ul style="list-style-type: none"> <li>• 1-1/2" top with choice of three edge styles</li> <li>• Orientation determines grain direction, to match adjacent units</li> <li>• 20" and 24" matches depth and height of towers</li> <li>• Four fixed shelves</li> <li>• Shelf finish matches shell (vertical surface finish)</li> </ul>	20 x 20 x 65"	KCSB2065R.E	<input type="checkbox"/>	<input type="checkbox"/>	<input type="checkbox"/>	115.0#
		24 x 24 x 65"	KCSB2465R.E	<input type="checkbox"/>	<input type="checkbox"/>	<input type="checkbox"/>	125.0#
		20 x 20 x 72"	KCSB2072R.E	<input type="checkbox"/>	<input type="checkbox"/>	<input type="checkbox"/>	120.0#
		24 x 24 x 72"	KCSB2472R.E	<input type="checkbox"/>	<input type="checkbox"/>	<input type="checkbox"/>	130.0#
 AEHPD	<b>Corner-Square Bookcase--Tower, Left</b> <ul style="list-style-type: none"> <li>• 1-1/2" top with choice of three edge styles</li> <li>• Orientation determines grain direction, to match adjacent units</li> <li>• 20" and 24" matches depth and height of towers</li> <li>• Four fixed shelves</li> <li>• Shelf finish matches shell (vertical surface finish)</li> </ul>	20 x 20 x 65"	KCSB2065L.E	<input type="checkbox"/>	<input type="checkbox"/>	<input type="checkbox"/>	115.0#
		24 x 24 x 65"	KCSB2465L.E	<input type="checkbox"/>	<input type="checkbox"/>	<input type="checkbox"/>	125.0#
		20 x 20 x 72"	KCSB2072L.E	<input type="checkbox"/>	<input type="checkbox"/>	<input type="checkbox"/>	120.0#
		24 x 24 x 72"	KCSB2472L.E	<input type="checkbox"/>	<input type="checkbox"/>	<input type="checkbox"/>	130.0#

A

B

C

D

### HOW TO ORDER

Indicate the following information on order form:

1. Quantity of each item.
2. Model number, including options. See "How To Build a Model Number".
3. Any special service required.

Note: • The  indicates that a choice is required.  
 • The absence of the  indicates that no choice is required.  
 • Alpha-numeric characters in place of  indicate that no other alternatives are available.

### HOW TO BUILD A MODEL NUMBER

- A** Select basic model.
- B** Select edge style.
- |    |                           |
|----|---------------------------|
| F  | - Flat edge               |
| P3 | - Three wave profile edge |
| P4 | - Four wave profile edge  |
- C** Select horizontal surface finish.  
Refer to color addendum at ki.com or KI Fabrics & Finishes binder.
- D** Select vertical surface finish.  
Refer to color addendum at ki.com or KI Fabrics & Finishes binder.



# Aristotle® Executive Storage

Square Bookcases

Delivered  
Pricing

\$ 538

637

\$ 538

637

\$ 815

993

879

1049

\$ 815

993

879

1049

## SPECIAL SERVICES

### Special Carton Marking

With specially marked information N/C

### Shipping

Shipped **assembled freight prepaid f.o.b.**  
**KI-Aristotle Brampton, Ontario L6T 5T6**  
factory. Freight class #85.

Specifications and prices are subject to  
change without prior notice.

# Aristotle® Executive Accessories

## Desktop Acrylic Screen

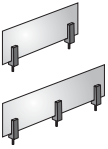
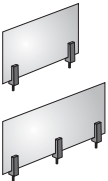
	MODEL	W x D x H	MODEL NUMBER		Approx. Packaged Weight
			Basic Model		
 ARFDT	<b>Desktop Acrylic Screen - 12" H</b> <ul style="list-style-type: none"> <li>• 24-54" wide require 2 desk top screen supports, specified separately</li> <li>• 60-72" wide require 3 desk top screen supports, specified separately</li> <li>• 1/4" frosted acrylic</li> <li>• Surface mounted attachment</li> <li>• Field installed</li> </ul>	21 x 1/4 x 12"	KDTP2412		2.0#
		27 x 1/4 x 12"	KDTP3012		3.0#
		33 x 1/4 x 12"	KDTP3612		4.0#
		39 x 1/4 x 12"	KDTP4212		5.0#
		45 x 1/4 x 12"	KDTP4812		6.0#
		51 x 1/4 x 12"	KDTP5412		7.0#
		57 x 1/4 x 12"	KDTP6012		8.0#
		63 x 1/4 x 12"	KDTP6612		9.0#
		69 x 1/4 x 12"	KDTP7212		10.0#
 ARFDT	<b>Desktop Acrylic Screen - 18" H</b> <ul style="list-style-type: none"> <li>• 24-54" wide require 2 desk top screen supports, specified separately</li> <li>• 60-72" wide require 3 desk top screen supports, specified separately</li> <li>• 1/4" frosted acrylic</li> <li>• Surface mounted attachment</li> <li>• Field installed</li> </ul>	21 x 1/4 x 18"	KDTP2418		3.0#
		27 x 1/4 x 18"	KDTP3018		5.0#
		33 x 1/4 x 18"	KDTP3618		6.0#
		39 x 1/4 x 18"	KDTP4218		8.0#
		45 x 1/4 x 18"	KDTP4818		9.0#
		51 x 1/4 x 18"	KDTP5418		11.0#
		57 x 1/4 x 18"	KDTP6018		12.0#
		63 x 1/4 x 18"	KDTP6618		14.0#
		69 x 1/4 x 18"	KDTP7218		15.0#

**A**

### HOW TO ORDER

Indicate the following information on order form:

1. Quantity of each item.
2. Model number, including options. See "How To Build a Model Number".
3. Any special service required.

Note: • The  indicates that a choice is required.

- The absence of the  indicates that no choice is required.
- Alpha-numeric characters in place of  indicate that no other alternatives are available.

### HOW TO BUILD A MODEL NUMBER

- A** Select basic model.



# Aristotle® Executive Accessories

Desktop Acrylic Screen

## Delivered Pricing

\$ 115
133
151
194
194
249
249
249
284
\$ 192
226
226
293
293
359
359
425
432

### SPECIAL SERVICES

#### Special Carton Marking

With specially marked information    N/C



#### Shipping

Shipped **assembled freight prepaid f.o.b. KI-Aristotle Brampton, Ontario L6T 5T6** factory. Freight class #85.

Specifications and prices are subject to change without prior notice.

# Aristotle® Executive Accessories

## Desktop Screen Support

	MODEL	W x D x H	MODEL NUMBER	
			Basic Model	Approx. Packaged Weight
 ARFDT	<b>Desktop Screen Support-6" High, Aluminum Finish</b>	1-1/2 x 1-1/2 x 6"	KDTPSA	1.0#
 ARFDT	<b>Desktop Screen Support-6" High, Black Finish</b>	1-1/2 x 1-1/2 x 6"	KDTPSB	1.0#
 ARFDT	<b>Desktop Screen Support-6" High, Charcoal Finish</b>	1-1/2 x 1-1/2 x 6"	KDTPSC	1.0#

**A**

### HOW TO ORDER

Indicate the following information on order form:

1. Quantity of each item.
2. Model number, including options. See "How To Build a Model Number".
3. Any special service required.

- Note:
- The  indicates that a choice is required.
  - The absence of the  indicates that no choice is required.
  - Alpha-numeric characters in place of  indicate that no other alternatives are available.

### HOW TO BUILD A MODEL NUMBER

- A** Select basic model.





Delivered  
Pricing

\$ 42

\$ 42

\$ 42

## SPECIAL SERVICES

### Special Carton Marking

With specially marked information N/C



### Shipping

Shipped **assembled freight prepaid f.o.b. KI-Aristotle Brampton, Ontario L6T 5T6** factory. Freight class #85.

Specifications and prices are subject to change without prior notice.

# Aristotle® Executive Accessories

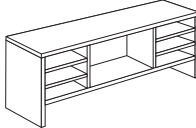
Paper Management

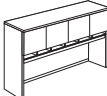
MODEL	W x D x H	MODEL NUMBER				Approx. Packaged Weight
		Basic Model	Edge Style	Horizontal Surface Finish	Vertical Surface Finish	
	60 x 16 x 22"	KSOH6022.E	<input type="checkbox"/>	<input type="checkbox"/>	<input type="checkbox"/>	105.0#
	66 x 16 x 22"	KSOH6622.E	<input type="checkbox"/>	<input type="checkbox"/>	<input type="checkbox"/>	112.0#
	72 x 16 x 22"	KSOH7222.E	<input type="checkbox"/>	<input type="checkbox"/>	<input type="checkbox"/>	120.0#
	78 x 16 x 22"	KSOH7822.E	<input type="checkbox"/>	<input type="checkbox"/>	<input type="checkbox"/>	129.0#
AEOVD						
	17 x 13-1/2 x 17-1/4"	KPOHD1713.H		<input type="checkbox"/>	<input type="checkbox"/>	30.0#
AROVD						
	17 x 13-1/2 x 17-1/4"	KPOHVD1713.H		<input type="checkbox"/>	<input type="checkbox"/>	31.0#
AROVD						
	22 x 13-1/2 x 5-1/4"	KOPS24.H			<input type="checkbox"/>	14.0#
	28 x 13-1/2 x 5-1/4"	KOPS30.H			<input type="checkbox"/>	17.0#
	34 x 13-1/2 x 5-1/4"	KOPS36.H			<input type="checkbox"/>	20.0#
	40 x 13-1/2 x 5-1/4"	KOPS42.H			<input type="checkbox"/>	23.0#
	46 x 13-1/2 x 5-1/4"	KOPS48.H			<input type="checkbox"/>	26.0#
	52 x 13-1/2 x 5-1/4"	KOPS54.H			<input type="checkbox"/>	29.0#
	58 x 13-1/2 x 5-1/4"	KOPS60.H			<input type="checkbox"/>	32.0#
	64 x 13-1/2 x 5-1/4"	KOPS66.H			<input type="checkbox"/>	35.0#
70 x 13-1/2 x 5-1/4"	KOPS72.H			<input type="checkbox"/>	38.0#	
76 x 13-1/2 x 5-1/4"	KOPS78.H			<input type="checkbox"/>	41.0#	

A

B

C

D

## HOW TO ORDER

Indicate the following information on order form:

- Quantity of each item.
- Model number, including options. See "How To Build a Model Number".
- Any special service required.

Note:

- The  indicates that a choice is required.
- The absence of the  indicates that no choice is required.
- Alpha-numeric characters in place of  indicate that no other alternatives are available.

## HOW TO BUILD A MODEL NUMBER

- A** Select basic model.
- B** Select edge style.
- |    |                           |
|----|---------------------------|
| F  | - Flat edge               |
| P3 | - Three wave profile edge |
| P4 | - Four wave profile edge  |
- C** Select horizontal surface finish.  
Refer to color addendum at ki.com or KI Fabrics & Finishes binder.
- D** Select vertical surface finish.  
Refer to color addendum at ki.com or KI Fabrics & Finishes binder.



Delivered  
Pricing

\$ 672  
700  
726  
757

\$ 234

\$ 234

\$ 353  
379  
404  
431  
456  
478  
508  
535  
560  
584

## SPECIAL SERVICES

### Special Carton Marking

With specially marked information N/C

### Shipping

Shipped **assembled freight prepaid f.o.b.**  
**KI-Aristotle Brampton, Ontario L6T 5T6**  
factory. Freight class #85.

Specifications and prices are subject to  
change without prior notice.

# Aristotle® Executive Accessories

## Tackboards

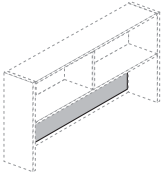
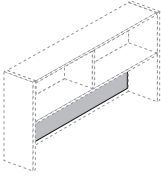
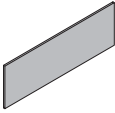
	MODEL	W x D x H	MODEL NUMBER		Approx. Packaged Weight
			Basic Model	Fabric Color	
 ARTAC	<b>Tackboard for 36" High Overhead</b> • Tackboards are attached to a horizontal load bar (supplied) with removable mounting brackets	30 x 3/4 x 17"	KTK30	<input type="checkbox"/> <input type="checkbox"/> <input type="checkbox"/> <input type="checkbox"/>	3.0#
		36 x 3/4 x 17"	KTK36	<input type="checkbox"/> <input type="checkbox"/> <input type="checkbox"/> <input type="checkbox"/>	4.0#
		42 x 3/4 x 17"	KTK42	<input type="checkbox"/> <input type="checkbox"/> <input type="checkbox"/> <input type="checkbox"/>	5.0#
		48 x 3/4 x 17"	KTK48	<input type="checkbox"/> <input type="checkbox"/> <input type="checkbox"/> <input type="checkbox"/>	6.0#
		54 x 3/4 x 17"	KTK54	<input type="checkbox"/> <input type="checkbox"/> <input type="checkbox"/> <input type="checkbox"/>	6.0#
		60 x 3/4 x 17"	KTK60	<input type="checkbox"/> <input type="checkbox"/> <input type="checkbox"/> <input type="checkbox"/>	8.0#
		66 x 3/4 x 17"	KTK66	<input type="checkbox"/> <input type="checkbox"/> <input type="checkbox"/> <input type="checkbox"/>	9.0#
		72 x 3/4 x 17"	KTK72	<input type="checkbox"/> <input type="checkbox"/> <input type="checkbox"/> <input type="checkbox"/>	10.0#
		78 x 3/4 x 17"	KTK78	<input type="checkbox"/> <input type="checkbox"/> <input type="checkbox"/> <input type="checkbox"/>	10.0#
 ARTAC	<b>Tackboard for 43" High Overhead</b> • Tackboards are attached to a horizontal load bar (supplied) with removable mounting brackets	30 x 3/4 x 24"	KTK3024	<input type="checkbox"/> <input type="checkbox"/> <input type="checkbox"/> <input type="checkbox"/>	3.0#
		36 x 3/4 x 24"	KTK3624	<input type="checkbox"/> <input type="checkbox"/> <input type="checkbox"/> <input type="checkbox"/>	4.0#
		42 x 3/4 x 24"	KTK4224	<input type="checkbox"/> <input type="checkbox"/> <input type="checkbox"/> <input type="checkbox"/>	5.0#
		48 x 3/4 x 24"	KTK4824	<input type="checkbox"/> <input type="checkbox"/> <input type="checkbox"/> <input type="checkbox"/>	6.0#
		54 x 3/4 x 24"	KTK5424	<input type="checkbox"/> <input type="checkbox"/> <input type="checkbox"/> <input type="checkbox"/>	6.0#
		60 x 3/4 x 24"	KTK6024	<input type="checkbox"/> <input type="checkbox"/> <input type="checkbox"/> <input type="checkbox"/>	8.0#
		66 x 3/4 x 24"	KTK6624	<input type="checkbox"/> <input type="checkbox"/> <input type="checkbox"/> <input type="checkbox"/>	9.0#
		72 x 3/4 x 24"	KTK7224	<input type="checkbox"/> <input type="checkbox"/> <input type="checkbox"/> <input type="checkbox"/>	10.0#
		78 x 3/4 x 24"	KTK7824	<input type="checkbox"/> <input type="checkbox"/> <input type="checkbox"/> <input type="checkbox"/>	10.0#
 ARTAC	<b>Wall-Mount Tackboards</b> • Tackboards are attached to a horizontal load bar (supplied) with removable mounting brackets	30 x 3/4 x 17"	KWMTK30	<input type="checkbox"/> <input type="checkbox"/> <input type="checkbox"/> <input type="checkbox"/>	3.0#
		36 x 3/4 x 17"	KWMTK36	<input type="checkbox"/> <input type="checkbox"/> <input type="checkbox"/> <input type="checkbox"/>	4.0#
		42 x 3/4 x 17"	KWMTK42	<input type="checkbox"/> <input type="checkbox"/> <input type="checkbox"/> <input type="checkbox"/>	5.0#
		54 x 3/4 x 17"	KWMTK54	<input type="checkbox"/> <input type="checkbox"/> <input type="checkbox"/> <input type="checkbox"/>	6.0#
		48 x 3/4 x 17"	KWMTK48	<input type="checkbox"/> <input type="checkbox"/> <input type="checkbox"/> <input type="checkbox"/>	6.0#
		60 x 3/4 x 17"	KWMTK60	<input type="checkbox"/> <input type="checkbox"/> <input type="checkbox"/> <input type="checkbox"/>	8.0#
		66 x 3/4 x 17"	KWMTK66	<input type="checkbox"/> <input type="checkbox"/> <input type="checkbox"/> <input type="checkbox"/>	9.0#
		72 x 3/4 x 17"	KWMTK72	<input type="checkbox"/> <input type="checkbox"/> <input type="checkbox"/> <input type="checkbox"/>	10.0#
		78 x 3/4 x 17"	KWMTK78	<input type="checkbox"/> <input type="checkbox"/> <input type="checkbox"/> <input type="checkbox"/>	10.0#
		30 x 3/4 x 24"	KWMTK3024	<input type="checkbox"/> <input type="checkbox"/> <input type="checkbox"/> <input type="checkbox"/>	3.0#
		36 x 3/4 x 24"	KWMTK3624	<input type="checkbox"/> <input type="checkbox"/> <input type="checkbox"/> <input type="checkbox"/>	4.0#
		42 x 3/4 x 24"	KWMTK4224	<input type="checkbox"/> <input type="checkbox"/> <input type="checkbox"/> <input type="checkbox"/>	5.0#
		48 x 3/4 x 24"	KWMTK4824	<input type="checkbox"/> <input type="checkbox"/> <input type="checkbox"/> <input type="checkbox"/>	6.0#
		54 x 3/4 x 24"	KWMTK5424	<input type="checkbox"/> <input type="checkbox"/> <input type="checkbox"/> <input type="checkbox"/>	6.0#
		60 x 3/4 x 24"	KWMTK6024	<input type="checkbox"/> <input type="checkbox"/> <input type="checkbox"/> <input type="checkbox"/>	8.0#
		66 x 3/4 x 24"	KWMTK6624	<input type="checkbox"/> <input type="checkbox"/> <input type="checkbox"/> <input type="checkbox"/>	9.0#
		72 x 3/4 x 24"	KWMTK7224	<input type="checkbox"/> <input type="checkbox"/> <input type="checkbox"/> <input type="checkbox"/>	10.0#
		78 x 3/4 x 24"	KWMTK7824	<input type="checkbox"/> <input type="checkbox"/> <input type="checkbox"/> <input type="checkbox"/>	10.0#

A

B

### HOW TO ORDER

Indicate the following information on order form:

- Quantity of each item.
- Model number, including options. See "How To Build a Model Number".
- Any special service required.

Note: • The  indicates that a choice is required.

- The absence of the  indicates that no choice is required.
- Alpha-numeric characters in place of  indicate that no other alternatives are available.

### HOW TO BUILD A MODEL NUMBER

**A** Select basic model.

**B** Select fabric color.

Refer to color addendum at [ki.com](http://ki.com) or in KI Fabrics & Finishes binder.



Delivered Pricing Fabric Grade 1 & C.O.M.	Delivered Pricing Fabric Grade 2	Delivered Pricing Fabric Grade 3 & Pallas Vertical Fabric Grade PV	Delivered Pricing Pallas Vertical Fabric Grade PV1	Delivered Pricing Pallas Vertical Fabric Grade PV2
\$ 134	\$ 140	\$ 142	\$ 151	\$ 164
151	161	161	170	181
167	173	174	184	201
181	191	192	204	219
196	207	211	227	242
232	240	242	259	280
237	250	251	268	286
245	256	258	276	295
247	262	267	286	306
\$ 181	\$ 193	\$ 197	\$ 210	\$ 225
206	218	222	239	255
227	240	245	262	280
246	262	267	285	305
267	283	288	309	331
314	334	340	364	389
321	341	348	372	398
333	353	361	385	412
343	364	371	397	424
\$ 139	\$ 148	\$ 148	\$ 161	\$ 170
158	165	165	174	190
172	179	180	194	208
207	219	224	240	256
187	198	198	211	226
234	245	247	261	282
239	251	252	270	289
248	259	260	278	298
250	266	271	289	310
188	200	204	218	234
215	228	233	248	266
234	247	252	270	289
255	271	276	296	316
275	291	298	318	341
317	336	343	367	392
324	344	351	375	402
338	357	365	390	418
350	371	378	405	434

**SPECIAL SERVICES**
**Special Carton Marking**

With specially marked information N/C

**Shipping**

Shipped k.d. freight prepaid f.o.b. Manitowoc, Wisconsin 54220 factory. Freight class #70.

Specifications and prices are subject to change without prior notice.

# Aristotle® Executive Accessories

## Tackboards

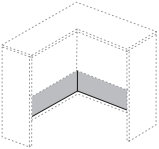
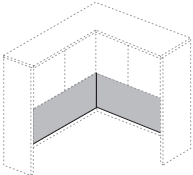
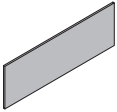
MODEL	W x D x H	MODEL NUMBER		Approx. Packaged Weight
		Basic Model	Fabric Color	
 <p><b>Tackboard for Corner Symmetrical 36" High Overhead</b></p> <ul style="list-style-type: none"> <li>Tackboards are attached to a horizontal load bar (supplied) with removable mounting brackets</li> </ul>	33 x 32-1/2 x 3/4 x 17"	KTKC3636	<input type="checkbox"/> <input type="checkbox"/> <input type="checkbox"/> <input type="checkbox"/>	4.0#
	39 x 38-1/2 x 3/4 x 17"	KTKC4242	<input type="checkbox"/> <input type="checkbox"/> <input type="checkbox"/> <input type="checkbox"/>	5.0#
	45 x 44-1/2 x 3/4 x 17"	KTKC4848	<input type="checkbox"/> <input type="checkbox"/> <input type="checkbox"/> <input type="checkbox"/>	6.0#
 <p><b>Tackboard for Corner Symmetrical 43" High Overhead</b></p> <ul style="list-style-type: none"> <li>Tackboards are attached to a horizontal load bar (supplied) with removable mounting brackets</li> </ul>	33 x 32-1/2 x 3/4 x 24"	KTKC363624	<input type="checkbox"/> <input type="checkbox"/> <input type="checkbox"/> <input type="checkbox"/>	4.0#
	39 x 38-1/2 x 3/4 x 24"	KTKC424224	<input type="checkbox"/> <input type="checkbox"/> <input type="checkbox"/> <input type="checkbox"/>	5.0#
	45 x 44-1/2 x 3/4 x 24"	KTKC484824	<input type="checkbox"/> <input type="checkbox"/> <input type="checkbox"/> <input type="checkbox"/>	6.0#
 <p><b>Tackboard for Gallery Reception Desk</b></p> <ul style="list-style-type: none"> <li>Tackboards are attached to a horizontal load bar (supplied) with removable mounting brackets</li> </ul>	66 x 3/4 x 13"	KTKG66	<input type="checkbox"/> <input type="checkbox"/> <input type="checkbox"/> <input type="checkbox"/>	9.0#
	72 x 3/4 x 13"	KTKG72	<input type="checkbox"/> <input type="checkbox"/> <input type="checkbox"/> <input type="checkbox"/>	10.0#

ARTAC

ARTAC

ARTAC

**A**

**B**

### HOW TO ORDER

Indicate the following information on order form:

- Quantity of each item.
- Model number, including options. See "How To Build a Model Number".
- Any special service required.

Note: • The  indicates that a choice is required.

- The absence of the  indicates that no choice is required.
- Alpha-numeric characters in place of  indicate that no other alternatives are available.

### HOW TO BUILD A MODEL NUMBER

- A** Select basic model.
- B** Select fabric color. Refer to color addendum at [ki.com](http://ki.com) or in KI Fabrics & Finishes binder.



Delivered Pricing Fabric Grade 1 & C.O.M.	Delivered Pricing Fabric Grade 2	Delivered Pricing Fabric Grade 3 & Pallas Vertical Fabric Grade PV	Delivered Pricing Pallas Vertical Fabric Grade PV1	Delivered Pricing Pallas Vertical Fabric Grade PV2
\$ 302	\$ 317	\$ 318	\$ 340	\$ 365
333	347	348	372	400
365	379	381	408	439
<hr/>				
\$ 410	\$ 434	\$ 443	\$ 474	\$ 507
453	480	489	524	560
496	525	537	574	614
<hr/>				
\$ 218	\$ 227	\$ 229	\$ 245	\$ 261
225	235	236	251	272

## SPECIAL SERVICES

### Special Carton Marking

With specially marked information N/C



### Shipping

Shipped k.d. freight prepaid f.o.b. Manitowoc, Wisconsin 54220 factory. Freight class #70.

Specifications and prices are subject to change without prior notice.

# Aristotle® Executive Accessories

## Connector Tops

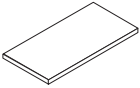
	MODEL	W x D x H	MODEL NUMBER			Approx. Packaged Weight
			Basic Model	Edge Style	Horizontal Surface Finish	
	<b>Desk Extension Table</b> • 1-1/2" top with choice of three edge styles • Woodgrain runs 45 degrees from straight edges • 30x30" metal X base standard	24 x 28 x 29"	KECT2424.E	<input type="checkbox"/>	<input type="checkbox"/>	50.0#
		30 x 35 x 29"	KECT3030.E	<input type="checkbox"/>	<input type="checkbox"/>	58.0#
AEFDT						
	<b>Half-Round Connector Top</b> • 1-1/2" top with choice of three edge styles • 3" black post leg standard • Woodgrain runs parallel to surface width	48 x 24 x 29"	KHRCT2424.E	<input type="checkbox"/>	<input type="checkbox"/>	50.0#
		54 x 27 x 29"	KHRCT2430.E	<input type="checkbox"/>	<input type="checkbox"/>	55.0#
		60 x 30 x 29"	KHRCT3030.E	<input type="checkbox"/>	<input type="checkbox"/>	60.0#
AEFDT						
	<b>Quarter-Round Connector Top</b> • 1-1/2" top with choice of three edge styles • Woodgrain runs parallel to one edge and 90 degrees to other	24 x 24 x 29"	KQRCT2424.E	<input type="checkbox"/>	<input type="checkbox"/>	30.0#
		24 x 30 x 29"	KQRCT2430.E	<input type="checkbox"/>	<input type="checkbox"/>	35.0#
		30 x 24 x 29"	KQRCT3024.E	<input type="checkbox"/>	<input type="checkbox"/>	35.0#
		30 x 30 x 29"	KQRCT3030.E	<input type="checkbox"/>	<input type="checkbox"/>	40.0#
AEFDT						
	<b>Connector Top</b> • 1-1/2" top with choice of three edge styles • Woodgrain runs parallel to surface width	24 x 24"	KBCT2424.E	<input type="checkbox"/>	<input type="checkbox"/>	25.0#
		24 x 30"	KBCT2430.E	<input type="checkbox"/>	<input type="checkbox"/>	30.0#
		30 x 24"	KBCT3024.E	<input type="checkbox"/>	<input type="checkbox"/>	30.0#
		30 x 30"	KBCT3030.E	<input type="checkbox"/>	<input type="checkbox"/>	35.0#
		36 x 24"	KBCT3624.E	<input type="checkbox"/>	<input type="checkbox"/>	35.0#
		36 x 30"	KBCT3630.E	<input type="checkbox"/>	<input type="checkbox"/>	40.0#
		42 x 24"	KBCT4224.E	<input type="checkbox"/>	<input type="checkbox"/>	40.0#
42 x 30"	KBCT4230.E	<input type="checkbox"/>	<input type="checkbox"/>	45.0#		

A

B

C

### HOW TO ORDER

Indicate the following information on order form:

- Quantity of each item.
- Model number, including options. See "How To Build a Model Number".
- Any special service required.

Note: • The  indicates that a choice is required.

- The absence of the  indicates that no choice is required.
- Alpha-numeric characters in place of  indicate that no other alternatives are available.

### HOW TO BUILD A MODEL NUMBER

**A** Select basic model.

**B** Select edge style.

F	- Flat edge
P3	- Three wave profile edge
P4	- Four wave profile edge

**C** Select horizontal surface finish.

Refer to color addendum at [ki.com](http://ki.com) or KI Fabrics & Finishes binder.





# Aristotle® Executive Accessories

Connector Tops

Delivered  
Pricing

\$ 943

980

\$ 608

705

810

\$ 354

465

465

524

\$ 308

319

319

338

338

354

354

369

## SPECIAL SERVICES

### Special Carton Marking

With specially marked information N/C

### Shipping

Shipped k.d. freight prepaid f.o.b.  
KI-Aristotle Brampton, Ontario L6T 5T6  
factory. Freight class #85.

Specifications and prices are subject to  
change without prior notice.

# Aristotle® Executive

## Slimline Metal Leg Set

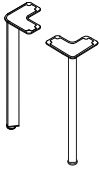
	MODEL	H	MODEL NUMBER		Approx. Packaged Weight	
			Basic Model	Leg Finish		
 <p>HRDPT</p>	<b>Slimline Metal Leg Set</b> <ul style="list-style-type: none"> <li>Black (BL) or Starlight Silver (SX)</li> <li>Set of two metal legs</li> <li>Specify one set of two legs for use with returns: specify two sets of two legs for use with table and desk worksurfaces</li> <li>Metal legs feature integrated wire management slot and adjustable glide</li> </ul>	28"	ARISLEGSET	<input type="checkbox"/> <input type="checkbox"/>	10.0#	

**A**

**B**

### HOW TO ORDER

Indicate the following information on order form:

- Quantity of each item.
- Model number, including options. See "How To Build a Model Number".
- Any special service required.

- Note:
- The  indicates that a choice is required.
  - The absence of the  indicates that no choice is required.
  - Alpha-numeric characters in place of  indicate that no other alternatives are available.

### HOW TO BUILD A MODEL NUMBER

- A** Select basic model.
- B** Select leg finish. Refer to color addendum at [ki.com](http://ki.com) or KI Fabrics & Finishes binder.



# Aristotle® Executive

Slimline Metal Leg Set

Delivered  
Pricing  
\$ 200

## SPECIAL SERVICES

### Special Carton Marking

With specially marked information N/C

### Shipping

Shipped **k.d. freight prepaid f.o.b.**  
**Bondel, Wisconsin 54107** factory. Freight  
class #85.

Specifications and prices are subject to  
change without prior notice.

# Aristotle® Executive

Table/Desk Worksurfaces

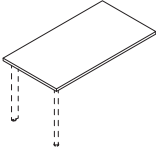
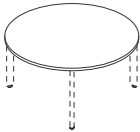
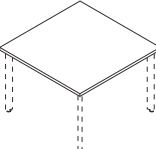
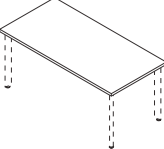
	MODEL	W x D	MODEL NUMBER			Approx. Packaged Weight
			Basic Model	Edge Style	Horizontal Surface Finish	
	<b>Return Worksurface</b> • Worksurface only • Does not accept modesty panel or end panel inserts, and is not retrofittable to accept the inserts at a later time • Specify slimline legs separately; requires one set of two legs	24 X 42"	KRWL42242LTO.E	<input type="checkbox"/>	<input type="checkbox"/>	35.0#
		24 X 48"	KRWL48242LTO.E	<input type="checkbox"/>	<input type="checkbox"/>	45.0#
		24 X 60"	KRWL60242LTO.E	<input type="checkbox"/>	<input type="checkbox"/>	65.0#
AECT						
	<b>Meeting Table Round Worksurface</b> • Worksurface only • 1-1/2" thick top • 30" and 36" tops accommodate 3 people, 42" accommodates 4 people, 48" accommodates 5 people • Specify slimline legs separately; requires 2 sets of legs, 4 legs total	30" dia	KRD304LTO.E	<input type="checkbox"/>	<input type="checkbox"/>	45.0#
		36" dia	KRD364LTO.E	<input type="checkbox"/>	<input type="checkbox"/>	55.0#
		42" dia	KRD424LTO.E	<input type="checkbox"/>	<input type="checkbox"/>	65.0#
		48" dia	KRD484LTO.E	<input type="checkbox"/>	<input type="checkbox"/>	75.0#
AECT						
	<b>Meeting Table Square Worksurface</b> • Worksurface only • 1-1/2" thick top • Worksurface accommodates 4 people • Specify slimline legs separately; requires 2 sets of legs, 4 legs total	30 x 30"	KSQ304LTO.E	<input type="checkbox"/>	<input type="checkbox"/>	45.0#
		36 x 36"	KSQ364LTO.E	<input type="checkbox"/>	<input type="checkbox"/>	55.0#
		42 x 42"	KSQ424LTO.E	<input type="checkbox"/>	<input type="checkbox"/>	65.0#
		48 x 48"	KSQ484LTO.E	<input type="checkbox"/>	<input type="checkbox"/>	75.0#
AECT						
	<b>Meeting Table Rectangular Worksurface</b> • Worksurface only • 1-1/2" thick top • Specify slimline legs separately; requires 2 sets of legs, 4 legs total	42 x 18"	KWSR42184LTO.E	<input type="checkbox"/>	<input type="checkbox"/>	26.0#
		48 x 24"	KWSR48244LTO.E	<input type="checkbox"/>	<input type="checkbox"/>	36.0#
		60 x 24"	KWSR60244LTO.E	<input type="checkbox"/>	<input type="checkbox"/>	40.0#
		60 x 30"	KWSR60304LTO.E	<input type="checkbox"/>	<input type="checkbox"/>	50.0#
		72 x 30"	KWSR72304LTO.E	<input type="checkbox"/>	<input type="checkbox"/>	58.0#
AECT						

A

B

C

## HOW TO ORDER

Indicate the following information on order form:

- Quantity of each item.
- Model number, including options. See "How To Build a Model Number".
- Any special service required.

Note: • The  indicates that a choice is required.  
 • The absence of the  indicates that no choice is required.  
 • Alpha-numeric characters in place of  indicate that no other alternatives are available.

## HOW TO BUILD A MODEL NUMBER

**A** Select basic model.

**B** Select edge style.

F	- Flat edge
P3	- Three wave profile edge
P4	- Four wave profile edge

**C** Select horizontal surface finish.

Refer to color addendum at [ki.com](http://ki.com) or KI Fabrics & Finishes binder.

 Delivered  
 Pricing

 \$ 455  
 464  
 483

 \$ 877  
 907  
 1008  
 1064

 \$ 838  
 869  
 971  
 1140

 \$ 801  
 806  
 871  
 933  
 973

**SPECIAL SERVICES**
**Special Carton Marking**

With specially marked information N/C



**Shipping**

 Shipped k.d. freight prepaid f.o.b.  
 KI-Aristotle Brampton, Ontario L6T 5T6  
 factory. Freight class #85.

 Specifications and prices are subject to  
 change without prior notice.

# Aristotle® Executive Accessories

Grommet, Wire Management Channel, Keyed Alike Kits

			MODEL NUMBER		Approx. Packaged Weight
MODEL	Features	W x D	Basic Model		
 HRDPT	<b>Grommet</b> • 2-3/4" diameter • Field installed • Requires 2-3/4" diameter hole • Black finish	2-3/4 x 2-3/4"	KGR	1.0#	
 HRDPT	<b>Wire Management Channel</b> • Attaches to back panel • Field installed • 12" J-channel • Conceals wires beneath desktop	12"	KWMC	1.0#	
HRDPT	<b>Keyed Alike Kits</b> • Provides single key workstation access • Field installed • Units can be quickly and easily re-keyed using a lock core removal key (included with kit) • Determine correct number of keyed alike locks required per office by referring to product illustrations (Note: some units have multiple locks)	1 lock	KKAK.1	1.0#	
		2 locks	KKAK.2	1.0#	
		3 locks	KKAK.3	1.0#	
		4 locks	KKAK.4	1.0#	
		5 locks	KKAK.5	1.0#	
		6 locks	KKAK.6	1.0#	

**A**

## HOW TO ORDER

Indicate the following information on order form:

1. Quantity of each item.
2. Model number, including options. See "How To Build a Model Number".
3. Any special service required.

- Note:
- The  indicates that a choice is required.
  - The absence of the  indicates that no choice is required.
  - Alpha-numeric characters in place of  indicate that no other alternatives are available.

## HOW TO BUILD A MODEL NUMBER

- A** Select basic model.



# Aristotle® Executive Accessories

Grommet, Wire Management Channel, Keyed Alike Kits

Delivered  
Pricing

\$ 4

\$ 4

\$ 11

29

41

55

70

83

## SPECIAL SERVICES

### Special Carton Marking

With specially marked information N/C

### Shipping

Shipped k.d. freight prepaid f.o.b.  
KI-Aristotle Brampton, Ontario L6T 5T6  
factory. Freight class #85.

Specifications and prices are subject to  
change without prior notice.

# Aristotle® Executive Accessories

## Task Lights

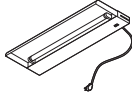
	MODEL	W x D	MODEL NUMBER	Approx. Packaged Weight
			Basic Model	
	<b>Universal Overhead Task Lights</b> • Task lights mount under overhead cabinets	24"	TLT5.24	3.9#
		36"	TLT5.36	5.3#
		48"	TLT5.48	6.7#

HRDPT

**A**

### HOW TO ORDER

Indicate the following information on order form:

1. Quantity of each item.
2. Model number, including options. See "How To Build a Model Number".
3. Any special service required.

- Note:
- The  indicates that a choice is required.
  - The absence of the  indicates that no choice is required.
  - Alpha-numeric characters in place of  indicate that no other alternatives are available.

### HOW TO BUILD A MODEL NUMBER

- A** Select basic model.





# Aristotle® Executive Accessories

Task Lights

Delivered  
Pricing

\$ 76  
83  
91

## SPECIAL SERVICES

### Special Carton Marking

With specially marked information N/C

### Shipping

Shipped k.d. freight prepaid f.o.b. Manitowoc, Wisconsin 54220 factory. Freight class #70.

Specifications and prices are subject to change without prior notice.

# Aristotle® Executive

Conference Room Furniture

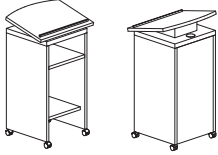
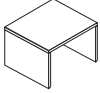
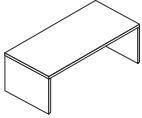
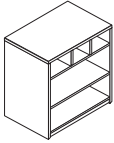
	MODEL	W x D x H	MODEL NUMBER				Approx. Packaged Weight
			Basic Model	Edge Style	Horizontal Surface Finish	Vertical Surface Finish	
	<b>Lectern</b> • Features two interior shelves • Grommet included • Locking casters • Ships assembled	18 x 18 x 44-1/2"	KLT1818.E	<input type="checkbox"/>	<input type="checkbox"/>	<input type="checkbox"/>	85.0#
AEACC							
	<b>End table</b> • Full width center support • Ships K.D.	24 x 24 x 18-1/2"	KET2424.E	<input type="checkbox"/>	<input type="checkbox"/>	<input type="checkbox"/>	40.0#
		30 x 30 x 18-1/2"	KET3030.E	<input type="checkbox"/>	<input type="checkbox"/>	<input type="checkbox"/>	50.0#
AEACC							
	<b>Coffee Table</b> • Full width center support • Ships K.D.	42 x 20 x 16-1/2"	KCT4220.E	<input type="checkbox"/>	<input type="checkbox"/>	<input type="checkbox"/>	50.0#
		48 x 24 x 16-1/2"	KCT4824.E	<input type="checkbox"/>	<input type="checkbox"/>	<input type="checkbox"/>	55.0#
AEACC							
	<b>Printer Table</b> • Three 8-1/2 x 2-3/4" high paper sorter cubbies • One pullout shelf with paper access • 12" upper and 8" lower shelf clearance • Rear cable management grommets • Ships assembled	30 x 24 x 29-1/2"	KPT3024.E	<input type="checkbox"/>	<input type="checkbox"/>	<input type="checkbox"/>	100.0#
		36 x 24 x 29-1/2"	KPT3624.E	<input type="checkbox"/>	<input type="checkbox"/>	<input type="checkbox"/>	110.0#
AEACC							
				<b>A</b>	<b>B</b>	<b>C</b>	<b>D</b>

## HOW TO ORDER

Indicate the following information on order form:

- Quantity of each item.
- Model number, including options. See "How To Build a Model Number".
- Any special service required.

Note: • The  indicates that a choice is required.

- The absence of the  indicates that no choice is required.
- Alpha-numeric characters in place of  indicate that no other alternatives are available.

## HOW TO BUILD A MODEL NUMBER

- A** Select basic model.
- B** Select edge style.
- |           |                           |
|-----------|---------------------------|
| <b>F</b>  | - Flat edge               |
| <b>P3</b> | - Three wave profile edge |
| <b>P4</b> | - Four wave profile edge  |
- C** Select horizontal surface finish.  
Refer to color addendum at [ki.com](http://ki.com) or KI Fabrics & Finishes binder.
- D** Select vertical surface finish.  
Refer to color addendum at [ki.com](http://ki.com) or KI Fabrics & Finishes binder.



Delivered  
Pricing

\$ 704

\$ 338

394

\$ 411

436

\$ 631

708

#### SPECIAL SERVICES

##### Special Carton Marking

With specially marked information N/C

##### Shipping

Unless noted, Shipped **assembled freight prepaid f.o.b. KI-Aristotle Brampton, Ontario L6T 5T6** factory. Freight class #85.

Specifications and prices are subject to change without prior notice.

# Aristotle® Executive

Conference Room Furniture

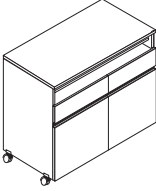
	MODEL	W x D x H	MODEL NUMBER					Approx. Packaged Weight
			Basic Model	Edge Style	Horizontal Surface Finish	Vertical Surface Finish	Pull Option	
 <p>AEACC</p>	<b>Single Service Cart</b> • Integral pull is standard; use xxx2 for optional pulls • Upper pull-out shelf • One box drawer • Storage cabinet features adjustable shelf • Non-locking • Ships assembled	19 x 21 x 36-1/2"	KSS1921.E	<input type="checkbox"/> <input type="checkbox"/>	<input type="checkbox"/> <input type="checkbox"/> <input type="checkbox"/>	<input type="checkbox"/> <input type="checkbox"/> <input type="checkbox"/>	<input type="checkbox"/> <input type="checkbox"/> <input type="checkbox"/> <input type="checkbox"/>	85.0#
 <p>AEACC</p>	<b>Double Service Cart</b> • Integral pull is standard; use xxx4 for optional pulls • Upper pull-out shelf • Two box drawers • Adjustable storage cabinet shelves • Non-locking • Ships assembled	32 x 21 x 36-1/2"	KSS3221.E	<input type="checkbox"/> <input type="checkbox"/>	<input type="checkbox"/> <input type="checkbox"/> <input type="checkbox"/>	<input type="checkbox"/> <input type="checkbox"/> <input type="checkbox"/>	<input type="checkbox"/> <input type="checkbox"/> <input type="checkbox"/> <input type="checkbox"/>	120.0#

**A**   **B**   **C**   **D**   **E**

## HOW TO ORDER

Indicate the following information on order form:

- Quantity of each item.
- Model number, including options. See "How To Build a Model Number".
- Any special service required.

Note: • The  indicates that a choice is required.  
 • The absence of the  indicates that no choice is required.  
 • Alpha-numeric characters in place of  indicate that no other alternatives are available.

## HOW TO BUILD A MODEL NUMBER

- A** Select basic model.
- B** Select edge style.
 

<b>F</b>	- Flat edge
<b>P3</b>	- Three wave profile edge
<b>P4</b>	- Four wave profile edge
- C** Select horizontal surface finish.  
Refer to color addendum at ki.com or KI Fabrics & Finishes binder.
- D** Select vertical surface finish.  
Refer to color addendum at ki.com or KI Fabrics & Finishes binder.
- E** Select pull option.
 

<b>BPA2</b>	- Silver bar pull (2)
<b>BPA4</b>	- Silver bar pull (4)
<b>KIB2</b>	- Waterfall black pull (2)
<b>KIB4</b>	- Waterfall black pull (4)
<b>KIS2</b>	- Waterfall silver pull (2)
<b>KIS4</b>	- Waterfall silver pull (4)
<b>RCP2</b>	- Rectangular silver pull (2)
<b>RCP4</b>	- Rectangular silver pull (4)



Delivered  
Pricing

\$ 894

\$ 1503

**SPECIAL SERVICES**

**Special Carton Marking**

With specially marked information N/C

**Shipping**

Shipped **assembled freight prepaid f.o.b. KI-Aristotle Brampton, Ontario L6T 5T6** factory. Freight class #85.

Specifications and prices are subject to change without prior notice.

# Aristotle® Executive

Conference Room Furniture

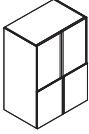
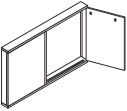
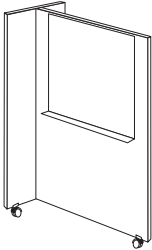
	MODEL	W x D x H	MODEL NUMBER					Approx. Packaged Weight
			Basic Model	Edge Style	Horizontal Surface Finish	Vertical Surface Finish	Pull Option	
 <p>AEACC</p>	<b>Audiovisual Cabinet</b> <ul style="list-style-type: none"> <li>1-1/2" top with choice of 3 edge styles</li> <li>Use xxx4 for pulls</li> <li>Upper doors retract inside cabinet</li> <li>Pull-out turntable for TV-29" high</li> <li>Upper VCR shelf-5" high</li> <li>Lower box drawer for media storage</li> <li>Lower right section with two adjustable shelves</li> <li>Cable management grommets in back</li> <li>Non-locking</li> <li>Ships assembled</li> </ul>	36 x 25 x 65-1/2"	KAV3625.E	<input type="checkbox"/> <input type="checkbox"/>	<input type="checkbox"/> <input type="checkbox"/> <input type="checkbox"/>	<input type="checkbox"/> <input type="checkbox"/> <input type="checkbox"/>	<input type="checkbox"/> <input type="checkbox"/> <input type="checkbox"/> <input type="checkbox"/>	260.0#
 <p>AEACC</p>	<b>Marker Board</b> <ul style="list-style-type: none"> <li>1-1/2" top with choice of 3 edge styles</li> <li>Use xxx2 for pulls</li> <li>Whiteboard for dry-erase markers</li> <li>Ledge for eraser and marker storage</li> <li>Left door-tackable corkboard</li> <li>Right door-flipchart pegs (on 17-1/2" centers)</li> <li>Two-piece cleat wall-mount system</li> <li>Ships assembled</li> </ul>	50 x 5 x 40-1/2"	KMB5040.E	<input type="checkbox"/> <input type="checkbox"/>	<input type="checkbox"/> <input type="checkbox"/> <input type="checkbox"/>	<input type="checkbox"/> <input type="checkbox"/> <input type="checkbox"/>	<input type="checkbox"/> <input type="checkbox"/> <input type="checkbox"/> <input type="checkbox"/>	140.0#
 <p>ARACC</p>	<b>Mobile White Board Divider</b> <ul style="list-style-type: none"> <li>Marker tray standard</li> <li>36 x 36" markerboard</li> <li>Ships K.D.</li> </ul>	48 x 28 x 72"	KMWD4872.H			<input type="checkbox"/> <input type="checkbox"/> <input type="checkbox"/>		120.0#
				<b>A</b>	<b>B</b>	<b>C</b>	<b>D</b>	<b>E</b>

## HOW TO ORDER

Indicate the following information on order form:

- Quantity of each item.
- Model number, including options. See "How To Build a Model Number".
- Any special service required.

Note:

- The  indicates that a choice is required.
- The absence of the  indicates that no choice is required.
- Alpha-numeric characters in place of  indicate that no other alternatives are available.

## HOW TO BUILD A MODEL NUMBER

- A** Select basic model.
- B** Select edge style.
- |    |                           |
|----|---------------------------|
| F  | - Flat edge               |
| P3 | - Three wave profile edge |
| P4 | - Four wave profile edge  |
- C** Select horizontal surface finish.  
Refer to color addendum at ki.com or KI Fabrics & Finishes binder.
- D** Select vertical surface finish.  
Refer to color addendum at ki.com or KI Fabrics & Finishes binder.
- E** Select pull option.
- |      |                               |
|------|-------------------------------|
| BPA2 | - Silver bar pull (2)         |
| BPA4 | - Silver bar pull (4)         |
| KIB2 | - Waterfall black pull (2)    |
| KIB4 | - Waterfall black pull (4)    |
| KIS2 | - Waterfall silver pull (2)   |
| KIS4 | - Waterfall silver pull (4)   |
| RCP2 | - Rectangular silver pull (2) |
| RCP4 | - Rectangular silver pull (4) |



Delivered  
Pricing  
\$ 3048

\$ 1375

\$ 1011

#### SPECIAL SERVICES

##### Special Carton Marking

With specially marked information N/C

##### Shipping

Unless noted, Shipped **assembled freight prepaid f.o.b. KI-Aristotle Brampton, Ontario L6T 5T6** factory. Freight class #85.

Specifications and prices are subject to change without prior notice.

# Aristotle® Executive

Conference Room Furniture

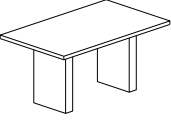
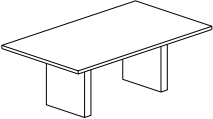
	MODEL	W x D x H	MODEL NUMBER					Approx. Packaged Weight
			Basic Model	Edge Style	Horizontal Surface Finish	Vertical Surface Finish	Power Station	
 <p>AECT</p>	<b>Rectangular Conference Table-18" Base</b>	60 x 36 x 29-1/2"	KRC6036182B.E	<input type="checkbox"/>	<input type="checkbox"/>	<input type="checkbox"/>	<input type="checkbox"/>	161.0#
	• Features two 4 x 18" rectangular bases with access doors and one rectangular single-piece top	66 x 36 x 29-1/2"	KRC6636182B.E	<input type="checkbox"/>	<input type="checkbox"/>	<input type="checkbox"/>	<input type="checkbox"/>	170.0#
	• Right hinged door on base provides cable access. Magnetic touch latch	72 x 36 x 29-1/2"	KRC7236182B.E	<input type="checkbox"/>	<input type="checkbox"/>	<input type="checkbox"/>	<input type="checkbox"/>	185.0#
	• Power Station, if specified, is centered on top (specify PS1)	84 x 36 x 29-1/2"	KRC8436182B.E	<input type="checkbox"/>	<input type="checkbox"/>	<input type="checkbox"/>	<input type="checkbox"/>	195.0#
	• Each power station features three grounded outlets, two jacks (RJ45/RJ11) and a 10-foot power cord. Hole diameter is 4-1/4"	96 x 36 x 29-1/2"	KRC9636182B.E	<input type="checkbox"/>	<input type="checkbox"/>	<input type="checkbox"/>	<input type="checkbox"/>	206.0#
• Ships K.D.								
 <p>AECT</p>	<b>Rectangular Conference Table-24" Base</b>	84 x 42 x 29-1/2"	KRC8442242B.E	<input type="checkbox"/>	<input type="checkbox"/>	<input type="checkbox"/>	<input type="checkbox"/>	233.0#
	• Features two 4 x 24" rectangular bases with access doors and one rectangular single-piece top	96 x 42 x 29-1/2"	KRC9642242B.E	<input type="checkbox"/>	<input type="checkbox"/>	<input type="checkbox"/>	<input type="checkbox"/>	249.0#
	• Right hinged door on base provides cable access. Magnetic touch latch	84 x 48 x 29-1/2"	KRC8448242B.E	<input type="checkbox"/>	<input type="checkbox"/>	<input type="checkbox"/>	<input type="checkbox"/>	243.0#
	• Power Station, if specified, is centered on top (specify PS1)	96 x 48 x 29-1/2"	KRC9648242B.E	<input type="checkbox"/>	<input type="checkbox"/>	<input type="checkbox"/>	<input type="checkbox"/>	259.0#
	• Each power station features three grounded outlets, two jacks (RJ45/RJ11) and a 10-foot power cord. Hole diameter is 4-1/4"							
• Ships K.D.								

A

B

C

D

E

## HOW TO ORDER

Indicate the following information on order form:

- Quantity of each item.
- Model number, including options. See "How To Build a Model Number".
- Any special service required.

Note: • The  indicates that a choice is required.  
 • The absence of the  indicates that no choice is required.  
 • Alpha-numeric characters in place of  indicate that no other alternatives are available.

## HOW TO BUILD A MODEL NUMBER

**A** Select basic model.

**B** Select edge style.

F	- Flat edge
P3	- Three wave profile edge
P4	- Four wave profile edge

**C** Select horizontal surface finish.

Refer to color addendum at [ki.com](http://ki.com) or KI Fabrics & Finishes binder.

**D** Select vertical surface finish.

Refer to color addendum at [ki.com](http://ki.com) or KI Fabrics & Finishes binder.

**E** Select power station.

PS0	- No Power Station
PS1	- One Power Station (for single-piece tops); add \$190





Delivered  
Pricing

\$ 1044  
1062  
1078  
1169  
1297

\$ 1196  
1320  
1416  
1542

**SPECIAL SERVICES**

**Special Carton Marking**

With specially marked information N/C

**Shipping**

Shipped k.d. freight prepaid f.o.b.  
KI-Aristotle Brampton, Ontario L6T 5T6  
factory. Freight class #85.

Specifications and prices are subject to  
change without prior notice.

# Aristotle® Executive

Conference Room Furniture

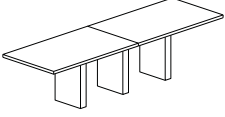
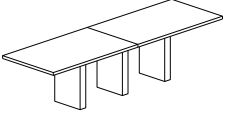
		MODEL NUMBER					Approx. Packaged Weight	
MODEL	W x D x H	Basic Model	Edge Style	Horizontal Surface Finish	Vertical Surface Finish	Power Station		
 <p>AECT</p>	<b>Rectangular Conference Table w/Two Piece Top</b>	120 x 36 x 29-1/2"	KRC12036183B.E	<input type="checkbox"/>	<input type="checkbox"/>	<input type="checkbox"/>	<input type="checkbox"/>	293.0#
	<ul style="list-style-type: none"> <li>Features three 4 x 18" rectangular bases with access doors and one two-piece rectangular top</li> <li>Top sections are not grain-matched</li> <li>Right hinged door on base provides cable access. Magnetic touch latch</li> <li>Power Stations, if specified, are centered on each top section (specify PS2)</li> <li>Each power station features three grounded outlets, two jacks (RJ45/RJ11) and a 10-foot power cord. Hole diameter is 4-1/4"</li> <li>Ships K.D.</li> </ul>	144 x 36 x 29-1/2"	KRC14436183B.E	<input type="checkbox"/>	<input type="checkbox"/>	<input type="checkbox"/>	<input type="checkbox"/>	328.0#
 <p>AECT</p>	<b>Rectangular Conference Table w/Two Piece Top</b>	120 x 48 x 29-1/2"	KRC12048243B.E	<input type="checkbox"/>	<input type="checkbox"/>	<input type="checkbox"/>	<input type="checkbox"/>	368.0#
	<ul style="list-style-type: none"> <li>Features three 4 x 24" rectangular bases with access doors and one two-piece rectangular top</li> <li>Top sections are not grain-matched</li> <li>Right hinged door on base provides cable access. Magnetic touch latch</li> <li>Power Stations, if specified, are centered on each top section (specify PS2)</li> <li>Each power station features three grounded outlets, two jacks (RJ45/RJ11) and a 10-foot power cord. Hole diameter is 4-1/4"</li> <li>Ships K.D.</li> </ul>	144 x 48 x 29-1/2"	KRC14448243B.E	<input type="checkbox"/>	<input type="checkbox"/>	<input type="checkbox"/>	<input type="checkbox"/>	411.0#
		168 x 48 x 29-1/2"	KRC16848243B.E	<input type="checkbox"/>	<input type="checkbox"/>	<input type="checkbox"/>	<input type="checkbox"/>	436.0#
		192 x 48 x 29-1/2"	KRC19248243B.E	<input type="checkbox"/>	<input type="checkbox"/>	<input type="checkbox"/>	<input type="checkbox"/>	468.0#
				<b>A</b>	<b>B</b>	<b>C</b>	<b>D</b>	<b>E</b>

### HOW TO ORDER

Indicate the following information on order form:

- Quantity of each item.
- Model number, including options. See "How To Build a Model Number".
- Any special service required.

Note:

- The  indicates that a choice is required.
- The absence of the  indicates that no choice is required.
- Alpha-numeric characters in place of  indicate that no other alternatives are available.

### HOW TO BUILD A MODEL NUMBER

- A** Select basic model.
- B** Select edge style.
 

<b>F</b>	- Flat edge
<b>P3</b>	- Three wave profile edge
<b>P4</b>	- Four wave profile edge
- C** Select horizontal surface finish. Refer to color addendum at ki.com or KI Fabrics & Finishes binder.
- D** Select vertical surface finish. Refer to color addendum at ki.com or KI Fabrics & Finishes binder.
- E** Select power station.
 

<b>PS0</b>	- No Power Station
<b>PS2</b>	- Two Power Stations (for two-piece tops); add \$380



Delivered  
Pricing

\$ 1732  
1758

\$ 2083  
2197  
2547  
2767

#### SPECIAL SERVICES

##### Special Carton Marking

With specially marked information N/C

##### Shipping

Shipped k.d. freight prepaid f.o.b.  
KI-Aristotle Brampton, Ontario L6T 5T6  
factory. Freight class #85.

Specifications and prices are subject to  
change without prior notice.

# Aristotle® Executive

Conference Room Furniture

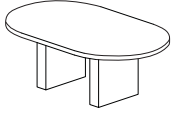
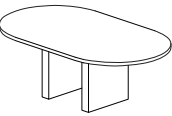
MODEL	W x D x H	MODEL NUMBER					Approx. Packaged Weight
		Basic Model	Edge Style	Horizontal Surface Finish	Vertical Surface Finish	Power Station	
 <p>AECT</p> <p><b>Racetrack Conference Table</b></p> <ul style="list-style-type: none"> <li>• Features two 4 x 18" rectangular bases with access doors and one racetrack single-piece top</li> <li>• Right hinged door on base provides cable access. Magnetic touch latch</li> <li>• Power Station, if specified, is centered on top (specify PS1)</li> <li>• Each power station features three grounded outlets, two jacks (RJ45/RJ11) and a 10-foot power cord. Hole diameter is 4-1/4"</li> <li>• Ships K.D.</li> </ul>	60 x 36 x 29-1/2"	KRT6036182B.E	<input type="checkbox"/>	<input type="checkbox"/>	<input type="checkbox"/>	<input type="checkbox"/>	159.0#
	66 x 36 x 29-1/2"	KRT6636182B.E	<input type="checkbox"/>	<input type="checkbox"/>	<input type="checkbox"/>	<input type="checkbox"/>	168.0#
	72 x 36 x 29-1/2"	KRT7236182B.E	<input type="checkbox"/>	<input type="checkbox"/>	<input type="checkbox"/>	<input type="checkbox"/>	183.0#
	84 x 36 x 29-1/2"	KRT8436182B.E	<input type="checkbox"/>	<input type="checkbox"/>	<input type="checkbox"/>	<input type="checkbox"/>	193.0#
	96 x 36 x 29-1/2"	KRT9636182B.E	<input type="checkbox"/>	<input type="checkbox"/>	<input type="checkbox"/>	<input type="checkbox"/>	204.0#
 <p>AECT</p> <p><b>Racetrack Conference Table</b></p> <ul style="list-style-type: none"> <li>• Features two 4 x 24" rectangular bases with access doors and one racetrack single-piece top</li> <li>• Right hinged door on base provides cable access. Magnetic touch latch</li> <li>• Power Station, if specified, is centered on top (specify PS1)</li> <li>• Each power station features three grounded outlets, two jacks (RJ45/RJ11) and a 10-foot power cord. Hole diameter is 4-1/4"</li> <li>• Ships K.D.</li> </ul>	84 x 42 x 29-1/2"	KRT8442242B.E	<input type="checkbox"/>	<input type="checkbox"/>	<input type="checkbox"/>	<input type="checkbox"/>	231.0#
	96 x 42 x 29-1/2"	KRT9642242B.E	<input type="checkbox"/>	<input type="checkbox"/>	<input type="checkbox"/>	<input type="checkbox"/>	247.0#
	84 x 48 x 29-1/2"	KRT8448242B.E	<input type="checkbox"/>	<input type="checkbox"/>	<input type="checkbox"/>	<input type="checkbox"/>	241.0#
	96 x 48 x 29-1/2"	KRT9648242B.E	<input type="checkbox"/>	<input type="checkbox"/>	<input type="checkbox"/>	<input type="checkbox"/>	257.0#
			<b>A</b>	<b>B</b>	<b>C</b>	<b>D</b>	<b>E</b>

## HOW TO ORDER

Indicate the following information on order form:

1. Quantity of each item.
2. Model number, including options. See "How To Build a Model Number".
3. Any special service required.

Note:

- The  indicates that a choice is required.
- The absence of the  indicates that no choice is required.
- Alpha-numeric characters in place of  indicate that no other alternatives are available.

## HOW TO BUILD A MODEL NUMBER

- A** Select basic model.
- B** Select edge style.
 

F	- Flat edge
P3	- Three wave profile edge
P4	- Four wave profile edge
- C** Select horizontal surface finish. Refer to color addendum at ki.com or KI Fabrics & Finishes binder.
- D** Select vertical surface finish. Refer to color addendum at ki.com or KI Fabrics & Finishes binder.
- E** Select power station.
 

PS0	- No Power Station
PS1	- One Power Station (for single-piece tops); add \$190



Delivered  
Pricing

\$ 1159  
1176  
1193  
1265  
1373

\$ 1253  
1361  
1510  
1617

**SPECIAL SERVICES**

**Special Carton Marking**

With specially marked information    N/C

**Shipping**

Shipped **k.d. freight prepaid f.o.b.**  
**KI-Aristotle Brampton, Ontario L6T 5T6**  
factory. Freight class #85.

Specifications and prices are subject to  
change without prior notice.

# Aristotle® Executive

Conference Room Furniture

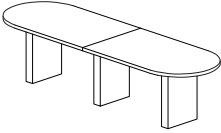
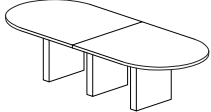
MODEL	W x D x H	MODEL NUMBER					Approx. Packaged Weight
		Basic Model	Edge Style	Horizontal Surface Finish	Vertical Surface Finish	Power Station	
 <p>AECT</p>	120 x 36 x 29-1/2"	KRT12036183B.E	<input type="checkbox"/>	<input type="checkbox"/>	<input type="checkbox"/>	<input type="checkbox"/>	291.0#
	144 x 36 x 29-1/2"	KRT14436183B.E	<input type="checkbox"/>	<input type="checkbox"/>	<input type="checkbox"/>	<input type="checkbox"/>	326.0#
 <p>AECT</p>	120 x 48 x 29-1/2"	KRT12048243B.E	<input type="checkbox"/>	<input type="checkbox"/>	<input type="checkbox"/>	<input type="checkbox"/>	366.0#
	144 x 48 x 29-1/2"	KRT14448243B.E	<input type="checkbox"/>	<input type="checkbox"/>	<input type="checkbox"/>	<input type="checkbox"/>	409.0#
	168 x 48 x 29-1/2"	KRT16848243B.E	<input type="checkbox"/>	<input type="checkbox"/>	<input type="checkbox"/>	<input type="checkbox"/>	434.0#
	192 x 48 x 29-1/2"	KRT19248243B.E	<input type="checkbox"/>	<input type="checkbox"/>	<input type="checkbox"/>	<input type="checkbox"/>	466.0#

- Racetrack Conference Table w/Two Piece Top**
- Features three 4 x 18" rectangular bases with access doors and one two-piece racetrack top
  - Top sections are not grain-matched
  - Right hinged door on base provides cable access. Magnetic touch latch
  - Power Stations, if specified, are centered on each top section (specify PS2)
  - Each power station features three grounded outlets, two jacks (RJ45/RJ11) and a 10-foot power cord. Hole diameter is 4-1/4"
  - Ships K.D.

- Racetrack Conference Table w/Two Piece Top**
- Features three 4 x 24" rectangular bases with access doors and one two-piece racetrack top
  - Top sections are not grain-matched
  - Right hinged door on base provides cable access. Magnetic touch latch
  - Power Stations, if specified, are centered on each top section (specify PS2)
  - Each power station features three grounded outlets, two jacks (RJ45/RJ11) and a 10-foot power cord. Hole diameter is 4-1/4"
  - Ships K.D.

**A**      **B**      **C**      **D**      **E**

## HOW TO ORDER

Indicate the following information on order form:

1. Quantity of each item.
2. Model number, including options. See "How To Build a Model Number".
3. Any special service required.

Note:

- The  indicates that a choice is required.
- The absence of the  indicates that no choice is required.
- Alpha-numeric characters in place of  indicate that no other alternatives are available.

## HOW TO BUILD A MODEL NUMBER

- A** Select basic model.
- B** Select edge style.
 

<b>F</b>	- Flat edge
<b>P3</b>	- Three wave profile edge
<b>P4</b>	- Four wave profile edge
- C** Select horizontal surface finish. Refer to color addendum at ki.com or KI Fabrics & Finishes binder.
- D** Select vertical surface finish. Refer to color addendum at ki.com or KI Fabrics & Finishes binder.
- E** Select power station.
 

<b>PS0</b>	- No Power Station
<b>PS2</b>	- Two Power Stations (for two-piece tops); add \$380



Delivered  
Pricing

\$ 1830

1855

\$ 2181

2296

2724

2913

**SPECIAL SERVICES**

**Special Carton Marking**

With specially marked information    N/C

**Shipping**

Shipped k.d. freight prepaid f.o.b.  
KI-Aristotle Brampton, Ontario L6T 5T6  
factory. Freight class #85.

Specifications and prices are subject to  
change without prior notice.

# Aristotle® Executive

Conference Room Furniture

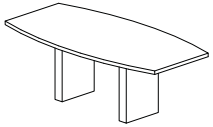
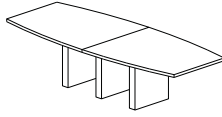
MODEL	W x D x H	MODEL NUMBER					Approx. Packaged Weight
		Basic Model	Edge Style	Horizontal Surface Finish	Vertical Surface Finish	Power Station	
 <p>AECT</p> <p><b>Boatshaped Conference Table</b></p> <ul style="list-style-type: none"> <li>• Features two 4 x 24" rectangular bases with access doors and one boatshaped single-piece top</li> <li>• Right hinged door on base provides cable access. Magnetic touch latch</li> <li>• Power Station, if specified, is centered on top (specify PS1)</li> <li>• Each power station features three grounded outlets, two jacks (RJ45/RJ11) and a 10-foot power cord. Hole diameter is 4-1/4"</li> <li>• Ships K.D.</li> </ul>	84 x 42 x 29-1/2"	KBS8442242B.E	<input type="checkbox"/>	<input type="checkbox"/>	<input type="checkbox"/>	<input type="checkbox"/>	229.0#
	96 x 42 x 29-1/2"	KBS9642242B.E	<input type="checkbox"/>	<input type="checkbox"/>	<input type="checkbox"/>	<input type="checkbox"/>	245.0#
	84 x 48 x 29-1/2"	KBS8448242B.E	<input type="checkbox"/>	<input type="checkbox"/>	<input type="checkbox"/>	<input type="checkbox"/>	239.0#
	96 x 48 x 29-1/2"	KBS9648242B.E	<input type="checkbox"/>	<input type="checkbox"/>	<input type="checkbox"/>	<input type="checkbox"/>	255.0#
 <p>AECT</p> <p><b>Boatshaped Conference Table w/Two Piece Top</b></p> <ul style="list-style-type: none"> <li>• Features three 4 x 24" rectangular bases with access doors and one two-piece boat-shaped top</li> <li>• Top sections are not grain-matched</li> <li>• Right hinged door on base provides cable access. Magnetic touch latch</li> <li>• Power Stations, if specified, are centered on each top section (specify PS2)</li> <li>• Each power station features three grounded outlets, two jacks (RJ45/RJ11) and a 10-foot power cord. Hole diameter is 4-1/4"</li> <li>• Ships K.D.</li> </ul>	120 x 48 x 29-1/2"	KBS12048243B.E	<input type="checkbox"/>	<input type="checkbox"/>	<input type="checkbox"/>	<input type="checkbox"/>	368.0#
	144 x 48 x 29-1/2"	KBS14448243B.E	<input type="checkbox"/>	<input type="checkbox"/>	<input type="checkbox"/>	<input type="checkbox"/>	411.0#
	168 x 48 x 29-1/2"	KBS16848243B.E	<input type="checkbox"/>	<input type="checkbox"/>	<input type="checkbox"/>	<input type="checkbox"/>	436.0#
	192 x 48 x 29-1/2"	KBS19248243B.E	<input type="checkbox"/>	<input type="checkbox"/>	<input type="checkbox"/>	<input type="checkbox"/>	468.0#
			<b>A</b>	<b>B</b>	<b>C</b>	<b>D</b>	<b>E</b>

## HOW TO ORDER

Indicate the following information on order form:

1. Quantity of each item.
2. Model number, including options. See "How To Build a Model Number".
3. Any special service required.

Note: • The  indicates that a choice is required.  
 • The absence of the  indicates that no choice is required.  
 • Alpha-numeric characters in place of  indicate that no other alternatives are available.

## HOW TO BUILD A MODEL NUMBER

- A** Select basic model.
- B** Select edge style.
- |           |                           |
|-----------|---------------------------|
| <b>F</b>  | - Flat edge               |
| <b>P3</b> | - Three wave profile edge |
| <b>P4</b> | - Four wave profile edge  |
- C** Select horizontal surface finish.  
Refer to color addendum at ki.com or KI Fabrics & Finishes binder.
- D** Select vertical surface finish.  
Refer to color addendum at ki.com or KI Fabrics & Finishes binder.
- E** Select power station.
- |            |  |
|------------|--|
| <b>PS0</b> | - No Power Station                                     |
| <b>PS1</b> | - One Power Station (for single-piece tops); add \$190 |
| <b>PS2</b> | - Two Power Stations (for two-piece tops); add \$380   |





Delivered  
Pricing

\$ 1289  
1397  
1510  
1617

\$ 2181  
2296  
2724  
2913

**SPECIAL SERVICES**

**Special Carton Marking**

With specially marked information N/C

**Shipping**

Shipped k.d. freight prepaid f.o.b.  
KI-Aristotle Brampton, Ontario L6T 5T6  
factory. Freight class #85.

Specifications and prices are subject to  
change without prior notice.

# Index

Model No.	Description	Page	Model No.	Description	Page
KAEP24	Aluminum Frame Profile with Modesty and End Panel Inserts: Add-On Acrylic End Panel	46		Pedestal Desk, Locking File/File Option G	230
KAMPL42	Aluminum Frame Profile with Modesty and End Panel Inserts: Add-On Acrylic Modesty Panel	46	KBDP6636G.H	Bow Front Double Pedestal Desks: Bow Front Double Pedestal Desk, Locking File/File Option G	12
KAV3625.E	Conference Room: Audiovisual Cabinet	442	KBOSG24.E	Gallery Reception Desks: Bow Front Reception Gallery	370
KAV3625.H	Conference Room: Audiovisual Cabinet	212	KBOSG24.H	Gallery Reception Desks: Bow Front Reception Gallery	142
KBC2429.E	Bookcases-24" Wide: Bookcase 24" Wide-One Adjustable Shelf, One Fixed Shelf	416	KBR3020.E	Bridges: Bridge - 20"	268
KBC2429.H	Bookcases-24" Wide: Bookcase 24" Wide-One Adjustable Shelf, One Fixed Shelf	186	KBR3020.H	Bridges: Bridge - 20"	48
KBC2448.E	Bookcases-24" Wide: Bookcase 24" Wide-Two Adjustable Shelves, One Fixed Shelf	416	KBR3024.E	Bridges: Bridge - 24"	268
KBC2448.H	Bookcases-24" Wide: Bookcase 24" Wide-Two Adjustable Shelves, One Fixed Shelf	186	KBR3024.H	Bridges: Bridge - 24"	48
KBC2465.E	Bookcases-24" Wide: Bookcase 24" Wide-Four Adjustable Shelves, One Fixed Shelf	416	KBSC3620.E	Lower Storage Units - Freestanding: Storage and File Cabinet-Freestanding, Nonlocking	400
KBC2465.H	Bookcases-24" Wide: Bookcase 24" Wide-Four Adjustable Shelves, One Fixed Shelf	186	KBSC3620.H	Lower Storage Units - Freestanding: Storage and File Cabinet-Freestanding, Nonlocking	172
KBC3029.E	Bookcases-30" Wide: Bookcase 30" Wide-One Adjustable Shelf, One Fixed Shelf	418	KBSC3620.E	Lower Storage Units - Freestanding: Storage and File Cabinet-Freestanding, Locking	400
KBC3029.H	Bookcases-30" Wide: Bookcase 30" Wide-One Adjustable Shelf, One Fixed Shelf	188	KBSC3620.H	Lower Storage Units - Freestanding: Storage and File Cabinet-Freestanding, Locking	172
KBC3048.E	Bookcases-30" Wide: Bookcase 30" Wide-Two Adjustable Shelves, One Fixed Shelf	418	KBSC.T.H	Lower Storage Units - Under Desk: Storage and File Cabinet-Under Desk, Nonlocking	166
KBC3048.H	Bookcases-30" Wide: Bookcase 30" Wide-Two Adjustable Shelves, One Fixed Shelf	188	KBSC.T.L.H	Lower Storage Units - Under Desk: Storage and File Cabinet-Under Desk, Locking	166
KBC3065.E	Bookcases-30" Wide: Bookcase 30" Wide-Four Adjustable Shelves, One Fixed Shelf	418	KBSP.L6636A.E	Bow Front Single Pedestal Desks-Pedestal on Left: Bow Front Single Pedestal Desk-Left, Box/File Option A	234
KBC3065.H	Bookcases-30" Wide: Bookcase 30" Wide-Four Adjustable Shelves, One Fixed Shelf	188	KBSP.L6636A.H	Bow Front Single Pedestal Desks-Pedestal on Left: Bow Front Single Pedestal Desk-Left, Box/File Option A	16
KBC3629.E	Bookcases-36" Wide: Bookcase 36" Wide-One Adjustable Shelf, One Fixed Shelf	420	KBSP.L6636B.E	Bow Front Single Pedestal Desks-Pedestal on Left: Bow Front Single Pedestal Desk-Left, Box/Box/File Option B	234
KBC3629.H	Bookcases-36" Wide: Bookcase 36" Wide-One Adjustable Shelf, One Fixed Shelf	190	KBSP.L6636B.H	Bow Front Single Pedestal Desks-Pedestal on Left: Bow Front Single Pedestal Desk-Left, Box/Box/File Option B	16
KBC3648.E	Bookcases-36" Wide: Bookcase 36" Wide-Two Adjustable Shelves, One Fixed Shelf	420	KBSP.L6636C.E	Bow Front Single Pedestal Desks-Pedestal on Left: Bow Front Single Pedestal Desk-Left, File/File Option C	234
KBC3648.H	Bookcases-36" Wide: Bookcase 36" Wide-Two Adjustable Shelves, One Fixed Shelf	190	KBSP.L6636C.H	Bow Front Single Pedestal Desks-Pedestal on Left: Bow Front Single Pedestal Desk-Left, File/File Option C	16
KBC3665.E	Bookcases-36" Wide: Bookcase 36" Wide-Four Adjustable Shelves, One Fixed Shelf	420	KBSP.R6636A.E	Bow Front Single Pedestal Desks-Pedestal on Right: Bow Front Single Pedestal Desk-Right, Box/File Option A	238
KBC3665.H	Bookcases-36" Wide: Bookcase 36" Wide-Four Adjustable Shelves, One Fixed Shelf	190	KBSP.R6636A.H	Bow Front Single Pedestal Desks-Pedestal on Right: Bow Front Single Pedestal Desk-Right, Box/File Option A	20
KBCT2424.E	Connector Tops: Connector Top	440	KBSP.R6636B.E	Bow Front Single Pedestal Desks-Pedestal on Right: Bow Front Single Pedestal Desk-Right, Box/Box/File Option B	238
KBCT2424.H	Connector Tops: Connector Top	210	KBSP.R6636B.H	Bow Front Single Pedestal Desks-Pedestal on Right: Bow Front Single Pedestal Desk-Right, Box/Box/File Option B	20
KBDP6636A.E	Bow Front Double Pedestal Desks: Bow Front Double Pedestal Desk, Box/File Option A	228	KBSP.R6636C.E	Bow Front Single Pedestal Desks-Pedestal on Right: Bow Front Single Pedestal Desk-Right, File/File Option C	238
KBDP6636A.H	Bow Front Double Pedestal Desks: Bow Front Double Pedestal Desk, Box/File Option A	10	KBSP.R6636C.H	Bow Front Single Pedestal Desks-Pedestal on Right: Bow Front Single Pedestal Desk-Right, File/File Option C	20
KBDP6636B.E	Bow Front Double Pedestal Desks: Bow Front Double Pedestal Desk, Box/Box/File Option B	228	KCC361818.E	Corner Units: Straight Corner	306
KBDP6636B.H	Bow Front Double Pedestal Desks: Bow Front Double Pedestal Desk, Box/Box/File Option B	10	KCC361818.H	Corner Units: Straight Corner	84
KBDP6636C.E	Bow Front Double Pedestal Desks: Bow Front Double Pedestal Desk, File/File Option C	228	KCDL.A6020.E	Extended Corner Desk Shells - 20" - Extended Left: Extended-Left Option A-Two Full End Panels	316
KBDP6636C.H	Bow Front Double Pedestal Desks: Bow Front Double Pedestal Desk, File/File Option C	10	KCDL.A6020.H	Extended Corner Desk Shells - 20" - Extended Left: Extended-Left Option A-Two Full End Panels	94
KBDP6636E	Bow Front Double Pedestal Desks: Bow Front Double Pedestal Desk, Box/Box/File Option F	230	KCDL.A6024.E	Extended Corner Desk Shells - 24" - Extended Left: Extended-Left Option A-Two Full End Panels	324
KBDP6636F	Bow Front Double Pedestal Desks: Bow Front Double Pedestal Desk, Box/Box/File Option F	12	KCDL.A6024.H	Extended Corner Desk Shells - 24" - Extended Left: Extended-Left Option A-Two Full End Panels	98
KBDP6636G.E	Bow Front Double Pedestal Desks: Bow Front Double Pedestal Desk, Box/Box/File Option F	12	KCDL.A6030.E	Extended Corner Desk Shells - 30" - Extended Left: Extended-Left Option A-Two Full End Panels	332
			KCDL.A6030.H	Extended Corner Desk Shells - 30" - Extended Left: Extended-Left Option A-Two Full End Panels	102
			KCDL.B6020.E	Extended Corner Desk Shells - 20" - Extended Left: Extended-Left, Option B - One Full/One Recessed End	



Model No.	Description	Page	Model No.	Description	Page
KCDLB6020.H	Panel, Interchangeable Extended Corner Desk Shells - 20" - Extended Left: Extended-Left, Option B - One Full/One Recessed End Panel, Interchangeable	316 94	KCDRB6020.H	Extended-Right Option B-One Full/One Recessed End Panel, Interchangeable Extended Corner Desk Shells - 20" - Extended Right: Extended-Right Option B-One Full/One Recessed End Panel, Interchangeable	320 96
KCDLB6024.E	Extended Corner Desk Shells - 24" - Extended Left: Extended-Left, Option B - One Full/One Recessed End Panel, Interchangeable	324	KCDRB6024.E	Extended Corner Desk Shells - 24" - Extended Right: Extended-Right Option B-One Full/One Recessed End Panel, Interchangeable	328
KCDLB6024.H	Extended Corner Desk Shells - 24" - Extended Left: Extended-Left, Option B - One Full/One Recessed End Panel, Interchangeable	98	KCDRB6024.H	Extended Corner Desk Shells - 24" - Extended Right: Extended-Right Option B-One Full/One Recessed End Panel, Interchangeable	100
KCDLB6030.E	Extended Corner Desk Shells - 30" - Extended Left: Extended-Left, Option B - One Full/One Recessed End Panel, Interchangeable	332	KCDRB6030.E	Extended Corner Desk Shells - 30" - Extended Right: Extended-Right Option B-One Full/One Recessed End Panel, Interchangeable	336
KCDLB6030.H	Extended Corner Desk Shells - 30" - Extended Left: Extended-Left, Option B - One Full/One Recessed End Panel, Interchangeable	102	KCDRB6030.H	Extended Corner Desk Shells - 30" - Extended Right: Extended-Right Option B-One Full/One Recessed End Panel, Interchangeable	104
KCDLC6020.E	Extended Corner Desk Shells - 20" - Extended Left: Extended-Left Option C-Two Recessed End Panels	318	KCDRC6020.E	Extended Corner Desk Shells - 20" - Extended Right: Extended-Right Option C-Two Recessed End Panels	322
KCDLC6020.H	Extended Corner Desk Shells - 20" - Extended Left: Extended-Left Option C-Two Recessed End Panels	94	KCDRC6020.H	Extended Corner Desk Shells - 20" - Extended Right: Extended-Right Option C-Two Recessed End Panels	96
KCDLC6024.E	Extended Corner Desk Shells - 24" - Extended Left: Extended-Left Option C-Two Recessed End Panels	326	KCDRC6024.E	Extended Corner Desk Shells - 24" - Extended Right: Extended-Right Option C-Two Recessed End Panels	330
KCDLC6024.H	Extended Corner Desk Shells - 24" - Extended Left: Extended-Left Option C-Two Recessed End Panels	98	KCDRC6024.H	Extended Corner Desk Shells - 24" - Extended Right: Extended-Right Option C-Two Recessed End Panels	100
KCDLC6030.E	Extended Corner Desk Shells - 30" - Extended Left: Extended-Left Option C-Two Recessed End Panels	334	KCDRC6030.E	Extended Corner Desk Shells - 30" - Extended Right: Extended-Right Option C-Two Recessed End Panels	338
KCDLC6030.H	Extended Corner Desk Shells - 30" - Extended Left: Extended-Left Option C-Two Recessed End Panels	102	KCDRC6030.H	Extended Corner Desk Shells - 30" - Extended Right: Extended-Right Option C-Two Recessed End Panels	104
KCDP6020A.E	Double Pedestal Credenzas: Double Pedestal Creden- zas, Box/File Option A	274	KCFF6020.E	Extended-Right Option C-Two Recessed End Panels Credenza-Lateral Files: Credenza-Double Lateral File	282
KCDP6020A.H	Double Pedestal Credenzas: Double Pedestal Creden- zas, Box/File Option A	54	KCFF6020.H	Credenza-Lateral Files: Credenza-Double Lateral File	60
KCDP6020B.E	Double Pedestal Credenzas: Double Pedestal Creden- zas, Box/Box/File Option B	274	KCFL6020.E	Credenza-Lateral Files: Credenza-Lateral File-Left	280
KCDP6020B.H	Double Pedestal Credenzas: Double Pedestal Creden- zas, Box/Box/File Option B	54	KCFL6020.H	Credenza-Lateral Files: Credenza-Lateral File-Left	60
KCDP6020C.E	Double Pedestal Credenzas: Double Pedestal Creden- zas, File/File Option C	274	KCFR6020.E	Credenza-Lateral Files: Credenza-Lateral File-Right	280
KCDP6020C.H	Double Pedestal Credenzas: Double Pedestal Creden- zas, File/File Option C	54	KCFR6020.H	Credenza-Lateral Files: Credenza-Lateral File-Right	60
KCDP6020F.E	Double Pedestal Credenzas: Double Pedestal Creden- zas, Box/Box/File Option F	276	KCFS6620.E	Credenza-Storage: Credenza-Lateral File-Left and Storage-Right	284
KCDP6020F.H	Double Pedestal Credenzas: Double Pedestal Creden- zas, Box/Box/File Option F	56	KCFS6620.H	Credenza-Storage: Credenza-Lateral File-Left and Storage-Right	64
KCDP6020G.E	Double Pedestal Credenzas: Double Pedestal Creden- zas, Box/File Option G	276	KCPL6020A.E	Single Pedestal Credenzas-Left: Single Pedestal Credenza-Left, Box/File Option A	270
KCDP6020G.H	Double Pedestal Credenzas: Double Pedestal Creden- zas, Box/File Option G	56	KCPL6020A.H	Single Pedestal Credenzas-Left: Single Pedestal Credenza-Left, Box/File Option A	50
KCDRA6020.E	Extended Corner Desk Shells - 20" - Extended Right: Extended-Right Option A-Two Full End Panels	320	KCPL6020B.E	Single Pedestal Credenzas-Left: Single Pedestal Credenza-Left, Box/Box/File Option B	270
KCDRA6020.H	Extended Corner Desk Shells - 20" - Extended Right: Extended-Right Option A-Two Full End Panels	96	KCPL6020B.H	Single Pedestal Credenzas-Left: Single Pedestal Credenza-Left, Box/Box/File Option B	50
KCDRA6024.E	Extended Corner Desk Shells - 24" - Extended Right: Extended-Right Option A-Two Full End Panels	328	KCPL6020C.E	Single Pedestal Credenzas-Left: Single Pedestal Credenza-Left, File/File Option C	270
KCDRA6024.H	Extended Corner Desk Shells - 24" - Extended Right: Extended-Right Option A-Two Full End Panels	100	KCPL6020C.H	Single Pedestal Credenzas-Left: Single Pedestal Credenza-Left, File/File Option C	50
KCDRA6030.E	Extended Corner Desk Shells - 30" - Extended Right: Extended-Right Option A-Two Full End Panels	336	KCPR6020A.E	Single Pedestal Credenzas-Right: Single Pedestal Credenza-Right, Box/File Option A	272
KCDRA6030.H	Extended Corner Desk Shells - 30" - Extended Right: Extended-Right Option A-Two Full End Panels	104	KCPR6020A.H	Single Pedestal Credenzas-Right: Single Pedestal Credenza-Right, Box/File Option A	52
KCDRB6020.E	Extended Corner Desk Shells - 20" - Extended Right:		KCPR6020B.E	Single Pedestal Credenzas-Right: Single Pedestal Credenza-Right, Box/Box/File Option B	272
			KCPR6020B.H	Single Pedestal Credenzas-Right: Single Pedestal Credenza-Right, Box/Box/File Option B	52
			KCPR6020C.E	Single Pedestal Credenzas-Right: Single Pedestal Credenza-Right, File/File Option C	272

# Index

Model No.	Description	Page	Model No.	Description	Page
KCPR6020C.H	Single Pedestal Credenzas-Right: Single Pedestal Credenza-Right, File/File Option C	52	KDBI2430.E	Recessed and One Full End Panel	90
KCSB2029L.E	Square Bookcases: Corner-Square Bookcase-Desk/ Credenza, Left	428	KDBI2430.H	Desk Shells-Inset Back Panel: Desk Shells-Inset Back Panel Option B - One Recessed and One Full End Panel (interchangeable)	314
KCSB2029L.H	Square Bookcases: Corner-Square Bookcase-Desk/ Credenza, Left	198	KDC2420.E	Desk Shells-20": Desk Shells-20" Option C - Two Recessed End Panels	308
KCSB2029R.E	Square Bookcases: Corner-Square Bookcase-Desk/ Credenza, Right	428	KDC2420.H	Desk Shells-20": Desk Shells-20" Option C - Two Recessed End Panels	86
KCSB2029R.H	Square Bookcases: Corner-Square Bookcase-Desk/ Credenza, Right	198	KDC2424.E	Desk Shells-24": Desk Shells-24" Option C - Two Recessed End Panels	310
KCSB2065L.E	Square Bookcases: Corner-Square Bookcase--Tower, Left	428	KDC2424.H	Desk Shells-24": Desk Shells-24" Option C - Two Recessed End Panels	88
KCSB2065L.H	Square Bookcases: Corner-Square Bookcase--Tower, Left	198	KDC2430.E	Desk Shells-30": Desk Shells-30" Option C - Two Recessed End Panels	312
KCSB2065R.E	Square Bookcases: Corner-Square Bookcase--Tower, Right	428	KDC2430.H	Desk Shells-30": Desk Shells-30" Option C - Two Recessed End Panels	90
KCSB2065R.H	Square Bookcases: Corner-Square Bookcase--Tower, Right	198	KDCM4824.E	With End Panel: D-Top with End Panel and Centered Modesty Panel	342
KCSF6620.E	Credenza-Storage: Credenza-Storage-Left and Lateral File-Right	284	KDCM4824.H	With End Panel: D-Top with End Panel and Centered Modesty Panel	108
KCSF6620.H	Credenza-Storage: Credenza-Storage-Left and Lateral File-Right	64	KDF4824.E	With End Panel: D-Top with End Panel	342
KCSS6620.E	Credenza-Double Storage: Credenza-Double Storage	286	KDF4824.H	With End Panel: D-Top with End Panel	108
KCSS6620.H	Credenza-Storage: Credenza-Double Storage	64	KDM6030.E	With End Panel: D-Top with End Panel and Offset Modesty Panel	342
KCV361818.E	Corner Units: Curvilinear Corner	306	KDM6030.H	With End Panel: D-Top with End Panel and Offset Modesty Panel	108
KCV361818.H	Corner Units: Curvilinear Corner	84	KDP6030A.E	Double Pedestal Desks: Double Pedestal Desk, Box/ File Option A	224
KCZ6020A.E	Credenza-Center Storage: Credenza-Center Storage and Double Box/File Pedestal	278	KDP6030A.H	Double Pedestal Desks: Double Pedestal Desk, Box/ File Option A	6
KCZ6020A.H	Credenza-Center Storage: Credenza-Center Storage and Double Box/File Pedestal	58	KDP6030B.E	Double Pedestal Desks: Double Pedestal Desk, Box/ Box/File Option B	224
KCZ6020B.E	Credenza-Center Storage: Credenza-Center Storage and Double Box/Box/File Pedestal	278	KDP6030B.H	Double Pedestal Desks: Double Pedestal Desk, Box/ Box/File Option B	6
KCZ6020B.H	Credenza-Center Storage: Credenza-Center Storage and Double Box/Box/File Pedestal	58	KDP6030C.E	Double Pedestal Desks: Double Pedestal Desk, File/File Option C	224
KCZ6020C.E	Credenza-Center Storage: Credenza-Center Storage and Double File/File Pedestal	278	KDP6030C.H	Double Pedestal Desks: Double Pedestal Desk, File/File Option C6	
KCZ6020C.H	Credenza-Center Storage: Credenza-Center Storage and Double File/File Pedestal	58	KDP6030F.E	Double Pedestal Desks: Double Pedestal Desk, Box/ Box/File Option F	226
KDA2420.E	Desk Shells-20": Desk Shells-20" Option A - Two Full End Panels	308	KDP6030F.H	Double Pedestal Desks: Double Pedestal Desk, Box/ Box/File Option F	8
KDA2420.H	Desk Shells-20": Desk Shells-20" Option A - Two Full End Panels	86	KDP6030G.E	Double Pedestal Desks: Double Pedestal Desk, Locking File/File Option G	226
KDA2424.E	Desk Shells-24": Desk Shells-24" Option A - Two Full End Panels	310	KDP6030G.H	Double Pedestal Desks: Double Pedestal Desk, Locking File/File Option G	8
KDA2424.H	Desk Shells-24": Desk Shells-24" Option A - Two Full End Panels	88	KDS3624.E	Suspended: Suspended D-Top	340
KDA2430.E	Desk Shells-30": Desk Shells-30" Option A - Two Full End Panels	312	KDS3624.H	Suspended: Suspended D-Top	106
KDA2430.H	Desk Shells-30": Desk Shells-30" Option A - Two Full End Panels	90	KDSM3624.E	Suspended: Suspended D-Top with Centered Modesty Panel	340
KDAI2430.E	Desk Shells-Inset Back Panel: Desk Shells-Inset Back Panel Option A - Two Full End Panels	314	KDSM3624.H	Suspended: Suspended D-Top with Centered Modesty Panel	106
KDAI2430.H	Desk Shells-Inset Back Panel: Desk Shells-Inset Back Panel Option A - Two Full End Panels	92	KDTCC662420L.E	D-Top Desks-Curved Cutaway: D-Top Desk-24" Extended Left, Curved Cutaway	250
KDB2420.E	Desk Shells-20": Desk Shells-20" Option B - One Recessed and One Full End Panel	308	KDTCC662420L.H	D-Top Desks-Curved Cutaway: D-Top Desk-24" Extended Left, Curved Cutaway	32
KDB2420.H	Desk Shells-20": Desk Shells-20" Option B - One Recessed and One Full End Panel	86	KDTCC662420R.E	D-Top Desks-Curved Cutaway: D-Top Desk-24" Extended Right, Curved Cutaway	250
KDB2424.E	Desk Shells-24": Desk Shells-24" Option B - One Recessed and One Full End Panel	310			
KDB2424.H	Desk Shells-24": Desk Shells-24" Option B - One Recessed and One Full End Panel	88			
KDB2430.E	Desk Shells-30": Desk Shells-30" Option B - One Recessed and One Full End Panel	312			
KDB2430.H	Desk Shells-30": Desk Shells-30" Option B - One Recessed and One Full End Panel				



Model No.	Description	Page	Model No.	Description	Page
KDTCC662420R.H	D-Top Desks-Curved Cutaway: D-Top Desk-24" Extended Right, Curved Cutaway	32	KECDS6620R.H	Bow Front Desks-Straight Cutaway: Bow Front Desk-Extended Right, Straight Cutaway	22
KDTCC663020L.E	D-Top Desks-Curved Cutaway: D-Top Desk-30" Extended Left, Curved Cutaway	254	KECT2424.E	Connector Tops: Desk Extension Table	440
KDTCC663020L.H	D-Top Desks-Curved Cutaway: D-Top Desk-30" Extended Left, Curved Cutaway	36	KECT2424.H	Connector Tops: Desk Extension Table	210
KDTCC663020R.E	D-Top Desks-Curved Cutaway: D-Top Desk-30" Extended Right, Curved Cutaway	254	KES24.H	Bookcase Accessories: Extra Shelf for 24" Wide Bookcase	192
KDTCC663020R.H	D-Top Desks-Curved Cutaway: D-Top Desk-30" Extended Right, Curved Cutaway	36	KES30.H	Bookcase Accessories: Extra Shelf for 30" Wide Bookcase	192
KDTCS662420L.E	D-Top Desks-Straight Cutaway: D-Top Desk-24" Extended Left, Straight Cutaway	248	KES36.H	Bookcase Accessories: Extra Shelf for 36" Wide Bookcase	192
KDTCS662420L.H	D-Top Desks-Straight Cutaway: D-Top Desk-24" Extended Left, Straight Cutaway	30	KF2BF.E	Full Height Pedestals: Full Height Pedestal-Box/Box/File	384
KDTCS662420R.E	D-Top Desks-Straight Cutaway: D-Top Desk-24" Extended Right, Straight Cutaway	248	KF2BF.H	Full Height Pedestals: Full Height Pedestal-Box/Box/File	156
KDTCS662420R.H	D-Top Desks-Straight Cutaway: D-Top Desk-24" Extended Right, Straight Cutaway	30	KF2F.E	Full Height Pedestals: Full Height Pedestal-File/File	384
KDTCS663020L.E	D-Top Desks-Straight Cutaway: D-Top Desk-30" Extended Left, Straight Cutaway	252	KF2F.H	Full Height Pedestals: Full Height Pedestal-File/File	156
KDTCS663020L.H	D-Top Desks-Straight Cutaway: D-Top Desk-30" Extended Left, Straight Cutaway	34	KFFS302065.E.AL	30 and 36" Storage and Wardrobe Towers: Storage Tower with Lateral Files-Frosted Glass Doors	414
KDTCS663020R.E	D-Top Desks-Straight Cutaway: D-Top Desk-30" Extended Right, Straight Cutaway	252	KFFS302065.H.AL	30" and 36" Storage Towers/36" Storage and Wardrobe Towers: Storage Tower with Lateral Files-Frosted Glass Doors	184
KDTCS663020R.H	D-Top Desks-Straight Cutaway: D-Top Desk-30" Extended Right, Straight Cutaway	34	KFRL3020.E	Flush-Left and Right, No Pedestal: Flush Return-Left, No Pedestal	264
KDTP2412	Desktop Acrylic Screen: Desktop Acrylic Screen - 12" H	200	KFRL3020.H	Flush-Left and Right, No Pedestal: Flush Return-Left, No Pedestal	44
KDTP2418	Desktop Acrylic Screen: Desktop Acrylic Screen - 18" H	200	KFRR3020.E	Flush-Left and Right, No Pedestal: Flush Return-Right, No Pedestal	264
KDTPSA	Desktop Screen Support: Desktop Screen Support-6" High, Aluminum Finish	202	KFRR3020.H	Flush-Left and Right, No Pedestal: Flush Return-Right, No Pedestal	44
KDTPSB	Desktop Screen Support: Desktop Screen Support-6" High, Black Finish	202	KFS302065.E	30" and 36" Storage Towers: Storage Tower with Lateral Files-Standard Doors	412
KDTPSC	Desktop Screen Support: Desktop Screen Support-6" High, Charcoal Finish	202	KFS302065.H	24"Wide Storage, Wardrobe and File Towers/30" and 36" Storage Towers: Storage Tower with Lateral Files-Standard Doors	182
KECDC6620L.E	Bow Front Desks-Curved Cutaway: Bow Front Desk-Extended Left, Curved Cutaway	242	KFSBF.E	Full Height Pedestals: Full Height Pedestal-Shelf/Box/File	384
KECDC6620L.H	Bow Front Desks-Curved Cutaway: Bow Front Desk-Extended Left, Curved Cutaway	24	KFSBF.H	Full Height Pedestals: Full Height Pedestal-Shelf/Box/File	156
KECDC6620R.E	Bow Front Desks-Curved Cutaway: Bow Front Desk-Extended Right, Curved Cutaway	242	KFTBF	Lateral Files-Freestanding: Front-to-Back Filing Hardware	164
KECDC6620R.H	Bow Front Desks-Curved Cutaway: Bow Front Desk-Extended Right, Curved Cutaway	24	KGDBL6636A.E	Bow Front Reception Desks: Bow Front Reception Desk-Left, Box/File Option A	294
KECDS6620L.E	Bow Front Desks-Straight Cutaway: Bow Front Desk-Extended Left, Straight Cutaway	240	KGDBL6636A.H	Bow Front Reception Desks: Bow Front Reception Desk-Left, Box/File Option A	72
KECDS6620L.H	Bow Front Desks-Straight Cutaway: Bow Front Desk-Extended Left, Straight Cutaway	22	KGDBL6636B.E	Bow Front Reception Desks: Bow Front Reception Desk-Left, Box/Box/File Option B	296
KECDS6620R.E	Bow Front Desks-Straight Cutaway: Bow Front Desk-Extended Right, Straight Cutaway	240	KGDBL6636B.H	Bow Front Reception Desks: Bow Front Reception Desk-Left, Box/Box/File Option B	74
			KGDBL6636C.E	Bow Front Reception Desks: Bow Front Reception Desk-Left, File/File Option C	298
			KGDBL6636C.H	Bow Front Reception Desks: Bow Front Reception Desk-Left, File/File Option C	76
			KGDBR6636A.E	Bow Front Reception Desks: Bow Front Reception Desk-Right, Box/File Option A	294
			KGDBR6636A.H	Bow Front Reception Desks: Bow Front Reception Desk-Right, Box/File Option A	72
			KGDBR6636B.E	Bow Front Reception Desks: Bow Front Reception Desk-Right, Box/Box/File Option B	296
			KGDBR6636B.H	Bow Front Reception Desks: Bow Front Reception Desk-Right, Box/Box/File Option B	74
			KGDBR6636C.E	Bow Front Reception Desks: Bow Front Reception Desk-Right, File/File Option C	298
			KGDBR6636C.H	Bow Front Reception Desks: Bow Front Reception Desk-Right, File/File Option C	76
			KGDL6630A.E	Reception Desks: Reception Desk-Left, Box/File Pedestal Option A	288
			KGDL6630A.H	Reception Desks: Reception Desk-Left, Box/File Pedestal Option A	66

## Index

Model No.	Description	Page	Model No.	Description	Page
KGDL6630B.E	Reception Desks: Reception Desk-Left, Box/Box/File Pedestal Option B	290	KM2BF.H	Mobile Pedestals: Mobile Pedestal-Box/Box/File	158
KGDL6630B.H	Reception Desks: Reception Desk-Left, Box/Box/File Pedestal Option B	68	KM2F.E	Mobile Pedestals: Full Height Pedestal-File/File	386
KGDL6630C.E	Reception Desks: Reception Desk-Left, File/File Pedestal Option C	292	KM2F.H	Mobile Pedestals: Full Height Pedestal-File/File	158
KGDL6630C.H	Reception Desks: Reception Desk-Left, File/File Pedestal Option C	70	KMB5040.E	Conference Room: Marker Board	442
KGDR6630A.E	Reception Desks: Reception Desk-Right, Box/File Pedestal Option A	288	KMB5040.H	Conference Room: Marker Board	212
KGDR6630A.H	Reception Desks: Reception Desk-Right, Box/File Pedestal Option A	66	KMBF.E	Mobile Pedestals: Mobile Pedestal-Box/File	386
KGDR6630B.E	Reception Desks: Reception Desk-Right, Box/Box/File Pedestal Option B	290	KMBF.H	Mobile Pedestals: Mobile Pedestal-Box/File	158
KGDR6630B.H	Reception Desks: Reception Desk-Right, Box/Box/File Pedestal Option B	68	KMFSB3020.E	Lower Storage Units - Freestanding: Multi-File Storage Cabinet-Freestanding	402
KGDR6630C.E	Reception Desks: Reception Desk-Right, File/File Pedestal Option C	292	KMFSB3020.H	Lower Storage Units - Freestanding: Multi-File Storage Cabinet-Freestanding	174
KGDR6630C.H	Reception Desks: Reception Desk-Right, File/File Pedestal Option C	70	KMFSBT30.H	Lower Storage Units - Under Desk: Multi-File Storage Cabinet-Under Desk	168
KGPS24.H	Extended Corner Reception Gallery: Reception Gallery Paper Sorter Insert	152	KMFSF3020.E	Lower Storage Units - Freestanding: Multi-File Storage Cabinet-Freestanding	402
KGR	Grommet, Wire Management Channel, Keyed Alike Kits: Grommet	218	KMFSF3020.H	Lower Storage Units - Freestanding: Multi-File Storage Cabinet-Freestanding	174
KGRL4224.E	Returns: Reception Return-Left, No Pedestal	304	KMFSFT30.H	Lower Storage Units - Under Desk: Multi-File Storage Cabinet-Under Desk	168
KGRL4224.H	Returns: Reception Return-Left, No Pedestal	82	KMSBF.E	Mobile Pedestals: Mobile Pedestal-Shelf/Box/File	386
KGRL4224A.E	Returns: Reception Return-Left, Box/File Pedestal Option A	300	KMSBF.H	Mobile Pedestals: Mobile Pedestal-Shelf/Box/File	158
KGRL4224A.H	Returns: Reception Return-Left, Box/File Pedestal Option A	78	KOCD3636.E	Closed Corner Overhead: Closed Corner Overhead, 36" High	366
KGRL4224B.E	Returns: Reception Return-Left, Box/Box/File Pedestal Option B	300	KOCD3636.H	Closed Corner Overhead: Closed Corner Overhead, 36" High	138
KGRL4224B.H	Returns: Reception Return-Left, Box/Box/File Pedestal Option B	78	KOCD3643.E	Closed Corner Overhead: Closed Corner Overhead, 43" High	368
KGRL4224C.E	Returns: Reception Return-Left, File/File Pedestal Option C	302	KOCD3643.H	Closed Corner Overhead: Closed Corner Overhead, 43" High	140
KGRL4224C.H	Returns: Reception Return-Left, File/File Pedestal Option C	80	KOCD4236.E	Closed Corner Overhead: Closed Corner Overhead, 36" High	366
KGRR4224.E	Returns: Reception Return-Right, No Pedestal	304	KOCD4236.H	Closed Corner Overhead: Closed Corner Overhead, 36" High	138
KGRR4224.H	Returns: Reception Return-Right, No Pedestal	82	KOCD4243.E	Closed Corner Overhead: Closed Corner Overhead, 43" High	368
KGRR4224A.E	Returns: Reception Return-Right, Box/File Pedestal Option A	300	KOCD4243.H	Closed Corner Overhead: Closed Corner Overhead, 43" High	140
KGRR4224A.H	Returns: Reception Return-Right, Box/File Pedestal Option A	78	KOCS3636.E	Open Corner Overhead: Open Corner Overhead, 36" High	364
KGRR4224B.E	Returns: Reception Return-Right, Box/Box/File Pedestal Option B	300	KOCS3636.H	Open Corner Overhead: Open Corner Overhead, 36" High	136
KGRR4224B.H	Returns: Reception Return-Right, Box/Box/File Pedestal Option B	78	KOCS3643.E	Open Corner Overhead: Open Corner Overhead, 43" High	364
KGRR4224C.E	Returns: Reception Return-Right, Pedestal Option C	302	KOCS3643.H	Open Corner Overhead: Open Corner Overhead, 43" High	136
KGRR4224C.H	Returns: Reception Return-Right, Pedestal Option C	80	KOD2436.E	Closed Overheads: Closed Overhead, 36" High	354
KGRTT42.E	Returns: Reception Return Transaction Top	304	KOD2436.H	Closed Overheads: Closed Overhead, 36" High	120
KGRTT42.H	Returns: Reception Return Transaction Top	82	KOD2443.E	Closed Overheads: Closed Overhead, 43" High	354
KH2B.E	Hanging Pedestals: Hanging Pedestal-Box/Box	382	KOD2443.H	Closed Overheads: Closed Overhead, 43" High	124
KH2B.H	Hanging Pedestals: Hanging Pedestal-Box/Box	154	KOD4836.E	Closed Overheads: Closed Overhead, 36" High	356
KHBF.E	Hanging Pedestals: Hanging Pedestal-Box/File	382	KOD4836.H	Closed Overheads: Closed Overhead, 36" High	122
KHBF.H	Hanging Pedestals: Hanging Pedestal-Box/File	154	KOD4843.E	Closed Overheads: Closed Overhead, 43" High	356
KHF.E	Hanging Pedestals: Hanging Pedestal-File	382	KOD4843.H	Closed Overheads: Closed Overhead, 43" High	126
KHF.H	Hanging Pedestals: Hanging Pedestal-File	154	KOD5436.E	Closed Overheads: Closed Overhead, 36" High	358
KHRCT2424.E	Connector Tops: Half-Round Connector Top	440	KOD5436.H	Closed Overheads: Closed Overhead, 36" High	122
KHRCT2424.H	Connector Tops: Half-Round Connector Top	210	KOD5443.E	Closed Overheads: Closed Overhead, 43" High	358
KKAK.1	Grommet, Wire Management Channel, Keyed Alike Kits: Keyed Alike Kits	218	KOD5443.H	Closed Overheads: Closed Overhead, 43" High	126
KL23020.E	Lateral Files-Integrated: Lateral File-Two Drawer Integrated	390	KOD02436.E	Closed Overheads-Open Back Below Shelf: Closed Overhead, 36" High-Open Back Below Shelf	352
KL23020.H	Lateral Files-Integrated: Lateral File-Two Drawer Integrated	162	KOD02436.H	Closed Overheads-Open Back Below Shelf: Closed Overhead, 36" High-Open Back Below Shelf	118
KLFT30.E	Lateral Files-Under Desk: Lateral File-Two Drawer Under Desk	388	KOD04836.E	Closed Overheads-Open Back Below Shelf: Closed Overhead, 36" High-Open Back Below Shelf	352
KLFT30.H	Lateral Files-Under Desk: Lateral File-Two Drawer Under Desk	160	KOD04836.H	Closed Overheads-Open Back Below Shelf: Closed Overhead, 36" High-Open Back Below Shelf	118
KM2BF.E	Mobile Pedestals: Mobile Pedestal-Box/Box/File	386	KOD05436.E	Closed Overheads-Open Back Below Shelf: Closed Overhead, 36" High-Open Back Below Shelf	352
			KOD05436.H	Closed Overheads-Open Back Below Shelf: Closed Overhead, 36" High-Open Back Below Shelf	118
			KOF6036.E.AL	Overhead - Frosted Glass Doors: Overhead-36" High, Frosted Glass Doors	360
			KOF6036.H.AL	Overhead - Frosted Glass Doors: Overhead-36" High, Frosted Glass Doors	132



Model No.	Description	Page	Model No.	Description	Page
KOF6043.E.AL	Overhead - Frosted Glass Doors: Overhead-43" High, Frosted Glass Doors	360	KPLF6036.E	With End Panel: P-Top with End Panel, Left	346
KOF6043.H.AL	Overhead - Frosted Glass Doors: Overhead-43" High, Frosted Glass Doors	132	KPLF6036.H	With End Panel: P-Top with End Panel, Left	112
KOPS24.H	Paper Management: Overhead Paper Sorter Insert	204	KPLM6036.E	With End Panel: P-Top with End Panel and Centered Modesty Panel, Left	346
KOS2436.E	Open Overheads: Open Overhead, 36" High	348	KPLM6036.H	With End Panel: P-Top with End Panel, Left with Centered Modesty Panel	112
KOS2436.H	Open Overheads: Open Overhead, 36" High	114	KPLS6036.E	Suspended: Suspended P-Top, Left	344
KOS2443.E	Open Overheads: Open Overhead, 43" High	350	KPLS6036.H	Suspended: Suspended P-Top, Left	110
KOS2443.H	Open Overheads: Open Overhead, 43" High	116	KPOHD1713.H	Paper Management: Paper Organizer	204
KOS4836.E	Open Overheads: Open Overhead, 36" High	348	KPOHVD1713.H	Paper Management: Paper Organizer	204
KOS4836.H	Open Overheads: Open Overhead, 36" High	114	KPRF6036.E	With End Panel: P-Top with End Panel, Right	346
KOS4843.E	Open Overheads: Open Overhead, 43" High	350	KPRF6036.H	With End Panel: P-Top with End Panel, Right	112
KOS4843.H	Open Overheads: Open Overhead, 43" High	116	KPRM6036.E	With End Panel: P-Top with End Panel and Centered Modesty Panel, Right	346
KOSD4236.E	Overheads-Sliding Frosted Acrylic Doors: Overhead-36" High, Sliding Frosted Acrylic Doors	362	KPRM6036.H	With End Panel: P-Top with End Panel, Right with Centered Modesty Panel	112
KOSD4236.H	Overheads-Sliding Frosted Acrylic Doors: Overhead-36" High, Sliding Frosted Acrylic Doors	134	KPRS6036.E	Suspended: Suspended P-Top, Right	344
KOSD4243.E	Overheads-Sliding Frosted Acrylic Doors: Overhead-43" High, Sliding Frosted Acrylic Doors	362	KPRS6036.H	Suspended: Suspended P-Top, Right	110
KOSD4243.H	Overheads-Sliding Frosted Acrylic Doors: Overhead-43" High, Sliding Frosted Acrylic Doors	134	KPTCC6620L.E	P-Top Desks-Curved Cutaway: P-Top Desk-Extended Left, Curved Cutaway	246
KOSG24.E	Gallery Reception Desks: Reception Gallery	370	KPTCC6620L.H	P-Top Desks-Curved Cutaway: P-Top Desk-Extended Left, Curved Cutaway	28
KOSG24.H	Gallery Reception Desks: Reception Gallery	142	KPTCC6620R.E	P-Top Desks-Curved Cutaway: P-Top Desk-Extended Right, Curved Cutaway	246
KOSGC36.E	Gallery Reception Desks: Corner Reception Gallery - 36"x36"	372	KPTCC6620R.H	P-Top Desks-Curved Cutaway: P-Top Desk-Extended Right, Curved Cutaway	28
KOSGC36.H	Gallery Reception Desks: Corner Reception Gallery - 36"x36"	144	KPTCS6620L.E	P-Top Desks-Straight Cutaway: P-Top Desk-Extended Left, Straight Cutaway	244
KOSGC42.E	Gallery Reception Desks: Corner Reception Gallery - 42"x42"	372	KPTCS6620L.H	P-Top Desks-Straight Cutaway: P-Top Desk-Extended Left, Straight Cutaway	26
KOSGC42.H	Gallery Reception Desks: Corner Reception Gallery - 42"x42"	144	KPTCS6620R.E	P-Top Desks-Straight Cutaway: P-Top Desk-Extended Right, Straight Cutaway	244
KOSGC48.E	Gallery Reception Desks: Corner Reception Gallery - 48"x48"	372	KPTCS6620R.H	P-Top Desks-Straight Cutaway: P-Top Desk-Extended Right, Straight Cutaway	26
KOSGC48.H	Gallery Reception Desks: Corner Reception Gallery - 48"x48"	144	KQRB1636L.E	Quarter-Round Bookcases: Quarter-Round Bookcase-Desk Top Stack-On Section, Left	424
KOSGCL6024.E	Extended Corner Reception Gallery: Extended Corner Reception Gallery-24", Left	374	KQRB1636L.H	Quarter-Round Bookcases: Quarter-Round Bookcase-Desk Top Stack-On Section, Left	194
KOSGCL6024.H	Extended Corner Reception Gallery: Extended Corner Reception Gallery-24", Left	146	KQRB1636R.E	Quarter-Round Bookcases: Quarter-Round Bookcase-Desk Top Stack-On Section, Right	424
KOSGCL6030.E	Extended Corner Reception Gallery: Extended Corner Reception Gallery-30", Left	376	KQRB1636R.H	Quarter-Round Bookcases: Quarter-Round Bookcase-Desk Top Stack-On Section, Right	194
KOSGCL6030.H	Extended Corner Reception Gallery: Extended Corner Reception Gallery-30", Left	148	KQRB1665L.E	Quarter-Round Bookcases: Quarter-Round Bookcase-Overhead, Left	426
KOSGCL6036.E	Extended Corner Reception Gallery: Extended Corner Reception Gallery-36", Left	378	KQRB1665L.H	Quarter-Round Bookcases: Quarter-Round Bookcase-Overhead, Left	196
KOSGCL6036.H	Extended Corner Reception Gallery: Extended Corner Reception Gallery-36", Left	150	KQRB1665R.E	Quarter-Round Bookcases: Quarter-Round Bookcase-Overhead, Right	426
KOSGCL6642.E	Extended Corner Reception Gallery: Extended Corner Reception Gallery-42", Left	380	KQRB1665R.H	Quarter-Round Bookcases: Quarter-Round Bookcase-Overhead, Right	196
KOSGCL6642.H	Extended Corner Reception Gallery: Extended Corner Reception Gallery-42", Left	152	KQRB2029L.E	Quarter-Round Bookcases: Quarter-Round Bookcase-Desk/Credenza, Left	424
KOSGCR6024.E	Extended Corner Reception Gallery: Extended Corner Reception Gallery-24", Right	374	KQRB2029L.H	Quarter-Round Bookcases: Quarter-Round Bookcase-Desk/Credenza, Left	194
KOSGCR6024.H	Extended Corner Reception Gallery: Extended Corner Reception Gallery-24", Right	146	KQRB2029R.E	Quarter-Round Bookcases: Quarter-Round Bookcase-Desk/Credenza, Right	424
KOSGCR6030.E	Extended Corner Reception Gallery: Extended Corner Reception Gallery-30", Right	376	KQRB2029R.H	Quarter-Round Bookcases: Quarter-Round Bookcase-Desk/Credenza, Right	194
KOSGCR6030.H	Extended Corner Reception Gallery: Extended Corner Reception Gallery-30", Right	148	KQRB2065L.E	Quarter-Round Bookcases: Quarter-Round Bookcase-Tower, Left	426
KOSGCR6036.E	Extended Corner Reception Gallery: Extended Corner Reception Gallery-36", Right	378	KQRB2065L.H	Quarter-Round Bookcases: Quarter-Round Bookcase-	
KOSGCR6036.H	Extended Corner Reception Gallery: Extended Corner Reception Gallery-36", Right	150			
KOSGCR6642.E	Extended Corner Reception Gallery: Extended Corner Reception Gallery-42", Right	380			
KOSGCR6642.H	Extended Corner Reception Gallery: Extended Corner Reception Gallery-42", Right	152			

## Index

Model No.	Description	Page	Model No.	Description	Page
	Tower, Left	196	KSPL4830A.E	Single Pedestal Desks-Pedestal on Left: Single Pedestal Desk-Left, Box/File Option A	232
KQRB2065R.E	Quarter-Round Bookcases: Quarter-Round Bookcase-Tower, Right	426	KSPL4830A.H	Single Pedestal Desks-Pedestal on Left: Single Pedestal Desk-Left, Box/File Option A	14
KQRB2065R.H	Quarter-Round Bookcases: Quarter-Round Bookcase-Tower, Right	196	KSPL4830B.E	Single Pedestal Desks-Pedestal on Left: Single Pedestal Desk-Left, Box/Box/File Option B	232
KQRCT2424.E	Connector Tops: Quarter-Round Connector Top	440	KSPL4830B.H	Single Pedestal Desks-Pedestal on Left: Single Pedestal Desk-Left, Box/Box/File Option B	14
KQRCT2424.H	Connector Tops: Quarter-Round Connector Top	210	KSPL4830C.E	Single Pedestal Desks-Pedestal on Left: Single Pedestal Desk-Left, File/File Option C	232
KRAL4224.E	Aluminum Frame Profile with Modesty and End Panel Inserts: Return-Aluminum Frame Profile	266	KSPL4830C.H	Single Pedestal Desks-Pedestal on Left: Single Pedestal Desk-Left, File/File Option C	14
KRAL4224.H	Aluminum Frame Profile with Modesty and End Panel Inserts: Return-Aluminum Frame Profile	46	KSPR4830A.E	Single Pedestal Desks-Pedestal on Right: Single Pedestal Desk-Right, Box/File Option A	236
KRAL4224EM.E	Aluminum Frame Profile with Modesty and End Panel Inserts: Return-Aluminum Frame Profile w/End and Modesty Panels	266	KSPR4830A.H	Single Pedestal Desks-Pedestal on Right: Single Pedestal Desk-Right, Box/File Option A	18
KRAL4224EM.H	Aluminum Frame Profile with Modesty and End Panel Inserts: Return-Aluminum Frame Profile w/End and Modesty Panels	46	KSPR4830B.E	Single Pedestal Desks-Pedestal on Right: Single Pedestal Desk-Right, Box/Box/File Option B	236
KRD304L	Metal Leg Tables and Desks: Meeting Table-Round with Slimline Metal Legs	216	KSPR4830B.H	Single Pedestal Desks-Pedestal on Right: Single Pedestal Desk-Right, Box/Box/File Option B	18
KRD304L.E	Metal Leg Tables and Desks: Meeting Table-Round with Slimline Metal Legs	446	KSPR4830C.E	Single Pedestal Desks-Pedestal on Right: Single Pedestal Desk-Right, File/File Option C	236
KRL3020A.E	Pedestal-Left: Pedestal Return-Left, Box/File Option A	256	KSPR4830C.H	Single Pedestal Desks-Pedestal on Right: Single Pedestal Desk-Right, File/File Option C	18
KRL3020A.H	Pedestal-Left: Pedestal Return-Left, Box/File Option A	38	KSQ304L	Metal Leg Tables and Desks: Meeting Table-Square with Slimline Metal Legs	216
KRL3020B.E	Pedestal-Left: Pedestal Return-Left, Box/Box/File Option B	256	KSQ304L.E	Metal Leg Tables and Desks: Meeting Table-Square with Slimline Metal Legs	446
KRL3020B.H	Pedestal-Left: Pedestal Return-Left, Box/Box/File Option B	38	KST242048L.E	24" Wide Storage Towers: Storage Tower-48" and 54" High, Left-Hinged Door	404
KRL3020C.E	Pedestal-Left: Pedestal Return-Left, File/File Option C	258	KST242048L.H	24" Wide Storage Towers: Storage Tower-48" and 54" High, Left-Hinged Door	176
KRL3020C.H	Pedestal-Left and Pedestal-Right: Pedestal Return-Left, File/File Option C	40	KST242048R.E	24" Wide Storage Towers: Storage Tower-48" and 54" High, Right-Hinged Door	404
KRR3020A.E	Pedestal-Right: Pedestal Return-Right, Box/File Option A	260	KST242048R.H	24" Wide Storage Towers: Storage Tower-48" and 54" High, Right-Hinged Door	176
KRR3020A.H	Pedestal-Right: Pedestal Return-Right, Box/File Option A	40	KST242065L.E	24" Wide Storage Towers: Storage Tower-65" and 72" High, Left-Hinged Door	404
KRR3020B.E	Pedestal-Right: Pedestal Return-Right, Box/Box/File Option B	260	KST242065L.H	24" Wide Storage Towers: Storage Tower-65" and 72" High, Left-Hinged Door	176
KRR3020B.H	Pedestal-Right: Pedestal Return-Right, Box/Box/File Option B	40	KST242465R.E	24" Wide Storage Towers: Storage Tower-65" and 72" High, Right-Hinged Door	404
KRR3020C.E	Pedestal-Right: Pedestal Return-Right, File/File Option C	262	KST362065.E	30 and 36" Storage and Wardrobe Towers: Storage Tower	414
KRR3020C.H	Pedestal-Left and Pedestal-Right: Pedestal Return-Right, File/File Option C	40	KST362065.H	30" and 36" Storage Towers/36" Storage and Wardrobe Towers: Storage Tower	184
KRWL42242L	Metal Leg Return: Metal Leg Return	214	KSW242065L.E	24" Wide Storage and Wardrobe Towers: Storage and Wardrobe Tower-65" and 72" High, Left-Hinged Door	406
KRWL42242L.E	Metal Leg Return: Metal Leg Return	444	KSW242065L.H	24" Wide Storage and Wardrobe Towers: Storage and Wardrobe Tower-65" and 72" High, Left-Hinged Door	178
KSC3020.E	Lower Storage Units - Freestanding: Storage Cabinet-Freestanding, Nonlocking	398	KSW242065R.E	24" Wide Storage and Wardrobe Towers: Storage and Wardrobe Tower-65" and 72" High, Right-Hinged Door	406
KSC3020.H	Lower Storage Units - Freestanding: Storage Cabinet-Freestanding, Nonlocking	170	KSW242065R.H	24" Wide Storage and Wardrobe Towers: Storage and Wardrobe Tower-65" and 72" High, Right-Hinged Door	178
KSCL3020.E	Lower Storage Units - Freestanding: Storage Cabinet-Freestanding, Locking	398	KSW362065.E	30 and 36" Storage and Wardrobe Towers: Storage and Wardrobe Tower	414
KSCL3020.H	Lower Storage Units - Freestanding: Storage Cabinet-Freestanding, Locking	170	KSW362065.H	30" and 36" Storage Towers/36" Storage and Wardrobe Towers: Storage and Wardrobe Tower	184
KSCT30.H	Lower Storage Units - Under Desk: Storage Cabinet-Under Desk, Nonlocking	166	KSWF242065L.E	24" Wide Storage, Wardrobe and File Towers: Storage, Wardrobe and File Tower-65" and 72" High, Left-Hinged	408
KSLF23020.E	Lateral Files-Freestanding: Lateral File-Two Drawer Freestanding	392			
KSLF23020.H	Lateral Files-Freestanding: Lateral File-Two Drawer Freestanding	164			
KSLF33020.E	Lateral Files-Freestanding: Lateral File-Three Drawer Freestanding	392			
KSLF33020.H	Lateral Files-Freestanding: Lateral File-Three Drawer Freestanding	164			
KSLF43020.E	Lateral Files-Freestanding: Lateral File-Four Drawer Freestanding	392			
KSLF43020.H	Lateral Files-Freestanding: Lateral File-Four Drawer Freestanding	164			
KSOH6022.E	Paper Management: Stack-On Organizer Hutch	434			
KSOH6022.H	Paper Management: Stack-On Organizer Hutch	204			





Model No.	Description	Page	Model No.	Description	Page
KSWF242065L.H	24" Wide Storage, Wardrobe and File Towers: Storage, Wardrobe and File Tower-65" and 72" High, Left-Hinged Door	180	KWT362065.E	Tower-48" and 54" High, Right-Hinged Door	178
KSWF242065R.E	24" Wide Storage, Wardrobe and File Towers: Storage, Wardrobe and File Tower-65" and 72" High, Right-Hinged Door	408	KWT362065.H	30" and 36" Storage and Wardrobe Towers: Wardrobe Tower	414
KSWF242065R.H	24" Wide Storage, Wardrobe and File Towers: Storage, Wardrobe and File Tower-65" and 72" High, Right-Hinged Door	180	KXCB3036.E	30" and 36" Storage Towers/36" Storage and Wardrobe Towers: Wardrobe Tower	184
KTK30	Tackboards: Tackboard for 36" High Overhead	206	KXCB3036.H	Bookcase Accessories: Desk Top Stack-On Bookcase	422
KTK3024	Tackboards: Tackboard for 43" High Overhead	206	KXES30.H	Bookcase Accessories: Desk Top Stack-On Bookcase	192
KTKC3636	Tackboards: Tackboard for Corner Symmetrical 36" High Overhead	208	TLT5.24	Bookcase Accessories: Extra Desk Top Shelves	192
KTKC363624	Tackboards: Tackboard for Corner Symmetrical 43" High Overhead	208		Task Lights: Universal Overhead Task Lights	220
KTKG66	Tackboards: Tackboard for Gallery Reception Desk	208			
KWFS242065L.E	24" Wide Wardrobe, File and Storage Towers: Wardrobe, File and Storage Tower-65" and 72" High, Left-Hinged Door	410			
KWFS242065L.H	24" Wide Storage, Wardrobe and File Towers/30" and 36" Storage Towers: Wardrobe, File and Storage Tower-65" and 72" High, Left-Hinged Door	182			
KWFS242065R.E	24" Wide Wardrobe, File and Storage Towers: Wardrobe, File and Storage Tower-65" and 72" High, Right-Hinged Door	410			
KWFS242065R.H	24" Wide Storage, Wardrobe and File Towers/30" and 36" Storage Towers: Wardrobe, File and Storage Tower-65" and 72" High, Right-Hinged Door	182			
KWMC	Grommet, Wire Management Channel, Keyed Alike Kits: Wire Management Channel	218			
KWMOD24.E	Closed Overheads: Closed Overhead-Wall Mount	354			
KWMOD24.H	Closed Overheads: Closed Overhead-Wall Mount	128			
KWMOD48.E	Closed Overheads: Closed Overhead-Wall Mount	356			
KWMOD48.H	Closed Overheads: Closed Overhead-Wall Mount	130			
KWMOD54.E	Closed Overheads: Closed Overhead-Wall Mount	358			
KWMOD54.H	Closed Overheads: Closed Overhead-Wall Mount	130			
KWMOF60.E.AL	Overhead - Frosted Glass Doors: Overhead-Wall Mount, Frosted Glass Doors	360			
KWMOF60.H.AL	Overhead - Frosted Glass Doors: Overhead-Wall Mount, Frosted Glass Doors	132			
KWMOS24.E	Open Overheads: Open Overhead-Wall Mount	350			
KWMOS24.H	Open Overheads: Open Overhead-Wall Mount	116			
KWMOS48.E	Open Overheads: Open Overhead-Wall Mount	350			
KWMOS48.H	Open Overheads: Open Overhead-Wall Mount	116			
KWMOSD42.E	Overheads-Sliding Frosted Acrylic Doors: Overhead-Wall Mount, Sliding Frosted Acrylic Doors	362			
KWMOSD42.H	Overheads-Sliding Frosted Acrylic Doors: Overhead-Wall Mount, Sliding Frosted Acrylic Doors	134			
KWMTK30	Tackboards: Wall-Mount Tackboards	206			
KWSR42184L	Metal Leg Tables and Desks: Freestanding Slimline Metal Leg Desks	216			
KWSR42184L.E	Metal Leg Tables and Desks: Freestanding Slimline Metal Leg Desks	446			
KWT242048L.E	24" Wide Storage and Wardrobe Towers: Wardrobe Tower-48" and 54" High, Left-Hinged Door	406			
KWT242048L.H	24" Wide Storage and Wardrobe Towers: Wardrobe Tower-48" and 54" High, Left-Hinged Door	178			
KWT242048R.E	24" Wide Storage and Wardrobe Towers: Wardrobe Tower-48" and 54" High, Right-Hinged Door	406			
KWT242048R.H	24" Wide Storage and Wardrobe Towers: Wardrobe				



KI  
1330 Bellevue Street  
P.O. Box 8100  
Green Bay, Wisconsin 54308-8100  
1-800-424-2432  
[www.ki.com](http://www.ki.com)

KI and Furnishing Knowledge  
are registered trademarks  
of Krueger International, Inc.

© 2011 KI  
All Rights Reserved.  
Litho in USA.  
Code KI-11578/SH/PDF/711

Printed using only water-based inks,  
including metallics. Please recycle.