

**Burke**<sup>®</sup>  
PLAY THAT MOVES YOU.



# PLAY THAT

Great playgrounds are born from great research. Watching children play and interact leads us to product lines like Novo™ Playful Furniture and Taktiks™ - products that move us to elevate our design of the best play environments for all children. The fusion

# MOVES YOU.®

of traditional and active-based play lays the foundation for an environment where everyone can develop physically, emotionally, socially and cognitively through play. It fosters opportunities for the types of experiences that bring communities together and move us in so many ways. Join our Movement and see how you can bring a higher level of play to your community!

## Burke.

WATCH THE VIDEO!



## CONTENTS

- 10 New Products
- 26 Inclusive Playgrounds
- 42 Themed Playgrounds
- 62 Play Environments
- 74 School Aged Playgrounds
- 98 Preschool Playgrounds
- 118 Structure Components
- 146 Play System Customization
- 148 Signature Play Systems
- 158 Motion Play
- 164 Early Play Centers
- 166 Freestanding Play
- 178 Swings
- 182 Novo Playful Furniture
- 184 Park & Site Amenities
- 188 Certifications & Partnerships
- 190 Burke Built™ Quality
- 191 Generations Warranty®
- 192 Color Options

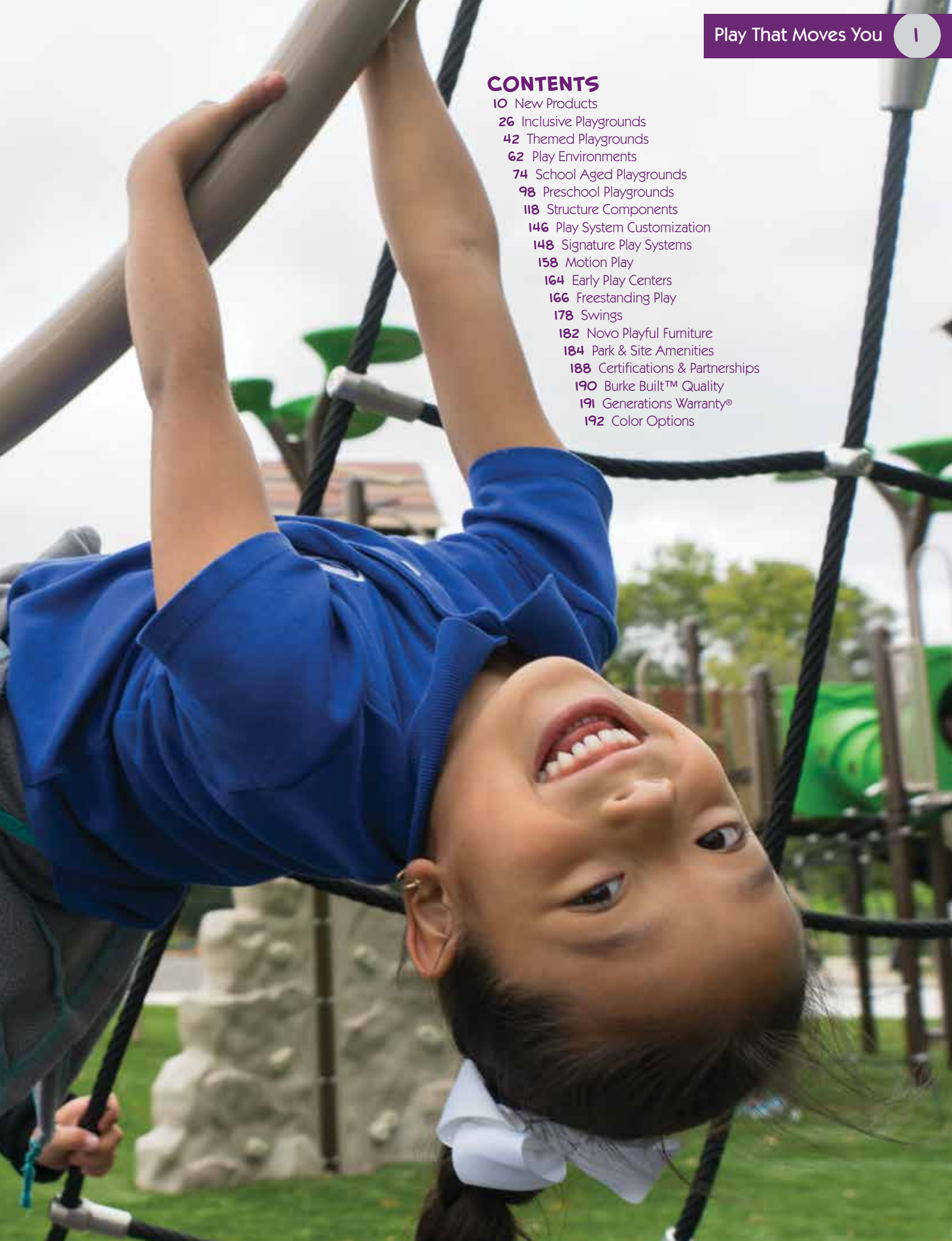



## LET'S GET MOVING!

Burke's unique Nucleus® and Intensity® playgrounds feature a fusion of traditional and fitness-based play to get kids moving like never before. Kids get a great workout while having fun! Our combination of traditional and active play events create a space where children of all abilities can play together.





## MOVE YOUR MIND!

Extensive research suggests that play provides tremendous developmental benefits to children. In fact, it's been said that children learn through play - it helps their brains and bodies develop. There's no such thing as too much of a good thing when it comes to play!



## INTERACTIONS THAT MOVE US

Play brings communities together and strengthens families and friendships. Burke's playgrounds provide amazing opportunities for kids to develop socially from playing independently at a young age, transitioning to parallel play and learning how to cooperatively play together as their development continues.



## MOTION THAT MOVES YOU

Movement is essential to life and to play. Motion play creates movement for children of all abilities and assists with many developmental areas, including increased spatial awareness, inner ear stimulation and balance. Motion can be soothing to children with sensory processing differences and offers an interactive activity for everyone to enjoy.



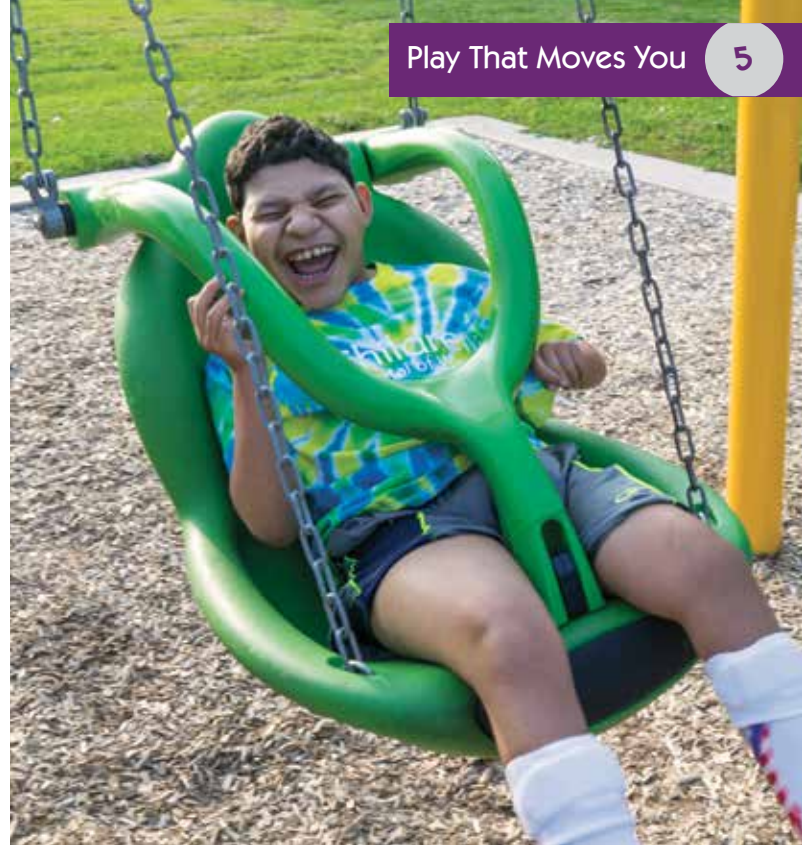

## PLAY THAT MOVES DEVELOPMENT

Play is an important part of a child's emotional development and it is often through play that they learn necessary skills such as patience and empathy. Play also helps children learn how to express and manage their feelings, which is the grounds for much of a child's future success and well-being.



## MOVE WITH US

Play brings communities together and parks and play environments provide multi-generational spaces for interaction, development and growth. With community support and participation, Friendship Park has become a true example of collaboration, dedication and care that moved an entire community to get outside and play!



## FRIENDSHIP PARK – AVONDALE, AZ

With a mission to provide community-focused open spaces and recreational opportunities, the City of Avondale, AZ worked with Play it Safe Playgrounds to involve the community in the new play environment design at Friendship Park. They did surveys, talked with community members at local events and began to envision the playspace needed for this amazing park. After developing four options, they opened it up for voting. The City of Avondale helped to encourage everyone to vote for their favorite design and the most popular design – a beautiful, colorful inclusive play environment – won the vote!

The inclusive playground is divided into multiple areas that encompass everything the community felt was important. There is a ramped play structure for ease of access for all children that includes the exciting Cruiser™ Wheelchair Accessible Rocker and an area of musical exploration and swinging in both individual and multi-user formats. There is an area of fitness play, designed to allow children to get the maximum amount of physical activity while playing. Finally, there is an area specifically for 2-5 year olds that helps them develop balance and coordination and offers an environment for them to take age-appropriate risks. Now the playground at Friendship Park is a main attraction and helps keep kids and families moving and active! Kids love the exciting variety of sliding, spinning, rocking, musical exploration and swinging!





## CAUSES THAT MOVE US

Burke cares about kids and communities. That's why we support local organizations like the Boys & Girls Club of Fond du Lac and the YMCA. These, and other supported organizations, share our mission for better communities that offer play and recreation for everyone. As part of a sustainable future for all of us, Burke's products are designed to be recyclable and minimize the impact on the environment. This commitment is demonstrated by our ISO 14001:2004 certification and environmental programs. Additionally, 100% of our factory's electricity comes from wind and other renewable sources. Burke is the only major playground manufacturer that has earned the green power partner designation from the U.S. Environmental Protection Agency.



## WORK THAT MOVES US

Bringing play to children is Work That Moves Us. We are driven to create quality and innovative playground equipment that brings a higher level of play to the communities we serve. With that, we are passionate about our customer experience and seek to maintain the best customer service in the industry.



## PRESCHOOL PLAY

Endless design options allow you to create your custom outdoor classroom, ensuring a perfect fit for your children's needs. Whether you choose a Nucleus or Intensity design to keep the little ones moving, Little Buddies® that is created and sized just for preschoolers or Voltage® for smaller budgets, we will bring you the most innovative, educational and fun playspaces.



## SCHOOL AGED PLAY

As kids grow, their play needs change and Burke is here every step of the way to make sure kids keep moving, playing and learning. Choose from our Nucleus, Intensity or Voltage product lines and know kids will receive a well-rounded education in fitness and play.



## PRODUCT LINE KEY

As you page through our catalog, look for the symbols below to identify which product family our playground designs belong to.



**NUCLEUS®**  
5" O.D. Posts  
KoreKonnnect®  
Ages 2-5 or 5-12



**INTENSITY®**  
5" O.D. Posts  
Direct-Bolt  
Ages 2-5 or 5-12



**VOLTAGE®**  
3 1/2" O.D. Posts  
KoreKonnnect  
Ages 2-5 or 5-12



**LITTLE BUDDIES®**  
2 3/8" O.D. Posts  
Direct-Bolt  
Ages 2-5



## THEMED PLAY

A themed playspace can tell a story, transform the ordinary into the extraordinary and let imaginations run wild! From nature to nautical and firefighter to astronaut, we at Burke want to move your imaginations and help create your dream playground. Theme your Nucleus playspace with Burke's awesome Ship, Rocket, Airplane or NaturePlay® products or create your unique design with our variety of Custom Panels.



## SITE FURNISHINGS

Burke offers a full line of park and site amenities that will add value and comfort to any playground, park, school or outdoor public area. A variety of PVC-Coated Steel, Wood or Recycled Plastic amenities are available for every environment.

## SAFETY SURFACING

At Burke, we offer great surfacing solutions to help keep your kids safer while providing an attractive, accessible playground site. Burke Turf® and Burke Tiles are eco-friendly, extremely-durable and look great!



WATCH THE VIDEO! 



## NEW VOLTA™ INCLUSIVE SPINNER

The universally designed Volta Inclusive Spinner is a spinning social space designed for users of all shapes, sizes and abilities. Multiple seating positions allow everyone to play in the same space - outward facing seats provide a high level of independence while inward facing seats with high backs allow for younger users to stay securely in place. For more advanced riders to challenge their balance and coordination, the Volta has a saddle seat that provides the adventure they are looking for! With room for up to nine children, Volta Inclusive Spinner provides opportunities for interaction and conversation while children of all abilities gain skills that transcend the playground.

SEE PAGE 158 FOR MORE INFORMATION.



### OUTWARD FACING SEATS

Designed for wheelchair access



### INWARD FACING SEATS





WATCH THE VIDEO!



## NEW ARA SHADES

The addition of Ara to a play environment can change the entire look of the space and elevate the design to a whole new level! Ara's appeal extends past a beautiful exterior. It provides protection from the sun with 97% UV screen protection and is designed to withstand up to 90 mph winds. With four new models to add to the existing shade line, Ara is more versatile and beautiful than ever.

SEE PAGE 144 FOR MORE INFORMATION.



ARA POLY SHADE



ARA CHI SHADE



ARA DIA SHADE



ARA CLOVER SHADE



**WATCH THE VIDEO!** 

## NEW NOVO™ PLAYFUL FURNITURE

*Patent Pending*

What if we could put the “play” back into playground furniture? What if we could create a category of multi-purpose site amenities that can be used in all NEW ways? Novo Playful Furniture is that category and the time is now. Novo Playful Furniture combines form and function to create fun and creative site amenities that can be seamlessly integrated into play areas or used as part of an outdoor classroom. Balance on the Novo Arc Bench, relax and socialize on the Novo Table or learn and interact at the Novo Teardrop Counter Climber. Whatever you decide to do while using Novo, you will be promoting socialization and multi-generational interaction.



**SEE PAGES 141 AND 182 FOR MORE INFORMATION.**

**NOVO ARC BENCH & STOOL**

**NOVO SIGNS**



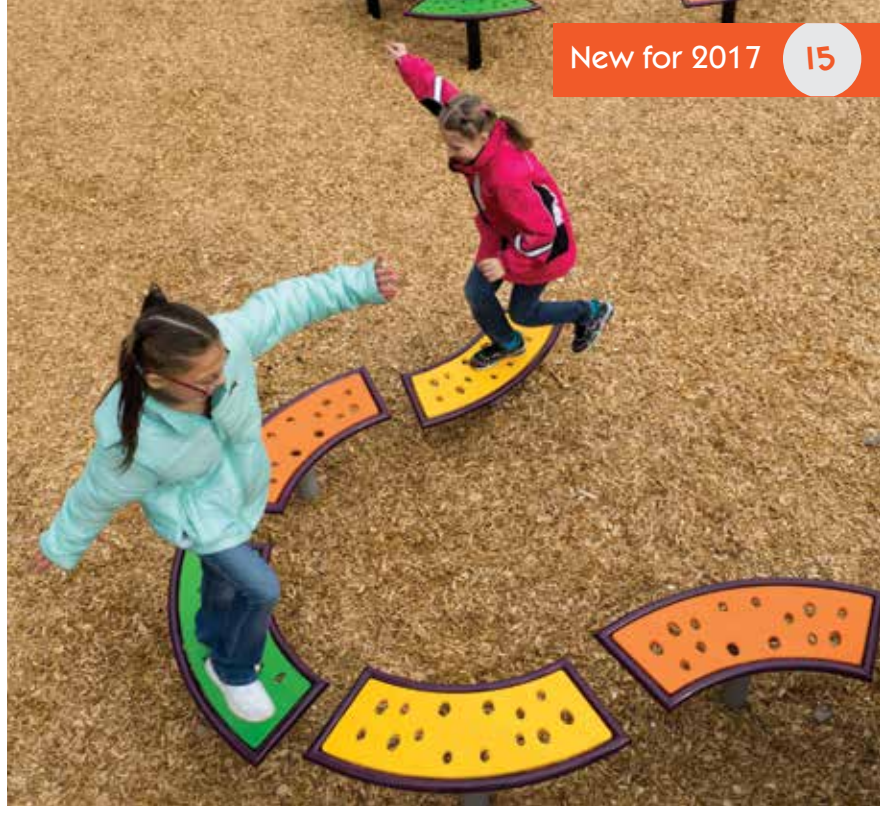

NOVO TABLE



NOVO BENCH

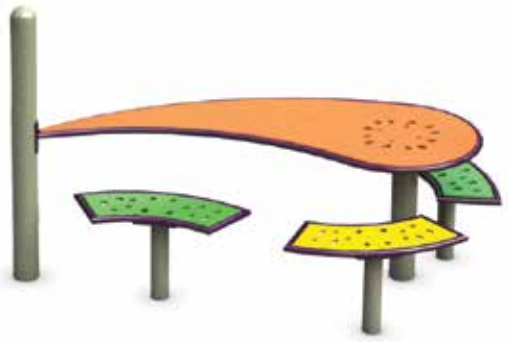

NOVO TEARDROP COUNTER CLIMBER



**WATCH THE VIDEO!**



## **NEW ZIPVENTURE™**

Flying through the air on a suspended cable, this ride is like nothing else on the playground! Fast and exhilarating, the ZipVenture Zip Line keeps you moving from one end to the other! With built-in elevation, kids will move fast and have fun while developing vestibular and proprioceptive senses, imaginative and social play and balance, coordination and strength.

**SEE PAGE 161 FOR MORE INFORMATION.**



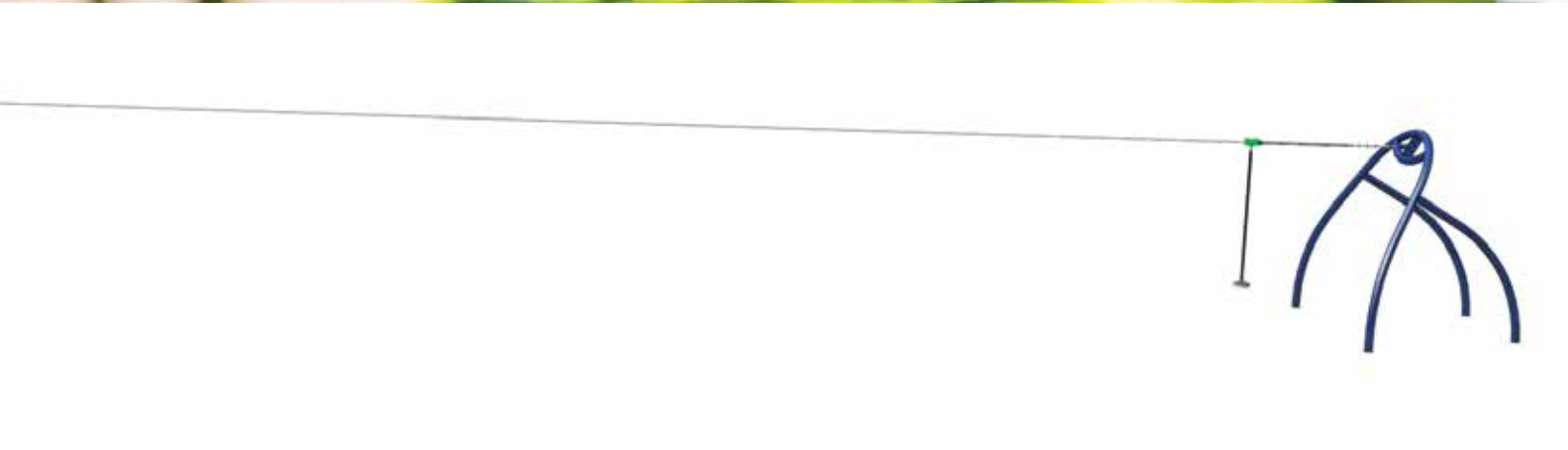

## NEW SLIDES

Slides have long been a playground staple and for good reason, they keep kids moving and having fun while they develop core strength and balance! Burke's latest innovation in sliding elevates the experience of the traditional slide! The Luge™ allows kids to race each other down to the bottom and the Velo™ offers a fun, fast ride with a little extra drop that makes kids want to slide again and again. Choose these or any of the Burke slides to add fun and excitement to your playground!

SEE PAGE 132-133 FOR MORE INFORMATION.



LUGE™ SLIDE



EXTRA DROP FOR  
A FUN, FAST RIDE!

VELO™ SLIDE





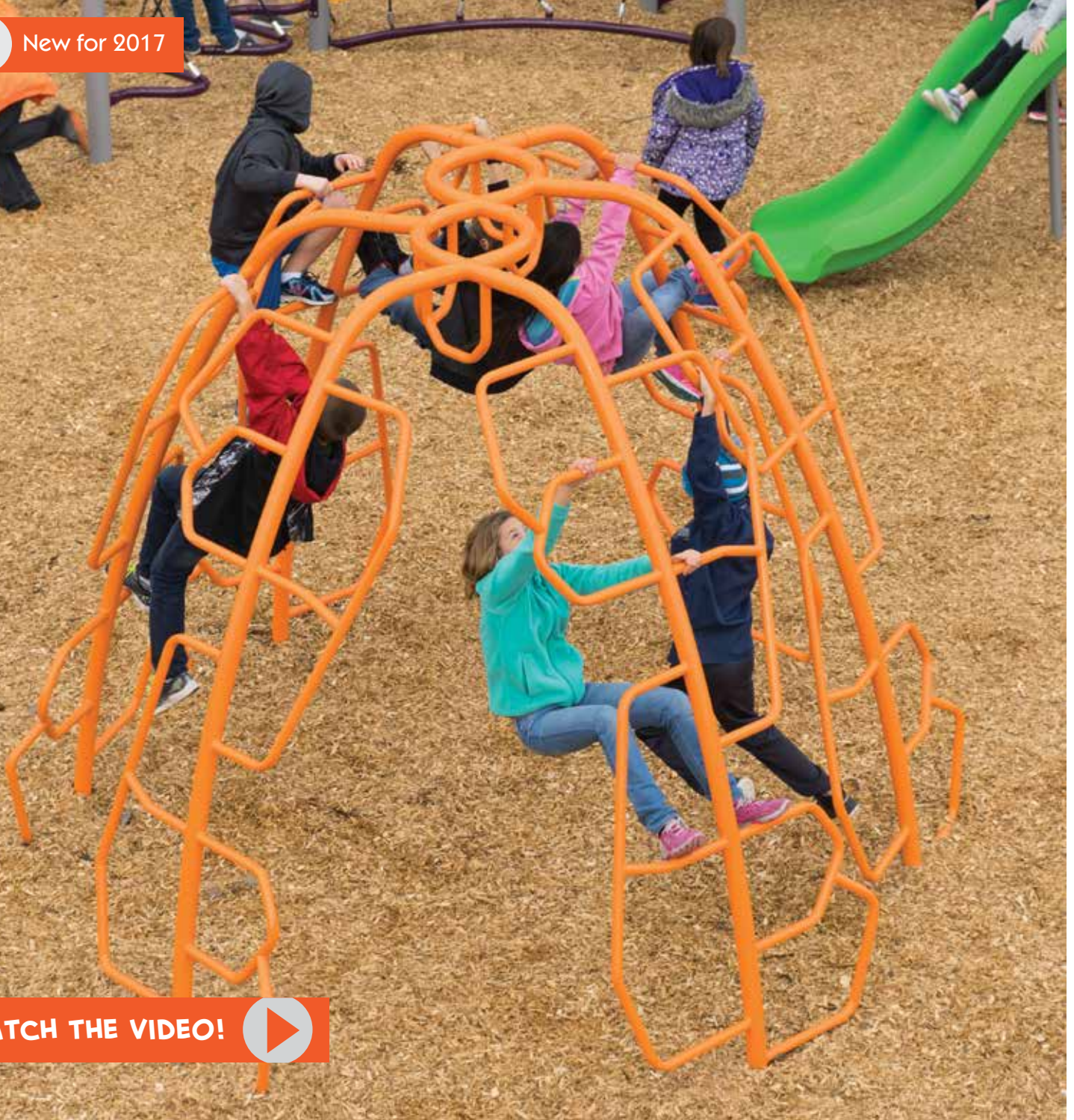

WATCH THE VIDEO!



## NEW VERVE™ CLIMBERS

Vigor. Energy. Spirit. Introducing Verve Climbing Systems - a climbing experience that encompasses all the meanings of its namesake with interesting, energetic design lines that provide random climbing paths for children. With Verve, choice is key and kids can choose to climb on the inside or outside, vertically, traverse or overhead. The collection itself offers five configurations and color customization options so the Verve can blend seamlessly into any play environment.

SEE PAGE 174 FOR MORE INFORMATION.



VERVE III



VERVE IV



VERVE V



VERVE VI

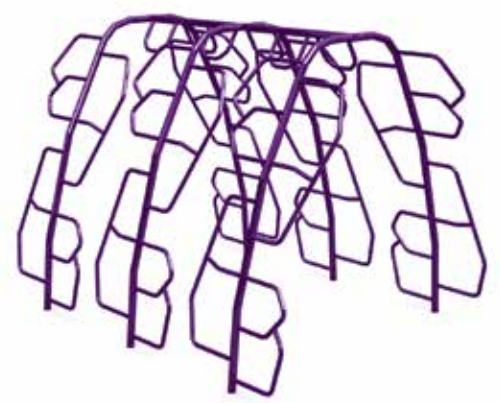

VERVE VI ARCH



WATCH THE VIDEO!







## NEW TAKTIKS™ BOLT

Taktiks is a manifestation of Play That Moves You with endless developmental opportunities and unmatched play value. The name hails from descriptors of this unique collection - Tactical, Tactile, Tactics - and provides users with an unforgettable experience. Using unexpected materials and shapes, Taktiks provides endless climbing, traversing and balancing opportunities for children ages 5-12. Taktiks is Burke's whole new way to see play and the collection is full of purposefully designed products that will move you!

SEE PAGE 118 FOR MORE INFORMATION.



TAKTIKS BOLT



## NEW PODSTEP CLIMBERS

Full of challenge and fun, PodStep Climbers will move kids' bodies and minds as they climb up, down and around these moving pods!

SEE PAGE 119 FOR MORE INFORMATION.



POD STEP LINK



POD STEP CLIMBER



WATCH THE VIDEO!



## NEW PLAYHOUSE

Imagination comes to life inside the Burke PlayHouse! Have a tea party, set-up a storefront or play games in this whimsical, fun play event that helps children to develop skills such as cooperation, problem solving and imaginative play. With countless options to customize colors throughout the space, you can make the PlayHouse your own!

SEE PAGE 166 FOR MORE INFORMATION.



**BENCH & COUNTER**



**PLAYHOUSE**



**BEAN BENCH**



WATCH THE VIDEO!



THE CRUISE



## OWEN'S PLAYGROUND

Through hard work and perseverance, dreams can become a reality. On the first day of first grade at Hillcrest, Margaret Chaidez watched her son Owen ride off in his wheelchair to play with friends on the playground. After the children went inside, Chaidez didn't see Owen and found him stuck behind one of the structures. That day she promised him she would find a way to create a playspace he could fully utilize, one that was safe and fun for all children. Enter Owen's Playground for Children of All Abilities. This universally designed play environment has double-wide ramps, a Cruiser™ Wheelchair Accessible Rocker, sensory panels, overheads and more - all with safety surfacing that accommodates wheelchairs and other mobility devices. Although at a school, Owen's Playground is open to the community and is the perfect place to bring everyone, of all abilities, together.





## HILLCREST ELEMENTARY – DOWNERS GROVE, IL

Number	Product ID	Description	Ages	Price*	Play Events	Capacity	ASTM Use Zone
	NUIN-2565	Entire Play Space**	5-12	\$301,100	111	616 Kids	126' x 239' (38.4m x 72.9m)
1	580-0172	Traditional Series 6' Bench	N/A	\$487	N/A	N/A	N/A
2	560-0583	RopeVenture® Vertex	5-12	\$15,000	1	25 Kids	28' x 28' (8.5m x 8.5m)
3	550-0186	Volito™ Multi-User Swing	2-12	\$5,470	1	4 Kids	30' x 27' (9.2m x 8.3m)
4	550-0187	Volito Add-On	2-12	\$6,236	1	4 Kids	N/A
5	NUIN-2566	Ramped Structure	5-12	\$200,800	57	457 Kids	91' x 117' (27.8 x 35.7m)
6	BB-2568	RockIt™ Climber	5-12	\$10,100	9	28 Kids	18' x 34' (5.5m x 10.4m)
7	BB-2321	Sound Garden	2-12	\$6,900	3	12 Kids	N/A
8	560-2571	Comet II	5-12	\$1,632	1	6 Kids	16' (4.9m) diameter
9	560-2570	Comet I	5-12	\$1,632	1	6 Kids	16' (4.9m) diameter
10	560-0576	REV8 Rotating Climber	5-12	\$16,115	8	25 Kids	25' (7.7m) diameter
11	590-0062	Funnel Ball®	2-12	\$860	1	6 Kids	N/A
12	see page 178	Arch Swings	2-12	See pages 178-181 for complete swing selection.			
13	see page 146	Custom Signs		Contact your local Burke Representative for more information.			

\*Approximate list price. Surfacing, freight, taxes and installation are extra. Specifications and pricing subject to change without notice.

\*\*Custom Signs not included in price.

**Warning:** Never install play equipment over hard surfaces such as asphalt, concrete, grass or compacted earth. Consult ASTM and CPSC guidelines for appropriate amounts of impact attenuating material.







WATCH THE VIDEO!



## FRIENDSHIP PARK – AVONDALE, AZ

Number	Product	Description	Ages	Price*	Play Events	Capacity	ASTM Use Zone
	NU-2601	Entire Playspace	2-5 & 5-12	\$223,500	63	438 Kids	140' x 122' (42.7m x 37.2m)
1	NU-2600	Ramp Structure**	5-12	\$84,600	21	206 Kids	53' x 72' (16.2m x 22m)
2	BB-2336	Sound Garden	2-12	\$3,600	3	12 Kids	N/A
3	560-0544	RockIt Tunnel	2-12	\$3,259	1	8 Kids	18' x 21' (5.5m x 6.4m)
4	NUIN-2533	Nucleus-Intensity Structure†	5-12	\$45,000	11	72 Kids	45' x 45' (13.8m x 13.8m)
5	560-0576	REV8 Rotating Climber	5-12	\$16,115	8	25 Kids	25' (7.7m) diameter
6	560-0573	Wobbly Web	2-12	\$6,306	1	10 Kids	23' (7m) diameter
7	550-0186	Volito Multi-User Swing	2-12	\$5,470	1	4 Kids	30' x 27' (9.2m x 8.3m)
8	550-0187	Volito Add-On	2-12	\$6,236	1	4 Kids	N/A
9	NUIN-2454	Intensity Structure**	2-5	\$32,700	15	60 Kids	42' x 39' (12.8m x 11.9m)
10	560-2573	KidForce Spinner	2-12	\$659	1	1 Kid	14' (4.3m) diameter
11	560-2570	Comet I	5-12	\$1,632	1	6 Kids	16' (4.9m) diameter
12	see page 178	Arch Swings	2-12				

See pages 178-181 for complete swing selection.

\*Approximate list price. Surfacing, freight, taxes and installation are extra. Specifications and pricing subject to change without notice.

\*\*Custom Arch Sign not included in price.

† Structure modified to meet ADA requirements outside this play environment.

**Warning:** Never install play equipment over hard surfaces such as asphalt, concrete, grass or compacted earth. Consult ASTM and CPSC guidelines for appropriate amounts of impact attenuating material.







Shade not provided by Burke.





WATCH THE VIDEO!



## HOPE PLAYGROUND - REDMOND, OR

Number	Product ID	Description	Ages	Price*	Play Events	Capacity	ASTM Use Zone
	NUIN-2606	Entire Playspace**	2-5 & 5-12	\$260,700	56	489 Kids	153' x 119' (46.7m x 36.3m)
1	NUIN-2605	Ramped Structure**	5-12	\$198,200	46	391 Kids	86' x 86' (26.3m x 26.3m)
2	550-0186	Volito Multi-User Swing	2-12	\$5,470	1	4 Kids	30' x 27' (9.2m x 8.3m)
3	NU-2315	Cruiser with Ramp	2-12	\$17,100	1	24 Kids	26' x 23' (8m x 7m)
4	560-0544	RockIt Tunnel	2-12	\$3,259	1	8 Kids	18' x 21' (5.5m x 6.4m)
5	580-0275	Step 'N' Scoot †	6-23 months	\$2,071	7 features	8 Kids	8' x 12' (2.5m x 3.7m)
6	580-0278	Kiddy Korral †	6-23 months	\$3,654	12 features	15 Kids	12' x 12' (3.7m x 3.7m)
7	550-0141	Tot Swing	2-5	\$980	1	1 Kid	19' x 17' (5.8m x 5.2m)
8	3D-1316	Double Rail Slide	2-12	\$3,300	1	7 Kids	24' x 16' (7.4m x 4.9m)
9	560-0559	NaturePlay® Log Tunnel	2-12	\$6,055	1	3 Kids	17' x 15' (5.2m x 4.6m)
10	560-0553	NaturePlay Stump - Small	2-12	\$660 each	1	1 Kid	N/A
11	560-0578	Freestanding Shade	N/A	\$4,329	N/A	N/A	N/A
12	N/A	Embankment Slide	5-12	Contact your Burke Representative for more information.			

\*Approximate list price. Surfacing, freight, taxes and installation are extra. Specifications and pricing subject to change without notice.

\*\*Custom Arch Sign not included in price. † Custom colors shown. Contact your Burke Representative for more information.

**Warning:** Never install play equipment over hard surfaces such as asphalt, concrete, grass or compacted earth. Consult ASTM and CPSC guidelines for appropriate amounts of impact attenuating material.





Site furnishings are not provided by Burke.





## SQUAW VALLEY PARK TOWNSHIP OF O'HARA, PA

Number	Product ID	Description	Ages	Price*	Play Events	Capacity	ASTM Use Zone
	NU-2569	Entire Playspace	2-5 & 5-12	\$130,200	44	295 Kids	76' x 69' (23.2m x 21.1m)
1	NU-2571	Ramp Structure**	2-12	\$114,900	33	257 Kids	59' x 64' (18m x 19.5m)
2	570-0768	Dolphin Rider	2-12	\$1,093	1	1 Kid	16' x 14' (4.9m x 4.3m)
3	IN-2570	Intensity Structure	5-12	\$7,400	5	18 Kids	32' x 19' (9.8m x 5.8m)
4	560-2570	Comet I	5-12	\$1,632	1	6 Kids	16' (4.9m) diameter
5	560-0007	Fireman Climber	5-12	\$1,236	1	8 Kids	16' (4.9m) diameter
6	580-1294	Full Color Welcome Sign	5-12	\$500	N/A	N/A	N/A
7	see page 178	Single Post Swings	2-12				

See pages 178-181 for complete swing selection.

\*Approximate list price. Surfacing, freight, taxes and installation are extra. Specifications and pricing subject to change without notice.

\*\*This playground, as designed, can be used by the 2-5 or 5-12 age group and complies with the ASTM and CPSC standards as written.

**Warning:** Never install play equipment over hard surfaces such as asphalt, concrete, grass or compacted earth. Consult ASTM and CPSC guidelines for appropriate amounts of impact attenuating material.





**WATCH THE VIDEO!** 





WATCH THE VIDEO!



## STONER-THOMAS SCHOOL - LEXINGTON, NC

Number	Product ID	Description	Ages	Price*	Play Events	Capacity	ASTM Use Zone
	NU-2575	Entire Playspace**	2-12	\$163,800	46	311 Kids	80' x 88' (24.4m x 26.9m)
1	NU-2576	Ramped Structure**	2-12	\$127,500	29	268 Kids	74' x 53' (22.6m x 16.2m)
2	580-1290	Double Sand & Water Table	2-12	\$2,941	3	14 Kids	N/A
3	BB-2321	Sound Garden	2-12	\$6,900	3	12 Kids	N/A
4	580-0172	Traditional Series 6' Bench	N/A	\$487	N/A	N/A	N/A
5	580-0226	Traditional Series 8' ADAAG Table	N/A	\$973	N/A	N/A	N/A
6	560-0580	Freestanding Shade	N/A	\$4,703	N/A	N/A	N/A
7	570-0823	Helicopter Rocker	2-12	\$1,093	1	1 Kid	16' x 14' (4.9m x 4.3m)
8	570-0836	Police Car Rocker	2-12	\$1,093	1	1 Kid	16' x 14' (4.9m x 4.3m)
9	570-0758	White Bronc Rock 'N' Ride	2-12	\$1,003	1	1 Kid	14' x 15' (4.3m x 4.6m)
10	570-0751	Antique Car Rock 'N' Ride	2-12	\$1,003	1	1 Kid	14' x 15' (4.3m x 4.6m)
11	See page 178	Arch Swings	2-12				See pages 178-181 for complete swing selection.

\*Approximate list price. Surfacing, freight, taxes and installation are extra. Specifications and pricing subject to change without notice.

\*\*This playground, as designed, can be used by the 2-5 or 5-12 age group and complies with the ASTM and CPSC standards as written. Custom Arch Sign not included in price.

**Warning:** Never install play equipment over hard surfaces such as asphalt, concrete, grass or compacted earth. Consult ASTM and CPSC guidelines for appropriate amounts of impact attenuating material.







## PLAY 60 ALL ACCESS PLAYGROUND OF MORRIS COUNTY

**NU-2395** Ages 5-12

Approximately \$176,700\*

46 Play Events | 423 Kid Capacity

81' x 96' (24.6m x 29.3m) ASTM Use Zone



\*Approximate list price. Surfacing, freight, taxes and installation are extra. Specifications and pricing subject to change without notice.

**Warning:** Never install play equipment over hard surfaces such as asphalt, concrete, grass or compacted earth. Consult ASTM and CPSC guidelines for appropriate amounts of impact attenuating material.





**NUIN-2592** Ages 2-5 & 5-12  
CONTACT YOUR LOCAL BURKE REPRESENTATIVE  
FOR DETAILS ON THIS INCLUSIVE DESIGN







TAKE THE TOUR! 

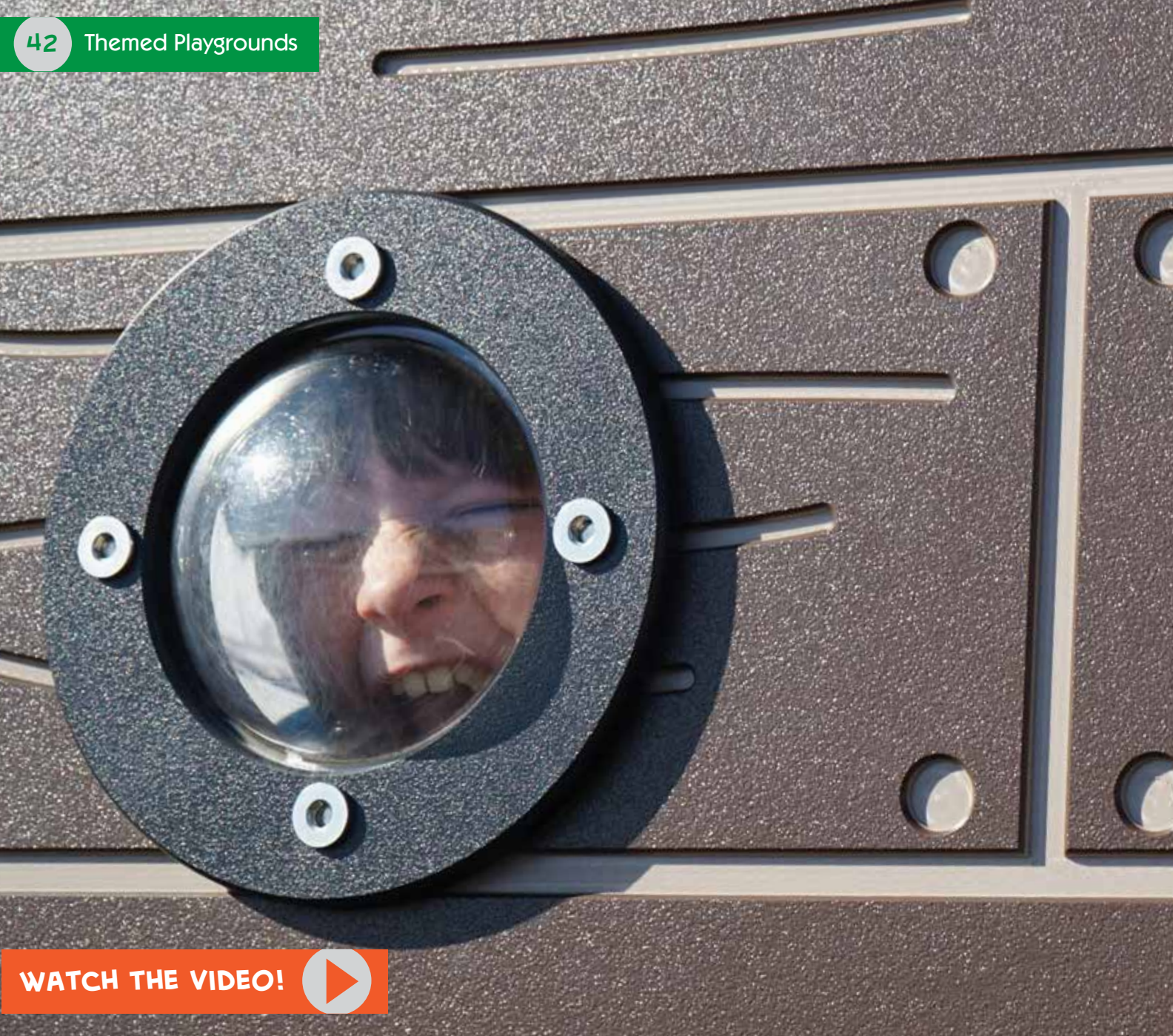

WATCH THE VIDEO!





## MARINE PARK

With a location overlooking Drayton Harbor in Blaine, WA, the Marine Park playground is an example of a fun, unique, creative and educational play environment that helps tell the history of a city. The water has long been an important part of Blaine, so a ship and lighthouse combination was a natural choice for the theme of the playspace. It not only offers excellent play value, but also pays tribute to a long relationship between the town and the body of water it relies on for industry, tourism and recreation.

Children love the imaginative play pieces such as numerous decks and panels that make it feel like a “real” ship. A large climbing rock, slides and plenty of room to run help kids stay active and have fun in this beautiful destination play environment.

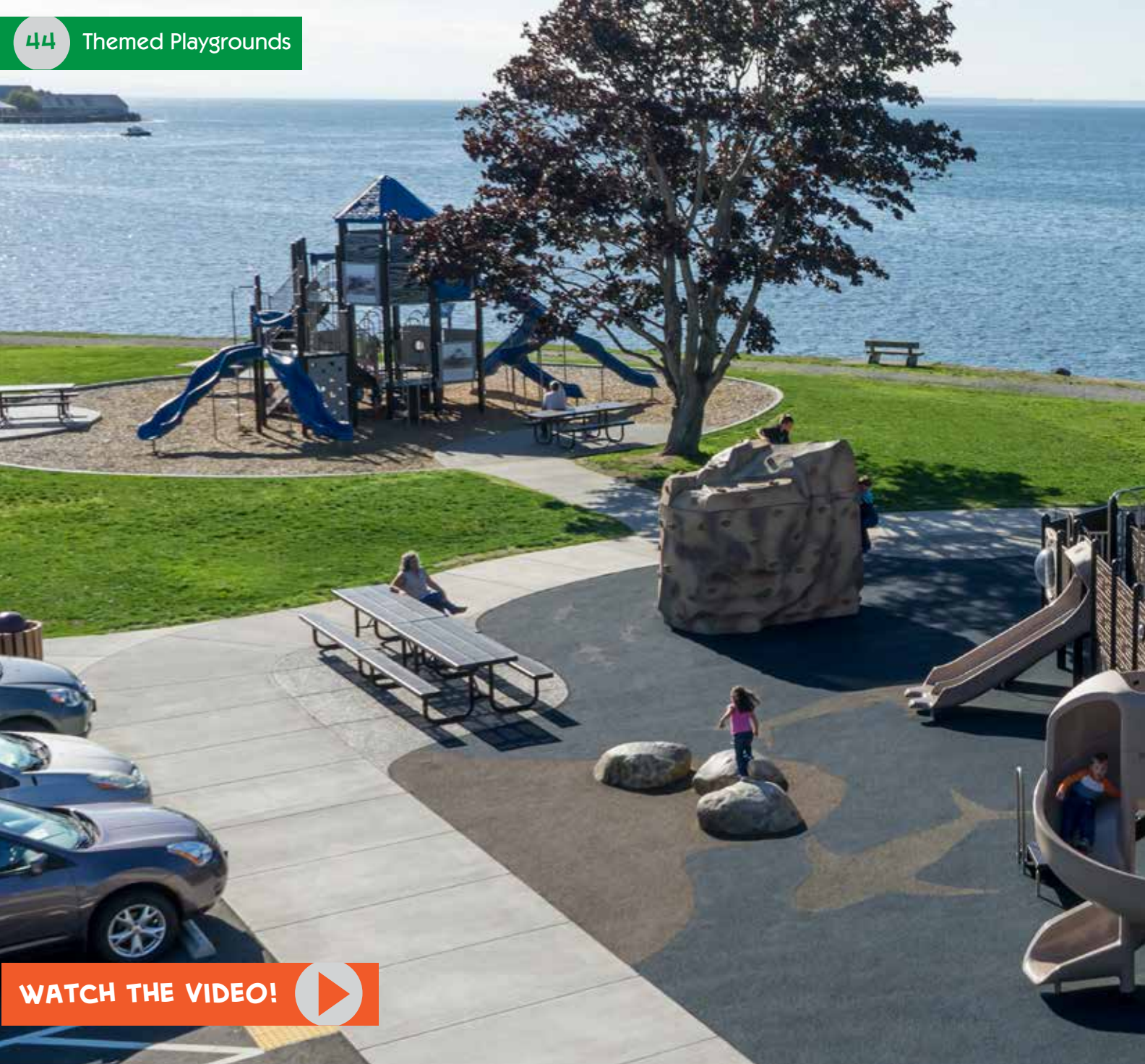

WATCH THE VIDEO! 



### MARINE PARK - BLAINE, WA

CONTACT YOUR LOCAL BURKE REPRESENTATIVE FOR MORE INFORMATION ON THIS CUSTOM DESIGN.

**Warning:** Never install play equipment over hard surfaces such as asphalt, concrete, grass or compacted earth. Consult ASTM and CPSC guidelines for appropriate amounts of impact attenuating material.







WATCH THE VIDEO! 



### CITY CENTER - BROKEN BOW, NE

CONTACT YOUR LOCAL BURKE REPRESENTATIVE FOR MORE INFORMATION ON THIS CUSTOM DESIGN.

**Warning:** Never install play equipment over hard surfaces such as asphalt, concrete, grass or compacted earth. Consult ASTM and CPSC guidelines for appropriate amounts of impact attenuating material.









WATCH THE VIDEO!



### PARKER'S PARK - WEST, TX

CONTACT YOUR LOCAL BURKE REPRESENTATIVE FOR MORE INFORMATION ON THIS CUSTOM DESIGN.

**Warning:** Never install play equipment over hard surfaces such as asphalt, concrete, grass or compacted earth. Consult ASTM and CPSC guidelines for appropriate amounts of impact attenuating material.





Fireman helmet roof not provided by Burke.





WATCH THE VIDEO!



## ST. MARY'S SPRINGS ACADEMY FOND DU LAC, WI

CONTACT YOUR LOCAL BURKE REPRESENTATIVE FOR MORE CLUBHOUSE DESIGNS.

Number	Product	Description	Ages	Price*	Play Events	Capacity	ASTM Use Zone
1	560-0576	REV8 Rotating Climber	5-12	\$16,115	8	25 Kids	25' (7.7m) diameter
2	NUNP-2438	ClubHouse Structure	5-12	\$92,800	28	172 Kids	54' x 57' (22m x 20.8m)
3	560-2570	Comet I	5-12	\$1,632	1	6 Kids	16' (4.9m) diameter

\*Approximate list price. Surfacing, freight, taxes and installation are extra. Specifications and pricing subject to change without notice.

**Warning:** Never install play equipment over hard surfaces such as asphalt, concrete, grass or compacted earth. Consult ASTM and CPSC guidelines for appropriate amounts of impact attenuating material.







## BURKE AIRPLANE

CONTACT YOUR LOCAL BURKE REPRESENTATIVE FOR MORE AIRPLANE DESIGNS.

**NU-2394** Ages 5-12

Approximately \$49,400\*

13 Play Events | 63 Kid Capacity

33' x 64' (10.1m x 19.5m) ASTM Use Zone



*\*Approximate list price. Surfacing, freight, taxes and installation are extra. Specifications and pricing subject to change without notice.*

**Warning:** Never install play equipment over hard surfaces such as asphalt, concrete, grass or compacted earth. Consult ASTM and CPSC guidelines for appropriate amounts of impact attenuating material.











NU-2082 Ages 2-5



LB-2590 Ages 2-5



CONTACT YOUR LOCAL BURKE REPRESENTATIVE FOR DETAILS ON THIS CUSTOM DESIGN.

WATCH THE VIDEO!



## BURKE TIMBER TOWER

CONTACT YOUR LOCAL BURKE REPRESENTATIVE FOR MORE TIMBER TOWER DESIGNS.

**NUNP-2376** Ages 5-12

Approximately \$77,600\*

7 Play Events | 35 Kid Capacity

30' x 36' (9.2m x 11m) ASTM Use Zone



A PART OF atkore

\*Approximate list price. Surfacing, freight, taxes and installation are extra. Specifications and pricing subject to change without notice.

**Warning:** Never install play equipment over hard surfaces such as asphalt, concrete, grass or compacted earth. Consult ASTM and CPSC guidelines for appropriate amounts of impact attenuating material.







NU-2439 Ages 2-5



NU-2185 Ages 5-12





CONTACT YOUR LOCAL BURKE REPRESENTATIVE FOR DETAILS ON THIS CUSTOM DESIGN.



CONTACT YOUR LOCAL BURKE REPRESENTATIVE FOR DETAILS ON THIS CUSTOM DESIGN.





**NUNP-2508** Ages 2-5 and 5-12  
CONTACT YOUR LOCAL BURKE REPRESENTATIVE  
FOR MORE CLUBHOUSE DESIGNS.



**NUNP-2472** Ages 5-12



**NUNP-2524** Ages 5-12





WATCH THE VIDEO!







## STARING LAKE PARK

Taking advantage of the natural features of the setting and incorporating all types of play from imaginative to cognitive to physical, the city of Eden Prairie began the redesign of Staring Lake Park's playground to give it a fresh look, make it more interesting to kids and families and create a multi-generational gathering space for the community to enjoy.

With a robust area for imaginative play that includes a "stage", Sound Garden and a PlayHouse, kids can let their imaginations guide them in hours of fun and cooperative play. The areas for children 2-5 and 5-12 engage kids physically and help them get much-needed exercise. Verto Climbers and embankment slides take advantage of the unique topography to make the transition up or down between play areas. The result of all of the efforts is an incredible, diverse play environment that offers an amazing experience for kids and families in the Eden Prairie area.





## STARLING LAKE PARK - EDEN PRAIRIE, MN

Number	Product ID	Description	Ages	Price*	Play Events	Capacity	ASTM Use Zone
1	BB-2321	Sound Garden	2-12	\$6,900	3	12 Kids	N/A
2	BB-2336	Sound Garden	2-12	\$3,600	3	12 Kids	N/A
3	560-2575	PlayHouse, Benches & Counter	2-5	\$4,794	14	12 Kids	18' x 23' (5.5m x 7m)
4	NUIN-2451	Nucleus-Intensity Structure	2-5	\$24,900	10	41 Kids	35' x 35' (10.7m x 10.7m)
5	560-2573	KidForce Spinner	2-12	\$659	1	1 Kid	14' (4.3m) diameter
6	570-0771	Tri-Rider	2-12	\$3,521	3	3 Kids	21' (6.4m) diameter
7	550-0141	Tot Swing	2-5	\$980	1	1 Kid	19' x 17' (5.8m x 5.2m)
8	370-0851	Verto Climber (5 shown)	5-12	\$1,871 each	1	3 Kids	15' x 15' (4.6m x 4.6m)
9	NUIN-2579	Nucleus-Intensity Structure	5-12	\$51,100	14	105 Kids	56' x 47' (17.1m x 14.4m)
10	560-0583	RopeVenture Vertex	5-12	\$15,000	1	25 Kids	28' x 28' (8.5m x 8.5m)
11	550-0186	Volito Multi-User Swing	2-12	\$5,470	1	4 Kids	30' x 27' (9.2m x 8.3m)
12	See page 178	Single Post Swings	2-12		See pages 178-181 for complete swing selection.		
13	N/A	Embarkment Slide	2-12		Contact your Burke Representative for more information.		

CONTACT YOUR LOCAL BURKE REPRESENTATIVE FOR MORE DETAILS ON THIS CUSTOM DESIGN.

\*Approximate list price. Surfacing, freight, taxes and installation are extra. Specifications and pricing subject to change without notice.

**Warning:** Never install play equipment over hard surfaces such as asphalt, concrete, grass or compacted earth. Consult ASTM and CPSC guidelines for appropriate amounts of impact attenuating material.





Shade structure not provided by Burke.





Number	Product ID	Description	Ages	Price*	Play Events	Capacity	ASTM Use Zone
	NUIN-2574	Entire Playspace	2-5 & 5-12	\$108,200	40	193 Kids	60' x 100' (18.3m x 30.5m)
1	560-2581	Verve Climber VI	5-12	Contact us	1	14 Kids	23' x 23' (7m x 7m)
2	560-0457	Swift Twist	2-12	\$1,054	1	1 Kid	14' (4.3m) diameter
3	NUIN-2572	Nucleus-Intensity Structure	5-12	\$57,100	18	81 Kids	51' x 45' (15.6m x 13.8m)
4	560-2575	PlayHouse, Benches & Counter	2-5	\$4,794	14	12 Kids	18' x 23' (5.5m x 7m)
5	NUIN-2573	Nucleus-Intensity Structure	2-5	\$28,900	13	57 Kids	40' x 39' (12.2m x 11.9m)
6	560-2579	Volta Inclusive Spinner	2-12	Contact us	1	9 Kids	20' (6m) diameter
7	580-1314	Novo Benches	N/A	Contact us	N/A	3 People	N/A
8	580-1313	Novo Table	N/A	Contact us	N/A	7 People	N/A
9	580-1312	Novo Arc Benches	N/A	Contact us	N/A	2 People	N/A

\*Approximate list price. Surfacing, freight, taxes and installation are extra. Specifications and pricing subject to change without notice.

**Warning:** Never install play equipment over hard surfaces such as asphalt, concrete, grass or compacted earth. Consult ASTM and CPSC guidelines for appropriate amounts of impact attenuating material.





**WATCH THE VIDEO!** 





## DELTA PARK - COON RAPIDS, MN

Number	Product ID	Description	Ages	Price*	Play Events	Capacity	ASTM Use Zone
	NUIN-2602	Entire Playspace	2-5 & 5-12	\$86,700	33	143 Kids	75' x 81' (22.9m x 24.7m)
1	NUIN-2583	Nucleus-Intensity Structure	5-12	\$53,400	16	90 Kids	58' x 47' (17.7m x 14.4m)
2	560-2573	KidForce Spinner	2-12	\$659	1	1 Kid	14' (4.3m) diameter
3	560-0457	Swift Twist Spinner	2-12	\$1,054	1	1 Kid	14' (4.3m) diameter
4	560-2571	Comet II	5-12	\$1,632	1	6 Kids	16' (4.9m) diameter
5	560-2575	PlayHouse, Benches & Counter	2-5	\$4,794	14	12 Kids	18' x 23' (5.5m x 7m)
6	NUIN-2584	Nucleus-Intensity Structure	2-5	\$21,400	7	28 Kids	28' x 35' (8.6m x 10.7m)
7	See page 178	Single Post Swings			See pages 178-181 for complete swing selection		

\*Approximate list price. Surfacing, freight, taxes and installation are extra. Specifications and pricing subject to change without notice.

**Warning:** Never install play equipment over hard surfaces such as asphalt, concrete, grass or compacted earth. Consult ASTM and CPSC guidelines for appropriate amounts of impact attenuating material.



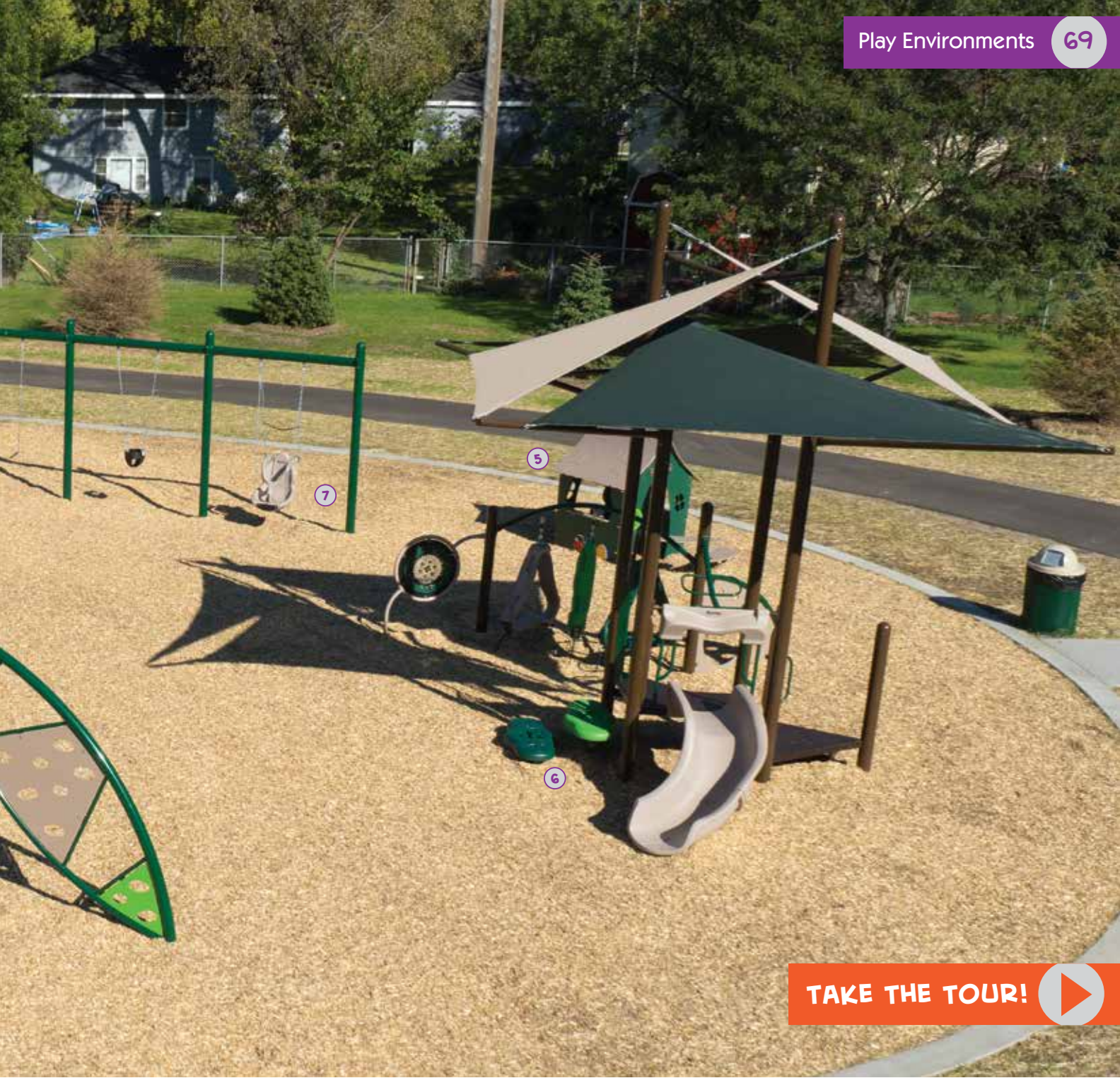



**WATCH THE VIDEO!** 

## PACIFIC PARK - SPRINGFIELD, OR

Number	Product ID	Description	Ages	Price*	Play Events	Kid Capacity	ASTM Use Zone
	NUIN-2607	Entire Playspace	2-5 & 5-12	\$80,100	53	145 Kids	100' x 170' (30.5m x 51.9m)
1	NUIN-2509	Nucleus-Intensity Structure	5-12	\$41,400	20	77 Kids	64' x 50' (19.5m x 15.3m)
2	IN-2523	Intensity Structure	2-5	\$29,200	24	50 Kids	33' x 44' (10.1m x 13.5m)
3	570-0770	Dynamic Surfer	2-12	\$1,214	1	2 Kids	14' x 16' (4.3m x 4.9m)
4	580-0280	Sand/Water Table	2-12	\$1,273	1	8 Kids	N/A
5	580-1294	Full Color Welcome Sign	5-12	\$500	N/A	N/A	N/A
6	580-1296	Full Color Welcome Sign	2-5	\$500	N/A	N/A	N/A
7	see page 178	Single Post Swings	2-12				

See pages 178-181 for complete swing selection.

\*Approximate list price. Surfacing, freight, taxes and installation are extra. Specifications and pricing subject to change without notice.

**Warning:** Never install play equipment over hard surfaces such as asphalt, concrete, grass or compacted earth. Consult ASTM and CPSC guidelines for appropriate amounts of impact attenuating material.







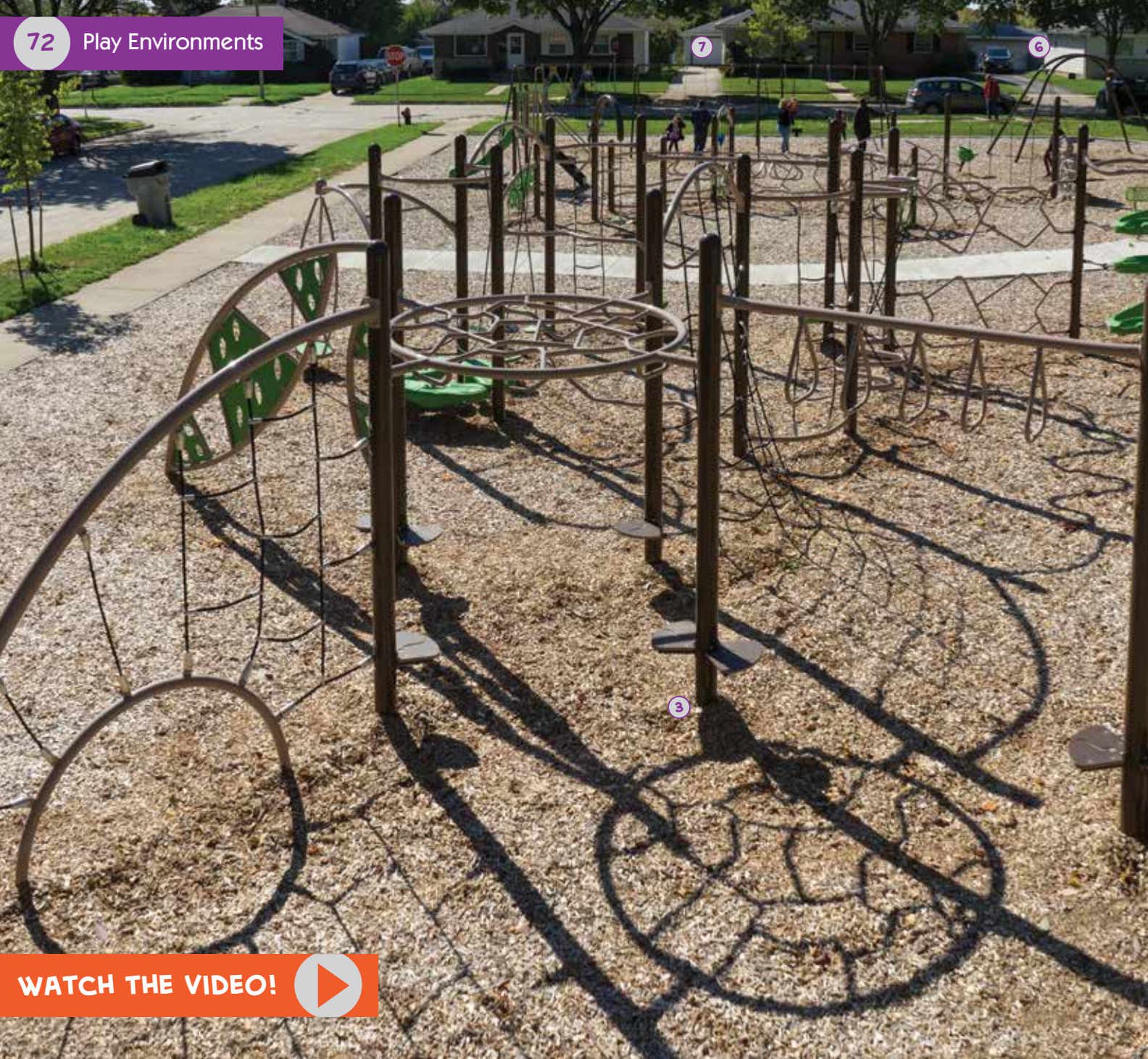

WATCH THE VIDEO!



## 67<sup>TH</sup> & SPOKANE MILWAUKEE, WI

Number	Product ID	Description	Ages	Price*	Play Events	Capacity	ASTM Use Zone
	IN-2610	Entire Playspace	2-5 & 5-12	\$114,900	56	252 Kids	140' x 117' (42.7m x 35.7m)
1	IN-2582	Intensity Structure	2-5	\$21,200	17	55 Kids	35' x 56' (10.7m x 17.1m)
2	3D-1704	Rock 'N' Roll Slide	2-12	\$3,100	1	7 Kids	24' x 16' (7.4m x 4.9m)
3	IN-2581	Intensity Structure	5-12	\$74,300	28	165 Kids	63' x 63' (19.2m x 19.2m)
4	3D-1912	Viper Spiral Slide	5-12	\$7,300	1	13 Kids	31' x 18' (9.5m x 5.5m)
5	560-2573	KidForce Spinner	2-12	\$659	1	1 Kid	14' (4.3m) diameter
6	550-0186	Volito Multi-User Swing	2-12	\$5,470	1	4 Kids	30' x 27' (9.2m x 8.3m)
7	See page 178	Contemporary Swings	2-12				

See pages 178-181 for complete swing selection.

Site furnishings not provided by Burke.

\*Approximate list price. Surfacing, freight, taxes and installation are extra. Specifications and pricing subject to change without notice.

**Warning:** Never install play equipment over hard surfaces such as asphalt, concrete, grass or compacted earth. Consult ASTM and CPSC guidelines for appropriate amounts of impact attenuating material.









## SEAWOLF PARK

With a beautiful site and gorgeous views, Seawolf Park offers some of Galveston Island's most popular tourist destinations, including WWII submarine, the USS Cavalla and one of only three destroyer escorts in the world, the USS Stewart. The remains of the tanker S.S. Selma, the largest concrete ship constructed, can be seen northwest of the park's fishing pier. With all of the traffic both tourist and local, Seawolf Park needed a play environment that offered the WOW factor, but also fit into the space without altering the views and other activities. Using color and taking into consideration the position of the sun and existing vegetation, Burke designed a space worthy of the location. Now the colorful playspace is a destination for families, community members and visitors alike and helps keep everyone moving and having fun!





TAKE THE TOUR!



## SEAWOLF PARK - GALVESTON, TX

**NUIN-2591** Ages 5-12

Approximately \$87,600\*

24 Play Events | 159 Kid Capacity

77' x 65' (23.5m x 19.9m) ASTM Use Zone

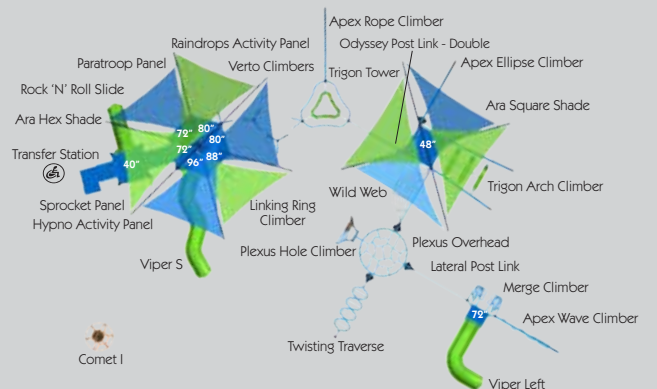

\*Approximate list price. Surfacing, freight, taxes and installation are extra. Specifications and pricing subject to change without notice.

**Warning:** Never install play equipment over hard surfaces such as asphalt, concrete, grass or compacted earth.





## CEDAR BLUFFS, NE

Number	Product ID	Description	Ages	Price*	Play Events	Capacity	ASTM Use Zone
	NUIN-2604	Entire Playspace**	5-12	\$124,200	29	199	85' x 115' (26m x 35.1m)
1	NUIN-2603	Nucleus-Intensity Structure	5-12	\$91,000	20	153 Kids	47' x 74' (14.4m x 22.6m)
2	560-0585	RopeVenture Sky5	5-12	\$15,000	1	28 Kids	38' x 38' (11.6m x 11.6m)
3	550-0186	Volito Multi-User Swing	2-12	\$5,470	1	4 Kids	30' x 27' (9.2m x 8.3m)
4	580-1314	Novo Benches	N/A	Contact us	N/A	3 People	N/A
5	560-0579	Freestanding Shade	N/A	\$4,329	N/A	N/A	N/A
6	See page 178	Swings			See pages 178-181 for complete swing selection.		

\*Approximate list price. Surfacing, freight, taxes and installation are extra. Specifications and pricing subject to change without notice.

\*\* Does not include small 2-5 structure.

**Warning:** Never install play equipment over hard surfaces such as asphalt, concrete, grass or compacted earth. Consult ASTM and CPSC guidelines for appropriate amounts of impact attenuating material.







3

1

WATCH THE VIDEO!





WATCH THE VIDEO!



## CROSSROADS PARK - GILBERT, AZ

**NU-2611** Ages 5-12

Approximately \$49,300\*

19 Play Events | 104 Kid Capacity

59' x 38' (18m x 11.6m) ASTM Use Zone

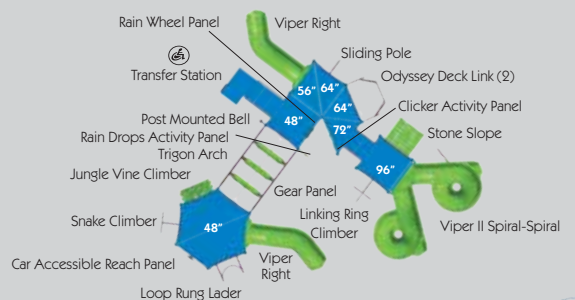

Shade not provided by Burke.

\*Approximate list price. Surfacing, freight, taxes and installation are extra. Specifications and pricing subject to change without notice.

**Warning:** Never install play equipment over hard surfaces such as asphalt, concrete, grass or compacted earth. Consult ASTM and CPSC guidelines for appropriate amounts of impact attenuating material.







**WATCH THE VIDEO!** 



**NUIN-2500** Ages 5-12  
 Approximately \$54,500\*  
 16 Play Events | 107 Kid Capacity  
 58' x 46' (11.7m x 14m)  
 ASTM Use Zone

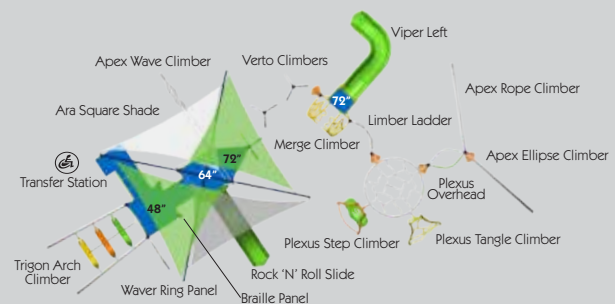

*\*Approximate list price. Surfacing, freight, taxes and installation are extra. Specifications and pricing subject to change without notice.*

**Warning:** Never install play equipment over hard surfaces such as asphalt, concrete, grass or compacted earth. Consult ASTM and CPSC guidelines for appropriate amounts of impact attenuating material.



**2015 GREAT PLAY GIVEAWAY WINNER!**  
 LEARN MORE AT [BCIBURKE.COM/PLAYGIVEAWAY](http://BCIBURKE.COM/PLAYGIVEAWAY)

## MULBERRY PARK - SHALLOTTE, NC

**NUIN-2578** Ages 5-12  
 Approximately \$53,500\*  
 15 Play Events | 108 Kid Capacity  
 47' x 57' (14.4m x 17.4m) ASTM Use Zone

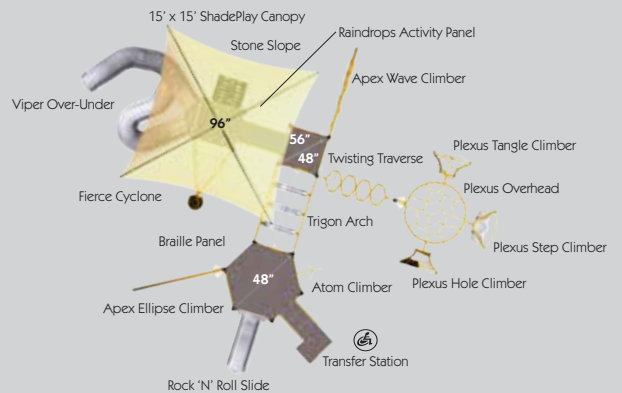

\*Approximate list price. Surfacing, freight, taxes and installation are extra. Specifications and pricing subject to change without notice.

**Warning:** Never install play equipment over hard surfaces such as asphalt, concrete, grass or compacted earth. Consult ASTM and CPSC guidelines for appropriate amounts of impact attenuating material.





## MEADOW HOMES - VANCOUVER, WA

### NUIN-2510 Ages 5-12

Approximately \$35,500\*

15 Play Events | 78 Kid Capacity

46' x 39' (14m x 11.9m) ASTM Use Zone

Swings sold separately.



\*Approximate list price. Surfacing, freight, taxes and installation are extra. Specifications and pricing subject to change without notice.

**Warning:** Never install play equipment over hard surfaces such as asphalt, concrete, grass or compacted earth. Consult ASTM and CPSC guidelines for appropriate amounts of impact attenuating material.







## NELSON MANDELA ELEMENTARY OMAHA, NE

**NUIN-2475** Ages 5-12  
 Approximately \$63,000\*  
 14 Play Events | 87 Kid Capacity  
 54' x 51' (16.5m x 15.6m) ASTM Use Zone

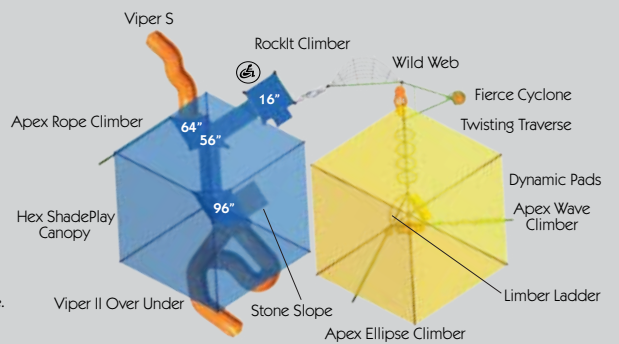

\*Approximate list price. Surfacing, freight, taxes and installation are extra. Specifications and pricing subject to change without notice.  
**Warning:** Never install play equipment over hard surfaces such as asphalt, concrete, grass or compacted earth. Consult ASTM and CPSC guidelines for appropriate amounts of impact attenuating material.

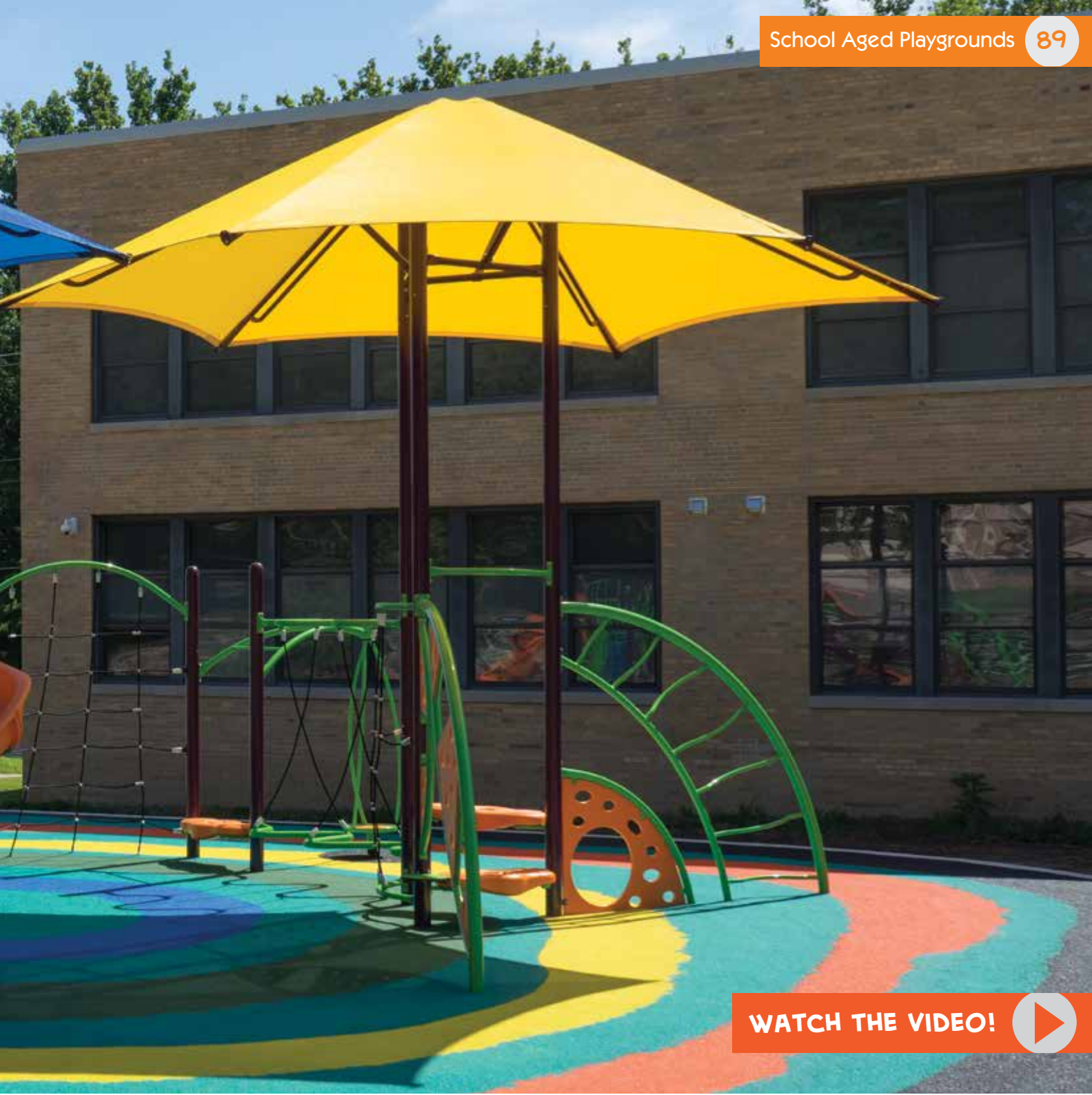

**WATCH THE VIDEO!** 



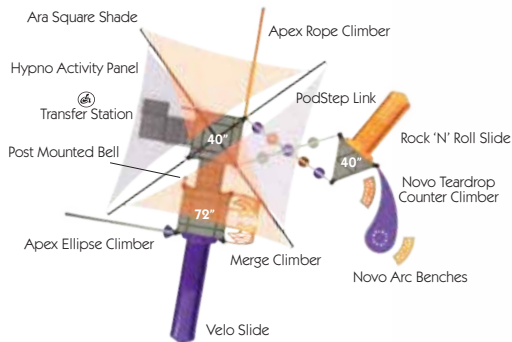

**NU-2596** Ages 5-12  
 Approximately \$34,400\*  
 10 Play Events | 62 Kid Capacity  
 41' x 39' (12.4m x 11.9m)  
 ASTM Use Zone

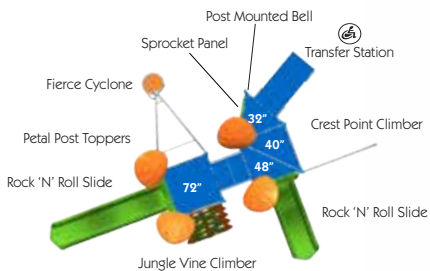

**3D-2504** Ages 5-12  
 Approximately \$19,700\*  
 7 Play Events | 33 Kid Capacity  
 35' x 30' (10.7m x 9.2m)  
 ASTM Use Zone





**IN-2492** Ages 5-12  
 Approximately \$11,100\*  
 5 Play Events | 26 Kid Capacity  
 31' x 34' (9.5m x 10.4m)  
 ASTM Use Zone



**IN-2585** Ages 5-12  
 Approximately \$34,600\*  
 10 Play Events | 64 Kid Capacity  
 40' x 44' (12.2m x 13.5m)  
 ASTM Use Zone





**IN-2586** Ages 5-12  
 Approximately \$25,400\*  
 8 Play Events | 49 Kid Capacity  
 49' x 35' (15m x 10.7m)  
 ASTM Use Zone

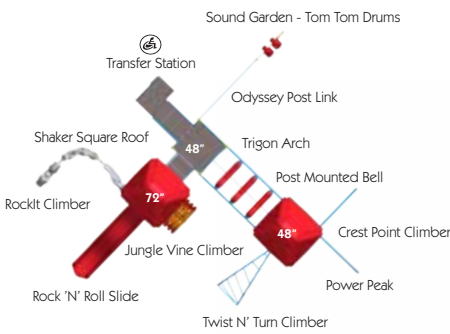

**3D-2503** Ages 5-12  
 Approximately \$31,000\*  
 12 Play Events | 75 Kid Capacity  
 41' x 39' (12.5m x 11.9m)  
 ASTM Use Zone



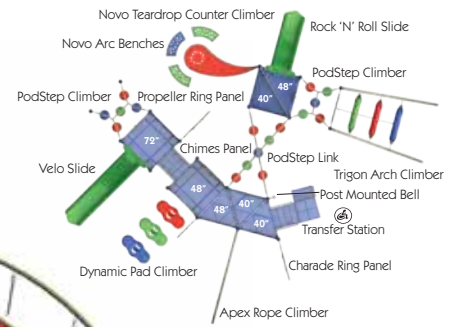

**NU-2597** Ages 5-12  
 Approximately \$49,500\*  
 17 Play Events | 98 Kid Capacity  
 46' x 39' (14.1m x 11.9m)  
 ASTM Use Zone

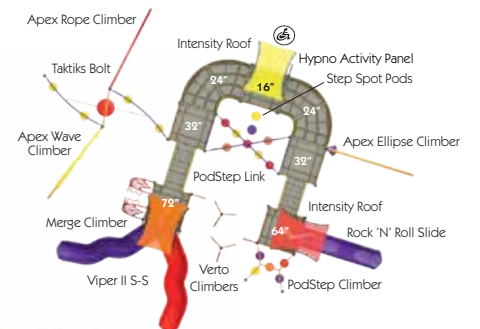

**NUIN-2587** Ages 5-12  
 Approximately \$69,700\*  
 16 Play Events | 136 Kid Capacity  
 53' x 45' (16.2m x 13.8m)  
 ASTM Use Zone



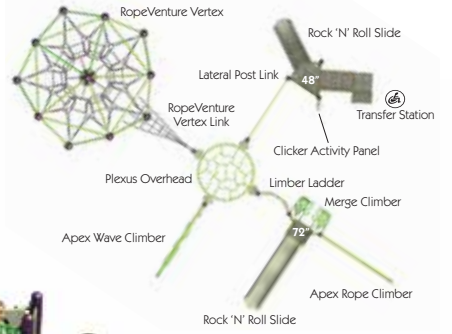

**NUIN-2511** Ages 5-12

Approximately \$40,300\*  
 11 Play Events | 85 Kid Capacity  
 59' x 44' (18m x 13.5m)  
 ASTM Use Zone

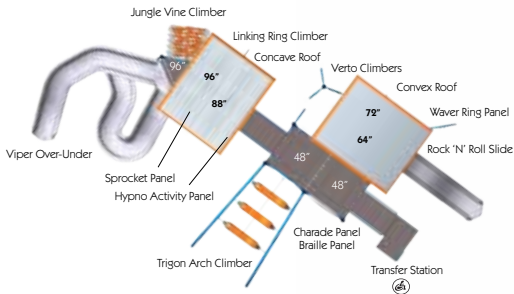

**NU-2480** Ages 5-12

Approximately \$51,900\*  
 15 Play Events | 80 Kid Capacity  
 35' x 49' (10.7m x 15m)  
 ASTM Use Zone





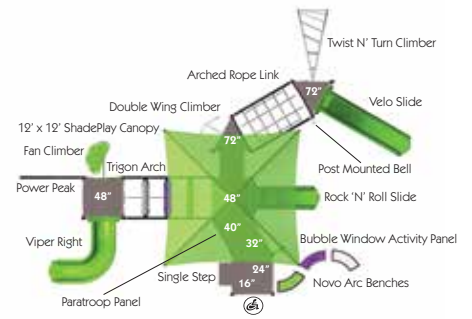

**3D-2595** Ages 5-12  
 Approximately \$38,300\*  
 15 Play Events | 77 Kid Capacity  
 38' x 48' (11.6m x 14.7m)  
 ASTM Use Zone

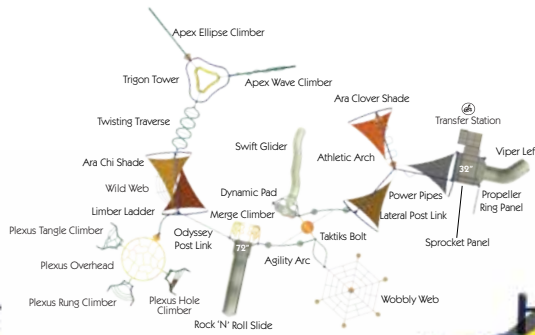

**IN-2588** Ages 5-12  
 Approximately \$71,500\*  
 23 Play Events | 130 Kid Capacity  
 54' x 70' (16.5m x 21.4m)  
 ASTM Use Zone





**IN-1362** Ages 5-12  
 Approximately \$10,700\*  
 6 Play Events | 15 Kid Capacity  
 26' x 28' (8m x 8.6m) ASTM Use Zone



**IN-2483** Ages 5-12  
 Approximately \$5,200\*  
 2 Play Events | 6 Kid Capacity  
 26' x 17' (8m x 5.2m) ASTM Use Zone



**NU-2493** Ages 5-12  
 Approximately \$12,800\*  
 4 Play Events | 24 Kid Capacity  
 24' x 29' (7.4m x 8.9m) ASTM Use Zone



**IN-2482** Ages 5-12  
 Approximately \$3,900\*  
 2 Play Events | 3 Kid Capacity  
 22' x 17' (6.7m x 5.2m) ASTM Use Zone





**NU-2308** Ages 5-12  
 Approximately \$3,800\*  
 3 Play Events | 12 Kid Capacity  
 21' x 23' (6.4m x 7m) ASTM Use Zone

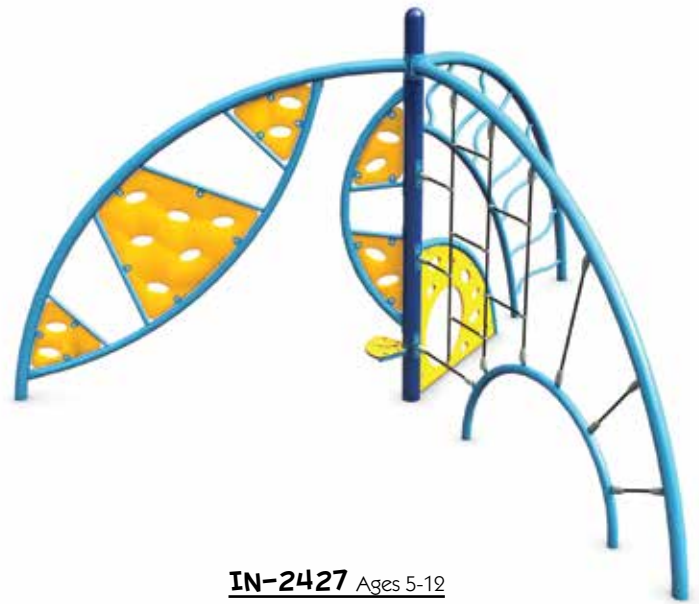

**IN-2427** Ages 5-12  
 Approximately \$7,700\*  
 3 Play Events | 24 Kid Capacity  
 27' x 30' (8.3m x 9.2m) ASTM Use Zone

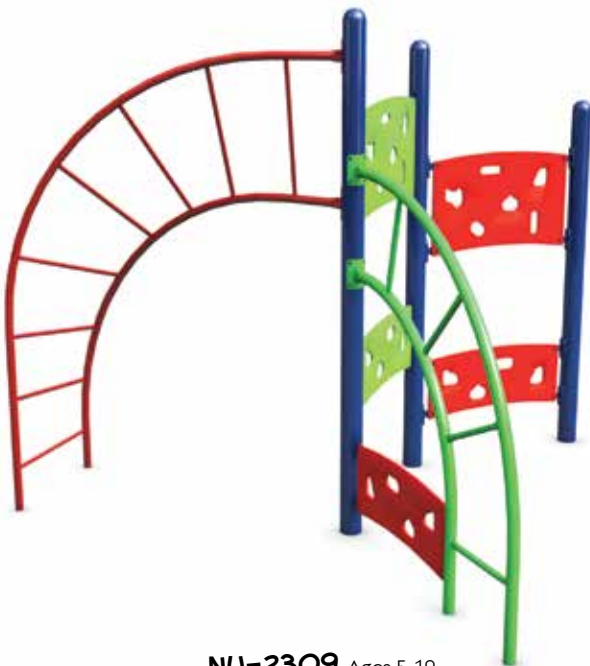

**NU-2309** Ages 5-12  
 Approximately \$4,200\*  
 4 Play Events | 14 Kid Capacity  
 24' x 23' (7.4m x 7m) ASTM Use Zone



**IN-2425** Ages 5-12  
 Approximately \$11,600\*  
 4 Play Events | 19 Kid Capacity  
 26' x 28' (8m x 8.6m) ASTM Use Zone





WATCH THE VIDEO!





## MUCKLESHOOT CDC

Outdoor classrooms combine learning and play providing an amazing opportunity for physical, cognitive and social development. The Muckleshoot Child Development Center features an outdoor classroom with three play areas for children ages six months to 12 years spread across five acres of natural space. With everything from social rest areas to active and motion play events to tactile and auditory playspaces, this incredible outdoor learning environment offers the chance to develop a variety of important skills they will use throughout their lives.





SEE YOUR LOCAL BURKE REPRESENTATIVE FOR DETAILS ON THIS PLAYSPACE.



WATCH THE VIDEO!





WATCH THE VIDEO!



1



1



## FIRST UNITED METHODIST CHURCH RICHARDSON, TX

Number	Product ID	Description	Ages	Price*	Play Events	Capacity	ASTM Use Zone
	NU-2609	Entire Playspace	2-5	\$119,200	36	182 Kids	50' x 100' (15.3m x 30.5m)
1	NU-2522	Nucleus Structure	2-5	\$67,600	19	96 Kids	50' x 47' (15.3m x 14.4m)
2	NU-2517	Nucleus Structure	2-5	\$51,600	17	86 Kids	36' x 49' (11m x 15m)

\*Approximate list price. Surfacing, freight, taxes and installation are extra. Specifications and pricing subject to change without notice.

**Warning:** Never install play equipment over hard surfaces such as asphalt, concrete, grass or compacted earth. Consult ASTM and CPSC guidelines for appropriate amounts of impact attenuating material.







2



2





TAKE THE TOUR!



## CAROLINA BEACH, NC

**NUIN-2496\*\*** Ages 2-5

Approximately \$25,800\*

10 Play Events | 44 Kid Capacity

35' x 35' (10.7m x 10.7m) ASTM Use Zone



\*Approximate list price. Surfacing, freight, taxes and installation are extra. Specifications and pricing subject to change without notice.

\*\* Does not include swings or 5-12 structure.

**Warning:** Never install play equipment over hard surfaces such as asphalt, concrete, grass or compacted earth.

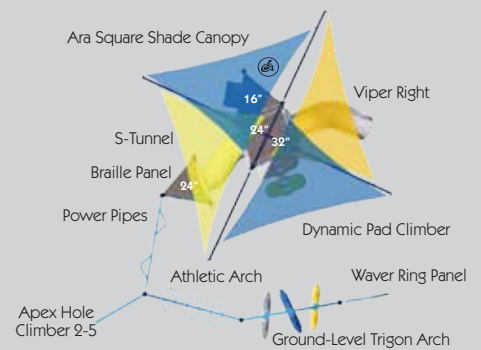



## MUCKLESHOOT CDC - AUBURN, WA

Number	Product ID	Description	Ages	Price*	Play Events	Capacity	ASTM Use Zone
	NU-2608	Entire Playspace	2-5 & 5-12	\$95,600	29	203 Kids	76' x 118' (23.2m x 36m)
1	NU-2405	Nucleus Structure	2-5	\$50,200	15	102 Kids	32' x 53' (9.8m x 16.2m)
2	3D-2406	Voltage Structure	2-5	\$26,800	11	52 Kids	33' x 40' (10.1m x 12.2m)
3	550-0186	Volito Multi-User Swing	2-12	\$5,470	1	4 Kids	30' x 27' (9.2m x 8.3m)
4	560-0007	Fireman Climber	5-12	\$1,236	1	8 Kids	16' (4.9m) diameter
5	570-0053	4 Seat Rocker	2-12	\$1,977	1	4 Kids	13' x 22' (4m x 6.7m)
6	580-1010	Traditional Series Tot Table	N/A	\$729	N/A	N/A	N/A
7	570-0772	Earthquake Surfer	2-12	\$1,704	1	2 Kids	18' (5.5m) diameter
8	570-0775	2 Seat, 2 Animal See-Saw	2-12	\$3,807	1	4 Kids	23' x 25' (7m x 7.7m)
9	550-0141	Tot Swing	2-5	\$980	1	1 Kid	19' x 17' (5.8m x 5.2m)
10	580-1291	Triple Sand and Water Table	2-12	\$4,950	5	18 Kids	N/A

\*Approximate list price. Surfacing, freight, taxes and installation are extra. Specifications and pricing subject to change without notice.

**Warning:** Never install play equipment over hard surfaces such as asphalt, concrete, grass or compacted earth. Consult ASTM and CPSC guidelines for appropriate amounts of impact attenuating material.



a part of atkore







## SHADOW RIDGE PARK FLOWER MOUND, TX

**NUIN-2521** Ages 2-5  
 Approximately \$42,000\*  
 12 Play Events | 70 Kid Capacity  
 33' x 59' (10m x 18m) ASTM Use Zone



*Swings, Comet and 5-12 structure not included in price.*  
*\*Approximate list price. Surfacing, freight, taxes and installation are extra. Specifications and pricing subject to change without notice.*  
**Warning:** Never install play equipment over hard surfaces such as asphalt, concrete, grass or compacted earth.

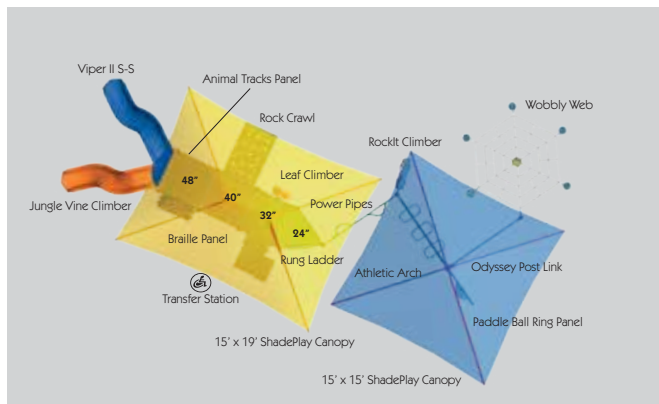





**LB-2407** Ages 2-5

Approximately \$24,900\*

11 Play Events | 55 Kid Capacity

34' x 26' (10.4m x 8m) ASTM Use Zone

Play panel fence sold separately.



A PART OF atkore

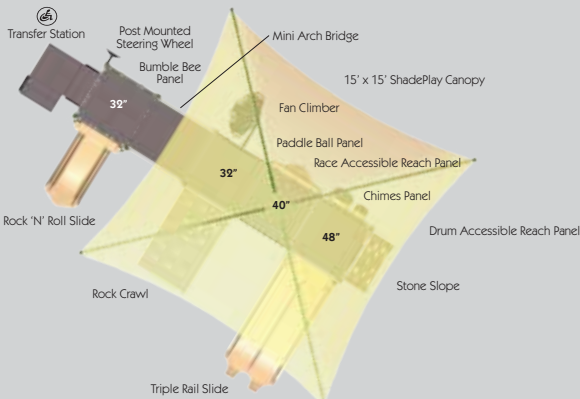

\*Approximate list price. Surfacing, freight, taxes and installation are extra. Specifications and pricing subject to change without notice.

**Warning:** Never install play equipment over hard surfaces such as asphalt, concrete, grass or compacted earth. Consult ASTM and CPSC guidelines for appropriate amounts of impact attenuating material.







WATCH THE VIDEO!



Number	Product ID	Description	Ages	Price*	Play Events	Capacity	ASTM Use Zone
1	IN-2450	Intensity Structure	2-5	\$11,300	7	21 Kids	26' x 29' (8m x 8.9m)
2	560-0538	Daisy Spinner	2-5	\$571	1	1 Kid	14' (4.3m) diameter
3	570-0835	Horse Rider	2-12	\$1,093	1	1 Kids	16' x 14' (4.9m x 4.3m)

\*Approximate list price. Surfacing, freight, taxes and installation are extra. Specifications and pricing subject to change without notice.

**Warning:** Never install play equipment over hard surfaces such as asphalt, concrete, grass or compacted earth. Consult ASTM and CPSC guidelines for appropriate amounts of impact attenuating material.

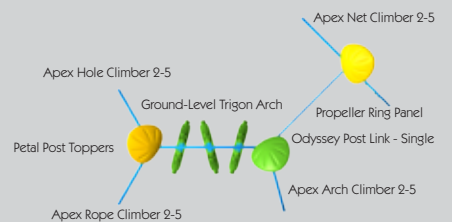



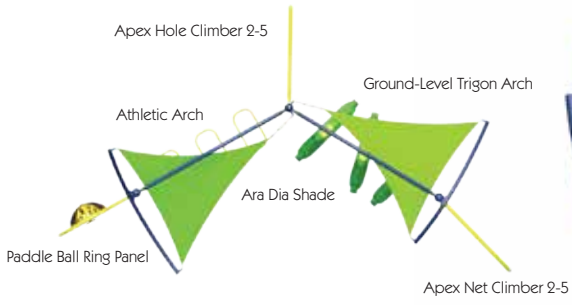

**IN-2589** Ages 2-5  
 Approximately \$11,700\*  
 5 Play Events | 18 Kid Capacity  
 26' x 28' (8m x 8.6m)  
 ASTM Use Zone

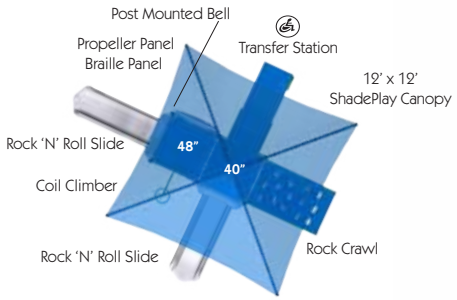

**LB-2513** Ages 2-5  
 Approximately \$15,600\*  
 7 Play Events | 30 Kid Capacity  
 30' x 28' (9.2m x 8.6m)  
 ASTM Use Zone



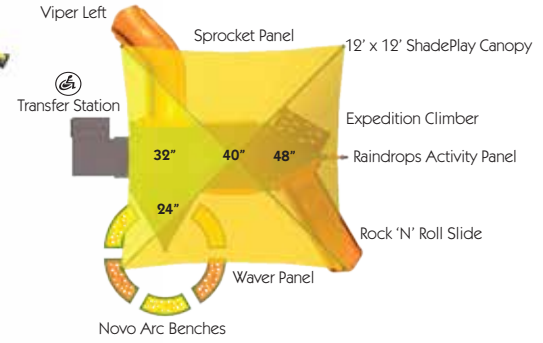

**3D-2599** Ages 2-5  
 Approximately \$20,700\*  
 11 Play Events | 41 Kid Capacity  
 29' x 29' (8.9m x 8.9m)  
 ASTM Use Zone

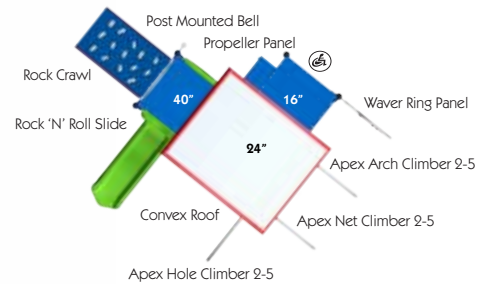

**NU-2497** Ages 2-5  
 Approximately \$22,500\*  
 8 Play Events | 38 Kid Capacity  
 27' x 31' (8.3m x 9.5m)  
 ASTM Use Zone



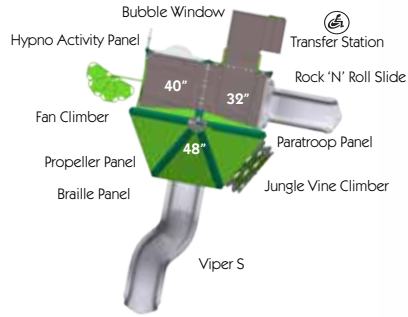

**3D-2431** Ages 2-5  
 Approximately \$17,500\*  
 9 Play Events | 42 Kid Capacity  
 28' x 31' (8.6m x 9.5m)  
 ASTM Use Zone

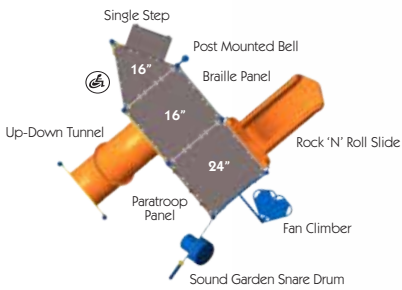

**LB-2514** Ages 2-5  
 Approximately \$10,100\*  
 7 Play Events | 30 Kid Capacity  
 23' x 24' (7m x 7.4m)  
 ASTM Use Zone



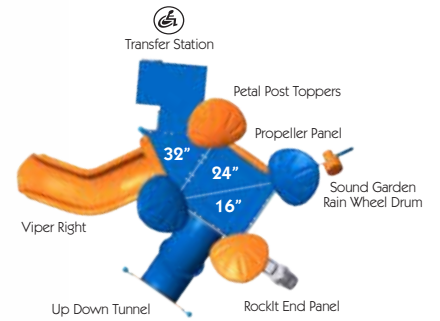

**3D-2499** Ages 2-5

Approximately \$13,900\*

5 Play Events | 22 Kid Capacity

23' x 27' (7m x 8.3m)

ASTM Use Zone

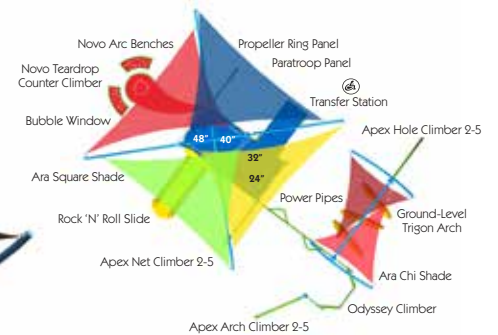

**NUIN-2598** Ages 2-5

Approximately \$30,600\*

12 Play Events | 51 Kid Capacity

40' x 33' (12.2m x 10.1m)

ASTM Use Zone





**WATCH THE VIDEO!** 

**Taktiks Bolt** Available for Nucleus and Intensity







**Merge Climber**

Platform: 72"

Available for Nucleus and Intensity



**NEW PodStep Climber**

Platform: 48", 56", 64" and 72"

Available for Nucleus



**NEW PodStep Link**

Platform: 32" - 40"

Available for Nucleus and Intensity



A

**THE VERTO COLLECTION**  
Exclusively From Burke



B



C

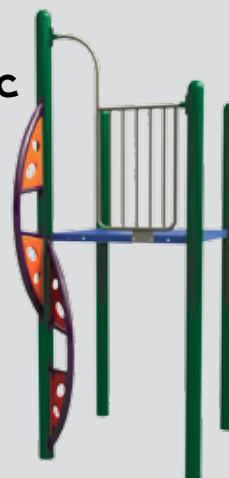

D



**Component**

**Description**

**Platform**

A	Verto Climber 3 Freestanding	N/A
B	Verto Climber 1	32" - 40"
C	Verto Climber 2	64" - 72"
D	Verto Climber 3	72" - 96"



## THE APEX COLLECTION

Exclusively From Burke

**B**

**C**

**D**

**E**

**G**

Component	Description	Platform
A	Apex Rope Climber	8" - 72"
B	Apex Ellipse Climber	8" - 72"
C	Apex Arch Climber 2-5	8" - 32"
D	Apex Hole Climber 2-5	8" - 32"
E	Apex Wave Climber	8" - 72"
F	Apex Net Climber 2-5	8" - 32"
G	Apex Rope Climber 2-5	8" - 32"



**Crater Point Climber**  
Platform: 40" - 64"



**Ridge Point Climber**  
Platform: 40" - 64"



**Crest Point Climber**  
Platform: 40" - 64"



**Power Peak Climber**  
Platform: 40" - 64"  
*Available with or without HDPE*



**Mountain Top Climber**  
Platform: 48", 56", 64", 72" and 96"



**Jungle Vine Climber**  
Platform: 48", 64", 72" and 96"



**Expedition Climber**  
Platform: 48", 56", 64", 72" and 96"



**Rugged Ridge Climber**  
Platform: 8" - 48"



**Steep Peak Climber**  
Platform: 48", 56", 64", 72" and 96"



**Stone Slope Climber**  
Platform: 48", 56", 64", 72" and 96"



**Wobbly Web**  
Available for Nucleus and Intensity  
Also available freestanding. See page 177. 



**Wild Web**  
Platform: 8" - 40"  
Available for Nucleus and Intensity



A

**THE TRIGON COLLECTION**  
Exclusively From Burke

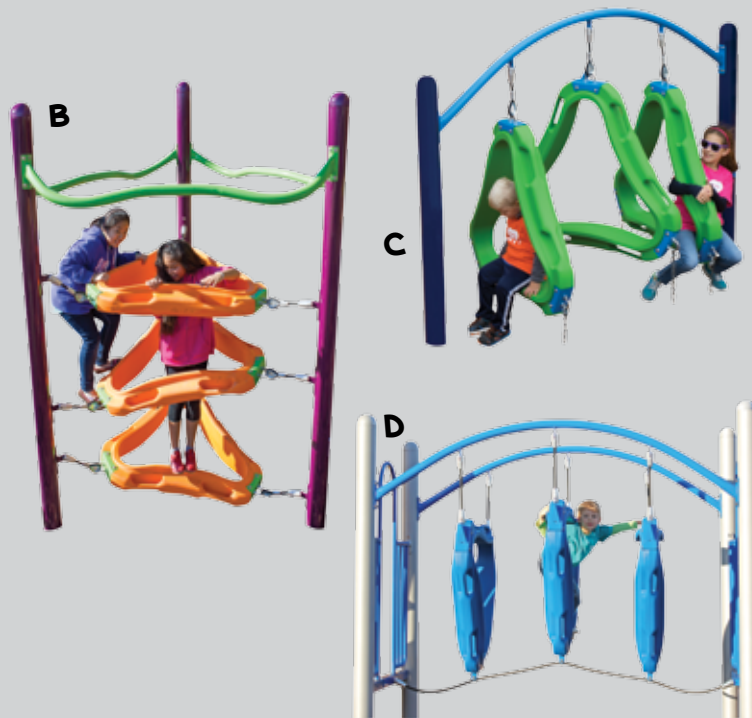

Component	Description	Platform
A	Trigon Arch Climber	48"
B	Trigon Tower	N/A
C	Ground-Level Trigon Arch	N/A
D	Trigon Arch (Deck-to-Deck)	8" - 48"



**Dynamic Discs**

Platform: 8" - 32"

Available for Nucleus and Intensity



**Suspension Rope Link**

Lower Platform: 48" and 56"

Higher Platform: 64" and 72"



**Spider Web Climber**

Platform: 8" - 48"



**Rope Link**

Platform: 48" - 72"



**Twisting Traverse**

Platform: 16" - 32"



**Arched Rope Climber**

Platform: 8" - 96"



**Nimble Net**

Platform: 8" - 48"

Available for Nucleus and Intensity



**Twist Net Climber**

Platform: 56" and 72"



**Agile Canyon**

Available for Nucleus and Intensity



**Coil Climber**  
Platform: 32" - 72"



**Leaf Climber**  
Platform: 16" - 72"



**Linking Ring Climber**  
Platform: 32" - 96"



**THE ODYSSEY COLLECTION**  
Exclusively From Burke

**A**

**B**

**C**

**D**

Component	Description	Platform
A	Odyssey Deck Link (2 shown)	8" - 72"
B	Odyssey Deck Link (Center Mount)	24" Offset
C	Odyssey Post Link - Double	8" - 48"
D	Odyssey Post Link - Single	8" - 16"



**Fan Climber**  
Platform: 16" - 72"



**Double Wing Climber**  
Platform: 32" - 72"



**Saturn Ring Climber**  
Platform: 32" - 56"



**Strength Stepper**  
*Available for Nucleus and Intensity*



**Dynamic Pad Link**  
Platform: 24" - 48"  
*Available for Nucleus only*



**Ring Mountain**  
Platform: 32" - 40"



**Dynamic Pad Climber**  
Platform: 32" - 48"  
*Available for Nucleus and Intensity*



**Lateral Post Link**  
Platform: 8" - 32"



**Hyper Helix**  
Platform: 48" - 72"  
Available for Nucleus and Intensity



**Twist N' Turn Climber**  
Platform: 48" - 72"



**Active Apex**  
Platform: 40" - 48"  
Available for Nucleus and Intensity in Steel or HDPE



A

**THE AMPED COLLECTION**  
Exclusively From Burke

Component	Description	Platform
A	Double Amped Link (Deck-to-Deck)	40" - 72"
B	Double Amped Climber	56" - 64"
C	Amped Climber I	32" - 64"
Not Pictured	Amped Link I (Deck-to-Deck)	8" - 40" Offset
D	Amped Link II	8" - 48"
Not Pictured	Amped Climber II	24" - 32"

VISIT [BCIBURKE.COM](http://BCIBURKE.COM) FOR MORE AMPED CLIMBER CONFIGURATIONS.





**Loop Climber**  
Platform: 32" - 72"



**Centipede Climber**  
Platform: 32" or 40"  
*Also available as Tall Centipede Climber*  
Platform: 48" - 72"



**Ribbon Climber**  
Platform: 48" - 56"  
*Also available Deck-to-Deck*



**Atom Climber**  
Platform: 32" - 96"



**Loop Rung Ladder**  
Platform: 24" - 72"  
*Also available as Convex Climber 24" - 48"*



**Snake Climber**  
Platform: 32" - 72"



**Sliding Pole**  
Platform: 32" - 72"



**Incline Vine Climber**  
Platform: 8" - 72"



**Power Pipes**  
Platform: 8" - 48"



**Rock Climber**  
Platform: 48" or 64"

**Sky Pods**

Platform: 16" - 40"

*Also available in 3 Pod configuration and as Powerful Pods for Intensity.***Board Climber**

Platform: 72"

**Tree Climber**

Platform: 32" - 72"

**Plank**

Platform: 32"

**Rock Crawl Climber**

Platform: 32" - 40"

**Rocking Catamaran Crossing**

Platform: 8" - 32"

**Wiggle Watchtower**

Platform: 64" - 72"

**Cargo Net**

Platform: 32" - 56"

*Handrail included at certain Platform heights.***Wiggle Ladder**

Platform: 64" - 72"

**Pod Walk**

Platform: 16" - 40"



### THE SATELLITE COLLECTION Exclusively From Burke

**B**

**C**

**D**

**E**

**F**

**G**

Component	Description	Platform
A	Satellite Climber	40", 48", 64" and 72"
B	Satellite Orbit	56" - 64"
C	Satellite Dock III	72"
D	Satellite Dock I	40", 48", 64" and 72"
E	Satellite Walkway	72"
F	Satellite Link	Low: 48" High 72"
G	Satellite Dock II	72"



**THE VIPER COLLECTION**  
Exclusively From Burke



Component	Description	Platform
A	Viper II Over Under	96"
B	Viper S	48", 56", 64", 72", 96" and 112"
C	Viper Left	32", 48", 56", 64", 72", 96" and 112"
D	Viper II Spiral-Spiral	96"
E	Viper Straight	48", 56", 64", 72" and 96"
F	Viper Right	32", 48", 56", 64", 72", 96" and 112"
G	Viper Spiral	96" and 112"
H	Viper II S-S	48", 56", 64", 72" and 96"
I	Viper III S-S-S	48", 56", 64", 72" and 96"
J	Viper II Spiral-S	96" and 112"
K	Viper III Spiral-S-L3	96" and 112"

CONTACT YOUR LOCAL BURKE REPRESENTATIVE FOR MORE CONFIGURATIONS.





**Rock 'N' Roll Slide**  
Platform: 24", 32" 40", 48", 64" and 72"



**The Velo Slide**  
Features an extra drop  
for a fun, fast ride!

**NEW Velo Slide**  
Platform: 64" and 72"



**Stainless Steel Double Wide Slide**  
Platform: 32" - 40"



**Stainless Steel Slide**  
Platform: 32" - 72"



**Stainless Steel Wavy Slide**  
Platform: 64" - 72"



**Spiral Tube Slide**  
Platform: 96" - 112"



**Thrill Ride Slide**  
Platform: 112"  
*Also available without Window*



**S Tube Slide with Window**  
Platform: 40", 48" and 56"  
*Contact your Burke Representative for more Tube Slide configurations.*



**Quarterturn Slide**  
Platform: 32" - 40"



**Double Rail Slide**  
Platform: 32" - 40"



**NEW Luge Slide**  
Platform: 48" - 56"  
**Coming Soon!**



**1-Piece Spiral Slide 360°**  
72" Height Attaches to  
Platform: 56", 64" and 72"



**48" Spiral Slide**  
Platform: 40" - 48"  
*Available for ages 2-5 only.*

**Short Straight Overhead**

Platform: 8" - 32"

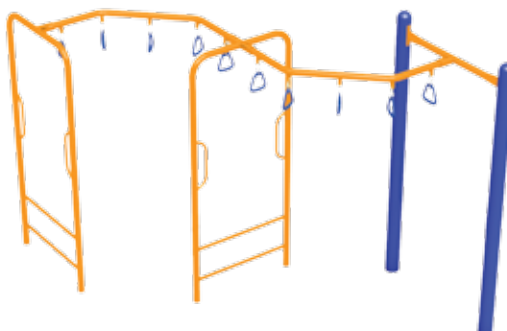
Available as Triangle (shown) or Ring Swing  
Also available as Triangle Traverse for Intensity**S or C Overhead**

Platform: 8" - 32"

Available as Triangle (shown) or Ring Swing

**Athletic Arch**

Platform: 8" - 32"

Available for Nucleus and Intensity

**Wrap-Around Loop**

Platform: 8" - 32"

**Long Straight Overhead**

Platform: 8" - 32"

Available as Triangle or Ring Swing (shown).

**90° Overhead**

Platform: 8" - 32"

Available as Triangle (shown) or Ring Swing.

**S Curve Triangle**

Platform: 8" - 32"

**S Shaped Horizontal Ladder**

Platform: 8" - 32"

**Horizontal Ladder**

Platform: 8" - 32"





**Round-A-Bout**  
Platform: 8" - 32"



**Horizontal Overhead**  
Ages 2-5 ASTM | Ages 4-5 CPSC



**C Shaped Horizontal Ladder**  
Platform: 8" - 32"



**OVERHEAD EVENTS THAT KEEP YOU MOVING**

**B**

**C**

**D**

Component	Description	Platform
A	Kid Koaster <i>Available as 12' or 18' Length.</i>	8" - 32"
B	Wheel Deal <i>Available with 3 or 4 Wheels.</i>	8" - 32"
C	Wheel-About <i>Also available as Zippy Whirl for Intensity.</i>	8" - 32"
D	Rocking Snake <i>Also available as Robust Rocker for Intensity.</i>	8" - 32"



**Sprocket Panel**  
2-Sided



**Rain Wheel Panel**  
2-Sided



**Cog Wheel Panel**



**A**



**MUSIC THAT MOVES YOUR SENSES**

**B**

**C**

**D**

**E**

**F**

**Component**

**Description**

- A Touch & Play Piano Panel
- B Touch & Play Drum Panel
- C Drum Panel
- D Accessible Reach Drum Panel
- E Single Large Drum Panel
- F Chimes Panel



**Braille Panel**  
2-Sided 



**Paratroop Panel**  
2-Sided



**Wheel of Fun Panel**



**Bumble Bee Panel**  
2-Sided



**Car Control Panel**



**Jet Panel**  
with Steering Wheel  
Also Available as Race Car  
Available for Nucleus and Voltage only.



**Gear Panel**  
2-Sided



**Rock-Paper-Scissors Panel**  
2-Sided  
Available for Nucleus and Voltage only.



**Tic-Tac-Toe Panel**  
2-Sided



**Signing Panel**  
2-Sided



**ABC/123 Panel**



**Animal Jump Panel**

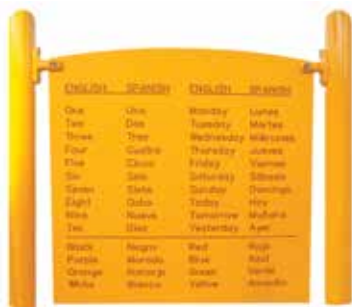

**Spanish/English Language Panel**  
2-Sided



**Shapes Panel**



**Animal Tracks Panel**



**A**



**B**

**THE CIRCULAR PANEL COLLECTION**

Choose from any of the activities below to insert into our heavy duty, UV-15 rotomold plastic Panel or Ring Panel for Nucleus and Intensity.

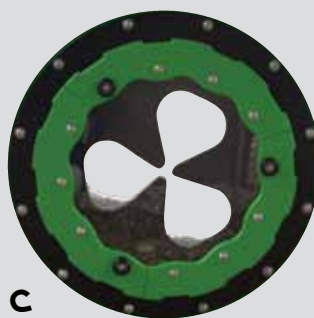

**C**

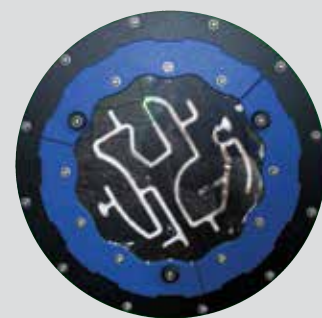

**D**



**E**

**Component**

- A
- B
- C
- D
- E

**Description**

- Waver Panel
- Paddle Ball Panel
- Propeller Panel
- Charade Panel
- Bubble Window

*Not available in Ring Panel.*



**Crazy Maze Panel**



**Solar System Panel**



**Name the States Panel**  
2-Sided



**Raindrops Activity Panel**  
2-Sided



**Clicker Activity Panel**  
2-Sided



**Bubble Mirror Activity Panel**  
2-Sided



**Hypno Activity Panel**  
2-Sided



**Spiral Spinner Panel**



**The Great Race Panel**  
2-Sided



**Bee Panel**  
2-Sided



**Finger Maze Panel**  
2-Sided



**Car Panel**



**Cruiser**  
Platform: 16"   
Also Available Freestanding. See page 160.



**Swift Glider**  
Available for Nucleus and Intensity



**Rapid Rails**  
Available for Nucleus and Intensity  
Also available as Banister Rail for  
32" - 40" Platforms.



**Fierce Cyclone**



**Extreme Cyclone**



**Activity Table**  
Platform: Under 40" Minimum



**Sand/Water Table**  
Platform: Under 40" Minimum



**Up-Down Tunnel**  
Platform: 8" - 112" or  
0" - 16" for 16" Only  
Available in 8", 16" and 24" Transitions



**S-Tunnel**  
Platform: 8" - 112"



**90° Tunnel**  
Platform: 8" - 112"



**Under Tunnel**  
Platform: 16" - 112"  
Also Available as Over Tunnel 8" - 112"



**NEW Novo Arc Benches**  
Arc Benches sold individually  
Patent Pending



**NEW Novo Teardrop Counter Climber**  
Arc Benches sold separately  
Patent Pending



**Burke Mart**  
Platform: Below at 56" and Below 72" - 112"  
Available for Nucleus Only



**Counter**  
Platform: Below 48" - 112"



**Storefront**  
Platform: Below at 56" and Below 72" - 112"  
Available for Voltage Only



**Fun Phone**



**Telescope**  
For Pipe Wall or Balcony (shown)  
Available in Black Only



**Post Mounted Bell**



**Steering Wheel**  
For Pipe Wall, Post Mounted or with Window  
Available in Black Only



**Long Buckle Bridge** with Guardrail  
Platform: 24" - 48"  
*Also Available with Barrier*



**Arched Catwalk Bridge**  
Platform: 8" - 112"



**Short Buckle Bridge** with Guardrail  
Platform: 24" - 48"  
*Also Available with Barrier | Available for Voltage Only*



**Short Arch Bridge** with Guardrail  
Platform: 8" - 40"  
*Also Available with Barrier - Platform 8" - 112"*



**Little Buddies Mini Arch Bridge**  
Platform: 8" - 48"



**Mini Arch Bridge** with Barrier  
Platform: 8" - 112"  
*Also Available with Guardrail - Platform: 8" - 40"*



**Long Arch Bridge** with Barrier  
Platform: 8" - 112"  
*Also Available with Guardrail - Platform: 8" - 40"*



**Short Straight Bridge** with Guardrail  
Platform: 8" - 48" | *Available for Voltage Only*  
*Also Available with Barrier - Platform 8" - 112"*



**Long Straight Bridge** with Barrier  
Platform: 8" - 112"  
*Also Available with Guardrail - Platform: 8" - 48"*



**Conveyor Belt Bridge**  
Platform: 24" - 48"  
*Available with Guardrail Only*  
*Available for Voltage Only*



**90° Platform**  
Platform: 8" - 112"  
*Curve Left or Curve Right*





**Balcony**  
Platform: 8" - 112"  
Available for Nucleus and Voltage  
Telescope Optional



**Transition Stairs** with Barriers  
16", 24", 32" and 40" Transitions  
Max Height 112" Platform  
Also Available with Guardrail 24", 32" and 40" Transitions  
Max Height 56" Platform



**Narrow Stairway** with Barrier  
Platform: 64", 72" and 96"  
Max Height 96" Platform  
Also Available with Handrail 32" - 56" Transitions  
Max Height 56" Platform



**Transfer Station**  
Platform: 32" - 48"  
Optional Attachment for Stairs



**NaturePlay Transfer Stump**  
Platform: 32" - 48"

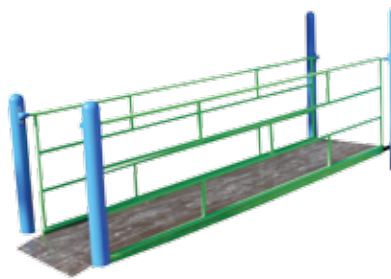

**ADAAG Ramp**  
Available with Guardrail (Shown) or Barrier  
Deck-to-Deck or Ground-to-Deck  
8' Nucleus and Voltage | 12' Nucleus Only



**Double Wide ADAAG Ramp**  
Available with Guardrail or Barrier (Shown)  
Deck-to-Deck or Ground-to-Deck  
Available for Nucleus Only

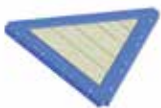

**Triangle Recycled Plastic Platform**  
Available for Nucleus Only



**Square Recycled Plastic Platform**  
Available for Nucleus Only

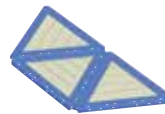

**Half-Hex Recycled Plastic Platform**  
Available for Nucleus Only



**Hexagon Recycled Plastic Platform**  
Available for Nucleus Only



**Square Platform**  
Available for Nucleus, Voltage and Little Buddies



**Half Platform**  
Available for Nucleus Only



**Triangle Platform**  
Available for Nucleus, Voltage and Little Buddies



**Half-Hex Platform**  
Available for Nucleus, Voltage and Little Buddies

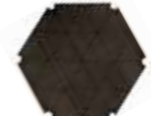

**Hexagon Platform**  
Available for Nucleus and Voltage



**Octagon Platform**  
Available for Voltage Only



**Hex Platform with Center Hole**  
Available for Nucleus and Voltage



**Split Square Platform**  
Available for Nucleus and Voltage  
8" Transition



**Pentagon Platform**  
Available for Nucleus Only

## THE ARA SHADE COLLECTION

Available for Nucleus and Intensity



**NEW** Ara Poly Shade



**NEW** Ara Dia Shade



**NEW** Ara Chi Shade

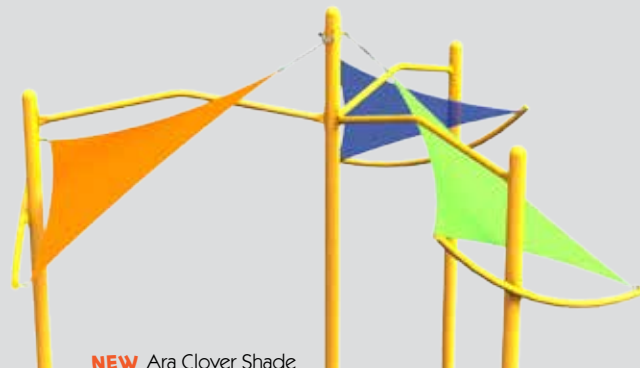

**NEW** Ara Clover Shade



Ara Square Shade



Ara Hex Shade



Hexagon Shade



Square Shade

### SHADEPLAY CANOPY OPTIONS

Square 12' x 12' (3.7m x 3.7m)

Square 15' x 15' (4.6m x 4.6m)

Rectangle 15' x 19' (4.6m x 5.8m)

Rectangle 15' x 21' (4.6m x 6.4m)

Available for Voltage Only

Single Post Square 12' x 12' (3.7m x 3.7m)\*\*

Single Post Square 15' x 15' (4.6m x 4.6m)\*\*

Hexagon on a Triangle

Hexagon

\*\*Also available freestanding. See page 186.



**Convex Aluminum Roof**  
Available for Nucleus Only



**Concave Aluminum Roof**  
Available for Nucleus Only



**Intensity Punched Steel Roof**  
Available for Nucleus and Intensity



**Steel Peak Roofs**  
Available as Square, Hexagon (Shown) and Half-Hex for Nucleus and Voltage. Pentagon is Available for Nucleus Only



**ClubHouse Tilt Roof**  
Available for Nucleus Only



**ClubHouse Retreat Roof**  
Available for Nucleus Only



**ClubHouse Hex Roof**  
Available for Nucleus Only



**Recycled Plastic Roofs**  
Available for Nucleus Only in Hexagon, Half-Hex and Square (Shown)



**Shaker Roofs**  
Available as Hexagon (Shown) or Square for Nucleus and Voltage. Multi-Color Options Available for Hexagon Only

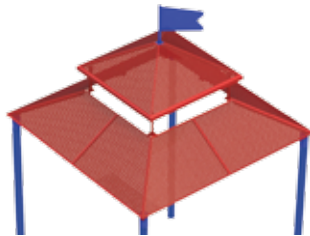

**Steel Quad Roof with Cupola**  
Available for Nucleus and Voltage

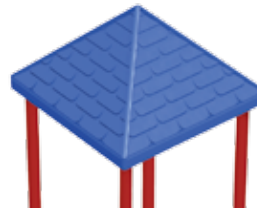

**Square Peak**  
Available for Little Buddies and Voltage

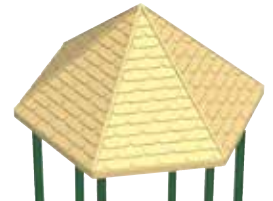

**Hexagonal Peak Roof**  
Available for Little Buddies and Voltage



**Evergreen Post Topper**  
Available for Nucleus, Intensity, Voltage and Little Buddies



**Pennant Post Topper**  
Available for Nucleus, Intensity, Voltage and Little Buddies with or without Full Color Graphic Insert



**Flag Post Topper**  
Available for Nucleus, Intensity, Voltage and Little Buddies with or without Full Color Graphic Insert



**Butterfly Post Topper**  
Available for Nucleus, Intensity, Voltage and Little Buddies



**Curved Post Toppers**  
Available for Nucleus and Intensity. Multiple Curved Post Toppers shown.



**Triple Petal Post Topper**  
Available for Nucleus and Intensity



**Petal Post Topper**  
Available for Nucleus, Voltage and Intensity



**Castle**  
NU-2442



**Custom Vehicle Panels**  
NU-2377



**Custom Full Color Pennant Post Topper**  
See Page 144



**CUSTOMIZE YOUR PLAYGROUND**

Add imagination to your playground with Burke's custom panels. Use a single panel to add a touch of personalization or combine several panels to theme entire structures. Our Custom Routed and Full Color Custom Panels are available in over a dozen standard sizes giving you unlimited design possibilities. Simply provide your ideas or artwork to your local Burke Representative and our in-house design team will create your custom playground.



**Custom Routed Panels**  
Available in over a dozen standard sizes



**Full Color Custom Panels**  
Available in 3 standard sizes



**Full Color Custom Panels**  
Available in 3 standard sizes



**Custom Arch Sign**



**NEW Novo Welcome Sign 5-12** 580-1315  
Also available for 2-5 and 2-12



**NEW Novo Custom Sign** 580-1310



**NEW Novo Custom Sign - Double** 580-1311



**Full Color Custom Sign** 580-1302



**Full Color Welcome Sign 2-5** 580-1296  
Also available for 2-5, 2-12 and 6-23 months



**Full Color Welcome Panel**

## CUSTOM SIGNS AND PANELS



**Custom Arch Sign**  
NU-1490

**Component**

- 580-1317
- 580-1315
- 580-1316
- 580-1310
- 580-1311
- NU-1490
- 3D-1201
- LB-1202
- 580-1302
- 580-1297
- 580-1296
- 580-1294
- 580-1295

**Description**

- Novo Welcome Sign (ages 2-5)\*\*
- Novo Welcome Sign (ages 5-12)\*\*
- Novo Welcome Sign (ages 2-12)\*\*
- Novo Custom Sign - Single
- Novo Custom Sign - Double
- 5" Post Custom Arch Sign
- 3.5" Post Custom Arch Sign
- 2 3/8" Post Custom Arch Sign
- 2-Sided Full Color Custom Sign
- 2-Sided Full Color Welcome Sign (ages 6-23 months)\*\*
- 2-Sided Full Color Welcome Sign (ages 2-5)\*\*
- 2-Sided Full Color Welcome Sign (ages 5-12)\*\*
- 2-Sided Full Color Welcome Sign (ages 2-12)\*\*

**Price**

- Contact us
- Contact us
- Contact us
- Contact us
- Contact us
- \$1,941\*
- \$1,689\*
- \$1,216\*
- \$552\*
- \$500\*
- \$500\*
- \$500\*
- \$500\*

Full Color Welcome Panel\*\* Available for ages 2-5, 5-12 and 2-12.

\*\*Contains ASTM required content.

**CONTACT YOUR LOCAL BURKE REPRESENTATIVE FOR MORE INFORMATION ON PLAY SYSTEM CUSTOMIZATION.**

**RopeVenture Vertex** 560-0583  
\$15,000\* | Ages 5-12  
25 Kid Capacity | 14' 3" (4.4m) Overall Height  
7' 9" (2.36m) ASTM, 14' 3" (3.45m) CPSC Fall Height  
28' x 29' (8.5m x 8.9m) ASTM Use Zone

WATCH THE VIDEO! 



## THE ROPEVENTURE® COLLECTION

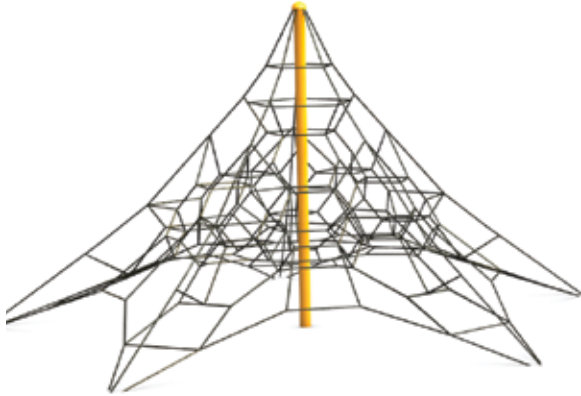

### RopeVenture Sky5 560-0585

\$15,000 \* | Ages 5-12 

28 Kid Capacity | 12' 8" (3.9m) Overall Height  
7' (2.14m) ASTM, 12' 10" (3.92m) CPSC Fall Height  
36' x 38' (11m x 11.6m) ASTM Use Zone

*Optional Perch Seats available and sold separately.  
Contact your Burke Representative for more details.*

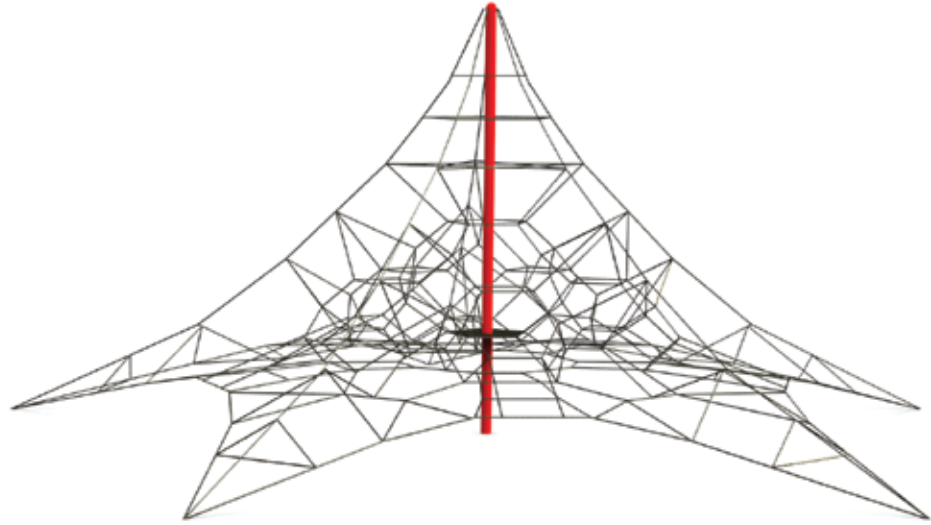

### RopeVenture Sky5 XL 560-0586

\$21,000\* | Ages 5-12 

44 Kid Capacity | 18' 7" (5.7m) Overall Height  
7' (2.14m) ASTM, 18' 9" (5.72m) CPSC Fall Height  
54' x 57' (16.5m x 17.4m) ASTM Use Zone

## CONNECT ANY ROPEVENTURE CLIMBER TO A BURKE PLAY STRUCTURE

*RopeVenture Link sold separately. Contact your Burke Representative for more information.*

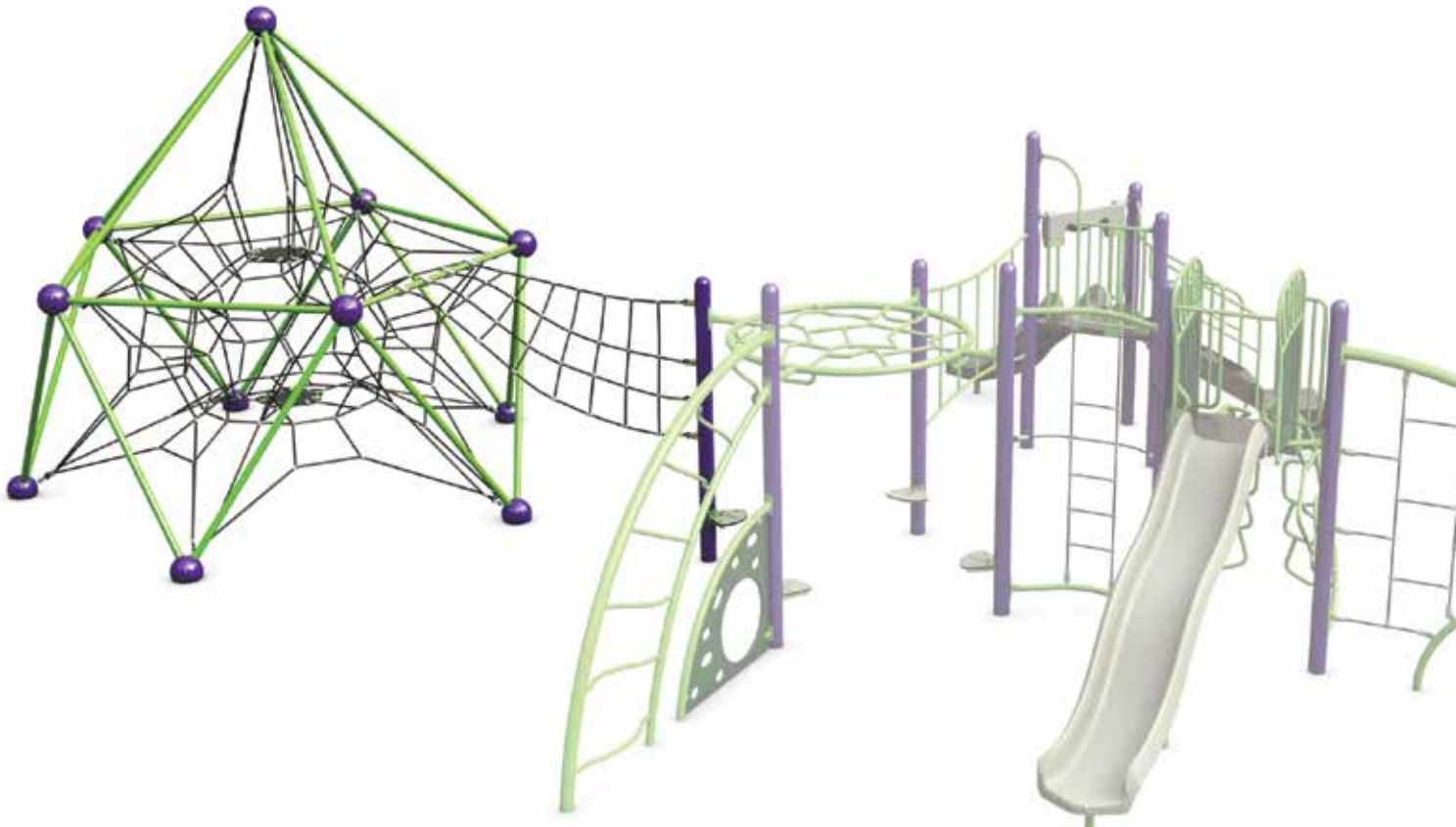

## THE PLEXUS COLLECTION

Exclusively From Burke



**IN-2424** Ages 5-12  
 Approximately \$6,900\*  
 5 Play Events | 22 Kid Capacity  
 25' x 25' (7.7m x 7.7m) ASTM Use Zone



**WATCH THE VIDEO!**

### LET'S MOVE!

We're taking the classic monkey bars to a whole new level with Plexus - a modular climbing and overhead play system. Kids will love being able to create their own path up, through, around and over these climbers. The original overhead design creates endless options for children to swing and traverse between different play events. Create a challenging, freestanding activity by using all the components shown on these pages or mix and match with other Nucleus and Intensity play events.

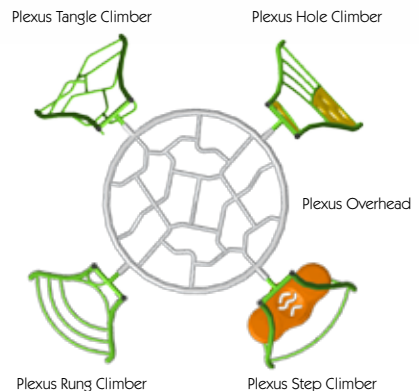



## PLEXUS COMPONENTS

Use the pieces below to build your Plexus playground. Attach the overhead or any of the 4 climbers to a playground structure or use it as a freestanding piece.



**Plexus Rung Climber**

*Links to Plexus Overhead and Nucleus or Intensity Structure*



**Plexus Tangle Climber**

*Links to Plexus Overhead and Nucleus or Intensity Structure*



**Plexus Hole Climber**

*Links to Plexus Overhead and Nucleus or Intensity Structure*



**Plexus Step Climber**

*Links to Plexus Overhead and Nucleus or Intensity Structure*

## CONNECT YOUR PLEXUS COMPONENTS TO A BURKE PLAY STRUCTURE



**Warning:** Never install play equipment over hard surfaces such as asphalt, concrete, grass or compacted earth. Consult ASTM and CPSC guidelines for appropriate amounts of impact attenuating material.

## THE ROCKVENTURE® COLLECTION

Use the pieces below to build your own custom RockVenture Climber. Attach it to a playground structure or use it as a freestanding piece.



**NaturePlay RockVenture**  
Platform: 48", 56", 64" and 72"  
*Rope Links and Ladder Optional*



**RockVenture Suspension Ladder**  
*Ladder Only Attaches to RockVenture*



**RockVenture Criss-Cross Link**  
*Links to RockVenture and Nucleus or Voltage Structure*

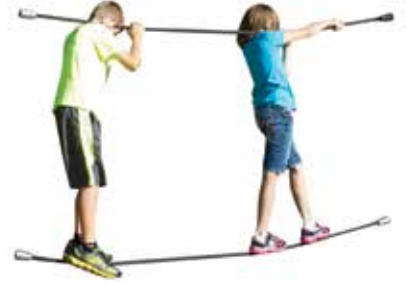

**RockVenture Traverse Link**  
*Links to RockVenture and Nucleus or Voltage Structure*

## CONNECT YOUR ROCKVENTURE DESIGN TO A BURKE PLAY STRUCTURE



## FREESTANDING ROCKVENTURE CLIMBERS



**Freestanding NaturePlay  
RockVenture** 560-0560  
\$12,035\* | Ages 5-12   
1 Play Event | 6 Kid Capacity  
19' x 18' (5.8m x 5.5m) ASTM Use Zone

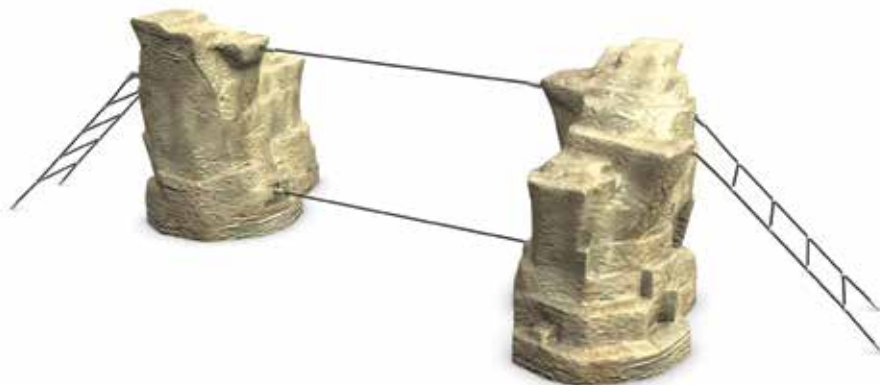

**BB-2318** Ages 5-12   
Approximately \$30,900\*  
5 Play Events | 19 Kid Capacity  
21' x 40' (6.4m x 12.2m) ASTM Use Zone

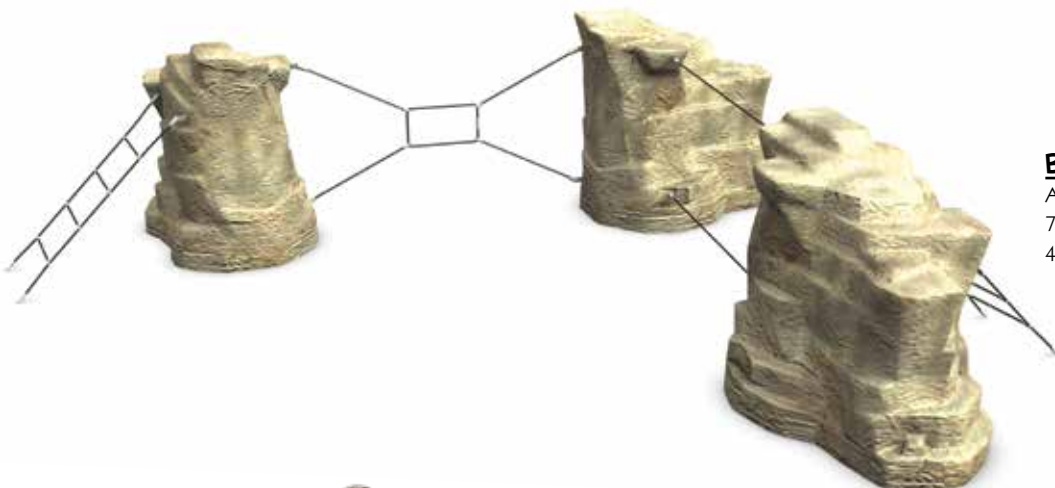

**BB-2319** Ages 5-12   
Approximately \$45,900\*  
7 Play Events | 28 Kid Capacity  
40' x 34' (12.2m x 10.4m) ASTM Use Zone



**BB-2312** Ages 5-12   
Approximately \$30,300\*  
4 Play Events | 17 Kid Capacity  
34' x 23' (10.4m x 7m) ASTM Use Zone

## THE ROCKIT™ COLLECTION

Use the pieces below to build your own custom Rockit Climber. Attach it to a playground structure or use it as a freestanding piece.



**Rockit Offset Panel**



**Rockit Curved Panel**



**Rockit End Panel**



**Rockit Curved Ladder**  
*Ladder Only Attaches to RockIt Panels*



**Rockit Odyssey Link**  
*Link Only Attaches to RockIt Panels*



**Rockit Lateral Link**  
*Link Only Attaches to RockIt Panels*



**Rockit Core Link**  
*Link Only Attaches to RockIt Panels*



**Rockit End Ladder**  
*Ladder Only Attaches to RockIt Panels*

## CONNECT YOUR ROCKIT DESIGN TO A BURKE PLAY STRUCTURE





**Rockit Left**  
Platform: 48", 56" and 72"



**Rockit Right**  
Platform: 48", 56" and 72"

**FREESTANDING ROCKIT DESIGNS**



**BB-1926** Ages 5-12   
Approximately \$8,800\*  
4 Play Events | 21 Kid Capacity  
24' x 24' (7.4m x 7.4m) ASTM Use Zone



**BB-2048** Ages 5-12   
Approximately \$5,600\*  
5 Play Events | 14 Kid Capacity  
18' x 24' (5.5m x 7.4m) ASTM Use Zone



**ROCKIT TUNNEL** Ages 2-12   
560-0544 | \$3,259\*  
1 Play Event | 8 Kid Capacity  
18' x 21' (5.5m x 6.4m) ASTM Use Zone



**BB-1930** Ages 2-12   
Approximately \$2,100\*  
2 Play Events | 4 Kid Capacity  
14' x 19' (4.3m x 5.8m) ASTM Use Zone



**BB-1931** Ages 5-12   
Approximately \$4,000\*  
3 Play Events | 8 Kid Capacity  
14' x 22' (4.3m x 6.7m) ASTM Use Zone



**BB-1932** Ages 5-12   
Approximately \$4,200\*  
5 Play Events | 14 Kid Capacity  
15' x 22' (4.6m x 6.7m) ASTM Use Zone



**BB-1995** Ages 2-12   
Approximately \$2,600\*  
3 Play Events | 8 Kid Capacity  
14' x 26' (4.3m x 8m) ASTM Use Zone



**BB-1976** Ages 5-12   
Approximately \$6,300\*  
5 Play Events | 16 Kid Capacity  
14' x 29' (4.3m x 8.9m) ASTM Use Zone

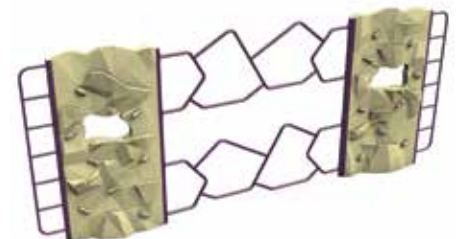

**BB-1977** Ages 5-12   
Approximately \$4,900\*  
5 Play Events | 16 Kid Capacity  
14' x 29' (4.3m x 8.9m) ASTM Use Zone

## THE SOUND GARDEN COLLECTION

Incorporate musical exploration into your playground with Burke's Sound Garden. Real piano, drum and rain sounds provide creative and collaborative play opportunities for children of all abilities. The different music panels can be configured in multiple orientations to incorporate a variety of musical activities. Two-sided educational panels add additional play value and allow more children to explore the excitement of music together. Use the pieces below to build your custom sound garden or attach one or several panels to a playground structure.



**Snare Drum**  
Available in left configuration only.



**Touch & Play Piano**  
Available in left configuration only.



**Rain Wheel & Drum**  
Available in left, center or right configurations.



**Touch & Play Drum**  
Available in right configuration only.



**Tom-Tom Drums**  
Available in right configuration only.



**Snare Drum Reverse**



**Touch & Play Piano Reverse**



**Rain Wheel & Drum Reverse**



**Touch & Play Drum Reverse**



**Tom-Tom Drums Reverse**

## CONNECT SOUND GARDEN PANELS TO A BURKE PLAY STRUCTURE



## FREESTANDING SOUND GARDEN CONFIGURATIONS



**BB-2320** Ages 2-12   
 Approximately \$5,300\*  
 2 Play Events | 8 Kid Capacity



**BB-2336** Ages 2-12   
 Approximately \$3,600\*  
 3 Play Events | 12 Kid Capacity



**BB-2321** Ages 2-12   
 Approximately \$6,900\*  
 3 Play Events | 12 Kid Capacity

**WATCH THE VIDEO!**



**Volta Inclusive Spinner 560-2579**Ages 2-12 

9 Kid Capacity

20' (6m) diameter

ASTM Use Zone

**WATCH THE VIDEO!**



Contact your Burke Representative for more information about the Volta Inclusive Spinner.

**REV8 560-0576**   
 \$16,115\* | Ages 5-12  
 25 Kid Capacity  
 25' (7.7m) diameter  
 ASTM Use Zone









**Comet I** 560-2570 (Shown Left)   
 \$1,632\* | Ages 5-12   
 6 Kid Capacity  
 16' (4.9m) diameter ASTM Use Zone  
 Also available as Comet II 560-2571  
 (Shown Below)





**Comet II**

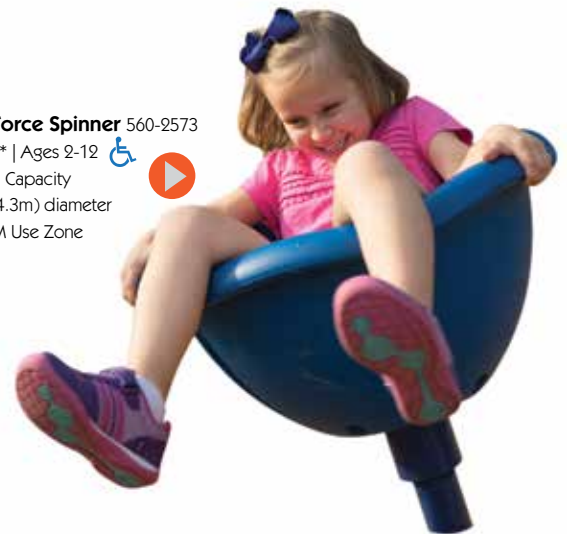

**Daisy Spinner** 560-0538  
 \$571\* | Ages 2-5   
 1 Kid Capacity   
 14' (4.3m) diameter  
 ASTM Use Zone



**KidForce Spinner** 560-2573  
 \$659\* | Ages 2-12   
 1 Kid Capacity   
 14' (4.3m) diameter  
 ASTM Use Zone



**Orbitron** 560-0532  
 \$2,801\* | Ages 5-12   
 8 Kid Capacity  
 20' (6.1m) diameter  
 ASTM Use Zone

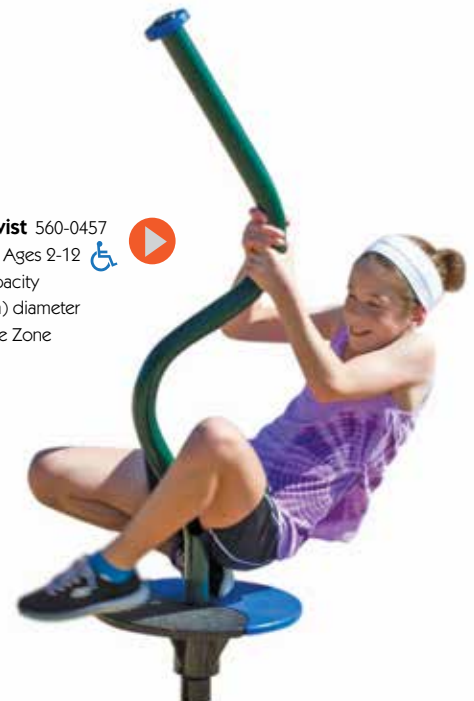

**Swift Twist** 560-0457   
 \$1,054\* | Ages 2-12   
 1 Kid Capacity  
 14' (4.3m) diameter  
 ASTM Use Zone



**Energy Orbiter** 560-0463  
\$3,876\* | Ages 5-12   
6 Kid Capacity  
19' (5.8m) diameter ASTM Use Zone  
*Hydraulic Speed Limiter promotes safer play.*



*Hydraulic Speed Limiter promotes safer play.*

**8' Carousel** 560-0044  
\$4,230\* | Ages 2-12   
8 Kid Capacity  
20' (6.1m) diameter ASTM Use Zone  
*Handrails come galvanized. Powder Coat handrails available with additional charge.*

**6' Carousel** 560-0045  
\$3,507\* | Ages 2-12   
6 Kid Capacity  
18' (5.5m) diameter ASTM Use Zone  
*Handrails come galvanized. Powder Coat handrails available with additional charge.*



**Kid Spinner** 560-0038  
\$1,324\* | Ages 2-12   
2 Kid Capacity  
14' (4.3m) diameter ASTM Use Zone





**Dynamic Surfer** 570-0770  
\$1,214\* | Ages 2-12   
2 Kid Capacity  
14' x 16' (4.3m x 4.9m) ASTM Use Zone



**Earthquake Surfer** 570-0772  
\$1,704\* | Ages 2-12   
2 Kid Capacity  
18' (5.5m) diameter ASTM Use Zone



**Cruiser** 560-0562  
\$12,137\* | Ages 2-12    
12 Kid Capacity  
20' x 23' (6.1m x 7m) ASTM Use Zone  
*Requires a 16" berm, not included.*



**2 Seat See-Saw** 570-0774  
\$1,278\* | Ages 2-5   
2 Kid Capacity  
18' x 14' (5.5m x 4.3m) ASTM Use Zone



**4 Seat See-Saw** 570-0777  
\$3,067\* | Ages 2-12   
4 Kid Capacity  
23' x 23' (7m x 7m) ASTM Use Zone





**2 Seat Rocker** 570-0055  
\$1,486\* | Ages 2-12   
2 Kid Capacity  
13' x 19' (4m x 5.8m) ASTM Use Zone



**4 Seat Rocker** 570-0053  
\$1,977\* | Ages 2-12   
4 Kid Capacity  
13' x 22' (4m x 6.7m) ASTM Use Zone



**Standing Rocker** 570-0054  
\$1,865\* | Ages 2-12   
2 Kid Capacity  
15' x 21' (4.6m x 6.4m) ASTM Use Zone

**ZipVenture** Ages 5-12  
75' (22.9m) | 550-0190   
100' (30.5m) | 550-0180 (shown)



Contact your Burke Representative for more information about ZipVenture.



**WATCH THE VIDEO!** 

**Warning:** Never install play equipment over hard surfaces such as asphalt, concrete, grass or compacted earth. Consult ASTM and CPSC guidelines for appropriate amounts of impact attenuating material.



**Motorcycle** 570-0769  
\$1,093\* | Ages 2-12   
16' x 14' (4.9m x 4.3m)  
ASTM Use Zone



**Dolphin** 570-0768  
\$1,093\* | Ages 2-12   
16' x 14' (4.9m x 4.3m)  
ASTM Use Zone



**Burke Fire Truck** 570-0767  
\$1,566\* | Ages 2-12   
16' x 14' (4.9m x 4.3m)  
ASTM Use Zone



**Burke Race Car** 570-0766  
\$1,093\* | Ages 2-12   
16' x 14' (4.9m x 4.3m)  
ASTM Use Zone



**Locomotive** 570-0754





**Duck** 570-0761



**White Bronc** 570-0758

### ALUMINUM CAST ROCK 'N' RIDES

\$1,003\* | Ages 2-12   
14' x 15' (4.3m x 4.6m) ASTM Use Zone

 Limit 3 on 10-business day Quickship.



**Zebra**  
570-0759



**Antique Car**  
570-0751



**Brown Bear**  
570-0752



**Squirrel**  
570-0757



**Frog**  
570-0762



**Turtle**  
570-0764



**Caterpillar**  
570-0760



**Brown Mare**  
570-0753

CHOOSE FROM THE DUCK, FROG, TURTLE OR CATERPILLAR ALUMINUM CAST  
ROCK 'N' RIDES SHOWN ABOVE TO CREATE A FUN ANIMAL SEE-SAW.



**2 Animal See-Saw** 570-0773  
\$2,610\* | Ages 2-5   
20' x 14' (6.1m x 4.3m) ASTM Use Zone



**2 Seat, 2 Animal See-Saw** 570-0775  
\$3,807\* | Ages 2-12   
23' x 25' (7m x 7.7m) ASTM Use Zone  
Also available with 4 Animals 570-0776 | \$4,541\*



**R-50 Recycled Rubber Mat**  
570-0016 | \$158\*  
Use to cover Rock 'N' Ride concrete footings

**THE THEMED RIDER COLLECTION**  
Exclusively From Burke



**Helicopter Rider** 570-0823  
*Helicopter for Tri-Rider 570-0829*



**Police Car Rider** 570-0836  
*Police Car for Tri-Rider 570-0833*



**Ambulance Rider** 570-0837  
*Ambulance for Tri-Rider 570-0834*



**Bull Rider** 570-0824  
*Bull for Tri-Rider 570-0830*



**Bison Rider** 570-0825  
*Bison for Tri-Rider 570-0831*



**Horse Rider** 570-0835  
*Horse for Tri-Rider 570-0832*

**THEMED RIDERS**

\$1,093\* | Ages 2-12   
16' x 14' (4.9m x 4.3m)  
ASTM Use Zone



**Wasp Rider** 570-0820  
*Wasp for Tri-Rider 570-0826*



**Snail Rider** 570-0821  
*Snail for Tri-Rider 570-0827*

**TRI-RIDER** 570-0771

\$3,521\* | Ages 2-12   
21' (6.4m) diameter  
ASTM Use Zone

*Choose any 3 Riders shown above  
to create your Themed Tri-Rider.*



**Ladybug Rider** 570-0822  
*Ladybug for Tri-Rider 570-0828*

**Step 'N' Scoot Plus SoftPlay** 580-1287

\$2,606\* | Ages 6 - 23 Months 

8 Play Features | 8 Kid Capacity

8' x 11' (2.5m x 3.4m) ASTM Use Zone

Also available In-Ground 580-0287 | \$2,680\*



**Kiddy Korral Plus** 580-1288  
\$3,642\* | Ages 6 - 23 Months ♿  
13 Play Features | 15 Kid Capacity  
12' x 12' (3.7m x 3.7m) ASTM Use Zone  
Also available In-Ground 580-0288 | \$3,897\*



**Kiddy Korral** 580-1278 ♿  
\$3,398\* | Ages 6 - 23 Months  
12 Play Features | 15 Kid Capacity  
12' x 12' (3.7m x 3.7m) ASTM Use Zone  
Also available In-Ground 580-0278 | \$3,654\*



**Step 'N' Scoot SoftPlay** 580-1276  
\$2,364\* | Ages 6 - 23 Months ♿  
7 Play Features | 8 Kid Capacity  
8' x 11' (2.5m x 3.4m) ASTM Use Zone  
Also available In-Ground 580-0276 | \$2,436\*

**Step 'N' Scoot Firm/Stable** 580-1275  
\$1,996\* | Ages 6 - 23 Months ♿  
7 Play Features | 8 Kid Capacity  
8' x 12' (2.5m x 3.7m) ASTM Use Zone  
Also available In-Ground 580-0275 | \$2,071\*

## EARLY PLAY CENTERS

Creative and challenging play is essential to early childhood development. Burke's Early Play Centers encourage physical and cognitive growth while providing hours of engaging, exploratory fun. Early Play Centers are available in bold, primary colors or gentle earth-tones with firm or soft platforms. Set up and installation are simple with pre-assembled panels and optional in-ground anchors.



**Climb 'N' Crawl SoftPlay** 580-1277  
\$2,704\* | Ages 6 - 23 Months ♿  
7 Play Features | 8 Kid Capacity  
10' x 11' (3m x 3.4m) ASTM Use Zone  
Also available In-Ground 580-0277 | \$2,801\*



**Climb 'N' Crawl Firm/Stable** 580-1279  
\$2,764\* | Ages 6 - 23 Months ♿  
7 Play Features | 8 Kid Capacity  
10' x 12' (3m x 3.7m) ASTM Use Zone  
Also available In-Ground 580-0279 | \$2,861\*



WATCH THE VIDEO!



## PLAY THAT MOVES YOUR IMAGINATION!



Number	Product ID	Description	Ages	Capacity	Play Features	Price*	Size
1	560-2575	PlayHouse, Benches & Counter	2-5	12 Kids	14	\$4,794	18' x 23' (5.5m x 7m) ASTM Use Zone
2	560-2578	PlayHouse	2-5	6 Kids	11	\$3,978	10' x 10' (3.1m x 3.1m) ASTM Use Zone
3	560-2576	Bean Bench	2-12	2 Kids	N/A	\$255	15' x 13' (4.6m x 4m) ASTM Use Zone
4	560-2577	Bench & Counter	2-12	4 Kids	N/A	\$561	17' x 14' (5.2m x 4.3m) ASTM Use Zone
5	580-0319	Engine	2-12	10 Kids	5	\$6,815	16' x 21' (4.9m x 6.4m) ASTM Use Zone
6	580-0321	Tanker	2-12	4 Kids	2	\$2,522	16' x 18' (4.9m x 5.5m) ASTM Use Zone
7	580-0320	Dining Car	2-12	6 Kids	5	\$4,722	16' x 17' (4.9m x 5.2m) ASTM Use Zone
8	580-0322	Sandbox Car (not pictured)	2-12	10 Kids	6	\$4,899	16' x 18' (4.9m x 5.5m) ASTM Use Zone
9	580-1289	Gas Station	2-12	2 Kids	1	\$1,083	3' x 1'4" x 7'6" (0.9m x 0.4m x 2.3m)
10	580-1293	Drive Thru (not pictured)	2-12	2 Kids	1	\$1,217	3'10" x 1'5" x 6' (1.2m x 0.5m x 1.9m)
11	580-1292	Drive Thru with Fun Phone	2-12	4 Kids	2	\$1,742	3'10" x 1'5" x 6' (1.2m x 0.5m x 1.9m)
12	580-0306	Fruit Stand Cozy Corner	2-12	7 Kids	4	\$2,079	7'2" x 2'6" x 4'9" (2.2m x 0.8m x 1.5m)
13	580-0307	Ice Cream Parlor Cozy Corner	2-12	7 Kids	4	\$2,079	7'2" x 2'6" x 4'9" (2.2m x 0.8m x 1.5m)
14	580-0245	Cottage Cozy Corner	2-12	7 Kids	4	\$2,079	7'2" x 2'6" x 4'9" (2.2m x 0.8m x 1.5m)
15	580-0261	Lunar Landing	2-12	13 Kids	8	\$5,931	25' x 17' (7.7m x 5.3m) ASTM Use Zone



12 Fruit Stand 580-0306





**Stop Sign**  
580-0308 | \$149\*



**Yield Sign**  
580-0309 | \$149\*



**Speed Limit Sign**  
580-0310 | \$149\*



9



11



**13 Ice Cream Parlor** 580-0307



**14 Cottage** 580-0245



**15 Lunar Landing** 580-0261



**Theater Paint Center** 580-0166  
\$1,154\* | Ages 2-12   
1 Play Feature | 4 Kid Capacity  
4' wide x 5' tall (1.3m wide x 1.6m tall)



**Under Sea Paint Center** 580-0317  
\$1,154\* | Ages 2-12   
1 Play Feature | 4 Kid Capacity  
4' wide x 5' tall (1.3m wide x 1.6m tall)



**Theater Puppet Show** 580-0318  
\$1,154\* | Ages 2-12   
1 Play Feature | 4 Kid Capacity  
4' wide x 5' tall (1.3m wide x 1.6m tall)



**Rotating Sand Table** 580-1019  
\$1,079\* | Ages 2-12   
3 Play Features | 6 Kid Capacity  
3' x 3' (1m x 1m)



**Single Sand or Water Table** 580-0280  
\$1,273\* | Ages 2-12   
1 Play Feature | 8 Kid Capacity  
4' x 4' x 25" tall (1.3m x 1.3m x 0.7m tall)



**Double Sand & Water Center** 580-1290  
\$2,941\* | Ages 2-12   
3 Play Features | 14 Kid Capacity  
4' x 8' x 25" tall (1.3m x 2.5m x 0.7m tall)



**Triple Sand & Water Center** 580-1291  
\$4,950\* | Ages 2-12   
5 Play Features | 18 kid capacity  
4' x 12' x 25" tall (1.3m x 3.7m x 0.7m tall)



**Single Hop Spot Pod** 560-0448  
\$400\* | Ages 5-12   
16" (40.7cm) Height  
14' (4.3m) diameter  
ASTM Use Zone



**Single Step Spot Pod** 560-0453  
\$260\* | Ages 2-12   
8" - 16" (20.3cm - 40.7cm) height  
14' (4.3m) diameter  
ASTM Use Zone  
*Also available at 20" - 30" height 560-0458*



**Single Drum Table** 580-0231  
\$462\* | Ages 2-12   
2 Kid Capacity  
2' x 2' (0.6m x 0.6m)





**Three Table** 580-0230  
\$1,140\* | Ages 2-12   
6 Kid Capacity  
3' x 5' (1m x 1.6m)





**Dynamic Pad** 560-0459  
\$553\* | Ages 2-12   
14' x 16' (4.3m x 4.9m)  
ASTM Use Zone



**Little Digger ADAAG** 590-0063  
\$635\* | Ages 2-12   
18' x 18' (5.5m x 5.5m)  
ASTM Use Zone  
 Limit 5 on 5-business day Quickship.



**Little Digger** 590-0064  
\$661\* | Ages 2-12   
18' x 18' (5.5m x 5.5m)  
ASTM Use Zone  
 Limit 5 on 5-business day Quickship.



**Straight Balance Beam** 200-0045  
\$451\* | Ages 2-12   
25' x 13' (7.7m x 4m)  
ASTM Use Zone



**S Balance Beam** 590-0058  
\$545\* | Ages 2-12   
15' x 23' (4.6m x 7m)  
ASTM Use Zone



**Z Balance Beam** 590-0386  
\$507\* | Ages 2-12   
20' x 17' (6.1m x 5.2m)  
ASTM Use Zone



4 NaturePlay Stump - Small 560-0553

6 Ladybug 560-0552

7 Dinosaur Fossil Dig - Small 560-0550

8 Dinosaur Fossil Dig - Large 560-0551



**NATUREPLAY® COLLECTION** 

Number	Product ID	Description	Ages	Capacity	Size	Price*
1	560-0556	NaturePlay Rock - Large	2-12	2 Kids	53" x 52" x 27 3/8" high (134.7cm x 132.1cm x 69.6cm)	\$1,100
2	560-0555	NaturePlay Rock - Small	2-12	1 Kid	41" x 38" x 16 1/2" high (104.2cm x 96.6cm x 41.9cm)	\$660
3	560-0554	NaturePlay Stump - Large	2-12	1 Kid	34" x 27" x 23" high (86.4cm x 68.6cm x 58.5cm)	\$770
4	560-0553	NaturePlay Stump - Small	2-12	1 Kid	25" x 22" x 16" high (63.5cm x 55.9cm x 40.7cm)	\$660
5	560-0559	NaturePlay Log Tunnel	2-12	3 Kids	17' x 15' (5.2m x 4.6m) ASTM Use Zone	\$6,055
6	560-0552	Ladybug	2-12	1 Kid	34" x 22" x 12" high (86.4cm x 55.9cm x 30.5cm)	\$879
7	560-0550	Dinosaur Fossil Dig - Small	2-12	4 Kids	24" x 47" x 1" thick (61cm x 119.4cm x 2.6cm)	\$440
8	560-0551	Dinosaur Fossil Dig - Large	2-12	8 Kids	59" x 59" x 1" thick (150cm x 150cm x 2.6cm)	\$1,211
9	560-0557	Treasure Chest	2-12	1 Kid	28" x 18" x 22" high (71.2cm x 45.8cm x 56.9cm)	\$1,100

**Warning:** Never install play equipment over hard surfaces such as asphalt, concrete, grass or compacted earth. Consult ASTM and CPSC guidelines for appropriate amounts of impact attenuating material.



**Ant Farm** 580-0311  
\$2,934\* | Ages 2-12 ♿  
5' x 8' (1.6m x 2.5m)



**Short Straight Tunnel** 580-0251  
\$1,205\* | Ages 2-12 ♿  
3' x 3' (1m x 1m)  
Also available with Square Entrance 580-0293



**Long Straight Tunnel** 580-0294  
\$1,822\* | Ages 2-12 ♿  
6' x 3' (1.9m x 1m)  
Also available with Cloud Entrance 580-0252



**90° Tunnel** 580-0253  
\$1,511\* | Ages 2-12 ♿  
5' x 5' (1.6m x 1.6m)  
Also available with Square Entrance 580-0295



**"S" Tunnel** 580-0296  
\$1,511\* | Ages 2-12 ♿  
5' x 5' (1.6m x 1.6m)  
Also available with Cloud Entrance 580-0254



**Arch Tunnel** 580-0255  
\$1,684\* | Ages 2-12 ♿  
6' x 3' (1.9m x 1m)  
Also available with Square Entrance 580-0297



**Viper S** 3D-2129  
\$5,574\* | Ages 2-12 ♿  
64" (1.7m) Platform Height  
29' x 19' (8.9m x 5.8m) ASTM Use Zone



**Viper II Over Under** 3D-1913  
\$9,884\* | Ages 5-12 ♿  
96" (2.5m) Platform Height  
35' x 24' (10.7m x 7.4m) ASTM Use Zone



**Viper III Left-Right** 3D-1163  
\$10,105\* | Ages 2-12 ♿  
72" (1.9m) Platform Height  
23' x 32' (7m x 9.8m) ASTM Use Zone



**Rock 'N' Roll Slide** 3D-2278  
\$4,606\* | Ages 2-12 ♿  
72" (1.9m) Platform Height  
29' x 16' (8.9m x 4.9m) ASTM Use Zone



**NEW Velo Slide** 3D-2594  
Ages 2-12 ♿  
72" (1.9m) Platform Height  
29' x 16' (8.9m x 4.9m) ASTM Use Zone



**One Piece Spiral Slide** 3D-1187  
\$8,103\* | Ages 2-12 ♿  
72" (1.9m) Platform Height  
27' x 18' (8.3m x 5.5m) ASTM Use Zone

CONTACT YOUR LOCAL BURKE REPRESENTATIVE FOR ADDITIONAL FREESTANDING SLIDE OPTIONS.



**Turtle Top** 580-0289 | \$4,631\*   
Manufactured Under USA Patent Number 7,766,755  
StoneBorders Included | Sand sold separately.



Easily close and lock the Turtle Top to protect the play area when not in use.

## STONEBORDERS & ACCESSORIES





**Wheelchair Access Ramp**  
046-0153 | \$989\*   
48" x 66" (1.3m x 1.7m)





**StoneBorder Sandbox or Planter**  
6' x 6' (1.9m x 1.9m) - 580-0150 | \$296\*  
12' x 12' (3.7m x 3.7m) - 580-0152 | \$596\*  
12' x 6' (3.7m x 1.9m) - 580-0151 | \$447\*  
Plants and/or sand sold separately.  
 Limit 5 on 5-business day Quickship.



**Play Mat** 046-0521 | \$155  
15 ft<sup>2</sup> (1.4m<sup>2</sup>) Surface Area   
36" x 60" x 2" (91.5cm x 152.4cm x 5.1cm)  
For use at slide exits and under swings.

**8" StoneBorders**  
046-0366 | \$37\*  
8" x 4' (20.4cm x 1.3m)  
with one 30" (76.2cm) Drive Pin  
 Limit 5 on 5-business day Quickship.

**12" StoneBorders**  
046-0053 | \$65\*  
12" x 6' (30.5cm x 1.9m)  
with two 30" (76.2cm) Drive Pins  
 Limit 5 on 5-business day Quickship.

<b>StoneBorder Parts</b>		
046-0054	Plug	\$18.38
046-0055	12" (30.5cm) End Cap	\$54
046-0056	30" (76.2cm) Drive Pin	\$14.57
046-0368	8" x 4' (20.4cm x 1.3m) Connector	\$22
046-0380	4' (1.3m) End Cap	\$22.97
	Limit 5 on 5-business day Quickship.	





## THE VERVE™ CLIMBER COLLECTION

Exclusively From Burke

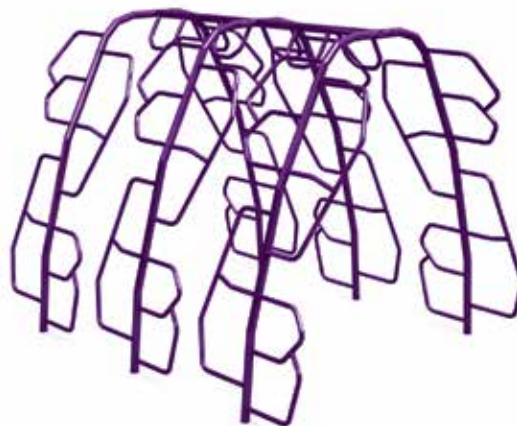

**NEW Verve VI** 560-2581  
Ages 5-12 | 14 Kid Capacity   
23' x 23' (7m x 7m) ASTM Use Zone



**NEW Verve VI Arch** 560-2585  
Ages 5-12 | 15 Kid Capacity   
20' x 23' (6.1m x 7m) ASTM Use Zone



**NEW Verve V** 560-2584  
Ages 5-12 | 13 Kid Capacity   
22' x 23' (6.7m x 6.8m) ASTM Use Zone



**NEW Verve IV** 560-2583  
Ages 5-12 | 9 Kid Capacity   
20' x 21' (6.7m x 6.5m) ASTM Use Zone



**NEW Verve III** 560-2580  
Ages 5-12 | 6 Kid Capacity   
19' x 20' (5.8m x 6.1m) ASTM Use Zone

Contact your Burke Representative for more information about Verve Climbers.



**Tight Rope** 560-0456  
\$696\* | Ages 2-5   
4 Kid Capacity  
20' x 13' (6.1m x 4m) ASTM Use Zone



**Triple Twist N' Turn** 560-0451  
\$2,181\* | Ages 5-12   
18 Kid Capacity  
25' x 24' (7.7m x 7.4m) ASTM Use Zone



**Fireman Climber** 560-0007  
\$1,108\* Galvanized   
\$1,236\* Powder Coat  
Ages 5-12 | 8 Kid Capacity  
16' (4.9m) diameter ASTM Use Zone





**Alpine Climber** 560-0533  
\$4,751\* | Ages 5-12  
12 Kid Capacity  
18' x 20' (5.5m x 6.1m) ASTM Use Zone



**Triple Verto Climber** BB-2465  
\$6,618 \* | Ages 5-12  
9 Kid Capacity  
21' x 20' (6.4m x 6.1m) ASTM Use Zone



**3 Tree Climber** 560-0001  
\$2,296\* | Ages 5-12  
11 Kid Capacity  
16' x 20' (4.9m x 6.1m) ASTM Use Zone



**Satellite Pod** 560-0442  
\$1,482\* | Ages 2-12  
9 Kid Capacity  
18' (5.5m) diameter ASTM Use Zone



**72" Satellite Climber** 600-0056  
\$3,733\* | Ages 5-12  
24 Kid Capacity  
19' 2" (5.9m) diameter ASTM Use Zone  
Also available at 48" height 600-0057 | \$2,806\*



**Satellite Station** 560-0443  
\$5,937\* | Ages 5-12  
24 Kid Capacity  
19' x 24' (5.8m x 7.4m)  
ASTM Use Zone



**Satellite Walk** 560-0444  
\$7,425\* | Ages 5-12  
30 Kid Capacity  
23' x 27' (7m x 8.3m)  
ASTM Use Zone



**Satellite Loop** 560-0445  
\$11,878\* | Ages 5-12  
60 Kid Capacity  
28' x 30' (8.6m x 9.2m)  
ASTM Use Zone



**Ant Hill** 560-0572  
\$1,898\* | Ages 2-5   
6 Kid Capacity  
20' x 15' (6.1m x 4.6m)  
ASTM Use Zone



**Spider Web** 560-0464  
\$2,444\* | Ages 5-12   
3 Kid Capacity  
19' x 16' (5.8m x 4.9m) ASTM Use Zone



**Sky Pods** 3D-942  
\$3,351\* | Ages 2-12   
8 Kid Capacity  
23' x 16' (7m x 4.9m) ASTM Use Zone



**NaturePlay Boulder - Small** 560-0429  
\$5,544\* | Ages 2-12   
18 Kid Capacity  
23' x 20' (7m x 6.1m) ASTM Use Zone





**NaturePlay Boulder - Large** 560-0430  
\$16,769\* | Ages 5-12   
22 Kid Capacity  
23' x 20' (7m x 6.1m) ASTM Use Zone



**Trigon Tower** NU-2440  
\$6,953\* | Ages 5-12   
9 Kid Capacity  
19' x 19' (5.8m x 5.8m) ASTM Use Zone



**Wobbly Web** 560-0573  
\$6,306\* | Ages 2-12    
10 Kid Capacity  
23' (7m) diameter ASTM Use Zone



560-0374



560-0375



560-0428

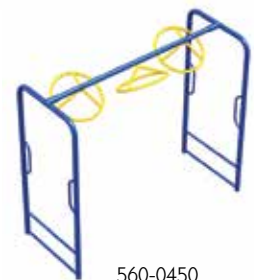

560-0450

Number	Description	Ages	Capacity	Price*	ASTM Use Zone
560-0374	Short Straight Triangle Overhead	5-12	5	\$1,458	16' x 19' (4.8m x 5.6m)
560-0375	Short Straight Ring Swing Overhead	5-12	5	\$1,458	16' x 19' (4.8m x 5.6m)
560-0428	Rocking Snake Overhead	5-12	6	\$1,852	16' x 19' (4.9m x 5.8m)
560-0450	Wheel Deal Overhead	5-12	3	\$2,356	16' x 21' (4.9m x 6.4m)

CONTACT YOUR LOCAL BURKE REPRESENTATIVE FOR MORE FREESTANDING OVERHEAD OPTIONS.



**Short S Curve Right Triangle** 560-0370  
\$1,311\* | Ages 5-12 | 7 Kid Capacity  
20' x 19' (6.1m x 5.8m) ASTM Use Zone  
Also available as Left Curve 560-0371

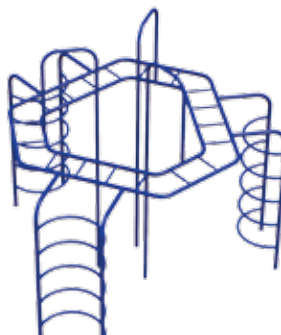

**Rally Round** 560-0032  
\$2,439\* | Ages 5-12   
18 Kid Capacity  
21' x 23' (6.4m x 7m) ASTM Use Zone



**12' (3.7m) Single Kid Koaster** 670-0387  
\$3,003\* | Ages 5-12  
26' x 15' (8m x 4.6m) ASTM Use Zone  
Also available in 18' (5.5m) 670-0388 | \$3,431\*  
**12' (3.7m) Dual Kid Koaster** 670-0389  
\$5,447\* | Ages 5-12  
26' x 18' (8m x 5.5m) ASTM Use Zone  
Also available in 18' (5.5m) 670-0390 | \$6,304\*



Volito 550-0186 with Add-On Bay 550-0187  
Seat(s) included.

WATCH THE VIDEO!



5" Double Post Tire Swing 550-0097  
Seat(s) included.



**Q10** Limit 3 on 10-business day Quickship.

5" Arch Tire Swing 550-0137  
Seat(s) included.



**Q10** Limit 3 on 10-business day Quickship.

T-Swing 550-9011  
Seats included.



**Q10** Limit 3 on 10-business day Quickship.

Tot Swing 550-0141  
Seat included.



#### Number

550-0186  
550-0187  
550-0188  
550-0097  
550-0098  
550-0137  
550-0138  
550-9011  
550-9111  
550-0141

#### Description

Volito Multi-User Swing  
Volito Add-On Bay  
Volito Multi-User Swing with Stainless Steel Chains (Not Pictured)  
5" (12.7cm) Double Post Tire Swing  
5" (12.7cm) Double Post Tire Swing Added Bay (Not Pictured)  
5" (12.7cm) Arch Tire Swing  
5" (12.7cm) Arch Tire Swing Added Bay (Not Pictured)  
T-Swing with Galvanized Chains (Ages 2-5 only.)  
T-Swing with PVC Chains (Ages 2-5 only.) (Not Pictured)  
Tot Swing (Ages 2-5 only.)

#### Beam Height

N/A  
N/A  
N/A  
7' (2.2m)  
7' (2.2m)  
7' (2.2m)  
7' (2.2m)  
7' (2.2m)  
7' (2.2m)  
N/A

#### Price\*

\$5,470  
\$6,236  
\$5,470  
\$3,345  
\$2,840  
\$3,155  
\$2,271  
\$1,374  
\$1,453  
\$980

#### ASTM Use Zone

30' x 27' (9.2m x 8.3m)  
N/A  
30' x 27' (9.2m x 8.3m)  
23' x 30' (7m x 9.2m)  
N/A  
23' x 30' (7m x 9.2m)  
N/A  
24' x 23' (8.6m x 7m)  
24' x 23' (8.6m x 7m)  
19' x 17' (5.8m x 5.2m)

SWING SELECTION

STEP 1: Choose your Swing Frame from pages 179-180. STEP 2: Choose your Swing Seats from page 181. STEP 3: Swing!



**Q10** Limit 3 on 10-business day Quickship.

**5" (12.7cm) Arch Swing 550-0135**  **Seats sold separately.**



**Q10** Limit 3 on 10-business day Quickship.

**5" Arch Swing with Single Seat Frame 550-0177**  **Seat sold separately.**



**5" Single Post Swing 550-0093**  **Seats sold separately.**



**5" Single Post Swing with Single Seat Frame 550-0178**  **Seat sold separately.**

Number	Description	Beam Height	Price*	ASTM Use Zone
550-0158	3½" (8.9cm) Arch Swing (Not Pictured)**	8' (2.5m)	\$1,471	32' x 24' (9.8m x 7.4m)
550-0159	3½" (8.9cm) Arch Swing Added Bay (Not Pictured)**	8' (2.5m)	\$931	N/A
550-0135	5" (12.7cm) Arch Swing**	8' (2.5m)	\$2,198	32' x 24' (9.8m x 7.4m)
550-0136	5" (12.7cm) Arch Swing Added Bay (Not Pictured)**	8' (2.5m)	\$1,476	N/A
550-0177	5" (12.7cm) Arch Swing with Single Seat Frame**	8' (2.5m)	\$2,198	32' x 20' (9.8m x 6.1m)
550-0189	5" (12.7cm) Arch Swing with Single Seat Frame Added Bay**	8' (2.5m)	\$1,431	N/A
550-0093	5" (12.7cm) Single Post Swing	8' (2.5m)	\$1,009	32' x 24' (9.8m x 7.4m)
550-0094	5" (12.7cm) Single Post Swing Added Bay (Not Pictured)	8' (2.5m)	\$856	N/A
550-0178	5" (12.7cm) Single Post Swing with Single Seat Frame	8' (2.5m)	\$1,009	32' x 20' (9.8m x 6.1m)
550-0185	5" (12.7cm) Single Post Swing with Single Seat Frame Added Bay	8' (2.5m)	\$856	N/A

\*\* **Q10** Limit 3 on 10-business day Quickship.

CONTACT YOUR LOCAL BURKE REPRESENTATIVE FOR MORE SWING OPTIONS.

**Warning:** Never install play equipment over hard surfaces such as asphalt, concrete, grass or compacted earth. Consult ASTM and CPSC guidelines for appropriate amounts of impact attenuating material.

## SWING SELECTION

STEP 1: Choose your Swing Frame from pages 179-180. STEP 2: Choose your Swing Seats from page 181. STEP 3: Swing!

Q10 Limit 3 on 10-business day Quickship.



**Traditional Two-Way End Support Swing** 550-0025   
*Seats sold separately.*



**Traditional Three-Way End Support Swing** 550-0021   
*Seats sold separately.*

Number	Description 	Galvanized*	Powder Coat*	ASTM Use Zone
550-0025	8' (2.5m) Traditional, Two-Way End Supports	\$884	\$981	32' x 28' (9.8m x 8.6m)
550-0023	10' (3.1m) Traditional, Two-Way End Supports ( <i>Not Pictured</i> )	\$931	\$1,035	40' x 29' (12.2m x 8.9m)
550-0021	8' (2.5m) Traditional, Three-Way End Supports	\$1,148	\$1,276	32' x 33' (9.8m x 10.1m)
550-0019	10' (3.1m) Traditional, Three-Way End Supports ( <i>Not Pictured</i> )	\$1,207	\$1,340	40' x 37' (12.2m x 11.3m)
550-0022	8' (2.5m) Traditional Added Bay ( <i>Not Pictured</i> )	\$570	\$633	N/A
550-0020	10' (3.1m) Traditional Added Bay ( <i>Not Pictured</i> )	\$598	\$663	N/A

CONTACT YOUR LOCAL BURKE REPRESENTATIVE FOR MORE SWING OPTIONS.



**Contemporary Two-Way End Support Swing** 550-0123   
*Seats sold separately.*



**Contemporary Three-Way End Support Swing** 550-0127   
*Seats sold separately.*

Number	Description 	Galvanized*	Powder Coat*	ASTM Use Zone
550-0123	8' (2.5m) Contemporary, Two-Way End Supports	\$922	\$1,023	32' x 26' (9.8m x 8m)
550-0125	10' (3.1m) Contemporary, Two-Way End Supports ( <i>Not Pictured</i> )	\$967	\$1,075	40' x 26' (12.2m x 8m)
550-0127	8' (2.5m) Contemporary Three-Way End Supports	\$1,262	\$1,348	32' x 33' (9.8m x 10.1m)
550-0128	10' (3.1m) Contemporary Three-Way End Supports ( <i>Not Pictured</i> )	\$1,287	\$1,429	40' x 35' (12.2m x 10.7m)
550-0124	8' (2.5m) Contemporary Added Bay	\$605	\$672	N/A
550-0126	10' (3.1m) Contemporary Added Bay ( <i>Not Pictured</i> )	\$617	\$685	N/A

CONTACT YOUR LOCAL BURKE REPRESENTATIVE FOR MORE SWING OPTIONS.



Freedom Seat



**Q3** No Limit on 3-business day Quickship.

Polyethylene Seat



**Q3** No Limit on 3-business day Quickship.

Molded Rubber Tot Seat



**Q3** No Limit on 3-business day Quickship.

Molded Rubber Seat

## SWING SEAT SELECTION

### Freedom Inclusive Swing Seat

Model #	Seats	Beam Height	Chains	Price*
550-0171	1	8' (2.5m)	Yes	\$831
550-0172	1	8' (2.5m)	Yes-PVC	\$915
550-0175	2	8' (2.5m)	Yes	\$1,663
550-0176	2	8' (2.5m)	Yes-PVC	\$1,831

### Polyethylene Seat

Model #	Seats	Beam Height	Chains	Price*
049-0072	1	N/A	No	\$64
550-0107	1	7' (2.2m) or 8' (2.5m)	Yes	\$114
550-0108	2	7' (2.2m) or 8' (2.5m)	Yes	\$228
550-0109	1	7' (2.2m) or 8' (2.5m)	Yes-PVC	\$149
550-0110	2	7' (2.2m) or 8' (2.5m)	Yes-PVC	\$297
550-0119	1	10' (3m)	Yes	\$120
550-0120	2	10' (3m)	Yes	\$241
550-0121	1	10' (3m)	Yes-PVC	\$191
550-0122	2	10' (3m)	Yes-PVC	\$383

### Molded Rubber Seat

Model #	Seats	Beam Height	Chains	Price*
018-0022	1	N/A	No	\$34
550-0103	1	7' (2.2m)	Yes	\$83
550-0104	2	7' (2.2m)	Yes	\$161
550-0105	1	7' (2.2m)	Yes-PVC	\$121
550-0106	2	7' (2.2m)	Yes-PVC	\$243
550-0111	1	8' (2.5m)	Yes	\$86
550-0112	2	8' (2.5m)	Yes	\$169
550-0113	1	8' (2.5m)	Yes-PVC	\$119
550-0114	2	8' (2.5m)	Yes-PVC	\$239
550-0115	1	10' (3m)	Yes	\$91
550-0116	2	10' (3m)	Yes	\$182
550-0117	1	10' (3m)	Yes-PVC	\$161
550-0118	2	10' (3m)	Yes-PVC	\$324

### Molded Rubber Tot Seat

Model #	Seats	Beam Height	Chains	Price*
018-0025	1	N/A	No	\$153
550-0099	1	7' (2.2m) or 8' (2.5m)	Yes	\$155
550-0100	2	7' (2.2m) or 8' (2.5m)	Yes	\$308
550-0101	1	7' (2.2m) or 8' (2.5m)	Yes-PVC	\$193
550-0102	2	7' (2.2m) or 8' (2.5m)	Yes-PVC	\$387

### Replacement Parts

Model #	Description	Price*
009-0018	S-Hook for Swings	\$2.11
031-0033	S-Hook Closer	\$414
009-0026	Chain	\$2.88/ft.
550-0061	2 3/8" (6cm) O.D. Hanger	\$44
550-0054	3 1/8" (9cm) O.D. Hanger	\$83
550-0146	Swing Hanger, Anti-Wrap 3 1/2" (9cm) with Hardware - 1 Bay	\$484
550-0147	Swing Hanger, Anti-Wrap 2 3/8" (6cm) with Hardware - 1 Bay	\$444
550-0148	Swing Hanger, Anti-Wrap 3 1/2" (9cm) with Hardware	\$128
550-0149	Swing Hanger, Anti-Wrap 2 3/8" (6cm) with Hardware	\$117
046-0314	Clevis Shackles with Bolt	\$8.81
046-0291	Loctite	\$6.27
046-0297	Shackle Pendulum	\$17.21
046-0319	"H" Shackle with Bolt	\$14.06

For more information on Swing Replacement Parts contact Customer Service at 800-356-2070.

**Q5** No Limit on 5-business day Quickship on Replacement Parts.

# NEW NOVO™ PLAYFUL FURNITURE

Patent Pending



**Novo Arc Bench** 580-1312  
3 Shown. Also connects to a Burke play structure as a play component. See page 141.



**Novo Teardrop Counter Climber** 580-1319  
Arc Benches or Stools sold separately.  
Also connects to a Burke play structure as a play component. See page 141.



**Novo Arc Stool** 580-1318  
3 Shown. Teardrop Counter Climber sold separately.



**Novo Table** 580-1313



**Novo Bench** 580-1314



**Novo Welcome Sign 5-12** 580-1315  
Also available for 2-5 and 2-12



**Novo Custom Sign - Single** 580-1310



**Novo Custom Sign - Double** 580-1311

**Number**  
580-1317  
580-1315  
580-1316  
580-1310  
580-1311

**Description**  
Novo Welcome Sign  
Novo Welcome Sign  
Novo Welcome Sign  
Novo Custom Sign - Single  
Novo Custom Sign - Double

**Age Group**  
2-5  
5-12  
2-12  
N/A  
N/A







Novo Playful Furniture products are available in Burke's standard colors shown on page 192-193.

**6' (1.9m) Standard Portable Table**

2 3/8" (6cm) O.D. Frame

580-0176 | \$875\*

**8' (2.5m) Portable Table**

580-1013 | \$1,022\*

Limit 5 on 10-business day Quickship.

**6' (1.9m) Tot Table**

1 1/2" (4.2cm) O.D. Frame

580-1010 | \$729\*

Limit 5 on 10-business day Quickship.

**Traditional Series****Portable Sit-A-Round Table**

2 3/8" (6cm) O.D. Frame

580-0177 | \$1,034\*

Limit 5 on 10-business day Quickship.

**Traditional Series 8' (2.5m)  ADAAG Table (2 Wheelchairs)**

2 3/8" (6cm) O.D. Frame

580-1012 | \$936\*

Limit 5 on 10-business day Quickship.

**Traditional Series 8' (2.5m)  ADAAG Table (1 Wheelchair)**

2 3/8" (6cm) O.D. Frame

580-0226 | \$973\*

Limit 5 on 10-business day Quickship.

**6' (1.9m) Stationary Bench**

580-0172 | \$487\*

Also available as Portable 580-0173  
or Surface Mount 580-0190

Limit 5 on 10-business day Quickship.

**8' (2.5m) Traditional Series Portable Bench**

580-0175 | \$560\*

Also available as Stationary 580-0174  
or Surface Mount 580-0193

Limit 5 on 10-business day Quickship.

**6' (1.9m) Traditional Series Stationary Backless Bench**

580-1008 | \$316\*

Also available as Portable 580-0192  
or Surface Mount 580-0191

Limit 5 on 10-business day Quickship.

**8' (1.9m) Traditional Series Portable Backless Bench**

580-0195 | \$339\*

Also available as Stationary 580-1009  
or Surface Mount 580-0194

Limit 5 on 10-business day Quickship.



**Personalized Series**  
**6' (1.9m) Portable Bench**  
580-0205 | \$913\* | \$75 Set-up charge  
Also available as Stationary 580-0204  
or Surface Mount 580-0203



**Personalized Series**  
**8' (2.5m) Stationary Bench**  
580-0207 | \$1,034\* | \$75 Set-up charge.  
Also available as Portable 580-0208  
or Surface Mount 580-0206



**Monogrammed Series**  
**6' (1.9m) Stationary Bench**  
580-0198 | \$851\* | \$75 Set-up charge  
Also available as Portable 580-0199  
or Surface Mount 580-0197



**Monogrammed Series**  
**8' (2.5m) Portable Bench**  
580-0202 | \$936\* | \$75 Set-up charge  
Also available as Stationary 580-0201  
or Surface Mount 580-0200

**6' (1.9m) Stationary Buddy Bench**  
580-1305 | \$851\*  
Also Available as Portable 580-1306  
or Surface Mount 580-1304

**8' (2.5m) Stationary Buddy Bench**  
580-1308 | \$936\*  
Also available as Portable 580-1309  
or Surface Mount 580-1307



**Traditional Series Portable**  
**Litter Container without Cover**  
32 Gallon | 580-0179 | \$303\*  
Also available as Stationary 580-0182 - \$339\*

**Q10** Limit 5 on 10-business day Quickship.



**Traditional Series Portable**  
**Litter Container with Flat Cover**  
32 Gallon | 580-0181 | \$395\*  
Also available as Stationary 580-0184 - \$431\*  
Covers available in black only.

**Q10** Limit 5 on 10-business day Quickship.



**Traditional Series Portable Litter**  
**Container with Plastic Dome Cover**  
32 Gallon | 580-0188 | \$401\*  
Also available as Stationary 580-0189 - \$438\*  
Covers available in black only.

**Q10** Limit 5 on 10-business day Quickship.



**Traditional Series Portable Litter**  
**Container with Metal Dome Cover**  
32 Gallon | 580-0180 | \$413\*  
Also available as Stationary 580-0183 - \$450\*  
Covers available in black only.

**Q10** Limit 5 on 10-business day Quickship.

**Traditional Series Site Amenities Color Selection:**





Pressure Treated Pine





Natural Pine



Recycled Plastic

ClubHouse

Number	Description	Size	Frame	Price*	Quickship
580-0156	ADAAG Pressure Treated Pine Table 	8' (2.5m)	2 3/8" (6cm) O.D.	\$563	Limit 5 on 10 Business days
580-0157	Pressure Treated Pine Table	6' (1.9m)	2 3/8" (6cm) O.D.	\$542	Limit 5 on 10 Business days
580-0158	Pressure Treated Pine Table	6' (1.9m)	1 5/8" (4.2cm) O.D.	\$464	Limit 5 on 10 Business days
580-0161	Pressure Treated Pine Table	8' (2.5m)	2 3/8" (6cm) O.D.	\$563	Limit 5 on 10 Business days
580-0162	Pressure Treated Pine Table	8' (2.5m)	1 5/8" (4.2cm) O.D.	\$517	Limit 5 on 10 Business days
580-0159	Pressure Treated Pine Pedestal Table	6' (1.9m)	2 3/8" (6cm) O.D.	\$681	Quickship not available
580-0160	Pressure Treated Pine Sit-A-Round Table	N/A	2 3/8" (6cm) O.D.	\$668	Limit 5 on 10 Business days
580-0153	Pressure Treated Pine Bench	6' (1.9m)	N/A	\$295	Limit 5 on 10 Business days
580-0154	Pressure Treated Pine Multi-Use Bench	6' (1.9m)	N/A	\$251	Limit 5 on 10 Business days
580-0163	Portable Pressure Treated Pine Litter Container	20 Gallon	N/A	\$388	Limit 5 on 10 Business days
580-0073	Natural Pine Table	6' (1.9m)	2 3/8" (6cm) O.D.	\$481	Limit 5 on 10 Business days
580-0087	ADAAG Natural Pine Table 	8' (2.5m)	2 3/8" (6cm) O.D.	\$613	Quickship not available
580-0004	Natural Pine Stationary Bench	6' (1.9m)	N/A	\$276	Limit 5 on 10 Business days
580-0136	Natural Pine Portable Bench	6' (1.9m)	N/A	\$319	Limit 5 on 10 Business days
580-0091	Recycled Plastic Table	6' (1.9m)	2 3/8" (6cm) O.D.	\$990	Quickship not available
580-0094	ADAAG Recycled Plastic Table 	8' (2.5m)	2 3/8" (6cm) O.D.	\$1,086	Quickship not available
580-0010	Recycled Plastic Bench	6' (1.9m)	N/A	\$476	Quickship not available
580-0001	Traditional Bench	4' (1.3m)	N/A	\$235	Limit 5 on 10 Business days
580-0003	Traditional Bench	6' (1.9m)	N/A	\$268	Limit 5 on 10 Business days
580-0298	ClubHouse Recycled Plastic Litter Container	20 Gallon	N/A	\$713	Quickship not available
580-0109	Dome Cover for ClubHouse and Pressure Treated Pine Litter Containers	N/A	N/A	\$137	Limit 5 on 10 Business days

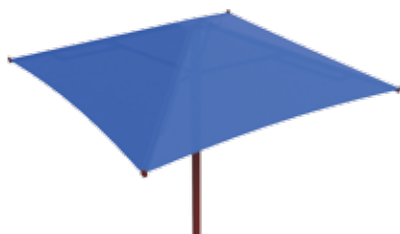

Freestanding Single Post Shade

560-0579 | 12' x 12' at 10' Entry height | \$4,329\*

560-0578 | 12' x 12' at 8' Entry height | \$4,329\*

560-0580 | 15' x 15' at 10' Entry height | \$4,703\*

560-0577 | 15' x 15' at 8' Entry height | \$4,703\*



Double Wide Grill

580-0099 | \$418\*

534 in<sup>2</sup> (0.4m<sup>2</sup>) Surface Area Limit 5 on 5-business day Quickship.

One-Piece Adjustable Single Grill

234 in<sup>2</sup> (0.2m<sup>2</sup>) Surface Area

580-0098 | \$248\*

 Limit 5 on 5-business day Quickship.

10' (3m) Single Face

Extra Heavy Duty Bike Rack

Capacity 10 bikes

Stationary Galvanized 580-0118 - \$554\*

Portable Galvanized 580-0120 - \$594\*

 Limit 5 on 5-business day Quickship.

10' (3m) Double Face

Extra Heavy Duty Bike Rack

Capacity 20 bikes

Portable Galvanized 580-0112 - \$619\*

Stationary Galvanized 580-0110 - \$578\*

 Limit 5 on 5-business day Quickship.

7'4" (2.3m) Stationary

Contemporary Bike Rack 580-0130

Galvanized \$458\* | Powder Coat \$514\*

Capacity 16 bikes

Ground Space 8' x 15' (2.5m x 4.6m)

5'4" (1.7m) Stationary

Contemporary Bike Rack 580-0131

Galvanized \$417\* | Powder Coat \$473\*

Capacity 12 bikes

Ground Space 6' x 15' (1.9m x 4.6m)

 Limit 5 on 5-business day Quickship.

**Funnel Ball®**  
590-0062 | \$860\*

**Sleeve** (For Removable Installation)  
590-0034 | \$140\*

**Q5** Limit 3 on 5-business day Quickship.



**Tetherball** 590-0003  
Galvanized - \$238\* | Powder Coat - \$254\*

**Replacement Ball & Cord**  
046-0029 | \$73\*

**Q5** Limit 3 on 5-business day Quickship.

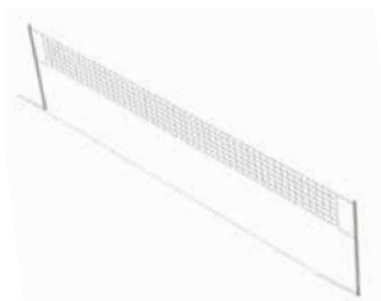

**Volleyball Posts**  
590-0009 | \$385\* pair

**Volleyball Net**  
3' x 32' (1.4m x 14.6m)  
018-0368 | \$154\*

**Permanent Soccer Goal**  
590-0011 | \$3,280\* pair

**Portable Soccer Goal**  
590-0012 | \$3,456\* pair

**Nylon Soccer Net**  
590-0076 | \$562\* pair  
21-Thread Twisted Nylon Net,  
Tar-Treated, Bound All Around, Black



**COMPLETE BASKETBALL PACKAGES** - Includes post, backboard, goal with double rim and nylon net.  
*Backboard attachment frame and hardware included with rectangular backboard package.*

**Package 1** 590-0038  
Rectangular Backboard | \$1,900\*  
4' (1.3m) Extension | Nylon Net  
4 1/2" (11.5cm) O.D. Gooseneck Post

**Package 2** 590-0039  
Rectangular Backboard | \$3,007\*  
6' (1.9m) Extension | Nylon Net  
5 1/16" (14.2cm) O.D. Gooseneck Post

**Package 3** 590-0040  
Fan Backboard | \$1,483\*  
4' (1.3m) Extension | Nylon Net  
4 1/2" (11.5cm) O.D. Gooseneck Post

**Package 4** 590-0041  
Fan Backboard | \$2,583\*  
6' (1.9m) Extension | Nylon Net  
5 1/16" (14.2cm) O.D. Gooseneck Post

**Q10** Limit 5 on 10-business day Quickship.



**Fan Shape Backboard**  
590-0024 | \$709\* each  
*Rim and Net sold separately.*



**Rectangular Backboard**  
590-0025 | \$808\* each  
*Rim and Net sold separately.*



**Double Rim Basketball Goal & Nylon Net**  
046-0038 | \$200\* each



**Double Rim Basketball Goal & Chain Net**  
046-0039 | \$200\* each

**BASKETBALL ACCESSORIES**

Model #	Description	Price*	Quickship
590-0026	4 1/2" (11.5cm) O.D. Upright Only - 4' (1.3m) Extension	\$662 each	Quickship not available
590-0027	5 1/16" (14.2cm) O.D. Upright Only - 6' (1.9m) Extension	\$1,763 each	Quickship not available
590-0028	Rectangular Backboard Attachment Frame with Hardware	\$325 each	Quickship not available
046-0037	Nylon Net	\$21.83 each	Limit 5 on 5 business day
046-0036	Chain Net	\$36 each	Limit 5 on 5 business day
046-0367	Backboard Shooters Square Decal	\$109 each	Limit 5 on 5 business day



### PLAYGROUNDS POWERED BY WIND

By participating in programs that support the development of clean energy, we are able to purchase **100%** of our electricity usage from wind and other renewables. This positions Burke as an environmental leader within the playground industry and helped us earn the Green Power Partner designation from the U.S. Environmental Protection Agency. For more information visit [epa.gov/greenpower](http://epa.gov/greenpower).

### SAFETY



**The Customer Product Safety Commission (CPSC)** created playground safety guidelines to help local communities, schools, day care centers and other groups build safe playgrounds. **The American Society for Testing and Materials (ASTM)** is an independent world renowned developer of technical standards utilized in testing products. ASTM and CPSC guidelines are built into our proprietary EZ Design program ensuring every Burke playground is designed to meet or exceed all their standards. To highlight our commitment to safety, BCI Burke is the only playground manufacturer to partner with the National Program for Playground Safety (NPPS) and provide a **FREE** Safe Playground Supervision Kit with each play system purchased.



BCI Burke Company, LLC, is a member in good standing of IPEMA, the International Play Equipment Manufacturers Association. IPEMA is a member-driven international trade organization which represents and promotes an open market for manufacturers of play equipment and surfacing.



In the interest of playground safety, the International Play Equipment Manufacturers Association (IPEMA) provides a Third Party Certification Service whereby a designated independent laboratory, with TÜV America (TÜV), validates an equipment manufacturer's certification of conformance to ASTM F1487, Standard Consumer Safety Performance Specification for Playground Equipment for Public Use, except sections 7.1.1, 10 & 12.6.1; to CAN/CSA Z614, Children's Playspaces and Equipment, except clauses 9.8, 10 & 11; or both. The use of the corresponding logo in Burke's Catalog signifies that Burke has received written validation from the independent laboratory that the product(s) associated with the use of the logo conforms to the requirements of the indicated standard.



Check IPEMA website [www.ipema.org](http://www.ipema.org) to confirm product validation.



In the interest of playground safety, the International Play Equipment Manufacturers Association (IPEMA) provides a Third Party Certification Service whereby a designated independent laboratory, with TÜV America (TÜV), validates a surfacing manufacturer's certification of conformance to ASTM F1292, Standard Specification for Impact Attenuation Under and Around Playground Equipment, except section 15, and for an engineered wood fiber manufacturer its certification of conformance, also to ASTM F2075, Standard Specification for Engineered Wood Fiber for use as a Playground Safety Surface Under and Around Playground Equipment, Section 4.4, for testing Sieve Analysis and Section 4.6, for testing the presence of Tramp Metal. The use of corresponding logo in Burke's Catalog signifies that Burke has received written validation from the independent laboratory that the product(s) associated with the use of the logo conforms to the requirements of the indicated standard.

Check IPEMA website [www.ipema.org](http://www.ipema.org) to confirm product validation, its thickness and critical height.

The space requirements shown in this publication are shown to ASTM Standards. Requirements for other standards may be different.



### ALLIED TUBE & CONDUIT

Allied Tube & Conduit is the leading supplier of galvanized and commercial quality tubing to both manufacturers and metal distributors in over 70 consumer and industrial markets. Their unique in-line galvanizing process produces superior corrosion resistance by utilizing a triple layer of protection. This advanced processing technique was first introduced in 1959 and is still relevant today.

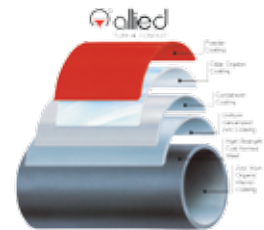

### ISO 9001:2008 AND ISO 14001:2004

NSF-ISR attests that BCI Burke Company, LLC is in compliance with ISO 9001:2008 and the International Environmental Management Standard ISO 14001:2004.



ISO 9001:2008 emphasizes processes to aid in continuous improvement in quality and customer service. ISO 14001:2004 ensures Burke follows strict environmental controls in manufacturing processes.



### FSC® CERTIFICATION

FSC certification ensures that products come from responsibly managed forests that provide environmental, social and economic benefits. The FSC Principles and Criteria provide a foundation for all forest management standards globally.



**VALUE ADDED RESOURCES**

**NPPS Safety Kit** - BCI Burke truly gives you the most value for your money. As part of our Total Cost of Ownership Package, we offer value-added resources FREE with every playground purchase. The National Program for Playground Safety (NPPS) Playground Supervision Safety Kit helps supervisors and educators be prepared on the playground. Learn more at [bciburke.com/safety](http://bciburke.com/safety).

**Customized Maintenance Kit** - To help maintain a safe, functioning playground we include a Custom Maintenance Schedule, Touch-up Paint, Graffiti Remover and Carrying Case FREE with every playground structure purchase.

**FUNDING SOLUTIONS**



**Financing** - If your organization needs a new Burke playground but doesn't have the capital on hand, BCI Burke's partnership with Marlin Financing can assist you in acquiring the funding you need so your kids can enjoy their new Burke playground today.



**Grant Resource Center** - We've partnered with The School Funding Center to provide up-to-date grant information along with expert grant writing services. The School Funding Center has one of the most comprehensive and current grant databases available on the internet today. They also maintain a network of experienced grant writers who can create grant applications for affordable fees. Learn more at [bciburke.com/funding](http://bciburke.com/funding).



**Funds for Fun** - Deciding to build a new playground or add equipment to a current playspace is easy. After the decision is made, the next question is, "Where will the money come from?" At BCI Burke, we understand the dedication and hard work it takes to raise the funds for playground equipment. That's why we have created a direct donation fundraising program to help your organization raise the funds it needs for your new park, recreation or school playground. Learn more at [bciburke.com/funding](http://bciburke.com/funding).

**PURCHASING COOPERATIVES**



**HGACBuy** is a unit of local government that strives to make the governmental procurement process more efficient by establishing competitively priced contracts for goods and services, and provides the customer service necessary to help its members achieve their procurement goals. Learn more at [bciburke.com/partnerships](http://bciburke.com/partnerships).



**National IPA** is redefining the future of cooperative purchasing. The cooperative purchasing organization is dedicated to serving public agencies and educational institutions nationwide. All cooperative agreements have been competitively solicited and publicly awarded by a public agency/governmental entity. There are no fees, minimums or obligations to participate. Learn more at [nationalipa.org](http://nationalipa.org).



**GSA** allows federal parks, child development programs, military bases and other agencies to purchase Burke playgrounds through Premier Playgrounds, the company's GSA contract (GS-07F-0081M ) for installation virtually anywhere in the world. Learn more at [premier-playgrounds.com](http://premier-playgrounds.com).



**CADDETAILS**

CADdetails is the leading provider of manufacturer-specific building product information, delivering to more than 452,000 architects, engineers, contractors, and other design industry professionals throughout North America.



**PARKS BUILD COMMUNITIES**

Bringing Play That Moves You to communities around the world is at the heart of Burke's mission. Participating in Parks Build Community, a national initiative aimed at demonstrating the transformative value of parks on the health and vitality of communities across America, with NRPA and other national donors is an exemplification of our mission. Learn more at [bciburke.com/partnerships](http://bciburke.com/partnerships).



**KABOOM!**

BCI Burke has been chosen as a Preferred Vendor for KaBOOM!, the national non-profit dedicated to bringing balanced and active play into the daily lives of all kids, particularly those growing up in poverty in America. Burke is proud to support KaBOOM! and its mission to give kids the playful childhood they deserve. Visit [kaboom.org/resources](http://kaboom.org/resources) and [kaboom.org/grants](http://kaboom.org/grants) to learn about KaBOOM! grant programs and do-it-yourself project tools that can help you through the planning process – from volunteer recruitment to fundraising, and everything in between.



**BOYS & GIRLS CLUB OF FOND DU LAC**

Boys & Girls Club of Fond du Lac is dedicated to empowering youth to reach their full potential. They offer a variety of programs and activities that positively change the lives and futures of children 6-18. Burke is proud to partner with a group that encourages physical, emotional and social growth of youth in our community.



**FOND DU LAC FAMILY YMCA**

The YMCA is a cause driven organization that is for youth development, for healthy living and for social responsibility. We believe a strong community can only be achieved when we invest in our kids, our health and our neighbors.



KoreKconnect

## BURKE BUILT QUALITY MADE IN THE USA

**KoreKconnect® Direct-Bolt Clamp System:** Nucleus and Voltage feature our Industry-leading KoreKconnect direct-bolt clamp system resulting in the strongest and most accurate connection system ever. Factory located connection points make for easy, precise installation and an error-free fit. Best of all, KoreKconnect is covered for 100 years under our non-prorated Generations Warranty.



Direct-Bolt

**Direct-Bolt Connection System:** Intensity, Intensity 2-5 and Little Buddies feature Burke's trusted direct-bolt connection that uses a durable, straightforward direct-bolt system to ensure a trouble-free installation and provide the necessary strength to accommodate the demands of playing children. Like our KoreKconnect system, Direct-Bolt connections are covered for 100 years under our Generations Warranty.



EZKconnect

**EZKconnect® Deck Mounting System:** Our exclusive self-leveling deck attachment and factory CNC construction allows for faster and more precise location of decks during installation. The 2-bolt per corner deck attachment increases overall structure strength and stability.



Stainless Steel Hardware

**Platforms:** Burke's oversized non-slip platforms are constructed of heavy-duty punched steel that can support more than 2 tons. Our vinyl coating is California compliant, free of lead and other hazardous heavy metals.

**Tamper-Resistant Stainless Steel Hardware:** All hardware is covered for 100 years under our Generations Warranty.



Powder Coating

**Premium Powder Coatings:** Our industry-leading powder coatings and finishes prevent fading, last longer and deter rust. We also offer a **"coastal package" powder coat system**. This special powder coat system for metal components and upright posts will provide additional corrosion and chemical protection along with added longevity to the color and gloss retention of the powder coated parts. Contact your Burke Representative for more information on colors, price and warranty.



Compound Plastics

**Compound Plastics with UV-15:** You'll get long wear and bright, vibrant colors that hold up for years thanks to our thick, durable rotomolded plastics with UV-15 protection, which is why we can cover them for 15 years under our non-prorated Generations Warranty.



Aluminum Connectors

**Climbing Cables:** Our climbing cables are flexible enough to provide movement, yet strong enough to last. Our ropes are made from 6 polyester cords with steel reinforcement wrapped around a synthetic fiber core. Each cord contains 8 galvanized steel strands tightly covered with polyester multi-fibers. Our RopeVenture cables consist of 6 strands, each containing 24 stainless steel reinforcing strands within a nylon sleeve, wrapped around a solid nylon core.

**Aluminum Connectors:** Swivel connectors at the end of our ropes allow assembly at any angle with no unwanted twists in the net. The aluminum fittings used to secure the joints are swaged in place to prevent any movement between the rope and fittings that could cause wear.



## BCI BURKE GENERATIONS WARRANTY®

### The Longest and Strongest warranty in the industry

BCI Burke Company, LLC ("Burke") warrants that all standard products are warranted to be free from defects in materials and workmanship, under normal use and service, for a period of one (1) year from the date of invoice.

#### We stand behind our products.

In addition, the following products are warranted, under normal use and service from the date of invoice as follows:

- One Hundred (100) Year Limited Warranty on aluminum and steel upright posts (including Intensity®, Voltage®, Nucleus® and Little Buddies®) against structural failure due to corrosion, deterioration or workmanship.
- One Hundred (100) Year Limited Warranty on KoreKonnnect® clamps against structural failure due to corrosion, deterioration or workmanship.
- One Hundred (100) Year Limited Warranty on Hardware (nuts, bolts, washers)
- One Hundred (100) Year Limited Warranty on bolt-through fastening and clamp systems (Voltage®, Intensity®, Nucleus® and Little Buddies®).
- Twenty-Five (25) Year Limited Warranty on spring assemblies and aluminum cast animals.
- Fifteen (15) Year Limited Warranty on main structure platforms and decks, metal roofs, table tops, bench tops, railings, loops and rungs.
- Fifteen (15) Year Limited Warranty on all plastic components including StoneBorders against structural failure due to materials or workmanship.
- Ten (10) Year Limited Warranty on ShadePlay Canopies fabric, threads, and cables against degradation, cracking or material breakdown resulting from ultra-violet exposure, natural deterioration or manufacturing defects. This warranty is limited to the design loads as stated in the specifications.
- Ten (10) Year Limited Warranty on NaturePlay® Boulders and GFRC products against structural failure due to natural deterioration or workmanship. Natural wear, which may occur with any concrete product with age, is excluded from this warranty
- Ten (10) Year Limited Warranty on Full Color Custom Signage against manufacturing defects that cause delamination or degradation of the sign. Full Color Custom Signs also carry a two (2) year warranty against premature fading of the print and graphics on the signs.
- Five (5) Year Limited Warranty on Intensity® and RopeVenture™ cables against premature wear due to natural deterioration or manufacturing defects. Determination of premature wear will be at the manufacturer's discretion.
- Five (5) Year Limited Warranty on swing seats and hangers; Kid Koaster® Trolleys and other moving parts against structural failure due to materials or workmanship.
- Three (3) Year Limited Warranty on electronic panel speakers, sound chips and circuit boards against electronic failure caused by manufacturing defects.

The warranty stated above is valid only if the equipment is erected in conformity with the layout plan and/or installation instructions furnished by BCI Burke Company, LLC using approved parts; have been maintained and inspected in accordance with BCI Burke Company, LLC instructions. Burke's liability and your exclusive remedy hereunder will be limited to repair or replacement of those parts found in Burke's reasonable judgment to be defective. Any claim made within the above stated warranty periods must be made promptly after discovery of the defect. A part is covered only for the original warranty period of the applicable part. Replacement parts carry the applicable warranty from the date of shipment of the replacement from Burke. After the expiration of the warranty period, you must pay for all parts, transportation and service charges.

Burke reserves the right to accept or reject any claim in whole or in part. Burke will not accept the return of any product without its prior written approval. Burke will assume transportation charges for shipment of the returned product if it is returned in strict compliance with Burke's written instructions.

**THE FOREGOING WARRANTIES ARE EXCLUSIVE AND IN LIEU OF ANY OTHER WARRANTY, EXPRESS OR IMPLIED, INCLUDING BUT NOT LIMITED TO ANY IMPLIED WARRANTY OR MERCHANTABILITY OR FITNESS FOR A PARTICULAR PURPOSE. IF THE FOREGOING DISCLAIMER OF ADDITIONAL WARRANTIES IS NOT GIVEN FULL FORCE AND EFFECT, ANY RESULTING ADDITIONAL WARRANTY SHALL BE LIMITED IN DURATION TO THE EXPRESS WARRANTIES AND BE OTHERWISE SUBJECT TO AND LIMITED BY THE TERMS OF BURKE'S PRODUCT WARRANTY. SOME STATES DO NOT ALLOW THE EXCLUSION OF CERTAIN IMPLIED WARRANTIES, SO THE ABOVE LIMITATION MAY NOT APPLY TO YOU.**

**Warranty Exclusions:** The above stated warranties do not cover: "cosmetic" defects, such as scratches, dents, marring, or fading; damage due to incorrect installation, vandalism, misuse, accident, wear and tear from normal use, exposure to extreme weather; immersion in salt or chlorine water, unauthorized repair or modification, abnormal use, lack of maintenance, or other cause not within Burke's control; and

**Limitation of Remedies:** Burke is not liable for consequential or incidental damages, including but not limited to labor costs or lost profits resulting from the use of or inability to use the products or from the products being incorporated in or becoming a component of any other product. If, after a reasonable number of repeated efforts, Burke is unable to repair or replace a defective or nonconforming product, Burke shall have the option to accept return of the product, or part thereof, if such does not substantially impair its value, and return the purchase price as the buyer's entire and exclusive remedy. Without limiting the generality of the foregoing, Burke will not be responsible for labor costs involved in the removal of products or the installation of replacement products. Some states do not allow the exclusion of incidental damages, so the above exclusion may not apply to you.

Contact your local Burke Representative for warranty information regarding Burke Turf® and Burke Tile products.

## TERMS OF SALE

**Pricing:** Prices published in this catalog are in USD, are approximate and do not include shipping & handling, surfacing, installation nor applicable taxes. All prices are subject to change without notice. Contact your Burke representative for current pricing. Payments are to be made in USD.

**Weights:** Weights are approximate and may vary with actual orders.

**Installation:** All equipment is shipped unassembled. For a list of factory-certified installers in your area, please contact your Burke representative.

**Specifications:** Product specifications in this catalog were correct at the time of publication. However, product improvements are ongoing at Burke, and we reserve the right to change or discontinue specifications without notice.

**Loss or Damage in Transit:** A signed bill of lading is our receipt from a carrier that our shipment to you was complete and in good condition upon arrival. Before you sign, please check the Bill of Lading carefully when the shipment arrives to make sure nothing is missing and there are no damages. Once the shipment leaves our plant, we are no longer responsible for any damage, loss or shortage.

For more information regarding the warranty, call Customer Service at 920-921-9220 or 1-800-356-2070.

01/2017

**POWDER COAT PAINT**



**ROTOMOLD PLASTIC**



**SHADE CANOPIES**

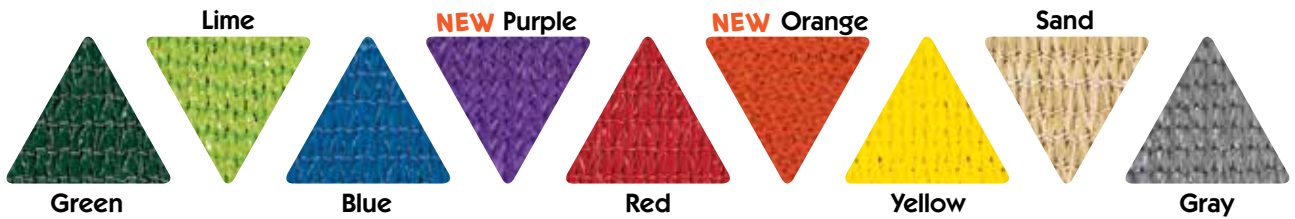

**PLATFORMS**

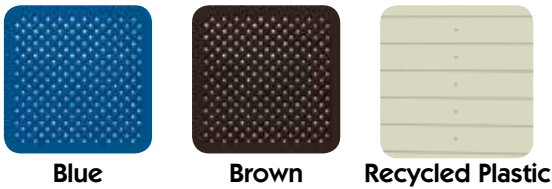

**ROCKIT CLIMBERS**

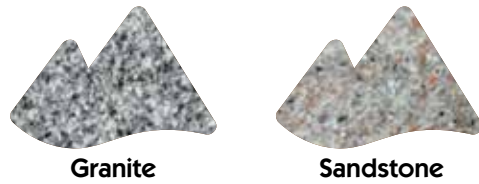

**Electric**

Navy posts, granite plastic, lime roofs, lime accessories, blue panels & blue platforms



**Marina**

Olive posts, blue plastic, blue roofs, tan accessories, blue panels & brown platforms



**Angelfish**

Navy posts, yellow plastic, yellow roofs, sky accessories, yellow panels & brown platforms



**NEW Aster**

Aqua posts, purple plastic, purple roofs, lemon accessories, purple panels & brown platforms



**Urban**

Silver posts, red plastic, red roofs, black accessories, red panels & brown platforms

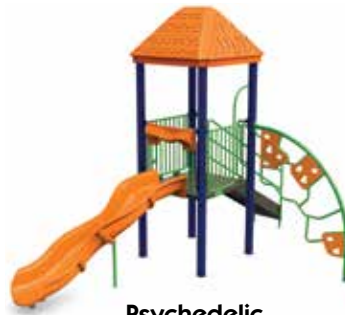

**Psychedelic**

Navy posts, orange plastic, orange roofs, lime accessories, orange panels & brown platforms



**Ocean**

Yellow posts, lime plastic, lime roofs, sky accessories, lime panels & brown platforms



**Freedom**

Sky posts, red plastic, red roofs, white accessories, red panels & brown platforms



**HDPE PLASTIC PANELS**



**NEW**



**NEW**



**Forest**

Burgundy posts, green plastic, green roofs, tan accessories, green panels & brown platforms



**Terrace**

Olive posts, tan plastic, tan roofs, black accessories, tan panels & brown platforms



**Enchanted**

Brown posts, lime plastic, lime roofs, tan accessories, lime panels & brown platforms



**NEW Sunflower**

Olive posts, yellow plastic, yellow roofs, redwood accessories, olive panels & brown platforms



**Circus**

Red posts, blue plastic, blue roofs, yellow accessories, blue panels & blue platforms



**NEW Viola**

Charcoal posts, purple plastic, purple roofs, orange accessories, purple panels & brown platforms



**NEW Parrot**

Sky posts, red plastic, red roofs, lemon accessories, red panels & brown platforms



**Tucan**

Yellow posts, orange plastic, orange roofs, blue accessories, orange panels & brown platforms

**VISIT [BCIBURKE.COM/COLORSELECTION](http://BCIBURKE.COM/COLORSELECTION) FOR MORE COLOR THEMES.**

# PLAY THAT MOVES YOU.®



**OWEN'S PLAYGROUND**  
WATCH THE STORY AT [BCIBURKE.COM](http://BCIBURKE.COM)!



**Burke**  
PLAY THAT MOVES YOU.

**BCI Burke Company**  
P.O. Box 549  
Fond du Lac, WI 54936-0549 USA  
800-266-1250 • 920-921-9220  
[bciburke.com](http://bciburke.com)

**BEN SHAFFER RECREATION Inc.**  
*Serving NJ since 1921*



PARK, PLAYGROUND & STREETSCAPE SOLUTIONS

**1-800-953-2021**

[www.benshaffer.com](http://www.benshaffer.com)

[sales@benshaffer.com](mailto:sales@benshaffer.com)

**DREAM \* DESIGN \* DELIVER**