

January 3, 2011

Updated January 2, 2017

800-424-2432





| | |
|---|----|
| CrossRoads® Library Furniture | |
| General Information | 2 |
| <hr/> | |
| CrossRoads® Study Tables | |
| Rectangular Tables | 4 |
| Square and Round Tables | 6 |
| Panel Leg Tables | 8 |
| <hr/> | |
| CrossRoads® Study Carrels | |
| Single Face Carrels | 10 |
| Double Face Carrels | 12 |
| <hr/> | |
| CrossRoads® Stand-up Computer Stations | |
| Single Face Stations | 14 |
| Double Face Stations | 16 |
| <hr/> | |
| CrossRoads® Shelving | |
| 42" High Shelving | 18 |
| 54" High Shelving | 20 |
| 60" High Shelving | 22 |
| 72" High Shelving | 24 |
| 82" High Shelving | 26 |
| 96" High Shelving | 28 |
| <hr/> | |
| CrossRoads® Metal Shelving | |
| 42" Metal Shelving | 32 |
| 54" Metal Shelving | 34 |
| 60" Metal Shelving | 36 |
| 72" Metal Shelving | 38 |
| 82" Metal Shelving | 40 |
| <hr/> | |
| CrossRoads® Periodical Shelving | |
| 42" High Periodical Shelving | 42 |
| 60" High Periodical Shelving | 44 |
| 82" High Periodical Shelving | 46 |
| <hr/> | |
| CrossRoads® Media Display Metal Shelving | |
| 42" Media Display Metal Shelving | 48 |
| 60" Media Display Metal Shelving | 50 |
| 82" Media Display Metal Shelving | 52 |
| <hr/> | |
| CrossRoads® Accessory Units | |
| Metal Shelving Accessories | 54 |
| Storage/Accessories | 56 |
| Newspaper Display Units | 58 |
| Atlas and Dictionary Stands | 60 |
| Rolling Book Carts | 62 |
| <hr/> | |
| CrossRoads Seating | |
| General Information | 64 |
| <hr/> | |
| CrossRoads® Seating | |
| Wood Chairs | 66 |
| <hr/> | |
| CrossRoads® Circulation Desk | |
| Typicals | 68 |
| <hr/> | |
| Index | 72 |

CrossRoads[®] Library Furniture

General Information

SPECIFICATIONS

Study Table Top

Tabletop is 1-1/4" thick, particleboard core construction with .05" high pressure laminate facer and .026" backer on the underside. All four edges shall be banded with a 1-1/4" thick and 2" wide solid oak or maple external knife edge laminated to core after application of the facer laminate. The edge is beveled to a .25" radiused bullnose at the top. The edge band has mitered corners. Table tops are offered without grommets, with grommets, or with PowerUp[®] modules. Grommets and PowerUp[®] modules fit in the same size top cutout. For grommet and PowerUp[®] options, placement on table top will either be in the table center or offset to one edge. Offset grommet or PowerUp[®] locations will be centered on the longest outside edge of the table and 7-3/4" from the table edge to the center of the grommets or PowerUp[®]. For round and square tables, grommet or PowerUp[®] placement on the outer edge of the table will be centered on the outer edge between two legs.

Study Table Legs

The legs are attached to the apron using a heavy gauge metal plate with two heavy-duty anchoring bolts. The legs are 2-1/4" square glued up face to face. All of the edges are eased with a 1/4" radius. For tables with grommets or PowerUp[®], cords are managed by the vertical leg wire manager or the wood routed wireway. Leg wireway is scuff-resistant, high-impact rigid Polypropylene plastic and is fastened to the leg with full-length adhesive bond. The solid wood routed wireway is 1" wide and 3/4" deep and runs from the bottom of the leg to just under the intersection with the apron. 1/4" solid wood cap attaches with (6) knurled thumbscrews.

Study Table Aprons

A 3/4" thick solid oak or maple apron rail is fit between the legs on all four sides of the table. The apron shall be machined to have a full length arch that is 3-7/8" high at the ends and 2" at the center. The apron rails are screwed to the underside of the top. Optional apron has straight bottom with a beveled face.

Study Table Glides

Each leg has a 2" diameter nylon-based adjustable leveling glide with a 1-1/2" thread stem.

Study Table Worksurface Height

Standard height is 29". Optional 27" or 32" heights may be specified.

Study Table Routed Wireway

Solid wood routed wireway, 1" wide x 3/4" deep runs from bottom of leg to just under intersection with apron. 1/4" solid wood cap attaches with (6) knurled thumbscrews.

Panel End Table Top

Tabletop is 1-1/4" thick, particleboard core construction with .05" high pressure laminate facer and .026" backer on the underside. All four edges shall be banded with a 1-1/4" thick and 2" wide solid oak or maple external knife edge laminated to core after application of the facer laminate. The edge is beveled to a .25" radiused bullnose at the top. The edge band is mitered at all four corners. Table tops are offered without grommets, with grommets, or with PowerUp[®] modules. Grommets and PowerUp[®] modules fit in the same size top cutout. For grommet and PowerUp[®] options, placement on table top will either be in the table center or offset to one edge. Offset grommet or PowerUp[®] locations will be centered on the longest outside edge of the table and 7-3/4" from the table edge to the center of the grommets or PowerUp[®].

Panel End Table End Panels

The end panels are 1-3/16" thick, particle core construction with select oak or maple veneer on both faces. The verticle edges of the panel are banded with a 1.5mm thick solid oak or maple external band with a 1/32" radius on all edges. The panel base is solid oak or maple with a .13" deep x .38" high reveal groove. The base is glued and screwed to the bottom of the end panel. The end panels are attached to the top using two 21" long, steel "L" brackets with six screws per bracket. The longitudinal stabilizing keel shall be 3/4" thick x 7" wide, particleboard construction with select oak or maple face and back. Bottom edge is banded with 1.5mm solid oak or maple and attached to the end panels and the top using mortise and tenon joinery. For tables with grommets or PowerUp[®], cords are managed by the vertical leg wire manager

Panel End Table Glides

Each end and intermediate panel has a pair of 1-1/8" diameter steel-based adjustable leveling glide with a 1-1/4" threaded stem.

Panel End Table Worksurface Height

Standard height is 29".

Study and Stand-up Carrels Top

The worksurface is 1-1/4" thick x 33-1/2" or 45-1/2" wide x 27-1/2" deep, particleboard core construction with .05" high pressure laminate facer and .026" backer on the underside. Exposed edge shall be banded with a 1-1/4" thick and 2" wide solid oak or maple external knife edge laminated to core after application of the facer laminate. The edge is beveled to a .25" radiused bullnose at the top. The worksurface is attached to the end panels and back with a 21" long, steel "L" bracket screwed into brass inserts in the panel and then screwed into the top of the worksurface.

Study and Stand-up Carrels End Panels

The end panels are 1-3/16" thick particleboard core construction with Grade A oak or maple veneer on both faces. The vertical

edges of the panel are banded with a 1.5mm thick solid oak or maple external band with a 1/32" radius on all edges. The panels have brass inserts for mounting the worksurface at four different heights (25", 27", 29" and 32" ADA heights). The panel base is select solid oak or maple with a .13" deep x .38" high reveal groove. The base is glued and screwed to the bottom of the end panel. End panels for study and stand-up carrels are machined on one side.

Study and Stand-up Carrels Shared Panels

The intermediate panels are the same construction as the end panels, however, the worksurface and shelf inserts are on both sides of the panel. Shared panels for study and stand-up carrels are machined on both sides.

Study and Stand-up Carrels Back Panels

The back panels are 3/4" thick, 5-ply particleboard core construction with Grade A oak or maple veneer on both faces. The top and bottom edges of the panel are banded with a 1.5mm thick solid oak or maple external band with a 1/32" radius on all edges. The top edge is located 6-1/2" down from the top of the end panels and 4" up from the bottom. Back panels are attached to end panels using cam-lock fasteners. Double-faced units share 1-3/4" thick back panel.

Study and Stand-up Carrels Shelf

The storage shelf shall be 3/4" thick x 33-1/2" or 45-1/2" wide x 10" deep, plywood core construction. Both faces will be covered with select oak or maple veneers and banded on the exposed edge with 1.5mm solid oak or maple. The study carrel shelf is located 15" above the worksurface. The stand-up carrel shelf is located 26" below the worksurface. Shelf is connected to end panels with shoulder screw and insert in panel and cam-lock fasteners in shelf bottom.

Study and Stand-up Carrels Glides

Each end and intermediate panel has a pair of 1-1/8" diameter steel-based adjustable leveling glides with a 1-1/4" threaded stem.

Circulation Desk Top

Joints are secured with steel "L" brackets. Desk top is 1-1/4" thick, particleboard core construction with .05" high-pressure laminate facer and .026" thick backer on the underside.

Circulation Desk Cabinet Construction

The front panels are 3/4" thick, 5-ply plywood with Grade A oak or maple veneer. All exterior faces are matched for color and grain. The side panels are 1-3/16" thick particleboard with Grade A oak or maple veneers and banded on the exposed edge with a 1.5mm solid oak or maple.

Circulation Desk Adjustable Shelves

Adjustable storage shelves are 3/4" thick, 5-ply plywood construction with select oak or

maple veneer and banded on exposed edge with solid oak or maple. Shelves are adjustable in 1-1/4" increments and are notched at the ends over metal dowel support.

Circulation Desk Hinged Doors

Doors are 3/4" thick, MDF construction with Grade A oak or maple veneer on both sides. All four edges are banded with solid oak or maple edge. Each door shall be fitted with brushed aluminum or flat black pull and lock.

Circulation Desk Storage Drawers

All drawer fronts are 3/4" thick, MDF construction with Grade A oak or maple veneer on both sides. All four edges are banded with solid oak or maple edge. Each drawer shall be fitted with brushed aluminum or flat black pull and lock.

Circulation Desk Heights

Depending on the component, various heights are available. 27", 29", 32" and 39" may be specified.

Power and Data Management

Study tables, panel leg tables, study carrels, stand-up computer stations and circulation desk modules are available with grommets, PowerUp[®] system. The PowerUp[®] module is 6-1/4" long x 3" wide x 2-1/2" high. The module is constructed of textured polycarbonate. The module has one duplex receptacle (110 volts) and two ports for data connectors. The standard module will accommodate most data connectors. The customer purchases the data connectors. The module has a dampened spring-loaded mechanism to allow the unit to open for use and close when not in use. Module comes standard with a 9 ft. cord and 3-prong plug. For both grommets and the PowerUp[®] system, the underside of the table is provided with a plastic channel (cord management trough, which covers the bottom of the module. This channel, furnished with metal dividers, is provided for the routing of the power supply cords and data lines. For starter and adder carrels with grommets or PowerUp[®] modules, round cutouts in the end panels allow wires to pass through from one unit to the other. PowerUp[®] door extrusion and vertical plastic wire manager are standard. Cords are further managed by the vertical leg wire manager, which comes standard with grommets or the PowerUp[®] system. Leg wireway is scuff-resistant, high-impact rigid Polypropylene plastic, and is fastened to the leg with full-length adhesive bond.

Shelving End Panel

The end panels are 1-3/16" thick, particle core construction with Grade A oak or maple veneer on both faces. The vertical edges of the panel are banded with a 1.5mm thick solid oak or maple external band with a 1/32" radius on all edges. The panel base has a .13" deep x .25" high vein line 4" from the bottom. Two stainless steel adjustable glides are at the bottom of each panel.



Shelving Shared Panel

Same construction as the end panels except brass inserts are on both sides of the panel. Shared panels for shelving are machined on both sides. Adder units are attached with 5/16" through bolts and nuts.

Top Shelf/Cornice Unit

Shelf is 3/4" thick oak or maple construction. The flush-fitting cornice rail at the face sides is 3/4" thick x 2-1/8" high solid oak or maple. Shelf is attached using 1-1/4" x 1-1/4" wood cleats with bolts and metal inserts in the end panels.

Base

Preassembled box with a finished outer kick rail enables shelving to be assembled in the vertical position. Bottom shelf is set into place and positioned by using steel pegs.

Adjustable Wood Shelves

Wood shelves are 3/4" thick solid oak or maple construction. The shelf is grooved on the underside to fit over turned and grooved steel pegs, which are inserted into holes in the end panels. Holes are spaced at 1-1/4" space intervals. Peg and groove design prevents accidental removal. The fixed middle shelf is mounted using wood cleats and screws on units 60-1/2" and higher.

Adjustable Metal Shelves

Metal shelves are 18-gauge steel with notches on the underside to rest on turned and grooved steel pegs. Flat shelf is 1" thick and triple bent front and back edges provide superior strength and eliminate sharp edges. Book stop shelf is bent upward to form 90-degree angle, 1-5/8" high above the shelf surface to function as a book stop. Electrostatically applied powder coat finish. Metal shelves accept spring-type overhead wire book support. Metal shelf units are shipped with a wood base shelf.

Periodical Shelving

End panels, shared panels, and top and bottom shelf assembly construction are the same as standard shelving. Adjustable shelves include 3/4" solid wood angled bracket supports and a 14-gauge steel shelf pivot bracket. A 3/4" solid wood shelf with a 1/2" x 1-1/2" stop rail is mounted at an angle of approximately 45° so that periodicals can be easily viewed. The shelf pivots and can be flipped up to lay flat for storage access below.

Media Shelving

End panels and top and bottom self assembly construction are the same as standard shelving. Media metal shelves are 18-gauge steel with notches on the underside to rest on turned and grooved steel pegs. Angled shelves have slots spaced 1-1/4" to accept metal partitions that can be adjusted to provide separation between displays. Electrostatically-applied powder coated finish for long-term durability. Media shelf units are shipped with a wood base shelf.

Book Truck

Truck sides and bottom are 3/4" plywood with top edge banded. No seams show where side panels adjoin. Descending platform is 3/4" plywood with plastic laminate top surface. Platform is guided on rollers and supported by spring compression. As the platform is loaded, it descends toward the bottom of the truck. The truck is mounted on four swivel casters.

Dictionary Stand

End panels are constructed of 1-3/16" particle core with oak or maple veneer and 1.5mm thick solid wood edge banding. The top and bottom surfaces are attached to the end panel using cam-lock fasteners. The top surface is constructed of 1-1/4" particle-board core construction with a plastic laminate worksurface (customer-specified). One 3/4" adjustable shelf has a 16" adjustability range using steel pins and drilled holes.

Atlas Stand

End panels are constructed of 1-3/16" particle core with oak or maple veneer and 1.5mm thick solid wood edge banding. The top and bottom surfaces are attached to the end panel using cam-lock fasteners. The top surface is constructed of particleboard core with a plastic laminate worksurface (customer-specified). Five 1-3/16" particleboard sliding shelves have a 3/4" x 2" stop rail at the edge of each shelf.

Newspaper Display Unit End Panels/ Shared Panels

End panels are constructed of 1-3/16" particle core with oak or maple veneer and 1.5mm thick solid wood edge banding. End panels for newspaper display units are machined on one side. Shared panels for newspaper display units are machined on both sides.

Newspaper Display Unit Top Shelf/ Cornice Unit

Shelf is 3/4" thick oak or maple construction. The flush-fitting cornice rail at the face sides is 3/4" thick x 3-1/4" high solid oak or maple.

Newspaper Display Unit Base

Pre-assembled box has a finished outer kick rail which enables shelving to be assembled in the vertical position. Two adjustable shelves are 3/4" thick solid oak or maple construction. The shelf is notched at the ends to fit over dowel pins and prevent accidental removal. Two 1" thick rails mounted on the end panels are notched to hold eight newspaper sticks at an angle for easy removal and display.

Rolling Book Cart

All end panels and shelves are 3/4" plywood with oak or maple veneer laminate and a 1.5mm solid wood edge banding. Shelves are attached to the end panels using cam-lock fasteners and solid wood dowels. Bottom shelf is reinforced with wood cleat screwed into the shelf and end panels. Casters are two swivel and two stationary.

Two cart sizes: 30" wide x 35" high x 15" deep with two shelves and 40" wide x 41" high x 15" deep with two shelves.

Rolling Book Cart With Slanted Shelves

All end panels and shelves are 3/4" plywood with oak or maple veneer laminate and a 1.5mm solid wood edge banding. Shelves are attached to the end panels using cam-lock fasteners and solid wood dowels. Bottom shelf is reinforced with wood cleat screwed into the shelf and end panels. Casters are two swivel and two stationary. Two cart sizes: 30" wide x 35" high x 16.5" deep with two shelves slanted inward with slanted shelf backs, and 40" wide x 41" high x 16.5" deep with two shelves slanted inward with slanted shelf backs, and 40" wide x 41" high x 16.5" deep with two shelves slanted inward with slanted shelf backs.

CrossRoads® Study Tables

Rectangular Tables

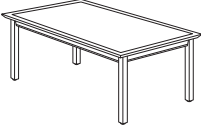
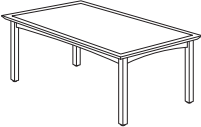
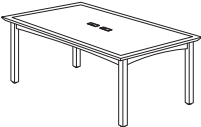
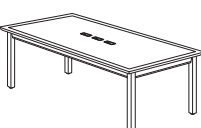
| | D x W | MODEL NUMBER | | | | | | | | | Approx. Packaged Weight |
|--|----------|--------------|--------------------------|---|---|--------------------------|---|--------------------------|--|--|-------------------------|
| | | Basic Model | Wood Type | Apron Detail | Height | Grommet/Module Type | Grommet/Module Location | Grommet/Module Color | Wood Finish | Surface Finish | |
|  <p>Straight Apron, No Grommets</p> | 30 x 60" | CRT3060 | <input type="checkbox"/> | <input type="checkbox"/> <input type="checkbox"/> <input type="checkbox"/> <input type="checkbox"/> | <input type="checkbox"/> <input type="checkbox"/> | <input type="checkbox"/> | <input type="checkbox"/> <input type="checkbox"/> <input type="checkbox"/> <input type="checkbox"/> | <input type="checkbox"/> | <input type="checkbox"/> <input type="checkbox"/> <input type="checkbox"/> | <input type="checkbox"/> <input type="checkbox"/> <input type="checkbox"/> | 140.0# |
| | 30 x 72" | CRT3072 | <input type="checkbox"/> | <input type="checkbox"/> <input type="checkbox"/> <input type="checkbox"/> <input type="checkbox"/> | <input type="checkbox"/> <input type="checkbox"/> | <input type="checkbox"/> | <input type="checkbox"/> <input type="checkbox"/> <input type="checkbox"/> <input type="checkbox"/> | <input type="checkbox"/> | <input type="checkbox"/> <input type="checkbox"/> <input type="checkbox"/> | <input type="checkbox"/> <input type="checkbox"/> <input type="checkbox"/> | 161.0# |
| | 30 x 84" | CRT3084 | <input type="checkbox"/> | <input type="checkbox"/> <input type="checkbox"/> <input type="checkbox"/> <input type="checkbox"/> | <input type="checkbox"/> <input type="checkbox"/> | <input type="checkbox"/> | <input type="checkbox"/> <input type="checkbox"/> <input type="checkbox"/> <input type="checkbox"/> | <input type="checkbox"/> | <input type="checkbox"/> <input type="checkbox"/> <input type="checkbox"/> | <input type="checkbox"/> <input type="checkbox"/> <input type="checkbox"/> | 174.0# |
| | 30 x 96" | CRT3096 | <input type="checkbox"/> | <input type="checkbox"/> <input type="checkbox"/> <input type="checkbox"/> <input type="checkbox"/> | <input type="checkbox"/> <input type="checkbox"/> | <input type="checkbox"/> | <input type="checkbox"/> <input type="checkbox"/> <input type="checkbox"/> <input type="checkbox"/> | <input type="checkbox"/> | <input type="checkbox"/> <input type="checkbox"/> <input type="checkbox"/> | <input type="checkbox"/> <input type="checkbox"/> <input type="checkbox"/> | 187.0# |
| | 36 x 60" | CRT3660 | <input type="checkbox"/> | <input type="checkbox"/> <input type="checkbox"/> <input type="checkbox"/> <input type="checkbox"/> | <input type="checkbox"/> <input type="checkbox"/> | <input type="checkbox"/> | <input type="checkbox"/> <input type="checkbox"/> <input type="checkbox"/> <input type="checkbox"/> | <input type="checkbox"/> | <input type="checkbox"/> <input type="checkbox"/> <input type="checkbox"/> | <input type="checkbox"/> <input type="checkbox"/> <input type="checkbox"/> | 145.0# |
|  <p>Curved Apron, No Grommets</p> | 36 x 72" | CRT3672 | <input type="checkbox"/> | <input type="checkbox"/> <input type="checkbox"/> <input type="checkbox"/> <input type="checkbox"/> | <input type="checkbox"/> <input type="checkbox"/> | <input type="checkbox"/> | <input type="checkbox"/> <input type="checkbox"/> <input type="checkbox"/> <input type="checkbox"/> | <input type="checkbox"/> | <input type="checkbox"/> <input type="checkbox"/> <input type="checkbox"/> | <input type="checkbox"/> <input type="checkbox"/> <input type="checkbox"/> | 166.0# |
| | 36 x 84" | CRT3684 | <input type="checkbox"/> | <input type="checkbox"/> <input type="checkbox"/> <input type="checkbox"/> <input type="checkbox"/> | <input type="checkbox"/> <input type="checkbox"/> | <input type="checkbox"/> | <input type="checkbox"/> <input type="checkbox"/> <input type="checkbox"/> <input type="checkbox"/> | <input type="checkbox"/> | <input type="checkbox"/> <input type="checkbox"/> <input type="checkbox"/> | <input type="checkbox"/> <input type="checkbox"/> <input type="checkbox"/> | 179.0# |
| | 36 x 96" | CRT3696 | <input type="checkbox"/> | <input type="checkbox"/> <input type="checkbox"/> <input type="checkbox"/> <input type="checkbox"/> | <input type="checkbox"/> <input type="checkbox"/> | <input type="checkbox"/> | <input type="checkbox"/> <input type="checkbox"/> <input type="checkbox"/> <input type="checkbox"/> | <input type="checkbox"/> | <input type="checkbox"/> <input type="checkbox"/> <input type="checkbox"/> | <input type="checkbox"/> <input type="checkbox"/> <input type="checkbox"/> | 192.0# |
| | 42 x 60" | CRT4260 | <input type="checkbox"/> | <input type="checkbox"/> <input type="checkbox"/> <input type="checkbox"/> <input type="checkbox"/> | <input type="checkbox"/> <input type="checkbox"/> | <input type="checkbox"/> | <input type="checkbox"/> <input type="checkbox"/> <input type="checkbox"/> <input type="checkbox"/> | <input type="checkbox"/> | <input type="checkbox"/> <input type="checkbox"/> <input type="checkbox"/> | <input type="checkbox"/> <input type="checkbox"/> <input type="checkbox"/> | 154.0# |
| | 42 x 72" | CRT4272 | <input type="checkbox"/> | <input type="checkbox"/> <input type="checkbox"/> <input type="checkbox"/> <input type="checkbox"/> | <input type="checkbox"/> <input type="checkbox"/> | <input type="checkbox"/> | <input type="checkbox"/> <input type="checkbox"/> <input type="checkbox"/> <input type="checkbox"/> | <input type="checkbox"/> | <input type="checkbox"/> <input type="checkbox"/> <input type="checkbox"/> | <input type="checkbox"/> <input type="checkbox"/> <input type="checkbox"/> | 171.0# |
|  <p>Curved Apron, 2 Grommets</p> | 42 x 84" | CRT4284 | <input type="checkbox"/> | <input type="checkbox"/> <input type="checkbox"/> <input type="checkbox"/> <input type="checkbox"/> | <input type="checkbox"/> <input type="checkbox"/> | <input type="checkbox"/> | <input type="checkbox"/> <input type="checkbox"/> <input type="checkbox"/> <input type="checkbox"/> | <input type="checkbox"/> | <input type="checkbox"/> <input type="checkbox"/> <input type="checkbox"/> | <input type="checkbox"/> <input type="checkbox"/> <input type="checkbox"/> | 185.0# |
| | 42 x 96" | CRT4296 | <input type="checkbox"/> | <input type="checkbox"/> <input type="checkbox"/> <input type="checkbox"/> <input type="checkbox"/> | <input type="checkbox"/> <input type="checkbox"/> | <input type="checkbox"/> | <input type="checkbox"/> <input type="checkbox"/> <input type="checkbox"/> <input type="checkbox"/> | <input type="checkbox"/> | <input type="checkbox"/> <input type="checkbox"/> <input type="checkbox"/> | <input type="checkbox"/> <input type="checkbox"/> <input type="checkbox"/> | 198.0# |
| | 48 x 60" | CRT4860 | <input type="checkbox"/> | <input type="checkbox"/> <input type="checkbox"/> <input type="checkbox"/> <input type="checkbox"/> | <input type="checkbox"/> <input type="checkbox"/> | <input type="checkbox"/> | <input type="checkbox"/> <input type="checkbox"/> <input type="checkbox"/> <input type="checkbox"/> | <input type="checkbox"/> | <input type="checkbox"/> <input type="checkbox"/> <input type="checkbox"/> | <input type="checkbox"/> <input type="checkbox"/> <input type="checkbox"/> | 171.0# |
|  <p>Straight Apron, 3 Grommets</p> | 48 x 72" | CRT4872 | <input type="checkbox"/> | <input type="checkbox"/> <input type="checkbox"/> <input type="checkbox"/> <input type="checkbox"/> | <input type="checkbox"/> <input type="checkbox"/> | <input type="checkbox"/> | <input type="checkbox"/> <input type="checkbox"/> <input type="checkbox"/> <input type="checkbox"/> | <input type="checkbox"/> | <input type="checkbox"/> <input type="checkbox"/> <input type="checkbox"/> | <input type="checkbox"/> <input type="checkbox"/> <input type="checkbox"/> | 198.0# |
| | 48 x 84" | CRT4884 | <input type="checkbox"/> | <input type="checkbox"/> <input type="checkbox"/> <input type="checkbox"/> <input type="checkbox"/> | <input type="checkbox"/> <input type="checkbox"/> | <input type="checkbox"/> | <input type="checkbox"/> <input type="checkbox"/> <input type="checkbox"/> <input type="checkbox"/> | <input type="checkbox"/> | <input type="checkbox"/> <input type="checkbox"/> <input type="checkbox"/> | <input type="checkbox"/> <input type="checkbox"/> <input type="checkbox"/> | 214.0# |
| | 48 x 96" | CRT4896 | <input type="checkbox"/> | <input type="checkbox"/> <input type="checkbox"/> <input type="checkbox"/> <input type="checkbox"/> | <input type="checkbox"/> <input type="checkbox"/> | <input type="checkbox"/> | <input type="checkbox"/> <input type="checkbox"/> <input type="checkbox"/> <input type="checkbox"/> | <input type="checkbox"/> | <input type="checkbox"/> <input type="checkbox"/> <input type="checkbox"/> | <input type="checkbox"/> <input type="checkbox"/> <input type="checkbox"/> | 230.0# |

CRT

Rectangular Table

- Choice of 2,3, (or without) grommets or PowerUp® modules
- Straight or curved apron

A B C D E F G H I

HOW TO ORDER

Indicate the following information on order form:

1. Quantity of each item.
2. Model number, including options. See "How To Build a Model Number".
3. Any special service required.

Note: • The indicates that a choice is required.

- The absence of the indicates that no choice is required.
- Alpha-numeric characters in place of indicate that no other alternatives are available.

HOW TO BUILD A MODEL NUMBER

- A** Select basic model.
- B** Select wood type.
 - O** - Oak
 - M** - Maple
- C** Select apron detail.
 - PCRV** - Curved apron
 - PSTR** - Straight apron
- D** Select height.
 - 27** - Junior height - 27"
 - 29** - Adult height - 29"
 - 32** - ADA wheelchair height - 32"
- E** Select grommet or PowerUp.
 - 60" & 72" wide tables are available with 2 grommets or 2 PowerUp modules or none.
 - 84" & 96" wide tables are available with 3 grommets or 3 PowerUp modules or none.
 - 2G** - 2 Grommets; add \$93
 - 2P** - 2 PowerUp modules; add \$225

- 3G** - 3 Grommets; add \$139
- 3P** - 3 PowerUp modules; add \$337
- NG** - No Grommets/PowerUp

- F** Select grommet or PowerUp location.
 - CTRG** - Center grommet/module location
 - EDGG** - Edge grommet/module location

If no grommet or PowerUp module were selected, then skip "location" selection.

- G** Select grommet/module color. Refer to color addendum at ki.com or KI Fabrics & Finishes binder.

- H** Select wood finish (for table edge & legs). Refer to color addendum at ki.com or KI Fabrics & Finishes binder. Stained finish colors \$29.

- I** Select surface finish. Refer to color addendum at ki.com or KI Fabrics & Finishes binder.

Additional plastic laminate surfaces are available but may require an up-charge and additional leadtime. Please contact KI.



| Oak | Maple |
|---------|---------|
| \$ 1661 | \$ 1794 |
| 1749 | 1889 |
| 1948 | 2307 |
| 2653 | 2864 |
| 2060 | 2229 |
| 2145 | 2394 |
| 2468 | 2690 |
| 2932 | 3197 |
| 2188 | 2375 |
| 2291 | 2518 |
| 2622 | 2845 |
| 3088 | 3350 |
| 2286 | 2467 |
| 2480 | 2679 |
| 2868 | 3099 |
| 3097 | 3348 |

FINISH INFORMATION

Additional Stains

Specially stained edges beyond the KI standard offering (as shown under the Edge Color column in color addendum) are also available. Contact KI.

OPTIONS

Electrical Ganging

Contact KI for electrical ganging of multiple tables.

Wood Leg Wireway

If grommets or PowerUp® modules are ordered, a routed wood leg wireway may be ordered in place of the standard wireway. Add /RL to the end of model number for routed wood leg wireway option and add \$130 to list.

SPECIAL SERVICES

Special Carton Marking

With specially marked information N/C



Shipping

Shipped **k.d. freight prepaid f.o.b. factory of origin** factory.
Freight class #85.

Specifications and prices are subject to change without prior notice.

CrossRoads® Study Tables

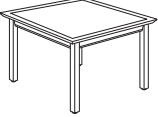
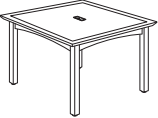
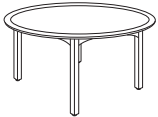
Square and Round Tables

| | | MODEL NUMBER | | | | | | | |
|--|----------|--------------|--------------------------|---|---|---|---|---|---|
| | | Basic Model | Wood Type | Apron Detail | Height | Grommet/Module Type | Grommet/Module Color | Wood Finish | Surface Finish |
| MODEL | D x W | | | | | | | | |
|  <p>Straight Apron, No Grommet</p> | 42 x 42" | CRT4242 | <input type="checkbox"/> | <input type="checkbox"/> <input type="checkbox"/> <input type="checkbox"/> <input type="checkbox"/> | <input type="checkbox"/> <input type="checkbox"/> | <input type="checkbox"/> <input type="checkbox"/> | <input type="checkbox"/> <input type="checkbox"/> | <input type="checkbox"/> <input type="checkbox"/> | <input type="checkbox"/> <input type="checkbox"/> |
| | 48 x 48" | CRT4848 | <input type="checkbox"/> | <input type="checkbox"/> <input type="checkbox"/> <input type="checkbox"/> <input type="checkbox"/> | <input type="checkbox"/> <input type="checkbox"/> | <input type="checkbox"/> <input type="checkbox"/> | <input type="checkbox"/> <input type="checkbox"/> | <input type="checkbox"/> <input type="checkbox"/> | <input type="checkbox"/> <input type="checkbox"/> |
|  <p>Curved Apron, 1 Grommet</p> | | | | | | | | | |
| | | | | | | | | | |
| CRT | | | | | | | | | |
|  <p>Curved Apron, No Grommet</p> | 44" | CRT42R | <input type="checkbox"/> | <input type="checkbox"/> <input type="checkbox"/> <input type="checkbox"/> <input type="checkbox"/> | <input type="checkbox"/> <input type="checkbox"/> | <input type="checkbox"/> <input type="checkbox"/> | <input type="checkbox"/> <input type="checkbox"/> | <input type="checkbox"/> <input type="checkbox"/> | <input type="checkbox"/> <input type="checkbox"/> |
| | 50" | CRT48R | <input type="checkbox"/> | <input type="checkbox"/> <input type="checkbox"/> <input type="checkbox"/> <input type="checkbox"/> | <input type="checkbox"/> <input type="checkbox"/> | <input type="checkbox"/> <input type="checkbox"/> | <input type="checkbox"/> <input type="checkbox"/> | <input type="checkbox"/> <input type="checkbox"/> | <input type="checkbox"/> <input type="checkbox"/> |
|  <p>Straight Apron, 1 Grommet</p> | | | | | | | | | |
| | | | | | | | | | |
| CRT | | | | | | | | | |

A **B** **C** **D** **E** **F** **G** **H**

HOW TO ORDER

Indicate the following information on order form:

- Quantity of each item.
- Model number, including options. See "How To Build a Model Number".
- Any special service required.

Note: • The indicates that a choice is required.

- The absence of the indicates that no choice is required.
- Alpha-numeric characters in place of indicate that no other alternatives are available.

HOW TO BUILD A MODEL NUMBER

- A** Select basic model.
- B** Select wood type.
 - O** - Oak
 - M** - Maple
- C** Select apron detail.
 - PCRV** - Curved apron
 - PSTR** - Straight apron
- D** Select height.
 - 27** - Junior height - 27"
 - 29** - Adult height - 29"
 - 32** - ADA wheelchair height - 32"
- E** Select grommet or PowerUp.
 - 1G** - 1 Grommet; add \$46
 - 1P** - 1 PowerUp module; add \$112
 - NG** - No Grommets/PowerUp
- F** Select grommet/module color. Refer to color addendum at ki.com or KI Fabrics & Finishes binder.

- G** Select wood finish (for table edge & legs). Refer to color addendum at ki.com or KI Fabrics & Finishes binder. Stained finish colors; add \$29.

- H** Select surface finish. Refer to color addendum at ki.com or KI Fabrics & Finishes binder. Additional plastic laminate surfaces are available but may require an up-charge and additional leadtime. Please contact KI.

FINISH INFORMATION

Additional Stains
Specially stained edges beyond the KI standard offering (as shown under the Edge Color column in color addendum) are also available. Contact KI.



| Approx. Packaged Weight | Oak | Maple |
|-------------------------|---------|---------|
| 125.0# | \$ 1489 | \$ 1687 |
| 130.0# | 1751 | 1989 |

| | | |
|--------|---------|---------|
| 140.0# | \$ 1759 | \$ 2150 |
| 145.0# | 2116 | 2372 |

OPTIONS

Electrical Ganging

Contact KI for electrical ganging of multiple tables.

Wood Leg Wireway

If grommets or PowerUp® modules are ordered, a routered wood leg wireway may be ordered in place of the standard wireway. Add /RL to the end of model number for routered wood leg wireway option and add \$130 to list.

SPECIAL SERVICES

Special Carton Marking

With specially marked information N/C





Shipping

Shipped **k.d. freight prepaid f.o.b. factory of origin** factory. Freight class #85.

Specifications and prices are subject to change without prior notice.

CrossRoads® Study Tables

Panel Leg Tables

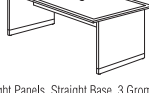
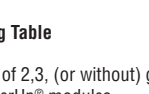
| | D x W | MODEL NUMBER | | | | | | | | | Approx. Packaged Weight |
|---|----------|--------------|--------------------------|-------|------|---------------------|-------------------------|----------------------|-------------|----------------|-------------------------|
| | | Basic Model | Wood Type | Panel | Base | Grommet/Module Type | Grommet/Module Location | Grommet/Module Color | Wood Finish | Surface Finish | |
|  | 36 x 60" | CRTP3660 | <input type="checkbox"/> | □□□□ | □□□□ | □□ | □□□□ | □□ | □□□□ | □□□□ | 161.0# |
| | 36 x 72" | CRTP3672 | <input type="checkbox"/> | □□□□ | □□□□ | □□ | □□□□ | □□ | □□□□ | □□□□ | 184.0# |
| | 36 x 84" | CRTP3684 | <input type="checkbox"/> | □□□□ | □□□□ | □□ | □□□□ | □□ | □□□□ | □□□□ | 211.0# |
| | 36 x 96" | CRTP3696 | <input type="checkbox"/> | □□□□ | □□□□ | □□ | □□□□ | □□ | □□□□ | □□□□ | 237.0# |
|  | 42 x 60" | CRTP4260 | <input type="checkbox"/> | □□□□ | □□□□ | □□ | □□□□ | □□ | □□□□ | □□□□ | 184.0# |
| | 42 x 72" | CRTP4272 | <input type="checkbox"/> | □□□□ | □□□□ | □□ | □□□□ | □□ | □□□□ | □□□□ | 209.0# |
| | 42 x 84" | CRTP4284 | <input type="checkbox"/> | □□□□ | □□□□ | □□ | □□□□ | □□ | □□□□ | □□□□ | 243.0# |
| | 42 x 96" | CRTP4296 | <input type="checkbox"/> | □□□□ | □□□□ | □□ | □□□□ | □□ | □□□□ | □□□□ | 277.0# |
|  | 48 x 60" | CRTP4860 | <input type="checkbox"/> | □□□□ | □□□□ | □□ | □□□□ | □□ | □□□□ | □□□□ | 222.0# |
| | 48 x 72" | CRTP4872 | <input type="checkbox"/> | □□□□ | □□□□ | □□ | □□□□ | □□ | □□□□ | □□□□ | 257.0# |
| | 48 x 84" | CRTP4884 | <input type="checkbox"/> | □□□□ | □□□□ | □□ | □□□□ | □□ | □□□□ | □□□□ | 291.0# |
| | 48 x 96" | CRTP4896 | <input type="checkbox"/> | □□□□ | □□□□ | □□ | □□□□ | □□ | □□□□ | □□□□ | 325.0# |
|  | | | | | | | | | | | |
| | | | | | | | | | | | |
| | | | | | | | | | | | |
|  | | | | | | | | | | | |
| | | | | | | | | | | | |
| | | | | | | | | | | | |
|  | | | | | | | | | | | |
| | | | | | | | | | | | |
| | | | | | | | | | | | |

CRTP

Panel Leg Table

- Choice of 2,3, (or without) grommets or PowerUp® modules
- 29" height only
- Curved or straight panels
- Curved or straight base

A **B** **C** **D** **E** **F** **G** **H** **I**

HOW TO ORDER

Indicate the following information on order form:

1. Quantity of each item.
2. Model number, including options. See "How To Build a Model Number".
3. Any special service required.

Note: • The indicates that a choice is required.

- The absence of the indicates that no choice is required.
- Alpha-numeric characters in place of indicate that no other alternatives are available.

HOW TO BUILD A MODEL NUMBER

A Select basic model.

B Select wood type.

- O** - Oak
M - Maple

C Select panel.

- PCRV** - Curved panel
PSTR - Straight panel

D Select base.

- BCRV** - Curved base
BSTR - Straight base

E Select grommet or PowerUp.

- 60" & 72" wide tables are available with 2 grommets or 2 PowerUp modules or none.
84" & 96" wide tables are available with 3 grommets or 3 PowerUp modules or none.
2G - 2 Grommets; add \$93
2P - 2 PowerUp modules; add \$225
3G - 3 Grommets; add \$139

3P - 3 PowerUp modules; add

\$337

NG - No Grommets/PowerUp

F Select grommet or PowerUp location.

CTRG - Center grommet/module location

EDGG - Edge grommet/module location

If no grommet or PowerUp module were selected, then skip "location" selection.

G Select grommet/module color.

Refer to color addendum at ki.com or KI Fabrics & Finishes binder.

H Select wood finish (for table edge & legs).

Refer to color addendum at ki.com or KI Fabrics & Finishes binder.
Stained finish colors; add \$42.

I Select surface finish.

Refer to color addendum at ki.com or KI Fabrics & Finishes binder.
Additional plastic laminate surfaces are

available but may require an upcharge and additional leadtime. Please contact KI.



| Oak | Maple |
|---------|---------|
| \$ 2651 | \$ 2719 |
| 2615 | 2922 |
| 3010 | 3285 |
| 3577 | 3900 |
| 2668 | 2896 |
| 2795 | 3070 |
| 3201 | 3473 |
| 3770 | 4088 |
| 2787 | 3007 |
| 3026 | 3267 |
| 3500 | 3781 |
| 3778 | 4086 |

FINISH INFORMATION

Additional Stains

Specially stained edges beyond the KI standard offering (as shown under the Edge Color column in color addendum) are also available. Contact KI.

OPTIONS

Electrical Ganging

Contact KI for electrical ganging of multiple tables.

SPECIAL SERVICES

Special Carton Marking

With specially marked information N/C

Shipping

Shipped **k.d. freight prepaid f.o.b. factory of origin** factory.
Freight class #85.

Specifications and prices are subject to change without prior notice.

CrossRoads® Study Carrels

Single Face Carrels

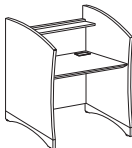
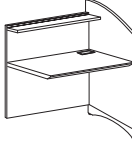
| | D x W | MODEL NUMBER | | | | | | | | | |
|--|--------------|--------------|--------------------------|---|---|---|---|---|---|---|---|
| | | Basic Model | Wood Type | Panel | Base | Height | Task Light | Grommet/Module Type | Grommet/Module Color | Wood Finish | Surface Finish |
|  | 30 x 36" | CRCS3036S | <input type="checkbox"/> | <input type="checkbox"/> <input type="checkbox"/> <input type="checkbox"/> <input type="checkbox"/> | <input type="checkbox"/> <input type="checkbox"/> <input type="checkbox"/> <input type="checkbox"/> | <input type="checkbox"/> <input type="checkbox"/> <input type="checkbox"/> <input type="checkbox"/> | <input type="checkbox"/> <input type="checkbox"/> | <input type="checkbox"/> <input type="checkbox"/> | <input type="checkbox"/> <input type="checkbox"/> | <input type="checkbox"/> <input type="checkbox"/> | <input type="checkbox"/> <input type="checkbox"/> |
| | 30 x 48" | CRCS3048S | <input type="checkbox"/> | <input type="checkbox"/> <input type="checkbox"/> <input type="checkbox"/> <input type="checkbox"/> | <input type="checkbox"/> <input type="checkbox"/> <input type="checkbox"/> <input type="checkbox"/> | <input type="checkbox"/> <input type="checkbox"/> <input type="checkbox"/> <input type="checkbox"/> | <input type="checkbox"/> <input type="checkbox"/> | <input type="checkbox"/> <input type="checkbox"/> | <input type="checkbox"/> <input type="checkbox"/> | <input type="checkbox"/> <input type="checkbox"/> | <input type="checkbox"/> <input type="checkbox"/> |
| <p>CRC Study Carrel Starter Unit-Single Face</p> <ul style="list-style-type: none"> • Curved or straight panel or base • Choice of 1 grommet or 1 PowerUp® module • Standard placement of grommet is in right rear corner of worksurface • Note: Provide a plan layout indicating grommet location on the worksurface, if other than standard • With or without task light • Adjustable or wheelchair-height adjustable | | | | | | | | | | | |
|  | 30 x 34-3/4" | CRCS3036A | <input type="checkbox"/> | <input type="checkbox"/> <input type="checkbox"/> <input type="checkbox"/> <input type="checkbox"/> | <input type="checkbox"/> <input type="checkbox"/> <input type="checkbox"/> <input type="checkbox"/> | <input type="checkbox"/> <input type="checkbox"/> | <input type="checkbox"/> <input type="checkbox"/> | <input type="checkbox"/> <input type="checkbox"/> | <input type="checkbox"/> <input type="checkbox"/> | <input type="checkbox"/> <input type="checkbox"/> | <input type="checkbox"/> <input type="checkbox"/> |
| | 30 x 46-1/2" | CRCS3048A | <input type="checkbox"/> | <input type="checkbox"/> <input type="checkbox"/> <input type="checkbox"/> <input type="checkbox"/> | <input type="checkbox"/> <input type="checkbox"/> <input type="checkbox"/> <input type="checkbox"/> | <input type="checkbox"/> <input type="checkbox"/> | <input type="checkbox"/> <input type="checkbox"/> | <input type="checkbox"/> <input type="checkbox"/> | <input type="checkbox"/> <input type="checkbox"/> | <input type="checkbox"/> <input type="checkbox"/> | <input type="checkbox"/> <input type="checkbox"/> |
| <p>CRC Study Carrel Adder Unit-Single Face</p> <ul style="list-style-type: none"> • Curved or straight panel or base • Choice of 1 grommet or 1 PowerUp® module • Standard placement of grommet is in right rear corner of worksurface • Note: Provide a plan layout indicating grommet location on the worksurface, if other than standard • With or without task light • Adjustable or wheelchair-height adjustable | | | | | | | | | | | |
| A B C D E F G H I J | | | | | | | | | | | |

HOW TO ORDER

Indicate the following information on order form:

- Quantity of each item.
- Model number, including options. See "How To Build a Model Number".
- Any special service required.

Note: • The indicates that a choice is required.

- The absence of the indicates that no choice is required.
- Alpha-numeric characters in place of indicate that no other alternatives are available.

HOW TO BUILD A MODEL NUMBER

A Select basic model.

B Select wood type.

- O** - Oak
- M** - Maple

C Select panel.

- PCRV** - Curved panel
- PSTR** - Straight panel

D Select base.

- BCRV** - Curved base
- BSTR** - Straight base

E Select height (worksurface).

- AH** - Adjustable height
- AH32** - Adjustable wheelchair height

F Select task light

- 1TL** - 1 Task light; add \$150
- NL** - No task light

G Select grommet or PowerUp.

1G - 1 Grommet-standard

1P - 1 PowerUp module; add \$112

H Select grommet or PowerUp module color.

Refer to color addendum at ki.com or KI Fabrics & Finishes binder.

I Select wood finish (for table edge & base).

Refer to color addendum at ki.com or KI Fabrics & Finishes binder. Stained finish colors\$47.

J Select surface finish.

Refer to color addendum at ki.com or KI Fabrics & Finishes binder. Additional plastic laminate surfaces are available but may require an upcharge and additional leadtime. Please contact KI.



| Approx. Packaged Weight | Oak | Maple |
|-------------------------|---------|---------|
| 201.0# | \$ 2994 | \$ 4380 |
| 231.0# | 3433 | 5028 |

| | | |
|--------|---------|---------|
| 146.0# | \$ 2251 | \$ 3160 |
| 176.0# | 2689 | 3809 |

FINISH INFORMATION

Additional Stains

Specially stained edges beyond the KI standard offering (as shown under the Edge Color column in color addendum) are also available. Contact KI.

SPECIAL SERVICES

Special Carton Marking

With specially marked information N/C

Shipping

Shipped **k.d. freight prepaid f.o.b. factory of origin** factory.
Freight class #100.

Specifications and prices are subject to change without prior notice.

CrossRoads® Study Carrels

Double Face Carrels

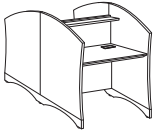
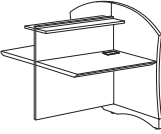
| | D x W | MODEL NUMBER | | | | | | | | | |
|--|--------------|--------------|--------------------------|--------------------------|--------------------------|--------------------------|--------------------------|--------------------------|--------------------------|--------------------------|--------------------------|
| | | Basic Model | Wood Type | Panel | Base | Height | Task Light | Grommet/Module Type | Grommet/Module Color | Wood Finish | Surface Finish |
|  <p>CRC Study Carrel Starter Unit-Double Face</p> <ul style="list-style-type: none"> • Curved or straight panel or base • Choice of 2 grommets or 2 PowerUp® modules (1 per worksurface) • Standard placement of grommet is in right rear corner of worksurface • Note: Provide a plan layout indicating grommet location on the worksurface, if other than standard • With or without task light • Adjustable or wheelchair-height adjustable | 60 x 36" | CRC6036S | <input type="checkbox"/> | <input type="checkbox"/> | <input type="checkbox"/> | <input type="checkbox"/> | <input type="checkbox"/> | <input type="checkbox"/> | <input type="checkbox"/> | <input type="checkbox"/> | <input type="checkbox"/> |
| | 60 x 48" | CRC6048S | <input type="checkbox"/> | <input type="checkbox"/> | <input type="checkbox"/> | <input type="checkbox"/> | <input type="checkbox"/> | <input type="checkbox"/> | <input type="checkbox"/> | <input type="checkbox"/> | <input type="checkbox"/> |
|  <p>CRC Study Carrel Adder Unit-Double Face</p> <ul style="list-style-type: none"> • Curved or straight panel or base • Choice of 2 grommets or 2 PowerUp® modules (1 per worksurface) • Standard placement of grommet is in right rear corner of worksurface • Note: Provide a plan layout indicating grommet location on the worksurface, if other than standard • With or without task light • Adjustable or wheelchair-height adjustable | 60 x 34-3/4" | CRC6036A | <input type="checkbox"/> | <input type="checkbox"/> | <input type="checkbox"/> | <input type="checkbox"/> | <input type="checkbox"/> | <input type="checkbox"/> | <input type="checkbox"/> | <input type="checkbox"/> | |
| | 60 x 46-3/4" | CRC6048A | <input type="checkbox"/> | <input type="checkbox"/> | <input type="checkbox"/> | <input type="checkbox"/> | <input type="checkbox"/> | <input type="checkbox"/> | <input type="checkbox"/> | <input type="checkbox"/> | |

A B C D E F G H I J

HOW TO ORDER

Indicate the following information on order form:

- Quantity of each item.
- Model number, including options. See "How To Build a Model Number".
- Any special service required.

Note: • The indicates that a choice is required.

- The absence of the indicates that no choice is required.
- Alpha-numeric characters in place of indicate that no other alternatives are available.

HOW TO BUILD A MODEL NUMBER

- A** Select basic model.
- B** Select wood type.
 - O** - Oak
 - M** - Maple
- C** Select panel.
 - PCRV** - Curved panel
 - PSTR** - Straight panel
- D** Select base.
 - BCRV** - Curved base
 - BSTR** - Straight base
- E** Select height (worksurface).
 - AH** - Adjustable height
 - AH32** - Adjustable wheelchair height
- F** Select task light
 - 2TL** - 2 Task lights (1 per worksurface); add \$303
 - NL** - No task light

- G** Select grommet or PowerUp.
 - 2G** - 2 Grommets (one per worksurface-standard)
 - 2P** - 2 PowerUp modules (one per worksurface); add \$225
- H** Select grommet or PowerUp module color. Refer to color addendum at ki.com or KI Fabrics & Finishes binder.
- I** Select wood finish (for table edge & base). Refer to color addendum at ki.com or KI Fabrics & Finishes binder. Stained finish colors; add \$47.
- J** Select surface finish. Refer to color addendum at ki.com or KI Fabrics & Finishes binder. Additional plastic laminate surfaces are available but may require an upcharge and additional leadtime. Please contact KI.



| Approx. Packaged Weight | Oak | Maple |
|-------------------------|---------|---------|
| 415.0# | \$ 4748 | \$ 6168 |
| 415.0# | 5352 | 6384 |

| | | |
|--------|---------|---------|
| 242.0# | \$ 3436 | \$ 4645 |
| 305.0# | 4040 | 5480 |

FINISH INFORMATION

Additional Stains

Specially stained edges beyond the KI standard offering (as shown under the Edge Color column in color addendum) are also available. Contact KI.

SPECIAL SERVICES

Special Carton Marking

With specially marked information N/C

Shipping

Shipped **k.d. freight prepaid f.o.b. factory of origin** factory.
Freight class #100.

Specifications and prices are subject to change without prior notice.

CrossRoads® Stand-up Computer Stations

Single Face Stations

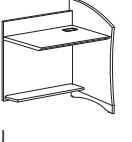
| | | MODEL NUMBER | | | | | | | | |
|---|--------------|--------------|--------------------------|---|---|---|---|--|--|----------|
| MODEL | D x W | Basic Model | Wood Type | Panel | Base | Grommet/PowerUp | Grommet/Module Color | Wood Finish | Surface Finish | |
|  <p>CRSU</p> <p>Stand-up Computer Station Starter Unit - Single Face</p> <ul style="list-style-type: none"> • O.P.A.C. - Online Patron Access Center • Curved or straight panel or base • Choice of 1 grommet or PowerUp® module • Standard placement of grommet is in right rear corner of worksurface • Provide a plan layout indicating grommet location on the worksurface, if other than standard • 39" high worksurface | 30 x 36" | CRSUS3036S | <input type="checkbox"/> | <input type="checkbox"/> <input type="checkbox"/> <input type="checkbox"/> <input type="checkbox"/> | <input type="checkbox"/> <input type="checkbox"/> <input type="checkbox"/> <input type="checkbox"/> | <input type="checkbox"/> <input type="checkbox"/> | <input type="checkbox"/> <input type="checkbox"/> | <input type="checkbox"/> <input type="checkbox"/> <input type="checkbox"/> | <input type="checkbox"/> <input type="checkbox"/> <input type="checkbox"/> | |
| | 30 x 48" | CRSUS3048S | <input type="checkbox"/> | <input type="checkbox"/> <input type="checkbox"/> <input type="checkbox"/> <input type="checkbox"/> | <input type="checkbox"/> <input type="checkbox"/> <input type="checkbox"/> <input type="checkbox"/> | <input type="checkbox"/> <input type="checkbox"/> | <input type="checkbox"/> <input type="checkbox"/> | <input type="checkbox"/> <input type="checkbox"/> <input type="checkbox"/> | <input type="checkbox"/> <input type="checkbox"/> <input type="checkbox"/> | |
|  <p>CRSU</p> <p>Stand-up Computer Station Adder Unit - Single Face</p> <ul style="list-style-type: none"> • O.P.A.C. - Online Patron Access Center • Curved or straight panel or base • Choice of 1 grommet or PowerUp® module • Standard placement of grommet is in right rear corner of worksurface • Provide a plan layout indicating grommet location on the worksurface, if other than standard • 39" high worksurface | 30 x 34-3/4" | CRSUS3036A | <input type="checkbox"/> | <input type="checkbox"/> <input type="checkbox"/> <input type="checkbox"/> <input type="checkbox"/> | <input type="checkbox"/> <input type="checkbox"/> <input type="checkbox"/> <input type="checkbox"/> | <input type="checkbox"/> <input type="checkbox"/> | <input type="checkbox"/> <input type="checkbox"/> | <input type="checkbox"/> <input type="checkbox"/> <input type="checkbox"/> | <input type="checkbox"/> <input type="checkbox"/> <input type="checkbox"/> | |
| | 30 x 46-3/4" | CRSUS3048A | <input type="checkbox"/> | <input type="checkbox"/> <input type="checkbox"/> <input type="checkbox"/> <input type="checkbox"/> | <input type="checkbox"/> <input type="checkbox"/> <input type="checkbox"/> <input type="checkbox"/> | <input type="checkbox"/> <input type="checkbox"/> | <input type="checkbox"/> <input type="checkbox"/> | <input type="checkbox"/> <input type="checkbox"/> <input type="checkbox"/> | <input type="checkbox"/> <input type="checkbox"/> <input type="checkbox"/> | |
| | | | A | B | C | D | E | F | G | H |

HOW TO ORDER

Indicate the following information on order form:

1. Quantity of each item.
2. Model number, including options. See "How To Build a Model Number".
3. Any special service required.

Note: • The indicates that a choice is required.

- The absence of the indicates that no choice is required.
- Alpha-numeric characters in place of indicate that no other alternatives are available.

HOW TO BUILD A MODEL NUMBER

- A** Select basic model.
- B** Select wood type.
 - O** - Oak
 - M** - Maple
- C** Select panel.
 - PCRV** - Curved panel
 - PSTR** - Straight panel
- D** Select base.
 - BCRV** - Curved base
 - BSTR** - Straight base
- E** Select grommet or PowerUp.
 - 1G** - 1 Grommet-standard
 - 1P** - 1 PowerUp module; add \$112
- F** Select grommet/module color. Refer to color addendum at ki.com or KI Fabrics & Finishes binder.
- G** Select wood finish (for table edge & base).

Refer to color addendum at ki.com or KI Fabrics & Finishes binder. Stained finish colors; add \$47.

- H** Select surface finish. Refer to color addendum at ki.com or KI Fabrics & Finishes binder. Additional plastic laminate surfaces are available but may require an up-charge and additional leadtime. Please contact KI.

FINISH INFORMATION

Additional Stains

Specially stained edges beyond the KI standard offering (as shown under the Edge Color column in color addendum) are also available. Contact KI.



CrossRoads® Stand-up Computer Stations

Single Face Stations

| Approx. Packaged Weight | Oak | Maple |
|-------------------------------|---------|---------|
| 197.0# | \$ 2995 | \$ 4381 |
| 227.0# | 3433 | 5029 |

| | | |
|--------|---------|---------|
| 146.0# | \$ 2251 | \$ 3160 |
| 176.0# | 2690 | 3809 |

SPECIAL SERVICES

Special Carton Marking

With specially marked information N/C

Shipping

Shipped **k.d. freight prepaid f.o.b. factory of origin** factory.
Freight class #100.

Specifications and prices are subject to change without prior notice.

CrossRoads® Stand-up Computer Stations

Double Face Stations

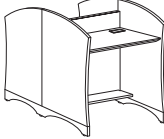
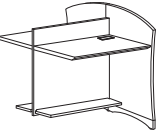
| | | MODEL NUMBER | | | | | | | | |
|---|--------------|--------------|--------------------------|---|---|---|---|--|--|----------|
| MODEL | D x W | Basic Model | Wood Type | Panel | Base | Grommet/PowerUp | Grommet/Module Color | Wood Finish | Surface Finish | |
|  <p>CRSU</p> <p>Stand-up Computer Station Starter Unit-Double Face</p> <ul style="list-style-type: none"> • O.P.A.C. - Online Patron Access Center • Curved or straight panel or base • Choice of 2 grommet or PowerUp® modules (1 per workstation) • Standard placement of grommet is in right rear corner of worksurface • Provide a plan layout indicating grommet location on the worksurface, if other than standard • 39" high worksurface | 60 x 36" | CRSUD6036S | <input type="checkbox"/> | <input type="checkbox"/> <input type="checkbox"/> <input type="checkbox"/> <input type="checkbox"/> | <input type="checkbox"/> <input type="checkbox"/> <input type="checkbox"/> <input type="checkbox"/> | <input type="checkbox"/> <input type="checkbox"/> | <input type="checkbox"/> <input type="checkbox"/> | <input type="checkbox"/> <input type="checkbox"/> <input type="checkbox"/> | <input type="checkbox"/> <input type="checkbox"/> <input type="checkbox"/> | |
| | 60 x 48" | CRSUD6048S | <input type="checkbox"/> | <input type="checkbox"/> <input type="checkbox"/> <input type="checkbox"/> <input type="checkbox"/> | <input type="checkbox"/> <input type="checkbox"/> <input type="checkbox"/> <input type="checkbox"/> | <input type="checkbox"/> <input type="checkbox"/> | <input type="checkbox"/> <input type="checkbox"/> | <input type="checkbox"/> <input type="checkbox"/> <input type="checkbox"/> | <input type="checkbox"/> <input type="checkbox"/> <input type="checkbox"/> | |
|  <p>CRSU</p> <p>Stand-up Computer Station Adder Unit-Double Face</p> <ul style="list-style-type: none"> • O.P.A.C. - Online Patron Access Center • Curved or straight panel or base • Choice of 2 grommet or PowerUp® modules (1 per workstation) • Standard placement of grommet is in right rear corner of worksurface • Provide a plan layout indicating grommet location on the worksurface, if other than standard • 39" high worksurface | 60 x 34-3/4" | CRSUD6036A | <input type="checkbox"/> | <input type="checkbox"/> <input type="checkbox"/> <input type="checkbox"/> <input type="checkbox"/> | <input type="checkbox"/> <input type="checkbox"/> <input type="checkbox"/> <input type="checkbox"/> | <input type="checkbox"/> <input type="checkbox"/> | <input type="checkbox"/> <input type="checkbox"/> | <input type="checkbox"/> <input type="checkbox"/> <input type="checkbox"/> | <input type="checkbox"/> <input type="checkbox"/> <input type="checkbox"/> | |
| | 60 x 46-3/4" | CRSUD6048A | <input type="checkbox"/> | <input type="checkbox"/> <input type="checkbox"/> <input type="checkbox"/> <input type="checkbox"/> | <input type="checkbox"/> <input type="checkbox"/> <input type="checkbox"/> <input type="checkbox"/> | <input type="checkbox"/> <input type="checkbox"/> | <input type="checkbox"/> <input type="checkbox"/> | <input type="checkbox"/> <input type="checkbox"/> <input type="checkbox"/> | <input type="checkbox"/> <input type="checkbox"/> <input type="checkbox"/> | |
| | | | A | B | C | D | E | F | G | H |

HOW TO ORDER

Indicate the following information on order form:

1. Quantity of each item.
2. Model number, including options. See "How To Build a Model Number".
3. Any special service required.

Note: • The indicates that a choice is required.

- The absence of the indicates that no choice is required.
- Alpha-numeric characters in place of indicate that no other alternatives are available.

HOW TO BUILD A MODEL NUMBER

- A** Select basic model.
- B** Select wood type.
 - O** - Oak
 - M** - Maple
- C** Select panel.
 - PCR** - Curved panel
 - PSTR** - Straight panel
- D** Select base.
 - BCR** - Curved base
 - BSTR** - Straight base
- E** Select grommet or PowerUp.
 - 2G** - 2 Grommets (one per worksurface-standard)
 - 2P** - 2 PowerUp modules (one per worksurface); add \$225
- F** Select grommet/module color. Refer to color addendum at ki.com or KI Fabrics & Finishes binder.

G Select wood finish (for table edge & base).

Refer to color addendum at ki.com or KI Fabrics & Finishes binder. Stained finish colors; add \$47.

H Select surface finish.

Refer to color addendum at ki.com or KI Fabrics & Finishes binder. Additional plastic laminate surfaces are available but may require an up-charge and additional leadtime. Please contact KI.

FINISH INFORMATION

Additional Stains

Specially stained edges beyond the KI standard offering (as shown under the Edge Color column in color addendum) are also available. Contact KI.



CrossRoads® Stand-up Computer Stations

Double Face Stations

| Approx. Packaged Weight | Oak | Maple |
|-------------------------------|---------|---------|
| 348.0# | \$ 4750 | \$ 6168 |
| 409.0# | 5353 | 6384 |

| | | |
|--------|---------|---------|
| 242.0# | \$ 3436 | \$ 4645 |
| 305.0# | 4040 | 5482 |

SPECIAL SERVICES

Special Carton Marking

With specially marked information N/C



Shipping

Shipped **k.d. freight prepaid f.o.b. factory of origin** factory.
Freight class #100.

Specifications and prices are subject to change without prior notice.

CrossRoads® Shelving

42" High Shelving

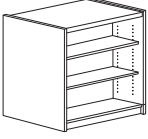
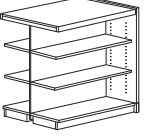
| | MODEL | D x W | MODEL NUMBER | | | | | Approx. Packaged Weight | |
|---|---|--------------|--------------|--------------------------|---|---|---|-------------------------|--|
| | | | Basic Model | Wood Type | End Panel | Back Panel | Wood Finish | | |
|  | Shelving Starter Unit-Single Face • Straight base only • Straight or curved end panel • With or without back panel • 2 adjustable and 1 fixed shelf • Recommended for use against wall only | 8 x 37-1/2" | CRFS4208S | <input type="checkbox"/> | <input type="checkbox"/> <input type="checkbox"/> <input type="checkbox"/> <input type="checkbox"/> | <input type="checkbox"/> <input type="checkbox"/> | <input type="checkbox"/> <input type="checkbox"/> | 38.0# | |
| | | 10 x 37-1/2" | CRFS4210S | <input type="checkbox"/> | <input type="checkbox"/> <input type="checkbox"/> <input type="checkbox"/> <input type="checkbox"/> | <input type="checkbox"/> <input type="checkbox"/> | <input type="checkbox"/> <input type="checkbox"/> | 50.0# | |
| | | 12 x 37-1/2" | CRFS4212S | <input type="checkbox"/> | <input type="checkbox"/> <input type="checkbox"/> <input type="checkbox"/> <input type="checkbox"/> | <input type="checkbox"/> <input type="checkbox"/> | <input type="checkbox"/> <input type="checkbox"/> | 57.0# | |
| | | 16 x 37-1/2" | CRFS4216S | <input type="checkbox"/> | <input type="checkbox"/> <input type="checkbox"/> <input type="checkbox"/> <input type="checkbox"/> | <input type="checkbox"/> <input type="checkbox"/> | <input type="checkbox"/> <input type="checkbox"/> | 79.0# | |
| | | | | | | | | | |
| CRF | | | | | | | | | |
|  | Shelving Adder Unit-Single Face • Straight end panel only • With or without back panel • 2 adjustable and 1 fixed shelf • Recommended for use against wall only | 8 x 36-1/4" | CRFS4208A | <input type="checkbox"/> | PSTR | <input type="checkbox"/> <input type="checkbox"/> | <input type="checkbox"/> <input type="checkbox"/> | 32.0# | |
| | | 10 x 36-1/4" | CRFS4210A | <input type="checkbox"/> | PSTR | <input type="checkbox"/> <input type="checkbox"/> | <input type="checkbox"/> <input type="checkbox"/> | 42.0# | |
| | | 12 x 36-1/4" | CRFS4212A | <input type="checkbox"/> | PSTR | <input type="checkbox"/> <input type="checkbox"/> | <input type="checkbox"/> <input type="checkbox"/> | 47.0# | |
| | | 16 x 36-1/4" | CRFS4216A | <input type="checkbox"/> | PSTR | <input type="checkbox"/> <input type="checkbox"/> | <input type="checkbox"/> <input type="checkbox"/> | 65.0# | |
| | | | | | | | | | |
| CRF | | | | | | | | | |
|  | Shelving Starter Unit-Double Face • Straight base only • Straight or curved end panel • With or without back panel • 4 adjustable and 2 fixed shelves | 16 x 37-1/2" | CRFD4216S | <input type="checkbox"/> | <input type="checkbox"/> <input type="checkbox"/> <input type="checkbox"/> <input type="checkbox"/> | <input type="checkbox"/> <input type="checkbox"/> | <input type="checkbox"/> <input type="checkbox"/> | 79.0# | |
| | | 20 x 37-1/2" | CRFD4220S | <input type="checkbox"/> | <input type="checkbox"/> <input type="checkbox"/> <input type="checkbox"/> <input type="checkbox"/> | <input type="checkbox"/> <input type="checkbox"/> | <input type="checkbox"/> <input type="checkbox"/> | 96.0# | |
| | | 24 x 37-1/2" | CRFD4224S | <input type="checkbox"/> | <input type="checkbox"/> <input type="checkbox"/> <input type="checkbox"/> <input type="checkbox"/> | <input type="checkbox"/> <input type="checkbox"/> | <input type="checkbox"/> <input type="checkbox"/> | 117.0# | |
| | | | | | | | | | |
| | | | | | | | | | |
| CRF | | | | | | | | | |
|  | Shelving Adder Unit-Double Face • Straight end panel only • With or without back panel • 4 adjustable and 2 fixed shelves | 16 x 36-1/4" | CRFD4216A | <input type="checkbox"/> | PSTR | <input type="checkbox"/> <input type="checkbox"/> | <input type="checkbox"/> <input type="checkbox"/> | 65.0# | |
| | | 20 x 36-1/4" | CRFD4220A | <input type="checkbox"/> | PSTR | <input type="checkbox"/> <input type="checkbox"/> | <input type="checkbox"/> <input type="checkbox"/> | 80.0# | |
| | | 24 x 36-1/4" | CRFD4224A | <input type="checkbox"/> | PSTR | <input type="checkbox"/> <input type="checkbox"/> | <input type="checkbox"/> <input type="checkbox"/> | 95.0# | |
| | | | | | | | | | |
| | | | | | | | | | |
| CRF | | | | | | | | | |

A **B** **C** **D** **E**

HOW TO ORDER

Indicate the following information on order form:

- Quantity of each item.
- Model number, including options. See "How To Build a Model Number".
- Any special service required.

Note: • The indicates that a choice is required.

- The absence of the indicates that no choice is required.
- Alpha-numeric characters in place of indicate that no other alternatives are available.

HOW TO BUILD A MODEL NUMBER

- A** Select basic model.
- B** Select wood type.
 - Oak
 - Maple
- C** Select end panel.
 - Curved panel
 - Straight panel
- D** Select back panel.
 - Back panel; add \$127
 - No back panel
- E** Select wood finish.
 Refer to color addendum at ki.com or KI Fabrics & Finishes binder.
 Stained finish colors; add \$56.

INFORMATION

Back Panel Weights

When ordering shelving with back panels add the following weights:

- 42" high add 15#
- 54" high add 18#
- 60" high add 20#
- 72" high add 24#
- 82" high add 27#
- 96" high add 35#

FINISH INFORMATION

Additional Stains

Specially stained edges beyond the KI standard offering (as shown under the Edge Color column in color addendum) are also available. Contact KI.



CrossRoads® Shelving

42" High Shelving

| Oak | Maple |
|---------|---------|
| \$ 898 | \$ 949 |
| 943 | 999 |
| 980 | 1032 |
| 1453 | 1547 |
| <hr/> | |
| \$ 728 | \$ 769 |
| 745 | 787 |
| 789 | 834 |
| 1175 | 1232 |
| <hr/> | |
| \$ 1393 | \$ 1481 |
| 1480 | 1575 |
| 1568 | 1671 |
| <hr/> | |
| \$ 1178 | \$ 1250 |
| 1242 | 1319 |
| 1302 | 1384 |

SPECIAL SERVICES

Special Carton Marking

With specially marked information N/C



Shipping

Shipped **k.d. freight prepaid f.o.b. factory of origin** factory.
Freight class #125.

Specifications and prices are subject to change without prior notice.

CrossRoads® Shelving

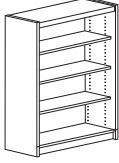
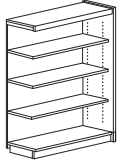
54" High Shelving

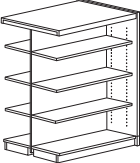
| | MODEL | D x W | MODEL NUMBER | | | | | Approx. Packaged Weight |
|---|---|--------------|--------------|--------------------------|---|---|--|-------------------------|
| | | | Basic Model | Wood Type | End Panel | Back Panel | Wood Finish | |
|  | Shelving Starter Unit-Single Face • Straight base only • Straight or curved end panel • With or without back panel • 3 adjustable and 1 fixed shelf • Recommended for use against wall only | 8 x 37-1/2" | CRFS5408S | <input type="checkbox"/> | <input type="checkbox"/> <input type="checkbox"/> <input type="checkbox"/> <input type="checkbox"/> | <input type="checkbox"/> <input type="checkbox"/> | <input type="checkbox"/> <input type="checkbox"/> <input type="checkbox"/> | 51.0# |
| | | 10 x 37-1/2" | CRFS5410S | <input type="checkbox"/> | <input type="checkbox"/> <input type="checkbox"/> <input type="checkbox"/> <input type="checkbox"/> | <input type="checkbox"/> <input type="checkbox"/> | <input type="checkbox"/> <input type="checkbox"/> <input type="checkbox"/> | 58.0# |
| | | 12 x 37-1/2" | CRFS5412S | <input type="checkbox"/> | <input type="checkbox"/> <input type="checkbox"/> <input type="checkbox"/> <input type="checkbox"/> | <input type="checkbox"/> <input type="checkbox"/> | <input type="checkbox"/> <input type="checkbox"/> <input type="checkbox"/> | 69.0# |
| | | 16 x 37-1/2" | CRFS5416S | <input type="checkbox"/> | <input type="checkbox"/> <input type="checkbox"/> <input type="checkbox"/> <input type="checkbox"/> | <input type="checkbox"/> <input type="checkbox"/> | <input type="checkbox"/> <input type="checkbox"/> <input type="checkbox"/> | 91.0# |
| CRF | | | | | | | | |
|  | Shelving Adder Unit-Single Face • Straight end panel only • With or without back panel • 3 adjustable and 1 fixed shelf • Recommended for use against wall only | 8 x 36-1/4" | CRFS5408A | <input type="checkbox"/> | PSTR | <input type="checkbox"/> <input type="checkbox"/> | <input type="checkbox"/> <input type="checkbox"/> <input type="checkbox"/> | 37.0# |
| | | 10 x 36-1/4" | CRFS5410A | <input type="checkbox"/> | PSTR | <input type="checkbox"/> <input type="checkbox"/> | <input type="checkbox"/> <input type="checkbox"/> <input type="checkbox"/> | 48.0# |
| | | 12 x 36-1/4" | CRFS5412A | <input type="checkbox"/> | PSTR | <input type="checkbox"/> <input type="checkbox"/> | <input type="checkbox"/> <input type="checkbox"/> <input type="checkbox"/> | 55.0# |
| | | 16 x 36-1/4" | CRFS5416A | <input type="checkbox"/> | PSTR | <input type="checkbox"/> <input type="checkbox"/> | <input type="checkbox"/> <input type="checkbox"/> <input type="checkbox"/> | 75.0# |
| CRF | | | | | | | | |
|  | Shelving Starter Unit-Double Face • Straight base only • Straight or curved end panel • With or without back panel • 6 adjustable and 2 fixed shelves | 16 x 37-1/2" | CRFD5416S | <input type="checkbox"/> | <input type="checkbox"/> <input type="checkbox"/> <input type="checkbox"/> <input type="checkbox"/> | <input type="checkbox"/> <input type="checkbox"/> | <input type="checkbox"/> <input type="checkbox"/> <input type="checkbox"/> | 93.0# |
| | | 20 x 37-1/2" | CRFD5420S | <input type="checkbox"/> | <input type="checkbox"/> <input type="checkbox"/> <input type="checkbox"/> <input type="checkbox"/> | <input type="checkbox"/> <input type="checkbox"/> | <input type="checkbox"/> <input type="checkbox"/> <input type="checkbox"/> | 114.0# |
| | | 24 x 37-1/2" | CRFD5424S | <input type="checkbox"/> | <input type="checkbox"/> <input type="checkbox"/> <input type="checkbox"/> <input type="checkbox"/> | <input type="checkbox"/> <input type="checkbox"/> | <input type="checkbox"/> <input type="checkbox"/> <input type="checkbox"/> | 135.0# |
| | | | | | | | | |
| CRF | | | | | | | | |
|  | Shelving Adder Unit-Double Face • Straight end panel only • With or without back panel • 6 adjustable and 2 fixed shelves | 16 x 36-1/4" | CRFD5416A | <input type="checkbox"/> | PSTR | <input type="checkbox"/> <input type="checkbox"/> | <input type="checkbox"/> <input type="checkbox"/> <input type="checkbox"/> | 75.0# |
| | | 20 x 36-1/4" | CRFD5420A | <input type="checkbox"/> | PSTR | <input type="checkbox"/> <input type="checkbox"/> | <input type="checkbox"/> <input type="checkbox"/> <input type="checkbox"/> | 93.0# |
| | | 24 x 36-1/4" | CRFD5424A | <input type="checkbox"/> | PSTR | <input type="checkbox"/> <input type="checkbox"/> | <input type="checkbox"/> <input type="checkbox"/> <input type="checkbox"/> | 107.0# |
| | | | | | | | | |
| CRF | | | | | | | | |

A **B** **C** **D** **E**

HOW TO ORDER

Indicate the following information on order form:

- Quantity of each item.
- Model number, including options. See "How To Build a Model Number".
- Any special service required.

Note: • The indicates that a choice is required.

- The absence of the indicates that no choice is required.
- Alpha-numeric characters in place of indicate that no other alternatives are available.

HOW TO BUILD A MODEL NUMBER

- A** Select basic model.
- B** Select wood type.
 - Oak
 - Maple
- C** Select end panel.
 - Curved panel
 - Straight panel
- D** Select back panel.
 - Back panel; add \$144
 - No back panel
- E** Select wood finish.
 Refer to color addendum at ki.com or KI Fabrics & Finishes binder.
 Stained finish colors; add \$56.

INFORMATION

Back Panel Weights

When ordering shelving with back panels add the following weights:

- 42" high add 15#
- 54" high add 18#
- 60" high add 20#
- 72" high add 24#
- 82" high add 27#
- 96" high add 35#

FINISH INFORMATION

Additional Stains

Specially stained edges beyond the KI standard offering (as shown under the Edge Color column in color addendum) are also available. Contact KI.



CrossRoads® Shelving

54" High Shelving

| Oak | Maple |
|---------|---------|
| \$ 1026 | \$ 1089 |
| 1083 | 1151 |
| 1141 | 1209 |
| 1651 | 1823 |
| | |
| | |
| | |
| \$ 833 | \$ 881 |
| 860 | 913 |
| 914 | 969 |
| 1273 | 1437 |
| | |
| | |
| | |
| \$ 1641 | \$ 1752 |
| 1747 | 1864 |
| 1873 | 1999 |
| | |
| | |
| | |
| \$ 1378 | \$ 1469 |
| 1463 | 1558 |
| 1545 | 1648 |

SPECIAL SERVICES

Special Carton Marking

With specially marked information N/C



Shipping

Shipped **k.d. freight prepaid f.o.b. factory of origin** factory.
Freight class #125.

Specifications and prices are subject to change without prior notice.

CrossRoads® Shelving

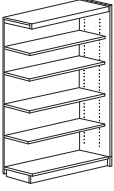
60" High Shelving

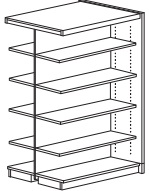
| | MODEL | D x W | MODEL NUMBER | | | | | Approx. Packaged Weight |
|---|---|--------------|--------------|--------------------------|---|---|---|-------------------------|
| | | | Basic Model | Wood Type | End Panel | Back Panel | Wood Finish | |
|  | Shelving Starter Unit-Single Face • Straight base only • Straight or curved end panel • With or without back panel • 4 adjustable and 1 fixed shelf • Recommended for use against wall only | 8 x 37-1/2" | CRFS6008S | <input type="checkbox"/> | <input type="checkbox"/> <input type="checkbox"/> <input type="checkbox"/> <input type="checkbox"/> | <input type="checkbox"/> <input type="checkbox"/> | <input type="checkbox"/> <input type="checkbox"/> | 54.0# |
| | | 10 x 37-1/2" | CRFS6010S | <input type="checkbox"/> | <input type="checkbox"/> <input type="checkbox"/> <input type="checkbox"/> <input type="checkbox"/> | <input type="checkbox"/> <input type="checkbox"/> | <input type="checkbox"/> <input type="checkbox"/> | 67.0# |
| | | 12 x 37-1/2" | CRFS6012S | <input type="checkbox"/> | <input type="checkbox"/> <input type="checkbox"/> <input type="checkbox"/> <input type="checkbox"/> | <input type="checkbox"/> <input type="checkbox"/> | <input type="checkbox"/> <input type="checkbox"/> | 81.0# |
| | | 16 x 37-1/2" | CRFS6016S | <input type="checkbox"/> | <input type="checkbox"/> <input type="checkbox"/> <input type="checkbox"/> <input type="checkbox"/> | <input type="checkbox"/> <input type="checkbox"/> | <input type="checkbox"/> <input type="checkbox"/> | 103.0# |
| | | | | | | | | |
| CRF | | | | | | | | |
|  | Shelving Adder Unit-Single Face • Straight end panel only • With or without back panel • 4 adjustable and 1 fixed shelf • Recommended for use against wall only | 8 x 36-1/4" | CRFS6008A | <input type="checkbox"/> | PSTR | <input type="checkbox"/> <input type="checkbox"/> | <input type="checkbox"/> <input type="checkbox"/> | 42.0# |
| | | 10 x 36-1/4" | CRFS6010A | <input type="checkbox"/> | PSTR | <input type="checkbox"/> <input type="checkbox"/> | <input type="checkbox"/> <input type="checkbox"/> | 55.0# |
| | | 12 x 36-1/4" | CRFS6012A | <input type="checkbox"/> | PSTR | <input type="checkbox"/> <input type="checkbox"/> | <input type="checkbox"/> <input type="checkbox"/> | 63.0# |
| | | 16 x 36-1/4" | CRFS6016A | <input type="checkbox"/> | PSTR | <input type="checkbox"/> <input type="checkbox"/> | <input type="checkbox"/> <input type="checkbox"/> | 85.0# |
| | | | | | | | | |
| CRF | | | | | | | | |
|  | Shelving Starter Unit-Double Face • Straight base only • Straight or curved end panel • With or without back panel • 8 adjustable and 2 fixed shelves | 16 x 37-1/2" | CRFD6016S | <input type="checkbox"/> | <input type="checkbox"/> <input type="checkbox"/> <input type="checkbox"/> <input type="checkbox"/> | <input type="checkbox"/> <input type="checkbox"/> | <input type="checkbox"/> <input type="checkbox"/> | 108.0# |
| | | 20 x 37-1/2" | CRFD6020S | <input type="checkbox"/> | <input type="checkbox"/> <input type="checkbox"/> <input type="checkbox"/> <input type="checkbox"/> | <input type="checkbox"/> <input type="checkbox"/> | <input type="checkbox"/> <input type="checkbox"/> | 133.0# |
| | | 24 x 37-1/2" | CRFD6024S | <input type="checkbox"/> | <input type="checkbox"/> <input type="checkbox"/> <input type="checkbox"/> <input type="checkbox"/> | <input type="checkbox"/> <input type="checkbox"/> | <input type="checkbox"/> <input type="checkbox"/> | 154.0# |
| | | | | | | | | |
| | | | | | | | | |
| CRF | | | | | | | | |
|  | Shelving Adder Unit-Double Face • Straight end panel only • With or without back panel • 8 adjustable and 2 fixed shelves | 16 x 36-1/4" | CRFD6016A | <input type="checkbox"/> | PSTR | <input type="checkbox"/> <input type="checkbox"/> | <input type="checkbox"/> <input type="checkbox"/> | 85.0# |
| | | 20 x 36-1/4" | CRFD6020A | <input type="checkbox"/> | PSTR | <input type="checkbox"/> <input type="checkbox"/> | <input type="checkbox"/> <input type="checkbox"/> | 106.0# |
| | | 24 x 36-1/4" | CRFD6024A | <input type="checkbox"/> | PSTR | <input type="checkbox"/> <input type="checkbox"/> | <input type="checkbox"/> <input type="checkbox"/> | 123.0# |
| | | | | | | | | |
| | | | | | | | | |
| CRF | | | | | | | | |

A **B** **C** **D** **E**

HOW TO ORDER

Indicate the following information on order form:

- Quantity of each item.
- Model number, including options. See "How To Build a Model Number".
- Any special service required.

Note: • The indicates that a choice is required.

- The absence of the indicates that no choice is required.
- Alpha-numeric characters in place of indicate that no other alternatives are available.

HOW TO BUILD A MODEL NUMBER

- A** Select basic model.
- B** Select wood type.
 - Oak
 - Maple
- C** Select end panel.
 - Curved panel
 - Straight panel
- D** Select back panel.
 - Back panel; add \$153
 - No back panel
- E** Select wood finish.
 Refer to color addendum at ki.com or KI Fabrics & Finishes binder.
 Stained finish colors; add \$70.

INFORMATION

Back Panel Weights

When ordering shelving with back panels add the following weights:

- 42" high add 15#
- 54" high add 18#
- 60" high add 20#
- 72" high add 24#
- 82" high add 27#
- 96" high add 35#

FINISH INFORMATION

Additional Stains

Specially stained edges beyond the KI standard offering (as shown under the Edge Color column in color addendum) are also available. Contact KI.



CrossRoads® Shelving

60" High Shelving



| Oak | Maple |
|---------|---------|
| \$ 1070 | \$ 1139 |
| 1130 | 1200 |
| 1198 | 1270 |
| 1756 | 1961 |

| | |
|--------|--------|
| \$ 864 | \$ 918 |
| 899 | 954 |
| 955 | 1016 |
| 1363 | 1581 |

| | |
|---------|---------|
| \$ 1725 | \$ 1842 |
| 1835 | 1960 |
| 1973 | 2109 |

| | |
|---------|---------|
| \$ 1445 | \$ 1540 |
| 1535 | 1636 |
| 1627 | 1733 |

SPECIAL SERVICES

Special Carton Marking

With specially marked information N/C



Shipping

Shipped **k.d. freight prepaid f.o.b. factory of origin** factory.
Freight class #125.

Specifications and prices are subject to change without prior notice.

CrossRoads® Shelving

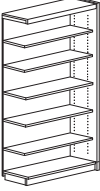
72" High Shelving

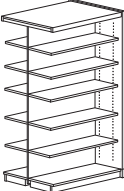
| MODEL | D x W | MODEL NUMBER | | | | | Approx. Packaged Weight |
|---|--------------|--------------|--------------------------|---|---|--|-------------------------|
| | | Basic Model | Wood Type | End Panel | Back Panel | Wood Finish | |
|  <p>Shelving Starter Unit-Single Face</p> <ul style="list-style-type: none"> • Straight base only • Straight or curved end panel • With or without back panel • 5 adjustable and 1 fixed shelf • Recommended for use against wall only | 8 x 37-1/2" | CRFS7208S | <input type="checkbox"/> | <input type="checkbox"/> <input type="checkbox"/> <input type="checkbox"/> <input type="checkbox"/> | <input type="checkbox"/> <input type="checkbox"/> | <input type="checkbox"/> <input type="checkbox"/> <input type="checkbox"/> | 59.0# |
| | 10 x 37-1/2" | CRFS7210S | <input type="checkbox"/> | <input type="checkbox"/> <input type="checkbox"/> <input type="checkbox"/> <input type="checkbox"/> | <input type="checkbox"/> <input type="checkbox"/> | <input type="checkbox"/> <input type="checkbox"/> <input type="checkbox"/> | 77.0# |
| | 12 x 37-1/2" | CRFS7212S | <input type="checkbox"/> | <input type="checkbox"/> <input type="checkbox"/> <input type="checkbox"/> <input type="checkbox"/> | <input type="checkbox"/> <input type="checkbox"/> | <input type="checkbox"/> <input type="checkbox"/> <input type="checkbox"/> | 91.0# |
| | 16 x 37-1/2" | CRFS7216S | <input type="checkbox"/> | <input type="checkbox"/> <input type="checkbox"/> <input type="checkbox"/> <input type="checkbox"/> | <input type="checkbox"/> <input type="checkbox"/> | <input type="checkbox"/> <input type="checkbox"/> <input type="checkbox"/> | 115.0# |
| CRF | | | | | | | |
|  <p>Shelving Adder Unit-Single Face</p> <ul style="list-style-type: none"> • Straight end panel only • With or without back panel • 5 adjustable and 1 fixed shelf • Recommended for use against wall only | 8 x 36-1/4" | CRFS7208A | <input type="checkbox"/> | PSTR | <input type="checkbox"/> <input type="checkbox"/> | <input type="checkbox"/> <input type="checkbox"/> <input type="checkbox"/> | 48.0# |
| | 10 x 36-1/4" | CRFS7210A | <input type="checkbox"/> | PSTR | <input type="checkbox"/> <input type="checkbox"/> | <input type="checkbox"/> <input type="checkbox"/> <input type="checkbox"/> | 61.0# |
| | 12 x 36-1/4" | CRFS7212A | <input type="checkbox"/> | PSTR | <input type="checkbox"/> <input type="checkbox"/> | <input type="checkbox"/> <input type="checkbox"/> <input type="checkbox"/> | 72.0# |
| | 16 x 36-1/4" | CRFS7216A | <input type="checkbox"/> | PSTR | <input type="checkbox"/> <input type="checkbox"/> | <input type="checkbox"/> <input type="checkbox"/> <input type="checkbox"/> | 92.0# |
| CRF | | | | | | | |
|  <p>Shelving Starter Unit-Double Face</p> <ul style="list-style-type: none"> • Straight base only • Straight or curved end panel • With or without back panel • 10 adjustable and 2 fixed shelves | 16 x 37-1/2" | CRFD7216S | <input type="checkbox"/> | <input type="checkbox"/> <input type="checkbox"/> <input type="checkbox"/> <input type="checkbox"/> | <input type="checkbox"/> <input type="checkbox"/> | <input type="checkbox"/> <input type="checkbox"/> <input type="checkbox"/> | 117.0# |
| | 20 x 37-1/2" | CRFD7220S | <input type="checkbox"/> | <input type="checkbox"/> <input type="checkbox"/> <input type="checkbox"/> <input type="checkbox"/> | <input type="checkbox"/> <input type="checkbox"/> | <input type="checkbox"/> <input type="checkbox"/> <input type="checkbox"/> | 151.0# |
| | 24 x 37-1/2" | CRFD7224S | <input type="checkbox"/> | <input type="checkbox"/> <input type="checkbox"/> <input type="checkbox"/> <input type="checkbox"/> | <input type="checkbox"/> <input type="checkbox"/> | <input type="checkbox"/> <input type="checkbox"/> <input type="checkbox"/> | 200.0# |
| CRF | | | | | | | |
|  <p>Shelving Adder Unit-Double Face</p> <ul style="list-style-type: none"> • Straight end panel only • With or without back panel • 10 adjustable and 2 fixed shelves | 16 x 36-1/4" | CRFD7216A | <input type="checkbox"/> | PSTR | <input type="checkbox"/> <input type="checkbox"/> | <input type="checkbox"/> <input type="checkbox"/> <input type="checkbox"/> | 92.0# |
| | 20 x 36-1/4" | CRFD7220A | <input type="checkbox"/> | PSTR | <input type="checkbox"/> <input type="checkbox"/> | <input type="checkbox"/> <input type="checkbox"/> <input type="checkbox"/> | 120.0# |
| | 24 x 36-1/4" | CRFD7224A | <input type="checkbox"/> | PSTR | <input type="checkbox"/> <input type="checkbox"/> | <input type="checkbox"/> <input type="checkbox"/> <input type="checkbox"/> | 139.0# |
| CRF | | | | | | | |

A B C D E

HOW TO ORDER

Indicate the following information on order form:

1. Quantity of each item.
2. Model number, including options. See "How To Build a Model Number".
3. Any special service required.

Note: • The indicates that a choice is required.

- The absence of the indicates that no choice is required.
- Alpha-numeric characters in place of indicate that no other alternatives are available.

HOW TO BUILD A MODEL NUMBER

- A** Select basic model.
- B** Select wood type.

| | |
|----------|---------|
| O | - Oak |
| M | - Maple |
- C** Select end panel.

| | |
|-------------|------------------|
| PCR | - Curved panel |
| PSTR | - Straight panel |
- D** Select back panel.

| | |
|-----------|-------------------------|
| BP | - Back panel; add \$179 |
| NP | - No back panel |
- E** Select wood finish. Refer to color addendum at ki.com or KI Fabrics & Finishes binder. Stained finish colors; add \$70.

INFORMATION

Back Panel Weights
 When ordering shelving with back panels add the following weights:
 42" high add 15#
 54" high add 18#
 60" high add 20#
 72" high add 24#
 82" high add 27#
 96" high add 35#

FINISH INFORMATION

Additional Stains
 Specially stained edges beyond the KI standard offering (as shown under the Edge Color column in color addendum) are also available. Contact KI.



CrossRoads® Shelving

72" High Shelving

| Oak | Maple |
|---------|---------|
| \$ 1218 | \$ 1294 |
| 1294 | 1376 |
| 1383 | 1469 |
| 1903 | 2152 |
| <hr/> | |
| \$ 980 | \$ 1038 |
| 1036 | 1100 |
| 1096 | 1167 |
| 1474 | 1714 |
| <hr/> | |
| \$ 2031 | \$ 2170 |
| 2185 | 2340 |
| 2357 | 2525 |
| <hr/> | |
| \$ 1686 | \$ 1800 |
| 1798 | 1917 |
| 1932 | 2063 |

SPECIAL SERVICES

Special Carton Marking

With specially marked information N/C

Shipping

Shipped **k.d. freight prepaid f.o.b. factory of origin** factory.
Freight class #125.

Specifications and prices are subject to change without prior notice.

CrossRoads® Shelving

82" High Shelving

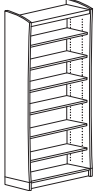
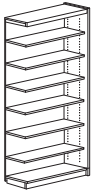
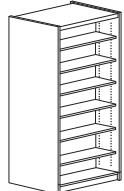
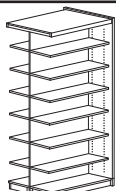
| | MODEL | D x W | MODEL NUMBER | | | | | Approx. Packaged Weight | |
|---|---|--------------|--------------|--------------------------|---|---|--|-------------------------|--|
| | | | Basic Model | Wood Type | End Panel | Back Panel | Wood Finish | | |
|  | Shelving Starter Unit-Single Face • Straight base only • Straight or curved end panel • With or without back panel • 6 adjustable and 1 fixed shelf • Recommended for use against wall only | 8 x 37-1/2" | CRFS8208S | <input type="checkbox"/> | <input type="checkbox"/> <input type="checkbox"/> <input type="checkbox"/> <input type="checkbox"/> | <input type="checkbox"/> <input type="checkbox"/> | <input type="checkbox"/> <input type="checkbox"/> <input type="checkbox"/> | 64.0# | |
| | | 10 x 37-1/2" | CRFS8210S | <input type="checkbox"/> | <input type="checkbox"/> <input type="checkbox"/> <input type="checkbox"/> <input type="checkbox"/> | <input type="checkbox"/> <input type="checkbox"/> | <input type="checkbox"/> <input type="checkbox"/> <input type="checkbox"/> | 87.0# | |
| | | 12 x 37-1/2" | CRFS8212S | <input type="checkbox"/> | <input type="checkbox"/> <input type="checkbox"/> <input type="checkbox"/> <input type="checkbox"/> | <input type="checkbox"/> <input type="checkbox"/> | <input type="checkbox"/> <input type="checkbox"/> <input type="checkbox"/> | 101.0# | |
| | | 16 x 37-1/2" | CRFS8216S | <input type="checkbox"/> | <input type="checkbox"/> <input type="checkbox"/> <input type="checkbox"/> <input type="checkbox"/> | <input type="checkbox"/> <input type="checkbox"/> | <input type="checkbox"/> <input type="checkbox"/> <input type="checkbox"/> | 127.0# | |
| | | | | | | | | | |
| CRF | | | | | | | | | |
|  | Shelving Adder Unit-Single Face • Straight end panel only • With or without back panel • 6 adjustable and 1 fixed shelf • Recommended for use against wall only | 8 x 36-1/4" | CRFS8208A | <input type="checkbox"/> | PSTR | <input type="checkbox"/> <input type="checkbox"/> | <input type="checkbox"/> <input type="checkbox"/> <input type="checkbox"/> | 54.0# | |
| | | 10 x 36-1/4" | CRFS8210A | <input type="checkbox"/> | PSTR | <input type="checkbox"/> <input type="checkbox"/> | <input type="checkbox"/> <input type="checkbox"/> <input type="checkbox"/> | 68.0# | |
| | | 12 x 36-1/4" | CRFS8212A | <input type="checkbox"/> | PSTR | <input type="checkbox"/> <input type="checkbox"/> | <input type="checkbox"/> <input type="checkbox"/> <input type="checkbox"/> | 81.0# | |
| | | 16 x 36-1/4" | CRFS8216A | <input type="checkbox"/> | PSTR | <input type="checkbox"/> <input type="checkbox"/> | <input type="checkbox"/> <input type="checkbox"/> <input type="checkbox"/> | 99.0# | |
| | | | | | | | | | |
| CRF | | | | | | | | | |
|  | Shelving Starter Unit-Double Face • Straight base only • Straight or curved end panel • With or without back panel • 12 adjustable and 2 fixed shelves | 16 x 37-1/2" | CRFD8216S | <input type="checkbox"/> | <input type="checkbox"/> <input type="checkbox"/> <input type="checkbox"/> <input type="checkbox"/> | <input type="checkbox"/> <input type="checkbox"/> | <input type="checkbox"/> <input type="checkbox"/> <input type="checkbox"/> | 127.0# | |
| | | 20 x 37-1/2" | CRFD8220S | <input type="checkbox"/> | <input type="checkbox"/> <input type="checkbox"/> <input type="checkbox"/> <input type="checkbox"/> | <input type="checkbox"/> <input type="checkbox"/> | <input type="checkbox"/> <input type="checkbox"/> <input type="checkbox"/> | 170.0# | |
| | | 24 x 37-1/2" | CRFD8224S | <input type="checkbox"/> | <input type="checkbox"/> <input type="checkbox"/> <input type="checkbox"/> <input type="checkbox"/> | <input type="checkbox"/> <input type="checkbox"/> | <input type="checkbox"/> <input type="checkbox"/> <input type="checkbox"/> | 198.0# | |
| | | | | | | | | | |
| | | | | | | | | | |
| CRF | | | | | | | | | |
|  | Shelving Adder Unit-Double Face • Straight end panel only • With or without back panel • 12 adjustable and 2 fixed shelves | 16 x 36-1/4" | CRFD8216A | <input type="checkbox"/> | PSTR | <input type="checkbox"/> <input type="checkbox"/> | <input type="checkbox"/> <input type="checkbox"/> <input type="checkbox"/> | 99.0# | |
| | | 20 x 36-1/4" | CRFD8220A | <input type="checkbox"/> | PSTR | <input type="checkbox"/> <input type="checkbox"/> | <input type="checkbox"/> <input type="checkbox"/> <input type="checkbox"/> | 135.0# | |
| | | 24 x 36-1/4" | CRFD8224A | <input type="checkbox"/> | PSTR | <input type="checkbox"/> <input type="checkbox"/> | <input type="checkbox"/> <input type="checkbox"/> <input type="checkbox"/> | 155.0# | |
| | | | | | | | | | |
| | | | | | | | | | |
| CRF | | | | | | | | | |
| | | | A | B | C | D | E | | |

HOW TO ORDER

Indicate the following information on order form:

- Quantity of each item.
- Model number, including options. See "How To Build a Model Number".
- Any special service required.

Note: • The indicates that a choice is required.

- The absence of the indicates that no choice is required.
- Alpha-numeric characters in place of indicate that no other alternatives are available.

HOW TO BUILD A MODEL NUMBER

- A** Select basic model.
- B** Select wood type.
 - Oak
 - Maple
- C** Select end panel.
 - Curved panel
 - Straight panel
- D** Select back panel.
 - Back panel; add \$200
 - No back panel
- E** Select wood finish.
 Refer to color addendum at ki.com or KI Fabrics & Finishes binder.
 Stained finish colors; add \$75.

INFORMATION

Back Panel Weights

When ordering shelving with back panels add the following weights:

- 42" high add 15#
- 54" high add 18#
- 60" high add 20#
- 72" high add 24#
- 82" high add 27#
- 96" high add 35#

FINISH INFORMATION

Additional Stains

Specially stained edges beyond the KI standard offering (as shown under the Edge Color column in color addendum) are also available. Contact KI.



CrossRoads® Shelving

82" High Shelving

| Oak | Maple |
|---------|---------|
| \$ 1266 | \$ 1346 |
| 1347 | 1436 |
| 1445 | 1536 |
| 2051 | 2215 |

| | |
|---------|---------|
| \$ 1017 | \$ 1080 |
| 1082 | 1151 |
| 1142 | 1218 |
| 1585 | 1848 |

| | |
|---------|---------|
| \$ 2132 | \$ 2278 |
| 2303 | 2465 |
| 2483 | 2660 |

| | |
|---------|---------|
| \$ 1769 | \$ 1889 |
| 1882 | 2012 |
| 2032 | 2171 |

SPECIAL SERVICES

Special Carton Marking

With specially marked information N/C

Shipping

Shipped **k.d. freight prepaid f.o.b. factory of origin** factory.
Freight class #125.

Specifications and prices are subject to change without prior notice.

CrossRoads® Shelving

96" High Shelving

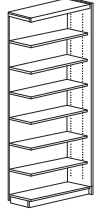
| | MODEL | D x W | MODEL NUMBER | | | | | Approx. Packaged Weight | |
|--|---|--------------|--------------|--------------------------|---|---|--|-------------------------|--|
| | | | Basic Model | Wood Type | End Panel | Back Panel | Wood Finish | | |
|  <p>CRF</p> | Shelving Starter Unit-Single Face • Straight base only • Straight or curved end panel • With or without back panel • 6 adjustable and 1 fixed shelf • Recommended for use against wall only | 12 x 37-1/2" | CRFS9612S | <input type="checkbox"/> | <input type="checkbox"/> <input type="checkbox"/> <input type="checkbox"/> <input type="checkbox"/> | <input type="checkbox"/> <input type="checkbox"/> | <input type="checkbox"/> <input type="checkbox"/> <input type="checkbox"/> | 124.0# | |
| | | | | | | | | | |
| | | | | | | | | | |
| | | | | | | | | | |
| | | | | | | | | | |
|  <p>CRF</p> | Shelving Adder Unit-Single Face • Straight end panel only • With or without back panel • 6 adjustable and 1 fixed shelf • Recommended for use against wall only | 12 x 36-1/4" | CRFS9612A | <input type="checkbox"/> | PSTR | <input type="checkbox"/> <input type="checkbox"/> | <input type="checkbox"/> <input type="checkbox"/> <input type="checkbox"/> | 96.0# | |
| | | | | | | | | | |
| | | | | | | | | | |
| | | | | | | | | | |
| | | | | | | | | | |

A **B** **C** **D** **E**

HOW TO ORDER

Indicate the following information on order form:

- Quantity of each item.
- Model number, including options. See "How To Build a Model Number".
- Any special service required.

Note: • The indicates that a choice is required.

- The absence of the indicates that no choice is required.
- Alpha-numeric characters in place of indicate that no other alternatives are available.

HOW TO BUILD A MODEL NUMBER

- A** Select basic model.
- B** Select wood type.

| | |
|----------|---------|
| O | - Oak |
| M | - Maple |
- C** Select end panel.

| | |
|-------------|------------------|
| PCRV | - Curved panel |
| PSTR | - Straight panel |
- D** Select back panel.

| | |
|-----------|-------------------------|
| BP | - Back panel; add \$217 |
| NP | - No back panel |
- E** Select wood finish.
 Refer to color addendum at ki.com or KI Fabrics & Finishes binder.
 Stained finish colors; add \$75.

INFORMATION

Back Panel Weights
 When ordering shelving with back panels add the following weights:
 42" high add 15#
 54" high add 18#
 60" high add 20#
 72" high add 24#
 82" high add 27#
 96" high add 35#

FINISH INFORMATION

Additional Stains
 Specially stained edges beyond the KI standard offering (as shown under the Edge Color column in color addendum) are also available. Contact KI.



CrossRoads[®] Shelving

96" High Shelving

| | |
|---------|---------|
| Oak | Maple |
| \$ 1627 | \$ 1733 |

| | |
|---------|---------|
| \$ 1248 | \$ 1332 |
|---------|---------|

SPECIAL SERVICES

Special Carton Marking

With specially marked information N/C

Shipping

Shipped **k. d. freight prepaid f. o. b. factory of origin** factory.
Freight class #125.

Specifications and prices are subject to change without prior notice.

CrossRoads® Shelving

96" High Shelving

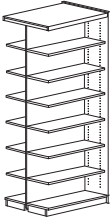
| MODEL | D x W | MODEL NUMBER | | | | | Approx. Packaged Weight |
|---|--------------|--------------|--------------------------|---|---|--|-------------------------|
| | | Basic Model | Wood Type | End Panel | Back Panel | Wood Finish | |
|  <p>Shelving Starter Unit-Double Face</p> <ul style="list-style-type: none"> • Straight base only • Straight or curved end panel • With or without back panel • 12 adjustable and 2 fixed shelves | 24 x 37-1/2" | CRFD9624S | <input type="checkbox"/> | <input type="checkbox"/> <input type="checkbox"/> <input type="checkbox"/> <input type="checkbox"/> | <input type="checkbox"/> <input type="checkbox"/> | <input type="checkbox"/> <input type="checkbox"/> <input type="checkbox"/> | 244.0# |
| | | | | | | | |
| | | | | | | | |
| | | | | | | | |
| | | | | | | | |
| CRF | | | | | | | |
|  <p>Shelving Adder Unit-Double Face</p> <ul style="list-style-type: none"> • Straight end panel only • With or without back panel • 12 adjustable and 2 fixed shelves | 24 x 36-1/4" | CRFD9624A | <input type="checkbox"/> | PSTR | <input type="checkbox"/> <input type="checkbox"/> | <input type="checkbox"/> <input type="checkbox"/> <input type="checkbox"/> | 185.0# |
| | | | | | | | |
| | | | | | | | |
| | | | | | | | |
| | | | | | | | |
| CRF | | | | | | | |

A **B** **C** **D** **E**

HOW TO ORDER

Indicate the following information on order form:

1. Quantity of each item.
2. Model number, including options. See "How To Build a Model Number".
3. Any special service required.

Note: • The indicates that a choice is required.

- The absence of the indicates that no choice is required.
- Alpha-numeric characters in place of indicate that no other alternatives are available.

HOW TO BUILD A MODEL NUMBER

- A** Select basic model.
- B** Select wood type.

| | |
|----------|---------|
| O | - Oak |
| M | - Maple |
- C** Select end panel.

| | |
|-------------|------------------|
| PCRV | - Curved panel |
| PSTR | - Straight panel |
- D** Select back panel.

| | |
|-----------|-------------------------|
| BP | - Back panel; add \$217 |
| NP | - No back panel |
- E** Select wood finish.
Refer to color addendum at ki.com or KI Fabrics & Finishes binder.
Stained finish colors; add \$75.

INFORMATION

Back Panel Weights
When ordering shelving with back panels add the following weights:
42" high add 15#
54" high add 18#
60" high add 20#
72" high add 24#
82" high add 27#
96" high add 35#

FINISH INFORMATION

Additional Stains
Specially stained edges beyond the KI standard offering (as shown under the Edge Color column in color addendum) are also available. Contact KI.



CrossRoads® Shelving

96" High Shelving

| | |
|---------|---------|
| Oak | Maple |
| \$ 2860 | \$ 3067 |

| | |
|--|--|
| | |
| | |
| | |
| | |
| | |
| | |
| | |
| | |
| | |
| | |

| | |
|---------|---------|
| \$ 2241 | \$ 2402 |
| | |
| | |
| | |
| | |
| | |
| | |
| | |
| | |
| | |

SPECIAL SERVICES

Special Carton Marking

With specially marked information N/C



Shipping

Shipped **k.d. freight prepaid f.o.b. factory of origin** factory.
Freight class #125.

Specifications and prices are subject to change without prior notice.

CrossRoads Metal Shelving

42" Metal Shelving

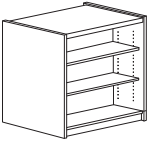
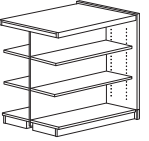
| | MODEL | D x W | MODEL NUMBER | | | | | | | Approx. Packaged Weight |
|--|--|--------------|--------------|--------------------------|--------------------------|--------------------------|--------------------------|--------------------------|-------------|-------------------------|
| | | | Basic Model | Wood Type | Back Panel | Shelf Type | End Panel | Wood Finish | Paint Color | |
|  | Metal Shelving Starter Unit-Single Face <ul style="list-style-type: none"> • Straight base only • Straight or curved end panel • With or without back panel • 2 adjustable wood bottom base shelves • Recommended for use against wall only | 12 x 37-1/2" | CRSSS4212S | <input type="checkbox"/> | <input type="checkbox"/> | <input type="checkbox"/> | <input type="checkbox"/> | <input type="checkbox"/> | SA | 57.0# |
| CRSS | | | | | | | | | | |
|  | Metal Shelving Adder Unit-Single Face <ul style="list-style-type: none"> • Straight end panel only • With or without back panel • 2 adjustable wood bottom base shelves • Recommended for use against wall only | 12 x 36-1/4" | CRSSS4212A | <input type="checkbox"/> | <input type="checkbox"/> | <input type="checkbox"/> | PSTR | <input type="checkbox"/> | SA | 47.0# |
| CRSS | | | | | | | | | | |
|  | Metal Shelving Starter Unit-Double Face <ul style="list-style-type: none"> • Straight base only • Straight or curved end panel • With or without back panel • 4 adjustable wood bottom base shelves | 24 x 37-1/2" | CRSSD4224S | <input type="checkbox"/> | <input type="checkbox"/> | <input type="checkbox"/> | <input type="checkbox"/> | <input type="checkbox"/> | SA | 117.0# |
| CRSS | | | | | | | | | | |
|  | Metal Shelving Adder Unit-Double Face <ul style="list-style-type: none"> • Straight end panel only • With or without back panel • 4 adjustable wood bottom base shelves | 24 x 36-1/4" | CRSSD4224A | <input type="checkbox"/> | <input type="checkbox"/> | <input type="checkbox"/> | PSTR | <input type="checkbox"/> | SA | 95.0# |
| CRSS | | | | | | | | | | |
| | | | | A | B | C | D | E | F | G |

HOW TO ORDER

Indicate the following information on order form:

- Quantity of each item.
- Model number, including options. See "How To Build a Model Number".
- Any special service required.

Note: • The indicates that a choice is required.

- The absence of the indicates that no choice is required.
- Alpha-numeric characters in place of indicate that no other alternatives are available.

HOW TO BUILD A MODEL NUMBER

A Select basic model.

B Select wood type.

- O** - Oak
M - Maple

C Select back panel.

- BP** - Back panel; add \$127
NP - No back panel

D Select shelf type.

- B** - Book stop shelf
F - Flat shelf

Book stop shelf is NOT available with Back panel.
 See pricing column for book stop shelf upcharge.

E Select end panel

- PCR** - Curved panel
PSTR - Straight panel

F Select wood finish.

Refer to color addendum at ki.com or KI Fabrics & Finishes binder.
 Stained finish colors; add \$44.

G Select shelf paint color.

SA - Sand
 Refer to color addendum at ki.com or KI Fabrics & Finishes binder.

INFORMATION

Back Panel Weights

When ordering shelving with back panels add the following weights:

- 42" high add 15#
 54" high add 18#
 60" high add 20#
 72" high add 24#
 82" high add 27#



CrossRoads Metal Shelving

42" Metal Shelving

| Oak | Maple | Book Stop Shelf add to list price |
|---------|---------|-----------------------------------|
| \$ 882 | \$ 929 | \$ 22 |
| \$ 710 | \$ 751 | \$ 22 |
| \$ 1411 | \$ 1505 | \$ 43 |
| \$ 1172 | \$ 1245 | \$ 43 |

FINISH INFORMATION

Additional Stains

Specially stained edges beyond the KI standard offering (as shown under the Edge Color column in color addendum) are also available. Contact KI.

SPECIAL SERVICES

Special Carton Marking

With specially marked information N/C



Shipping

Shipped **k.d. freight prepaid f.o.b. factory of origin** factory.
Freight class #125.

Specifications and prices are subject to change without prior notice.

CrossRoads Metal Shelving

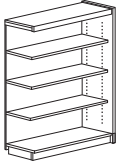
54" Metal Shelving

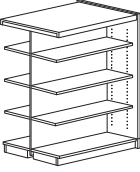
| MODEL | D x W | MODEL NUMBER | | | | | | | | Approx. Packaged Weight |
|--|--------------|--------------|--------------------------|--------------------------|--------------------------|--------------------------|--------------------------|-------------|--------|-------------------------|
| | | Basic Model | Wood Type | Back Panel | Shelf Type | End Panel | Wood Finish | Paint Color | | |
|  <p>Metal Shelving Starter Unit-Single Face</p> <ul style="list-style-type: none"> • Straight base only • Straight or curved end panel • With or without back panel • 3 adjustable wood bottom base shelves • Recommended for use against wall only | 12 x 37-1/2" | CRSSS5412S | <input type="checkbox"/> | <input type="checkbox"/> | <input type="checkbox"/> | <input type="checkbox"/> | <input type="checkbox"/> | SA | 69.0# | |
| CRSS | | | | | | | | | | |
|  <p>Metal Shelving Adder Unit-Single Face</p> <ul style="list-style-type: none"> • Straight end panel only • With or without back panel • 3 adjustable wood bottom base shelves • Recommended for use against wall only | 12 x 36-1/4" | CRSSS5412A | <input type="checkbox"/> | <input type="checkbox"/> | <input type="checkbox"/> | PSTR | <input type="checkbox"/> | SA | 55.0# | |
| CRSS | | | | | | | | | | |
|  <p>Metal Shelving Starter Unit-Double Face</p> <ul style="list-style-type: none"> • Straight base only • Straight or curved end panel • With or without back panel • 6 adjustable wood bottom base shelves | 24 x 37-1/2" | CRSSD5424S | <input type="checkbox"/> | <input type="checkbox"/> | <input type="checkbox"/> | <input type="checkbox"/> | <input type="checkbox"/> | SA | 135.0# | |
| CRSS | | | | | | | | | | |
|  <p>Metal Shelving Adder Unit-Double Face</p> <ul style="list-style-type: none"> • Straight end panel only • With or without back panel • 6 adjustable wood bottom base shelves | 24 x 36-1/4" | CRSSD5424A | <input type="checkbox"/> | <input type="checkbox"/> | <input type="checkbox"/> | PSTR | <input type="checkbox"/> | SA | 107.0# | |
| CRSS | | | | | | | | | | |

A B C D E F G

HOW TO ORDER

Indicate the following information on order form:

- Quantity of each item.
- Model number, including options. See "How To Build a Model Number".
- Any special service required.

Note: • The indicates that a choice is required.

- The absence of the indicates that no choice is required.
- Alpha-numeric characters in place of indicate that no other alternatives are available.

HOW TO BUILD A MODEL NUMBER

- A** Select basic model.

- B** Select wood type.
 - Oak
 - Maple
- C** Select back panel.
 BP - Back panel; add \$144
 NP - No back panel
- D** Select shelf type.
 B - Book stop shelf
 F - Flat shelf
 Book stop shelf is NOT available with Back panel.
 See pricing column for book stop shelf upcharge.
- E** Select end panel
 PCRV - Curved panel
 PSTR - Straight panel
- F** Select wood finish.

Refer to color addendum at ki.com or KI Fabrics & Finishes binder. Stained finish colors; add \$44.

- G** Select shelf paint color.
 SA - Sand
 Refer to color addendum at ki.com or KI Fabrics & Finishes binder.

INFORMATION

Back Panel Weights

When ordering shelving with back panels add the following weights:

- 42" high add 15#
- 54" high add 18#
- 60" high add 20#
- 72" high add 24#
- 82" high add 27#



CrossRoads Metal Shelving

54" Metal Shelving

| Oak | Maple | Book Stop Shelf add to list price |
|---------|---------|-----------------------------------|
| \$ 1028 | \$ 1089 | \$ 33 |
| \$ 822 | \$ 872 | \$ 33 |
| \$ 1685 | \$ 1798 | \$ 65 |
| \$ 1389 | \$ 1483 | \$ 65 |

FINISH INFORMATION

Additional Stains

Specially stained edges beyond the KI standard offering (as shown under the Edge Color column in color addendum) are also available. Contact KI.

SPECIAL SERVICES

Special Carton Marking

With specially marked information N/C



Shipping

Shipped **k.d. freight prepaid f.o.b. factory of origin** factory.
Freight class #125.

Specifications and prices are subject to change without prior notice.

CrossRoads Metal Shelving

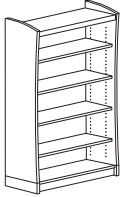
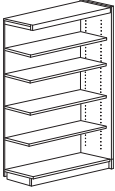
60" Metal Shelving

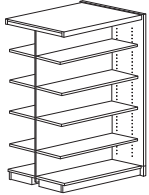
| MODEL | D x W | MODEL NUMBER | | | | | | | | Approx. Packaged Weight |
|--|--------------|--------------|--------------------------|--------------------------|--------------------------|--------------------------|--------------------------|-------------|--------|-------------------------|
| | | Basic Model | Wood Type | Back Panel | Shelf Type | End Panel | Wood Finish | Paint Color | | |
|  <p>Metal Shelving Starter Unit-Single Face</p> <ul style="list-style-type: none"> • Straight base only • Straight or curved end panel • With or without back panel • 4 adjustable wood bottom base shelves • Recommended for use against wall only | 12 x 37-1/2" | CRSS6012S | <input type="checkbox"/> | <input type="checkbox"/> | <input type="checkbox"/> | <input type="checkbox"/> | <input type="checkbox"/> | SA | 81.0# | |
| CRSS | | | | | | | | | | |
|  <p>Metal Shelving Adder Unit-Single Face</p> <ul style="list-style-type: none"> • Straight end panel only • With or without back panel • 4 adjustable wood bottom base shelves • Recommended for use against wall only | 12 x 36-1/4" | CRSS6012A | <input type="checkbox"/> | <input type="checkbox"/> | <input type="checkbox"/> | PSTR | <input type="checkbox"/> | SA | 63.0# | |
| CRSS | | | | | | | | | | |
|  <p>Metal Shelving Starter Unit-Double Face</p> <ul style="list-style-type: none"> • Straight base only • Straight or curved end panel • With or without back panel • 8 adjustable wood bottom base shelves | 24 x 37-1/2" | CRSSD6024S | <input type="checkbox"/> | <input type="checkbox"/> | <input type="checkbox"/> | <input type="checkbox"/> | <input type="checkbox"/> | SA | 154.0# | |
| CRSS | | | | | | | | | | |
|  <p>Metal Shelving Adder Unit-Double Face</p> <ul style="list-style-type: none"> • Straight end panel only • With or without back panel • 8 adjustable wood bottom base shelves | 24 x 36-1/4" | CRSSD6024A | <input type="checkbox"/> | <input type="checkbox"/> | <input type="checkbox"/> | PSTR | <input type="checkbox"/> | SA | 123.0# | |
| CRSS | | | | | | | | | | |

A B C D E F G

HOW TO ORDER

Indicate the following information on order form:

- Quantity of each item.
- Model number, including options. See "How To Build a Model Number".
- Any special service required.

Note: • The indicates that a choice is required.

- The absence of the indicates that no choice is required.
- Alpha-numeric characters in place of indicate that no other alternatives are available.

HOW TO BUILD A MODEL NUMBER

- A** Select basic model.

- B** Select wood type.
 - Oak
 - Maple

- C** Select back panel.
 BP - Back panel; add \$153
 NP - No back panel

- D** Select shelf type.
 B - Book stop shelf
 F - Flat shelf
 Book stop shelf is NOT available with Back panel.
 See pricing column for book stop shelf upcharge.

- E** Select end panel
 PCR - Curved panel
 PSTR - Straight panel

- F** Select wood finish.

Refer to color addendum at ki.com or KI Fabrics & Finishes binder. Stained finish colors ; add \$57.

- G** Select shelf paint color.
 SA - Sand
 Refer to color addendum at ki.com or KI Fabrics & Finishes binder.

INFORMATION

Back Panel Weights
 When ordering shelving with back panels add the following weights:
 42" high add 15#
 54" high add 18#
 60" high add 20#
 72" high add 24#
 82" high add 27#



CrossRoads Metal Shelving

60" Metal Shelving

| Oak | Maple | Book Stop Shelf add to list price |
|---------|---------|-----------------------------------|
| \$ 1077 | \$ 1143 | \$ 43 |
| \$ 859 | \$ 914 | \$ 43 |
| \$ 1777 | \$ 1898 | \$ 87 |
| \$ 1465 | \$ 1560 | \$ 87 |

FINISH INFORMATION

Additional Stains

Specially stained edges beyond the KI standard offering (as shown under the Edge Color column in color addendum) are also available. Contact KI.

SPECIAL SERVICES

Special Carton Marking

With specially marked information N/C



Shipping

Shipped **k.d. freight prepaid f.o.b. factory of origin** factory.
Freight class #125.

Specifications and prices are subject to change without prior notice.

CrossRoads Metal Shelving

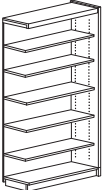
72" Metal Shelving

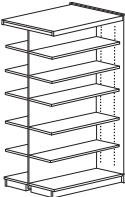
| MODEL | D x W | MODEL NUMBER | | | | | | | | Approx. Packaged Weight |
|--|--------------|--------------|--------------------------|--------------------------|--------------------------|--------------------------|--------------------------|-------------|--------|-------------------------|
| | | Basic Model | Wood Type | Back Panel | Shelf Type | End Panel | Wood Finish | Paint Color | | |
|  <p>Metal Shelving Starter Unit-Single Face</p> <ul style="list-style-type: none"> • Straight base only • Straight or curved end panel • With or without back panel • 5 adjustable wood bottom base shelves • Recommended for use against wall only | 12 x 37-1/2" | CRSSS7212S | <input type="checkbox"/> | <input type="checkbox"/> | <input type="checkbox"/> | <input type="checkbox"/> | <input type="checkbox"/> | SA | 91.0# | |
| CRSS | | | | | | | | | | |
|  <p>Metal Shelving Adder Unit-Single Face</p> <ul style="list-style-type: none"> • Straight end panel only • With or without back panel • 5 adjustable wood bottom base shelves • Recommended for use against wall only | 12 x 36-1/4" | CRSSS7212A | <input type="checkbox"/> | <input type="checkbox"/> | <input type="checkbox"/> | PSTR | <input type="checkbox"/> | SA | 72.0# | |
| CRSS | | | | | | | | | | |
|  <p>Metal Shelving Starter Unit-Double Face</p> <ul style="list-style-type: none"> • Straight base only • Straight or curved end panel • With or without back panel • 10 adjustable wood bottom base shelves | 24 x 37-1/2" | CRSSD7224S | <input type="checkbox"/> | <input type="checkbox"/> | <input type="checkbox"/> | <input type="checkbox"/> | <input type="checkbox"/> | SA | 200.0# | |
| CRSS | | | | | | | | | | |
|  <p>Metal Shelving Adder Unit-Double Face</p> <ul style="list-style-type: none"> • Straight end panel only • With or without back panel • 10 adjustable wood bottom base shelves | 24 x 36-1/4" | CRSSD7224A | <input type="checkbox"/> | <input type="checkbox"/> | <input type="checkbox"/> | PSTR | <input type="checkbox"/> | SA | 139.0# | |
| CRSS | | | | | | | | | | |

A B C D E F G

HOW TO ORDER

Indicate the following information on order form:

- Quantity of each item.
- Model number, including options. See "How To Build a Model Number".
- Any special service required.

Note: • The indicates that a choice is required.

- The absence of the indicates that no choice is required.
- Alpha-numeric characters in place of indicate that no other alternatives are available.

HOW TO BUILD A MODEL NUMBER

- A** Select basic model.

- B** Select wood type.
 - Oak
 - Maple

- C** Select back panel.
 - Back panel; add \$179
 - No back panel

- D** Select shelf type.
 - Book stop shelf
 - Flat shelf
 Book stop shelf is NOT available with Back panel.
 See pricing column for book stop shelf upcharge.

- E** Select end panel
 - Curved panel
 - Straight panel

- F** Select wood finish.

Refer to color addendum at ki.com or KI Fabrics & Finishes binder. Stained finish colors; add \$57.

- G** Select shelf paint color.
 - Sand
 Refer to color addendum at ki.com or KI Fabrics & Finishes binder.

INFORMATION

Back Panel Weights

When ordering shelving with back panels add the following weights:

- 42" high add 15#
- 54" high add 18#
- 60" high add 20#
- 72" high add 24#
- 82" high add 27#



CrossRoads Metal Shelving

72" Metal Shelving

| Oak | Maple | Book Stop Shelf add to list price |
|---------|---------|-----------------------------------|
| \$ 1244 | \$ 1320 | \$ 55 |
| \$ 987 | \$ 1050 | \$ 55 |
| \$ 2120 | \$ 2272 | \$ 108 |
| \$ 1739 | \$ 1857 | \$ 108 |

FINISH INFORMATION

Additional Stains

Specially stained edges beyond the KI standard offering (as shown under the Edge Color column in color addendum) are also available. Contact KI.

SPECIAL SERVICES

Special Carton Marking

With specially marked information N/C

Shipping

Shipped **k.d. freight prepaid f.o.b. factory of origin** factory.
Freight class #125.

Specifications and prices are subject to change without prior notice.

CrossRoads Metal Shelving

82" Metal Shelving

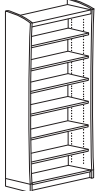
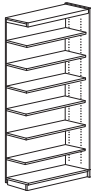
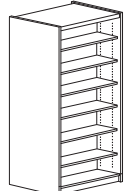
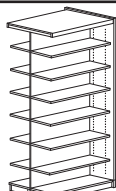
| MODEL | D x W | MODEL NUMBER | | | | | | | | Approx. Packaged Weight |
|--|--------------|--------------|--------------------------|--------------------------|--------------------------|--------------------------|--------------------------|--------------------------|----|-------------------------|
| | | Basic Model | Wood Type | Back Panel | Shelf Type | End Panel | Wood Finish | Paint Color | | |
|  <p>Metal Shelving Starter Unit-Single Face</p> <ul style="list-style-type: none"> • Straight base only • Straight or curved end panel • With or without back panel • 6 adjustable wood bottom base shelves • Recommended for use against wall only | 12 x 37-1/2" | CRSSS8212S | <input type="checkbox"/> | <input type="checkbox"/> | <input type="checkbox"/> | <input type="checkbox"/> | <input type="checkbox"/> | <input type="checkbox"/> | SA | 101.0# |
| CRSS | | | | | | | | | | |
|  <p>Metal Shelving Adder Unit-Single Face</p> <ul style="list-style-type: none"> • Straight end panel only • With or without back panel • 6 adjustable wood bottom base shelves • Recommended for use against wall only | 12 x 36-1/4" | CRSSS8212A | <input type="checkbox"/> | <input type="checkbox"/> | <input type="checkbox"/> | PSTR | <input type="checkbox"/> | <input type="checkbox"/> | SA | 81.0# |
| CRSS | | | | | | | | | | |
|  <p>Metal Shelving Starter Unit-Double Face</p> <ul style="list-style-type: none"> • Straight base only • Straight or curved end panel • With or without back panel • 12 adjustable wood bottom base shelves | 24 x 37-1/2" | CRSSD8224S | <input type="checkbox"/> | <input type="checkbox"/> | <input type="checkbox"/> | <input type="checkbox"/> | <input type="checkbox"/> | <input type="checkbox"/> | SA | 198.0# |
| CRSS | | | | | | | | | | |
|  <p>Metal Shelving Adder Unit-Double Face</p> <ul style="list-style-type: none"> • Straight end panel only • With or without back panel • 12 adjustable wood bottom base shelves | 24 x 36-1/4" | CRSSD8224A | <input type="checkbox"/> | <input type="checkbox"/> | <input type="checkbox"/> | PSTR | <input type="checkbox"/> | <input type="checkbox"/> | SA | 155.0# |
| CRSS | | | | | | | | | | |

A B C D E F G

HOW TO ORDER

Indicate the following information on order form:

- Quantity of each item.
- Model number, including options. See "How To Build a Model Number".
- Any special service required.

Note: • The indicates that a choice is required.

- The absence of the indicates that no choice is required.
- Alpha-numeric characters in place of indicate that no other alternatives are available.

HOW TO BUILD A MODEL NUMBER

- A** Select basic model.

- B** Select wood type.
 - Oak
 - Maple
- C** Select back panel.
 BP - Back panel; add \$200
 NP - No back panel
- D** Select shelf type.
 B - Book stop shelf
 F - Flat shelf
 Book stop shelf is NOT available with Back panel.
 See pricing column for book stop shelf upcharge.
- E** Select end panel.
 PCR - Curved panel
 PSTR - Straight panel
- F** Select wood finish.

Refer to color addendum at ki.com or KI Fabrics & Finishes binder. Stained finish colors; add \$61.

- G** Select shelf paint color.
 SA - Sand
 Refer to color addendum at ki.com or KI Fabrics & Finishes binder.

INFORMATION

Back Panel Weights

When ordering shelving with back panels add the following weights:

- 42" high add 15#
- 54" high add 18#
- 60" high add 20#
- 72" high add 24#
- 82" high add 27#



CrossRoads Metal Shelving

82" Metal Shelving

| | Oak | Maple | Book Stop Shelf add to list price |
|--|---------|---------|-----------------------------------|
| | \$ 1301 | \$ 1383 | \$ 65 |
| | \$ 1028 | \$ 1096 | \$ 65 |
| | \$ 2235 | \$ 2395 | \$ 130 |
| | \$ 1829 | \$ 1954 | \$ 130 |

FINISH INFORMATION

Additional Stains

Specially stained edges beyond the KI standard offering (as shown under the Edge Color column in color addendum) are also available. Contact KI.

SPECIAL SERVICES

Special Carton Marking

With specially marked information N/C

Shipping

Shipped **k.d. freight prepaid f.o.b. factory of origin** factory.
Freight class #125.

Specifications and prices are subject to change without prior notice.

CrossRoads® Periodical Shelving

42" High Periodical Shelving

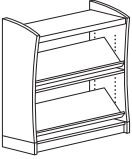
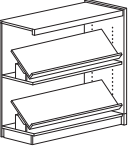
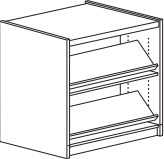
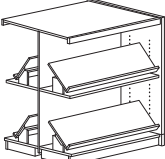
| | MODEL | D x W x H | MODEL NUMBER | | | | Approx. Packaged Weight |
|--|--|-------------------|--------------|--------------------------|---|--|-------------------------|
| | | | Basic Model | Wood Type | End Panel | Wood Finish | |
|  | 42" Periodical Shelving Starter Unit - Single Face • Straight base only with back panel • 2 adjustable pivoted shelves • Curved or straight end panel • Recommended for use against wall only | 12 x 37-1/2 x 42" | CRPERS4212S | <input type="checkbox"/> | <input type="checkbox"/> <input type="checkbox"/> <input type="checkbox"/> <input type="checkbox"/> | <input type="checkbox"/> <input type="checkbox"/> | 92.0# |
| | | 16 x 37-1/2 x 42" | CRPERS4216S | <input type="checkbox"/> | <input type="checkbox"/> <input type="checkbox"/> <input type="checkbox"/> <input type="checkbox"/> | <input type="checkbox"/> <input type="checkbox"/> | 114.0# |
| CRPER | | | | | | | |
|  | 42" Periodical Shelving Adder Unit - Single Face • Straight base only with back panel • 2 adjustable pivoted shelves • Straight end panel only • Recommended for use against wall only | 12 x 36-1/4 x 42" | CRPERS4212A | <input type="checkbox"/> | PSTR | <input type="checkbox"/> <input type="checkbox"/> <input type="checkbox"/> | 82.0# |
| | | 16 x 36-1/4 x 42" | CRPERS4216A | <input type="checkbox"/> | PSTR | <input type="checkbox"/> <input type="checkbox"/> <input type="checkbox"/> | 100.0# |
| CRPER | | | | | | | |
|  | 42" Periodical Shelving Starter Unit - Double Face • Straight base only with back panel • 4 adjustable pivoted shelves • Curved or straight end panel | 24 x 37-1/2 x 42" | CRPERD4224S | <input type="checkbox"/> | <input type="checkbox"/> <input type="checkbox"/> <input type="checkbox"/> <input type="checkbox"/> | <input type="checkbox"/> <input type="checkbox"/> | 152.0# |
| | | | | | | | |
| CRPER | | | | | | | |
|  | 42" Periodical Shelving Adder Unit - Double Face • Straight base only with back panel • 4 adjustable pivoted shelves • Straight end panel only | 24 x 36-1/4 x 42" | CRPERD4224A | <input type="checkbox"/> | PSTR | <input type="checkbox"/> <input type="checkbox"/> <input type="checkbox"/> | 130.0# |
| | | | | | | | |
| CRPER | | | | | | | |

A

B

C

D

HOW TO ORDER

Indicate the following information on order form:

- Quantity of each item.
- Model number, including options. See "How To Build a Model Number".
- Any special service required.

Note: • The indicates that a choice is required.

- The absence of the indicates that no choice is required.
- Alpha-numeric characters in place of indicate that no other alternatives are available.

HOW TO BUILD A MODEL NUMBER

A Select basic model.

B Select wood type.

O - Oak
M - Maple

C Select end panel.

PCR - Curved panel
PSTR - Straight panel

D Select wood finish.

Refer to color addendum at ki.com or KI Fabrics & Finishes binder.
Stained finish colors; add \$76.

FINISH INFORMATION

Additional Stains

Specially stained edges beyond the KI standard offering (as shown under the Edge Color column in color addendum) are also available. Contact KI.



CrossRoads® Periodical Shelving

42" High Periodical Shelving

| Oak | Maple |
|---------|---------|
| \$ 3432 | \$ 3775 |
| 3522 | 3871 |
| | |
| \$ 2926 | \$ 3216 |
| 2979 | 3276 |
| | |
| \$ 5452 | \$ 5997 |
| | |
| \$ 4888 | \$ 5379 |
| | |

SPECIAL SERVICES

Special Carton Marking

With specially marked information N/C



Shipping

Shipped **k.d. freight prepaid f.o.b. factory of origin** factory.
Freight class #125.

Specifications and prices are subject to change without prior notice.

CrossRoads® Periodical Shelving

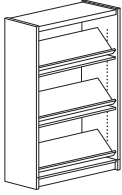
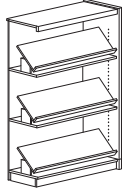
60" High Periodical Shelving

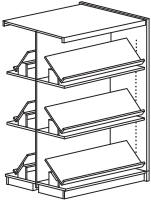
| | MODEL | D x W x H | MODEL NUMBER | | | | Approx. Packaged Weight |
|--|--|-------------------|--------------|--------------------------|---|---|-------------------------|
| | | | Basic Model | Wood Type | End Panel | Wood Finish | |
|  | 60" Periodical Shelving Starter Unit - Single Face • Straight base only with back panel • 3 adjustable pivoted shelves • Curved or straight end panel • Recommended for use against wall only | 12 x 37-1/2 x 60" | CRPERS6012S | <input type="checkbox"/> | <input type="checkbox"/> <input type="checkbox"/> <input type="checkbox"/> <input type="checkbox"/> | <input type="checkbox"/> <input type="checkbox"/> | 121.0# |
| | | 16 x 37-1/2 x 60" | CRPERS6016S | <input type="checkbox"/> | <input type="checkbox"/> <input type="checkbox"/> <input type="checkbox"/> <input type="checkbox"/> | <input type="checkbox"/> <input type="checkbox"/> | 143.0# |
| CRPER | | | | | | | |
|  | 60" Periodical Shelving Adder Unit - Single Face • Straight base only with back panel • 3 adjustable pivoted shelves • Straight end panel only • Recommended for use against wall only | 12 x 36-1/4 x 60" | CRPERS6012A | <input type="checkbox"/> | PSTR | <input type="checkbox"/> <input type="checkbox"/> | 103.0# |
| | | 16 x 36-1/4 x 60" | CRPERS6016A | <input type="checkbox"/> | PSTR | <input type="checkbox"/> <input type="checkbox"/> | 125.0# |
| CRPER | | | | | | | |
|  | 60" Periodical Shelving Starter Unit - Double Face • Straight base only with back panel • 6 adjustable pivoted shelves • Curved or straight end panel | 24 x 37-1/2 x 60" | CRPERD6024S | <input type="checkbox"/> | <input type="checkbox"/> <input type="checkbox"/> <input type="checkbox"/> <input type="checkbox"/> | <input type="checkbox"/> <input type="checkbox"/> | 194.0# |
| | | | | | | | |
| CRPER | | | | | | | |
|  | 60" Periodical Shelving Adder Unit - Double Face • Straight base only with back panel • 6 adjustable pivoted shelves • Straight end panel only | 24 x 36-1/4 x 60" | CRPERD6024A | <input type="checkbox"/> | PSTR | <input type="checkbox"/> <input type="checkbox"/> | 163.0# |
| | | | | | | | |
| CRPER | | | | | | | |

A **B** **C** **D**

HOW TO ORDER

Indicate the following information on order form:

- Quantity of each item.
- Model number, including options. See "How To Build a Model Number".
- Any special service required.

Note: • The indicates that a choice is required.

- The absence of the indicates that no choice is required.
- Alpha-numeric characters in place of indicate that no other alternatives are available.

HOW TO BUILD A MODEL NUMBER

- A** Select basic model.
- B** Select wood type.
- | | |
|----------|---------|
| O | - Oak |
| M | - Maple |
- C** Select end panel.
- | | |
|-------------|------------------|
| PCR | - Curved panel |
| PSTR | - Straight panel |
- D** Select wood finish (for edge & sides). Refer to color addendum at ki.com or KI Fabrics & Finishes binder. Stained finish colors; add \$76.

FINISH INFORMATION

Additional Stains

Specially stained edges beyond the KI standard offering (as shown under the Edge Color column in color addendum) are also available. Contact KI.



CrossRoads® Periodical Shelving

60" High Periodical Shelving



| Oak | Maple |
|---------|---------|
| \$ 4008 | \$ 4408 |
| 4128 | 4539 |

| | |
|---------|---------|
| \$ 3495 | \$ 3845 |
| 3559 | 3913 |

| | |
|---------|---------|
| \$ 6435 | \$ 7076 |
|---------|---------|

| | |
|---------|---------|
| \$ 5821 | \$ 6404 |
|---------|---------|

SPECIAL SERVICES

Special Carton Marking

With specially marked information N/C



Shipping

Shipped **k.d. freight prepaid f.o.b. factory of origin** factory.
Freight class #125.

Specifications and prices are subject to change without prior notice.

CrossRoads® Periodical Shelving

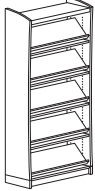
82" High Periodical Shelving

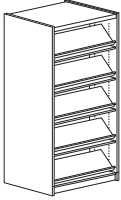
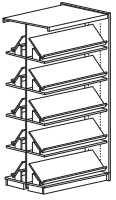
| | MODEL | D x W x H | MODEL NUMBER | | | | Approx. Packaged Weight |
|---|--|-------------------|--------------|--------------------------|---|---|-------------------------|
| | | | Basic Model | Wood Type | End Panel | Wood Finish | |
|  | 82" Periodical Shelving Starter Unit - Single Face • Straight base only with back panel • 5 adjustable pivoted shelves • Curved or straight end panel • Recommended for use against wall only | 12 x 37-1/2 x 82" | CRPERS8212S | <input type="checkbox"/> | <input type="checkbox"/> <input type="checkbox"/> <input type="checkbox"/> <input type="checkbox"/> | <input type="checkbox"/> <input type="checkbox"/> | 148.0# |
| | | 16 x 37-1/2 x 82" | CRPERS8216S | <input type="checkbox"/> | <input type="checkbox"/> <input type="checkbox"/> <input type="checkbox"/> <input type="checkbox"/> | <input type="checkbox"/> <input type="checkbox"/> | 174.0# |
| CRPER | | | | | | | |
|  | 82" Periodical Shelving Adder Unit - Single Face • Straight base only with back panel • 5 adjustable pivoted shelves • Straight end panel only • Recommended for use against wall only | 12 x 36-1/4 x 82" | CRPERS8212A | <input type="checkbox"/> | PSTR | <input type="checkbox"/> <input type="checkbox"/> | 128.0# |
| | | 16 x 36-1/4 x 82" | CRPERS8216A | <input type="checkbox"/> | PSTR | <input type="checkbox"/> <input type="checkbox"/> | 146.0# |
| CRPER | | | | | | | |
|  | 82" Periodical Shelving Starter Unit - Double Face • Straight base only with back panel • 10 adjustable pivoted shelves • Curved or straight end panel | 24 x 37-1/2 x 82" | CRPERD8224S | <input type="checkbox"/> | <input type="checkbox"/> <input type="checkbox"/> <input type="checkbox"/> <input type="checkbox"/> | <input type="checkbox"/> <input type="checkbox"/> | 245.0# |
| | | | | | | | |
| CRPER | | | | | | | |
|  | 82" Periodical Shelving Adder Unit - Double Face • Straight base only with back panel • 10 adjustable pivoted shelves • Straight end panel only | 24 x 36-1/4 x 82" | CRPERD8224A | <input type="checkbox"/> | PSTR | <input type="checkbox"/> <input type="checkbox"/> | 202.0# |
| | | | | | | | |
| CRPER | | | | | | | |

A

B

C

D

HOW TO ORDER

Indicate the following information on order form:

- Quantity of each item.
- Model number, including options. See "How To Build a Model Number".
- Any special service required.

Note: • The indicates that a choice is required.

- The absence of the indicates that no choice is required.
- Alpha-numeric characters in place of indicate that no other alternatives are available.

HOW TO BUILD A MODEL NUMBER

A Select basic model.

B Select wood type.

O - Oak
M - Maple

C Select end panel.

PCR - Curved panel
PSTR - Straight panel

D Stained finish colors; add \$76.

Refer to color addendum at ki.com or KI Fabrics & Finishes binder.

FINISH INFORMATION

Additional Stains

Specially stained edges beyond the KI standard offering (as shown under the Edge Color column in color addendum) are also available. Contact KI.



CrossRoads® Periodical Shelving

82" High Periodical Shelving



| Oak | Maple |
|---------|---------|
| \$ 5619 | \$ 6179 |
| 5709 | 6279 |

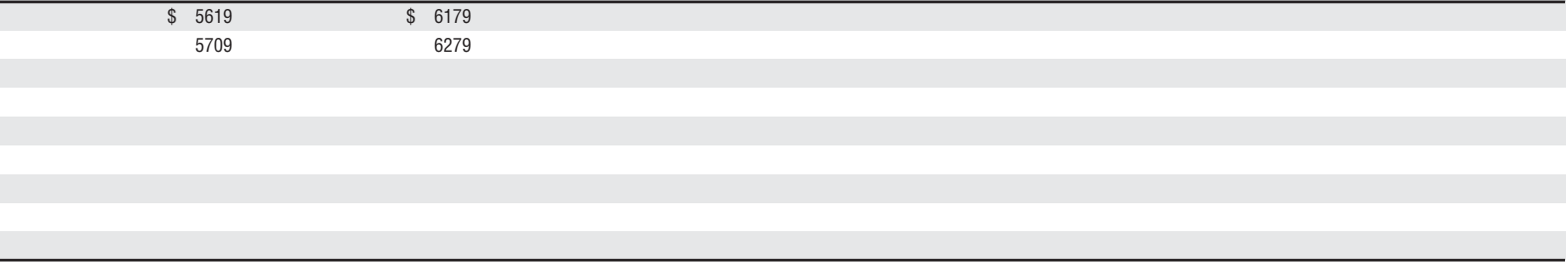

| | |
|---------|---------|
| \$ 5024 | \$ 5526 |
| 5111 | 5619 |

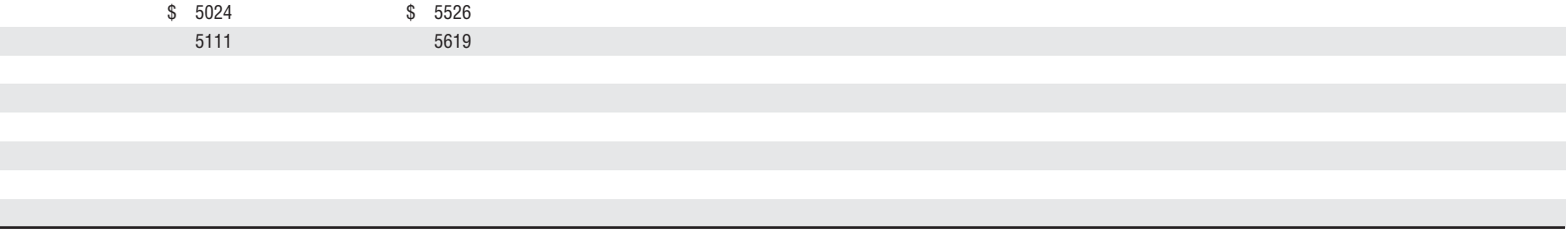

| | |
|---------|---------|
| \$ 6872 | \$ 7563 |
|---------|---------|



| | |
|---------|---------|
| \$ 6285 | \$ 6911 |
|---------|---------|

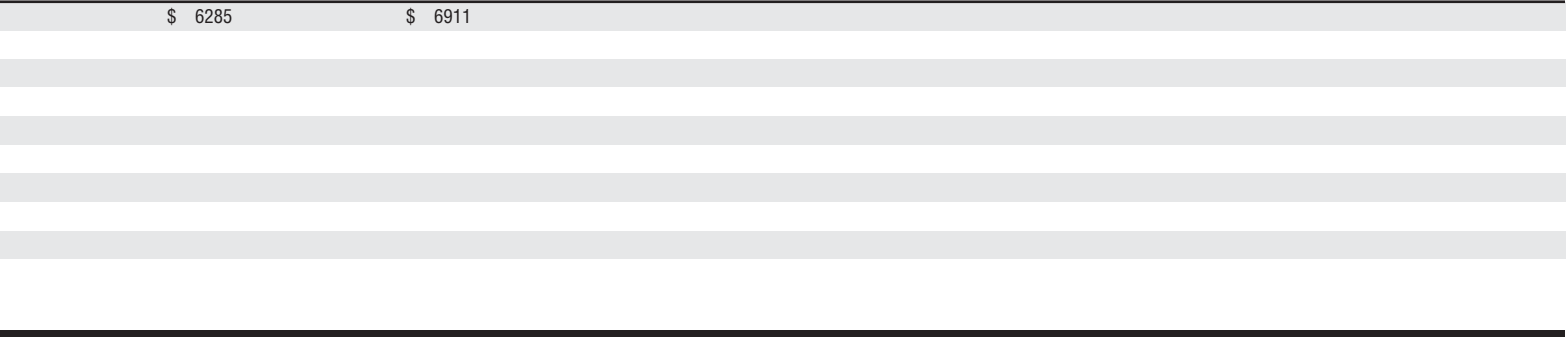

SPECIAL SERVICES

Special Carton Marking

With specially marked information N/C

Shipping

Shipped **k.d. freight prepaid f.o.b. factory of origin** factory.
Freight class #125.

Specifications and prices are subject to change without prior notice.

CrossRoads® Media Display Metal Shelving

42" Media Display Metal Shelving

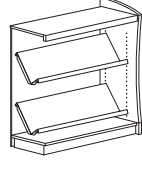
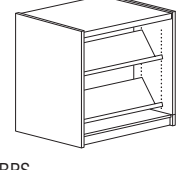
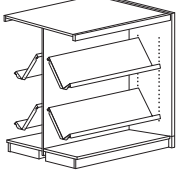
| | MODEL | D x W x H | MODEL NUMBER | | | | | Approx. Packaged Weight |
|---|-------|-------------------|--------------|--------------------------|---|--|-------------|-------------------------|
| | | | Basic Model | Wood Type | End Panel | Wood Finish | Paint Color | |
|  <p>42" Metal Shelving Starter Unit-Single Face</p> <ul style="list-style-type: none"> • Straight base only with back panel • 2 adjustable angled steel shelves • Each shelf ships with 6 metal dividers • Curved or straight end panel • Recommended for use against wall only | | 12 x 37-1/2 x 42" | CRMSS4212S | <input type="checkbox"/> | <input type="checkbox"/> <input type="checkbox"/> <input type="checkbox"/> <input type="checkbox"/> | <input type="checkbox"/> <input type="checkbox"/> | SA | 92.0# |
| CRPS | | | | | | | | |
|  <p>42" Metal Shelving Adder Unit-Single Face</p> <ul style="list-style-type: none"> • Straight base only with back panel • 2 adjustable angled steel shelves • Each shelf ships with 6 metal dividers • Straight end panel only • Recommended for use against wall only | | 12 x 36-1/4 x 42" | CRMSS4212A | <input type="checkbox"/> | PSTR | <input type="checkbox"/> <input type="checkbox"/> <input type="checkbox"/> | SA | 82.0# |
| CRPS | | | | | | | | |
|  <p>42" Metal Shelving Starter Unit-Double Face</p> <ul style="list-style-type: none"> • Straight base only with back panel • 4 adjustable angled steel shelves • Each shelf ships with 6 metal dividers • Curved or straight end panel | | 24 x 37-1/2 x 42" | CRMSD4224S | <input type="checkbox"/> | <input type="checkbox"/> <input type="checkbox"/> <input type="checkbox"/> <input type="checkbox"/> | <input type="checkbox"/> <input type="checkbox"/> | SA | 152.0# |
| CRPS | | | | | | | | |
|  <p>42" Metal Shelving Adder Unit-Double Face</p> <ul style="list-style-type: none"> • Straight base only with back panel • 4 adjustable angled steel shelves • Each shelf ships with 6 metal dividers • Straight end panel only | | 24 x 36-1/4 x 42" | CRMSD4224A | <input type="checkbox"/> | PSTR | <input type="checkbox"/> <input type="checkbox"/> <input type="checkbox"/> | SA | 130.0# |
| CRPS | | | | | | | | |

A

B

C

D

E

HOW TO ORDER

Indicate the following information on order form:

1. Quantity of each item.
2. Model number, including options. See "How To Build a Model Number".
3. Any special service required.

Note: • The indicates that a choice is required.

- The absence of the indicates that no choice is required.
- Alpha-numeric characters in place of indicate that no other alternatives are available.

HOW TO BUILD A MODEL NUMBER

A Select basic model.

B Select wood type.

O - Oak
M - Maple

C Select end panel

PCR - Curved panel
PSTR - Straight panel

D Select wood finish.

Refer to color addendum at ki.com or KI Fabrics & Finishes binder.
Stained finish colors; add \$44.

E Select shelf paint color.

SA - Sand
Refer to color addendum at ki.com or KI Fabrics & Finishes binder.

FINISH INFORMATION

Additional Stains

Specially stained edges beyond the KI standard offering (as shown under the Edge Color column in color addendum) are also available. Contact KI.



CrossRoads® Media Display Metal Shelving

42" Media Display Metal Shelving

| Oak | Maple |
|---------|---------|
| \$ 3089 | \$ 3397 |
| \$ 2634 | \$ 2895 |
| \$ 4907 | \$ 5397 |
| \$ 4399 | \$ 4841 |

SPECIAL SERVICES

Special Carton Marking

With specially marked information N/C



Shipping

Shipped **k.d. freight prepaid f.o.b. factory of origin** factory.
Freight class #125.

Specifications and prices are subject to change without prior notice.

CrossRoads® Media Display Metal Shelving

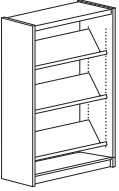
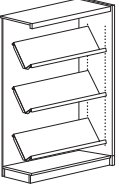
60" Media Display Metal Shelving

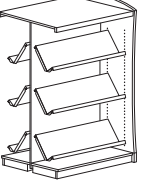
| | MODEL | D x W x H | MODEL NUMBER | | | | | Approx. Packaged Weight |
|--|-------------------|------------|--------------------------|-----------|-----------|-------------|-------------|-------------------------|
| | | | Basic Model | Wood Type | End Panel | Wood Finish | Paint Color | |
|  <p>60" Metal Shelving Starter Unit-Single Face</p> <ul style="list-style-type: none"> • Straight base only with back panel • 3 adjustable angled steel shelves • Each shelf ships with 6 metal dividers • Curved or straight end panel • Recommended for use against wall only | 12 x 37-1/2 x 60" | CRMSS6012S | <input type="checkbox"/> | □□□□ | □□□ | SA | 121.0# | |
| CRPS | | | | | | | | |
|  <p>60" Metal Shelving Adder Unit-Single Face</p> <ul style="list-style-type: none"> • Straight base only with back panel • 3 adjustable angled steel shelves • Each shelf ships with 6 metal dividers • Straight end panel only • Recommended for use against wall only | 12 x 36-1/4 x 60" | CRMSS6012A | <input type="checkbox"/> | PSTR | □□□ | SA | 103.0# | |
| CRPS | | | | | | | | |
|  <p>60" Metal Shelving Starter Unit-Double Face</p> <ul style="list-style-type: none"> • Straight base only with back panel • 6 adjustable angled steel shelves • Each shelf ships with 6 metal dividers • Curved or straight end panel | 24 x 37-1/2 x 60" | CRMSD6024S | <input type="checkbox"/> | □□□□ | □□□ | SA | 194.0# | |
| CRPS | | | | | | | | |
|  <p>60" Metal Shelving Adder Unit-Double Face</p> <ul style="list-style-type: none"> • Straight base only with back panel • 6 adjustable angled steel shelves • Each shelf ships with 6 metal dividers • Straight end panel only | 24 x 36-1/4 x 60" | CRMSD6024A | <input type="checkbox"/> | PSTR | □□□ | SA | 163.0# | |
| CRPS | | | | | | | | |

A B C D E

HOW TO ORDER

Indicate the following information on order form:

1. Quantity of each item.
2. Model number, including options. See "How To Build a Model Number".
3. Any special service required.

Note: • The indicates that a choice is required.

- The absence of the indicates that no choice is required.
- Alpha-numeric characters in place of indicate that no other alternatives are available.

HOW TO BUILD A MODEL NUMBER

- A** Select basic model.
- B** Select wood type.

| | |
|----------|---------|
| O | - Oak |
| M | - Maple |
- C** Select end panel

| | |
|-------------|------------------|
| PCRV | - Curved panel |
| PSTR | - Straight panel |
- D** Select wood finish. Refer to color addendum at ki.com or KI Fabrics & Finishes binder. Stained finish colors; add \$57.
- E** Select shelf paint color.

| | |
|-----------|--------|
| SA | - Sand |
|-----------|--------|

 Refer to color addendum at ki.com or KI Fabrics & Finishes binder.

FINISH INFORMATION

Additional Stains

Specially stained edges beyond the KI standard offering (as shown under the Edge Color column in color addendum) are also available. Contact KI.



CrossRoads® Media Display Metal Shelving

60" Media Display Metal Shelving

| | |
|---------|---------|
| Oak | Maple |
| \$ 3608 | \$ 3968 |

| | |
|---------|---------|
| \$ 3145 | \$ 3461 |
|---------|---------|

| | |
|---------|---------|
| \$ 5792 | \$ 6368 |
|---------|---------|

| | |
|---------|---------|
| \$ 5238 | \$ 5764 |
|---------|---------|

SPECIAL SERVICES

Special Carton Marking

With specially marked information N/C

Shipping

Shipped **k.d. freight prepaid f.o.b. factory of origin** factory.
Freight class #125.

Specifications and prices are subject to change without prior notice.

CrossRoads® Media Display Metal Shelving

82" Media Display Metal Shelving

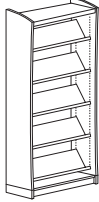
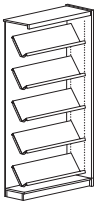
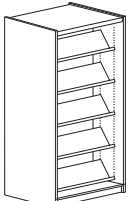
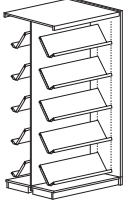
| | MODEL | D x W x H | MODEL NUMBER | | | | | Approx. Packaged Weight |
|--|-------------------|------------|--------------------------|---|--|-------------|-------------|-------------------------|
| | | | Basic Model | Wood Type | End Panel | Wood Finish | Paint Color | |
|  <p>82" Metal Shelving Starter Unit-Single Face</p> <ul style="list-style-type: none"> • Straight base only with back panel • 5 adjustable angled steel shelves • Each shelf ships with 6 metal dividers • Curved or straight end panel • Recommended for use against wall only | 12 x 37-1/2 x 82" | CRMSS8212S | <input type="checkbox"/> | <input type="checkbox"/> <input type="checkbox"/> <input type="checkbox"/> <input type="checkbox"/> | <input type="checkbox"/> <input type="checkbox"/> <input type="checkbox"/> | SA | 148.0# | |
| CRPS | | | | | | | | |
|  <p>82" Metal Shelving Adder Unit-Single Face</p> <ul style="list-style-type: none"> • Straight base only with back panel • 5 adjustable angled steel shelves • Each shelf ships with 6 metal dividers • Straight end panel only • Recommended for use against wall only | 12 x 36-1/4 x 82" | CRMSS8212A | <input type="checkbox"/> | PSTR | <input type="checkbox"/> <input type="checkbox"/> <input type="checkbox"/> | SA | 128.0# | |
| CRPS | | | | | | | | |
|  <p>82" Metal Shelving Starter Unit-Double Face</p> <ul style="list-style-type: none"> • Straight base only with back panel • 10 adjustable angled steel shelves • Each shelf ships with 6 metal dividers • Curved or straight end panel | 24 x 37-1/2 x 82" | CRMSD8224S | <input type="checkbox"/> | <input type="checkbox"/> <input type="checkbox"/> <input type="checkbox"/> <input type="checkbox"/> | <input type="checkbox"/> <input type="checkbox"/> <input type="checkbox"/> | SA | 245.0# | |
| CRPS | | | | | | | | |
|  <p>82" Metal Shelving Adder Unit-Double Face</p> <ul style="list-style-type: none"> • Straight base only with back panel • 10 adjustable angled steel shelves • Each shelf ships with 6 metal dividers • Straight end panel only | 24 x 36-1/4 x 82" | CRMSD8224A | <input type="checkbox"/> | PSTR | <input type="checkbox"/> <input type="checkbox"/> <input type="checkbox"/> | SA | 202.0# | |
| CRPS | | | | | | | | |

A

B

C

D

E

HOW TO ORDER

Indicate the following information on order form:

1. Quantity of each item.
2. Model number, including options. See "How To Build a Model Number".
3. Any special service required.

Note: • The indicates that a choice is required.

- The absence of the indicates that no choice is required.
- Alpha-numeric characters in place of indicate that no other alternatives are available.

HOW TO BUILD A MODEL NUMBER

A Select basic model.

B Select wood type.

O - Oak
M - Maple

C Select end panel

PCRV - Curved panel
PSTR - Straight panel

D Select wood finish.

Refer to color addendum at ki.com or KI Fabrics & Finishes binder.
Stained finish colors; add \$61.

E Select shelf paint color.

SA - Sand
Refer to color addendum at ki.com or KI Fabrics & Finishes binder.

FINISH INFORMATION

Additional Stains

Specially stained edges beyond the KI standard offering (as shown under the Edge Color column in color addendum) are also available. Contact KI.

CrossRoads® Accessory Units

Metal Shelving Accessories

| | MODEL | MODEL NUMBER | Approx. Packaged Weight |
|-------|--|--------------|-------------------------|
| | | Basic Model | |
| HRDPT | Overhead Wire Book Support <ul style="list-style-type: none"> • Use with KI metal shelving • Extends down 9" • Chrome finish | OHWBS | 1.0# |
| | | | |
| | | | |

A

HOW TO ORDER

Indicate the following information on order form:

1. Quantity of each item.
2. Model number, including options. See "How To Build a Model Number".
3. Any special service required.

Note: • The indicates that a choice is required.

- The absence of the indicates that no choice is required.
- Alpha-numeric characters in place of indicate that no other alternatives are available.

HOW TO BUILD A MODEL NUMBER

A Select basic model.



Delivered
Pricing
\$ 22

SPECIAL SERVICES

Special Carton Marking

With specially marked information N/C



Shipping

Shipped **assembled freight prepaid f.o.b. factory of origin** factory.
Freight class #100.

Specifications and prices are subject to change without prior notice.

CrossRoads® Accessory Units

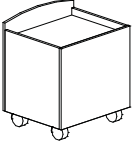
Storage/Accessories

| | MODEL | D x W x H | MODEL NUMBER | | | | | Approx. Packaged Weight |
|--|--|---------------------------|--------------|--------------------------|--|--|--|-------------------------|
| | | | Basic Model | Wood Type | Wood Finish | Surface Finish | Pull Color | |
|  <p>CRD</p> | Descending Platform Book Truck • Sits under the Book Return Module • 4 swivel casters | 22 x 26 x 28-1/2' | CRDBT | <input type="checkbox"/> | <input type="checkbox"/> <input type="checkbox"/> <input type="checkbox"/> | | | 84.0# |
| | | | | | | | | |
| | | | | | | | | |
| | | | | | | | | |
|  <p>CRD</p> | Wood Mobile Pedestal • Box/Box/File - (2) 6" drawers and (1) 12" drawer | 24-1/4 x 16-1/4 x 27-3/8" | CRDMP | <input type="checkbox"/> | <input type="checkbox"/> <input type="checkbox"/> <input type="checkbox"/> | <input type="checkbox"/> <input type="checkbox"/> <input type="checkbox"/> | <input type="checkbox"/> <input type="checkbox"/> <input type="checkbox"/> | 60.0# |
| | | | | | | | | |
| | | | | | | | | |
| | | | | | | | | |
| | | | A | B | C | D | E | |

HOW TO ORDER

Indicate the following information on order form:

- Quantity of each item.
- Model number, including options. See "How To Build a Model Number".
- Any special service required.

Note: • The indicates that a choice is required.

- The absence of the indicates that no choice is required.
- Alpha-numeric characters in place of indicate that no other alternatives are available.

HOW TO BUILD A MODEL NUMBER

A Select basic model.
For a complete circulation desk price quotation, a sketch or drawing of the modular arrangement must be included.

B Select wood type.
 - Oak
 - Maple

C Select wood finish. (for worksurface edge, shelf, side & back panels)
Refer to color addendum at ki.com or KI Fabrics & Finishes binder.
Stained finish colors; add \$72.

D Select surface finish.
Refer to color addendum at ki.com or KI Fabrics & Finishes binder.
Additional plastic laminate surfaces are available but may require an upcharge and additional leadtime. Please contact KI.

E Select drawer pull color.

Refer to color addendum at ki.com or KI Fabrics & Finishes binder.

FINISH INFORMATION

Additional Stains

Specially stained edges beyond the KI standard offering (as shown under the Edge Color column in color addendum) are also available. Contact KI.



CrossRoads® Accessory Units

Storage/Accessories

| | |
|---------|---------|
| Oak | Maple |
| \$ 2504 | \$ 2756 |

| | |
|---------|---------|
| \$ 1087 | \$ 1197 |
|---------|---------|

SPECIAL SERVICES

Special Carton Marking

With specially marked information N/C

Shipping

Shipped **assembled freight prepaid f.o.b. factory of origin** factory.
Freight class #100.

Specifications and prices are subject to change without prior notice.

CrossRoads® Accessory Units

Newspaper Display Units

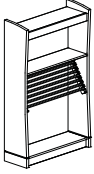
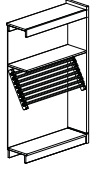
| | MODEL | D x W x H | MODEL NUMBER | | | | Approx. Packaged Weight |
|---|--|-------------------|--------------|--------------------------|---|--|-------------------------|
| | | | Basic Model | Wood Type | End Panel | Wood Finish | |
|  | Newspaper Display Starter Unit • 2 heights • Straight or curved end panels • Recommended for use against wall only | 12 x 37-1/2 x 60" | CRNEW6012S | <input type="checkbox"/> | <input type="checkbox"/> <input type="checkbox"/> <input type="checkbox"/> <input type="checkbox"/> | <input type="checkbox"/> <input type="checkbox"/> | 825.0# |
| | | 12 x 37-1/2 x 82" | CRNEW8212S | <input type="checkbox"/> | <input type="checkbox"/> <input type="checkbox"/> <input type="checkbox"/> <input type="checkbox"/> | <input type="checkbox"/> <input type="checkbox"/> | 1022.0# |
| | | | | | | | |
| CRNWS | | | | | | | |
|  | Newspaper Display Adder Unit • 2 heights • Straight or curved end panels • Recommended for use against wall only | 12 x 36-1/4 x 60" | CRNEW6012A | <input type="checkbox"/> | PSTR | <input type="checkbox"/> <input type="checkbox"/> <input type="checkbox"/> | 705.0# |
| | | 12 x 36-1/4 x 82" | CRNEW8212A | <input type="checkbox"/> | PSTR | <input type="checkbox"/> <input type="checkbox"/> <input type="checkbox"/> | 853.0# |
| | | | | | | | |
| CRNWS | | | | | | | |
| | | | A | B | C | D | |

HOW TO ORDER

Indicate the following information on order form:

- Quantity of each item.
- Model number, including options. See "How To Build a Model Number".
- Any special service required.

Note: • The indicates that a choice is required.

- The absence of the indicates that no choice is required.
- Alpha-numeric characters in place of indicate that no other alternatives are available.

HOW TO BUILD A MODEL NUMBER

- A** Select basic model.
- B** Select wood type.

| | |
|----------|---------|
| O | - Oak |
| M | - Maple |
- C** Select end panel.

| | |
|-------------|------------------|
| PCRV | - Curved panel |
| PSTR | - Straight panel |

- D** Select wood finish.
 Refer to color addendum at ki.com or KI Fabrics & Finishes binder.
 Stained finish colors add \$72.

FINISH INFORMATION

Additional Stains

Specially stained edges beyond the KI standard offering (as shown under the Edge Color column in color addendum) are also available. Contact KI.



CrossRoads[®] Accessory Units

Newspaper Display Units



| Oak | Maple |
|---------|---------|
| \$ 3425 | \$ 3767 |
| 3662 | 4025 |

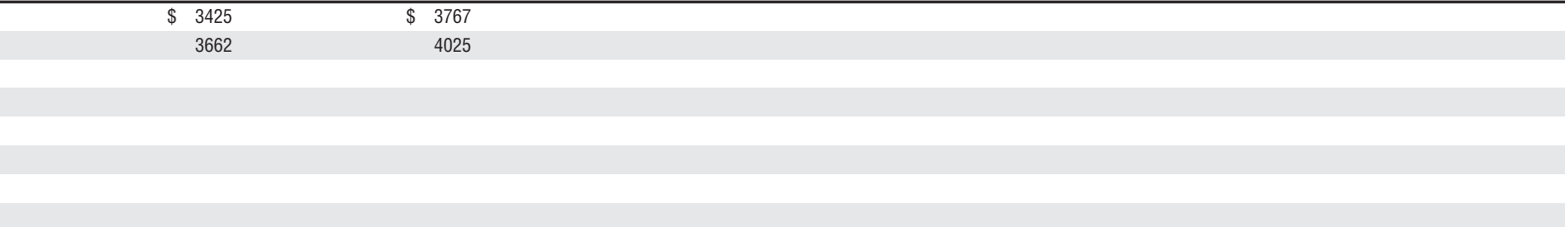

| | |
|---------|---------|
| \$ 2834 | \$ 3117 |
| 3053 | 3360 |



SPECIAL SERVICES

Special Carton Marking

With specially marked information N/C

Shipping

Shipped **k.d. freight prepaid f.o.b. factory of origin** factory.
Freight class #100.

Specifications and prices are subject to change without prior notice.

CrossRoads® Accessory Units

Atlas and Dictionary Stands

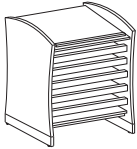
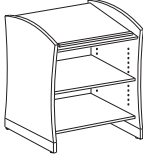
| MODEL | D x W x H | MODEL NUMBER | | | | | Approx. Packaged Weight |
|---|---------------|--------------|--------------------------|---|--|--|-------------------------|
| | | Basic Model | Wood Type | End Panel | Wood Finish | Surface Finish | |
|  <p>Atlas Stand</p> <ul style="list-style-type: none"> • Straight or curved end panels • 5 sliding shelves • Recommended for use against wall only | 29 x 36 x 45" | CRATLAS | <input type="checkbox"/> | <input type="checkbox"/> <input type="checkbox"/> <input type="checkbox"/> <input type="checkbox"/> | <input type="checkbox"/> <input type="checkbox"/> <input type="checkbox"/> | <input type="checkbox"/> <input type="checkbox"/> <input type="checkbox"/> | 148.0# |
| | | | | | | | |
| | | | | | | | |
| | | | | | | | |
| CRATL | | | | | | | |
|  <p>Dictionary Stand</p> <ul style="list-style-type: none"> • Straight or curved end panels • 1 adjustable shelf • Recommended for use against wall only | 29 x 36 x 45" | CRDICTN | <input type="checkbox"/> | <input type="checkbox"/> <input type="checkbox"/> <input type="checkbox"/> <input type="checkbox"/> | <input type="checkbox"/> <input type="checkbox"/> <input type="checkbox"/> | <input type="checkbox"/> <input type="checkbox"/> <input type="checkbox"/> | 105.0# |
| | | | | | | | |
| | | | | | | | |
| | | | | | | | |
| CRDCT | | | | | | | |
| | | A | B | C | D | E | |

HOW TO ORDER

Indicate the following information on order form:

1. Quantity of each item.
2. Model number, including options. See "How To Build a Model Number".
3. Any special service required.

Note: • The indicates that a choice is required.

- The absence of the indicates that no choice is required.
- Alpha-numeric characters in place of indicate that no other alternatives are available.

HOW TO BUILD A MODEL NUMBER

- A** Select basic model.
- B** Select wood type.
- | | |
|----------|---------|
| O | - Oak |
| M | - Maple |
- C** Select end panel.
- | | |
|-------------|------------------|
| PCRV | - Curved panel |
| PSTR | - Straight panel |
- D** Select wood finish.
Refer to color addendum at ki.com or KI Fabrics & Finishes binder.
Stained finish colors add \$72.
- E** Select surface finish.
Refer to color addendum at ki.com or KI Fabrics & Finishes binder.
Additional plastic laminate surfaces are available but may require an upcharge and additional leadtime. Please contact KI.

FINISH INFORMATION

Additional Stains

Specially stained edges beyond the KI standard offering (as shown under the Edge Color column in color addendum) are also available. Contact KI.



Oak
\$ 3310

Maple
\$ 3642

\$ 2393

\$ 2632

SPECIAL SERVICES

Special Carton Marking

With specially marked information N/C

Shipping

Shipped **assembled freight prepaid f.o.b. factory of origin** factory.
Freight class #100.

Specifications and prices are subject to change without prior notice.

CrossRoads® Accessory Units

Rolling Book Carts

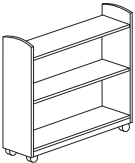
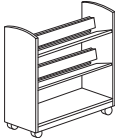
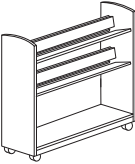
| | MODEL | D x W x H | MODEL NUMBER | | | Approx. Packaged Weight |
|---|---|-------------------|--------------|--------------------------|--|-------------------------|
| | | | Basic Model | Wood Type | Wood Finish | |
|  | Rolling Book Cart-30" Wide • 3 flat shelves • Lower shelf clearance 12" • Middle shelf clearance 11-1/2" | 15 x 30 x 35" | CRTRK3530 | <input type="checkbox"/> | <input type="checkbox"/> <input type="checkbox"/> <input type="checkbox"/> | 43.0# |
| CRTRK | | | | | | |
|  | Rolling Book Cart-40" Wide • 3 flat shelves • Lower shelf clearance 15-1/2" • Middle shelf clearance 13-1/2" | 15 x 40 x 41" | CRTRK4140 | <input type="checkbox"/> | <input type="checkbox"/> <input type="checkbox"/> <input type="checkbox"/> | 43.0# |
| CRTRK | | | | | | |
|  | Rolling Book Cart with Slanted Shelves • 2 double-face slanted shelves • 1 flat shelf • Lower shelf clearance 11" • Middle shelf clearance 13-3/4" | 16-1/2 x 30 x 35" | CRTRK3530SL | <input type="checkbox"/> | <input type="checkbox"/> <input type="checkbox"/> <input type="checkbox"/> | 43.0# |
| CRTRK | | | | | | |
|  | Rolling Book Cart with Slanted Shelves • 2 double-face slanted shelves • 1 flat shelf • Lower shelf clearance 16" • Middle shelf clearance 10-3/4" | 16-1/2 x 40 x 41" | CRTRK4140SL | <input type="checkbox"/> | <input type="checkbox"/> <input type="checkbox"/> <input type="checkbox"/> | 43.0# |
| CRTRK | | | | | | |

A

B

C

HOW TO ORDER

Indicate the following information on order form:

- Quantity of each item.
- Model number, including options. See "How To Build a Model Number".
- Any special service required.

Note: • The indicates that a choice is required.

- The absence of the indicates that no choice is required.
- Alpha-numeric characters in place of indicate that no other alternatives are available.

HOW TO BUILD A MODEL NUMBER

A Select basic model.

B Select wood type.

O - Oak
M - Maple

C Select wood finish.

Refer to color addendum at ki.com or KI Fabrics & Finishes binder. Stained finish colors add \$72.

FINISH INFORMATION

Additional Stains

Specially stained edges beyond the KI standard offering (as shown under the Edge Color column in color addendum) are also available. Contact KI.

CrossRoads Seating

General Information

SPECIFICATIONS

Chair Back Posts

Back posts shall be made of 5/4" stock, steam bent to shape and finished to 1" thickness.

Chair Front Posts

Front posts shall be made of 8/4" stock and tapered on two inside faces. The front outside corners are shaped to a 3/4" radius. Finished size is 1-3/4" x 1-3/4" at the top and 1-1/4" x 1-1/4" at the bottom.

Chair Side Rails

Side rails shall be made of 4/4" stock, finished to 13/16" thickness x 2" wide and double doweled to the front and back posts using 5/8" x 2" dowels.

Chair Side Stretchers

Side stretchers shall be made of 4/4" stock, finished to 13/16" x 13/16". The stretchers shall be fastened to the front and back posts using 9/16" chucks with each joint pinned to further reinforce the joint.

Chair Top Slat

The top slat shall be made of 4/4" stock finished to 13/16" thickness and steam bent to a 24" radius. The top slat shall be shaped to form and double doweled to the back posts using 3/8" x 1-1/2" dowels.

Chair Bottom Slat

The bottom slat shall be made of 4/4" stock, steam bent to a 24" radius, finished to 13/16" thickness x 3-3/8" wide and double doweled to the back posts using 3/8" x 1-1/2" dowels.

Chair Banisters

Banisters shall be made of 6/4" stock finished 3/8" x 1" wide, steam bent to shape and mortised into the top and bottom slats.

Chair Front Rail

The front rail shall be made of 4/4" stock, finished to 13/16" x 2" wide and double doweled to the front posts using 3/8" x 2" dowels.

Chair Cross Stretchers

Cross stretchers shall be made of 4/4" stock, finished to 13/16" x 13/16" and fastened to the side stretchers using 9/16" chucks with each joint pinned to further reinforce the joint.

Chair Wood Seat

Seats shall be made of 5/4" stock, surfaced to 13/16" prior to being defect ripped on a straight-line rip saw. Individual seat pieces shall not exceed 3-1/2". Seat stock will be mechanically glued to ensure uniform coating of polyvinyl acetate emulsion glue prior to being clamped using a pneumatic torque drive to insure proper pressure on glue joints. Seat blanks will be double surfaced prior to shaping to form and saddling. Seat shall be gained into bottom slat and fastened to each back post by one 12 x 2-1/4" tapping screw concealed by a wood button. Two 12 x 2" tapping screws secure the seat to

the front rail and one 12 x 2" tapping screw shall secure the seat to each side rail.

Chair Corner Blocks

Corner blocks shall further reinforce the frame and are glued and screwed in place. Two 10 x 1-1/4" twin fast screws and one 12 x 2-1/4" tapping screw shall secure each block to the frame.

Chair Glue

The glue used in final chair assembly shall be polyvinyl alcohol ester blend with polyvinyl acetate.

Chair Glides

7/8" diameter rubber cushion chrome-plated glides are standard.



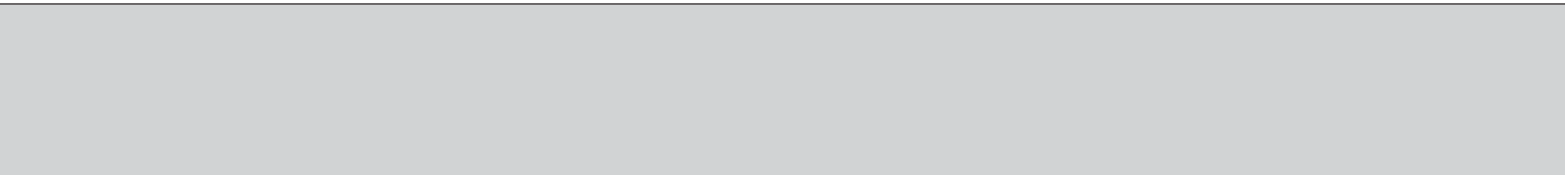

Fabric

Fabric will be applied as swatched by the fabric manufacturer. Fabric that is required to be applied differently than is swatched will need a Special Cost Request written specifying the direction the fabric is to be applied. The posted standard lead time will apply to the Special Cost Request.



CrossRoads® Seating

Wood Chairs

| | MODEL | SEAT HEIGHT | MODEL NUMBER | | | | Approx. Packaged Weight | Delivered Pricing Unupholstered |
|--|--|-------------|--------------|--------------------------|--|---|-------------------------|---------------------------------|
| | | | Basic Model | Wood Type | Wood Finish | Upholstery Color | | |
|  | Wood Chair • No arms • No upholstery • 3 sizes - 14", 16", 18" | 14" | CRCHR14 | <input type="checkbox"/> | <input type="checkbox"/> <input type="checkbox"/> <input type="checkbox"/> | | 29.0# | \$ 403 |
| | | 16" | CRCHR16 | <input type="checkbox"/> | <input type="checkbox"/> <input type="checkbox"/> <input type="checkbox"/> | | 32.0# | 403 |
| | | 18" | CRCHR18 | <input type="checkbox"/> | <input type="checkbox"/> <input type="checkbox"/> <input type="checkbox"/> | | 35.0# | 416 |
| | | | | | | | | |
| CRCHR | | | | | | | | |
|  | Wood Chair • No arms • Upholstered seat • 3 sizes - 14", 16", 18" | 14" | CRCHRU14 | <input type="checkbox"/> | <input type="checkbox"/> <input type="checkbox"/> <input type="checkbox"/> | <input type="checkbox"/> <input type="checkbox"/> <input type="checkbox"/> <input type="checkbox"/> | 31.0# | N/A |
| | | 16" | CRCHRU16 | <input type="checkbox"/> | <input type="checkbox"/> <input type="checkbox"/> <input type="checkbox"/> | <input type="checkbox"/> <input type="checkbox"/> <input type="checkbox"/> <input type="checkbox"/> | 34.0# | N/A |
| | | 18" | CRCHRU18 | <input type="checkbox"/> | <input type="checkbox"/> <input type="checkbox"/> <input type="checkbox"/> | <input type="checkbox"/> <input type="checkbox"/> <input type="checkbox"/> <input type="checkbox"/> | 37.0# | N/A |
| | | | | | | | | |
| CRCHR | | | | | | | | |
|  | Wood Chair • With recessed arms • No upholstery • 18" size only | 18" | CRCHRA18 | <input type="checkbox"/> | <input type="checkbox"/> <input type="checkbox"/> <input type="checkbox"/> | | 45.0# | \$ 560 |
| | | | | | | | | |
| | | | | | | | | |
| | | | | | | | | |
| CRCHR | | | | | | | | |
|  | Wood Chair • With recessed arms • Upholstered seat • 18" size only | 18" | CRCHRAU18 | <input type="checkbox"/> | <input type="checkbox"/> <input type="checkbox"/> <input type="checkbox"/> | <input type="checkbox"/> <input type="checkbox"/> <input type="checkbox"/> <input type="checkbox"/> | 47.0# | N/A |
| | | | | | | | | |
| | | | | | | | | |
| | | | | | | | | |
| CRCHR | | | | | | | | |

A **B** **C** **D**

HOW TO ORDER

Indicate the following information on order form:

- Quantity of each item.
- Model number, including options. See "How To Build a Model Number".
- Any special service required.

Note: • The indicates that a choice is required.

- The absence of the indicates that no choice is required.
- Alpha-numeric characters in place of indicate that no other alternatives are available.

HOW TO BUILD A MODEL NUMBER

- A** Select basic model.
- B** Select wood type.
 - Oak
 - Maple
- C** Select wood finish.
 Refer to color addendum at ki.com or KI Fabrics & Finishes binder.
 Stained finish colors; add \$22.
- D** Select upholstery grade and color.
 Refer to color addendum at ki.com or KI Fabrics & Finishes binder.

FINISH INFORMATION

Additional Stains

Specially stained edges beyond the KI standard offering (as shown under the Edge Color column in color addendum) are also available. Contact KI.



| Delivered Pricing Fabric Grade 1 & C.O.M. | Delivered Pricing Fabric Grade 2 | Delivered Pricing Fabric Grade 3 | Delivered Pricing Vinyl Group 2 | Delivered Pricing Pallas Fabric Group P0 | Delivered Pricing Pallas Fabric Group P1 | Delivered Pricing Pallas Fabric Group P2 | Delivered Pricing Pallas Fabric Group P3 | Delivered Pricing Pallas Fabric Group P4 |
|---|----------------------------------|----------------------------------|---------------------------------|--|--|--|--|--|
| \$ 479 | \$ 511 | \$ 527 | \$ 527 | \$ 512 | \$ 550 | \$ 586 | \$ 648 | \$ 686 |
| 479 | 511 | 527 | 527 | 512 | 550 | 586 | 648 | 686 |
| 491 | 522 | 539 | 539 | 524 | 561 | 596 | 658 | 696 |
| \$ 638 | \$ 668 | \$ 687 | \$ 687 | \$ 672 | \$ 709 | \$ 745 | \$ 805 | \$ 844 |

SPECIAL SERVICES

Special Carton Marking

With specially marked information N/C

Shipping

Shipped **assembled freight prepaid f.o.b. factory of origin** factory.
Freight class #125.

Specifications and prices are subject to change without prior notice.

CrossRoads® Circulation Desk

Typicals

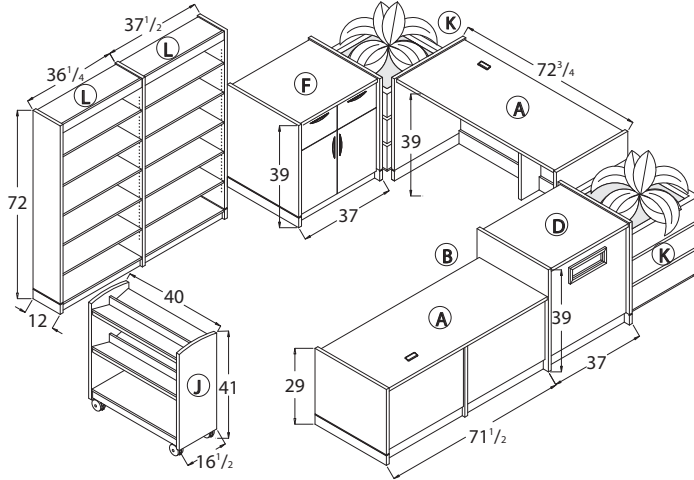

Typical C-Shape Circulation Desk
 Work Space: 132 sq. ft.
 Oak Budget List Price to be quoted
 Maple Budget List Price to be quoted

Circulation Desk Features:

- A. Extended desk modules
- B. Mobile pedestals
- D. Book return module
- E. Descending platform book truck
- F. Cupboard storage unit
- J. Rolling book cart
- L. Shelving units
- K. Logix planters

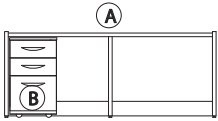

Extended Desk w/Mobile

Inside view

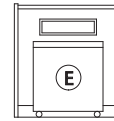

Book Return Unit w/Book

D

Inside view

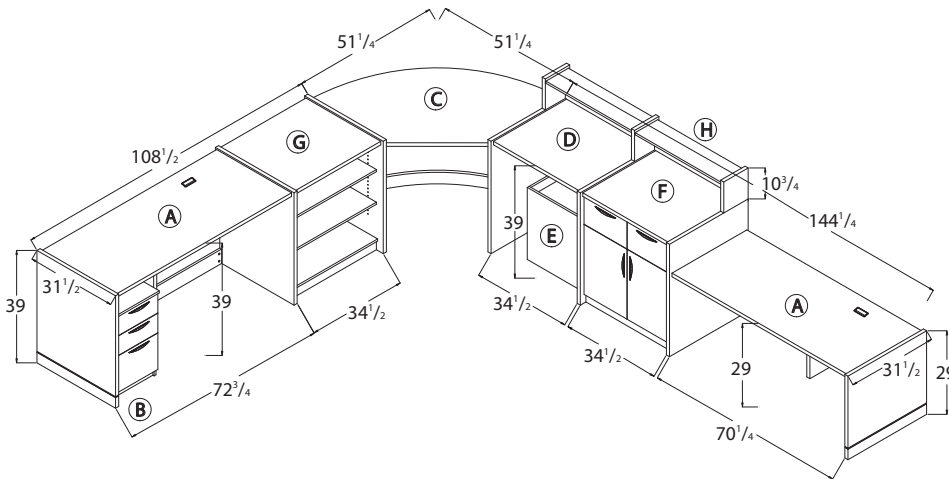

Typical L-Shape Circulation Desk
 Work Space: 216 sq. ft.
 Oak Budget List Price to be quoted
 Maple Budget List Price to be quoted

Circulation Desk Features:

- A. Extended desk modules
- B. Mobile pedestal
- C. Extended corner unit
- D. Book return module
- E. Descending platform book truck
- F. Cupboard storage unit
- G. Open storage unit
- H. Transaction counter

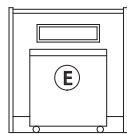

Book Return Module:
 Inside view

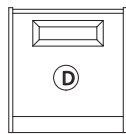

Book Return Module:
 Outside view

Note: Drawing is required prior to quote for circulation desks. Contact KI



CrossRoads® Circulation Desk

Typicals

Typical O-Shape Circulation Desk
Work Space: 250 sq. ft.
Oak Budget List Price to be quoted
Maple Budget List Price to be quoted

Circulation Desk Features:

- A. Extended desk modules
- B. Mobile pedestal
- C. Extended corner units
- D. Book return module
- E. Descending platform book trucks
- F. Cupboard storage unit
- G. Open storage unit

Typical U-Shape Circulation Desk
Work Space: 240 sq. ft.
Oak Budget List Price to be quoted
Maple Budget List Price to be quoted

Circulation Desk Features:

- A. Extended desk modules
- B. Mobile pedestals
- C. Extended corner units
- D. Book return modules
- E. Descending platform book trucks
- F. Cupboard storage unit
- G. Open storage unit

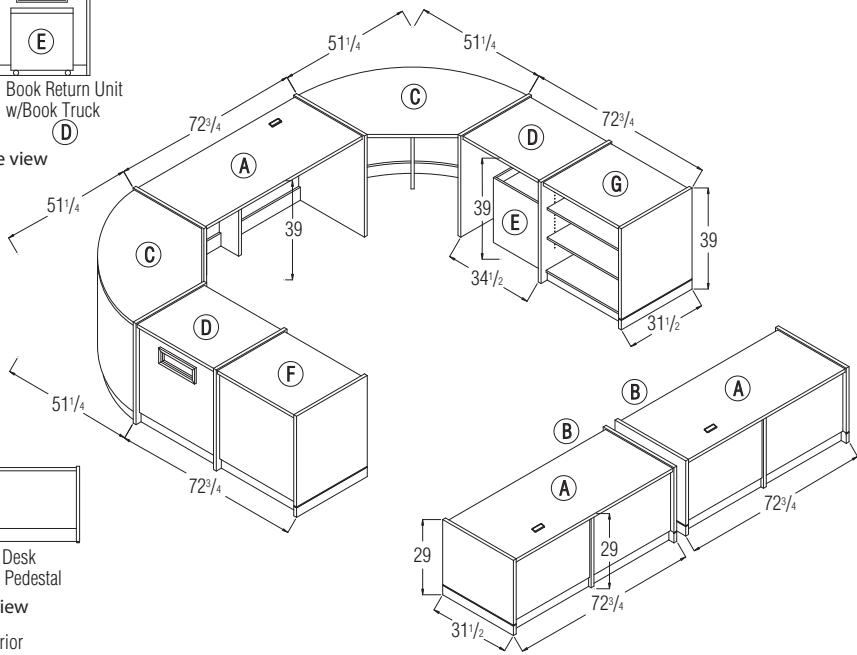
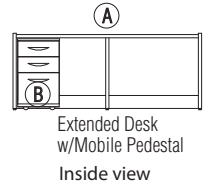
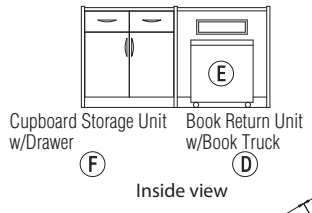
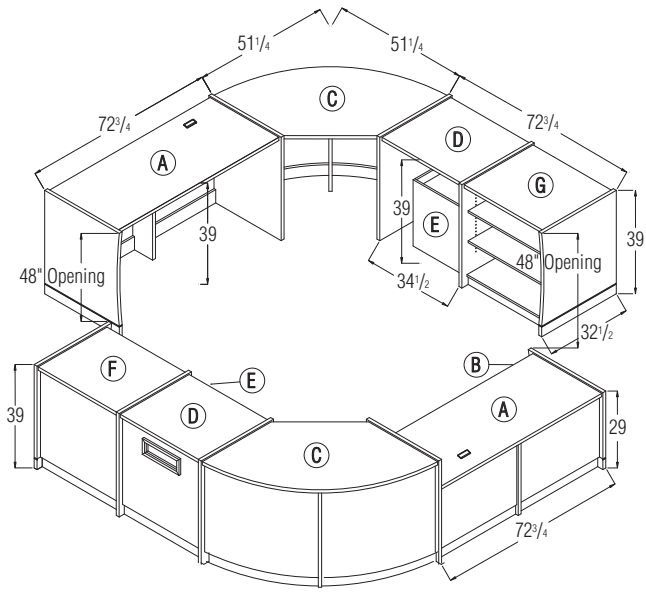
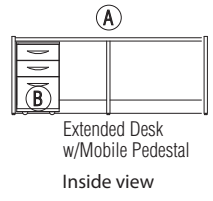
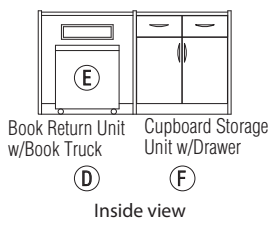

Note: Drawing is required prior to quote for circulation desks. Contact KI

CrossRoads® Circulation Desk

Typicals

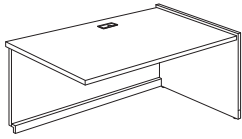

- Standard Desk Module
- straight base only
 - 1 grommet or 1 PowerUp module
 - 29", 32" or 39" height
 - 31 $\frac{1}{2}$ "D x 35 $\frac{3}{4}$ "W

Oak w/ grommet budget list price to be quoted
 Oak w/ PowerUp budget list price to be quoted
 Maple w/ grommet budget list price to be quoted
 Maple w/ PowerUp budget list price to be quoted

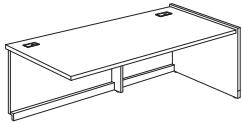

- Extended Desk Module
- straight base only
 - 2 grommets or 2 PowerUp modules
 - knife bracket supports center of unit
 - 29", 32" or 39" height
 - 31 $\frac{1}{2}$ "D x 71 $\frac{1}{2}$ "W

Oak w/ grommets budget list price to be quoted
 Oak w/ PowerUp budget list price to be quoted
 Maple w/ grommets budget list price to be quoted
 Maple w/ PowerUp budget list price to be quoted

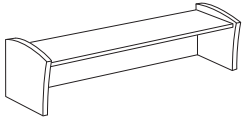

- Transaction Counter with End Panels
- veneer with wood banding
 - for use with extended desk module
 - 10"D x 72 $\frac{3}{4}$ "W x 10 $\frac{3}{4}$ "H

Oak budget list price to be quoted
 Maple budget list price to be quoted

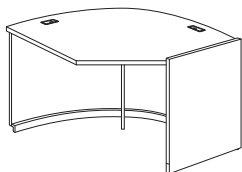

- 90° Extended Corner Module
- 2-piece unit
 - straight base only
 - 2 grommets or 2 PowerUp modules
 - overall radius 51.21°
 - 29" or 39" height
 - 36.2"D x 73"W (outer corner to outer corner)

Oak w/ grommet budget list price to be quoted
 Oak w/ PowerUp budget list price to be quoted
 Maple w/ grommet budget list price to be quoted
 Maple w/ PowerUp budget list price to be quoted

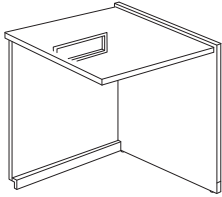

Book Return Module with Slot

- for use with Descending Platform Book Truck
- book slot opening measure 18"W x 4"H
- 39" height
- 31½"D x 35¾"W

Oak budget list price to be quoted
Maple budget list price to be quoted

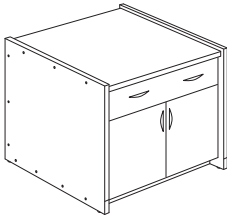

Cupboard Storage Unit with Drawer

- 1 adjustable and 1 fixed shelf
- drilled holes in outer panels for attachment to other modules
- 39" height
- 31½"D x 37"W

Oak budget list price to be quoted
Maple budget list price to be quoted

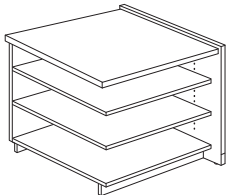

Open Storage Unit

- 2 adjustable and 2 fixed shelf
- 39" height
- 31½"D x 35¾"W

Oak budget list price to be quoted
Maple budget list price to be quoted

Index

| Model No. | Description | Page | Model No. | Description | Page |
|------------|---|------|-------------|--|------|
| CRATLAS | Atlas and Dictionary Stands: Atlas Stand | 60 | CRNEW6012S | Newspaper Display Units: Newspaper Display Starter Unit | 58 |
| CRCD6036A | Double Face Carrels: Study Carrel Adder Unit-Double Face | 12 | CRPERD4224A | 42" High Periodical Shelving: 42" Periodical Shelving Adder Unit-Double Face | 42 |
| CRCD6036S | Double Face Carrels: Study Carrel Starter Unit-Double Face | 12 | CRPERD4224S | 42" High Periodical Shelving: 42" Periodical Shelving Starter Unit-Double Face | 42 |
| CRCHR14 | Wood Chairs: Wood Chair | 66 | CRPERD6024A | 60" High Periodical Shelving: 60" Periodical Shelving Adder Unit-Double Face | 44 |
| CRCHRA18 | Wood Chairs: Wood Chair | 66 | CRPERD6024S | 60" High Periodical Shelving: 60" Periodical Shelving Starter Unit-Double Face | 44 |
| CRCHRAU18 | Wood Chairs: Wood Chair | 66 | CRPERD8224A | 82" High Periodical Shelving: 82" Periodical Shelving Adder Unit-Double Face | 46 |
| CRCHRU14 | Wood Chairs: Wood Chair | 66 | CRPERD8224S | 82" High Periodical Shelving: 82" Periodical Shelving Starter Unit-Double Face | 46 |
| CRCS3036A | Single Face Carrels: Study Carrel Adder Unit-Single Face | 10 | CRPERS4212A | 42" High Periodical Shelving: 42" Periodical Shelving Adder Unit-Single Face | 42 |
| CRCS3036S | Single Face Carrels: Study Carrel Starter Unit-Single Face | 10 | CRPERS4212S | 42" High Periodical Shelving: 42" Periodical Shelving Starter Unit-Single Face | 42 |
| CRDBT | Storage/Accessories: Descending Platform Book Truck | 56 | CRPERS6012A | 60" High Periodical Shelving: 60" Periodical Shelving Adder Unit-Single Face | 44 |
| CRDICTN | Atlas and Dictionary Stands: Dictionary Stand | 60 | CRPERS6012S | 60" High Periodical Shelving: 60" Periodical Shelving Starter Unit-Single Face | 44 |
| CRDMP | Storage/Accessories: Wood Mobile Pedestal | 56 | CRPERS8212A | 82" High Periodical Shelving: 82" Periodical Shelving Adder Unit-Single Face | 46 |
| CRFD4216A | 42" High Shelving: Shelving Adder Unit-Double Face | 18 | CRPERS8212S | 82" High Periodical Shelving: 82" Periodical Shelving Starter Unit-Single Face | 46 |
| CRFD4216S | 42" High Shelving: Shelving Starter Unit-Double Face | 18 | CRSSD4224A | 42" Metal Shelving: Metal Shelving Adder Unit-Double Face | 32 |
| CRFD5416A | 54" High Shelving: Shelving Adder Unit-Double Face | 20 | CRSSD4224S | 42" Metal Shelving: Metal Shelving Starter Unit-Double Face | 32 |
| CRFD5416S | 54" High Shelving: Shelving Starter Unit-Double Face | 20 | CRSSD5424A | 54" Metal Shelving: Metal Shelving Adder Unit-Double Face | 34 |
| CRFD6016A | 60" High Shelving: Shelving Adder Unit-Double Face | 22 | CRSSD5424S | 54" Metal Shelving: Metal Shelving Starter Unit-Double Face | 34 |
| CRFD6016S | 60" High Shelving: Shelving Starter Unit-Double Face | 22 | CRSSD6024A | 60" Metal Shelving: Metal Shelving Adder Unit-Double Face | 36 |
| CRFD7216A | 72" High Shelving: Shelving Adder Unit-Double Face | 24 | CRSSD6024S | 60" Metal Shelving: Metal Shelving Starter Unit-Double Face | 36 |
| CRFD7216S | 72" High Shelving: Shelving Starter Unit-Double Face | 24 | CRSSD7224A | 72" Metal Shelving: Metal Shelving Adder Unit-Double Face | 38 |
| CRFD8216A | 82" High Shelving: Shelving Adder Unit-Double Face | 26 | CRSSD7224S | 72" Metal Shelving: Metal Shelving Starter Unit-Double Face | 38 |
| CRFD8216S | 82" High Shelving: Shelving Starter Unit-Double Face | 26 | CRSSD8224A | 82" Metal Shelving: Metal Shelving Adder Unit-Double Face | 40 |
| CRFD9624A | 96" High Shelving: Shelving Adder Unit-Double Face | 30 | CRSSD8224S | 82" Metal Shelving: Metal Shelving Starter Unit-Double Face | 40 |
| CRFD9624S | 96" High Shelving: Shelving Starter Unit-Double Face | 30 | CRSSS4212A | 42" Metal Shelving: Metal Shelving Adder Unit-Single Face | 32 |
| CRFS4208A | 42" High Shelving: Shelving Adder Unit-Single Face | 18 | CRSSS4212S | 42" Metal Shelving: Metal Shelving Starter Unit-Single Face | 32 |
| CRFS4208S | 42" High Shelving: Shelving Starter Unit-Single Face | 18 | CRSSS5412A | 54" Metal Shelving: Metal Shelving Adder Unit-Single Face | 34 |
| CRFS5408A | 54" High Shelving: Shelving Adder Unit-Single Face | 20 | CRSSS5412S | 54" Metal Shelving: Metal Shelving Starter Unit-Single Face | 34 |
| CRFS5408S | 54" High Shelving: Shelving Starter Unit-Single Face | 20 | CRSSS6012A | 60" Metal Shelving: Metal Shelving Adder Unit-Single Face | 36 |
| CRFS6008A | 60" High Shelving: Shelving Adder Unit-Single Face | 22 | CRSSS6012S | 60" Metal Shelving: Metal Shelving Starter Unit-Single Face | 36 |
| CRFS6008S | 60" High Shelving: Shelving Starter Unit-Single Face | 22 | CRSSS7212A | 72" Metal Shelving: Metal Shelving Adder Unit-Single Face | 38 |
| CRFS7208A | 72" High Shelving: Shelving Adder Unit-Single Face | 24 | CRSSS7212S | 72" Metal Shelving: Metal Shelving Starter Unit-Single Face | 38 |
| CRFS7208S | 72" High Shelving: Shelving Starter Unit-Single Face | 24 | CRSSS8212A | 82" Metal Shelving: Metal Shelving Adder Unit-Single Face | 40 |
| CRFS8208A | 82" High Shelving: Shelving Adder Unit-Single Face | 26 | CRSSS8212S | 82" Metal Shelving: Metal Shelving Starter Unit-Single Face | 40 |
| CRFS8208S | 82" High Shelving: Shelving Starter Unit-Single Face | 26 | CRSUD6036A | Double Face Stations: Stand-up Computer Station Adder Unit-Double Face | 16 |
| CRFS9612A | 96" High Shelving: Shelving Adder Unit-Single Face | 28 | CRSUD6036S | Double Face Stations: Stand-up Computer Station Starter Unit-Double Face | 16 |
| CRFS9612S | 96" High Shelving: Shelving Starter Unit-Single Face | 28 | CRSUS3036A | Single Face Stations: Stand-up Computer Station Adder Unit-Single Face | 14 |
| CRMSD4224A | 42" Media Display Metal Shelving: 42" Metal Shelving Adder Unit-Double Face | 48 | CRSUS3036S | Single Face Stations: Stand-up Computer Station Starter Unit-Single Face | 14 |
| CRMSD4224S | 42" Media Display Metal Shelving: 42" Metal Shelving Starter Unit-Double Face | 48 | CRT3060 | Rectangular Tables: Rectangular Table | 4 |
| CRMSD6024A | 60" Media Display Metal Shelving: 60" Metal Shelving Adder Unit-Double Face | 50 | CRT4242 | Square and Round Tables: Square Table | 6 |
| CRMSD6024S | 60" Media Display Metal Shelving: 60" Metal Shelving Starter Unit-Double Face | 50 | CRT42R | Square and Round Tables: Round Table | 6 |
| CRMSD8224A | 82" Media Display Metal Shelving: 82" Metal Shelving Adder Unit-Double Face | 52 | CRTP3660 | Panel Leg Tables: Panel Leg Table | 8 |
| CRMSD8224S | 82" Media Display Metal Shelving: 82" Metal Shelving Starter Unit-Double Face | 52 | CRTRK3530 | Rolling Book Carts: Rolling Book Cart-30" Wide | 62 |
| CRMSS4212A | 42" Media Display Metal Shelving: 42" Metal Shelving Adder Unit-Single Face | 48 | CRTRK3530SL | Rolling Book Carts: Rolling Book Cart with Slanted Shelves | 62 |
| CRMSS4212S | 42" Media Display Metal Shelving: 42" Metal Shelving Starter Unit-Single Face | 48 | CRTRK4140 | Rolling Book Carts: Rolling Book Cart-40" Wide | 62 |
| CRMSS6012A | 60" Media Display Metal Shelving: 60" Metal Shelving Adder Unit-Single Face | 50 | CRTRK4140SL | Rolling Book Carts: Rolling Book Cart with Slanted Shelves | 62 |
| CRMSS6012S | 60" Media Display Metal Shelving: 60" Metal Shelving Starter Unit-Single Face | 50 | | | |
| CRMSS8212A | 82" Media Display Metal Shelving: 82" Metal Shelving Adder Unit-Single Face | 52 | | | |
| CRMSS8212S | 82" Media Display Metal Shelving: 82" Metal Shelving Starter Unit-Single Face | 52 | | | |
| CRNEW6012A | Newspaper Display Units: Newspaper Display Adder Unit | 58 | | | |



| Model No. | Description | Page |
|-----------|--|------|
| OHWBS | Metal Shelving Accessories: Overhead Wire Book Support | 54 |



KI
1330 Bellevue Street
P.O. Box 8100
Green Bay, Wisconsin 54308-8100
1-800-424-2432
www.ki.com

KI and Furnishing Knowledge
are registered trademarks
of Krueger International, Inc.

© 2011 KI
All Rights Reserved.
Litho in USA.
Code KI-11395R2/KI/VL/211

Printed using only water-based inks,
including metallics. Please recycle.