

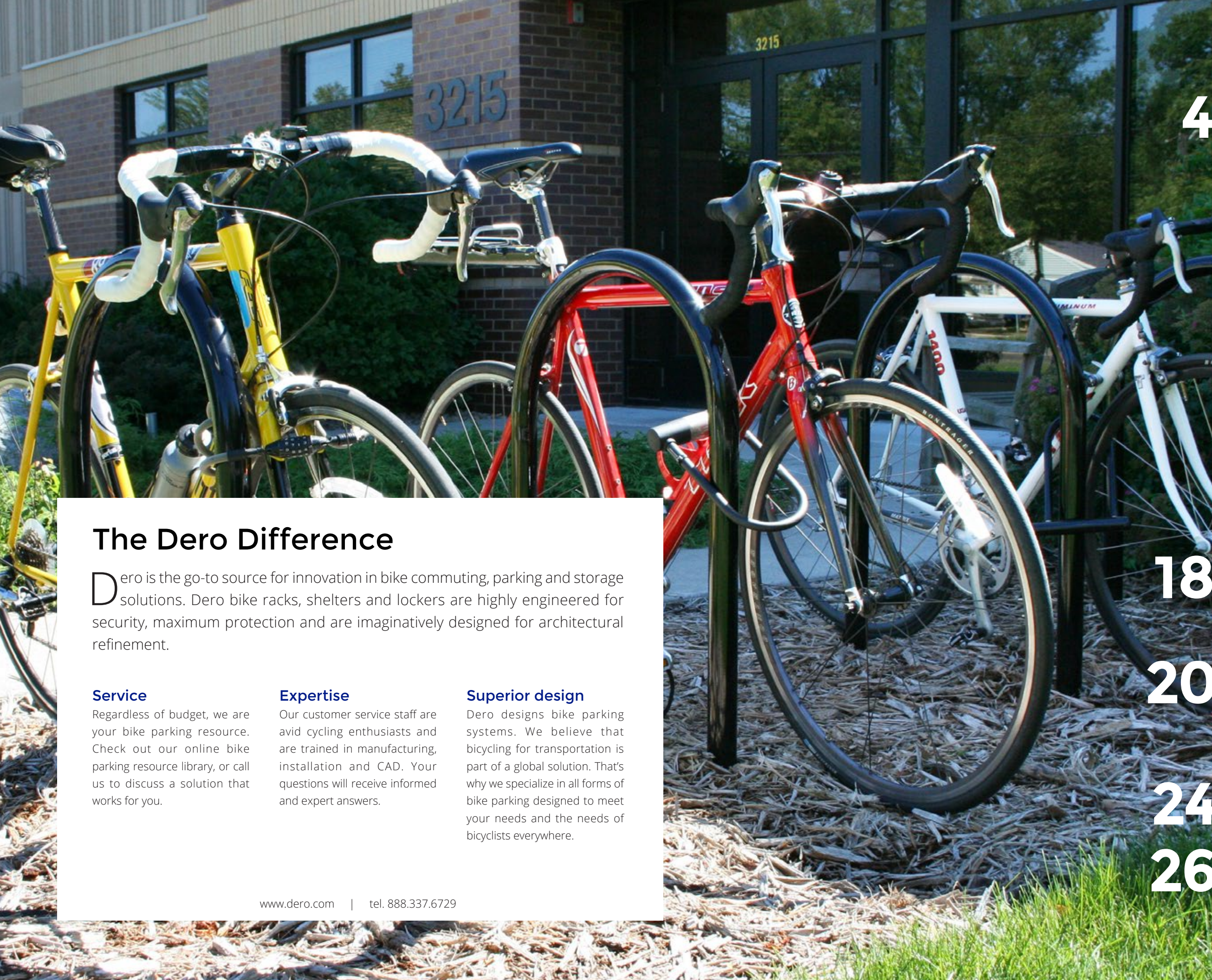

**DERO**  
A PLAYCORE Company

2014 Catalog

INNOVATIVE BICYCLE PARKING, STORAGE AND COMMUTING SOLUTIONS



## The Dero Difference

Dero is the go-to source for innovation in bike commuting, parking and storage solutions. Dero bike racks, shelters and lockers are highly engineered for security, maximum protection and are imaginatively designed for architectural refinement.

### Service

Regardless of budget, we are your bike parking resource. Check out our online bike parking resource library, or call us to discuss a solution that works for you.

### Expertise

Our customer service staff are avid cycling enthusiasts and are trained in manufacturing, installation and CAD. Your questions will receive informed and expert answers.

### Superior design

Dero designs bike parking systems. We believe that bicycling for transportation is part of a global solution. That's why we specialize in all forms of bike parking designed to meet your needs and the needs of bicyclists everywhere.

[www.dero.com](http://www.dero.com) | tel. 888.337.6729

# Contents

# 4

## Commercial Bike Racks

- 5 Hoop Rack  
Hoop Rack Heavy Duty
- 6 Bike Hitch  
Swerve Rack  
Arc Rack  
Round Rack
- 7 Downtown Rack  
Helix Rack
- 8 Rolling Rack  
Broadway Rack
- 9 Campus Rack  
HiRoller
- 10 Recycle Racks  
Bike Bike Rack
- 11 U-Lockit™  
Event Rack  
Compack Rack  
Bike Hook Solo  
Wall Rack  
Meter Hitch  
Switchback™  
Lock Dock
- 13 Ultra Space Saver  
Ultra Space Saver Single  
Track Rack  
Bike File
- 14 Cycle Stall Elite  
Cycle Stall Basic
- 15 Dero Decker  
Dero Duplex
- 16 Custom Bike Racks  
Laser Cut Designs
- 17 Image Infusion Finish

# 18

## Bike Maintenance

- 18 Fixit
- 19 Air Kit 2  
Air Kit 3  
Tool Kit  
Pump Stop

# 20

## Bike Shelters

- 21 Kolo Shelter  
Cycle Station
- 22 Bike Haven  
Pocket Shelter
- 23 Vizor™ Shelter

# 24

## Bike Lockers

- 25 300 Series  
350 Series

# 26

## Product Options

- 26 Finish Options
- 27 Mounting Options

# Commercial Bike Racks



## Hoop Rack

The Hoop Rack is a proven design that provides high security and easy bike parking. The Hoop Rack uses thick pipe construction, and the full radius of the bend makes the Hoop an attractive and functional bike rack.

Parks 2 bikes

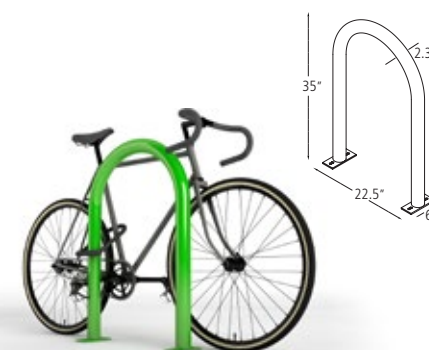

## Hoop Rack Heavy Duty

For added security and peace of mind, the Heavy Duty Hoop Rack uses a larger, thicker pipe than our standard Hoop Rack.

Parks 2 bikes





### Bike Hitch

The Bike Hitch is specifically designed for sidewalks and other narrow space applications. The design of this bicycle rack restricts bikes to parking parallel with the rack, so bikes won't intrude into the sidewalk or street.

Parks 2 bikes



### Arc Rack

Square tubing provides function and style with clean geometric lines and resistance to pipe-cutters – a tool of choice among bike thieves.

Parks 2 bikes

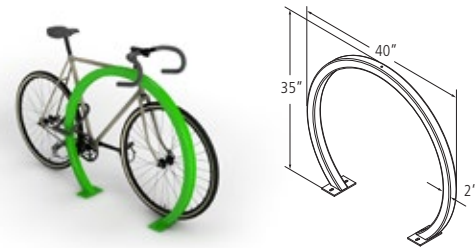

### Round Rack

The Round Rack enhances public spaces while providing secure parking for two bikes.

Parks 2 bikes

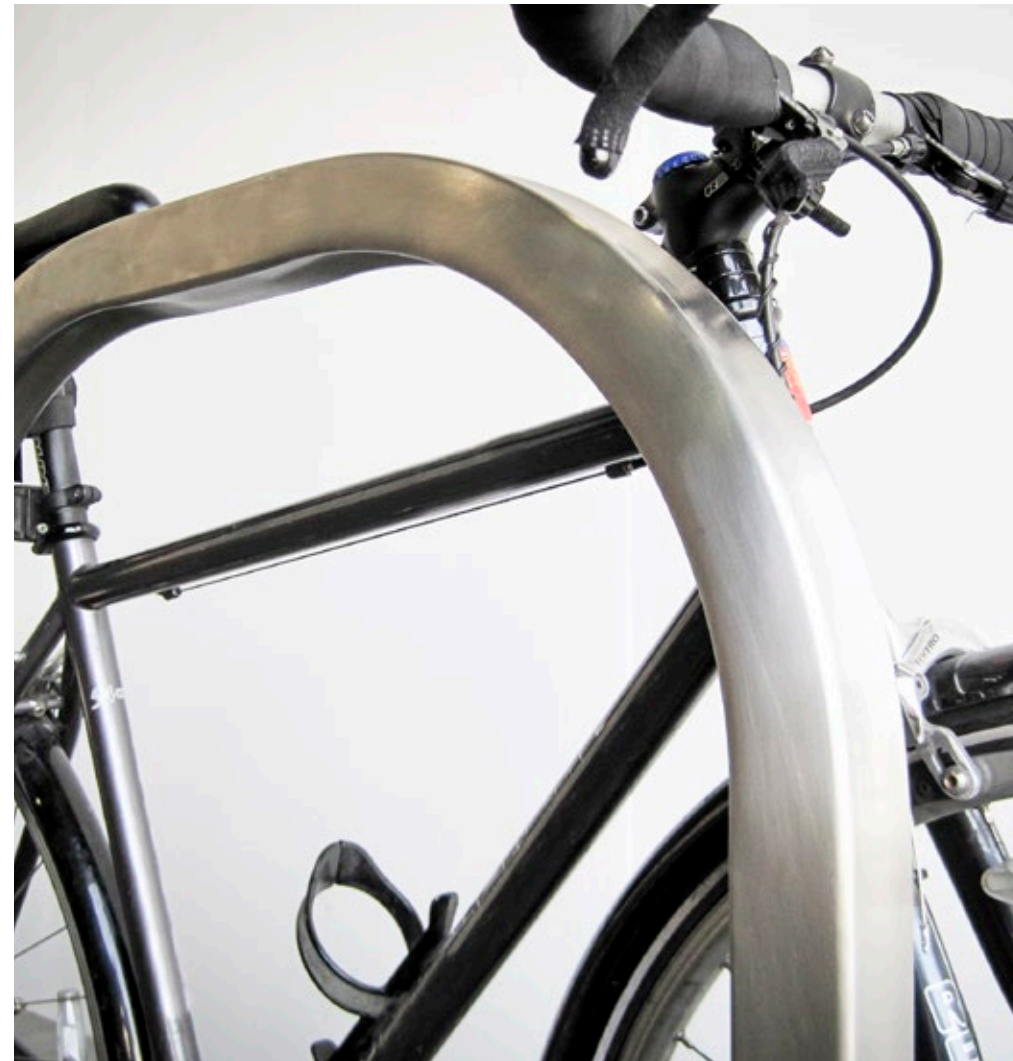
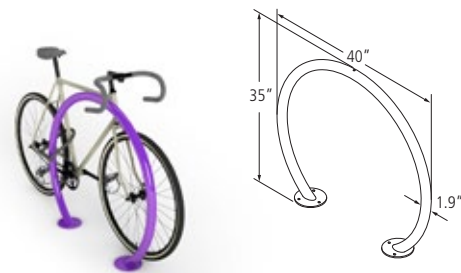

### Downtown Rack

The Downtown Rack uses thick, square-tube construction that can't be cut with a pipe cutter.

Parks 2 bikes

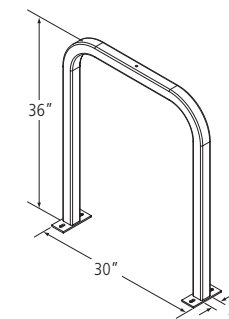

### Helix Rack

The Helix Rack is a whimsical, space efficient bicycle rack. It supports bicycles at two points and provides secure bike parking.

Parks 6 bikes

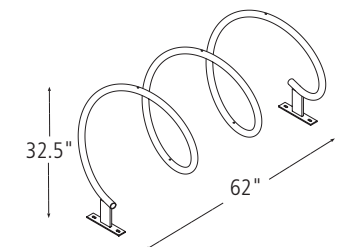



### Rolling Rack

This rack uses thick pipe construction and allows for one of the wheels and frame to be secured using a u-style bike lock.

The Rolling Rack is available in a variety of lengths to suit your bike capacity needs.

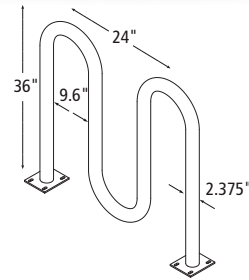

- RR2H  
38"  
5 Bikes
- RR3H  
63"  
7 Bikes
- RR4H  
87"  
9 Bikes
- RR5H  
111"  
11 Bikes



### Broadway Rack

The Broadway Rack is a great fit in areas where maximum security is a top priority. Made of thick, two-inch square steel, the Broadway Rack renders pipe-cutters useless.

The Broadway Rack is available in a variety of lengths to best suit your bike parking capacity needs.

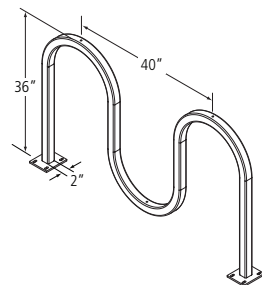

- BR2H  
60"  
5 Bikes
- BR3H  
100"  
7 Bikes
- BR4H  
139"  
9 Bikes



### Campus Rack

The Campus Rack provides you with superior bike support, orderly bicycle parking and high security. Available in single or double-sided models in various lengths.

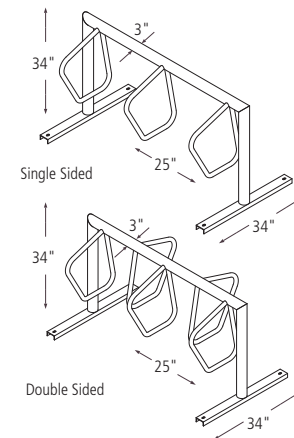

- S3  
64"  
Parks 3 bikes
- S4  
89"  
Parks 4 bikes
- S5  
114"  
Parks 5 bikes
- S6  
139"  
Parks 6 bikes
- D5  
64"  
Parks 5 bikes
- D7  
89"  
Parks 7 bikes
- D9  
114"  
Parks 9 bikes
- D11  
139"  
Parks 11 bikes



### Hi Roller

By adding an extra bend to a rolling-style rack, the Hi Roller provides a much greater degree of bicycle support than standard serpentine style racks.

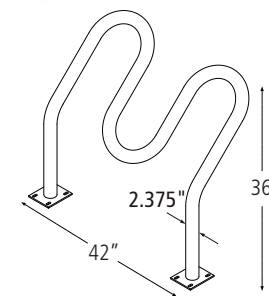

- Hi2H  
42"  
4 Bikes
- Hi3H  
66"  
5 Bikes
- Hi4H  
90"  
6 Bikes
- Hi5H  
114"  
7 Bikes



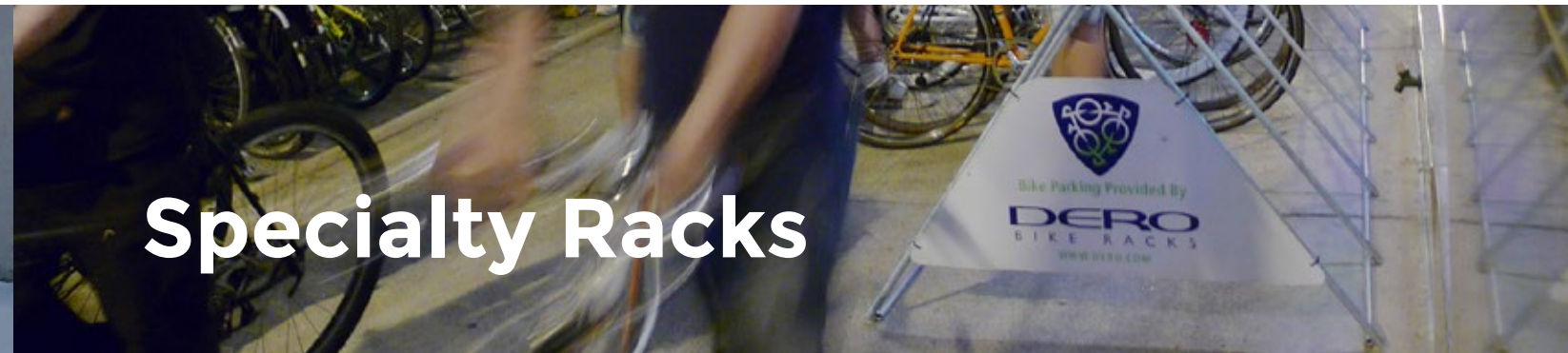

# Specialty Racks



## Recycle Rack

The Recycle Racks are made of 96% recycled content, using solid 1" rebar "cut-offs" and are available in environmentally-friendly, powder coated finishes.

Parks 2 bikes

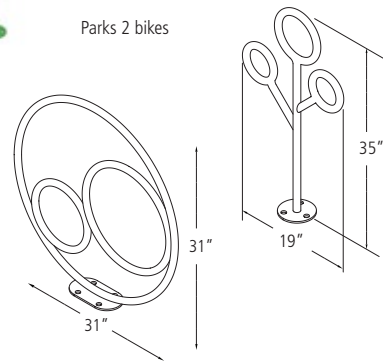

## Bike Bike Rack

The Bike Bike Rack is an eye-catching, functional piece of street art that playfully reminds us that we could be riding our bike today, and rewards those that do with a secure, convenient place to lock up.

Parks 2-4 bikes

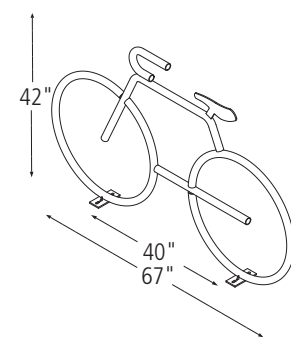

## U-Lockit™

New!

Perfect for smaller applications and short-term parking at schools, churches, and small businesses. Modular design can be expanded to fit your capacity needs.



## Wall Rack

Bike owners like this option for garage and home storage. The rubber coating keeps bikes from getting scratched. Two bikes can be hung up and locked securely, as the Wall Rack is fully u-Lock compatible for both bikes.

Parks 2 bikes



## Event Rack

The Event Rack is an innovative design that addresses the needs of any game, festival, or event requiring temporary and secure bike parking. It is easily moveable, stackable and requires no assembly.

Parks 14 Bikes



## Meter Hitch

Based on our popular Bike Hitch, the Meter Hitch is designed to fit into the streetscape, using existing meter poles with or without meter heads. The Meter Hitch has a minimal footprint and is a bicyclist favorite for its ease of use and solid bike support.

Parks 2 bikes



## Compack Rack

The Compack Rack is a portable, stackable and u-lock compatible rack. The Compack Rack is well suited for children's bikes at parks and schools.

Parks 8 bikes



## Switchback™

New!

The Switchback™ Rack allows for horizontal bike parking along a wall when your space is limited.

Parks 1 bike



## Bike Hook Solo

The Bike Hook Solo provides a simple, space-efficient way to store and lock up your bike.

Parks 1 bike



## Lock Dock

The Dero Lock Dock will keep your staff or regular clients' locks readily available and eliminate the need for them to be carried back and forth everyday.



## Ultra Space Saver

The Ultra Space Saver is an easy to install, modular system. It can be made to fit in nearly any space. Options include: wall-mount, floor-mount, and double-sided.

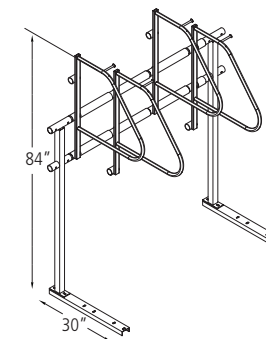

## Ultra Space Saver Single

A smaller version of our Space Saver Modular System, the Single parks your bike vertically and mounts onto nearly any wall type (except metal studs).

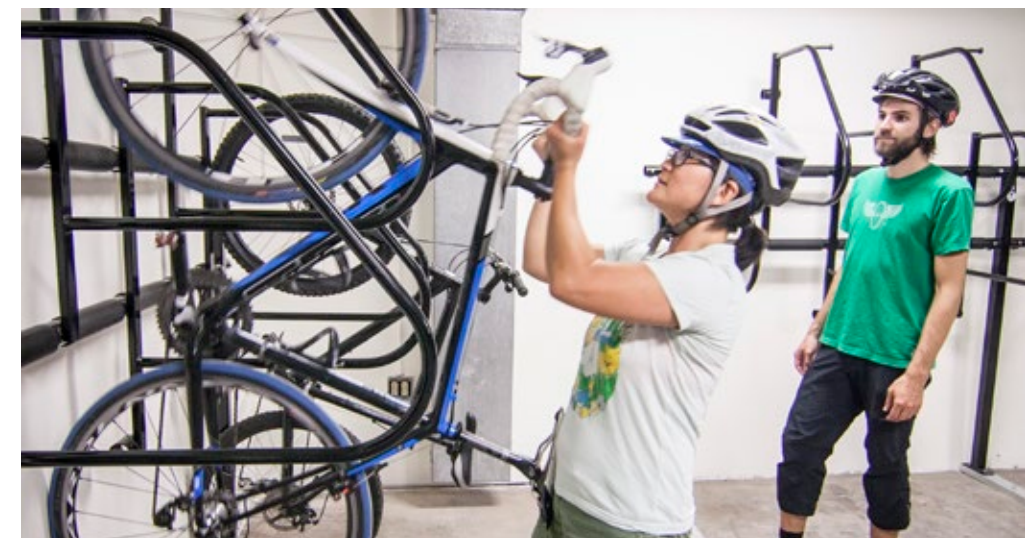

## Track Rack

The Track Rack's unique staggered, sliding hook design creates the greatest parking efficiency while still providing easy access to any particular bike. When adding or removing a bike to the rack, simply push the surrounding bikes out of the way.

\*Not lockable

Parks 13 bikes per section



## Bike File

The Bike File is our most space efficient u-lock compatible product. Sturdy sliding hangers allow nine bikes to be securely stored in an eight-foot section while allowing for easy loading and unloading of bikes.

Parks 9 bikes per section



### Cycle Stall Elite

The Cycle Stall Elite from Dero turns a standard on-street car parking stall into protected bike parking. The Cycle Stall Elite includes everything needed for the conversion of a parking space from car to bike parking.

Parks 14 bikes



### Cycle Stall Basic

The Cycle Stall Basic kit covers the needs of cities and businesses that want to provide an on-street bike corral at a low cost with minimal changes to infrastructure.

Parks 10 bikes

### Build Your Own!

Nearly all of our commercial grade bike racks are as functional on the street as they are on a sidewalk. We offer everything you need to assemble a bike corral to suit your own requirements for aesthetics, security and capacity.

# 2-Tier Bike Parking

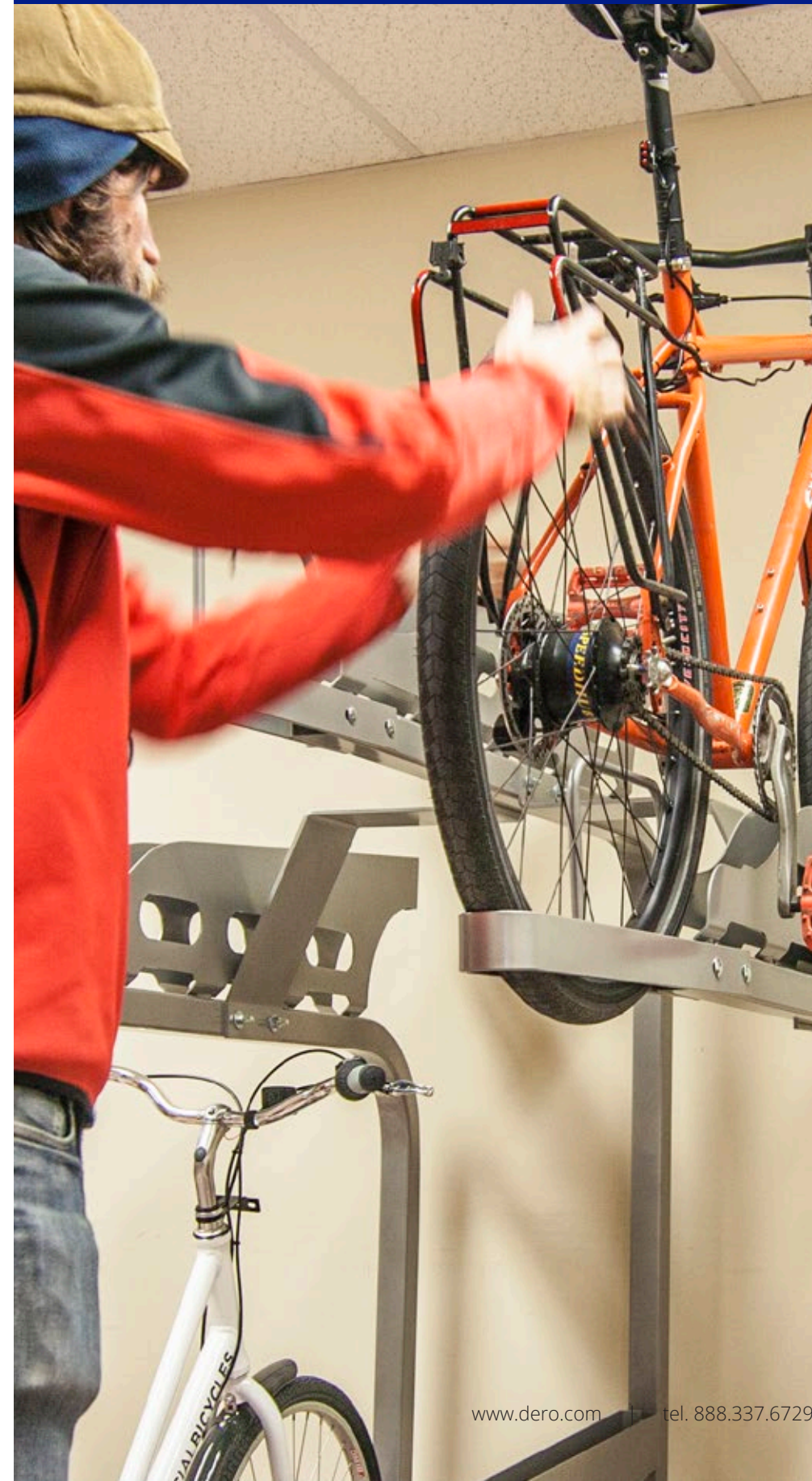

New look!



### Dero Decker

The Dero Decker has a front wheel safety locking lever and tray dampers to provide safe lowering of upper trays. The vertical load trays also reduce the required aisle space, giving the Dero Decker the smallest footprint on the market.

New look!



### Dero Duplex

Sturdy trays with high sides keep bikes from slipping off while loading or unloading and also make the Duplex compatible with most standard u-locks.

# On-street Bike Parking



# Custom Bike Rack Designs

We have produced hundreds of custom bike rack designs in all shapes and sizes. Choose a rack from our existing line of artistic racks or have us design something especially for you – we'll even do the design work for free!

To see our existing designs visit [www.dero.com](http://www.dero.com)

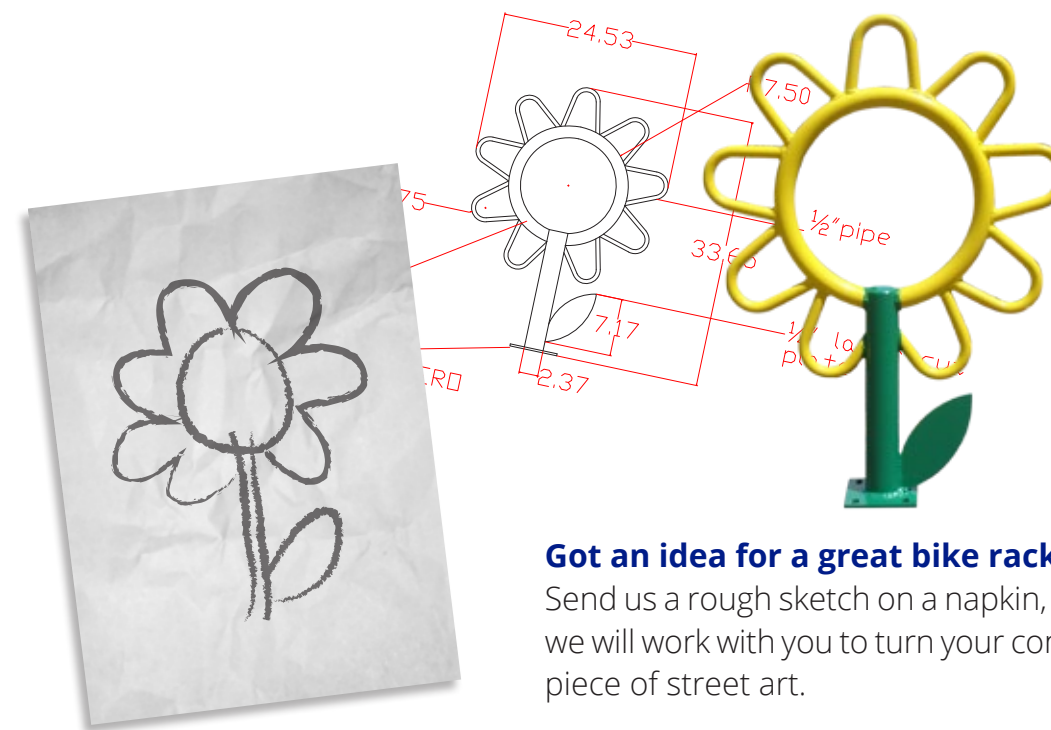

### Got an idea for a great bike rack?

Send us a rough sketch on a napkin, a logo, or just an idea, and we will work with you to turn your concept into a fully functional piece of street art.

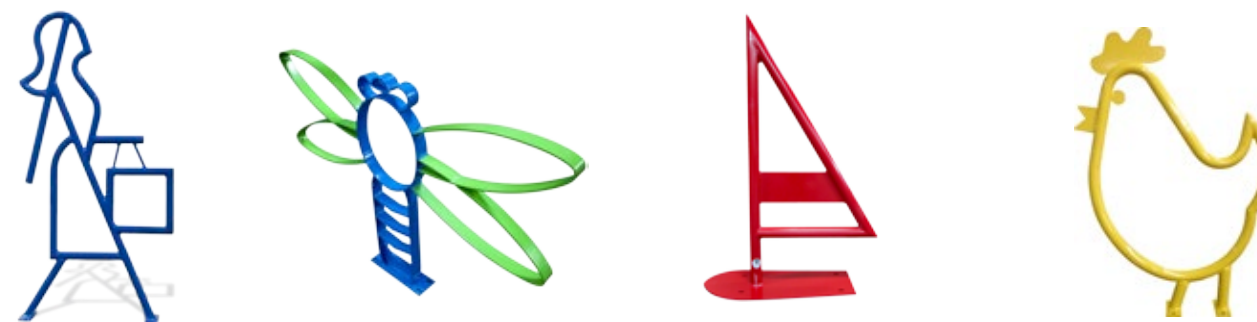

## Laser Cut Designs

As a lower cost alternative to a fully custom designed rack, we can laser cut your logo or other design into steel plate and weld it into one of our standard bike racks.



## Image Infusion

Achieve visually stunning, photo-quality images with the durability of powder coating. Unlike stick-on decals, Image Infusion bakes your graphic right into the finish.

Image Infusion is now available on our Bike Hitch, Hoop Rack, and Bike Bike Racks.





# Public Bike Maintenance

## Fixit

The Fixit includes all the tools necessary to perform basic repairs and maintenance, from changing a flat to adjusting brakes and derailleurs. The tools and air pump are securely attached to the stand with stainless steel cables and tamper-proof fasteners. Hanging the bike from the hanger arms allows the pedals and wheels to spin freely while making adjustments.

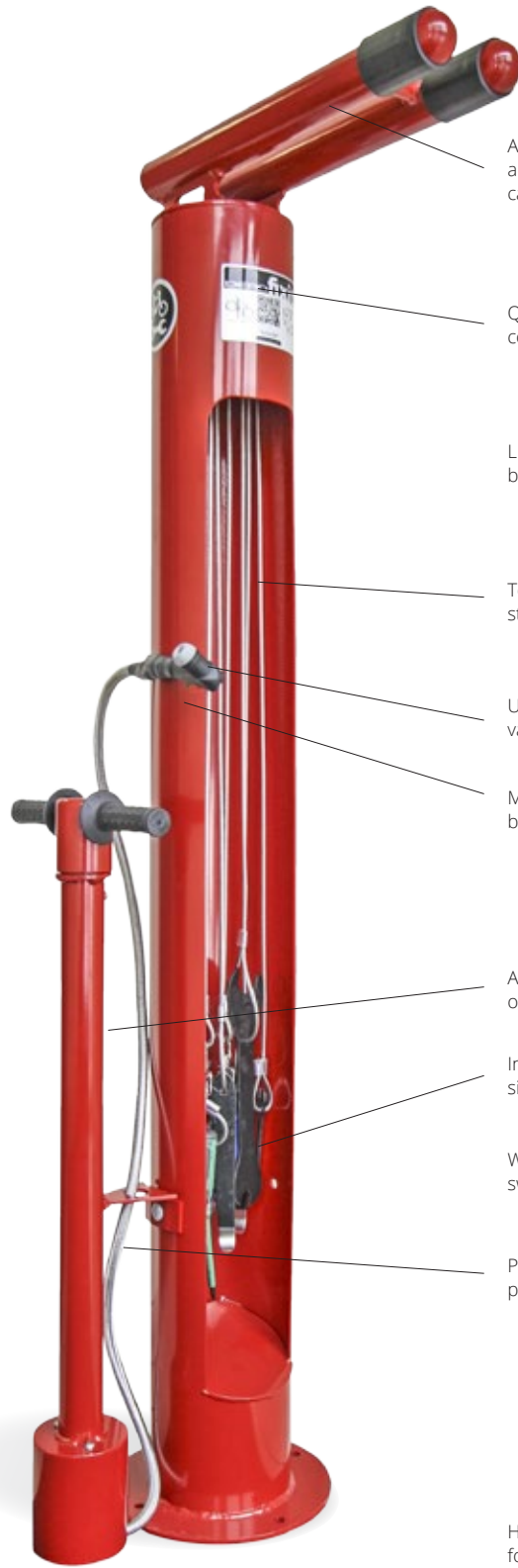
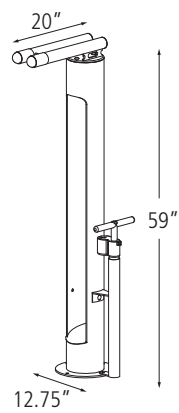

ADA compliant hanger arms accommodate most types of bikes and can be mounted at 12, 3, 6, or 9 o'clock

QR code takes smart phone users to comprehensive bike repair web site

Large surface area for sponsorship, branding, or way-finding signage

Tools are secured with braided stainless steel aircraft cables

Universal pump head accommodates all valve stem types

Magnetic pump head attaches to Fixit body

Air Kit 2 can be mounted on either side or back of Fixit

Includes most commonly used tools for simple bike maintenance

Wrenches and screwdrivers are on swivel connectors for easier use

Pump hose is reinforced for maximum protection

Hanger and pump pack inside main body for easy, inexpensive shipping

Patent D680,914 S



## Air Kit 2

The Air Kit 2 is specifically designed for the heavy duty use public bike pumps receive. Universal pump head accommodates both Schrader and Presta valves. Can mount to Fixit or to ground.



## Air Kit 3

The Dero Air Kit 3 is designed for heavy duty, repeated public use. The waterproof gauge and burly construction mean that this pump will continue to work long after others have failed.



## Pump Stop

For bikes without kickstands be sure to include this handy accessory which holds bikes firmly upright while users fill up their tires.



## Tool Kit

The Dero Tool Kit includes all the necessary tools to perform routine bicycle maintenance. Available in a surface mount or wall mount.





# Bike Shelters

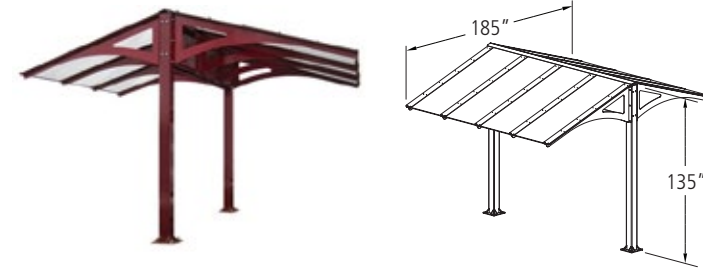

## Kolo Shelter

The unique styling of our Kolo Shelter will help beautify your facility and provide secure, covered bike parking for cyclists. The Kolo is designed to accommodate a variety of bike parking options, including vertical and two-tiered arrangements, to best suit your needs. The Kolo comes in 80", 117" or 154" modular lengths.

Parks 5 - 30 bikes depending on configuration

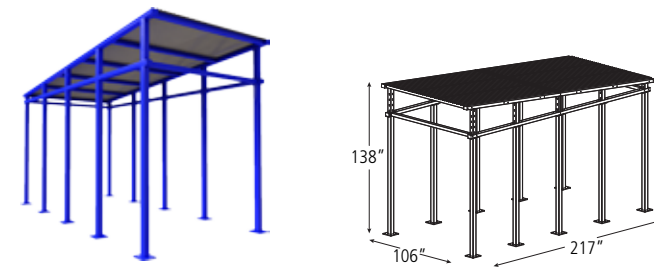

## Cycle Station

The Cycle Station provides high-capacity, covered bike parking for bicycle commuters. With a high roof and open platform, the Cycle Station allows horizontal, vertical or two-tiered bike parking configured to meet your specific needs.

Parks 8 - 16 bikes depending on configuration



All Dero shelters are modular and can be added to for increased capacity. Multiple options are available for benches, walls, security and lighting. Call or email us to design a shelter that fits your needs.

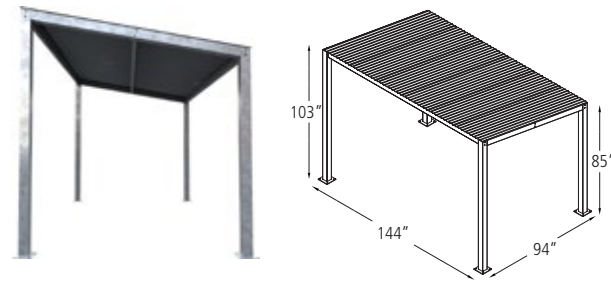

### Bike Haven

The Dero Bike Haven bridges the gap between short and long term bike parking. Starting with a simple canopy design, the Dero design team worked to provide a solid, cost-effective, and easy-to-assemble structure. Optional polycarbonate side and back panels are available for additional protection.

Parks 4 - 14 bikes depending on configuration

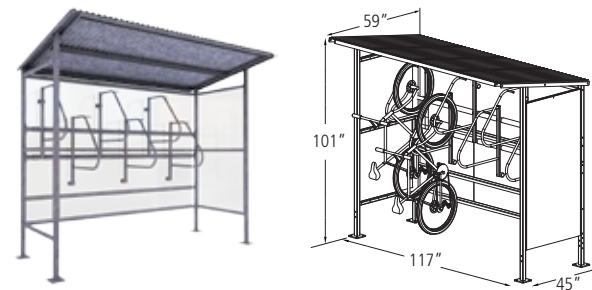

### Pocket Shelter

Small and versatile, the Pocket Shelter stores bikes in areas that would not normally accommodate bike parking. This shelter is a modular system that provides covered and secure bike storage but is extremely space efficient and cost-effective. Compatible with Ultra Space Saver or Bike File.

Parks 6-10 bikes

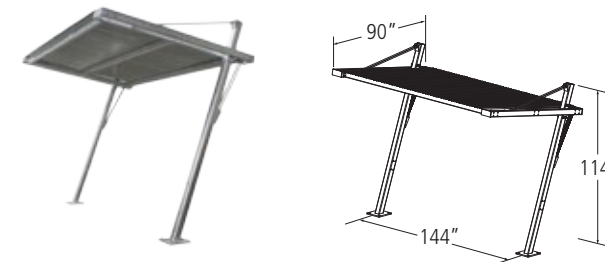

### Vizor™ Shelter

The Vizor™ is a beautiful cantilever designed shelter that is able to accommodate any Dero bike rack system, including two-tiered models.

All Dero shelters are modular and can be added to for increased capacity. Multiple options are available for benches, walls, security and lighting. Call or email us to design a shelter that fits your needs.

# Bike Lockers



## 300 Series

- Ships fully assembled
- Each unit self-contained
- Choice of two colors
- Stackable option
- Budget priced

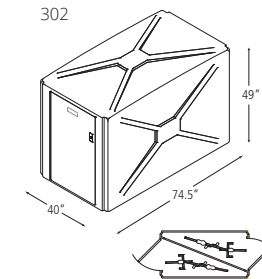
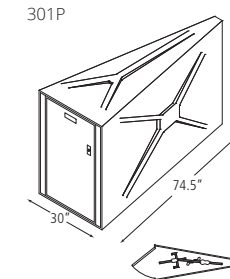
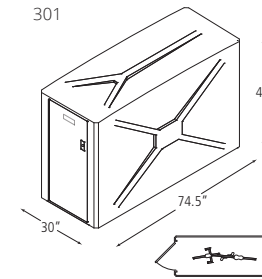

## 350 Series

- Modular construction - lockers can share walls
- Choice of seven colors
- Stainless steel hardware
- Air vents
- Gear hooks
- Number plates included
- Requires on-site assembly

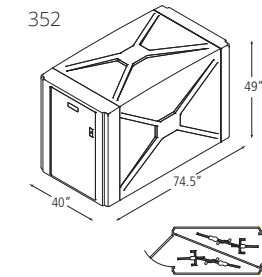
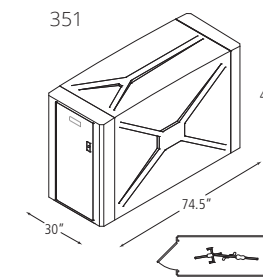

# Standard Finish Options



## Galvanized

Hot dipped galvanized is an extremely durable and low cost finish option. The bike racks are hot-dipped galvanized after fabrication and then hand ground to ensure a clean, safe surface.



## Stainless

Stainless steel is the most beautiful and durable option. We use a 304 grade stainless steel material finished in either a high luster electropolished shine or a satin #4 finish. Both finish options include the Spectra Shield finish for maximum corrosion protection.



## PVC Dip

Dero offers a rubbery, durable PVC coating in a range of colors on many models of bike racks. A rust-inhibiting pre-treatment is applied to the underlying steel before being dipped in UV-stabilized PVC. The coating is subsequently cured to produce a colorful coating that offers excellent protection against abrasion, impact, and corrosion. The PVC coating can be applied to galvanized racks to provide an even greater level of corrosion protection.

## Powder Coating

Powder coating provides a durable finish using a solvent-free process that is better for the environment than liquid paints. If our 20 standard colors aren't enough we can match to over 250 custom colors.

Black	White	Light Gray	Deep Red
Yellow	Bright Yellow	Orange	Blue
Sky Blue	Hunter Green	Light Green	Green
Sepia Brown	Bronze	Silver	Dark Purple
Flat Black	Wine Red	Beige	Iron Gray

## Thermoplastic Coating

Surface preparation for applying a thermoplastic finish is the same as is done with powder coating. However, unlike powder coating, no primer is required. The thickness of the thermoplastic finish is more than powder coating, typically from 8 - 10 mils. In addition to increased thickness, the thermoplastic finish offers superior impact resistance over powder coating, is the most bicycle-friendly finish as it will not scratch bike frames, and is added over a galvanized finish for maximum durability.

Black	Blue	Green	Red
Gray	Brown		

# Standard Mounting Options

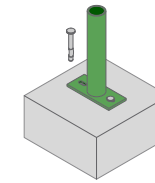

## Surface Mount

For surface mounted racks a variety of anchors may be used depending on the surface material. Standard anchors are included in the cost of the rack, and tamper proof anchors may be purchased for an additional charge. Please contact us for more information about tamper proof options.

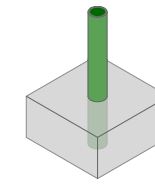

## In-Ground Mount

In-ground mounted racks are embedded into a concrete base, approximately 6-10" below ground level.

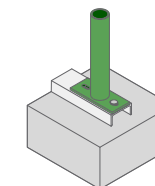

## Rail Mount (Freestanding)

Bike racks mounted onto rails may be anchored to the ground for maximum security and easiest installation, or they may be left freestanding. This provides the greatest flexibility for placing racks on a variety of surfaces such as gravel and grass, where permanent anchoring is not an option.

## Tamper Resistant Fasteners

The concrete spike is a permanent anchor. The top of the wedge anchor can also be pounded sideways after installation so that it cannot be removed. Other tamper resistant fasteners are also available for purchase.



Breakaway Nut



Stainless Tamper-Proof Nut



Triple-Slot Nut



Concrete Spike

## Product Downloads

[www.dero.com/downloads.html](http://www.dero.com/downloads.html)



3 Part Specs



CAD



Revit



Sketchup



Brochures



Photos



**DERO**  
A **PLAYCORE** Company

504 Malcolm Avenue SE, Suite 100  
Minneapolis, MN 55414  
tel 888.337.6729  
fax 612.331.2731  
[www.dero.com](http://www.dero.com)