

DRAPER®

AV416R RETAIL PRICE LIST
EFFECTIVE APRIL 11, 2016

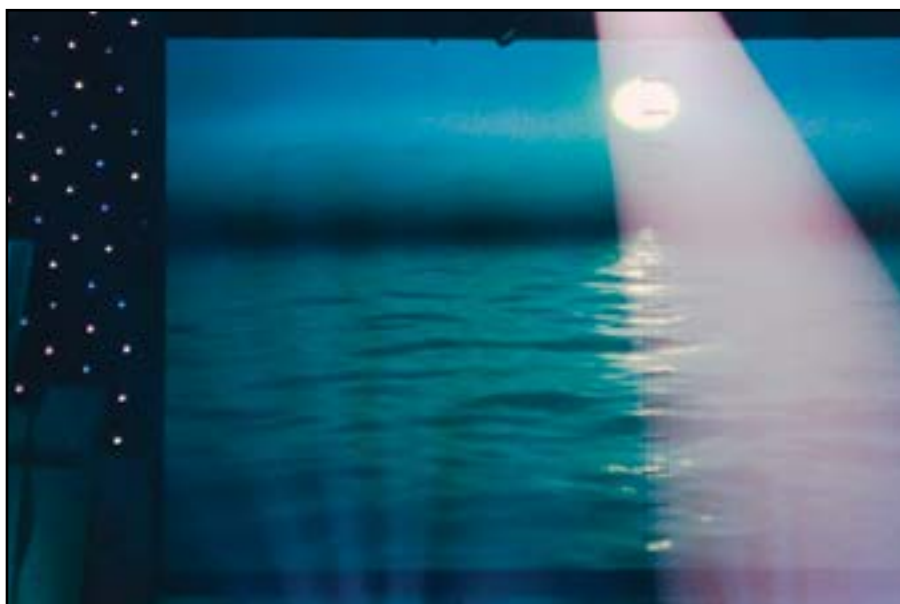

PROJECTION
SCREENS
& RELATED EQUIPMENT

2016
PRICE LIST

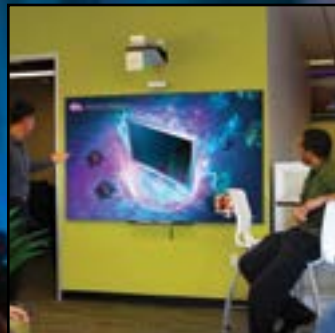

SIGN UP FOR THE DRAPER **PRO** PORTAL!

DOWNLOAD YOUR CURRENT PRICING, CHECK ORDER STATUS, TRACK YOUR SHIPMENTS, AND ACCESS SOME OF THE BEST TOOLS IN THE INDUSTRY LIKE THE DRAPER PROJECTION PLANNER:

[DRAPERINC.COM/DRAPER**PRO**](http://DRAPERINC.COM/DRAPERPRO)

Motorized
Screens

Manual
Screens

Permanently
Tensioned Screens

Portable
Screens

Presentation
Easels

Rear
Screens

Projector &
FlatScreen Lifts

Utility Line
Hoisting System

Contacting
Draper

What's New in this Price List?

NEW! Ultimate Access XL

The newest product in the Draper motorized screen line is the Ultimate Access XL. This ceiling-recessed screen with an automatic closure is available in sizes through 22' wide! The Ultimate Access XL also replaces the discontinued Signature Series/E & V. See page 16 for more details.

Ultimate Access and Access XL

The newly redesigned Ultimate Access and Access XL feature a steel constructed case. **IMPORTANT: All part numbers for these products have been replaced.** Download our Excel price list to help update your documentation. Additional information can be found on page 16.

MAP Pricing

You'll notice that Draper has enacted a MAP policy effective June 1, 2016. For the complete Draper MAP (Minimum Advertised Price) policy, see page 106.

2016 Product Changes

In order to streamline our product offering, we have discontinued the Signature Series/E & V, the Diplomat tripod screen (replaced by the sturdier Diplomat/R), and many of our Presentation Easels. We have also discontinued the Apex, MicroScreen, V Screen, Home Theatre Stage Curtain, and DiamondScreen.

Fly Brackets for Folding Screens

With the addition of fly brackets for all of our folding screens, you will be able to suspend them without needing leg supports.

AeroLift

Draper's popular AeroLift projector lifts have been improved! All models are now UL listed! They also have increased lifting capacity to handle a larger variety of projectors so we've changed their names accordingly: Additional details can be found on page 98.

TecVision

With 8 surface options available, our TecVision line of premium surfaces continues to grow. We are also pleased to announce that our TecVision surfaces are now **8K** ready and available in larger sizes.

Visit www.draperinc.com/go/TecVision.htm for the latest on TecVision!

In-House Graphic Printing

Draper's now offers in-house printing! This means that for most orders that involve graphic printing, you'll benefit from bright, vivid colors, and prompt shipping.

Glass Beaded Discontinued

Glass Beaded CH3200E will no longer be offered as a surface option in the OptiView Family. Please see page 4 for other surfaces.

Are you a Draper PRO?

Did you miss the last new price list, or an important product announcement? You need to sign up for the **Draper Pro Portal**, where you can quickly find everything you need! Sign up with your Draper account number (see mailing label) and you can instantly download your current pricing, check order status, track your shipments and use tools like the Draper Projection Planner. Be sure to leave the "accept emails" box checked so we can send you pricing and product updates. You'll never feel like you're missing something again. See some of the tools we make available in the Pro Portal:

- Price list download
- Order status
- FocalPoint configuration
- StageScreen configuration
- Projection Planner
- Projector Lift Selector
- Shipment tracking
- Inventory level
- Freight quotations
- Resource library

Register here: www.draperinc.com/DraperPro

Ordering from this Price List

This price list contains part numbers for most products. The part numbers represent the most popular standard features. If you order options listed in the "Options" paragraph for each product, such as a non-standard case color, extra drop or built-in controls, you will see a product description rather than a part number on your acknowledgment, packing list or invoice. If you order a standard product with no variation, our paperwork will show the part number followed by a short description.

If you choose to order using part numbers, please remember that any options you want to add must be fully described in your order.

All orders are subject to the terms and conditions outlined on page 105-107 and on Draper order acknowledgments.

Dimensional Weights

Small-package services, such as UPS, ship most packages by actual weight. However, when a package is unusually large or bulky for its weight, a weight factor is calculated based on the dimensions of the carton.

accurately, we've provided dimensional weights wherever available in this price list. Wherever there is no dimensional weight, you may use the shipping weight for your freight calculation.

Certain Draper products are charged for dimensional weight when shipped via parcel service. In order to help you estimate your shipping costs more

Some air freight shipments may also ship under a dimensional weight. Contact Draper for a freight estimate.

Table of Contents

| | | | |
|---|----|-------------------------------------|-----|
| Viewing Surfaces | 3 | Rigid Rear Projection Screens | 87 |
| Viewing Surface Descriptions | 4 | Projector & FlatScreen Lifts..... | 91 |
| Environmental Certifications | 6 | TorkStar Utility Line Set | 101 |
| Recycling Your AV Equipment..... | 6 | Communicating with Draper..... | 103 |
| Screen Size Selection | 7 | Part Number Prefix Key | 105 |
| Motorized Projection Screens | 8 | Terms and Conditions..... | 105 |
| Manually Operated Projection Screens | 37 | Patent Information..... | 105 |
| Portable Projection Screens..... | 64 | MAP Policy | 106 |
| Presentation Easels | 86 | Freight Considerations..... | 107 |
| Permanently Tensioned Projection Screens..... | 51 | Alphabetical Index..... | 108 |

Viewing Surface Families and Names

Draper offers the widest selection of viewing surfaces in the industry, giving you the flexibility to choose the right surface for ANY installation.

With such a wide selection, choosing the right surface can seem like a challenge. To make it simple, we have grouped our surfaces into five families. In addition, each surface has been given a unique and descriptive name with numeric parameters to help anyone understand their qualities and purpose at a glance.

Having trouble choosing the right screen? Visit our website and check out our Screen Selection Tools. There you will find multiple tools that will aid you in making the best decision. www.draperinc.com/go/FrontScreens.htm

Families of Viewing Surfaces

Draper viewing surfaces are divided into five distinct families: *OptiView*, *OptiFlex*, *CineFlex* and *ClearSound*.



OptiView: Our OptiView surfaces are all self-supporting and do not require tensioning to perform properly. These surfaces are generally installed on operable roller screens with a dowel. Most surfaces in this group have a tearproof fiberglass base textile. OptiView surfaces are extremely sturdy and suitable for use in a variety of settings.



OptiFlex: The OptiFlex surfaces are suitable for tensioning and are available on permanently tensioned screens, tab tensioned roller-operated screens, and portable screens. Choose OptiFlex for the flattest viewing surfaces.



CineFlex: Draper has offered a CineFlex flexible rear projection surface for many years. CineFlex is now a family, offering choices of gain and color to meet a range of rear and dual front/rear projection needs. CineFlex surfaces are available on a wide range of permanently tensioned, portable, and tab tensioned projection screen models.

ClearSound: All surfaces in the ClearSound family are acoustically transparent. Standard and microscopic perforations are available, and the innovative woven acoustically transparent fabrics—first available through Draper—are also still in the line. The combination of self-supporting and tensioned surfaces means that almost any Draper projection screen model can be provided with a ClearSound surface.

TecVision: TecVision surfaces are now 8K ready, suitable for tensioning and are available on many permanently tensioned screens, or tab tensioned roller-operated screens. Choose TecVision for unmatched consistency as it pertains to uniformity, gain, contrast, ambient light rejection and gloss. This premium surface is not sold online and is [available in a separate price list](#). Please call Draper for additional details.

Finding Your Surface: Cracking the Code

Now that you've found the right family, the viewing surface name helps you complete your selection. The name consists of a short descriptive phrase followed by an alphanumeric code which tells you about the viewing cone, contrast, gain, and family.

For example, our standard self-supporting Matt White surface is named Matt White XT1000E, and is part of the OptiView family of viewing surfaces. Here is a breakdown of that name.

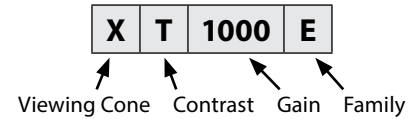

Viewing Cone

- **X:** Extra-wide. Half gain is greater than 60 degrees.
- **M:** Moderate. Half gain is 30-60 degrees.
- **C:** Controlled. Half gain is less than 30 degrees.

Contrast

- **T:** Typical. Surfaces with "typical" contrast are white in color and are generally recommended for use where ambient light is controlled.
- **H:** High. Surfaces with "high" contrast usually have a grey surface or substrate. Their black retention is enhanced and they perform well under reasonable levels of ambient light.
- **S:** Superior. This designation is reserved for surfaces with remarkable contrast and resistance to ambient light. Our "Superior" surfaces will meet or exceed the contrast offered by any competitive viewing surface.

Gain

The numeric portion of the surface name is its typical peak gain x 1000. Gain levels of Draper surfaces cover the full range from 0.6 to 3.2. Lower gain surfaces offer excellent uniformity across wide viewing cones, for excellent edge blending and consistent reproduction with short throw projectors. Higher gain surfaces can grab the viewer with brilliant images in a variety of settings.

Family

Surface names also include a suffix of V, E, or X. V indicates the surface is flexible or suitable for tensioning (including OptiFlex, CineFlex, and some ClearSound surfaces); E indicates the surface is a self-supporting material (including OptiView and some ClearSound surfaces). X indicates the surface is from the TecVision family.

PRO PORTAL

NEED HELP SELECTING THE RIGHT SURFACE?

Draper's Projection Planner is here to help. Built with the knowledge and expertise of nearly 60 years in the AV industry, the Draper Projection Planner is a valuable tool when it comes to picking the right surface for every situation.

register here: www.DraperInc.com/DraperPRO

Viewing Surface Descriptions

OptiView Family of Surfaces



Self-supporting and do not require tensioning to lay flat. These front projection surfaces are generally installed on operable roller screens with a dowel. Most surfaces in this group have a tearproof fiberglass base textile. OptiView surfaces are extremely sturdy and suitable for use in a variety of settings. All viewing surfaces in this family are compatible with 4K and UHD projectors.

Matt White XT1000E

Extra Wide Viewing Cone / Typical Contrast / On-Axis Gain of 1.0

The standard to which all other screen surfaces are compared. Preferred viewing surface in educational and commercial markets. A matt white surface diffuses projected light in all directions, so the image can be seen from any angle. Offers accurate color rendition, and superior clarity due to its smooth, non-embossed surface. Requires adequate provision for the control of ambient light in the audience area. Unity gain with a panoramic 180° cone.

This surface is GREENGUARD GOLD certified.

Contrast Grey XH800E

Extra Wide Viewing Cone / High Contrast / On-Axis Gain of 0.8

Smooth grey surface offers excellent resolution and enhances color contrast and black levels in the projected image. Recommended for use with moderate and high output digital projectors. Performs well in conditions of ambient light. Full 180° viewing cone. This surface was previously named "High Contrast Grey."

This surface is GREENGUARD GOLD certified.

Contrast White XH1100E

Extra Wide Viewing Cone / High Contrast / On-Axis Gain of 1.1

Diffuse white coating over a grey base material, yields a surface with the best qualities of both matt white and contrast grey screen fabrics. Recommended for use with low to moderate light output digital projectors, where some provision for light control exists. Improves the quality of blacks without affecting whites. Flame and mildew resistant.

Argent White XH1500E

Extra Wide Viewing Cone / High Contrast / On-Axis Gain of 1.5

Matt white base material with luminous coating. Offers high reflectivity, while maintaining a broad viewing cone. Provides excellent resolution and color balance. Consider for use with moderate light output projectors in situations where ambient light cannot be adequately controlled. Flame and mildew resistant.

Pearl White CH1900E

Controlled Viewing Cone / High Contrast / On-Axis Gain of 1.9

Matt white surface with pearlescent surface coating. Offers excellent resolution, color balance and uniformity. Tolerates a higher ambient light level than many front projection screen surfaces. Moderate viewing cone. Flame and mildew resistant.

OptiFlex Family of Surfaces



OptiFlex surfaces are suitable for tensioning and are available on permanently tensioned screens, tab tensioned roller-operated screens, or both. Choose OptiFlex for the flattest front projection viewing surfaces. All viewing surfaces in this family are compatible with 4K and UHD projectors.

Matt White XT1000V

Extra Wide Viewing Cone / Typical Contrast / On-Axis Gain of 1.0

Unity gain: the perfect matt white diffusing surface. Recommended for use with all types of projectors provided ambient light can be reasonably controlled. Reflects a uniformly bright image over complete 180° viewing cone with precise resolution and accurate color balance. This surface was previously named "M1300." Optionally available with black backing as Matt White XT1000VB.

This surface is GREENGUARD GOLD certified.

Grey XH600V

Extra Wide Viewing Cone / High Contrast / On-Axis Gain of 0.6

Grey front projection surface provides excellent contrast and black reproduction. Intended for use with moderate to high output digital projectors. Grey color enhances color contrast and black levels in the projected image. Also allows for more ambient light in the audience area than matt white surfaces. Relatively broad viewing cone. This surface was previously named "HiDef Grey." Optionally available with black backing as Grey XH600VB.

This surface is GREENGUARD GOLD certified.

Pure White XT1300V

Extra Wide Viewing Cone / Typical Contrast / On-Axis Gain of 1.3

Draper Pure White XT1300V offers a 30% boost in brightness over a traditional matt white surface while still maintaining an extremely wide viewing cone, with half gain angle over 90 degrees. No color shift at any angle, excellent white field uniformity. Pure White XT1300V is a great surface where lighting is well controlled and where enhanced image brightness is needed due to limited projector brightness. **Please Note:** This surface will contain one or more seams if image area surpasses 90" high.

Pearl White MH1500V

Moderate Viewing Cone / High Contrast / On-Axis Gain of 1.5

Matt white surface with pearlescent coating. Offers excellent resolution, color balance and uniformity. Tolerates a higher ambient light level than many front projection screen surfaces. Moderate viewing cone. This surface was previously named "CH1900V."

ReAct MS1000V

Moderate Viewing Cone / Superior Contrast / On-Axis Gain of 1.0

Silver/grey surface offers enhanced color contrast even in ambient light. Draper's ReAct MS1000V is fully HD compliant and is available on both permanently tensioned and tab-tensioned screen models. This surface is ideal for multipurpose spaces where lights remain on.

Viewing Surface Descriptions

ClearSound Family of Surfaces

All surfaces in the ClearSound family are acoustically transparent. Standard and microscopic perforations are available, and the innovative woven acoustically transparent fabrics—first available through Draper—are also still in the line. The combination of self-supporting and tensioned surfaces means that almost any Draper projection screen model can be provided with a ClearSound surface.

ClearSound White Weave XT900E



Extra Wide Viewing Cone / Typical Contrast / On-Axis Gain of 0.9

The most innovative and versatile acoustically transparent screen material available. Reflects uniform image over full 180° field with accurate color fidelity. Acoustical properties are comparable to the highest quality speaker grille cloth. Some control of ambient light is recommended. Flame and mildew resistant. This surface was previously named "AT1200." Not recommended for viewing less than 10' from screen.

ClearSound Grey Weave XH600E



Extra Wide Viewing Cone / High Contrast / On-Axis Gain of 0.6

Offers the acoustical properties of ClearSound White Weave XT900E, while providing the best optical qualities of both matt white and contrast grey screen fabrics. Provides vivid color contrast over a full 180° viewing cone. Flame and mildew resistant. This surface was previously named "AT Grey." Not recommended for viewing less than 10' from screen.

ClearSound NanoPerf XT800V



Extra Wide Viewing Cone / Typical Contrast / On-Axis Gain of 0.8

Microscopic perforations in the fabric create an acoustically transparent surface that does not compromise audio quality when speakers are placed behind the screen, while providing a beautiful image. The projected image is gorgeous, with a full 180° viewing cone and accurate color reproduction. Ideal for home theatre. Not recommended for viewing less than 10' from screen.

ClearSound Perf XT900V

Extra Wide Viewing Cone / Typical Contrast / On-Axis Gain of 0.9

Flexible matt white perforated surface. Reasonable control of ambient light is recommended. Not recommended for viewing less than 20' from screen. For shorter viewing distances, or 4K/UHD projection, we recommend ClearSound NanoPerf XT800V.

ClearSound Perf XT950E

Extra Wide Viewing Cone / Typical Contrast / On-Axis Gain of 0.95

Textile backed matt white perforated surface. Not recommended for viewing less than 20' from screen. For shorter viewing distances, or 4K/UHD projection, we recommend ClearSound White Weave XT900E and ClearSound Grey Weave XH600E.

CineFlex Family of Surfaces



Draper has offered a CineFlex flexible rear projection surface for many years. CineFlex is now a family, offering choices of gain and color to meet a range of rear and dual front/rear projection needs. CineFlex surfaces are available on a wide range of permanently tensioned, portable, and tab tensioned projection screen models.

CineFlex CH1200V

Controlled Viewing Cone / High Contrast / On-Axis Gain of 1.2

Neutral grey rear projection diffusing surface. Provides high resolution and excellent contrast, even in lighted rooms. Recommended for use with low to medium output projectors. Moderate viewing cone. This surface was previously named "Cineflex."

CineFlex MH800V

Moderate Viewing Cone / High Contrast / On-Axis Gain of 0.8

Low gain flexible rear material. Designed for use with high light output projectors and wide audience seating patterns. Offers rich color contrast, well-defined resolution, and a broad viewing cone. This surface was previously named "Low-Gain Cineflex."

CineFlex White XT600V

Extra Wide Viewing Cone / Typical Contrast / On-Axis Gain of 0.6

This white rear projection surface works well for edge matching or edge blending applications, and also for short throw rear projection. Broad viewing cone and high resolution. Reasonable control of ambient light is recommended. This surface was previously named "CineFlex Dual"

Custom Printed Backgrounds

Many Draper projection screen models can be utilized as high quality video conferencing backdrops or signage with custom printing. Simply submit your completed artwork, and Draper will print your graphics on with high quality CMYK digital printing presses. See page 6 for details.

Chroma Key Backgrounds

Green and Blue Chroma Key surfaces are available by quotation—contact your Draper representative. Chroma Key backgrounds (also known as "green screen" or "blue screen") are used in video production and video conferencing. See page 6 for details.

Custom Printed Backgrounds

Many Draper projection screen models can be easily used to display signage or video conferencing backdrops with custom printed graphics.

Custom graphics are available on select Draper motorized, manual, or even portable projection screen models. Permanently installed models are great for company signage, or can proudly display your logo in boardrooms for video conferencing backgrounds. Portable models are ideal for trade show signage, point-of-purchase advertising, or even as mobile video conferencing backgrounds.

No matter the message or artwork, custom printed graphic surfaces offer unlimited potential. Simply submit your completed artwork, and Draper will print your graphics on with state-of-the-art digital CMYK printing presses.

Call Draper for quotation on custom printing needs.

Printed Background Processing

For best results, please follow these simple guidelines when creating your artwork. Draper prefers AI (Adobe Illustrator) or EPS (Encapsulated PostScript) formats for images. These illustrations should be vector based, with all text converted to paths (outlines).

We also accept TIF files created in Adobe PhotoShop or similar software. TIF files should be flattened (no layers), CMYK color mode, and 300 dpi (dots per inch) or greater.

Graphic size should match the final print size plus one inch for both height and width.

Contact your Draper sales representative to get started with custom graphics today!



Above: a Draper projection screen with custom printed graphics in use as a video conferencing background.

Chroma Key Backgrounds

In addition to custom printed graphics, you can also utilize many Draper projection screen models as video production backgrounds with Chroma Key surfaces.

Draper offers industry standard Chroma Key blue and green surfaces (commonly known as "green screen" or "blue screen" surfaces) for use as video production or video conferencing backgrounds.

Would your video conferencing benefit from changing background images or even live action video footage? Draper's Chroma Key surfaces make it easy.

Call Draper for quotation on Chroma Key surfaces.

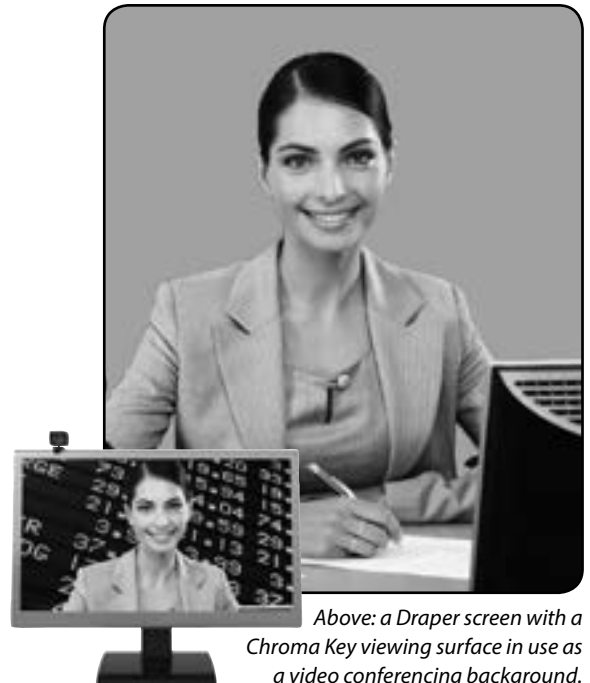

Above: a Draper screen with a Chroma Key viewing surface in use as a video conferencing background.

Environmental and Recycling Information

Draper is a leader in the projection screen industry in sustainable products and manufacturing. Not only do we offer products bearing prestigious third party certifications such as GREENGUARD GOLD, and Cradle to Cradle, but we are also a member of the U.S Green Building Council and a founding member of the InfoComm AV Sustainability Task Force. We are dedicated to sustainable building.

For information about how to recycle a Draper product or Draper's sustainability initiatives, please visit our website:

www.draperinc.com/go/green/



Screen Size Selection

One of the most important decisions in screen selection is to determine the correct size of screen based upon:

1. The dimensions of the audience area.
2. The projection format(s) to be used.

In some situations, these two questions yield the same answer; in others they do not and compromises must be made. Here are the key considerations:

- **Audience Area**—In determining the correct screen size in relation to the audience area, the goal is to make the screen large enough so those in the rear of the audience area can read the subject matter easily, but not so large that those in the front of the audience area have difficulty seeing the full width of the projected image.
- **Height**—Use the following formulas for calculating screen height for maximum legibility. For 16:10, 16:9, 1.85:1, or 2.35:1 projection, screen height should equal or exceed $\frac{1}{3}$ the distance from the screen to the optimum seat. For 4:3 moving video and entertainment, screen height should be at least $\frac{1}{6}$ the distance from the screen to the furthest seat; for charts and data, as in a conference or lecture room, use $\frac{1}{4}$; for complex graphics, as in a command/control center, use $\frac{1}{2}$.
- **Width**—Screen width is generally determined by the height of the screen and the projection formats to be used.

- **Ceiling Height**—The bottom of the screen should be approximately 40–48" above the floor in a room with a level floor and several rows of seats. In rooms with theatre seating or only one or two rows, such as a home theatre, the bottom of the screen should usually be 24–36" above the floor. Try to make sure that the lower part of the screen will be visible from all seats. Extra drop may be required to position the screen at a comfortable viewing level in a room with a high ceiling.
- **Projection Format**—Once you have determined the correct size of screen for the audience area, that size may be modified based upon the type(s) of projection equipment to be used. If the screen will only be used with one type of projector (NTSC video, HDTV, etc.), it is easy to determine exact screen dimensions based upon the projection format of that projector. Projection formats are expressed in terms of aspect ratio, which is the relationship of the height of the projected image to its width. Aspect ratios of common projection formats are listed below.

Get help online—Draper's website offers several useful tools designed to help you select the right screen size. For more information, visit: www.draperinc.com/go/FrontScreens.htm

Projection Formats

Most models of Draper screens are offered in 16:10, HDTV, audiovisual, and 4:3 NTSC video formats. Many models are also offered in Scope format. Now, Draper also offers many screens in 16:10 and 15:9 aspect ratios, commonly used for projecting native laptop computer displays.

We provide almost any Draper screen in the size and projection format of your choice. We can provide any size up to and including the largest published size. If you do not find the size and format you need listed, please call or fax your requirements to us, and we will be delighted to quote your request.

Audiovisual (or AV) format screens are intended for general use. They accommodate a variety of projector types and range from square to wide horizontal in aspect ratio. **AV format screens** are described in terms of height x width and are standard without black borders, although borders are optionally available. Screens with Draper's Tab Tensioning System always include black borders and 12" black drop at the top.

The **NTSC format** is strictly defined as a 4:3 rectangle (4 wide by 3 high), and the size is usually described in terms of a nominal diagonal. Conventional models of video format screens are furnished with black borders to frame the image on all four sides, allowing for projector overscan. Draper's standard is to furnish Tab-Tensioned electric screens with black borders at the sides and bottom and 12" of black drop at the top. **16:10 format** is a native aspect ratio for some computer laptop displays. **HDTV format** (16:9) is also available for high-definition television projection. The ultimate in home theater, **Scope format** (2.35:1) allows projection of movies in their full native width without letterboxing. Other formats including 15:9, 1.90:1, 2.39:1, and 1.85:1 are available by quotation.

Aspect Ratios of Common Projection Formats

| W:H | | W:H | |
|--------|--|--------|---|
| 1:1 | Square, overhead projector, square format photography. | 1.78:1 | High-Definition (16:9): 720p, 1080p |
| 1.33:1 | Standard Definition (4:3): NTSC, SDTV | 1.90:1 | 2K/4K Full; 2K/4K projector native res, DCP Full Container |
| 15:9 | Native computer format | 2.35:1 | Scope |
| 1.6:1 | Wide Computer (16:10): WXGA, WUXGA | 2.39:1 | 2K/4K Scope. 2K/4K projector with anamorphic lens, DCP Scope. |

How to Calculate a Custom Size

Draper manufactures custom size screens to meet your specification. Virtually any size within the maximum shown for a given model is available. Please call for pricing on special sizes. If you need to calculate a custom size, the following formulas may be useful (D = exact diagonal; H = viewing area height; W = viewing area width).

| 4:3 Standard Definition | 16:9 HDTV | 2.35:1 Scope | 15:9 | 1.90:1 | 2.39:1 | 16:10 |
|-------------------------|----------------|----------------|----------------|-----------------|-----------------|----------------|
| H = D x .6 | H = D x .49 | H = D x .3915 | H = D x .5146 | H = D x .46625 | H = D x .38625 | H = D x .5299 |
| W = D x .8 | W = D x .87146 | W = D x .92 | W = D x .8576 | W = D x .88375 | W = D x .92375 | W = D x .848 |
| D = H x 1.667 | D = H x 2.04 | D = H x 2.554 | D = H x 1.9433 | D = H x 2.14375 | D = H x 2.59125 | D = H x 1.8868 |
| D = W x 1.25 | D = W x 1.1475 | D = W x 1.0868 | D = W x 1.166 | D = W x 1.13 | D = W x 1.08375 | D = W x 1.1793 |

Tab-Tensioned and Self-Supporting Motorized Projection Screens

Self-supporting (non-tensioned) motorized screens are manufactured with textile-backed materials. These screens offer surfaces from the OptiView and ClearSound families that remain flat by virtue of the thickness and weight of the screen surface and dowel. An important part of Draper's inspection process for screens of this type is to make sure the screen is as flat as possible.

Several Draper models feature Draper's Tab-Tensioning System with unsupported vinyl viewing surfaces. These screens feature surfaces from the OptiFlex family that offer a perfectly flat projection surface, suitable for even the most demanding applications. CineFlex and ClearSound surfaces may also be available. Computer-driven data and graphics presentations, as well as large-screen video images, always look their best on a tensioned screen.

Self-supporting screens in AV format are normally furnished without black borders, while these screens in all other formats include borders to frame the image on all four sides. Self-supporting HDTV and 16:10 formats have 12" of black drop as standard in screen sizes 113" diagonal and smaller. Standard tab-tensioned screens in all formats are furnished with black borders at the sides and bottom and 12" black drop at top. Custom tab-tensioned screens are furnished with black borders at sides and bottom. Extra drop may be specified as needed. Additional black masking above the image area is optionally available for all standard and custom screens.

Tab-Tensioned Motorized Screens

Ceiling-Recessed Motorized Screens

Access and Access FIT/Series V—Tab-tensioned screen for ceiling-recessed installation. "Plug-in" wiring connections enable installation of case early in construction and screen later. No exposed fasteners. Sizes through 16' wide.

Redesigned! Access XL/Series V—Draper's popular Access projection screen available in larger sizes. Sizes through 20' wide.

Redesigned! Ultimate Access/Series V—All the features of the Access, plus an independently motorized ceiling closure that opens into the case. Sizes through 13' wide.

NEW! Ultimate Access XL/Series V—All the features of the Access, plus an independently motorized ceiling closure that opens into the case. **Sizes through 22' wide.**

Wall- or Ceiling-Mounted Motorized Screens

Premier—Our most popular tab-tensioned motorized screen. The Premier is housed in a black pentagonal steel case and utilizes a quiet tubular motor-in-roller design. Sizes through 16' wide.

Silhouette/Series V—Tab-tensioned screen for wall/ceiling installation, with streamlined extruded aluminum case. No exposed fasteners or mounting fixtures. Sizes through 96" wide.

Artisan/Series V—Designed for wall mounting. Offered in your choice of seven hardwood finishes or any plastic laminate, with four hardwood case styles. Complements the furnishings of a boardroom or home theatre. Sizes through 96" wide.

Heavy-Duty Motorized Screens

Paragon/Series V—Features extruded aluminum case. Operates on a 6" steel roller powered by an extremely strong tubular motor-in-roller. Sizes through 24' wide.

Non-Tensioned Motorized Screens

Ceiling-Recessed Motorized Screens

Access and Access FIT/Series E—Motor-in-roller electric screen for ceiling-recessed installation. Suitable for use in return air plenum. "Plug-in" wiring connections enable installation of case early in construction and screen later. Sizes through 16' wide.

Redesigned! Access XL/Series E—Draper's popular Access projection screen available in larger sizes. Sizes through 20' wide.

Redesigned! Ultimate Access/Series E—All the features of the Access, plus an independently motorized ceiling closure that opens into the case. Sizes through 13' wide.

NEW! Ultimate Access XL/Series E—All the features of the Access, plus an independently motorized ceiling closure that opens into the case. **Sizes through 22' wide.**

Ambassador—An extremely rugged ceiling closure-type screen which operates quietly on a 5" diameter steel roller. Sizes to 12' wide.

Envoy—Utilizes a quiet tubular motor mounted inside a 3" roller. Smaller case dimensions than the Ambassador and somewhat less expensive. Sizes through 12' wide.

Wall- or Ceiling-Mounted Motorized Screens

Targa—Popular electric screen. Housed in a pentagonal steel case, finished white. Very reasonably priced; powered by a quiet tubular motor-in-roller. Sizes through 16' wide.

Artisan/Series E—Identical in appearance to the Artisan/Series V, but with a conventional textile-backed viewing surface. Wall or ceiling mount. Sizes through 96" wide.

Silhouette/Series E—The shape of the future. Viewing surfaces from the OptiView and ClearSound families with motor-in-roller, housed in a strikingly contemporary extruded aluminum case. Sizes through 96" wide.

Salara—Elliptical extruded aluminum case with white finish installs quickly to wall brackets. Hardwired and Plug & Play™ versions available. Plug & Play comes with 10' power cord and IR remote, so no wiring is needed. Conventional electric screen with motor-in-roller. Sizes through 96" wide.

Baronet—Popular, low-cost motorized screen with scratch-resistant white polyester finish and universal mounting brackets. Motor-in-roller design provides quiet, trouble-free operation. Comes with 10' power cord with inline switch—no wiring necessary. Sizes through 96" wide.

Outdoor Motorized Screens

Nocturne®/Series E—Designed for outdoor use on your patio, by your pool deck, or any other outdoor space. Weather and insect resistant solid aluminum headbox includes built-in hinge for easy installation and service. Includes cable guides, weighted dowel, and both wall and deck mount cable guide brackets. Sizes through 116" wide.

Heavy-Duty Motorized Screens

Paragon/Series E—Features extruded aluminum case. Operates on a 6" steel roller powered by an extremely strong tubular motor-in-roller. Sizes through 28' wide.

Rolleramic—Heavy-duty motorized screen housed in a square case of high compression particle board painted flat black and is offered in sizes through 20' wide.

Multiple Format Motorized Screens

Access MultiView—Motor-in-roller electric screen with integral masking system. Choose Series E or Series V. For ceiling-recessed installation. Masking system is independently motorized and changes surface from HDTV or WideScreen format to NTSC video. Sizes to 133" diagonal HDTV or 132" diagonal Scope format, which may be reduced to 108" diagonal NTSC or 106" diagonal HDTV format.

Overall Screen Width Breakdown for Access Cases

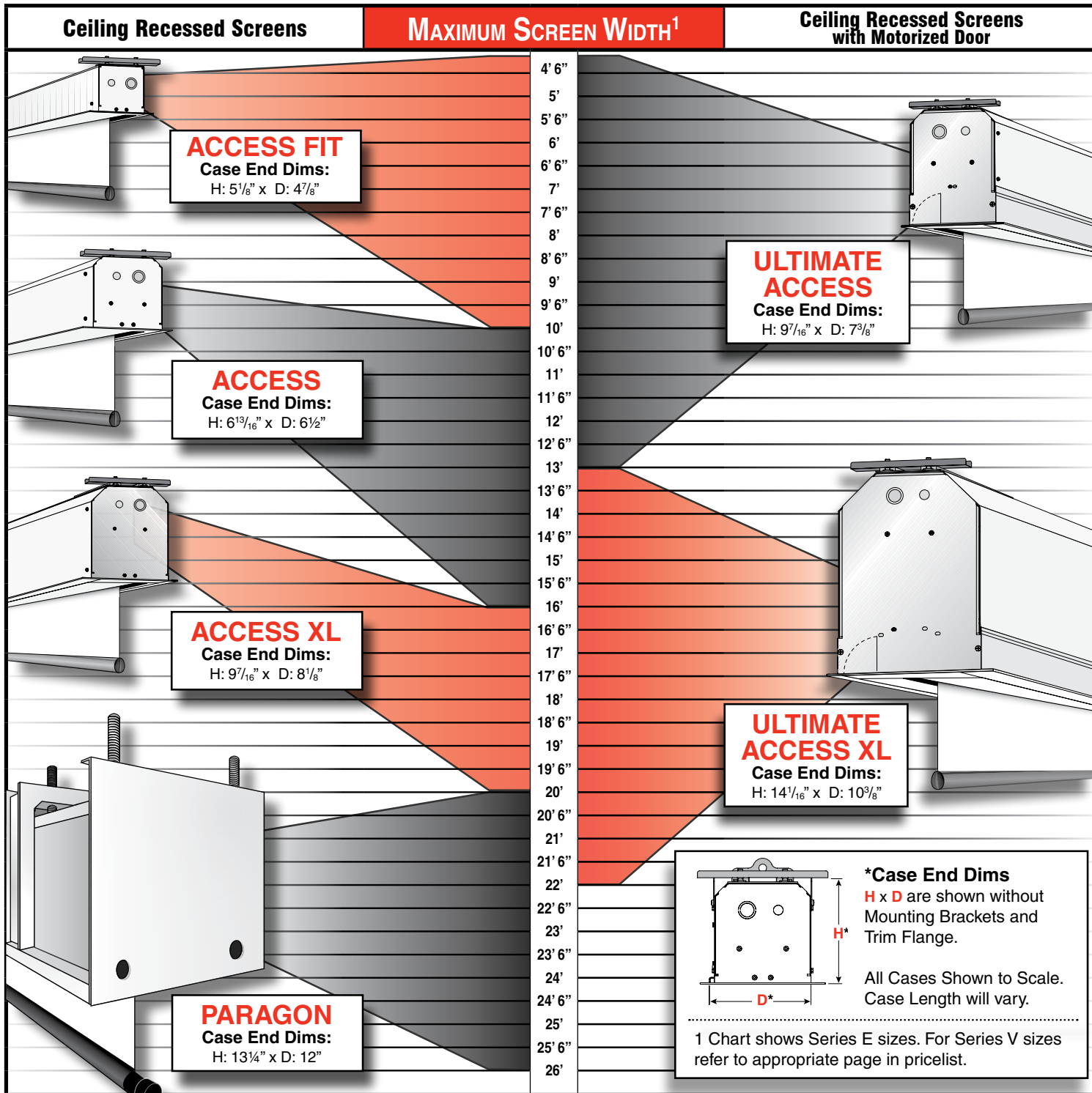

The Access Family: Case Now, Screen Later.

You can install the case during the "dirty" phase of the construction process and keep the screen safe until you install the projector. Screen (motor-in-roller and attached viewing surface) installs in seconds with preset latching roller brackets and electrical pin connectors. Eliminates job site damage. Screens may be installed in cases up to 20" wider than the standard case lengths shown.

- **Options:** Some optional controls, including LVC-IV, may be built into case: refer to page 35 for information and pricing. Built-in controls may reduce available space for screen: call Draper for dimensions. All ceiling recessed cases can be painted black upon request. **Important Notice for Compatibility**—If you are planning to install an Access case first and screen later, and you want any of the built-in Low Voltage Motor or Control options, you must specify when ordering the case to assure compatibility with your screen.

| Access Case | PRICE |
|-----------------|-------|
| Access FIT | \$700 |
| Access | 700 |
| Ultimate Access | 900 |

Cases may be ordered and pre-installed. If ordering case in advance of screen, price of case will be deducted when screen is ordered. Specify case length at time of order. If you are unsure of future size, call Draper for suggestions or use printed size information for your most logical choice.

Access FIT/Series V

The Access FIT/Series V features a new lower-profile case to fit in smaller spaces. New hinged door cover makes installation and service easier. Access FIT/V is tab-tensioned for ceiling-recessed installation. White finished case. "Plug-in" wiring connections allow installation of case early and screen later. Plenum rated case (UL approved "Suitable for Use in Environmental Air Space"). Includes one 110-120v 3-position switch. **An Access FIT case may be ordered and installed prior to selecting a screen size, type and format. Please see page 9 for cases.**

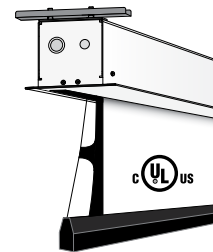

Standard Specs

- Sizes and Formats:** Custom sizes by quotation. Custom sizes need to be specified in detail, including extra drop, if desired.
- Case Dimensions:** 7 3/4" depth x 5 1/16" high including flange and mounting brackets. Extra drop may increase case length: call for dimensions.
- Black Borders:** Image area fully framed with black. 12" black drop at top of viewing surface (standard).

Options

- Motor/Control Options:** Quiet Motor (Q), or Built-in Low Voltage Controller (U or L) available. See page 35 for details. 220V motor is also available at no extra cost.
- Case Options:** For more information on how to order case in advance of screen, see page 9. Black case available on request.
- Extra Drop:** Additional drop above image (specify color—12" black is standard; surface color available on request). May increase case length. See page 36.

Viewing Surface:

CineFlex CH1200V (CB), CineFlex MH800V (CA), and CineFlex White XT600V (CC) rear projection surfaces available by quotation—add 2-letter suffix noted above to any Matt White XT1000V part number. Also available: ClearSound Perf XT900V, a perforated matt white—add the suffix SD to any Matt White XT1000V part number. See page 5.

OptiFlex Viewing Surfaces

| H x W / Diagonal | Image Area | Matt White | | | Pearl White | | | ReAct | | | Case Length | Shipping Wt./lbs. | Freight Class | | |
|------------------------------|-------------------|------------|-------------|--------------------|-------------|--------|----------|---------|--------|----------|-------------|-------------------|---------------|-----|--------|
| | | XT1000V | Grey XH600V | Pure White XT1300V | MH1500V | PRICE | MAP | MS1000V | PRICE | MAP | | | | | |
| 16:10 Format | | | | | | | | | | | | | | | |
| 94" | 50" x 80" | 140035 | 140035FB | 140035FN | \$2797 | \$2238 | 140035FJ | \$2867 | \$2294 | 140035FR | \$3007 | \$2406 | 107" | 84 | 125 |
| 109" | 57 1/2" x 92" | 140036 | 140036FB | 140036FN | 3057 | 2446 | 140036FJ | 3134 | 2507 | 140036FR | 3287 | 2630 | 119" | 85 | 125 |
| 113" | 60" x 96" | 140037 | 140037FB | 140037FN | 3212 | 2570 | 140037FJ | 3292 | 2634 | 140037FR | 3454 | 2763 | 126" | 92 | 125 |
| 123" | 65" x 104" | 140038 | 140038FB | 140038FN | 3341 | 2673 | 140038FJ | 3424 | 2739 | 140038FR | 3591 | 2873 | 131" | 94 | 125 |
| 16:9 HDTV Format | | | | | | | | | | | | | | | |
| 92" | 45" x 80" | 140025 | 140025FB | 140025FN | \$2797 | \$2238 | 140025FJ | \$2867 | \$2294 | 140025FR | \$3007 | \$2406 | 107" | 86 | 125 |
| 100" | 49" x 87" | 140026 | 140026FB | 140026FN | 2957 | 2366 | 140026FJ | 3031 | 2424 | 140026FR | 3179 | 2543 | 113" | 90 | 125 |
| 106" | 52" x 92" | 140027 | 140027FB | 140027FN | 3057 | 2446 | 140027FJ | 3134 | 2507 | 140027FR | 3287 | 2630 | 119" | 98 | 125 |
| 110" | 54" x 96" | 140028 | 140028FB | 140028FN | 3212 | 2570 | 140028FJ | 3292 | 2634 | 140028FR | 3454 | 2763 | 126" | 105 | 125 |
| 119" | 58" x 104" | 140029 | 140029FB | 140029FN | 3341 | 2673 | 140029FJ | 3424 | 2739 | 140029FR | 3591 | 2873 | 131" | 107 | 125 |
| 4:3 NTSC Video Format | | | | | | | | | | | | | | | |
| 6" | 42 1/2" x 56 1/2" | 140014 | 140014FB | 140014FN | \$2404 | \$1923 | 140014FJ | \$2464 | \$1971 | 140014FR | \$2584 | \$2067 | 85" | 72 | 125 P+ |
| 7" | 50" x 66 1/2" | 140015 | 140015FB | 140015FN | 2622 | 2098 | 140015FJ | 2687 | 2150 | 140015FR | 2819 | 2255 | 92" | 79 | 125 P+ |
| 100" | 60" x 80" | 140016 | 140016FB | 140016FN | 2864 | 2291 | 140016FJ | 2936 | 2348 | 140016FR | 3079 | 2463 | 107" | 95 | 125 |
| 10" | 72" x 96" | 140017 | 140017FB | 140017FN | 3121 | 2496 | 140017FJ | 3199 | 2559 | 140017FR | 3354 | 2683 | 126" | 105 | 125 |
| 11" | 78" x 104" | 140018 | 140018FB | 140018FN | 3416 | 2733 | 140018FJ | 3501 | 2801 | -- | -- | -- | 132" | 109 | 125 |
| AV Format | | | | | | | | | | | | | | | |
| 50" x 50" | | 140001 | 140001FB | 140001FN | \$2274 | \$1819 | 140001FJ | \$2330 | \$1864 | -- | -- | -- | 76" | 64 | 125 P+ |
| 60" x 60" | | 140002 | 140002FB | 140002FN | 2474 | 1979 | 140002FJ | 2536 | 2028 | -- | -- | -- | 87" | 72 | 125 P+ |
| 70" x 70" | | 140003 | 140003FB | 140003FN | 2752 | 2202 | 140003FJ | 2821 | 2256 | -- | -- | -- | 98" | 85 | 125 P+ |
| 84" x 84" | | 140004 | 140004FB | 140004FN | 3047 | 2438 | 140004FJ | 3124 | 2499 | -- | -- | -- | 113" | 94 | 125 |
| 72" x 96" | | 140017 | 140017FB | 140017FN | 3121 | 2496 | 140017FJ | 3199 | 2559 | -- | -- | -- | 126" | 105 | 125 |

ClearSound Viewing Surfaces

| H x W / Diagonal | Image Area | ClearSound NanoPerf | | | Case Length | Shipping Wt./lbs. | Freight Class |
|------------------------------|-------------------|---------------------|--------|--------|-------------|-------------------|---------------|
| | | XT800V | PRICE | MAP | | | |
| 16:10 Format | | | | | | | |
| 94" | 50" x 80" | 140035SC | \$3131 | \$2505 | 107" | 84 | 125 |
| 109" | 57 1/2" x 92" | 140036SC | 3391 | 2713 | 119" | 85 | 125 |
| 113" | 60" x 96" | 140037SC | 3546 | 2837 | 126" | 92 | 125 |
| 123" | 65" x 104" | 140038SC | 3674 | 2939 | 131" | 94 | 125 |
| 16:9 HDTV Format | | | | | | | |
| 92" | 45" x 80" | 140025SC | \$3131 | \$2505 | 107" | 86 | 125 |
| 100" | 49" x 87" | 140026SC | 3291 | 2633 | 113" | 90 | 125 |
| 106" | 52" x 92" | 140027SC | 3391 | 2713 | 119" | 98 | 125 |
| 110" | 54" x 96" | 140028SC | 3546 | 2837 | 126" | 105 | 125 |
| 119" | 58" x 104" | 140029SC | 3674 | 2939 | 131" | 107 | 125 |
| 4:3 NTSC Video Format | | | | | | | |
| 6" | 42 1/2" x 56 1/2" | 140014SC | \$2737 | \$2190 | 85" | 72 | 125 P+ |
| 7" | 50" x 66 1/2" | 140015SC | 2956 | 2364 | 92" | 79 | 125 P+ |
| 100" | 60" x 80" | 140016SC | 3197 | 2558 | 107" | 95 | 125 |
| 10" | 72" x 96" | 140017SC | 3454 | 2763 | 126" | 105 | 125 |
| 11" | 78" x 104" | 140018SC | 3749 | 2999 | 132" | 109 | 125 |
| AV Format | | | | | | | |
| 50" x 50" | | 140001SC | \$2607 | \$2086 | 76" | 64 | 125 P+ |
| 60" x 60" | | 140002SC | 2807 | 2246 | 87" | 72 | 125 P+ |
| 70" x 70" | | 140003SC | 3086 | 2468 | 98" | 85 | 125 P+ |
| 84" x 84" | | 140004SC | 3381 | 2705 | 113" | 94 | 125 |
| 72" x 96" | | 140017SC | 3454 | 2763 | 126" | 105 | 125 |

CHART CONTINUED BELOW



Note: for alternate installation of Access screens, additional set of brackets is required.

Part No. C502.233.

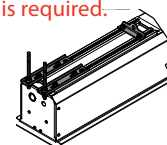

Access/Series V—Access now comes in larger sizes, up to 16' wide, with an efficient profile to maximize space. New hinged door cover makes installation and service easier. Access/V is tab-tensioned for ceiling-recessed installation. White finished case. "Plug-in" wiring connections allow installation of case early and screen later. Plenum rated case (UL approved "Suitable for Use in Environmental Air Space"). Includes one 110-120v 3-position switch. **An Access case may be ordered and installed prior to selecting a screen size, type and format. Please see page 9 for cases.**

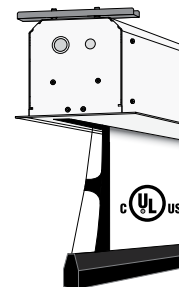

Standard Specs

- **Sizes and Formats:** Custom sizes by quotation. Custom sizes need to be specified in detail, including extra drop, if desired.
- **Case Dimensions:** 8 1/16" depth x 7 3/8" high including flange and mounting brackets. Extra drop may increase case length: call for dimensions.
- **Black Borders:** Image area fully framed with black. 12" black drop at top of viewing surface (standard).

Options

- **Motor/Control Options:** Quiet Motor (Q), or Built-in Low Voltage Controller (U or L) available. See page 35 for details. 220V motor is also available at no extra cost.
- **Case Options:** For more information on how to order case in advance of screen, see page 9. Black case available on request.

- **Extra Drop:** Additional drop above image (specify color—12" black is standard; surface color available on request). May increase case length. See page 36.
- **Viewing Surface:** CineFlex CH1200V (CB), CineFlex MH800V (CA), and CineFlex White XT600V (CC) rear projection surfaces available by quotation—add 2-letter suffix noted above to any Matt White XT1000V part number. Also available: ClearSound Perf XT900V, a perforated matt white—add the suffix SD to any Matt White XT1000V part number. See page 5.

OptiFlex Viewing Surfaces

| H x W / Diagonal | Image Area | Matt | | | Pearl White | | | ReAct | | | Case Length | Shipping Wt./lbs. | Freight Class | | |
|------------------------------|----------------|---------------|-------------|--------------------|---------------|--------|----------|---------|--------|----------|-------------|-------------------|---------------|-----|-----|
| | | White XT1000V | Grey XH600V | Pure White XT1300V | White MH1500V | PRICE | MAP | MS1000V | PRICE | MAP | | | | | |
| 16:10 Format | | | | | | | | | | | | | | | |
| 137" | 72 1/2" x 116" | 140039 | 140039FB | 140039FN | \$3636 | \$2909 | 140039FJ | \$3727 | \$2982 | 140039FR | \$3909 | \$3127 | 143" | 114 | 125 |
| 165" | 87 1/2" x 140" | 140040 | 140040FB | 140040FN | 4646 | 3717 | 140040FJ | 4763 | 3810 | -- | -- | -- | 168" | 148 | 125 |
| 189" | 100" x 160" | 140041 | 140041FB | 140041FN | 5444 | 4356 | 140041FJ | 5581 | 4465 | -- | -- | -- | 187" | 168 | 125 |
| 198" | 105" x 168" | 140042 | 140042FB | 140042FN | 8142 | 6513 | 140042FJ | 8345 | 6676 | -- | -- | -- | 196" | 564 | 125 |
| 226" | 120" x 192" | 140043 | 140043FB | 140043FN | 8523 | 6819 | 140043FJ | 8737 | 6989 | -- | -- | -- | 223" | 631 | 125 |
| 16:9 HDTV Format | | | | | | | | | | | | | | | |
| 133" | 65" x 116" | 140030 | 140030FB | 140030FN | \$3636 | \$2909 | 140030FJ | \$3727 | \$2982 | 140030FR | \$3909 | \$3127 | 143" | 112 | 125 |
| 161" | 79" x 140" | 140031 | 140031FB | 140031FN | 4646 | 3717 | 140031FJ | 4763 | 3810 | 140031FR | 4994 | 3995 | 168" | 146 | 125 |
| 184" | 90" x 160" | 140032 | 140032FB | 140032FN | 5444 | 4356 | 140032FJ | 5581 | 4465 | -- | -- | -- | 187" | 166 | 125 |
| 193" | 94 1/2" x 168" | 140033 | 140033FB | 140033FN | 8142 | 6513 | 140033FJ | 8345 | 6676 | -- | -- | -- | 195" | 561 | 125 |
| 220" | 108" x 192" | 140034 | 140034FB | 140034FN | 8432 | 6745 | 140034FJ | 8642 | 6913 | -- | -- | -- | 223" | 615 | 125 |
| 4:3 NTSC Video Format | | | | | | | | | | | | | | | |
| 150" | 87" x 116" | 140019 | 140019FB | 140019FN | \$3719 | \$2975 | 140019FJ | \$3812 | \$3050 | -- | -- | -- | 143" | 140 | 125 |
| 15" | 108" x 144" | 140020 | 140020FB | 140020FN | 4759 | 3807 | 140020FJ | 4878 | 3902 | -- | -- | -- | 172" | 146 | 125 |
| 200" | 118" x 158" | 140021 | 140021FB | 140021FN | 5479 | 4384 | 140021FJ | 5616 | 4493 | -- | -- | -- | 188" | 170 | 125 |
| 210" | 126" x 168" | 140022 | 140022FB | 140022FN | 8040 | 6432 | 140022FJ | 8242 | 6593 | -- | -- | -- | 198" | 566 | 125 |
| 220" | 132" x 176" | 140023 | 140023FB | 140023FN | 8280 | 6624 | 140023FJ | 8487 | 6789 | -- | -- | -- | 206" | 615 | 125 |
| 240" | 144" x 192" | 140024 | -- | 140024FN | 8523 | 6819 | -- | -- | -- | -- | -- | -- | 223" | 637 | 125 |
| AV Format | | | | | | | | | | | | | | | |
| 96" x 96" | | 140005 | 140005FB | 140005FN | \$3361 | \$2689 | 140005FJ | \$3444 | \$2755 | -- | -- | -- | 123" | 105 | 125 |
| 7" x 9" | | 140006 | 140006FB | 140006FN | 3461 | 2769 | 140006FJ | 3547 | 2838 | -- | -- | -- | 136" | 113 | 125 |
| 9" x 9" | | 140007 | 140007FB | 140007FN | 3719 | 2975 | 140007FJ | 3812 | 3050 | -- | -- | -- | 136" | 131 | 125 |
| 8" x 10" | | 140008 | 140008FB | 140008FN | 3794 | 3035 | 140008FJ | 3889 | 3111 | -- | -- | -- | 147" | 131 | 125 |
| 10" x 10" | | 140009 | 140009FB | 140009FN | 4142 | 3314 | 140009FJ | 4246 | 3397 | -- | -- | -- | 150" | 144 | 125 |
| 9" x 12" | | 140020 | 140020FB | 140020FN | 4759 | 3807 | 140020FJ | 4878 | 3902 | -- | -- | -- | 172" | 146 | 125 |
| 12" x 12" | | 140010 | -- | 140010FN | 5126 | 4101 | -- | -- | -- | -- | -- | -- | 175" | 154 | 125 |
| 10" 6" x 14" | | 140011 | 140011FB | 140011FN | 8040 | 6432 | 140011FJ | 8242 | 6593 | -- | -- | -- | 198" | 566 | 125 |
| 14" x 14" | | 140012 | -- | 140012FN | 8218 | 6575 | -- | -- | -- | -- | -- | -- | 206" | 587 | 125 |
| 12" x 16" | | 140013 | -- | 140013FN | 8518 | 6815 | -- | -- | -- | -- | -- | -- | 223" | 637 | 125 |

ClearSound Viewing Surfaces

| H x W / Diagonal | Image Area | ClearSound | | PRICE | MAP | Case Length | Shipping Wt./lbs. | Freight Class |
|------------------------------|----------------|-----------------|-------------|--------|--------|-------------|-------------------|---------------|
| | | NanoPerf XT800V | Perf XT900V | | | | | |
| 16:10 Format | | | | | | | | |
| 137" | 72 1/2" x 116" | 140039SC | 140039SD | \$3969 | \$3175 | 143" | 114 | 125 |
| 165" | 87 1/2" x 140" | 140040SC | 140040SD | 4979 | 3983 | 168" | 148 | 125 |
| 189" | 100" x 160" | 140041SC | 140041SD | 5778 | 4622 | 187" | 168 | 125 |
| 198" | 105" x 168" | 140042SC | 140042SD | 8475 | 6780 | 196" | 564 | 125 |
| 226" | 120" x 192" | 140043SC | 140043SD | 8857 | 7086 | 223" | 631 | 125 |
| 16:9 HDTV Format | | | | | | | | |
| 133" | 65" x 116" | 140030SC | 140030SD | \$3969 | \$3175 | 143" | 112 | 125 |
| 161" | 79" x 140" | 140031SC | 140031SD | 4979 | 3983 | 168" | 146 | 125 |
| 184" | 90" x 160" | 140032SC | 140032SD | 5778 | 4622 | 187" | 166 | 125 |
| 193" | 94 1/2" x 168" | 140033SC | 140033SD | 8475 | 6780 | 195" | 561 | 125 |
| 220" | 108" x 192" | 140034SC | 140034SD | 8765 | 7012 | 223" | 615 | 125 |
| 4:3 NTSC Video Format | | | | | | | | |
| 150" | 87" x 116" | 140019SC | 140019SD | \$4052 | \$3242 | 143" | 140 | 125 |
| 15" | 108" x 144" | 140020SC | 140020SD | 5093 | 4074 | 172" | 146 | 125 |
| 200" | 118" x 158" | 140021SC | 140021SD | 5813 | 4650 | 188" | 170 | 125 |
| 210" | 126" x 168" | 140022SC | 140022SD | 8373 | 6698 | 198" | 566 | 125 |
| 220" | 132" x 176" | 140023SC | 140023SD | 8613 | 6890 | 206" | 615 | 125 |
| 240" | 144" x 192" | 140024SC | 140024SD | 8857 | 7086 | 223" | 637 | 125 |
| AV Format | | | | | | | | |
| 96" x 96" | | 140005SC | 140005SD | \$3694 | \$2955 | 123" | 105 | 125 |
| 7" x 9" | | 140006SC | 140006SD | 3794 | 3035 | 136" | 113 | 125 |
| 9" x 9" | | 140007SC | 140007SD | 4052 | 3242 | 136" | 131 | 125 |
| 8" x 10" | | 140008SC | 140008SD | 4127 | 3302 | 147" | 131 | 125 |
| 10" x 10" | | 140009SC | 140009SD | 4476 | 3581 | 150" | 144 | 125 |
| 9" x 12" | | 140020SC | 140020SD | 5093 | 4074 | 172" | 146 | 125 |
| 12" x 12" | | 140010SC | 140010SD | 5459 | 4367 | 175" | 154 | 125 |
| 10" 6" x 14" | | 140011SC | 140011SD | 8373 | 6698 | 198" | 566 | 125 |
| 14" x 14" | | 140012SC | 140012SD | 8552 | 6842 | 206" | 587 | 125 |
| 12" x 16" | | 140013SC | 140013SD | 8852 | 7082 | 223" | 637 | 125 |

CHART CONTINUED BELOW

Note: for alternate installation of Access screens, additional set of brackets is required.

Part No. C502.240.

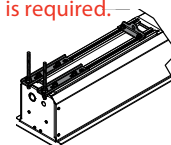

Redesigned! Access XL/Series V

The Access XL line of Tab-Tensioned projection screens are motorized, ceiling-recessed, and offer the same great features as other Access screens—now in a range of large sizes. Includes one 110-120v 3-position switch. Case lengths below include flange to support ceiling tile or trim ceiling opening. Plenum rated case (UL approved "Suitable for Use in Environmental Air Space"). Viewing surfaces from the OptiFlex and CineFlex families.

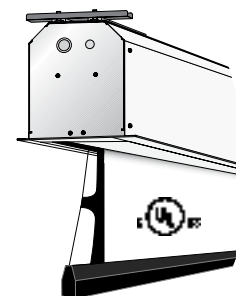

Standard Specs

- **Sizes and Formats:** Custom sizes by quotation. Custom sizes need to be specified in detail, including extra drop, if desired.
- **Case Dimensions:** Case is 10 1/8" H x 9 7/16" D (includes flange and mounting brackets). Built-in controls may increase length of case: call Draper for dimensions.
- **Black Borders:** Image area fully framed in black. **12" black drop at top of viewing surface (standard).**

Options

- **Motor/Control Options:** Built-in Low Voltage Controller (U or L) available. See page 35 for details. 220V motor available at no extra cost.
- **Case Options:** All ceiling recessed cases can be painted black upon request.
- **Extra Drop:** Additional drop above image area optional (specify color—black is standard; surface color available upon request). Extra drop may increase case length. See page 36.

and CineFlex MH800V (CA) rear projection surfaces, and CineFlex White XT600V (CC) front/rear projection surface available by quotation—add the 2-letter suffix noted above to any Matt White XT1000V part number. See page 5



OptiFlex Viewing Surfaces

| H x W/ Diagonal | Image Area | Matt White XT1000V | Grey XH600V | Pure White XT1300V | PRICE | Pearl White MH1500V | PRICE | Case Length | Shipping Wt./lbs. | Freight Class |
|------------------------------|-----------------|-----------------------|----------------|-----------------------|--------|------------------------|---------|----------------|----------------------|------------------|
| 16:10 Format | | | | | | | | | | |
| 255" | 135" x 216" | 147007 | 147007FB | 147007FN | \$9684 | 147007FJ | \$10070 | 246 5/8" | 702 | 125 |
| 16:9 HDTV Format | | | | | | | | | | |
| 248" | 121 1/2" x 216" | 147006 | 147006FB | 147006FN | \$9684 | 147006FJ | \$10070 | 244 7/8" | 637 | 125 |
| 4:3 NTSC Video Format | | | | | | | | | | |
| 250" | 148" x 198" | 147004 | -- | 147004FN | \$9040 | -- | -- | 228 5/8" | 630 | 125 |
| 270" | 162" x 216" | 147005 | -- | 147005FN | 9879 | -- | -- | 248 5/8" | 707 | 125 |
| AV Format | | | | | | | | | | |
| 16' x 16' | | 147001 | -- | 147001FN | \$9412 | -- | -- | 229" | 653 | 125 |
| 13' 6" x 18' | | 147002 | -- | 147002FN | 9774 | -- | -- | 248 5/8" | 707 | 125 |
| 18' x 18' | | 147003 | -- | 147003FN | 10590 | -- | -- | 254 7/8" | 724 | 125 |

ClearSound Viewing Surfaces

| H x W/ Diagonal | Image Area | ClearSound NanoPerf XT800V | ClearSound Perf XT900V | PRICE | Case Length | Shipping Wt./lbs. | Freight Class |
|------------------------------|-----------------|----------------------------------|------------------------------|---------|----------------|----------------------|------------------|
| 16:10 Format | | | | | | | |
| 255" | 135" x 216" | 147007SC | 147007SD | \$10017 | 246 5/8" | 702 | 125 |
| 16:9 HDTV Format | | | | | | | |
| 248" | 121 1/2" x 216" | 147006SC | 147006SD | \$10017 | 244 7/8" | 637 | 125 |
| 4:3 NTSC Video Format | | | | | | | |
| 250" | 148" x 198" | 147004SC | 147004SD | \$9374 | 228 5/8" | 630 | 125 |
| 270" | 162" x 216" | 147005SC | 147005SD | 10212 | 248 5/8" | 707 | 125 |
| AV Format | | | | | | | |
| 16' x 16' | | 147001SC | 147001SD | \$9745 | 229" | 653 | 125 |
| 13' 6" x 18' | | 147002SC | 147002SD | 10107 | 248 5/8" | 707 | 125 |
| 18' x 18' | | 147003SC | 147003SD | 10924 | 254 7/8" | 724 | 125 |

Note: for alternate installation of Access screens, additional set of brackets is required. Part No. C502.281.

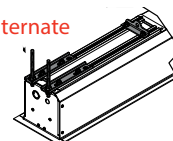
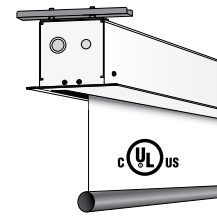

CHART
CONTINUED
BELOW

Access FIT/Series E—The Access FIT/Series E features a new lower-profile case to fit in smaller spaces. New hinged door cover makes installation and service easier. Access FIT/Series E is motor-in-roller for ceiling-recessed installation. White finished case. "Plug-in" wiring connections allow installation of case early and screen later. Plenum rated case (UL approved "Suitable for Use in Environmental Air Space"). Includes one 110-120v 3-position switch. **An Access case may be ordered and installed prior to selecting a screen size, type and format. Please see page 9 for cases.**



Motorized Screens
Ceiling-Recessed

Standard Specs

- **Sizes and Formats:** Custom sizes by quotation. Custom sizes need to be specified in detail, including extra drop, if desired.
- **Case Dimensions:** 7 3/4" depth x 5 1/16" high including flange and mounting brackets. Extra drop may increase case size; call for dimensions.
- **Black Borders:** NTSC, HDTV and 16:10 format have image area framed with black on all four sides. Black side borders are available on request for AV format screens.

Options

- **Motor/Control Options:** Quiet Motor (Q), or Built-in Low Voltage Controller (U or L) available. See page 35 for details. 220V motor is also available at no extra cost.
- **Case Options:** For more information on how to order case in advance of screen, see page 9. Black case available on request.
- **Extra Drop:** Additional drop above image area (specify color—surface color standard for AV format; black standard for all others). See page 36.

| OptiView Surfaces | | | | | | | | | | | |
|------------------------------|-------------------|-------------------|--------------------|----------------------|------------------------|----------------------|---------------------|--------|-------------|-------------------|---------------|
| H x W / Diagonal | Image Area | Overall Size | Matt White XT1000E | Contrast Grey XH800E | Contrast White XH1100E | Argent White XH1500E | Pearl White CH1900E | PRICE | Case Length | Shipping Wt./lbs. | Freight Class |
| 16:10 Format | | | | | | | | | | | |
| 94" | 50" x 80" | 62" x 83 1/2" | 139037 | 139037EC | 139037EG | 139037EH | 139037EJ | \$2325 | 102" | 73 | 125 |
| 109" | 57 1/2" x 92" | 69 1/2" x 96" | 139038 | 139038EC | 139038EG | 139038EH | 139038EJ | 2355 | 113" | 81 | 125 |
| 113" | 60" x 96" | 72" x 100" | 139039 | 139039EC | 139039EG | 139039EH | -- | 2380 | 119" | 85 | 125 |
| 123" | 65" x 104" | 69" x 108" | 139040 | 139040EC | 139040EG | 139040EH | -- | 2390 | 126" | 88 | 125 |
| 137" | 72 1/2" x 116" | 76 1/2" x 120" | 139041 | 139041EC | 139041EG | 139041EH | -- | 2420 | 136" | 98 | 125 |
| 16:9 HDTV Format | | | | | | | | | | | |
| 92" | 45" x 80" | 57" x 83 1/2" | 139027 | 139027EC | 139027EG | 139027EH | 139027EJ | \$2325 | 102" | 75 | 125 |
| 100" | 49" x 87" | 61" x 91" | 139028 | 139028EC | 139028EG | 139028EH | 139028EJ | 2342 | 107" | 87 | 125 |
| 106" | 52" x 92" | 64" x 96" | 139029 | 139029EC | 139029EG | 139029EH | 139029EJ | 2355 | 113" | 90 | 125 |
| 110" | 54" x 96" | 66" x 100" | 139030 | 139030EC | 139030EG | 139030EH | -- | 2380 | 119" | 76 | 125 |
| 119" | 58" x 104" | 62" x 108" | 139031 | 139031EC | 139031EG | 139031EH | -- | 2390 | 126" | 100 | 125 |
| 133" | 65" x 116" | 69" x 120" | 139032 | 139032EC | 139032EG | 139032EH | -- | 2420 | 136" | 85 | 125 |
| 4:3 NTSC Video Format | | | | | | | | | | | |
| 6' | 42 1/2" x 56 1/2" | 46 1/2" x 59 1/2" | 139016 | 139016EC | 139016EG | 139016EH | 139016EJ | \$2269 | 76" | 59 | 125 P+ |
| 7' | 50" x 66 1/2" | 53 1/2" x 69 1/2" | 139017 | 139017EC | 139017EG | 139017EH | 139017EJ | 2285 | 85" | 66 | 125 P+ |
| 100" | 60" x 80" | 64" x 83 1/2" | 139018 | 139018EC | 139018EG | 139018EH | 139018EJ | 2339 | 102" | 77 | 125 |
| 10' | 69" x 92" | 73" x 96" | 139019 | 139019EC | 139019EG | 139019EH | 139019EJ | 2389 | 113" | 87 | 125 |
| 11' | 78" x 104" | 83" x 108" | 139020 | 139020EC | 139020EG | 139020EH | -- | 2445 | 126" | 105 | 125 |
| 150" | 87" x 116" | 92" x 120" | 139021 | 139021EC | 139021EG | 139021EH | -- | 2465 | 136" | 86 | 125 |
| AV Format | | | | | | | | | | | |
| 50" x 50" | | | 139001 | 139001EC | 139001EG | 139001EH | 139001EJ | \$2230 | 66" | 55 | 125 P+ |
| 60" x 60" | | | 139002 | 139002EC | 139002EG | 139002EH | 139002EJ | 2257 | 76" | 59 | 125 P+ |
| 70" x 70" | | | 139003 | 139003EC | 139003EG | 139003EH | 139003EJ | 2285 | 85" | 68 | 125 P+ |
| 72" x 96" | | | 139005 | 139005EC | 139005EG | 139005EH | 139005EJ | 2370 | 102" | 87 | 125 |
| 84" x 84" | | | 139004 | 139004EC | 139004EG | 139004EH | 139004EJ | 2347 | 102" | 72 | 125 |
| 96" x 96" | | | 139006 | 139006EC | 139006EG | 139006EH | 139006EJ | 2417 | 113" | 84 | 125 |
| 7' x 9' | | | 139007 | 139007EC | 139007EG | 139007EH | -- | 2482 | 126" | 95 | 125 |
| 9' x 9' | | | 139008 | 139008EC | 139008EG | 139008EH | -- | 2527 | 126" | 95 | 125 |
| 8' x 10' | | | 139009 | 139009EC | 139009EG | 139009EH | -- | 2564 | 136" | 103 | 125 |
| 10' x 10' | | | 139010 | 139010EC | 139010EG | 139010EH | -- | 2612 | 136" | 98 | 125 |

*These sizes include 12" black drop as standard—NO EXTRA CHARGE!

CHART CONTINUED BELOW

| ClearSound Surfaces | | | | | | | | | | |
|------------------------------|-------------------|-------------------|-------------------------------|------------------------------|--------|-------------|-------------------|---------------|--|--|
| H x W / Diagonal | Image Area | Overall Size | ClearSound White Weave XT900E | ClearSound Grey Weave XH600E | PRICE | Case Length | Shipping Wt./lbs. | Freight Class | | |
| 16:10 Format | | | | | | | | | | |
| 94" | 50" x 80" | 62" x 83 1/2" | 139037SA | 139037SB | \$5349 | 102" | 73 | 125 | | |
| 109" | 57 1/2" x 92" | 69 1/2" x 96" | 139038SA | 139038SB | 5418 | 113" | 81 | 125 | | |
| 113" | 60" x 96" | 72" x 100" | 139039SA | 139039SB | 5474 | 119" | 85 | 125 | | |
| 123" | 65" x 104" | 69" x 108" | 139040SA | 139040SB | 5498 | 126" | 88 | 125 | | |
| 137" | 72 1/2" x 116" | 76 1/2" x 120" | 139041SA | 139041SB | 5568 | 136" | 98 | 125 | | |
| 16:9 HDTV Format | | | | | | | | | | |
| 92" | 45" x 80" | 57" x 83 1/2" | 139027SA | 139027SB | \$5094 | 102" | 75 | 125 | | |
| 100" | 49" x 87" | 61" x 91" | 139028SA | 139028SB | 6545 | 107" | 87 | 125 | | |
| 106" | 52" x 92" | 64" x 96" | 139029SA | 139029SB | 6805 | 113" | 90 | 125 | | |
| 110" | 54" x 96" | 66" x 100" | 139030SA | 139030SB | 6908 | 119" | 76 | 125 | | |
| 119" | 58" x 104" | 62" x 108" | 139031SA | 139031SB | 6965 | 126" | 100 | 125 | | |
| 133" | 65" x 116" | 69" x 120" | 139032SA | 139032SB | 7138 | 136" | 85 | 125 | | |
| 4:3 NTSC Video Format | | | | | | | | | | |
| 6' | 42 1/2" x 56 1/2" | 46 1/2" x 59 1/2" | 139016SA | 139016SB | \$5218 | 76" | 59 | 125 P+ | | |
| 7' | 50" x 66 1/2" | 53 1/2" x 69 1/2" | 139017SA | 139017SB | 5256 | 85" | 66 | 125 P+ | | |
| 100" | 60" x 80" | 64" x 83 1/2" | 139018SA | 139018SB | 5379 | 102" | 77 | 125 | | |
| 10' | 69" x 92" | 73" x 96" | 139019SA | 139019SB | 6916 | 113" | 87 | 125 | | |
| 11' | 78" x 104" | 83" x 108" | 139020SA | 139020SB | 7211 | 126" | 105 | 125 | | |
| 150" | 87" x 116" | 92" x 120" | 139021SA | 139021SB | 7251 | 136" | 86 | 125 | | |
| AV Format | | | | | | | | | | |
| 50" x 50" | | | 139001SA | 139001SB | \$5129 | 66" | 55 | 125 P+ | | |
| 60" x 60" | | | 139002SA | 139002SB | 5191 | 76" | 59 | 125 P+ | | |
| 70" x 70" | | | 139003SA | 139003SB | 5256 | 85" | 68 | 125 P+ | | |
| 72" x 96" | | | 139005SA | 139005SB | 5453 | 102" | 87 | 125 | | |
| 84" x 84" | | | 139004SA | 139004SB | 5398 | 102" | 72 | 125 | | |
| 96" x 96" | | | 139006SA | 139006SB | 5559 | 113" | 84 | 125 | | |
| 7' x 9' | | | 139007SA | 139007SB | 5709 | 126" | 95 | 125 | | |
| 9' x 9' | | | -- | -- | -- | 126" | 95 | 125 | | |
| 8' x 10' | | | 139009SA | 139009SB | 5896 | 136" | 103 | 125 | | |
| 10' x 10' | | | -- | -- | -- | 136" | 98 | 125 | | |

Note: for alternate installation of Access screens, additional set of brackets is required. Part No. C502.233.

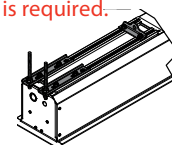

Access/Series E—Motor-in-roller electric screen for ceiling-recessed installation. New hinged door cover makes installation and service easier. White finished case. "Plug-in" wiring connections allow installation of case early and screen later. Plenum rated case (UL approved "Suitable for Use in Environmental Air Space"). Includes one 110-120v 3-position switch. **An Access case may be ordered and installed prior to selecting a screen size, type and format. Please see page 9 for cases. Note:** for alternate installation of Access screens, additional set of brackets is required. **Part no.C502.240.**

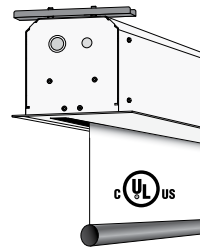

Standard Specs

- **Sizes and Formats:** Custom sizes by quotation. Custom sizes need to be specified in detail, including extra drop, if desired.
- **Case Dimensions:** 8 1/16" depth x 7 3/8" high including flange and mounting brackets. Extra drop may increase case size: call for dimensions.
- **Black Borders:** NTSC, HDTV and 16:10 format have image area framed with black on all four sides. Black side borders are available on request for AV format screens.

Options

- **Motor/Control Options:** Quiet Motor (Q), or Built-in Low Voltage Controller (U or L) available. See page 35 for details. 220V motor is also available at no extra cost.
- **Case Options:** For more information on how to order case in advance of screen, see page 9. Black case available on request.
- **Extra Drop:** Additional drop above image area (specify color—surface color standard for AV format; black standard for all others). See page 36.

| H x W / Diagonal | Image Area | Overall Size | OptiView Viewing Surfaces | | | ClearSound Viewing Surfaces | | | Case Length | Shipping Wt./lbs. | Freight Class |
|------------------------------|-----------------|-----------------|---------------------------|----------------------|--------|-------------------------------|------------------------------|--------|-------------|-------------------|---------------|
| | | | Matt White XT1000E | Contrast Grey XH800E | PRICE | ClearSound White Weave XT900E | ClearSound Grey Weave XH600E | PRICE | | | |
| 16:10 Format | | | | | | | | | | | |
| 165" | 87 1/2" x 140" | 92 1/2" x 144" | 139042 | 139042EC | \$2504 | 139042SA | 139042SB | 5759 | 158" | 124 | 125 |
| 189" | 100" x 160" | 105" x 164" | 139043 | 139043EC | 2566 | 139043SA | 139043SB | 5901 | 178" | 144 | 125 |
| 198" | 105" x 168" | 110" x 172" | 139044 | 139044EC | 6815 | 139044SA | 139044SB | 15673 | 186" | 534 | 125 |
| 222" | 117 1/2" x 188" | 122 1/2" x 192" | 139045 | 139045EC | 7075 | -- | -- | -- | 206" | 588 | 125 |
| 16:9 HDTV Format | | | | | | | | | | | |
| 161" | 79" x 140" | 84" x 144" | 139033 | 139033EC | \$2504 | 139033SA | 139033SB | \$7496 | 158" | 118 | 125 |
| 184" | 90" x 160" | 95" x 164" | 139034 | 139034EC | 2566 | 139034SA | 139034SB | 7782 | 178" | 512 | 125 |
| 193" | 94 1/2" x 168" | 99 1/2" x 172" | 139035 | 139035EC | 6815 | 139035SA | 139035SB | 15673 | 186" | 534 | 125 |
| 220" | 106" x 188" | 111" x 192" | 139036 | 139036EC | 7075 | 139036SA | 139036SB | 16272 | 206" | 588 | 125 |
| 4:3 NTSC Video Format | | | | | | | | | | | |
| 15' | 105" x 140" | 109" x 144" | 139022 | 139022EC | \$2552 | 139022SA | 139022SB | \$5870 | 158" | 127 | 125 |
| 200" | 118" x 158" | 123" x 162" | 139023 | 139023EC | 2614 | -- | -- | -- | 176" | 507 | 125 |
| 210" | 126" x 168" | 131" x 172" | 139024 | 139024EC | 6815 | -- | -- | -- | 186" | 534 | 125 |
| 220" | 132" x 176" | 137" x 180" | 139025 | 139025EC | 6998 | -- | -- | -- | 194" | 556 | 125 |
| 240" | 141" x 188" | 146" x 192" | 139026 | 139026EC | 7075 | -- | -- | -- | 206" | 588 | 125 |
| AV Format | | | | | | | | | | | |
| 9' x 12' | | | 139011 | 139011EC | \$2696 | 139011SA | 139011SB | \$6200 | 158" | 120 | 125 |
| 12' x 12' | | | 139012 | 139012EC | 2937 | -- | -- | -- | 158" | 141 | 125 |
| 10' 6" x 14' | | | 139013 | 139013EC | 6815 | -- | -- | -- | 182" | 523 | 125 |
| 14' x 14' | | | 139014 | 139014EC | 7228 | -- | -- | -- | 182" | 523 | 125 |
| 12' x 16' | | | 139015 | 139015EC | 7075 | -- | -- | -- | 206" | 588 | 125 |

Redesigned! Access XL/Series E—The Access XL/Series E line of projection screens are motorized, ceiling-recessed, and offer the same great features as other Access screens—now in a range of large sizes. Includes one 110-120v 3-position switch. Viewing surfaces available from the OptiView family. Case lengths below include flange to support ceiling tile or trim ceiling opening. Plenum rated case (UL approved "Suitable for Use in Environmental Air Space"). **Note:** for alternate installation of Access screens, additional set of brackets is required. **Part No. C502.281.**

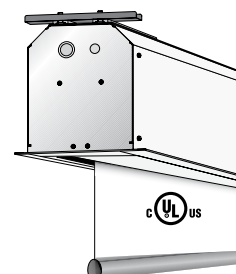

Standard Specs

- **Sizes and Formats:** Custom sizes by quotation. Custom sizes need to be specified in detail, including extra drop, if desired.
- **Case Dimensions:** Case is 10 1/8" H x 9 7/16" D (includes flange and mounting brackets). Built-in controls may increase length of case: call Draper for dimensions.
- **Black Borders:** NTSC, HDTV and 16:10 format have image area framed with black on all four sides. Black side borders are available on request for AV format screens.

- **Viewing Surface:** Also available with ClearSound Perf XT950E, a perforated matt white, by quotation —Add the suffix SE to any Matt White XT1000E part number. See page 5.

Options

- **Motor/Control Options:** Built-in Low Voltage Controller (U or L) available. See page 35 for details. 220V motor is also available at no extra cost.
- **Case Options:** Black case available on request.
- **Extra Drop:** Additional drop above image area (specify color—surface color standard for AV format; black standard for all others). See page 36.

| Size H x W / Diagonal | Image Area | Overall Size | OptiView Viewing Surfaces | | Case Length | Shipping Wt./lbs. | Freight Class |
|------------------------------|-----------------|-----------------|---------------------------|--------|-------------|-------------------|---------------|
| | | | Matt White XT1000E | PRICE | | | |
| 16:10 Format | | | | | | | |
| 255" | 135" x 216" | 140" x 220" | 146012 | \$8240 | 233 3/4" | 664 | 125 |
| 278" | 147 1/2" x 236" | 152 1/2" x 240" | 146013 | 8697 | 253 3/4" | 718 | 125 |
| 16:9 HDTV Format | | | | | | | |
| 248" | 121 1/2" x 216" | 126 1/2" x 220" | 146010 | \$8240 | 233 3/4" | 664 | 125 |
| 270" | 133" x 236" | 138 1/2" x 240" | 146011 | 8697 | 253 3/4" | 718 | 125 |
| 4:3 NTSC Video Format | | | | | | | |
| 250" | 148" x 198" | 153" x 202" | 146007 | \$7783 | 215 3/4" | 615 | 125 |
| 270" | 162" x 216" | 167" x 220" | 146008 | 8332 | 233 3/4" | 664 | 125 |
| 295" | 177" x 236" | 182" x 240" | 146009 | 8790 | 253 3/4" | 718 | 125 |
| AV Format | | | | | | | |
| 16' x 16' | | | 146001 | 7892 | 205 3/4" | 588 | 125 |
| 13' 6" x 18' | | | 146002 | 8293 | 229 3/4" | 653 | 125 |
| 18' x 18' | | | 146003 | 8405 | 229 3/4" | 653 | 125 |
| 8' x 20' | | | 146004 | 8652 | 253 3/4" | 718 | 125 |
| 15' x 20' | | | 146005 | 8790 | 253 3/4" | 718 | 125 |
| 20' x 20' | | | 146006 | 9479 | 253 3/4" | 718 | 125 |



Redesigned! Ultimate Access/Series V—

Tab-tensioned screen for ceiling-recessed installation. White finished folded steel case with “plug-in” wiring connections that enable installation of case early in construction, and viewing surface later. Independently motorized ceiling closure opens into the case. No exposed fasteners. Plenum rated case (UL approved “Suitable for Use in Environmental Air Space”). Includes one 110-120v 3-position switch. Left hand motor location only. Viewing surfaces from the OptiFlex, and CineFlex families. **An Ultimate Access case may be ordered and installed prior to selecting a screen size, type and format. Please see page 9 for cases.**

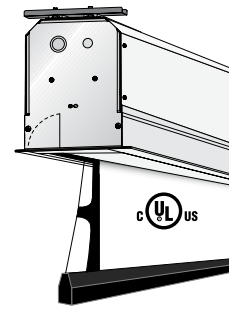

Standard Specs

- **Sizes and Formats:** Custom sizes by quotation. Custom sizes need to be specified in detail, including extra drop, if desired.
- **Case Dimensions:** Case is 9 7/8" H x 8" D (includes flange and mounting brackets). Case lengths below include flange to support ceiling tile or trim ceiling opening. Extra drop will increase length of case: call Draper for dimensions.
- **Black Borders:** Image area fully framed in black. **12" black drop at top of viewing surface (standard).**

Options

- **Motor/Control Options:** Quiet Motor (Q), and Built-in Low Voltage Controller (U) available. See page 35 for details. 220V motor is also available at no extra cost.
- **Case Options:** For more information on how to order case in advance of screen, see page 9. All ceiling recessed cases can be painted black upon request.
- **Extra Drop:** Additional drop above image (specify color—12" black is standard; surface color available on request). Extra drop may increase case length. See page 36.

Viewing Surface:

CineFlex CH1200V (CB) and CineFlex MH800V (CA) rear projection surfaces, and CineFlex White XT600V (CC) front/rear projection surface available by quotation—add the 2-letter suffix noted above to any Matt White XT1000V part number. Also available with ClearSound Perff XT900V, a perforated matt white—add the suffix SD to any Matt White XT1000V part number. See page 5.



| | | OptiFlex Viewing Surfaces | | | | | | | | | | | | |
|------------------------------|-------------------|---------------------------|-------------|--------------------|--------|---------------------|--------|---------------|--------|-------------|-------------------|---------------|--|--|
| H x W / Diagonal | Image Area | Matt White XT1000V | Grey XH600V | Pure White XT1300V | PRICE | Pearl White MH1500V | PRICE | ReAct MS1000V | PRICE | Case Length | Shipping Wt./lbs. | Freight Class | | |
| 16:10 Format | | | | | | | | | | | | | | |
| 94" | 50" x 80" | 143025 | 143025FB | 143025FN | \$4656 | 143025FJ | \$4866 | 143025FR | \$5004 | 103 3/8" | 128 | 125 | | |
| 109" | 57 1/2" x 92" | 143026 | 143026FB | 143026FN | 4861 | 143026FJ | 5079 | 143026FR | 5226 | 116 3/8" | 138 | 125 | | |
| 113" | 60" x 96" | 143027 | 143027FB | 143027FN | 5053 | 143027FJ | 5279 | 143027FR | 5431 | 120 3/8" | 148 | 125 | | |
| 123" | 65" x 104" | 143028 | 143028FB | 143028FN | 5429 | 143028FJ | 5674 | 143028FR | 5836 | 128 3/8" | 158 | 125 | | |
| 137" | 72 1/2" x 116" | 143029 | 143029FB | 143029FN | 5835 | 143029FJ | 6098 | 143029FR | 6273 | 141 1/2" | 189 | 125 | | |
| 165" | 87 1/2" x 140" | 143030 | 143030FB | 143030FN | 6258 | 143030FJ | 6540 | -- | -- | 167" | 200 | 125 | | |
| 16:9 HDTV Format | | | | | | | | | | | | | | |
| 92" | 45" x 80" | 143018 | 143018FB | 143018FN | \$4656 | 143018FJ | \$4866 | 143018FR | \$5004 | 103 3/8" | 128 | 125 | | |
| 100" | 49" x 87" | 143019 | 143019FB | 143019FN | 4769 | 143019FJ | 4984 | 143019FR | 5128 | 110 3/8" | 124 | 125 | | |
| 106" | 52" x 92" | 143020 | 143020FB | 143020FN | 4861 | 143020FJ | 5079 | 143020FR | 5226 | 115 3/8" | 140 | 125 | | |
| 110" | 54" x 96" | 143021 | 143021FB | 143021FN | 5053 | 143021FJ | 5279 | 143021FR | 5431 | 120 3/8" | 158 | 125 | | |
| 119" | 58" x 104" | 143022 | 143022FB | 143022FN | 5429 | 143022FJ | 5674 | 143022FR | 5836 | 128 3/8" | 161 | 125 | | |
| 133" | 65" x 116" | 143023 | 143023FB | 143023FN | 5835 | 143023FJ | 6098 | 143023FR | 6273 | 140 3/8" | 189 | 125 | | |
| 161" | 79" x 140" | 143024 | 143024FB | 143024FN | 6258 | 143024FJ | 6540 | 143024FR | 6728 | 165 1/2" | 194 | 125 | | |
| 4:3 NTSC Video Format | | | | | | | | | | | | | | |
| 6' | 42 1/2" x 56 1/2" | 143011 | 143011FB | 143011FN | \$4122 | 143011FJ | \$4308 | 143011FR | \$4431 | 79 7/8" | 115 | 125 P+ | | |
| 7' | 50" x 66 1/2" | 143012 | 143012FB | 143012FN | 4398 | 143012FJ | 4596 | 143012FR | 4728 | 89 7/8" | 124 | 125 P+ | | |
| 100" | 60" x 80" | 143013 | 143013FB | 143013FN | 4719 | 143013FJ | 4931 | 143013FR | 5073 | 104 3/8" | 128 | 125 | | |
| 10' | 72" x 96" | 143014 | 143014FB | 143014FN | 4946 | 143014FJ | 5169 | 143014FR | 5316 | 121 1/2" | 148 | 125 | | |
| 11' | 78" x 104" | 143015 | 143015FB | 143015FN | 5588 | 143015FJ | 5840 | 143015FR | 6006 | 129 1/2" | 177 | 125 | | |
| 150" | 87" x 116" | 143016 | 143016FB | 143016FN | 5863 | 143016FJ | 6126 | -- | -- | 143" | 181 | 125 | | |
| 15' | 108" x 144" | 143017 | 143017FB | 143017FN | 6336 | 143017FJ | 6621 | -- | -- | 171 1/2" | 208 | 125 | | |
| AV Format | | | | | | | | | | | | | | |
| 50" x 50" | | 143001 | 143001FB | 143001FN | \$3996 | 143001FJ | \$4176 | -- | -- | 73 3/8" | 113 | 125 P+ | | |
| 60" x 60" | | 143002 | 143002FB | 143002FN | 4264 | 143002FJ | 4456 | -- | -- | 84 3/8" | 120 | 125 P+ | | |
| 70" x 70" | | 143003 | 143003FB | 143003FN | 4444 | 143003FJ | 4644 | -- | -- | 95 1/2" | 124 | 125 | | |
| 84" x 84" | | 143004 | 143004FB | 143004FN | 4929 | 143004FJ | 5151 | -- | -- | 109 1/2" | 135 | 125 | | |
| 72" x 96" | | 143014 | 143014FB | 143014FN | 4946 | 143014FJ | 5169 | -- | -- | 121 1/2" | 148 | 125 | | |
| 96" x 96" | | 143005 | 143005FB | 143005FN | 5298 | 143005FJ | 5536 | -- | -- | 123" | 158 | 125 | | |
| 7' x 9' | | 143006 | 143006FB | 143006FN | 5423 | 143006FJ | 5666 | -- | -- | 133 1/2" | 162 | 125 | | |
| 9' x 9' | | 143007 | 143007FB | 143007FN | 5663 | 143007FJ | 5918 | -- | -- | 135 1/2" | 165 | 125 | | |
| 8' x 10' | | 143008 | 143008FB | 143008FN | 5863 | 143008FJ | 6126 | -- | -- | 147" | 172 | 125 | | |
| 10' x 10' | | 143009 | 143009FB | 143009FN | 6101 | 143009FJ | 6376 | -- | -- | 149 1/8" | 196 | 125 | | |
| 9' x 12' | | 143017 | 143017FB | 143017FN | 6336 | 143017FJ | 6621 | -- | -- | 171 1/2" | 208 | 125 | | |
| 12' x 12' | | 143010 | -- | -- | 7773 | -- | -- | -- | -- | 174 7/8" | 220 | 125 | | |

Note: for alternate installation of Access screens, additional set of brackets is required. Part No. C502.279.

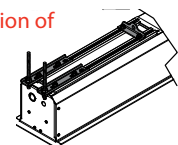

NEW! Ultimate Access XL/Series V—Tab-

tensioned screen for ceiling-recessed installation. White finished folded steel case with "plug-in" wiring connections that enable installation of case early in construction, and viewing surface later. Independently motorized ceiling closure opens into the case. No exposed fasteners. Plenum rated case (UL approved "Suitable for Use in Environmental Air Space"). Includes one 110-120v 3-position switch. Left hand motor location only. Viewing surfaces from the OptiFlex, and CineFlex families.

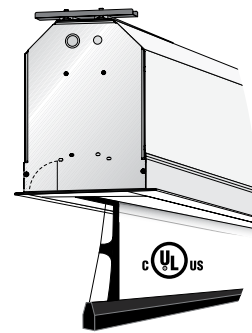

Standard Specs

- **Sizes and Formats:** Custom sizes by quotation. Custom sizes need to be specified in detail, including extra drop, if desired.
- **Case Dimensions:** Case is 14 1/16" H x 10 3/8" D (includes flange and mounting brackets). Case lengths below include flange to support ceiling tile or trim ceiling opening. Extra drop will increase length of case: call Draper for dimensions.
- **Black Borders:** Image area fully framed in black. **12" black drop at top of viewing surface (standard).**

Options

- **Motor/Control Options:** Built-in Low Voltage Controller (U) available. *See page 35 for details.* 220V motor is also available at no extra cost.
- **Case Options:** All ceiling recessed cases can be painted black upon request.
- **Extra Drop:** Additional drop above image (specify color—12" black is standard; surface color available on request). Extra drop may increase case length. *See page 36.*

and CineFlex MH800V (CA) rear projection surfaces, and CineFlex White XT600V (CC) front/rear projection surface available by quotation—add the 2-letter suffix noted above to any Matt White XT1000V part number. Also available with ClearSound Perf XT900V, a perforated matt white—add the suffix SD to any Matt White XT1000V part number. *See page 5.*

Note: for alternate installation of Access screens, additional set of brackets is required. Part No. C502.280.

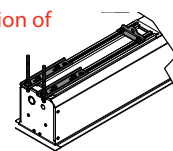

• **Viewing Surface:** CineFlex CH1200V (CB)

OptiFlex Viewing Surfaces

| H x W / Diagonal | Image Area | Matt White XT1000V | Grey XH600V | Pure White XT1300V | PRICE | Pearl White MH1500V | PRICE | Case Length | Shipping Wt./lbs. | Freight Class |
|------------------------------|-----------------|--------------------|-------------|--------------------|--------|---------------------|--------|-------------|-------------------|---------------|
| 16:10 Format | | | | | | | | | | |
| 189" | 100" x 160" | 145001 | 145001FB | 145001FN | \$6596 | 145001FJ | \$6893 | 186 3/4" | 274 | 125 |
| 198" | 105" x 168" | 145002 | 145002FB | 145002FN | 7051 | 145002FJ | 7368 | 195 1/4" | 280 | 125 |
| 226" | 120" x 192" | 145003 | 145003FB | 145003FN | 8452 | 145003FJ | 8832 | 220 7/8" | 320 | 125 |
| 234" | 124" x 198" | 145004 | 145004FB | 145004FN | 8877 | 145004FJ | 9277 | 226 7/8" | 331 | 125 |
| 255" | 135" x 216" | 145005 | 145005FB | 145005FN | 11836 | 145005FJ | 12369 | 246 5/8" | 361 | 125 |
| 278" | 147" x 236" | 145006 | 145006FB | 145006FN | 12778 | -- | -- | 270 1/8" | 393 | 125 |
| 307" | 162" x 260" | 145007 | 145007FB | 145007FN | 13503 | -- | -- | 296 1/8" | 434 | 125 |
| 16:9 HDTV Format | | | | | | | | | | |
| 184" | 90" x 160" | 145008 | 145008FB | 145008FN | \$6596 | 145008FJ | \$6893 | 186 3/4" | 275 | 125 |
| 193" | 94 1/2" x 168" | 145009 | 145009FB | 145009FN | 7051 | 145009FJ | 7368 | 194 3/4" | 280 | 125 |
| 220" | 108" x 192" | 145010 | 145010FB | 145010FN | 8452 | 145010FJ | 8832 | 219 1/4" | 320 | 125 |
| 227" | 111" x 198" | 145011 | 145011FB | 145011FN | 8877 | 145011FJ | 9277 | 225 1/4" | 325 | 125 |
| 248" | 121 1/2" x 216" | 145012 | 145012FB | 145012FN | 11836 | 145012FJ | 12369 | 244 7/8" | 351 | 125 |
| 270" | 133" x 236" | 145013 | 145013FB | 145013FN | 12778 | 145013FJ | 13353 | 270 1/8" | 382 | 125 |
| 300" | 146" x 260" | 145014 | 145014FB | 145014FN | 13503 | -- | -- | 294 1/8" | 425 | 125 |
| 4:3 NTSC Video Format | | | | | | | | | | |
| 200" | 118" x 158" | 145015 | 145015FB | 145015FN | \$6460 | 145015FJ | \$6750 | 186 7/8" | 265 | 125 |
| 210" | 126" x 168" | 145016 | 145016FB | 145016FN | 7380 | 145016FJ | 7712 | 196 7/8" | 295 | 125 |
| 220" | 132" x 176" | 145017 | 145017FB | 145017FN | 8177 | 145017FJ | 8545 | 204 7/8" | 300 | 125 |
| 230" | 138" x 184" | 145018 | 145018FB | 145018FN | 8485 | 145018FJ | 8867 | 214 5/8" | 315 | 125 |
| 240" | 144" x 192" | 145019 | 145019FB | 145019FN | 8835 | -- | -- | 222 5/8" | 343 | 125 |
| 250" | 148" x 198" | 145020 | 145020FB | 145020FN | 9169 | -- | -- | 228 5/8" | 354 | 125 |
| 270" | 162" x 216" | 145021 | 145021FB | 145021FN | 11961 | -- | -- | 248 5/8" | 382 | 125 |
| 295" | 177" x 236" | 145022 | 145022FB | 145022FN | 13128 | -- | -- | 274 1/4" | 417 | 125 |
| 330" | 194" x 260" | 145023 | 145023FB | 145023FN | 14170 | -- | -- | 300 1/2" | 467 | 125 |
| AV Format | | | | | | | | | | |
| 10' 6" x 14' | | 145024 | 145024FB | 145024FN | \$7380 | 145024FJ | \$7712 | 196 7/8" | 295 | 125 |
| 14' x 14' | | 145025 | 145025FB | 145025FN | 8340 | -- | -- | 202 3/4" | 315 | 125 |
| 12' x 14' | | 145026 | 145026FB | 145026FN | 8835 | -- | -- | 222 5/8" | 343 | 125 |
| 16' x 16' | | 145027 | 145027FB | 145027FN | 9544 | -- | -- | 229" | 384 | 125 |
| 13' 6" x 18' | | 145028 | 145028FB | 145028FN | 11961 | -- | -- | 248 5/8" | 382 | 125 |
| 18' x 18' | | 145029 | 145029FB | 145029FN | 12753 | -- | -- | 258 3/8" | 432 | 125 |
| 15' x 20' | | 145030 | 145030FB | 145030FN | 13128 | -- | -- | 278 1/4" | 425 | 125 |
| 11' x 22' | | 145031 | 145031FB | 145031FN | 13586 | -- | -- | 296 3/8" | 418 | 125 |
| 16' 6" x 22' | | 145032 | 145032FB | 145032FN | 14170 | -- | -- | 306 3/8" | 467 | 125 |



Freight Class Key
Number LTL freight class
P Parcel service
 + . . . \$8.50 surcharge (over 60" long)
Example: a freight code of 125 P+ indicates an item that may ship as freight class 125 or via parcel service with \$8.50 surcharge.

Redesigned! Ultimate Access/Series E—Motor-in-roller electric screen for ceiling-recessed installation. White finished folded steel case with “plug-in” wiring connections that enable installation of case early in construction, and viewing surface later. No exposed fasteners. Independently motorized ceiling closure opens into the case. Plenum rated case (**UL approved** “Suitable for Use in Environmental Air Space”). Includes one 110-120v 3-position switch. Left hand motor location only. Viewing surfaces available from the OptiView and ClearSound families. **An Ultimate Access case may be ordered and installed prior to selecting a screen size, type and format. Please see page 9 for cases.**

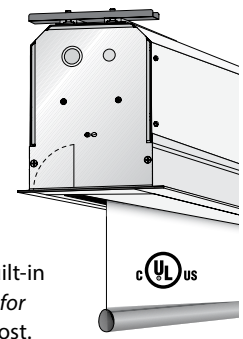

Standard Specs

- **Sizes and Formats:** Custom sizes by quotation. Custom sizes need to be specified in detail, including extra drop, if desired.
- **Case Dimensions:** Case is 9 7/8" H x 8" D (includes flange and mounting brackets). Case lengths below include flange to support ceiling tile or trim ceiling opening. Built in controls may increase length of case: call Draper for dimensions.
- **Black Borders:** NTSC, HDTV and 16:10 format have image area framed with black on all four sides. Black side borders are available on request for AV format screens.

Options

- **Motor/Control Options:** Quiet Motor (Q) , or Built-in Low Voltage Controller (U) available. See page 35 for details. 220V motor is also available at no extra cost.
- **Case Options:** For more information on how to order case in advance of screen, see page 9. All ceiling recessed cases can be painted black upon request.
- **Extra Drop:** Additional drop above image (specify color— surface color standard for AV format; black standard for all others). See page 36.
- **Viewing Surface:** Also available with ClearSound Perf XT950E, a perforated matt white, by quotation —Add the suffix SE to any Matt White XT1000E part number. See page 5.



| H x W / Diagonal | Image Area | Overall Size | OptiView Viewing Surfaces | | | | | ClearSound Viewing Surfaces | | | Case Length | Ship Wt./ lbs. | Freight Class | |
|------------------------------|-------------------|-------------------|---------------------------|----------------------|------------------------|----------------------|---------------------|-----------------------------|-------------------------------|------------------------------|-------------|----------------|---------------|--------|
| | | | Matt White XT1000E | Contrast Grey XH800E | Contrast White XH1100E | Argent White XH1500E | Pearl White CH1900E | PRICE | ClearSound White Weave XT900E | ClearSound Grey Weave XH600E | | | | PRICE |
| 16:10 Format | | | | | | | | | | | | | | |
| 94"* | 50" x 80" | 62" x 83 1/2" | 142027 | 142027EC | 142027EG | 142027EH | 142027EJ | \$3417 | 142027SA | 142027SB | \$7266 | 98 1/2" | 112 | 125 |
| 109"* | 57 1/2" x 92" | 69 1/2" x 96" | 142028 | 142028EC | 142028EG | 142028EH | 142028EJ | 3446 | 142028SA | 142028SB | 7970 | 111" | 122 | 125 |
| 113"* | 60" x 96" | 72" x 100" | 142029 | 142029EC | 142029EG | 142029EH | -- | 3562 | 142029SA | 142029SB | 8673 | 115" | 125 | 125 |
| 123" | 65" x 104" | 69" x 108" | 142030 | 142030EC | 142030EG | 142030EH | -- | 3572 | 142030SA | 142030SB | 9344 | 123" | 132 | 125 |
| 137" | 72 1/2" x 116" | 76 1/2" x 120" | 142031 | 142031EC | 142031EG | 142031EH | -- | 3692 | 142031SA | 142031SB | 10154 | 135" | 162 | 125 |
| 165" | 87 1/2" x 140" | 92 1/2" x 144" | 142032 | 142032EC | -- | -- | -- | 3774 | 142032SA | 142032SB | 10375 | 159" | 172 | 125 |
| 16:9 HDTV Format | | | | | | | | | | | | | | |
| 92"* | 45" x 80" | 57" x 83 1/2" | 142020 | 142020EC | 142020EG | 142020EH | 142020EJ | \$3417 | 142020SA | 142020SB | \$7266 | 98 1/2" | 112 | 125 |
| 100"* | 49" x 87" | 61" x 91" | 142021 | 142021EC | 142021EG | 142021EH | 142021EJ | 3429 | 142021SA | 142021SB | 7617 | 106" | 122 | 125 |
| 106"* | 52" x 92" | 64" x 96" | 142022 | 142022EC | 142022EG | 142022EH | 142022EJ | 3446 | 142022SA | 142022SB | 8673 | 111" | 122 | 125 |
| 110"* | 54" x 96" | 66" x 100" | 142023 | 142023EC | 142023EG | 142023EH | -- | 3562 | 142023SA | 142023SB | 9127 | 115" | 122 | 125 |
| 119" | 58" x 104" | 62" x 108" | 142024 | 142024EC | 142024EG | 142024EH | -- | 3572 | 142024SA | 142024SB | 9344 | 123" | 133 | 125 |
| 133" | 65" x 116" | 69" x 120" | 142025 | 142025EC | 142025EG | 142025EH | -- | 3692 | 142025SA | 142025SB | 10154 | 135" | 162 | 125 |
| 161" | 79" x 140" | 84" x 144" | 142026 | 142026EC | -- | -- | -- | 3774 | 142026SA | 142026SB | 10375 | 159" | 170 | 125 |
| 4:3 NTSC Video Format | | | | | | | | | | | | | | |
| 6' | 42 1/2" x 56 1/2" | 46 1/2" x 59 1/2" | 142013 | 142013EC | 142013EG | 142013EH | 142013EJ | \$3359 | 142013SA | 142013SB | \$7055 | 74 1/2" | 100 | 125 |
| 7' | 50" x 66 1/2" | 53 1/2" x 69 1/2" | 142014 | 142014EC | 142014EG | 142014EH | 142014EJ | 3389 | 142014SA | 142014SB | 7116 | 84 1/2" | 103 | 125 |
| 100" | 60" x 80" | 64" x 83 1/2" | 142015 | 142015EC | 142015EG | 142015EH | 142015EJ | 3489 | 142015SA | 142015SB | \$7657 | 98 1/2" | 109 | 125 |
| 10' | 69" x 92" | 73" x 96" | 142016 | 142016EC | 142016EG | 142016EH | 142016EJ | 3516 | 142016SA | 142016SB | 9657 | 111" | 124 | 125 |
| 11' | 78" x 104" | 83" x 108" | 142017 | 142017EC | 142017EG | 142017EH | -- | 3676 | 142017SA | 142017SB | 10120 | 123" | 148 | 125 |
| 150" | 87" x 116" | 92" x 120" | 142018 | 142018EC | 142018EG | 142018EH | -- | 3786 | 142018SA | 142018SB | 10375 | 135" | 152 | 125 |
| 15' | 105" x 140" | 109" x 144" | 142019 | 142019EC | -- | -- | -- | 3869 | 142019SA | 142019SB | 10834 | 159" | 172 | 125 |
| AV Format | | | | | | | | | | | | | | |
| 50" x 50" | | | 142001 | 142001EC | 142001EG | 142001EH | 142001EJ | \$3324 | 142001SA | 142001SB | \$6648 | 64 1/2" | 87 | 125 P+ |
| 60" x 60" | | | 142002 | 142002EC | 142002EG | 142002EH | 142002EJ | 3359 | 142002SA | 142002SB | 7055 | 74 1/2" | 92 | 125 |
| 70" x 70" | | | 142003 | 142003EC | 142003EG | 142003EH | 142003EJ | 3389 | 142003SA | 142003SB | 7116 | 84 1/2" | 102 | 125 |
| 84" x 84" | | | 142004 | 142004EC | 142004EG | 142004EH | 142004EJ | 3489 | 142004SA | 142004SB | 7657 | 98 1/2" | 118 | 125 |
| 72" x 96" | | | 142005 | 142005EC | 142005EG | 142005EH | 142005EJ | 3516 | 142005SA | 142005SB | 9657 | 111" | 119 | 125 |
| 96" x 96" | | | 142006 | 142006EC | 142006EG | 142006EH | 142006EJ | 3572 | 142006SA | 142006SB | 9889 | 111" | 147 | 125 |
| 7' x 9' | | | 142007 | 142007EC | 142007EG | 142007EH | -- | 3676 | 142007SA | 142007SB | 10120 | 123" | 150 | 125 |
| 9' x 9' | | | 142008 | 142008EC | -- | -- | -- | 3709 | 142008SA | 142008SB | 10249 | 123" | 152 | 125 |
| 8' x 10' | | | 142009 | 142009EC | 142009EG | 142009EH | -- | 3786 | 142009SA | 142009SB | 10375 | 135" | 161 | 125 |
| 10' x 10' | | | 142010 | 142010EC | -- | -- | -- | 3851 | -- | -- | -- | 135" | 167 | 125 |
| 9' x 12' | | | 142011 | 142011EC | -- | -- | -- | 3869 | -- | -- | -- | 159" | 182 | 125 |
| 12' x 12' | | | 142012 | 142012EC | -- | -- | -- | 4006 | -- | -- | -- | 159" | 190 | 125 |

*These sizes include 12" black drop as standard—NO EXTRA CHARGE!

Note: for alternate installation of Access screens, additional set of brackets is required. Part No. C502.279.

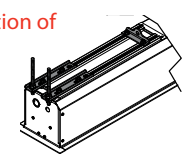

NEW! Ultimate Access XL/Series E—Motor-in-roller electric screen for ceiling-recessed installation. White finished folded steel case with “plug-in” wiring connections that enable installation of case early in construction, and viewing surface later. No exposed fasteners. Independently motorized ceiling closure opens into the case. Plenum rated case (UL approved “Suitable for Use in Environmental Air Space”). Includes one 110-3-position switch. Left hand motor location only. Viewing surfaces available from the OptiView and ClearSound families.

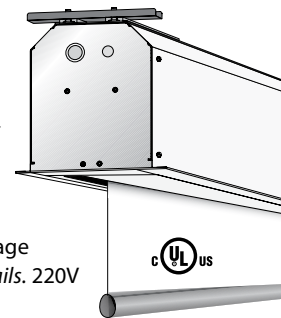

Standard Specs

- **Sizes and Formats:** Custom sizes by quotation. Custom sizes need to be specified in detail, including extra drop, if desired.
- **Case Dimensions:** Case is 14 1/16" H x 10 3/8" D (includes flange and mounting brackets). Case lengths below include flange to support ceiling tile or trim ceiling opening. Built in controls may increase length of case: call Draper for dimensions.
- **Black Borders:** NTSC, HDTV and 16:10 format have image area framed with black on all four sides. Black side borders are available on request for AV format screens.

Options

- **Motor/Control Options:** Built-in Low Voltage Controller (U) available. See page 35 for details. 220V motor is also available at no extra cost.
- **Case Options:** All ceiling recessed cases can be painted black upon request.
- **Extra Drop:** Additional drop above image (specify color— surface color standard for AV format; black standard for all others). See page 36.
- **Viewing Surface:** Also available with ClearSound Perf XT950E, a perforated matt white, by quotation —Add the suffix SE to any Matt White XT1000E part number. See page 5.



| H x W / Diagonal | Image Area | Overall Size | OptiView Viewing Surfaces | | | ClearSound Viewing Surfaces | | | Case Length | Ship Wt./ lbs. | Freight Class |
|------------------------------|-----------------|-----------------|---------------------------|----------------------|--------|-------------------------------|------------------------------|--------|-------------|----------------|---------------|
| | | | Matt White XT1000E | Contrast Grey XH800E | PRICE | ClearSound White Weave XT900E | ClearSound Grey Weave XH600E | PRICE | | | |
| 16:10 Format | | | | | | | | | | | |
| 189" | 100" x 160" | 105" x 164" | 144001 | 144001EC | \$4059 | 144001SA | 144001SB | \$9337 | 177 3/4" | 273 | 125 |
| 198" | 105" x 168" | 110" x 172" | 144002 | 144002EC | 5509 | 144002SA | 144002SB | 12673 | 185 3/4" | 278 | 125 |
| 222" | 117 1/2" x 188" | 122" x 192" | 144003 | 144003EC | 6685 | -- | -- | -- | 205 3/4" | 326 | 125 |
| 255" | 135" x 216" | 140" x 220" | 144004 | 144004EC | 9694 | -- | -- | -- | 233 3/4" | 375 | 125 |
| 278" | 147 1/2" x 236" | 152 1/2" x 240" | 144005 | 144005EC | 10085 | -- | -- | -- | 257 1/4" | 409 | 125 |
| 307" | 162 1/2" x 260" | 167 1/2" x 264" | 144006 | 144006EC | 10252 | -- | -- | -- | 281 1/4" | 451 | 125 |
| 16:9 HDTV Format | | | | | | | | | | | |
| 184" | 90" x 160" | 95" x 164" | 144007 | 144007EC | \$4059 | 144007SA | 144007SB | \$9337 | 177 3/4" | 273 | 125 |
| 193" | 94 1/2" x 168" | 99 1/2" x 172" | 144008 | 144008EC | 5509 | 144008SA | 144008SB | 12673 | 185 3/4" | 278 | 125 |
| 220" | 106" x 188" | 111" x 192" | 144009 | 144009EC | 6685 | 144009SA | 144009SB | 15375 | 205 3/4" | 288 | 125 |
| 248" | 121 1/2" x 216" | 126 1/2" x 220" | 144010 | 144010EC | 9694 | -- | -- | -- | 233 3/4" | 365 | 125 |
| 270" | 133" x 236" | 138 1/2" x 240" | 144011 | 144011EC | 10085 | -- | -- | -- | 257 1/4" | 397 | 125 |
| 300" | 146" x 260" | 151" x 264" | 144012 | 144012EC | 10252 | -- | -- | -- | 281 1/4" | 441 | 125 |
| 4:3 NTSC Video Format | | | | | | | | | | | |
| 200" | 118" x 158" | 123" x 162" | 144013 | 144013EC | \$4084 | -- | -- | -- | 175 3/4" | 278 | 125 |
| 210" | 126" x 168" | 131" x 172" | 144014 | 144014EC | 5618 | -- | -- | -- | 185 3/4" | 288 | 125 |
| 220" | 132" x 176" | 137" x 180" | 144015 | 144015EC | 6021 | -- | -- | -- | 193 3/4" | 298 | 125 |
| 230" | 138" x 184" | 143" x 188" | 144016 | 144016EC | 6405 | -- | -- | -- | 201 3/4" | 313 | 125 |
| 240" | 141" x 188" | 146" x 192" | 144017 | 144017EC | 6810 | -- | -- | -- | 205 3/4" | 340 | 125 |
| 250" | 148" x 198" | 153" x 202" | 144018 | 144018EC | 9210 | -- | -- | -- | 215 3/4" | 368 | 125 |
| 270" | 162" x 216" | 167" x 220" | 144019 | 144019EC | 10085 | -- | -- | -- | 233 3/4" | 397 | 125 |
| 295" | 177" x 236" | 182" x 240" | 144020 | 144020EC | 10544 | -- | -- | -- | 257 1/4" | 434 | 125 |
| 330" | 194" x 260" | 198" x 264" | 144021 | 144021EC | 10752 | -- | -- | -- | 281 1/4" | 485 | 125 |
| AV Format | | | | | | | | | | | |
| 12' x 14' | | | 144022 | 144022EC | \$5481 | -- | -- | -- | 181 3/4" | 463 | 125 |
| 14' x 14' | | | 144023 | 144023EC | 6810 | -- | -- | -- | 185 3/4" | 504 | 125 |
| 16' x 16' | | | 144024 | 144024EC | 7176 | -- | -- | -- | 205 3/4" | 564 | 125 |
| 13' 6" x 18' | | | 144025 | 144025EC | 10085 | -- | -- | -- | 229 3/4" | 562 | 125 |
| 18' x 18' | | | 144026 | 144026EC | 9960 | -- | -- | -- | 233 3/4" | 380 | 125 |
| 8' x 20' | | | 144027 | 144027EC | 10252 | -- | -- | -- | 253 3/4" | 635 | 125 |
| 15' x 20' | | | 144028 | 144028EC | 10544 | -- | -- | -- | 257 1/4" | 625 | 125 |
| 20' x 20' | | | 144029 | 144029EC | 10961 | -- | -- | -- | 257 1/4" | 499 | 125 |
| 11' x 22' | | | 144030 | 144030EC | 10335 | -- | -- | -- | 281 1/4" | 614 | 125 |
| 16' 6" x 22' | | | 144031 | 144031EC | 10752 | -- | -- | -- | 281 1/4" | 686 | 125 |

*These sizes include 12" black drop as standard—NO EXTRA CHARGE!

Note: for alternate installation of Access screens, additional set of brackets is required. Part No. C502.280.

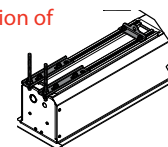

Access MultiView/Series V—Motor-in-roller electric screen with integral masking system for automatic switching between two formats. For ceiling-recessed installation. Masking system is independently motorized and changes surface from Scope to HDTV format, or HDTV to NTSC format. Two 110-120 volt 3-position wall switches included—one per motor. Plenum rated case (UL approved “Suitable for Use in Environmental Air Space”).

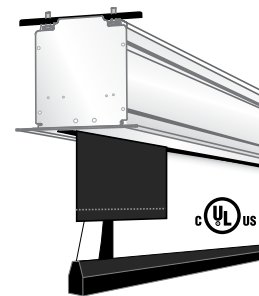

Motorized
Screens

Ceiling-Recessed

Standard Specs

- **Case Dimensions:** Case is 8" H x 9" D (includes flange and mounting brackets). Case lengths below include flange to support ceiling tile or trim ceiling opening. Built-in controls and/or extra drop on a Series V may increase length of case: call Draper for dimensions.
- **Black Borders: 12" black drop above image area standard;** more available by quotation. Maximum overall size, including drop, is 90".

Options

- **Motor/Control Options:** Control options can be seen below. 220V motor is also available at no extra cost.
- **Case Options:** All ceiling recessed cases can be painted black upon request.
- **Extra Drop:** Additional drop above image (black standard; surface color available on request). Extra drop may increase case length. See page 36.
- **Viewing Surface:** Available with CineFlex CH1200V and CineFlex MH800V rear projection surfaces, and CineFlex White XT600V front/rear projection surface by quotation. Also available with ClearSound Perf XT900V, a perforated matt white —add the suffix SD to any Matt White XT1000V part number. See page 5.

| OptiFlex Viewing Surfaces | | | | | | | | | | |
|--|----------------|--------------|-------------------|--------------------|-------------|--------------------|--------|-------------|-------------------|---------------|
| Screen Diag. | Image Area | Masked Diag. | Masked Image Area | Matt White XT1000V | Grey XH600V | Pure White XT1300V | PRICE | Case Length | Shipping Wt./lbs. | Freight Class |
| 2.35:1 CinemaScope to 16:9 HDTV | | | | | | | | | | |
| 103" | 40 1/2" x 95" | 82" | 40 1/2" x 72" | 105051 | 105057 | 105051FN | \$4511 | 117 1/4" | 112 | 125 |
| 115" | 45" x 105 3/4" | 92" | 45" x 80" | 105052 | 105058 | 105052FN | 4736 | 132 3/4" | 120 | 125 |
| 132" | 52" x 122" | 106" | 52" x 92" | 105053 | 105059 | 105053FN | 5278 | 149" | 155 | 125 |
| 16:9 HDTV to 4:3 NTSC Video | | | | | | | | | | |
| 92" | 45" x 80" | 75" | 45" x 60" | 105001 | 105033 | 105001FN | \$4361 | 110 1/4" | 110 | 125 |
| 106" | 52" x 92" | 86" | 52" x 69" | 105002 | 105034 | 105002FN | 4556 | 125" | 120 | 125 |
| 123" | 60" x 107" | 100" | 60" x 80" | 105003 | 105035 | 105003FN | 4708 | 140" | 135 | 125 |
| 133" | 65" x 116" | 108" | 65" x 87" | 105004 | 105049 | 105004FN | 5481 | 151" | 160 | 125 |

CHART
CONTINUED
BELOW

| OptiFlex Viewing Surfaces | | | | | | | | | | ClearSound Viewing Surfaces | | |
|--|----------------|--------------|-------------------|---------------------|--------|---------------|--------|----------------------------|--------|-----------------------------|-------------------|---------------|
| Screen Diag. | Image Area | Masked Diag. | Masked Image Area | Pearl White MH1500V | PRICE | ReAct MS1000V | PRICE | ClearSound NanoPerf XT800V | PRICE | Case Length | Shipping Wt./lbs. | Freight Class |
| 2.35:1 CinemaScope to 16:9 HDTV | | | | | | | | | | | | |
| 103" | 40 1/2" x 95" | 82" | 40 1/2" x 72" | 105054 | \$4781 | 105051FR | \$4849 | 105051SC | \$4844 | 117 1/4" | 112 | 125 |
| 115" | 45" x 105 3/4" | 92" | 45" x 80" | 105055 | 5019 | 105052FR | 5091 | 105052SC | 5069 | 132 3/4" | 120 | 125 |
| 132" | 52" x 122" | 106" | 52" x 92" | 105056 | 5594 | 105053FR | 5673 | 105053SC | 5611 | 149" | 155 | 125 |
| 16:9 HDTV to 4:3 NTSC Video | | | | | | | | | | | | |
| 92" | 45" x 80" | 75" | 45" x 60" | 105009 | \$4623 | 105001FR | \$4688 | 105001SC | \$4694 | 110 1/4" | 110 | 125 |
| 106" | 52" x 92" | 86" | 52" x 69" | 105010 | 4829 | 105002FR | 4898 | 105002SC | 4889 | 125" | 120 | 125 |
| 123" | 60" x 107" | 100" | 60" x 80" | 105011 | 4989 | 105003FR | 5061 | 105003SC | 5041 | 140" | 135 | 125 |
| 133" | 65" x 116" | 108" | 65" x 87" | 105012 | 5809 | 105004FR | 5893 | 105004SC | 5814 | 151" | 160 | 125 |

Access MultiView Control (two SS-1R switches are standard)

| Description | Model Name | Part No. | PRICE |
|---|------------|----------|-------|
| 24v, 6-button, single gang wall switch and white cover plate | AMV-C | 121048 | \$530 |
| 24v, 6-button, single gang wall switch and ivory cover plate | | 121049 | 530 |
| Wireless Remote Control | AMV-IR | 121052 | 795 |
| Two multi-channel Infrared Controls, two receivers and one transmitter | | | |
| Wireless Control with L.V. Wall Switch | AMV-IRW | 121053 | 755 |
| IGC/3N1, two Wall Switches with built-in Infrared Receivers and one transmitter | | | |

Note: for alternate installation of Access screens, additional set of brackets is required. Part No. C502.082.

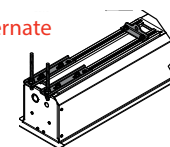

Access MultiView/Series E—Motor-in-roller electric screen with integral masking system for automatic switching between two formats. For ceiling-recessed installation. Masking system is independently motorized and changes surface from Scope to HDTV format, or HDTV to NTSC format. Two 110-120 volt 3-position wall switches included—one per motor. Plenum rated case (UL approved “Suitable for Use in Environmental Air Space”).

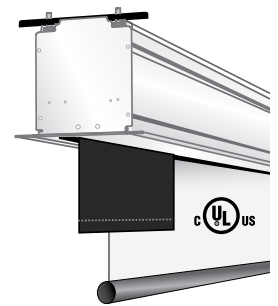

Standard Specs

- **Case Dimensions:** Case is 8" H x 9" D (includes flange and mounting brackets). Case lengths below include flange to support ceiling tile or trim ceiling opening. Built-in controls and/or extra drop on a Series V may increase length of case: call Draper for dimensions.
- **Black Borders:** 12" black drop above image area standard; more available by quotation. Maximum overall size, including drop, is 90".

Options

- **Motor/Control Options:** Control options can be seen below. 220V motor is also available at no extra cost.
- **Case Options:** All ceiling recessed cases can be painted black upon request.
- **Extra Drop:** Additional drop above image (specify color— surface color standard for AV format; black standard for all others). See page 36

OptiView Viewing Surfaces

| Screen Diagonal | Image Area | Masked Diagonal | Masked Image Area | Matt White XT1000E | Contrast Grey XH800E | Contrast White XH1100E | Argent White XH1500E | Pearl White CH1900E | PRICE | Case Length | Shipping Wt./lbs. | Freight Class |
|--|----------------|-----------------|-------------------|--------------------|----------------------|------------------------|----------------------|---------------------|--------|-------------|-------------------|---------------|
| 2.35:1 CinemaScope to 16:9 HDTV | | | | | | | | | | | | |
| 103" | 40 1/2" x 95" | 82" | 40 1/2" x 72" | 106081 | 106087 | 106081EG | 106081EH | 106081EJ | \$2984 | 111 1/4" | 96 | 125 |
| 115" | 45" x 105 3/4" | 92" | 45" x 80" | 106082 | 106088 | 106082EG | 106082EH | -- | 3044 | 126 3/4" | 110 | 125 |
| 132" | 52" x 122" | 106" | 52" x 92" | 106083 | 106089 | -- | -- | -- | 3082 | 143" | 125 | 125 |
| 16:9 HDTV to 4:3 NTSC Video | | | | | | | | | | | | |
| 92" | 45" x 80" | 75" | 45" x 60" | 106001 | 106041 | 106001EG | 106001EH | 106001EJ | \$2966 | 104 5/8" | 90 | 125 |
| 106" | 52" x 92" | 86" | 52" x 69" | 106002 | 106042 | 106002EG | 106002EH | 106002EJ | 3012 | 117 5/8" | 96 | 125 |
| 123" | 60" x 107" | 100" | 60" x 80" | 106003 | 106043 | 106003EG | 106003EH | -- | 3044 | 132 5/8" | 106 | 125 |
| 133" | 65" x 116" | 108" | 65" x 87" | 106004 | 106044 | 106004EG | 106004EH | -- | 3082 | 141 5/8" | 160 | 125 |

ClearSound Viewing Surfaces

| Screen Diagonal | Image Area | Masked Diagonal | Masked Image Area | ClearSound White Weave XT900E | ClearSound Grey Weave XH600E | PRICE | Case Length | Shipping Wt./lbs. | Freight Class |
|--|----------------|-----------------|-------------------|-------------------------------|------------------------------|--------|-------------|-------------------|---------------|
| 2.35:1 CinemaScope to 16:9 HDTV | | | | | | | | | |
| 103" | 40 1/2" x 95" | 82" | 40 1/2" x 72" | 106090 | 106093 | \$6738 | 111 1/4" | 96 | 125 |
| 115" | 45" x 105 3/4" | 92" | 45" x 80" | 106091 | 106094 | 7203 | 126 3/4" | 110 | 125 |
| 132" | 52" x 122" | 106" | 52" x 92" | 106092 | 106095 | 8010 | 143" | 125 | 125 |
| 16:9 HDTV to 4:3 NTSC Video | | | | | | | | | |
| 92" | 45" x 80" | 75" | 45" x 60" | 106017 | 106057 | \$5858 | 104 5/8" | 90 | 125 |
| 106" | 52" x 92" | 86" | 52" x 69" | 106018 | 106058 | 6806 | 117 5/8" | 96 | 125 |
| 123" | 60" x 107" | 100" | 60" x 80" | 106019 | 106059 | 7203 | 132 5/8" | 106 | 125 |
| 133" | 65" x 116" | 108" | 65" x 87" | 106020 | 106060 | 8010 | 141 5/8" | 160 | 125 |

CHART CONTINUED BELOW

Access MultiView Control (two SS-1R switches are standard)

| Description | Model Name | Part No. | PRICE |
|---|------------|----------|-------|
| 24v, 6-button, single gang wall switch and white cover plate | AMV-C | 121048 | \$530 |
| 24v, 6-button, single gang wall switch and ivory cover plate | | 121049 | 530 |
| Wireless Remote Control | AMV-IR | 121052 | 795 |
| Two multi-channel Infrared Controls, two receivers and one transmitter | | | |
| Wireless Control with L.V. Wall Switch | AMV-IRW | 121053 | 755 |
| IGC/3N1, two Wall Switches with built-in Infrared Receivers and one transmitter | | | |

Note: for alternate installation of Access screens, additional set of brackets is required. Part No. C502.082.

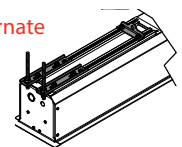

Envoy—Designed for ceiling-recessed installation. Black all-wood case. Utilizes a tubular motor mounted inside a 3" roller. Includes one 110-120v 3-position switch. Viewing surfaces from the OptiView family.

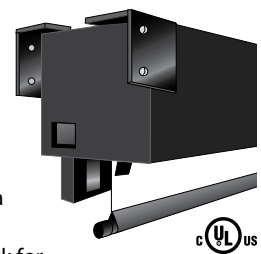

Standard Specs®

- **Sizes and Formats:** Custom sizes available by quotation. Custom sizes need to be specified in detail, including extra drop, if desired.
- **Case Dimensions:** 7 9/16" H x 7 9/16" D. Mounting brackets extend 2" beyond each end of case.
- **Black Borders:** NTSC, HDTV and 16:10 format have image area framed with black on all four sides. Black side borders are available on request for AV format screens.

Options

- **Motor/Control Options:** Quiet Motor (Q), or Built-in Low Voltage Controller (U or L) available. See page 35 for details. 220V motor is also available at no extra cost.

• **Extra Drop:**

Additional drop above image area: specify color of extra drop (surface color standard for AV; black for other formats). See page 36.

• **Viewing Surface:**

Also available with ClearSound Perf XT950E, a perforated matt white, by quotation —Add the suffix SE to any Matt White XT1000E part number. See page 5.



OptiView Viewing Surfaces

| H x W / Diagonal | Image Area | Overall Size | Matt White XT1000E | Contrast Grey XH800E | PRICE | Case Length | Shipping Wt./lbs. | Freight Class |
|------------------------------|-------------------|-------------------|--------------------|----------------------|--------|-------------|-------------------|---------------|
| 16:10 Format | | | | | | | | |
| 94" | 50" x 80" | 62" x 83 1/2" | 112229 | 112228 | \$1959 | 99" | 106 | 125 |
| 109" | 57 1/2" x 92" | 69 1/2" x 96" | 112232 | 112231 | 1979 | 111" | 120 | 125 |
| 113" | 60" x 96" | 72" x 100" | 112268 | 112270 | 2005 | 115" | 124 | 125 |
| 123" | 65" x 104" | 69" x 108" | 112235 | 112234 | 2070 | 123" | 128 | 125 |
| 137" | 72 1/2" x 116" | 76 1/2" x 120" | 112238 | 112237 | 2120 | 135" | 140 | 125 |
| 165" | 87 1/2" x 140" | 92 1/2" x 144" | 112241 | 112240 | 2192 | 159" | 173 | 125 |
| 16:9 HDTV Format | | | | | | | | |
| 92" | 45" x 80" | 57" x 83 1/2" | 112215 | 112219 | \$1959 | 99" | 106 | 125 |
| 106" | 52" x 92" | 64" x 96" | 112216 | 112220 | 1979 | 111" | 120 | 125 |
| 110" | 54" x 96" | 66" x 100" | 112262 | 112264 | 2005 | 115" | 124 | 125 |
| 119" | 58" x 104" | 62" x 108" | 112207 | 112213 | 2070 | 123" | 128 | 125 |
| 133" | 65" x 116" | 69" x 120" | 112022 | 112177 | 2120 | 135" | 140 | 125 |
| 161" | 79" x 140" | 84" x 144" | 112023 | 112178 | 2192 | 159" | 173 | 125 |
| 4:3 NTSC Video Format | | | | | | | | |
| 6' | 42 1/2" x 56 1/2" | 46 1/2" x 59 1/2" | 112013 | 112169 | \$1902 | 75" | 85 | 125 P+ |
| 7' | 50" x 66 1/2" | 53 1/2" x 69 1/2" | 112014 | 112170 | 1920 | 85" | 93 | 125 P+ |
| 100" | 60" x 80" | 64" x 83 1/2" | 112015 | 112171 | 1972 | 99" | 104 | 125 |
| 10' | 69" x 92" | 73" x 96" | 112016 | 112172 | 2022 | 111" | 120 | 125 |
| 11' | 78" x 104" | 83" x 108" | 112017 | 112173 | 2092 | 123" | 130 | 125 |
| 150" | 87" x 116" | 92" x 120" | 112018 | 112174 | 2117 | 135" | 140 | 125 |
| 15' | 105" x 140" | 109" x 144" | 112019 | 112261 | 2189 | 159" | 168 | 125 |
| AV Format | | | | | | | | |
| 50" x 50" | | | 112001 | 112161 | \$1867 | 65" | 75 | 125 P+ |
| 60" x 60" | | | 112002 | 112162 | 1894 | 75" | 83 | 125 P+ |
| 70" x 70" | | | 112003 | 112163 | 1920 | 85" | 92 | 125 P+ |
| 84" x 84" | | | 112004 | 112164 | 1984 | 99" | 110 | 125 |
| 72" x 96" | | | 112005 | 112165 | 1999 | 111" | 116 | 125 |
| 96" x 96" | | | 112006 | 112166 | 2047 | 111" | 119 | 125 |
| 7' x 9' | | | 112007 | 112167 | 2119 | 123" | 130 | 125 |
| 9' x 9' | | | 112008 | 112258 | 2174 | 123" | 135 | 125 |
| 8' x 10' | | | 112009 | 112168 | 2200 | 135" | 140 | 125 |
| 10' x 10' | | | 112010 | 112259 | 2264 | 135" | 146 | 125 |
| 9' x 12' | | | 112011 | 112257 | 2319 | 159" | 162 | 125 |
| 12' x 12' | | | 112012 | 112260 | 2552 | 159" | 184 | 125 |

***These sizes include 12" black drop— NO EXTRA CHARGE!**

Ambassador—Ceiling closure-type screen with an end-mounted motor operates quietly on a 5" diameter aluminum roller. Black all-wood case. Includes one 110-120v 3-position switch. Viewing surfaces from the OptiView family.

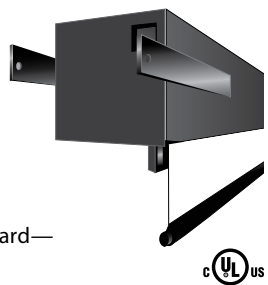

Standard Specs®

- **Sizes and Formats:** Other formats available by quotation.
- **Case Dimensions:** 9 7/8" H x 10 1/4" D. Mounting brackets extend 4" beyond ends of case.
- **Black Borders:** Black side borders are available on request for AV format screens.

Options

- **Motor/Control Options:** 220V motor available at \$79 upcharge. See page 35.
- **Hinge Type:** Please specify hinge type when ordering (standard, offset, or extended for ceiling tile).

• **Extra Drop:**

Additional drop above image area (surface color standard— please specify). See page 36.

• **Viewing Surface:**

Also available with ClearSound Perf XT950E, a perforated matt white, by quotation —Add the suffix SE to any Matt White XT1000E part number. See page 5.



OptiView Viewing Surfaces

| Size H x W | Matt White XT1000E | Contrast Grey XH800E | PRICE | Case Length | Shipping Wt./lbs. | Freight Class |
|------------------|--------------------|----------------------|--------|-------------|-------------------|---------------|
| AV Format | | | | | | |
| 50" x 50" | 113001 | 113028 | \$2501 | 74" | 122 | 125 P+ |
| 60" x 60" | 113002 | 113029 | 2517 | 84" | 152 | 125 |
| 70" x 70" | 113003 | 113030 | 2547 | 94" | 160 | 125 |
| 84" x 84" | 113004 | 113031 | 2649 | 108" | 173 | 125 |
| 72" x 96" | 113005 | 113032 | 2686 | 120" | 181 | 125 |
| 96" x 96" | 113006 | 113033 | 2774 | 120" | 191 | 125 |
| 7' x 9' | 113007 | 113034 | 2872 | 132" | 204 | 125 |
| 9' x 9' | 113008 | 113036 | 2914 | 132" | 208 | 125 |
| 8' x 10' | 113009 | 113035 | 2981 | 144" | 221 | 125 |
| 10' x 10' | 113010 | 113038 | 3039 | 144" | 226 | 125 |
| 9' x 12' | 113011 | 113037 | 3066 | 168" | 237 | 125 |
| 12' x 12' | 113012 | 113039 | 3509 | 168" | 242 | 125 |

Freight Class Key
Number LTL freight class
P Parcel service
 + ... \$8.50 surcharge (over 60" long)
Example: a freight code of 125 P+ indicates an item that may ship as freight class 125 or via parcel service with \$8.50 surcharge.

Paragon—The Paragon is a large, ceiling-recessed screen designed for auditoriums and lecture halls. Offered in both tab-tensioned, and non tab-tensioned, it features a white extruded aluminum case. Operates on a 6" steel roller powered by an extremely strong tubular motor-in-roller. Plenum rated case (UL approved "Suitable for Use in Environmental Air Space.") Includes one 110-120V 3-position switch. **Paragon sizes with a case length of 300" or more require special handling. Request a freight estimate.**

Standard Specs

- **Case Dimensions:** Case is 13 1/4" H x 12" D.
- **Black Borders:** Image area framed with black on all four sides. **12" black drop at top of viewing surface (standard).**

Options

- **Motor/Control Options:** 220V options available. See page 35.
- **Case Options:** All ceiling recessed cases can be painted black upon request.

Paragon/Series V— Options

- **Extra Drop:** Additional drop above image (Black is standard; surface color available upon request). Extra drop may increase case length. See page 36.
- **Viewing Surface:** CineFlex CH1200V (CB) and CineFlex MH800V (CA) rear projection surfaces, and CineFlex White XT600V (CC) front/rear projection surface available by quotation—add the 2-letter suffix noted above to any Matt White XT1000V part number. See page 5.

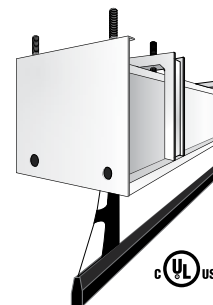

| H x W/ Diagonal | Image Area | OptiFlex Surfaces | | | ClearSound Surfaces | | Case Length | Shipping Wt./lbs. | Freight Class |
|------------------------------|---------------|-----------------------|-----------------------|--------|---------------------------|--------|----------------|----------------------|------------------|
| | | Matt White XT1000V | Pure White XT1300V | PRICE | ClearSound Perf XT900V | PRICE | | | |
| 16:10 Format | | | | | | | | | |
| 234" | 124" x 198" | 114616 | 114616FN | \$5419 | 114616SD | \$5753 | 220 1/4" | 750 | 125 |
| 278" | 147" x 236" | 114617 | 114617FN | 7353 | 114617SD | 7687 | 260" | 871 | 125 |
| 307" | 162" x 260" | 114618 | 114618FN | 7730 | 114618SD | 8063 | 286" | 880 | 125 |
| 335" | 177" x 284" | 114619 | 114619FN | 8768 | 114619SD | 9102 | 312 1/8" | 950 | 125 |
| 16:9 HDTV Format | | | | | | | | | |
| 227" | 111" x 198" | 114612 | 114612FN | \$5419 | 114612SD | \$5753 | 218 5/8" | 759 | 125 |
| 270" | 133" x 236" | 114613 | 114613FN | 7353 | 114613SD | 7687 | 260" | 844 | 125 |
| 300" | 146" x 260" | 114614 | 114614FN | 7730 | 114614SD | 8063 | 284" | 957 | 125 |
| 324" | 160" x 284" | 114615 | 114615FN | 8768 | 114615SD | 9102 | 310" | 1040 | 125 |
| 4:3 NTSC Video Format | | | | | | | | | |
| 250" | 148" x 198" | 114608 | 114608FN | \$5658 | 114608SD | \$5991 | 222" | 750 | 125 |
| 25" | 177" x 236" | 114609 | 114609FN | 9955 | 114609SD | 10289 | 264 1/8" | 820 | 125 |
| 27' 6" | 194" x 260" | 114610 | 114610FN | 10435 | 114610SD | 10769 | 290 3/8" | 880 | 125 |
| 30" | 212" x 284" | 114611 | 114611FN | 11831 | 114611SD | 12164 | 316 1/4" | 960 | 125 |
| AV Format | | | | | | | | | |
| 13' 6" x 18' | | 114600 | 114600FN | \$5920 | 114600SD | \$6253 | 242" | 770 | 125 |
| 18' x 18' | | 114601 | 114601FN | 10745 | 114601SD | 11079 | 248 1/4" | 796 | 125 |
| 15' x 20' | | 114602 | 114602FN | 9955 | 114602SD | 10289 | 268 1/8" | 820 | 125 |
| 11' x 22' | | 114603 | 114603FN | 10200 | 114603SD | 10534 | 286 1/4" | 880 | 125 |
| 16' 6" x 22' | | 114605 | 114605FN | 10435 | 114605SD | 10769 | 296 1/4" | 925 | 125 |
| 12' x 24' | | 114606 | 114606FN | 11154 | 114606SD | 11487 | 312" | 950 | 125 |
| 18' x 24' | | 114607 | 114607FN | 11831 | 114607SD | 12164 | 320 1/4" | 1042 | 125 |

Paragon/Series E— Options

- **Extra Drop:** Additional drop above image (specify color—surface color is standard for AV; black is standard for others). See page 36.
- **Viewing Surface:** Also available with ClearSound Perf XT950E, a perforated matt white, by quotation —Add the suffix SE to any Matt White XT1000E part number. See page 5.

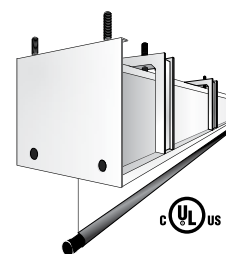

| H x W/ Diagonal | Image Area | Overall Size | OptiView Surface | | Case Length | Shipping Wt./lbs. | Freight Class |
|------------------------------|-----------------|-----------------|--------------------------|--------|----------------|----------------------|------------------|
| | | | Matt White XT1000E | PRICE | | | |
| 16:10 Format | | | | | | | |
| 278" | 147 1/2" x 236" | 152 1/2" x 240" | 114228 | \$5224 | 250" | 775 | 125 |
| 307" | 162 1/2" x 260" | 167 1/2" x 264" | 114229 | 5499 | 274" | 950 | 125 |
| 335" | 177" x 284" | 182" x 288" | 114230 | 7146 | 298" | 970 | 125 |
| 363" | 192 1/2" x 308" | 197 1/2" x 312" | 114231 | 16785 | 322" | 1039 | 125 |
| 392" | 207 1/2" x 332" | 212 1/2" x 336" | 114232 | 18699 | 346" | 1220 | 125 |
| 16:9 HDTV Format | | | | | | | |
| 270" | 133" x 236" | 138" x 240" | 114209 | \$5224 | 250" | 828 | 125 |
| 300" | 146" x 260" | 151" x 264" | 114210 | 5499 | 274" | 950 | 125 |
| 324" | 160" x 284" | 165" x 288" | 114211 | 7146 | 298" | 970 | 125 |
| 354" | 173" x 308" | 178" x 312" | 114216 | 16785 | 322" | 1039 | 125 |
| 384" | 187" x 332" | 192" x 336" | 114208 | 18699 | 346" | 1220 | 125 |
| 4:3 NTSC Video Format | | | | | | | |
| 25" | 177" x 236" | 182" x 240" | 114113 | \$5224 | 250" | 872 | 125 |
| 27' 6" | 194" x 260" | 198" x 264" | 114115 | 5499 | 274" | 895 | 125 |
| 30" | 212" x 284" | 217" x 288" | 114117 | 7146 | 298" | 1033 | 125 |
| 32' 6" | 230" x 308" | 235" x 312" | 114119 | 16932 | 322" | 1045 | 125 |
| 35" | 248" x 332" | 253" x 336" | 114121 | 19594 | 346" | 1280 | 125 |
| AV Format | | | | | | | |
| 15' x 20' | | | 114081 | \$5224 | 250" | 796 | 125 |
| 20' x 20' | | | 114083 | 5559 | 250" | 805 | 125 |
| 11' x 22' | | | 114085 | 5361 | 274" | 840 | 125 |
| 16' 6" x 22' | | | 114087 | 5499 | 274" | 850 | 125 |
| 22' x 22' | | | 114089 | 5644 | 274" | 861 | 125 |
| 12' x 24' | | | 114091 | 5698 | 298" | 925 | 125 |
| 18' x 24' | | | 114093 | 7146 | 298" | 950 | 125 |
| 24' x 24' | | | 114095 | 9013 | 298" | 961 | 125 |
| 13' x 26' | | | 114097 | 12964 | 322" | 970 | 125 |
| 19' 6" x 26' | | | 114099 | 17495 | 322" | 980 | 125 |
| 14' x 28' | | | 114101 | 16478 | 346" | 1000 | 125 |
| 21' x 28' | | | 114103 | 19594 | 346" | 1294 | 125 |

Accessories for Paragon/Series V and E

| Part No. | PRICE | Shipping Wt./lbs | Freight Class |
|--|-------|---------------------|------------------|
| Wall Mounting Brackets (pr.) —For wall installation. Includes hardware for attaching brackets to case. | | | |
| 121204 | \$128 | 6 | 50 P |
| Ceiling Trim Flange for Paragon endcaps (pr.) —For endcaps. Includes hardware for attaching flanges to case. | | | |
| 121205 | \$43 | 1 | 50 P |
| Ceiling Trim Flange for Paragon case —12' length of ceiling trim flange, with hardware for attaching it to case. Please divide length of case requiring trim (in feet) by 12 and round up to determine number of kits to order. Remember to order trim for both front and back of case if required. | | | |
| 121206 | \$43 | 5 | 77.5 P |

Rolleramic—The Rolleramic's heavy-duty gear motor operates a 5" diameter roller. It is housed in a square case of high compression particle board painted flat black. Includes one 110-120v 3-position switch. Viewing surfaces from the OptiView family. Universal mounting brackets are included (two for sizes to 14' x 14'; three for larger sizes). Additional brackets available. Part No. 211350

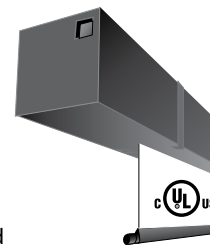

Standard Specs

- **Sizes and Formats:** Other formats and custom sizes available by quotation. Custom sizes need to be specified in detail, including extra drop, if desired.
- **Case Dimensions:** Case 9 1/8" H x 9 1/8" D (excluding brackets).
- **Black Borders:** NTSC, HDTV and 16:10 format have image area framed with black on all four sides. Black side borders are available on request for AV format screens.

Options

- **Motor/Control Options:** 220V options available. See page 35.
- **Extra Drop:** Additional drop above image area (specify color of extra drop—surface color standard for AV; black for other formats). See page 36.
- **Viewing Surface:** Also available with ClearSound Perf XT950E, a perforated matt white, by quotation —Add the suffix SE to any Matt White XT1000E part number. See page 5.

Heavy-Duty Motor Rules

Note: Sizes 10'6" x 14' and larger include heavy-duty motor and roller. This motor is also required whenever total fabric (including extra drop) exceeds 144 sq. ft. Add 6" to case length and \$152 to prices below. See page 35.

*These sizes include 12" black drop as standard—NO EXTRA CHARGE!

| OptiView Surfaces | | | | | | | | | |
|------------------------------|-------------------|-------------------|--------------------|----------------------|--------|-------------|-------------------|---------------|--|
| H x W / Diagonal | Image Area | Overall Size | Matt White XT1000E | Contrast Grey XH800E | PRICE | Case Length | Shipping Wt./lbs. | Freight Class | |
| 16:10 Format | | | | | | | | | |
| 94" | 50" x 80" | 62" x 83 1/2" | 115380 | 115400 | \$2117 | 108" | 136 | 125 | |
| 109" | 57 1/2" x 92" | 70" x 96" | 115381 | 115401 | 2147 | 120" | 154 | 125 | |
| 113" | 60" x 96" | 72" x 100" | 115511 | 115513 | 2150 | 124" | 160 | 125 | |
| 123" | 65" x 104" | 69" x 108" | 115382 | 115402 | 2159 | 132" | 172 | 125 | |
| 137" | 72 1/2" x 116" | 76 1/2" x 120" | 115383 | 115403 | 2344 | 144" | 183 | 125 | |
| 165" | 87 1/2" x 140" | 92 1/2" x 144" | 115384 | 115404 | 2509 | 168" | 220 | 125 | |
| 189" | 100" x 160" | 105" x 164" | 115385 | 115440 | 2596 | 194" | 435 | 125 | |
| 198" | 105" x 168" | 110" x 172" | 115386 | 115441 | 3017 | 202" | 495 | 125 | |
| 222" | 117 1/2" x 188" | 122 1/2" x 192" | 115387 | 115442 | 3249 | 222" | 530 | 125 | |
| 234" | 123 3/4" x 198" | 128 3/4" x 202" | 115388 | 115443 | 3279 | 232" | 545 | 125 | |
| 278" | 147 1/2" x 236" | 152 1/2" x 240" | 115389 | -- | 4248 | 270" | 640 | 125 | |
| 16:9 HDTV Format | | | | | | | | | |
| 92" | 45" x 80" | 57" x 83 1/2" | 115244 | 115264 | \$2117 | 108" | 146 | 125 | |
| 106" | 52" x 92" | 64" x 96" | 115245 | 115265 | 2147 | 120" | 154 | 125 | |
| 110" | 54" x 96" | 66" x 100" | 115505 | 115507 | 2150 | 124" | 130 | 125 | |
| 119" | 58" x 104" | 62" x 108" | 115246 | 115266 | 2159 | 132" | 170 | 125 | |
| 133" | 65" x 116" | 69" x 120" | 115247 | 115267 | 2344 | 144" | 180 | 125 | |
| 161" | 79" x 140" | 84" x 144" | 115248 | 115268 | 2509 | 168" | 200 | 125 | |
| 184" | 90" x 160" | 95" x 164" | 115249 | 115269 | 2596 | 194" | 347 | 125 | |
| 193" | 94 1/2" x 168" | 99 1/2" x 172" | 115250 | 115451 | 3017 | 202" | 352 | 125 | |
| 220" | 106" x 188" | 111" x 192" | 115251 | 115452 | 3249 | 222" | 437 | 125 | |
| 227" | 111 1/2" x 198" | 116 1/2" x 202" | 115252 | 115453 | 3279 | 232" | 459 | 125 | |
| 270" | 133" x 236" | 138" x 240" | 115253 | 115454 | 4248 | 270" | 509 | 125 | |
| 4:3 NTSC Video Format | | | | | | | | | |
| 6' | 42 1/2" x 56 1/2" | 46 1/2" x 59 1/2" | 115022 | 115171 | \$2040 | 84" | 120 | 125 P+ | |
| 7' | 50" x 66 1/2" | 53 1/2" x 69 1/2" | 115023 | 115172 | 2062 | 94" | 130 | 125 | |
| 100" | 60" x 80" | 64" x 83 1/2" | 115024 | 115173 | 2109 | 108" | 138 | 125 | |
| 10' | 69" x 92" | 73" x 96" | 115025 | 115174 | 2122 | 120" | 154 | 125 | |
| 11' | 78" x 104" | 83" x 108" | 115026 | 115175 | 2300 | 132" | 170 | 125 | |
| 150" | 87" x 116" | 92" x 120" | 115027 | 115176 | 2390 | 144" | 180 | 125 | |
| 15' | 105" x 140" | 109" x 144" | 115028 | 115455 | 2554 | 168" | 200 | 125 | |
| 200" | 118" x 158" | 123" x 162" | 115029 | 115456 | 2996 | 192" | 345 | 125 | |
| 20' | 141" x 188" | 146" x 192" | 115030 | 115457 | 3461 | 222" | 403 | 125 | |
| 250" | 148" x 198" | 153" x 202" | 115031 | -- | 4154 | 232" | 442 | 125 | |
| 25' | 177" x 236" | 182" x 240" | 115032 | -- | 4831 | 270" | 510 | 125 | |
| AV Format | | | | | | | | | |
| 50" x 50" | | | 115001 | 115162 | \$2029 | 74" | 120 | 125 P+ | |
| 60" x 60" | | | 115002 | 115163 | 2049 | 84" | 132 | 125 P+ | |
| 70" x 70" | | | 115003 | 115164 | 2062 | 94" | 144 | 125 | |
| 84" x 84" | | | 115004 | 115165 | 2109 | 108" | 161 | 125 | |
| 72" x 96" | | | 115005 | 115166 | 2120 | 120" | 167 | 125 | |
| 96" x 96" | | | 115006 | 115167 | 2177 | 120" | 178 | 125 | |
| 7' x 9' | | | 115007 | 115168 | 2254 | 132" | 185 | 125 | |
| 9' x 9' | | | 115008 | 115445 | 2364 | 132" | 191 | 125 | |
| 8' x 10' | | | 115009 | 115169 | 2390 | 144" | 197 | 125 | |
| 10' x 10' | | | 115010 | 115447 | 2450 | 144" | 197 | 125 | |
| 9' x 12' | | | 115011 | 115446 | 2554 | 168" | 229 | 125 | |
| 12' x 12' | | | 115012 | 115450 | 2992 | 168" | 235 | 125 | |
| 10' 6" x 14' | | | 115013 | 115448 | 3294 | 198" | 314 | 125 | |
| 14' x 14' | | | 115014 | -- | 3444 | 198" | 415 | 125 | |
| 12' x 16' | | | 115015 | 115449 | 3732 | 222" | 462 | 125 | |
| 16' x 16' | | | 115016 | -- | 3986 | 222" | 469 | 125 | |
| 13' 6" x 18' | | | 115017 | -- | 4348 | 246" | 477 | 125 | |
| 18' x 18' | | | 115018 | -- | 4603 | 246" | 486 | 125 | |
| 8' x 20' | | | 115019 | 115444 | 4733 | 270" | 505 | 125 | |
| 15' x 20' | | | 115020 | -- | 4831 | 270" | 509 | 125 | |
| 20' x 20' | | | 115021 | -- | 5314 | 270" | 517 | 125 | |

Premier—Our most popular tab-tensioned motorized screen. The Premier is housed in a black pentagonal steel case and utilizes a tubular motor-in-roller design. The endcaps on the Premier are also its universal mounting bracket. Viewing surfaces from the OptiFlex, ClearSound and CineFlex families.

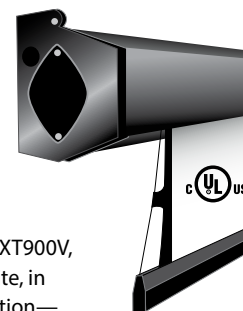

Standard Specs

- **Sizes and Formats:** Custom sizes available by quotation. Custom sizes need to be specified in detail, including extra drop, if desired.
- **Case Dimensions:** Standard case is 5 7/8" H x 5 1/4" D, including endcaps with universal mounting brackets. Optional built-in controls and extra drop may increase case length: call Draper for dimensions.
- **Black Borders:** Image area fully framed with black; with **12" black drop at top of viewing surface (standard).**

Options

- **Motor/Control Options:** (Q) Quiet Motor, (U or L) Built-in Low Voltage Controller, and (P) Plug & Play™ available. See page 35 for details. 220V motor is also available at no extra cost.
- **Extra Drop:** Additional drop above image (black standard; surface color available on request). Extra drop will increase case length. See page 36.
- **Viewing Surface:** CineFlex CH1200V (CB) and CineFlex MH800V (CA) rear projection surfaces, and CineFlex White XT600V (CC) front/rear projection surface available by quotation—add the 2-letter suffix noted above to any Matt

White XT1000V part number. Also available with ClearSound Perf XT900V, a perforated matt white, in limited sizes by quotation—add the suffix SD to any Matt White XT1000V part number. See page 5.

- **Ceiling Opening Trim Kit:** Optional trim kit finishes opening for recessed installation in acoustical drop ceilings. See page 25.
- **Floating Screen Brackets** Optional wall/ceiling mounting brackets for added flexibility. For use with small case only. See page 25.

***Bold sizes noted below require larger case**—Extruded aluminum, 6 3/4" x 6 3/4". These are not compatible with 6" extension brackets, floating brackets, Ceiling Opening Trim Kit, Floating Brackets, or optional Q and QL motors.

12" black drop is standard—NO EXTRA CHARGE!

| H x W / Diagonal | Image Area | OptiFlex Viewing Surfaces | | | | | | Case Length | Shipping Wt./lbs. | Dim Wt./lbs. | Freight Class |
|------------------------------|-----------------------|---------------------------|---------------|--------------------|-------------|---------------------|-------------|-----------------|-------------------|--------------|---------------|
| | | Matt White XT1000V | Grey XH600V | Pure White XT1300V | PRICE | Pearl White MH1500V | PRICE | | | | |
| 16:10 Format | | | | | | | | | | | |
| 67" | 35 1/4" x 56 1/2" | 101635 | 101643 | 101635FN | \$1800 | 101651 | \$1999 | 72 1/2" | 49 | | 125 P+ |
| 76" | 40" x 64" | 101636 | 101644 | 101636FN | 1945 | 101652 | 2159 | 81" | 59 | 60 | 125 P+ |
| 85" | 45" x 72" | 101637 | 101645 | 101637FN | 2097 | 101653 | 2327 | 89" | 66 | | 125 P+ |
| 94" | 50" x 80" | 101638 | 101646 | 101638FN | 2165 | 101654 | 2404 | 97" | 68 | | 125 P+ |
| 109" | 57 1/2" x 92" | 101639 | 101647 | 101639FN | 2224 | 101655 | 2469 | 110" | 73 | | 125 |
| 113" | 60" x 96" | 101794 | 101796 | 101794FN | 2284 | 101798 | 2536 | 113 7/8" | 75 | | 125 |
| 123" | 65" x 104" | 101640 | 101648 | 101640FN | 2469 | 101656 | 2741 | 122" | 80 | | 125 |
| 137" | 72 1/2" x 116" | 101641 | 101649 | 101641FN | 2659 | 101657 | 2951 | 135" | 88 | | 125 |
| 165" | 87 1/2" x 140" | 101642 | 101650 | 101642FN | 3067 | 101658 | 3404 | 160 1/2" | 105 | | 125 |
| 189" | 100" x 160" | 101755 | 101757 | 101755FN | 3362 | 101756 | 3732 | 180 1/2" | 118 | | 125 |
| 198** | 105" x 168" | 101779 | 101781 | 101779FN | 3851 | 101780 | 4274 | 191 5/8" | 393 | | 125 |
| 226** | 120" x 192" | 101782 | 101784 | 101782FN | 4386 | 101783 | 4868 | 217 1/4" | 441 | | 125 |
| 16:9 HDTV Format | | | | | | | | | | | |
| 65" | 31 3/4" x 56 1/2" | 101324 | 101330 | 101324FN | \$1800 | 101327 | \$1999 | 72 1/2" | 49 | | 125 P+ |
| 73" | 36" x 64" | 101325 | 101331 | 101325FN | 1945 | 101328 | 2159 | 80" | 59 | 60 | 125 P+ |
| 82" | 40 1/2" x 72" | 101326 | 101332 | 101326FN | 2097 | 101329 | 2327 | 89" | 66 | | 125 P+ |
| 92" | 45" x 80" | 101059 | 101276 | 101059FN | 2165 | 101206 | 2404 | 97 1/2" | 68 | | 125 P+ |
| 100" | 49" x 87" | 101761 | 101765 | 101761FN | 2195 | 101762 | 2437 | 104" | 65 | | 125 |
| 106" | 52" x 92" | 101060 | 101277 | 101060FN | 2224 | 101207 | 2469 | 110" | 74 | | 125 |
| 110" | 54" x 96" | 101770 | 101774 | 101770FN | 2284 | 101771 | 2536 | 114" | 76 | | 125 |
| 119" | 58" x 104" | 101305 | 101309 | 101305FN | 2469 | 101306 | 2741 | 122" | 81 | | 125 |
| 133" | 65" x 116" | 101185 | 101278 | 101185FN | 2659 | 101208 | 2951 | 135" | 89 | | 125 |
| 161" | 79" x 140" | 101186 | 101347 | 101186FN | 3067 | 101209 | 3404 | 160 1/4" | 105 | | 125 |
| 184" | 90" x 160" | 101361 | 101348 | 101361FN | 3362 | 101362 | 3732 | 180 3/4" | 118 | | 125 |
| 193** | 94 1/2" x 168" | 101689 | 101690 | 101689FN | 3851 | 101691 | 4274 | 191 1/8" | 428 | | 125 |
| 220** | 108" x 192" | 101391 | 101393 | 101391FN | 4386 | 101392 | 4868 | 215 5/8" | 437 | | 125 |
| 4:3 NTSC Video Format | | | | | | | | | | | |
| 6" | 42 1/2" x 56 1/2" | 101181 | 101273 | 101181FN | \$1804 | 101202 | \$2002 | 74" | 49 | 65 | 125 P+ |
| 7" | 50" x 66 1/2" | 101182 | 101274 | 101182FN | 1950 | 101203 | 2165 | 84 1/4" | 59 | 69 | 125 P+ |
| 100" | 60" x 80" | 101056 | 101275 | 101056FN | 2179 | 101057 | 2419 | 97 3/4" | 66 | 69 | 125 P+ |
| 10' | 72" x 96" | 101058 | 101271 | 101058FN | 2234 | 101196 | 2479 | 115" | 76 | | 125 |
| 11' | 78" x 104" | 101183 | 101345 | 101183FN | 2569 | 101204 | 2852 | 124 1/4" | 80 | | 125 |
| 150" | 87" x 116" | 101184 | 101346 | 101184FN | 2679 | 101205 | 2974 | 136 1/4" | 89 | | 125 |
| 15' | 108" x 144" | 101179 | 101373 | 101179FN | 3171 | 101201 | 3519 | 165 3/4" | 117 | | 125 |
| 200" | 118" x 158" | 101359 | 101375 | 101359FN | 3362 | 101360 | 3732 | 180 3/4" | 120 | | 125 |
| 210** | 126" x 168" | 101686 | 101687 | 101686FN | 3851 | 101688 | 4274 | 193 1/4" | 393 | | 125 |
| 220** | 132" x 176" | 101385 | -- | 101385FN | 3987 | -- | -- | 201 1/4" | 437 | | 125 |
| 230** | 138" x 184" | 101386 | -- | 101386FN | 4228 | -- | -- | 211" | 452 | | 125 |
| 20** | 144" x 192" | 101387 | -- | 101387FN | 4486 | -- | -- | 219" | 481 | | 125 |
| AV Format | | | | | | | | | | | |
| 50" x 50" | | 101170 | 101267 | 101170FN | \$1675 | 101192 | \$1860 | 68" | 44 | 60 | 125 P+ |
| 60" x 60" | | 101171 | 101268 | 101171FN | 1795 | 101193 | 1992 | 78 3/4" | 50 | 66 | 125 P+ |
| 70" x 70" | | 101172 | 101269 | 101172FN | 2030 | 101194 | 2254 | 89" | 60 | 66 | 125 P+ |
| 84" x 84" | | 101173 | 101270 | 101173FN | 2225 | 101195 | 2470 | 104 1/4" | 65 | | 125 |
| 72" x 96" | | 101058 | 101271 | 101058FN | 2234 | 101196 | 2479 | 115" | 76 | | 125 |
| 96" x 96" | | 101174 | 101272 | 101174FN | 2324 | 101197 | 2579 | 117 3/4" | 79 | | 125 |
| 7' x 9' | | 101175 | 101343 | 101175FN | 2460 | 101198 | 2731 | 128 1/4" | 86 | | 125 |
| 9' x 9' | | 101176 | 101344 | 101176FN | 2741 | 101199 | 3042 | 129 3/4" | 89 | | 125 |
| 8' x 10' | | 101177 | 101371 | 101177FN | 2852 | 101200 | 3166 | 141 3/4" | 93 | | 125 |
| 10' x 10' | | 101178 | 101372 | 101178FN | 2942 | 101215 | 3266 | 143 1/2" | 95 | | 125 |
| 9' x 12' | | 101179 | 101373 | 101179FN | 3171 | 101201 | 3519 | 165 3/4" | 117 | | 125 |
| 12' x 12' | | 101180 | -- | 101180FN | 3449 | -- | -- | 171 1/2" | 139 | | 125 |
| 10' 6" x 14** | | 101686 | 101687 | 101686FN | 3851 | 101688 | 4274 | 193 1/4" | 393 | | 125 |
| 14' x 14** | | 101381 | -- | 101381FN | 3897 | -- | -- | 199 1/8" | 413 | | 125 |
| 12' x 16** | | 101382 | -- | 101382FN | 4486 | -- | -- | 219" | 481 | | 125 |

CHART CONTINUED

Accessories for Premier—*These accessories are compatible with Premier using small case only.*

Ceiling Opening Trim Kit—Designed for recessed installation in acoustical drop ceilings of Premier motorized screens. Ships KD; assembles quickly with fasteners provided. Trims out the ceiling tile opening and attaches to screen endcaps. Painted white. Slot includes finished flange to accept acoustical ceiling tile or grid. Slot measures 2 1/8" in depth. Once installed, the finished slot length is equal to the Premier screen case length.

| Finished Slot Length | Screen Case Length | Part No. | PRICE | Shipping Wt./lbs. | Freight Class |
|----------------------|----------------------|----------|-------|-------------------|---------------|
| 102 1/2" | 102 1/2" and shorter | 121202 | \$172 | 31 | 77.5 |
| 126 1/2" | 102 1/2" – 126 1/2" | 121203 | 188 | 36 | 77.5 |
| 174" | 126 1/2" – 174" | 121207 | 213 | 49 | 77.5 |

Floating Screen Brackets—Use Draper's Floating Screen Brackets for added flexibility and secure mounting of Premier even when available installation points are not located at the end of the case. Simply secure front and rear case brackets to screen case, attach wall/ceiling brackets to secure install points, then attach case brackets to wall/ceiling brackets. Available in black or white finish.

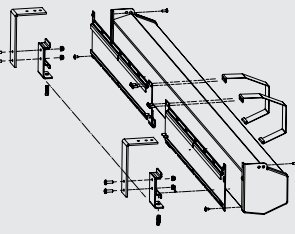

| Floating Screen Brackets (pr.) | Part No. | PRICE | Shipping Wt./lbs. |
|--------------------------------|----------|-------|-------------------|
| White Finish | 227025 | \$85 | 11 |
| Black Finish | 227024 | 85 | 11 |

| Non-Adjustable Wall Brackets | Part No. | PRICE | Shipping Wt./lbs. |
|------------------------------|----------|-------|-------------------|
| 6" Extension (white) | 227212 | \$20 | 2 |
| 6" Extension (black) | 227213 | 20 | 2 |

Screen Boom—Draper's Screen Boom allows the installation of a motorized projection screen onto a motorized operable arm. The system is stored, with the screen retracted, nearly flat against the wall. Operate the Screen Boom first to swing the screen out into the room, any distance up to 90 degrees, then lower the screen for use. See page 93 for more details and pricing.

| H x W / Diagonal | Image Area | OptiFlex Viewing Surfaces | | ClearSound Viewing Surfaces | | | | Case Length | Shipping Wt./lbs. | Dim Wt./lbs. | Freight Class |
|------------------------------|-----------------------|---------------------------|--------|-----------------------------|-------------|-------------|-------------|-----------------|-------------------|--------------|---------------|
| | | ReAct MS1000V | PRICE | ClearSound NanoPerf XT800V | PRICE | MAP | NET | | | | |
| 16:10 Format | | | | | | | | | | | |
| 67" | 35 1/4" x 56 1/2" | 101635FR | \$1935 | 101635SC | \$2134 | \$1707 | \$1280 | 72 1/2" | 49 | | 125 P+ |
| 76" | 40" x 64" | 101636FR | 2092 | 101636SC | 2279 | 1823 | 1367 | 81" | 59 | 60 | 125 P+ |
| 85" | 45" x 72" | 101637FR | 2254 | 101637SC | 2430 | 1944 | 1458 | 89" | 66 | | 125 P+ |
| 94" | 50" x 80" | 101638FR | 2327 | 101638SC | 2499 | 1999 | 1499 | 97" | 68 | | 125 P+ |
| 109" | 57 1/2" x 92" | 101639FR | 2390 | 101639SC | 2557 | 2046 | 1534 | 110" | 73 | | 125 |
| 113" | 60" x 96" | 101794FR | 2455 | 101794SC | 2617 | 2094 | 1570 | 113 7/8" | 75 | | 125 |
| 123" | 65" x 104" | 101640FR | 2654 | 101640SC | 2802 | 2242 | 1681 | 122" | 80 | | 125 |
| 137" | 72 1/2" x 116" | 101641FR | 2859 | 101641SC | 2992 | 2394 | 1795 | 135" | 88 | | 125 |
| 165" | 87 1/2" x 140" | -- | -- | 101642SC | 3401 | 2721 | 2040 | 160 1/2" | 105 | | 125 |
| 189" | 100" x 160" | -- | -- | 101755SC | 3696 | 2957 | 2217 | 180 1/2" | 118 | | 125 |
| 198"* | 105" x 168" | -- | -- | 101779SC | 4184 | 3347 | 2510 | 191 5/8" | 393 | | 125 |
| 226"* | 120" x 192" | -- | -- | 101782SC | 4719 | 3775 | 2831 | 217 1/4" | 441 | | 125 |
| 16:9 HDTV Format | | | | | | | | | | | |
| 65" | 31 3/4" x 56 1/2" | 101324FR | \$1935 | 101324SC | \$2134 | \$1707 | \$1280 | 72 1/2" | 49 | | 125 P+ |
| 73" | 36" x 64" | 101325FR | 2092 | 101325SC | 2279 | 1823 | 1367 | 80" | 59 | 60 | 125 P+ |
| 82" | 40 1/2" x 72" | 101326FR | 2254 | 101326SC | 2430 | 1944 | 1458 | 89" | 66 | | 125 P+ |
| 92" | 45" x 80" | 101059FR | 2327 | 101059SC | 2499 | 1999 | 1499 | 97 1/2" | 68 | | 125 P+ |
| 100" | 49" x 87" | 101761FR | 2360 | 101761SC | 2529 | 2023 | 1517 | 104" | 65 | | 125 |
| 106" | 52" x 92" | 101060FR | 2390 | 101060SC | 2557 | 2046 | 1534 | 110" | 74 | | 125 |
| 110" | 54" x 96" | 101770FR | 2455 | 101770SC | 2617 | 2094 | 1570 | 114" | 76 | | 125 |
| 119" | 58" x 104" | 101305FR | 2654 | 101305SC | 2802 | 2242 | 1681 | 122" | 81 | | 125 |
| 133" | 65" x 116" | 101185FR | 2859 | 101185SC | 2992 | 2394 | 1795 | 135" | 89 | | 125 |
| 161" | 79" x 140" | 101186FR | 3297 | 101186SC | 3401 | 2721 | 2040 | 160 1/4" | 105 | | 125 |
| 184" | 90" x 160" | -- | -- | 101361SC | 3696 | 2957 | 2217 | 180 3/4" | 118 | | 125 |
| 193"* | 94 1/2" x 168" | -- | -- | 101689SC | 4184 | 3347 | 2510 | 191 1/8" | 428 | | 125 |
| 220"* | 108" x 192" | -- | -- | 101391SC | 4719 | 3775 | 2831 | 215 5/8" | 437 | | 125 |
| 4:3 NTSC Video Format | | | | | | | | | | | |
| 6" | 42 1/2" x 56 1/2" | 101181FR | \$1939 | 101181SC | \$2137 | \$1710 | \$1282 | 74" | 49 | 65 | 125 P+ |
| 7" | 50" x 66 1/2" | 101182FR | 2097 | 101182SC | 2284 | 1827 | 1370 | 84 1/4" | 59 | 69 | 125 P+ |
| 100" | 60" x 80" | 101056FR | 2342 | 101056SC | 2512 | 2010 | 1507 | 97 3/4" | 66 | 69 | 125 P+ |
| 10' | 72" x 96" | 101058FR | 2401 | 101058SC | 2567 | 2054 | 1540 | 115" | 76 | | 125 |
| 11' | 78" x 104" | 101183FR | 2762 | 101183SC | 2902 | 2322 | 1741 | 124 1/4" | 80 | | 125 |
| 150" | 87" x 116" | -- | -- | 101184SC | 3012 | 2410 | 1807 | 136 1/4" | 89 | | 125 |
| 15' | 108" x 144" | -- | -- | 101179SC | 3504 | 2803 | 2102 | 165 3/4" | 117 | | 125 |
| 200" | 118" x 158" | -- | -- | 101359SC | 3696 | 2957 | 2217 | 180 3/4" | 120 | | 125 |
| 210"* | 126" x 168" | -- | -- | 101686SC | 4184 | 3347 | 2510 | 193 1/4" | 393 | | 125 |
| 220"* | 132" x 176" | -- | -- | 101385SC | 4321 | 3457 | 2592 | 201 1/4" | 437 | | 125 |
| 230"* | 138" x 184" | -- | -- | 101386SC | 4561 | 3649 | 2736 | 211" | 452 | | 125 |
| 20"* | 144" x 192" | -- | -- | 101387SC | 4819 | 3855 | 2891 | 219" | 481 | | 125 |
| AV Format | | | | | | | | | | | |
| 50" x 50" | -- | -- | -- | 101170SC | \$2009 | \$1607 | \$1205 | 68" | 44 | 60 | 125 P+ |
| 60" x 60" | -- | -- | -- | 101171SC | 2129 | 1703 | 1277 | 78 3/4" | 50 | 66 | 125 P+ |
| 70" x 70" | -- | -- | -- | 101172SC | 2364 | 1891 | 1418 | 89" | 60 | 66 | 125 P+ |
| 84" x 84" | -- | -- | -- | 101173SC | 2559 | 2047 | 1535 | 104 1/4" | 65 | | 125 |
| 72" x 96" | -- | -- | -- | 101058SC | 2567 | 2054 | 1540 | 115" | 76 | | 125 |
| 96" x 96" | -- | -- | -- | 101174SC | 2657 | 2126 | 1594 | 117 3/4" | 79 | | 125 |
| 7' x 9' | -- | -- | -- | 101175SC | 2794 | 2235 | 1676 | 128 1/4" | 86 | | 125 |
| 9' x 9' | -- | -- | -- | 101176SC | 3074 | 2459 | 1844 | 129 3/4" | 89 | | 125 |
| 8' x 10' | -- | -- | -- | 101177SC | 3186 | 2549 | 1911 | 141 3/4" | 93 | | 125 |
| 10' x 10' | -- | -- | -- | 101178SC | 3276 | 2621 | 1965 | 143 1/2" | 95 | | 125 |
| 9' x 12' | -- | -- | -- | 101179SC | 3504 | 2803 | 2102 | 165 3/4" | 117 | | 125 |
| 12' x 12' | -- | -- | -- | 101180SC | 3782 | 3026 | 2269 | 171 1/2" | 139 | | 125 |
| 10' 6" x 14'* | -- | -- | -- | 101686SC | 4184 | 3347 | 2510 | 193 1/4" | 393 | | 125 |
| 14' x 14'* | -- | -- | -- | 101381SC | 4231 | 3385 | 2538 | 199 1/8" | 413 | | 125 |
| 12' x 16'* | -- | -- | -- | 101382SC | 4819 | 3855 | 2891 | 219" | 481 | | 125 |

Targa— Popular electric screen. Housed in a pentagonal steel case, finished white with matching endcaps that also serve as a universal mounting bracket. Very reasonably priced; powered by a tubular motor-in-roller. Includes one 110-120v 3-position switch. Viewing surfaces from the OptiView and ClearSound families.

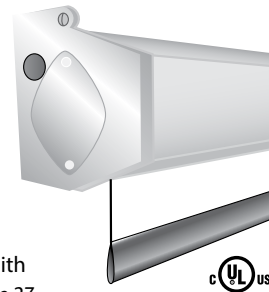

Standard Specs

- **Sizes and Formats:** Custom sizes by quotation. Custom sizes need to be specified in detail, including extra drop, if desired.
- **Case Dimensions:** Standard case is 5 7/8" H x 5 1/4" D. Optional built-in controls and extra drop may increase case length: call Draper for dimensions.
- **Black Borders:** Image area framed with black on all four sides. **12" black drop at top of viewing surface (standard).**

Options

- **Motor/Control Options:** (Q) Quiet Motor, (U or L) Built-in Low Voltage Controller and (P) Plug & Play™ available. See page 35 for details. 220V motor is also available at no extra cost.
- **Extra Drop:** Additional drop above image area (specify color—viewing area color standard for AV; black for other formats).
- **Ceiling Opening Trim Kit:** Optional trim kit finishes opening for recessed installation in acoustical drop ceilings. See page 27.
- **Floating Screen Brackets** Optional wall/

ceiling mounting brackets for added flexibility. Can only be used with small case. See page 27.

- **Viewing Surface:** Also available with ClearSound Perf XT950E, a perforated matt white, by quotation —Add the suffix SE to any Matt White XT1000E part number. See page 5.

***Bold sizes footnoted below require larger case**—Extruded aluminum, 6 3/4" x 6 3/4". These are not compatible with 6" extension brackets, floating brackets, Ceiling Opening Trim Kit, or optional Q and QL motors.

¹ **Sizes footnoted below include 12" black drop as standard—NO EXTRA CHARGE!**

OptiView Viewing Surfaces

| H x W / Diagonal | Image Area | Overall Size | Matt White XT1000E | Contrast Grey XH800E | Contrast White XH1100E | Argent White XH1500E | Pearl White CH1900E | PRICE | Case Length | Shipping Wt./lbs. | Dim Wt./lbs. | Freight Class |
|------------------------------|------------------------|-----------------------|--------------------|----------------------|------------------------|----------------------|---------------------|-------------|-----------------|-------------------|--------------|---------------|
| 16:10 Format | | | | | | | | | | | | |
| 67" ¹ | 35 1/4" x 56 1/2" | 47 1/4" x 59 1/2" | 116364 | 116372 | 116364EG | 116364EH | 116364EJ | \$875 | 66 1/2" | 46 | 57 | 125 P+ |
| 76" ¹ | 40" x 64" | 52" x 69 1/2" | 116365 | 116373 | 116365EG | 116365EH | 116365EJ | 905 | 76 1/2" | 51 | 64 | 125 P+ |
| 85" ¹ | 45" x 72" | 57" x 74" | 116366 | 116374 | 116366EG | 116366EH | 116366EJ | 929 | 81" | 53 | 67 | 125 P+ |
| 94" ¹ | 50" x 80" | 62" x 83 1/2" | 116367 | 116375 | 116367EG | 116367EH | 116367EJ | 952 | 90 1/2" | 57 | 77 | 125 P+ |
| 109" ¹ | 57 1/2" x 92" | 69 1/2" x 96" | 116368 | 116376 | 116368EG | 116368EH | 116368EJ | 989 | 103" | 62 | 71 | 125 P+ |
| 113" ¹ | 60" x 96" | 72" x 100" | 116530 | 116532 | 116530EG | 116530EH | -- | 1012 | 107" | 64 | 125 | |
| 123" ¹ | 65" x 104" | 69" x 108" | 116369 | 116377 | 116369EG | 116369EH | -- | 1045 | 115" | 68 | 125 | |
| 137" ¹ | 72 1/2" x 116" | 76 1/2" x 120" | 116370 | 116378 | 116370EG | 116370EH | -- | 1100 | 127" | 78 | 125 | |
| 165" ¹ | 87 1/2" x 140" | 92 1/2" x 144" | 116371 | 116379 | -- | -- | -- | 1167 | 151" | 93 | 125 | |
| 189" ¹ | 100" x 160" | 105" x 164" | 116482 | 116502 | -- | -- | -- | 2212 | 171" | 102 | 125 | |
| 198"* | 105" x 168" | 110" x 172" | 116485 | 116503 | -- | -- | -- | 2616 | 180 7/8" | 250 | 125 | |
| 222"* | 117 1/2" x 188" | 122" x 192" | 116486 | 116504 | -- | -- | -- | 3249 | 200 7/8" | 274 | 125 | |
| 16:9 HDTV Format | | | | | | | | | | | | |
| 65" ¹ | 31 3/4" x 56 1/2" | 43 3/4" x 59 1/2" | 116278 | 116284 | 116278EG | 116278EH | 116278EJ | \$875 | 66 1/2" | 46 | 57 | 125 P+ |
| 73" ¹ | 36" x 64" | 48" x 69 1/2" | 116279 | 116285 | 116279EG | 116279EH | 116279EJ | 905 | 76 1/2" | 51 | 64 | 125 P+ |
| 82" ¹ | 40 1/2" x 72" | 52 1/2" x 74" | 116280 | 116286 | 116280EG | 116280EH | 116280EJ | 929 | 81" | 53 | 67 | 125 P+ |
| 92" ¹ | 45" x 80" | 57" x 83 1/2" | 116300 | 116304 | 116300EG | 116300EH | 116300EJ | 952 | 90 1/2" | 58 | 77 | 125 P+ |
| 100" ¹ | 49" x 87" | 61" x 91" | 116454 | 116456 | 116454EG | 116454EH | 116454EJ | 974 | 98" | 60 | 70 | 125 P+ |
| 106" ¹ | 52" x 92" | 64" x 96" | 116301 | 116305 | 116301EG | 116301EH | 116301EJ | 989 | 103" | 62 | 71 | 125 P+ |
| 110" ¹ | 54" x 96" | 66" x 100" | 116469 | 116471 | 116469EG | 116469EH | -- | 1012 | 107" | 64 | 125 | |
| 119" ¹ | 58" x 104" | 62" x 108" | 116240 | 116247 | 116240EG | 116240EH | -- | 1045 | 115" | 65 | 125 | |
| 133" ¹ | 65" x 116" | 69" x 120" | 116022 | 116193 | 116022EG | 116022EH | -- | 1100 | 127" | 68 | 125 | |
| 161" ¹ | 79" x 140" | 84" x 144" | 116023 | 116194 | -- | -- | -- | 1167 | 151" | 90 | 125 | |
| 184" ¹ | 90" x 160" | 95" x 164" | 116255 | 116257 | -- | -- | -- | 2212 | 171" | 100 | 125 | |
| 193"* | 94 1/2" x 168" | 99 1/2" x 172" | 116343 | 116510 | -- | -- | -- | 2616 | 180 7/8" | 243 | 125 | |
| 220"* | 106" x 188" | 111" x 192" | 116344 | 116511 | -- | -- | -- | 3249 | 200 7/8" | 274 | 125 | |
| 4:3 NTSC Video Format | | | | | | | | | | | | |
| 6' | 42 1/2" x 56 1/2" | 46 1/2" x 59 1/2" | 116013 | 116185 | 116013EG | 116013EH | 116013EJ | \$865 | 66 1/2" | 40 | 57 | 125 P+ |
| 7' | 50" x 66 1/2" | 53 1/2" x 69 1/2" | 116014 | 116186 | 116014EG | 116014EH | 116014EJ | 892 | 76 1/2" | 51 | 64 | 125 P+ |
| 100" | 60" x 80" | 64" x 83 1/2" | 116015 | 116187 | 116015EG | 116015EH | 116015EJ | 949 | 90 1/2" | 53 | 77 | 125 P+ |
| 10' | 69" x 92" | 73" x 96" | 116016 | 116188 | 116016EG | 116016EH | 116016EJ | 995 | 103" | 62 | 71 | 125 P+ |
| 11' | 78" x 104" | 83" x 108" | 116017 | 116189 | 116017EG | 116017EH | -- | 1065 | 115" | 64 | 125 | |
| 150" | 87" x 116" | 92" x 120" | 116018 | 116190 | 116018EG | 116018EH | -- | 1090 | 127" | 74 | 125 | |
| 15' | 105" x 140" | 109" x 144" | 116019 | 116512 | -- | -- | -- | 1249 | 151" | 92 | 125 | |
| 200" | 118" x 158" | 123" x 162" | 116249 | 116513 | -- | -- | -- | 2095 | 169" | 118 | 125 | |
| 210"* | 126" x 168" | 131" x 172" | 116341 | 116514 | -- | -- | -- | 2697 | 180 7/8" | 266 | 125 | |
| 240"* | 141" x 188" | 146" x 192" | 116342 | 116515 | -- | -- | -- | 3249 | 200 7/8" | 283 | 125 | |
| AV Format | | | | | | | | | | | | |
| 50" x 50" | | | 116001 | 116177 | 116001EG | 116001EH | 116001EJ | \$830 | 56 1/2" | 36 | 53 | 125 P+ |
| 60" x 60" | | | 116002 | 116178 | 116002EG | 116002EH | 116002EJ | 839 | 66 1/2" | 41 | 57 | 125 P+ |
| 70" x 70" | | | 116003 | 116179 | 116003EG | 116003EH | 116003EJ | 862 | 76 1/2" | 47 | 64 | 125 P+ |
| 84" x 84" | | | 116004 | 116180 | 116004EG | 116004EH | 116004EJ | 947 | 90 1/2" | 53 | 77 | 125 P+ |
| 72" x 96" | | | 116005 | 116181 | 116005EG | 116005EH | 116005EJ | 970 | 103" | 60 | 125 | |
| 96" x 96" | | | 116006 | 116182 | 116006EG | 116006EH | 116006EJ | 1022 | 103" | 66 | 125 | |
| 7' x 9' | | | 116007 | 116183 | 116007EG | 116007EH | -- | 1049 | 115" | 68 | 125 | |
| 9' x 9' | | | 116008 | 116505 | -- | -- | -- | 1177 | 115" | 73 | 125 | |
| 8' x 10' | | | 116009 | 116184 | 116009EG | 116009EH | -- | 1162 | 127" | 74 | 125 | |
| 10' x 10' | | | 116010 | 116507 | -- | -- | -- | 1285 | 127" | 75 | 125 | |
| 9' x 12' | | | 116011 | 116506 | -- | -- | -- | 1335 | 151" | 95 | 125 | |
| 12' x 12' | | | 116012 | 116508 | -- | -- | -- | 2129 | 151" | 108 | 125 | |
| 14' x 14'* | | | 116338 | -- | -- | -- | -- | 2671 | 176 7/8" | 268 | 125 | |
| 12' x 16'* | | | 116339 | 116509 | -- | -- | -- | 3067 | 200 7/8" | 298 | 125 | |
| 16' x 16'* | | | 116340 | -- | -- | -- | -- | 3157 | 200 7/8" | 300 | 125 | |

Please Note: Case length will increase by 1" for Targa with (U) Built-in Low Voltage Controller LVC-IV.

CHART CONTINUED

Accessories for Targa—*These accessories are compatible with Targa using small case only.*

Ceiling Opening Trim Kit—Designed for recessed installation in acoustical drop ceilings of Targa motorized screens. Ships KD; assembles quickly with fasteners provided. Trims out the ceiling tile opening and attaches to screen endcaps. Painted white. Slot includes finished flange to accept acoustical ceiling tile or grid. Slot measures 2 1/8" in depth. Once installed, the finished slot length is equal to the Targa screen case length.

| Finished Slot Length | Screen Case Length | Part No. | PRICE | Shipping Wt./lbs. | Freight Class |
|----------------------|----------------------|----------|-------|-------------------|---------------|
| 102 1/2" | 102 1/2" and shorter | 121202 | \$172 | 31 | 77.5 |
| 126 1/2" | 102 1/2" – 126 1/2" | 121203 | 188 | 36 | 77.5 |
| 174" | 126 1/2" – 174" | 121207 | 213 | 49 | 77.5 |

Note: When ordering a **Targa** projection screen for use with a Ceiling Opening Trim Kit, Draper recommends adding 12" of extra black drop at the top of the screen. Pricing for extra drop appears on page 36.

Floating Screen Brackets—Use Draper's Floating Screen Brackets for added flexibility and secure mounting of Targa even when available installation points are not located at the end of the case. Simply secure front and rear case brackets to screen case, attach wall/ceiling brackets to secure install points, then attach case brackets to wall/ceiling brackets. Available in black or white finish.

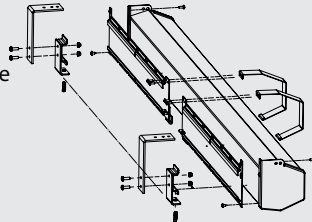

| Floating Screen Brackets (pr.) | Part No. | PRICE | Shipping Wt./lbs. |
|--------------------------------|----------|-------|-------------------|
| White Finish | 227025 | \$85 | 11 |
| Black Finish | 227024 | 85 | 11 |

| Non-Adjustable Wall Brackets | Part No. | PRICE | Shipping Wt./lbs. |
|------------------------------|----------|-------|-------------------|
| 6" Extension (white) | 227212 | \$20 | 2 |
| 6" Extension (black) | 227213 | 20 | 2 |
| 10"/14" Extension (black) | 227214 | 30 | 3 |
| 10"/14" Extension (white) | 227215 | 30 | 3 |

Screen Boom—Draper's Screen Boom allows the installation of a motorized projection screen onto a motorized operable arm. The system is stored, with the screen retracted, nearly flat against the wall. Operate the Screen Boom first to swing the screen out into the room, any distance up to 90 degrees, then lower the screen for use. See page 93 for more details and pricing.

Targa—(Continued)

| | | ClearSound Viewing Surfaces | | | | | | | | | |
|------------------------------|-------------------|-----------------------------|-------------------------------|------------------------------|--------|-------------|-------------------|--------------|---------------|--|--|
| H x W / Diagonal | Image Area | Overall Size | ClearSound White Weave XT900E | ClearSound Grey Weave XH600E | PRICE | Case Length | Shipping Wt./lbs. | Dim Wt./lbs. | Freight Class | | |
| 16:10 Format | | | | | | | | | | | |
| 67" ¹ | 35 3/4" x 56 1/2" | 47 1/4" x 59 1/2" | 1163645A | 1163645B | \$2807 | 66 1/2" | 46 | 57 | 125 P+ | | |
| 76" ¹ | 40" x 64" | 52" x 69 1/2" | 1163655A | 1163655B | 3117 | 76 1/2" | 51 | 64 | 125 P+ | | |
| 85" ¹ | 45" x 72" | 57" x 74" | 1163665A | 1163665B | 3464 | 81" | 53 | 67 | 125 P+ | | |
| 94" ¹ | 50" x 80" | 62" x 83 1/2" | 1163675A | 1163675B | 3849 | 90 1/2" | 57 | 77 | 125 P+ | | |
| 109" ¹ | 57 1/2" x 92" | 69 1/2" x 96" | 1163685A | 1163685B | 4278 | 103" | 62 | 71 | 125 P+ | | |
| 113" ¹ | 60" x 96" | 72" x 100" | 1165305A | 1165305B | 4753 | 107" | 64 | | 125 | | |
| 123" | 65" x 104" | 69" x 108" | 1163695A | 1163695B | 5281 | 115" | 68 | | 125 | | |
| 137" | 72 1/2" x 116" | 76 1/2" x 120" | 1163705A | 1163705B | 5868 | 127" | 78 | | 125 | | |
| 165" | 87 1/2" x 140" | 92 1/2" x 144" | -- | -- | -- | 151" | 93 | | 125 | | |
| 189" | 100" x 160" | 105" x 164" | -- | -- | -- | 171" | 102 | | 125 | | |
| 198" [*] | 105" x 168" | 110" x 172" | -- | -- | -- | 180 7/8" | 250 | | 125 | | |
| 222" [*] | 117 1/2" x 188" | 122" x 192" | -- | -- | -- | 200 7/8" | 274 | | 125 | | |
| 16:9 HDTV Format | | | | | | | | | | | |
| 65" ¹ | 31 3/4" x 56 1/2" | 43 3/4" x 59 1/2" | 1162785A | 1162785B | \$2557 | 66 1/2" | 46 | 57 | 125 P+ | | |
| 73" ¹ | 36" x 64" | 48" x 69 1/2" | 1162795A | 1162795B | 2842 | 76 1/2" | 51 | 64 | 125 P+ | | |
| 82" ¹ | 40 1/2" x 72" | 52 1/2" x 74" | 1162805A | 1162805B | 3159 | 81" | 53 | 67 | 125 P+ | | |
| 92" ¹ | 45" x 80" | 57" x 83 1/2" | 116298 | 116298 | 3509 | 90 1/2" | 58 | 77 | 125 P+ | | |
| 100" ¹ | 49" x 87" | 61" x 91" | 116453 | 116452 | 4012 | 98" | 60 | 70 | 125 P+ | | |
| 106" ¹ | 52" x 92" | 64" x 96" | 116299 | 116297 | 4696 | 103" | 62 | 71 | 125 P+ | | |
| 110" ¹ | 54" x 96" | 66" x 100" | 116468 | 116467 | 4861 | 107" | 64 | | 125 | | |
| 119" | 58" x 104" | 62" x 108" | 116244 | 116239 | 5713 | 115" | 65 | | 125 | | |
| 133" | 65" x 116" | 69" x 120" | 116110 | 116234 | 5829 | 127" | 68 | | 125 | | |
| 161" | 79" x 140" | 84" x 144" | 116444 | 116445 | 5941 | 151" | 90 | | 125 | | |
| 184" | 90" x 160" | 95" x 164" | 116434 | 116435 | 6650 | 171" | 100 | | 125 | | |
| 193" [*] | 94 1/2" x 168" | 99 1/2" x 172" | -- | -- | -- | 180 7/8" | 243 | | 125 | | |
| 220" [*] | 106" x 188" | 111" x 192" | -- | -- | -- | 200 7/8" | 274 | | 125 | | |
| 4:3 NTSC Video Format | | | | | | | | | | | |
| 6' | 42 1/2" x 56 1/2" | 46 1/2" x 59 1/2" | 1163435A | 1163435B | \$3084 | 66 1/2" | 40 | 57 | 125 P+ | | |
| 7' | 50" x 66 1/2" | 53 1/2" x 69 1/2" | 1163445A | 1163445B | 3426 | 76 1/2" | 51 | 64 | 125 P+ | | |
| 100" | 60" x 80" | 64" x 83 1/2" | 116106 | 116230 | 3807 | 90 1/2" | 53 | 77 | 125 P+ | | |
| 10' | 69" x 92" | 73" x 96" | 116107 | 116231 | 5558 | 103" | 62 | 71 | 125 P+ | | |
| 11' | 78" x 104" | 83" x 108" | 116450 | 116451 | 5781 | 115" | 64 | | 125 | | |
| 150" | 87" x 116" | 92" x 120" | 116446 | 116447 | 5814 | 127" | 74 | | 125 | | |
| 15' | 105" x 140" | 109" x 144" | -- | -- | -- | 151" | 92 | | 125 | | |
| 200" | 118" x 158" | 123" x 162" | -- | -- | -- | 169" | 118 | | 125 | | |
| 210" [*] | 126" x 168" | 131" x 172" | -- | -- | -- | 180 7/8" | 266 | | 125 | | |
| 240" [*] | 141" x 188" | 146" x 192" | -- | -- | -- | 200 7/8" | 283 | | 125 | | |
| AV Format | | | | | | | | | | | |
| 50" x 50" | -- | -- | -- | -- | -- | 56 1/2" | 36 | 53 | 125 P+ | | |
| 60" x 60" | -- | -- | -- | -- | -- | 66 1/2" | 41 | 57 | 125 P+ | | |
| 70" x 70" | -- | -- | -- | -- | -- | 76 1/2" | 47 | 64 | 125 P+ | | |
| 84" x 84" | -- | -- | -- | -- | -- | 90 1/2" | 53 | 77 | 125 P+ | | |
| 72" x 96" | -- | -- | -- | -- | -- | 103" | 60 | | 125 | | |
| 96" x 96" | -- | -- | -- | -- | -- | 103" | 66 | | 125 | | |
| 7' x 9' | -- | -- | -- | -- | -- | 115" | 68 | | 125 | | |
| 9' x 9' | -- | -- | -- | -- | -- | 115" | 73 | | 125 | | |
| 8' x 10' | -- | -- | -- | -- | -- | 127" | 74 | | 125 | | |
| 10' x 10' | -- | -- | -- | -- | -- | 127" | 75 | | 125 | | |
| 9' x 12' | -- | -- | -- | -- | -- | 151" | 95 | | 125 | | |
| 12' x 12' | -- | -- | -- | -- | -- | 151" | 108 | | 125 | | |
| 14' x 14" [*] | -- | -- | -- | -- | -- | 176 7/8" | 268 | | 125 | | |
| 12' x 16" [*] | -- | -- | -- | -- | -- | 200 7/8" | 298 | | 125 | | |
| 16' x 16" [*] | -- | -- | -- | -- | -- | 200 7/8" | 300 | | 125 | | |

Please Note: Case length will increase by 1" for Targa with (U) Built-in Low Voltage Controller LVC-IV.

Silhouette/Series V—Tab-tensioned screen for wall/ceiling installation, with streamlined extruded white aluminum case. No exposed fasteners or mounting fixtures. Includes one 110-120v 3-position switch. Viewing surfaces from the OptiFlex, ClearSound and CineFlex families.



Standard Specs

- **Sizes and Formats:** Custom sizes by quotation. Custom sizes need to be specified in detail, including extra drop, if desired.
- **Case Dimensions:** 6" H x 4¾" D. Optional built-in controls and extra drop may increase case length: call Draper for dimensions.
- **Black Borders:** Image area framed with black on all four sides. **12" black drop at top of viewing surface (standard).**

Options

- **Motor/Control Options:** (Q) Quiet Motor, (U or L) Built-in Low Voltage Controller, or (P) Plug & Play™ available. See page 35 for details. 220V motor is also available at no extra cost.
- **Finish Options:** Black or Dove Grey case finish available at no extra charge.

- **Extra Drop:** Additional drop above image (specify color—black standard; surface color available). See page 36.
- **Viewing Surface:** CineFlex CH1200V (CB) and CineFlex MH800V (CA) rear projection surfaces, and CineFlex White XT600V (CC) front/rear projection surface available by quotation—add the 2-letter suffix noted above to any Matt White XT1000V part number. Also available with ClearSound Perf XT900V, a perforated matt white—add the suffix SD noted above to any Matt White XT1000V part number. See page 5.

OptiFlex Viewing Surfaces

| H x W / Diagonal | Image Area | Matt White XT1000V | Grey XH600V | Pure White XT1300V | PRICE | Pearl White MH1500V | PRICE | Case Length | Shipping Wt./lbs. | Dim Wt./lbs. | Freight Class |
|-------------------------------|-------------------|--------------------|-------------|--------------------|--------|---------------------|--------|-------------|-------------------|--------------|---------------|
| 16:10 Format | | | | | | | | | | | |
| 67" | 35 1/4" x 56 1/2" | 107337 | 107342 | 107337FN | \$2115 | 107347 | \$2327 | 77 1/4" | 50 | 63 | 125 P+ |
| 76" | 40" x 64" | 107338 | 107343 | 107338FN | 2269 | 107348 | 2495 | 85 3/4" | 56 | 64 | 125 P+ |
| 85" | 45" x 72" | 107339 | 107344 | 107339FN | 2430 | 107349 | 2674 | 93 3/4" | 62 | 70 | 125 P+ |
| 94" | 50" x 80" | 107340 | 107345 | 107340FN | 2534 | 107350 | 2787 | 101 3/4" | 68 | | 125 P+ |
| 109" | 57 1/2" x 92" | 107341 | 107346 | 107341FN | 2597 | 107351 | 2857 | 114 3/4" | 83 | | 125 |
| 113" | 60" x 96" | 107403 | 107405 | 107403FN | 2614 | 107407 | 2876 | 118 5/8" | 83 | | 125 |
| 16:9 HDTV Format | | | | | | | | | | | |
| 65" | 31 3/4" x 56 1/2" | 107319 | 107325 | 107319FN | \$2115 | 107322 | \$2327 | 77 1/4" | 50 | 58 | 125 P+ |
| 73" | 36" x 64" | 107320 | 107326 | 107320FN | 2269 | 107323 | 2495 | 84 3/4" | 55 | 64 | 125 P+ |
| 82" | 40 1/2" x 72" | 107321 | 107327 | 107321FN | 2430 | 107324 | 2674 | 93 3/4" | 62 | 70 | 125 P+ |
| 92" | 45" x 80" | 107250 | 107302 | 107250FN | 2534 | 107263 | 2787 | 102 3/4" | 66 | | 125 P+ |
| 100" | 49" x 87" | 107397 | 107401 | 107397FN | 2564 | 107398 | 2821 | 108 3/4" | 70 | | 125 |
| 106" | 52" x 92" | 107251 | 107303 | 107251FN | 2597 | 107264 | 2857 | 114 3/4" | 85 | | 125 |
| 110" | 54" x 96" | 107409 | 107411 | 107409FN | 2614 | 107413 | 2876 | 118 5/8" | 75 | | 125 |
| 4:3 NTSC Video Formats | | | | | | | | | | | |
| 6" | 42 1/2" x 56 1/2" | 107247 | 107299 | 107247FN | \$2119 | 107260 | \$2330 | 79 1/4" | 47 | 60 | 125 P+ |
| 7" | 50" x 66 1/2" | 107248 | 107300 | 107248FN | 2272 | 107261 | 2499 | 89 1/4" | 59 | 60 | 125 P+ |
| 100" | 60" x 80" | 107249 | 107301 | 107249FN | 2531 | 107262 | 2784 | 103 3/4" | 70 | | 125 |
| 10' | 72" x 96" | 107245 | 107297 | 107245FN | 2594 | 107258 | 2854 | 119 3/4" | 90 | | 125 |
| AV Format | | | | | | | | | | | |
| 50" x 50" | | 107241 | 107293 | 107241FN | \$1980 | 107254 | \$2179 | 72 3/4" | 50 | 56 | 125 P+ |
| 60" x 60" | | 107242 | 107294 | 107242FN | 2109 | 107255 | 2320 | 83 3/4" | 54 | 64 | 125 P+ |
| 70" x 70" | | 107243 | 107295 | 107243FN | 2359 | 107256 | 2596 | 93 3/4" | 62 | 69 | 125 P+ |
| 84" x 84" | | 107244 | 107296 | 107244FN | 2577 | 107257 | 2836 | 109" | 70 | | 125 |
| 72" x 96" | | 107245 | 107297 | 107245FN | 2594 | 107258 | 2854 | 119 3/4" | 90 | | 125 |
| 96" x 96" | | 107246 | 107298 | 107246FN | 2684 | 107259 | 2952 | 122 1/2" | 78 | | 125 |

OptiFlex Viewing Surfaces

ClearSound Viewing Surface

| H x W / Diagonal | Image Area | ReAct MS1000V | PRICE | ClearSound NanoPerf XT800V | PRICE | Case Length | Shipping Wt./lbs. | Dim Wt./lbs. | Freight Class |
|------------------------------|-------------------|---------------|--------|----------------------------|--------|-------------|-------------------|--------------|---------------|
| 16:10 Format | | | | | | | | | |
| 67" | 35 1/4" x 56 1/2" | 107337FR | \$2274 | 107337SC | \$2449 | 77 1/4" | 50 | 63 | 125 P+ |
| 76" | 40" x 64" | 107338FR | 2439 | 107338SC | 2602 | 85 3/4" | 56 | 64 | 125 P+ |
| 85" | 45" x 72" | 107339FR | 2612 | 107339SC | 2764 | 93 3/4" | 62 | 70 | 125 P+ |
| 94" | 50" x 80" | 107340FR | 2724 | 107340SC | 2867 | 101 3/4" | 68 | | 125 P+ |
| 109" | 57 1/2" x 92" | 107341FR | 2792 | 107341SC | 2931 | 114 3/4" | 83 | | 125 |
| 113" | 60" x 96" | 107403FR | 2811 | 107403SC | 2947 | 118 5/8" | 83 | | 125 |
| 16:9 HDTV Format | | | | | | | | | |
| 65" | 31 3/4" x 56 1/2" | 107319FR | \$2274 | 107319SC | \$2449 | 77 1/4" | 50 | 58 | 125 P+ |
| 73" | 36" x 64" | 107320FR | 2439 | 107320SC | 2602 | 84 3/4" | 55 | 64 | 125 P+ |
| 82" | 40 1/2" x 72" | 107321FR | 2612 | 107321SC | 2764 | 93 3/4" | 62 | 70 | 125 P+ |
| 92" | 45" x 80" | 107250FR | 2724 | 107250SC | 2867 | 102 3/4" | 66 | | 125 P+ |
| 100" | 49" x 87" | 107397FR | 2756 | 107397SC | 2897 | 108 3/4" | 70 | | 125 |
| 106" | 52" x 92" | 107251FR | 2792 | 107251SC | 2931 | 114 3/4" | 85 | | 125 |
| 110" | 54" x 96" | 107409FR | 2811 | 107409SC | 2947 | 118 5/8" | 75 | | 125 |
| 4:3 NTSC Video Format | | | | | | | | | |
| 6" | 42 1/2" x 56 1/2" | 107247FR | \$2277 | 107247SC | \$2452 | 79 1/4" | 47 | 60 | 125 P+ |
| 7" | 50" x 66 1/2" | 107248FR | 2442 | 107248SC | 2606 | 89 1/4" | 59 | 60 | 125 P+ |
| 100" | 60" x 80" | 107249FR | 2721 | 107249SC | 2864 | 103 3/4" | 70 | | 125 |
| 10' | 72" x 96" | -- | -- | 107245SC | 2927 | 119 3/4" | 90 | | 125 |
| AV Format | | | | | | | | | |
| 50" x 50" | | -- | -- | 107241SC | \$2314 | 72 3/4" | 50 | 56 | 125 P+ |
| 60" x 60" | | -- | -- | 107242SC | 2442 | 83 3/4" | 54 | 64 | 125 P+ |
| 70" x 70" | | -- | -- | 107243SC | 2692 | 93 3/4" | 62 | 69 | 125 P+ |
| 84" x 84" | | -- | -- | 107244SC | 2911 | 109" | 70 | | 125 |
| 72" x 96" | | -- | -- | 107245SC | 2927 | 119 3/4" | 90 | | 125 |
| 96" x 96" | | -- | -- | 107246SC | 3017 | 122 1/2" | 78 | | 125 |

CHART CONTINUED BELOW

Silhouette/Series E—Self-supporting screen for wall/ceiling installation, with streamlined extruded white aluminum case. No exposed fasteners or mounting fixtures. Viewing surfaces from the OptiView and ClearSound families.

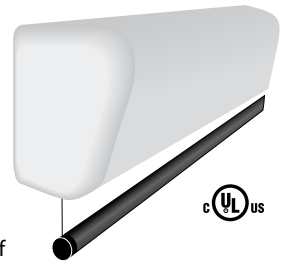

Motorized Screens
Wall/Ceiling Mounted

Standard Specs

- **Sizes and Formats:** Custom sizes by quotation. Custom sizes need to be specified in detail, including extra drop, if desired.
- **Case Dimensions:** 6" H x 4 3/4" D. Optional built-in controls and extra drop may increase case length: call Draper for dimensions.
- **Black Masking Borders:** NTSC, HDTV and 16:10 format have image area framed with black on all four sides. Black side borders are available on request for AV format screens.

Options

- **Motor/Control Options:** (Q) Quiet Motor, (U or L) Built-in Low Voltage Controller, or (P) Plug & Play™ available. See page 35 for details. 220V motor is also available at no extra cost.
- **Finish Options:** Black or Dove Grey case finish available at no extra charge.
- **Extra Drop:** Extra drop above image area optional—See page 36 (specify color: surface color standard for AV; black for other formats).

• **Viewing Surface:**

Also available with ClearSound Perf XT950E, a perforated matt white, by quotation. Add the suffix SE to any Matt White XT1000E part number. See page 5.



*These sizes include 12" black drop as standard—NO EXTRA CHARGE!

| OptiView Viewing Surfaces | | | | | | | | | | | | | |
|------------------------------|-------------------|-------------------|--------------------|----------------------|------------------------|----------------------|---------------------|--------|-------------|-------------------|--------------|---------------|--|
| H x W / Diagonal | Image Area | Overall Size | Matt White XT1000E | Contrast Grey XH800E | Contrast White XH1100E | Argent White XH1500E | Pearl White CH1900E | PRICE | Case Length | Shipping Wt./lbs. | Dim Wt./lbs. | Freight Class | |
| 16:10 Format | | | | | | | | | | | | | |
| 67" | 35 1/4" x 56 1/2" | 47 1/4" x 59 1/2" | 108350 | 108355 | 108350EG | 108350EH | 108350EJ | \$1200 | 71 1/2" | 42 | 57 | 125 P+ | |
| 76" | 40" x 64" | 52" x 69 1/2" | 108351 | 108356 | 108351EG | 108351EH | 108351EJ | 1234 | 81 1/2" | 48 | 62 | 125 P+ | |
| 85" | 45" x 72" | 57" x 74" | 108352 | 108357 | 108352EG | 108352EH | 108352EJ | 1282 | 86" | 50 | 62 | 125 P+ | |
| 94" | 50" x 80" | 62" x 83 1/2" | 108353 | 108358 | 108353EG | 108353EH | 108353EJ | 1304 | 95 1/2" | 54 | 76 | 125 P+ | |
| 109" | 57 1/2" x 92" | 69 1/2" x 96" | 108354 | 108359 | 108354EG | 108354EH | 108354EJ | 1354 | 108" | 60 | 108 | 125 | |
| 113" | 60" x 96" | 72" x 100" | 108410 | 108412 | 108410EG | 108410EH | -- | 1377 | 112" | 60 | 112 | 125 | |
| 16:9 HDTV Format | | | | | | | | | | | | | |
| 65" | 31 3/4" x 56 1/2" | 43 3/4" x 59 1/2" | 108300 | 108306 | 108300EG | 108300EH | 108300EJ | \$1200 | 71 1/2" | 42 | 57 | 125 P+ | |
| 73" | 36" x 64" | 48" x 69 1/2" | 108301 | 108307 | 108301EG | 108301EH | 108301EJ | 1234 | 81 1/2" | 48 | 62 | 125 P+ | |
| 82" | 40 1/2" x 72" | 52 1/2" x 74" | 108302 | 108308 | 108302EG | 108302EH | 108302EJ | 1282 | 86" | 52 | 62 | 125 P+ | |
| 92" | 45" x 80" | 57" x 83 1/2" | 108322 | 108326 | 108322EG | 108322EH | 108322EJ | 1304 | 95 1/2" | 54 | 72 | 125 P+ | |
| 100" | 49" x 87" | 61" x 91" | 108392 | 108394 | 108392EG | 108392EH | 108392EJ | 1329 | 103" | 58 | 66 | 125 P+ | |
| 106" | 52" x 92" | 64" x 96" | 108323 | 108327 | 108323EG | 108323EH | 108323EJ | 1354 | 108" | 60 | 108 | 125 | |
| 110" | 54" x 96" | 66" x 100" | 108400 | 108402 | 108400EG | 108400EH | -- | 1377 | 112" | 60 | 112 | 125 | |
| 4:3 NTSC Video Format | | | | | | | | | | | | | |
| 6" | 42 1/2" x 56 1/2" | 46 1/2" x 59 1/2" | 108220 | 108276 | 108220EG | 108220EH | 108220EJ | \$1192 | 71 1/2" | 42 | 57 | 125 P+ | |
| 7" | 50" x 66 1/2" | 53 1/2" x 69 1/2" | 108221 | 108277 | 108221EG | 108221EH | 108221EJ | 1227 | 81 1/2" | 48 | 67 | 125 P+ | |
| 100" | 60" x 80" | 64" x 83 1/2" | 108222 | 108278 | 108222EG | 108222EH | 108222EJ | 1290 | 95 1/2" | 55 | 76 | 125 P+ | |
| 10' | 69" x 92" | 73" x 96" | 108223 | 108279 | 108223EG | 108223EH | 108223EJ | 1347 | 108" | 61 | 108 | 125 | |
| AV Format | | | | | | | | | | | | | |
| 50" x 50" | | | 108214 | 108270 | 108214EG | 108214EH | 108214EJ | \$1154 | 61 1/2" | 38 | 49 | 125 P+ | |
| 60" x 60" | | | 108215 | 108271 | 108215EG | 108215EH | 108215EJ | 1165 | 71 1/2" | 42 | 57 | 125 P+ | |
| 70" x 70" | | | 108216 | 108272 | 108216EG | 108216EH | 108216EJ | 1187 | 81 1/2" | 45 | 62 | 125 P+ | |
| 84" x 84" | | | 108217 | 108273 | 108217EG | 108217EH | 108217EJ | 1289 | 95 1/2" | 57 | 79 | 125 P+ | |
| 72" x 96" | | | 108218 | 108274 | 108218EG | 108218EH | 108218EJ | 1315 | 108" | 59 | 108 | 125 | |
| 96" x 96" | | | 108219 | 108275 | 108219EG | 108219EH | 108219EJ | 1382 | 108" | 72 | 108 | 125 | |

| ClearSound Viewing Surfaces | | | | | | | | | | | | | |
|------------------------------|-------------------|-------------------|-------------------------------|------------------------------|--------|-------------|-------------------|--------------|---------------|--|--|--|--|
| H x W / Diagonal | Image Area | Overall Size | ClearSound White Weave XT900E | ClearSound Grey Weave XH600E | PRICE | Case Length | Shipping Wt./lbs. | Dim Wt./lbs. | Freight Class | | | | |
| 16:10 Format | | | | | | | | | | | | | |
| 67" | 35 1/4" x 56 1/2" | 47 1/4" x 59 1/2" | 108350SA | 108350SB | \$3841 | 71 1/2" | 42 | 57 | 125 P+ | | | | |
| 76" | 40" x 64" | 52" x 69 1/2" | 108351SA | 108351SB | 3947 | 81 1/2" | 48 | 62 | 125 P+ | | | | |
| 85" | 45" x 72" | 57" x 74" | 108352SA | 108352SB | 4102 | 86" | 50 | 62 | 125 P+ | | | | |
| 94" | 50" x 80" | 62" x 83 1/2" | 108353SA | 108353SB | 4171 | 95 1/2" | 54 | 76 | 125 P+ | | | | |
| 109" | 57 1/2" x 92" | 69 1/2" x 96" | 108354SA | 108354SB | 4331 | 108" | 60 | 108 | 125 | | | | |
| 113" | 60" x 96" | 72" x 100" | 108410SA | 108410SB | 4406 | 112" | 60 | 112 | 125 | | | | |
| 16:9 HDTV Format | | | | | | | | | | | | | |
| 65" | 31 3/4" x 56 1/2" | 43 3/4" x 59 1/2" | 108300SA | 108300SB | \$3841 | 71 1/2" | 42 | 57 | 125 P+ | | | | |
| 73" | 36" x 64" | 48" x 69 1/2" | 108301SA | 108301SB | 3947 | 81 1/2" | 48 | 62 | 125 P+ | | | | |
| 82" | 40 1/2" x 72" | 52 1/2" x 74" | 108302SA | 108302SB | 4102 | 86" | 52 | 62 | 125 P+ | | | | |
| 92" | 45" x 80" | 57" x 83 1/2" | 108320 | 108318 | 4189 | 95 1/2" | 54 | 72 | 125 P+ | | | | |
| 100" | 49" x 87" | 61" x 91" | 108391 | 108390 | 4279 | 103" | 58 | 66 | 125 P+ | | | | |
| 106" | 52" x 92" | 64" x 96" | 108321 | 108319 | 5903 | 108" | 60 | 108 | 125 | | | | |
| 110" | 54" x 96" | 66" x 100" | 108406 | 108408 | 6113 | 112" | 60 | 112 | 125 | | | | |
| 4:3 NTSC Video Format | | | | | | | | | | | | | |
| 6" | 42 1/2" x 56 1/2" | 46 1/2" x 59 1/2" | 108220SA | 108220SB | \$3814 | 71 1/2" | 42 | 57 | 125 P+ | | | | |
| 7" | 50" x 66 1/2" | 53 1/2" x 69 1/2" | 108221SA | 108221SB | 3926 | 81 1/2" | 48 | 67 | 125 P+ | | | | |
| 100" | 60" x 80" | 64" x 83 1/2" | 108240 | 108296 | 4259 | 95 1/2" | 55 | 76 | 125 P+ | | | | |
| 10' | 69" x 92" | 73" x 96" | 108241 | 108297 | 5968 | 108" | 61 | 108 | 125 | | | | |
| AV Format | | | | | | | | | | | | | |
| 50" x 50" | | | -- | -- | -- | 61 1/2" | 38 | 49 | 125 P+ | | | | |
| 60" x 60" | | | -- | -- | -- | 71 1/2" | 42 | 57 | 125 P+ | | | | |
| 70" x 70" | | | -- | -- | -- | 81 1/2" | 45 | 62 | 125 P+ | | | | |
| 84" x 84" | | | -- | -- | -- | 95 1/2" | 57 | 79 | 125 P+ | | | | |
| 72" x 96" | | | -- | -- | -- | 108" | 59 | 108 | 125 | | | | |
| 96" x 96" | | | -- | -- | -- | 108" | 72 | 108 | 125 | | | | |

CHART CONTINUED BELOW

Artisan/Series V—Stylish solid hardwood case offered in your choice of seven hardwood finishes or any plastic laminate, with four hardwood case styles. Complements the furnishings of a boardroom or home theatre. Includes one 110-120v 3-position switch. Viewing surfaces from the OptiFlex and ClearSound families.

Natural Wood Finishes: The unique beauty of natural hardwood means that the color of your Artisan case may vary from printed reproductions and even from the samples Draper can provide representing our standard species, stains, and finishes. If you are seeking to match existing furnishings, please request custom stain matching and provide a physical sample for best results. Contact Draper for more information.

Standard Specs

- **Sizes and Formats:** Custom sizes by quotation. Custom sizes need to be specified in detail, including extra drop, if desired.
- **Case Dimensions:** Case size: 6 3/8" H x 6" D (Bevel style case is 7 1/2" high).
- **Black Borders:** Image area fully framed with black on all four sides.
12" black drop at top of viewing surface (standard).

Options

- **Motor/Control Options:** (Q) Quiet Motor available. See page 35 for details. 220V motor is also available at no extra cost.
- **Extra Drop:** Additional drop above image (black standard; surface color available on request). Extra drop will increase length of case for tab-tensioned screens. See page 36.
- **Viewing Surface:** CineFlex CH1200V, CineFlex MH800V rear projection surfaces, CineFlex White XT600V front/rear projection surface available by quotation—please specify at time of order. Also available with ClearSound surfaces. See page 5 for surface information.

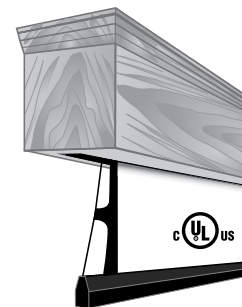

OptiFlex Viewing Surfaces

| | |
|---|------------------------|
| Matt White XT1000V, Pure White XT1300V or Grey XH600V | Pearl White MH1500V |
|---|------------------------|

| H x W / Diagonal | Image Area | PRICE | PRICE | Case Length | Shipping Wt./lbs. | Freight Class |
|------------------------------|-------------------|--------|--------|----------------|----------------------|------------------|
| 16:10 Format | | | | | | |
| 94" | 50" x 80" | \$3384 | \$3706 | 102 3/8" | 100 | 125 |
| 109" | 57 1/2" x 92" | 3737 | 4092 | 115 5/8" | 105 | 125 |
| 16:9 HDTV Format | | | | | | |
| 92" | 45" x 80" | \$3384 | \$3706 | 103 1/8" | 100 | 125 |
| 106" | 52" x 92" | 3737 | 4092 | 115 5/8" | 105 | 125 |
| 4:3 NTSC Video Format | | | | | | |
| 6' | 42 1/2" x 56 1/2" | \$2914 | \$3191 | 79 5/8" | 75 | 125 P+ |
| 7' | 50" x 66 1/2" | 3122 | 3419 | 89 7/8" | 85 | 125 P+ |
| 100" | 60" x 80" | 3384 | 3706 | 103 3/8" | 100 | 125 |
| 10' | 72" x 96" | 3737 | 4092 | 120 5/8" | 105 | 125 |
| AV Format | | | | | | |
| 50" x 50" | | \$2731 | \$2991 | 73 3/8" | 70 | 125 P+ |
| 60" x 60" | | 2914 | 3191 | 84 3/8" | 75 | 125 P+ |
| 70" x 70" | | 3122 | 3419 | 94 5/8" | 85 | 125 |
| 84" x 84" | | 3384 | 3706 | 109 7/8" | 100 | 125 |
| 72" x 96" | | 3737 | 4092 | 120 5/8" | 105 | 125 |
| 96" x 96" | | 3849 | 4214 | 123 3/8" | 110 | 125 |

When ordering Artisan/Series V and Artisan/Series E, please specify:

Case Finish

- **Hardwood:** natural or medium cherry, natural maple, light or medium oak, walnut or mahogany
- **Plastic laminate:** white, burgundy, dove grey, beige or black
- **Custom finishes by quotation:** NO extra charge for hardwood custom color match

Case Style

- **Hardwood:** Rectilinear, radius, bevel or traditional
- **Plastic Laminate:** Rectilinear only

Freight Class Key

Number LTL freight class
P Parcel service
 + ... \$8.50 surcharge (over 60" long)

Example: a freight code of 125 P+ indicates an item that may ship as freight class 125 or via parcel service with \$8.50 surcharge.

Artisan/Series E—Identical to the Artisan/Series V except as noted below. Viewing surfaces from the OptiView family. Also available with ClearSound Perf XT950E, a perforated matt white, by quotation.

Natural Wood Finishes: The unique beauty of natural hardwood means that the color of your Artisan case may vary from printed reproductions and even from the samples Draper can provide representing our standard species, stains, and finishes. If you are seeking to match existing furnishings, please request custom stain matching and provide a physical sample for best results. Contact Draper for more information.

Standard Specs

- **Sizes and Formats:** Custom sizes by quotation. Custom sizes need to be specified in detail, including extra drop, if desired.
- **Case Dimensions:** Case size: 5 1/4" H x 5 1/4" D (Bevel style case is 6 3/8" high).
- **Black Borders:** NTSC, HDTV and 16:10 format have image area framed with black on all four sides. Black side borders are available on request for AV format screens.

Options

- **Motor/Control Options:** (Q) Quiet Motor available. See page 35 for details. 220V motor is also available at no extra cost.
- **Extra Drop:** Additional drop above image (specify color—black is standard; surface color standard for AV format for all others). Please specify case finish and case style: see bottom of page. See page 30.
- **Viewing Surface:** Also available with ClearSound Perf XT950E, a perforated matt white, by quotation See page 5.

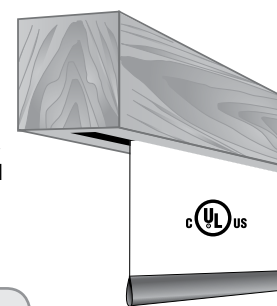

OptiView Viewing Surfaces
 Matt White XT1000E,
 Contrast Grey XH800E,
 Contrast White XH1100E,
 Argent White XH1500E,
 or Pearl White CH1900E.

| H x W / Diagonal | Image Area | Overall Size | PRICE | Case Length | Shipping Wt./lbs. | Freight Class |
|------------------------------|-------------------|-------------------|--------|-------------|-------------------|---------------|
| 16:10 Format | | | | | | |
| 94"* | 50" x 80" | 62" x 83 1/2" | \$1769 | 96" | 90 | 125 |
| 109"* | 57 1/2" x 92" | 69 1/2" x 96" | 1880 | 108" | 95 | 125 |
| 16:9 HDTV Format | | | | | | |
| 92"* | 45" x 80" | 57" x 83 1/2" | 1769 | 96" | 90 | 125 |
| 106"* | 52" x 92" | 64" x 96" | 1880 | 108" | 95 | 125 |
| 4:3 NTSC Video Format | | | | | | |
| 6' | 42 1/2" x 56 1/2" | 46 1/2" x 59 1/2" | \$1520 | 72" | 70 | 125 P+ |
| 7' | 50" x 66 1/2" | 53 1/2" x 69 1/2" | 1607 | 82" | 80 | 125 P+ |
| 100" | 60" x 80" | 64" x 83 1/2" | 1769 | 96" | 90 | 125 |
| 10' | 69" x 92" | 73" x 96" | 1880 | 108" | 95 | 125 |
| AV Format | | | | | | |
| 50" x 50" | | | \$1435 | 62" | 65 | 125 P+ |
| 60" x 60" | | | 1520 | 72" | 70 | 125 P+ |
| 70" x 70" | | | 1607 | 82" | 80 | 125 P+ |
| 84" x 84" | | | 1769 | 96" | 90 | 125 |
| 72" x 96" | | | 1880 | 108" | 95 | 125 |
| 96" x 96" | | | 1905 | 108" | 100 | 125 |

***These sizes include 12" black drop as standard—NO EXTRA CHARGE!**

Nocturne®/Series E—Designed for outdoor use on your patio, by your pool deck, or any other outdoor space. Weather and insect resistant solid aluminum headbox includes built-in hinge for easy installation and service. Ships standard with cable guides and weighted dowel. Both wall and deck mount cable guide brackets included. Choose the Nocturne®/Series C for manual crank operation. Viewing surfaces from the OptiView and ClearSound families.

Standard Specs

- **Sizes and Formats:** Custom sizes by quotation. Custom sizes need to be specified in detail, including extra drop, if desired.
- **Case Dimensions:** 4" H x 5" D. Optional built-in controls may increase case length: call Draper for dimensions.
- **Black Borders:** Image area framed with 2" black border on all four sides.

Options

- **Motor/Control Options:** 120V Motor is standard. 220V motor is also available. ***Important*** Optional switches and controls are **not** water resistant. It is the installers responsibility to ensure that any hard wired controls are placed in an appropriate weatherproof fixture or location. See page 35
- **Finish Options:** Headbox and exposed hardware standard in white. Also available in silver, ivory, charcoal bronze, or black.
- **Extra Drop:** Additional drop above image (specify color—black standard; surface color available). See page 36.
- **Viewing Surface:** Also available with ClearSound Perf XT950E, a perforated matt white, by quotation. Add the suffix SE to any Matt White XT1000E part number listed here. Other surfaces from the ClearSound family are available by quotation—Contact Draper or see page 5 for details.



| H x W / Diagonal | Image Area | OptiView Viewing Surfaces | | | Case Length | Shipping Wt./lbs. | Freight Class |
|------------------------------|-------------------|---------------------------|----------------------|--------|-------------|-------------------|---------------|
| | | Matt White XT1000E | Contrast Grey XH800E | PRICE | | | |
| 16:10 Format | | | | | | | |
| 94"* | 50" x 80" | 138019 | 138020 | \$1145 | 86 7/8" | 44 | 125 P+ |
| 102"* | 54" x 87" | 138021 | 138022 | 1192 | 94 3/8" | 47 | 125 P+ |
| 109"* | 57 1/2" x 92" | 138023 | 138024 | 1225 | 99 3/8" | 49 | 125 |
| 113"* | 60" x 96" | 138025 | 138026 | 1254 | 103 3/8" | 51 | 125 |
| 123" | 65" x 104" | 138027 | 138028 | 1335 | 111 3/8" | 73 | 125 |
| 137" | 72 1/2" x 116" | 138029 | 138030 | 1475 | 123 3/8" | 96 | 125 |
| 16:9 HDTV Format | | | | | | | |
| 65"* | 31 3/4" x 56 1/2" | 138001 | 138002 | \$1034 | 62 7/8" | 34 | 125 P+ |
| 73"* | 36" x 64" | 138003 | 138004 | 1077 | 72 7/8" | 38 | 125 P+ |
| 82"* | 40 1/2" x 70" | 138005 | 138006 | 1104 | 77 3/8" | 40 | 125 P+ |
| 92"* | 45" x 80" | 138007 | 138008 | 1139 | 86 7/8" | 44 | 125 P+ |
| 100"* | 49" x 87" | 138009 | 138010 | 1190 | 94 3/8" | 47 | 125 P+ |
| 106"* | 52" x 92" | 138011 | 138012 | 1217 | 99 3/8" | 49 | 125 |
| 110"* | 54" x 96" | 138013 | 138014 | 1250 | 103 3/8" | 81 | 125 |
| 119" | 58" x 104" | 138015 | 138016 | 1322 | 111 3/8" | 83 | 125 |
| 133" | 65" x 116" | 138017 | 138018 | 1487 | 123 3/8" | 96 | 125 |
| 4:3 NTSC Video Format | | | | | | | |
| 6' | 42" x 56 1/2" | 138031 | 138032 | \$1030 | 62 7/8" | 34 | 125 P+ |
| 7' | 50" x 66 1/2" | 138033 | 138034 | 1077 | 72 7/8" | 38 | 125 P+ |
| 100" | 60" x 80" | 138035 | 138036 | 1140 | 86 7/8" | 44 | 125 P+ |
| 10' | 69" x 92" | 138037 | 138038 | 1280 | 99 3/8" | 80 | 125 |
| 11' | 78" x 104" | 138039 | 138040 | 1355 | 111 3/8" | 83 | 125 |
| 150" | 87" x 116" | 138041 | 138042 | 1409 | 123 3/8" | 81 | 125 |

***These sizes include 12" black drop as standard—NO EXTRA CHARGE!**

Salara/HW—Elliptical extruded aluminum case with white finish installs quickly to wall brackets. Hardwired like other Draper projection screens. Can be furnished with any standard control option. Viewing surfaces from the OptiView and ClearSound families.

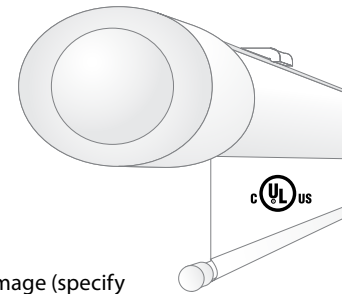

Standard Specs

- **Case Dimensions:** Case is 3 13/16" H x 5 1/16" D.
- **Black Borders:** NTSC, HDTV and 16:10 format have image area framed with black on all four sides. Black side borders are available on request for AV format screens.

Options

- **Motor/Control Options:** 120V motor is standard. 220V motor is also available. See page 35 for controls.
- **Extra Drop:** Additional drop above image (specify color—black is standard; surface color standard for AV format for all others). See page 36.
- **Viewing Surface:** Also available with ClearSound Perf XT950E, a perforated matt white, by quotation —Add the suffix SE to any Matt White XT1000E part number. See page 5.

*These sizes include 12" black drop as standard—NO EXTRA CHARGE!

| OptiView Viewing Surfaces | | | | | | | | | | | | |
|------------------------------|-------------------|-------------------|--------------------|----------------------|------------------------|----------------------|---------------------|-------|-------------|-------------------|--------------|---------------|
| H x W / Diagonal | Image Area | Overall Size | Matt White XT1000E | Contrast Grey XH800E | Contrast White XH1100E | Argent White XH1500E | Pearl White CH1900E | PRICE | Case Length | Shipping Wt./lbs. | Dim Wt./lbs. | Freight Class |
| 16:10 Format | | | | | | | | | | | | |
| 67"* | 35 1/4" x 56 1/2" | 47 1/4" x 59 1/2" | 132171 | 132176 | 132171EG | 132171EH | 132171EJ | \$667 | 67 1/8" | 31 | 40 | 125 P+ |
| 76"* | 40" x 64" | 52" x 69 1/2" | 132172 | 132177 | 132172EG | 132172EH | 132172EJ | 693 | 77 1/8" | 36 | 46 | 125 P+ |
| 85"* | 45" x 72" | 57" x 74" | 132173 | 132178 | 132173EG | 132173EH | 132173EJ | 730 | 81 3/8" | 38 | 48 | 125 P+ |
| 94"* | 50" x 80" | 62" x 83 1/2" | 132174 | 132179 | 132174EG | 132174EH | 132174EJ | 740 | 91 1/8" | 40 | 53 | 125 P+ |
| 109"* | 57 1/2" x 92" | 69 1/2" x 96" | 132175 | 132180 | 132175EG | 132175EH | 132175EJ | 782 | 103 5/8" | 46 | | 125 |
| 16:9 HDTV Format | | | | | | | | | | | | |
| 65"* | 31 3/4" x 56 1/2" | 43 3/4" x 59 1/2" | 132085 | 132091 | 132085EG | 132085EH | 132085EJ | \$667 | 67 1/8" | 31 | 40 | 125 P+ |
| 73"* | 36" x 64" | 48" x 69 1/2" | 132086 | 132092 | 132086EG | 132086EH | 132086EJ | 693 | 77 1/8" | 36 | 46 | 125 P+ |
| 82"* | 40 1/2" x 72" | 52 1/2" x 74" | 132087 | 132093 | 132087EG | 132087EH | 132087EJ | 730 | 81 3/8" | 38 | 49 | 125 P+ |
| 92"* | 45" x 80" | 57" x 83 1/2" | 132103 | 132107 | 132103EG | 132103EH | 132103EJ | 740 | 91 1/8" | 40 | 53 | 125 P+ |
| 100"* | 49" x 87" | 61" x 91" | 132211 | 132213 | 132211EG | 132211EH | 132211EJ | 760 | 98 3/8" | 46 | 57 | 125 P+ |
| 106"* | 52" x 92" | 64" x 96" | 132104 | 132108 | 132104EG | 132104EH | 132104EJ | 782 | 103 5/8" | 50 | | 125 |
| 4:3 NTSC Video Format | | | | | | | | | | | | |
| 6' | 42 1/2" x 56 1/2" | 46 1/2" x 59 1/2" | 132006 | 132032 | 132006EG | 132006EH | 132006EJ | \$660 | 67 1/8" | 31 | 40 | 125 P+ |
| 7' | 50" x 66 1/2" | 53 1/2" x 69 1/2" | 132007 | 132033 | 132007EG | 132007EH | 132007EJ | 687 | 77 1/8" | 36 | 46 | 125 P+ |
| 100" | 60" x 80" | 64" x 83 1/2" | 132008 | 132034 | 132008EG | 132008EH | 132008EJ | 740 | 91 1/8" | 42 | 55 | 125 P+ |
| 10' | 69" x 92" | 73" x 96" | 132009 | 132035 | 132009EG | 132009EH | 132009EJ | 782 | 103 5/8" | 47 | | 125 |
| AV Format | | | | | | | | | | | | |
| 50" x 50" | | | 132001 | 132027 | 132001EG | 132001EH | 132001EJ | \$633 | 57 1/8" | 28 | 35 | 125 P+ |
| 60" x 60" | | | 132002 | 132028 | 132002EG | 132002EH | 132002EJ | 642 | 67 1/8" | 32 | 40 | 125 P+ |
| 70" x 70" | | | 132003 | 132029 | 132003EG | 132003EH | 132003EJ | 660 | 77 1/8" | 37 | 46 | 125 P+ |
| 84" x 84" | | | 132004 | 132030 | 132004EG | 132004EH | 132004EJ | 740 | 91 1/8" | 43 | 53 | 125 P+ |
| 72" x 96" | | | 132079 | 132081 | 132079EG | 132079EH | 132079EJ | 765 | 103 5/8" | 47 | | 125 |
| 96" x 96" | | | 132005 | 132031 | 132005EG | 132005EH | 132005EJ | 810 | 103 5/8" | 50 | | 125 |

| ClearSound Viewing Surfaces | | | | | | | | | | |
|------------------------------|-------------------|-------------------|-------------------------------|------------------------------|--------|-------------|-------------------|--------------|---------------|--|
| H x W / Diagonal | Image Area | Overall Size | ClearSound White Weave XT900E | ClearSound Grey Weave XH600E | PRICE | Case Length | Shipping Wt./lbs. | Dim Wt./lbs. | Freight Class | |
| 16:10 Format | | | | | | | | | | |
| 67"* | 35 1/4" x 56 1/2" | 47 1/4" x 59 1/2" | 132171SA | 132171SB | \$3116 | 67 1/8" | 31 | 40 | 125 P+ | |
| 76"* | 40" x 64" | 52" x 69 1/2" | 132172SA | 132172SB | 3462 | 77 1/8" | 36 | 46 | 125 P+ | |
| 85"* | 45" x 72" | 57" x 74" | 132173SA | 132173SB | 3847 | 81 3/8" | 38 | 48 | 125 P+ | |
| 94"* | 50" x 80" | 62" x 83 1/2" | 132174SA | 132174SB | 4274 | 91 1/8" | 40 | 53 | 125 P+ | |
| 109"* | 57 1/2" x 92" | 69 1/2" x 96" | 132175SA | 132175SB | 4749 | 103 5/8" | 46 | | 125 | |
| 16:9 HDTV Format | | | | | | | | | | |
| 65"* | 31 3/4" x 56 1/2" | 43 3/4" x 59 1/2" | 132085SA | 132085SB | \$2302 | 67 1/8" | 31 | 40 | 125 P+ | |
| 73"* | 36" x 64" | 48" x 69 1/2" | 132086SA | 132086SB | 2557 | 77 1/8" | 36 | 46 | 125 P+ | |
| 82"* | 40 1/2" x 72" | 52 1/2" x 74" | 132087SA | 132087SB | 2841 | 81 3/8" | 38 | 49 | 125 P+ | |
| 92"* | 45" x 80" | 57" x 83 1/2" | 132119 | 132127 | 3157 | 91 1/8" | 40 | 53 | 125 P+ | |
| 100"* | 49" x 87" | 61" x 91" | 132217 | 132218 | 3744 | 98 3/8" | 46 | 57 | 125 P+ | |
| 106"* | 52" x 92" | 64" x 96" | 132120 | 132128 | 4331 | 103 5/8" | 50 | | 125 | |
| 4:3 NTSC Video Format | | | | | | | | | | |
| 6' | 42 1/2" x 56 1/2" | 46 1/2" x 59 1/2" | 132006SA | 132006SB | \$2794 | 67 1/8" | 31 | 40 | 125 P+ | |
| 7' | 50" x 66 1/2" | 53 1/2" x 69 1/2" | 132007SA | 132007SB | 3104 | 77 1/8" | 36 | 46 | 125 P+ | |
| 100" | 60" x 80" | 64" x 83 1/2" | 132117 | 132125 | 3449 | 91 1/8" | 42 | 55 | 125 P+ | |
| 10' | 69" x 92" | 73" x 96" | 132118 | 132126 | 5168 | 103 5/8" | 47 | | 125 | |
| AV Format | | | | | | | | | | |
| 50" x 50" | | | -- | -- | -- | 57 1/8" | 28 | 35 | 125 P+ | |
| 60" x 60" | | | -- | -- | -- | 67 1/8" | 32 | 40 | 125 P+ | |
| 70" x 70" | | | -- | -- | -- | 77 1/8" | 37 | 46 | 125 P+ | |
| 84" x 84" | | | -- | -- | -- | 91 1/8" | 43 | 53 | 125 P+ | |
| 72" x 96" | | | -- | -- | -- | 103 5/8" | 47 | | 125 | |
| 96" x 96" | | | -- | -- | -- | 103 5/8" | 50 | | 125 | |

CHART
CONTINUED
BELOW



Salara/Plug & Play™ — Identical to Salara/HW, but comes with 10' power cord that plugs right into your wall's power outlet. Also includes IR remote. Replacement IR Remote— part #121250 Conventional electric screen with motor-in-roller. **No wiring needed!**

***These sizes include 12" black drop as standard—NO EXTRA CHARGE!**

| OptiView Viewing Surfaces | | | | | | | | | | | | |
|------------------------------|-------------------|-------------------|--------------------|----------------------|------------------------|----------------------|---------------------|-------|-------------|-------------------|--------------|---------------|
| H x W / Diagonal | Image Area | Overall Size | Matt White XT1000E | Contrast Grey XH800E | Contrast White XH1100E | Argent White XH1500E | Pearl White CH1900E | PRICE | Case Length | Shipping Wt./lbs. | Dim Wt./lbs. | Freight Class |
| 16:10 Format | | | | | | | | | | | | |
| 67" | 35 1/4" x 56 1/2" | 47 1/4" x 59 1/2" | 136193 | 136198 | 136193EG | 136193EH | 136193EJ | \$940 | 67 1/8" | 31 | 40 | 125 P+ |
| 76" | 40" x 64" | 52" x 69 1/2" | 136194 | 136199 | 136194EG | 136194EH | 136194EJ | 965 | 77 1/8" | 36 | 46 | 125 P+ |
| 85" | 45" x 72" | 57" x 74" | 136195 | 136200 | 136195EG | 136195EH | 136195EJ | 1004 | 81 5/8" | 38 | 48 | 125 P+ |
| 94" | 50" x 80" | 62" x 83 1/2" | 136196 | 136201 | 136196EG | 136196EH | 136196EJ | 1022 | 91 1/8" | 44 | 53 | 125 P+ |
| 109" | 57 1/2" x 92" | 69 1/2" x 96" | 136197 | 136202 | 136197EG | 136197EH | 136197EJ | 1069 | 103 5/8" | 48 | | 125 |
| 16:9 HDTV Format | | | | | | | | | | | | |
| 65" | 31 3/4" x 56 1/2" | 43 3/4" x 59 1/2" | 136085 | 136091 | 136085EG | 136085EH | 136085EJ | \$940 | 67 1/8" | 31 | 40 | 125 P+ |
| 73" | 36" x 64" | 48" x 69 1/2" | 136086 | 136092 | 136086EG | 136086EH | 136086EJ | 965 | 77 1/8" | 36 | 46 | 125 P+ |
| 82" | 40 1/2" x 72" | 52 1/2" x 74" | 136087 | 136093 | 136087EG | 136087EH | 136087EJ | 1004 | 81 5/8" | 38 | 48 | 125 P+ |
| 92" | 45" x 80" | 57" x 83 1/2" | 136103 | 136107 | 136103EG | 136103EH | 136103EJ | 1022 | 91 1/8" | 45 | 55 | 125 P+ |
| 100" | 49" x 87" | 61" x 91" | 136236 | 136238 | 136236EG | 136236EH | 136236EJ | 1047 | 98 5/8" | 46 | 57 | 125 P+ |
| 106" | 52" x 92" | 64" x 96" | 136104 | 136108 | 136104EG | 136104EH | 136104EJ | 1069 | 103 5/8" | 48 | | 125 |
| 4:3 NTSC Video Format | | | | | | | | | | | | |
| 6' | 42 1/2" x 56 1/2" | 46 1/2" x 59 1/2" | 136006 | 136032 | 136006EG | 136006EH | 136006EJ | \$934 | 67 1/8" | 26 | 40 | 125 P+ |
| 7' | 50" x 66 1/2" | 53 1/2" x 69 1/2" | 136007 | 136033 | 136007EG | 136007EH | 136007EJ | 959 | 77 1/8" | 30 | 42 | 125 P+ |
| 100" | 60" x 80" | 64" x 83 1/2" | 136008 | 136034 | 136008EG | 136008EH | 136008EJ | 1012 | 91 1/8" | 42 | 55 | 125 P+ |
| 10' | 69" x 92" | 73" x 96" | 136009 | 136035 | 136009EG | 136009EH | 136009EJ | 1055 | 103 5/8" | 47 | | 125 |
| AV Format | | | | | | | | | | | | |
| 50" x 50" | | | 136001 | 136027 | 136001EG | 136001EH | 136001EJ | \$897 | 57 1/8" | 28 | 35 | 125 P+ |
| 60" x 60" | | | 136002 | 136028 | 136002EG | 136002EH | 136002EJ | 905 | 67 1/8" | 32 | 40 | 125 P+ |
| 70" x 70" | | | 136003 | 136029 | 136003EG | 136003EH | 136003EJ | 925 | 77 1/8" | 34 | 46 | 125 P+ |
| 84" x 84" | | | 136004 | 136030 | 136004EG | 136004EH | 136004EJ | 1004 | 91 1/8" | 40 | 53 | 125 P+ |
| 72" x 96" | | | 136079 | 136081 | 136079EG | 136079EH | 136079EJ | 1012 | 103 5/8" | 46 | | 125 |
| 96" x 96" | | | 136005 | 136031 | 136005EG | 136005EH | 136005EJ | 1082 | 103 5/8" | 50 | | 125 |

| ClearSound Viewing Surfaces | | | | | | | | | | |
|------------------------------|-------------------|-------------------|-------------------------------|------------------------------|--------|-------------|-------------------|--------------|---------------|--|
| H x W / Diagonal | Image Area | Overall Size | ClearSound White Weave XT900E | ClearSound Grey Weave XH600E | PRICE | Case Length | Shipping Wt./lbs. | Dim Wt./lbs. | Freight Class | |
| 16:10 Format | | | | | | | | | | |
| 67" | 35 1/4" x 56 1/2" | 47 1/4" x 59 1/2" | 136193SA | 136193SB | \$3296 | 67 1/8" | 31 | 40 | 125 P+ | |
| 76" | 40" x 64" | 52" x 69 1/2" | 136194SA | 136194SB | 3662 | 77 1/8" | 36 | 46 | 125 P+ | |
| 85" | 45" x 72" | 57" x 74" | 136195SA | 136195SB | 4069 | 81 5/8" | 38 | 48 | 125 P+ | |
| 94" | 50" x 80" | 62" x 83 1/2" | 136196SA | 136196SB | 4521 | 91 1/8" | 44 | 53 | 125 P+ | |
| 109" | 57 1/2" x 92" | 69 1/2" x 96" | 136197SA | 136197SB | 5023 | 103 5/8" | 48 | | 125 | |
| 16:9 HDTV Format | | | | | | | | | | |
| 65" | 31 3/4" x 56 1/2" | 43 3/4" x 59 1/2" | 136085SA | 136085SB | \$2499 | 67 1/8" | 31 | 40 | 125 P+ | |
| 73" | 36" x 64" | 48" x 69 1/2" | 136086SA | 136086SB | 2777 | 77 1/8" | 36 | 46 | 125 P+ | |
| 82" | 40 1/2" x 72" | 52 1/2" x 74" | 136087SA | 136087SB | 3086 | 81 5/8" | 38 | 48 | 125 P+ | |
| 92" | 45" x 80" | 57" x 83 1/2" | 136119 | 136127 | 3429 | 91 1/8" | 45 | 55 | 125 P+ | |
| 100" | 49" x 87" | 61" x 91" | 136242 | 136243 | 4016 | 98 5/8" | 46 | 57 | 125 P+ | |
| 106" | 52" x 92" | 64" x 96" | 136120 | 136128 | 4603 | 103 5/8" | 48 | | 125 | |
| 4:3 NTSC Video Format | | | | | | | | | | |
| 6' | 42 1/2" x 56 1/2" | 46 1/2" x 59 1/2" | 136006SA | 136006SB | \$3014 | 67 1/8" | 26 | 40 | 125 P+ | |
| 7' | 50" x 66 1/2" | 53 1/2" x 69 1/2" | 136007SA | 136007SB | 3349 | 77 1/8" | 30 | 42 | 125 P+ | |
| 100" | 60" x 80" | 64" x 83 1/2" | 136117 | 136125 | 3721 | 91 1/8" | 42 | 55 | 125 P+ | |
| 10' | 69" x 92" | 73" x 96" | 136118 | 136126 | 5441 | 103 5/8" | 47 | | 125 | |
| AV Format | | | | | | | | | | |
| 50" x 50" | | | -- | -- | -- | 57 1/8" | 28 | 35 | 125 P+ | |
| 60" x 60" | | | -- | -- | -- | 67 1/8" | 32 | 40 | 125 P+ | |
| 70" x 70" | | | -- | -- | -- | 77 1/8" | 34 | 46 | 125 P+ | |
| 84" x 84" | | | -- | -- | -- | 91 1/8" | 40 | 53 | 125 P+ | |
| 72" x 96" | | | -- | -- | -- | 103 5/8" | 46 | | 125 | |
| 96" x 96" | | | -- | -- | -- | 103 5/8" | 50 | | 125 | |

CHART CONTINUED BELOW

Freight Class Key
 Number LTL freight class
 P Parcel service
 + . . . \$8.50 surcharge (over 60" long)
Example: a freight code of 125 P+ indicates an item that may ship as freight class 125 or via parcel service with \$8.50 surcharge.

Baronet—Popular, low-cost motorized screen with scratch-resistant white polyester finish and universal mounting brackets. Motor-in-roller design provides quiet, trouble-free operation. Comes with 10' power cord with inline switch—no wiring necessary. Viewing surfaces from the OptiView family.

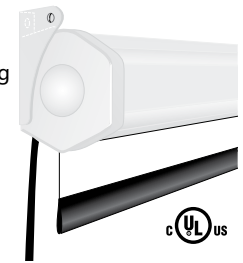

Standard Specs

- **Case Dimensions:** Case is 3 3/4" H x 3 1/4" D.
- **Black Borders:** NTSC, HDTV and 16:10 format have image area framed with black on all four sides. Black side borders are available on request for AV format screens.

Options

- **Viewing Surface:** Also available with ClearSound Perf XT950E, a perforated matt white, by quotation —Add the suffix SE to any Matt White XT1000E part number. See page 5.
- **Motor:** Hard wired and 220V versions are also available.

*These sizes include 12" black drop as standard—NO EXTRA CHARGE!

| H x W / Diagonal | Image Area | Overall Size | OptiView Surfaces | | | | | PRICE | Case Length | Shipping Wt./lbs. | Freight Class |
|------------------------------|-------------------|-------------------|--------------------|----------------------|------------------------|----------------------|---------------------|-------|-------------|-------------------|---------------|
| | | | Matt White XT1000E | Contrast Grey XH800E | Contrast White XH1100E | Argent White XH1500E | Pearl White CH1900E | | | | |
| 16:10 Format | | | | | | | | | | | |
| 67"* | 35 1/4" x 56 1/2" | 47 1/4" x 59 1/2" | 129141 | 129146 | 129141EG | 129141EH | 129141EJ | \$513 | 65 1/4" | 24 | 125 P+ |
| 76"* | 40" x 64" | 52" x 69 1/2" | 129142 | 129147 | 129142EG | 129142EH | 129142EJ | 547 | 75 1/4" | 26 | 125 P+ |
| 85"* | 45" x 72" | 57" x 74" | 129143 | 129148 | 129143EG | 129143EH | 129143EJ | 555 | 79 3/4" | 30 | 125 P+ |
| 94"* | 50" x 80" | 62" x 83 1/2" | 129144 | 129149 | 129144EG | 129144EH | 129144EJ | 563 | 89 1/4" | 35 | 125 P+ |
| 109"* | 57 1/2" x 92" | 69 1/2" x 96" | 129145 | 129150 | 129145EG | 129145EH | 129145EJ | 768 | 101 3/4" | 37 | 125 P+ |
| 16:9 HDTV Format | | | | | | | | | | | |
| 65"* | 31 3/4" x 56 1/2" | 43 3/4" x 59 1/2" | 129106 | 129112 | 129106EG | 129106EH | 129106EJ | \$513 | 65 1/4" | 24 | 125 P+ |
| 73"* | 36" x 64" | 48" x 69 1/2" | 129107 | 129113 | 129107EG | 129107EH | 129107EJ | 547 | 75 1/4" | 26 | 125 P+ |
| 82"* | 40 1/2" x 72" | 52 1/2" x 74" | 129108 | 129114 | 129108EG | 129108EH | 129108EJ | 555 | 79 3/4" | 30 | 125 P+ |
| 92"* | 45" x 80" | 57" x 83 1/2" | 129124 | 129128 | 129124EG | 129124EH | 129124EJ | 563 | 89 1/4" | 35 | 125 P+ |
| 106"* | 52" x 92" | 64" x 96" | 129125 | 129129 | 129125EG | 129125EH | 129125EJ | 768 | 101 3/4" | 37 | 125 P+ |
| 4:3 NTSC Video Format | | | | | | | | | | | |
| 6' | 42 1/2" x 56 1/2" | 46 1/2" x 59 1/2" | 129006 | 129071 | 129006EG | 129006EH | 129006EJ | \$513 | 65 1/4" | 24 | 125 P+ |
| 7' | 50" x 66 1/2" | 53 1/2" x 69 1/2" | 129007 | 129072 | 129007EG | 129007EH | 129007EJ | 547 | 75 1/4" | 26 | 125 P+ |
| 100" | 60" x 80" | 64" x 83 1/2" | 129008 | 129073 | 129008EG | 129008EH | 129008EJ | 563 | 89 1/4" | 35 | 125 P+ |
| 10' | 69" x 92" | 73" x 96" | 129009 | 129074 | 129009EG | 129009EH | 129009EJ | 768 | 101 3/4" | 37 | 125 P+ |
| AV Format | | | | | | | | | | | |
| 50" x 50" | | | 129001 | 129066 | 129001EG | 129001EH | 129001EJ | \$495 | 55 1/4" | 20 | 125 P+ |
| 60" x 60" | | | 129002 | 129067 | 129002EG | 129002EH | 129002EJ | 513 | 65 1/4" | 24 | 125 P+ |
| 70" x 70" | | | 129003 | 129068 | 129003EG | 129003EH | 129003EJ | 547 | 75 1/4" | 26 | 125 P+ |
| 84" x 84" | | | 129004 | 129069 | 129004EG | 129004EH | 129004EJ | 598 | 89 1/4" | 35 | 125 P+ |
| 72" x 96" | | | 129103 | 129105 | 129103EG | 129103EH | 129103EJ | 768 | 101 3/4" | 36 | 125 P+ |
| 96" x 96" | | | 129005 | 129070 | 129005EG | 129005EH | 129005EJ | 812 | 101 3/4" | 37 | 125 P+ |

Accessories for Baronet

| Finish | Part No. | PRICE | Shipping Wt./lbs. | Freight Class |
|--|----------|---------|-------------------|---------------|
| 6" Non-Adjustable Wall Brackets (pr.) | | | | |
| White | 227212 | \$20.00 | 2 | 50 P |
| Black | 227213 | 20.00 | 2 | 50 P |

Patriot—**Motorized American Flag.** The Patriot displays an American flag either vertically or horizontally. Standard product includes a sewn, nylon American flag. Options include state flags or school banners, provided by customer (call for quotation). The flag rolls up into the case for storage, and rolls down for presentation at the touch of a button.

Choose Vertical or Horizontal display. Custom sizes available. Contact Draper or visit: www.draperinc.com/go/Patriot.htm for more details.

| Description | Part No. | PRICE | Case Length | Shipping Wt./Lbs. | Freight Class |
|--------------------------------|----------|-------|-------------|-------------------|---------------|
| 18' x 12' - Vertical Display | 500101 | 3502 | 14'10" | 240 | 240 |
| 12' x 18' - Horizontal Display | 500102 | 4016 | 20'10" | 356 | 125 |



Vertical Display shown

Accessories for Motorized Screens & Quiet Motors & Built-in Control Options—

The newest version of our screen controls, offer an all inclusive option at no additional cost to you. With the ability to build the control in to many of our motorized screens, we have you covered for all wall and ceiling installations. The LVC-IV includes the RF receiver, RS232 capabilities, dry contact relays, and a VIC trigger for 3V-28V.

Draper projection screens with 110–120V motors are furnished with one control switch (SS-1R). Optional motors shown below can be provided for the additional cost shown. Please specify at time of order by using part number suffix shown below.

Motor Options—

Size limitations are listed in charts below.

| | Part No. Suffix | PRICE |
|---|-----------------|-------|
| Quiet Motor: Reduces motor noise by approximately 30%. | Q | \$167 |
| Low Voltage Control (LVC-IV) built in with Standard Motor: Eliminates the need for additional external wiring. Adds 2" to the case length of Premier screens. Adds 1 1/2" to the case length of Targa screens. LVC-S Included. | U | 250 |
| Low Voltage Control (LVC-IV) built in with Quiet Motor: Building the new LVC-IV into the screen case combined with a quiet motor gives the benefit of having a larger screen with a quiet/low voltage control configuration. LVC-S Included. | QU | 417 |

To order a screen with one of these optional motors instead of standard motor, add the part number suffix (above) after the screen part number (or description when ordering an Artisan). Example: Access/Series E – 10' diagonal NTSC format, Matt White XT1000E with optional Quiet Motor: Part number 139019Q.

Optional quiet motors and/or built-in low voltage controls are now available on these Draper motorized projection screen models:

Special Motor Availability and Size Limitations

| Screen Model | Quiet Motor (Q) | Built-In LVC-IV (U) | Quiet Motor with Built-In LVC-IV (QU) |
|-----------------------------------|-----------------|---------------------|---------------------------------------|
| Access FIT/Series E and V | See Chart | All Sizes | See Chart |
| Access/Series E and V | See Chart | All Sizes | See Chart |
| Access XL/Series E and V | N/A | All Sizes | N/A |
| Ultimate Access/Series E and V | All Sizes | All Sizes | All Sizes |
| Ultimate Access XL/Series E and V | N/A | All Sizes | N/A |
| Artisan/Series E and V | See Chart | N/A | N/A |
| Silhouette/Series E and V | See Chart | All Sizes | See Chart |
| Premier | See Chart | All Sizes | See Chart |
| Targa | See Chart | All Sizes | See Chart |
| Envoy | See Chart | All Sizes | See Chart |

Quiet Motor Size Limitations (Q, and QU)

| | AV | NTSC | HDTV | 16:10 |
|---|-------------|-------------|-------------|--------------|
| Tab Tensioned Screens | 108" x 144" | 180" | 161" | 165" |
| Non-Tab Tensioned with OptiView Surfaces | 144" x 144" | 200" | 184" | 189" |
| Quiet Motor (Q) Size Limitations for Envoy | AV | NTSC | HDTV | 16:10 |
| Envoy with OptiView viewing surfaces | 108" x 144" | 180" | 161" | 165" |

Optional Controls for Motorized Screens

| | MODEL NAMES | Part No. | PRICE |
|---|--------------------|----------|-------|
| 110-120V Controls | | | |
| Replacement single station wall switch (Black/Silver) | SS-1R (Standard) | 121001 | \$60 |
| Replacement single station wall switch (White decorator style) | SS-1R (White) | 121102 | 60 |
| 2-station control | MS-3R & MS-4R | 121002 | 120 |
| Additional control stations | MS-4R | 121005 | 60 |
| *Low Voltage Control (24v) | | | |
| L.V. control module, no switches | LVC-IV | 121222 | 213 |
| Single station, L.V. control combo | LVC-IV & LVC-S | 121223 | 257 |
| 2-station L.V. control combo | LVC-IV & 2 LVC-S | 121224 | 298 |
| Additional L.V. control stations | LVC-S | 121225 | 60 |
| LVC-S with locking cover plate | | 121232 | 128 |
| RF Wireless Transmitter | WRT | 121226 | 68 |
| *Infrared Remote Transmitter/Receiver | | | |
| Extra IR remote transmitter | IRT | 121227 | 85 |
| | IRT | 121228 | 68 |
| L.V. control with RF Wireless Transmitter | LVC-IV/WRT Kit | 121233 | 298 |
| L.V. control with IR Remote Transmitter | LVC-IV/IRT Kit | 121234 | 298 |
| Note—You must have low voltage control module (LVC-IV) to use RF or IR wireless control. Wireless receiver plugs into LVC-IV | | | |
| Key Operated Switches | | | |
| Power supply switch (on-off) | KS-1 | 121017 | \$85 |
| Power supply and single station switch combo | KS-1/SS-1R | 121032 | 145 |
| 3-position (up-off-down) key control switch (maintained) | KS-3 | 121018 | 95 |
| 3-position (up-off-down) key control switch (momentary) | SP-KSM | 121022 | 95 |
| Switch with locking cover plate | SP-KPS-I | 121019 | 113 |
| Replacement Motors | | | |
| Baronet, Targa, Premier, Envoy, Artisan/Series E and V, Access/Series E and V, Signature, Salara, Silhouette | | | \$332 |
| Rolleramic (through 12' x 12'), Ambassador | | | 643 |
| Rolleramic (over 12' x 12') | | | 1845 |
| Paragon | | | 680 |
| Replacement motors for other models available by request | | | |
| 220V, 50HZ Motors | | | |
| 220V Standard and Quiet Motors available by request. | | | |
| Networking Communication | | | |
| Ethernet to Serial Bridge | LS100 | C103.062 | \$257 |
| Network Serial Communication Kit | LVC-IV & LS100 Kit | 121243 | 470 |

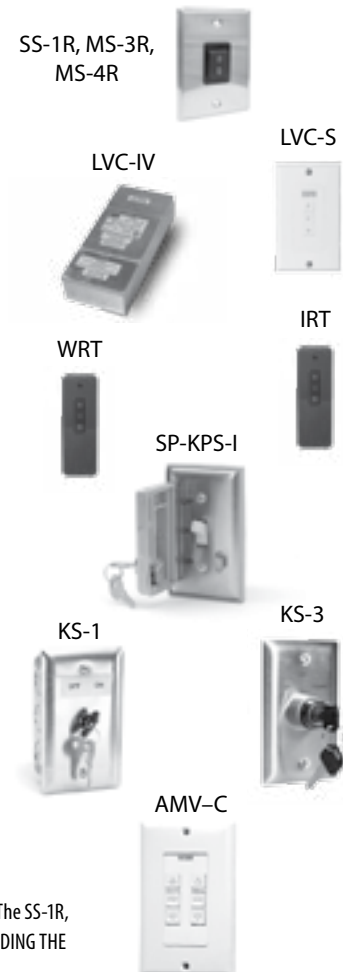

PLEASE NOTE—Most electric screens (except Access MultiView, Salara/Plug & Play and Baronet) are furnished with one 110-120v control switch (SS-1R). The SS-1R, and many optional controls, are packaged separately but shipped inside the same carton as the screen. BE SURE TO REMOVE THE CONTROLS BEFORE DISCARDING THE SHIPPING CARTON! When shipped separately, one item ships parcel service.

Accessories for Motorized Screens

| Extra Drop (Per Square Foot)—Extra Drop may increase case length for Tab Tensioned projection screens. | | PRICE |
|---|--|-------|
| OptiView Viewing Surfaces: Matt White XT1000E, Contrast Grey XH800E, Contrast White XH1100E, Argent White XH1500E, and Pearl White CH1900E. | | \$4 |
| OptiFlex Viewing Surfaces: Matt White XT1000V, Pure White XT1300V, Pearl White MH1500V, Grey XH600V, ReAct MS1000V | | 4 |
| CineFlex Viewing Surfaces: CineFlex CH1200V, CineFlex MH800V, and CineFlex White XT600V available by quotation. | | — |
| ClearSound Viewing Surfaces: ClearSound White Weave XT900E, ClearSound Grey Weave XH600E, ClearSound NanoPerf XT800V, ClearSound Perf XT900V, and ClearSound Perf XT950E available by quotation. | | — |

| Non-Adjustable Wall Brackets | For use with: | Part No. (White Finish) | Part No. (Black Finish) | PRICE (pair) | Shipping Wt./lbs. | Freight Class |
|------------------------------|---------------------------|-------------------------|-------------------------|--------------|-------------------|---------------|
| 6" Extension | Targa, Baronet, & Premier | 227212 | 227213 | \$20 | 2 | 50 P |
| 6" Extension | Silhouette | 227225 | 227227 | 20 | 2 | 50 P |
| 10"/14" Extension | Silhouette | 227226 | 227228 | 30 | 4 | 50 P |
| 10"/14" Extension | Premier, Targa | 227214 | 227215 | 30 | 4 | 50 P |

| Floating Screen Brackets | For use with: | Part No. (White Finish) | Part No. (Black Finish) | PRICE (pair) | Shipping Wt./lbs. | Freight Class |
|------------------------------------|-----------------|-------------------------|-------------------------|--------------|-------------------|---------------|
| For floating wall/ceiling mounting | Targa & Premier | 227025 | 227024 | \$85 | 8 | 50 P |

Note: for alternate installation of Access, Access FIT, Access XL, Ultimate Access, Ultimate Access XL, and Access MultiView Series screens, additional set of brackets is required. See below for pricing.

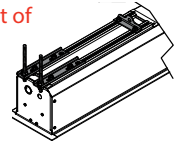

| Case | Part |
|--------------------|----------|
| Access Fit | C502.233 |
| Access | C502.240 |
| Access MultiView | C502.082 |
| Access XL | C502.281 |
| Ultimate Access | C502.279 |
| Ultimate Access XL | C502.280 |
| PRICE | |
| \$17 | |

Optional Motors (ILT)—Draper projection screens with 110–120V motors are furnished with one control switch (SS-1R). Optional motors shown below can be provided for the additional cost shown. Please specify at time of order by using part number suffix shown below.



Motor Options—These motors offer all the features of the motors on page 35, and the limits may be set from special wall switch provided.

| | Part No. Suffix | PRICE |
|--|-----------------|-------|
| Motor with built-in Low Voltage Controller: Eliminates the need for an external low voltage control module. Price includes wall switch to operate screen and set limit switches, plus 25' cable. | L | \$250 |
| Quiet Motor with built-in Low Voltage Controller: Combines the benefits of quiet operation and low voltage control and eliminates the need for an external low voltage control module. Price includes wall switch to operate screen and set limit switches, plus 25' cable. | QL | 417 |
| Plug & Play Motor with built-in Low Voltage Controller: Features a 10' power cord that plugs into a standard 110V wall outlet. Built-in Low Voltage Controller eliminates the need for an external low voltage control module. Price includes wall switch to operate screen and set limit switches. | LP | 267 |
| Quiet Plug & Play Motor with built-in Low Voltage Controller: Adds the convenience of a Plug & Play motor to Draper's Quiet Motor with built-in Low Voltage Controller. Features a 10' power cord that plugs into a standard 110V wall outlet. Price includes wall switch to operate screen and set limit switches. | QLP | 433 |

To order a screen with one of these optional motors instead of the standard motor, add the part number suffix above after the screen part number (or description in the case of an Artisan). Example: Access FIT/Series E – 10' diagonal NTSC format, Matt White XT1000E with optional Quiet Motor with Built-In Low Voltage Controller: Part number 139019QL.

Optional quiet motors and/or built-in low voltage controls are now available on these Draper motorized projection screen models:

Special Motor Availability and Limitations

| Screen Model | Motor with Built-In Low Voltage Control (L) | Quiet Motor with Built-In Low Voltage Control (QL) | Plug & Play Motor with built-in Low Voltage Controller (LP) | Quiet Plug & Play Motor with built-in Low Voltage Controller (QLP) |
|-----------------------------------|---|--|---|--|
| Access FIT/Series E and V | All Sizes | See Chart | N/A | N/A |
| Access/Series E and V | All Sizes | See Chart | N/A | N/A |
| Access XL/Series E and V | All Sizes | N/A | N/A | N/A |
| Ultimate Access/Series E and V | N/A | N/A | N/A | N/A |
| Ultimate Access XL/Series E and V | N/A | N/A | N/A | N/A |
| Silhouette/Series E and V | All Sizes | See Chart | All Sizes | See Chart |
| Premier | All Sizes | See Chart | All Sizes | See Chart |
| Targa | All Sizes | See Chart | All Sizes | See Chart |
| Envoy | All Sizes | See Chart | N/A | N/A |

Size Limitations for Motors with Built-in Low Voltage Controller (L, LP, QL, and QLP)

| | AV | NTSC | HDTV | 16:10 |
|---|-------------|-------------|-------------|--------------|
| Tab Tensioned Screens | 96" x 96" | 11" | 119" | 123" |
| Non-Tab Tensioned w/OptiView surfaces | 108" x 144" | 180" | 184" | 165" |
| Quiet Motor (QL) Size Limits for Envoy | AV | NTSC | HDTV | 16:10 |
| Envoy w/OptiView viewing surfaces | 108" x 108" | 150" | 133" | 123" |

Optional Controls for Motors (ILT) with Built-in Low Voltage Controller (L, LP, QL, and QLP)

Control options for motors with built-in low voltage controller. These controls are not compatible with LVC-IV. See page 35 for external LVC-IV and its control options.

| | Part No. | PRICE |
|---|----------|-------|
| Additional or Replacement Single Station Low Voltage Wall Switch with cover plate and 25' cable | 121171 | \$57 |
| RF Type Wireless Transmitter/Receiver | 121167 | 253 |
| Extra RF Type Wireless Transmitter | 121168 | 153 |
| Infrared Wireless Transmitter Receiver | 121169 | 130 |
| Extra Infrared Transmitter | 121170 | 98 |
| Optional 3 Button Single Station Low Voltage Wall Switch with locking cover plate and 25' cable | 121185 | 147 |
| Optional 3 Position Single Station Low Voltage ILT Key Operated Wall Switch (Momentary) and 25' cable | 121179 | 147 |
| Replacement 4 jack splitter | C156.096 | 50 |

Manually Operated Screens

All Draper manually operated screens are carefully assembled and fully tested before packaging to make sure they operate perfectly. A significant benefit of Draper's spring-roller screens is that the opening in the case through which the fabric passes is wider than that of our competitors' screens. This significantly reduces friction between the viewing surface and the lips of the case—the greatest single source of spring-roller screen failure.

Wall/Ceiling Screens

Premier/Series C—This screen offers a perfectly flat viewing surface, thanks to Draper's Tab-Tensioning System, but is raised and lowered by using a detachable crank instead of a motor. Intended for data-graphics and video applications where a motorized screen cannot be used. Pentagonal shaped black steel case. Sizes through 12' wide. Advantages of Tab-Tensioning System on page 8.

Salara/Series M—Elliptical extruded aluminum case with domed endcaps and white finish. Floating gunlatch wall brackets grip the screen securely and are barely visible. Sizes through 96" wide. **Also available with AutoReturn.**

Silhouette/Series C—The functional equivalent of the Premier/Series C, housed in a strikingly contemporary white extruded aluminum case. Sizes through 96" wide. Advantages of Tab-Tensioning System on page 8.

Silhouette/Series M—Spring-roller operated screen in gently radiused aluminum case with matching die cast aluminum endcaps. White (standard). No exposed fasteners. Sizes through 96" wide. The shape of the future. **Also available with AutoReturn.**

Access and Access FIT/Series M—Spring-roller operated screen with folded steel case for recessed ceiling installation. Flanges around all four sides support acoustical ceiling tile, or serve to trim the opening of any type of ceiling. Case may be installed during "dirty" phase of construction and latching brackets enable installation of screen into case any time thereafter. Sizes through 12' wide. **Also available with AutoReturn.**

Artisan/Series M—The most attractive spring-roller operated screen money can buy. The Artisan/Series M is housed in your choice of a solid, hand-rubbed hardwood case, or a plastic laminate case in your choice of colors and finishes. Hardwood case styles include rectilinear, radius, bevel and traditional. The Artisan/Series M will complement any room decor. Sizes through 96" wide.

Luma 2—Our largest, most rugged spring-roller operated screen, the Luma 2 is housed in a white pentagonal-shaped steel case. All cases are formed of one continuous piece of steel without splices or welds. Sizes through 12' wide. A variation of the Luma 2, the Luma 2/R is intended to mount upside down in a custom floor stand, forming a portable roller-operated screen in sizes up to and including 12' wide. **Also available with AutoReturn.**

Luma—Our most popular spring-roller operated screen. The Luma features a white pentagonal-shaped steel case and is offered in sizes up to and including 96" wide. This attractive screen enjoys strong sales in the commercial and educational markets. **Also available with AutoReturn.**

Star—Housed in a white cylindrical steel case, the Star is our budget classroom wall screen. It is offered in sizes through 84" wide.

Evenroll—Rope and pulley screen utilizes nylon marine pulleys and flanged spools for smooth operation with no mistracking cords. Sizes through 30' wide.

Outdoor Screens

Nocturne®/Series C—Crank operated, designed for outdoor use on your patio, by your pool deck, or any other outdoor space. Weather and insect resistant solid aluminum headbox includes built-in hinge for easy installation and service. Ships standard with cable guides and weighted dowel. Both wall and deck mount cable guide brackets included. Sizes through 116" wide.



AutoReturn Roller for Draper Manual Projection Screens—Draper is pleased to offer the AutoReturn feature for our unparalleled line of manual projection screens. In a manual projection screen with AutoReturn, the roller mechanism gently raises the screen surface back into the case with a simple tug on the handle/pull cord.

Watch for the above logo in the following pages identifying screens that offer AutoReturn.

Access/Series M Family—Access FIT features a low-profile case to fit in smaller spaces. New hinged door cover makes installation and service easier. Access/M is spring-roller operated screen with white folded steel case, for ceiling-recessed installation. Also available with AutoReturn. Sizes above 70" in height include pull cord.

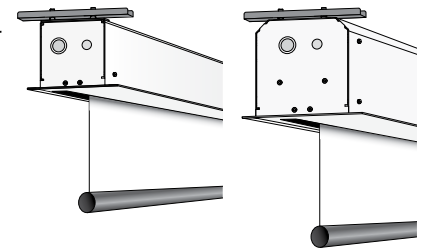

Standard Specs

- **Sizes and Formats:** Custom sizes by quotation. Custom sizes need to be specified in detail, including extra drop, if desired.
- **Case Dimensions:** All case dimensions below include ceiling flange and mounting brackets. Extra drop may increase case length: call for dimensions.
- **Black Borders:** NTSC, HDTV and 16:10 format have image area framed with black on all four sides. Black side borders are available on request for AV format screens.

Options

- **Case Options:** For more information on how to order case in advance of screen, see page 39. All ceiling recessed cases can be painted black upon request.
- **Extra Drop:** Additional drop above image area (specify color—surface color standard for AV format; black standard for all others). See page 36
- **Operating pole:** Aluminum operating pole is a popular option. See page 49

Access FIT/Series M: Case dimensions 7 3/4" wide x 5 1/16" high including flange and mounting brackets

Note: for alternate installation of Access screens, additional set of brackets is required. Part No. C502.233.

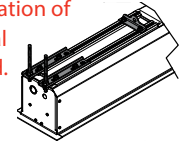

| | | OptiView Surfaces | | | | | | | | | | | | |
|------------------------------|-------------------|-------------------|--------------------|-------|----------------------|------------------------|----------------------|---------------------|-------|-------------|-------------------|--------------|---------------|--|
| H x W / Diagonal | Image Area | Overall Size | Matt White XT1000E | PRICE | Contrast Grey XH800E | Contrast White XH1100E | Argent White XH1500E | Pearl White CH1900E | PRICE | Case Length | Shipping Wt./lbs. | Dim Wt./lbs. | Freight Class | |
| 16:10 Format | | | | | | | | | | | | | | |
| 94" | 50" x 80" | 62" x 83 1/2" | 197027 | \$820 | 197027EC | 197027EG | 197027EH | 197027EJ | \$857 | 92" | 58 | 75 | 85 P+ | |
| 109" | 57 1/2" x 92" | 69 1/2" x 96" | 197028 | 879 | 197028EC | 197028EG | 197028EH | 197028EJ | 917 | 102" | 67 | 80 | 125 P+ | |
| 113" | 60" x 96" | 72" x 100" | 197029 | 925 | 197029EC | 197029EG | 197029EH | -- | 969 | 107" | 68 | 85 | 125 | |
| 123" | 65" x 104" | 69" x 108" | 197030 | 1027 | 197030EC | 197030EG | 197030EH | -- | 1087 | 114" | 77 | 85 | 125 | |
| 137" | 72 1/2" x 116" | 76 1/2" x 120" | 197031 | 1149 | 197031EC | 197031EG | 197031EH | -- | 1214 | 126" | 87 | 125 | 125 | |
| 16:9 HDTV Format | | | | | | | | | | | | | | |
| 92" | 45" x 80" | 57" x 83 1/2" | 197020 | \$820 | 197020EC | 197020EG | 197020EH | 197020EJ | \$857 | 92" | 58 | 80 | 125 P+ | |
| 106" | 52" x 92" | 64" x 96" | 197022 | 879 | 197022EC | 197022EG | 197022EH | 197022EJ | 917 | 102" | 67 | 75 | 85 P+ | |
| 110" | 54" x 96" | 66" x 100" | 197023 | 925 | 197023EC | 197023EG | 197023EH | -- | 969 | 107" | 68 | 85 | 125 | |
| 119" | 58" x 104" | 62" x 108" | 197024 | 1027 | 197024EC | 197024EG | 197024EH | -- | 1087 | 114" | 77 | 125 | 125 | |
| 133" | 65" x 116" | 69" x 120" | 197025 | 1149 | 197025EC | 197025EG | 197025EH | -- | 1214 | 126" | 78 | 125 | 125 | |
| 4:3 NTSC Video Format | | | | | | | | | | | | | | |
| 6" | 42 1/2" x 56 1/2" | 46 1/2" x 59 1/2" | 197013 | \$762 | 197013EC | 197013EG | 197013EH | 197013EJ | \$790 | 66" | 40 | 60 | 125 P+ | |
| 7" | 50" x 66 1/2" | 53 1/2" x 69 1/2" | 197014 | 800 | 197014EC | 197014EG | 197014EH | 197014EJ | 830 | 76" | 50 | 67 | 125 P+ | |
| 100" | 60" x 80" | 64" x 83 1/2" | 197015 | 847 | 197015EC | 197015EG | 197015EH | 197015EJ | 882 | 92" | 59 | 75 | 125 P+ | |
| 10" | 69" x 92" | 73" x 96" | 197016 | 912 | 197016EC | 197016EG | 197016EH | 197016EJ | 952 | 102" | 68 | 80 | 125 P+ | |
| 11" | 78" x 104" | 83" x 108" | 197017 | 1149 | 197017EC | 197017EG | 197017EH | -- | 1210 | 114" | 78 | 125 | 125 | |
| 150" | 87" x 116" | 92" x 120" | 197018 | 1197 | 197018EC | 197018EG | 197018EH | -- | 1259 | 126" | 89 | 125 | 125 | |
| AV Format | | | | | | | | | | | | | | |
| 50" x 50" | | | 197001 | \$753 | 197001EC | 197001EG | 197001EH | 197001EJ | \$773 | 56" | 39 | 52 | 125 P+ | |
| 60" x 60" | | | 197002 | 762 | 197002EC | 197002EG | 197002EH | 197002EJ | 790 | 66" | 45 | 60 | 125 P+ | |
| 70" x 70" | | | 197003 | 800 | 197003EC | 197003EG | 197003EH | 197003EJ | 830 | 76" | 52 | 67 | 125 P+ | |
| 84" x 84" | | | 197004 | 847 | 197004EC | 197004EG | 197004EH | 197004EJ | 882 | 92" | 61 | 70 | 125 P+ | |
| 72" x 96" | | | 197005 | 912 | 197005EC | 197005EG | 197005EH | 197005EJ | 952 | 102" | 67 | 75 | 125 P+ | |
| 96" x 96" | | | 197006 | 942 | 197006EC | 197006EG | 197006EH | 197006EJ | 979 | 102" | 70 | 80 | 125 P+ | |
| 7" x 9" | | | 197007 | 1084 | 197007EC | 197007EG | 197007EH | -- | 1145 | 114" | 77 | 125 | 125 | |
| 9" x 9" | | | 197008 | 1120 | 197008EC | -- | -- | -- | 1182 | 114" | 82 | 125 | 125 | |
| 8" x 10" | | | 197009 | 1197 | 197009EC | 197009EG | 197009EH | -- | 1259 | 126" | 88 | 125 | 125 | |
| 10" x 10" | | | 197010 | 1279 | 197010EC | -- | -- | -- | 1342 | 126" | 93 | 125 | 125 | |

*These sizes include 12" black drop as standard—NO EXTRA CHARGE!

Access/Series M: Case dimensions 8 1/16" wide x 7 3/8" high including flange and mounting brackets

Note: for alternate installation of Access screens, additional set of brackets is required. Part No. C502.240.

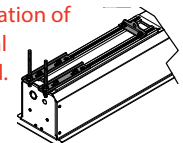

| | | OptiView Surfaces | | | | | | | | | |
|------------------------------|----------------|-------------------|--------------------|--------|----------------------|--------|-------------|-------------------|--------------|---------------|--|
| H x W / Diagonal | Image Area | Overall Size | Matt White XT1000E | PRICE | Contrast Grey XH800E | PRICE | Case Length | Shipping Wt./lbs. | Dim Wt./lbs. | Freight Class | |
| 16:10 Format | | | | | | | | | | | |
| 165" | 87 1/2" x 140" | 92 1/2" x 144" | 197032 | \$1274 | 197032EC | \$1342 | 150" | 106 | 85 | 85 | |
| 16:9 HDTV Format | | | | | | | | | | | |
| 161" | 79" x 140" | 84" x 144" | 197026 | \$1274 | 197026EC | \$1342 | 150" | 106 | 85 | 85 | |
| 4:3 NTSC Video Format | | | | | | | | | | | |
| 15" | 105" x 140" | 109" x 144" | 197019 | \$1440 | 197019EC | \$1509 | 150" | 110 | 85 | 85 | |
| AV Format | | | | | | | | | | | |
| 9' x 12' | | | 197011 | \$1440 | 197011EC | \$1509 | 150" | 111 | 85 | 85 | |
| 12' x 12' | | | 197012 | 1505 | 197012EC | 1575 | 150" | 111 | 85 | 85 | |

Access FIT/Series M with

Case dimensions 7 3/4" wide x 5 11/16" high including flange and mounting brackets

See page 37 for a description of the AutoReturn feature.

Note: for alternate installation of Access screens, additional set of brackets is required. Part No. C502.233.

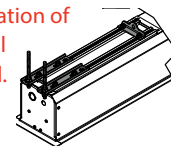

| H x W / Diagonal | Image Area | Overall Size | OptiView Surfaces | | | | | | | Case Length | Shipping Wt./lbs. | Dim Wt./lbs. | Freight Class |
|------------------------------|-------------------|-------------------|--------------------|-------|----------------------|------------------------|----------------------|---------------------|-------|-------------|-------------------|--------------|---------------|
| | | | Matt White XT1000E | PRICE | Contrast Grey XH800E | Contrast White XH1100E | Argent White XH1500E | Pearl White CH1900E | PRICE | | | | |
| 16:10 Format | | | | | | | | | | | | | |
| 94" | 50" x 80" | 62" x 83 1/2" | 197059 | \$884 | 197059EC | 197059EG | 197059EH | 197059EJ | \$919 | 92" | 58 | 75 | 85 P+ |
| 109" | 57 1/2" x 92" | 69 1/2" x 96" | 197060 | 939 | 197060EC | 197060EG | 197060EH | 197060EJ | 977 | 102" | 67 | 80 | 85 P+ |
| 113" | 60" x 96" | 72" x 100" | 197061 | 980 | 197061EC | 197061EG | 197061EH | -- | 1027 | 107" | 68 | 85 | 85 |
| 123" | 65" x 104" | 69" x 108" | 197062 | 1074 | 197062EC | 197062EG | 197062EH | -- | 1135 | 114" | 77 | 85 | 85 |
| 137" | 72 1/2" x 116" | 76 1/2" x 120" | 197063 | 1220 | 197063EC | 197063EG | 197063EH | -- | 1285 | 126" | 87 | 85 | 85 |
| 16:9 HDTV Format | | | | | | | | | | | | | |
| 92" | 45" x 80" | 57" x 83 1/2" | 197052 | \$884 | 197052EC | 197052EG | 197052EH | 197052EJ | \$919 | 92" | 58 | 80 | 85 P+ |
| 106" | 52" x 92" | 64" x 96" | 197054 | 939 | 197054EC | 197054EG | 197054EH | 197054EJ | 977 | 102" | 67 | 75 | 85 P+ |
| 110" | 54" x 96" | 66" x 100" | 197055 | 980 | 197055EC | 197055EG | 197055EH | -- | 1027 | 107" | 68 | 85 | 85 |
| 119" | 58" x 104" | 62" x 108" | 197056 | 1074 | 197056EC | 197056EG | 197056EH | -- | 1135 | 114" | 77 | 85 | 85 |
| 133" | 65" x 116" | 69" x 120" | 197057 | 1220 | 197057EC | 197057EG | 197057EH | -- | 1285 | 126" | 78 | 85 | 85 |
| 4:3 NTSC Video Format | | | | | | | | | | | | | |
| 6' | 42 1/2" x 56 1/2" | 46 1/2" x 59 1/2" | 197045 | \$837 | 197045EC | 197045EG | 197045EH | 197045EJ | \$865 | 66" | 40 | 60 | 85 P+ |
| 7' | 50" x 66 1/2" | 53 1/2" x 69 1/2" | 197046 | 874 | 197046EC | 197046EG | 197046EH | 197046EJ | 902 | 76" | 50 | 67 | 85 P+ |
| 100" | 60" x 80" | 64" x 83 1/2" | 197047 | 919 | 197047EC | 197047EG | 197047EH | 197047EJ | 954 | 92" | 59 | 75 | 85 P+ |
| 10' | 69" x 92" | 73" x 96" | 197048 | 982 | 197048EC | 197048EG | 197048EH | 197048EJ | 1022 | 102" | 68 | 80 | 85 P+ |
| 11' | 78" x 104" | 83" x 108" | 197049 | 1212 | 197049EC | 197049EG | 197049EH | -- | 1274 | 114" | 78 | 85 | 85 |
| 150" | 87" x 116" | 92" x 120" | 197050 | 1260 | 197050EC | 197050EG | 197050EH | -- | 1327 | 126" | 89 | 85 | 85 |
| AV Format | | | | | | | | | | | | | |
| 50" x 50" | | | 197033 | \$828 | 197033EC | 197033EG | 197033EH | 197033EJ | \$849 | 56" | 39 | 52 | 85 P+ |
| 60" x 60" | | | 197034 | 837 | 197034EC | 197034EG | 197034EH | 197034EJ | 865 | 66" | 45 | 60 | 85 P+ |
| 70" x 70" | | | 197035 | 874 | 197035EC | 197035EG | 197035EH | 197035EJ | 902 | 76" | 52 | 67 | 85 P+ |
| 84" x 84" | | | 197036 | 919 | 197036EC | 197036EG | 197036EH | 197036EJ | 954 | 92" | 61 | 70 | 85 P+ |
| 72" x 96" | | | 197037 | 982 | 197037EC | 197037EG | 197037EH | 197037EJ | 1022 | 102" | 67 | 75 | 85 P+ |
| 96" x 96" | | | 197038 | 1012 | 197038EC | 197038EG | 197038EH | 197038EJ | 1049 | 102" | 70 | 80 | 85 P+ |
| 7' x 9' | | | 197039 | 1147 | 197039EC | 197039EG | 197039EH | -- | 1209 | 114" | 77 | 85 | 85 |
| 9' x 9' | | | 197040 | 1212 | 197040EC | -- | -- | -- | 1274 | 114" | 82 | 85 | 85 |
| 8' x 10' | | | 197041 | 1260 | 197041EC | 197041EG | 197041EH | -- | 1327 | 126" | 88 | 85 | 85 |
| 10' x 10' | | | 197042 | 1342 | 197042EC | -- | -- | -- | 1407 | 126" | 93 | 85 | 85 |

*These sizes include 12" black drop as standard—NO EXTRA CHARGE!

Access/Series M with

Case dimensions 8 1/16" wide x 7 3/8" high including flange and mounting brackets

See page 37 for a description of the AutoReturn feature.

Note: for alternate installation of Access screens, additional set of brackets is required. Part No. C502.240.

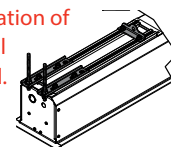

| H x W / Diagonal | Image Area | Overall Size | OptiView Surfaces | | | | Case Length | Shipping Wt./lbs. | Dim Wt./lbs. | Freight Class |
|------------------------------|----------------|----------------|--------------------|--------|----------------------|--------|-------------|-------------------|--------------|---------------|
| | | | Matt White XT1000E | PRICE | Contrast Grey XH800E | PRICE | | | | |
| 16:10 Format | | | | | | | | | | |
| 165" | 87 1/2" x 140" | 92 1/2" x 144" | 197064 | \$1342 | 197064EC | \$1412 | 150" | 108 | 85 | 85 |
| 16:9 HDTV Format | | | | | | | | | | |
| 161" | 79" x 140" | 84" x 144" | 197058 | \$1342 | 197058EC | \$1412 | 150" | 106 | 85 | 85 |
| 4:3 NTSC Video Format | | | | | | | | | | |
| 15' | 105" x 140" | 109" x 144" | 197051 | \$1505 | 197051EC | \$1575 | 150" | 111 | 85 | 85 |
| AV Format | | | | | | | | | | |
| 9' x 12' | | | 197043 | \$1505 | 197043EC | \$1575 | 150" | 111 | 85 | 85 |
| 12' x 12' | | | 197044 | 1570 | 197044EC | 1640 | 150" | 127 | 85 | 85 |

The Access Family: Case Now, Screen Later.

You can install the case during the "dirty" phase of the construction process and keep the screen safe until you install the projector. Screen (motor-in-roller and attached viewing surface) installs in seconds with preset latching roller brackets and electrical pin connectors. Eliminates job site damage. Screens may be installed in cases up to 20" wider than the standard case lengths shown.

- **Options:** All ceiling recessed cases can be painted black upon request.

Cases may be ordered and pre-installed. If ordering case in advance of screen, price of case will be deducted when screen is ordered. Please specify case length at time of order. If you are unsure of future size, please call Draper for suggestions or use printed size information for your most logical choice.

Premier/Series C—This screen offers a perfectly flat viewing surface, thanks to Draper's Tab-Tensioning System (see page 8), but is raised and lowered by using a detachable crank instead of a motor. Pentagonal shaped black steel case with matching endcaps and universal mounting brackets. Detachable crank is polished aluminum.



Standard Specs

- **Sizes and Formats:** Custom sizes available by quotation. Custom sizes need to be specified in detail, including extra drop, if desired.
- **Case Dimensions:** 5 7/8" H x 5 1/4" D. Extra drop o will increase length of case.

- **Black Borders:** Image area fully framed with black on all four sides and 12" black drop at top of viewing surface (standard).

Options

- **Extra Drop:** For additional drop *see page 49* (specify color: black is standard).

- **Viewing Surface:** CineFlex CH1200V and CineFlex MH800V rear projection surfaces, CineFlex White XT600V front/rear projection surface, and ClearSound NanoPerf XT800V, ClearSound Perf XT900V surfaces are available by quotation. *See page 5.*

| H x W / Diagonal | Image Area | OptiFlex Surfaces | | | | Case Length | Shipping Wt./lbs. | Dim Wt./lbs. | Freight Class | | |
|------------------------------|-------------------|--------------------|-------------|--------------------|---------------------|-------------|-------------------|--------------|---------------|-------|-------|
| | | Matt White XT1000V | Grey XH600V | Pure White XT1300V | Pearl White MH1500V | | | | | PRICE | |
| 16:9 HDTV Format | | | | | | | | | | | |
| 92" | 45" x 80" | 200099 | 200142 | 200099FN | \$1632 | 200123 | \$1869 | 97 3/4" | 64 | 76 | 85 P+ |
| 106" | 52" x 92" | 200100 | 200143 | 200100FN | 1689 | 200124 | 1934 | 110" | 65 | | 85 |
| 119" | 58" x 104" | 200150 | 200152 | 200150FN | 1935 | 200151 | 2207 | 122" | 81 | | 85 |
| 133" | 65" x 116" | 200101 | 200144 | 200101FN | 2124 | 200125 | 2415 | 135" | 90 | | 85 |
| 161" | 79" x 140" | 200102 | 200157 | 200102FN | 2534 | 200126 | 2871 | 160 1/4" | 100 | | 85 |
| 4:3 NTSC Video Format | | | | | | | | | | | |
| 6' | 42 1/2" x 56 1/2" | 200094 | 200139 | 200094FN | \$1272 | 200118 | \$1472 | 74" | 50 | 58 | 85 P+ |
| 7' | 50" x 66 1/2" | 200095 | 200140 | 200095FN | 1417 | 200119 | 1632 | 84 1/2" | 54 | 66 | 85 P+ |
| 100" | 60" x 80" | 200096 | 200141 | 200096FN | 1645 | 200120 | 1885 | 97 3/8" | 65 | 68 | 85 P+ |
| 10' | 72" x 96" | 200086 | 200137 | 200086FN | 1700 | 200112 | 1944 | 115" | 73 | | 85 |
| 11' | 78" x 104" | 200097 | 200155 | 200097FN | 2035 | 200121 | 2319 | 124 1/4" | 70 | | 125 |
| 150" | 87" x 116" | 200098 | 200156 | 200098FN | 2145 | 200122 | 2440 | 136 1/4" | 89 | | 125 |
| 15' | 108" x 144" | 200092 | -- | 200092FN | 2564 | 200117 | 2906 | 165 3/4" | 95 | | 85 |
| AV Format | | | | | | | | | | | |
| 50" x 50" | | 200082 | 200133 | 200082FN | \$1142 | 200108 | \$1325 | 68" | 39 | 55 | 85 P+ |
| 60" x 60" | | 200083 | 200134 | 200083FN | 1260 | 200109 | 1459 | 78 3/4" | 54 | 62 | 85 P+ |
| 70" x 70" | | 200084 | 200135 | 200084FN | 1497 | 200110 | 1720 | 89" | 60 | 69 | 85 P+ |
| 84" x 84" | | 200085 | 200136 | 200085FN | 1690 | 200111 | 1935 | 104 1/4" | 65 | | 85 |
| 72" x 96" | | 200086 | 200137 | 200086FN | 1700 | 200112 | 1944 | 115" | 73 | | 85 |
| 96" x 96" | | 200087 | 200138 | 200087FN | 1790 | 200113 | 2045 | 117 3/4" | 79 | | 85 |
| 7' x 9' | | 200088 | 200153 | 200088FN | 1927 | 200114 | 2197 | 128 1/4" | 84 | | 125 |
| 9' x 9' | | 200089 | 200154 | 200089FN | 2207 | 200115 | 2511 | 129 3/4" | 88 | | 125 |
| 8' x 10' | | 200090 | -- | 200090FN | 2319 | 200116 | 2632 | 141 3/4" | 85 | | 85 |
| 10' x 10' | | 200091 | -- | 200091FN | 2409 | 200132 | 2732 | 143 1/2" | 88 | | 85 |
| 9' x 12' | | 200092 | -- | 200092FN | 2564 | 200117 | 2906 | 165 3/4" | 95 | | 85 |
| 12' x 12' | | 200093 | -- | 200093FN | 2916 | -- | -- | 171 1/2" | 105 | | 85 |

Silhouette/Series C—Crank operated screen housed in a contemporary extruded white aluminum case featuring Draper's Tab-Tensioning System (see page 8). Detachable crank is polished aluminum.



Standard Specs

- **Sizes and Formats:** Custom sizes available by quotation. Custom sizes need to be specified in detail, including extra drop, if desired.
- **Case Dimensions:** 6" H x 4 3/4" D. Extra drop will increase length of case.
- **Black Borders:** Image area fully framed with black on all four sides and 12" black drop at top of viewing surface (standard).

Options

- **Options:** Black or Dove Grey finished case—no charge. Additional drop, *see page 49* (specify color: black standard; surface color available).
- **Viewing Surface:** CineFlex CH1200V and CineFlex MH800V rear projection surfaces, CineFlex White XT600V front/rear projection surface, and ClearSound NanoPerf XT800V, ClearSound Perf XT900V surfaces are available by quotation. *See page 5.*

| H x W / Diagonal | Image Area | OptiFlex Surfaces | | | | Case Length | Shipping Wt./lbs. | Dim Wt./lbs. | Freight Class | | |
|------------------------------|-------------------|--------------------|-------------|--------------------|---------------------|-------------|-------------------|--------------|---------------|-------|-------|
| | | Matt White XT1000V | Grey XH600V | Pure White XT1300V | Pearl White MH1500V | | | | | PRICE | |
| 16:9 HDTV Format | | | | | | | | | | | |
| 92" | 45" x 80" | 201090 | 201116 | 201090FN | \$1862 | 201103 | \$2102 | 102 3/4" | 69 | | 85 |
| 106" | 52" x 92" | 201091 | 201117 | 201091FN | 1925 | 201104 | 2172 | 114 3/4" | 95 | | 85 |
| 4:3 NTSC Video Format | | | | | | | | | | | |
| 6' | 42 1/2" x 56 1/2" | 201087 | 201113 | 201087FN | \$1449 | 201100 | \$1645 | 79 1/4" | 44 | 62 | 85 P+ |
| 7' | 50" x 66 1/2" | 201088 | 201114 | 201088FN | 1600 | 201101 | 1815 | 89 1/4" | 56 | 69 | 85 P+ |
| 100" | 60" x 80" | 201089 | 201115 | 201089FN | 1859 | 201102 | 2099 | 103 3/4" | 65 | | 85 |
| 10' | 72" x 96" | 201085 | 201111 | 201085FN | 1922 | 201098 | 2167 | 119 3/4" | 91 | | 85 |
| AV Format | | | | | | | | | | | |
| 50" x 50" | | 201081 | 201107 | 201081FN | \$1309 | 201094 | \$1492 | 72 3/4" | 49 | 58 | 85 P+ |
| 60" x 60" | | 201082 | 201108 | 201082FN | 1439 | 201095 | 1635 | 83 3/4" | 44 | 66 | 85 P+ |
| 70" x 70" | | 201083 | 201109 | 201083FN | 1687 | 201096 | 1909 | 93 3/4" | 60 | 74 | 85 P+ |
| 84" x 84" | | 201084 | 201110 | 201084FN | 1905 | 201097 | 2147 | 109" | 65 | | 85 |
| 72" x 96" | | 201085 | 201111 | 201085FN | 1922 | 201098 | 2167 | 119 3/4" | 72 | | 85 |
| 96" x 96" | | 201086 | 201112 | 201086FN | 2012 | 201099 | 2267 | 122 1/2" | 91 | | 85 |

Silhouette/Series M—Spring-roller operated screen in gently radiused white aluminum case with matching die cast aluminum endcaps. No exposed fasteners. Also available with AutoReturn. Sizes above 70" in height include pull cord. Viewing surfaces from the OptiView family.

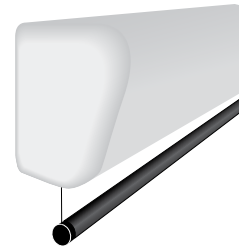

Standard Specs

- **Sizes and Formats:** Custom sizes available by quotation. Custom sizes need to be specified in detail, including extra drop, if desired.
- **Case Dimensions:** 6" H x 4 3/4" D.
- **Black Borders:** NTSC, HDTV and 16:10 format have image area framed with black on all four sides. Black side borders are available on request for AV format screens.

Options

- **Case Finish:** Black or Dove Grey finished case—no charge.
- **Extra Drop:** Extra drop above image area, see page 49 (specify color: surface color standard; black available).

*These sizes include 12" black drop as standard—NO EXTRA CHARGE!

| OptiView Surfaces | | | | | | | | | | | | | |
|------------------------------|-------------------|-------------------|--------------------|-------|----------------------|------------------------|----------------------|---------------------|-------|-------------|-------------------|--------------|---------------|
| H x W / Diagonal | Image Area | Overall Size | Matt White XT1000E | PRICE | Contrast Grey XH800E | Contrast White XH1100E | Argent White XH1500E | Pearl White CH1900E | PRICE | Case Length | Shipping Wt./lbs. | Dim Wt./lbs. | Freight Class |
| 16:10 Format | | | | | | | | | | | | | |
| 67"* | 35 1/4" x 56 1/2" | 47 1/4" x 59 1/2" | 202215 | \$362 | 202219 | 202215EG | 202215EH | 202215EJ | \$390 | 62 1/2" | 31 | 46 | 85 P+ |
| 76"* | 40" x 64" | 52" x 69 1/2" | 202216 | 412 | 202220 | 202216EG | 202216EH | 202216EJ | 440 | 72 1/2" | 38 | 54 | 85 P+ |
| 85"* | 45" x 72" | 57" x 74" | 202217 | 425 | 202221 | 202217EG | 202217EH | 202217EJ | 460 | 77" | 40 | 61 | 85 P+ |
| 94"* | 50" x 80" | 62" x 83 1/2" | 202218 | 432 | 202222 | 202218EG | 202218EH | 202218EJ | 467 | 86 1/2" | 42 | 62 | 85 P+ |
| 109"* | 57 1/2" x 92" | 69 1/2" x 96" | 202302 | 468 | 202303 | 202302EG | 202302EH | 202302EJ | 507 | 99" | 47 | 70 | 85 P+ |
| 16:9 HDTV Format | | | | | | | | | | | | | |
| 65"* | 31 3/4" x 56 1/2" | 43 3/4" x 59 1/2" | 202200 | \$362 | 202206 | 202200EG | 202200EH | 202200EJ | \$390 | 62 1/2" | 31 | 46 | 85 P+ |
| 73"* | 36" x 64" | 48" x 69 1/2" | 202201 | 412 | 202207 | 202201EG | 202201EH | 202201EJ | 440 | 72 1/2" | 38 | 54 | 85 P+ |
| 82"* | 40 1/2" x 72" | 52 1/2" x 74" | 202202 | 425 | 202208 | 202202EG | 202202EH | 202202EJ | 460 | 77" | 40 | 61 | 85 P+ |
| 92"* | 45" x 80" | 57" x 83 1/2" | 202209 | 432 | 202213 | 202209EG | 202209EH | 202209EJ | 467 | 86 1/2" | 41 | 62 | 85 P+ |
| 100"* | 49" x 87" | 61" x 91" | 202306 | 447 | 202308 | 202306EG | 202306EH | 202306EJ | 485 | 94" | 46 | 71 | 85 P+ |
| 106"* | 52" x 92" | 64" x 96" | 202210 | 468 | 202214 | 202210EG | 202210EH | 202210EJ | 507 | 99" | 51 | 75 | 85 P+ |
| 4:3 NTSC Video Format | | | | | | | | | | | | | |
| 6' | 42 1/2" x 56 1/2" | 46 1/2" x 59 1/2" | 202168 | \$355 | 202194 | 202168EG | 202168EH | 202168EJ | \$383 | 62 1/2" | 31 | 50 | 85 P+ |
| 7' | 50" x 66 1/2" | 53 1/2" x 69 1/2" | 202169 | 405 | 202195 | 202169EG | 202169EH | 202169EJ | 433 | 72 1/2" | 38 | 54 | 85 P+ |
| 100" | 60" x 80" | 64" x 83 1/2" | 202170 | 420 | 202196 | 202170EG | 202170EH | 202170EJ | 455 | 86 1/2" | 42 | 62 | 85 P+ |
| 10' | 69" x 92" | 73" x 96" | 202171 | 462 | 202197 | 202171EG | 202171EH | 202171EJ | 500 | 99" | 52 | 69 | 85 P+ |
| AV Format | | | | | | | | | | | | | |
| 50" x 50" | | | 202162 | \$333 | 202188 | 202162EG | 202162EH | 202162EJ | \$353 | 52 1/2" | 28 | 38 | 85 P |
| 60" x 60" | | | 202163 | 355 | 202189 | 202163EG | 202163EH | 202163EJ | 383 | 62 1/2" | 31 | 46 | 85 P+ |
| 70" x 70" | | | 202164 | 385 | 202190 | 202164EG | 202164EH | 202164EJ | 415 | 72 1/2" | 38 | 53 | 85 P+ |
| 84" x 84" | | | 202165 | 413 | 202191 | 202165EG | 202165EH | 202165EJ | 448 | 86 1/2" | 42 | 61 | 85 P+ |
| 72" x 96" | | | 202166 | 462 | 202192 | 202166EG | 202166EH | 202166EJ | 500 | 99" | 47 | 70 | 85 P+ |
| 96" x 96" | | | 202167 | 480 | 202193 | 202167EG | 202167EH | 202167EJ | 518 | 99" | 45 | 75 | 85 P+ |

Silhouette/Series M with AutoReturn

See page 37 for a description of the AutoReturn feature.

*These sizes include 12" black drop as standard—NO EXTRA CHARGE!

| OptiView Surfaces | | | | | | | | | | | | | |
|------------------------------|-------------------|-------------------|--------------------|-------|----------------------|------------------------|----------------------|---------------------|-------|-------------|-------------------|--------------|---------------|
| H x W / Diagonal | Image Area | Overall Size | Matt White XT1000E | PRICE | Contrast Grey XH800E | Contrast White XH1100E | Argent White XH1500E | Pearl White CH1900E | PRICE | Case Length | Shipping Wt./lbs. | Dim Wt./lbs. | Freight Class |
| 16:10 Format | | | | | | | | | | | | | |
| 67"* | 35 1/4" x 56 1/2" | 47 1/4" x 59 1/2" | 202231 | \$435 | 202236 | 202231EG | 202231EH | 202231EJ | \$463 | 64 1/8" | 31 | 46 | 85 P+ |
| 76"* | 40" x 64" | 52" x 69 1/2" | 202232 | 487 | 202237 | 202232EG | 202232EH | 202232EJ | 517 | 74 1/8" | 38 | 54 | 85 P+ |
| 85"* | 45" x 72" | 57" x 74" | 202233 | 502 | 202238 | 202233EG | 202233EH | 202233EJ | 537 | 78 1/8" | 40 | 69 | 85 P+ |
| 94"* | 50" x 80" | 62" x 83 1/2" | 202234 | 508 | 202239 | 202234EG | 202234EH | 202234EJ | 543 | 88 1/8" | 42 | 62 | 85 P+ |
| 109"* | 57 1/2" x 92" | 69 1/2" x 96" | 202235 | 567 | 202240 | 202235EG | 202235EH | 202235EJ | 605 | 100 5/8" | 57 | 71 | 85 P+ |
| 16:9 HDTV Format | | | | | | | | | | | | | |
| 65"* | 31 3/4" x 56 1/2" | 43 3/4" x 59 1/2" | 202287 | \$435 | 202293 | 202287EG | 202287EH | 202287EJ | \$463 | 64 1/8" | 31 | 46 | 85 P+ |
| 73"* | 36" x 64" | 48" x 69 1/2" | 202288 | 487 | 202294 | 202288EG | 202288EH | 202288EJ | 517 | 74 1/8" | 38 | 52 | 85 P+ |
| 82"* | 40 1/2" x 72" | 52 1/2" x 74" | 202289 | 502 | 202295 | 202289EG | 202289EH | 202289EJ | 537 | 78 1/8" | 40 | 60 | 85 P+ |
| 92"* | 45" x 80" | 57" x 83 1/2" | 202296 | 508 | 202300 | 202296EG | 202296EH | 202296EJ | 543 | 88 1/8" | 41 | 62 | 85 P+ |
| 100"* | 49" x 87" | 61" x 91" | 202309 | 537 | 202311 | 202309EG | 202309EH | 202309EJ | 575 | 95 5/8" | 46 | 67 | 85 P+ |
| 106"* | 52" x 92" | 64" x 96" | 202297 | 567 | 202301 | 202297EG | 202297EH | 202297EJ | 605 | 100 5/8" | 51 | 70 | 85 P+ |
| 4:3 NTSC Video Format | | | | | | | | | | | | | |
| 6' | 42 1/2" x 56 1/2" | 46 1/2" x 59 1/2" | 202257 | \$428 | 202281 | 202257EG | 202257EH | 202257EJ | \$457 | 64 1/8" | 31 | 46 | 85 P+ |
| 7' | 50" x 66 1/2" | 53 1/2" x 69 1/2" | 202258 | 480 | 202282 | 202258EG | 202258EH | 202258EJ | 508 | 74 1/8" | 38 | 52 | 85 P+ |
| 100" | 60" x 80" | 64" x 83 1/2" | 202259 | 498 | 202283 | 202259EG | 202259EH | 202259EJ | 533 | 88 1/8" | 50 | 62 | 85 P+ |
| 10' | 69" x 92" | 73" x 96" | 202260 | 558 | 202284 | 202260EG | 202260EH | 202260EJ | 598 | 100 5/8" | 52 | 70 | 85 P+ |
| AV Format | | | | | | | | | | | | | |
| 50" x 50" | | | 202251 | \$397 | 202275 | 202251EG | 202251EH | 202251EJ | \$417 | 54 1/8" | 28 | 39 | 85 P |
| 60" x 60" | | | 202252 | 422 | 202276 | 202252EG | 202252EH | 202252EJ | 450 | 64 1/8" | 31 | 46 | 85 P+ |
| 70" x 70" | | | 202253 | 458 | 202277 | 202253EG | 202253EH | 202253EJ | 488 | 74 1/8" | 38 | 52 | 85 P+ |
| 84" x 84" | | | 202254 | 490 | 202278 | 202254EG | 202254EH | 202254EJ | 525 | 88 1/8" | 42 | 62 | 85 P+ |
| 72" x 96" | | | 202255 | 558 | 202279 | 202255EG | 202255EH | 202255EJ | 598 | 100 5/8" | 47 | 70 | 85 P+ |
| 96" x 96" | | | 202256 | 588 | 202280 | 202256EG | 202256EH | 202256EJ | 625 | 100 5/8" | 50 | 75 | 85 P+ |

Salara/Series M—Elliptical extruded aluminum case with domed endcaps and white finish. Floating wall brackets grip the screen securely anywhere along the back of the case, and are barely visible. Sizes 70" or above in height include pull cord. Viewing surfaces from the OptiView family.

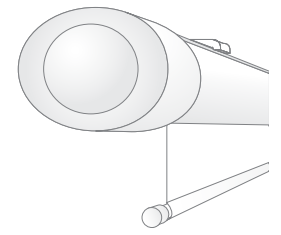

Standard Specs

- **Sizes and Formats:** Custom sizes available by quotation. Custom sizes need to be specified in detail, including extra drop, if desired.
- **Case Dimensions:** 3 13/16" H x 5 1/16" D.
- **Black Borders:** NTSC, HDTV and 16:10 format have image area framed with black on all four sides. Black side borders are available on request for AV format screens.

Options

- **Extra Drop:** Extra drop above image area, see page 49 (specify color: surface color is standard for AV format; black for others).

***These sizes include 12" black drop as standard—NO EXTRA CHARGE!**

| H x W / Diagonal | Image Area | Overall Size | OptiView Surfaces | | | | | Case Length | Shipping Wt./lbs. | Dim Wt./lbs. | Freight Class | | |
|------------------------------|-------------------|-------------------|--------------------|-------|----------------------|------------------------|----------------------|-------------|-------------------|--------------|---------------|---------------------|--------|
| | | | Matt White XT1000E | PRICE | Contrast Grey XH800E | Contrast White XH1100E | Argent White XH1500E | | | | | Pearl White CH1900E | PRICE |
| 16:10 Format | | | | | | | | | | | | | |
| 67"* | 35 1/4" x 56 1/2" | 47 1/4" x 59 1/2" | 137112 | \$312 | 137117 | 137112EG | 137112EH | 137112EJ | \$338 | 67 1/8" | 26 | 40 | 125 P+ |
| 76"* | 40" x 64" | 52" x 69 1/2" | 137113 | 338 | 137118 | 137113EG | 137113EH | 137113EJ | 367 | 77 1/8" | 31 | 46 | 125 P+ |
| 85"* | 45" x 72" | 57" x 74" | 137114 | 357 | 137119 | 137114EG | 137114EH | 137114EJ | 393 | 81 5/8" | 34 | 48 | 125 P+ |
| 94"* | 50" x 80" | 62" x 83 1/2" | 137115 | 367 | 137120 | 137115EG | 137115EH | 137115EJ | 403 | 91 1/8" | 35 | 53 | 125 P+ |
| 109"* | 57 1/2" x 92" | 69 1/2" x 96" | 137116 | 407 | 137121 | 137116EG | 137116EH | 137116EJ | 447 | 103 5/8" | 37 | | 125 |
| 16:9 HDTV Format | | | | | | | | | | | | | |
| 65"* | 31 3/4" x 56 1/2" | 43 3/4" x 59 1/2" | 137043 | \$312 | 137049 | 137043EG | 137043EH | 137043EJ | \$338 | 67 1/8" | 26 | 40 | 85 P+ |
| 73"* | 36" x 64" | 48" x 69 1/2" | 137044 | 338 | 137050 | 137044EG | 137044EH | 137044EJ | 367 | 77 1/8" | 31 | 46 | 85 P+ |
| 82"* | 40 1/2" x 72" | 52 1/2" x 74" | 137045 | 357 | 137051 | 137045EG | 137045EH | 137045EJ | 393 | 81 5/8" | 37 | 48 | 85 P+ |
| 92"* | 45" x 80" | 57" x 83 1/2" | 137052 | 367 | 137056 | 137052EG | 137052EH | 137052EJ | 403 | 91 1/8" | 41 | 53 | 125 P+ |
| 100"* | 49" x 87" | 61" x 91" | 137152 | 387 | 137154 | 137152EG | 137152EH | 137152EJ | 425 | 98 5/8" | 45 | 58 | 85 P+ |
| 106"* | 52" x 92" | 64" x 96" | 137053 | 407 | 137057 | 137053EG | 137053EH | 137053EJ | 447 | 103 5/8" | 45 | | 125 |
| 4:3 NTSC Video Format | | | | | | | | | | | | | |
| 6" | 42 1/2" x 56 1/2" | 46 1/2" x 59 1/2" | 137006 | \$302 | 137032 | 137006EG | 137006EH | 137006EJ | \$332 | 67 1/8" | 26 | 40 | 85 P+ |
| 7" | 50" x 66 1/2" | 53 1/2" x 69 1/2" | 137007 | 330 | 137033 | 137007EG | 137007EH | 137007EJ | 358 | 77 1/8" | 31 | 46 | 125 P+ |
| 100" | 60" x 80" | 64" x 83 1/2" | 137008 | 357 | 137034 | 137008EG | 137008EH | 137008EJ | 393 | 91 1/8" | 37 | 55 | 125 P+ |
| 10" | 69" x 92" | 73" x 96" | 137009 | 412 | 137035 | 137009EG | 137009EH | 137009EJ | 452 | 103 5/8" | 42 | | 125 |
| AV Format | | | | | | | | | | | | | |
| 50" x 50" | | | 137001 | \$285 | 137027 | 137001EG | 137001EH | 137001EJ | \$308 | 57 1/8" | 23 | 35 | 85 P+ |
| 60" x 60" | | | 137002 | 302 | 137028 | 137002EG | 137002EH | 137002EJ | 332 | 67 1/8" | 27 | 40 | 85 P+ |
| 70" x 70" | | | 137003 | 322 | 137029 | 137003EG | 137003EH | 137003EJ | 350 | 77 1/8" | 32 | 41 | 85 P+ |
| 84" x 84" | | | 137004 | 348 | 137030 | 137004EG | 137004EH | 137004EJ | 383 | 91 1/8" | 38 | 55 | 85 P+ |
| 72" x 96" | | | 137040 | 395 | 137042 | 137040EG | 137040EH | 137040EJ | 432 | 103 5/8" | 42 | | 85 |
| 96" x 96" | | | 137005 | 412 | 137031 | 137005EG | 137005EH | 137005EJ | 452 | 103 5/8" | 45 | | 85 |

Salara/Series M with AutoReturn

See page 37 for a description of the AutoReturn feature.

***These sizes include 12" black drop as standard—NO EXTRA CHARGE!**

| H x W / Diagonal | Image Area | Overall Size | OptiView Surfaces | | | | | Case Length | Shipping Wt./lbs. | Dim Wt./lbs. | Freight Class | | |
|------------------------------|-------------------|-------------------|--------------------|-------|----------------------|------------------------|----------------------|-------------|-------------------|--------------|---------------|---------------------|--------|
| | | | Matt White XT1000E | PRICE | Contrast Grey XH800E | Contrast White XH1100E | Argent White XH1500E | | | | | Pearl White CH1900E | PRICE |
| 16:10 Format | | | | | | | | | | | | | |
| 67"* | 35 1/4" x 56 1/2" | 47 1/4" x 59 1/2" | 137132 | \$383 | 137137 | 137132EG | 137132EH | 137132EJ | \$412 | 67 1/8" | 26 | 40 | 125 P+ |
| 76"* | 40" x 64" | 52" x 69 1/2" | 137133 | 412 | 137138 | 137133EG | 137133EH | 137133EJ | 442 | 77 1/8" | 31 | 46 | 125 P+ |
| 85"* | 45" x 72" | 57" x 74" | 137134 | 433 | 137139 | 137134EG | 137134EH | 137134EJ | 470 | 81 5/8" | 34 | 48 | 125 P+ |
| 94"* | 50" x 80" | 62" x 83 1/2" | 137135 | 447 | 137140 | 137135EG | 137135EH | 137135EJ | 482 | 91 1/8" | 35 | 55 | 125 P+ |
| 109"* | 57 1/2" x 92" | 69 1/2" x 96" | 137136 | 495 | 137141 | 137136EG | 137136EH | 137136EJ | 533 | 103 5/8" | 37 | | 85 |
| 16:9 HDTV Format | | | | | | | | | | | | | |
| 65"* | 31 3/4" x 56 1/2" | 43 3/4" x 59 1/2" | 137097 | \$383 | 137103 | 137097EG | 137097EH | 137097EJ | \$412 | 67 1/8" | 26 | 40 | 125 P+ |
| 73"* | 36" x 64" | 48" x 69 1/2" | 137098 | 412 | 137104 | 137098EG | 137098EH | 137098EJ | 442 | 77 1/8" | 31 | 46 | 125 P+ |
| 82"* | 40 1/2" x 72" | 52 1/2" x 74" | 137099 | 433 | 137105 | 137099EG | 137099EH | 137099EJ | 470 | 81 5/8" | 35 | 48 | 125 P+ |
| 92"* | 45" x 80" | 57" x 83 1/2" | 137106 | 447 | 137110 | 137106EG | 137106EH | 137106EJ | 482 | 91 1/8" | 37 | 53 | 125 P+ |
| 100"* | 49" x 87" | 61" x 91" | 137155 | 470 | 137157 | 137155EG | 137155EH | 137155EJ | 508 | 98 5/8" | 36 | 51 | 125 P+ |
| 106"* | 52" x 92" | 64" x 96" | 137107 | 495 | 137111 | 137107EG | 137107EH | 137107EJ | 533 | 103 5/8" | 37 | | 125 |
| 4:3 NTSC Video Format | | | | | | | | | | | | | |
| 6" | 42 1/2" x 56 1/2" | 46 1/2" x 59 1/2" | 137066 | \$383 | 137088 | 137066EG | 137066EH | 137066EJ | \$412 | 67 1/8" | 26 | 40 | 125 P+ |
| 7" | 50" x 66 1/2" | 53 1/2" x 69 1/2" | 137067 | 412 | 137089 | 137067EG | 137067EH | 137067EJ | 442 | 77 1/8" | 31 | 46 | 125 P+ |
| 100" | 60" x 80" | 64" x 83 1/2" | 137068 | 440 | 137090 | 137068EG | 137068EH | 137068EJ | 475 | 91 1/8" | 37 | 53 | 125 P+ |
| 10" | 69" x 92" | 73" x 96" | 137069 | 492 | 137091 | 137069EG | 137069EH | 137069EJ | 530 | 103 5/8" | 42 | | 125 |
| AV Format | | | | | | | | | | | | | |
| 50" x 50" | | | 137061 | \$352 | 137083 | 137061EG | 137061EH | 137061EJ | \$372 | 57 1/8" | 23 | 35 | 125 P+ |
| 60" x 60" | | | 137062 | 372 | 137084 | 137062EG | 137062EH | 137062EJ | 402 | 67 1/8" | 27 | 40 | 125 P+ |
| 70" x 70" | | | 137063 | 398 | 137085 | 137063EG | 137063EH | 137063EJ | 427 | 77 1/8" | 32 | 46 | 125 P+ |
| 84" x 84" | | | 137064 | 420 | 137086 | 137064EG | 137064EH | 137064EJ | 457 | 91 1/8" | 38 | 53 | 125 P+ |
| 72" x 96" | | | 137094 | 492 | 137096 | 137094EG | 137094EH | 137094EJ | 530 | 103 5/8" | 42 | | 125 |
| 96" x 96" | | | 137065 | 505 | 137087 | 137065EG | 137065EH | 137065EJ | 543 | 103 5/8" | 45 | | 125 |

Artisan/Series M—The most attractive spring-roller operated screen money can buy. Housed in your choice of a solid, hand-rubbed hardwood case, or a plastic laminate case in your choice of colors and finishes to complement any room decor. Hardwood case styles include rectilinear, radius, bevel and traditional. Sizes above 70" in height include pull cord. Viewing surfaces from the OptiView family.

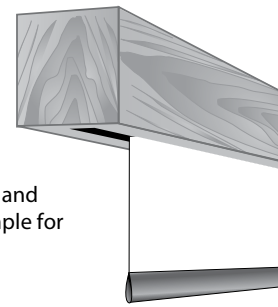

Natural Wood Finishes—The unique beauty of natural wood means that the color of your Artisan case may vary from printed reproductions and even from the samples Draper can provide representing our standard species, stains, and finishes. If you are seeking to match existing furnishings, please request custom stain matching and provide a physical sample for best results. Contact Draper for more information.

Standard Specs

- **Sizes and Formats:** Custom sizes available by quotation. Custom sizes need to be specified in detail, including extra drop, if desired.
- **Case Dimensions:** If overall screen width is 70" or less, case is 3 1/2" x 3 1/2". If screen width is larger, case is 4 1/4" x 4 1/4". Bevel style increases the height of any Artisan case by 1 1/8".
- **Black Borders:** NTSC, HDTV and 16:10 format have image area framed with black on all four sides. Black side borders are available on request for AV format screens.

Options:

- **Case Finish:** Please specify hardwood (natural or medium cherry, natural maple, light or medium oak, walnut or mahogany) or plastic laminate (white, burgundy, dove grey, beige or black). Custom finishes by quotation.
- **Case Style:** Please specify rectilinear, radius, bevel or traditional. (plastic laminate units are rectilinear).

*These sizes include 12" black drop as standard—NO EXTRA CHARGE!

| H x W / Diagonal | Image Area | Overall Size | OptiView Surfaces | | Case Length | Shipping Wt./lbs. | Freight Class |
|------------------------------|---------------|-------------------|-----------------------------|--|-------------|-------------------|---------------|
| | | | Matt White XT1000E PRICE | Contrast Grey XH800E, Contrast White XH1100E, Argent White XH1500E, or Pearl White CH1900E PRICE | | | |
| 16:10 Format | | | | | | | |
| 94"* | 50" x 80" | 62" x 83 1/2" | \$1060 | \$1094 | 88" | 35 | 85 P+ |
| 109"* | 57 1/2" x 92" | 69 1/2" x 96" | 1179 | 1214 | 100" | 40 | 85 P+ |
| 16:9 HDTV Format | | | | | | | |
| 92"* | 45" x 80" | 57" x 83 1/2" | \$1060 | \$1094 | 88" | 35 | 85 P+ |
| 106"* | 52" x 92" | 64" x 96" | 1179 | 1214 | 100" | 40 | 85 P+ |
| 4:3 NTSC Video Format | | | | | | | |
| 6' | 42" x 56 1/2" | 46 1/2" x 59 1/2" | \$812 | \$837 | 63" | 21 | 85 P+ |
| 7' | 50" x 66 1/2" | 53 1/2" x 69 1/2" | 864 | 889 | 73" | 23 | 85 P+ |
| 100" | 60" x 80" | 64" x 83 1/2" | 1069 | 1102 | 88" | 37 | 85 P+ |
| 10' | 69" x 92" | 73" x 96" | 1187 | 1222 | 100" | 40 | 85 P+ |
| AV Format | | | | | | | |
| 50" x 50" | | | \$768 | \$795 | 53" | 19 | 85 P |
| 60" x 60" | | | 812 | 837 | 63" | 21 | 85 P+ |
| 70" x 70" | | | 864 | 889 | 73" | 23 | 85 P+ |
| 84" x 84" | | | 1069 | 1102 | 88" | 39 | 85 P+ |
| 72" x 96" | | | 1187 | 1222 | 100" | 42 | 85 P+ |
| 96" x 96" | | | 1214 | 1247 | 100" | 45 | 85 P+ |

When ordering Artisan/Series M, please specify:

Case Finish

- **Hardwood:** natural or medium cherry, natural maple, light or medium oak, walnut or mahogany
- **Plastic laminate:** white, burgundy, dove grey, beige or black
- **Custom finishes by quotation:** NO extra charge for hardwood custom color match

Case Style

- **Hardwood:** Rectilinear, radius, bevel or traditional
- **Plastic Laminate:** Rectilinear only

Freight Class Key

Number LTL freight class
P Parcel service
 + ... \$8.50 surcharge (over 60" long)
Example: a freight code of 125 P+ indicates an item that may ship as freight class 125 or via parcel service with \$8.50 surcharge.

Luma—The Luma features a white pentagonal-shaped steel case with matching endcaps that also serve as universal mounting brackets. Also available with AutoReturn. Sizes above 70" in height include pull cord. Viewing surfaces from the OptiView family.



Standard Specs

- **Sizes and Formats:** Custom sizes available by quotation. Custom sizes need to be specified in detail, including extra drop, if desired.
- **Case Dimensions:** 3 ¾" H x 3 ¼" D.
- **Black Borders:** NTSC, HDTV and 16:10 format have image area framed with black on all four sides. Black side borders are available on request for AV format screens.

Options

- **Extra Drop:** Additional drop, see page 49 (specify color: surface color standard for AV format; black for other formats).

*These sizes include 12" black drop as standard—NO EXTRA CHARGE!

Manual Screens

Wall-Mounted

| OptiView Surfaces | | | | | | | | | |
|------------------------------|---------------|---------------|------------|-------|-------------|-------------------|--------------|---------------|----|
| H x W / Diagonal | Image Area | Overall Size | Matt White | | Case Length | Shipping Wt./lbs. | Dim Wt./lbs. | Freight Class | |
| | | | XT1000E | PRICE | | | | | |
| 16:10 Format | | | | | | | | | |
| 67"* | 35 ¼" x 56 ½" | 47 ¼" x 59 ½" | 207163 | \$132 | 62 ¾" | 14 | 17 | 85 | P+ |
| 76"* | 40" x 64" | 52" x 69 ½" | 207164 | 146 | 72 ¾" | 17 | 26 | 85 | P+ |
| 85"* | 45" x 72" | 57" x 74" | 207165 | 208 | 76 ¾" | 19 | 28 | 85 | P+ |
| 94"* | 50" x 80" | 62" x 83 ½" | 207166 | 214 | 86 ¾" | 20 | 31 | 85 | P+ |
| 109"* | 57 ½" x 92" | 69 ½" x 96" | 207167 | 238 | 98 ¾" | 26 | 35 | 85 | P+ |
| 16:9 HDTV Format | | | | | | | | | |
| 65"* | 31 ¾" x 56 ½" | 43 ¾" x 59 ½" | 207091 | \$132 | 62 ¾" | 14 | 17 | 85 | P+ |
| 73"* | 36" x 64" | 48" x 69 ½" | 207092 | 146 | 72 ¾" | 17 | 26 | 85 | P+ |
| 82"* | 40 ½" x 72" | 52 ½" x 74" | 207093 | 208 | 76 ¾" | 19 | 23 | 85 | P+ |
| 92"* | 45" x 80" | 57" x 83 ½" | 207100 | 214 | 86 ¾" | 22 | 31 | 85 | P+ |
| 100"* | 49" x 87" | 61" x 91" | 207205 | 228 | 93 ¾" | 25 | 34 | 85 | P+ |
| 106"* | 52" x 92" | 64" x 96" | 207101 | 238 | 98 ¾" | 27 | 35 | 85 | P+ |
| 4:3 NTSC Video Format | | | | | | | | | |
| 6' | 42 ½" x 56 ½" | 46 ½" x 59 ½" | 207007 | \$122 | 62 ¾" | 14 | 22 | 85 | P+ |
| 7' | 50" x 66 ½" | 53 ½" x 69 ½" | 207008 | 136 | 72 ¾" | 17 | 26 | 85 | P+ |
| 100" | 60" x 80" | 64" x 83 ½" | 207009 | 174 | 86 ¾" | 23 | 31 | 85 | P+ |
| 10' | 69" x 92" | 73" x 96" | 207010 | 200 | 98 ¾" | 28 | 35 | 85 | P+ |
| AV Format | | | | | | | | | |
| 50" x 50" | | | 207001 | \$96 | 52 ¾" | 13 | 20 | 85 | P |
| 60" x 60" | | | 207002 | 106 | 62 ¾" | 15 | 23 | 85 | P+ |
| 70" x 70" | | | 207003 | 114 | 72 ¾" | 18 | 26 | 85 | P+ |
| 84" x 84" | | | 207004 | 166 | 86 ¾" | 23 | 31 | 85 | P+ |
| 72" x 96" | | | 207005 | 200 | 98 ¾" | 26 | 35 | 85 | P+ |
| 96" x 96" | | | 207006 | 214 | 98 ¾" | 28 | 35 | 85 | P+ |

| OptiView Surfaces | | | | | | |
|--|------------|-------|-------------|-------------------|--------------|---------------|
| H x W / Diagonal | Matt White | | Case Length | Shipping Wt./lbs. | Dim Wt./lbs. | Freight Class |
| | XT1000E | PRICE | | | | |
| AV Format with 1 ½" Black Masking Borders | | | | | | |
| 60" x 60" | 207040 | \$96 | 62 ¾" | 14 | 26 | 85 P+ |
| 70" x 70" | 207041 | 102 | 72 ¾" | 17 | 26 | 26 |

See previous page for more information, and page 37 for a description of the AutoReturn feature.

***These sizes include 12" black drop as standard—NO EXTRA CHARGE!**

| OptiView Surfaces | | | | | | | | |
|------------------------------|-------------------|-------------------|--------------------|-------|-------------|-------------------|--------------|---------------|
| H x W / Diagonal | Image Area | Overall Size | Matt White XT1000E | PRICE | Case Length | Shipping Wt./lbs. | Dim Wt./lbs. | Freight Class |
| 16:10 Format | | | | | | | | |
| 67 ^{1/8} * | 35 1/4" x 56 1/2" | 47 1/4" x 59 1/2" | 207183 | \$256 | 62 3/8" | 14 | 23 | 85 P+ |
| 76 ^{1/8} * | 40" x 64" | 52" x 69 1/2" | 207184 | 280 | 72 3/8" | 17 | 22 | 85 P+ |
| 85 ^{1/8} * | 45" x 72" | 57" x 74" | 207185 | 310 | 76 7/8" | 20 | 21 | 85 P+ |
| 94 ^{1/8} * | 50" x 80" | 62" x 83 1/2" | 207186 | 348 | 86 3/8" | 22 | 31 | 85 P+ |
| 109 ^{1/8} * | 57 1/2" x 92" | 69 1/2" x 96" | 207187 | 402 | 98 7/8" | 26 | 35 | 85 P+ |
| 16:9 HDTV Format | | | | | | | | |
| 65 ^{1/8} * | 31 3/4" x 56 1/2" | 43 3/4" x 59 1/2" | 207146 | \$256 | 62 3/8" | 14 | 17 | 85 P+ |
| 73 ^{1/8} * | 36" x 64" | 48" x 69 1/2" | 207147 | 280 | 72 3/8" | 17 | 22 | 85 P+ |
| 82 ^{1/8} * | 40 1/2" x 72" | 52 1/2" x 74" | 207148 | 310 | 76 7/8" | 20 | 23 | 85 P+ |
| 92 ^{1/8} * | 45" x 80" | 57" x 83 1/2" | 207155 | 348 | 86 3/8" | 22 | 23 | 85 P+ |
| 100 ^{1/8} * | 49" x 87" | 61" x 91" | 207208 | 376 | 93 7/8" | 25 | 25 | 85 P+ |
| 106 ^{1/8} * | 52" x 92" | 64" x 96" | 207156 | 402 | 98 7/8" | 26 | 35 | 85 P+ |
| 4:3 NTSC Video Format | | | | | | | | |
| 6' | 42 1/2" x 56 1/2" | 46 1/2" x 59 1/2" | 207116 | \$238 | 62 3/8" | 14 | 17 | 85 P+ |
| 7' | 50" x 66 1/2" | 53 1/2" x 69 1/2" | 207117 | 262 | 72 3/8" | 17 | 26 | 85 P+ |
| 100" | 60" x 80" | 64" x 83 1/2" | 207118 | 314 | 86 3/8" | 20 | 31 | 85 P+ |
| 10' | 69" x 92" | 73" x 96" | 207119 | 362 | 98 7/8" | 30 | 35 | 85 P+ |
| AV Format | | | | | | | | |
| 50" x 50" | | | 207110 | 208 | 52 3/8" | 12 | | 85 P |
| 60" x 60" | | | 207111 | 224 | 62 3/8" | 14 | 17 | 85 P+ |
| 70" x 70" | | | 207112 | 238 | 72 3/8" | 18 | 26 | 85 P+ |
| 84" x 84" | | | 207113 | 318 | 86 3/8" | 23 | | 85 P+ |
| 72" x 96" | | | 207114 | 362 | 98 7/8" | 26 | | 85 P+ |
| 96" x 96" | | | 207115 | 400 | 98 7/8" | 28 | | 85 P+ |

| OptiView Surfaces | | | | | | |
|--|--------------------|-------|-------------|-------------------|--------------|---------------|
| H x W / Diagonal | Matt White XT1000E | PRICE | Case Length | Shipping Wt./lbs. | Dim Wt./lbs. | Freight Class |
| AV Format with 1 1/2" Black Masking Borders | | | | | | |
| 60" x 60" | 207161 | \$228 | 62 3/8" | 14 | 26 | 85 P+ |
| 70" x 70" | 207162 | 242 | 72 3/8" | 18 | 30 | 85 P+ |

Freight Class Key
Number LTL freight class
P Parcel service
 + ... \$8.50 surcharge (over 60" long)
Example: a freight code of 125 P+ indicates an item that may ship as freight class 125 or via parcel service with \$8.50 surcharge.

Manual Screens
Wall Mounted

Luma 2—Our largest spring-roller operated screen, the Luma 2 is housed in a white pentagonal-shaped steel case (black optional) with matching endcaps and universal mounting brackets. Also available with AutoReturn. Sizes above 70" in height include pull cord. Viewing surfaces from the OptiView family.



Standard Specs

- **Sizes and Formats:** Custom sizes available by quotation. Custom sizes need to be specified in detail, including extra drop, if desired.
- **Case Dimensions:** 5 7/8" H x 5 1/4" D.
- **Black Borders:** NTSC, HDTV and 16:10 format have image area framed with black on all four sides. Black side borders are available on request for AV format screens.

Options

- **Case Color:** White is standard. Black case available at no charge. Please specify at time of order.
- **Extra Drop:** Additional drop, see page 49 (specify color: surface color standard for AV format; black for other formats).
- **Luma 2/R:** The Luma 2 can also be used as a portable screen with the optional Floor Stand—see page 66.

• **Operating Pole:**

The aluminum operating pole is a popular option. See page 49

• **Floating Screen Brackets**

Optional wall/ceiling mounting brackets for added flexibility. See page 49.

***These sizes include 12" black drop—NO EXTRA CHARGE!**

OptiView Surfaces

| H x W / Diagonal | Image Area | Overall Size | Matt White | | Contrast Grey XH800E | Contrast White XH1100E | Argent White XH1500E | Pearl White CH1900E | PRICE | Case Length | Shipping Wt./lbs. | Dim Wt./lbs. | Freight Class |
|------------------------------|----------------|----------------|------------|-------|----------------------|------------------------|----------------------|---------------------|-------|-------------|-------------------|--------------|---------------|
| | | | XT1000E | PRICE | | | | | | | | | |
| 16:10 Format | | | | | | | | | | | | | |
| 94"* | 50" x 80" | 62" x 83 1/2" | 206171 | \$398 | 206176 | 206171EG | 206171EH | 206171EJ | \$438 | 86 1/2" | 38 | 73 | 85 P+ |
| 109"* | 57 1/2" x 92" | 69 1/2" x 96" | 206172 | 436 | 206177 | 206172EG | 206172EH | 206172EJ | 486 | 99" | 46 | 76 | 85 P+ |
| 113"* | 60" x 96" | 72" x 100" | 206230 | 454 | 206231 | 206230EG | 206230EH | -- | 502 | 103 1/2" | 50 | | 85 |
| 123" | 65" x 104" | 69" x 108" | 206173 | 488 | 206178 | 206173EG | 206173EH | -- | 560 | 111 1/2" | 50 | | 85 |
| 137" | 72 1/2" x 116" | 76 1/2" x 120" | 206174 | 640 | 206179 | 206174EG | 206174EH | -- | 720 | 123 1/2" | 59 | | 85 |
| 165" | 87 1/2" x 140" | 92 1/2" x 144" | 206175 | 840 | 206180 | -- | -- | -- | 926 | 147 1/2" | 80 | | 85 |
| 16:9 HDTV Format | | | | | | | | | | | | | |
| 92"* | 45" x 80" | 57" x 83 1/2" | 206084 | \$398 | 206088 | 206084EG | 206084EH | 206084EJ | \$438 | 86 1/2" | 38 | 73 | 85 P+ |
| 100"* | 49" x 87" | 61" x 91" | 206193 | 416 | 206195 | 206193EG | 206193EH | 206193EJ | 462 | 94" | 46 | 80 | 85 P+ |
| 106"* | 52" x 92" | 64" x 96" | 206085 | 436 | 206089 | 206085EG | 206085EH | 206085EJ | 486 | 99" | 46 | 83 | 85 P+ |
| 110"* | 54" x 96" | 66" x 100" | 206201 | 454 | 206200 | 206201EG | 206201EH | -- | 502 | 103 1/2" | 50 | | 85 |
| 119" | 58" x 104" | 62" x 108" | 206080 | 488 | 206082 | 206080EG | 206080EH | -- | 560 | 111 1/2" | 50 | | 85 |
| 133" | 65" x 116" | 69" x 120" | 206020 | 640 | 206077 | 206020EG | 206020EH | -- | 720 | 123 1/2" | 59 | | 85 |
| 161" | 79" x 140" | 84" x 144" | 206021 | 840 | 206078 | -- | -- | -- | 926 | 147 1/2" | 80 | | 85 |
| 4:3 NTSC Video Format | | | | | | | | | | | | | |
| 100" | 60" x 80" | 64" x 83 1/2" | 206013 | \$386 | 206066 | 206013EG | 206013EH | 206013EJ | \$426 | 86 1/2" | 40 | 74 | 85 P+ |
| 10' | 69" x 92" | 73" x 96" | 206014 | 424 | 206067 | 206014EG | 206014EH | 206014EJ | 472 | 99" | 47 | 83 | 85 P+ |
| 11' | 78" x 104" | 83" x 108" | 206015 | 488 | 206074 | 206015EG | 206015EH | -- | 560 | 111 1/2" | 50 | | 85 |
| 150" | 87" x 116" | 92" x 120" | 206016 | 640 | 206075 | 206016EG | 206016EH | -- | 720 | 123 1/2" | 61 | | 85 |
| 15' | 105" x 140" | 109" x 144" | 206017 | 960 | 206224 | -- | -- | -- | 1046 | 147 1/2" | 80 | | 85 |
| AV Format | | | | | | | | | | | | | |
| 50" x 50" | | | 206001 | \$268 | 206058 | 206001EG | 206001EH | 206001EJ | \$294 | 52 1/2" | 26 | 46 | 85 P |
| 60" x 60" | | | 206002 | 292 | 206059 | 206002EG | 206002EH | 206002EJ | 324 | 62 1/2" | 30 | 55 | 85 P+ |
| 70" x 70" | | | 206003 | 332 | 206060 | 206003EG | 206003EH | 206003EJ | 370 | 72 1/2" | 37 | 65 | 85 P+ |
| 84" x 84" | | | 206004 | 356 | 206061 | 206004EG | 206004EH | 206004EJ | 402 | 86 1/2" | 42 | 62 | 85 P+ |
| 72" x 96" | | | 206005 | 414 | 206062 | 206005EG | 206005EH | 206005EJ | 460 | 99" | 47 | 83 | 85 P+ |
| 96" x 96" | | | 206006 | 442 | 206063 | 206006EG | 206006EH | 206006EJ | 492 | 99" | 47 | 83 | 85 P+ |
| 7' x 9' | | | 206007 | 456 | 206064 | 206007EG | 206007EH | -- | 530 | 111 1/2" | 53 | | 85 |
| 9' x 9' | | | 206008 | 730 | 206220 | -- | -- | -- | 806 | 111 1/2" | 56 | | 85 |
| 8' x 10' | | | 206009 | 748 | 206065 | 206009EG | 206009EH | -- | 828 | 123 1/2" | 61 | | 85 |
| 10' x 10' | | | 206010 | 848 | 206222 | -- | -- | -- | 928 | 123 1/2" | 63 | | 85 |
| 9' x 12' | | | 206011 | 950 | 206221 | -- | -- | -- | 1036 | 147 1/2" | 84 | | 85 |
| 12' x 12' | | | 206012 | 976 | 206223 | -- | -- | -- | 1062 | 147 1/2" | 84 | | 85 |

See previous page for more information, and page 37 for a description of the AutoReturn feature.

| OptiView Surfaces | | | | | | | | | | | | | | |
|------------------------------|----------------|-----------------|--------------------------|-------|----------------------------|------------------------------|----------------------------|---------------------------|-------|-------|----------------|----------------------|-----------------|------------------|
| H x W / Diagonal | Image Area | Overall Size | Matt White XT1000E | | Contrast Grey XH800E | Contrast White XH1100E | Argent White XH1500E | Pearl White CH1900E | PRICE | | Case Length | Shipping Wt./lbs. | Dim Wt./lbs. | Freight Class |
| | | | | PRICE | | | | | | PRICE | | | | |
| 16:10 Format | | | | | | | | | | | | | | |
| 94"* | 50" x 80" | 62" x 83 1/2" | 206207 | \$584 | 206206 | 206207EG | 206207EH | 206207EJ | \$628 | | 86 1/2" | 38 | 77 | 85 P+ |
| 109"* | 57 1/2" x 92" | 69 1/2" x 96" | 206210 | 706 | 206209 | 206210EG | 206210EH | 206210EJ | 752 | | 99" | 46 | 80 | 85 P+ |
| 113"* | 60" x 96" | 72" x 100" | 206233 | 722 | 206234 | 206233EG | 206233EH | -- | 768 | | 103 1/2" | 50 | 85 | 85 |
| 123" | 65" x 104" | 69" x 108" | 206213 | 762 | 206212 | 206213EG | 206213EH | -- | 838 | | 111 1/2" | 50 | 85 | 85 |
| 137" | 72 1/2" x 116" | 76 1/2" x 120" | 206216 | 952 | 206215 | 206216EG | 206216EH | -- | 1032 | | 123 1/2" | 65 | 85 | 85 |
| 165" | 87 1/2" x 140" | 92 1/2" x 144" | 206219 | 1120 | 206218 | -- | -- | -- | 1208 | | 147 1/2" | 80 | 85 | 85 |
| 16:9 HDIV Format | | | | | | | | | | | | | | |
| 92"* | 45" x 80" | 57" x 83 1/2" | 206165 | \$584 | 206169 | 206165EG | 206165EH | 206165EJ | \$628 | | 86 1/2" | 38 | 73 | 85 P+ |
| 100"* | 49" x 87" | 61" x 91" | 206196 | 676 | 206198 | 206196EG | 206196EH | 206196EJ | 726 | | 94" | 46 | 80 | 85 P+ |
| 106"* | 52" x 92" | 64" x 96" | 206166 | 706 | 206170 | 206166EG | 206166EH | 206166EJ | 752 | | 99" | 46 | 83 | 85 P+ |
| 110"* | 54" x 96" | 66" x 100" | 206204 | 722 | 206203 | 206204EG | 206204EH | -- | 768 | | 103 1/2" | 50 | 85 | 85 |
| 119" | 58" x 104" | 62" x 108" | 206162 | 762 | 206164 | 206162EG | 206162EH | -- | 838 | | 111 1/2" | 50 | 85 | 85 |
| 133" | 65" x 116" | 69" x 120" | 206112 | 952 | 206159 | 206112EG | 206112EH | -- | 1032 | | 123 1/2" | 59 | 85 | 85 |
| 161" | 79" x 140" | 84" x 144" | 206113 | 1120 | 206160 | -- | -- | -- | 1208 | | 147 1/2" | 80 | 85 | 85 |
| 4:3 NTSC Video Format | | | | | | | | | | | | | | |
| 100" | 60" x 80" | 64" x 83 1/2" | 206107 | \$580 | 206151 | 206107EG | 206107EH | 206107EJ | \$624 | | 86 1/2" | 42 | 73 | 85 P+ |
| 10' | 69" x 92" | 73" x 96" | 206108 | 702 | 206152 | 206108EG | 206108EH | 206108EJ | 748 | | 99" | 47 | 83 | 85 P+ |
| 11' | 78" x 104" | 83" x 108" | 206109 | 830 | 206157 | 206109EG | 206109EH | -- | 904 | | 111 1/2" | 50 | 85 | 85 |
| 150" | 87" x 116" | 92" x 120" | 206110 | 946 | 206158 | 206110EG | 206110EH | -- | 1028 | | 123 1/2" | 61 | 85 | 85 |
| 15' | 105" x 140" | 109" x 144" | 206111 | 1212 | 206229 | -- | -- | -- | 1296 | | 147 1/2" | 80 | 85 | 85 |
| AV Format | | | | | | | | | | | | | | |
| 50" x 50" | | | 206095 | \$520 | 206143 | 206095EG | 206095EH | 206095EJ | \$548 | | 52 1/2" | 26 | 46 | 85 P |
| 60" x 60" | | | 206096 | 568 | 206144 | 206096EG | 206096EH | 206096EJ | 604 | | 62 1/2" | 30 | 55 | 85 P+ |
| 70" x 70" | | | 206097 | 600 | 206145 | 206097EG | 206097EH | 206097EJ | 636 | | 72 1/2" | 37 | 65 | 85 P+ |
| 84" x 84" | | | 206098 | 654 | 206146 | 206098EG | 206098EH | 206098EJ | 698 | | 86 1/2" | 42 | 74 | 85 P+ |
| 72" x 96" | | | 206099 | 698 | 206147 | 206099EG | 206099EH | 206099EJ | 746 | | 99" | 47 | 83 | 85 P+ |
| 96" x 96" | | | 206100 | 728 | 206148 | 206100EG | 206100EH | 206100EJ | 774 | | 99" | 47 | 83 | 85 P+ |
| 7' x 9' | | | 206101 | 740 | 206149 | 206101EG | 206101EH | -- | 816 | | 111 1/2" | 53 | 85 | 85 |
| 9' x 9' | | | 206102 | 920 | 206226 | -- | -- | -- | 996 | | 111 1/2" | 53 | 85 | 85 |
| 8' x 10' | | | 206103 | 930 | 206150 | 206103EG | 206103EH | -- | 1010 | | 123 1/2" | 61 | 85 | 85 |
| 10' x 10' | | | 206104 | 1042 | 206227 | -- | -- | -- | 1120 | | 123 1/2" | 63 | 85 | 85 |
| 9' x 12' | | | 206105 | 1190 | 206225 | -- | -- | -- | 1276 | | 147 1/2" | 81 | 85 | 85 |
| 12' x 12' | | | 206106 | 1204 | 206228 | -- | -- | -- | 1288 | | 147 1/2" | 84 | 85 | 85 |

Manual
Screens

Wall Mounted

Freight Class Key
Number LTL freight class
P Parcel service
+ . . . \$8.50 surcharge (over 60" long)
Example: a freight code of 125 P+ indicates
 an item that may ship as freight class
 125 or via parcel service with \$8.50 surcharge.

Star—Housed in a white cylindrical steel case with matching endcaps and universal mounting brackets. Sizes above 70" in height include pull cord.



Standard Specs

- **Sizes and Formats:** Custom sizes available by quotation. Custom sizes need to be specified in detail, including extra drop, if desired.
- **Case Dimensions:** 3 1/8" high x 2 3/4" wide.

OptiView Surfaces

| Size H x W | Matt White XT1000E | PRICE | Case Length | Shipping Wt./lbs. | Dim Wt./lbs. | Freight Class |
|------------------|-----------------------|-------|----------------|----------------------|-----------------|------------------|
| AV Format | | | | | | |
| 50" x 50" | 209001 | \$80 | 52 1/4" | 10 | | 85 P |
| 60" x 60" | 209002 | 90 | 62 1/4" | 12 | | 85 P+ |
| 70" x 70" | 209003 | 100 | 72 1/4" | 14 | | 85 P+ |
| 84" x 84" | 209004 | 160 | 86 1/4" | 18 | 31 | 85 P+ |

Manual
Screens

Wall-Mounted

Evenroll Rope & Pulley Screen—

Normally supplied without black borders. 2" black borders, no extra charge upon request. See page 37 for descriptions of products on this page.

OptiView Surface Matt White XT1000E

| Size H x W | Image Area | PRICE | Shipping Wt./lbs. | Freight Class |
|----------------------------------|---------------|--------|----------------------|------------------|
| 16:9 HDTV Format | | | | |
| 16' 4" | 96" x 168" | \$2105 | 70 | 85 |
| 18' 4" | 108" x 192" | 2214 | 80 | 85 |
| 21' 5" | 126" x 216" | 2444 | 100 | 85 |
| 22' 11" | 135" x 240" | 2717 | 110 | 85 |
| 27' 6" | 162" x 288" | 2874 | 280 | 85 |
| 4:3 NTSC Video Format | | | | |
| 17' 6" | 126" x 168" | \$2160 | 70 | 85 |
| 20' | 144" x 192" | 2269 | 80 | 85 |
| 22' 6" | 162" x 216" | 2509 | 110 | 85 |
| 25' | 180" x 240" | 2791 | 230 | 85 |
| 30' | 216" x 288" | 2947 | 300 | 85 |
| AV Format | | | | |
| 14' x 14' | | \$2305 | 80 | 85 |
| 16' x 16' | | 2479 | 110 | 85 |
| 18' x 18' | | 2746 | 230 | 85 |
| 20' x 20' | | 2864 | 280 | 85 |
| 24' x 24' | | 3387 | 425 | 85 |
| 2.35:1 CinemaScope Format | | | | |
| 15' 4" | 72" x 168" | \$1995 | 70 | 85 |
| 17' 6" | 82" x 192" | 2095 | 80 | 85 |
| 19' 7" | 92" x 216" | 2325 | 90 | 85 |
| 21' 8" | 102" x 240" | 2582 | 100 | 85 |
| 26' 2" | 123" x 288" | 2727 | 250 | 85 |

Accessories for Evenroll

| | Part No. | PRICE |
|---|------------|--------|
| Extra Drop (per square foot) | — | \$4.10 |
| Wall Mounting Brackets (ea.)—12" extension. Black finish. Divide screen width in feet by 5 for proper number. | 228001 | 38.00 |
| Extra Cord (per foot)—Note—All cord is doubled from screen to wall. | C065.024 | 0.60 |
| Extra Double Wheel Pulley for wall | C002.403SA | 22.00 |
| Single Cord Cleat Tieback on Plate | 228003 | 10.00 |
| Double Cord Cleat Tieback on Plate | 228002 | 26.00 |

Nocturne®/Series C—Crank operated, designed for outdoor use on your patio, by your pool deck, or any other outdoor space. Weather and insect resistant solid aluminum headbox includes built-in hinge for easy installation and service. Ships standard with cable guides and weighted dowel. Both wall and deck mount cable guide brackets included. Choose the Nocturne®/Series E for motorized operation. Viewing surfaces from the OptiView and ClearSound families.



Standard Specs

• **Sizes and Formats:** Custom sizes available by quotation. Custom sizes need to be specified in detail, including extra drop, if desired.

- **Case Dimensions:** 4" H x 5" D.
- **Black Borders:** Image area framed with black on all four sides.

Options

- **Finish Options:** Headbox and exposed hardware standard in white. Also available in silver, ivory, charcoal bronze, or black.
- **Extra Drop:** Additional drop above image (specify color—black standard; surface color available). *See above.*
- **Viewing Surface:** Surfaces from the ClearSound family are available by quotation—Contact Draper or see page 5 for details.

***These sizes include 12" black drop—NO EXTRA CHARGE!**

OptiView Viewing Surfaces

| H x W / Diagonal | Image Area | Matt White XT1000E | Contrast Grey XH800E | PRICE | Case Length | Net Wt./lbs. | Freight Class |
|------------------------------|-------------------|--------------------|----------------------|-------|-------------|--------------|---------------|
| 16:10 Format | | | | | | | |
| 94"* | 50" x 80" | 200519 | 200520 | \$957 | 86 7/8" | 44 | 125 P+ |
| 102"* | 54" x 87" | 200521 | 200522 | 1005 | 94 3/8" | 47 | 125 P+ |
| 109"* | 57 1/2" x 92" | 200523 | 200524 | 1035 | 99 3/8" | 49 | 125 |
| 113"* | 60" x 96" | 200525 | 200526 | 1067 | 103 3/8" | 51 | 125 |
| 123" | 65" x 104" | 200527 | 200528 | 1144 | 111 3/8" | 73 | 125 |
| 137" | 72 1/2" x 116" | 200529 | 200530 | 1285 | 123 3/8" | 81 | 125 |
| 16:9 HDTV Format | | | | | | | |
| 65"* | 31 3/4" x 56 1/2" | 200501 | 200502 | \$847 | 62 7/8" | 34 | 125 P+ |
| 73"* | 36" x 64" | 200503 | 200504 | 889 | 72 7/8" | 38 | 125 P+ |
| 82"* | 40 1/2" x 70" | 200505 | 200506 | 915 | 77 3/8" | 40 | 125 P+ |
| 92"* | 45" x 80" | 200507 | 200508 | 952 | 86 7/8" | 44 | 125 P+ |
| 100"* | 49" x 87" | 200509 | 200510 | 1004 | 94 3/8" | 47 | 125 P+ |
| 106"* | 52" x 92" | 200511 | 200512 | 1029 | 99 3/8" | 77 | 125 |
| 110"* | 54" x 96" | 200513 | 200514 | 1062 | 103 3/8" | 51 | 125 |
| 119" | 58" x 104" | 200515 | 200516 | 1132 | 111 3/8" | 73 | 125 |
| 133" | 65" x 116" | 200517 | 200518 | 1297 | 123 3/8" | 81 | 125 |
| 4:3 NTSC Video Format | | | | | | | |
| 6' | 42 1/2" x 56 1/2" | 200531 | 200532 | \$842 | 62 7/8" | 34 | 125 P+ |
| 7' | 50" x 66 1/2" | 200533 | 200534 | 889 | 72 7/8" | 38 | 125 P+ |
| 100" | 60" x 80" | 200535 | 200536 | 952 | 86 7/8" | 44 | 125 P+ |
| 10' | 69" x 92" | 200537 | 200538 | 1090 | 99 3/8" | 59 | 125 |
| 11' | 78" x 104" | 200539 | 200540 | 1165 | 111 3/8" | 73 | 125 |
| 150" | 87" x 116" | 200541 | 200542 | 1219 | 123 3/8" | 83 | 125 |

Accessories for Manual Screens

| Accessory | For use with: | Part No. (White Finish) | Part No. (Black Finish) | PRICE (PR.) | Shipping Wt./lbs. | Freight Class |
|--|------------------------------------|-------------------------|-------------------------|-------------|-------------------|---------------|
| Adjustable Wall Brackets | | | | | | |
| 18"-24" Extension | Star, Luma, Luma 2 to 8' wide | 227216 | 227217 | \$36 | 6 | 50 P |
| Non-Adjustable Wall Brackets | | | | | | |
| 6" Extension | Star, Luma, & Luma 2 | 227212 | 227213 | \$20 | 2 | 50 P |
| 6" Extension | Silhouette | 227225 | 227227 | 20 | 2 | 50 P |
| 10"/14" Extension | Star, Luma, Luma 2 to 8' wide | 227214 | 227215 | 30 | 4 | 50 P |
| 10"/14" Extension | Silhouette | 227226 | 227228 | 30 | 3 | 50 P |
| Floating Screen Brackets | | | | | | |
| For flexible wall/ceiling mounting | Luma 2 | 227025 | 227024 | \$85 | 8 | 50 P |
| T-Bar Twist Clips | | | | | | |
| Price per pair | Star & Luma to 70" wide | | 227016 | \$12 | 1 | 50 P |
| Magnetic Keystone Eliminator | | | | | | |
| | Manual screens with pull cord/bail | | 227023 | \$5 | 1 | 77.5 P |
| Aluminum Operating Pole | | | | | | |
| 4' length | All other models | | 227008 | \$14 | 5 | 85 P |
| 6' length | All other models | | 227010 | 20 | 6 | 85 P |
| Extra Drop (Price per sq. ft., selected manual screens) | | | | | | |
| OptiView Viewing Surfaces: Matt White XT1000E, Contrast Grey XH800E, Contrast White XH1100E, Argent White XH1500E, and Pearl White CH1900E. | | | | \$4 | | |
| OptiFlex Viewing Surfaces: Matt White XT1000V, Pure White XT1300V, Pearl White MH1500V, and Grey XH600V. | | | | 4 | | |

Note: Extra Drop may increase case length for Tab Tensioned projection screens.

Manual Screens

Outdoor

Replacement Viewing Surfaces

For all roller-operated non-tensioned screens. Specify model when ordering. Surfaces ship with tape for attachment to roller; dowel not included. Viewing surfaces from the OptiView family. NTSC, HDTV, and 16:10 format surfaces have black borders on all four sides.

*These sizes include 12" black drop as standard—NO EXTRA CHARGE!

Manual
Screens

Wall-Mounted

| | | | OptiView Surfaces | |
|------------------------------|-----------------------|-------------------------|-----------------------|---|
| | | | Matt White XT1000E | Contrast Grey XH800E, Contrast White XH1100E, Argent White XH1500E, or Pearl White CH1900E |
| H x W / Diagonal | Image Area (H x W) | Overall Size (H x W) | PRICE | PRICE |
| 16:10 Format | | | | |
| 70" | 37" x 56 1/2" | 49" x 59 1/2" | \$128 | \$160 |
| 76" | 40" x 64" | 52" x 69 1/2" | 138 | 172 |
| 85" | 45" x 72" | 57" x 74" | 190 | 232 |
| 94" | 50" x 80" | 62" x 83 1/2" | 212 | 254 |
| 103" | 54 1/2" x 87" | 66 1/2" x 91" | 222 | 264 |
| 109" | 57 1/2" x 92" | 69 1/2" x 96" | 232 | 278 |
| 113" | 60" x 96" | 72" x 100" | 318 | 380 |
| 123" | 65" x 104" | 69" x 108" | 402 | 476 |
| 137" | 72 1/2" x 116" | 76 1/2" x 120" | 496 | 574 |
| 165" | 87 1/2" x 140" | 92 1/2" x 144" | 634 | 718 |
| 16:9 HDTV Format | | | | |
| 65" | 31 3/4" x 56 1/2" | 43 3/4" x 59 1/2" | \$128 | \$160 |
| 73" | 36" x 64" | 48" x 69 1/2" | 138 | 172 |
| 82" | 40 1/2" x 72" | 52 1/2" x 74" | 190 | 232 |
| 92" | 45" x 80" | 57" x 83 1/2" | 212 | 254 |
| 100" | 49" x 87" | 61" x 91" | 222 | 264 |
| 106" | 52" x 92" | 64" x 96" | 232 | 278 |
| 110" | 54" x 96" | 66" x 100" | 318 | 380 |
| 119" | 58" x 104" | 62" x 108" | 402 | 476 |
| 133" | 65" x 116" | 69" x 120" | 496 | 574 |
| 161" | 79" x 140" | 84" x 144" | 634 | 718 |
| 4:3 NTSC Video Format | | | | |
| 6' | 42 1/2" x 56 1/2" | 46 1/2" x 59 1/2" | \$128 | \$160 |
| 7' | 50" x 66 1/2" | 53 1/2" x 69 1/2" | 138 | 172 |
| 100" | 60" x 80" | 64" x 83 1/2" | 212 | 254 |
| 10' | 69" x 92" | 73" x 96" | 232 | 278 |
| 11' | 78" x 104" | 83" x 108" | 402 | 476 |
| 150" | 87" x 116" | 92" x 120" | 496 | 574 |
| 15' | 105" x 140" | 109" x 144" | 634 | 718 |
| 200" | 118" x 158" | 123" x 162" | 972 | 1086 |
| 20' | 141" x 188" | 146" x 192" | 1194 | 1330 |
| 250" | 148" x 198" | 153" x 202" | 1448 | 1606 |
| 25' | 177" x 236" | 182" x 240" | 1890 | 2080 |
| AV Format | | | | |
| 40" x 40" | | | \$64 | \$84 |
| 50" x 50" | | | 74 | 98 |
| 60" x 60" | | | 84 | 118 |
| 70" x 70" | | | 94 | 132 |
| 84" x 84" | | | 168 | 212 |
| 72" x 96" | | | 190 | 236 |
| 96" x 96" | | | 212 | 258 |
| 7' x 9' | | | 358 | 432 |
| 9' x 9' | | | 422 | 496 |
| 8' x 10' | | | 454 | 534 |
| 10' x 10' | | | 528 | 606 |
| 9' x 12' | | | 590 | 676 |
| 12' x 12' | | | 686 | 764 |
| 10' 6" x 14' | | | 928 | 1046 |
| 14' x 14' | | | 1046 | 1150 |
| 12' x 16' | | | 1150 | 1288 |
| 16' x 16' | | | 1288 | 1414 |
| 13' 6" x 18' | | | 1394 | 1552 |
| 18' x 18' | | | 1594 | 1752 |
| 15' x 20' | | | 1826 | 2006 |
| 20' x 20' | | | 2038 | 2218 |

BOOKMARK OUR MOBILE TOOLKIT

Draper's mobile toolkit includes searchable document libraries for all AV products and the assembly map tools for our popular StageScreen and FocalPoint screens. It also includes our Screen Surface Selector. Scan the code with your smartphone or visit:

www.draperinc.com/drapermobile



Freight Class Key

Number LTL freight class
P Parcel service
+ ... \$8.50 surcharge (over 60" long)

Example: a freight code of 125 P+ indicates an item that may ship as freight class 125 or via parcel service with \$8.50 surcharge.

Permanently Tensioned Projection Screens

The primary advantage of Permanently Tensioned Screens is that the screen surface is perfectly flat, which provides excellent image quality. Screens of this type are permanently installed on the wall, and do not roll up into a headbox.

Cineperm—The Cineperm consists of a 1" tubular aluminum frame, which assembles without tools using slip fittings. It is permanently mounted to the wall and has a snap-on viewing surface. The Cineperm is offered in a wide range of standard sizes and can be manufactured in virtually any custom size. Large sizes may require truss construction.

Clarion—The Clarion's aluminum frame forms an attractive 2" border, for a clean, theatre-like appearance. The standard frame color is black; Vel-Tex, a black, velvety textile covering is a recommended option that cuts reflection and conceals all trace of joints in the frame. Fabric attaches without snaps for quick assembly and a perfectly smooth viewing surface.

Onyx—The Onyx has a 4" wide, beveled trim frame and a proprietary adjustable surface tensioning system that keeps the viewing surface perfectly flat, with no puckering. No snaps—assembles easily in minutes. The frame is wider to handle overscan, and provides up to 1½" of horizontal or vertical viewing surface tension adjustment. Black painted aluminum frame is standard; Vel-Tex, a black, velvety textile covering, is a recommended option that cuts reflection and conceals all trace of joints in the frame. The Onyx enjoys a particularly good following in the home theatre market.

Curved Frame Clarion and Onyx—Draper offers their Onyx and Clarion projection screens with factory-curved frames featuring Vel-Tex covered extruded aluminum frames. Standard is 40' radius; custom radii available.

ShadowBox Clarion—This product utilizes a 1½" tubular aluminum frame painted flat black. The viewing surface attaches to the back side of the frame. Hence, the frame is visible and serves as a black border around the perimeter of the image area. Vel-Tex black, velvety textile covering, is a recommended option.

Edgeless Clarion—The viewing surface of this product wraps completely around the frame and attaches to the back side. Formerly named WrapAround Clarion, The Edgeless Clarion does not have a border of any kind—from the audience side you see only a solid screen surface.

Scribe—The new Scribe, front projection write-on screen, has a matte surface to maintain the contrast, clarity, and impact of your projected content. With 80% lower gloss than the typical whiteboard, Scribe can maximize your picture quality and interactivity.

Profile—Draper's newest permanently tensioned screen, The Profile, creates the clean, high tech look of a flat panel screen on your wall—but in larger sizes that are only possible with projection. Its slender frame is less than ¾" wide and 1½" deep. Features Draper's proprietary surface tensioning system to keep the viewing surface perfectly flat with no puckering.

Permanently Tensioned Screens

Permanently Tensioned Screens ship K.D. (knocked-down) with viewing surface rolled on a core. Only by request will Draper ship a permanently tensioned screen assembled. Assembled screens ship in crates and cannot be shipped parcel service. Contact Draper for crate and freight estimate.

Screen Fabric Only, Cut to Size

Prices per square foot, based on overall size, no hem, no black border.

| Prices per square foot | PRICE |
|--|---------|
| OptiView (Self-Supporting) | |
| Contrast Grey XH800E | \$7.40 |
| Matt White XT1000E | 5.75 |
| Contrast White XH1100E | 7.40 |
| Argent White XH1500E | 7.40 |
| Pearl White CH1900E | 7.40 |
| OptiFlex (Flexible) | |
| Grey XH600V | \$7.75 |
| Matt White XT1000V | 6.10 |
| Pure White XT1300V | 6.10 |
| Pearl White MH1500V | 7.75 |
| ReAct MS1000V | 6.75 |
| CineFlex (Rear/Dual Projection) | |
| CineFlex White XT600V | \$12.65 |
| CineFlex MH800 | 12.65 |
| CineFlex CH1200 | 12.65 |
| ClearSound (Acoustically Transparent) | |
| ClearSound NanoPerf XT800V | \$27.85 |
| ClearSound Perf XT900V | 27.85 |
| ClearSound Grey Weave XH600E | 28.35 |
| ClearSound White Weave XT900E | 28.35 |
| Chroma Key | |
| Chroma Key Green | \$10.10 |
| Chroma Key Blue | 10.10 |

Freight Class Key
Number LTL freight class
P Parcel service
 + . . . \$8.50 surcharge (over 60" long)
Example: a freight code of 125 P+ indicates an item that may ship as freight class 125 or via parcel service with \$8.50 surcharge.

Curved Frame Screens—

Draper is proud to offer curved Clarion and Onyx projection screens featuring Vel-Tex covered extruded aluminum frames.

Why Curved?

Curved projection screens offer several key advantages over flat projection screens. A curved screen helps offset pincushion distortion from a horizontal expansion lens, and also wraps the image around your periphery more than a flat screen for greater engagement with your projected image. In addition, the curved image is subject to less ambient reflected light from your room, while your projector's light is more accurately reflected by the perfectly smooth viewing surface for an ideal picture.

Curvature

The curve is defined by its radius in feet. Draper's curved screens are available with a standard radius of 40'. Custom radii are available—call Draper for consultation.

Size ranges

Curved Onyx is available in sizes up to 19' wide.
Curved Clarion is available in sizes up to 13' wide.
Custom sizes are available—contact Draper for details.

Mounting Brackets

All standard curved Onyx or Clarion screens include a set of mounting brackets: two brackets to attach the center of the curve to the wall at the top and bottom, and two extension brackets to attach the sides. For custom curves and special applications, floor or ceiling brackets may be needed. Call Draper for consultation or custom mounting requirements.

How to Order

Choose your Clarion (page 56) or Onyx (page 58) projection screen. After the 6-digit part number shown for the screen of your choice, add the letter "C" plus the radius in feet.

For example, if you choose a 148" diagonal Scope format Clarion screen with a Matt White XT1000V viewing surface, and you would like a 40' radius curve, the part number would become 252172C40.

Planning Sheet

Download and complete a planning sheet to collect and confirm your ordering details.

Download a planning sheet at the following address:
www.draperinc.com/go/CurvedScreens.htm

Planning sheet required with purchase order.

Custom Curved Screens

Lace & Grommet, Edgeless Clarion, and ShadowBox Clarion can also be curved. Please call Draper for pricing and details.

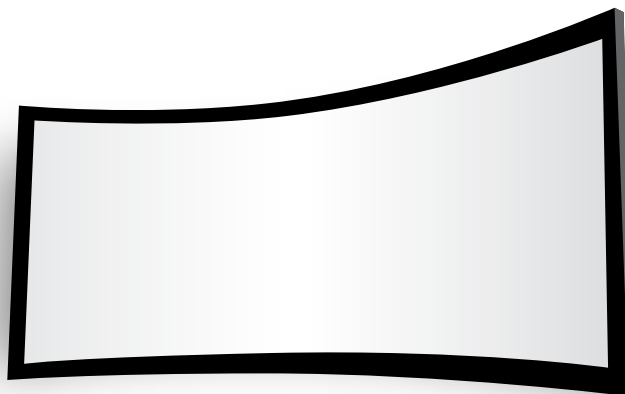

Understanding Radii

Draper curved projection screens are offered with a variety of radii available, including our standard 40 ft. radius. Imagine a circle with a 40' radius (the distance from the center of the circle to a point on the circle). The curvature of your projection screen will match a line segment of proportionate length cut from the circle.

The smaller the radius, the more curve a screen will have. The appropriate radius of your screen will be determined by several factors—contact Draper for assistance.

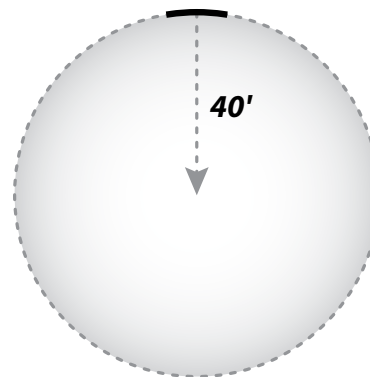

Curved Frame Clarion and Onyx—add the appropriate price below to the standard Clarion prices on page 56 or Onyx prices on page 58.

Vel-Tex will be added to all curved screens if it is not already included in the part number.

| Frame Width of original screen | PRICE |
|--------------------------------|-------|
| ≤ 72" | \$693 |
| 72 1/8"–84" | 780 |
| 84 1/8"–96" | 869 |
| 96 1/8"–108" | 955 |
| 108 1/8"–120" | 1042 |
| 120 1/8"–132" | 1130 |
| 132 1/8"–144" | 1217 |
| 144 1/8"–156" | 1304 |
| 156 1/8"–168" | 1390 |
| 168 1/8"–180" | 1479 |
| 180 1/8"–192" | 1565 |
| 192 1/8"–204" | 1652 |
| 204 1/8"–216" | 1739 |
| 216 1/8"–228" | 1827 |

*Curved Clarion available up to 13' wide.

TECVISION

Engineered Screen Technology

“Finding the color fidelity of high gain materials close to that of no gain materials was wonderful... Compliments to the engineer!”

-Joel Silver, President and Founder, Imaging Science Foundation

In recent years, projectors and projection screen technology have been advancing quickly.

Draper has worked to advance our screens as well. We have focused a lot of resources on product design, with innovations like the Access family of motorized screens, improved tab tensioning system and revolutionary modular portable screens.

Over three years ago we moved our primary focus to the surfaces themselves, and their optical performance. We built a world class testing lab, and worked with consultants and key suppliers to identify and refine ingredients to improve the optical performance of our surfaces. Since then we have introduced many new surfaces to address specific needs in the marketplace. This also led to the development of the new standard in surface planning tools, the Draper Surface Selector PRO.

There are few companies in the world who are experts in designing projection screen surfaces. Most screen fabrics are made by firms whose primary business is manufacturing textiles for other purposes. We have made a major investment in equipment, expert personnel and research time specifically to offer a line of revolutionary new surfaces that are unmatched by any other screen manufacturer in the world.

TecVision Engineered Surface Technology is offered in eight exclusive formulations on Draper tab-tensioned and permanently-tensioned screens. Five white surfaces are available with gains ranging from 1.0 to 1.8 over remarkably wide viewing cones. Three grey surfaces offer excellent performance under higher room light levels.

These premium surfaces are not sold online and are only available through qualified Draper dealers. For more information, contact your Draper salesperson or visit:

www.draperinc.com/go/TecVision.htm

Cineperm—The Cineperm consists of a 1" tubular aluminum frame, which assembles without tools using slip fittings. It is permanently mounted to the wall and has a snap-on viewing surface. Mounting fasteners not provided.

- **Black Borders:** Snap-on viewing surfaces have 2" black vinyl borders.
- **Options:** Custom sizes available by quotation. *CineFlex MH800V* rear projection surface and *CineFlex White XT600V* front/rear projection surface are also available at the same price as *CineFlex CH1200V*. See page 4 for viewing surface details. When ordering these surfaces, use the *CineFlex CH1200V* part number followed by the appropriate suffix: **CA** for *CineFlex MH800V*, and **CC** for *CineFlex White XT600V*.

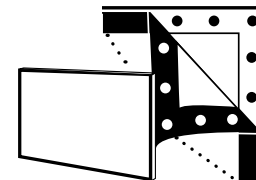

Truss-style construction includes a 6" border and is required for flown installations. **Standard Cineperm cannot be flown.** Truss Cineperm Fly bracket is required. See page 55 for details.



*This size requires truss-style construction. Price listed reflects truss-style construction.

Permanently Tensioned Screens

| | | OptiFlex Surfaces | | | | | | | | | |
|----------------------------------|-------------------|-------------------|--------------------|--------------------|-------|-------------|-------|---------------------|--------|---------------|-------|
| Nom. Diag. | Image Area | Overall Size | Matt White XT1000V | Pure White XT1300V | PRICE | Grey XH600V | PRICE | Pearl White MH1500V | PRICE | ReAct MS1000V | PRICE |
| 16:10 Format | | | | | | | | | | | |
| 67" | 35 1/4" x 56 1/2" | 39 1/4" x 60 1/2" | 251060 | 251060FN | \$422 | 251068 | \$468 | 251076 | \$482 | 251060FR | \$453 |
| 76" | 40" x 64" | 44" x 68" | 251061 | 251061FN | 448 | 251069 | 497 | 251077 | 510 | 251061FR | 482 |
| 85" | 45" x 72" | 49" x 76" | 251062 | 251062FN | 515 | 251070 | 570 | 251078 | 587 | 251062FR | 553 |
| 94" | 50" x 80" | 54" x 84" | 251063 | 251063FN | 590 | 251071 | 655 | 251079 | 672 | 251063FR | 635 |
| 109" | 57 1/2" x 92" | 61 1/2" x 96" | 251064 | 251064FN | 723 | 251072 | 803 | 251080 | 823 | 251064FR | 778 |
| 113" | 60" x 96" | 64" x 100" | 251139 | 251139FN | 743 | 251140 | 823 | 251141 | 847 | 251139FR | 798 |
| 123" | 65" x 104" | 69" x 108" | 251065 | 251065FN | 817 | 251073 | 907 | 251081 | 934 | 251065FR | 879 |
| 137" | 72 1/2" x 116" | 76 1/2" x 120" | 251066 | 251066FN | 872 | 251074 | 967 | 251082 | 994 | 251066FR | 937 |
| 165" | 87 1/2" x 140" | 91 1/2" x 144" | 251067 | 251067FN | 1055 | 251075 | 1172 | 251083 | 1205 | -- | -- |
| 16:9 HDTV Format | | | | | | | | | | | |
| 65" | 31 3/4" x 56 1/2" | 35 3/4" x 60 1/2" | 250124 | 250124FN | \$422 | 250130 | \$468 | 250127 | \$482 | 250124FR | \$453 |
| 73" | 36" x 64" | 40" x 68" | 250125 | 250125FN | 448 | 250131 | 497 | 250128 | 510 | 250125FR | 482 |
| 82" | 40 1/2" x 72" | 44 1/2" x 76" | 250126 | 250126FN | 515 | 250132 | 570 | 250129 | 587 | 250126FR | 553 |
| 92" | 45" x 80" | 49" x 84" | 250022 | 250022FN | 590 | 250092 | 655 | 250047 | 672 | 250022FR | 635 |
| 100" | 49" x 87" | 53" x 91" | 251121 | 251121FN | 638 | 251124 | 708 | 251122 | 728 | 251121FR | 687 |
| 106" | 52" x 92" | 56" x 96" | 250023 | 250023FN | 723 | 250093 | 803 | 250048 | 823 | 250023FR | 778 |
| 110" | 54" x 96" | 58" x 100" | 251127 | 251127FN | 743 | 251130 | 823 | 251128 | 847 | 251127FR | 798 |
| 119" | 58" x 104" | 62" x 108" | 250120 | 250120FN | 817 | 250123 | 907 | 250121 | 934 | 250120FR | 879 |
| 133" | 65" x 116" | 69" x 120" | 250024 | 250024FN | 872 | 250094 | 967 | 250049 | 994 | 250024FR | 937 |
| 161" | 79" x 140" | 84" x 144" | 250025 | 250025FN | 1055 | 250095 | 1172 | 250050 | 1205 | 250025FR | 1134 |
| 193" | 95" x 169" | 99" x 173" | 251109 | 251109FN | 1324 | 251112 | 1472 | 251110 | 1509 | -- | -- |
| 220" | 108" x 192" | 112" x 196" | 251115 | 251115FN | 1549 | 251118 | 1719 | 251116 | 1764 | -- | -- |
| 4:3 NTSC Video Format | | | | | | | | | | | |
| 6' | 43" x 57" | 47" x 61" | 250011 | 250011FN | \$397 | 250084 | \$438 | 250039 | \$452 | 250011FR | \$427 |
| 6' 6" | 47" x 63" | 51" x 67" | 250012 | 250012FN | 440 | 250085 | 490 | 250040 | 502 | 250012FR | 473 |
| 7' 6" | 54" x 72" | 58" x 76" | 250013 | 250013FN | 528 | 250086 | 587 | 250041 | 602 | 250013FR | 568 |
| 100" | 60" x 80" | 64" x 84" | 250014 | 250014FN | 588 | 250087 | 652 | 250042 | 670 | 250014FR | 632 |
| 10' | 72" x 96" | 76" x 100" | 250005 | 250005FN | 723 | 250078 | 803 | 250035 | 823 | 250005FR | 778 |
| 11' | 78" x 104" | 82" x 108" | 250016 | 250016FN | 817 | 250088 | 907 | 250044 | 934 | 250016FR | 879 |
| 150" | 90" x 120" | 94" x 124" | 250007 | 250007FN | 872 | 250080 | 967 | 250037 | 994 | -- | -- |
| 15' | 108" x 144" | 112" x 148" | 250009 | 250009FN | 1055 | 250133 | 1172 | 250038 | 1205 | -- | -- |
| 200" | 120" x 160" | 124" x 164" | 250019 | 250019FN | 1279 | 251058 | 1419 | -- | -- | -- | -- |
| 240"* | 144" x 194" | 156" x 206" | 250020 | 250020FN | 3714 | 251059 | 4121 | -- | -- | -- | -- |
| 25"* | 180" x 240" | 192" x 252" | 250021 | 250021FN | 4941 | -- | -- | -- | -- | -- | -- |
| 2.35:1 CinemaScope Format | | | | | | | | | | | |
| 115" | 45" x 105 3/4" | 49" x 109 3/4" | 251035 | 251035FN | 889 | 251043 | \$985 | 251039 | \$1014 | 251035FR | \$955 |
| 132" | 52" x 122" | 56" x 126" | 251036 | 251036FN | 1095 | 251044 | 1215 | 251040 | 1247 | 251036FR | 1177 |
| 148" | 58" x 136 1/4" | 62" x 140 1/4" | 251037 | 251037FN | 1210 | 251045 | 1342 | 251041 | 1379 | 251037FR | 1300 |
| 153" | 60" x 141" | 64" x 145" | 251133 | 251133FN | 1334 | 251134 | 1480 | 251135 | 1519 | 251133FR | 1434 |
| 166" | 65" x 152 3/4" | 69" x 156 3/4" | 251038 | 251038FN | 1435 | 251046 | 1594 | 251042 | 1637 | 251038FR | 1544 |

CHART CONTINUED

Custom Size Cineperm

Cineperm screens are available in virtually any custom size. Overall size, including frame, equals image area + 4". Base fabric cost on overall square footage including frame. Frame cost is per lineal foot, rounded up to next full foot (example—round 23'4" up to 24').

Frame (per lineal foot)

| Frame Length | PRICE |
|----------------|---------|
| 0-50 lin. feet | \$14.35 |
| 50+ lin. feet | 10.50 |

Viewing Surface: 0-50 sq. ft.

| Viewing Surface | PRICE |
|-----------------------|---------|
| Matt White XT1000V | \$12.35 |
| Pure White XT1300V | 12.35 |
| Pearl White MH1500V | 13.65 |
| Grey XH600V | 13.65 |
| ReAct MS1000V | 13.25 |
| CineFlex CH1200V | 15.00 |
| CineFlex MH800V | 15.00 |
| CineFlex White XT600V | 15.00 |

Viewing Surface: 50-100 sq. ft.

| Viewing Surface | PRICE |
|-----------------------|---------|
| Matt White XT1000V | \$10.60 |
| Pure White XT1300V | 10.60 |
| Pearl White MH1500V | 11.60 |
| Grey XH600V | 11.60 |
| ReAct MS1000V | 11.35 |
| CineFlex CH1200V | 13.00 |
| CineFlex MH800V | 13.00 |
| CineFlex White XT600V | 13.00 |

Viewing Surface: 100+ sq. ft.

| Viewing Surface | PRICE |
|-----------------------|--------|
| Matt White XT1000V | \$8.60 |
| Pure White XT1300V | 8.60 |
| Pearl White MH1500V | 9.40 |
| Grey XH600V | 9.40 |
| ReAct MS1000V | 9.25 |
| CineFlex CH1200V | 10.35 |
| CineFlex MH800V | 10.35 |
| CineFlex White XT600V | 10.35 |

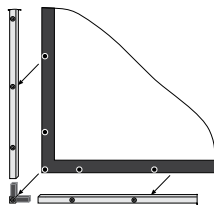

Standard Construction

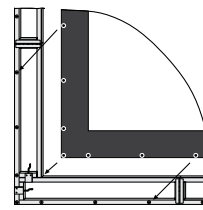

Truss Style Construction (very large sizes only)

Cineperm—(Continued)

*This size requires truss-style construction. Price listed reflects truss-style construction.

| Nom. Diag. | Image Area | Overall Size | CineFlex Surfaces | | ClearSound Surfaces | | | | | Shipping Wt./lbs. | Dim Wt./lbs. | Freight Class |
|----------------------------------|-------------------|-------------------|-------------------|-------|----------------------------|--------|-------------------------------|------------------------------|--------|-------------------|--------------|---------------|
| | | | CineFlex CH1200V | PRICE | ClearSound NanoPerf XT800V | PRICE | ClearSound White Weave XT900E | ClearSound Grey Weave XH600E | PRICE | | | |
| 16:10 Format | | | | | | | | | | | | |
| 67" | 35 1/4" x 56 1/2" | 39 1/4" x 60 1/2" | -- | -- | 251060SC | \$1457 | 251060SA | 251060SB | \$1540 | 19 | 32 | 85 P+ |
| 76" | 40" x 64" | 44" x 68" | -- | -- | 251061SC | 1489 | 251061SA | 251061SB | 1572 | 20 | 39 | 85 P+ |
| 85" | 45" x 72" | 49" x 76" | -- | -- | 251062SC | 1519 | 251062SA | 251062SB | 1602 | 21 | 39 | 85 P+ |
| 94" | 50" x 80" | 54" x 84" | -- | -- | 251063SC | 1550 | 251063SA | 251063SB | 1634 | 22 | 43 | 85 P+ |
| 109" | 57 1/2" x 92" | 61 1/2" x 96" | -- | -- | 251064SC | 2270 | 251064SA | 251064SB | 2354 | 23 | 33 | 85 P+ |
| 113" | 60" x 96" | 64" x 100" | -- | -- | 251139SC | 2332 | 251139SA | 251139SB | 2415 | 26 | 51 | 85 P+ |
| 123" | 65" x 104" | 69" x 108" | -- | -- | 251065SC | 2747 | 251065SA | 251065SB | 2831 | 26 | 33 | 85 P+ |
| 137" | 72 1/2" x 116" | 76 1/2" x 120" | -- | -- | 251066SC | 2834 | 251066SA | 251066SB | 2917 | 30 | 40 | 85 P+ |
| 165" | 87 1/2" x 140" | 91 1/2" x 144" | -- | -- | 251067SC | 3742 | 251067SA | 251067SB | 3826 | 35 | 47 | 85 P+ |
| 16:9 HDTV Format | | | | | | | | | | | | |
| 65" | 31 3/4" x 56 1/2" | 35 3/4" x 60 1/2" | 251032 | \$505 | 250124SC | \$1427 | 250124SA | 250124SB | \$1510 | 19 | 32 | 85 P+ |
| 73" | 36" x 64" | 40" x 68" | 251033 | 537 | 250125SC | 1459 | 250125SA | 250125SB | 1542 | 20 | 39 | 85 P+ |
| 82" | 40 1/2" x 72" | 44 1/2" x 76" | 251034 | 617 | 250126SC | 1534 | 250126SA | 250126SB | 1617 | 20 | 40 | 85 P+ |
| 92" | 45" x 80" | 49" x 84" | 251022 | 707 | 250022SC | 1550 | 250065 | 250110 | 1635 | 22 | 43 | 85 P+ |
| 100" | 49" x 87" | 53" x 91" | 251126 | 767 | 251121SC | 1685 | 251123 | 251125 | 1770 | 22 | 47 | 85 P+ |
| 106" | 52" x 92" | 56" x 96" | 251023 | 869 | 250023SC | 2270 | 250066 | 250111 | 2355 | 22 | 31 | 85 P+ |
| 110" | 54" x 96" | 58" x 100" | 251132 | 890 | 251127SC | 2332 | 251129 | 251131 | 2417 | 22 | 51 | 85 P+ |
| 119" | 58" x 104" | 62" x 108" | 251031 | 980 | 250120SC | 2747 | 250122 | 250119 | 2832 | 26 | 33 | 85 P+ |
| 133" | 65" x 116" | 69" x 120" | 251024 | 1045 | 250024SC | 2834 | 250067 | 250112 | 2921 | 27 | 37 | 85 P+ |
| 161" | 79" x 140" | 84" x 144" | 251025 | 1269 | 250025SC | 3742 | 250068 | 250113 | 3827 | 34 | 45 | 85 P+ |
| 193" | 95" x 169" | 99" x 173" | 251114 | 1589 | 251109SC | 4229 | 251111 | 251113 | 4314 | 45 | 51 | 85 P+ |
| 220" | 108" x 192" | 112" x 196" | 251120 | 1704 | 251115SC | 4516 | 251117 | 251119 | 4601 | 54 | | 85 |
| 4:3 NTSC Video Format | | | | | | | | | | | | |
| 6' | 43" x 57" | 47" x 61" | 251011 | \$473 | 250011SC | \$1504 | 250011SA | 250011SB | \$1587 | 24 | 31 | 85 P+ |
| 6' 6" | 47" x 63" | 51" x 67" | 251012 | 530 | 250012SC | 1619 | 250012SA | 250012SB | 1702 | 25 | 35 | 85 P+ |
| 7' 6" | 54" x 72" | 58" x 76" | 251013 | 633 | 250013SC | 1940 | 250013SA | 250013SB | 2024 | 22 | 39 | 85 P+ |
| 100" | 60" x 80" | 64" x 84" | 251014 | 703 | 250014SC | 1980 | 250063 | 250108 | 2065 | 24 | 34 | 85 P+ |
| 10' | 72" x 96" | 76" x 100" | 251005 | 869 | 250005SC | 2574 | 250064 | 250109 | 2659 | 30 | 40 | 85 P+ |
| 11' | 78" x 104" | 82" x 108" | 251016 | 980 | 250016SC | 2777 | -- | -- | -- | 34 | 43 | 85 P+ |
| 150" | 90" x 120" | 94" x 124" | 251007 | 1045 | 250007SC | 2914 | -- | -- | -- | 36 | 49 | 85 P+ |
| 15' | 108" x 144" | 112" x 148" | 251009 | 1269 | 250009SC | 3776 | -- | -- | -- | 43 | | 85 |
| 200" | 120" x 160" | 124" x 164" | 251019 | 1534 | 250019SC | 4092 | -- | -- | -- | 48 | | 85 |
| 240"* | 144" x 194" | 156" x 206" | 251020 | 4456 | 250020SC | 5835 | -- | -- | -- | 100 | | 85 |
| 25"* | 180" x 240" | 192" x 252" | 251021 | 5930 | 250021SC | 6826 | -- | -- | -- | 172 | | 85 |
| 2.35:1 CinemaScope Format | | | | | | | | | | | | |
| 115" | 45" x 105 3/4" | 49" x 109 3/4" | -- | -- | 251035SC | \$2250 | 251047 | 251051 | \$2335 | 22 | 30 | 85 P+ |
| 132" | 52" x 122" | 56" x 126" | -- | -- | 251036SC | 2907 | 251048 | 251052 | 2992 | 26 | 34 | 85 P+ |
| 148" | 58" x 136 1/4" | 62" x 140 1/4" | -- | -- | 251037SC | 3539 | 251049 | 251053 | 3624 | 28 | 38 | 85 P+ |
| 153" | 60" x 141" | 64" x 145" | -- | -- | 251133SC | 3939 | 251137 | 251138 | 4024 | 47 | | 85 P+ |
| 166" | 65" x 152 3/4" | 69" x 156 3/4" | -- | -- | 251038SC | 4353 | 251050 | 251054 | 4438 | 33 | 41 | 85 P+ |

Accessories for Truss Cineperm

| | Part No. | PRICE |
|----------------------|----------|-------|
| Fly Bracket (single) | 385223 | \$50 |
| Fly Bracket (pair) | 385224 | 92 |

Permanently
Tensioned
Screens

Clarion—The Clarion's aluminum frame forms an attractive 2" border for a clean, theatre-like appearance. The standard frame color is black. Fabric attaches without snaps for quick assembly and a perfectly smooth viewing surface. Permanent wall mounting brackets included.

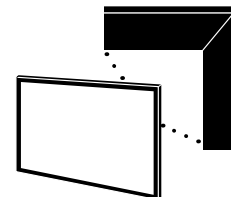

• **Options:** Custom sizes available by quotation. Vel-Tex, a black, velvety textile covering is a recommended option that cuts reflection and conceals all trace of joints in the frame. **To include Vel-Tex on a Clarion screen where it is not standard, add the letter "V" after the part number when ordering (for example, Part number 252019V).**

CineFlex MH800V rear projection surface and CineFlex White XT600V front/rear projection surface are also available at the same price as CineFlex CH1200V. See page 4 for viewing surface details. When ordering these surfaces, use the CineFlex CH1200V part number followed by the appropriate suffix: **CA** for CineFlex MH800V, and **CC** for CineFlex White XT600V. **For ClearSound screen surfaces in sizes not listed, call Draper for quotation.**

Permanently Tensioned Screens

| Nom. Diag. | Image Area | Overall Size | OptiFlex Surfaces | | | | | | | | |
|---|-------------------|-------------------|--------------------|--------------------|--------|-------------|--------|---------------------|--------|---------------|--------|
| | | | Matt White XT1000V | Pure White XT1300V | PRICE | Grey XH600V | PRICE | Pearl White MH1500V | PRICE | ReAct MS1000V | PRICE |
| 16:10 Format | | | | | | | | | | | |
| 67" | 35 1/4" x 56 1/2" | 39 1/4" x 60 1/2" | 252190 | 252190FN | \$742 | 252198 | \$780 | 252206 | \$800 | 252190FR | \$797 |
| 76" | 40" x 64" | 44" x 68" | 252191 | 252191FN | 783 | 252199 | 828 | 252207 | 847 | 252191FR | 842 |
| 85" | 45" x 72" | 49" x 76" | 252192 | 252192FN | 872 | 252200 | 920 | 252208 | 942 | 252192FR | 937 |
| 94" | 50" x 80" | 54" x 84" | 252193 | 252193FN | 994 | 252201 | 1047 | 252209 | 1074 | 252193FR | 1069 |
| 109" | 57 1/2" x 92" | 61 1/2" x 96" | 252194 | 252194FN | 1237 | 252202 | 1305 | 252210 | 1337 | 252194FR | 1330 |
| 113" | 59 7/8" x 95 3/4" | 63 7/8" x 99 3/4" | 252295 | 252295FN | 1350 | 252298 | 1425 | 252299 | 1459 | 252295FR | 1452 |
| 123" | 65" x 104" | 69" x 108" | 252195 | 252195FN | 1464 | 252203 | 1545 | 252211 | 1580 | 252195FR | 1574 |
| 137" | 72 1/2" x 116" | 76 1/2" x 120" | 252196 | 252196FN | 1690 | 252204 | 1782 | 252212 | 1827 | 252196FR | 1817 |
| 165" | 87 1/2" x 140" | 91 1/2" x 144" | 252197 | 252197FN | 1917 | 252205 | 2024 | 252213 | 2070 | -- | -- |
| 16:9 HDTV Format | | | | | | | | | | | |
| 65" | 31 3/4" x 56 1/2" | 35 3/4" x 60 1/2" | 252139 | 252139FN | \$742 | 252145 | \$780 | 252142 | \$800 | 252139FR | \$797 |
| 73" | 36" x 64" | 40" x 68" | 252140 | 252140FN | 783 | 252146 | 828 | 252143 | 847 | 252140FR | 842 |
| 82" | 40 1/2" x 72" | 44 1/2" x 76" | 252141 | 252141FN | 872 | 252147 | 920 | 252144 | 942 | 252141FR | 937 |
| 92" | 45" x 80" | 49" x 84" | 252016 | 252016FN | 994 | 252104 | 1047 | 252040 | 1074 | 252016FR | 1069 |
| 100" | 49" x 87" | 53" x 91" | 252247 | 252247FN | 1085 | 252250 | 1145 | 252248 | 1172 | 252247FR | 1167 |
| 106" | 52" x 92" | 56" x 96" | 252017 | 252017FN | 1237 | 252105 | 1305 | 252041 | 1337 | 252017FR | 1330 |
| 110" | 54" x 96" | 58" x 100" | 252256 | 252256FN | 1302 | 252259 | 1374 | 252257 | 1407 | 252256FR | 1400 |
| 119" | 58" x 104" | 62" x 108" | 252133 | 252133FN | 1464 | 252138 | 1545 | 252134 | 1580 | 252133FR | 1574 |
| 133" | 65" x 116" | 69" x 120" | 252018 | 252018FN | 1690 | 252106 | 1782 | 252042 | 1827 | 252018FR | 1817 |
| 161" | 79" x 140" | 84" x 144" | 252019 | 252019FN | 1917 | 252107 | 2024 | 252043 | 2070 | 252019FR | 2060 |
| 16:9 HDTV Format with Vel-Tex | | | | | | | | | | | |
| 82" | 40 1/2" x 72" | 44 1/2" x 76" | 252283 | 252283FN | \$1042 | 252285 | \$1092 | 252284 | \$1112 | 252283FR | \$1107 |
| 92" | 45" x 80" | 49" x 84" | 252087 | 252087FN | 1164 | 252151 | 1219 | 252278 | 1244 | 252087FR | 1239 |
| 100" | 49" x 87" | 53" x 91" | 252252 | 252252FN | 1255 | 252253 | 1315 | 252279 | 1344 | 252252FR | 1339 |
| 106" | 52" x 92" | 56" x 96" | 252088 | 252088FN | 1409 | 252152 | 1477 | 252280 | 1507 | 252088FR | 1502 |
| 110" | 54" x 96" | 58" x 100" | 252261 | 252261FN | 1474 | 252262 | 1545 | 252281 | 1577 | 252261FR | 1572 |
| 119" | 58" x 104" | 62" x 108" | 252137 | 252137FN | 1635 | 252153 | 1715 | 252282 | 1752 | 252137FR | 1747 |
| 133" | 65" x 116" | 69" x 120" | 252277 | 252277FN | 1860 | 252286 | 1954 | 252287 | 1997 | 252277FR | 1989 |
| 161" | 80" x 140" | 84" x 144" | 252290 | 252290FN | 2089 | 252291 | 2194 | 252292 | 2242 | 252290FR | 2234 |
| 4:3 NTSC Video Format | | | | | | | | | | | |
| 6" | 43" x 57" | 47" x 61" | 252008 | 252008FN | \$680 | 252096 | \$715 | 252032 | \$733 | 252008FR | \$732 |
| 6' 6" | 47" x 63" | 51" x 67" | 252009 | 252009FN | 758 | 252097 | 800 | 252033 | 818 | 252009FR | 815 |
| 7" | 50" x 67" | 54" x 71" | 252010 | 252010FN | 802 | 252098 | 845 | 252034 | 867 | 252010FR | 862 |
| 7' 6" | 54" x 72" | 58" x 76" | 252011 | 252011FN | 950 | 252099 | 1004 | 252035 | 1027 | 252011FR | 1022 |
| 100" | 60" x 80" | 64" x 84" | 252012 | 252012FN | 994 | 252100 | 1047 | 252036 | 1074 | 252012FR | 1069 |
| 10' | 72" x 96" | 76" x 100" | 252013 | 252013FN | 1237 | 252101 | 1305 | 252037 | 1337 | 252013FR | 1330 |
| 150" | 90" x 120" | 94" x 124" | 252014 | 252014FN | 1690 | 252102 | 1782 | 252038 | 1827 | -- | -- |
| 15' | 108" x 144" | 112" x 148" | 252015 | 252015FN | 2179 | 252156 | 2299 | 252039 | 2352 | -- | -- |
| 4:3 NTSC Video Format with Vel-Tex | | | | | | | | | | | |
| 7" | 50" x 67" | 54" x 71" | 252084 | 252084FN | \$972 | -- | -- | -- | -- | 252084FR | \$1032 |
| 100" | 60" x 80" | 64" x 84" | 252085 | 252085FN | 1164 | -- | -- | -- | -- | 252085FR | 1239 |
| 10' | 72" x 96" | 76" x 100" | 252086 | 252086FN | 1409 | -- | -- | -- | -- | 252086FR | 1500 |
| 2.35:1 CinemaScope Format | | | | | | | | | | | |
| 115" | 45" x 105 3/4" | 49" x 109 3/4" | 252244 | 252244FN | \$1429 | -- | -- | -- | -- | 252244FR | \$1535 |
| 132" | 52" x 122" | 56" x 126" | 252245 | 252245FN | 1717 | -- | -- | -- | -- | 252245FR | 1845 |
| 148" | 58" x 136 1/4" | 62" x 140 1/4" | 252246 | 252246FN | 1967 | -- | -- | -- | -- | 252246FR | 2115 |
| 2.35:1 CinemaScope Format with Vel-Tex | | | | | | | | | | | |
| 115" | 45" x 105 3/4" | 49" x 109 3/4" | 252170 | 252170FN | \$1599 | 252178 | \$1679 | 252174 | \$1732 | 252170FR | \$1892 |
| 132" | 52" x 122" | 56" x 126" | 252171 | 252171FN | 1889 | 252179 | 1982 | 252175 | 2042 | 252171FR | 2200 |
| 148" | 58" x 136 1/4" | 62" x 140 1/4" | 252172 | 252172FN | 2137 | 252180 | 2245 | 252176 | 2312 | 252172FR | 2469 |
| 153" | 60" x 141" | 64" x 145" | 252271 | 252271FN | 2332 | 252272 | 2450 | 252273 | 2522 | 252271FR | 2509 |
| 166" | 65" x 152 3/4" | 69" x 156 3/4" | 252173 | 252173FN | 2475 | 252181 | 2602 | 252177 | 2679 | 252173FR | 2662 |

Custom Size Clarion—Clarion screens are available in any desired custom size up to the standard sizes shown above. Some fabrics available in limited sizes.

Overall size, including frame, equals image area plus four inches. Base fabric cost on overall square footage including frame. Frame cost is per lineal foot, rounded up to next even foot (example—round 137" up to 14').

Add Vel-Tex to frame.

Viewing Surface (per square foot)

| Viewing Surface | PRICE |
|---------------------|---------|
| Matt White XT1000V | \$13.75 |
| Pure White XT1300V | 13.75 |
| Pearl White MH1500V | 14.90 |
| Grey XH600V | 14.90 |
| ReAct MS1000V | 14.75 |
| CineFlex CH1200V | 16.40 |
| CineFlex MH800V | 16.40 |

Frame (per lineal foot)

| Viewing Surface | PRICE |
|-------------------------------|---------|
| CineFlex White XT600V | \$16.40 |
| ClearSound NanoPerf XT800V | 18.10 |
| ClearSound White Weave XT900E | 18.65 |
| ClearSound Grey Weave XH600E | 18.65 |

CHART CONTINUED

Clarion—(Continued)

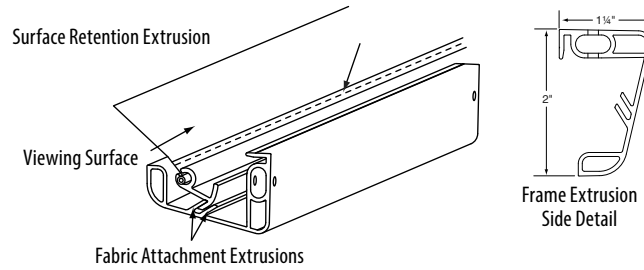

| Nom. Diag. | Image Area | Overall Size | CineFlex Surface | | ClearSound NanoPerf XT800V | ClearSound PRICE | ClearSound Surfaces | | | Shipping Wt./lbs. | Dim Wt./lbs. | Freight Class |
|---|-------------------|-------------------|------------------|-------|----------------------------|------------------|-------------------------|-----------------------------|--------|-------------------|--------------|---------------|
| | | | CineFlex CH1200V | PRICE | | | ClearSound White XT900E | ClearSound GreyWeave XH600E | PRICE | | | |
| 16:10 Format | | | | | | | | | | | | |
| 67" | 35 1/4" x 56 1/2" | 39 1/4" x 60 1/2" | -- | -- | 252190SC | \$1799 | 252190SA | 252190SB | \$1882 | 36 | | 85 P+ |
| 76" | 40" x 64" | 44" x 68" | -- | -- | 252191SC | 1835 | 252191SA | 252191SB | 1919 | 21 | 38 | 85 P+ |
| 85" | 45" x 72" | 49" x 76" | -- | -- | 252192SC | 1984 | 252192SA | 252192SB | 2067 | 24 | 41 | 85 P+ |
| 94" | 50" x 80" | 54" x 84" | -- | -- | 252193SC | 2145 | 252193SA | 252193SB | 2229 | 26 | 45 | 85 P+ |
| 109" | 57 1/2" x 92" | 61 1/2" x 96" | -- | -- | 252194SC | 3136 | 252194SA | 252194SB | 3219 | 31 | 51 | 85 P+ |
| 113" | 59 7/8" x 95 3/4" | 63 7/8" x 99 3/4" | -- | -- | 252295SC | 3459 | 252295SA | 252295SB | 3542 | 36 | | 85 |
| 123" | 65" x 104" | 69" x 108" | -- | -- | 252195SC | 3781 | 252195SA | 252195SB | 3864 | 47 | | 85 |
| 137" | 72 1/2" x 116" | 76 1/2" x 120" | -- | -- | 252196SC | 3901 | 252196SA | 252196SB | 3984 | 41 | | 85 |
| 165" | 87 1/2" x 140" | 91 1/2" x 144" | -- | -- | 252197SC | 5136 | 252197SA | 252197SB | 5219 | 52 | | 85 |
| 16:9 HDTV Format | | | | | | | | | | | | |
| 65" | 31 3/4" x 56 1/2" | 35 3/4" x 60 1/2" | 252165 | \$895 | 252139SC | \$1664 | 252139SA | 252139SB | \$1747 | 35 | | 85 P+ |
| 73" | 36" x 64" | 40" x 68" | 252166 | 950 | 252140SC | 1799 | 252140SA | 252140SB | 1882 | 40 | | 85 P+ |
| 82" | 40 1/2" x 72" | 44 1/2" x 76" | 252167 | 1037 | 252141SC | 1944 | 252141SA | 252141SB | 2027 | 23 | 41 | 85 P+ |
| 92" | 45" x 80" | 49" x 84" | 252168 | 1185 | 252016SC | 2145 | 252075 | 252123 | 2232 | 25 | 45 | 85 P+ |
| 100" | 49" x 87" | 53" x 91" | -- | -- | 252247SC | 2352 | 252249 | 252251 | 2439 | 47 | 48 | 85 P+ |
| 106" | 52" x 92" | 56" x 96" | -- | -- | 252017SC | 3136 | 252076 | 252124 | 3221 | 30 | 51 | 85 P+ |
| 110" | 54" x 96" | 58" x 100" | -- | -- | 252256SC | 3302 | 252258 | 252260 | 3389 | 30 | 53 | 85 P+ |
| 119" | 58" x 104" | 62" x 108" | -- | -- | 252133SC | 3781 | 252136 | 252132 | 3867 | 32 | | 85 |
| 133" | 65" x 116" | 69" x 120" | -- | -- | 252018SC | 3901 | 252077 | 252125 | 3986 | 39 | | 85 |
| 161" | 79" x 140" | 84" x 144" | -- | -- | 252019SC | 5136 | 252078 | 252126 | 5221 | 50 | | 85 |
| 16:9 HDTV Format with Vel-Tex | | | | | | | | | | | | |
| 82" | 40 1/2" x 72" | 44 1/2" x 76" | -- | -- | 252283SC | \$2152 | 252283SA | 252283SB | \$2235 | 23 | | 85 |
| 92" | 45" x 80" | 49" x 84" | -- | -- | 252087SC | 2317 | 252239 | 252240 | 2402 | 27 | 44 | 85 P+ |
| 100" | 49" x 87" | 53" x 91" | -- | -- | 252252SC | 2524 | 252254 | 252255 | 2609 | 28 | 48 | 85 P+ |
| 106" | 52" x 92" | 56" x 96" | -- | -- | 252088SC | 3306 | 252241 | 252242 | 3392 | 31 | 51 | 85 P+ |
| 110" | 54" x 96" | 58" x 100" | -- | -- | 252261SC | 3474 | 252263 | 252264 | 3559 | 31 | 53 | 85 P+ |
| 119" | 58" x 104" | 62" x 108" | -- | -- | 252137SC | 3952 | 252243 | 252238 | 4037 | 34 | | 85 |
| 133" | 65" x 116" | 69" x 120" | -- | -- | 252277SC | 4072 | 252288 | 252289 | 4157 | 38 | | 85 |
| 161" | 80" x 140" | 84" x 144" | -- | -- | 252290SC | 5308 | 252293 | 252294 | 5393 | 50 | | 85 |
| 4:3 NTSC Video Format | | | | | | | | | | | | |
| 6" | 43" x 57" | 47" x 61" | 252160 | \$828 | 252008SC | \$2045 | 252008SA | 252008SB | \$2129 | 35 | | 85 P+ |
| 6' 6" | 47" x 63" | 51" x 67" | 252161 | 917 | 252009SC | 1962 | 252009SA | 252009SB | 2045 | 23 | 37 | 85 P+ |
| 7" | 50" x 67" | 54" x 71" | 252162 | 950 | 252010SC | 2180 | 252010SA | 252010SB | 2264 | 24 | 39 | 85 P+ |
| 7' 6" | 54" x 72" | 58" x 76" | 252163 | 1150 | 252011SC | 2422 | 252011SA | 252011SB | 2506 | 25 | 41 | 85 P+ |
| 100" | 60" x 80" | 64" x 84" | 252164 | 1194 | 252012SC | 2692 | 252073 | 252121 | 2779 | 29 | 45 | 85 P+ |
| 10' | 72" x 96" | 76" x 100" | -- | -- | 252013SC | 3537 | 252074 | 252122 | 3622 | 34 | 53 | 85 P+ |
| 150" | 90" x 120" | 94" x 124" | -- | -- | 252014SC | 3956 | 252014SA | 252014SB | 4039 | 47 | | 85 |
| 15' | 108" x 144" | 112" x 148" | -- | -- | 252015SC | 5161 | 252015SA | 252015SB | 5244 | 59 | | 85 |
| 4:3 NTSC Video Format with Vel-Tex | | | | | | | | | | | | |
| 7" | 50" x 67" | 54" x 71" | -- | -- | 252084SC | \$2389 | 252084SA | 252084SB | \$2472 | 40 | | 85 P+ |
| 100" | 60" x 80" | 64" x 84" | -- | -- | 252085SC | 2864 | 252085SA | 252085SB | 2947 | 30 | 45 | 85 P+ |
| 10' | 72" x 96" | 76" x 100" | -- | -- | 252086SC | 3707 | 252086SA | 252086SB | 3791 | 58 | | 85 P+ |
| 2.35:1 CinemaScope Format | | | | | | | | | | | | |
| 115" | 45" x 105 3/4" | 49" x 109 3/4" | -- | -- | 252244SC | \$2676 | 252265 | 252266 | \$2761 | 32 | | 85 |
| 132" | 52" x 122" | 56" x 126" | -- | -- | 252245SC | 3392 | 252267 | 252268 | 3477 | 38 | | 85 |
| 148" | 58" x 136 1/4" | 62" x 140 1/4" | -- | -- | 252246SC | 4064 | 252269 | 252270 | 4151 | 42 | | 85 |
| 2.35:1 CinemaScope Format with Vel-Tex | | | | | | | | | | | | |
| 115" | 45" x 105 3/4" | 49" x 109 3/4" | -- | -- | 252170SC | \$2847 | 252182 | 252186 | \$2932 | 47 | | 85 |
| 132" | 52" x 122" | 56" x 126" | -- | -- | 252171SC | 3562 | 252183 | 252187 | 3647 | 54 | | 85 |
| 148" | 58" x 136 1/4" | 62" x 140 1/4" | -- | -- | 252172SC | 4236 | 252184 | 252188 | 4321 | 56 | | 85 |
| 153" | 60" x 141" | 64" x 145" | -- | -- | 252271SC | 4599 | 252275 | 252276 | 4686 | 55 | | 85 |
| 166" | 65" x 152 3/4" | 69" x 156 3/4" | -- | -- | 252173SC | 5109 | 252185 | 252189 | 5194 | 48 | | 85 |

Permanently Tensioned Screens

Accessories for Clarion

| | Part No. | PRICE |
|---|----------|-------|
| Corner Reinforcement Kit —The Corner Reinforcement Kit is required for any Clarion that: will be suspended or "flown," is used with TorkStar, or has a viewing area greater than 120" in either height or width. | 252154 | \$82 |
| Vel-Tex ®—A velvety black textile that cuts reflections to virtually zero and conceals all trace of joints in the frame. To include Vel-Tex on a Clarion screen where it is not standard, add the letter "V" after the part number when ordering (for example, Part number 252019V). | — | 208 |

Onyx—The Onyx has a 4" wide, beveled trim frame and a proprietary adjustable surface tensioning system that keeps the viewing surface perfectly flat, with no puckering. No snaps—assembles easily in minutes. The miter cut frame is wider to handle overscan, and provides up to 1½" of horizontal or vertical viewing surface tension adjustment. Black painted aluminum frame is standard.

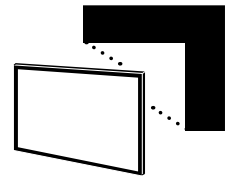

• **Options:** Custom sizes, by quotation. Vel-Tex, a black, velvety textile covering, is a recommended option that cuts reflection and conceals all trace of joints in the frame. To include Vel-Tex on an Onyx screen where it is not standard, add the letter "V" after the part number when ordering (for example, Part number 253215V).

CineFlex MH800V rear projection surface and CineFlex White XT600V front/rear projection surface are also available at the same price as CineFlex CH1200V. See page 4 for viewing surface details. When ordering these surfaces, use the CineFlex CH1200V part number followed by the appropriate suffix: **CA** for CineFlex MH800V, and **CC** for CineFlex White XT600V. **For ClearSound screen surfaces in sizes not listed below, call Draper for quotation.**

Permanently Tensioned Screens

| | | OptiFlex Surfaces | | | | | | | | | |
|---|---------------|-------------------|------------|----------|--------|------------|--------|---------|---------------|--------|--|
| Nom. Diag. | Image Area | Overall Size | Matt White | | | Pure White | | | Pearl White | | |
| | | | XT1000V | XT1300V | PRICE | XH600V | PRICE | MH1500V | ReAct MS1000V | PRICE | |
| 16:10 Format | | | | | | | | | | | |
| 67" | 35 ¼" x 56 ½" | 43 ¼" x 64 ½" | 253817 | 253817FN | \$763 | 253816 | \$805 | 253818 | 253817FR | \$820 | |
| 76" | 40" x 64" | 48" x 72" | 253821 | 253821FN | 808 | 253820 | 854 | 253822 | 253821FR | 869 | |
| 85" | 45" x 72" | 53" x 80" | 253825 | 253825FN | 897 | 253824 | 947 | 253826 | 253825FR | 964 | |
| 94" | 50" x 80" | 58" x 88" | 253831 | 253831FN | 1024 | 253830 | 1080 | 253832 | 253831FR | 1100 | |
| 109" | 57 ½" x 92" | 65 ½" x 100" | 253837 | 253837FN | 1275 | 253836 | 1345 | 253838 | 253837FR | 1370 | |
| 113" | 60" x 96" | 68" x 104" | 253892 | 253892FN | 1324 | 253893 | 1397 | 253894 | 253892FR | 1424 | |
| 123" | 65" x 104" | 73" x 112" | 253843 | 253843FN | 1507 | 253842 | 1590 | 253844 | 253843FR | 1620 | |
| 137" | 72 ½" x 116" | 80 ½" x 124" | 253849 | 253849FN | 1740 | 253848 | 1835 | 253850 | 253849FR | 1870 | |
| 165" | 87 ½" x 140" | 95 ½" x 148" | 253855 | 253855FN | 1975 | 253854 | 2084 | 253856 | -- | 2124 | |
| 16:10 Format with Vel-Tex | | | | | | | | | | | |
| 67" | 35 ¼" x 56 ½" | 43 ¼" x 64 ½" | 253859 | 253859FN | \$935 | 253858 | \$987 | 253860 | 253859FR | \$1005 | |
| 76" | 40" x 64" | 48" x 72" | 253862 | 253862FN | 979 | 253861 | 1032 | 253863 | 253862FR | 1052 | |
| 85" | 45" x 72" | 53" x 80" | 253865 | 253865FN | 1069 | 253864 | 1127 | 253866 | 253865FR | 1149 | |
| 94" | 50" x 80" | 58" x 88" | 253870 | 253870FN | 1194 | 253869 | 1259 | 253871 | 253870FR | 1284 | |
| 109" | 57 ½" x 92" | 65 ½" x 100" | 253875 | 253875FN | 1445 | 253874 | 1525 | 253876 | 253875FR | 1554 | |
| 113" | 60" x 96" | 68" x 104" | 253898 | 253898FN | 1495 | 253930 | 1577 | 253931 | 253898FR | 1607 | |
| 123" | 65" x 104" | 73" x 112" | 253880 | 253880FN | 1679 | 253879 | 1770 | 253881 | 253880FR | 1805 | |
| 137" | 72 ½" x 116" | 80 ½" x 124" | 253883 | 253883FN | 1912 | 253882 | 2017 | 253884 | 253883FR | 2055 | |
| 16:9 HDTV Format | | | | | | | | | | | |
| 65" | 31 ¾" x 56 ½" | 39 ¾" x 64 ½" | 253606 | 253606FN | \$763 | 253612 | \$805 | 253609 | 253606FR | \$820 | |
| 73" | 36" x 64" | 44" x 72" | 253607 | 253607FN | 808 | 253613 | 854 | 253610 | 253607FR | 869 | |
| 82" | 40 ½" x 72" | 48 ½" x 80" | 253608 | 253608FN | 897 | 253614 | 947 | 253611 | 253608FR | 964 | |
| 92" | 45" x 80" | 53" x 88" | 253216 | 253216FN | 1024 | 253304 | 1080 | 253240 | 253216FR | 1100 | |
| 100" | 49" x 87" | 57" x 95" | 253699 | 253699FN | 1212 | 253497 | 1279 | 253792 | 253699FR | 1304 | |
| 106" | 52" x 92" | 60" x 100" | 253217 | 253217FN | 1275 | 253305 | 1345 | 253241 | 253217FR | 1370 | |
| 110" | 54" x 96" | 62" x 104" | 253379 | 253379FN | 1324 | 253461 | 1397 | 253507 | 253379FR | 1424 | |
| 119" | 58" x 104" | 66" x 112" | 253338 | 253338FN | 1507 | 253340 | 1590 | 253339 | 253338FR | 1620 | |
| 133" | 65" x 116" | 73" x 124" | 253218 | 253218FN | 1740 | 253306 | 1835 | 253242 | 253218FR | 1870 | |
| 161" | 79" x 140" | 87" x 148" | 253219 | 253219FN | 1975 | 253307 | 2084 | 253243 | 253219FR | 2124 | |
| 193" | 95" x 169" | 103" x 177" | 253773 | 253773FN | 2319 | 253772 | 2447 | 253774 | -- | 2492 | |
| 220" | 108" x 192" | 116" x 200" | 253784 | 253784FN | 2502 | 253783 | 2641 | 253785 | -- | 2691 | |
| 16:9 HDTV Format with Vel-Tex | | | | | | | | | | | |
| 65" | 31 ¾" x 56 ½" | 39 ¾" x 64 ½" | 253620 | 253620FN | \$935 | 253626 | \$987 | 253623 | 253620FR | \$1005 | |
| 73" | 36" x 64" | 44" x 72" | 253621 | 253621FN | 979 | 253627 | 1032 | 253624 | 253621FR | 1052 | |
| 82" | 40 ½" x 72" | 48 ½" x 80" | 253622 | 253622FN | 1069 | 253628 | 1127 | 253625 | 253622FR | 1149 | |
| 92" | 45" x 80" | 53" x 88" | 253287 | 253287FN | 1194 | 253342 | 1259 | 253392 | 253287FR | 1284 | |
| 100" | 49" x 87" | 57" x 95" | 253476 | 253476FN | 1382 | 253375 | 1459 | 253659 | 253476FR | 1485 | |
| 106" | 52" x 92" | 60" x 100" | 253288 | 253288FN | 1445 | 253343 | 1525 | 253387 | 253288FR | 1554 | |
| 110" | 54" x 96" | 62" x 104" | 253383 | 253383FN | 1495 | 253514 | 1577 | 253811 | 253383FR | 1607 | |
| 119" | 58" x 104" | 66" x 112" | 253374 | 253374FN | 1679 | 253344 | 1770 | 253435 | 253374FR | 1805 | |
| 133" | 65" x 116" | 73" x 124" | 253399 | 253399FN | 1912 | 253384 | 2017 | 253654 | 253399FR | 2055 | |
| 161" | 79" x 140" | 87" x 148" | 253429 | 253429FN | 2145 | 253433 | 2264 | 253436 | 253429FR | 2307 | |
| 193" | 95" x 169" | 103" x 177" | 253779 | 253779FN | 2489 | 253778 | 2626 | 253780 | -- | 2676 | |
| 220" | 108" x 192" | 116" x 200" | 253790 | 253790FN | 2672 | 253789 | 2819 | 253791 | -- | 2872 | |
| 4:3 NTSC Video Format | | | | | | | | | | | |
| 6" | 43" x 57" | 51" x 65" | 253208 | 253208FN | \$700 | 253296 | \$738 | 253232 | 253208FR | \$753 | |
| 6' 6" | 47" x 63" | 55" x 71" | 253209 | 253209FN | 780 | 253297 | 823 | 253233 | 253209FR | 839 | |
| 7' | 50" x 67" | 58" x 75" | 253210 | 253210FN | 825 | 253298 | 870 | 253234 | 253210FR | 887 | |
| 7' 6" | 54" x 72" | 62" x 80" | 253211 | 253211FN | 977 | 253299 | 1030 | 253235 | 253211FR | 1050 | |
| 100" | 60" x 80" | 68" x 88" | 253212 | 253212FN | 1024 | 253300 | 1080 | 253236 | 253212FR | 1100 | |
| 10" | 72" x 96" | 80" x 104" | 253213 | 253213FN | 1275 | 253301 | 1345 | 253237 | 253213FR | 1370 | |
| 150" | 90" x 120" | 98" x 128" | 253214 | 253214FN | 1740 | 253302 | 1835 | 253238 | -- | 1870 | |
| 15' | 108" x 144" | 116" x 152" | 253215 | 253215FN | 2245 | 253705 | 2369 | 253239 | -- | 2414 | |
| 4:3 NTSC Video Format with Vel-Tex | | | | | | | | | | | |
| 7' | 50" x 67" | 58" x 75" | 253284 | 253284FN | \$997 | 253404 | \$1052 | -- | 253284FR | \$1072 | |
| 100" | 60" x 80" | 68" x 88" | 253285 | 253285FN | 1194 | 253341 | 1259 | 253373 | 253285FR | 1284 | |
| 10' | 72" x 96" | 80" x 104" | 253286 | 253286FN | 1445 | 253463 | 1525 | -- | 253286FR | 1554 | |
| 2.35:1 CinemaScope Format with Vel-Tex | | | | | | | | | | | |
| 115" | 45" x 105 ¾" | 53" x 113 ¾" | 253748 | 253748FN | \$1644 | 253747 | \$1734 | 253749 | 253748FR | \$1767 | |
| 132" | 52" x 122" | 60" x 130" | 253753 | 253753FN | 1897 | 253752 | 2002 | 253754 | 253753FR | 2039 | |
| 148" | 58" x 136 ¼" | 66" x 144 ¼" | 253758 | 253758FN | 2345 | 253757 | 2474 | 253759 | 253758FR | 2522 | |
| 153" | 60" x 141" | 68" x 149" | 253886 | 253886FN | 2546 | 253887 | 2686 | 253888 | 253886FR | 2737 | |
| 166" | 65" x 152 ¾" | 73" x 160 ¾" | 253763 | 253763FN | 2674 | 253762 | 2821 | 253764 | 253763FR | 2874 | |
| 204" | 80" x 188" | 88" x 196" | 253768 | 253768FN | 3542 | 253767 | 3737 | 253769 | 253768FR | 3807 | |

CHART CONTINUED

Custom Size Onyx—Onyx screens are available in any desired custom size up to 20' x 20'. Some fabrics available in limited sizes Overall size, including frame, equals image area plus eight inches. Base fabric cost on overall square footage including frame. Frame cost is per lineal foot, rounded up to next even foot (example—round 18'4" up to 19').
Add Vel-Tex to frame.

Viewing Surface (per square foot)

| Viewing Surface | PRICE |
|---------------------|---------|
| Matt White XT1000V | \$14.10 |
| Pure White XT1300V | 14.10 |
| Pearl White MH1500V | 15.40 |
| ReAct MS1000V | 15.15 |
| Grey XH600V | 15.40 |
| CineFlex CH1200V | 17.00 |

Frame (per lineal foot)

| Viewing Surface | PRICE |
|----------------------------|---------|
| CineFlex MH800V | \$17.00 |
| CineFlex White XT600V | 17.00 |
| ClearSound NanoPerf XT800V | 18.60 |

Onyx—(Continued)

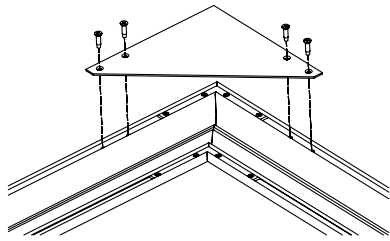

Corner Reinforcement Kit

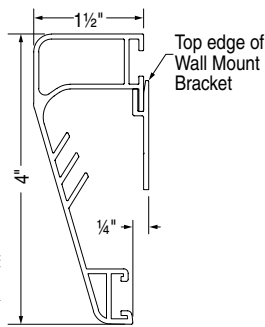

Frame Extrusion Side Detail

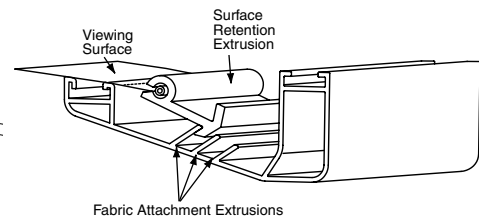
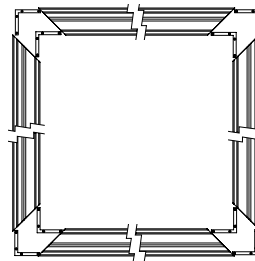

| Nom. Diag. | Image Area | Overall Size | CineFlex Surface | | ClearSound NanoPerf XT800V | | ClearSound White Weave XT900E | | ClearSound Grey Weave XH600E | | Shipping Wt./lbs. | Dim Wt./lbs. | Freight Class |
|---|-------------------|-------------------|------------------|-------|----------------------------|--------|-------------------------------|----------|------------------------------|-----|-------------------|--------------|---------------|
| | | | CH1200V | PRICE | PRICE | PRICE | PRICE | | | | | | |
| 16:10 Format | | | | | | | | | | | | | |
| 67" | 35 1/4" x 56 1/2" | 43 1/4" x 64 1/2" | 253819 | \$924 | 253817SC | \$1785 | 253817SA | 253817SB | \$1869 | 35 | | 85 | P+ |
| 76" | 40" x 64" | 48" x 72" | 253823 | 977 | 253821SC | 1930 | 253821SA | 253821SB | 2014 | 37 | 38 | 85 | P+ |
| 85" | 45" x 72" | 53" x 80" | 253827 | 1069 | 253825SC | 2087 | 253825SA | 253825SB | 2170 | 39 | 42 | 85 | P+ |
| 94" | 50" x 80" | 58" x 88" | 253833 | 1220 | 253831SC | 2257 | 253829 | 253828 | 2340 | 42 | 46 | 85 | P+ |
| 109" | 57 1/2" x 92" | 65 1/2" x 100" | 253839 | 1535 | 253837SC | 3301 | 253835 | 253834 | 3384 | 43 | 53 | 85 | P+ |
| 113" | 60" x 96" | 68" x 104" | 253895 | 1589 | 253892SC | 3707 | 253897 | 253896 | 3791 | 44 | 47 | 85 | P+ |
| 123" | 65" x 104" | 73" x 112" | 253845 | 1795 | 253843SC | 3977 | 253841 | 253840 | 4061 | 46 | | 85 | |
| 137" | 72 1/2" x 116" | 80 1/2" x 124" | 253851 | 2065 | 253849SC | 4102 | 253847 | 253846 | 4186 | 53 | | 85 | |
| 165" | 87 1/2" x 140" | 95 1/2" x 148" | 253857 | 2334 | 253855SC | 5398 | 253853 | 253852 | 5481 | 66 | | 85 | |
| 16:10 Format with Vel-Tex | | | | | | | | | | | | | |
| 67" | 35 1/4" x 56 1/2" | 43 1/4" x 64 1/2" | -- | -- | 253859SC | \$1994 | 253859SA | 253859SB | \$2077 | 28 | 36 | 85 | P+ |
| 76" | 40" x 64" | 48" x 72" | -- | -- | 253862SC | 2139 | 253862SA | 253862SB | 2222 | 31 | 39 | 85 | P+ |
| 85" | 45" x 72" | 53" x 80" | -- | -- | 253865SC | 2295 | 253865SA | 253865SB | 2379 | 33 | 42 | 85 | P+ |
| 94" | 50" x 80" | 58" x 88" | -- | -- | 253870SC | 2429 | 253868 | 253867 | 2512 | 44 | 45 | 85 | P+ |
| 109" | 57 1/2" x 92" | 65 1/2" x 100" | -- | -- | 253875SC | 3471 | 253873 | 253872 | 3554 | 50 | 51 | 85 | P+ |
| 113" | 60" x 96" | 68" x 104" | -- | -- | 253898SC | 3811 | 253933 | 253932 | 3894 | 55 | | 85 | |
| 123" | 65" x 104" | 73" x 112" | -- | -- | 253880SC | 4149 | 253878 | 253877 | 4233 | 57 | | 85 | |
| 137" | 72 1/2" x 116" | 80 1/2" x 124" | -- | -- | 253883SC | 4311 | -- | -- | -- | 62 | | 85 | |
| 16:9 HDTV Format | | | | | | | | | | | | | |
| 65" | 31 3/4" x 56 1/2" | 39 3/4" x 64 1/2" | 253615 | \$924 | 253606SC | \$1740 | 253606SA | 253606SB | \$1824 | 35 | | 85 | P+ |
| 73" | 36" x 64" | 44" x 72" | 253616 | 977 | 253607SC | 1882 | 253607SA | 253607SB | 1965 | 37 | | 85 | P+ |
| 82" | 40 1/2" x 72" | 48 1/2" x 80" | 253617 | 1069 | 253608SC | 2034 | 253608SA | 253608SB | 2117 | 39 | 41 | 85 | P+ |
| 92" | 45" x 80" | 53" x 88" | 253628 | 1220 | 253216SC | 2257 | 253275 | 253359 | 2340 | 42 | 46 | 85 | P+ |
| 100" | 49" x 87" | 57" x 95" | 253794 | 1454 | 253699SC | 2662 | 253793 | 253795 | 2746 | 45 | 48 | 85 | P+ |
| 106" | 52" x 92" | 60" x 100" | 253329 | 1535 | 253217SC | 3301 | 253276 | 253360 | 3384 | 49 | 52 | 85 | P+ |
| 110" | 54" x 96" | 62" x 104" | 253809 | 1589 | 253379SC | 3707 | 253808 | 253810 | 3791 | 50 | 53 | 85 | P+ |
| 119" | 58" x 104" | 66" x 112" | 253330 | 1795 | 253338SC | 3977 | 253369 | 253368 | 4061 | 54 | | 85 | |
| 133" | 65" x 116" | 73" x 124" | 253331 | 2065 | 253218SC | 4102 | 253277 | 253361 | 4186 | 60 | 85 | | |
| 161" | 79" x 140" | 87" x 148" | 253332 | 2334 | 253219SC | 5398 | 253278 | 253362 | 5481 | 73 | | 85 | |
| 193" | 95" x 169" | 103" x 177" | 253775 | 2782 | 253773SC | 5713 | 253771 | 253770 | 5796 | 74 | | 85 | |
| 220" | 108" x 192" | 116" x 200" | 253786 | 3001 | 253784SC | 6171 | 253782 | 253781 | 6255 | 96 | | 85 | |
| 16:9 HDTV Format with Vel-Tex | | | | | | | | | | | | | |
| 65" | 31 3/4" x 56 1/2" | 39 3/4" x 64 1/2" | -- | -- | 253620SC | \$1949 | 253620SA | 253620SB | \$2032 | 35 | | 85 | P+ |
| 73" | 36" x 64" | 44" x 72" | -- | -- | 253621SC | 2090 | 253621SA | 253621SB | 2174 | 39 | | 85 | P+ |
| 82" | 40 1/2" x 72" | 48 1/2" x 80" | -- | -- | 253622SC | 2242 | 253622SA | 253622SB | 2325 | 41 | | 85 | P+ |
| 92" | 45" x 80" | 53" x 88" | -- | -- | 253287SC | 2429 | 253406 | 253381 | 2512 | 42 | 47 | 85 | P+ |
| 100" | 49" x 87" | 57" x 95" | -- | -- | 253476SC | 2834 | 253566 | 253796 | 2917 | 48 | | 85 | P+ |
| 106" | 52" x 92" | 60" x 100" | -- | -- | 253288SC | 3471 | 253412 | 253510 | 3554 | 49 | 52 | 85 | P+ |
| 110" | 54" x 96" | 62" x 104" | -- | -- | 253383SC | 3879 | 253582 | 253675 | 3962 | 52 | | 85 | P+ |
| 119" | 58" x 104" | 66" x 112" | -- | -- | 253374SC | 4149 | 253483 | 253431 | 4233 | 55 | | 85 | |
| 133" | 65" x 116" | 73" x 124" | -- | -- | 253399SC | 4274 | 253425 | 253597 | 4358 | 60 | 85 | | |
| 161" | 79" x 140" | 87" x 148" | -- | -- | 253429SC | 5569 | 253722 | 253636 | 5653 | 72 | | 85 | |
| 193" | 95" x 169" | 103" x 177" | -- | -- | 253779SC | 5883 | 253777 | 253776 | 5966 | 113 | | 85 | |
| 220" | 108" x 192" | 116" x 200" | -- | -- | 253790SC | 6341 | 253788 | 253787 | 6425 | 80 | | 85 | |
| 4:3 NTSC Video Format | | | | | | | | | | | | | |
| 6" | 43" x 57" | 51" x 65" | 253320 | \$852 | 253208SC | \$1859 | 253208SA | 253208SB | \$1942 | 35 | | 85 | P+ |
| 6'6" | 47" x 63" | 55" x 71" | 253321 | 945 | 253209SC | 2065 | 253209SA | 253209SB | 2149 | 38 | | 85 | P+ |
| 7" | 50" x 67" | 58" x 75" | 253322 | 977 | 253210SC | 2294 | 253210SA | 253210SB | 2377 | 39 | | 85 | P+ |
| 7'6" | 54" x 72" | 62" x 80" | 253323 | 1185 | 253211SC | 2549 | 253211SA | 253211SB | 2632 | 41 | | 85 | P+ |
| 100" | 60" x 80" | 68" x 88" | 253324 | 1230 | 253212SC | 2832 | 253273 | 253357 | 2916 | 45 | | 85 | P+ |
| 10' | 72" x 96" | 80" x 104" | 253325 | 1527 | 253213SC | 3721 | 253274 | 253358 | 3804 | 51 | | 85 | P+ |
| 150" | 90" x 120" | 98" x 128" | 253326 | 2065 | 253214SC | 4007 | 253812 | 253813 | 4091 | 62 | | 85 | |
| 15' | 108" x 144" | 116" x 152" | 253327 | 2719 | 253215SC | 4406 | 253814 | 253815 | 4489 | 74 | | 85 | |
| 4:3 NTSC Video Format with Vel-Tex | | | | | | | | | | | | | |
| 7" | 50" x 67" | 58" x 75" | -- | -- | 253284SC | \$2502 | 253284SA | 253284SB | \$2586 | 39 | | 85 | P+ |
| 100" | 60" x 80" | 68" x 88" | -- | -- | 253285SC | 3041 | 253285SA | 253285SB | 3124 | 45 | | 85 | P+ |
| 10' | 72" x 96" | 80" x 104" | -- | -- | 253286SC | 3929 | 253286SA | 253286SB | 4012 | 51 | | 85 | P+ |
| 2.35:1 CinemaScope Format with Vel-Tex | | | | | | | | | | | | | |
| 115" | 45" x 105 3/4" | 53" x 113 3/4" | -- | -- | 253748SC | \$3136 | 253745 | 253746 | \$3219 | 61 | | 85 | |
| 132" | 52" x 122" | 60" x 130" | -- | -- | 253753SC | 3889 | 253750 | 253751 | 3972 | 64 | | 85 | |
| 148" | 58" x 136 1/4" | 66" x 144 1/4" | -- | -- | 253758SC | 4626 | 253755 | 253756 | 4709 | 67 | | 85 | |
| 153" | 60" x 141" | 68" x 149" | -- | -- | 253886SC | 4989 | 253890 | 253891 | 5073 | 68 | | 85 | |
| 166" | 65" x 152 3/4" | 73" x 160 3/4" | -- | -- | 253763SC | 5503 | 253760 | 253761 | 5586 | 75 | | 85 | |
| 204" | 80" x 188" | 88" x 196" | -- | -- | 253768SC | 7737 | 253765 | 253766 | 7820 | 78 | | 85 | |

Permanently Tensioned Screens

Accessories for Onyx

| | Part No. | PRICE |
|---|----------|-------|
| Corner Reinforcement Kit —The Corner Reinforcement Kit is required for any Onyx that: will be suspended or "flown," or used with TorkStar. | 253696 | \$98 |

Vel-Tex®—A velvety black textile that cuts reflections to virtually zero and conceals all trace of joints in the frame. To include Vel-Tex on an Onyx screen where it is not standard, add the letter "V" after the part number when ordering (for example, Part number 253215V). — 208

ShadowBox Clarion—Utilizes a 1½" tubular aluminum frame painted flat black. The viewing surface attaches to the back side of the frame. Hence, the frame is visible and serves as a black border around the perimeter of the image area.

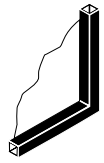

• **Options:** Custom sizes and Scope sizes available by quotation. Vel-Tex, a black, velvety textile covering, is a recommended option that cuts reflection and conceals all trace of joints in the frame. To include Vel-Tex on a ShadowBox Clarion, add the letter "V" after the part number when ordering (for example, Part number 253103V).

CineFlex MH800V rear projection surface and CineFlex White XT600V front/rear projection surface are also available at the same price as CineFlex CH1200V. See page 4 for viewing surface details. When ordering these surfaces, use the CineFlex CH1200V part number followed by the appropriate suffix: **CA** for CineFlex MH800V, and **CC** for CineFlex White XT600V.

ShadowBox Clarion is now available curved, on legs, or with suspension brackets by request - please call for quotation.

Permanently Tensioned Screens

| Nom. Diag. | Image Area | Overall Size | OptiFlex Surfaces | | | | | | |
|------------------------------|--------------|--------------|--------------------|--------------------|-------|-------------|-------|---------------------|--------|
| | | | Matt White XT1000V | Pure White XT1300V | PRICE | Grey XH600V | PRICE | Pearl White MH1500V | PRICE |
| 16:10 Format | | | | | | | | | |
| 94" | 50" x 80" | 53" x 83" | 253124 | 253124FN | \$942 | 253123 | \$994 | 253125 | \$1017 |
| 109" | 57 ½" x 92" | 60 ½" x 95" | 253128 | 253128FN | 1167 | 253127 | 1232 | 253129 | 1260 |
| 113" | 60" x 96" | 63" x 99" | 253143 | 253143FN | 1232 | 253144 | 1300 | 253145 | 1330 |
| 123" | 65" x 104" | 68" x 107" | 253132 | 253132FN | 1377 | 253131 | 1452 | 253133 | 1487 |
| 137" | 72 ½" x 116" | 75 ½" x 119" | 253136 | 253136FN | 1594 | 253135 | 1682 | 253137 | 1722 |
| 165" | 87 ½" x 140" | 90 ½" x 143" | 253140 | 253140FN | 1822 | 253139 | 1922 | 253141 | 1967 |
| 16:9 HDTV Format | | | | | | | | | |
| 92" | 45" x 80" | 48" x 83" | 253016 | 253016FN | \$942 | 253088 | \$994 | 253040 | \$1017 |
| 100" | 49" x 87" | 52" x 90" | 253115 | 253115FN | 1072 | 253118 | 1130 | 253116 | 1157 |
| 106" | 52" x 92" | 55" x 95" | 253017 | 253017FN | 1167 | 253089 | 1232 | 253041 | 1260 |
| 110" | 54" x 96" | 57" x 99" | 253119 | 253119FN | 1232 | 253122 | 1300 | 253120 | 1330 |
| 119" | 58" x 104" | 61" x 107" | 253097 | 253097FN | 1377 | 253100 | 1452 | 253098 | 1487 |
| 133" | 65" x 116" | 68" x 119" | 253018 | 253018FN | 1594 | 253090 | 1682 | 253042 | 1722 |
| 161" | 79" x 140" | 83" x 143" | 253019 | 253019FN | 1822 | 253091 | 1922 | 253043 | 1967 |
| 193" | 95" x 169" | 98" x 172" | 253103 | 253103FN | 1965 | 253108 | 2072 | 253104 | 2122 |
| 220" | 108" x 192" | 111" x 195" | 253109 | 253109FN | 2129 | 253112 | 2247 | 253110 | 2300 |
| 4:3 NTSC Video Format | | | | | | | | | |
| 6' | 43" x 57" | 46" x 60" | 253008 | 253008FN | \$650 | 253080 | \$685 | 253032 | \$700 |
| 6'6" | 47" x 63" | 50" x 66" | 253009 | 253009FN | 723 | 253081 | 762 | 253033 | 780 |
| 7' | 50" x 67" | 53" x 70" | 253010 | 253010FN | 762 | 253082 | 805 | 253034 | 823 |
| 90" | 54" x 72" | 57" x 75" | 253011 | 253011FN | 872 | 253083 | 919 | 253035 | 942 |
| 100" | 60" x 80" | 63" x 83" | 253012 | 253012FN | 940 | 253084 | 992 | 253036 | 1015 |
| 10' | 72" x 96" | 75" x 99" | 253013 | 253013FN | 1167 | 253085 | 1232 | 253037 | 1260 |
| 150" | 90" x 120" | 93" x 123" | 253014 | 253014FN | 1585 | 253086 | 1672 | 253038 | 1712 |
| 15' | 108" x 144" | 111" x 147" | 253015 | 253015FN | 1814 | 253102 | 1912 | 253039 | 1959 |

CHART CONTINUED BELOW

| Nom. Diag. | Image Area | Overall Size | OptiFlex Surfaces | | CineFlex Surface | | ClearSound Surface | | Shipping Wt./lbs. | Dim Wt./lbs. | Freight Class |
|------------------------------|--------------|--------------|-------------------|--------|------------------|--------|----------------------------|--------|-------------------|--------------|---------------|
| | | | ReAct MS1000V | PRICE | CineFlex CH1200V | PRICE | ClearSound NanoPerf XT800V | PRICE | | | |
| 16:10 Format | | | | | | | | | | | |
| 94" | 50" x 80" | 53" x 83" | 253124FR | \$1012 | 253126 | \$1139 | 253124SC | \$1990 | 35 | 42 | 85 P+ |
| 109" | 57 ½" x 92" | 60 ½" x 95" | 253128FR | 1255 | 253130 | 1414 | 253128SC | 2212 | 36 | 49 | 85 P+ |
| 113" | 60" x 96" | 63" x 99" | 253143FR | 1324 | 253146 | 1232 | 253143SC | 2417 | 37 | | 85 |
| 123" | 65" x 104" | 68" x 107" | 253132FR | 1480 | 253134 | 1665 | 253132SC | 2597 | 40 | | 85 |
| 137" | 72 ½" x 116" | 75 ½" x 119" | 253136FR | 1714 | 253138 | 1929 | 253136SC | 2794 | 43 | | 85 |
| 165" | 87 ½" x 140" | 90 ½" x 143" | -- | -- | 253142 | 2204 | 253140SC | 3119 | 55 | | 85 |
| 16:9 HDTV Format | | | | | | | | | | | |
| 92" | 45" x 80" | 48" x 83" | 253016FR | \$1012 | 253064 | \$1140 | 253016SC | \$1990 | 35 | 42 | 85 P+ |
| 100" | 49" x 87" | 52" x 90" | 253115FR | 1152 | 253117 | 1299 | 253115SC | 2110 | 36 | 46 | 85 P+ |
| 106" | 52" x 92" | 55" x 95" | 253017FR | 1255 | 253065 | 1414 | 253017SC | 2212 | 37 | 48 | 85 P+ |
| 110" | 54" x 96" | 57" x 99" | 253119FR | 1324 | 253121 | 1492 | 253119SC | 2417 | 38 | 50 | 85 P+ |
| 119" | 58" x 104" | 61" x 107" | 253097FR | 1480 | 253099 | 1665 | 253097SC | 2597 | 40 | | 85 |
| 133" | 65" x 116" | 68" x 119" | 253018FR | 1714 | 253066 | 1929 | 253018SC | 2794 | 46 | | 85 |
| 161" | 79" x 140" | 83" x 143" | 253019FR | 1959 | 253067 | 2204 | 253019SC | 3119 | 55 | | 85 |
| 193" | 95" x 169" | 98" x 172" | -- | -- | 253107 | 2377 | -- | -- | 65 | | 85 |
| 220" | 108" x 192" | 111" x 195" | -- | -- | 253111 | 2577 | -- | -- | 80 | | 85 |
| 4:3 NTSC Video Format | | | | | | | | | | | |
| 6' | 43" x 57" | 46" x 60" | 253008FR | \$698 | 253056 | \$787 | 253008SC | 1852 | 29 | 31 | 85 P+ |
| 6'6" | 47" x 63" | 50" x 66" | 253009FR | 778 | 253057 | 875 | 253009SC | 1889 | 31 | 34 | 85 P+ |
| 7' | 50" x 67" | 53" x 70" | 253010FR | 818 | 253058 | 924 | 253010SC | 1927 | 33 | 36 | 85 P+ |
| 90" | 54" x 72" | 57" x 75" | 253011FR | 937 | 253059 | 1054 | 253011SC | 1967 | 34 | 38 | 85 P+ |
| 100" | 60" x 80" | 63" x 83" | 253012FR | 1010 | 253060 | 1137 | 253012SC | 2007 | 35 | 42 | 85 P+ |
| 10' | 72" x 96" | 75" x 99" | 253013FR | 1255 | 253061 | 1414 | 253013SC | 2427 | 42 | 50 | 85 P+ |
| 150" | 90" x 120" | 93" x 123" | -- | -- | 253062 | 1919 | -- | -- | 54 | | 85 |
| 15' | 108" x 144" | 111" x 147" | -- | -- | 253063 | 2192 | -- | -- | 65 | | 85 |

Custom Size ShadowBox Clarion—ShadowBox Clarion screens are available in any desired custom size up to the maximum standard sizes shown above. Some surfaces are available in greater widths: consult Draper.

Overall size, including frame, equals image area + 3". Base fabric cost on overall square footage including frame. Frame cost is per lineal foot, rounded up to next even foot (example—round 23¼" up to 24").

Viewing Surface (per square foot)

| Viewing Surface | PRICE |
|---------------------|---------|
| Matt White XT1000V | \$12.85 |
| Pure White XT1300V | 12.85 |
| Pearl White MH1500V | 14.00 |
| Grey XH600V | 14.00 |
| ReAct MS1000V | 13.85 |

Viewing Surface (per square foot)

| Viewing Surface | PRICE |
|----------------------------|---------|
| CineFlex CH1200V | \$15.50 |
| CineFlex MH800V | 15.50 |
| CineFlex White XT600V | 15.50 |
| ClearSound NanoPerf XT800V | 17.10 |

Frame (per lineal foot)

| PRICE |
|---------|
| \$27.25 |

Accessories for ShadowBox Clarion

PRICE

Vel-Tex®—A velvety black textile that cuts reflections to virtually zero and conceals all trace of joints in the frame. To add Vel-Tex on a ShadowBox Clarion, add the suffix "V" to the part number when ordering.

\$208

Edgeless Clarion—The viewing surface of this product wraps completely around the frame and attaches to the back side. Formerly named WrapAround Clarion, The Edgeless Clarion does not have a border of any kind—from the audience side you see only a solid screen surface. The image area will match the overall size. • **Options:** Custom sizes and Scope sizes available by quotation.

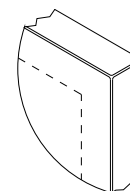

Edgeless Clarion is now available curved, on legs, or with suspension brackets by request - please call for quotation.

| Nom. Diag. | Image Area | Overall Size | OptiFlex Surfaces | | | | | | |
|------------------------------|---------------|---------------|--------------------|--------------------|--------|-------------|--------|---------------------|--------|
| | | | Matt White XT1000V | Pure White XT1300V | PRICE | Grey XH600V | PRICE | Pearl White MH1500V | PRICE |
| 16:10 Format | | | | | | | | | |
| 85" | 45" x 72" | 45" x 72" | 255023 | 255023FN | \$1070 | 255042 | \$1129 | 255024 | \$1155 |
| 94" | 50" x 80" | 50" x 80" | 255025 | 255025FN | 1232 | 255043 | 1300 | 255026 | 1330 |
| 109" | 57 1/2" x 92" | 57 1/2" x 92" | 255027 | 255027FN | 1494 | 255044 | 1575 | 255028 | 1614 |
| 113" | 60" x 96" | 60" x 96" | 255049 | 255049FN | 1575 | 255050 | 1630 | 255051 | 1669 |
| 123" | 65" x 104" | 65" x 104" | 255029 | 255029FN | 1759 | 255045 | 1855 | 255030 | 1899 |
| 16:9 HDTV Format | | | | | | | | | |
| 82" | 40 1/2" x 72" | 40 1/2" x 72" | 255015 | 255015FN | \$1070 | 255038 | \$1129 | 255016 | \$1155 |
| 92" | 45" x 80" | 45" x 80" | 255017 | 255017FN | 1232 | 255039 | 1300 | 255018 | 1330 |
| 106" | 52" x 92" | 52" x 92" | 255019 | 255019FN | 1494 | 255040 | 1575 | 255020 | 1614 |
| 110" | 54" x 96" | 54" x 96" | 255046 | 255046FN | 1575 | 255047 | 1630 | 255048 | 1669 |
| 119" | 58" x 104" | 58" x 104" | 255021 | 255021FN | 1759 | 255041 | 1855 | 255022 | 1899 |
| 133" | 65" x 116" | 65" x 116" | 255031 | 255031FN | 2094 | 255033 | 2207 | 255032 | 2260 |
| 4:3 NTSC Video Format | | | | | | | | | |
| 90" | 54" x 72" | 54" x 72" | 255007 | 255007FN | \$1274 | 255034 | \$1344 | 255008 | \$1375 |
| 100" | 60" x 80" | 60" x 80" | 255009 | 255009FN | 1472 | 255035 | 1552 | 255010 | 1589 |
| 120" | 72" x 96" | 72" x 96" | 255011 | 255011FN | 1902 | 255036 | 2005 | 255012 | 2054 |
| 132" | 78" x 104" | 78" x 104" | 255013 | 255013FN | 2132 | 255037 | 2250 | 255014 | 2304 |

Permanently Tensioned Screens

| Nom. Diag. | Image Area | Overall Size | OptiFlex Surfaces | | ClearSound Surfaces | | Shipping Wt./lbs. | Freight Class |
|------------------------------|---------------|---------------|-------------------|--------|----------------------------|--------|-------------------|---------------|
| | | | ReAct MS1000V | PRICE | ClearSound NanoPerf XT800V | PRICE | | |
| 16:10 Format | | | | | | | | |
| 85" | 45" x 72" | 45" x 72" | 255023FR | \$1150 | 255023SC | \$1884 | 33 | 85 P+ |
| 94" | 50" x 80" | 50" x 80" | 255025FR | 1324 | 255025SC | 2094 | 34 | 85 P+ |
| 109" | 57 1/2" x 92" | 57 1/2" x 92" | 255027FR | 1605 | 255027SC | 2375 | 35 | 85 P+ |
| 113" | 60" x 96" | 60" x 96" | 255049FR | 1694 | 255049SC | 2584 | 37 | 85 P+ |
| 123" | 65" x 104" | 65" x 104" | 255029FR | 1890 | 255029SC | 2747 | 38 | 85 |
| 16:9 HDTV Format | | | | | | | | |
| 82" | 40 1/2" x 72" | 40 1/2" x 72" | -- | -- | 255015SC | \$1845 | 33 | 85 P+ |
| 92" | 45" x 80" | 45" x 80" | 255017FR | \$1324 | 255017SC | 2094 | 35 | 85 P+ |
| 106" | 52" x 92" | 52" x 92" | 255019FR | 1605 | 255019SC | 2375 | 37 | 85 P+ |
| 110" | 54" x 96" | 54" x 96" | 255046FR | 1694 | 255046SC | 2584 | 38 | 85 |
| 119" | 58" x 104" | 58" x 104" | 255021FR | 1890 | 255021SC | 2747 | 39 | 85 |
| 133" | 65" x 116" | 65" x 116" | 255031FR | 2250 | 255031SC | 2947 | 40 | 85 |
| 4:3 NTSC Video Format | | | | | | | | |
| 90" | 54" x 72" | 54" x 72" | 255007FR | \$1369 | 255007SC | \$1922 | 34 | 85 P+ |
| 100" | 60" x 80" | 60" x 80" | 255009FR | 1582 | 255009SC | 2137 | 36 | 85 P+ |
| 120" | 72" x 96" | 72" x 96" | 255011FR | 2045 | 255011SC | 2584 | 42 | 85 P+ |
| 132" | 78" x 104" | 78" x 104" | 255013FR | 2292 | 255013SC | 2769 | 54 | 85 |

CHART CONTINUED BELOW

Custom Size Edgeless Clarion—Available in any desired custom size up to the maximum standard sizes above. Some surfaces are available in greater widths: consult Draper.

Viewing Surface (per square foot)

| OptiFlex Surfaces | PRICE |
|---------------------|---------|
| Matt White XT1000V | \$17.90 |
| Pure White XT1300V | 17.90 |
| Pearl White MH1500V | 19.75 |
| Grey XH600V | 19.75 |
| ReAct MS1000V | 19.35 |
| ClearSound Surface | PRICE |
| NanoPerf XT800V | \$28.65 |

Frame (per lineal foot)

| PRICE |
|---------|
| \$38.60 |

BOOKMARK OUR MOBILE TOOLKIT

Draper's mobile toolkit includes searchable document libraries for all AV products and the assembly map tools for our popular StageScreen and FocalPoint screens. It also includes our Screen Surface Selector. Scan the code with your smartphone or visit: www.draperinc.com/drapermobile



Profile—The Profile permanently tensioned screen creates the clean, high tech look of a flat panel screen on your wall, but in larger sizes that are only possible with projection. Its slender frame is less than 3/8" wide and 1/2" deep. Features Draper's proprietary surface tensioning system to keep the viewing surface perfectly flat with no puckering. Assembles without snaps. Finished in black. Ships knocked down.

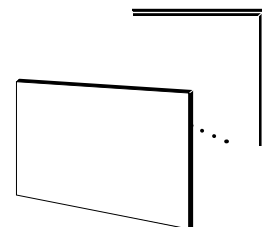

• **Options:** Custom sizes, by quotation.

Permanently Tensioned Screens

| OptiFlex Surfaces | | | | | | | | | | | | |
|----------------------------------|----------------|--------------------|------------|----------|--------|--------|--------|-------------|--------|-------------------|---------------|----|
| Nom. Diag. | Image Area | Overall Size | Matt White | | PRICE | Grey | | Pearl White | | Shipping Wt./lbs. | Freight Class | |
| | | | XT1000V | XT1300V | | XH600V | PRICE | MH1500V | PRICE | | | |
| 16:10 Format | | | | | | | | | | | | |
| 94" | 50" x 80" | 50 3/4" x 80 3/4" | 254207 | 254207FN | \$1125 | | 254224 | \$1187 | 254241 | \$1210 | 47 | 85 |
| 109" | 57 1/2" x 92" | 58 1/4" x 92 3/4" | 254208 | 254208FN | 1404 | | 254225 | 1480 | 254242 | 1507 | 53 | 85 |
| 113" | 60" x 96" | 60 3/4" x 96 3/4" | 254209 | 254209FN | 1457 | | 254226 | 1539 | 254243 | 1565 | 55 | 85 |
| 123" | 65" x 104" | 65 3/4" x 104 3/4" | 254210 | 254210FN | 1657 | | 254227 | 1750 | 254244 | 1782 | 63 | 85 |
| 137" | 72 1/2" x 116" | 73 1/4" x 116 3/4" | 254211 | 254211FN | 1915 | | 254228 | 2022 | 254245 | 2059 | 68 | 85 |
| 165" | 87 1/2" x 140" | 88 1/4" x 140 3/4" | 254212 | 254212FN | 2174 | | 254229 | 2294 | 254246 | 2335 | 83 | 85 |
| 16:9 HDTV Format | | | | | | | | | | | | |
| 92" | 45" x 80" | 45 3/4" x 80 3/4" | 254200 | 254200FN | \$1125 | | 254217 | \$1187 | 254234 | \$1210 | 47 | 85 |
| 100" | 49" x 87" | 49 3/4" x 87 3/4" | 254201 | 254201FN | 1334 | | 254218 | 1407 | 254235 | 1432 | 50 | 85 |
| 106" | 52" x 92" | 52 3/4" x 92 3/4" | 254202 | 254202FN | 1404 | | 254219 | 1480 | 254236 | 1507 | 54 | 85 |
| 110" | 54" x 96" | 54 3/4" x 96 3/4" | 254203 | 254203FN | 1457 | | 254220 | 1539 | 254237 | 1565 | 56 | 85 |
| 119" | 58" x 104" | 58 3/4" x 104 3/4" | 254204 | 254204FN | 1657 | | 254221 | 1750 | 254238 | 1782 | 59 | 85 |
| 133" | 65" x 116" | 65 3/4" x 116 3/4" | 254205 | 254205FN | 1915 | | 254222 | 2022 | 254239 | 2059 | 68 | 85 |
| 161" | 79" x 140" | 79 3/4" x 140 3/4" | 254206 | 254206FN | 2174 | | 254223 | 2294 | 254240 | 2335 | 70 | 85 |
| 2.35:1 CinemaScope Format | | | | | | | | | | | | |
| 115" | 45" x 105 3/4" | 45 3/4" x 106 1/2" | 254213 | 254213FN | \$1620 | | 254230 | \$1720 | 254247 | \$1755 | 53 | 85 |
| 132" | 52" x 122" | 52 3/4" x 122 3/4" | 254214 | 254214FN | 1899 | | 254231 | 2012 | 254248 | 2054 | 57 | 85 |
| 148" | 58" x 136 1/4" | 58 3/4" x 137" | 254215 | 254215FN | 2392 | | 254232 | 2536 | 254249 | 2587 | 72 | 85 |
| 166" | 65" x 152 3/4" | 65 3/4" x 153 1/2" | 254216 | 254216FN | 2754 | | 254233 | 2916 | 254250 | 2974 | 80 | 85 |

| OptiFlex Surfaces | | | | | | |
|----------------------------------|----------------|--------------------|----------|--------|------------------|-------|
| Nom. Diag. | Image Area | Overall Size | ReAct | | Shipping Freight | |
| | | | MS1000V | PRICE | Wt./lbs. | Class |
| 16:10 Format | | | | | | |
| 94" | 50" x 80" | 50 3/4" x 80 3/4" | 254207FR | \$1210 | 47 | 85 |
| 109" | 57 1/2" x 92" | 58 1/4" x 92 3/4" | 254208FR | 1509 | 53 | 85 |
| 113" | 60" x 96" | 60 3/4" x 96 3/4" | 254209FR | 1567 | 55 | 85 |
| 123" | 65" x 104" | 65 3/4" x 104 3/4" | 254210FR | 1782 | 63 | 85 |
| 137" | 72 1/2" x 116" | 73 1/4" x 116 3/4" | 254211FR | 2059 | 68 | 85 |
| 165" | 87 1/2" x 140" | 88 1/4" x 140 3/4" | -- | -- | 83 | 85 |
| 16:9 HDTV Format | | | | | | |
| 92" | 45" x 80" | 45 3/4" x 80 3/4" | 254200FR | \$1210 | 47 | 85 |
| 100" | 49" x 87" | 49 3/4" x 87 3/4" | 254201FR | 1434 | 50 | 85 |
| 106" | 52" x 92" | 52 3/4" x 92 3/4" | 254202FR | 1509 | 54 | 85 |
| 110" | 54" x 96" | 54 3/4" x 96 3/4" | 254203FR | 1567 | 56 | 85 |
| 119" | 58" x 104" | 58 3/4" x 104 3/4" | 254204FR | 1782 | 59 | 85 |
| 133" | 65" x 116" | 65 3/4" x 116 3/4" | 254205FR | 2059 | 68 | 85 |
| 161" | 79" x 140" | 79 3/4" x 140 3/4" | 254206FR | 2337 | 70 | 85 |
| 2.35:1 CinemaScope Format | | | | | | |
| 115" | 45" x 105 3/4" | 45 3/4" x 106 1/2" | 254213FR | \$1742 | 53 | 85 |
| 132" | 52" x 122" | 52 3/4" x 122 3/4" | 254214FR | 2040 | 57 | 85 |
| 148" | 58" x 136 1/4" | 58 3/4" x 137" | 254215FR | 2572 | 72 | 85 |
| 166" | 65" x 152 3/4" | 65 3/4" x 153 1/2" | 254216FR | 2961 | 80 | 85 |

CHART CONTINUED BELOW

Custom Size Profile—Profile screens are available in any desired custom size up to 156" x 156". Some fabrics available in limited sizes. Base fabric cost on overall square footage including frame. Frame cost is per lineal foot, rounded up to next even foot (example—round 18'4" up to 19').

Viewing Surface (per square foot) Frame (per lineal foot)

| Viewing Surface | PRICE |
|---------------------|---------|
| Matt White XT1000V | \$16.35 |
| Pure White XT1300V | 16.35 |
| Pearl White MH1500V | 17.75 |
| Grey XH600V | 17.75 |
| ReAct MS1000V | 17.50 |

| PRICE |
|---------|
| \$36.60 |

Scribe Write-On Screen— In today's collaborative classrooms and meeting rooms, interaction between a projected image, speaker, and audience enriches presentations and empowers learning. When a presenter adds comments, colors, or drawings to an image, the audience needs a clear view of both the image and the additions. Projecting a short throw image on a standard whiteboard results in high glare and distracting hot spots.

The new Scribe front projection write-on screen has a matte surface to maintain the contrast, clarity, and impact of your projected content. With 80% lower gloss than the typical whiteboard, Scribe can maximize your picture quality and interactivity.

Scribe's Unique Features:

- Magnetic surface allows for multiple uses and attachment of interactive components to the screen.
- Scribe has an 80% lower gloss rating than traditional whiteboards.
- Low profile black bezel frame eliminates large unwanted borders.
- Easy flush wall mounting with sliding brackets, integrated in the back of the frame, allow you to easily find secure mounting points.
- Scribe ships with eraser, dry erase markers, and a liquid cleaner.



| Nom. Diag. | Image Area | Overall Size | Scribe Part No. | PRICE | Shipping Wt./lbs. | Freight Class |
|-------------------------|-------------------|-------------------|-----------------|-------|-------------------|---------------|
| 16:10 Format | | | | | | |
| 68" | 36" x 57 1/2" | 36 1/2" x 58" | 800315 | \$812 | 39 | 85 |
| 87" | 46 1/8" x 73 3/4" | 46 5/8" x 74 1/4" | 800317 | 904 | 39 | 85 |
| 16:9 HDTV Format | | | | | | |
| 73 1/2" | 36" x 64" | 36 1/2" x 64 1/2" | 800316 | \$820 | 43 | 85 |
| 94" | 46 1/8" x 82 1/8" | 46 5/8" x 82 5/8" | 800318 | 909 | 60 | 85 |

Accessories for Scribe

| | Part No. | PRICE |
|-------------------------|----------|-------|
| Dry Erase Accessory Kit | 800319 | \$25 |
| Magnets (24 pack) | 352008 | 28 |
| Additional Pen Tray | 800320 | 43 |

Lace & Grommet— Draper's Lace & Grommet projection screen is versatile, wall mounted, and is ideal for use in blending, multiformat, and curved applications. It includes a 3" powder coated aluminum frame (black standard) and unique wall mounting brackets used for either flat or curved applications. One of the greatest features of our Lace & Grommet screen is its simple and secure assembly. The frame sections attach with quick connectors while bungees ship laced, and attached to the frame. This removes the tedious process of lace threading and ensures the install will be that much easier.

- **Options:** Custom sizes, up to 100' wide, available by quotation. Two decorative trim options available: choose from rigid PVC with Vel-Tex covering or soft IFR (Inherently Flame Retardant) Velour, both in black finish.



Lace & Grommet Screen Pricing

Prices per square foot, based on overall size, including 2" black webbing border. Lacing Cord—10¢/ft. figured at 3 times screen circumference.

| Prices per square foot | Maximum Size | PRICE |
|-----------------------------------|---------------|---------|
| OptiView (Self-Supporting) | | |
| Contrast Grey XH800E | 10' x 40' | \$10.15 |
| Matt White XT1000E | 15' x 60' | 8.85 |
| Contrast White XH1100E | 8' x 40' | 10.15 |
| Argent White XH1500E | 8' x 40' | 10.15 |
| Pearl White CH1900E | 8' x 40' | 10.15 |
| OptiFlex (Flexible) | | |
| Grey XH600V | 30' x 100' | \$10.15 |
| Matt White XT1000V | 40' x 100' | 8.85 |
| Pure White XT1300V | 40' x 100' | 10.15 |
| Pearl White MH1500V | 30' x 100' | 10.15 |
| ReAct MS1000V | 6 3/4' x 100' | 10.15 |

Please note: There is a 10% upcharge for any surface that exceeds 60' in wide or 20' high.

Accessories for Lace & Grommet

| | Part No. | PRICE |
|--------------------------|------------|-------|
| Wall Mount Bracket | C002.987SA | \$42 |
| Telescoping Wall Bracket | C041.057 | 67 |

Please note: Lace and Grommet frames cannot exceed 22' in a suspended application. Frames cannot exceed 28' high for wall mounts. Surface can only be made to shown maximum sizes.

| Prices per square foot | Maximum Size | PRICE |
|--|--------------|---------|
| CineFlex (Rear/Dual Projection) | | |
| CineFlex White XT600V | 40' x 60' | \$14.90 |
| CineFlex MH800 | 40' x 60' | 14.90 |
| CineFlex CH1200 | 40' x 60' | 14.90 |
| ClearSound (Acoustically Transparent) | | |
| ClearSound NanoPerf XT800V | 40' x 100' | \$16.25 |
| ClearSound Perf XT900V | 40' x 100' | 16.25 |
| ClearSound Perf XT950E | 10' x 40' | 16.25 |
| Chroma Key | | |
| Chroma Key Green | 40' x 100' | \$12.85 |
| Chroma Key Blue | 40' x 100' | 12.85 |

Frame Pricing

| Price per lineal foot | PRICE |
|----------------------------------|-------|
| Frame | |
| Flat Frame | \$60 |
| Curved Frame | 77 |
| Trim | |
| Rigid - PVC with Vel-Tex (black) | \$30 |
| Soft - IFR Velour (black) | 30 |

Permanently Tensioned Screens

Portable Projection Screens

Tripod Screens

Consul—Significantly less expensive than the Diplomat/R, the Consul sets the quality standard in its price range. Can be purchased with or without keystone eliminator. Extremely popular in the educational market. Sizes through 70" x 70".

Diplomat/R—An even more substantial tripod screen designed primarily for the audiovisual rental market. The Diplomat/R includes special modifications for that purpose. It is available in either a scratch-resistant black case finish or a non-scratchable carpeted finish. Includes rigid Steel Endcaps. Sizes through 96" x 96".

Folding/Modular Screens

StageScreen®—Fly it or use it with legs. The StageScreen is the strongest and most rigid screen on the market. Available in silver anodized or black frame finish. The 8" truss frame is completely modular. All available sizes of StageScreen are built from combinations of the same 6 standard color-coded frame sections (including optional legs). If a frame section should ever become lost or damaged you can replace it in seconds without tools. Standard sizes through 60' wide. Custom sizes available by quotation.

FocalPoint®—With 4" modular frame segments made of sturdy extruded aluminum, the FocalPoint is extremely rigid and durable, while remaining lightweight. With no hinges, the FocalPoint is strong, and still features quick and easy assembly. All available sizes are built from combinations of the same frame segments. Screen legs are also constructed using these frame segments. Sizes through 20' wide.

Ultimate Folding Screen—The Ultimate Folding Screen is the first screen manufactured with 100% CNC (Computer Numerical Controlled) components and assembly. The tubing is CNC machined, surfaces and borders are CNC cut; even rivet and snap holes are CNC placed. No competitive product meets this standard. Sizes through 16' wide.

Cinefold—Portable folding screen in a wide range of sizes: through 14' wide with standard construction or 30' wide as **Truss Cinefold**. Complete with carrying case. Available with interchangeable front and rear projection surfaces. Dress Kit and Pipe & Drape Runoffs (PDRs) form a complete system. Rotational molded polyethylene case comes complete with wheels.

Other Portable Screens

RoadWarrior—Lightweight spring-roller operated screen designed for use with portable LCD and DLP projectors. Travels in its own stylish extruded aluminum case and sets up in seconds on floor or table. Pneumatic cylinders hold screen securely at desired height. Up to 80" NTSC, 73" HDTV, or 76" 16:10 diagonal sizes.

Traveller—Lighter weight cousin of the RoadWarrior, this spring-roller operated screen can be used with portable LCD and DLP projectors. Sets up in seconds on floor or table. Infinitely adjustable telescoping mast tensions screen in desired position. Sizes through 100" NTSC, 92" HDTV format., or 94" 16:10 diagonal sizes.

Piper—Lightweight portable screen. It's a breeze to set up: lift the upright, choose its height and raise the screen. The show is on the road! Sizes through 84" NTSC, 77" HDTV, or 79" 16:10 diagonal sizes.

Luma 2/R—Spring-roller operated screen, inverted and cradled in a floor stand (sold separately). Sizes through 12' x 12'.

RoadWarrior—Lightweight spring-roller screen with pneumatic lift system. Stows in black tubular case. Detachable shoulder strap included.

- **Black Borders:** Includes ¾" black borders and 30" black "rise" to clear a standard tabletop.
- **Carrying Case:** Optional padded carrying case with zipper and removable heavy nylon shoulder strap.

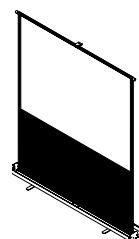
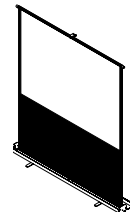

CHART
CONTINUED
BELOW

| Nom. Diag. | Image Area | OptiView Surfaces | | | | | | | Case Length | Shipping Wt./lbs. | Freight Class |
|------------------------------|------------|--------------------|-------|----------------------|------------------------|----------------------|---------------------|-------|-------------|-------------------|---------------|
| | | Matt White XT1000E | PRICE | Contrast Grey XH800E | Contrast White XH1100E | Argent White XH1500E | Pearl White CH1900E | PRICE | | | |
| 16:10 Format | | | | | | | | | | | |
| 57" | 30" x 48" | 230009 | \$534 | 230008 | 230009EG | 230009EH | 230009EJ | \$558 | 53 ½" | 23 | 85 P+ |
| 76" | 40" x 64" | 230012 | 656 | 230011 | 230012EG | 230012EH | 230012EJ | 682 | 69 ½" | 24 | 85 P+ |
| 16:9 HDTV Format | | | | | | | | | | | |
| 55" | 27" x 48" | 230005 | \$534 | 230049 | 230005EG | 230005EH | 230005EJ | \$558 | 53 ½" | 23 | 85 P+ |
| 73" | 36" x 64" | 230006 | 656 | 230050 | 230006EG | 230006EH | 230006EJ | 682 | 69 ½" | 24 | 85 P+ |
| 4:3 NTSC Video Format | | | | | | | | | | | |
| 60" | 36" x 48" | 230001 | \$534 | 230047 | 230001EG | 230001EH | 230001EJ | \$558 | 53 ½" | 22 | 85 P+ |
| 80" | 48" x 64" | 230003 | 656 | 230048 | 230003EG | 230003EH | 230003EJ | 682 | 69 ½" | 27 | 85 P+ |

| Nom. Diag. | Image Area | Height Range (set up) | Case Length | Closed Dimensions (D x H x L) | Padded Carrying Case | PRICE | Carrying Case Length | Shipping Wt./lbs. | Dim Wt./lbs. | Freight Class |
|------------------------------|------------|-----------------------|-------------|-------------------------------|----------------------|-------|----------------------|-------------------|--------------|---------------|
| 16:10 Format | | | | | | | | | | |
| 57" | 30" x 48" | 35" - 65" | 53 ½" | 4 ½" x 5" x 53 ½" | 230058 | \$120 | 60" | 4 | 10 | 70 P |
| 76" | 40" x 64" | 45" - 75" | 69 ½" | 4 ½" x 5" x 69 ½" | C091.023 | 132 | 80" | 3 | 11 | 70 P |
| 16:9 HDTV Format | | | | | | | | | | |
| 55" | 27" x 48" | 32" - 62" | 53 ½" | 4 ½" x 5" x 53 ½" | 230058 | \$120 | 60" | 4 | 10 | 70 P |
| 73" | 36" x 64" | 41" - 71" | 69 ½" | 4 ½" x 5" x 69 ½" | C091.023 | 132 | 80" | 3 | 11 | 70 P |
| 4:3 NTSC Video Format | | | | | | | | | | |
| 60" | 36" x 48" | 41" - 71" | 53 ½" | 4 ½" x 5" x 53 ½" | 230058 | \$120 | 60" | 4 | 10 | 70 P |
| 80" | 48" x 64" | 53" - 83" | 69 ½" | 4 ½" x 5" x 69 ½" | C091.023 | 132 | 80" | 3 | 11 | 70 P |

Traveller—Sets up in seconds on floor or table. With a new and improved design, Traveller features an infinitely adjustable telescoping mast that tensions screen in desired position. Upright stores in case. Detachable shoulder strap included. Features black extruded aluminum case with black powder coat finish.



- **Black Borders:** Includes 3/4" black borders and 30" black "rise".
- **Options:** Padded carrying case with zipper and removable heavy nylon shoulder strap.

| Nom. Diag. | Image Area | OptiView Surfaces | | | | Case Length | Shipping Wt./lbs. | Dim Wt./lbs. | Freight Class | | | |
|------------------------------|---------------|--------------------|-------|----------------------|------------------------|-------------|-------------------|--------------|---------------|----------------------|---------------------|-------|
| | | Matt White XT1000E | PRICE | Contrast Grey XH800E | Contrast White XH1100E | | | | | Argent White XH1500E | Pearl White CH1900E | PRICE |
| 16:10 Format | | | | | | | | | | | | |
| 47" | 25" x 40" | 230135 | \$478 | 230140 | 230135EG | 230135EH | 230135EJ | \$500 | 46 1/2" | 16 | 19 | 85 P |
| 57" | 30" x 48" | 230136 | 494 | 230141 | 230136EG | 230136EH | 230136EJ | 518 | 54 1/2" | 17 | 23 | 85 P+ |
| 68 1/2" | 36 1/4" x 58" | 230137 | 548 | 230142 | 230137EG | 230137EH | 230137EJ | 572 | 64" | 21 | 27 | 85 P+ |
| 76" | 40" x 64" | 230138 | 594 | 230143 | 230138EG | 230138EH | 230138EJ | 620 | 70 1/2" | 24 | 30 | 85 P+ |
| 94" | 50" x 80" | 230139 | 714 | 230144 | 230139EG | 230139EH | 230139EJ | 764 | 86 1/2" | 31 | 35 | 85 P+ |
| 16:9 HDTV Format | | | | | | | | | | | | |
| 46" | 22 1/2" x 40" | 230116 | \$478 | 230126 | 230116EG | 230116EH | 230116EJ | \$500 | 46 1/2" | 16 | 19 | 85 P |
| 55" | 27" x 48" | 230117 | 494 | 230127 | 230117EG | 230117EH | 230117EJ | 518 | 54 1/2" | 17 | 23 | 85 P+ |
| 66 1/2" | 32 1/2" x 58" | 230118 | 548 | 230128 | 230118EG | 230118EH | 230118EJ | 572 | 64" | 21 | 27 | 85 P+ |
| 73" | 36" x 64" | 230119 | 594 | 230129 | 230119EG | 230119EH | 230119EJ | 620 | 70 1/2" | 24 | 30 | 85 P+ |
| 92" | 45" x 80" | 230120 | 714 | 230130 | 230120EG | 230120EH | 230120EJ | 764 | 86 1/2" | 27 | 35 | 85 P+ |
| 4:3 NTSC Video Format | | | | | | | | | | | | |
| 50" | 30" x 40" | 230101 | \$478 | 230111 | 230101EG | 230101EH | 230101EJ | \$500 | 46 1/2" | 16 | 20 | 85 P |
| 60" | 36" x 48" | 230103 | 494 | 230112 | 230103EG | 230103EH | 230103EJ | 518 | 54 1/2" | 19 | 23 | 85 P+ |
| 72" | 43 1/2" x 58" | 230105 | 548 | 230113 | 230105EG | 230105EH | 230105EJ | 572 | 64" | 21 | 27 | 85 P+ |
| 80" | 48" x 64" | 230107 | 594 | 230114 | 230107EG | 230107EH | 230107EJ | 620 | 70 1/2" | 24 | 29 | 85 P+ |
| 100" | 60" x 80" | 230109 | 714 | 230115 | 230109EG | 230109EH | 230109EJ | 764 | 86 1/2" | 31 | 35 | 85 P+ |

CHART CONTINUED BELOW

| Nom. Diag. | Image Area | Height Range (set up) | Closed Dimensions (D x H x L) | Padded Carrying Case | PRICE | Carrying Case | | | |
|------------------------------|---------------|-----------------------|-------------------------------|----------------------|-------|---------------|-------------------|--------------|---------------|
| | | | | | | Case Length | Shipping Wt./lbs. | Dim Wt./lbs. | Freight Class |
| 16:10 Format | | | | | | | | | |
| 47" | 25" x 40" | 30" - 60" | 4 1/2" x 5" x 46 1/2" | C091.019 | \$114 | 50" | 3 | 10 | 70 P |
| 57" | 30" x 48" | 35" - 65" | 4 1/2" x 5" x 54 1/2" | 230058 | 120 | 60" | 4 | 10 | 70 P |
| 68 1/2" | 36 1/4" x 58" | 41 1/4" - 71 1/4" | 4 1/2" x 5" x 64" | C091.020 | 126 | 72" | 2 | 10 | 55 P |
| 76" | 40" x 64" | 45" - 75" | 4 1/2" x 5" x 70 1/2" | C091.023 | 132 | 80" | 3 | 11 | 70 P |
| 94" | 50" x 80" | 55" - 85" | 4 1/2" x 5" x 86 1/2" | C091.021 | 152 | 100" | 4 | 10 | 55 P |
| 16:9 HDTV Format | | | | | | | | | |
| 46" | 22 1/2" x 40" | 27 1/2" - 57 1/2" | 4 1/2" x 5" x 46 1/2" | C091.019 | \$114 | 50" | 3 | 10 | 70 P |
| 55" | 27" x 48" | 32" - 62" | 4 1/2" x 5" x 54 1/2" | 230058 | 120 | 60" | 4 | 10 | 70 P |
| 66 1/2" | 32 1/2" x 58" | 37 1/2" - 67 1/2" | 4 1/2" x 5" x 64" | C091.020 | 126 | 72" | 2 | 10 | 55 P |
| 73" | 36" x 64" | 41" - 71" | 4 1/2" x 5" x 70 1/2" | C091.023 | 132 | 80" | 3 | 11 | 70 P |
| 92" | 45" x 80" | 50" - 80" | 4 1/2" x 5" x 86 1/2" | C091.021 | 152 | 100" | 4 | 10 | 55 P |
| 4:3 NTSC Video Format | | | | | | | | | |
| 50" | 30" x 40" | 35" - 65" | 4 1/2" x 5" x 46 1/2" | C091.019 | \$114 | 50" | 3 | 10 | 70 P |
| 60" | 36" x 48" | 41" - 71" | 4 1/2" x 5" x 54 1/2" | 230058 | 120 | 60" | 4 | 10 | 70 P |
| 72" | 43 1/2" x 58" | 48 1/2" - 78 1/2" | 4 1/2" x 5" x 64" | C091.020 | 126 | 72" | 2 | 10 | 55 P |
| 80" | 48" x 64" | 53" - 83" | 4 1/2" x 5" x 70 1/2" | C091.023 | 132 | 80" | 3 | 11 | 70 P |
| 100" | 60" x 80" | 65" - 95" | 4 1/2" x 5" x 86 1/2" | C091.021 | 152 | 100" | 4 | 10 | 55 P |

Replacement Traveller Telescopic Upright Pole

| Part No. | For Screens | PRICE |
|----------|-----------------|-------|
| 400520 | 60" and smaller | \$54 |
| 400521 | Over 60" | 64 |

Portable Screens

Piper—Lightweight portable screen with black powder coated extruded aluminum case. Tearproof Matt White XT1000E viewing surface. Upright clamps to matt black case for transportation or storage.



- **Black Borders:** Black borders and black "rise" below the image area. "Rise" height varies depending on screen size. See Draper for details.
- **Carrying Case:** Optional padded carrying case available—see below.

| Nom. Diag. | Image Area | OptiView Surface | | Height Range (set up) | Closed Dimensions (D x H x L) | Case Length | Shipping Wt./lbs. | Dim Wt./lbs. | Freight Class | Part No. | Carrying Case PRICE |
|------------------------------|-------------------|--------------------|-------|-----------------------|-------------------------------|-------------|-------------------|--------------|---------------|----------|---------------------|
| | | Matt White XT1000E | PRICE | | | | | | | | |
| 16:10 Format | | | | | | | | | | | |
| 57" | 30" x 48" | 230174 | 358 | 35" - 65" | 4" x 4 7/8" x 53 1/4" | 53 1/4" | 15 | 23 | 85 P+ | C091.039 | \$74 |
| 67" | 36 1/4" x 58" | 230175 | 384 | 41 1/4" - 71-1/4" | 4" x 4 7/8" x 63 1/4" | 63 1/4" | 17 | 27 | 85 P+ | C091.040 | 67 |
| 79" | 42" x 67 1/4" | 230176 | 404 | 47" - 77" | 4" x 4 7/8" x 72 1/2" | 72 1/2" | 19 | 29 | 85 P+ | C091.041 | 70 |
| 16:9 HDTV Format | | | | | | | | | | | |
| 55" | 27" x 48" | 230164 | \$358 | 32" - 62" | 4" x 4 7/8" x 53 1/4" | 53 1/4" | 15 | 24 | 85 P+ | C091.039 | \$74 |
| 66 1/2" | 32 1/2" x 58" | 230165 | 384 | 37-1/2" - 67-1/2" | 4" x 4 7/8" x 63 1/4" | 63 1/4" | 17 | 27 | 85 P+ | C091.040 | 67 |
| 77" | 37 3/4" x 67 1/4" | 230166 | 404 | 42-3/4" - 72-3/4" | 4" x 4 7/8" x 72 1/2" | 72 1/2" | 19 | 31 | 85 P+ | C091.041 | 70 |
| 4:3 NTSC Video Format | | | | | | | | | | | |
| 60" | 36" x 48" | 230161 | \$358 | 41" - 71" | 4" x 4 7/8" x 53 1/4" | 53 1/4" | 15 | 23 | 85 P+ | C091.039 | \$74 |
| 72" | 43 1/2" x 58" | 230162 | 384 | 48-1/2" - 78-1/2" | 4" x 4 7/8" x 63 1/4" | 63 1/4" | 17 | 35 | 85 P+ | C091.040 | 67 |
| 84" | 50 1/2" x 67 1/4" | 230163 | 404 | 55-1/2" - 85-1/2" | 4" x 4 7/8" x 72 1/2" | 72 1/2" | 20 | 31 | 85 P+ | C091.041 | 70 |

Luma 2/R Screen for use with Floor Stand* — Spring-roller operated heavy duty screen, inverted and cradled in a floor stand (sold separately). Floor Stand is required in order to operate Luma 2/R correctly. Case is scratch-resistant black finished steel (plastisol) or covered with black carpet. Viewing surface is Matt White XT1000E.

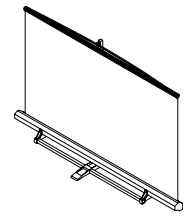

- **Sizes and Formats:** Custom sizes available by quotation. Custom sizes need to be specified in detail, including extra drop, if desired.
- **Options:** 2" wide black borders on AV format screens, no extra charge on request.

| H x W / Diagonal | Image Area | Overall Size | Matt White XT1000E | | | | Case Length | Shipping Wt./lbs. | Dim Wt./lbs. | Freight Class |
|------------------------------|-------------|--------------|--------------------|----------------------------|----------|---------------------------|-------------|-------------------|--------------|---------------|
| | | | Part No. | Black Plastisol Case PRICE | Part No. | Black Carpeted Case PRICE | | | | |
| 4:3 NTSC Video Format | | | | | | | | | | |
| 10' | 69" x 92" | 73" x 96" | 211009 | \$482 | 211021 | \$618 | 98 5/8" | 39 | 69 | 85 P+ |
| 11' | 78" x 104" | 83" x 108" | 211010 | 518 | 211022 | 706 | 111 1/4" | 45 | 69 | 85 |
| 150" | 87" x 116" | 92" x 120" | 211011 | 748 | 211023 | 960 | 123 1/4" | 50 | 69 | 85 |
| 15' | 105" x 140" | 109" x 144" | 211012 | 984 | 211024 | 1164 | 147 1/4" | 100 | 69 | 85 |
| AV Format | | | | | | | | | | |
| 72" x 96" | | | 211001 | \$482 | 211013 | \$618 | 98 5/8" | 39 | 69 | 85 P+ |
| 96" x 96" | | | 211002 | 506 | 211014 | 650 | 98 5/8" | 41 | 69 | 85 P+ |
| 7' x 9' | | | 211003 | 518 | 211015 | 706 | 111" | 45 | 69 | 85 |
| 9' x 9' | | | 211004 | 758 | 211016 | 964 | 111" | 48 | 69 | 85 |
| 8' x 10' | | | 211005 | 806 | 211017 | 1016 | 123 1/4" | 50 | 69 | 85 |
| 10' x 10' | | | 211006 | 880 | 211018 | 1094 | 123 1/4" | 64 | 69 | 85 |
| 9' x 12' | | | 211007 | 984 | 211019 | 1164 | 147 1/4" | 75 | 69 | 85 |
| 12' x 12' | | | 211008 | 1056 | 211020 | 1230 | 147 1/4" | 86 | 69 | 85 |

***Floor Stand** — Sturdy support for Luma 2/R. Screen case rests in "cradle"; viewing surface pulls up. Adjustable upright permits square-format screens to be used in movie, NTSC and slide formats. Floor Stand is required in order to operate Luma 2/R correctly.

| Part No. | PRICE | Shipping Wt./lbs. | Freight Class |
|----------|-------|-------------------|---------------|
| 212001 | \$576 | 25 | 85 P+ |

Portable Screens

Skirts for Mobile AV Carts and Tables — Removable skirts include hook and loop for instant attachment. Three fabrics: 10 oz. Poly-Knit satiny polyester, 12 oz. Classic Twill wrinkle-resistant polyester and 12 oz. Vellite brushed polyester with a crushed appearance.

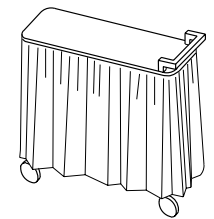

- **Colors:** Poly-Knit and Vellite are available in Navy or Black. Classic Twill is available in Navy or Black, other colors available on request.

| Cart Size H x W x L | Skirt Size H x W | No. of Sides | Black Poly-Knit | | Black Classic Twill | | Black Vellite | | Freight Class |
|---------------------|------------------|--------------|-----------------|-------|---------------------|-------|---------------|-------|---------------|
| | | | Part No. | PRICE | Part No. | PRICE | Part No. | PRICE | |
| 26" x 18" x 24" | 22" x 84" | 4 | C168.194 | \$47 | C168.222 | \$65 | C168.166 | \$65 | 70 P |
| 34" x 18" x 24" | 30" x 84" | 4 | C168.195 | 48 | C168.223 | 67 | C168.167 | 82 | 70 P |
| 42" x 18" x 24" | 38" x 84" | 4 | C168.196 | 60 | C168.224 | 85 | C168.168 | 90 | 70 P |
| 42" x 25" x 30" | 38" x 94" | 3 | C168.197 | 77 | C168.225 | 97 | C168.169 | 100 | 70 P |
| | 38" x 110" | 4 | C168.198 | 85 | C168.226 | 113 | C168.170 | 117 | 70 P |
| 48" x 25" x 30" | 38" x 116" | 4 | C168.199 | 88 | C168.227 | 122 | C168.171 | 128 | 70 P |
| | 44" x 94" | 3 | C168.200 | 83 | C168.228 | 120 | C168.172 | 103 | 70 P |
| | 44" x 110" | 4 | C168.201 | 90 | C168.229 | 138 | C168.173 | 123 | 70 P |
| 54" x 25" x 30" | 44" x 116" | 4 | C168.202 | 95 | C168.230 | 150 | C168.174 | 130 | 70 P |
| | 50" x 94" | 3 | C168.203 | 82 | C168.231 | 123 | C168.175 | 93 | 70 P |
| | 50" x 110" | 4 | C168.204 | 97 | C168.232 | 140 | C168.176 | 112 | 70 P |
| #203-56 | 50" x 116" | 4 | C168.205 | 103 | C168.233 | 153 | C168.177 | 128 | 70 P |
| | | 4 | C168.206 | 112 | C168.234 | 182 | C168.178 | 137 | 70 P |
| #425 | | 4 | C168.207 | 147 | C168.235 | 247 | C168.179 | 147 | 70 P |

Available on request: 1) Custom sizes (no minimum order); 2) 100% cotton Velour.

Diplomat/R—A tripod screen designed primarily with special modifications for the audiovisual rental market. Steel case is finished in baked-on black plastisol or black carpeting. Viewing surfaces from the OptiView family. **The Diplomat/R has gone through new rigorous testing to become stronger and more durable than ever before. We have upgraded the strength of the internal roller mechanism and changed to steel end caps in order to handle the rigors of carrying a portable screen.**

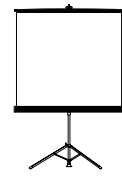

- **Black Borders:** NTSC, HDTV and 16:10 format have image area framed with black on all four sides. Black side borders are available on request for AV format screens.

- **Options:** Additional viewing surfaces and formats available by request.

| H x W / Diagonal | Image Area | Overall Size | Black Plastisol Case— OptiView Surface | | Black Carpeted Case— OptiView Surface | | Optional Carrying Case | | Case Length | Shipping Wt./lbs. | Freight Class |
|------------------------------|-------------------|-------------------|---|-------|--|-------|------------------------|-------|-------------|-------------------|---------------|
| | | | Matt White XT1000E | PRICE | Matt White XT1000E | PRICE | Part No. | PRICE | | | |
| 16:10 Format | | | | | | | | | | | |
| 67" | 35 1/2" x 56 1/2" | 39 1/2" x 59 1/2" | 215021 | \$294 | -- | -- | 214002 | \$40 | 70 1/2" | 33 | 85 P+ |
| 78" | 41 1/2" x 66 1/2" | 45" x 69 1/2" | 215022 | 320 | -- | -- | 214003 | 42 | 72 1/4" | 38 | 85 P+ |
| 94" | 50" x 80" | 54" x 83 1/2" | 215023 | 406 | -- | -- | 214004 | 52 | 92" | 44 | 85 P+ |
| 109" | 57 1/2" x 92" | 61 1/2" x 96" | 215024 | 436 | -- | -- | 214005 | 53 | 104" | 47 | 85 P+ |
| 16:9 HDTV Format | | | | | | | | | | | |
| 65" | 31 1/2" x 56 1/2" | 34 1/2" x 59 1/2" | 215029 | \$294 | -- | -- | 214002 | \$40 | 70 1/2" | 33 | 85 P+ |
| 76" | 37 1/2" x 66 1/2" | 41 1/2" x 69 1/2" | 215030 | 320 | -- | -- | 214003 | 42 | 72 1/4" | 38 | 85 P+ |
| 92" | 45" x 80" | 49" x 83 1/2" | 215031 | 406 | -- | -- | 214004 | 52 | 92" | 42 | 85 P+ |
| 106" | 51 1/2" x 92" | 55 1/2" x 96" | 215032 | 436 | -- | -- | 214005 | 53 | 104" | 47 | 85 P+ |
| 4:3 NTSC Video Format | | | | | | | | | | | |
| 6' | 42 1/2" x 56 1/2" | 46 1/2" x 59 1/2" | 215007 | \$294 | 215017 | \$336 | 214002 | \$40 | 70 1/2" | 33 | 85 P+ |
| 7' | 50" x 66 1/2" | 53 1/2" x 69 1/2" | 215008 | 320 | 215018 | 362 | 214003 | 42 | 72 1/4" | 38 | 85 P+ |
| 100" | 60" x 80" | 64" x 83 1/2" | 215009 | 406 | 215019 | 484 | 214004 | 52 | 92" | 44 | 85 P+ |
| 10' | 69" x 92" | 73" x 96" | 215010 | 436 | 215020 | 530 | 214005 | 53 | 104" | 47 | 85 P+ |
| AV Format | | | | | | | | | | | |
| 50" x 50" | | | 215001 | \$270 | 215011 | \$314 | 214001 | \$40 | 57 1/2" | 28 | 85 P+ |
| 60" x 60" | | | 215002 | 294 | 215012 | 336 | 214002 | 40 | 70 1/2" | 33 | 85 P+ |
| 70" x 70" | | | 215003 | 320 | 215013 | 362 | 214003 | 42 | 72 1/4" | 38 | 85 P+ |
| 84" x 84" | | | 215004 | 406 | 215014 | 484 | 214004 | 52 | 92" | 44 | 85 P+ |
| 72" x 96" | | | 215005 | 436 | 215015 | 530 | 214005 | 53 | 104" | 47 | 85 P+ |
| 96" x 96" | | | 215006 | 502 | 215016 | 596 | 214005 | 53 | 104" | 49 | 85 P+ |

Portable Screens

Consul—Economical tripod screen with black case finish.

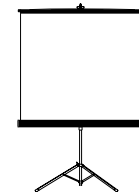

| Size H x W | OptiView Surface | | Optional Carrying Case | PRICE | Case Length | Shipping Wt./lbs. | Freight Class |
|------------------|-----------------------|----------|------------------------|---------|-------------|-------------------|---------------|
| | Matt White XT1000E | PRICE | | | | | |
| AV Format | | | | | | | |
| 40" x 40" | 216001B | \$123.00 | 217001 | \$48.00 | 46 5/8" | 16 | 85 P |
| 50" x 50" | 216002B | 133.00 | 217002 | 48.00 | 53 5/8" | 17 | 85 P |
| 60" x 60" | 216003B | 152.00 | 217003 | 48.00 | 63 5/8" | 21 | 85 P+ |
| 70" x 70" | 216004B | 160.00 | 217004 | 50.00 | 73 5/8" | 23 | 85 P+ |

Skirts for Tripod Screens—All skirts are 38" high and attach with hook and loop. (supplied). When used with carpeted Diplomat/R, please specify hook side on skirt for easier attachment. Loop side of attachment is standard on skirt, with adhesive hook strip included for attachment to screen case.

- **Vellite and Poly-Knit colors:** Navy or Black.
- **Classic Twill colors:** Navy or Black, other colors available on request.

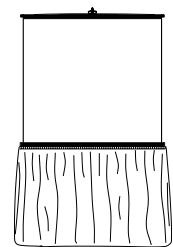

| Screen Size H x W | Screen Size Diag. | Skirt Size H x W | Black Poly-Knit | | Black Classic Twill | | Black Vellite | | Freight Class |
|-------------------|-------------------|------------------|-----------------|-------|---------------------|-------|---------------|-------|---------------|
| | | | Part No. | PRICE | Part No. | PRICE | Part No. | PRICE | |
| 50" x 50" | — | 38" x 53" | C168.156 | \$57 | C168.001 | \$67 | C168.146 | \$77 | 70 P |
| 60" x 60" | 6' | 38" x 63" | C168.157 | 60 | C168.030 | 70 | C168.147 | 80 | 70 P |
| 70" x 70" | 7' | 38" x 73" | C168.158 | 68 | C168.059 | 85 | C168.148 | 98 | 70 P |
| 84" x 84" | 100" | 38" x 87" | C168.159 | 78 | C168.088 | 98 | C168.149 | 120 | 70 P |
| 72" x 96" | 10' | 38" x 99" | C168.160 | 97 | C168.117 | 118 | C168.150 | 137 | 70 P |

StageScreen®—Fly it or use it with legs. The StageScreen is the strongest and most rigid screen on the market. Available in silver anodized or black frame finish. Freight Class: 85.

The 8" truss frame is **completely modular**. All available sizes of StageScreen are built from combinations of the same 6 standard color-coded frame sections (including optional legs). If a frame section should ever become lost or damaged you can replace it in seconds without tools.

A complete StageScreen consists of frame, viewing surface with pouch, an appropriate number of protective floor tarps and carrying cases. Leg package includes 2 legs, clamps to attach legs to frame, and any necessary additional carrying cases. Legs are made up of the same pieces that make the frame.

All viewing area sizes are exact true format. Custom sizes available—call for quotation.

Viewing surface attachment

The viewing surface attaches quickly and easily with the attached **DuraLoop™** bungees and handy nylon pull-tabs. Simply hook the surface to the posts on the frame.

Carrying Case

A wheeled heavy-duty polyethylene carrying case is included. UFS Carrying Case optionally available when a smaller case will suffice: See page 62 or contact Draper for details.

Viewing surfaces

The viewing surface is stretched perfectly flat, resulting in the highest picture quality. Standard viewing surfaces include **Black-Backed Matt White XT1000VB**—The perfect matt white diffusing surface; or **CineFlex CH1200V**—A neutral grey for rear projection. **CineFlex MH800V**, a lower gain rear projection surface and **CineFlex White XT600V** front/rear projection surface are also available. See page 5 for viewing surface details.

StageScreen Planning

Do you need a complete screen? Follow these steps to help find the right pricing in the charts on the following pages:

- 1. Choose your frame finish (silver anodized or black)**
- 2. Choose your viewing surface (Black-Backed XT1000VB, CineFlex CH1200V, CineFlex MH800V, or CineFlex White XT600V)**
- 3. Add legs if needed**

Do you need multiple sizes from one kit? You can also utilize our easy online StageScreen configurator by visiting the address at the right, or call 800-989-0112 for assistance.

StageScreen Packages

Increase your ROI by purchasing a single, complete package that can be configured for multiple sizes. See page 75

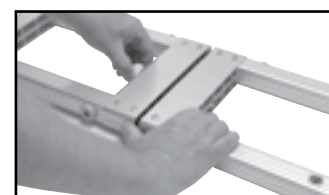
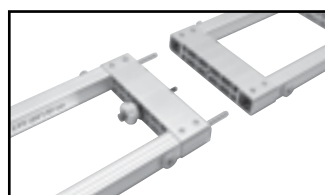

PRO PORTAL

Online StageScreen Configurator

Draper's online StageScreen configurator allows you to quickly and easily see what screen sizes your inventory can build, or see what frame pieces are required to create one or a whole list of sizes.

Mobile StageScreen Configurator

Draper now offers several mobile tools that work on any smartphone, including our popular StageScreen and FocalPoint configurators.

register here:

www.DraperInc.com/DraperPRO

StageScreen with Silver Anodized Frame & Black-Backed Matt White XT1000VB Front Projection Surface

Sewn white borders are optionally available—add 5% to the cost of the surface. See special StageScreen Packages on page 75.

| Image Area (Feet) | Image Area (Inches) | Diagonal | Overall Size | Frame, Surface, and Case(s) | | Ship Wt./ lbs. | Optional Silver Legs (pr.) | | | Surface Only | |
|------------------------------|------------------------|----------|---------------------|-----------------------------|---------|-------------------|----------------------------|---------|--------|--------------|--------|
| | | | | Part No. | PRICE | | Part No. | Leg Kit | PRICE | Part No. | PRICE |
| 16:10 Format | | | | | | | | | | | |
| 5' x 8' | 60" x 96" | 113" | 76 1/2" x 112 1/2" | 383295 | \$3067 | 89 | 383781 | A | \$2883 | 383163 | \$698 |
| 6' 3" x 10' | 75" x 120" | 142" | 94 1/2" x 136 1/2" | 383296 | 3539 | 119 | 383781 | A | 2883 | 383164 | 797 |
| 7' 6" x 12' | 90" x 144" | 170" | 106 1/2" x 160 1/2" | 383297 | 4233 | 208 | 383781 | A | 2883 | 383165 | 865 |
| 8' 9" x 14' | 105" x 168" | 198" | 124 1/2" x 184 1/2" | 383298 | 4751 | 163 | 383782 | B | 3132 | 383166 | 1022 |
| 10' x 16' | 120" x 192" | 226" | 136 1/2" x 208 1/2" | 383299 | 5096 | 178 | 383782 | B | 3132 | 383167 | 1270 |
| 11' 3" x 18' | 135" x 216" | 255" | 154 1/2" x 232 1/2" | 383300 | 5711 | 191 | 383783 | C | 3363 | 383168 | 1749 |
| 12' 6" x 20' | 150" x 240" | 283" | 166 1/2" x 256 1/2" | 383301 | 6210 | 272 | 383783 | C | 3363 | 383169 | 2190 |
| 15' x 24' | 180" x 288" | 340" | 196 1/2" x 304 1/2" | 383302 | 6871 | 369 | 383784 | D | 4260 | 383170 | 2647 |
| 18' 9" x 30' | 225" x 360" | 425" | 244 1/2" x 376 1/2" | 383303 | 10100 | 485 | — | — | — | 383171 | 4739 |
| 25' x 40' | 300" x 480" | 566" | 316 1/2" x 496 1/2" | 383304 | 15253 | 644 | — | — | — | 383172 | 8433 |
| 16:9 HDTV Format | | | | | | | | | | | |
| 4' 6" x 8' | 54" x 96" | 110" | 70 1/2" x 112 1/2" | 383285 | \$3042 | 139 | 383781 | A | \$2883 | 383153 | \$680 |
| 5' 7 1/2" x 10' | 67 1/2" x 120" | 138" | 88 1/2" x 136 1/2" | 383286 | 3324 | 121 | 383781 | A | 2883 | 383154 | 783 |
| 6' 9" x 12' | 81" x 144" | 165" | 100 1/2" x 160 1/2" | 383287 | 3524 | 216 | 383781 | A | 2883 | 383155 | 852 |
| 7' 10 1/2" x 14' | 94 1/2" x 168" | 193" | 112 1/2" x 184 1/2" | 383288 | 4117 | 138 | 383781 | A | 2883 | 383156 | 957 |
| 9' x 16' | 108" x 192" | 220" | 124 1/2" x 208 1/2" | 383289 | 5016 | 270 | 383782 | B | 3132 | 383157 | 1215 |
| 10' 1 1/2" x 18' | 121 1/2" x 216" | 248" | 142 1/2" x 232 1/2" | 383290 | 5489 | 506 | 383782 | B | 3132 | 383158 | 1752 |
| 11' 3" x 20' | 135" x 240" | 275" | 154 1/2" x 256 1/2" | 383291 | 6115 | 333 | 383783 | C | 3363 | 383159 | 2130 |
| 13' 6" x 24' | 162" x 288" | 330" | 178 1/2" x 304 1/2" | 383292 | 6706 | 375 | 383783 | C | 3363 | 383160 | 2517 |
| 16' 10 1/2" x 30' | 202 1/2" x 360" | 413" | 220 1/2" x 376 1/2" | 383293 | 9747 | 453 | — | — | — | 383161 | 4344 |
| 22' 6" x 40' | 270" x 480" | 551" | 286 1/2" x 496 1/2" | 383294 | 14781 | 594 | — | — | — | 383162 | 7732 |
| 4:3 NTSC Video Format | | | | | | | | | | | |
| 6' x 8' | 72" x 96" | 120" | 88 1/2" x 112 1/2" | 383275 | \$3169 | 114 | 383781 | A | \$2883 | 383143 | \$740 |
| 7' 6" x 10' | 90" x 120" | 150" | 106 1/2" x 136 1/2" | 383276 | 3629 | 148 | 383781 | A | 2883 | 383144 | 830 |
| 9' x 12' | 108" x 144" | 180" | 124 1/2" x 160 1/2" | 383277 | 4386 | 269 | 383782 | B | 3132 | 383145 | 925 |
| 10' 6" x 14' | 126" x 168" | 210" | 142 1/2" x 184 1/2" | 383278 | 5086 | 201 | 383782 | B | 3132 | 383146 | 1339 |
| 12' x 16' | 144" x 192" | 240" | 160 1/2" x 208 1/2" | 383279 | 5384 | 315 | 383783 | C | 3363 | 383147 | 1467 |
| 13' 6" x 18' | 162" x 216" | 270" | 178 1/2" x 232 1/2" | 383280 | 5910 | 244 | 383783 | C | 3363 | 383148 | 1857 |
| 15' x 20' | 180" x 240" | 300" | 196 1/2" x 256 1/2" | 383281 | 6471 | 346 | 383784 | D | 4260 | 383149 | 2384 |
| 18' x 24' | 216" x 288" | 360" | 232 1/2" x 304 1/2" | 383282 | 7473 | 393 | 383784 | D | 4260 | 383150 | 3024 |
| 22' 6" x 30' | 270" x 360" | 450" | 286 1/2" x 376 1/2" | 383283 | 12241 | 501 | — | — | — | 383151 | 6563 |
| 30' x 40' | 360" x 480" | 600" | 376 1/2" x 496 1/2" | 383284 | 16488 | 709 | — | — | — | 383152 | 9372 |
| MultiFormat | | | | | | | | | | | |
| 12' x 40' | 144" x 480" | 501" | 160 1/2" x 496 1/2" | 383305 | \$11796 | 489 | — | — | — | 383173 | \$4046 |
| 15' x 50' | 180" x 600" | 626" | 196 1/2" x 616 1/2" | 383306 | 13661 | 642 | — | — | — | 383174 | 6326 |
| 18' x 60' | 216" x 720" | 752" | 232 1/2" x 736 1/2" | 383307 | 17147 | 756 | — | — | — | 383175 | 9113 |

Portable
Screens

StageScreen with Black Frame & Black-Backed Matt White XT1000VB Front Projection Surface

Sewn white borders are optionally available—add 5% to the cost of the case. See special StageScreen Packages on page 75.

| Image Area (Feet) | Image Area (Inches) | Diagonal | Overall Size | Frame, Surface, and Case(s) | | Ship Wt./ lbs. | Optional Black Legs (pr.) | | | Surface Only | |
|------------------------------|------------------------|----------|---------------------|-----------------------------|---------|-------------------|---------------------------|---------|--------|--------------|--------|
| | | | | Part No. | PRICE | | Part No. | Leg Kit | PRICE | Part No. | PRICE |
| 16:10 Format | | | | | | | | | | | |
| 5' x 8' | 60" x 96" | 113" | 76 1/2" x 112 1/2" | 383504 | \$3217 | 89 | 383785 | A | \$3116 | 383163 | \$698 |
| 6' 3" x 10' | 75" x 120" | 142" | 94 1/2" x 136 1/2" | 383505 | 3737 | 119 | 383785 | A | 3116 | 383164 | 797 |
| 7' 6" x 12' | 90" x 144" | 170" | 106 1/2" x 160 1/2" | 383506 | 4451 | 151 | 383785 | A | 3116 | 383165 | 865 |
| 8' 9" x 14' | 105" x 168" | 198" | 124 1/2" x 184 1/2" | 383507 | 5024 | 163 | 383786 | B | 3377 | 383166 | 1022 |
| 10' x 16' | 120" x 192" | 226" | 136 1/2" x 208 1/2" | 383508 | 5379 | 178 | 383786 | B | 3377 | 383167 | 1270 |
| 11' 3" x 18' | 135" x 216" | 255" | 154 1/2" x 232 1/2" | 383509 | 6040 | 191 | 383787 | C | 3641 | 383168 | 1749 |
| 12' 6" x 20' | 150" x 240" | 283" | 166 1/2" x 256 1/2" | 383510 | 6585 | 272 | 383787 | C | 3641 | 383169 | 2190 |
| 15' x 24' | 180" x 288" | 340" | 196 1/2" x 304 1/2" | 383511 | 7298 | 369 | 383788 | D | 4608 | 383170 | 2647 |
| 18' 9" x 30' | 225" x 360" | 425" | 244 1/2" x 376 1/2" | 383512 | 10729 | 485 | — | — | — | 383171 | 4739 |
| 25' x 40' | 300" x 480" | 566" | 316 1/2" x 496 1/2" | 383513 | 16113 | 644 | — | — | — | 383172 | 8433 |
| 16:9 HDTV Format | | | | | | | | | | | |
| 4' 6" x 8' | 54" x 96" | 110" | 70 1/2" x 112 1/2" | 383494 | \$3181 | 217 | 383785 | A | \$3116 | 383153 | \$680 |
| 5' 7 1/2" x 10' | 67 1/2" x 120" | 138" | 88 1/2" x 136 1/2" | 383495 | 3492 | 218 | 383785 | A | 3116 | 383154 | 783 |
| 6' 9" x 12' | 81" x 144" | 165" | 100 1/2" x 160 1/2" | 383496 | 3711 | 210 | 383785 | A | 3116 | 383155 | 852 |
| 7' 10 1/2" x 14' | 94 1/2" x 168" | 193" | 112 1/2" x 184 1/2" | 383497 | 4373 | 175 | 383785 | A | 3116 | 383156 | 957 |
| 9' x 16' | 108" x 192" | 220" | 124 1/2" x 208 1/2" | 383498 | 5299 | 232 | 383786 | B | 3377 | 383157 | 1215 |
| 10' 1 1/2" x 18' | 121 1/2" x 216" | 248" | 142 1/2" x 232 1/2" | 383499 | 5794 | 268 | 383786 | B | 3377 | 383158 | 1752 |
| 11' 3" x 20' | 135" x 240" | 275" | 154 1/2" x 256 1/2" | 383500 | 6485 | 324 | 383787 | C | 3641 | 383159 | 2130 |
| 13' 6" x 24' | 162" x 288" | 330" | 178 1/2" x 304 1/2" | 383501 | 7123 | 347 | 383787 | C | 3641 | 383160 | 2517 |
| 16' 10 1/2" x 30' | 202 1/2" x 360" | 413" | 220 1/2" x 376 1/2" | 383502 | 10364 | 453 | — | — | — | 383161 | 4344 |
| 22' 6" x 40' | 270" x 480" | 551" | 286 1/2" x 496 1/2" | 383503 | 15615 | 594 | — | — | — | 383162 | 7732 |
| 4:3 NTSC Video Format | | | | | | | | | | | |
| 6' x 8' | 72" x 96" | 120" | 88 1/2" x 112 1/2" | 383484 | \$3321 | 114 | 383785 | A | \$3116 | 383143 | \$740 |
| 7' 6" x 10' | 90" x 120" | 150" | 106 1/2" x 136 1/2" | 383485 | 3834 | 145 | 383785 | A | 3116 | 383144 | 830 |
| 9' x 12' | 108" x 144" | 180" | 124 1/2" x 160 1/2" | 383486 | 4623 | 157 | 383786 | B | 3377 | 383145 | 925 |
| 10' 6" x 14' | 126" x 168" | 210" | 142 1/2" x 184 1/2" | 383487 | 5358 | 201 | 383786 | B | 3377 | 383146 | 1339 |
| 12' x 16' | 144" x 192" | 240" | 160 1/2" x 208 1/2" | 383488 | 5678 | 228 | 383787 | C | 3641 | 383147 | 1467 |
| 13' 6" x 18' | 162" x 216" | 270" | 178 1/2" x 232 1/2" | 383489 | 6260 | 244 | 383787 | C | 3641 | 383148 | 1857 |
| 15' x 20' | 180" x 240" | 300" | 196 1/2" x 256 1/2" | 383490 | 6870 | 350 | 383788 | D | 4608 | 383149 | 2384 |
| 18' x 24' | 216" x 288" | 360" | 232 1/2" x 304 1/2" | 383491 | 7888 | 393 | 383788 | D | 4608 | 383150 | 3024 |
| 22' 6" x 30' | 270" x 360" | 450" | 286 1/2" x 376 1/2" | 383492 | 12859 | 501 | — | — | — | 383151 | 6563 |
| 30' x 40' | 360" x 480" | 600" | 376 1/2" x 496 1/2" | 383493 | 17342 | 709 | — | — | — | 383152 | 9372 |
| MultiFormat | | | | | | | | | | | |
| 12' x 40' | 144" x 480" | 501" | 160 1/2" x 496 1/2" | 383514 | \$11759 | 489 | — | — | — | 383173 | \$4046 |
| 15' x 50' | 180" x 600" | 626" | 196 1/2" x 616 1/2" | 383515 | 14613 | 642 | — | — | — | 383174 | 6326 |
| 18' x 60' | 216" x 720" | 752" | 232 1/2" x 736 1/2" | 383516 | 18295 | 477 | — | — | — | 383175 | 9113 |

StageScreen with **Silver Anodized Frame & CineFlex CH1200V Rear Projection Surface**

CineFlex MH800V rear projection surface and CineFlex White XT600V front/rear projection surface are also available at the same price as CineFlex CH1200V. See page 4 for viewing surface details. When ordering these surfaces, use the CineFlex CH1200V part number followed by the appropriate suffix: **CA** for CineFlex MH800V, and **CC** for CineFlex White XT600V. Sewn white borders are optionally available—add 5% to the cost of the surface.

| Image Area (Feet) | Image Area (Inches) | Diagonal | Overall Size | Frame, Surface, and Case(s) | | Ship Wt./ lbs. | Optional Silver Legs (pr.) | | | Surface Only | |
|------------------------------|---------------------|----------|---------------------|-----------------------------|---------|----------------|----------------------------|---------|--------|--------------|--------|
| | | | | Part No. | PRICE | | Part No. | Leg Kit | PRICE | Part No. | PRICE |
| 16:10 Format | | | | | | | | | | | |
| 5' x 8' | 60" x 96" | 113" | 76 1/2" x 112 1/2" | 383328 | \$3232 | 89 | 383781 | A | \$2883 | 383196 | \$725 |
| 6' 3" x 10' | 75" x 120" | 142" | 94 1/2" x 136 1/2" | 383329 | 3729 | 119 | 383781 | A | 2883 | 383197 | 823 |
| 7' 6" x 12' | 90" x 144" | 170" | 106 1/2" x 160 1/2" | 383330 | 4459 | 208 | 383781 | A | 2883 | 383198 | 1082 |
| 8' 9" x 14' | 105" x 168" | 198" | 124 1/2" x 184 1/2" | 383331 | 4999 | 163 | 383782 | B | 3132 | 383199 | 1410 |
| 10' x 16' | 120" x 192" | 226" | 136 1/2" x 208 1/2" | 383332 | 5409 | 178 | 383782 | B | 3132 | 383200 | 2182 |
| 11' 3" x 18' | 135" x 216" | 255" | 154 1/2" x 232 1/2" | 383333 | 6051 | 191 | 383783 | C | 3363 | 383201 | 2627 |
| 12' 6" x 20' | 150" x 240" | 283" | 166 1/2" x 256 1/2" | 383334 | 6578 | 272 | 383783 | C | 3363 | 383202 | 2856 |
| 15' x 24' | 180" x 288" | 340" | 196 1/2" x 304 1/2" | 383335 | 7275 | 369 | 383784 | D | 4260 | 383203 | 3441 |
| 18' 9" x 30' | 225" x 360" | 425" | 244 1/2" x 376 1/2" | 383336 | 10815 | 485 | — | — | — | 383204 | 5783 |
| 25' x 40' | 300" x 480" | 566" | 316 1/2" x 496 1/2" | 383337 | 16343 | 644 | — | — | — | 383205 | 10305 |
| 16:9 HDTV Format | | | | | | | | | | | |
| 4' 6" x 8' | 54" x 96" | 110" | 70 1/2" x 112 1/2" | 383318 | \$3207 | 139 | 383781 | A | \$2883 | 383186 | \$705 |
| 5' 7 1/2" x 10' | 67 1/2" x 120" | 138" | 88 1/2" x 136 1/2" | 383319 | 3501 | 121 | 383781 | A | 2883 | 383187 | 813 |
| 6' 9" x 12' | 81" x 144" | 165" | 100 1/2" x 160 1/2" | 383320 | 3707 | 216 | 383781 | A | 2883 | 383188 | 1069 |
| 7' 10 1/2" x 14' | 94 1/2" x 168" | 193" | 112 1/2" x 184 1/2" | 383321 | 4336 | 138 | 383781 | A | 2883 | 383189 | 1322 |
| 9' x 16' | 108" x 192" | 220" | 124 1/2" x 208 1/2" | 383322 | 5326 | 270 | 383782 | B | 3132 | 383190 | 2089 |
| 10' 1 1/2" x 18' | 121 1/2" x 216" | 248" | 142 1/2" x 232 1/2" | 383323 | 5829 | 506 | 383782 | B | 3132 | 383191 | 2654 |
| 11' 3" x 20' | 135" x 240" | 275" | 154 1/2" x 256 1/2" | 383324 | 6480 | 333 | 383783 | C | 3363 | 383192 | 2779 |
| 13' 6" x 24' | 162" x 288" | 330" | 178 1/2" x 304 1/2" | 383325 | 7103 | 375 | 383783 | C | 3363 | 383193 | 3274 |
| 16' 10 1/2" x 30' | 202 1/2" x 360" | 413" | 220 1/2" x 376 1/2" | 383326 | 10440 | 453 | — | — | — | 383194 | 5306 |
| 22' 6" x 40' | 270" x 480" | 551" | 286 1/2" x 496 1/2" | 383327 | 15143 | 594 | — | — | — | 383195 | 9450 |
| 4:3 NTSC Video Format | | | | | | | | | | | |
| 6' x 8' | 72" x 96" | 120" | 88 1/2" x 112 1/2" | 383308 | \$3337 | 114 | 383781 | A | \$2883 | 383176 | \$763 |
| 7' 6" x 10' | 90" x 120" | 150" | 106 1/2" x 136 1/2" | 383309 | 3819 | 148 | 383781 | A | 2883 | 383177 | 857 |
| 9' x 12' | 108" x 144" | 180" | 124 1/2" x 160 1/2" | 383310 | 4654 | 269 | 383782 | B | 3132 | 383178 | 1200 |
| 10' 6" x 14' | 126" x 168" | 210" | 142 1/2" x 184 1/2" | 383311 | 5401 | 201 | 383782 | B | 3132 | 383179 | 1917 |
| 12' x 16' | 144" x 192" | 240" | 160 1/2" x 208 1/2" | 383312 | 5704 | 315 | 383783 | C | 3363 | 383180 | 2104 |
| 13' 6" x 18' | 162" x 216" | 270" | 178 1/2" x 232 1/2" | 383313 | 6261 | 244 | 383783 | C | 3363 | 383181 | 2792 |
| 15' x 20' | 180" x 240" | 300" | 196 1/2" x 256 1/2" | 383314 | 6855 | 346 | 383784 | D | 4260 | 383182 | 3099 |
| 18' x 24' | 216" x 288" | 360" | 232 1/2" x 304 1/2" | 383315 | 7915 | 393 | 383784 | D | 4260 | 383183 | 3931 |
| 22' 6" x 30' | 270" x 360" | 450" | 286 1/2" x 376 1/2" | 383316 | 13128 | 501 | — | — | — | 383184 | 7311 |
| 30' x 40' | 360" x 480" | 600" | 376 1/2" x 496 1/2" | 383317 | 17660 | 709 | — | — | — | 383185 | 11449 |
| MultiFormat | | | | | | | | | | | |
| 12' x 40' | 144" x 480" | 501" | 160 1/2" x 496 1/2" | 383338 | \$12861 | 489 | — | — | — | 383206 | \$4944 |
| 15' x 50' | 180" x 600" | 626" | 196 1/2" x 616 1/2" | 383339 | 14828 | 642 | — | — | — | 383207 | 7727 |
| 18' x 60' | 216" x 720" | 752" | 232 1/2" x 736 1/2" | 383340 | 19334 | 756 | — | — | — | 383208 | 11141 |

StageScreen with **Black Frame & CineFlex CH1200V Rear Projection Surface**

CineFlex MH800V rear projection surface and CineFlex White XT600V front/rear projection surface are also available at the same price as CineFlex CH1200V. See page 4 for viewing surface details. When ordering these surfaces, use the CineFlex CH1200V part number followed by the appropriate suffix: **CA** for CineFlex MH800V, and **CC** for CineFlex White XT600V. Sewn white borders are optionally available—add 5% to the cost of the surface.

| Image Area (Feet) | Image Area (Inches) | Diagonal | Overall Size | Frame, Surface, and Case(s) | | Ship Wt./ lbs. | Optional Black Legs (pr.) | | | Surface Only | |
|------------------------------|---------------------|----------|---------------------|-----------------------------|---------|----------------|---------------------------|---------|--------|--------------|--------|
| | | | | Part No. | PRICE | | Part No. | Leg Kit | PRICE | Part No. | PRICE |
| 16:10 Format | | | | | | | | | | | |
| 5' x 8' | 60" x 96" | 113" | 76 1/2" x 112 1/2" | 383570 | \$3392 | 89 | 383785 | A | \$3116 | 383196 | \$725 |
| 6' 3" x 10' | 75" x 120" | 142" | 94 1/2" x 136 1/2" | 383571 | 4111 | 119 | 383785 | A | 3116 | 383197 | 823 |
| 7' 6" x 12' | 90" x 144" | 170" | 106 1/2" x 160 1/2" | 383572 | 4689 | 151 | 383785 | A | 3116 | 383198 | 1082 |
| 8' 9" x 14' | 105" x 168" | 198" | 124 1/2" x 184 1/2" | 383573 | 5288 | 163 | 383786 | B | 3377 | 383199 | 1410 |
| 10' x 16' | 120" x 192" | 226" | 136 1/2" x 208 1/2" | 383574 | 5709 | 178 | 383786 | B | 3377 | 383200 | 2182 |
| 11' 3" x 18' | 135" x 216" | 255" | 154 1/2" x 232 1/2" | 383575 | 6401 | 191 | 383787 | C | 3641 | 383201 | 2627 |
| 12' 6" x 20' | 150" x 240" | 283" | 166 1/2" x 256 1/2" | 383576 | 6976 | 272 | 383787 | C | 3641 | 383202 | 2856 |
| 15' x 24' | 180" x 288" | 340" | 196 1/2" x 304 1/2" | 383577 | 7727 | 369 | 383788 | D | 4608 | 383203 | 3441 |
| 18' 9" x 30' | 225" x 360" | 425" | 244 1/2" x 376 1/2" | 383578 | 11491 | 485 | — | — | — | 383204 | 5783 |
| 25' x 40' | 300" x 480" | 566" | 316 1/2" x 496 1/2" | 383579 | 17263 | 644 | — | — | — | 383205 | 10305 |
| 16:9 HDTV Format | | | | | | | | | | | |
| 4' 6" x 8' | 54" x 96" | 110" | 70 1/2" x 112 1/2" | 383560 | \$3354 | 217 | 383785 | A | \$3116 | 383186 | \$705 |
| 5' 7 1/2" x 10' | 67 1/2" x 120" | 138" | 88 1/2" x 136 1/2" | 383561 | 3681 | 218 | 383785 | A | 3116 | 383187 | 813 |
| 6' 9" x 12' | 81" x 144" | 165" | 100 1/2" x 160 1/2" | 383562 | 3909 | 210 | 383785 | A | 3116 | 383188 | 1069 |
| 7' 10 1/2" x 14' | 94 1/2" x 168" | 193" | 112 1/2" x 184 1/2" | 383563 | 4603 | 175 | 383785 | A | 3116 | 383189 | 1322 |
| 9' x 16' | 108" x 192" | 220" | 124 1/2" x 208 1/2" | 383564 | 5624 | 232 | 383786 | B | 3377 | 383190 | 2089 |
| 10' 1 1/2" x 18' | 121 1/2" x 216" | 248" | 142 1/2" x 232 1/2" | 383565 | 6151 | 268 | 383786 | B | 3377 | 383191 | 2654 |
| 11' 3" x 20' | 135" x 240" | 275" | 154 1/2" x 256 1/2" | 383566 | 6866 | 324 | 383787 | C | 3641 | 383192 | 2779 |
| 13' 6" x 24' | 162" x 288" | 330" | 178 1/2" x 304 1/2" | 383567 | 7545 | 347 | 383787 | C | 3641 | 383193 | 3274 |
| 16' 10 1/2" x 30' | 202 1/2" x 360" | 413" | 220 1/2" x 376 1/2" | 383568 | 11099 | 453 | — | — | — | 383194 | 5306 |
| 22' 6" x 40' | 270" x 480" | 551" | 286 1/2" x 496 1/2" | 383569 | 17293 | 594 | — | — | — | 383195 | 9450 |
| 4:3 NTSC Video Format | | | | | | | | | | | |
| 6' x 8' | 72" x 96" | 120" | 88 1/2" x 112 1/2" | 383550 | \$3497 | 114 | 383785 | A | \$3116 | 383176 | \$763 |
| 7' 6" x 10' | 90" x 120" | 150" | 106 1/2" x 136 1/2" | 383551 | 4037 | 145 | 383785 | A | 3116 | 383177 | 857 |
| 9' x 12' | 108" x 144" | 180" | 124 1/2" x 160 1/2" | 383552 | 4904 | 157 | 383786 | B | 3377 | 383178 | 1200 |
| 10' 6" x 14' | 126" x 168" | 210" | 142 1/2" x 184 1/2" | 383553 | 5691 | 201 | 383786 | B | 3377 | 383179 | 1917 |
| 12' x 16' | 144" x 192" | 240" | 160 1/2" x 208 1/2" | 383554 | 6018 | 228 | 383787 | C | 3641 | 383180 | 2104 |
| 13' 6" x 18' | 162" x 216" | 270" | 178 1/2" x 232 1/2" | 383555 | 6630 | 244 | 383787 | C | 3641 | 383181 | 2792 |
| 15' x 20' | 180" x 240" | 300" | 196 1/2" x 256 1/2" | 383556 | 7273 | 350 | 383788 | D | 4608 | 383182 | 3099 |
| 18' x 24' | 216" x 288" | 360" | 232 1/2" x 304 1/2" | 383557 | 8353 | 393 | 383788 | D | 4608 | 383183 | 3931 |
| 22' 6" x 30' | 270" x 360" | 450" | 286 1/2" x 376 1/2" | 383558 | 13789 | 501 | — | — | — | 383184 | 7311 |
| 30' x 40' | 360" x 480" | 600" | 376 1/2" x 496 1/2" | 383559 | 18574 | 709 | — | — | — | 383185 | 11449 |
| MultiFormat | | | | | | | | | | | |
| 12' x 40' | 144" x 480" | 501" | 160 1/2" x 496 1/2" | 383580 | \$12663 | 489 | — | — | — | 383206 | \$4944 |
| 15' x 50' | 180" x 600" | 626" | 196 1/2" x 616 1/2" | 383581 | 15972 | 642 | — | — | — | 383207 | 7727 |
| 18' x 60' | 216" x 720" | 752" | 232 1/2" x 736 1/2" | 383582 | 20411 | 477 | — | — | — | 383208 | 11141 |

StageScreen Components with Silver Anodized Finish

Colors below refer to the color-coded knobs on frame sections.

| Description | Part No. | Overall Size | PRICE |
|-------------------------------------|----------|-----------------------------|-------|
| 2' (Yellow) Frame Section | 383001 | 24" x 8" | \$190 |
| 3' (Red) Frame Section | 383002 | 36" x 8" | 220 |
| 3 1/2' (Green) Frame Section | 383003 | 42" x 8" | 228 |
| 4' (Blue) Frame Section | 383004 | 48" x 8" | 255 |
| 5' (Orange) Frame Section | 383005 | 60" x 8" | 270 |
| 6' (Purple) Frame Section | 383006 | 72" x 8" | 300 |
| Frame Corner | 383007 | 14 1/4" x 8" | 197 |
| Leg T-Section | 383008 | 14 1/4" x 20 1/2" | 327 |
| Top T-Section | 383825 | 24" x 24" | 328 |
| Bottom T-Section | 383826 | 24" x 24" | 335 |
| Frame Stiffener Bar | 383009 | 2" x 22" | 37 |
| Dual Frame Stiffener Bar | 383789 | 4" x 22" | 368 |
| Anti-Sway Stabilizer (pair) | 383808 | 2" x 22" | 363 |
| Leg Attachment Clamp (black finish) | 383482 | 2" x 2" | 60 |
| Carrying Case | 219200 | 15 5/8" x 20 1/2" x 84 1/4" | 563 |
| Tarp | 383483 | 144" x 216" | 40 |

Combinations
of these few
pieces make up
ANY SIZE
frame and legs!

StageScreen Components with Black Anodized Finish

Colors below refer to the color-coded knobs on frame sections.

| Description | Part No. | Overall Size | PRICE |
|-------------------------------------|----------|-----------------------------|-------|
| 2' (Yellow) Frame Section | 383473 | 24" x 8" | \$208 |
| 3' (Red) Frame Section | 383474 | 36" x 8" | 243 |
| 3 1/2' (Green) Frame Section | 383475 | 42" x 8" | 252 |
| 4' (Blue) Frame Section | 383476 | 48" x 8" | 285 |
| 5' (Orange) Frame Section | 383477 | 60" x 8" | 302 |
| 6' (Purple) Frame Section | 383478 | 72" x 8" | 343 |
| Frame Corner | 383479 | 14 1/4" x 8" | 197 |
| Leg T-Section | 383480 | 14 1/4" x 20 1/2" | 325 |
| Top T-Section | 383823 | 24" x 24" | 328 |
| Bottom T-Section | 383824 | 24" x 24" | 335 |
| Frame Stiffener Bar | 383481 | 2" x 22" | 37 |
| Dual Frame Stiffener Bar | 383790 | 4" x 22" | 369 |
| Anti-Sway Stabilizer (pair) | 383805 | 2" x 22" | 363 |
| Leg Attachment Clamp (black finish) | 383482 | 2" x 2" | 60 |
| Carrying Case | 219200 | 15 5/8" x 20 1/2" x 84 1/4" | 563 |
| Tarp | 383483 | 144" x 216" | 40 |

PRO PORTAL

Online StageScreen Configurator

Draper's online StageScreen configurator allows you to quickly and easily see what screen sizes your inventory can build, or see what frame pieces are required to create one or a whole list of sizes.

Mobile StageScreen Configurator

Draper now offers several mobile tools that work on any smartphone, including our popular StageScreen and FocalPoint configurators.

register here: www.DraperInc.com/DraperPRO

Portable
Screens

StageScreen Accessories

| Description | Part No. | PRICE |
|------------------------|----------|-------|
| Bungee loop repair kit | 383829 | \$6 |
| Pull-Tab repair kit | 383831 | 3 |
| Wall Mount Bracket | 383827 | 70 |
| Fly Bracket (single) | 385221 | 50 |
| Fly Bracket (pair) | 385222 | 92 |

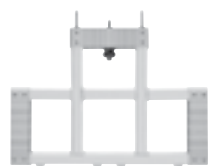

Leg T-Section

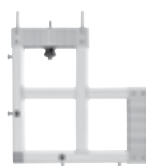

Frame Corner



Leg Attachment
Clamp



Frame Stiffener Bar



2' (Yellow)
Frame Section



3' (Red)
Frame Section



3 1/2' (Green)
Frame Section



4' (Blue)
Frame Section



5' (Orange)
Frame Section



6' (Purple)
Frame Section

StageScreen Dress Kits

A complete StageScreen Dress Kit includes a 68" tall skirt, 14" tall valance, universal valance bars, a pair of 32" wide side drapes and adjustable drapery bars. Valance and drapery bars fit snugly onto the StageScreen frame—no tools needed. The skirt attaches with a Duraloop™ bungee on each end, and convenient built-in magnetic fasteners. A wheeled heavy-duty polyethylene carrying case is included. UFS Carrying Case optionally available when a smaller case will suffice: See page 83 or contact Draper for details.



Inherently Flame Retardant (IFR) Velour is standard for StageScreen Dress Kits, also available in 20 oz. Velour. Draper's IFR Velour never needs retreating—it is flame retardant for the life of the fabric. More resistant to wrinkling than standard Velour, yet 15% lighter weight for easier installation and fabric management.

- **Options:** Black is standard, also available in rich navy or a variety of custom colors—details available on request. 20 oz Velour (treated for flame retardancy) also available. Masking strips are optional.

Flame Retardancy Standards—Draper's Inherently Flame Retardant Velour is manufactured and certified to meet these flame retardancy standards: *NFPA 701, MVS-302, BIFMA-F-1-1978, SC-191-53 Class 1 California, and UFAC Class 1.*

| Image Area (Feet) | Image Area (Inches) | Diag. | IFR Dress Kit with Case(s) | | | IFR Skirt Only | | | Velour Dress Kit with Case(s) | | | Velour Skirt Only | | | Freight Class |
|------------------------------|---------------------|-------|----------------------------|--------|-------------------|----------------|-------|----------|-------------------------------|-------------------|----------|-------------------|----|--|---------------|
| | | | Part No. | PRICE | Shipping Wt./lbs. | Part No. | PRICE | Part No. | PRICE | Shipping Wt./lbs. | Part No. | PRICE | | | |
| 16:10 Format | | | | | | | | | | | | | | | |
| 5' x 8' | 60" x 96" | 113" | 384017 | \$1911 | 85 | 384041 | \$477 | 384065 | \$1866 | 90 | 384089 | \$453 | 70 | | |
| 6' 3" x 10' | 75" x 120" | 142" | 384018 | 2189 | 100 | 384042 | 585 | 384066 | 2141 | 105 | 384090 | 557 | 70 | | |
| 7' 6" x 12' | 90" x 144" | 170" | 384019 | 2466 | 112 | 384043 | 692 | 384067 | 2411 | 115 | 384091 | 657 | 70 | | |
| 8' 9" x 14' | 105" x 168" | 198" | 384020 | 3042 | 116 | 384044 | 725 | 384068 | 2976 | 120 | 384092 | 687 | 70 | | |
| 10' x 16' | 120" x 192" | 226" | 384021 | 3009 | 120 | 384045 | 914 | 384069 | 2943 | 123 | 384093 | 867 | 70 | | |
| 11' 3" x 18' | 135" x 216" | 255" | 384022 | 3173 | 125 | 384046 | 986 | 384070 | 3110 | 124 | 384094 | 936 | 70 | | |
| 12' 6" x 20' | 150" x 240" | 283" | 384023 | 3323 | 130 | 384047 | 1056 | 384071 | 3263 | 130 | 384095 | 1004 | 70 | | |
| 15' x 24' | 180" x 288" | 340" | 384024 | 3992 | 140 | 384048 | 1235 | 384072 | 3912 | 145 | 384096 | 1173 | 70 | | |
| 16:9 HDTV Format | | | | | | | | | | | | | | | |
| 4' 6" x 8' | 54" x 96" | 110" | 384009 | \$1899 | 85 | 384033 | \$477 | 384057 | \$1853 | 90 | 384081 | \$453 | 70 | | |
| 5' 7 1/2" x 10' | 67 1/2" x 120" | 138" | 384010 | 2063 | 100 | 384034 | 548 | 384058 | 2019 | 105 | 384082 | 521 | 70 | | |
| 6' 9" x 12' | 81" x 144" | 165" | 384011 | 2327 | 112 | 384035 | 656 | 384059 | 2279 | 115 | 384083 | 623 | 70 | | |
| 7' 10 1/2" x 14' | 94 1/2" x 168" | 193" | 384012 | 2595 | 116 | 384036 | 762 | 384060 | 2541 | 120 | 384084 | 726 | 70 | | |
| 9' x 16' | 108" x 192" | 220" | 384013 | 2756 | 85 | 384037 | 836 | 384061 | 2703 | 123 | 384085 | 794 | 70 | | |
| 10' 1 1/2" x 18' | 121 1/2" x 216" | 248" | 384014 | 3147 | 120 | 384038 | 986 | 384062 | 3083 | 124 | 384086 | 936 | 70 | | |
| 11' 3" x 20' | 135" x 240" | 275" | 384015 | 3299 | 130 | 384039 | 1056 | 384063 | 3236 | 130 | 384087 | 1004 | 70 | | |
| 13' 6" x 24' | 162" x 288" | 330" | 384016 | 3954 | 140 | 384040 | 1235 | 384064 | 3873 | 145 | 384088 | 1173 | 70 | | |
| 4:3 NTSC Video Format | | | | | | | | | | | | | | | |
| 6' x 8' | 72" x 96" | 120" | 384001 | \$1953 | 90 | 384025 | \$741 | 384049 | \$1908 | 90 | 384073 | \$704 | 70 | | |
| 7' 6" x 10' | 90" x 120" | 150" | 384002 | 2405 | 105 | 384026 | 908 | 384050 | 2334 | 107 | 384074 | 861 | 70 | | |
| 9' x 12' | 108" x 144" | 180" | 384003 | 2722 | 115 | 384027 | 1107 | 384051 | 2651 | 117 | 384075 | 1052 | 70 | | |
| 10' 6" x 14' | 126" x 168" | 210" | 384004 | 2667 | 125 | 384028 | 1178 | 384052 | 2616 | 128 | 384076 | 1119 | 70 | | |
| 12' x 16' | 144" x 192" | 240" | 384005 | 2831 | 138 | 384029 | 1478 | 384053 | 3071 | 140 | 384077 | 1404 | 70 | | |
| 13' 6" x 18' | 162" x 216" | 270" | 384006 | 2981 | 144 | 384030 | 1311 | 384054 | 2910 | 145 | 384078 | 1247 | 70 | | |
| 15' x 20' | 180" x 240" | 300" | 384007 | 3384 | 150 | 384031 | 1622 | 384055 | 3326 | 150 | 384079 | 1541 | 70 | | |
| 18' x 24' | 216" x 288" | 360" | 384008 | 4065 | 178 | 384032 | 2117 | 384056 | 3992 | 180 | 384080 | 2012 | 70 | | |

All products in above table are in freight class 70.

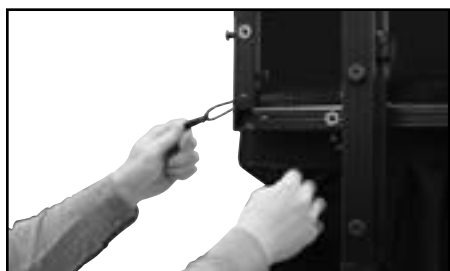

Attaching the Dress Kit Skirt to a StageScreen



Valance Bar



Two-piece Drapery Bar

Valance Bar—Attach Valance Bars to the top of your StageScreen as needed to hang an attractive top valance. Quickly snaps onto viewing surface attachment posts and hang your valance. Black finish.

Two-Piece Drapery Bar—Allows you to add side drapes to your StageScreen. Quickly hangs onto viewing surface attachment posts. Two piece assembly allows for easy storage. Purchase individually or in pairs. Black finish.

StageScreen Dress Kit Accessories

| Description | Part No. | PRICE |
|---|----------|--------------------|
| Two-Piece Drapery Bar (Pair) | 384100 | \$112 |
| Two-Piece Drapery Bar (Single) | 384099 | 55 |
| Drapery Bar Replacement Piece (Upper Portion) | 384097 | 30 |
| Drapery Bar Replacement Piece (Lower Portion) | 384098 | 32 |
| Valance Bar | 384101 | 43 |
| Carrying Case | 219200 | 563 |
| Masking Strips for StageScreen | | Call for quotation |

FocalPoint® — With small profile frame sections made of sturdy extruded aluminum, the FocalPoint is extremely rigid and durable, while remaining lightweight. With no hinges, the FocalPoint is strong, and still features quick and easy assembly. All available sizes of FocalPoint are built from different length combinations of the same frame sections. Screen legs are also constructed using these frame sections.

AV rental dealers can **improve their ROI** while streamlining inventory with the FocalPoint. You can easily build multiple screen sizes from a common inventory of frame sections, you only need to purchase separate viewing surfaces for different sizes. Special FocalPoint packages are available on page 75.

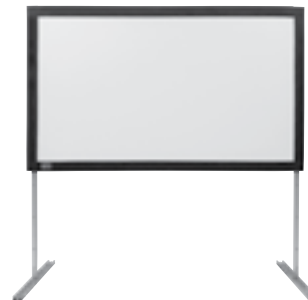

FocalPoint with Black-Backed Matt White XT1000VB Viewing Surface

| Image Area Diagonal | Image Area (H x W) | Overall Size | Complete Screen with Silver Anodized Frame | | Complete Screen with Black Anodized Frame | | Matt White XT1000VB Surface Only | | Complete Shipping Wt./lbs. | Freight Class |
|------------------------------|-----------------------|-----------------|---|--------|--|--------|----------------------------------|-------|----------------------------------|------------------|
| | | | Part No.* | PRICE | Part No.* | PRICE | Surface Part No. | PRICE | | |
| 16:10 Format | | | | | | | | | | |
| 94" | 50" x 80" | 62" x 92" | 385066 | \$2275 | 385122 | \$2292 | 386132 | \$637 | 101 | 85 |
| 113" | 60" x 96" | 68" x 104" | 385067 | 2387 | 385123 | 2417 | 386133 | 715 | 138 | 85 |
| 142" | 75" x 120" | 86" x 128" | 385069 | 3027 | 385125 | 3054 | 386134 | 817 | 150 | 85 |
| 170" | 90" x 144" | 98" x 152" | 385070 | 3682 | 385126 | 3722 | 386135 | 999 | 162 | 85 |
| 198" | 105" x 168" | 116" x 176" | 385071 | 3969 | 385127 | 4029 | 386136 | 1115 | 173 | 85 |
| 226" | 120" x 192" | 128" x 200" | 385072 | 4788 | 385128 | 4856 | 386137 | 1484 | 190 | 85 |
| 255" | 135" x 216" | 146" x 224" | 385073 | 5301 | 385129 | 5373 | 386138 | 1722 | 215 | 85 |
| 283" | 150" x 240" | 158" x 248" | 385074 | 5751 | 385130 | 5828 | 386139 | 2040 | 255 | 85 |
| 16:9 HDTV Format | | | | | | | | | | |
| 92" | 45" x 80" | 56" x 92" | 385046 | \$2249 | 385102 | \$2277 | 386116 | \$623 | 97 | 85 |
| 110" | 54" x 96" | 62" x 104" | 385047 | 2355 | 385103 | 2372 | 386117 | 695 | 99 | 85 |
| 138" | 67 1/2" x 120" | 80" x 128" | 385049 | 2979 | 385105 | 3014 | 386118 | 782 | 149 | 85 |
| 165" | 81" x 144" | 92" x 152" | 385050 | 3606 | 385106 | 3779 | 386119 | 939 | 161 | 85 |
| 193" | 94 1/2" x 168" | 104" x 176" | 385051 | 3899 | 385107 | 3962 | 386120 | 1080 | 172 | 85 |
| 220" | 108" x 192" | 116" x 200" | 385052 | 4414 | 385108 | 4479 | 386121 | 1214 | 184 | 85 |
| 248" | 121 1/2" x 216" | 134" x 224" | 385053 | 5041 | 385109 | 5278 | 386122 | 1689 | 205 | 85 |
| 275" | 135" x 240" | 146" x 248" | 385054 | 5639 | 385110 | 5714 | 386123 | 1954 | 257 | 85 |
| 4:3 NTSC Video Format | | | | | | | | | | |
| 100" | 60" x 80" | 68" x 92" | 385030 | \$2324 | 385086 | \$2409 | 386100 | \$677 | 120 | 85 |
| 120" | 72" x 96" | 80" x 104" | 385031 | 2507 | 385087 | 2536 | 386101 | 760 | 153 | 85 |
| 150" | 90" x 120" | 98" x 128" | 385032 | 3342 | 385088 | 3517 | 386102 | 867 | 165 | 85 |
| 180" | 108" x 144" | 116" x 152" | 385033 | 3754 | 385089 | 3816 | 386103 | 1029 | 168 | 85 |
| 210" | 126" x 168" | 134" x 176" | 385034 | 4659 | 385090 | 4709 | 386104 | 1317 | 178 | 85 |
| 240" | 144" x 192" | 152" x 200" | 385035 | 5138 | 385091 | 5216 | 386105 | 1557 | 199 | 85 |
| 270" | 162" x 216" | 170" x 224" | 385036 | 5548 | 385092 | 5619 | 386106 | 1860 | 223 | 85 |
| 300" | 180" x 240" | 188" x 248" | 385037 | 6055 | 385093 | 6151 | 386107 | 2224 | 272 | 85 |

*Screen part numbers include complete screen: frame, surface, legs and carrying case(s).

FocalPoint Accessories & Components

Frame section colors below refer to the color-coded knobs.

| Description | Overall Size | Silver Finish | | Black Finish | |
|--|-------------------------|---------------|-------|--------------|-------|
| | | Part No. | PRICE | Part No. | PRICE |
| 2' (Yellow) Frame Section | | 385008 | \$93 | 385001 | \$95 |
| 3' (Red) Frame Section | | 385009 | 115 | 385002 | 120 |
| 3 1/2' (Green) Frame Section | | 385010 | 148 | 385003 | 155 |
| 4' (Blue) Frame Section | | 385011 | 165 | 385004 | 168 |
| Frame Corner | 14 1/4" x 8" | 385007 | 115 | 385005 | 117 |
| Frame Corner for Large Screens | | 385197 | 120 | 385196 | 120 |
| Leg Package A (pair)* | — | 385018 | 1019 | 385016 | 1044 |
| Leg Package B (pair)* | — | 385022 | 1545 | 385020 | 1587 |
| Leg Package C (pair)* | — | 385026 | 1836 | 385024 | 1889 |
| Heavy Duty Leg Brace (pr) | 2" x 22" | 385148 | 120 | 385146 | 122 |
| Heavy Duty Leg Brace (single) | 2" x 22" | 385149 | 60 | 385147 | 62 |
| Anti-sway Stabilizer (pr) | — | 385144 | 230 | 385142 | 233 |
| Anti-sway Stabilizer (single) | — | 385145 | 116 | 385143 | 116 |
| 2 1/8" Crank for Anti-Sway with HD Leg Brace | — | 385028 | 14 | 385028 | 14 |
| 1 3/4" Crank for HD Leg Brace | — | 385214 | 14 | 385214 | 14 |
| 1.31" Crank for Anti-Sway | — | 385215 | 14 | 385215 | 14 |
| Leg Base "front" | 4" x 12" | 385014 | 57 | 385012 | 57 |
| Tall Leg Base "front" | 40" x 12" | 385220 | 107 | 385219 | 107 |
| Tall Leg Base "front" (pair) | 40" x 12" | 385199 | 205 | 385198 | 205 |
| Carrying Case | 16 3/8" x 17 1/4" x 60" | 219098 | 279 | 219098 | 279 |
| Tarp | 144" x 216" | 383483 | 40 | 383483 | 40 |
| Bungee Loop Repair Kit | — | 385216 | 7 | 385216 | 7 |
| Pull-Tab Loop Repair Kit | — | 383829 | 6 | 383829 | 6 |
| FocalPoint Fly bracket (single) | — | — | — | 385217 | 50 |
| FocalPoint Fly bracket (pair) | — | — | — | 385218 | 92 |

*Leg Package A (includes 8-24", 2-48", 2-T pieces) is for use with 72" high image areas or below, Leg Package B (includes 4-24", 4-36", 4-48", 2-T pieces, anti-sway and HD support) is for use with 73" to 126" image height screens, Leg Package C (includes 2-24", 6-36", 6-48", 2-T pieces, anti-sway and HD support) is for screens with 127" or larger image heights.

FocalPoint Dress Kit Accessories

| Description | Part No. | PRICE |
|---|----------|-------|
| 2 pc. Drape Bar (pair) | 387100 | \$88 |
| 2 pc. Drape Bar (single) | 387099 | 45 |
| Drape Bar Replacement Piece (upper portion) | 384097 | 30 |
| Drape Bar Replacement Piece (lower portion) | 387098 | 32 |
| Valance Bar (single)* | 384101 | 43 |
| Carrying Case | 219098 | 279 |

*Attach Valance Bars to top of FocalPoint as needed to hang an attractive top valance. Wider screens will require more.

PRO PORTAL

Online FocalPoint Configurator

Draper's online FocalPoint configurator allows you to quickly and easily see what screen sizes your inventory can build, or see what frame pieces are required to create one or a whole list of sizes.

Mobile FocalPoint Configurator

Draper now offers our popular FocalPoint configurator for mobile use.

register here: www.DraperInc.com/DraperPRO

Format Masking Strips are available for FocalPoint.
Call for quotation.

FocalPoint with CineFlex CH1200V Rear Viewing Surface—CineFlex MH800V rear projection surface and CineFlex White XT600V front/rear projection surface are also available at the same price as CineFlex CH1200V. See page 4 for viewing surface details. When ordering these surfaces, use the CineFlex CH1200V part number followed by the appropriate suffix: **CA** for CineFlex MH800V, and **CC** for CineFlex White XT600V.

| Image Area Diagonal | Image Area (H x W) | Overall Size | Complete Screen with Silver Anodized Frame | | Complete Screen with Black Anodized Frame | | CineFlex CH1200V Surface Only | | Complete Shipping Wt./lbs. | Freight Class |
|------------------------------|--------------------|--------------|--|--------|---|--------|-------------------------------|-------|----------------------------|---------------|
| | | | Part No.* | PRICE | Part No.* | PRICE | Part No. | PRICE | | |
| 16:10 Format | | | | | | | | | | |
| 94" | 50" x 80" | 62" x 92" | 385077 | \$2427 | 385133 | \$2445 | 386140 | \$688 | 101 | 85 |
| 113" | 60" x 96" | 68" x 104" | 385078 | 2547 | 385134 | 2581 | 386141 | 770 | 138 | 85 |
| 142" | 75" x 120" | 86" x 128" | 385080 | 3504 | 385136 | 3536 | 386142 | 1077 | 150 | 85 |
| 170" | 90" x 144" | 98" x 152" | 385081 | 4369 | 385137 | 4606 | 386143 | 1309 | 162 | 85 |
| 198" | 105" x 168" | 116" x 176" | 385082 | 4776 | 385138 | 5054 | 386144 | 1597 | 173 | 85 |
| 226" | 120" x 192" | 128" x 200" | 385083 | 5766 | 385139 | 6090 | 386145 | 2182 | 190 | 85 |
| 255" | 135" x 216" | 146" x 224" | 385084 | 7255 | 385140 | 7348 | 386146 | 2374 | 215 | 85 |
| 283" | 150" x 240" | 158" x 248" | 385085 | 7607 | 385141 | 7712 | 386147 | 2624 | 255 | 85 |
| 16:9 HDTV Format | | | | | | | | | | |
| 92" | 45" x 80" | 56" x 92" | 385055 | \$2397 | 385111 | \$2429 | 386124 | \$670 | 97 | 85 |
| 110" | 54" x 96" | 62" x 104" | 385056 | 2497 | 385112 | 2516 | 386125 | 732 | 99 | 85 |
| 138" | 67 1/2" x 120" | 80" x 128" | 385058 | 3447 | 385114 | 3494 | 386126 | 1037 | 149 | 85 |
| 165" | 81" x 144" | 92" x 152" | 385059 | 4343 | 385115 | 4593 | 386127 | 1299 | 161 | 85 |
| 193" | 94 1/2" x 168" | 104" x 176" | 385060 | 4698 | 385116 | 4968 | 386128 | 1549 | 172 | 85 |
| 220" | 108" x 192" | 116" x 200" | 385061 | 5396 | 385117 | 5701 | 386129 | 1874 | 184 | 85 |
| 248" | 121 1/2" x 216" | 134" x 224" | 385062 | 6900 | 385118 | 6978 | 386130 | 2330 | 205 | 85 |
| 275" | 135" x 240" | 146" x 248" | 385063 | 7458 | 385119 | 7560 | 386131 | 2512 | 257 | 85 |
| 4:3 NTSC Video Format | | | | | | | | | | |
| 100" | 60" x 80" | 68" x 92" | 385038 | \$2497 | 385094 | \$2534 | 386108 | \$745 | 120 | 85 |
| 120" | 72" x 96" | 80" x 104" | 385039 | 2674 | 385095 | 2707 | 386109 | 818 | 153 | 85 |
| 150" | 90" x 120" | 98" x 128" | 385040 | 4027 | 385096 | 4069 | 386110 | 1142 | 163 | 85 |
| 180" | 108" x 144" | 116" x 152" | 385041 | 4523 | 385097 | 4784 | 386111 | 1414 | 168 | 85 |
| 210" | 126" x 168" | 134" x 176" | 385042 | 5613 | 385098 | 5910 | 386112 | 1889 | 178 | 85 |
| 240" | 144" x 192" | 152" x 200" | 385043 | 6186 | 385099 | 6545 | 386113 | 2287 | 199 | 85 |
| 270" | 162" x 216" | 170" x 224" | 385044 | 7955 | 385100 | 8055 | 386114 | 2822 | 223 | 85 |
| 300" | 180" x 240" | 188" x 248" | 385045 | 8395 | 385101 | 8525 | 386115 | 3144 | 272 | 85 |

*Screen part numbers include complete screen: frame, surface, legs and carrying case(s).

FocalPoint Dress Kits—Inherently Flame Retardant (IFR) & Standard 20 oz. Velour

| Image Area Diagonal | Image Area (H x W) | Overall Size | IFR Dress Kit Complete with Case(s) | | IFR Skirt Only | | Velour Dress Kit Complete with Case(s) | | Velour Skirt Only | | Complete Shipping Wt./lbs. | Freight Class |
|------------------------------|--------------------|--------------|-------------------------------------|--------|----------------|-------|--|--------|-------------------|-------|----------------------------|---------------|
| | | | Dress Kit Part No.* | PRICE | Skirt Part No. | PRICE | Dress Kit Part No.* | PRICE | Skirt Part No. | PRICE | | |
| 16:10 Format | | | | | | | | | | | | |
| 94" | 50" x 80" | 62" x 92" | 387017 | \$1650 | 387041 | \$428 | 387065 | \$1535 | 387089 | \$402 | 45 | 70 |
| 113" | 60" x 96" | 68" x 104" | 387018 | 1665 | 387042 | 464 | 387066 | 1545 | 387090 | 435 | 52 | 70 |
| 142" | 75" x 120" | 86" x 128" | 387019 | 1949 | 387043 | 537 | 387067 | 1809 | 387091 | 507 | 54 | 70 |
| 170" | 90" x 144" | 98" x 152" | 387020 | 2150 | 387044 | 632 | 387068 | 2001 | 387092 | 596 | 57 | 70 |
| 198" | 105" x 168" | 116" x 176" | 387021 | 2447 | 387045 | 702 | 387069 | 2276 | 387093 | 666 | 64 | 70 |
| 226" | 120" x 192" | 128" x 200" | 387022 | 2604 | 387046 | 842 | 387070 | 2432 | 387094 | 792 | 102 | 70 |
| 255" | 135" x 216" | 146" x 224" | 387023 | 2843 | 387047 | 974 | 387071 | 2643 | 387095 | 906 | 125 | 70 |
| 283" | 150" x 240" | 158" x 248" | 387024 | 3356 | 387048 | 1152 | 387072 | 3119 | 387096 | 1079 | 130 | 70 |
| 16:9 HDTV Format | | | | | | | | | | | | |
| 92" | 45" x 80" | 56" x 92" | 387009 | \$1637 | 387033 | \$428 | 387057 | \$1521 | 387081 | \$402 | 45 | 70 |
| 110" | 54" x 96" | 62" x 104" | 387010 | 1653 | 387034 | 464 | 387058 | 1533 | 387082 | 435 | 51 | 70 |
| 138" | 67 1/2" x 120" | 80" x 128" | 387011 | 1934 | 387035 | 537 | 387059 | 1797 | 387083 | 507 | 53 | 70 |
| 165" | 81" x 144" | 92" x 152" | 387012 | 2139 | 387036 | 632 | 387060 | 1989 | 387084 | 596 | 55 | 70 |
| 193" | 94 1/2" x 168" | 104" x 176" | 387013 | 2420 | 387037 | 702 | 387061 | 2252 | 387085 | 666 | 62 | 70 |
| 220" | 108" x 192" | 116" x 200" | 387014 | 2580 | 387038 | 881 | 387062 | 2406 | 387086 | 828 | 65 | 70 |
| 248" | 121 1/2" x 216" | 134" x 224" | 387015 | 2804 | 387039 | 960 | 387063 | 2619 | 387087 | 906 | 98 | 70 |
| 275" | 135" x 240" | 146" x 248" | 387016 | 2975 | 387040 | 1038 | 387064 | 2844 | 387088 | 978 | 102 | 70 |
| 4:3 NTSC Video Format | | | | | | | | | | | | |
| 100" | 60" x 80" | 68" x 92" | 387001 | \$1665 | 387025 | \$428 | 387049 | \$1493 | 387073 | \$402 | 45 | 70 |
| 120" | 72" x 96" | 80" x 104" | 387002 | 1745 | 387026 | 464 | 387050 | 1572 | 387074 | 435 | 52 | 70 |
| 150" | 90" x 120" | 98" x 128" | 387003 | 1971 | 387027 | 537 | 387051 | 1836 | 387075 | 507 | 55 | 70 |
| 180" | 108" x 144" | 116" x 152" | 387004 | 2201 | 387028 | 632 | 387052 | 2048 | 387076 | 596 | 59 | 70 |
| 210" | 126" x 168" | 134" x 176" | 387005 | 2484 | 387029 | 702 | 387053 | 2315 | 387077 | 666 | 60 | 70 |
| 240" | 144" x 192" | 152" x 200" | 387006 | 2652 | 387030 | 837 | 387054 | 2481 | 387078 | 792 | 63 | 70 |
| 270" | 162" x 216" | 170" x 224" | 387007 | 2880 | 387031 | 965 | 387055 | 2691 | 387079 | 906 | 100 | 70 |
| 300" | 180" x 240" | 188" x 248" | 387008 | 3060 | 387032 | 1038 | 387056 | 2864 | 387080 | 978 | 110 | 70 |

*Dress Kit part numbers include: a 58" tall skirt, 14" tall valance, universal valance bars, a pair of 30" wide side drapes and adjustable drapery bars and needed case(s).

Portable Screens

Modular Screen Packages— FocalPoint and StageScreen Packages offer a fantastic opportunity to start changing your screen inventory over to stronger and more versatile product. With these packages, you can build any of the three sizes listed—and add almost any smaller size with just a viewing surface. This system allows for the increased flexibility to handle more jobs while cutting costs. Each package includes all of the frame sections required plus front and rear surfaces. Custom packages are also available. Please call Draper for details.

Take a look at the FocalPoint and StageScreen calculators on our website (*see URLs listed below*). Enter the list of frame sections seen in the last column of each package, and you will see a list of all possible screen sizes. We think you will be amazed what other screens you can make. No one offers anything like this in the industry. All you have to decide is the maximum size and number of screens you need available at one time.

FocalPoint Packages— FocalPoint offers fast set up, amazing strength, and a clean appearance. If you use traditional screen sizes for small and medium sized events, then this product is for you. www.draperinc.com/go/FocalPoint.htm

| Package Number | Front & Rear Surface Sizes Included | Diagonal Size | Format | Black Frame Package Price | | Silver Frame Package Price | | Frame Section Sizes Included | Quantity of Sections Included in Package |
|----------------|-------------------------------------|---------------|--------|---------------------------|-------|----------------------------|--------|------------------------------|--|
| | | | | Part No. | PRICE | Part No. | PRICE | | |
| 1 | 72" x 96" (6' x 8') | 120" | NTSC | 385190 | 8360 | 385193 | \$8185 | 24", 36" | 8 each |
| | 90" x 120" (7.5' x 10') | 150" | NTSC | | | | | 10515 | 8412 |
| | 67.5" x 120" | 138" | HDTV | | | | | 12317 | 9854 |
| 2 | 108" x 144" (9' x 12') | 180" | NTSC | 385191 | 10620 | 385194 | 10515 | 24", 36" | 6 each |
| | 81" x 144" | 165" | HDTV | | | | | 8200 | 6560 |
| | 90" x 144" (7.5' x 12') | 170" | 16:10 | | | | | 9784 | 7827 |
| 3 | 126" x 168" (10.5' x 14') | 210" | NTSC | 385192 | 12317 | 385195 | 12317 | 24", 36" | 8 each |
| | 94.5" x 168" | 193" | HDTV | | | | | 42" | 2 |
| | 105" x 168" | 198" | 16:10 | | | | | 48" | 12 |
| 4 | 90" x 120" (7.5' x 10') | 150" | NTSC | 385200 | 7038 | 385204 | 6270 | 24", 36" | 8 each |
| | 67.5" x 120" | 138" | HDTV | | | | | 42" | 2 |
| | — | — | — | | | | | 48" | 6 |
| 5 | 108" x 144" (9' x 12') | 180" | NTSC | 385201 | 8270 | 385205 | 7379 | 24", 36" | 6 each |
| | 81" x 144" | 165" | HDTV | | | | | 42" | 0 |
| | — | — | — | | | | | 48" | 12 |
| 6 | 126" x 168" (10.5' x 14') | 210" | NTSC | 385202 | 9854 | 385206 | 8804 | 24", 36" | 8 each |
| | 94.5" x 168" | 193" | HDTV | | | | | 42" | 2 |
| | — | — | — | | | | | 48" | 10 |
| 7 | 144" x 192" (12' x 16') | 240" | NTSC | 385203 | 11262 | 385207 | 11192 | 24" | 4 |
| | 108" x 192" (9' x 16') | 220" | HDTV | | | | | 36" | 10 |
| | — | — | — | | | | | 48" | 6 |

Each FocalPoint package above includes Frame Sections listed, both Front and Rear Surfaces in sizes listed, 1 Leg Package, Tarp, 4 Corners and any needed Anti-Sway Stabilizers, Leg Braces, HD Leg Braces, Leg Cranks, and Carrying Cases. Additional leg kits and accessories available. *See page 73.*

StageScreen Packages— StageScreen is available in a range of larger sizes and offers fantastic strength up to 80 feet wide and beyond. It has the same great features as the FocalPoint and is already proven in the industry. Packages include all the components for flown installation; leg packages are optionally available. See pages 60-61 for leg package pricing. Additional components and accessories are available on page 71.

www.draperinc.com/go/StageScreen.htm

| Package Number | Front & Rear Surface Sizes Included | Diagonal Size | Format | Black Frame Package Price | | Silver Frame Package Price | | Frame Section Sizes Included | Quantity of Sections Included in Package |
|----------------|-------------------------------------|---------------|--------------|---------------------------|---------|----------------------------|---------|------------------------------|--|
| | | | | Part No. | PRICE | Part No. | PRICE | | |
| 1 | 144" x 192" (12' x 16') | 240" | NTSC | 383811 | \$14686 | 383814 | \$14510 | 36", 72" | 2 each |
| | 108" x 192" (9' x 16') | 220" | HDTV | | | | | 48" | 4 |
| | 120" x 192" (10' x 16') | 226" | 16:10 | | | | | 60", Stiffeners | 8 each |
| 2 | 180" x 240" (15' x 20') | 300" | NTSC | 383812 | 19157 | 383815 | 18999 | 36", 42" | 2 |
| | 135" x 240" (11.25' x 20') | 275" | HDTV | | | | | 24", 60" | 4 |
| | 150" x 240" (12.5' x 20') | 283" | 16:10 | | | | | 72" | 6 |
| 3 | 216" x 288" (18' x 24') | 360" | NTSC | 383813 | 25150 | 383816 | 24973 | Stiffeners | 10 |
| | 162" x 288" (13.5' x 24') | 330" | HDTV | | | | | 36", 42" | 2 each |
| | 180" x 288" (15' x 24') | 340" | 16:10 | | | | | 60" | 4 |
| 4 | 180" x 240" (15' x 20') | 300" | NTSC | 383817 | 14968 | 383820 | 14828 | 72", Stiffeners | 10 each |
| | 135" x 240" (11.25' x 20') | 275" | HDTV | | | | | 42" | 2 |
| | — | — | — | | | | | 24", 60" | 4 each |
| 5 | 216" x 288" (18' x 24') | 360" | NTSC | 383818 | 18740 | 383821 | 18565 | 72" | 6 |
| | 162" x 288" (13.5' x 24') | 330" | HDTV | | | | | Stiffeners | 10 |
| | — | — | — | | | | | 36", 42" | 2 each |
| 6 | 270" x 480" (22.5' x 40') | 450" | NTSC | 383819 | 33430 | 383822 | 33255 | 60" | 4 |
| | 144" x 480" (12' x 40') | — | Multi Format | | | | | 72", Stiffeners | 10 each |
| | — | — | — | | | | | 36", 42", 48" | 2 each |
| | — | — | — | | | | | 60" | 4 |
| | — | — | — | | | | | 72" | 18 |
| | — | — | — | | | | | Stiffeners | 26 |

Each StageScreen package includes frame sections listed above, front and rear viewing surfaces in sizes listed, 4 Corners, needed Tarps and Carrying Cases.

Portable Screens

Ultimate Folding Screen

The Ultimate Folding Screen is the first screen manufactured with 100% CNC (Computer Numerical Controlled) components and assembly. The tubing is CNC machined, surfaces and borders are CNC cut; even rivet and snap holes are CNC placed. No competitive product meets this standard—and we did not stop there. Our Lock & Load latch is designed for ease of operation and maximum life. Couple these advantages with clear anodized 1.25" x .070" wall aluminum tubing, and you've got the precision and stability that allows Draper to offer the Ultimate Folding Screen in sizes through 16' wide.

The Ultimate Folding Screen is available with *Matt White XT1000V* for front projection. For rear projection, choose *CineFlex CH1200V* or *CineFlex MH800V* rear projection surfaces, or *CineFlex White XT600V* front/rear projection surface. For maximum flexibility, choose multiple surfaces! All surfaces—front and rear—have square corners. Borders are electronically welded using a PVC material that provides straight, clean edges. Ultimate Folding Screen standard viewing surfaces may be interchanged freely with Cinefold surfaces and have 2 3/4" black masking borders.

Standard Legs support the Ultimate Folding Screen in a vertical position. The screen may also be tilted for keystone elimination using the Heavy-Duty Legs which offer extra stability with an adjustable gusset (recommended for sizes larger than 7 1/2' high). For maximum stability, Extra Heavy-Duty Legs are recommended in sizes 10 1/2' high or larger. The Ultimate Folding Screen comes packed in Draper's heavy-duty, molded polyethylene wheeled carrying case.

Note—Custom sizes are not available.



Lock & Load latch open



Lock & Load latch closed



Corner Hinge open



Corner Hinge closed

Our Lock & Load latch is designed for ease of operation and maximum life. Lock & Load mortise latches bite down when the surface is attached, making the frame extremely rigid. The most user-friendly and incredibly durable hinge locking mechanism available.

Ultimate Folding Screen with Flexible Matt White XT1000V Front Projection Surface

| Overall Size H x W | Image Area | Nom. Diag. | Complete with Standard Legs | | Complete with Heavy Duty Legs | | Complete with Extra Heavy Duty Legs | | Surface Only | | Carrying Case Part No. | Complete Shipping Wt./lbs. | Freight Class |
|------------------------------|---------------------|------------|-----------------------------|-------|-------------------------------|--------|-------------------------------------|--------|--------------|-------|------------------------|----------------------------|---------------|
| | | | Part No. | PRICE | Part No. | PRICE | Part No. | PRICE | Part No. | PRICE | | | |
| 16:10 Format | | | | | | | | | | | | | |
| 56" x 86" | 50 1/2" x 80 3/4" | 95" | 241281 | \$857 | 241301 | \$1065 | 241311 | \$1139 | 241291 | \$315 | 219025 | 75 | 85 P |
| 62" x 96" | 56 1/2" x 90 1/2" | 107" | 241282 | 896 | 241302 | 1104 | 241312 | 1176 | 241292 | 330 | 219025 | 82 | 85 P |
| 69" x 107" | 63 1/2" x 101 1/2" | 120" | 241283 | 1001 | 241303 | 1212 | 241313 | 1284 | 241293 | 453 | 219025 | 67 | 85 P |
| 83" x 130" | 77 1/2" x 124" | 146" | 241284 | 1142 | 241304 | 1352 | 241314 | 1424 | 241294 | 477 | 219025 | 70 | 85 P |
| 97" x 152" | 91 1/2" x 146 1/2" | 173" | 241323 | 1308 | 241325 | 1518 | 241327 | 1590 | 241335 | 711 | 219098 | 95 | 85 |
| 112" x 176" ¹ | 106 1/2" x 170 1/2" | 201" | 241285 | 1527 | 241305 | 1737 | 241315 | 1809 | 241295 | 759 | 219098 | 98 | 85 P |
| 16:9 HDTV Format | | | | | | | | | | | | | |
| 56" x 96" | 50 1/2" x 90 1/2" | 106" | 241013 | \$857 | 241035 | \$1065 | 241248 | \$1139 | 241057 | \$315 | 219025 | 75 | 85 P |
| 62" x 108" | 56 1/2" x 102 1/2" | 119" | 241014 | 896 | 241036 | 1104 | 241249 | 1176 | 241058 | 330 | 219025 | 82 | 85 P |
| 69" x 120" | 63 1/2" x 114 1/2" | 133" | 241015 | 1001 | 241037 | 1212 | 241250 | 1284 | 241059 | 453 | 219025 | 66 | 85 P |
| 83" x 144" | 77 1/2" x 138 1/2" | 161" | 241181 | 1142 | 241182 | 1352 | 241251 | 1428 | 241183 | 638 | 219025 | 71 | 85 P |
| 97" x 168" | 91 1/2" x 162 1/2" | 186" | 241329 | 1308 | 241331 | 1518 | 241333 | 1590 | 241337 | 711 | 219098 | 95 | 85 |
| 112" x 196" ¹ | 106 1/2" x 190 1/2" | 220" | 241016 | 1527 | 241038 | 1737 | 241252 | 1809 | 241060 | 759 | 219098 | 99 | 85 P |
| 4:3 NTSC Video Format | | | | | | | | | | | | | |
| 54" x 74" | 48 1/2" x 68 1/2" | 90" | 241007 | \$639 | 241028 | \$849 | 241241 | \$923 | 241050 | \$201 | 219025 | 59 | 85 P |
| 62" x 83" | 56 1/2" x 77 1/2" | 100" | 241008 | 810 | 241029 | 1022 | 241242 | 1094 | 241051 | 227 | 219025 | 61 | 85 P |
| 6' x 8' | 66 1/2" x 90 1/2" | 10' | 241009 | 872 | 241030 | 1083 | 241243 | 1155 | 241052 | 315 | 219025 | 64 | 85 P |
| 7' 6" x 10' ¹ | 84 1/2" x 114 1/2" | 150" | 241010 | 1001 | 241031 | 1212 | 241244 | 1284 | 241053 | 467 | 219025 | 73 | 85 P |
| 9' x 12' ¹ | 102 1/2" x 138 1/2" | 15' | 241011 | 1142 | 241032 | 1352 | 241245 | 1424 | 241054 | 636 | 219025 | 74 | 85 P |
| 10' 6" x 14' ² | 120 1/2" x 162 1/2" | 200" | 241012 | 1308 | 241033 | 1518 | 241246 | 1590 | 241055 | 831 | 219025 | 85 | 85 P |
| 12' x 16' ² | 138 1/2" x 186 1/2" | 20' | -- | -- | 241034 | 1817 | 241214 | 1890 | 241056 | 1020 | 219098 | 99 | 85 P |
| 1:1 Square Format | | | | | | | | | | | | | |
| 6' x 6' | 66 1/2" x 66 1/2" | | 241001 | \$795 | 241022 | \$1004 | 241235 | \$1077 | 241044 | \$240 | 219025 | 72 | 85 P |
| 7' x 7' | 78 1/2" x 78 1/2" | | 241002 | 867 | 241023 | 1077 | 241236 | 1151 | 241045 | 315 | 219025 | 82 | 85 P |
| 8' x 8' ¹ | 90 1/2" x 90 1/2" | | 241003 | 932 | 241024 | 1142 | 241237 | 1215 | 241046 | 384 | 219025 | 82 | 85 P |
| 9' x 9' ¹ | 102 1/2" x 102 1/2" | | 241004 | 1029 | 241025 | 1238 | 241238 | 1311 | 241047 | 537 | 219025 | 72 | 85 P |
| 10' x 10' ¹ | 114 1/2" x 114 1/2" | | 241005 | 1088 | 241026 | 1296 | 241239 | 1368 | 241048 | 611 | 219025 | 75 | 85 P |
| 12' x 12' ² | 138 1/2" x 138 1/2" | | 241006 | 1280 | 241027 | 1488 | 241240 | 1560 | 241049 | 762 | 219098 | 83 | 85 P |

¹Heavy-Duty Legs are recommended for frame heights greater than 7'6". All Heavy-Duty Legs are 144" tall.

²Extra Heavy-Duty Legs are recommended for added stability on frame heights measuring 10'6" or greater.

Ultimate Folding Screen with CineFlex CH1200V Rear Projection Surfaces

CineFlex MH800V rear projection surface and CineFlex White XT600V front/rear projection surface are also available at the same price as CineFlex CH1200V. See page 4 for viewing surface details. When ordering these surfaces, use the CineFlex CH1200V part number followed by the appropriate suffix: **CA** for CineFlex MH800V, and **CC** for CineFlex White XT600V.

| Overall Size H x W | Image Area | Nom. Diag. | Complete with Standard Legs Part No. PRICE | Complete with Heavy Duty Legs Part No. PRICE | Complete with Extra Heavy Duty Legs Part No. PRICE | Surface Only Part No. PRICE | Carrying Case Part No. | Complete Shipping Wt./lbs. | Freight Class |
|------------------------------|---------------------|------------|--|--|--|-----------------------------|------------------------|----------------------------|---------------|
| 16:10 Format | | | | | | | | | |
| 56" x 86" | 50 1/2" x 80 3/4" | 95" | 241286 \$1085 | 241306 \$1293 | 241316 \$1365 | 241296 \$530 | 219025 | 75 | 85 P |
| 62" x 96" | 56 1/2" x 90 1/2" | 107" | 241287 1115 | 241307 1325 | 241317 1397 | 241297 537 | 219025 | 82 | 85 P |
| 69" x 107" | 63 1/2" x 101 1/2" | 120" | 241288 1289 | 241308 1497 | 241318 1572 | 241298 741 | 219025 | 67 | 85 P |
| 83" x 130" | 77 1/2" x 124" | 146" | 241289 1596 | 241309 1806 | 241319 1880 | 241299 1041 | 219025 | 70 | 85 P |
| 97" x 152" | 91 1/2" x 146 1/2" | 173" | 241324 1698 | 241326 1907 | 241328 1979 | 241336 1083 | 219098 | 95 | 85 |
| 112" x 176" ¹ | 106 1/2" x 170 1/2" | 201" | 241290 1955 | 241310 2163 | 241320 2235 | 241300 1103 | 219098 | 98 | 85 P |
| 16:9 HDTV Format | | | | | | | | | |
| 56" x 96" | 50 1/2" x 90 1/2" | 106" | 241078 \$1085 | 241100 \$1293 | 241271 \$1365 | 241122 \$530 | 219025 | 75 | 85 P |
| 62" x 108" | 56 1/2" x 102 1/2" | 119" | 241079 1115 | 241101 1325 | 241272 1397 | 241123 537 | 219025 | 82 | 85 P |
| 69" x 120" | 63 1/2" x 114 1/2" | 133" | 241080 1289 | 241102 1497 | 241273 1572 | 241124 741 | 219025 | 66 | 85 P |
| 83" x 144" | 77 1/2" x 138 1/2" | 161" | 241184 1596 | 241185 1806 | 241274 1880 | 241186 1041 | 219025 | 71 | 85 P |
| 97" x 168" | 91 1/2" x 162 1/2" | 186" | 241330 1698 | 241332 1907 | 241334 1979 | 241338 1083 | 219098 | 95 | 85 |
| 112" x 196" ¹ | 106 1/2" x 190 1/2" | 220" | 241081 1955 | 241103 2163 | 241275 2235 | 241125 1103 | 219098 | 99 | 85 P |
| 4:3 NTSC Video Format | | | | | | | | | |
| 54" x 74" | 48 1/2" x 68 1/2" | 90" | 241072 \$750 | 241093 \$962 | 241264 \$1034 | 241115 \$333 | 219025 | 59 | 85 P |
| 62" x 83" | 56 1/2" x 77 1/2" | 100" | 241073 1002 | 241094 1214 | 241265 1286 | 241116 398 | 219025 | 61 | 85 P |
| 6' x 8' | 66 1/2" x 90 1/2" | 10' | 241074 1085 | 241095 1293 | 241266 1365 | 241117 530 | 219025 | 64 | 85 P |
| 7' 6" x 10' ¹ | 84 1/2" x 114 1/2" | 150" | 241075 1289 | 241096 1515 | 241267 1572 | 241118 741 | 219025 | 73 | 85 P |
| 9' x 12' ¹ | 102 1/2" x 138 1/2" | 15' | 241076 1596 | 241097 1806 | 241268 1880 | 241119 1041 | 219025 | 74 | 85 P |
| 10' 6" x 14' ² | 120 1/2" x 162 1/2" | 200" | 241077 1698 | 241098 1907 | 241269 1979 | 241120 1218 | 219025 | 85 | 85 P |
| 12' x 16' ² | 138 1/2" x 186 1/2" | 20' | -- -- | 241099 2402 | 241270 2475 | 241121 1448 | 219098 | 107 | 85 P |
| 1:1 Square Format | | | | | | | | | |
| 6' x 6' | 66 1/2" x 66 1/2" | | 241066 \$950 | 241087 \$1161 | 241258 \$1233 | 241109 \$393 | 219025 | 72 | 85 P |
| 7' x 7' | 78 1/2" x 78 1/2" | | 241067 1079 | 241088 1289 | 241259 1361 | 241110 531 | 219025 | 82 | 85 P |
| 8' x 8' ¹ | 90 1/2" x 90 1/2" | | 241068 1232 | 241089 1442 | 241260 1515 | 241111 671 | 219025 | 82 | 85 P |
| 9' x 9' ¹ | 102 1/2" x 102 1/2" | | 241069 1331 | 241090 1541 | 241261 1613 | 241112 828 | 219025 | 72 | 85 P |
| 10' x 10' ¹ | 114 1/2" x 114 1/2" | | 241070 1493 | 241091 1704 | 241262 1776 | 241113 999 | 219025 | 75 | 85 P |
| 12' x 12' ² | 138 1/2" x 138 1/2" | | 241071 1671 | 241092 1881 | 241263 1955 | 241114 1155 | 219098 | 83 | 85 P |

¹Heavy-Duty Legs are recommended for frame heights greater than 7'6". All Heavy-Duty Legs are 144" tall.

²Extra Heavy-Duty Legs are recommended for added stability on frame heights measuring 10'6" or greater.

Ultimate Folding Screen Accessories

| Accessory | Part No. | PRICE |
|---|----------|-------------|
| Heavy-Duty Legs, ordered separately (pr.) | 382104 | \$428 |
| Extra Heavy-Duty Legs, ordered separately (pr.) | 382107 | 500 |
| Anti-Sway Stabilizers (pr.) | 382119 | 137 |
| Standard T-Legs—115" tall (pr.) | 382101 | 284 |
| Standard T-Legs—126" tall (pr.) | 382113 | 284 |
| Standard T-Legs—144" tall (pr.) | 382116 | 284 |
| Crank with large washer, for use only with UFS Adjustable Skirt Bar | 219060 | 5 |
| Handy Crank (2.25") | 219004 | 5 |
| Handy Crank (2.75") | 219059 | 5 |
| Carrying Case for Screen see page 83 | 219025 | 237 |
| Carrying Case for Dress Kit see page 83 | 219025 | 237 |
| StageHand for UFS | 382125 | 237 |
| Repair Kit for UFS with tools | 382155 | 380 |
| Repair Kit for UFS without tools | 382156 | 216 |
| HDTV to NTSC Masking Strips | | see page 83 |
| Fly Bracket (single) | 385221 | 50 |
| Fly Bracket (pair) | 385222 | 92 |

BOOKMARK OUR MOBILE TOOLKIT

Draper's mobile toolkit includes searchable document libraries for all AV products and the assembly map tools for our popular StageScreen and FocalPoint screens. It also includes our Screen Surface Selector. Scan the code with your smartphone or visit:

www.draperinc.com/drapermobile



Freight Class Key

Number LTL freight class
P Parcel service
+ ... \$8.50 surcharge (over 60" long)

Example: a freight code of 125 P+ indicates an item that may ship as freight class 125 or via parcel service with \$8.50 surcharge.

Portable
Screens

Dress Kits for Ultimate Folding Screen with standard Velour—

Standard fabric is 20 oz. black cotton Velour, treated for flame retardancy. A complete Dress Kit includes 46" height skirt, 12" height valance, and two 32" width side drapes. 100% CNC (Computer Numerical Controlled) valance bar and drapery bars fit snugly into the top of the Ultimate Folding Screen frame—no tools needed. The viewing surface is fitted with snaps to accept the skirt.

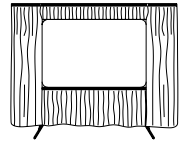

- **Options:** Also available in rich navy or a variety of custom colors. Details available on request. The Adjustable Skirt Bar allows you to quickly and easily change the aspect ratio of your screen by masking the bottom of the viewing surface—infinately adjustable. Replacement carrying case see page 83.

Note: Heavy-Duty or Extra Heavy-Duty Legs are recommended for extra stability. Weights include carrying case.

| Overall Screen Size | Part No. | Dress Kit with Case | | Dress Kit without Case | | Adjustable Skirt Bar | | Skirt Only | | Dress Kit Shipping Wt./lbs. | Freight Class |
|------------------------------|----------|---------------------|----------|------------------------|----------|----------------------|----------|------------|----|-----------------------------|---------------|
| | | PRICE | Part No. | PRICE | Part No. | PRICE | Part No. | PRICE | | | |
| 16:10 Format | | | | | | | | | | | |
| 56" x 86" | 242193 | \$1556 | 242198 | \$1314 | 242203 | \$252 | 242208 | \$350 | 55 | 70 P | |
| 62" x 96" | 242194 | 1620 | 242199 | 1377 | 242204 | 255 | 242209 | 395 | 65 | 70 P | |
| 69" x 107" | 242195 | 1704 | 242200 | 1460 | 242205 | 258 | 242210 | 431 | 73 | 70 P | |
| 83" x 130" | 242196 | 1859 | 242201 | 1616 | 242206 | 278 | 242211 | 482 | 87 | 70 P | |
| 97" x 152" | 242269 | 1950 | 242270 | 1713 | 242273 | 287 | 242275 | 530 | 87 | 70 P | |
| 112" x 176"* | 242197 | 2021 | 242202 | 1775 | 242207 | 302 | 242212 | 581 | 96 | 70 P | |
| 16:9 HDTV Format | | | | | | | | | | | |
| 56" x 96" | 242014 | \$1556 | 242038 | \$1314 | 242096 | \$252 | 242073 | \$350 | 55 | 70 P | |
| 62" x 108" | 242015 | 1620 | 242039 | 1377 | 242097 | 255 | 242074 | 395 | 65 | 70 P | |
| 69" x 120" | 242016 | 1704 | 242040 | 1460 | 242098 | 258 | 242075 | 431 | 73 | 70 P | |
| 83" x 144" | 242017 | 1859 | 242041 | 1616 | 242099 | 278 | 242076 | 482 | 87 | 70 P | |
| 97" x 168" | 242271 | 1950 | 242272 | 1713 | 242274 | 287 | 242277 | 530 | 87 | 70 P | |
| 112" x 196"* | 242018 | 2021 | 242042 | 1775 | 242118 | 302 | 242077 | 581 | 96 | 70 P | |
| 4:3 NTSC Video Format | | | | | | | | | | | |
| 54" x 74" | 242007 | \$1376 | 242031 | \$1131 | 242089 | \$246 | 242066 | \$279 | 49 | 70 P | |
| 62" x 83" | 242008 | 1491 | 242032 | 1248 | 242090 | 249 | 242067 | 329 | 52 | 70 P | |
| 6' x 8' | 242009 | 1556 | 242033 | 1314 | 242091 | 252 | 242068 | 350 | 59 | 70 P | |
| 7' 6" x 10' | 242010 | 1709 | 242034 | 1464 | 242092 | 258 | 242069 | 431 | 62 | 70 P | |
| 9' x 12' | 242011 | 1859 | 242035 | 1616 | 242093 | 278 | 242070 | 482 | 68 | 70 P | |
| 10' 6" x 14' | 242012 | 1989 | 242036 | 1746 | 242094 | 287 | 242071 | 530 | 75 | 70 P | |
| 12' x 16' | 242024 | 2126 | 242037 | 1883 | 242095 | 302 | 242072 | 576 | 98 | 70 P | |
| 1:1 Square Format | | | | | | | | | | | |
| 6' x 6' | 242001 | \$1413 | 242025 | \$1170 | 242083 | \$246 | 242060 | \$279 | 55 | 70 P | |
| 7' x 7' | 242002 | 1539 | 242026 | 1295 | 242084 | 249 | 242061 | 329 | 65 | 70 P | |
| 8' x 8' | 242003 | 1614 | 242027 | 1368 | 242085 | 252 | 242062 | 350 | 73 | 70 P | |
| 9' x 9' | 242004 | 1685 | 242028 | 1443 | 242086 | 255 | 242063 | 395 | 76 | 70 P | |
| 10' x 10' | 242005 | 1790 | 242029 | 1547 | 242087 | 258 | 242064 | 431 | 79 | 70 P | |
| 12' x 12' | 242006 | 1961 | 242030 | 1718 | 242088 | 278 | 242065 | 482 | 94 | 70 P | |

*Extra Heavy-Duty Legs recommended for these screens with full dress kit.

| Overall Screen Size | Part No. | Valance Bar | | Valance | | Drapery Bars (pr.) | | Drapes (pr.) | |
|------------------------------|----------|-------------|----------|---------|----------|--------------------|----------|--------------|--|
| | | PRICE | Part No. | PRICE | Part No. | PRICE | Part No. | PRICE | |
| 16:10 Format | | | | | | | | | |
| 56" x 86" | 242213 | \$191 | 220305 | \$194 | 382112 | \$197 | 220310 | \$372 | |
| 62" x 96" | 242214 | 195 | 220306 | 201 | 382112 | 197 | 220311 | 378 | |
| 69" x 107" | 242215 | 198 | 220307 | 219 | 382112 | 197 | 220312 | 405 | |
| 83" x 130" | 242216 | 216 | 220308 | 236 | 382112 | 197 | 220313 | 474 | |
| 97" x 152" | 242279 | 219 | 220325 | 255 | 382112 | 197 | 220329 | 536 | |
| 112" x 176" | 242217 | 227 | 220309 | 278 | 382112 | 197 | 220314 | 480 | |
| 16:9 HDTV Format | | | | | | | | | |
| 56" x 96" | 242106 | \$191 | 220177 | \$194 | 382112 | \$197 | 220185 | \$372 | |
| 62" x 108" | 242107 | 195 | 220178 | 201 | 382112 | 197 | 220186 | 378 | |
| 69" x 120" | 242108 | 198 | 220179 | 219 | 382112 | 197 | 220187 | 405 | |
| 83" x 144" | 242109 | 216 | 220180 | 236 | 382112 | 197 | 220188 | 474 | |
| 97" x 168" | 242280 | 219 | 220327 | 255 | 382112 | 197 | 220331 | 536 | |
| 112" x 196" | 242110 | 227 | 220191 | 278 | 382112 | 197 | 220195 | 480 | |
| 4:3 NTSC Video Format | | | | | | | | | |
| 54" x 74" | 242103 | \$143 | 220189 | \$168 | 382112 | \$197 | 220193 | \$335 | |
| 62" x 83" | 242104 | 185 | 220072 | 182 | 382112 | 197 | 220152 | 345 | |
| 6' x 8' | 242051 | 191 | 220073 | 194 | 382112 | 197 | 220153 | 372 | |
| 7' 6" x 10' | 242052 | 198 | 220074 | 219 | 382112 | 197 | 220154 | 410 | |
| 9' x 12' | 242053 | 216 | 220075 | 236 | 382112 | 197 | 220155 | 474 | |
| 10' 6" x 14' | 242105 | 219 | 220076 | 255 | 382112 | 197 | 220156 | 536 | |
| 12' x 16' | 242054 | 227 | 220190 | 270 | 382112 | 197 | 220194 | 599 | |
| 1:1 Square Format | | | | | | | | | |
| 6' x 6' | 242057 | \$143 | 220065 | \$161 | 382112 | \$197 | 220098 | \$372 | |
| 7' x 7' | 242058 | 185 | 220066 | 168 | 382112 | 197 | 220099 | 392 | |
| 8' x 8' | 242059 | 191 | 220067 | 182 | 382112 | 197 | 220100 | 429 | |
| 9' x 9' | 242100 | 195 | 220068 | 194 | 382112 | 197 | 220101 | 443 | |
| 10' x 10' | 242101 | 198 | 220069 | 201 | 382112 | 197 | 220102 | 489 | |
| 12' x 12' | 242102 | 216 | 220070 | 219 | 382112 | 197 | 220103 | 575 | |

Dress Kits for Ultimate Folding Screen with IFR Velour—

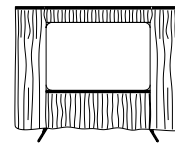

Draper's Inherently Flame Retardant (IFR) Velour never needs retreating—it is flame retardant for the life of the fabric. More resistant to wrinkling than standard Velour, yet 15% lighter weight for easier installation and fabric management.

Flame Retardancy Standards—Draper's Inherently Flame Retardant Velour is manufactured and certified to meet these flame retardancy standards: *NFPA 701, MVS-302, BIFMA-F-1-1978, SC-191-53 Class 1 California, and UFAC Class 1.*

A complete Dress Kit includes 46" height skirt, 12" height valance, and two 32" width side drapes, all in IFR Velour. 100% CNC (Computer Numerical Controlled) valance bar and drapery bars fit snugly into the top of the Ultimate Folding Screen frame—no tools needed. The viewing surface is fitted with snaps to accept the skirt.

- **Options:** The Adjustable Skirt Bar allows you to quickly and easily change the aspect ratio of your screen by masking the bottom of the viewing surface—infinately adjustable. Replacement carrying case—see page 83.

Note: Heavy-Duty Legs are recommended for extra stability. Weights include carrying case.

| Overall Screen Size | Part No. | Dress Kit with Case | | Dress Kit without Case | | Adjustable Skirt Bar | | Skirt Only | | Dress Kit Shipping Wt./lbs. | Freight Class |
|------------------------------|----------|---------------------|----------|------------------------|----------|----------------------|----------|------------|----|-----------------------------|---------------|
| | | PRICE | Part No. | PRICE | Part No. | PRICE | Part No. | PRICE | | | |
| 16:10 Format | | | | | | | | | | | |
| 56" x 86" | 242218 | \$1638 | 242223 | \$1406 | 242203 | \$252 | 242233 | \$386 | 55 | 70 P | |
| 62" x 96" | 242219 | 1710 | 242224 | 1478 | 242204 | 255 | 242234 | 438 | 65 | 70 P | |
| 69" x 107" | 242220 | 1815 | 242225 | 1584 | 242205 | 258 | 242235 | 485 | 73 | 70 P | |
| 83" x 130" | 242221 | 1977 | 242226 | 1746 | 242206 | 278 | 242236 | 540 | 87 | 70 P | |
| 97" x 152" | 242244 | 2075 | 242245 | 1769 | 242273 | 287 | 242276 | 564 | 87 | 70 P | |
| 112" x 176"* | 242222 | 2175 | 242227 | 1944 | 242207 | 302 | 242237 | 656 | 96 | 70 P | |
| 16:9 HDTV Format | | | | | | | | | | | |
| 56" x 96" | 242136 | \$1638 | 242160 | \$1406 | 242096 | \$252 | 242183 | \$386 | 55 | 70 P | |
| 62" x 108" | 242137 | 1710 | 242161 | 1478 | 242097 | 255 | 242184 | 438 | 65 | 70 P | |
| 69" x 120" | 242138 | 1815 | 242162 | 1584 | 242098 | 258 | 242185 | 485 | 73 | 70 P | |
| 83" x 144" | 242139 | 1977 | 242163 | 1746 | 242099 | 278 | 242186 | 540 | 87 | 70 P | |
| 97" x 168" | 242246 | 2075 | 242247 | 1769 | 242274 | 287 | 242278 | 564 | 87 | 70 P | |
| 112" x 196"* | 242140 | 2175 | 242164 | 1944 | 242118 | 302 | 242187 | 656 | 96 | 70 P | |
| 4:3 NTSC Video Format | | | | | | | | | | | |
| 54" x 74" | 242130 | \$1433 | 242153 | \$1203 | 242089 | \$246 | 242176 | \$300 | 49 | 70 P | |
| 62" x 83" | 242131 | 1571 | 242154 | 1338 | 242090 | 249 | 242177 | 362 | 52 | 70 P | |
| 6' x 8' | 242132 | 1649 | 242155 | 1418 | 242091 | 252 | 242178 | 386 | 59 | 70 P | |
| 7' 6" x 10' | 242133 | 1830 | 242156 | 1596 | 242092 | 258 | 242179 | 485 | 62 | 70 P | |
| 9' x 12'* | 242134 | 1997 | 242157 | 1766 | 242093 | 278 | 242180 | 540 | 68 | 70 P | |
| 10' 6" x 14'* | 242135 | 2144 | 242158 | 1913 | 242094 | 287 | 242181 | 593 | 75 | 70 P | |
| 12' x 16'* | 242146 | 2297 | 242159 | 2066 | 242095 | 302 | 242182 | 647 | 98 | 70 P | |
| 1:1 Square Format | | | | | | | | | | | |
| 6' x 6' | 242124 | \$1482 | 242147 | \$1251 | 242083 | \$246 | 242170 | \$300 | 55 | 70 P | |
| 7' x 7' | 242125 | 1628 | 242148 | 1397 | 242084 | 249 | 242171 | 362 | 65 | 70 P | |
| 8' x 8' | 242126 | 1718 | 242149 | 1485 | 242085 | 252 | 242172 | 386 | 73 | 70 P | |
| 9' x 9'* | 242127 | 1809 | 242150 | 1580 | 242086 | 255 | 242173 | 438 | 76 | 70 P | |
| 10' x 10'* | 242128 | 1929 | 242151 | 1698 | 242087 | 258 | 242174 | 485 | 79 | 70 P | |
| 12' x 12'* | 242129 | 2115 | 242152 | 1884 | 242088 | 278 | 242175 | 540 | 94 | 70 P | |

*Extra Heavy-Duty Legs recommended for these screens with full dress kit.

| Overall Screen Size | Part No. | Valance Bar | | Valance | | Drapery Bars (pr.) | | Drapes (pr.) | |
|------------------------------|----------|-------------|----------|---------|----------|--------------------|----------|--------------|--|
| | | PRICE | Part No. | PRICE | Part No. | PRICE | Part No. | PRICE | |
| 16:10 Format | | | | | | | | | |
| 56" x 86" | 242213 | \$191 | 220315 | \$207 | 382112 | \$197 | 220320 | \$431 | |
| 62" x 96" | 242214 | 195 | 220316 | 221 | 382112 | 197 | 220321 | 434 | |
| 69" x 107" | 242215 | 198 | 220317 | 240 | 382112 | 197 | 220322 | 473 | |
| 83" x 130" | 242216 | 216 | 220318 | 260 | 382112 | 197 | 220323 | 543 | |
| 97" x 152" | 242279 | 219 | 220326 | 267 | 382112 | 197 | 220330 | 602 | |
| 112" x 176" | 242217 | 227 | 220319 | 303 | 382112 | 197 | 220324 | 570 | |
| 16:9 HDTV Format | | | | | | | | | |
| 56" x 96" | 242106 | \$191 | 220288 | \$207 | 382112 | \$197 | 220292 | \$431 | |
| 62" x 108" | 242107 | 195 | 220289 | 221 | 382112 | 197 | 220293 | 434 | |
| 69" x 120" | 242108 | 198 | 220290 | 240 | 382112 | 197 | 220294 | 473 | |
| 83" x 144" | 242109 | 216 | 220291 | 260 | 382112 | 197 | 220295 | 543 | |
| 97" x 168" | 242280 | 219 | 220328 | 267 | 382112 | 197 | 220332 | 602 | |
| 112" x 196" | 242110 | 227 | 220298 | 303 | 382112 | 197 | 220302 | 570 | |
| 4:3 NTSC Video Format | | | | | | | | | |
| 54" x 74" | 242103 | \$143 | 220296 | \$173 | 382112 | \$197 | 220300 | \$393 | |
| 62" x 83" | 242104 | 185 | 220236 | 194 | 382112 | 197 | 220272 | 411 | |
| 6' x 8' | 242051 | 191 | 220237 | 207 | 382112 | 197 | 220273 | 444 | |
| 7' 6" x 10' | 242052 | 198 | 220238 | 240 | 382112 | 197 | 220274 | 486 | |
| 9' x 12' | 242053 | 216 | 220239 | 260 | 382112 | 197 | 220275 | 560 | |
| 10' 6" x 14' | 242105 | 219 | 220240 | 282 | 382112 | 197 | 220276 | 632 | |
| 12' x 16' | 242054 | 227 | 220297 | 300 | 382112 | 197 | 220301 | 702 | |
| 1:1 Square Format | | | | | | | | | |
| 6' x 6' | 242057 | \$143 | 220230 | \$173 | 382112 | \$197 | 220246 | \$444 | |
| 7' x 7' | 242058 | 185 | 220231 | 194 | 382112 | 197 | 220247 | 470 | |
| 8' x 8' | 242059 | 191 | 220232 | 207 | 382112 | 197 | 220248 | 512 | |
| 9' x 9' | 242100 | 195 | 220233 | 221 | 382112 | 197 | 220249 | 537 | |
| 10' x 10' | 242101 | 198 | 220234 | 240 | 382112 | 197 | 220250 | 587 | |
| 12' x 12' | 242102 | 216 | 220235 | 260 | 382112 | 197 | 220251 | 680 | |

Portable Screens

Cinefold—Portable folding screen complete with carrying case. Available with interchangeable front and rear projection surfaces. Rotational molded polyethylene case comes complete with wheels.

Complete unit includes frame, legs and snap-on surface with protective soft pouch in one polyethylene carrying case. Shipping weights are based on one standard complete Cinefold. Addition of a replacement surface or other options may increase the weight. Heavy-Duty Legs and anti-sway stabilizers are recommended for any Cinefold when used with a dress kit. Silver finish. Multi-image and custom sizes available: call for quotation.

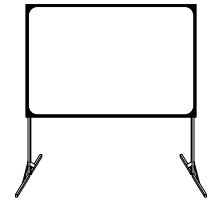

Cinefold with Flexible Matt White XT1000V Front Projection Surface

| Overall Size | Image Area | Nom. Diag. | Complete with Standard Legs | | Complete with HD Legs | | Surface Only | | Carrying Case Part No. | Shipping Wt./lbs. Complete | Dim Wt./lbs. Complete | Freight Class |
|------------------------------|-------------|------------|-----------------------------|-------|-----------------------|--------|--------------|-------|------------------------|----------------------------|-----------------------|---------------|
| | | | Part No. | PRICE | Part No. | PRICE | Part No. | PRICE | | | | |
| 16:9 HDTV Format | | | | | | | | | | | | |
| 56" x 96" | 52" x 92" | 106" | 218177 | \$843 | 218193 | \$1050 | 218181 | \$311 | 219024 | 50 | | 85 P |
| 62" x 108" | 58" x 104" | 119" | 218178 | 881 | 218194 | 1088 | 218182 | 326 | 219024 | 52 | | 85 P |
| 69" x 120" | 65" x 116" | 133" | 218179 | 987 | 218195 | 1193 | 218183 | 446 | 219024 | 60 | | 85 P |
| 83" x 144" | 79" x 140" | 161" | 218180 | 1124 | 218196 | 1331 | 218184 | 627 | 219025 | 65 | 66 | 85 P |
| 4:3 NTSC Video Format | | | | | | | | | | | | |
| 47" x 60" | 43" x 56" | 72" | 218008 | \$611 | 218084 | \$819 | 218027 | \$194 | 219024 | 50 | 66 | 85 P |
| 54" x 74" | 50" x 70" | 90" | 218009 | 630 | 218085 | 837 | 218028 | 200 | 219024 | 45 | | 85 P |
| 62" x 83" | 58" x 79" | 100" | 218010 | 798 | 218086 | 1004 | 218029 | 224 | 219025 | 54 | 66 | 85 P |
| 6' x 8' | 68" x 92" | 10' | 218011 | 860 | 218087 | 1065 | 218030 | 311 | 219024 | 56 | | 85 P |
| 7' 6" x 10' | 86" x 116" | 150" | 218012 | 987 | 218088 | 1193 | 218031 | 458 | 219025 | 68 | | 85 P |
| 9' x 12' ¹ | 104" x 140" | 15' | 218013 | 1124 | 218089 | 1331 | 218032 | 626 | 219025 | 75 | | 85 P |
| 10' 6" x 14' ² | 122" x 164" | 200" | 218014 | 1289 | 218090 | 1494 | 218033 | 818 | 219025 | 85 | | 85 P |
| 1:1 Square Format | | | | | | | | | | | | |
| 5' x 5' | 56" x 56" | | 218001 | \$771 | 218077 | \$986 | 218020 | \$228 | 219024 | 56 | 66 | 85 P |
| 6' x 6' | 68" x 68" | | 218002 | 782 | 218078 | 990 | 218021 | 237 | 219024 | 60 | | 85 P |
| 7' x 7' | 80" x 80" | | 218003 | 854 | 218079 | 1061 | 218022 | 311 | 219025 | 65 | 66 | 85 P |
| 8' x 8' | 92" x 92" | | 218004 | 917 | 218080 | 1124 | 218023 | 378 | 219098 | 77 | 121 | 85 P |
| 9' x 9' ¹ | 104" x 104" | | 218005 | 1011 | 218081 | 1221 | 218024 | 528 | 219025 | 75 | | 85 P |
| 10' x 10' ¹ | 116" x 116" | | 218006 | 1070 | 218082 | 1278 | 218025 | 602 | 219025 | 80 | | 85 P |
| 12' x 12' ² | 140" x 140" | | 218007 | 1259 | 218083 | 1467 | 218026 | 750 | 219098 | 90 | 121 | 85 P |

¹ Heavy-Duty Legs recommended.

² Heavy-Duty Legs recommended, and anti-sway stabilizers recommended but not included in any price above. See Accessories for prices.

Cinefold with CineFlex CH1200V Rear Projection Surface

CineFlex MH800V rear projection surface and CineFlex White XT600V front/rear projection surface are also available at the same price as CineFlex CH1200V. See page 4 for viewing surface details. When ordering these surfaces, use the CineFlex CH1200V part number followed by the appropriate suffix: **CA** for CineFlex MH800V, and **CC** for CineFlex White XT600V.

| Overall Size | Image Area | Nom. Diag. | Complete with Standard Legs | | Complete with HD Legs | | Surface Only | | Carrying Case Part No. | Shipping Wt./lbs. Complete | Dim Wt./lbs. Complete | Freight Class |
|------------------------------|-------------|------------|-----------------------------|--------|-----------------------|--------|--------------|-------|------------------------|----------------------------|-----------------------|---------------|
| | | | Part No. | PRICE | Part No. | PRICE | Part No. | PRICE | | | | |
| 16:9 HDTV Format | | | | | | | | | | | | |
| 56" x 96" | 52" x 92" | 106" | 218185 | \$1067 | 218197 | \$1274 | 218189 | \$521 | 219024 | 50 | | 85 P |
| 62" x 108" | 58" x 104" | 119" | 218186 | 1097 | 218198 | 1304 | 218190 | 528 | 219024 | 52 | | 85 P |
| 69" x 120" | 65" x 116" | 133" | 218187 | 1269 | 218199 | 1476 | 218191 | 731 | 219024 | 60 | | 85 P |
| 83" x 144" | 79" x 140" | 161" | 218188 | 1574 | 218200 | 1779 | 218192 | 1026 | 219025 | 65 | 66 | 85 P |
| 4:3 NTSC Video Format | | | | | | | | | | | | |
| 47" x 60" | 43" x 56" | 72" | 218046 | \$734 | 218103 | \$941 | 218065 | \$326 | 219024 | 50 | 66 | 85 P |
| 54" x 74" | 50" x 70" | 90" | 218047 | 740 | 218104 | 945 | 218066 | 329 | 219024 | 45 | | 85 P |
| 62" x 83" | 58" x 79" | 100" | 218048 | 989 | 218105 | 1194 | 218067 | 392 | 219025 | 54 | 66 | 85 P |
| 6' x 8' | 68" x 92" | 10' | 218049 | 1067 | 218106 | 1274 | 218068 | 521 | 219024 | 56 | | 85 P |
| 7' 6" x 10' | 86" x 116" | 150" | 218050 | 1269 | 218107 | 1493 | 218069 | 731 | 219025 | 68 | | 85 P |
| 9' x 12' ¹ | 104" x 140" | 15' | 218051 | 1574 | 218108 | 1779 | 218070 | 1026 | 219025 | 75 | | 85 P |
| 10' 6" x 14' ² | 122" x 164" | 200" | 218052 | 1671 | 218109 | 1878 | 218071 | 1200 | 219025 | 85 | | 85 P |
| 1:1 Square Format | | | | | | | | | | | | |
| 5' x 5' | 56" x 56" | | 218039 | \$923 | 218096 | \$1133 | 218058 | \$383 | 219024 | 56 | 66 | 85 P |
| 6' x 6' | 68" x 68" | | 218040 | 936 | 218097 | 1145 | 218059 | 387 | 219024 | 50 | | 85 P |
| 7' x 7' | 80" x 80" | | 218041 | 1062 | 218098 | 1269 | 218060 | 524 | 219025 | 65 | 66 | 85 P |
| 8' x 8' | 92" x 92" | | 218042 | 1215 | 218099 | 1419 | 218061 | 660 | 219098 | 77 | 121 | 85 P |
| 9' x 9' ¹ | 104" x 104" | | 218043 | 1311 | 218100 | 1518 | 218062 | 816 | 219025 | 75 | | 85 P |
| 10' x 10' ¹ | 116" x 116" | | 218044 | 1473 | 218101 | 1677 | 218063 | 986 | 219025 | 80 | | 85 P |
| 12' x 12' ² | 140" x 140" | | 218045 | 1646 | 218102 | 1853 | 218064 | 1139 | 219098 | 90 | 121 | 85 P |

¹ Heavy-Duty Legs recommended.

² Heavy-Duty Legs recommended, and anti-sway stabilizers recommended but not included in any price above. See Accessories for prices.

Dress Kits for Cinefold with standard Velour — Black 20 oz. cotton

Velour is standard, treated for flame retardancy. A complete Cinefold Dress Kit includes 46" height skirt, valance, valance bar, 2 drapes and 2 drapery bars.

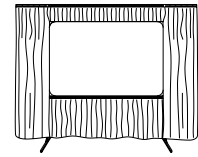

- **Options:** Blue 20 oz. Velour available at no additional charge. Other colors available by quotation. Heavy-Duty Legs and anti-sway stabilizers recommended but not included in prices below. See Cinefold Accessories on page 82 for price. Wheeled polyethylene carrying case—see page 83.

* **Weight Includes Carrying Case.**

| Overall Screen Size | Part No. | Dress Kit with Case PRICE | Part No. | Dress Kit without Case PRICE | Part No. | Optional Skirt Bar PRICE | Part No. | Skirt Only PRICE | Dress Kit Ship Wt./ lbs.* | Dress Kit Dim Wt./ lbs.* | Freight Class |
|------------------------------|----------|---------------------------|----------|------------------------------|----------|--------------------------|----------|------------------|---------------------------|--------------------------|---------------|
| 16:9 HDTV Format | | | | | | | | | | | |
| 56" x 96" | 220157 | \$1526 | 220161 | \$1289 | 220165 | \$248 | 220169 | \$344 | 55 | 66 | 70 P |
| 62" x 108" | 220158 | 1589 | 220162 | 1350 | 220166 | 251 | 220170 | 386 | 65 | 66 | 70 P |
| 69" x 120" | 220159 | 1670 | 220163 | 1430 | 220167 | 254 | 220171 | 422 | 73 | | 70 P |
| 83" x 144" | 220160 | 1821 | 220164 | 1584 | 220168 | 270 | 220172 | 473 | 57 | 66 | 70 P |
| 4:3 NTSC Video Format | | | | | | | | | | | |
| 62" x 83" | 220120 | \$1461 | 220008 | \$1223 | 220024 | \$245 | 220040 | \$323 | 48 | 66 | 70 P |
| 6' x 8' | 220121 | 1526 | 220009 | 1289 | 220025 | 248 | 220041 | 344 | 59 | 66 | 70 P |
| 7' 6" x 10' | 220122 | 1674 | 220010 | 1434 | 220026 | 254 | 220042 | 422 | 62 | 66 | 70 P |
| 9' x 12' | 220123 | 1821 | 220011 | 1584 | 220027 | 270 | 220043 | 473 | 68 | 66 | 70 P |
| 10' 6" x 14' | 220124 | 1950 | 220012 | 1710 | 220028 | 281 | 220044 | 518 | 75 | | 70 P |
| 1:1 Square Format | | | | | | | | | | | |
| 5' x 5' | 220113 | \$1301 | 220001 | \$1098 | 220017 | \$236 | 220033 | \$260 | 43 | 66 | 70 P |
| 6' x 6' | 220114 | 1385 | 220002 | 1148 | 220018 | 240 | 220034 | 272 | 55 | 66 | 70 P |
| 7' x 7' | 220115 | 1511 | 220003 | 1269 | 220019 | 245 | 220035 | 323 | 65 | 66 | 70 P |
| 8' x 8' | 220116 | 1583 | 220004 | 1344 | 220020 | 248 | 220036 | 344 | 73 | 73 | 70 P |
| 9' x 9' | 220117 | 1652 | 220005 | 1415 | 220021 | 251 | 220037 | 386 | 76 | | 70 P |
| 10' x 10' | 220118 | 1755 | 220006 | 1517 | 220022 | 254 | 220038 | 422 | 79 | | 70 P |
| 12' x 12' | 220119 | 1922 | 220007 | 1683 | 220023 | 270 | 220039 | 473 | 94 | | 70 P |

| Overall Screen Size | Part No. | Valance Bar PRICE | Part No. | Valance PRICE | Part No. | Drapery Bars (pr.) PRICE | Part No. | Drapes (pr.) PRICE | Carrying Case Part No. |
|------------------------------|----------|-------------------|----------|---------------|----------|--------------------------|----------|--------------------|------------------------|
| 16:9 HDTV Format | | | | | | | | | |
| 56" x 96" | 220173 | \$171 | 220177 | \$194 | 220181 | \$179 | 220185 | \$372 | 219025 |
| 62" x 108" | 220174 | 173 | 220178 | 201 | 220182 | 179 | 220186 | 378 | 219025 |
| 69" x 120" | 220175 | 174 | 220179 | 219 | 220183 | 179 | 220187 | 405 | 219025 |
| 83" x 144" | 220176 | 192 | 220180 | 236 | 220184 | 179 | 220188 | 474 | 219098 |
| 4:3 NTSC Video Format | | | | | | | | | |
| 62" x 83" | 220056 | \$168 | 220072 | \$182 | 220147 | \$179 | 220152 | \$345 | 219025 |
| 6' x 8' | 220057 | 171 | 220073 | 194 | 220148 | 179 | 220153 | 372 | 219025 |
| 7' 6" x 10' | 220058 | 174 | 220074 | 219 | 220149 | 179 | 220154 | 410 | 219025 |
| 9' x 12' | 220059 | 192 | 220075 | 236 | 220150 | 179 | 220155 | 474 | 219098 |
| 10' 6" x 14' | 220060 | 195 | 220076 | 255 | 220151 | 179 | 220156 | 536 | 219098 |
| 1:1 Square Format | | | | | | | | | |
| 5' x 5' | 220049 | \$126 | 220065 | \$161 | 220081 | \$179 | 220097 | \$353 | 219024 |
| 6' x 6' | 220050 | 131 | 220066 | 168 | 220082 | 179 | 220098 | 372 | 219025 |
| 7' x 7' | 220051 | 168 | 220067 | 182 | 220083 | 179 | 220099 | 392 | 219025 |
| 8' x 8' | 220052 | 171 | 220068 | 194 | 220084 | 179 | 220100 | 429 | 219098 |
| 9' x 9' | 220053 | 173 | 220069 | 201 | 220085 | 179 | 220101 | 443 | 219098 |
| 10' x 10' | 220054 | 174 | 220070 | 219 | 220086 | 179 | 220102 | 489 | 219098 |
| 12' x 12' | 220055 | 192 | 220071 | 236 | 220087 | 179 | 220103 | 575 | 219098 |

Portable Screens

BOOKMARK OUR MOBILE TOOLKIT

Draper's mobile toolkit includes searchable document libraries for all AV products and the assembly map tools for our popular StageScreen and FocalPoint screens. It also includes our Screen Surface Selector. Scan the code with your smartphone or visit: www.draperinc.com/drapermobile



Freight Class Key

Number LTL freight class
 P Parcel service
 + . . . \$8.50 surcharge (over 60" long)
Example: a freight code of 125 P+ indicates an item that may ship as freight class 125 or via parcel service with \$8.50 surcharge.

Dress Kits for Cinefold with IFR Velour

—Draper's Inherently Flame Retardant Velour never needs retreating. It is flame retardant for the life of the fabric (see page 79 for details). More resistant to wrinkling than standard Velour, yet 15% lighter weight for easier installation and transportation.

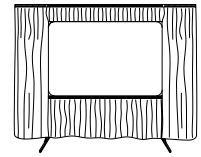

A complete Cinefold Dress Kit includes skirt, valance, valance bar, 2 drapes, 2 drapery bars and 1 molded polypropylene case with wheels.

- **Options:** Black is standard. Other colors available by quotation. Heavy-Duty Legs and anti-sway stabilizers recommended but not included in prices below. See Cinefold Accessories below for price. Wheeled polyethelene carrying case—see page 83.

* **Weight Includes Carrying Case.**

| Overall Screen Size | Part No. | Dress Kit with Case PRICE | Part No. | Dress Kit without Case PRICE | Part No. | Optional Skirt Bar PRICE | Part No. | Skirt Only PRICE | Dress Kit Ship Wt./ lbs.* | Dress Kit Dim Wt./ lbs.* | Freight Class |
|------------------------------|----------|---------------------------|----------|------------------------------|----------|--------------------------|----------|------------------|---------------------------|--------------------------|---------------|
| 16:9 HDTV Format | | | | | | | | | | | |
| 56" x 96" | 220304 | \$1605 | 220280 | \$1377 | 220165 | \$248 | 220284 | \$378 | 55 | 70 P | 55 |
| 62" x 108" | 220277 | 1676 | 220281 | 1449 | 220166 | 251 | 220285 | 429 | 65 | 70 P | 65 |
| 69" x 120" | 220278 | 1779 | 220282 | 1551 | 220167 | 254 | 220286 | 476 | 48 | 70 P | 73 |
| 83" x 144" | 220279 | 1940 | 220283 | 1712 | 220168 | 270 | 220287 | 528 | 87 | 70 P | 87 |
| 4:3 NTSC Video Format | | | | | | | | | | | |
| 62" x 83" | 220263 | \$1539 | 220204 | \$1311 | 220024 | \$245 | 220220 | \$356 | 52 | 70 P | 52 |
| 6' x 8' | 220264 | 1616 | 220205 | 1389 | 220025 | 248 | 220221 | 378 | 59 | 70 P | 59 |
| 7' 6" x 10' | 220265 | 1793 | 220206 | 1563 | 220026 | 254 | 220222 | 528 | 62 | 70 P | 62 |
| 9' x 12' | 220266 | 1958 | 220207 | 1730 | 220027 | 270 | 220223 | 540 | 68 | 70 P | 68 |
| 10' 6" x 14' | 220267 | 2100 | 220208 | 1874 | 220028 | 281 | 220224 | 581 | 75 | 70 P | 75 |
| 1:1 Square Format | | | | | | | | | | | |
| 5' x 5' | 220256 | \$1410 | 220197 | \$1184 | 220017 | \$236 | 220213 | \$281 | 43 | 70 P | 43 |
| 6' x 6' | 220257 | 1454 | 220198 | 1227 | 220018 | 240 | 220214 | 294 | 55 | 70 P | 55 |
| 7' x 7' | 220258 | 1596 | 220199 | 1368 | 220019 | 245 | 220215 | 356 | 65 | 70 P | 65 |
| 8' x 8' | 220259 | 1683 | 220200 | 1457 | 220020 | 248 | 220216 | 378 | 73 | 70 P | 73 |
| 9' x 9' | 220260 | 1775 | 220201 | 1547 | 220021 | 251 | 220217 | 429 | 76 | 70 P | 50 |
| 10' x 10' | 220261 | 1892 | 220202 | 1664 | 220022 | 254 | 220218 | 476 | 79 | 70 P | 66 |
| 12' x 12' | 220262 | 2073 | 220203 | 1847 | 220023 | 270 | 220219 | 528 | 94 | 70 P | 94 |

Portable Screens

| Overall Screen Size | Part No. | Valance Bar PRICE | Part No. | Valance PRICE | Part No. | Drapery Bars (pr.) PRICE | Part No. | Drapes (pr.) PRICE | Carrying Case Part No. |
|------------------------------|----------|-------------------|----------|---------------|----------|--------------------------|----------|--------------------|------------------------|
| 16:9 HDTV Format | | | | | | | | | |
| 56" x 96" | 220173 | \$171 | 220288 | \$207 | 220181 | \$179 | 220292 | \$431 | 219025 |
| 62" x 108" | 220174 | 173 | 220289 | 221 | 220182 | 179 | 220293 | 434 | 219025 |
| 69" x 120" | 220175 | 174 | 220290 | 240 | 220183 | 179 | 220294 | 473 | 219025 |
| 83" x 144" | 220176 | 192 | 220291 | 260 | 220184 | 179 | 220295 | 543 | 219098 |
| 4:3 NTSC Video Format | | | | | | | | | |
| 62" x 83" | 220056 | \$168 | 220236 | \$194 | 220147 | \$179 | 220272 | \$411 | 219025 |
| 6' x 8' | 220057 | 171 | 220237 | 207 | 220148 | 179 | 220273 | 444 | 219025 |
| 7' 6" x 10' | 220058 | 174 | 220238 | 240 | 220149 | 179 | 220274 | 486 | 219025 |
| 9' x 12' | 220059 | 192 | 220239 | 260 | 220150 | 179 | 220275 | 560 | 219098 |
| 10' 6" x 14' | 220060 | 195 | 220240 | 282 | 220151 | 179 | 220276 | 632 | 219098 |
| 1:1 Square Format | | | | | | | | | |
| 5' x 5' | 220049 | \$126 | 220229 | \$165 | 220081 | \$179 | 220245 | \$428 | 219024 |
| 6' x 6' | 220050 | 131 | 220230 | 173 | 220082 | 179 | 220246 | 444 | 219025 |
| 7' x 7' | 220051 | 168 | 220231 | 194 | 220083 | 179 | 220247 | 470 | 219025 |
| 8' x 8' | 220052 | 171 | 220232 | 207 | 220084 | 179 | 220248 | 512 | 219098 |
| 9' x 9' | 220053 | 173 | 220233 | 221 | 220085 | 179 | 220249 | 537 | 219098 |
| 10' x 10' | 220054 | 174 | 220234 | 240 | 220086 | 179 | 220250 | 587 | 219098 |
| 12' x 12' | 220055 | 192 | 220235 | 260 | 220087 | 179 | 220251 | 680 | 219098 |

Truss & Cinefold Accessories

| Accessory | Part No. | PRICE |
|--|----------|-------|
| Heavy-Duty Legs—7 1/2' tall, ordered separately (pr.) | 219006 | \$408 |
| Heavy-Duty Legs—9' tall, ordered separately (pr.) | 219007 | 408 |
| Heavy-Duty Legs—12' tall, ordered separately (pr.) | 219008 | 408 |
| Standard T-Legs—7 1/2' tall (pr.) | 219009 | 284 |
| Standard T-Legs—9' tall (pr.) | 219010 | 284 |
| Standard T-Legs—12' tall (pr.) | 219011 | 284 |
| Anti-Sway Stabilizers for Cinefold (pr.)—Heavy Duty Legs required. | 219001 | 137 |
| Anti-Sway Stabilizers for Truss Cinefold (pr.) | 219044 | 137 |
| Stiffener bar for Truss Cinefold | 219053 | 47 |
| Screen Connection Strip (white or black) | | 99 |
| Screen Connection Clamps (pr.) | 219002 | 18 |
| Hinge Clamps (pr.) | 219003 | 42 |
| Truss Cinefold Feet (pr.) | 219047 | 290 |
| Truss Cinefold foot Stage Left | 219048 | 152 |
| Truss Cinefold foot Stage Right | 219049 | 152 |

| Accessory | Part No. | PRICE |
|--|-------------|-------|
| Standard crank used for all UFS, Cinefold and Truss Cinefold screens except as noted below | 219004 | \$5 |
| Short crank for use only with L-Section at top of Truss Cinefold | 219058 | 5 |
| Repair Kit for Cinefold with tools | 219005 | 380 |
| Repair Kit for Cinefold without tools | 219057 | 216 |
| Carrying Case for screen | see page 83 | 237 |
| Carrying Case for Dress Kit | see page 83 | 237 |
| StageHand for Cinefold | 219054 | 258 |
| Fly Bracket (single) | 385223 | 50 |
| Fly Bracket (pair) | 385224 | 92 |

Freight Class Key
Number LTL freight class
P Parcel service
 + . . . \$8.50 surcharge (over 60" long)
Example: a freight code of 125 P+ indicates an item that may ship as freight class 125 or via parcel service with \$8.50 surcharge.

Portable Folding Screen and Dress Kit Cases—

Designed for service and dependability. Each case has two wheels. Handles are molded into each end of case. Lid handle is steel with rubber grip, recessed in inset. Lid is secured with two adjustable straps. Stacks with lids on or nests compactly with lids off.

Draper has redesigned our portable screen cases for FocalPoint, StageScreen and Truss Cinefold! Stronger and more stackable than ever, these cases hold larger sizes and are even easier to use. They also feature more internal space and a dramatically reinforced shell.

Cases for Complete Screens

| Part Number | Case Dimensions | Case Shipping Wt./lbs. | Accommodates the following sizes: | | | PRICE | Replacement Case Strap PRICE | |
|--|-----------------------------|------------------------|---|--------------------------------------|---------------------------------------|-------|------------------------------|-------|
| | | | Square | NTSC | HDTV | | Case Strap | PRICE |
| 219024 | 9 1/2" x 13 1/2" x 45" | 19 | 5' x 5' 6' x 6' | 47" x 60" 54" x 74" | 56" x 96" 62" x 108" | \$237 | 219100 | \$10 |
| Part No. 219024 is for Cinefold screens only. UFS in these sizes requires Part No. 219025 | | | | | | | | |
| 219025 | 12" x 15 3/4" x 52" | 29 | 7' x 7' 9' x 9' 10' x 10' | 62" x 83" 72" x 96" 76" x 101" | 56" x 96" 62" x 108" 69" x 120" | 237 | 219101 | 10 |
| 219098 | 16 3/8" x 17 1/4" x 60" | 37 | 8' x 8' 12' x 12' | 9' x 12' 10'6" x 14' | 83" x 144" 112" x 196" | 279 | 219102 | 10 |
| 219200 | 15 5/8" x 20 1/2" x 84 1/2" | 51 | Standard for all StageScreen and Truss Cinefold sizes | | | 563 | 219103 | 10 |

Cases for Complete Dress Kits

| Part Number | Case Dimensions | Case Shipping Wt./lbs. | Accommodates the following sizes: | | | PRICE | Replacement Case Strap PRICE | |
|-------------|-----------------------------|------------------------|---|--------------------------------------|---------------------------|-------|------------------------------|-------|
| | | | Square | NTSC | HDTV | | Case Strap | PRICE |
| 219024 | 9 1/2" x 13 1/2" x 45" | 19 | 5' x 5' | 47" x 60" | 56" x 96" | \$237 | 219100 | \$10 |
| 219025 | 12" x 15 3/4" x 52" | 29 | 6' x 6' 7' x 7' | 62" x 83" 72" x 96" | 56" x 96" 62" x 108" | 237 | 219101 | 10 |
| 219098 | 16 3/8" x 17 1/4" x 60" | 37 | 8' x 8' 9' x 9' 10' x 10' 12' x 12' | 9' x 12' 10'6" x 14' 12' x 16' | 83" x 144" 112" x 196" | 279 | 219102 | 10 |
| 219200 | 15 5/8" x 20 1/2" x 84 1/2" | 51 | Standard for all StageScreen and Truss Cinefold sizes | | | 563 | 219103 | 10 |

Please Note—Case(s) are provided with each Ultimate Folding Screen and Cinefold portable projection screen. Case(s) are optionally available for the Ultimate Folding Screen or Cinefold Dress Kits.

Screen Format Masking Strips—Quickly and easily convert your HDTV folding screen to NTSC format with these black masking strips. Available in black Velour. Also available for StageScreen or 16:10 Formats—call for quotation.

| HDTV Screen Size without Masking | | NTSC Screen Size with Masking | | Part No. | PRICE (PR) | Shipping Wt./Lbs. | Freight Class |
|--|---------------------|-------------------------------|--------------------|----------|------------|-------------------|---------------|
| Nominal Diagonal | Image Area HxW | Nominal Diagonal | Image Area HxW | | | | |
| Truss Cinefold/Cineperm Masking—16:9 HDTV to 4:3 NTSC | | | | | | | |
| 220" | 108" x 192" | 180" | 108" x 144" | 219094 | \$348 | 13 | 70 P |
| 250" | 120" x 218" | 200" | 120" x 160" | 219095 | 372 | 16 | 70 P |
| 275" | 135" x 240" | 225" | 135" x 180" | 219096 | 413 | 17 | 70 P |
| 330" | 162" x 288" | 270" | 162" x 216" | 219097 | 465 | 19 | 70 P |
| Cinefold Masking—16:9 HDTV to 4:3 NTSC | | | | | | | |
| 106" | 52" x 92" | 90" | 52" x 70" | 219090 | \$137 | 7 | 70 P |
| 119" | 58" x 104" | 100" | 58" x 79" | 219091 | 168 | 8 | 70 P |
| 133" | 65" x 116" | 109" | 65" x 87" | 219092 | 176 | 9 | 70 P |
| 161" | 79" x 140" | 133" | 79" x 106" | 219093 | 191 | 11 | 70 P |
| UFS Masking—16:9 HDTV to 4:3 NTSC | | | | | | | |
| 106" | 50 1/2" x 90 1/2" | 84" | 50 1/2" x 67 1/2" | 219085 | \$137 | 7 | 70 P |
| 119" | 56 1/2" x 102 1/2" | 95" | 56 1/2" x 75 1/2" | 219086 | 168 | 8 | 70 P |
| 133" | 63 1/2" x 114 1/2" | 105" | 63 1/2" x 84 1/2" | 219087 | 176 | 9 | 70 P |
| 161" | 77 1/2" x 138 1/2" | 103" | 77 1/2" x 103 1/2" | 219088 | 191 | 11 | 70 P |
| 186" | 91 1/2" x 162 1/2" | 151" | 91 1/2" x 121" | 219202 | 243 | 11 | 70 P |
| 220" | 106 1/2" x 190 1/2" | 178" | 106 1/2" x 142" | 219089 | 312 | 13 | 70 P |



StageHand—This handy little tool helps you save a lot of time and money by allowing one person to set up most folding screens. The StageHand is a simple device consisting of two "hooks" mounted on the end of a telescoping pole. The pole has a non-skid rubber tip. The hooks firmly hold and lift the top of a folding screen frame. Extend the pole to support the screen as a "third leg". This frees the tech to unfold and lock the screen's legs. Then just lift the screen fully onto its feet and remove the hook.

Draper's StageHand comes in two sizes, to fit either 1" folding screen frames (like Draper's Cinefold) or 1 1/4" frames (like Draper's Ultimate Folding Screen). It telescopes from 65" to 120" in length, and is suitable for use with screens in sizes through 7'6" x 10'.

| Description | Part No. | PRICE |
|---------------------------------------|----------|-------|
| StageHand for Ultimate Folding Screen | 382125 | \$237 |
| StageHand for Cinefold | 219054 | 258 |

Freight Class Key
Number LTL freight class
P Parcel service
 + ...\$8.50 surcharge (over 60" long)
Example: a freight code of 125 P+ indicates an item that may ship as freight class 125 or via parcel service with \$8.50 surcharge.

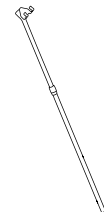

Portable Screens

Truss-Style Cinefold—Complete unit includes truss frame, truss legs, snap-on surface with soft case, Heavy-Duty Legs, anti-sway stabilizers, frame stiffeners for all horizontal hinges and heavy-duty carrying case. Case dimensions are 15 5/8" x 20 1/2" x 84 1/4". Shipping weight and number of cases are based on one complete truss-style Cinefold. Frame finish is scratch-resistant silver. Screens with additional viewing surfaces, hardware and draperies will be heavier and may require additional cases.

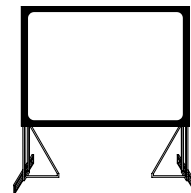

• **Options:** Replacement heavy-duty carrying case: Part No. 219200, Price—\$563

Multi-image and custom sizes available—call for quotation. *CineFlex MH800V* rear projection surface and *CineFlex White XT600V* front/rear projection surface are also available at the same price as *CineFlex CH1200V*. See page 4 for viewing surface details. When ordering these surfaces, use the *CineFlex CH1200V* part number followed by the appropriate suffix: **CA** for *CineFlex MH800V*, and **CC** for *CineFlex White XT600V*.

| Overall Size | Viewing Area | Flexible Matt White XT1000V Front Screen | | | | CineFlex CH1200V Rear Screen | | | | Shipping Wt./lbs. | Freight Class | No. of Cases |
|------------------------------|--------------|--|--------|--------------|--------|------------------------------|--------|--------------|--------|-------------------|---------------|--------------|
| | | Complete Unit | | Surface Only | | Complete Unit | | Surface Only | | | | |
| Part No. | PRICE | Part No. | PRICE | Part No. | PRICE | Part No. | PRICE | Part No. | PRICE | | | |
| 16:9 HDTV Format | | | | | | | | | | | | |
| 10' x 17' | 9' x 16' | 221049 | \$4110 | 221053 | \$1083 | 221057 | \$4763 | 221061 | \$1394 | 220 | 85 | 2 |
| 11' x 19' | 10' x 18' | 221050 | 4419 | 221054 | 1344 | 221058 | 5852 | 221062 | 2048 | 240 | 85 | 2 |
| 12' 3" x 21' | 11' 3" x 20' | 221051 | 5639 | 221055 | 1653 | 221059 | 7200 | 221063 | 2523 | 293 | 85 | 2 |
| 14' 6" x 25' | 13' 6" x 24' | 221052 | 6521 | 221056 | 2321 | 221060 | 8867 | 221064 | 3545 | 398 | 85 | 2 |
| 4:3 NTSC Video Format | | | | | | | | | | | | |
| 7' x 9' | 6' x 8' | 221005 | \$2136 | 221016 | \$515 | 221027 | \$2427 | 221038 | \$624 | 143 | 85 | 2 |
| 8' 6" x 11' | 7' 6" x 10' | 221006 | 3128 | 221017 | 663 | 221028 | 3605 | 221039 | 929 | 152 | 85 | 2 |
| 10' x 13' | 9' x 12' | 221007 | 3629 | 221018 | 843 | 221029 | 4355 | 221040 | 1278 | 276 | 85 | 2 |
| 11' 6" x 15' | 10' 6" x 14' | 221008 | 4031 | 221019 | 1098 | 221030 | 5190 | 221041 | 1698 | 286 | 85 | 2 |
| 13' x 17' | 12' x 16' | 221009 | 4842 | 221020 | 1418 | 221031 | 6185 | 221042 | 2165 | 312 | 85 | 2 |
| 16' x 21' | 15' x 20' | 221010 | 6048 | 221021 | 2154 | 221032 | 8226 | 221043 | 3284 | 340 | 85 | 2 |
| 19' x 25' | 18' x 24' | 221011 | 9437 | 221022 | 3030 | 221033 | 10611 | 221044 | 4752 | 371 | 85 | 2 |
| 1:1 Square Format | | | | | | | | | | | | |
| 9' x 9' | 8' x 8' | 221001 | \$3000 | 221012 | \$518 | 221023 | \$3359 | 221034 | \$804 | 147 | 85 | 2 |
| 10' x 10' | 9' x 9' | 221002 | 3137 | 221013 | 641 | 221024 | 3726 | 221035 | 995 | 130 | 85 | 2 |
| 11' x 11' | 10' x 10' | 221003 | 3378 | 221014 | 788 | 221025 | 4050 | 221036 | 1188 | 200 | 85 | 2 |
| 13' x 13' | 12' x 12' | 221004 | 3947 | 221015 | 1083 | 221026 | 5084 | 221037 | 1661 | 240 | 85 | 2 |

Please Note—Case(s) provided with each Truss Style Cinefold portable projection screen and each Truss Style Dress Kit.

Truss-Style Dress Kits with standard Velour—Black 20 oz cotton Velour is standard, treated for flame retardancy. Complete Truss Dress Kit includes skirt, valance, valance bar, 2 drapes, 2 drapery bars and wheeled heavy-duty carrying case. Case dimensions are 15 5/8" x 20 1/2" x 84 1/4".

• **Options:** Blue 20 oz. Velour available at prices listed below. Other colors, custom and multi-image sizes by quotation.

| Overall Size | Image Area | Complete Dress Kit | | Optional Skirt Bar | | Skirt Only | | Complete Dress Kit Shipping Wt./lbs. | Freight Class |
|------------------------------|--------------|--------------------|--------|--------------------|-------|------------|-------|--------------------------------------|---------------|
| | | Part No. | PRICE | Part No. | PRICE | Part No. | PRICE | | |
| 16:9 HDTV Format | | | | | | | | | |
| 10' x 17' | 9' x 16' | 222045 | \$2151 | 222049 | \$444 | 222053 | \$611 | 107 | 70 |
| 11' x 19' | 10' x 18' | 222046 | 2504 | 222050 | 462 | 222054 | 686 | 117 | 70 |
| 12' 3" x 21' | 11' 3" x 20' | 222047 | 3080 | 222051 | 518 | 222055 | 759 | 128 | 70 |
| 14' 6" x 25' | 13' 6" x 24' | 222048 | 3261 | 222052 | 537 | 222056 | 905 | 140 | 70 |
| 4:3 NTSC Video Format | | | | | | | | | |
| 7' x 9' | 6' x 8' | 222005 | \$1412 | 222016 | \$297 | 222027 | \$408 | 90 | 70 |
| 8' 6" x 11' | 7' 6" x 10' | 222006 | 2096 | 222017 | 387 | 222028 | 474 | 107 | 70 |
| 10' x 13' | 9' x 12' | 222007 | 2280 | 222018 | 395 | 222029 | 530 | 117 | 70 |
| 11' 6" x 15' | 10' 6" x 14' | 222008 | 2456 | 222019 | 437 | 222030 | 608 | 128 | 70 |
| 13' x 17' | 12' x 16' | 222009 | 2642 | 222020 | 444 | 222031 | 611 | 140 | 70 |
| 16' x 21' | 15' x 20' | 222010 | 3024 | 222021 | 518 | 222032 | 759 | 150 | 70 |
| 19' x 25' | 18' x 24' | 222011 | 3513 | 222022 | 537 | 222033 | 905 | 180 | 70 |
| 1:1 Square Format | | | | | | | | | |
| 9' x 9' | 8' x 8' | 222001 | \$2084 | 222012 | \$297 | 222023 | \$408 | 95 | 70 |
| 10' x 10' | 9' x 9' | 222002 | 2109 | 222013 | 380 | 222024 | 447 | 106 | 70 |
| 11' x 11' | 10' x 10' | 222003 | 2127 | 222014 | 387 | 222025 | 474 | 110 | 70 |
| 13' x 13' | 12' x 12' | 222004 | 2406 | 222015 | 395 | 222026 | 530 | 120 | 70 |

Truss-Style Dress Kits with IFR Velour—Draper's Inherently Flame Retardant Velour never needs retreating. It is flame retardant for the life of the fabric (see page 63 for details). More resistant to wrinkling than standard Velour, yet 15% lighter weight for easier installation and fabric management. Complete Truss Dress Kit includes skirt, valance, valance bar, 2 drapes, 2 drapery bars and wheeled heavy-duty carrying case. Case dimensions are 15 5/8" x 20 1/2" x 84 1/4".

| Overall Size | Image Area | Complete Dress Kit | | Optional Skirt Bar | | Skirt Only | | Complete Dress Kit Shipping Wt./lbs. | Freight Class |
|------------------------------|--------------|--------------------|--------|--------------------|-------|------------|-------|--------------------------------------|---------------|
| | | Part No. | PRICE | Part No. | PRICE | Part No. | PRICE | | |
| 16:9 HDTV Format | | | | | | | | | |
| 10' x 17' | 9' x 16' | 222154 | \$2313 | 222049 | \$444 | 222158 | \$669 | 107 | 70 |
| 11' x 19' | 10' x 18' | 222155 | 2672 | 222050 | 462 | 222159 | 750 | 117 | 70 |
| 12' 3" x 21' | 11' 3" x 20' | 222156 | 3230 | 222051 | 518 | 222160 | 833 | 128 | 70 |
| 14' 6" x 25' | 13' 6" x 24' | 222157 | 3459 | 222052 | 537 | 222161 | 992 | 140 | 70 |
| 4:3 NTSC Video Format | | | | | | | | | |
| 7' x 9' | 6' x 8' | 222136 | \$1517 | 222016 | \$297 | 222147 | \$444 | 90 | 70 |
| 8' 6" x 11' | 7' 6" x 10' | 222137 | 2193 | 222017 | 387 | 222148 | 518 | 107 | 70 |
| 10' x 13' | 9' x 12' | 222138 | 2390 | 222018 | 395 | 222149 | 579 | 117 | 70 |
| 11' 6" x 15' | 10' 6" x 14' | 222139 | 2579 | 222019 | 437 | 222150 | 666 | 128 | 70 |
| 13' x 17' | 12' x 16' | 222140 | 2789 | 222020 | 444 | 222151 | 669 | 140 | 70 |
| 16' x 21' | 15' x 20' | 222141 | 3210 | 222021 | 518 | 222152 | 833 | 150 | 70 |
| 19' x 25' | 18' x 24' | 222142 | 3731 | 222022 | 537 | 222153 | 992 | 180 | 70 |
| 1:1 Square Format | | | | | | | | | |
| 9' x 9' | 8' x 8' | 222132 | \$2166 | 222012 | \$297 | 222143 | \$444 | 95 | 70 |
| 10' x 10' | 9' x 9' | 222133 | 2196 | 222013 | 380 | 222144 | 489 | 106 | 70 |
| 11' x 11' | 10' x 10' | 222134 | 2237 | 222014 | 387 | 222145 | 518 | 110 | 70 |
| 13' x 13' | 12' x 12' | 222135 | 2528 | 222015 | 395 | 222146 | 579 | 120 | 70 |

Pipe & Drape Runoffs

Free-standing modular drapery system for use with StageScreen, FocalPoint, Cinefold, and Ultimate Folding Screen portable projection screens. A variety of hardware and drapery configurations are available.

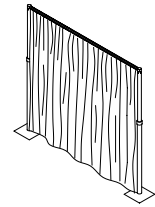

| | Net Wt.*/lbs. | Part No. | PRICE | Freight Class |
|--|---------------|----------|-------|---------------|
| Telescopic Uprights With Slip-Lok Feature | | | | |
| 3'–5' model | 3 | 223001 | \$120 | 85 P |
| 7'–12' model | 6 | 223002 | 135 | 85 P |
| 9'–16' model | 7 | 223003 | 145 | 85 P |
| 7'–17' three-piece upright. | 14 | 223019 | 233 | 85 P |
| *Shipping notes: 1 to 10 uprights will ship in one 10 lb carton. (Studs can be packed with uprights.) | | | | |
| Flat Steel Bases & Stud | | | | |
| 3/8" x 18" x 18" | 35 | 223004 | \$108 | 85 P |
| 3/16" x 18" x 18" | 18 | 223005 | 83 | 85 P |
| (For use with telescoping uprights. Draper does not recommend the use of lighter bases with fabric panels 12' and higher.) | | | | |
| *Shipping notes: Single pieces will ship at listed weight. Two or more bases will ship on one, 30 lb. skid. | | | | |
| Mobile Base Cart | | | | |
| Mobile PDR Flat Steel Base Cart. | 90 | 223020 | \$725 | 50 P |
| Horizontal Drape Supports | | | | |
| 6'8"/10' | 4 | 223007 | \$59 | 85 P |
| 7'10"/12' | 3 | 223008 | 70 | 85 P |
| Adjustable Drape Support Bracket | 4 | 223021 | 33 | 85 |
| *Shipping notes: Single pieces ship in one, 10 lb. carton. Up to 25 pieces will fit in one, 10 lb. carton. | | | | |
| Replacement Parts | | | | |
| Upright Repair Ends for 2 pc upright | 1 | 223009 | \$13 | 85 P |
| Upright Repair Ends for 3 pc upright | 1 | 223028 | 17 | 85 P |
| Horizontal Bar Repair End - Large Bar | 3 | C057.008 | 8 | 85 P |
| Horizontal Bar Repair End - Small Bar | 3 | C057.007 | 8 | 85 P |
| Collar Repair Kit for 2 or 3 pc upright | 3 | C121.026 | 100 | 85 P |
| Stud & Screw for Bases - 2" x 6" | 1 | 223010 | 17 | 85 P |
| Stud & Screw for Bases - 2" x 4" | 1 | 223027 | 17 | 50 |
| Carrying Cases | | | | |
| Zippered Pouch—Accommodates up to 12 uprights and/or horizontal supports. | 8 | 223018 | \$201 | 70 P |
| Heavy-Duty Carrying Case ¹ | 50 | 219200 | 563 | 150 P+ |
| Optional Carrying Case ² | 30 | 219098 | 279 | 250 P |

¹ Case size is 15 3/8" x 20 1/2" x 84 1/2" and accommodates up to 4 drape panels @ 13' x 12' or 13' x 16'; or 8 panels @ 50" x 16'.

² Case size is 16 3/8" x 17 1/4" x 60" and accommodates up to 2 drape panels @ 13' x 12' or 13' x 16'; or 6 panels @ 50" x 16'.

Portable Screens

Draperies

Widths shown below are actual cloth width, to be reduced for fullness. Draper does not recommend more than one 13' panel per drape support.

- **Standard 16 oz. Velour:** Black cotton Velour, treated for flame retardancy. 20 oz. optionally available.
- **Inherently Flame Retardant Velour:** Draper's Inherently Flame Retardant Velour never needs retreating. It is flame retardant for the life of the fabric. More resistant to wrinkling than standard Velour.
- **Vellite, Poly-Knit and Velour colors:** Navy or Black.
- **Classic Twill colors:** Navy or Black, other colors available on request.

| Size H x W | Part No. | Black 16 oz. Velour (0.9 Opacity) PRICE | Inherently Flame Retardant Black Velour (0.9 Opacity) Part No. PRICE | Vellite (0.75 Opacity) PRICE | Classic Twill (0.5 Opacity) PRICE | Poly-Knit (0.5 Opacity) PRICE | Shipping Wt./lbs. | Freight Class |
|---------------------------------|----------|---|--|------------------------------------|---|-------------------------------------|----------------------|------------------|
| Drape Panels | | | | | | | | |
| 12' x 50" | 223013 | \$179 | 223023 \$252 | -- | -- | -- | 10 | 70 P |
| 16' x 50" | 223014 | 267 | 223025 342 | -- | -- | -- | 11 | 70 P |
| 12' x 13' | 223015 | 715 | 223022 743 | \$530 | \$417 | \$320 | 18 | 70 P |
| 16' x 13' | 223016 | 849 | 223024 1014 | 633 | 495 | 384 | 23 | 70 P |
| Skirt and Valance Panels | | | | | | | | |
| 12" x 50" | -- | \$84 | -- \$105 | \$71 | \$71 | \$86 | 7 | 70 P |
| 48" x 50" | -- | 105 | -- 132 | 95 | 95 | 123 | 9 | 70 P |
| 60" x 50" | -- | 114 | -- 140 | 107 | 107 | 129 | 11 | 70 P |

Freight Class Key
Number LTL freight class
P Parcel service
 + \$8.50 surcharge (over 60' long)
Example: a freight code of 125 P+ indicates
 an item that may ship as freight class
 125 or via parcel service with \$8.50 surcharge.



DR990 Heavy-Duty Easel

Presentation Easels

We're streamlining our easel product offering and keeping the best.

Draper Heavy Duty Easels are designed to last, even under the wear and tear of rental use. The 1" square tubular aluminum frame stands up to the demands of constant setup, teardown, and transportation.

| Model | Part No. | Description | PRICE | Shipping Wt./lbs. | Freight Class |
|--------------------------|----------|---|-------|-------------------|---------------|
| Heavy-Duty Easels | | | | | |
| DR890 Black | 350070 | Our classic heavy-duty non-folding easel is now finished in all black. The matte powder coat finish is highly scratch resistant. Stands 6' tall and folds flat for storage or transportation. | \$369 | 25 | 125 P+ |
| DR895 | 350061 | Similar to the DR890, the DR895 stands 6' tall and features a satin silver leg finish with folding legs for more compact storage. The folding legs allow the entire unit to fold to a compact 6" x 29" x 39". | 423 | 25 | 85 P |
| DR990 | 350068 | This heavy-duty easel features a dry-erase writing panel and satin silver anodized frame. Stands 6' tall and folds flat for storage | 403 | 25 | 125 P+ |

Easel Accessories

| | Part No. | PRICE |
|-------------------------|----------|-------|
| Dry Erase Accessory Kit | 800319 | \$25 |
| Magnets (24 pack) | 352008 | 28 |

Additional easel models and accessories are available while supplies last. Contact your Draper salesperson for details!

Freight Class Key
Number LTL freight class
P Parcel service
 + ...\$8.50 surcharge (over 60" long)
Example: a freight code of 125 P+ indicates an item that may ship as freight class 125 or via parcel service with \$8.50 surcharge.

Rigid Rear Projection Screens

Draper offers several distinct types of rear projection screens—traditional diffusion, optical screens, and exclusive IRUS technology.

Diffusion Rear Screens—A transparent substrate, either glass or acrylic, with a permanently bonded diffusion medium. The diffusion medium distributes projected light and creates a uniform high-resolution reproduction of the projected image. Cinescreen, Draper's diffusion rear screen, is unique among rear screens because its diffusion medium consists of both an optical coating and an optical tint—each formulated for specific requirements. (Optical coatings and optical tints are described on page 88).

The advantages of diffusion screens are superior clarity of image and availability in extremely large sizes. Accordingly, diffusion screens are great for high resolution applications.

• Cinescreen®

Only Draper offers you a choice of optical coatings and unique optical tints. With a Draper Cinescreen, you can select the optimum combination of optical coating and tint based upon your projection equipment, audience seating pattern, desired contrast level, screen aspect ratio, ambient light level and aesthetic considerations. Only Draper offers you this versatility. Custom gains and tints are available by quotation.

Draper uses the finest plate glass and clear acrylic as Cinescreen substrates. Virtually identical optical qualities.

- **Cineglass®**—Recommended for maximum sound isolation, scratch resistance, service life and any application that requires multiple projectors. Weighs approximately twice as much as acrylic, must be installed by a glazier. Recommended for wide and multiple projection installs.
- **Cineplex®**—Lightweight, durable and break resistant. Easier to install. Requires more care in cleaning, as acrylic scratches more easily than glass. Not recommended for multiple projection installs.

When ordering a Cinescreen, we need to know the following:

- Dimensions
- Substrate
- Thickness
- Optical coating
- Tint
- If NonGlare is required
- If factory-installed framing is required (specify framing system number and finish)

IRUS Technology—The Draper IRUS—Infinite Resolution Uniformity Screen—is specifically designed to provide maximum legibility with any projector. Today's projectors offer higher resolution than ever before—and that means more information for your audience to absorb. The IRUS is up to the challenge. In order to convey an increasing amount of information to the viewer, the IRUS uses

proprietary technology to display the sharpest, most uniform image you've ever seen. An extra wide angle view makes this screen perfect for short throw projectors or blending applications.

VersaRoll—Draper now offers our standard rear screens, rolled up for shipping, whether you use the Cinescreen or IRUS product. The new VersaRoll frame solutions and lighter acrylic substrate provide a more cost effective shipping and handling solution and are a suitable option for blending when glass is not possible. The same great Cinescreen and IRUS coatings are still available but now with new VersaRoll substrate and frame.

Optical Rear Screens—Made of cast acrylic, incorporating a Fresnel lens on the projector side. The Fresnel lens gathers the light from the projector and refracts it directly through the screen. Optical screens are a necessity for multiple screens in the same room or videowalls.

Custom Requirements—Draper offers many custom and unique possibilities with rigid front and rear projection screens, or even when projection is not used.

- **Video Conferencing Camera Portal**
- **Rollable Rigid Rear Screens**
- **Curved Rigid Front or Rear Screens**
- **Custom Shapes**
- **Write-On Front or Rear Screen**
- **Transparent Rear Screens**
- **Custom Coatings**
- **VideoWalls**
- **Zero Edge Framing System**
- **MultiScreen System**
- **Projector Support Structures and Custom Cube Stands**
- **Flat Panel Video Walls**
- **LED Walls**
- **Outdoor Monitor Enclosures**



What is Gain?—Gain is a measure of brightness as compared to a block of barium sulfate, which serves as an industry standard for gain of 1.0. A more familiar “real-world” comparison is with a matt white projection screen. Most matt white screens have a fairly uniform light distribution pattern with gain of approximately 1.0. Screens that appear brighter on axis are concentrating reflected or transmitted light in a narrower area: the gain may be 2.5 on axis but 0.5 at 60° to the side. With today's brighter, high output projectors, gain is not as important as it once was because the screen no longer has to make up for a lack of projector brightness. Other factors—such as color contrast and accuracy, uniformity, reproduction of black and the ability to perform with more ambient light in the audience area—are equally important.

Rigid Rear Projection Screens

IRUS—Infinite Resolution Uniformity Screen

The Draper IRUS is specifically designed for blending and wide viewing applications. Unique antiglare finish on glass or acrylic substrate with 0.7 gain and 180° viewing cone. IRUS is an improvement for every rear screen application, but is particularly suited for short throw projectors or blending images.

- **Substrates available:** Acrylic, Glass (for use with multiple projectors).

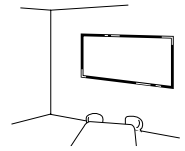

IRUS with Curved or Semi Rigid VersaRoll—VersaRoll curved screens typically utilize 3/16" or 1/4" thick, IRUS substrate. Maximum standard size for 3/16" thick curved screens is 100" high by 360". Maximum standard size for 1/4" thick curved screens is 104" high by 192" wide. Minimum curve radius is 8'. Some tighter radius curves may require custom framing. Please call Draper for pricing and additional product details.

Cinescreen® Rear Screens—Our optical coatings are specially formulated to your requested tint and gain. This advantage is at no extra charge to you.

Cinescreen® with Curved or Semi Rigid VersaRoll—VersaRoll curved screens typically utilize 3/16" or 1/4" thick, Cinescreen® substrate. Maximum standard size for 3/16" thick curved screens is 100" high by 360". Maximum standard size for 1/4" thick curved screens is 104" high by 192" wide. Minimum curve radius is 8'. Some tighter radius curves may require custom framing. Please call Draper for pricing and additional product details.

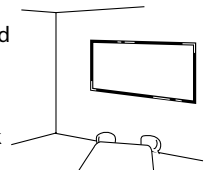

Rear Screen Freight Information

Freight Damage Policy

It is the customer's responsibility to open the crate immediately, inspect and note any freight damage on the carrier's receiving bill of lading, while the driver is present. If no damage is noted, then it is your responsibility to report and file your own freight damage claim. The damaged product must be held at the original shipping address and in its original crate.

If the above procedure is not followed, or if the shipment is not insured, Draper cannot assume any responsibility for freight damage or collection of resulting claim. **Please call for freight quote.** Some large sizes require contract haul and also require special handling and framing considerations. Please discuss with Draper before you quote your customer.

Please Note—All Cinescreen returns and credits must be authorized by Draper, and a Return Material Authorization number must be issued. If a return is authorized, we will extend as much credit as possible for the screen based on its salvage value upon receipt by Draper.

Optical Coatings and Tints for Cinescreen

Draper's optical coatings and unique optical tints allow you to select the optimum combination based upon your projection equipment, audience seating pattern, desired contrast level, screen aspect ratio, ambient light level and aesthetic considerations. Optical coating determines the brightness and viewing angle. Optical tint influences image contrast and color value.

Optical Coatings

- Cine 10: Gain of 1.0.
- Cine 13: Gain of 1.3.
- Cine 15: Gain of 1.5.
- Custom coatings available. Contact Draper for details.

Optical Tints

- HC High Contrast (e.g. Cine 13HC)—Dark grey tint.
- NG Standard formulation (e.g. Cine 13NG)—Medium grey tint.
- W White (e.g. Cine 13W)—White optical tint.
- Custom coatings available. Contact Draper for details

Special Coatings

NonGlare—Optional NonGlare coating on polished (uncoated) side of screen. Add 15% to standard screen prices and to custom screen prices.

ArmorKote—Protective coating applied over diffusion coating.

Custom coatings available—call Draper for your special needs!

Freight Class Key

Number LTL freight class
P Parcel service
+ ... \$8.50 surcharge (over 60" long)
Example: a freight code of 125 P+ indicates
an item that may ship as freight class
125 or via parcel service with \$8.50 surcharge.

CineScreen, and IRUS Order Info

Call Draper to request a quote. On a standard part, please provide us with the Size, Screen Choice, and Frame Part seen below. **Note: Adding frame changes overall sizes.**

| Nominal Diagonal | Image Area | Overall Size | Recommended Thickness (in.) | Recommended Substrate | IRUS | | CINESCREEN | | FRAME | |
|------------------------------|---------------|---------------|-----------------------------|-----------------------|--------|--|------------|--|----------------------|--------|
| | | | | | PRICE | | PRICE | | Frame Part Available | PRICE |
| 16:10 Format | | | | | | | | | | |
| 94" | 50" x 80" | 51" x 81" | ¼" | Plex | \$2492 | | \$2492 | | 200, 350, 400 | \$1284 |
| 109" | 57 ½" x 92" | 58 ½" x 93" | ¼" | Plex | 3326 | | 3326 | | 200, 350, 400 | 1517 |
| 142" | 75" x 120" | 76" x 121" | ⅜" | Plex | 6301 | | 6301 | | 200, 350, 400 | 2042 |
| 177" | 93 ¾" x 150" | 94 ¾" x 151" | ½" | Plex | 14836 | | 14836 | | 200, 350, 400 | 2450 |
| 16:9 HDTV Format | | | | | | | | | | |
| 92" | 45" x 80" | 46" x 81" | ¼" | Plex | \$2484 | | \$2484 | | 200, 350, 400 | \$1250 |
| 106" | 52" x 92" | 53" x 93" | ¼" | Plex | 3317 | | 3317 | | 200, 350, 400 | 1492 |
| 138" | 67 ½" x 120" | 68 ½" x 121" | ⅜" | Plex | 6143 | | 6143 | | 200, 350, 400 | 2034 |
| 172" | 84 ½" x 150" | 85 ½" x 151" | ½" | Plex | 14753 | | 14753 | | 200, 350, 400 | 2399 |
| 4:3 NTSC Video Format | | | | | | | | | | |
| 84" | 50 ½" x 67 ¼" | 51 ½" x 68 ¼" | ¼" | Plex | \$2000 | | \$2000 | | 200, 350, 400 | \$1159 |
| 100" | 60" x 80" | 61" x 81" | ¼" | Plex | 2826 | | 2826 | | 200, 350, 400 | 1375 |
| 120" | 72" x 96" | 73" x 97" | ⅜" | Plex | 5059 | | 5059 | | 200, 350, 400 | 1750 |
| 150" | 90" x 120" | 91" x 121" | ½" | Plex | 11419 | | 11419 | | 200, 350, 400 | 2159 |
| 172" | 102" x 136" | 103" x 137" | ½" | Plex | 14920 | | 14920 | | 350, 400 | 2467 |
| Multi Format | | | | | | | | | | |
| | 50" x 160" | 51" x 161" | ⅜" | Glass | \$9719 | | \$9719 | | 200, 350, 400 | \$2100 |
| | 60" x 192" | 61" x 193" | ⅜" | Glass | 29573 | | 29573 | | 350, 400 | 2509 |

New! VersaRoll Screen—Same great optical choices of using the IRUS or Cinescreen but in a Semi Rigid ⅜" thickness. What you get with this product is an easy way to get a rigid screen into a building. Unroll once inside the room, attach fasteners, flatten in the hole opening, and you have a great product that does not move from air pressure changes. Call Draper for quotations Available up to 100" x 360" by quotation and wider choices may be available, discuss with your Draper representative.

Cineframe® Factory-Installed Frames—Draper offers three factory-mounted aluminum framing systems for both standard and custom size glass and acrylic screens. Pricing for several standard rear screens with framing systems included can be found in each rear screen model price grid. Please note size limits for various models in the dimensions chart at bottom.

Cineframe Dimensions

| | SYSTEM 200 | SYSTEM 350 | SYSTEM 400 |
|------------------------------|------------|-------------|-------------|
| Cinescreen or IRUS thickness | ¼", ⅜" | ½" | all sizes |
| Cineglass through: | 7' x 16' | all sizes | all sizes |
| Cineplex through: | 7' x 16' | all sizes | all sizes |
| IRUS through | 7' x 16' | all sizes | all sizes |
| Weight per linear foot | 1 lb. | 1 lb. 7 oz. | 1 lb. 7 oz. |

Size Chart—

| | | | |
|--|-----|-----|-----|
| A. Deduct from overall screen size for net image area: | 1" | 1½" | 1" |
| B. Add to overall screen size for overall frame size: | 4¼" | 1½" | 1⅝" |

*This is the overall size of that portion of the System 400 Cineframe which is within the rough opening. Refer to drawing below for complete System 400 dimensions. Recommended rough opening should be ⅜" larger than overall frame size.

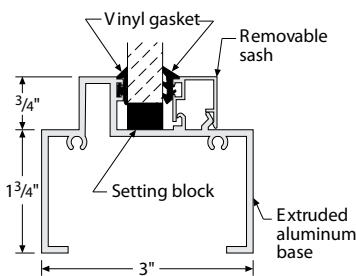

SYSTEM 200 dimensions

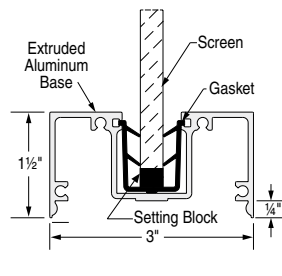

SYSTEM 350 dimensions

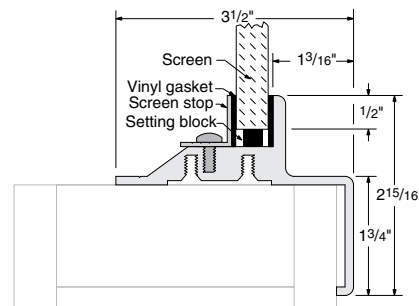

SYSTEM 400 dimensions

Draper RPX Rear Projection Systems—The world's best engineered, most precise projector/first surface mirror mounting systems. Easy to install, adjust and fine tune. Draper's RPX line offers more product for your money. Its sturdy 1 3/4" x 1 3/4" aluminum extrusion allows incredible adjustment and easy assembly. Each RPX consists of—

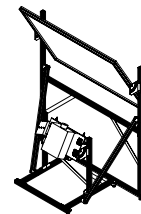

1. A cradle, with multi-axis adjustment, built specifically to fit your projector.
2. A high quality (94% reflective) first surface mirror.
3. A sturdy frame, built specifically for your requirement, to support and position the projector and mirror in precisely the right positions relative to the rear projection screen and to each other.
4. A 6-axis adjustment system is standard.

Draper offers three Rear Projection Systems—

RPX—Designed for use with most projectors. Custom built to accommodate any required screen size or height.

RPX/Precision—Highly sophisticated RPX designed for use with applications that require high resolution pixel alignment, wherever edge matching of images or absolute precision in a single projected image is required. Includes all the adjustment features of the RPX.

RPX/Complete—See below.

RPX Systems

| Model | Shipping Wt./lbs. | PRICE |
|-------------------------|-------------------|--------|
| Standard RPX | | |
| Mirrors up to 36" x 43" | 400 | \$6032 |
| Dual Mirror RPX | | |
| Mirrors up to 48" x 72" | 475 | \$7322 |
| RPX/Precision | | |
| Mirrors up to 36" x 43" | 550 | \$6945 |

Call Draper to request a drawing on any RPX.

An Exclusive Concept in Rear Projection—The RPX/Complete

The RPX/Complete combines the features of an RPX with a framed rear screen attached to structural uprights. Comes with your choice of an IRUS, or Cinescreen through 8' wide. The RPX/Complete allows the framed screen to "float" in wall opening and allows for easier installation and image alignment. The wall does not bear the weight of the screen, so no finishing or reinforcement of opening is required. Cut a rough opening, and set up the system.

| Nominal Diagonal | Image Area (HxW) | Overall Size (HxW) |
|------------------------------|-------------------|--------------------|
| 4:3 NTSC Video Format | | |
| 84" | 50 1/2" x 67 1/4" | 51 1/2" x 68 1/4" |
| 90" | 54" x 72" | 55" x 73" |
| 96" | 57 5/8" x 76 7/8" | 58 3/8" x 77 7/8" |
| 100" | 60" x 80" | 61" x 81" |
| 120" | 72" x 96" | 73" x 97" |
| 16:9 HDTV Format | | |
| 92" | 45" x 80" | 46" x 81" |
| 106" | 52" x 92" | 53" x 93" |

Pricing by quotation only—Contact Draper for details!

Engineering Service—If you upgrade projectors, our Engineering Staff can provide a revised drawing to upgrade your RPX. Price varies according to requirement.

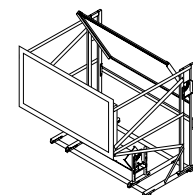

Rear Screens

Mirror Manager—Available with any Mirror System or Draper RPX unit.

The Mirror Manager allows you to fine tune the image within minutes, not hours. Individual adjustments for each corner or side of the image can be made with the turn of a knob.

| Part Number | PRICE |
|-------------|--------|
| 254019 | \$1644 |

As substitute for standard mirror and frame.
Mirror Manager is available with First Surface Mirrors when sold separately. Price may increase for larger mirrors.

First Surface Mirrors—Draper

first surface mirrors are 1/4" glass, optical grade, 94% reflective—the highest quality, commercially available first surface mirrors in the world. First surface mirrors are offered with or without frame. Frame is extruded aluminum with compression gasket to prevent distortion, in black anodized finish. Purchase of mirror complete with frame simplifies installation. Mirrors ship freight class 100. Custom sizes also available—call for quotation.

| Mirror Size (H x W) | Part No. | Mirror Only | Mirror Assembly Complete with Frame | |
|---------------------|----------|-------------|-------------------------------------|--------|
| | | PRICE | Part No. | PRICE |
| 25" x 40" | 254001 | \$905 | 254009 | \$1675 |
| 30" x 40" | 254002 | 1104 | 254010 | 1962 |
| 43" x 50" | 254003 | 1684 | 254011 | 2946 |
| 43" x 60" | 254004 | 2375 | 254012 | 3496 |
| 43" x 72" | 254005 | 2846 | 254013 | 4341 |
| 48" x 60" | 254006 | 3767 | 254014 | 4896 |
| 48" x 72" | 254017 | 4019 | 254018 | 5243 |
| 60" x 90" | 254007 | 6640 | 254015 | 9420 |
| 72" x 96" | 254022 | 7136 | 254023 | 10655 |

MiroClear—A superior quality cleaning and restoration kit designed specifically for all first surface glass mirrors. Improves image quality, maintains new mirrors to the highest standards, brings new life to older mirrors and restores reflectivity loss caused by dust, dirt, fingerprints and grime build-up that accumulates and robs mirror of critical reflectivity.

| Part No. | PRICE |
|----------|-------|
| 254020 | \$40 |

Projector & FlatScreen Lifts

Draper offers the finest quality and widest variety of projector and flatscreen lifts, and continues to grow and innovate an unparalleled product line.

Credenza Lift—Draper's new motorized projector lift designed to hide your projector inside cabinetry, and raise it at the touch of a button. See page 99.

FlatScreen Lift—Conceal a flatscreen television or display when it is not in use, and raise it into view for "showtime." See page 92.

Custom Lifts—You provide the inspiration, and we will custom design a lift system to meet your need. See page 98.

Micro Projector Lift—Designed to fit within a 2' x 2' ceiling grid system. Lowers the projector up to 4' with compact scissor mechanisms. Three sets of scissors. Now offered as UL approved. See page 94.

LCD Lift—Compact projector lift with bomb bay door closure. Available in two sizes. Furnished complete with Environmental Airspace Housing. See page 94.

Scissor Lift—Draper's Scissor Lift SL and SLX are redesigned, offered as UL approved, and better than ever! With travel distances from 4' to 28', there is a Scissor Lift to fit a vast range of needs. See page 95.

Revelation—This unique projector mount permanently conceals the projector above the ceiling—and hides its noise as well. See page 96.

Phantom—Phantom conceals the projector above the ceiling—and quickly dips into position when you are ready for a show. See page 97.

Phantom Table Mount—Install the Phantom inside a table top. See page 97.

Orbiter—Orbiter conceals the projector above the ceiling and smoothly rotates into position when you are ready for a show. See page 97.

Orbiter Wall Mount—Install the Orbiter with a projector or an LCD display in a wall. See page 97.

AeroLift—Projector lift with a simplified design to install in even the tightest spots. Now offered as UL approved! See page 98.

Controls for Projector Lifts—See page 100.



Scissor Lift SLX24

PRO PORTAL

Online Projector Lift Selector

Draper's online Projector Lift Selector allows you to quickly and easily see what projector lift best suits your needs.

register here: www.DraperInc.com/DraperPRO

Draper Projector Lifts

| | Model | Required Height above ceiling (inches) | Overall Size (inches) | Travel Distance | Lifting Capacity (lbs.) | Special Features |
|-------|---------------------|--|-----------------------------|---------------------------------|-------------------------------|--|
| UL US | MPL | varies | 23 1/2" x 23 1/2" | 4' | 35 | fits within a 2' x 2' ceiling grid system |
| | LCD A | 17 3/4" | 24 1/2" x 24 1/2" | Projector right below ceiling | 65 | bomb bay doors; furnished complete with Environmental Airspace Housing and ceiling closure |
| | LCD B | 22 3/4" | 29 1/2" x 29 1/2" | Projector right below ceiling | 65 | bomb bay doors; furnished complete with Environmental Airspace Housing and ceiling closure |
| | Revelation A | 13 5/8" | 38 1/4" x 34" | N/A | 100 | conceals the projector above the ceiling |
| | Revelation B | 13 5/8" | 38 1/4" x 44" | N/A | 100 | conceals the projector above the ceiling |
| UL US | Scissor Lift SL | varies | 24" x 24" | 4'-12' | 100 | fits within a 2' x 2' ceiling grid system; "store", "show" and "service" positions |
| | Scissor Lift SLX | varies | 37 1/16" x 38 5/16" | 10'-28' | 350 | "store", "show" and "service" positions |
| | Phantom A | 14" | 25 9/16" x 17 3/8" | Projector right below ceiling | 26 | ceiling closure pivots down to reveal projector |
| | Phantom B | 17" | 32 3/4" x 21 3/16" | Projector right below ceiling | 26 | ceiling closure pivots down to reveal projector |
| | Phantom Table Mount | — | — | Projector right above table top | 26 | installs in table |
| | Orbiter A | 13 3/4" | 23" x 25 5/16" | Projector right below ceiling | 26 | rotates 180° to reveal projector |
| | Orbiter B | 15 3/4" | 27" x 29 1/2" | Projector right below ceiling | 26 | rotates 180° to reveal projector |
| | Orbiter Wall Mount | — | — | — | 26 | installs projector or small LCD display in wall |
| UL US | AeroLift 35 | varies | 23 1/2" x 14 1/16" | 24 1/2" | 35 | installs in even the tightest spots |
| | AeroLift 100 | varies | 29 1/2" x 29 1/2" | 38 1/2" | 100 | installs in even the tightest spots |
| | AeroLift 150 | varies | 29" x 39 1/2" | 38 1/2" | 150 | installs in even the tightest spots |

Credenza Projector Lift—The Credenza Lift conceals your projector in a credenza, cabinet, or table and raises it quickly and quietly into position when it's time for a conference to begin. When concealed, your projector is protected and out of the way. Features 12" vertical travel and a tiny footprint, making it easy to install in virtually any conference room furnishings. Interior shelf height is adjustable. Required opening in furnishing top is lift shelf size (width and depth) + ½".

Includes single wall switch. Weight limit is 100 lbs.

| Travel Range | Part No. | PRICE | Interior Shelf Dimensions | Shipping Wt. /lbs. | Freight Class |
|--------------|----------|--------|---------------------------|--------------------|---------------|
| 12" | 300450 | \$3016 | 20"W x 10"H x 20"D | 30 | 85 P |

*Custom sizes are also available. Please call Draper for additional information and pricing.

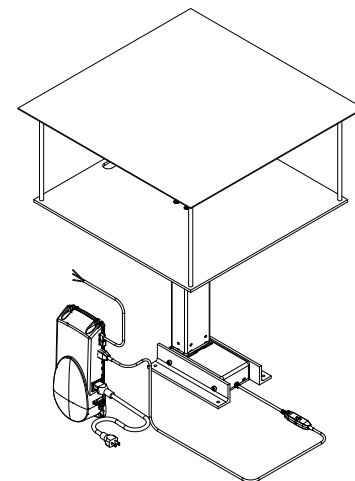

FlatScreen Lift—Draper's FlatScreen Lift is a unique product featuring universal mounting and easy "drop-in" installation into your cabinetry or furniture, allowing you to conceal a flatscreen television or display when it is not in use, and raise it into view for "showtime."

Always aiming high, Draper's FlatScreen Lift far surpasses the competition. Its "stored" dimensions are significantly more compact, and yet the extension (to 2.5 times the stored height of the flatscreen) is greater than competitors' lifts which extend no more than the height of the display. Infinitely adjustable stopping position means you can set our lift to stop at the optimum height. In addition, the interior dimensions of the cabinet only need to exceed the height of the stored lift by two inches! The FlatScreen Lift offers more flexibility for the installer or furniture manufacturer.

Draper's FlatScreen Lift can accommodate virtually any available model of flatscreen display less than 210 lbs, and features a unique secondary shelf beneath the display itself, allowing you to attach a matching trim piece to fill most of the opening left by the open cabinet lid for a clean, finished appearance when raised.

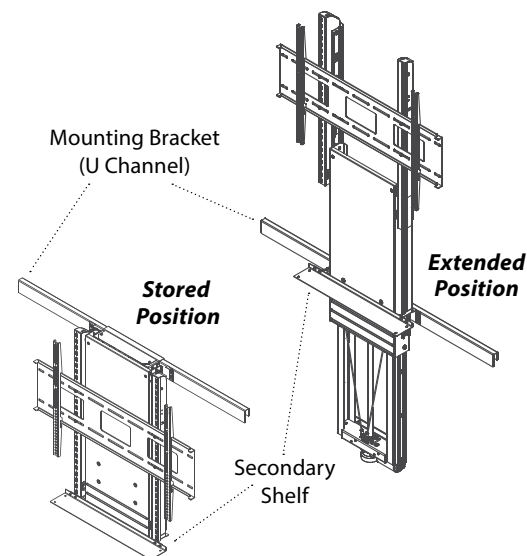

| Model | Part No. | PRICE | Shipping Wt./lbs. | No. of Cartons |
|-------------------------------------|----------|--------|-------------------|----------------|
| FSL-F FlatScreen Lift (Std control) | 300501 | \$2050 | 120 | 2 |

| Accessories | Part No. | PRICE | Shipping Wt./lbs. | No. of Cartons |
|----------------------|----------|-------|-------------------|----------------|
| Cable Management Kit | 300550 | \$172 | 2 | 1 |

| FSL-F | |
|-------------------------------------|----------------|
| Display Size | Up to 210 lbs. |
| Lift Height | 29¾" (756 mm) |
| Lift Width without Mounting Bracket | 17" (430 mm) |
| Overall Lift Depth | 4⅞" (103 mm) |
| Display Bracket Depth | 1" (25 mm) |
| Lift Height at Max Ext. | 73½" (1867 mm) |
| Extension | 43¾" (1111 mm) |
| Extension Time | 33 seconds |
| Max. Weight Capacity | 210 lb. |

*Some larger sizes may require a simple field modification to work properly—contact Draper for details.

Information and prices subject to change without notice.

BOOKMARK OUR MOBILE TOOLKIT

Draper's mobile toolkit includes searchable document libraries for all AV products and the assembly map tools for our popular StageScreen and FocalPoint screens. It also includes our Screen Surface Selector. Scan the code with your smartphone or visit: www.draperinc.com/drapermobile



Freight Class Key
Number LTL freight class
P Parcel service
 + ... \$8.50 surcharge (over 60" long)
Example: a freight code of 125 P+ indicates an item that may ship as freight class 125 or via parcel service with \$8.50 surcharge.

Custom Lifts

— Do your customers ever ask for help concealing their AV equipment? Do they ask for mechanisms you've never seen before? Now Draper can help.

Draper's Custom Lifts are not based on standard lift products, but rather are custom designed to fit any need. Whether you want to conceal a single video conferencing camera or you want 20 flat panel displays to move in concert, Draper's Custom Lifts can help. **You provide the inspiration, and we will design a customized lifting system to fit your need.** The possibilities are endless. If you have a requirement not easily addressed by Draper's or other manufacturers' standard lift products, give us a call. We'll consider anything.

Full details at: www.draperinc.com/go/CustomLifts.htm

What products would you like to conceal?

- Projectors
- Flat panel displays
- Videoconferencing cameras
- Speakers
- Microphones
- Computer monitors and keyboards
- Document cameras
- Controls, touch panels and remotes

How would you like your lift to move your product?

- Lift up
- Drop down
- Pull out
- Swing down
- Swivel
- Pivot
- Turn
- Rotate

Where would you like to conceal them?

- Walls
- Ceilings
- Floors
- Tables
- Credenzas
- Cabinets
- Furniture

How would you like to control your Custom Lifts?

- RF Remote
- IR Remote
- Touch pad
- Wall Switch

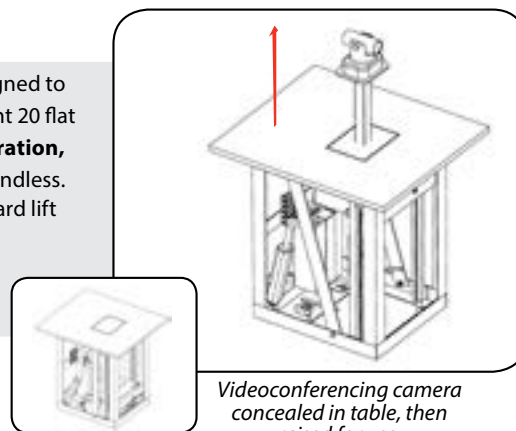

Videoconferencing camera concealed in table, then raised for use.

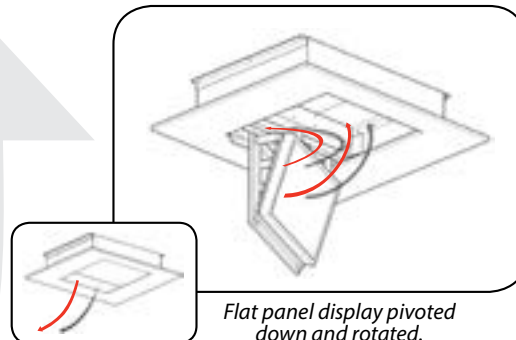

Flat panel display pivoted down and rotated.

Screen Boom

— The new and unique Screen Boom solves an old problem and allows the installation of a motorized projection screen in new settings. The screen is mounted on a motorized operable arm. The whole system can be stored, with the screen retracted, nearly flat against the wall. Operate the Screen Boom first to swing the screen out into the room, any distance up to 90 degrees, then lower the screen for use. Perfect for use under high vaulted ceilings, in gymnasiums, and other settings where typical ceiling or wall installation is impractical or won't meet the viewers' needs.

Screen Boom accommodates Targa and Premier in sizes through 12' wide (image area). It includes all hardware for mounting the screen to the operable arm. Includes one SS-1R operating switch; optional controls are available. The stored position may be either in front or behind the viewing position.

The operable arm is 198 1/8" long and 2 1/2" O.D. It may be cut in the field to a shorter length if needed. A plastic cap finishes the cut end of the arm. Available with black or white finish.

| Description | Part. No. | PRICE |
|---------------------|-----------|--------|
| Screen Boom (White) | 503290 | \$2384 |
| Screen Boom (Black) | 503291 | 2384 |

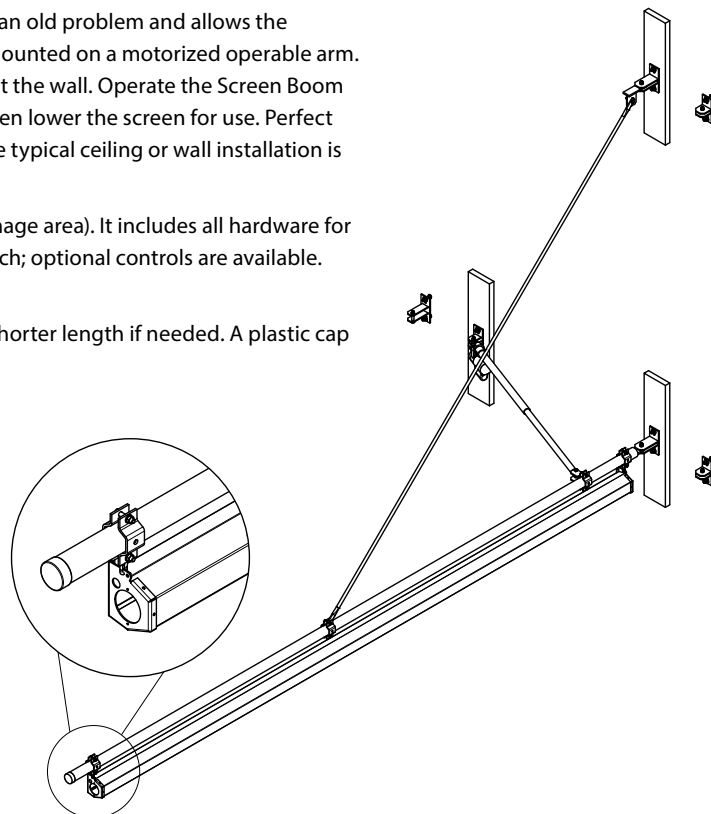

Projector &
FlatScreen Lifts

Micro Projector Lift—Designed specifically with today's smaller, lighter projectors in mind, Draper's MPL fits within an existing 2' x 2' ceiling grid. Three sets of scissors—left, right, and rear—stabilize projector laterally and front-to-back, while a tubular motor lowers the unit up to 48". Lifting capacity is 35 lbs. The MPL has a retracted height of only 5" (without projector, Environmental Airspace Housing, or closure).

Note: MPL orders require a completed planning sheet. See <http://www.draperinc.com/go/MPL.htm> for downloadable copies.

Options: See page 100 for control options.

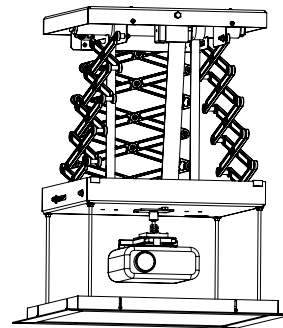

Shown with optional ceiling closure panel.



| Model | Part No. | PRICE | Shipping Wt./lbs. | Freight Class |
|-------|----------|--------|-------------------|---------------|
| MPL | 300198 | \$3399 | 39 | 77.5 P |

Micro Projector Lift Optional Accessories

| Description | White Part No. | Black Part No. | PRICE |
|---|----------------|----------------|--------|
| Factory installed cables for HDMI, RGBHV, Video and Control* | — | — | \$1090 |
| Environmental Airspace Housing | 300200 | 300573 | 872 |
| Ceiling Closure Panel | 300201 | 300574 | 567 |
| Ceiling Finish Kit (Consists of ceiling closure panel and mating trim ring) | 300202 | 300575 | 950 |
| Universal Projector Mount (maximum load of 26 lbs) | 300212 | — | 305 |

***Factory-Installed Cables for HDMI, RGBHV, Video and Control**—Draper will furnish and factory install cables for your projector's HDMI, RGBHV, Video, and control. Please see the Micro Projector Lift Planning sheet mentioned above.

LCD Lift—Draper's LCD Lift is compact, lightweight and accommodates most LCD/DLP projectors. Bomb bay doors open into the room, and the projector descends with the lift's traveling pan. Or choose the LCD Lift with flat closure. Closure can accept ceiling tile to match surrounding ceiling. LCD Lift comes with Environmental Airspace Housing and Bomb Bay or Flat Ceiling Closure.

Options: See page 100 for control options.

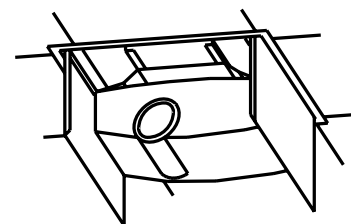

| Model | Bomb Bay Doors Part No. | PRICE | Flat Closure Part No. | PRICE | Shipping Wt./lbs. | Freight Class |
|------------|-------------------------|--------|-----------------------|--------|-------------------|---------------|
| LCD Lift A | 300031 | \$3269 | 300037 | \$3442 | 95 | 150 P |
| LCD Lift B | 300051 | 3521 | 300058 | 3694 | 130 | 150 P |

LCD Lift Optional Accessories

| Description | Part No. | PRICE |
|---|----------|-------|
| Factory Installed Cables (HDMI, RGBHV, Video, RS232) | — | \$871 |
| Universal Projector Mount (maximum load of 26 lbs) | 300212 | 305 |
| Replacement single station wall switch (Black/Silver) | 121001 | 60 |

Ceiling Access Doors—If you plan to install your Draper Projector Lift above a finished ceiling, these access doors provide above-the-ceiling access for cleaning, maintenance or repairs without damage to the ceiling. Available with a white painted finish, or recessed to accept ceiling tile.

| Description | Part No. | PRICE | Shipping Wt./lbs. |
|----------------------|----------|-------|-------------------|
| White Finish | 300007 | \$373 | 35 |
| Accepts Ceiling Tile | 300008 | 680 | 25 |

Freight Class Key

Number LTL freight class
P Parcel service
 + ... \$8.50 surcharge (over 60" long)
Example: a freight code of 125 P+ indicates an item that may ship as freight class 125 or via parcel service with \$8.50 surcharge.

Scissor Lifts—Draper's redesigned SL & SLX Series Scissor Lifts (11 distinct models) are better than ever—offering UL approval, easier installation, adjustment, and maximum travel ranges from 4' to 28'. SL Series Scissor Lifts fit perfectly in 24" x 24" (60 cm x 60 cm) grid ceiling while the slightly larger 37 1/16" x 38 5/16" (96 cm x 97 cm) footprint of SLX Series allows for extended travel. Three position settings for "store", "show" and "service" are easy to adjust during installation.

Three sets of scissors—an exclusive Draper feature—assure both lateral and front-to-back stability.

The lifting capacity of the SLX Series is 350 lbs. (159 kg); the SL Series comfortably lifts 100 lbs. (45 kg). The movement of Scissor Lifts is driven by a gearmotor with a powerful, reliable metal chain drive system. Each lift is equipped with a fail-safe inertial safety belt system, and a cable management system that includes a pre-wired power cable on the back scissor, bringing 110V or 220V current right to your projector. Projector can be mounted using optional compact universal-style mount (maximum load of 26 lbs), or bolted directly to the lift's bottom plate.

| Scissor Lift SL Series Models | Height of lift in closed position ¹ | Max. down travel (service position) | Part No. | PRICE | Shipping Wt./lbs. | Freight Class |
|-------------------------------|--|-------------------------------------|----------|--------|-------------------|---------------|
| SL4 | 8" (20 cm) | 4' (1.2 m) | 300270 | \$5054 | 113 | 77.5 P |
| SL6 | 10" (25 cm) | 6' (1.8m) | 300271 | 5403 | 123 | 77.5 P |
| SL8 | 12" (30 cm) | 8' (2.4 m) | 300272 | 5926 | 131 | 77.5 P |
| SL10 | 14" (36 cm) | 10' (3 m) | 300273 | 6275 | 141 | 77.5 P |
| SL12 | 16" (41 cm) | 12' (3.6 m) | 300278 | 6623 | 146 | 77.5 P |

| Scissor Lift SLX Series Models | Height of lift in closed position ¹ | Max. down travel (service position) | Part No. | PRICE | Shipping Wt./lbs. | Freight Class |
|--------------------------------|--|-------------------------------------|----------|--------|-------------------|---------------|
| SLX10 | 14 1/16" (36 cm) | 10'7" (3.2 m) | 300250 | \$6971 | 343 | 77.5 P |
| SLX14 | 16 5/16" (41 cm) | 14'2" (4.3 m) | 300251 | 7755 | 301 | 150 P |
| SLX17 | 18 3/16" (47 cm) | 17'8" (5.4 m) | 300252 | 9245 | 335 | 150 P |
| SLX21 | 20 13/16" (53 cm) | 21'3" (6.5 m) | 300253 | 9987 | 364 | 150 P |
| SLX24 | 23 1/16" (59 cm) | 24'9" (7.5 m) | 300254 | 11851 | 395 | 150 P |
| SLX28 | 25 5/16" (64 cm) | 28'5" (8.7 m) | 300255 | 13246 | 425 | 150 P |

¹ Overall height of projector, optional mount, optional ceiling closure, and optional Environmental Air Space Housing all add to the overall height of equipment installed above ceiling.

Scissor Lift SL Series Accessories

| | White Part No. | Black Part no. | PRICE |
|---|----------------|----------------|--------|
| (SL) Ceiling Finish Kit (18 1/4"W x 21 13/16"L projector space) | 300286 | 300579 | \$1004 |
| (SL) Ceiling Closure Panel (18 1/4"W x 21 13/16"L projector space) | 300291 | 300580 | 783 |
| (SL) Environmental Airspace Housing (18 1/4"W x 21 13/16"L projector space) | 300282 | 300581 | 1115 |
| (B) Ceiling Finish Kit (28 1/8"W x 25 3/8"L projector space) | 300284 | 300582 | 1004 |
| (B) Ceiling Closure Panel (28 1/8"W x 25 3/8"L projector space) | 300289 | 300583 | 783 |
| (B) Environmental Airspace Housing (28 1/8"W x 25 3/8"L projector space) | 300280 | 300584 | 1115 |
| (E) Ceiling Finish Kit (25 1/8"W x 38 3/16"L projector space) | 300285 | 300585 | 1004 |
| (E) Ceiling Closure Panel (25 1/8"W x 38 3/16"L projector space) | 300290 | 300586 | 783 |
| (E) Environmental Airspace Housing (25 1/8"W x 38 3/16"L projector space) | 300281 | 300587 | 1115 |
| (U) Ceiling Finish Kit (34 7/8"W x 26 1/8"L projector space) | 300287 | 300588 | 1004 |
| (U) Ceiling Closure Panel (34 7/8"W x 26 1/8"L projector space) | 300292 | 300589 | 783 |
| (U) Environmental Airspace Housing (34 7/8"W x 26 1/8"L projector space) | 300283 | 300590 | 1115 |
| Optional Current Sensor | 300382 | 300384 | 262 |

Scissor Lift SLX Series Accessories

| | White Part No. | Black Part no. | PRICE |
|---|----------------|----------------|--------|
| SLX Ceiling Finish Kit (35"W x 39"L projector space) | 300264 | 300591 | \$1004 |
| SLX Ceiling Closure Panel (35"W x 39"L projector space) | 300265 | 300592 | 783 |
| SLX Environmental Airspace Housing (35"W x 39"L projector space) | 300266 | 300593 | 1115 |
| SLXR Ceiling Finish Kit (35"W x 45"L projector space) | 300293 | 300594 | 1004 |
| SLXR Ceiling Closure Panel (35"W x 45"L projector space) | 300294 | 300595 | 783 |
| SLXR Environmental Airspace Housing (35"W x 45"L projector space) | 300295 | 300596 | 1115 |
| Optional Current Sensor | 300382 | 300384 | 262 |

Factory Installed Cables for Scissor Lift

| | Part No. | PRICE |
|---|----------|--------|
| Factory installed cables (HDMI, RGBHV, Video & RS232) for SL | — | \$1090 |
| Factory installed cables (HDMI, RGBHV, Video & RS232) for SLX10-SL17 | — | 1307 |
| Factory installed cables (HDMI, RGBHV, Video & RS232) for SLX21-SLX28 | — | 1569 |

Standard Controls



Show Position Switch 121059



Key Operated Switch for Service Position 121022

Additional Controls Available—
See page 100

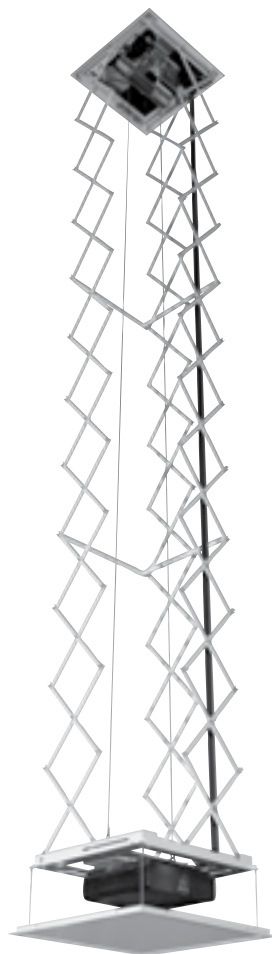

Universal Projector Mounts—

Maximum load of 26 lbs.

| Description | Part No. | PRICE |
|----------------------------|----------|-------|
| Mount for SLX-white | 300213 | \$305 |
| Mount for AeroLift-black | 300215 | 305 |
| Mount for MPL,LCD,SL-white | 300212 | 305 |

Projector & FlatScreen Lifts

Max Projector Sizes

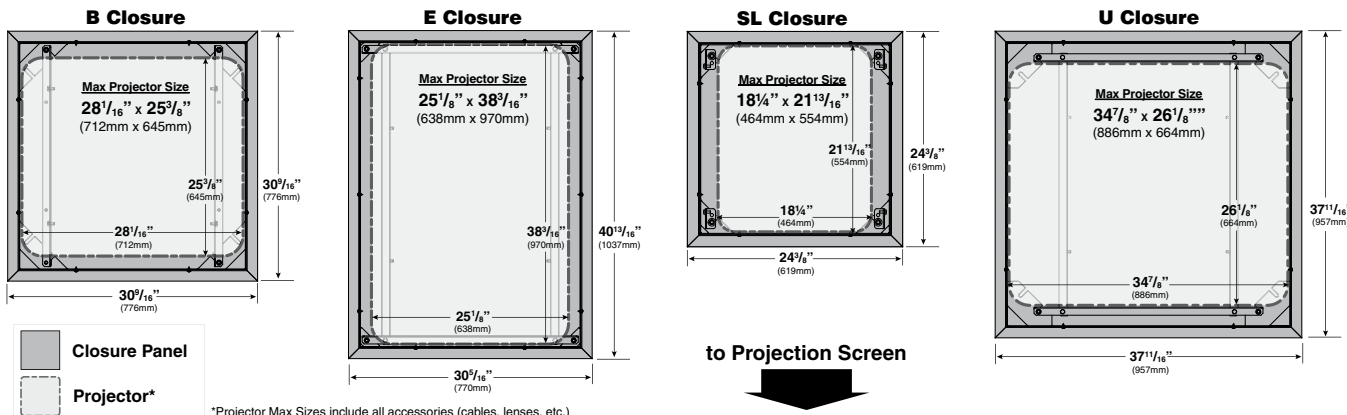

Revelation—Motorized Ceiling-Recessed Projector Mount. With a Revelation, the projector is permanently concealed above the ceiling. You won't see or hear the projector—not before, during or after the show. Revelation fits into a 2' x 2' grid style ceiling. Mirrors are optical grade glass—94% reflective. The Revelation's highly reflective dual first surface mirror system delivers a perfect picture to your screen at the touch of a switch or wireless controller. 220v transformer available.

Visit <http://www.draperinc.com/go/RevelationPlanSheet.htm> for a planning sheet.

Options: See page 100 for control options.



| Revelation | Part No. | PRICE | Shipping Wt./lbs. | Freight Class |
|---|----------|--------|-------------------|---------------|
| With Environmental Airspace Housing | | | | |
| Model A | 300027 | \$4968 | 189 | 150 P |
| Model B | 300023 | 5054 | 209 | 150 P |
| Without Environmental Airspace Housing | | | | |
| Model A | 300025 | \$3617 | 186 | 150 P |
| Model B | 300019 | 3747 | 170 | 300 P |
| Environmental Airspace Housing Only | | | | |
| Model A | 300014 | \$1482 | 184 | 300 P |
| Model B | 300021 | 1482 | 89 | 300 P |

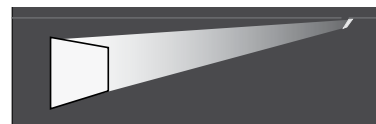

Revelation Optional Accessories

| Revelation Accessory | Part No. | PRICE | Shipping Wt./lbs. |
|-----------------------------|----------|-------|-------------------|
| Revelation Shield | 300030 | \$793 | 13 |
| MiroClear | 254020 | 40 | 2 |
| Ceiling Access Doors | | | |
| White Finish | 300007 | \$373 | 35 |
| Accepts Ceiling Tile | 300008 | 680 | 25 |

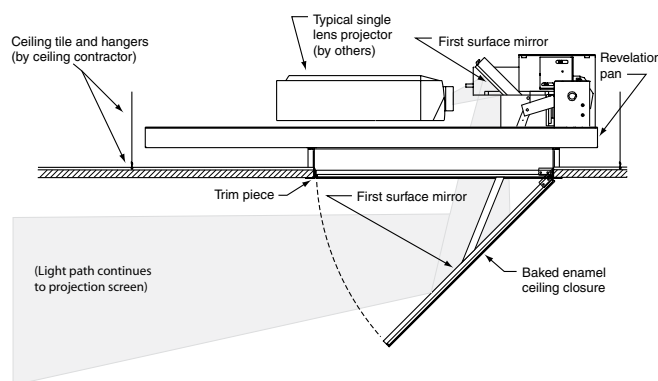

Revelation Shield—Made of anti-reflective glass and installed in the main pan of the Revelation and between the first and second mirror/ceiling closure. The Shield serves two valuable purposes: It reduces projector noise in the audience area by more than 80%, and it prevents cigarette smoke, grease or other harmful substances from reaching the projector. Virtually none of the projected light is lost as it passes through the Shield.

MiroClear—A superior quality cleaning and restoration kit designed specifically for all first surface glass mirrors. Improves image quality, maintains new mirrors to the highest standards, brings new life to older mirrors and restores reflectivity loss caused by dust, dirt, fingerprints and grimy build-up that accumulates and robs mirror of critical reflectivity.

Ceiling Access Door—If you plan to install your Draper Projector Lift above a finished ceiling, these access doors provide above-the-ceiling access for cleaning, maintenance or repairs without damage to the ceiling. Available with a white painted finish, or recessed to accept ceiling tile.

Projector & FlatScreen Lifts

BOOKMARK OUR MOBILE TOOLKIT

Draper's mobile toolkit includes searchable document libraries for all AV products and the assembly map tools for our popular StageScreen and FocalPoint screens. It also includes our Screen Surface Selector. Scan the code with your smartphone or visit: www.draperinc.com/drapermobile



Freight Class Key
Number LTL freight class
P Parcel service
 + . . . \$8.50 surcharge (over 60" long)
Example: a freight code of 125 P+ indicates an item that may ship as freight class 125 or via parcel service with \$8.50 surcharge.

Phantom—The totally unique Phantom is a clever alternative to other projector lifts. It quickly and quietly dips the projector out of the ceiling and into the “show” position at the touch of a switch or wireless transmitter. The projector is mounted into a framework above the ceiling. When activated, a trapdoor lowers the projector into your room using a precision actuator with pre-set limits. The projector is easily aligned during installation to provide a direct light path onto your Draper projection screen.

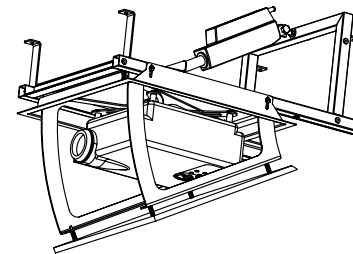

The Phantom is supplied with a universal-style bracket that allows for easy attachment of a variety of projector models. Two models to choose from as determined by size of projector. The Phantom motor is a DC–Low Voltage Motor, 24v, which allows for easier control and wiring of the lift. The Phantom can also be used for video conferencing cameras, speakers, etc. See page 100 for control options

| <i>Phantom Model</i> | Part No. | PRICE | Shipping Wt./lbs. | Freight Class |
|---|----------|--------|-------------------|---------------|
| Model A Lift | 300370 | \$2702 | 45 | 300 P |
| Model B Lift | 300371 | 2702 | 48 | 300 P |
| Phantom Environmental Airspace Housing | | | | |
| Environmental Airspace Housing for Model A | 300375 | \$445 | 17 | 300 P |
| Environmental Airspace Housing for Model B | 300374 | 480 | 24 | 150 P |



Table-Mounted Installation—The Phantom can also be installed in the table top or other piece of furniture in your conference room, boardroom or home theatre, to be raised up at the appropriate moment. Perfect for rooms where the ceiling is inaccessible or inconvenient for installation of a projector lift.

| <i>Table Mounted Phantom Model</i> | Part No. | PRICE | Shipping Wt./lbs. | Freight Class |
|------------------------------------|----------|--------|-------------------|---------------|
| Model A Lift | 300378 | \$2702 | 38 | 300 P |
| Model B Lift | 300379 | 2702 | 48 | 300 P |



Phantom mounted in a table top with custom closure lid (provided by others)

Orbiter—The Orbiter is an exciting projector mounting solution. This totally unique lift conceals your projector above the ceiling and rotates it into the “show” position at the touch of a switch or wireless transmitter.

Ingenious design allows the Orbiter to fit in small ceiling cavities. The Orbiter is supplied with a universal-style bracket that allows for easy attachment of a variety of projector models. The Orbiter can be used for video conferencing cameras, speakers, etc. Angled ceiling adapter allows Orbiter to be installed on angled ceilings.

Operated by optional IR or RF remote control, standard wall switch, or integrated into your control system, Orbiter will add a touch of class and sophistication to any room. The Orbiter motor is a DC–Low Voltage Motor, 12v, which allows for easier control and wiring of the lift. See page 100 for control options.

| <i>Orbiter Lift</i> | Part No. | PRICE | Shipping Wt./lbs. | Freight Class |
|---|----------|--------|-------------------|---------------|
| Model A Lift | 300350 | \$3051 | 33 | 150 P |
| Model B Lift | 300351 | 3051 | 41 | 150 P |
| Orbiter Environmental Airspace Housing | | | | |
| Environmental Airspace Housing for Model A | 300357 | \$523 | 27 | 300 P |
| Environmental Airspace Housing for Model B | 300356 | 523 | 22 | 300 P |
| Orbiter Angled Ceiling Adapter | | | | |
| Adapter for Model A | 300354 | \$95 | 2 | 200 P |
| Adapter for Model B | 300355 | 95 | 2 | 200 P |

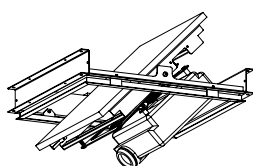
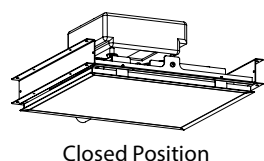
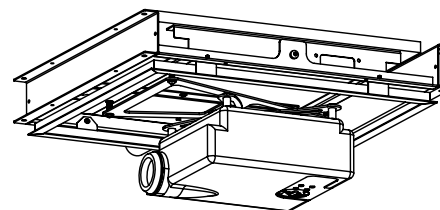

Wall-Mounted Installation—For ultimate convenience, the Orbiter can be mounted vertically in walls, allowing it to accommodate small LCD displays as well as projectors and other equipment.

| <i>Wall-Mounted Orbiter Lift</i> | Part No. | PRICE | Shipping Wt./lbs. | Freight Class |
|----------------------------------|----------|--------|-------------------|---------------|
| Model A Lift | 300360 | \$3137 | 57 | 85 P |
| Model B Lift | 300361 | 3137 | 77 | 85 P |



Orbiter mounted in a wall with an LCD screen attached

Projector & FlatScreen Lifts

AeroLift—The cleverly designed AeroLift keeps overall footprint and height to a minimum. All models are now UL listed! In order to allow for installation in extra tight spots, the AeroLift 35 is also available in a Non-UL version. Lifting capacity has also increased to handle a larger variety of projectors. The smallest model, AeroLift 35, actually installs easily between standard 2" thick ceiling joists on 16" centers! Choose your model based on desired weight capacity: 35, 100 or 150 pounds. The AeroLift is powered by a motor-in-roller design, and features a stabilizing arm which can also be used for cable management.

Built-in adjustability allows you to deal with job site conditions quickly and easily. Projector may be mounted flush to bottom pan.

Note: The AeroLift may also be used to recess speakers, security cameras, video conferencing cameras or document cameras.

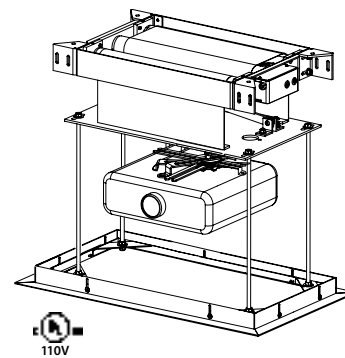

AeroLift 35 shown with optional small closure panel

| Model | Lifting Capacity (lbs.) | Travel Distance |  Part No. | PRICE | Shipping Wt./lbs. | Freight Class |
|--------------|-------------------------|-----------------|--|--------|-------------------|---------------|
| AeroLift 35 | 35 | 24 1/2" | 300319 | \$2613 | 28 | 77.5 P |
| AeroLift 100 | 100 | 38 1/2" | 300321 | 3661 | 50 | 150 P |
| AeroLift 150 | 150 | 38 1/2" | 300323 | 4619 | 57 | 150 P |

| Model | Lifting Capacity (lbs.) | Travel Distance | Non-UL Part No. | PRICE | MAP | NET | Shipping Wt./lbs. | Freight Class |
|-------------|-------------------------|-----------------|-----------------|--------|--------|--------|-------------------|---------------|
| AeroLift 35 | 35 | 24 1/2" | 300317 | \$2613 | \$2091 | \$1568 | 28 | 77.5 P |

AeroLift Optional Accessories

| Accessory Description | White Part No. | Black Part No. | PRICE | Shipping Wt./lbs. |
|---|----------------|----------------|--------|-------------------|
| For AeroLift 35 | | | | |
| Large Environmental Airspace Housing—23 1/2" x 23 1/2"—For 2' x 2' grid ceiling (same as Micro Projector Lift option) | 300200 | 300573 | 872 | 50 |
| Ceiling Closure Panel—For 2' x 2' grid ceiling (same as Micro Projector Lift option) | 300201 | 300574 | 567 | 18 |
| Ceiling Finish Kit (Closure and trim ring)—For 2' x 2' grid ceiling (same as Micro Projector Lift option) | 300202 | 300575 | 950 | 45 |
| Small Environmental Airspace Housing (14 9/16" x 23 7/8") | 300222 | 300576 | \$523 | 42 |
| Small Ceiling Closure Panel (15 5/8" x 25") | 300223 | 300577 | 567 | 10 |
| Small Ceiling Finish Kit | 300224 | 300578 | 697 | 15 |
| For AeroLift 100 | | | | |
| Environmental Airspace Housing | 300280 | 300584 | \$1115 | 141 |
| Ceiling Closure Panel | 300332 | 300583 | 697 | 26 |
| Ceiling Finish Kit (Closure and trim ring) | 300333 | 300582 | 950 | 40 |
| For AeroLift 150 | | | | |
| Environmental Airspace Housing | 300281 | 300587 | \$1115 | 190 |
| Ceiling Closure Panel | 300331 | 300586 | 783 | 37 |
| Ceiling Finish Kit (Closure and trim ring) | 300334 | 300585 | 1004 | 50 |
| For All AeroLifts | | | | |
| Ceiling Access Door for above-ceiling access. White Finish. (Description on page 96) | 300007 | | \$373 | 35 |
| Ceiling Access Door to accept ceiling tile for above-ceiling access. (Description on page 96) | 300008 | | 680 | 25 |
| Universal Projector Mount (maximum load of 26 lbs) | 300212 | | 305 | 6 |

AeroLift Video Conferencing Camera Shelf and Closure—The Video Conferencing

Camera Shelf and Closure enables the installation of the video conferencing camera of your choice on the AeroLift 35. This shelf ensures that the structure to mount the ceiling closure is out of the camera's field of view. The footprint is smaller to better match the dimensions of a camera. It is a clean, simple way to mount your camera and then conceal in the ceiling.

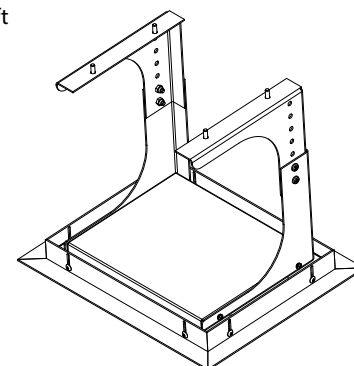

| Accessory Description | White Part No. | Black Part No. | PRICE | Shipping Wt./lbs. |
|--|----------------|----------------|-------|-------------------|
| Video Conferencing Closure /Shelf and Plenum for AeroLift 35 only | | | | |
| Plenum | 300216 | 300217 | \$523 | 10 |
| Closure/Shelf | 300218 | 300219 | 697 | 42 |

BOOKMARK OUR MOBILE TOOLKIT

Draper's mobile toolkit includes searchable document libraries for all AV products and the assembly map tools for our popular StageScreen and FocalPoint screens. It also includes our Screen Surface Selector. Scan the code with your smartphone or visit: www.draperinc.com/drapermobile



Freight Class Key
Number LTL freight class
P Parcel service
 + ... \$8.50 surcharge (over 60" long)
Example: a freight code of 125 P+ indicates an item that may ship as freight class 125 or via parcel service with \$8.50 surcharge.

Video Conferencing Solutions

Video Conferencing Camera Lift – CEILING

Draper's ceiling Video Conferencing Camera Lift (VCCL/Ceiling) is a unique product designed expressly for video conferencing cameras. It conceals the camera just above the ceiling when not in use, lowering it into position immediately below the bottom edge of a ceiling mounted projection screen in "down" position. Ceiling-recessed case features motorized door closures and installs directly behind screen case.

The VCCL/Ceiling can be used with any ceiling recessed projection screen and has a vertical travel range of 72" to 103" with +/- 2" of adjustability. If you are using a Draper screen give us the model and size and we will tell you the exact distance from the ceiling line to the bottom of the dowel, hence which size of VCCL/Ceiling you need to order. If you are using another brand of screen it is your responsibility to tell us the total distance from the ceiling line to the bottom of the dowel. Contact Draper for special quotation if you need

| | Travel Range | Part No. | PRICE | Case Dimensions (excluding tile lip) | Shipping Wt./lbs. | Freight Class |
|---|--------------|----------|---------|--------------------------------------|-------------------|---------------|
| Add \$150 if you want VCCL/Ceiling case and screen case to be exactly the same width. | 72" | VCCL72 | \$12286 | 10 1/2" H x 102" W x 9 1/2" D | 244 | 125 |
| Includes single wall switch (SS-1R), see page 105 for other control options. | 78" | VCCL78 | 12474 | 10 1/2" H x 109" W x 9 1/2" D | 261 | 125 |
| | 84" | VCCL84 | 12669 | 10 1/2" H x 116" W x 9 1/2" D | 277 | 125 |
| | 90" | VCCL90 | 12874 | 10 1/2" H x 123" W x 9 1/2" D | 294 | 125 |
| | 94" | VCCL94 | 13303 | 10 1/2" H x 127 1/2" W x 9 1/2" D | 305 | 125 |
| | 103" | VCCL103 | 13754 | 10 1/2" H x 140" W x 9 1/2" D | 336 | 125 |



Video Conferencing Camera Lift – CREDENZA

The Video Conferencing Camera Lift - Credenza conceals your camera in a credenza, cabinet, or table and raises it quickly and quietly into position when it's time for a conference to begin. When concealed your video conferencing camera is protected and out of the way.

Draper's Video Conferencing Camera Lift - Credenza features 12" vertical travel and a tiny footprint, making it easy to install in virtually any conference room furnishings. Two interior shelf sizes available to accommodate almost any video conferencing camera. Interior shelf height is adjustable.

Required opening in furnishing top is lift shelf size (width and depth) + 1/2". Includes single wall switch (MS-3R), see page 105 for other control options.

| | Travel Range | Part No. | PRICE | Interior Camera Shelf Dimensions | Shipping Wt./lbs. | Freight Class |
|--------------------------|--------------|----------|--------|----------------------------------|-------------------|---------------|
| Weight limit is 150 lbs. | 12" | 300400 | \$3016 | 10" H x 9" W x 7 1/2" D | 30 | 85 |
| | 12" | 300402 | 3016 | 10" H x 12" W x 9" D | 42 | 150 |

*Custom sizes are also available. Please call Draper for additional information and pricing.



Video Conferencing Camera Adapter Bracket—

The Video Conferencing Camera Adapter Bracket enables the installation of the video conferencing camera of your choice into three of Draper's most popular video projector lifts (AeroLift 35, AeroLift 100, or Micro Projector Lift). All are designed to safely conceal your camera above the ceiling line when not in use and lower it into position for video conferencing. Available in two sizes. Special brackets available for oversize or dual camera installation.. Contact Draper for quotation.

| Dimensions (H x W x D) | Part No. | PRICE |
|------------------------|----------|-------|
| 7 1/2" x 9" x 7 1/2" | 125205 | \$342 |
| 9" x 12" x 9" | 125206 | 342 |



*Due to the smaller footprint of most video conferencing cameras, a smaller ceiling closure panel may be required. Custom ceiling closures are available. Please call Draper for additional information and pricing.

Video Conferencing Camera Box—

Draper's Video Conferencing Camera Box recesses a camera in the wall, behind a hinged tempered glass door. Makes installing a video conferencing camera quick and easy. No additional hardware or brackets are required. The built-in bezel trims the wall opening. All visible surfaces are finished with black powder coat. Five convenient cable exits make wire management simple. Suitable for use with thin panels or gypsum board wall openings. Includes lock to protect sensitive equipment. Two keys provided.

| Model | Enclosure Size (H x W x D) | Part Number | PRICE | Shipping Wt./lbs. | Freight Class |
|--------------------|----------------------------|-------------|-------|-------------------|---------------|
| Locking Camera Box | 10 1/16" x 14 3/16" x 11" | 125204 | \$460 | 22 | 150 P |



Projector & FlatScreen Lifts

Lift Control Options

| | Model Number | Part Number | PRICE |
|--|------------------|-------------|-------|
| 110-120V Controls | | | |
| Replacement single station wall switch (Black/Silver) | SS-1R (Standard) | 121001 | \$60 |
| Replacement single station wall switch (White decorator style) | SS-1R (White) | 121102 | 60 |
| 2-Station Control | MS-3R & MS-4R | 121002 | 120 |
| Additional control stations | MS-4R | 121005 | 60 |



SS-1R, MS-3R,
MS-4R

| Low Voltage Control (24v) | | | |
|---------------------------------------|---------------------------|--------|-------|
| Lift L.V. control, no switch | Lift L.V. Control | 121244 | \$213 |
| Additional Lift L.V. control stations | Lift L.V. Control Station | 121246 | 60 |
| *Lift RF Kit (Transmitter/Receiver) | Lift WRT/R | 121249 | 240 |
| Extra wireless transmitter (RF type) | Lift WRT | 121248 | 68 |
| *Lift IR Kit (Transmitter/Receiver) | Lift IRT/R | 121251 | 85 |
| Extra IR remote transmitter | Lift IRT | 121250 | 68 |



Lift L.V.
Control
Station

***Note—You must have Lift L.V. Control to use either RF or IR wireless control. Wireless receiver plugs into the control. You must also have the control if you are using an these in conjunction with a Crestron/AMX/Extron master control system. Revelation does not require a Lift L.V. Control to interface with a Crestron/AMX/Extron master control system.**

| Key Operated Switches | | | |
|--|----------|--------|------|
| Power supply switch (on-off) | KS-1 | 121017 | \$85 |
| 3-position (up-off-down) key control switch (maintained) | KS-3 | 121018 | 95 |
| 3-position (up-off-down) key control switch (momentary) | SP-KSM | 121022 | 95 |
| Switch with locking cover plate | SP-KPS-I | 121019 | 113 |



Lift WRT

| Video Interface Control | | | |
|--|------------|--------|-------|
| For LCD Lift only | VIC-115 | 121026 | \$137 |
| For Revelation, Aerolift, and Miicro Projector Lift only | VIC-12 Kit | 121033 | 137 |



Lift IRT

Scissor Lift (SL and SLX)

| | Model Number | Part Number | PRICE |
|---|---------------------------|-------------|-------|
| Single Station Controls | | | |
| Standard: 12V toggle switch to lower projector from "stored" to "show" positions, and 1 momentary key switch which allows you to easily place the lift in the service position. | | | |
| Additional Lift L.V. control stations | Lift L.V. Control Station | 121246 | \$60 |
| Replacement Key Switch for Service Position | SP-KSM | 121022 | 95 |

| Wireless Control (24v) | | | |
|--------------------------------------|------------|--------|-------|
| Lift RF Kit (Transmitter/Receiver) | Lift WRT/R | 121249 | \$240 |
| Extra wireless transmitter (RF type) | Lift WRT | 121248 | 68 |
| Lift IR Kit (Transmitter/Receiver) | Lift IRT/R | 121251 | 85 |
| Extra IR remote transmitter | Lift IRT | 121250 | 68 |

Orbiter/Phantom

| | Model Number | Part Number | PRICE |
|--------------------------------------|---------------------------|-------------|-------|
| DC Motor Control | | 121161 | \$257 |
| *Lift RF Kit (Transmitter/Receiver) | Lift WRT/R | 121249 | 240 |
| Extra wireless transmitter (RF type) | Lift WRT | 121248 | 68 |
| *Lift IR Kit (Transmitter/Receiver) | Lift IRT/R | 121251 | 85 |
| Extra IR remote transmitter | Lift IRT | 121250 | 68 |
| Low voltage wall switch | Lift L.V. Control Station | 121246 | 60 |
| Obstruction Shut-Off Control Kit | | 300214 | 305 |



KS-1

***Note—You must have DC Motor Control to use either RF or IR wireless control or if using control systems like AMX, Crestron, or Extron. The DC Motor Control replaces the Lift L.V. Control commonly used with other lift products.**

For All Lifts

| | Part Number | PRICE |
|---|-------------|-------|
| Serial Controls | | |
| R2D7-RS232 Translator (converts ASCII commands into Draper controller commands) | C156.066 | \$187 |
| Serial Port Adapter (converts 9 pin serial port to an RJ11 modular phone cable) | C103.042 | 17 |



KS-3



SP-KPS-I

Information and prices subject to change without notice.

Freight Class Key
Number LTL freight class
P Parcel service
 + ... \$8.50 surcharge (over 60" long)
Example: a freight code of 125 P+ indicates an item that may ship as freight class 125 or via parcel service with \$8.50 surcharge.

TorkStar Utility Line Set

TorkStar is designed to raise and lower a wide range of products commonly used on stages, in gymnasiums and churches and other public venues. It consists of a motor winch and one or more PosiSpools™, connected by a drive shaft and mounted to the ceiling structure. TorkStar utilizes aircraft cable lift lines with a lifting capacity of 500 lbs. each.

A TorkStar Utility Line Set System consists of:

- One TS1000/TS1000 VFD Motor Winch.
- One or more PS500 PosiSpools.
- Drive Shaft

| Name | Part No. | Description. | PRICE | Shipping Wt./ Lbs. |
|---|----------|---|--------|--------------------|
| TS1000 Motor Winch | 503106 | 800 lb lifting capacity. Includes 50 ft. of cable and one Key Operating Switch. | \$3272 | 85 |
| TS1000 VFD Motor Winch with Low Voltage Control | 503201 | 1000 lb lifting capacity. Includes 50 ft. of cable and one Low Voltage Key Operating Switch | 8203 | 86 |
| PS500 PosiSpool | 503108 | Up to 500 lb capacity. Includes 50 ft. of cable and two PS500SC Drive Shaft Couplings. | 2439 | 54 |
| Drive Shaft | 503132 | 2 3/8" O.D. / 2" I.D. Schedule 40 pipe. Available from Draper in 21' lengths, or you can source locally. Purchase longer lengths than required and cut to exact size on job site. | 283 | 77 |

TS1000/TS1000 VFD Motor Winches and PosiSpools are shipped with 50 ft. of 3/16" 7x19 stainless aircraft cable with an S-409 swaged button on one end. Includes 3/16" thimble and two G-249 3/16" Fist Grip Clips.

Note: You can use up to 5 PosiSpools, spaced on 10-15 ft. centers, so total width of system can be up to 50-75 ft.

Restrictions:

1. Total lift weight must not exceed lifting capacity of motor.
2. Maximum weight per lift line must not exceed 500 lbs.
3. Maximum vertical travel is 34'.

Use TorkStar to raise and lower:

- Projection Screens
- Lighting (House Lights, Front of House Lighting, Stage Lighting)
- Speakers
- Backdrops
- Background Sets
- Scenery
- Draperies
- Curtains
- Scrim
- Signs
- Banners
- Flags
- Chandeliers

TorkStar Utility Line Set with Accessories:

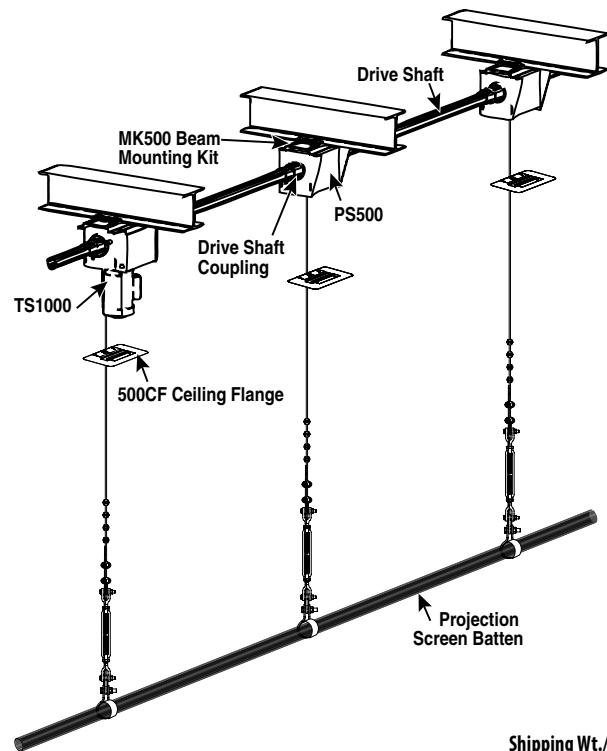

TorkStar Accessories

| Name | Part No. | Description | PRICE | Shipping Wt./ Lbs. |
|--|---------------|--|-------|--------------------|
| MK500 Beam Mounting Kit | C504.063 | OPTIONAL—One per Motor or PosiSpool. For attaching to steel beam that is perpendicular to the Line Set. | \$312 | 12 |
| TS90 Parallel Beam Adapter Plate | C010.295.01SA | OPTIONAL—One per MK500 Mounting Kit. For attaching to steel beam that is parallel to and directly above the Line Set. | 175 | 17 |
| 500CF Ceiling Flange | C504.064 | OPTIONAL—One per lift line. | 140 | 2 |
| Electrical Cable Management System | 503113 | OPTIONAL— Assists in providing power to a motorized projection screen. 35' long adjustable industrial-grade precision cable reel. 300 Volt, 8 amp, 4 conductor with stripped ends. Includes electrical connector and strain relief. UL and CSA Listed. | 1325 | 35 |
| Electrical Cable Management System Beam Mounting Kit | 503110 | OPTIONAL—For mounting cable management system to beam. Consists of one MK500 Beam Mounting Kit, one cable reel mounting plate, and hardware. | 303 | 15 |
| Operating Switch (Replacement for TS1000 & TS1000 VFD) | C112.135 | Single gang key switch. | 100 | 2 |
| Motor Test Cord | 503109 | 6' long with inline 3-position up/down/stop switch. | 88 | 2 |

DISCLAIMER: Draper hereby states that no persons should be working, performing, or standing under the TorkStar Utility Line Set during operation.

See next page for additional TorkStar pricing and information

TorkStar Utility Line Set—See previous page for full description of this product.

Projection Screen Mounting Kits for TorkStar

Draper offers the following projection screens for use with the TorkStar system: *Targa*, *Premier*, *Paragon*, *Signature®/Series V*, *Cineperm*, *Truss Cineperm*, *StageScreen*, and *Onyx*. The appropriate mounting kit below is **REQUIRED** when using a projection screen with the TorkStar system.

Projection Screen Mounting Kits For Direct Attachment To TorkStar Cables—For use with screens with a case length of 220" or less:

| Projection Screen Direct Cable Kits | Part No. | PRICE | Shipping Wt./Lbs. |
|---|----------|-------|-------------------|
| Targa / Premier (Small Case) Direct Cable Kit | 503115 | \$230 | 3 |
| Targa / Premier (Large Case) Direct Cable Kit | 503117 | 230 | 7 |
| Paragon Direct Cable Kit | 503123 | 230 | 6 |
| Onyx Direct Cable Kit ¹ | 503125 | 230 | 4 |
| Cineperm Direct Cable Kit | 503127 | 230 | 4 |
| Truss Cineperm / StageScreen Direct Cable Kit | 503129 | 230 | 5 |

See Premier (page 24) or Targa (page 28) to determine if your Premier or Targa projection screen utilizes a large or small style case.

Projection Screen Mounting Kits For Attachment To Projection Screen Batten—For use with any screen size. Required for screens (except the Truss Cineperm) with a case length over 220". When a Projection Screen Batten is required it **MUST** be supplied by Draper (see Projection Screen Batten pricing and requirements below).

| Projection Screen Cable Batten Mounting Kits | Part No. | PRICE | Shipping Wt./Lbs. |
|--|----------|---------|-------------------|
| Targa / Premier (Small Case) Cable Batten Mounting Kit | 503114 | \$275 | 12 |
| Targa / Premier (Large Case) Cable Batten Mounting Kit | 503116 | 275 | 14 |
| Paragon Cable Batten Mounting Kit | 503122 | 275 | 17 |
| Onyx Cable Batten Mounting Kit ¹ | 503124 | 275 | 12 |
| Cineperm Cable Batten Mounting Kit | 503126 | 275 | 13 |
| Truss Cineperm Cable Batten Mounting Kit | 503128 | 275 | 12 |
| Projection Screen Batten —2.5" O.D. x 13 gauge steel tube. Must be 24" longer than projection screen case or frame. Battens longer than 20' will be provided in two equal sections and require a Splice Kit. ² | C073.122 | 5.00/ft | varies |
| Projection Screen Batten Splice Kit —36" x 2.25" O.D. 14 gauge steel tube, factory predrilled to receive four screws and four lock nuts (included). | 503134 | 118 | 7 |

See Premier (page 24) or Targa (page 28) to determine if your Premier or Targa projection screen utilizes a large or small style case.

¹ Use of Onyx screens with TorkStar requires the Onyx Corner Reinforcement Kit (Part No. 253696).

² Projection Screen Batten **MUST** be supplied by Draper and **MUST** be 24" longer than screen case or frame. If over 20' (240") long, a Projection Screen Batten Splice Kit is required (see price above). If a Splice Kit is required, the two equal sections of Projection Screen Batten will be factory pre-drilled to receive the Splice Kit in the field. Completed splice must be located at the center point of the Projection Screen Batten.

Guidelines for use of projection screens with TorkStar

All motorized screens with case lengths over 220" **MUST USE ALL** of the following:

1. A Projection Screen Batten (**MUST** be supplied by Draper)—2.5" O.D. by minimum of 13 gauge steel tube.
2. The specific projection screen Cable Batten Kit.
3. The Projection Screen Batten Splice Kit.
4. A minimum of two (2) PosiSpools if using a TS1000/TS1000 VFD Motor Winch.

All Truss Cineperms and StageScreens over 220" wide **MUST USE** the following:

1. A Truss Cineperm / StageScreen Direct Cable Kit or Truss Cineperm Cable Batten Kit.
2. If using a Truss Cineperm with a Cable Batten Kit, the Projection Screen Batten is required and **MUST** be supplied by Draper. It **MUST** be 24" longer than Truss Cineperm frame. If using a StageScreen with a Cable Batten Kit, please contact Draper.
3. If using the Cable Batten Kit, the Projection Screen Batten Splice Kit **MUST** also be used.
4. A minimum of two (2) PosiSpools if using the TS1000/TS1000 VFD Motor Winch.

Note: All Draper motorized projection screens with TorkStar require power supply cable management. See page 101 TorkStar Accessories, Part No. 503113 Electrical Cable Management System.

DISCLAIMER: Draper hereby states that no persons should be working, performing, or standing under the TorkStar Utility Line Set during operation.

Your Key Sales Department Contacts

Audiovisual Market

| Region | Regional Sales Manager | AV Video Backup |
|--|---|---|
| Canada | Eric Guffey, LEED®AP, CTS Direct: 765.856.1300 eguffey@draperinc.com | Todd Hiday, CTS Direct: 765.856.1264 thiday@draperinc.com |
| CT, ME, MA, NH, NJ, NY, PA, RI, VT | Dave Trapani Mobile: 917.270.0846 dtrapani@draperinc.com | Lindsey Martin Direct: 765.856.1252 lmartin@draperinc.com |
| DC, DE, MD, VA, WV | Jody Zarbano Mobile: 703.268.1006 jzarbano@draperinc.com | Kimberly McCormick, CTS Direct: 765.856.1263 kmcormick@draperinc.com |
| AL, FL, GA, LA, MS, NC, SC | Gretchen Donaldson Mobile: 813.597.4797 gdonaldson@draperinc.com | Curt Huntley, CTS Direct: 765.856.1260 chuntley@draperinc.com |
| IL, IN, IA, MI, MO, OH, WI, KY | Brian Kunz, LEED®AP, CTS Direct: 765.856.1270 bkunz@draperinc.com | Carol Phelps, CTS Direct: 765.856.1266 cphelps@draperinc.com |
| TX | Chad Tabor, CTS, CSI Direct: 765.856.1255 ctabor@draperinc.com | Sandra Whitehead Direct: 765.856.1294 swhitehead@draperinc.com |
| CO, ID, KS, MN, NE, WY, NM, ND, SD, Kansas City | Leo Nickel 800.238.7999, ext: 3111 lnickel@draperinc.com | Todd Hiday, CTS Direct: 765.856.1264 thiday@draperinc.com |
| AK, CA (northern), MT, NV (northern), OR, UT, WA | Ken Hartling Mobile: 415.423.7437 khartling@draperinc.com | Marita Roberson Direct: 765.856.1268 mroberson@draperinc.com |
| AZ, CA (southern), NV (southern), HI | Randy Reece 866.987.7999, ext. 3105 Mobile: 714.308.9343 rreece@draperinc.com | Marita Roberson Direct: 765.856.1268 mroberson@draperinc.com |
| AR, OK, TN | Ross Rhoades, CSI Mobile: 615.427.8227 800.238.7999, ext: 3108 rrhoades@draperinc.com | Kimberly McCormick, CTS Direct: 765.856.1263 kmcormick@draperinc.com |

Contract Market

| Region | Regional Sales Manager | Architectural Screens Backup |
|---|---|--|
| CT, MA, ME, NH, RI, VT, Canada | Eric Guffey, LEED®AP, CTS Direct: 765.856.1300 eguffey@draperinc.com | Cory Knight Direct: 765.856.1234 cknight@draperinc.com Linda Daubenspeck Direct: 765.856.1262 linda.daubenspeck@draperinc.com |
| NJ, NY, PA | Todd Garner, CSI Direct: 765.856.1249 tgarner@draperinc.com | Tom Boxell Direct: 765.856.1232 tboxell@draperinc.com |
| DC, DE, KY, MD, VA, WV | Jody Zarbano Mobile: 703.268.1006 jzarbano@draperinc.com | Cory Knight Direct: 765.856.1234 cknight@draperinc.com |
| FL, GA, NC, SC | Matt Schultz, LEED®AP, CDT, CSI Direct: 770.562.4757 mschultz@draperinc.com | Cory Knight Direct: 765.856.1234 cknight@draperinc.com |
| IL, IN, MI, OH | Art Tober, CSI, CDT Direct: 586.416.0829 atober@draperinc.com | Tom Boxell Direct: 765.856.1232 tboxell@draperinc.com |
| WI | | Linda Daubenspeck Direct: 765.856.1262 linda.daubenspeck@draperinc.com |
| TX | Chad Tabor, CTS, CSI Direct: 765.856.1255 ctabor@draperinc.com | Jim Judy Direct: 765.856.1261 jjudy@draperinc.com |
| MN, MT, NE, ND, SD | | Linda Daubenspeck Direct: 765.856.1262 linda.daubenspeck@draperinc.com |
| CO, ID, KS, UT, WY, MO (Kansas City) | Leo Nickel 800.238.7999, ext: 3111 lnickel@draperinc.com | Cory Knight Direct: 765.856.1234 cknight@draperinc.com |
| NM | | Jim Judy Direct: 765.856.1261 jjudy@draperinc.com |
| AK, CA (northern), NV (northern), OR, WA, Western Canada (AB, BC, YT) | Ron Wathen Mobile: 415.744.4952 rwathen@draperinc.com | Linda Daubenspeck Direct: 765.856.1262 linda.daubenspeck@draperinc.com |
| AZ, CA (southern), NV (southern), HI | Kathy Greenway, CSI, CDT Mobile: 714.396.9732 866.987.7999, ext. 3101 kgreenway@draperinc.com | Linda Daubenspeck Direct: 765.856.1262 linda.daubenspeck@draperinc.com |
| AL, AR, IA, LA, MO, MS, TN | Ross Rhoades, CSI Mobile: 615.427.8227 800.238.7999, ext: 3108 rrhoades@draperinc.com | Linda Daubenspeck Direct: 765.856.1262 linda.daubenspeck@draperinc.com |
| OK | | Jim Judy Direct: 765.856.1261 jjudy@draperinc.com |

Sales Department Personnel (continued)

Telephone - U.S. and Canada

Call us toll-free, or dial your contact on their direct line shown here:

| | |
|-----------------------------|--------------|
| PHONE All Depts..... | 800-238-7999 |
| Architectural Screens | 800-989-0117 |
| AV/Video | 800-989-0112 |
| Window Shades | 800-989-0126 |

Fax

Please fax orders to the appropriate number below:

| | |
|---------------------------------------|--------------|
| FAX AV/Video Sales | 866-637-5612 |
| FAX Architectural/Contract Sales..... | 866-637-5612 |
| FAX Customer Service..... | 866-397-7353 |

Sales/Marketing Management

| | Extension | Direct Line | E-mail Address |
|---|-----------|--------------|--|
| Bob Mathes—AV/Video Market Manager | 1243 | 765-856-1243 | bmathes@draperinc.com |
| Chris Broome, CSI, LEED® AP—Contract Market Manager | 1205 | 765-856-1205 | cbroome@draperinc.com |
| Lee Denhart, LEED® AP—Field Sales Manager | 1211 | 765-856-1211 | ldenhart@draperinc.com |
| Penny Sitler, CDT, LEED® AP—Marketing Manager | 1221 | 765-856-1221 | psitler@draperinc.com |
| Stacie Lowhorn—Sales Administration | 1271 | 765-856-1271 | slowhorn@draperinc.com |
| Amy Bradway—Executive Assistant | 2329 | 765-987-7999 | abradway@draperinc.com |

Product/Market Managers

| | | | |
|---|------|--------------|--|
| Jentry Wittkamper, CTS—Export Manager | 1248 | 765-856-1248 | jwittkamper@draperinc.com |
| Jim Hoodlebrink, CTS—Rental Products and Rear Screens | 1287 | 765-856-1287 | jhoodlebrink@draperinc.com |
| Jim Judy—Architectural Screens | 1261 | 765-856-1261 | jjudy@draperinc.com |
| Amy Madden, MBA, CTS, LEED® AP—Residential Market Manager, Projector Lifts and Video Conferencing | 1212 | 765-856-1212 | amadden@draperinc.com |
| Steve Cook—National AV Consultant Manager | 3113 | 765-987-7999 | scook@draperinc.com |

Internet

Our Web site, www.draperinc.com, is a convenient, 24-hour source for product information. Email addresses are available above and in the Contact Us section of our website.

Product/Market Specialists AV, Video & Home Theatre

AV & Video

| | Ext. | Direct | Email |
|-------------------------|------|--------------|--|
| Todd Hiday, CTS | 1264 | 765.856.1264 | thiday@draperinc.com |
| Brad Barker (CA Office) | 3104 | 866.987.7999 | bbarker@draperinc.com |
| Curt Huntley, CTS | 1260 | 765.856.1260 | chuntley@draperinc.com |
| Lindsey Martin | 1252 | 765-856-1252 | lmartin@draperinc.com |
| Carol Phelps, CTS | 1266 | 765.856.1266 | cphelps@draperinc.com |
| Marita Roberson | 1268 | 765.856.1268 | mroberson@draperinc.com |
| Scott Shaffer | 1247 | 765.856.1247 | sshaffer@draperinc.com |
| Diana Swim, CTS | 1265 | 765.856.1265 | dswim@draperinc.com |
| Eric Swim, CTS, ISF | 1298 | 765.856.1298 | eswim@draperinc.com |
| Kimberly McCormick, CTS | 1263 | 765.856.1263 | kmccormick@draperinc.com |
| Sandra Whitehead | 1294 | 765.856.1294 | swhitehead@draperinc.com |

Residential Market Manager

| | | | |
|--------------------------------|------|--------------|--|
| Amy Madden, MBA, CTS, LEED® AP | 1212 | 765.856.1212 | amadden@draperinc.com |
|--------------------------------|------|--------------|--|

Rear Projection Screens and Information Display Systems

| | | | |
|----------------------|------|--------------|--|
| Jim Hoodlebrink, CTS | 1287 | 765.856.1287 | jhoodlebrink@draperinc.com |
| Ryan Dishman | 1215 | 765.856.1215 | ryan.dishman@draperinc.com |

Projector and Flat-Screen Lifts

| | | | |
|--------------------------------|------|--------------|--|
| Amy Madden, MBA, CTS, LEED® AP | 1212 | 765.856.1212 | amadden@draperinc.com |
| Eric Swim, CTS, ISF | 1298 | 765.856.1298 | eswim@draperinc.com |
| Ben Hamm | 1258 | 765.856.1258 | bhamm@draperinc.com |

Video Conferencing Solutions

| | | | |
|--------------------------------|------|--------------|--|
| Amy Madden, MBA, CTS, LEED® AP | 1212 | 765.856.1212 | amadden@draperinc.com |
|--------------------------------|------|--------------|--|

Projection Specialist

| | | | |
|---------------------|------|--------------|--|
| Eric Swim, CTS, ISF | 1298 | 765.856.1298 | eswim@draperinc.com |
|---------------------|------|--------------|--|

Green Building Coordinator

| | | | |
|---------------------------|------|--------------|--|
| Clint Childress, LEED® AP | 1240 | 765.856.1240 | cchildress@draperinc.com |
|---------------------------|------|--------------|--|

AV/School Bids

| | | | |
|-----------------|------|--------------|--|
| Todd Hiday, CTS | 1264 | 765.856.1264 | thiday@draperinc.com |
|-----------------|------|--------------|--|

Contract Sales (Architectural)

Projection Screens & Related Products

| | | | |
|-------------------------|------|--------------|--|
| Jim Judy | 1261 | 765.856.1261 | jjudy@draperinc.com |
| Tom Boxell | 1232 | 765.856.1232 | tboxell@draperinc.com |
| Cory Knight | 1234 | 765.856.1234 | cknight@draperinc.com |
| Linda Daubenspeck | 1262 | 765.856.1262 | linda.daubenspeck@draperinc.com |
| Brad Barker (CA Office) | 3104 | 866.987.7999 | bbarker@draperinc.com |

Special Assistance

Technical Support

| | | | |
|---------------|------|--------------|--|
| Scott Shaffer | 1247 | 765.856.1247 | sshaffer@draperinc.com |
| Ben Hamm, CTS | 1258 | 765.856.1258 | bhamm@draperinc.com |
| Ryan Dishman | 1215 | 765.856.1215 | ryan.dishman@draperinc.com |

Export

| | | | |
|------------------------|------|--------------|--|
| Jentry Wittkamper, CTS | 1248 | 765.856.1248 | jwittkamper@draperinc.com |
| Amy Howard | 2308 | — | ahoward@draperinc.com |
| Nate LaMar, MBA | 1269 | 765.856.1269 | nlar@draperinc.com |
| Monica Peavie | 2341 | — | mpeavie@draperinc.com |
| Raul Pinon | 1280 | 765.856.1280 | rpion@draperinc.com |
| Heather Sipes | 2247 | — | hsipes@draperinc.com |

Credit Manager

| | | | |
|---------------|------|--------------|--|
| Debbie Searcy | 1224 | 765.856.1224 | dsearcy@draperinc.com |
|---------------|------|--------------|--|

Accounts Receivable—Accounts A-H

| | | | |
|-----------|------|--------------|--|
| Amy Magee | 1256 | 765.856.1256 | amagee@draperinc.com |
|-----------|------|--------------|--|

Accounts Receivable—Accounts I-Z

| | | | |
|------------|------|--------------|--|
| Leonor New | 1209 | 765.856.1209 | lnew@draperinc.com |
|------------|------|--------------|--|

Accounts Receivable

| | | | |
|----------------|------|--------------|--|
| Diane Criswell | 1214 | 765.856.1214 | dcriswell@draperinc.com |
|----------------|------|--------------|--|

Image & Logo Requests

| | | | |
|-------------|------|--------------|--|
| Gini Deaton | 1228 | 765.856.1228 | gdeaton@draperinc.com |
| Jeff Irving | 1229 | 765.856.1229 | jirving@draperinc.com |

Media Relations

| | | | |
|--------------|------|--------------|--|
| Terry Coffey | 1230 | 765.856.1230 | tcoffey@draperinc.com |
|--------------|------|--------------|--|

Customer Service

Customer Service Manager

| | | | |
|------------------|------|--------------|--|
| Beverly Ferguson | 1206 | 765.856.1206 | bferguson@draperinc.com |
|------------------|------|--------------|--|

Returns

| | | | |
|------------|------|--------------|--|
| Jodi Reece | 1293 | 765.856.1293 | jreece@draperinc.com |
|------------|------|--------------|--|

Traffic Support

| | | | |
|---------------|------|--------------|--|
| Tina Loveless | 1213 | 765.856.1213 | tloveless@draperinc.com |
|---------------|------|--------------|--|

Order Status

| | | | |
|--------------|------|--------------|--|
| Debbie Spera | 1217 | 765.856.1217 | dspera@draperinc.com |
|--------------|------|--------------|--|

Customer Service Support

| | | | |
|----------------|------|--------------|--|
| Carol McLemore | 1253 | 765.856.1253 | cmclmore@draperinc.com |
| Lisa Knotts | 1218 | 765.856.1218 | lknotts@draperinc.com |

Part Number Prefix Key

| | | | |
|----------|---|----------|------------------------------------|
| 101..... | Premier | 201..... | Silhouette/Series C |
| 105..... | Access MultiView/Series V | 202..... | Silhouette/Series M |
| 106..... | Access MultiView/Series E | 206..... | Luma 2 |
| 107..... | Silhouette/Series V | 207..... | Luma |
| 108..... | Silhouette/Series E | 209..... | Star |
| 112..... | Envoy | 211..... | Luma 2/R |
| 113..... | Ambassador | 215..... | Diplomat/R |
| 114..... | Paragon | 216..... | Consul |
| 115..... | Rolleramic | 218..... | Cinefold |
| 116..... | Targa | 219..... | Cinefold Accessories |
| 120..... | Ultimate Access Cases | 220..... | Cinefold Dress Kits |
| 121..... | Motorized Screen Controls | 221..... | Truss-Style Cinefold |
| 125..... | VCCB | 222..... | Truss-Style Cinefold Dress Kits |
| 129..... | Baronet | 223..... | Pipe & Drape Runoffs |
| 132..... | Salara/HW | 227..... | Accessories for Manual Screens |
| 136..... | Salara/Plug & Play™ | 230..... | RoadWarrior, Traveller, and Piper |
| 137..... | Salara/Series M | 241..... | Ultimate Folding Screen |
| 138..... | Nocturne®/Series E | 242..... | Ultimate Folding Screen Dress Kits |
| 139..... | Access and Access FIT/Series E | 251..... | Cineperm and TheatreMask |
| 140..... | Access and Access FIT/Series V | 252..... | Clarion |
| 142..... | Ultimate Access/Series E | 253..... | Onyx and ShadowBox Clarion |
| 143..... | Ultimate Access/Series V | 254..... | Profile |
| 144..... | Ultimate Access XL/Series E | 254..... | First Surface Mirrors/MiroClear |
| 145..... | Ultimate Access XL/Series V | 300..... | Projector and FlatScreen Lifts |
| 146..... | Access XL/Series E | 350..... | Easels |
| 147..... | Access XL/Series V | 384..... | StageScreen® |
| 197..... | Access and Access FIT/Series M | 385..... | FocalPoint® |
| 200..... | Premier/Series C and Nocturne®/Series C | 503..... | TorkStar Utility Line Set |
| | | 800..... | Scribe Screen |

Terms and Conditions

- Draper sells only to authorized Draper dealers under this price list. Possession of the price list does not necessarily constitute an offer to sell.
- All prices FOB factory unless otherwise specified. Prices and specifications subject to change without notice.
- **Orders are entered subject to Draper's terms. These terms may only be revised by a written agreement signed by a duly authorized representative of Draper, Inc. Any additional or different terms or conditions in the customer's order or confirmation are not accepted by Draper, Inc. Our invoice constitutes the final written expression of all terms of sale and is a complete and exclusive statement of those terms. Any and all representations, promises, warranties or statements made or given to customer that differ in any way from the terms of our written invoice shall be given no force or effect.**
- **Quotations: Purchase orders received by Draper without a valid quotation number will be processed and invoiced at regular net prices. In the event you later produce a valid quotation number, a processing fee of 2% may be added to the invoice.**
- *Phone orders:* We encourage you to place orders in writing. We make every attempt to fill verbal orders accurately, but we cannot guarantee mistakes resulting from verbal miscommunication will be resolved in your favor.
- *Payment terms:* 30 days net with approved credit. Payment by Visa, MasterCard and Discover Card accepted, with no surcharge.
- *Change Policy:* Draper needs to receive any changes to orders within 24 hours. After that point, change fees may apply.
- *Return policy:* No product may be returned without a written Return Material Authorization. Returns are subject to a restocking charge (except warranty repairs), and must be shipped freight prepaid according to Draper's instructions.
- *Cancellation Policy:* Cancelled orders may result in cancellation charges. While we will make every effort to minimize such charges, once an order is entered for manufacture, its cancellation may result in charges for material, labor, shipping or restocking.
- *Warranty:* All products in this price list are warranted for one year against defects in materials and workmanship. Detailed warranty terms are available upon request.

Draper Patent Information

Draper's engineering team is continually creating new and unique products and design improvements. Many of our innovations are covered by patents. You may see a list of patented products here: <http://www.draperinc.com/legal/patents/>

Minimum Advertised Price (MAP) Policy—Effective June 1, 2016

This Policy applies to all Draper, Inc. (“Draper”) projection screens and related equipment.

At Draper, we recognize that our distributors and authorized dealers are keys to our ability to successfully operate in a competitive environment where customers have a myriad of choices. It is necessary that we take steps to encourage our distributors and authorized dealers to invest time and resources to deliver an extraordinary customer experience through their knowledgeable staff and their compelling marketing and educational materials. Draper is committed to supporting its distributors and authorized dealers in their efforts to grow their businesses by promoting Draper-branded products.

To ensure profit margins for our distributors and authorized dealers that are commensurate with their investments, to protect the value of the Draper brand, and to maintain brand equity by emphasizing the value and quality of Draper’s products through advertising and education, Draper, in its unilateral and sole determination, establishes this procompetitive Minimum Advertised Price Policy (MAP Policy) for the advertising and marketing of Draper products by distributors and authorized dealers. Draper is confident this MAP Policy will strengthen its competitiveness and benefit all of its distributors and authorized dealers.

This Policy applies only to advertised prices and does not apply to actual resale prices. Draper does not dictate the price at which a distributor or an authorized dealer sells Draper products, and they are free to sell products individually or bundled with other third party products or services at any price they choose.

Advertising a price lower than the MAP next to the featured MAP Product in any advertisement will be viewed as a violation of this MAP Policy. This MAP Policy applies to all advertisements of MAP Products in any and all media, including, without limitation, flyers, posters, coupons, mailers, inserts, newspapers, magazines catalogs, mail order catalogs, internet or similar electronic media including websites, forums, email newsletters, email solicitations, television, radio, and public signage. Such website features as “Click for price”, automated “bounce – back” pricing e-mails, pre-formatted e-mail responses, forms, automatic price display for any items prior to being placed in a customer’s shopping cart, and other similar features are considered to be communications initiated by the distributor or authorized dealer (rather than by the customer) and such communications that disclose or advertise prices below MAP constitute prohibited “advertising” under this MAP Policy.

It is not a violation of this MAP Policy for distributors and authorized dealers to direct their customers to call or email their customer service representatives regarding the MAP Product’s price, so long as the price is not otherwise published. Distributors and authorized dealers may also make coupons or similar promotions available to customers after customers have added MAP Products to their online basket of goods.

Prices for Draper products that are below MAP may not appear in any online search tool (e.g., Google Shopper, Price Grabber, NextTag, etc.) where your website is linked as the source.

Note: Certain online sales strategies result in advertised pricing that is below MAP Policy pricing. In the case of “add to cart” or “click here to see our low price” strategies, for example; Google Checkout will advertise the last price paid. Therefore, when products are sold at prices below MAP Policy pricing, an advertising event occurs to the next consumer because they see the product and the “last price sold” without having to “add to cart.” This inadvertent advertising is not permitted and must be monitored by the distributor or authorized dealer or risk violating the MAP Policy.

Prices with a “strike-thru” and a redirection to “Check-out Cart” to see a price that is below MAP Policy pricing is considered a violation of the MAP Policy. Advertising discounts on products prior to those products being added to an online basket is not permitted (e.g., distributors and authorized dealers cannot state “10% off Draper products when added to the cart”).

CURRENT MAP

MAP Policy pricing for all Draper projection screens with TecVision viewing surfaces is equal to MSRP. For all other products covered under this policy MAP Policy pricing is equal to MSRP less 20%. A complete MSRP list is attached hereto as Exhibit A.

Draper reserves in its unilateral discretion the right to use promotional prices from time to time that may or may not indicate the use of instant, mail-in, or online rebates. These promotional prices may be marketed by distributors and authorized dealers with strict adherence to guidance provided by Draper. This includes site-wide promotions such as “10% off on all items at checkout for a limited time.” All inquiries regarding use of Draper promotional prices should be directed to Draper’s Marketing Manager, Penny Sitler, at psitler@DraperInc.com or (765) 987-7999.

Finally, in order to further protect Draper’s procompetitive business interests and strategy as outlined above, Draper in its sole discretion chooses to sell or distribute products only through distributors and authorized dealers that themselves impose MAP policies on their reseller customers. Draper reserves in its unilateral discretion the right to terminate its relationship with any distributor or authorized dealer that does not have a MAP policy for its resellers.

ENFORCEMENT

This Policy is a unilateral statement of Draper’s preference concerning the advertising practices of accounts to which Draper chooses to resell its products. It is not the purpose of this Policy to restrict, coerce, force or reach agreement with a customer to charge a particular price for any Draper product. The Policy is not a contract or an offer to form a contract, agreement or any other form of mutual understanding. Rather, the Policy describes the terms under which Draper may, in its sole discretion, choose to sell its products subject to the Policy; Draper does not ask for, and will not accept, any agreement to comply with this Policy.

Draper has a four strike policy on MAP violations. For the first and second violations, Draper will send written warnings to the offending party. For the third violation, the offending party will forfeit its business relationship with Draper for a period of 30 days. If the party violates the MAP policy a fourth time, Draper will suspend the party’s business relationship with Draper indefinitely. Upon termination of the offending party’s business relationship with Draper, all outstanding balances shall become due and payable immediately. The offending party may request to be reinstated after the next annual pricing update, but Draper reserves the right to decide whether to accommodate this request. If the distributor or the authorized dealer is allowed to be reinstated, and another violation occurs, this likely will result in the removal of the distributor or the authorized dealer from Draper’s distribution channel entirely.

Draper reserves the right, in its unilateral discretion, to take other action, including litigation, with respect to any distributor or authorized dealer that violates this MAP Policy. The MAP Policy will be enforced by Draper at its sole discretion in the best manner possible.

Since this policy is subject to change by Draper from time to time, distributors and authorized dealers must monitor Draper’s website for the most current information related to MAP and review the posted MAP Policy regularly to ensure their continued compliance.

Draper representatives and employees are strictly prohibited from discussing the Policy or pricing practices with any account, as well as accepting any assurances of an account’s compliance with the Policy. All inquiries regarding this Policy should be directed to Draper’s Marketing Manager, Penny Sitler, at psitler@DraperInc.com or (765) 987-7999.

Finally, Draper will not discuss the business dealing of any account with any other account. Draper does not seek and will not accept any complaints or comments about the advertising or pricing policies of any other account. Draper continues to reserve the right to choose any accounts with which it will do business and reserves the right to accept or reject any purchase order from any account at any time.

Freight Considerations

- Shipments are made by the least expensive surface method except when you request special routing at the time of order. On small parcel ground shipments, we use UPS—unless you specify otherwise. Several items in this price list “dim out” to a larger weight than their actual physical weight. When one item ships alone, it may have to ship under its dimensional weight or may incur an “Oversize” charge under parcel service regulations. Some items may also be too big for parcel service, and will ship common carrier. Please see key below, and notes on each individual product page. If in doubt, please request a freight estimate.
- Dimensional weights in this price list apply to parcel service shipments. Air freight shipments may also ship under a dimensional weight, which is calculated with a different formula. Contact Draper for a freight estimate.
- When you or your customer are expecting a delivery weighing more than 100 lbs., please plan appropriately for unloading the truck. The carrier is not responsible for unloading. If you need notification to do this, please request a call before delivery.
- We are glad to quote delivered prices based on your specific requirements. Unless you request it at the time of quotation, our delivered prices do not include extraordinary charges such as COD fees, inside delivery, construction site delivery, arrival notice or reconsignment.
- All shipments are prepaid and added to the invoice.
- Products throughout this price list are marked with their freight classification or with a “P” to indicate that they may be shipped via a small parcel ground service. Many products are marked with a designation such as “85P+” or “125”. Larger quantities may ship more economically via common carrier and will ship under the freight classification shown.
- Small parcel ground shipment frequently is not available for products shipping to Canada. Please see key below, and notes on each individual product page. If in doubt, please request a freight estimate.
- Actual shipping weights for crated products may vary due to crating methods and materials.
- Need a freight quote? Draper’s sales staff is always pleased to provide a freight estimate based on your specific needs. Just call 800.238.7999 or 765.987.7999, fax 765.987.7142.

Freight Classifications for Draper Products

| | | | | | |
|--------------------------------|-----|-----------------------------------|----------|-------------------------------|-----|
| Motorized Screens | 125 | Projector Lifts | 85/200 | Video Conferencing Camera Box | 70 |
| Wall/Ceiling Screens | 85 | Revelation | 110 | RPX Rear Projection System | 125 |
| Portable Screens | 85 | Cineglass Rear Projection Screens | 100/125* | First Surface Mirrors | 100 |
| Permanently Tensioned Screens | 85 | Cineplex Rear Projection Screens | 100/125* | TorkStar | 85 |
| Pipe & Drape Runoffs | | IRUS | 100/125* | | |
| Skirts and Draping | 70 | VideoWalls | 85* | | |
| Bases | 50 | Projector Support Structures | 100/200 | | |
| Uprights & Horizontal Supports | 85 | MultiScreen System | 125 | | |

*Depending on dimensions: call for freight quotation.

Freight Damage Policy—Please Read

One of our biggest mutual headaches is freight damage. There are two kinds—

Obvious Freight Damage—If you receive a shipment from us with obvious freight damage, **REFUSE IT** and inform us immediately so we can supply a replacement. We will charge you for the replacement at the originally quoted price and credit you upon the return of the original.

If you accept a shipment with obvious freight damage noted on the driver receipt and report it to us after the fact, we will supply a replacement at the originally quoted price and provide a partial credit upon the return of the original, based on its salvage value. The damaged product must be held at the original delivery address and in its original packaging.

Concealed Freight Damage—If you accept a shipment, it is **your responsibility** to open it immediately and report any concealed freight damage to the delivering carrier immediately and in writing. Pursuing the claim is also your responsibility, but we will assist you to the best of our ability to secure a favorable settlement from the carrier.

We will also provide a replacement product at the originally quoted price; and, if your claim is denied, we may accept the return of the freight damaged product for whatever credit we can provide, based upon its salvage value.

If you fail to report concealed freight damage to the delivering carrier immediately, neither you nor we have any recourse. We will provide a replacement product at the originally quoted price and, if you wish, we will accept the return of the damaged product for whatever credit we can provide, based upon its salvage value.

Please Note—

1. This policy applies to all shipments whether to you or to your customers.
2. Freight damaged rigid rear screens have no salvage value.
3. Neither Draper nor the freight carrier will pay back charges, accessorial fees or expedited replacement charges in regard to freight damaged product and replacement.

Alphabetical Index

| | | | |
|---|-----|--|-----|
| Access Cases | 9 | MultiScreen System | 87 |
| Access FIT/Series E | 13 | Networking Controls | 35 |
| Access FIT/Series V | 10 | Nocturne®/Series C | 49 |
| Access/Series E | 14 | Nocturne®/Series E | 31 |
| Access/Series V | 11 | Onyx | 58 |
| Access MultiView/Series E | 20 | Orbiter | 97 |
| Access MultiView/Series V | 19 | Paragon/Series E | 22 |
| Accessories for Manual Screens | 49 | Paragon/Series V | 22 |
| Accessories for Motorized Screens | 35 | Part Number Prefix Key | 105 |
| Access/Series M | 38 | Patriot | 34 |
| Access FIT/Series M | 38 | Permanently Tensioned Projection Screens | 51 |
| Access XL/Series E | 14 | Phantom | 97 |
| Access XL/Series V | 12 | Pipe & Drape Runoffs | 85 |
| AeroLift | 98 | Piper | 65 |
| Ambassador | 21 | Portable Projection Screens | 64 |
| Artisan/Series E | 31 | Premier | 24 |
| Artisan/Series M | 43 | Premier/Series C | 40 |
| Artisan/Series V | 30 | Presentation Easels | 86 |
| AutoReturn Roller for Manual Projection Screens | 37 | Profile | 62 |
| Baronet | 34 | Projector Lifts | 91 |
| Ceiling Access Doors | 94 | Projector Support Structures | 87 |
| Cinefold | 80 | Quiet Motors and Built-in Controls | 35 |
| Cineframe® | 89 | Replacement Viewing Surfaces | 50 |
| Cineperm | 54 | Revelation | 96 |
| Cinescreen® Rear Screens | 88 | Rigid Rear Projection Screens | 87 |
| Clarion | 56 | RoadWarrior | 64 |
| Communicating with Draper | 103 | Rolleramic | 23 |
| Consul | 67 | RPX Rear Projection Systems | 90 |
| Credenza Projector Lift | 92 | Salara/HW | 32 |
| Curved Frame Screens | 52 | Salara/Plug & Play™ | 33 |
| Custom Cube Stands | 87 | Salara/Series M | 42 |
| Custom Lifts | 93 | Scissor Lifts | 95 |
| Diplomat/R | 67 | Screen Fabric Only, Cut to Size | 51 |
| Draperies | 85 | Scribe Write-On Screen | 63 |
| Dress Kits for Cinefold | 81 | ShadowBox Clarion | 60 |
| Dress Kits for Truss-Style Cinefold | 84 | Silhouette/Series C | 40 |
| Dress Kits for Ultimate Folding Screen | 78 | Silhouette/Series E | 29 |
| Easels and Accessories | 86 | Silhouette/Series M | 41 |
| Edgeless Clarion | 61 | Silhouette/Series V | 28 |
| Envoy | 21 | Skirts for Mobile AV Carts and Tables | 66 |
| Evenroll Rope & Pulley Screen | 48 | Skirts For Tripod Screens | 67 |
| First Surface Mirrors | 90 | Screen Boom | 93 |
| FlatScreen Lift | 92 | StageHand | 83 |
| FocalPoint® | 73 | StageScreen® | 68 |
| FocalPoint® Dress Kits | 74 | StageScreen® Dress Kits | 72 |
| FocalPoint® Packages | 75 | StageScreen® Packages | 75 |
| Freight Considerations | 107 | Star | 48 |
| Freight Damage Policy | 107 | Targa | 26 |
| IRUS—Infinite Resolution Uniformity Screen | 88 | Terms and Conditions | 105 |
| Lace & Grommet Screens | 63 | TorkStar Utility Line Set | 101 |
| LCD Lift | 94 | Traveller | 65 |
| Lift Control Options | 100 | Truss-Style Cinefold | 84 |
| Luma | 44 | Ultimate Access/Series E | 17 |
| Luma 2 | 46 | Ultimate Access/Series V | 15 |
| Luma 2/R Screen for use with Floor Stand | 66 | Ultimate Access XL/Series E | 18 |
| Manually Operated Screens | 37 | Ultimate Access XL/Series V | 16 |
| Micro Projector Lift | 94 | Ultimate Folding Screen | 76 |
| MiroClear | 90 | Ultimate Folding Screen and Cinefold Cases | 83 |
| Mirror Manager | 90 | Video Conferencing Solutions | 99 |
| Modular Screen Packages | 75 | VideoWalls | 87 |
| Motorized Projection Screens | 8 | | |

Detailed product brochures are available on request. You may also find the most current photos, descriptions and specifications on the Internet at:

www.drapersinc.com

DRAPER®

411 S. Pearl St., Spiceland, IN 47385 USA ■ 765-987-7999

www.drapersinc.com ■ fax 765-987-7142

© 2016 Draper, Inc.

Form AV416R

Printed in USA