



www.enwork.com

quotes@enwork.com

orders@enwork.com

2017 Price List V12

Effective
March 1, 2017



Tables & Support Furniture
Steel Casegoods
Laminate Casegoods
Benching Environments
Seating



Revisions

P21	03/17	Clear knife edge undercut color
P54	03/17	Step 2 Grommet (one, center) +\$18
P82	03/17	EBZ4896 and EBZ6096 have inset legs at center of table
P111, 116, 132 142, 144	03/17	Routing hole option available
P170	03/17	PDEJUMPXX description
P203	03/17	Cabinet & Bookcase Shelf capacity 140 lbs
P314	03/17	Removed UTITLE24; consolidated 8-wire 4-circuit Added 8-wire 4-circuit w/ controlled stamp
P358, 359	03/17	Removed Available through Dec. 2017 note

INTRODUCTION

COM Yardage	16
Contact Information - Sales and Customer Service Center	11
Damages and Returns	15
Finishes	22
Finish Edge and Color Defaults	21
Freight and Minimum Quantities	13
Shipping Claims and Damages	15
GSA and State Contracts	11
Index by Part Number	370-371
Lead Times	13
Lock Program	17
Ordering and Shipping	12-13
Pricing Policy	13
Product Information	20-21
Specifications	28-31
Tables of Contents	
By Application and Product Type	6
By Enwork Product Line	3
Terms and Conditions	13
Warranty	14

Note: For the most current information go to www.enwork.com

CONTENTS BY PRODUCT NAME

FOR CONTENTS BY PRODUCT TYPE, SEE PAGE 6

Affinity™ Laminate Casegoods	223-245
Desk Shells & Supports	226-233
Mobile Storage	239
Reception	234
Storage	236-245
Apex™ Steel Casegoods	201-221, 337
Desks and Desk Shells	214-221
Mobile Storage	211, 337
Storage	204-213, 337
Apron	66
Avant Height-Adjustable Benching Environments	248-257
Concurrence	68-78
Conference Base Assemblies and Bases w/ Build-Your-Own Bases & Beam Trough Kits	68-73
Monitor Walls	78
Video Sharing (VS) Tables, Cabinets and VS Power/Data Units	74-77
Designer Finishes	40-51, 60-61
Disc Bases	80-81
eBench	82, 258-270
Tables	82
Benching Environments	258-270
Equilibrium	84-85
Foundation	86-103, 178-180
Conference Bases and Base & Trough Assemblies	86-103
Credenzas	178-179
Lecterns	180

CONTENTS BY PRODUCT NAME
 FOR CONTENTS BY PRODUCT TYPE, SEE PAGE 6

Grid Benching Environments	272-336
Electrical Components	314-315
End Panels	311
Frames	292-301
Frame Supports and Connectors for Workstations	308-309
Landscape Storage	334-336
Screens – Privacy, Topper, Modesty	326-330
Steel Storage	336-337
Tiles	302-307
Worksurfaces	316-324
Worksurface Supports for Workstations	310-311
Worktools	333
XTB Adjustable-height Bases and Connectors	312-313
Gyration 2.0	104-105
Angular and Straight T-legs	104-105
Flipping and Nesting Legs and Bases	104-105
Impression	106-123, 182-187, 192
Adjustable-height Table Bases and Legs	111, 114, 118-121
Crank	118
Café (Bar Height)	116-117
Classroom Tables	122-123
Conference TT- Legs	108
Credenzas	182
Flipping and Nesting Bases	107
Folding Legs	106
Lecterns and Command Centers	184-187
Occasional Tables	192
Powerlex Training Tables	112, 123
Set Screw	111, 114
Straight, C-, T-, X-, and O-legs	106, 110, 114-117
XT-Series ANSI/BIFMA Electric Bases	120-121
Landing	124-125
Landscape Storage	334-336
Lugano	126-127
Luminesse	62-63, 156-157
Conference Rectangle Tops	62-63
Stealth Base Option	156-157
Monitor Arms	256, 268, 332
Occasional Tables	192, 365
Perimeter Whiteboards	198-199
Pixley	364-365
Tables	365
Lounge Seating	364
Power Data Assemblies	164-175
PowerEdge Tops	64-65
Sawhorse	128
Conference Bases	128
Training Table Legs	128

CONTENTS BY PRODUCT NAME
FOR CONTENTS BY PRODUCT TYPE, SEE PAGE 6

Seating	339-369
Sensation	130-136, 188-189, 192
Adjustable-height Table Legs and Bases	130, 133-134
C-, T-, Y-, and X-legs	130, 132-134
Café (Bar Height)	132
Credenzas	188-189
Conference Bases	130, 136
Flipping and Nesting Legs and Bases	131, 133, 135
Folding Legs	130
Lecterns	189
Occasional Tables	192
Screens, Modesty Panels & Accessories	194-197
Solano (<i>formerly Captiva</i>)	138-153
Adjustable-height Table Bases and Legs	142, 146-150
Café (Bar Height)	144-145
Classroom Tables	152-153
Conference TT- Legs	140
Crank	146
Fast Crank	146
Flipping and Nesting Bases	139
Folding Legs	138
Powerlex Training Tables	143, 153
Set Screw	142
Straight, C-, T-, and X-legs	138, 142, 144-145
VT-Series Electric Bases	148
XT-Series ANSI/BIFMA Electric Bases	149-150
Square Bases	80
Statement	40-51, 60, 154
Bases	154
Designer Finish Tops	40-51, 60
Stealth	156-161, 190
Conference Table Base and Trough Assemblies	156-158
Credenzas	190
Team Tables	160-161
Table Tops	32-65
Universal Support Furniture	193
Cabinets	193
Carts	193
Cubby Shelves	193
Value	162-163
Adjustable-height Table Bases	163
Folding & Flip Legs	162-163
Straight, C-, H-, T-, TT-, and X-Legs	162-163
XTB Adjustable-height Flexible Benches	274-275, 280-281 286-287, 291, 312-313

CONTENTS BY PRODUCT TYPE
 FOR CONTENTS BY PRODUCT NAME, SEE PAGE 3

Accessories	
Cable Managers	288-289, 332
Magnets	198
Monitor Arms	256, 268, 332
Refrigerator	178
Steel Drawer & Accessories	217
Whiteboards	198-199
Work Tools and Trays	199, 333
Adjustable-height	
Tables	(see Tables – Adjustable-height Legs)
Workstations	248-257, 280-281, 285-287, 291, 312-313
Bases	(see Tables – Bases and Legs)
Benching Systems	
Adjustable-height Workstations (Crank, Electric, Knob)	248-257, 280-281, 291, 312-313
Workstations	258-270, 282-333
Bookcases	
Laminate	225, 238-239, 245
Steel	203, 206-207, 334-336
Cabinets	
Laminate	225, 238-240, 244-245
Steel	203-205, 208, 213
Café (Bar Height) Table Bases	80-81, 114, 116-117, 128, 132, 144-145
Carts	193
Casegoods	
Laminate	223-245
Steel	201-221, 337
Conference Tables	(see Tables – Bases and Legs)
Corner Cabinets	193, 245
Credenzas – Veneer and Laminate	178-179, 182, 188-190
Tops	60-61
Designer Finishes	40-51, 60-61
Desks	
Laminate Casegoods	226-232
Steel	214-216
Disc Table Bases	80-81
Drum Bases	102-103
Education and Training Furniture	
Classroom Tables	122-123, 152-153
Command Centers	185-187
Laptop Storage Tables	153
Lecterns	180, 184, 189
Training Tables	32-39, 104-107, 110-112, 128-135, 138-139, 142-143
Ganging Brackets	197
Lecterns	180, 184, 189
Legs	(see Tables – Bases and Legs)

CONTENTS BY PRODUCT TYPE

FOR CONTENTS BY PRODUCT NAME, SEE PAGE 3

Markerboards	198-199
Modesty Panels	195-196, 329-330
Monitor Arms	256, 268, 332
Monitor Lift Tables	122, 152
Monitor Walls	78
Open Plan Environments	
Adjustable-height, Linked Benches	248-257, 280-281, 312-313
Storage	334-337
Workstations and Components	248-257, 258-269, 272-330
Pedestals	203, 211, 225, 239, 270, 337
Power and Data	
Cable Management Accessories	176, 332
Conference Applications	167
Data Jacks/Couplers and Telecom Plates	174-175
How to Choose for Tables	164-165
Media Sharing Applications	86-89, 365
Open Plan Workstations	250, 260-261, 277-278
Training Applications	166
Presentation Cabinets	193
Privacy Screens	194-195, 326-329
Private Offices	
Laminate Desks and Casegoods	223-245
Steel Desks and Storage	201-221
Reception Desks	234
Screens	194-195, 326-329
Seating	339-369
Task	348-354, 358-359, 368-369
Conference	346, 350, 366, 368
Multi-Purpose	356-357, 360-363
Lounge	364
Square Table Bases/Legs	80, 115, 126, 128
Storage – Laminate	236-245
Storage – Steel	204-213, 334-337
Storage – Landscape	334-336
Storage – Mobile	211, 239, 270, 337
Support Furniture	
Credenzas	178-179, 182, 188-190
Lecterns and Command Centers	180, 184-187, 189
Occasional Tables	192, 365
Tables – Accessories	
Brackets, Casters, Plates, Braces, Grommets, Ganging	197
Privacy/Modesty	194-196

Tables – Adjustable-height Conference Bases, Assemblies, & Legs	
Conference	127
Crank	118, 146
Electric	120-121, 127, 148-150
Extended Corners (L)	118, 120-121, 146, 148-150
Pin, Knob, and Set Screw	111, 114, 130, 133-134, 142, 163
120 Planning	118, 120-121, 146, 148-150
Tables – Bases and Legs	
Adjustable-height Legs and Bases	(see Tables – Adjustable Height Legs)
C-Legs	110-112, 118, 120-121, 133, 142-143 146, 148-150, 162
Conference Bases – Laminate and Veneer	68-73, 86-99, 102-103, 108 126-127, 140, 154-158
Conference Bases – Metal	68-73, 82, 84-85, 108, 115, 126-127 128, 130, 136, 140, 156-158, 162
Conference Bases with Trough Kits	68-73, 84-99, 156-158
Drum Bases	102-103
Disc and Café (Bar Height) Bases	80-81, 114, 116-117, 128, 132, 144-145
Flip Legs	104-105, 107, 117, 131-133, 135, 139, 162-163
Folding Legs	106, 130, 138, 162-163
H-Legs	162
O-Legs	115, 310
Sawhorse	128
Square and Café Bases	80
Straight	114-115, 132, 163
T-Legs	106-107, 130-131, 138-139, 162
TT-Legs	108, 130, 140
X-Bases	116-117, 132, 144-145, 163
Y-Legs	134-136
Tables – Complete	
Apron	66
Classroom	122-123, 152-153
Conference	82
Laptop Storage	153
Occasional	192, 365
Team Tables	124-125, 160-161
Video Sharing Tables	74-75, 365
Tables – Occasional	192, 365
Tables – Power Data Units	
Conference Applications	167
How to Specify	164-167
Training Applications	166
Tables – Replacement Parts	197

CONTENTS BY PRODUCT TYPE

FOR CONTENTS BY PRODUCT NAME, SEE PAGE 3

Tables – Tops	
Conference Tops	40-65
Designer Finishes – Glass, KrystalCast® Acrylic, Solid Surface, Quartz, Birch Ply Edge	31, 40-51, 60
LED Edge Lit	62-63
Powered	64-65
Training and Small Table Tops	32-39
Team Tables	124-125, 160-161
Towers	
Laminate	242-244
Steel	210, 334
Training Tables	32-39, 104-107, 110-112, 128-135, 138-139, 142-143
Upholstered (Lounge) Seating	364
Video Sharing (VS)	74-77, 365
Wall Cubbies	193
Whiteboards	198-199
Worksurfaces	
Tables	32-65
Workstations	316-324

Notes

Enwork Sales, Customer Service, & GSA Information

Sales and Customer Service Center

Enwork

12900 Christopher Drive

Lowell, MI 49331

TEL 800.815.7251 FAX 616.987.9446 (8 a.m. to 5:30 p.m. EST)

www.enwork.com

info@enwork.com | quotes@enwork.com | orders@enwork.com | literature@enwork.com | gsainfo@enwork.com

GSA Customer Information

For questions, email gsainfo@enwork.com or call customer service at 800.815.7251. See the GSA Price List on www.enwork.com/government for an exact listing of products.

Maximize your dollar further without sacrificing aesthetic design, quality or service with Enwork.

We are pleased to offer our products and services to government, state, and non-state agencies through several state contracts and our GSA Schedule GS-28F-0028U.

Online access to contract ordering information, terms and conditions, and up-to-date pricing is accessible at www.enwork.com/government.

If you have any questions regarding contract specifics:

Contact Customer Service at 800.815.7251

Email gsainfo@enwork.com

Or email one of the contacts provided at <http://enwork.com/government/enwork-contacts/>

FSC Class 7100 – Office Furniture

Contractor: ASSA Group, Inc.

Ordering Address:

12900 Christopher Dr., c/o Participating Dealer (if applicable)

Lowell, MI 49331

Contract Number: GS-28F-0028U

Contract Period: June 4, 2008 through June 3, 2018

Business Size: Small

Cage Code: 4N2C2

DUNS: 166580121

EIN: 20-4467006

NAICS No: 337211 (Primary), 337214

Actively registered in System for Award Management (SAM)? Yes

Electronic Pricing, SIN categories, and additional information available at: <http://1.usa.gov/WciCL3>

Ordering and Shipping

Order Information

Order Processing

Orders are processed by fax (616-987-9446) or email (orders@enwork.com)

Acknowledgments

All orders will be acknowledged within 24 hours unless clarification, special engineering, or material sourcing is needed. Orders will be accepted, manufactured and invoiced based upon the information and terms on the acknowledgment. If there is any discrepancy, it is the responsibility of the dealer to notify our Customer Service department immediately at 800-815-7251.

Quoting Department

- > For any special provisions, requests, or pricing questions, submit an email to quotes@enwork.com and our department will work quickly and efficiently to answer your questions.
- > Quotes are typically turned around within 24-48 hrs.

Changes and Cancellations

Change or cancellation requests must be made in written form. Orders may not be changed or cancelled without the written consent of Enwork. Per the following guidelines, Enwork may accept changes if an order is in progress and/or material has been ordered.

- > Order is within 7 business days of shipping; Enwork cannot change or cancel without 100% fee.
- > Order is scheduled to ship more than 7 business days from receipt of written request: Dealer will be responsible for any manufacturing costs incurred as well as a \$250 (net) change/restock fee.

Product Non-Obsolescence Policy

Enwork reserves the right to make changes in product design, or detail, and to discontinue any product or material without notice. Enwork will make a good faith effort to maintain product compatibility within our various generations of product platforms to provide our customers with spaces that adapt to change. Enwork's non-obsolescence policy commits to provide our customers with products of comparable function or operational characteristics for a term equal to the warranty period.

Shipment of Goods

Enwork ships products in the most efficient manner. Direct shipments and arrival appointments are available upon request for full truck load shipment. These appointments are occasionally delayed by unforeseen circumstances, including traffic, equipment problems, inclement weather, and local limitations for large trailers. For shipments less than a truck load in size, Enwork will work with carriers to try to meet specific delivery date requests. **Enwork does not guarantee arrival times for small orders (less than a truckload (LTL)).** Delivery by appointment (e.g. 9 am) is possible for an upcharge. Most of Enwork's LTL carriers can provide a 2-4 hour window in advance for delivery. Standard deliveries are made Monday through Friday between the hours of 8:00am and 5:00pm. The receiving party is responsible for unloading all freight at time of delivery. If your delivery requires special accommodations not outlined here (e.g. driver assist), please contact Enwork prior to shipment. Accommodations may carry an upcharge.

All tracking information can be found in the Dealer section of www.enwork.com. Tracking information isn't available until the day after the products have shipped.

Transit Time Guide (in business days – not guaranteed)

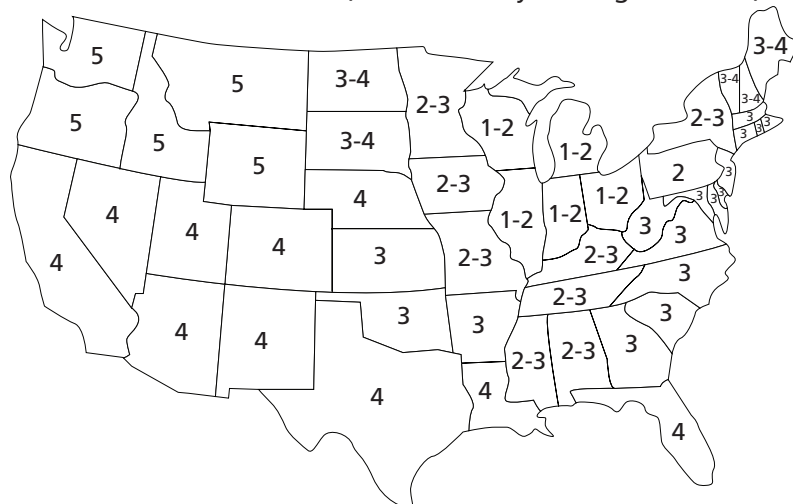

Ordering and Shipping

International Shipping

Enwork will drop ship to any US port of embarkation (excluding Alaska & Hawaii) and will not be responsible for any additional packaging required after that point. Products that come standard assembled can be KD upon request. Enwork will provide estimated weight & cube, but the dealer or freight forwarder is responsible for all customs/shipping paperwork as well as marine insurance. Product title transfers at port of embarkation.

Storage of Completed Orders

Enwork cannot store product beyond the acknowledged ship date. In the event that a customer cannot accept delivery of a finished order, the customer can request that the order is shipped to an alternate address. In the event that no alternate address is provided, Enwork may choose to send the product to a storage facility. The customer will be responsible for charges associated with storage (including transportation to storage) as well as damage or loss risks.

Freight and Minimum Quantities

- > Product is FOB Enwork freight prepaid in the continental United States. Title passes to dealer when it leaves our dock.
- > Orders less than \$1000 net are assessed a \$100 net freight fee with two exceptions.
 - > A \$30 freight fee per chair or box applies to chair orders of 1-3 units. For orders of 4 or more chairs, a freight fee of \$100 net is applied to orders less than \$1000 net. Refer to the Ordering Information for each chair.
 - > There is no freight fee for orders less than \$100 net that can be sent FedEx (e.g. small legs, brackets and lighting).

Lead Time

Lead times vary. For current lead times by product category, consult Resources/Dealer Support at www.enwork.com.

Mock-ups

An accelerated lead time is available. Enwork will notify you of the anticipated ship date on your Order Acknowledgment.

Terms and Conditions

Exclusive Application of Terms and Conditions. These terms and conditions apply to all sales and related dealings between you, the customer ("Buyer"), and ASSA Group, Inc., also known as Enwork, a Michigan corporation ("Seller"). No additional or contrary terms, whether contained in an order, acknowledgment, or other document from Buyer, shall be binding upon Seller unless agreed to in writing signed by an authorized officer of Seller, and Seller expressly rejects all such additional or contrary terms as may be contained in Buyer's documents. Seller's performance is conditioned on Buyer's unmodified consent exclusively to these Terms and Conditions. BUYER'S ACCEPTANCE OF ANY TENDER OF DELIVERY CONSTITUTES ACCEPTANCE OF ALL OF THESE TERMS AND CONDITIONS.

Price, Payment & Delivery. All prices are those indicated on this document or a separate term sheet incorporated by reference. If pricing is based on Buyer purchasing a certain quantity of goods and Buyer subsequently reduces the quantity purchased, whether by return, cancellation or otherwise, the pricing will be adjusted based on the amount actually purchased. The price and terms of this Agreement are confidential and Buyer shall not disclose them to any person or entity without Seller's written consent, other than to essential personnel. Seller reserves the right at any time to demand payment in advance of shipment. Prices are subject to change at any time without notice. Prices do not include handling or taxes, and Buyer is responsible to pay all taxes of any type or kind regardless of whether collected by Seller. The purchase price is due and payable 30 calendar days from the date of invoice or the date of delivery, whichever is sooner. Seller may refuse to ship where Buyer is in default under this Agreement or any other agreement between the parties. Any payments not timely received by Seller will accrue interest at a rate of 1.5% per month, unless not permitted by law, in which case the interest charge shall be the highest rate permitted by law. In order to ensure payment, and in addition to all security interests granted by operation of law, Buyer grants Seller a security interest in all items sold pursuant to this Agreement and agrees to allow Seller to sign all documents allowing Seller to perfect this security interest. In the event that such items could be deemed to be inventory, Buyer agrees to allow Seller to do all things necessary to perfect its security interest including, but not limited to, notifying existing secured parties and filing a financing statement prior to delivery of the goods. If any payment required under this Agreement is past due, Buyer shall be in default and Seller may exercise all of its legal rights and remedies, including those set forth in Articles 2 and/or 9 of the Uniform Commercial Code. Delivery is F.O.B. Seller's point of shipment. Title passes on Seller's delivery to the carrier. Delivery dates are estimates only, and Seller is not responsible for any delays of any type or kind. Seller may cancel this Agreement without advance notice in the event of Buyer's breach, for failure to give adequate assurances of future performance after Seller's request for such assurances, or for any other reason in Seller's sole discretion. If Buyer terminates this Agreement, it shall only do so on 30 days advanced written notice, and Buyer will remain liable to Seller for all costs, commitments and liabilities incurred by Seller while fulfilling its obligations under this Agreement, including overhead allocated by Seller to such costs and Seller's anticipated profit from this Agreement. If this Agreement is placed in the hands of an attorney for collection of any amounts due, Buyer shall pay all of Seller's actual attorneys fees and costs of collection.

Warranty

Exclusive 10 Year Limited Warranty

Enwork warrants that the goods shall be free from defects in materials or workmanship for a period of ten (10) years except as follows. Chairs are warranted for single shift, standard commercial usage, defined as a standard 8-hour work day, five days a week, when the product is used by a person weighing less than 250 lbs. Lighting, height-adjustable tables, monitor arms, electrical components, pneumatic cylinders, locks, drawer slides, and glides are warranted for a period of five (5) years. Casters are warranted for a period of one (1) year. There is no warranty for "self-edge" chipping or peeling, or on refrigerators.

Upholstery fabrics, vinyl, and polyurethanes are warranted from defects in material and workmanship for five (5) years except for Pixley, Milan, Capri, Ardi, Reko, and Monaco chairs which are warranted for three (3) years. Customer's own materials (COM) are not covered by this warranty. Consult with upholstery materials suppliers for performance criteria and suitability of individual materials. Textiles and laminates are sold subject to minor variations of color. Since textiles vary in weave, thickness and memory, some creasing and/or gathering may occur during the upholstery application process. Because leather is a natural product, variations of texture are common and should be expected.

This warranty excludes any type of misuse, abuse, as well as ordinary wear and tear.

Pursuant to this warranty, if a product fails under ordinary use as a result of a defect in materials or workmanship, Enwork will, at its option, (a) repair the affected product at no charge, (b) replace the affected product at no charge with a new or refurbished product of comparable function, performance, and quality, or (c) refund the original purchase price for the affected product if repair or replacement is not commercially practicable or cannot be completed in a timely manner. This warranty applies solely to the original Buyer with the period starting on the date of shipment, and only for products shipped to and sold for use in the U.S. and Canada. This is Enwork's sole and exclusive warranty, and the Buyer waives all others.

The foregoing warranty shall not apply to damage caused under the following circumstances: (a) damage caused during shipping (this will be handled under separate terms); (b) modifications or attachments to the product that are not Enwork approved; (c) products that were not installed, used or maintained in accordance with product instructions and normal industry practice; (d) products used for rental purpose; (e) damage caused by misapplication of cleaning product; (f) natural variations in wood grain, figure, or the presence of character marks; or (g) changes in surface finishes due to aging or exposure to light. If a damaged product is repairable, Enwork may, at its option, permit the Buyer to repair the item and Enwork will issue a credit to the Buyer in accordance with Enwork's repair allowance schedule.

Warranty Disclaimer. Enwork expressly and unconditionally disclaims any and all warranties, express or implied, including but not limited to any warranties of fitness for a particular purpose or merchantability, or warranties based on oral representations from Enwork's personnel or agents, affirmations, models, drawings, samples, promotional literature whether in print, on the internet or in any other format or media.

Limitation of Liability. Enwork's maximum cumulative liability to buyer shall not exceed the purchase price of the goods claimed defective. In no event shall Enwork be liable for any indirect, incidental, special or consequential damages of any type or kind, including but not limited to lost profits, lost business opportunities or lost goodwill, relating to the goods sold hereunder, their installation or use, whether in contract, tort pursuant to statute or otherwise, even if Enwork has been advised of the possibility of such damages.

Indemnity. Buyer shall indemnify and save Enwork harmless from and against all claims of any type or kind for personal injury or property damage, including all costs and attorney's fees, made or alleged as a result of Buyer in any way or manner incorporating or installing any item purchased herein into another product manufactured, assembled, sold or marketed by Buyer.

No Design or other services provided. . This agreement involves the sale of goods only. Buyer does not hire Enwork to perform any design services or for the production of any drawing or other media relative to the goods sold pursuant to this Agreement or Buyer's end product. To the extent that Enwork offers any advice or produces any drawings or other media, Enwork does so as a courtesy to the Buyer and Buyer agrees that it will not rely on such advice, drawing or other media and Enwork shall not be liable for any matter arising from such advice, drawings or other media. Buyer shall have no recourse against Enwork for any services of any type or kind. Buyer shall be solely and exclusively responsible for use and/or installation of all items purchased herein. The items sold herein are based on Buyer's descriptions and Buyer bears sole responsibility for ensuring that the products sold meet Buyer's needs and expectations and are suitable for Buyer's intended use. Enwork is not responsible for Buyer's inaccurate or inadequate design or Buyer's furnishing of incorrect information.

Correction of Errors. Enwork shall have the right to correct any errors, whether clerical or mathematical, which are contained in this Agreement or any term sheet or invoice.

Warranty, Returns and Allowances, and Pricing

(Warranty Continued)

Disputes. All disputes of any type or kind, shall be determined by a court of competent jurisdiction which is situated in Kent County, Michigan. Buyer irrevocably consents to such exclusive venue and jurisdiction.

Miscellaneous. Buyer shall not assign any rights under this Agreement without the prior written consent of Seller. Failure to exercise any rights under this Agreement shall not constitute a waiver and a waiver on one occasion will not constitute a waiver of the same item on any subsequent occasion. No waiver or amendment to this Agreement shall be effective unless it is in writing and signed by authorized representatives of both parties. Paragraph headings are for reference only and are of no legal force or effect. All notices shall be provided to the addresses set forth in this Agreement and if none is provided, to the party's resident agent in the state of incorporation or organization. This Agreement shall be governed by the law of the State of Michigan without regard to any conflicts of law principles. Wherever possible, all terms shall be interpreted consistently. In the event of a conflict with regard to price, payment terms or delivery, the typed provisions on a separate or attached term sheet shall control over the printed provisions on this Agreement. For any other conflict, these Terms and Conditions shall control. No usage in trade shall create a conflict with the terms of this Agreement. Seller reserves the right to correct any typographical errors anywhere in this Agreement. A facsimile signature or a legally valid electronic substitute for a signature shall bind Buyer. If any provisions are determined to be unenforceable, the remainder of the Agreement shall remain in full force and effect.

Entire Agreement. This is the complete and exclusive statement of the terms and conditions relating to the subject matter of this Agreement and all negotiations and representations, if any, made prior to the execution of this Agreement are merged into this Agreement. Seller shall not be bound by any agent's or employee's representations, promises, or inducements not set forth in this writing unless such representation, promise or inducement is set forth in writing, dated subsequent to this Agreement, and signed by an authorized officer of Seller.

Product Issue Instructions

Shipping Damages and Claims

Should you receive any portion of a shipment in damaged condition, either apparent or concealed, it is the duty of the customer to note any suspected damage on the carrier's delivery receipt, to accept the damaged goods, and to contact Enwork immediately to begin the freight claim process. Do not install damaged product. All damaged product and packaging must be retained until the freight claim is settled. Failure to retain damaged product and packaging will result in a transfer of liability from Enwork to the customer. Enwork will not warranty custom one-piece tops over 96" from freight damage. **Concealed Damage:** Enwork has 15 days from receipt to file a concealed damage claim with the carrier. Failure to report concealed damage to Enwork within 10 days of receipt will result in a transfer of liability from Enwork to the customer. All returns and allowances requests/questions can be submitted to info@enwork.com.

Defective Products

Enwork may request samples, photos, or videos demonstrating the defect before further action. No merchandise shall be returned or scrapped without prior approval from Enwork. All unauthorized returns may be refused by Enwork and returned to the customer. Credit or reimbursement will be issued for the original purchase price or a replacement will be sent. Enwork reserves the right to request the return of any or all of the defective products. Enwork also reserves the right to repair defects in the field with an Enwork-provided repair team.

Repair Authorization

Requests for Enwork funded repairs by Enwork dealers must be submitted in writing prior to repair work. Repairs made without Enwork's consent will not be funded. Repair costs for warranty or defect issues must be reasonable.

Credit for Returned Goods

Credit will not be honored for returned merchandise until all returned goods have been checked by the Enwork Quality Control Division.

Pricing

Prices in this Price List are United States list prices and include freight (subject to minimum order quantities) within the continental U.S. and to most of Canada. Canadian market orders can be invoiced and paid in U.S. or Canadian dollars. Enwork's USD:CAD conversion rate is posted on www.enwork.com and typically updated quarterly. Canadian market orders must specify USD or CAD on the order. The Canadian Dollar price will be based on the conversion rate in effect at the time the order is received. For convenience, the exchange rate and GST will be included as separate line items on order acknowledgements and invoices.

Lock Program

Lock program does not apply to eBench mobile peds.

Lock Cores

Lock cores are LL Series. UM Series and alternate lock cores on select products are available upon request.

Keyed Random

Random locks automatically ship with the product unless otherwise specified. Random means no effort has been made to match key numbers, or to make them different.

Keyed Alike

For the convenience of the user, furniture may be keyed alike at no charge. Using the keyed alike instructions, order lock cylinders and keys as line items on your purchase order. The Enwork Grand Rapids Lock Center will select key numbers. Key numbers will not be repeated unless the standard range has been exceeded. Lock cylinders will ship separately from the product, ready for field installation.

Installing Lock Cylinders

Installation of lock cylinders will be on-site. Enwork will not be responsible for lock cylinder installation. Lock cylinders are installed or removed using a change key. A change key is provided at no charge with each key-alike request. To order additional change keys, specify part number NWCHANGE (\$20 list) on your purchase order. Cylinders must be in the unlocked position to be removed.

Lock Distribution

All lock orders are packaged and shipped from the Grand Rapids Lock Center, regardless of where the products are manufactured. Lock cylinders and keys will ship via FedEx. Please provide a contact name on your purchase order to receive the keys.

Lock Part Numbers

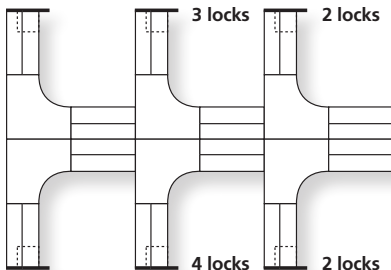

Part #	Description	List Price
NWSPEC2	Set of 2 locks	N/C
NWSPEC3	Set of 3 locks	N/C
NWSPEC4	Set of 4 locks	N/C
NWSPEC5	Set of 5 locks	N/C
NWCHANGE	Change Key	\$20
NWMASTER	Master Key	\$20

How to Specify Keyed Alike

Following is an example of how to specify keyed alike locks for a 6-pack of workstations.

Step 1 – Using the floor plan (left), count the number of locks in each workstation.

Step 2 – Count the number of workstations with the same quantity of locks. Group together the workstations with a like number of locks.

3 workstations with 4 locks per station

1 workstation with 3 locks per station

2 workstations with 2 locks per station

Step 3 – For the first group (3 sets of 4 locks), enter the number of workstations in the quantity column.

QTY	Part #	Description	List Price	Ext. List
3				

Step 4 – Then enter the part number NWSPEC__ and add a suffix for the number of locks for that group (i.e. for 4 locks per station, add the suffix "4").

Step 5 – Repeat for other groups.

QTY	Part #	Description	List Price	Ext. List
3	NWSPEC4	Set of 4 locks	N/C	N/C
1	NWSPEC3	Set of 3 locks	N/C	N/C
2	NWSPEC2	Set of 2 locks	N/C	N/C

Enwork will select key numbers for each set from the available numbers.



Tables

Tops

Bases and Legs

Power Data

Support Furniture

Accessories

Revisions

P21	03/17	Clear knife edge undercut color
P54	03/17	Step 2 Grommet (one, center) +\$18
P82	03/17	EBZ4896 and EBZ6096 have inset legs at center of table
P111, 116,132 142,144	03/17	Routing hole option available
P170	03/17	PDEJUMPXX description

Enwork Product Information

Product Information

Worksurfaces (Tops)

Worksurfaces are made of 1-3/16" M3 rated 45-pound, furniture-grade particle board, laminate and backer. Wood cores have ISO 140001 certification and are made from 98-100% post-industrial recycled contents. Wood cores have been granted Environmentally Preferable Product Certification by the CPA relating to their formaldehyde emissions, which are less than 0.09 PPM (CARB phase 2) meeting the current California Air Resources (CARB) requirement.

Grain Direction on all wood grain laminates runs as shown below. Alternative grain directions are available for a charge.

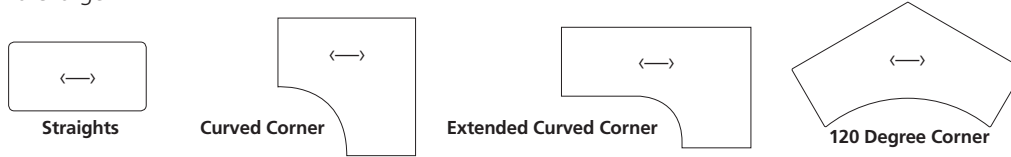

Grid Worksurface Sizing Grid worksurfaces can be sized to fit into Enwork Grid frames or into another manufacturer's panel system (ex.: Steelcase Kick®, Herman Miller Action Office®) as a blending solution. If you do not see a particular system in our price list, specify "M" for "Other" along with the manufacturer and system name so Enwork can work with you to fulfill your order.

Standard Laminate worksurfaces are made of High Pressure Laminate (HPL) and pass all applicable industry specifications. Edge choices include 3mm, Knife or PVC Ply. Grid worksurfaces will have the selected edge profile on the front edge and a 1mm edge on the sides and back to accommodate tight worksurface-to-worksurface fit. Table worksurfaces have the 3mm or 3mm Ply PVC Edge all the way around the worksurface.

Contour Laminate worksurfaces offer a seamless look (no visible edgebands or t-molds) and the attractive ergonomic Taper edge. They are made of rigid thermofoil plastic (RTF) which provides quality levels that are comparable to HPL, but are slightly more susceptible to nail polish remover and heat. Maximum depth of contour laminate is 48."

Veneer Worksurfaces are available in Maple, Cherry, and Walnut. Maple, Cherry, and Walnut have an open pore finish, are natural slip-matched and full-cut (not quartered). Veneer layup on 2-piece conference table tops is long grain.

Veneer Stains are defined by species:

- > Maple veneer is stained to match Kensington Maple (D) laminate.
- > Cherry veneer is stained to match either Wild Cherry (J) or Select Cherry (9) laminate.
- > Walnut veneer is stained to match either Cafelle (N), or Prestige Walnut (8) laminate.
- > Alternative stains are available upon request. The fee to match a stain is \$700 list. Additionally, there is a 10% upcharge to each item's list price. The matching and approval process must take place prior to order entry. For stain matching approval process email quotes@enwork.com or call customer service at 800.815.7251 for information.

Laminate Tables with wood edge have the following solid wood edge thicknesses (top view):

1. 3mm edge is 0.12" wide.
2. Taper edge is 1.75" wide.
3. Knife edge is 1.9" wide.
4. Bullnose edge is 1.25" wide.

Veneer Tables with wood edge have the following solid wood edge thicknesses (top view).

1. 3mm edge is 0.12" wide.
2. Knife edge is 0.12" wide (3mm). Undercut is MDF stained to match.
3. Bullnose edge is 1.25" wide.
4. Taper edge is 1.75" wide.
5. Ultra edge is 1.75" wide.

Enwork Product Information

TOPS	TABLES STEP 1 - TOPS
BASES	
POWER DATA	
SUPPORT FURNITURE	
ACCESSORIES	

Cable Management Solutions are offered in a variety of styles. The following options are available:

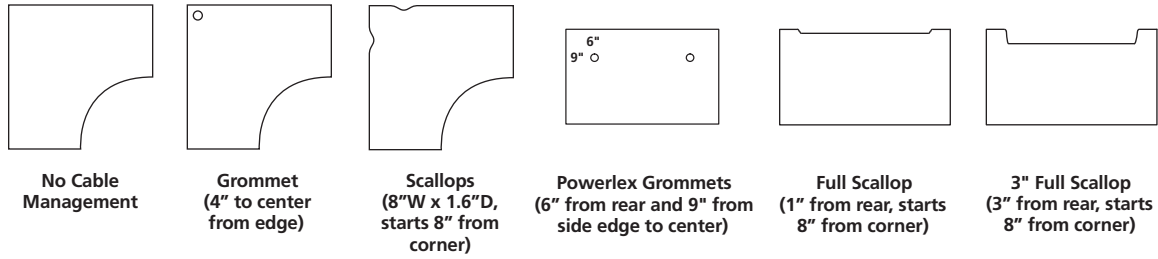

Edge and Grommet Finish Defaults

Enwork offers the following HPL laminate finishes with default edge colors:

Laminate Name	Finish Letter	3mm/Knife Edge Color	Grommet Color	Knife Edge Undercut Color
Wilsonart Kensington Maple (10776-60)	A	Kensington Maple	Grey	Clear
Wilsonart Monticello Maple (7925-38)	B	Monticello Maple	Grey	Clear
Wilsonart Wild Cherry (7054-60)	C	Wild Cherry	Black	Clear
Wilsonart Fashion Grey (D381-60)	E	Fashion Grey	Grey	Clear
Wilsonart White Tigris (4783-60)	F	Medium Grey	Grey	Clear
Wilsonart Cafelle (7933K-07)	G	Cafelle	Black	Clear
Wilsonart Frosty White (1573-60)	M	Frosty White	White	Clear
Wilsonart Slate Grey (D91-60)	P	Slate Grey	Grey	Clear
Wilsonart Black (1595-60)	R	Black	Black	Clear
Wilsonart Brazilwood (7946-38)	U	Brazilwood	Grey	Clear
Wilsonart River Cherry (7937-38)	V	River Cherry	Grey	Clear
Wilsonart Designer White (D354-60)	W	Designer White	White	Clear
Formica Neutral Twill (8826-58)	3	Neutral Twill	Grey	Clear
Formica Bleached Legno (8845-58)	4	Bleached Legno	Grey	Clear
Formica Prestige Walnut (6209-43)	5	Prestige Walnut	Black	Clear
Formica Select Cherry (7759-43)	7	Select Cherry	Black	Clear

Tip: Contour Laminate default grommet colors are as follows: Natural Maple (Grey), Designer White (Grey), Hayward Cherry (Black), Studio White (Grey), Urban Walnut (Black), River Cherry (Grey).

Tip: Veneer default grommet color is black. Laminate with veneer edge grommet color defaults to the laminate.

Tip: Additional 3mm edge colors can be used. For availability and pricing, email quotes@enwork.com.

Tip: When specifying a special laminate, please freeform a standard edge color on order. If a non-standard edge is needed, contact quotes@enwork.com for availability and pricing.

Paint Finishes

Enwork offers the following paint colors:

Paint/Name	Finish Letter
Black	R
Slate Grey	G
Silver	S
Medium Tone	T
Arctic White (textured)	W

Some Steelcase, Herman Miller, Knoll, Haworth, and Allsteel paints are available for a \$350 List fee per order. Call/email for availability of specific colors. Additional custom paints (e.g. Tiger Dry Lac) must be quoted through quotes@enwork.com.

Enwork Finishes

S = Standard
U = Upcharge

	Tables						
	Tops	Solano CT-Series	Gyration 2.0	Legs and Bases (except Solano and Gyration 2.0), Modesty	Affinity	Apex	Grid
Fabrics							
Ped Cushions - Camira Era and the Mill Collection						S	S
Tackboards/Grid - Camira Mill L2 and Lucia				S		S	
For Pixley fabric information, see page 364							
For Seating fabric & mesh information, see pages 346-369							
Top Laminates							
Wilsonart Kensington Maple (10776-60 Matte Finish)	S				S	S	S
Wilsonart Monticello Maple (7925-38 Matte Finish)	S				S	S	S
Wilsonart Wild Cherry (7054-60 Matte Finish)	S				S	S	S
Wilsonart Fashion Grey (D381-60 Matte Finish)	S				S	S	S
Wilsonart White Tigris (4783-60 Matte Finish)	S				S	S	S
Wilsonart Cafelle (7933K-07)	S				S	S	S
Wilsonart Black (1595-60)	S				S	S	S
Wilsonart Frosty White (1573-60)	S				S	S	S
Wilsonart Designer White (D354-60 Matte Finish)	S				S	S	S
Wilsonart River Cherry (7937-38 Matte Finish)	S				S	S	S
Wilsonart Slate Grey (D91-60)	S				S	S	S
Wilsonart Brazilwood (7946-38)	S				S	S	S
Formica Neutral Twill (8826-58, Matte Finish)	S				S	S	S
Formica Bleached Legno (8845-58, Matte Finish)	S				S	S	S
Formica Prestige Walnut (6209-43 Artisan Collection)	S				S	S	S
Formica Select Cherry (7759-43, Artisan Collection)	S				S	S	S
Top Laminates, Contour							
Natural Maple	S						S
Hayward Cherry	S						S
Studio White Matrix	S						S
Designer White	S						S
Urban Walnut	S						S
River Cherry	S						S
Top and Casegoods Veneers							
Maple	S			S			
Cherry	S			S			
Walnut	S			S			
Laminate Casegoods							
Wilsonart Kensington Maple (10776-60)				S	S		S
Wilsonart Monticello Maple (7925-38)				S	S		S
Wilsonart Wild Cherry (7054-60)				S	S		S
Wilsonart Fashion Grey (D381-60)				S	S		S
Wilsonart Cafelle (7933K-07)				S	S		S
Wilsonart Black (1595-60)				S	S		S
Wilsonart Frosty White (1573-60)				S	S		S
Wilsonart Designer White (D354-60)				S	S		S
Wilsonart River Cherry (7937-38)				S	S		S
Wilsonart Slate Grey (D91-60)				S	S		S
Wilsonart Brazilwood (7946-38)				S	S		S
Formica Bleached Legno (8845-58)				S	S		S
Formica Neutral Twill (8826-58, Matte Finish)				S	S		S
Formica Prestige Walnut (6209-43)				S	S		S
Formica Select Cherry (7759-43)				S	S		S
Paints							
Black			U	S	S	S	S
Slate Grey			U	S	S	S	S
Silver		S	S	S	S	S	S
Medium Tone			U	S	S	S	S
Arctic White (textured)		S	U	S	S	S	S

Enwork Supports and Bracing

Worksurface (Top) Support and Bracing Rules

- > **Conference and training table tops 60" wide and wider come with support braces (NWBRACE) at no charge, if required. See page 24 for a list of how many braces are included per top.**
- > **Grid worksurfaces do not include braces due to unknown applications (peds, lats, etc.).** Standard laminate worksurface (NWBRACE) support is required on unsupported spans 54"W and wider. Supports can be fixed peds, legs, or braces.
- > **The maximum allowable span between legs or supports is 72" - even with braces.**
- > As an alternate to braces, legs may be inset from table ends.
- > All 30"D tops 72"W or wider, as well as tops 36"D or deeper and 60"W or wider, require two braces instead of one. Braces are included automatically on all conference and table tops, if required.
- > Foundation Panel Base Trough Kits, Stealth, Lugano, and Concurrence conference tables are designed with support and don't utilize stand-alone (NWBRACE) braces.

TOPS	TABLES STEP 1 - TOPS
BASES	
POWER DATA	
SUPPORT FURNITURE	
ACCESSORIES	

Any Top - Any Base

Any Top

Any Base

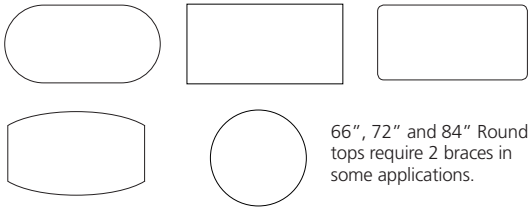

66", 72" and 84" Round tops require 2 braces in some applications.

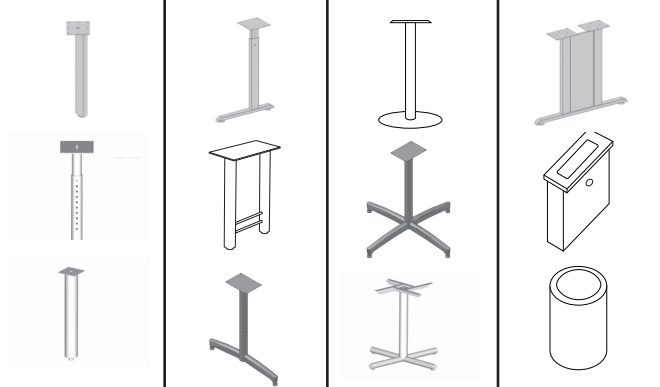

	Depth	Width	Number of Straight Legs	Number of T/C/H Legs	Number of X/Disc Bases	Number of Conf. Bases	Number of Braces
	18/24/30	30	4	2	1	n/a	0
	18/24/30	36	4	2	1	n/a	0
	18/24/30	42	4	2	1	n/a	0
	18/24/30	48	4	2	2	n/a	0
	18/24/30	54	4	2	2	n/a	0
	18/24/30	60	4	2	2	n/a	1
	18/24/30	66	4	2	2	n/a	1
	18/24/30	72	4	2	2	n/a	1
Worksurfaces longer than 72" must have a third leg in the middle or legs must be inset to a maximum span of 72".	18/24/30	78	4 or 6	2* or 3	2*	n/a	1
	18/24/30	84	4* or 6	2* or 3	2*	n/a	1
	18/24/30	90	4* or 6	2* or 3	2*	n/a	1
	18/24/30	96	4* or 6	2* or 3	2*	n/a	1
	36/42	36	4	2	1	n/a	0
	36/42	42	4	2	1	n/a	0
	36/42	48	4	2	1	n/a	0
	36/42	54	4	2	2	n/a	0
	36/42	60	4	2	2	n/a	2
	36/42	66	4	2	2	n/a	2
	36/42	72	4	2	2	n/a	2
	36/42	78	4* or 6	2* or 3	2*	2*	2
	36/42	84	4* or 6	2* or 3	2*	2*	2
	36/42	90	4* or 6	2* or 3	2*	2*	2
	36/42	96	4* or 6	2* or 3	2*	2*	2
	48	48	4	2	1	2	0
	48	54	4	2	2	2	0
	48	60	4	2	2	2	2
	48	66	4	2	2	2	2
	48	72	4	2	2	2	2
	48	78	4* or 6	2* or 3	2*	2*	2
	48	84	4* or 6	2* or 3	2*	2*	2
	48	90	4* or 6	2* or 3	2*	2*	2
See page 23 and 25 for more information.	48/60	96	4* or 6	2* or 3	2	2**	2
	48/60	108	6**	3**	3**	3**	0
	48/60	120	6**	3**	3**	3**	0
	48/60	132	6**	3**	3**	3**	0
	48/60	144	6**	3**	3**	3**	0
	48/60	156	6**	3**	3**	3**	0
	48/60	168	6**	3**	3**	3**	4
	48/60	180	6**	3**	3**	3**	4
	48/60	192	6**	3**	3**	3**	4
	48/60	204	8**	4**	4**	4**	0
48/60	216	8**	4**	4**	4**	0	
48/60	228	8**	4**	4**	4**	6	
48/60	240	8**	4**	4**	4**	6	

Base Locations

Foundation, Statement Individual Panel Base Location

96" Table

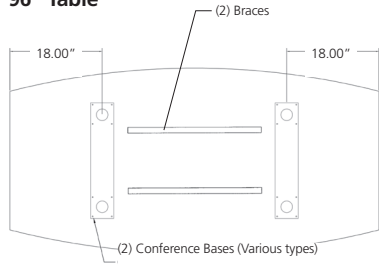

108"-156" Table

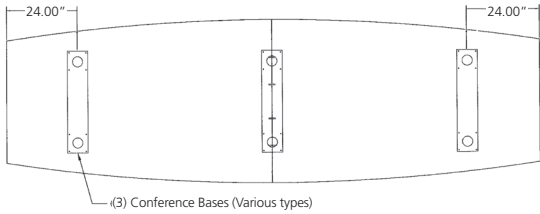

168"-192" Table

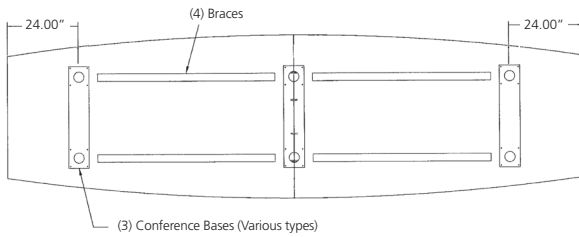

204"-216" Table

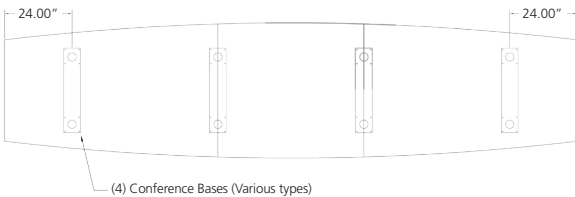

228"-240" Table

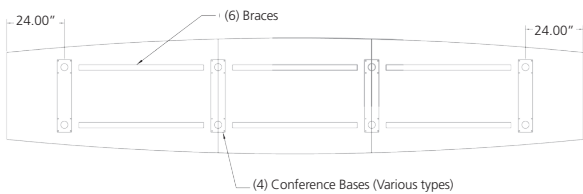

Foundation Panel Base and Trough Kits

72"-96" Table

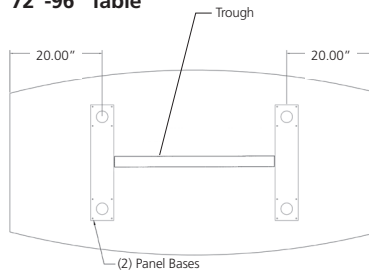

108"-192" Table

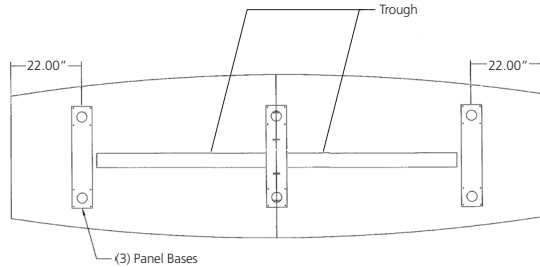

204"-240" Table

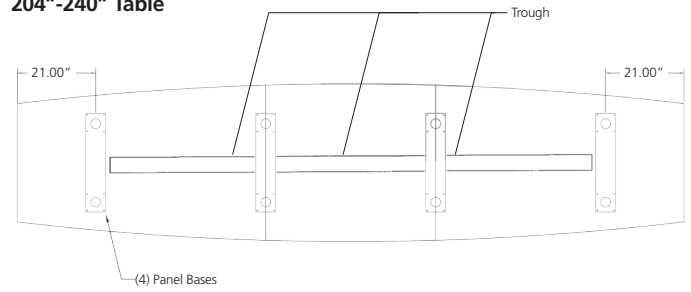

Concurrence and Stealth Base and Trough Tables

72"-96" Table

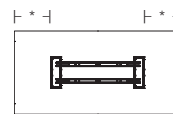

108"-168" Table

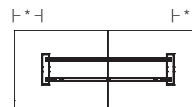

180"-192" Table

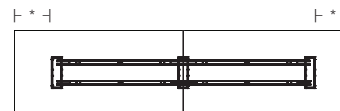

204"-240" Table

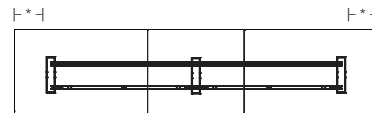

Table Width	Concurrence	Stealth	Overhang*
72	16.4"	15.375"	
84	16.4"	15.375"	
96	16.4"	15.375"	
108	22.4"	21.375"	
120	22.4"	21.375"	
132	22.4"	21.375"	
144	22.4"	21.375"	
156	22.4"	21.375"	
168	22.4"	21.375"	
180	22.4"	21.375"	
192	22.4"	21.375"	
204	22.4"	21.375"	
216	22.4"	21.375"	
228	22.4"	21.375"	
240	22.4"	21.375"	

TOPS

BASES

POWER DATA

SUPPORT FURNITURE

ACCESSORIES

TABLES STEP 1 - TOPS

Boat, Ellipse, and Racetrack Table Individual Base "Depth" Recommendations

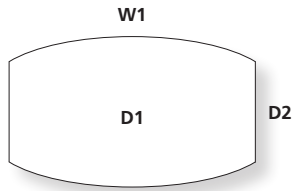

Ordering Information:

- > All bases must be the same depth when using Concurrence Individual Bases with beams.
- > Concurrence and Stealth Base and Trough Kits for 36" and 42" D conference rectangle tops do not fit 36" and 42" D Boat, Ellipse, or Capsule tops because of the tapered ends.
- > Foundation Base Kits are available for 36" and 42" D rectangle tops but not 36" and 42" Boat, Ellipse, or Capsule tops because of the tapered ends.

D1	D2	W1	Individual Panel Base Depth Recommendation for Boat Tables						Total Bases	Knee space Between Bases	
			18"	24"	36"	6"	10"				
36	24	72	2	+	0	+	0	2	*30	*26	
36	24	84	2	+	0	+	0	2	*42	*38	
36	24	96	2	+	0	+	0	2	42	38	
42	30	72	2	+	0	+	0	2	*30	*26	
42	30	84	2	+	0	+	0	2	*42	*38	
42	30	96	2	+	0	+	0	2	42	38	
48	36	72	0	+	2	+	0	2	*30	*26	
48	36	84	0	+	2	+	0	2	*42	*38	
48	36	96	0	+	2	+	0	2	42	38	
48	36	108	2	+	1	+	0	3	24	20	
48	36	120	2	+	1	+	0	3	30	26	
48	36	132	2	+	1	+	0	3	36	32	
48	36	144	2	+	1	+	0	3	42	38	
48	36	156	2	+	1	+	0	3	48	44	
48	36	168	2	+	1	+	0	3	54	50	
48	36	180	2	+	1	+	0	3	*42	*38	
48	36	192	2	+	1	+	0	3	*46	*42	
48	36	204	2	+	2	+	0	4	46	42	
48	36	216	2	+	2	+	0	4	50	46	
48	36	228	2	+	2	+	0	4	54	50	
48	36	240	2	+	2	+	0	4	58	54	
60	48	96	0	+	2	+	0	2	42	38	
60	48	108	0	+	2	+	1	3	24	2	
60	48	120	0	+	2	+	1	3	30	26	
60	48	132	0	+	2	+	1	3	36	32	
60	48	144	0	+	2	+	1	3	42	38	
60	48	156	0	+	2	+	1	3	48	44	
60	48	168	0	+	2	+	1	3	54	50	
60	48	180	0	+	2	+	1	3	*42	*38	
60	48	192	0	+	2	+	1	3	*46	*42	
60	48	204	0	+	2	+	2	4	46	42	
60	48	216	0	+	2	+	2	4	50	46	
60	48	228	0	+	2	+	2	4	54	50	
60	48	240	0	+	2	+	2	4	58	54	

*These individual bases are set in 18" to center from end of table, all others are 24" to center from end of table.

Conference Table Power/Data Standard Cut-outs

Centered (Qty. 1)

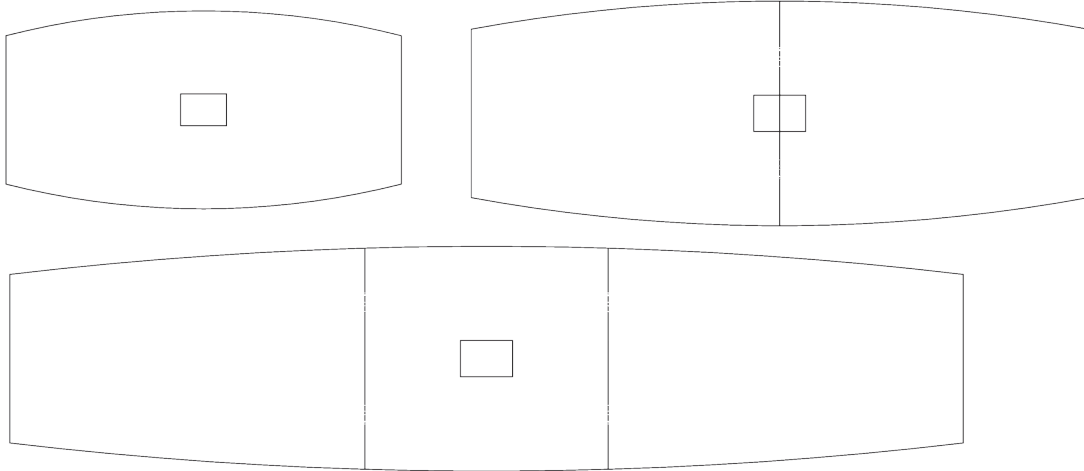

Between Bases (Qty. 2)

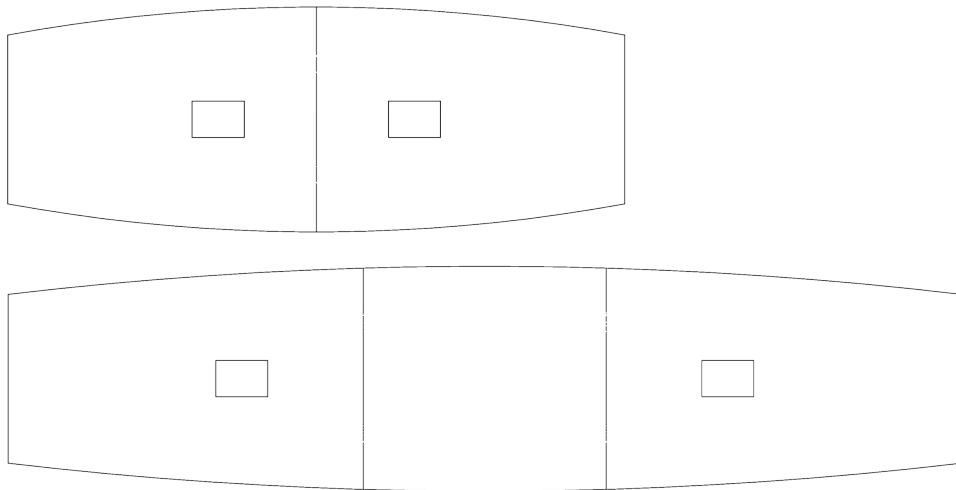

Between Bases (Qty. 3)

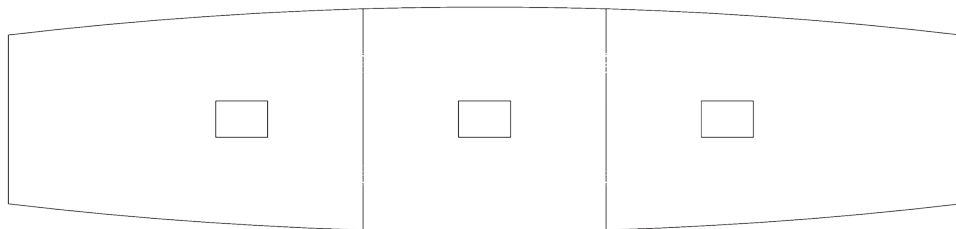

TOPS	TABLES STEP 1 - TOPS
BASES	
POWER DATA	
SUPPORT FURNITURE	
ACCESSORIES	

Table Leg and Base Specifications

Concurrence

- > Base height is 27.75"
- > 7 gauge top plate
- > Aluminum extrusion (.090 wall thickness) construction with particle board support
- > 5" or 12"W individual bases
- > Cable access door optional on 12"W individual base
- > Levelers included

Disc Bases

- > Base height is 27.75", Bar Height is 40.75"
- > 7 gauge top plate
- > Bolted base - 3/8" plate steel
- > Vertical tubing is 3" or 4" tubing and 17 gauge or 14 gauge
- > Levelers (available on select part numbers) have 5/8" adjustment

Foundation Panel Bases

- > Base height is 27.75"
- > 3/4" double sided melamine construction, cam lock and doweled
- > Levelers included

Foundation Drum Bases

- > Base height is 27.75"
- > 1/4" BendiPly wrapping, 3/4" thick HPL construction
- > Levelers included

Gyration

Tubular Legs

- > Leg height is 27.75"
- > 7 gauge top plate
- > Fully welded construction
- > Vertical tubing is 1.5" diameter, 14 gauge
- > Levelers are 3/8-16.1"
- > Casters are 3" Nylon Twin Wheel with brake and all locking

Blade Legs

- > Leg height is 27.75"
- > 7 gauge top plate
- > Fully welded construction
- > Vertical tubing is 1.9" diameter, 14 gauge
- > Feet are made of .6" laser cut plate steel
- > Levelers are 3/8-16x1"
- > Casters are 3" Nylon Twin Wheel with brake and all locking
- > Flip tables lock in up (vertical) and down (horizontal) positions and have a die cast aluminum release handle

Impression

- > Leg height is 27.75"
- > 8 gauge foot and top plate
- Top plate sizes:
 - 6" x 6" – Straight Leg, 4-Post X-Base (qty. 4)
 - 6" x 8" – C, T, TT (qty. 2) Legs
 - 12" x 12" – X-Base
- > Vertical rectangular tubing is 3"x1.5", 14 gauge for all fixed legs
- > Vertical square tubing is 2.5"x2.5", 14 gauge for all fixed X bases and 1.5" x 1.5" for straight legs
- > 12 gauge crossbars on adjustable height legs
- > 20 gauge powerlex modesty
- > Levelers have 1" of adjustment
- > Casters are all locking
- > Flip tables lock in up (vertical) and down (horizontal) positions and have a die cast aluminum release handle
- > Optional Routing Holes are 2"W x 2.75"H

Lugano

- > Post-formed laminate cabinet
- > 11- and 14-gauge steel mitered, tapered plinth and top plate
- > Electric height-adjustable range is 30"-49.5"
- > Electric height-adjustable base supports 300 lbs.
- > Levelers included

Sawhorse

- > Leg height is 27.75"
- > Vertical rectangular tubing is 3"x1.5", 14 gauge
- > Levelers have 1" of adjustment
- > Square tubing is 1.5" x 1.5", 14 gauge
- > 7 gauge top plate

Sensation

- > Leg height is 27.75"
- > 7 gauge top plate
- Top plate sizes:
 - 6" x 6" – Straight Leg, 4-Post X-Base (qty. 4)
 - 6" x 8" – C, T, TT (qty. 2), Y Legs, Split Y-Leg Bases
 - 9.5" x 9.5" – LMXA/LMXB X-Bases
 - 12" x 12" – LMXC/LMXD X-Bases, LMYB Y-Leg Bases
- > Pin set adjustable height is 24.75"-33.75"
- > Welded column, bolted feet construction
- > Feet are made of die cast aluminum
- > Vertical tubing is 2.36" diameter, 14 gauge
- > Levelers are 3/8-16x1"
- > Casters are 3" Nylon Twin Wheel with brake and all locking
- > Flip tables lock in up (vertical) and down (horizontal) positions and have a die cast aluminum release handle
- > Optional Routing Holes are 1.5" diameter.

Solano (formerly Captiva)

- > Leg height is 27.75"
- > 7 gauge steel foot
- > 8 gauge steel top plate
- Top plate sizes:
 - 6" x 6" – Straight Leg, 4-Post X-Base (qty. 4)
 - 6" x 8" – C, T, TT (qty. 2) Legs
 - 12" x 12" – X-Base
- > Vertical rectangular tubing is 3" x 1.5", 14 gauge for all fixed legs
- > Vertical square tubing is 2.5" x 2.5", 14 gauge for all fixed X bases and 1.5" x 1.5" for straight legs
- > 12 gauge crossbars on adjustable height legs
- > 20 gauge powerlex modesty
- > Levelers have 1" of adjustment
- > Casters are all locking
- > Flip tables lock in up (vertical) and down (horizontal) positions and have a die cast aluminum release handle
- > Optional Routing Holes are 2"W x 2.75"H

Solano Fast Crank

- > Height range is 26" - 44" (including top)
- > Lifts 110 lbs when moving, 210 lbs when static (load capacity includes weight of worksurface)
- > Requires approximately two turns per inch

Square Bases

- > Base height is 27.75", Bar Height is 40.75"
- > 7 gauge top plate
- > Bolted base - 3/8" plate steel
- > Vertical tubing is 3" or 4" tubing and 17 gauge or 14 gauge
- > Levelers (available on select part numbers) have 5/8" adjustment

Stealth

- > Base height is 27.75"
- > Aluminum extrusion (.090 wall thickness) construction with particle board support
- > Levelers included
- > 7 gauge top plate

Value

- > Leg height is 27.75"
- > 7 gauge top plate
- > Fully welded construction
- > Vertical tubing is 1.9" diameter, 14 gauge
- > Horizontal feet are 1.9" diameter tubing, 14 gauge
- > Levelers are 3/8-16x1.375"
- > Casters are 2" Nylon Twin Wheel with brake and all locking
- > Flip tables lock in up (vertical) and down (horizontal) positions and have a die cast aluminum release handle

TOPS

BASES

POWER
DATASUPPORT
FURNITURE

ACCESSORIES

TABLES STEP 1 - TOPS

Top (Worksurface) Specifications

General Information on Wood Cores

- > Passes all NEMA and BIFMA tests for high pressure laminate worksurfaces.
- > Core material is 1.125" thick, M3 rated (45 lb.) furniture grade particleboard.
- > FSC Mixed Sources accreditation.
- > ISO 14001 certification for wood cores.
- > Made from 30% post-consumer and 70% pre-consumer recycled content.
- > Eco-Certified Composite Grademark Program (ECC) certified by Composite Panel Association (CPA).
- > CARB Phase 2 compliant for formaldehyde emissions less than 0.09ppm.
- > Adhesives are solvent free water based PVA (poly vinyl acetate).
- > Formaldehyde-free cores are available via special quote at quotes@enwork.com.
- > Tables have a 200 pound load capacity (functional load).

Standard Laminates

- > HPL (high pressure laminate) construction, .030" or .050" thick depending on color.
- > Backer is moisture-resistant phenolic material for balanced construction.
- > Laminates and backers are Greenguard certified for Indoor Air Quality.
- > PVC (default) or ABS (upon request) edge choices in 3mm, and Knife.
- > Other edge choices include Veneer and Solid Wood.

Contour Laminates

- > Commonly known as Rigid Thermofoil (RTF).
- > Contour Laminate is high performance, with comparable durability to HPL laminate.
- > The taper edge is seamless with no visible edgeband or t-molds, offering an inherent anti-microbial sealed surface.

Woods

- > Natural veneers are used in Maple, Cherry, and Walnut species.
- > Two and three piece tops use full-cut slip-matched veneers.
- > Edge choices in 3mm (wood), Taper (solid wood), Knife (wood), Bullnose (solid wood) and Ultra (solid wood).

Designer Finish Top Specifications

Back-Painted Glass

- > 3/8" thick, annealed, flat-polished low iron. Available as clear glass (B) or satin-etched/frosted glass (D). 1-1/8" knife edge MDF substrate painted to match. Bright white as standard. Any Benjamin Moore color available upon request. \$2000 list custom color fee applies for orders of less than 250 sq. ft. There is also a 20% upcharge to each top's list price for custom colors. Actual depth of 60"D tops is 59" due to yield.

KrystalCast®

- > Acrylic on MDF or birch ply is available in any Benjamin Moore color. Super White is by far the most popular. See www.KrystalCast.com for technical specs and care instructions.

Solid Surface (Wilsonart)

- > Designer White as standard. See <http://wilsonart.com/commercial/solid-surfaces/designs> for additional finish/color choices. Price varies by finish/color, contact quotes@enwork.com with your preferred selection.

Quartz (Cambria)

- > See www.cambriausa.com for finish/color choices. 13/16" thick. Undersized 1-1/8" knife edge substrate painted black. Due to sheet size availability, some 60"D (only) tops come in twice the quantity of pieces. (For example, a top that normally comes in 3 pieces will come in 6 pieces.)

Tip: Due to the extra weight, Quartz conference table tops are only recommended for use on Concurrence, Stealth, and Foundation (with trough) table bases.

Birch Ply Edges

- > Edge is clear coated when specified with laminate and stained-to-match when sold with veneer. Actual width of 96"W is 95". Actual width of 192"W is 190" due to yield.

TOPS	TABLES STEP 1 - TOPS
BASES	
POWER DATA	
SUPPORT FURNITURE	
ACCESSORIES	

Training Table Tops (18"D)

STEP 1

(XX) Top Shape Prefix List:

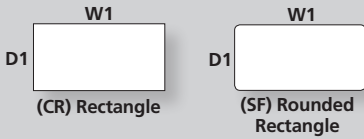

STEP 2

(&) Finish and Edge Suffix List:

- A Standard Laminate – 3mm Edge
- L Standard Laminate – PVC Edge w/ Ply look
- K Standard Laminate – Knife Edge (front only, sides/back flat)
- C Standard Laminate – Knife Edge (all sides)
- T Contour Laminate – Taper Edge
- E Standard Laminate – 3mm Wood Edge
- P Standard Veneer – 3mm Wood Edge

STEP 3

(@) Cable Management Suffix List:

- N No Cable Management No charge
- G Grommet (one, center rear) +\$18
- P Powerlex Grommet (one left, one right) +\$36
- U Power/Data Cut-out (one, center rear) +\$36
- K Power/Data Cut-out (one, center of table) +\$36
- X Other TBD

STEP 4

(#) Laminate Suffix List:

- A Wilsonart Kensington Maple (10776-60)
- B Wilsonart Monticello Maple (7925-38)
- C Wilsonart Wild Cherry (7054-60)
- E Wilsonart Fashion Grey (D381-60)
- F Wilsonart White Tigris (4783-60)
- G Wilsonart Cafelle (7933K-07)
- M Wilsonart Frosty White (1573-60)
- P Wilsonart Slate Grey (D91-60)
- R Wilsonart Black (1595-60)
- U Wilsonart Brazilwood (7946-38)
- V Wilsonart River Cherry (7937-38)
- W Wilsonart Designer White (D354-60)
- 3 Formica Neutral Twill (8826-58)
- 4 Formica Bleached Legno (8845-58)
- 5 Formica Prestige Walnut (6209-43)
- 7 Formica Select Cherry (7759-43)
- X *Wilsonart Non-Premium laminates (-38, -60). +10%
Orders of 100+ units have no upcharge.
- Y *Formica Non-Premium (58, 43, MC, SP and NT finishes) and Wilsonart Premium (-01, -07, -12, -18, -52, -78) laminates. +19%
- Z *Pionite Non-Premium, Nevamar Non-Premium, Formica Premium (WR, 42, 77, 46, RD Finishes), and whiteboard laminates. +25%

*Add \$350 list fee for Special Laminate orders of less than 10 units. See page 21 for edge selection.

(#) Contour Laminate Suffix List:

- G Natural Maple
- R Hayward Cherry
- S Studio White Matrix
- V River Cherry
- W Designer White
- Y Urban Walnut

(#) Veneer Suffix List:

- D Maple (stained similar to Kensington Maple laminate)
- J Cherry (stained similar to Wild Cherry laminate)
- N Walnut (stained similar to Cafelle laminate)
- 8 Walnut (stained similar to Prestige Walnut laminate)
- 9 Cherry (stained similar to Select Cherry laminate)
- X Stain Match (add a one-time \$700 list Stain Match fee) +10%

Ordering Information:

- > **BRACES ARE INCLUDED WITH TABLE TOPS IF REQUIRED. See below for quantities.** (Stealth, Concurrence, and Foundation Trough Kit bases do not need braces). Maximum span between legs is 72".
- > Tops for Grid, XTB, and freestanding height-adjustable table bases can be found on pages 316-324.
- > **A freight fee of \$100 net is assessed on orders less than \$1000 net. See page 13.**

Laminate & Veneer

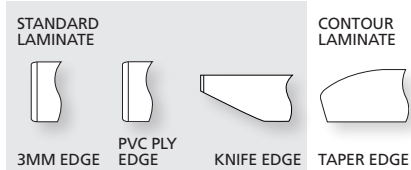

D1	W1	BRACES INCLD.	Part Number	Suffix A	Suffix L	Suffix K Suffix C	Suffix T
18	30	0	- XX1830&@#	\$230	\$264	\$299	\$308
18	36	0	- XX1836&@#	\$249	\$286	\$323	\$337
18	42	0	- XX1842&@#	\$280	\$322	\$364	\$373
18	48	0	- XX1848&@#	\$301	\$346	\$391	\$400
18	54	0	- XX1854&@#	\$372	\$427	\$483	\$497
18	60	1	- XX1860&@#	\$429	\$493	\$557	\$576
18	66	1	- XX1866&@#	\$475	\$546	\$617	\$622
18	72	1	- XX1872&@#	\$475	\$546	\$617	\$622
18	78	1	- XX1878&@#	\$606	\$696	\$787	\$800
18	84	1	- XX1884&@#	\$606	\$696	\$787	\$800
18	90	1	- XX1890&@#	\$619	\$711	\$804	\$843
18	96	1	- XX1896&@#	\$619	\$711	\$804	\$843

TOPS	TABLES STEP 1 - TOPS
BASES	
POWER DATA	
SUPPORT FURNITURE	
ACCESSORIES	

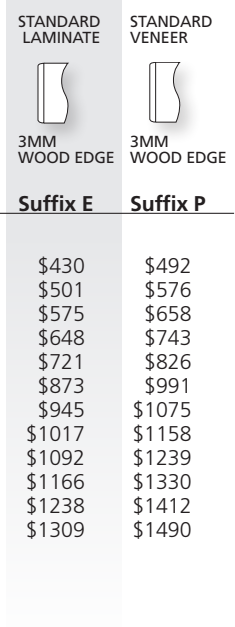

D1	W1	BRACES INCLD.	Part Number	Suffix E	Suffix P
18	30	0	- XX1830&@#	\$430	\$492
18	36	0	- XX1836&@#	\$501	\$576
18	42	0	- XX1842&@#	\$575	\$658
18	48	0	- XX1848&@#	\$648	\$743
18	54	0	- XX1854&@#	\$721	\$826
18	60	1	- XX1860&@#	\$873	\$991
18	66	1	- XX1866&@#	\$945	\$1075
18	72	1	- XX1872&@#	\$1017	\$1158
18	78	1	- XX1878&@#	\$1092	\$1239
18	84	1	- XX1884&@#	\$1166	\$1330
18	90	1	- XX1890&@#	\$1238	\$1412
18	96	1	- XX1896&@#	\$1309	\$1490

Training Table Tops (24"D)

STEP 1

(XX) Top Shape Prefix List:

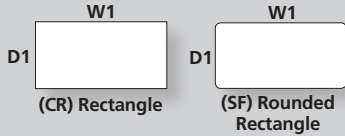

STEP 2

(&) Finish and Edge Suffix List:

- A Standard Laminate – 3mm Edge
- L Standard Laminate – PVC Edge w/ Ply look
- K Standard Laminate – Knife Edge (front only, sides/back flat)
- C Standard Laminate – Knife Edge (all sides)
- T Contour Laminate – Taper Edge
- E Standard Laminate – 3mm Wood Edge
- P Standard Veneer – 3mm Wood Edge

STEP 3

(@) Cable Management Suffix List:

- N No Cable Management No charge
- G Grommet (one, center rear) +\$18
- P Powerlex Grommet (one left, one right) +\$36
- U Power/Data Cut-out (one, center rear) +\$36
- K Power/Data Cut-out (one, center of table) +\$36
- X Other TBD

STEP 4

(#) Laminate Suffix List:

- A Wilsonart Kensington Maple (10776-60)
- B Wilsonart Monticello Maple (7925-38)
- C Wilsonart Wild Cherry (7054-60)
- E Wilsonart Fashion Grey (D381-60)
- F Wilsonart White Tigris (4783-60)
- G Wilsonart Cafelle (7933K-07)
- M Wilsonart Frosty White (1573-60)
- P Wilsonart Slate Grey (D91-60)
- R Wilsonart Black (1595-60)
- U Wilsonart Brazilwood (7946-38)
- V Wilsonart River Cherry (7937-38)
- W Wilsonart Designer White (D354-60)
- 3 Formica Neutral Twill (8826-58)
- 4 Formica Bleached Legno (8845-58)
- 5 Formica Prestige Walnut (6209-43)
- 7 Formica Select Cherry (7759-43)
- X *Wilsonart Non-Premium laminates (-38, -60). +10%
Orders of 100+ units have no upcharge.
- Y *Formica Non-Premium (58, 43, MC, SP and +19%
NT finishes) and Wilsonart Premium (-01, -07, -12,
-18, -52, -78) laminates.
- Z *Pionite Non-Premium, Nevamar Non-Premium, +25%
Formica Premium (WR, 42, 77, 46, RD Finishes),
and whiteboard laminates.

*Add \$350 list fee for Special Laminate orders of less than 10 units. See page 21 for edge selection.

(#) Contour Laminate Suffix List:

- G Natural Maple
- R Hayward Cherry
- S Studio White Matrix
- V River Cherry
- W Designer White
- Y Urban Walnut

(#) Veneer Suffix List:

- D Maple (stained similar to Kensington Maple laminate)
- J Cherry (stained similar to Wild Cherry laminate)
- N Walnut (stained similar to Cafelle laminate)
- 8 Walnut (stained similar to Prestige Walnut laminate)
- 9 Cherry (stained similar to Select Cherry laminate)
- X Stain Match (add a one-time \$700 list Stain Match fee) +10%

Ordering Information:

- > BRACES ARE INCLUDED WITH TABLE TOPS IF REQUIRED. See below for quantities. (Stealth, Concurrence, and Foundation Trough Kit bases do not need braces). Maximum span between legs is 72".
- > Tops for Grid, XTB, and freestanding height-adjustable table bases can be found on pages 316-324.
- > A freight fee of \$100 net is assessed on orders less than \$1000 net. See page 13.

Laminate & Veneer

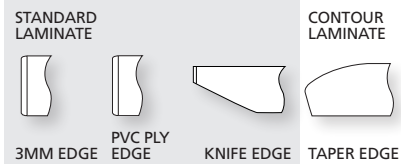

D1	W1	BRACES INCLD.	Part Number	Suffix A	Suffix L	Suffix K Suffix C	Suffix T
24	24	0	- XX2424&@#	\$222	\$255	\$288	\$304
24	30	0	- XX2430&@#	\$233	\$267	\$302	\$319
24	36	0	- XX2436&@#	\$255	\$293	\$331	\$348
24	42	0	- XX2442&@#	\$285	\$327	\$370	\$381
24	48	0	- XX2448&@#	\$308	\$354	\$400	\$410
24	54	0	- XX2454&@#	\$374	\$430	\$486	\$499
24	60	1	- XX2460&@#	\$432	\$496	\$561	\$579
24	66	1	- XX2466&@#	\$479	\$550	\$622	\$625
24	72	1	- XX2472&@#	\$479	\$550	\$622	\$625
24	78	1	- XX2478&@#	\$609	\$700	\$791	\$803
24	84	1	- XX2484&@#	\$609	\$700	\$791	\$803
24	90	1	- XX2490&@#	\$622	\$715	\$808	\$848
24	96	1	- XX2496&@#	\$622	\$715	\$808	\$848

TOPS	TABLES STEP 1 - TOPS
BASES	
POWER DATA	
SUPPORT FURNITURE	
ACCESSORIES	

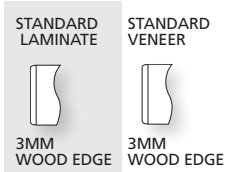

D1	W1	BRACES INCLD.	Part Number	Suffix E	Suffix P
24	24	0	- XX2424&@#	\$449	\$511
24	30	0	- XX2430&@#	\$536	\$616
24	36	0	- XX2436&@#	\$625	\$718
24	42	0	- XX2442&@#	\$715	\$823
24	48	0	- XX2448&@#	\$806	\$930
24	54	0	- XX2454&@#	\$895	\$1036
24	60	1	- XX2460&@#	\$1066	\$1217
24	66	1	- XX2466&@#	\$1155	\$1326
24	72	1	- XX2472&@#	\$1244	\$1429
24	78	1	- XX2478&@#	\$1337	\$1535
24	84	1	- XX2484&@#	\$1426	\$1640
24	90	1	- XX2490&@#	\$1515	\$1746
24	96	1	- XX2496&@#	\$1603	\$1851

Training Table Tops (30"D)

STEP 1

(XX) Top Shape Prefix List:

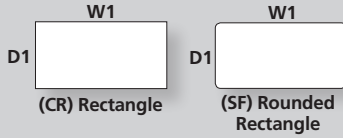

STEP 2

(&) Finish and Edge Suffix List:

- A Standard Laminate – 3mm Edge
- L Standard Laminate – PVC Edge w/ Ply look
- K Standard Laminate – Knife Edge (front only, sides/back flat)
- C Standard Laminate – Knife Edge (all sides)
- T Contour Laminate – Taper Edge
- E Standard Laminate – 3mm Wood Edge
- P Standard Veneer – 3mm Wood Edge

STEP 3

(@) Cable Management Suffix List:

- N No Cable Management No charge
- G Grommet (one, center rear) +\$18
- P Powerflex Grommet (one left, one right) +\$36
- U Power/Data Cut-out (one, center rear) +\$36
- K Power/Data Cut-out (one, center of table) +\$36
- X Other TBD

STEP 4

(#) Laminate Suffix List:

- A Wilsonart Kensington Maple (10776-60)
- B Wilsonart Monticello Maple (7925-38)
- C Wilsonart Wild Cherry (7054-60)
- E Wilsonart Fashion Grey (D381-60)
- F Wilsonart White Tigris (4783-60)
- G Wilsonart Cafelle (7933K-07)
- M Wilsonart Frosty White (1573-60)
- P Wilsonart Slate Grey (D91-60)
- R Wilsonart Black (1595-60)
- U Wilsonart Brazilwood (7946-38)
- V Wilsonart River Cherry (7937-38)
- W Wilsonart Designer White (D354-60)
- 3 Formica Neutral Twill (8826-58)
- 4 Formica Bleached Legno (8845-58)
- 5 Formica Prestige Walnut (6209-43)
- 7 Formica Select Cherry (7759-43)
- X *Wilsonart Non-Premium laminates (-38, -60). +10%
Orders of 100+ units have no upcharge.
- Y *Formica Non-Premium (58, 43, MC, SP and +19%
NT finishes) and Wilsonart Premium (-01, -07, -12,
-18, -52, -78) laminates.
- Z *Pionite Non-Premium, Nevamar Non-Premium, +25%
Formica Premium (WR, 42, 77, 46, RD Finishes),
and whiteboard laminates.

*Add \$350 list fee for Special Laminate orders of less than 10 units. See page 21 for edge selection.

(#) Contour Laminate Suffix List:

- G Natural Maple
- R Hayward Cherry
- S Studio White Matrix
- V River Cherry
- W Designer White
- Y Urban Walnut

(#) Veneer Suffix List:

- D Maple (stained similar to Kensington Maple laminate)
- J Cherry (stained similar to Wild Cherry laminate)
- N Walnut (stained similar to Cafelle laminate)
- 8 Walnut (stained similar to Prestige Walnut laminate)
- 9 Cherry (stained similar to Select Cherry laminate)
- X Stain Match (add a one-time \$700 list Stain Match fee) +10%

Ordering Information:

- > **BRACES ARE INCLUDED WITH TABLE TOPS IF REQUIRED. See below for quantities.** (Stealth, Concurrence, and Foundation Trough Kit bases do not need braces). Maximum span between legs is 72".
- > Tops for Grid, XTB, and freestanding height-adjustable table bases can be found on pages 316-324.
- > **A freight fee of \$100 net is assessed on orders less than \$1000 net. See page 13.**

Laminate & Veneer

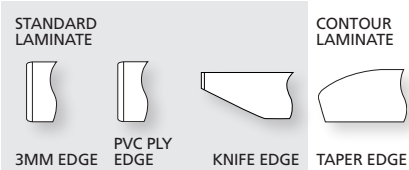

D1	W1	BRACES INCLD.	Part Number	Suffix A	Suffix L	Suffix K Suffix C	Suffix T
30	30	0	- XX3030&@#	\$284	\$326	\$369	\$629
30	36	0	- XX3036&@#	\$324	\$372	\$421	\$685
30	42	0	- XX3042&@#	\$350	\$402	\$455	\$708
30	48	0	- XX3048&@#	\$374	\$430	\$486	\$745
30	54	0	- XX3054&@#	\$441	\$507	\$573	\$834
30	60	1	- XX3060&@#	\$498	\$572	\$647	\$916
30	66	1	- XX3066&@#	\$571	\$656	\$742	\$991
30	72	2	- XX3072&@#	\$555	\$638	\$721	\$991
30	78	2	- XX3078&@#	\$673	\$773	\$874	\$1134
30	84	2	- XX3084&@#	\$673	\$773	\$874	\$1134
30	90	2	- XX3090&@#	\$701	\$806	\$911	\$1197
30	96	2	- XX3096&@#	\$701	\$806	\$911	\$1197

TOPS	TABLES STEP 1 - TOPS
BASES	
POWER DATA	
SUPPORT FURNITURE	
ACCESSORIES	

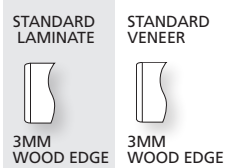

D1	W1	BRACES INCLD.	Part Number	Suffix E	Suffix P
30	30	0	- XX3030&@#	\$643	\$742
30	36	0	- XX3036&@#	\$752	\$868
30	42	0	- XX3042&@#	\$857	\$993
30	48	0	- XX3048&@#	\$966	\$1119
30	54	0	- XX3054&@#	\$1073	\$1245
30	60	1	- XX3060&@#	\$1260	\$1452
30	66	1	- XX3066&@#	\$1368	\$1577
30	72	2	- XX3072&@#	\$1474	\$1702
30	78	2	- XX3078&@#	\$1582	\$1829
30	84	2	- XX3084&@#	\$1688	\$1954
30	90	2	- XX3090&@#	\$1795	\$2080
30	96	2	- XX3096&@#	\$1902	\$2206

Training Table Tops (36"D)

STEP 1

(XX) Top Shape Prefix List:

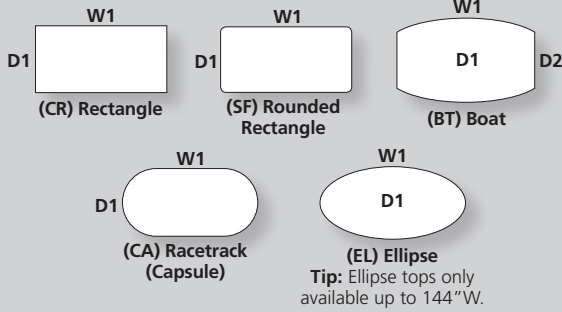

STEP 2

(&) Finish and Edge Suffix List:

- A Standard Laminate – 3mm Edge
- L Standard Laminate – PVC Edge w/ Ply look
- K Standard Laminate – Knife Edge (front only, sides/back flat)
- C Standard Laminate – Knife Edge (all sides)
- T Contour Laminate – Taper Edge
- E Standard Laminate – 3mm Wood Edge
- P Standard Veneer – 3mm Wood Edge
- Q Standard Veneer – Taper Wood Edge
- R Standard Veneer – Knife Wood Edge
- U Standard Veneer – Bullnose Wood Edge
- V Standard Veneer – Ultra Wood Edge

STEP 3

(@) Cable Management Suffix List:

- N No Cable Management No charge
- G Grommet (one, center rear) +\$18
- P Powerlex Grommet (one left, one right) +\$36
- U Power/Data Cut-out (one, center rear) +\$36
- K Power/Data Cut-out (one, center of table) +\$36
- X Other TBD

STEP 4

(#) Laminate Suffix List:

- A Wilsonart Kensington Maple (10776-60)
- B Wilsonart Monticello Maple (7925-38)
- C Wilsonart Wild Cherry (7054-60)
- E Wilsonart Fashion Grey (D381-60)
- F Wilsonart White Tigris (4783-60)
- G Wilsonart Cafelle (7933K-07)
- M Wilsonart Frosty White (1573-60)
- P Wilsonart Slate Grey (D91-60)
- R Wilsonart Black (1595-60)
- U Wilsonart Brazilwood (7946-38)
- V Wilsonart River Cherry (7937-38)
- W Wilsonart Designer White (D354-60)
- 3 Formica Neutral Twill (8826-58)
- 4 Formica Bleached Legno (8845-58)
- 5 Formica Prestige Walnut (6209-43)
- 7 Formica Select Cherry (7759-43)
- X *Wilsonart Non-Premium laminates (-38, -60). +10%
Orders of 100+ units have no upcharge.
- Y *Formica Non-Premium (58, 43, MC, SP and NT finishes) +19%
and Wilsonart Premium (-01, -07, -12, -18, -52, -78) laminates.
- Z *Pionite Non-Premium, Nevamar Non-Premium, Formica +25%
Premium (WR, 42, 77, 46, RD Finishes), and whiteboard laminates.

*Add \$350 list fee for Special Laminate orders of less than 10 units.
See page 21 for edge selection.

(#) Contour Laminate Suffix List:

- G Natural Maple
- R Hayward Cherry
- S Studio White Matrix
- V River Cherry
- W Designer White
- Y Urban Walnut

(#) Veneer Suffix List:

- D Maple (stained similar to Kensington Maple laminate)
- J Cherry (stained similar to Wild Cherry laminate)
- N Walnut (stained similar to Cafelle laminate)
- 8 Walnut (stained similar to Prestige Walnut laminate)
- 9 Cherry (stained similar to Select Cherry laminate)
- X Stain Match (add a one-time \$700 list Stain Match fee) +10%

Product Specifications:

- > D2 is 12" less than D1 on Boat tops.
- > Veneer knife wood edge (R) is 0.12" wide (3mm).

Ordering Information:

- > **BRACES ARE INCLUDED WITH TABLE TOPS IF REQUIRED.** See below for quantities. (Stealth, Concurrence, and Foundation Trough Kit bases do not need braces). Maximum span between legs is 72".
- > Tops for Grid, XTB, and freestanding height-adjustable table bases can be found on pages 316-324.
- > **A freight fee of \$100 net is assessed on orders less than \$1000 net. See page 13.**

Laminate & Veneer

D1	W1	BRACES INCLD.	Part Number	Laminate & Veneer			
				Suffix A	Suffix L	Suffix K	Suffix T
36	36	0	- XX3636&@#	\$346	\$397	\$449	\$714
36	42	0	- XX3642&@#	\$410	\$471	\$533	\$788
36	48	0	- XX3648&@#	\$438	\$503	\$569	\$842
36	54	0	- XX3654&@#	\$539	\$619	\$700	\$978
36	60	2	- XX3660&@#	\$701	\$806	\$911	\$1140
36	66	2	- XX3666&@#	\$771	\$886	\$1002	\$1238
36	72	2	- XX3672&@#	\$771	\$886	\$1002	\$1238
36	78	2	- XX3678&@#	\$931	\$1070	\$1210	\$1454
36	84	2	- XX3684&@#	\$931	\$1070	\$1210	\$1454
36	90	2	- XX3690&@#	\$931	\$1070	\$1210	\$1454
36	96	2	- XX3696&@#	\$931	\$1070	\$1210	\$1454

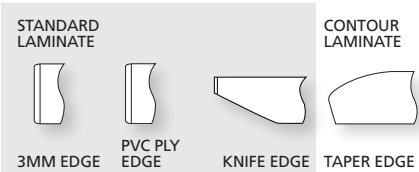

TOPS	TABLES STEP 1 - TOPS
BASES	
POWER DATA	
SUPPORT FURNITURE	
ACCESSORIES	

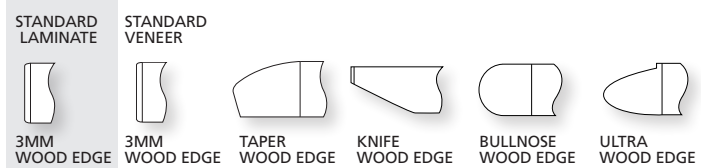

D1	W1	BRAES INCLD.	Part Number	Suffix E	Suffix P	Suffix Q	Suffix R	Suffix U	Suffix V
36	36	0	- XX3636&@#	\$876	\$1014	n/a	n/a	n/a	n/a
36	42	0	- XX3642&@#	\$1001	\$1161	n/a	n/a	n/a	n/a
36	48	0	- XX3648&@#	\$1124	\$1309	n/a	n/a	n/a	n/a
36	54	0	- XX3654&@#	\$1250	\$1455	n/a	n/a	n/a	n/a
36	60	2	- XX3660&@#	\$1535	\$1764	n/a	n/a	n/a	n/a
36	66	2	- XX3666&@#	\$1663	\$1912	n/a	n/a	n/a	n/a
36	72	2	- XX3672&@#	\$1786	\$2056	\$2843	\$2181	\$2539	\$2843
36	78	2	- XX3678&@#	\$1913	\$2209	n/a	n/a	n/a	n/a
36	84	2	- XX3684&@#	\$2036	\$2352	\$3223	\$2475	\$2886	\$3223
36	90	2	- XX3690&@#	\$2159	\$2498	n/a	n/a	n/a	n/a
36	96	2	- XX3696&@#	\$2283	\$2643	\$3597	\$2766	\$3228	\$3597

Conference Table Tops (36"D)

STEP 1

(XX) Top Shape Prefix List:

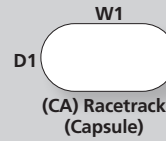
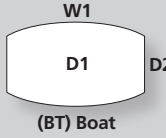
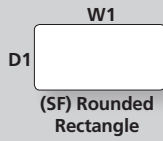
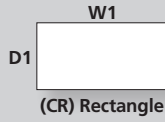

Tip: Ellipse tops only available up to 144"W.

STEP 2

(&) Finish and Edge Suffix List:

- A Standard Laminate – 3mm Edge
- L Standard Laminate – PVC Edge w/ Ply look
- K Standard Laminate – Knife Edge
- T Contour Laminate – Taper Edge
- E Standard Laminate – 3mm Wood Edge
- F Standard Laminate – Taper Wood Edge
- G Standard Laminate – Knife Wood Edge
- H Standard Laminate – Bullnose Wood Edge
- P Standard Veneer – 3mm Wood Edge
- Q Standard Veneer – Taper Wood Edge
- R Standard Veneer – Knife Wood Edge
- U Standard Veneer – Bullnose Wood Edge
- V Standard Veneer – Ultra Wood Edge
- B Back-Painted Glass on 1-1/8" Knife Edge MDF
- D Back-Painted Glass (frosted) on 1-1/8" Knife Edge MDF
- 5 KrystalCast® on MDF - Knife Edge
- 6 KrystalCast® on Ply - Flat Ply Edge
- M Designer White Solid Surface (Wilsonart) - 2 1/8" Flat Edge
- N Designer White Solid Surface (Wilsonart) - 1-1/4" Knife Edge
- J **Quartz (Cambria) on MDF - 3mm Edge
- Y Statement Laminate Top - 2 1/8" Flat Ply Edge
- 3 Statement Laminate Top - Knife Ply Edge
- Z Statement Veneer Top - 2 1/8" Flat Ply Edge
- 4 Statement Veneer Top - Knife Ply Edge

** 30% Upcharge for Luxury Cambria Quartz Colors: Brittanica, Ella, Oakmoor, Roxwell, and Whitecliff.

STEP 3

(@) Cable Management Suffix List:

- N No Cable Management No charge
- G Grommet (one, center) +\$18
- K One Pwr/Data Cut-out, Centered (all size tops) +\$36
- C Two Pwr/Data Cut-outs, Between Bases (2-pc tops) +\$72
- D Two Pwr/Data Cut-outs, Between Outer Bases (3-pc tops) +\$72
- E Three Pwr/Data Cut-outs, Between Bases (3-pc tops) +\$108
- F Foundation Trough Door Kit Cut Out (n/a Designer Finishes) +\$99
- X Other TBD

STEP 4 - Laminate, Veneer, and Statement Ply Only

(#) Laminate Suffix List:

- A Wilsonart Kensington Maple (10776-60)
- B Wilsonart Monticello Maple (7925-38)
- C Wilsonart Wild Cherry (7054-60)
- E Wilsonart Fashion Grey (D381-60)
- F Wilsonart White Tigris (4783-60)
- G Wilsonart Cafelle (7933K-07)
- M Wilsonart Frosty White (1573-60)
- P Wilsonart Slate Grey (D91-60)
- R Wilsonart Black (1595-60)
- U Wilsonart Brazilwood (7946-38)
- V Wilsonart River Cherry (7937-38)
- W Wilsonart Designer White (D354-60)
- 3 Formica Neutral Twill (8826-58)
- 4 Formica Bleached Legno (8845-58)
- 5 Formica Prestige Walnut (6209-43)
- 7 Formica Select Cherry (7759-43)
- X *Wilsonart Non-Premium laminates (-38, -60). +10%
Orders of 100+ units have no upcharge.
- Y *Formica Non-Premium (58, 43, MC, SP and NT finishes) and Wilsonart Premium (-01, -07, -12, -18, -52, -78) laminates. +19%
- Z *Pionite Non-Premium, Nevamar Non-Premium, Formica Premium (WR, 42, 77, 46, RD Finishes), and whiteboard laminates. +25%

*Add \$350 list fee for Special Laminate orders of less than 10 units. See page 21 for edge selection.

(#) Contour Laminate Suffix List: (n/a on Statement Ply)

- G Natural Maple
- R Hayward Cherry
- S Studio White Matrix
- V River Cherry
- W Designer White
- Y Urban Walnut

(#) Veneer Suffix List:

- D Maple (stained similar to Kensington Maple laminate)
- J Cherry (stained similar to Wild Cherry laminate)
- N Walnut (stained similar to Cafelle laminate)
- 8 Walnut (stained similar to Prestige Walnut laminate)
- 9 Cherry (stained similar to Select Cherry laminate)
- X Stain Match (add a one-time \$700 list Stain Match fee) +10%

Laminate & Veneer

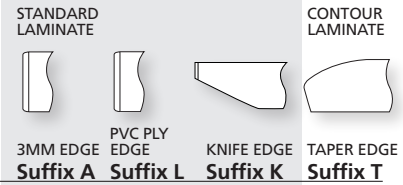

D1	W1	BRACES INCLD.	Part Number	STANDARD LAMINATE				CONTOUR LAMINATE
				Suffix A	Suffix L	Suffix K	Suffix T	
36	108	0	2pcs	XX36108&@#	\$1178	\$1354	\$1531	\$2334
36	120	0	2pcs	XX36120&@#	\$1213	\$1394	\$1576	\$2382
36	132	0	2pcs	XX36132&@#	\$1333	\$1532	\$1732	\$2560
36	144	0	2pcs	XX36144&@#	\$1366	\$1570	\$1775	\$2609
36	156	0	2pcs	XX36156&@#	\$1445	\$1661	\$1878	\$2724
36	168	4	2pcs	XX36168&@#	\$1793	\$2061	\$2330	\$3383
36	180	4	2pcs	XX36180&@#	\$2012	\$2313	\$2615	\$3470
36	192	4	2pcs	XX36192&@#	\$2020	\$2323	\$2626	\$3478
36	204	0	3pcs	XX36204&@#	\$2344	\$2695	\$3047	\$3858
36	216	0	3pcs	XX36216&@#	\$2359	\$2712	\$3066	\$3946
36	228	6	3pcs	XX36228&@#	\$2850	\$3277	\$3705	\$4615
36	240	6	3pcs	XX36240&@#	\$3289	\$3782	\$4275	\$5214

Designer Finishes

WHITE BACK-PAINTED GLASS ON MDF | WHITE BACK-PAINTED GLASS (FROSTED) ON MDF

For other color options, see page 31.



D1	W1	BRACES INCLD.	Part Number	WHITE BACK-PAINTED GLASS ON MDF		WHITE BACK-PAINTED GLASS (FROSTED) ON MDF	
				Suffix B	Suffix D	Suffix B	Suffix D
36	72	2	-	XX3672&@	\$5950	\$6898	
36	84	2	-	XX3684&@	\$6613	\$7720	
36	96	2	-	XX3696&@	\$7409	\$8673	
36	108	0	2pcs	XX36108&@	\$11,679	\$13,576	
36	120	0	2pcs	XX36120&@	\$12,566	\$14,673	
36	132	0	2pcs	XX36132&@	\$13,451	\$15,769	
36	144	0	2pcs	XX36144&@	\$14,336	\$16,865	
36	156	0	2pcs	XX36156&@	\$15,223	\$17,962	
36	168	4	2pcs	XX36168&@	\$16,107	\$19,057	
36	180	4	2pcs	XX36180&@	\$16,993	\$20,153	
36	192	4	2pcs	XX36192&@	\$18,449	\$21,819	
36	204	0	3pcs	XX36204&@	\$20,468	\$24,049	
36	216	0	3pcs	XX36216&@	\$21,352	\$25,144	
36	228	6	3pcs	XX36228&@	\$22,677	\$26,680	
36	240	6	3pcs	XX36240&@	\$23,562	\$27,776	

Product Specifications:

- > Edge profile is the same on all sides.
- > D2 is 12" less than D1 on Boat tops.
- > Multi-piece tops come with alignment hardware.
- > See page 31 for Designer Finish specifications.
- > Laminate knife wood edge (G) is 1.9" wide. Veneer knife wood edge (R) is 0.12" wide (3mm).

Ordering Information:

- > **BRACES ARE INCLUDED WITH TABLE TOPS IF REQUIRED. See below for quantities.** (Stealth, Concurrence, and Foundation Trough Kit bases do not need braces). Maximum span between legs is 72".
- > Tops for Grid, XTB, and freestanding height-adjustable table bases can be found on pages 316-324.
- > **A freight fee of \$100 net is assessed on orders less than \$1000 net. See page 13.**

D1	W1	BRACES INCLD.	Part Number	STANDARD LAMINATE WOOD EDGE				STANDARD VENEER				
				Suffix E	Suffix F	Suffix G	Suffix H	Suffix P	Suffix Q	Suffix R	Suffix U	Suffix V
36	108	0	2pcs XX36108&@#	\$3243	\$4158	\$4258	\$3751	\$3774	\$4876	\$4062	\$4471	\$4877
36	120	0	2pcs XX36120&@#	\$3554	\$4542	\$4653	\$4102	\$4142	\$5334	\$4437	\$4897	\$5334
36	132	0	2pcs XX36132&@#	\$3866	\$4930	\$5046	\$4457	\$4510	\$5795	\$4814	\$5322	\$5795
36	144	0	2pcs XX36144&@#	\$4175	\$5313	\$5427	\$4808	\$4879	\$6251	\$5187	\$5747	\$6251
36	156	0	2pcs XX36156&@#	\$4486	\$5697	\$5833	\$5160	\$5245	\$6710	\$5561	\$6172	\$6710
36	168	4	2pcs XX36168&@#	\$5122	\$6408	\$6551	\$5837	\$5939	\$7494	\$6260	\$6921	\$7494
36	180	4	2pcs XX36180&@#	\$5533	\$7410	\$7751	\$6727	\$6325	\$8143	\$6675	\$7476	\$8143
36	192	4	2pcs XX36192&@#	\$5864	\$7838	\$8198	\$7121	\$6706	\$8622	\$7065	\$7917	\$8622
36	204	0	3pcs XX36204&@#	\$6575	\$8777	\$9178	\$7976	\$7474	\$9605	\$7956	\$8820	\$9605
36	216	0	3pcs XX36216&@#	\$6861	\$9039	\$9435	\$8247	\$7814	\$9920	\$8294	\$9144	\$9920
36	228	6	3pcs XX36228&@#	\$7212	\$9485	\$9899	\$8660	\$8216	\$10,417	\$8704	\$9606	\$10,417
36	240	6	3pcs XX36240&@#	\$7559	\$9930	\$10,362	\$9069	\$8613	\$10,911	\$9109	\$10,065	\$10,911

D1	W1	BRACES INCLD.	Part Number	KRYSTALCAST® ON MDF		KRYSTALCAST® ON PLY		DESIGNER WHITE SOLID SURFACE (WILSONART)		**QUARTZ (CAMBRIA)	STATEMENT LAMINATE TOP W/ BIRCH PLY EDGE		STATEMENT VENEER TOP W/ BIRCH PLY EDGE	
				KNIFE EDGE	FLAT PLY EDGE	2-1/8" FLAT EDGE	1 1/4" KNIFE EDGE	FLAT EDGE	2-1/8" FLAT EDGE	1-1/4" KNIFE EDGE	2-1/8" FLAT EDGE	1-1/4" KNIFE EDGE		
36	72	2	- XX3672&@#	\$5872	\$6710	\$6247	\$5622	\$7908	\$2894	\$3274	\$3244	\$3624		
36	84	2	- XX3684&@#	\$6851	\$7829	\$7168	\$6485	\$9226	\$3239	\$3660	\$3648	\$4068		
36	96	2	- XX3696&@#	\$8217	\$9336	\$8092	\$7347	\$10,544	\$3587	\$4047	\$4052	\$4511		
36	108	0	2pcs XX36108&@#	\$13,686	\$15,363	\$11,364	\$10,501	\$15,816	\$4935	\$5456	\$5535	\$6057		
36	120	0	2pcs XX36120&@#	\$14,991	\$16,856	\$12,523	\$11,601	\$17,574	\$5321	\$5882	\$5988	\$6549		
36	132	0	2pcs XX36132&@#	\$16,295	\$18,346	\$13,684	\$12,701	\$19,332	\$5720	\$6328	\$6451	\$7060		
36	144	0	2pcs XX36144&@#	\$17,600	\$19,838	\$14,844	\$13,803	\$21,089	\$6094	\$6734	\$6891	\$7532		
36	156	0	2pcs XX36156&@#	\$18,905	\$21,328	\$16,003	\$14,903	\$22,846	\$6481	\$7161	\$7345	\$8023		
36	168	4	2pcs XX36168&@#	\$20,211	\$22,820	\$17,164	\$16,003	\$24,603	\$6868	\$7586	\$7797	\$8516		
36	180	4	2pcs XX36180&@#	\$21,516	\$24,312	\$18,325	\$17,106	\$26,361	\$7255	\$8012	\$8249	\$9007		
36	192	4	2pcs XX36192&@#	\$22,820	\$25,803	\$19,485	\$18,206	\$28,119	\$7642	\$8439	\$8701	\$9498		
36	204	0	3pcs XX36204&@#	\$25,678	\$28,847	\$20,644	\$19,306	\$29,877	\$8461	\$9351	\$9594	\$10,482		
36	216	0	3pcs XX36216&@#	\$26,983	\$30,339	\$21,805	\$20,407	\$31,633	\$8776	\$9654	\$9972	\$10,850		
36	228	6	3pcs XX36228&@#	\$28,289	\$31,829	\$22,965	\$21,508	\$33,391	\$9161	\$10,079	\$10,424	\$11,342		
36	240	6	3pcs XX36240&@#	\$29,594	\$33,322	\$24,125	\$22,608	\$35,148	\$9550	\$10,507	\$10,877	\$11,834		

TOPS

BASES

POWER DATA

SUPPORT FURNITURE

ACCESSORIES

TABLES STEP 1 - TOPS

Conference Table Tops (42"D)

STEP 1

(XX) Top Shape Prefix List:

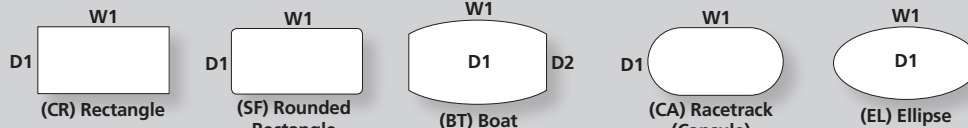

STEP 2

(&) Finish and Edge Suffix List:

- A Standard Laminate – 3mm Edge
- L Standard Laminate – PVC Edge w/ Ply look
- K Standard Laminate – Knife Edge
- T Contour Laminate – Taper Edge
- E Standard Laminate – 3mm Wood Edge
- F Standard Laminate – Taper Wood Edge
- G Standard Laminate – Knife Wood Edge
- H Standard Laminate – Bullnose Wood Edge
- P Standard Veneer – 3mm Wood Edge
- Q Standard Veneer – Taper Wood Edge
- R Standard Veneer – Knife Wood Edge
- U Standard Veneer – Bullnose Wood Edge
- V Standard Veneer – Ultra Wood Edge
- B Back-Painted Glass on 1-1/8" Knife Edge MDF
- D Back-Painted Glass (frosted) on 1-1/8" Knife Edge MDF
- 5 KrystalCast® on MDF - Knife Edge
- 6 KrystalCast® on Ply - Flat Ply Edge
- M Designer White Solid Surface (Wilsonart) - 2 1/8" Flat Edge
- N Designer White Solid Surface (Wilsonart) - 1-1/4" Knife Edge
- J **Quartz (Cambria) on MDF - 3mm Edge
- Y Statement Laminate Top - 2 1/8" Flat Ply Edge
- 3 Statement Laminate Top - Knife Ply Edge
- Z Statement Veneer Top - 2 1/8" Flat Ply Edge
- 4 Statement Veneer Top - Knife Ply Edge

** 30% Upcharge for Luxury Cambria Quartz Colors: Brittanica, Ella, Oakmoor, Roxwell, and Whitecliff.

STEP 3

(@) Cable Management Suffix List:

- N No Cable Management No charge
- G Grommet (one, center) +\$18
- K One Pwr/Data Cut-out, Centered (all size tops) +\$36
- C Two Pwr/Data Cut-outs, Between Bases (2-pc tops) +\$72
- D Two Pwr/Data Cut-outs, Between Outer Bases (3-pc tops) +\$72
- E Three Pwr/Data Cut-outs, Between Bases (3-pc tops) +\$108
- F Foundation Trough Door Kit Cut Out (n/a Designer Finishes) +\$99
- X Other TBD

STEP 4 - Laminate, Veneer, and Statement Ply Only

(#) Laminate Suffix List:

- A Wilsonart Kensington Maple (10776-60)
- B Wilsonart Monticello Maple (7925-38)
- C Wilsonart Wild Cherry (7054-60)
- E Wilsonart Fashion Grey (D381-60)
- F Wilsonart White Tigris (4783-60)
- G Wilsonart Cafelle (7933K-07)
- M Wilsonart Frosty White (1573-60)
- P Wilsonart Slate Grey (D91-60)
- R Wilsonart Black (1595-60)
- U Wilsonart Brazilwood (7946-38)
- V Wilsonart River Cherry (7937-38)
- W Wilsonart Designer White (D354-60)
- 3 Formica Neutral Twill (8826-58)
- 4 Formica Bleached Legno (8845-58)
- 5 Formica Prestige Walnut (6209-43)
- 7 Formica Select Cherry (7759-43)
- X *Wilsonart Non-Premium laminates (-38, -60). +10%
Orders of 100+ units have no upcharge.
- Y *Formica Non-Premium (58, 43, MC, SP and NT finishes) +19%
and Wilsonart Premium (-01, -07, -12, -18, -52, -78) laminates.
- Z *Pionite Non-Premium, Nevamar Non-Premium, Formica +25%
Premium (WR, 42, 77, 46, RD Finishes), and whiteboard laminates.

*Add \$350 list fee for Special Laminate orders of less than 10 units. See page 21 for edge selection.

(#) Contour Laminate Suffix List: (n/a on Statement Ply)

- G Natural Maple
- R Hayward Cherry
- S Studio White Matrix
- V River Cherry
- W Designer White
- Y Urban Walnut

(#) Veneer Suffix List:

- D Maple (stained similar to Kensington Maple laminate)
- J Cherry (stained similar to Wild Cherry laminate)
- N Walnut (stained similar to Cafelle laminate)
- 8 Walnut (stained similar to Prestige Walnut laminate)
- 9 Cherry (stained similar to Select Cherry laminate)
- X Stain Match (add a one-time \$700 list Stain Match fee) +10%

Laminate & Veneer

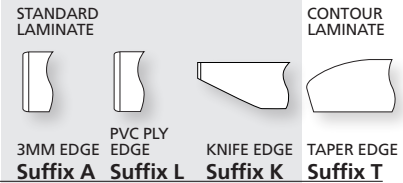

D1	W1	BRACES INCLD.		Part Number	STANDARD LAMINATE				CONTOUR LAMINATE	
					Suffix A	Suffix L	Suffix K	Suffix T	3MM EDGE	PVC PLY EDGE
42	42	0	-	XX4242&@#	\$453	\$520	\$588	\$1206		
42	48	0	-	XX4248&@#	\$514	\$591	\$668	\$1227		
42	54	0	-	XX4254&@#	\$603	\$693	\$783	\$1352		
42	60	2	-	XX4260&@#	\$755	\$868	\$981	\$1515		
42	66	2	-	XX4266&@#	\$832	\$956	\$1081	\$1613		
42	72	2	-	XX4272&@#	\$832	\$956	\$1081	\$1613		
42	78	2	-	XX4278&@#	\$943	\$1084	\$1225	\$1835		
42	84	2	-	XX4284&@#	\$943	\$1084	\$1225	\$1835		
42	90	2	-	XX4290&@#	\$998	\$1147	\$1297	\$1835		
42	96	2	-	XX4296&@#	\$998	\$1147	\$1297	\$1835		
42	108	0	2pcs	XX42108&@#	\$1381	\$1588	\$1795	\$2334		
42	120	0	2pcs	XX42120&@#	\$1422	\$1635	\$1848	\$2382		
42	132	0	2pcs	XX42132&@#	\$1498	\$1722	\$1947	\$2560		
42	144	0	2pcs	XX42144&@#	\$1535	\$1765	\$1995	\$2609		
42	156	0	2pcs	XX42156&@#	\$1765	\$2029	\$2294	\$2724		
42	168	4	2pcs	XX42168&@#	\$1844	\$2120	\$2397	\$3383		
42	180	4	2pcs	XX42180&@#	\$2012	\$2313	\$2615	\$3470		
42	192	4	2pcs	XX42192&@#	\$2020	\$2323	\$2626	\$3478		
42	204	0	3pcs	XX42204&@#	\$2411	\$2772	\$3134	\$3858		
42	216	0	3pcs	XX42216&@#	\$2426	\$2789	\$3153	\$3946		
42	228	6	3pcs	XX42228&@#	\$2850	\$3277	\$3705	\$4615		
42	240	6	3pcs	XX42240&@#	\$3289	\$3782	\$4275	\$5214		

Designer Finishes

WHITE BACK-PAINTED GLASS ON MDF
WHITE BACK-PAINTED GLASS (FROSTED) ON MDF
For other color options, see page 31.



D1	W1	BRACES INCLD.		Part Number	WHITE BACK-PAINTED GLASS ON MDF	
					Suffix B	Suffix D
42	72	2	-	XX4272&@	\$6746	\$7852
42	84	2	-	XX4284&@	\$7521	\$8810
42	96	2	-	XX4296&@	\$8295	\$9770
42	108	0	2pcs	XX42108&@	\$11,679	\$13,576
42	120	0	2pcs	XX42120&@	\$12,566	\$14,673
42	132	0	2pcs	XX42132&@	\$13,451	\$15,769
42	144	0	2pcs	XX42144&@	\$14,336	\$16,865
42	156	0	2pcs	XX42156&@	\$15,223	\$17,962
42	168	4	2pcs	XX42168&@	\$16,107	\$19,057
42	180	4	2pcs	XX42180&@	\$16,993	\$20,153
42	192	4	2pcs	XX42192&@	\$18,449	\$21,819
42	204	0	3pcs	XX42204&@	\$20,468	\$24,049
42	216	0	3pcs	XX42216&@	\$21,352	\$25,144
42	228	6	3pcs	XX42228&@	\$22,677	\$26,680
42	240	6	3pcs	XX42240&@	\$23,562	\$27,776

Product Specifications:

- > Edge profile is the same on all sides.
- > D2 is 12" less than D1 on Boat tops.
- > Multi-piece tops come with alignment hardware.
- > See page 31 for Designer Finish specifications.
- > Laminate knife wood edge (G) is 1.9" wide. Veneer knife wood edge (R) is 0.12" wide (3mm).

Ordering Information:

- > **BRACES ARE INCLUDED WITH TABLE TOPS IF REQUIRED. See below for quantities.** (Stealth, Concurrence, and Foundation Trough Kit bases do not need braces). Maximum span between legs is 72".
- > Tops for Grid, XTB, and freestanding height-adjustable table bases can be found on pages 316-324.
- > **A freight fee of \$100 net is assessed on orders less than \$1000 net. See page 13.**

D1	W1	BRACES INCLD.	Part Number	STANDARD LAMINATE WOOD EDGE				STANDARD VENEER				
				Suffix E	Suffix F	Suffix G	Suffix H	Suffix P	Suffix Q	Suffix R	Suffix U	Suffix V
42	42	0	- XX4242&@#	\$1118	\$1652	\$1712	\$1415	\$1301	\$1949	\$1415	\$1711	\$1949
42	48	0	- XX4248&@#	\$1253	\$1828	\$1891	\$1573	\$1463	\$2156	\$1618	\$1903	\$2156
42	54	0	- XX4254&@#	\$1397	\$2006	\$2073	\$1735	\$1629	\$2368	\$1786	\$2095	\$2368
42	60	2	- XX4260&@#	\$1697	\$2342	\$2414	\$2056	\$1953	\$2737	\$2116	\$2450	\$2737
42	66	2	- XX4266&@#	\$1836	\$2520	\$2597	\$2217	\$2120	\$2949	\$2284	\$2644	\$2949
42	72	2	- XX4272&@#	\$1974	\$2695	\$2776	\$2376	\$2283	\$3156	\$2449	\$2835	\$3156
42	78	2	- XX4278&@#	\$2115	\$2873	\$2958	\$2538	\$2450	\$3368	\$2619	\$3032	\$3368
42	84	2	- XX4284&@#	\$2254	\$3047	\$3138	\$2696	\$2611	\$3577	\$2786	\$3223	\$3577
42	90	2	- XX4290&@#	\$2390	\$3225	\$3316	\$2853	\$2774	\$3783	\$2953	\$3415	\$3783
42	96	2	- XX4296&@#	\$2527	\$3397	\$3493	\$3010	\$2935	\$3991	\$3116	\$3606	\$3991
42	108	0	2pcs XX42108&@#	\$3243	\$4158	\$4258	\$3751	\$3774	\$4876	\$4062	\$4471	\$4877
42	120	0	2pcs XX42120&@#	\$3554	\$4542	\$4653	\$4102	\$4142	\$5334	\$4437	\$4897	\$5334
42	132	0	2pcs XX42132&@#	\$3866	\$4930	\$5046	\$4457	\$4510	\$5795	\$4814	\$5322	\$5795
42	144	0	2pcs XX42144&@#	\$4175	\$5313	\$5427	\$4808	\$4879	\$6251	\$5187	\$5747	\$6251
42	156	0	2pcs XX42156&@#	\$4486	\$5697	\$5833	\$5160	\$5245	\$6710	\$5561	\$6172	\$6710
42	168	4	2pcs XX42168&@#	\$5122	\$6408	\$6551	\$5837	\$5939	\$7494	\$6260	\$6921	\$7494
42	180	4	2pcs XX42180&@#	\$5533	\$7410	\$7751	\$6727	\$6325	\$8143	\$6675	\$7476	\$8143
42	192	4	2pcs XX42192&@#	\$5864	\$7838	\$8198	\$7121	\$6706	\$8622	\$7065	\$7917	\$8622
42	204	0	3pcs XX42204&@#	\$6575	\$8777	\$9178	\$7976	\$7474	\$9605	\$7956	\$8820	\$9605
42	216	0	3pcs XX42216&@#	\$6861	\$9039	\$9435	\$8247	\$7814	\$9920	\$8294	\$9144	\$9920
42	228	6	3pcs XX42228&@#	\$7212	\$9485	\$9899	\$8660	\$8216	\$10,417	\$8704	\$9606	\$10,417
42	240	6	3pcs XX42240&@#	\$7559	\$9930	\$10,362	\$9069	\$8613	\$10,911	\$9109	\$10,065	\$10,911

D1	W1	BRACES INCLD.	Part Number	KRYSTALCAST® ON MDF		KRYSTALCAST® ON PLY		DESIGNER WHITE SOLID SURFACE (WILSONART)		**QUARTZ (CAMBRIA)	STATEMENT LAMINATE TOP W/ BIRCH PLY EDGE		STATEMENT VENEER TOP W/ BIRCH PLY EDGE	
				KNIFE EDGE	FLAT PLY EDGE	2-1/8" FLAT EDGE	1 1/4" KNIFE EDGE	FLAT EDGE	2-1/8" FLAT EDGE	1-1/4" KNIFE EDGE	2-1/8" FLAT EDGE	1-1/4" KNIFE EDGE		
				Suffix 5	Suffix 6	Suffix M	Suffix N	Suffix J	Suffix Y	Suffix 3	Suffix Z	Suffix 4		
42	72	2	- XX4272&@#	\$7239	\$8217	\$7065	\$6410	\$9226	\$3139	\$3519	\$3490	\$3870		
42	84	2	- XX4284&@#	\$8381	\$9522	\$8105	\$7392	\$10,764	\$3487	\$3907	\$3894	\$4313		
42	96	2	- XX4296&@#	\$9522	\$10,827	\$9147	\$8374	\$12,302	\$3833	\$4292	\$4298	\$4756		
42	108	0	2pcs XX42108&@#	\$13,686	\$15,363	\$11,364	\$10,501	\$15,816	\$4935	\$5456	\$5535	\$6057		
42	120	0	2pcs XX42120&@#	\$14,991	\$16,856	\$12,523	\$11,601	\$17,574	\$5321	\$5882	\$5988	\$6549		
42	132	0	2pcs XX42132&@#	\$16,295	\$18,346	\$13,684	\$12,701	\$19,332	\$5720	\$6328	\$6451	\$7060		
42	144	0	2pcs XX42144&@#	\$17,600	\$19,838	\$14,844	\$13,803	\$21,089	\$6094	\$6734	\$6891	\$7532		
42	156	0	2pcs XX42156&@#	\$18,905	\$21,328	\$16,003	\$14,903	\$22,846	\$6481	\$7161	\$7345	\$8023		
42	168	4	2pcs XX42168&@#	\$20,211	\$22,820	\$17,164	\$16,003	\$24,603	\$6868	\$7586	\$7797	\$8516		
42	180	4	2pcs XX42180&@#	\$21,516	\$24,312	\$18,325	\$17,106	\$26,361	\$7255	\$8012	\$8249	\$9007		
42	192	4	2pcs XX42192&@#	\$22,820	\$25,803	\$19,485	\$18,206	\$28,119	\$7642	\$8439	\$8701	\$9498		
42	204	0	3pcs XX42204&@#	\$25,678	\$28,847	\$20,644	\$19,306	\$29,877	\$8461	\$9351	\$9594	\$10,482		
42	216	0	3pcs XX42216&@#	\$26,983	\$30,339	\$21,805	\$20,407	\$31,633	\$8776	\$9654	\$9972	\$10,850		
42	228	6	3pcs XX42228&@#	\$28,289	\$31,829	\$22,965	\$21,508	\$33,391	\$9161	\$10,079	\$10,424	\$11,342		
42	240	6	3pcs XX42240&@#	\$29,594	\$33,322	\$24,125	\$22,608	\$35,148	\$9550	\$10,507	\$10,877	\$11,834		

TOPS

BASES

POWER DATA

SUPPORT FURNITURE

ACCESSORIES

TABLES STEP 1 - TOPS

Conference Table Tops (48"D)

STEP 1

(XX) Top Shape Prefix List:

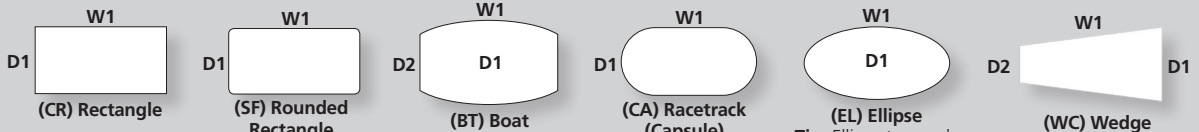

STEP 2

(&) Finish and Edge Suffix List:

- A Standard Laminate – 3mm Edge
 - L Standard Laminate – PVC Edge w/ Ply look
 - K Standard Laminate – Knife Edge
 - T Contour Laminate – Taper Edge
 - E Standard Laminate – 3mm Wood Edge
 - F Standard Laminate – Taper Wood Edge
 - G Standard Laminate – Knife Wood Edge
 - H Standard Laminate – Bullnose Wood Edge
 - P Standard Veneer – 3mm Wood Edge
 - Q Standard Veneer – Taper Wood Edge
 - R Standard Veneer – Knife Wood Edge
 - U Standard Veneer – Bullnose Wood Edge
 - V Standard Veneer – Ultra Wood Edge
 - B Back-Painted Glass on 1-1/8" Knife Edge MDF
 - D Back-Painted Glass (frosted) on 1-1/8" Knife Edge MDF
 - 5 KrystalCast® on MDF - Knife Edge
 - 6 KrystalCast® on Ply - Flat Ply Edge
 - M Designer White Solid Surface (Wilsonart) - 2 1/8" Flat Edge
 - N Designer White Solid Surface (Wilsonart) - 1-1/4" Knife Edge
 - J **Quartz (Cambria) on MDF - 3mm Edge
 - Y Statement Laminate Top - 2 1/8" Flat Ply Edge
 - 3 Statement Laminate Top - Knife Ply Edge
 - Z Statement Veneer Top - 2 1/8" Flat Ply Edge
 - 4 Statement Veneer Top - Knife Ply Edge
- ** 30% Upcharge for Luxury Cambria Quartz Colors:
Brittanica, Ella, Oakmoor, Roxwell, and Whitecliff.

(EL) Ellipse
Tip: Ellipse tops only available up to 144"W.

(WC) Wedge
Tip: Wedge tops available 72-240"W.

STEP 3

(@) Cable Management Suffix List:

- N No Cable Management No charge
- G Grommet (one, center) +\$18
- K One Pwr/Data Cut-out, Centered (all size tops) +\$36
- C Two Pwr/Data Cut-outs, Between Bases (2-pc tops) +\$72
- D Two Pwr/Data Cut-outs, Between Outer Bases (3-pc tops) +\$72
- E Three Pwr/Data Cut-outs, Between Bases (3-pc tops) +\$108
- F Foundation Trough Door Kit Cut Out (n/a Designer Finishes) +\$99
- X Other TBD

STEP 4 - Laminate, Veneer, and Statement Ply Only

(#) Laminate Suffix List:

- A Wilsonart Kensington Maple (10776-60)
- B Wilsonart Monticello Maple (7925-38)
- C Wilsonart Wild Cherry (7054-60)
- E Wilsonart Fashion Grey (D381-60)
- F Wilsonart White Tigris (4783-60)
- G Wilsonart Cafelle (7933K-07)
- M Wilsonart Frosty White (1573-60)
- P Wilsonart Slate Grey (D91-60)
- R Wilsonart Black (1595-60)
- U Wilsonart Brazilwood (7946-38)
- V Wilsonart River Cherry (7937-38)
- W Wilsonart Designer White (D354-60)
- 3 Formica Neutral Twill (8826-58)
- 4 Formica Bleached Legno (8845-58)
- 5 Formica Prestige Walnut (6209-43)
- 7 Formica Select Cherry (7759-43)
- X *Wilsonart Non-Premium laminates (-38, -60). +10%
Orders of 100+ units have no upcharge.
- Y *Formica Non-Premium (58, 43, MC, SP and NT finishes) +19%
and Wilsonart Premium (-01, -07, -12, -18, -52, -78) laminates.
- Z *Pionite Non-Premium, Nevamar Non-Premium, Formica +25%
Premium (WR, 42, 77, 46, RD Finishes), and whiteboard laminates.

*Add \$350 list fee for Special Laminate orders of less than 10 units.
See page 21 for edge selection.

(#) Contour Laminate Suffix List: (n/a on Statement Ply)

- G Natural Maple
- R Hayward Cherry
- S Studio White Matrix
- V River Cherry
- W Designer White
- Y Urban Walnut

(#) Veneer Suffix List:

- D Maple (stained similar to Kensington Maple laminate)
- J Cherry (stained similar to Wild Cherry laminate)
- N Walnut (stained similar to Cafelle laminate)
- 8 Walnut (stained similar to Prestige Walnut laminate)
- 9 Cherry (stained similar to Select Cherry laminate)
- X Stain Match (add a one-time \$700 list Stain Match fee) +10%

Laminate & Veneer

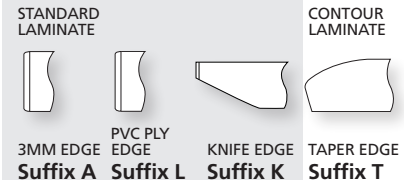

D1	W1	BRACES INCLD.		Part Number	STANDARD LAMINATE			
					Suffix A	Suffix L	Suffix K	Suffix T
48	48	0	-	XX4848&@#	\$514	\$591	\$668	\$1286
48	54	0	-	XX4854&@#	\$603	\$693	\$783	\$1411
48	60	2	-	XX4860&@#	\$755	\$868	\$981	\$1575
48	66	2	-	XX4866&@#	\$832	\$956	\$1081	\$1679
48	72	2	-	XX4872&@#	\$832	\$956	\$1081	\$1679
48	78	2	-	XX4878&@#	\$943	\$1084	\$1225	\$1833
48	84	2	-	XX4884&@#	\$943	\$1084	\$1225	\$1833
48	90	2	-	XX4890&@#	\$998	\$1147	\$1297	\$1905
48	96	2	-	XX4896&@#	\$998	\$1147	\$1297	\$1905
48	108	0	2 pcs	XX48108&@#	\$1381	\$1588	\$1795	\$2334
48	120	0	2 pcs	XX48120&@#	\$1422	\$1635	\$1848	\$2382
48	132	0	2 pcs	XX48132&@#	\$1498	\$1722	\$1947	\$2560
48	144	0	2 pcs	XX48144&@#	\$1535	\$1765	\$1995	\$2609
48	156	0	2 pcs	XX48156&@#	\$1765	\$2029	\$2294	\$2724
48	168	4	2 pcs	XX48168&@#	\$1844	\$2120	\$2397	\$3383
48	180	4	2 pcs	XX48180&@#	\$2012	\$2313	\$2615	\$3470
48	192	4	2 pcs	XX48192&@#	\$2020	\$2323	\$2626	\$3478
48	204	0	3 pcs	XX48204&@#	\$2411	\$2772	\$3134	\$3858
48	216	0	3 pcs	XX48216&@#	\$2426	\$2789	\$3153	\$3946
48	228	6	3 pcs	XX48228&@#	\$2850	\$3277	\$3705	\$4615
48	240	6	3 pcs	XX48240&@#	\$3289	\$3782	\$4275	\$5214

Designer Finishes

WHITE BACK-PAINTED GLASS ON MDF
WHITE BACK-PAINTED GLASS (FROSTED) ON MDF

For other color options, see page 31.



D1	W1	BRACES INCLD.		Part Number	KNIFE EDGE	
					Suffix B	Suffix D
48	72	2	-	XX4872&@	\$7409	\$8673
48	84	2	-	XX4884&@	\$8295	\$9770
48	96	2	-	XX4896&@	\$9180	\$10,865
48	108	0	2 pcs	XX48108&@	\$11,679	\$13,576
48	120	0	2 pcs	XX48120&@	\$12,566	\$14,673
48	132	0	2 pcs	XX48132&@	\$13,451	\$15,769
48	144	0	2 pcs	XX48144&@	\$14,336	\$16,865
48	156	0	2 pcs	XX48156&@	\$15,223	\$17,962
48	168	4	2 pcs	XX48168&@	\$16,107	\$19,057
48	180	4	2 pcs	XX48180&@	\$16,993	\$20,153
48	192	4	2 pcs	XX48192&@	\$18,449	\$21,819
48	204	0	3 pcs	XX48204&@	\$20,468	\$24,049
48	216	0	3 pcs	XX48216&@	\$21,352	\$25,144
48	228	6	3 pcs	XX48228&@	\$22,677	\$26,680
48	240	6	3 pcs	XX48240&@	\$23,562	\$27,776

Product Specifications:

- > Edge profile is the same on all sides.
- > D2 is 12" less than D1 on Boat tops.
- > For wedge tops, 72-96"W D2 is 12" less than D1; 108-192"W D2 is 18" less than D1; 204-240"W D2 is 24" less than D1.
- > Multi-piece tops come with alignment hardware.
- > See page 31 for Designer Finish specifications.
- > Laminate knife wood edge (G) is 1.9" wide. Veneer knife wood edge (R) is 0.12" wide (3mm).

Ordering Information:

- > **BRACES ARE INCLUDED WITH TABLE TOPS IF REQUIRED. See below for quantities.** (Stealth, Concurrence, and Foundation Trough Kit bases do not need braces). Maximum span between legs is 72".
- > Tops for Grid, XTB, and freestanding height-adjustable table bases can be found on pages 316-324.
- > **A freight fee of \$100 net is assessed on orders less than \$1000 net. See page 13.**

TOPS	TABLES STEP 1 - TOPS
BASES	
POWER DATA	
SUPPORT FURNITURE	
ACCESSORIES	

D1	W1	BRACES INCLD.	Part Number	STANDARD LAMINATE WOOD EDGE				STANDARD VENEER					
				Suffix E	Suffix F	Suffix G	Suffix H	Suffix P	Suffix Q	Suffix R	Suffix U	Suffix V	
48	48	0	-	XX4848&@#	\$1410	\$2021	\$2089	\$1750	\$1648	\$2386	\$1805	\$2115	\$2386
48	54	0	-	XX4854&@#	\$1568	\$2215	\$2287	\$1929	\$1833	\$2618	\$1994	\$2330	\$2618
48	60	2	-	XX4860&@#	\$1885	\$2570	\$2644	\$2265	\$2180	\$3008	\$2344	\$2706	\$3008
48	66	2	-	XX4866&@#	\$2041	\$2763	\$2843	\$2443	\$2363	\$3238	\$2533	\$2918	\$3238
48	72	2	-	XX4872&@#	\$2196	\$2735	\$3039	\$2609	\$2545	\$3466	\$2717	\$3129	\$3466
48	78	2	-	XX4878&@#	\$2355	\$3150	\$3237	\$2797	\$2733	\$3698	\$2908	\$3344	\$3698
48	84	2	-	XX4884&@#	\$2509	\$3341	\$3433	\$2971	\$2916	\$3926	\$3093	\$3555	\$3926
48	90	2	-	XX4890&@#	\$2664	\$3532	\$3631	\$3147	\$3101	\$4155	\$3281	\$3769	\$4155
48	96	2	-	XX4896&@#	\$2818	\$3726	\$3826	\$3323	\$3244	\$4347	\$3428	\$3942	\$4347
48	108	0	2 pcs	XX48108&@#	\$3243	\$4158	\$4258	\$3751	\$3774	\$4876	\$4062	\$4471	\$4877
48	120	0	2 pcs	XX48120&@#	\$3554	\$4542	\$4653	\$4102	\$4142	\$5334	\$4437	\$4897	\$5334
48	132	0	2 pcs	XX48132&@#	\$3866	\$4930	\$5046	\$4457	\$4510	\$5795	\$4814	\$5322	\$5795
48	144	0	2 pcs	XX48144&@#	\$4175	\$5313	\$5427	\$4808	\$4879	\$6251	\$5187	\$5747	\$6251
48	156	0	2 pcs	XX48156&@#	\$4486	\$5697	\$5833	\$5160	\$5245	\$6710	\$5561	\$6172	\$6710
48	168	4	2 pcs	XX48168&@#	\$5122	\$6408	\$6551	\$5837	\$5939	\$7494	\$6260	\$6921	\$7494
48	180	4	2 pcs	XX48180&@#	\$5533	\$7410	\$7751	\$6727	\$6325	\$8143	\$6675	\$7476	\$8143
48	192	4	2 pcs	XX48192&@#	\$5864	\$7838	\$8198	\$7121	\$6706	\$8622	\$7065	\$7917	\$8622
48	204	0	3 pcs	XX48204&@#	\$6575	\$8777	\$9178	\$7976	\$7474	\$9605	\$7956	\$8820	\$9605
48	216	0	3 pcs	XX48216&@#	\$6861	\$9039	\$9435	\$8247	\$7814	\$9920	\$8294	\$9144	\$9920
48	228	6	3 pcs	XX48228&@#	\$7212	\$9485	\$9899	\$8660	\$8216	\$10,417	\$8704	\$9606	\$10,417
48	240	6	3 pcs	XX48240&@#	\$7559	\$9930	\$10,362	\$9069	\$8613	\$10,911	\$9109	\$10,065	\$10,911

D1	W1	BRACES INCLD.	Part Number	KRYSTALCAST® ON MDF		KRYSTALCAST® ON PLY		DESIGNER WHITE SOLID SURFACE (WILSONART)		**QUARTZ (CAMBRIA)	STATEMENT LAMINATE TOP W/ BIRCH PLY EDGE		STATEMENT VENEER TOP W/ BIRCH PLY EDGE	
				KNIFE EDGE	FLAT PLY EDGE	2-1/8" FLAT EDGE	1 1/4" KNIFE EDGE	FLAT EDGE	2-1/8" FLAT EDGE	1-1/4" KNIFE EDGE	2-1/8" FLAT EDGE	1-1/4" KNIFE EDGE		
Suffix 5	Suffix 6	Suffix M	Suffix N	Suffix J	Suffix Y	Suffix 3	Suffix Z	Suffix 4						
48	72	2	-	XX4872&@#	\$8217	\$9336	\$7884	\$7199	\$10,544	\$3414	\$3814	\$3812	\$4213	
48	84	2	-	XX4884&@#	\$9522	\$10,827	\$9042	\$8299	\$12,302	\$3799	\$4240	\$4265	\$4704	
48	96	2	-	XX4896&@#	\$11,022	\$12,513	\$10,203	\$9401	\$14,058	\$4188	\$4666	\$4716	\$5196	
48	108	0	2 pcs	XX48108&@#	\$13,686	\$15,363	\$11,364	\$10,501	\$15,816	\$4935	\$5456	\$5535	\$6057	
48	120	0	2 pcs	XX48120&@#	\$14,991	\$16,856	\$12,523	\$11,601	\$17,574	\$5321	\$5882	\$5988	\$6549	
48	132	0	2 pcs	XX48132&@#	\$16,295	\$18,346	\$13,684	\$12,701	\$19,332	\$5720	\$6328	\$6451	\$7060	
48	144	0	2 pcs	XX48144&@#	\$17,600	\$19,838	\$14,844	\$13,803	\$21,089	\$6094	\$6734	\$6891	\$7532	
48	156	0	2 pcs	XX48156&@#	\$18,905	\$21,328	\$16,003	\$14,903	\$22,846	\$6481	\$7161	\$7345	\$8023	
48	168	4	2 pcs	XX48168&@#	\$20,211	\$22,820	\$17,164	\$16,003	\$24,603	\$6868	\$7586	\$7797	\$8516	
48	180	4	2 pcs	XX48180&@#	\$21,516	\$24,312	\$18,325	\$17,106	\$26,361	\$7255	\$8012	\$8249	\$9007	
48	192	4	2 pcs	XX48192&@#	\$22,820	\$25,803	\$19,485	\$18,206	\$28,119	\$7642	\$8439	\$8701	\$9498	
48	204	0	3 pcs	XX48204&@#	\$25,678	\$28,847	\$20,644	\$19,306	\$29,877	\$8461	\$9351	\$9594	\$10,482	
48	216	0	3 pcs	XX48216&@#	\$26,983	\$30,339	\$21,805	\$20,407	\$31,633	\$8776	\$9654	\$9972	\$10,850	
48	228	6	3 pcs	XX48228&@#	\$28,289	\$31,829	\$22,965	\$21,508	\$33,391	\$9161	\$10,079	\$10,424	\$11,342	
48	240	6	3 pcs	XX48240&@#	\$29,594	\$33,322	\$24,125	\$22,608	\$35,148	\$9550	\$10,507	\$10,877	\$11,834	

Conference Table Tops (54"D)

STEP 1

(XX) Top Shape Prefix List:

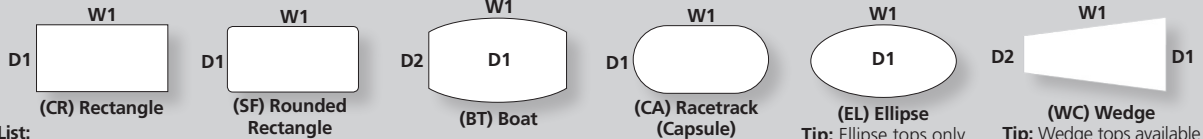

STEP 2

(&) Finish and Edge Suffix List:

- A Standard Laminate – 3mm Edge
- L Standard Laminate – PVC Edge w/ Ply look
- K Standard Laminate – Knife Edge
- T Contour Laminate – Taper Edge
- E Standard Laminate – 3mm Wood Edge
- F Standard Laminate – Taper Wood Edge
- G Standard Laminate – Knife Wood Edge
- H Standard Laminate – Bullnose Wood Edge
- P Standard Veneer – 3mm Wood Edge
- Q Standard Veneer – Taper Wood Edge
- R Standard Veneer – Knife Wood Edge
- U Standard Veneer – Bullnose Wood Edge
- V Standard Veneer – Ultra Wood Edge
- B Back-Painted Glass on 1-1/8" Knife Edge MDF
- D Back-Painted Glass (frosted) on 1-1/8" Knife Edge MDF
- 5 KrystalCast® on MDF - Knife Edge
- 6 KrystalCast® on Ply - Flat Ply Edge
- M Designer White Solid Surface (Wilsonart) - 2 1/8" Flat Edge
- N Designer White Solid Surface (Wilsonart) - 1-1/4" Knife Edge
- J **Quartz (Cambria) on MDF - 3mm Edge
- Y Statement Laminate Top - 2 1/8" Flat Ply Edge
- 3 Statement Laminate Top - Knife Ply Edge
- Z Statement Veneer Top - 2 1/8" Flat Ply Edge
- 4 Statement Veneer Top - Knife Ply Edge

** 30% Upcharge for Luxury Cambria Quartz Colors: Brittanica, Ella, Oakmoor, Roxwell, and Whitecliff.

STEP 3

(@) Cable Management Suffix List:

- N No Cable Management No charge
- G Grommet (one, center) +\$18
- K One Pwr/Data Cut-out, Centered (all size tops) +\$36
- C Two Pwr/Data Cut-outs, Between Bases (2-pc tops) +\$72
- D Two Pwr/Data Cut-outs, Between Outer Bases (3-pc tops) +\$72
- E Three Pwr/Data Cut-outs, Between Bases (3-pc tops) +\$108
- F Foundation Trough Door Kit Cut Out (n/a Designer Finishes) +\$99
- X Other TBD

STEP 4 - Laminate, Veneer, and Statement Ply Only

(#) Laminate Suffix List:

- A Wilsonart Kensington Maple (10776-60)
- B Wilsonart Monticello Maple (7925-38)
- C Wilsonart Wild Cherry (7054-60)
- E Wilsonart Fashion Grey (D381-60)
- F Wilsonart White Tigris (4783-60)
- G Wilsonart Cafelle (7933K-07)
- M Wilsonart Frosty White (1573-60)
- P Wilsonart Slate Grey (D91-60)
- R Wilsonart Black (1595-60)
- U Wilsonart Brazilwood (7946-38)
- V Wilsonart River Cherry (7937-38)
- W Wilsonart Designer White (D354-60)
- 3 Formica Neutral Twill (8826-58)
- 4 Formica Bleached Legno (8845-58)
- 5 Formica Prestige Walnut (6209-43)
- 7 Formica Select Cherry (7759-43)
- X *Wilsonart Non-Premium laminates (-38, -60). +10%
Orders of 100+ units have no upcharge.
- Y *Formica Non-Premium (58, 43, MC, SP and NT finishes) and Wilsonart Premium (-01, -07, -12, -18, -52, -78) laminates. +19%
- Z *Pionite Non-Premium, Nevamar Non-Premium, Formica Premium (WR, 42, 77, 46, RD Finishes), and whiteboard laminates. +25%

*Add \$350 list fee for Special Laminate orders of less than 10 units. See page 21 for edge selection.

(#) Contour Laminate Suffix List: (n/a on Statement Ply)

- G Natural Maple
- R Hayward Cherry
- S Studio White Matrix
- V River Cherry
- W Designer White
- Y Urban Walnut

(#) Veneer Suffix List:

- D Maple (stained similar to Kensington Maple laminate)
- J Cherry (stained similar to Wild Cherry laminate)
- N Walnut (stained similar to Cafelle laminate)
- 8 Walnut (stained similar to Prestige Walnut laminate)
- 9 Cherry (stained similar to Select Cherry laminate)
- X Stain Match (add a one-time \$700 list Stain Match fee) +10%

Laminate & Veneer

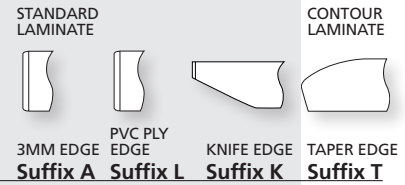

D1	W1	BRACES INCLD.	Part Number	STANDARD LAMINATE				CONTOUR LAMINATE		
				Suffix A	Suffix L	Suffix K	Suffix T	3MM EDGE	PVC PLY EDGE	KNIFE EDGE
54	54	0	-	XX5454&@#	\$778	\$894	\$1011	n/a		
54	72	2	-	XX5472&@#	\$886	\$1018	\$1151	n/a		
54	84	2	-	XX5484&@#	\$1088	\$1251	\$1414	n/a		
54	96	2	-	XX5496&@#	\$1088	\$1251	\$1414	n/a		
54	108	0	2pcs	XX54108&@#	\$1549	\$1781	\$2013	n/a		
54	120	0	2pcs	XX54120&@#	\$1577	\$1813	\$2050	n/a		
54	132	0	2pcs	XX54132&@#	\$1738	\$1998	\$2259	n/a		
54	144	0	2pcs	XX54144&@#	\$1796	\$2065	\$2334	n/a		
54	156	0	2pcs	XX54156&@#	\$2071	\$2381	\$2692	n/a		
54	168	4	2pcs	XX54168&@#	\$2122	\$2440	\$2758	n/a		
54	180	4	2pcs	XX54180&@#	\$2312	\$2658	\$3005	n/a		
54	192	4	2pcs	XX54192&@#	\$2320	\$2668	\$3016	n/a		
54	204	0	3pcs	XX54204&@#	\$2854	\$3282	\$3710	n/a		
54	216	0	3pcs	XX54216&@#	\$2863	\$3292	\$3721	n/a		
54	228	6	3pcs	XX54228&@#	\$3495	\$4019	\$4543	n/a		
54	240	6	3pcs	XX54240&@#	\$3504	\$4029	\$4555	n/a		

Designer Finishes

WHITE BACK-PAINTED GLASS ON MDF | WHITE BACK-PAINTED GLASS (FROSTED) ON MDF

For other color options, see page 31.



D1	W1	BRACES INCLD.	Part Number	WHITE BACK-PAINTED GLASS ON MDF		WHITE BACK-PAINTED GLASS (FROSTED) ON MDF	
				Suffix B	Suffix D	KNIFE EDGE	KNIFE EDGE
54	54	0	-	XX5454&@	\$10,427	\$12,323	
54	72	2	-	XX5472&@	\$11,586	\$13,693	
54	84	2	-	XX5484&@	\$9,269	\$10,954	
54	96	2	-	XX5496&@	\$11,586	\$13,693	
54	108	0	2pcs	XX54108&@	\$13,304	\$15,674	
54	120	0	2pcs	XX54120&@	\$14,411	\$17,045	
54	132	0	2pcs	XX54132&@	\$16,190	\$19,087	
54	144	0	2pcs	XX54144&@	\$17,297	\$20,457	
54	156	0	2pcs	XX54156&@	\$18,974	\$22,398	
54	168	4	2pcs	XX54168&@	\$20,083	\$23,769	
54	180	4	2pcs	XX54180&@	\$21,188	\$25,139	
54	192	4	2pcs	XX54192&@	\$22,295	\$26,509	
54	204	0	3pcs	XX54204&@	\$25,125	\$29,602	
54	216	0	3pcs	XX54216&@	\$26,231	\$30,971	
54	228	6	3pcs	XX54228&@	\$27,338	\$32,341	
54	240	6	3pcs	XX54240&@	\$28,446	\$33,713	

Product Specifications:

- > Edge profile is the same on all sides.
- > D2 is 12" less than D1 on Boat tops.
- > For wedge tops, 72-96"W D2 is 12" less than D1; 108-192"W D2 is 18" less than D1; 204-240"W D2 is 24" less than D1.
- > Multi-piece tops come with alignment hardware.
- > See page 31 for Designer Finish specifications.
- > Laminate knife wood edge (G) is 1.9" wide. Veneer knife wood edge (R) is 0.12" wide (3mm).

Ordering Information:

- > **BRACES ARE INCLUDED WITH TABLE TOPS IF REQUIRED. See below for quantities.** (Stealth, Concurrence, and Foundation Trough Kit bases do not need braces). Maximum span between legs is 72".
- > Tops for Grid, XTB, and freestanding height-adjustable table bases can be found on pages 316-324.
- > **A freight fee of \$100 net is assessed on orders less than \$1000 net. See page 13.**

TOPS	TABLES STEP 1 - TOPS
BASES	
POWER DATA	
SUPPORT FURNITURE	
ACCESSORIES	

D1	W1	BRACES INCLD.	Part Number	STANDARD LAMINATE WOOD EDGE				STANDARD VENEER					
				Suffix E	Suffix F	Suffix G	Suffix H	Suffix P	Suffix Q	Suffix R	Suffix U	Suffix V	
54	54	0	-	XX5454&@#	\$2717	\$3503	\$3591	\$3153	\$3180	\$4131	\$3333	\$3783	\$4131
54	72	2	-	XX5472&@#	\$3058	\$3941	\$4040	\$3547	\$3577	\$4648	\$3749	\$4255	\$4648
54	84	2	-	XX5484&@#	\$3397	\$4379	\$4489	\$3942	\$3975	\$5165	\$4166	\$4730	\$5165
54	96	2	-	XX5496&@#	\$3397	\$4379	\$4489	\$3942	\$3975	\$5165	\$4166	\$4730	\$5165
54	108	0	2pcs	XX54108&@#	\$4308	\$5445	\$5571	\$4939	\$5037	\$6411	\$5345	\$5906	\$6411
54	120	0	2pcs	XX54120&@#	\$4312	\$5448	\$5574	\$4942	\$5041	\$6415	\$5348	\$5909	\$6415
54	132	0	2pcs	XX54132&@#	\$4692	\$5903	\$6037	\$5364	\$5492	\$6956	\$5806	\$6418	\$6956
54	144	0	2pcs	XX54144&@#	\$5068	\$6355	\$6497	\$5784	\$5942	\$7496	\$6263	\$6924	\$7496
54	156	0	2pcs	XX54156&@#	\$5448	\$6808	\$6959	\$6204	\$6390	\$8034	\$6720	\$7431	\$8034
54	168	4	2pcs	XX54168&@#	\$6154	\$7587	\$7746	\$6950	\$7166	\$8901	\$7501	\$8263	\$8901
54	180	4	2pcs	XX54180&@#	\$6678	\$8651	\$9011	\$7934	\$7662	\$9577	\$8021	\$8873	\$9577
54	192	4	2pcs	XX54192&@#	\$7080	\$9152	\$9529	\$8400	\$8130	\$10,141	\$8494	\$9402	\$10,141
54	204	0	3pcs	XX54204&@#	\$7819	\$9995	\$10,392	\$9205	\$8937	\$11,045	\$9418	\$10,269	\$11,045
54	216	0	3pcs	XX54216&@#	\$8221	\$10,497	\$10,910	\$9669	\$9406	\$11,605	\$9894	\$10,795	\$11,605
54	228	6	3pcs	XX54228&@#	\$8663	\$11,035	\$11,469	\$10,172	\$9912	\$12,210	\$10,408	\$11,363	\$12,210
54	240	6	3pcs	XX54240&@#	\$9067	\$11,538	\$11,988	\$10,639	\$10,381	\$12,773	\$10,885	\$11,894	\$12,773

D1	W1	BRACES INCLD.	Part Number	KRYSTALCAST® ON MDF		KRYSTALCAST® ON PLY		DESIGNER WHITE SOLID SURFACE (WILSONART)		**QUARTZ (CAMBRIA)	STATEMENT LAMINATE TOP W/ BIRCH PLY EDGE		STATEMENT VENEER TOP W/ BIRCH PLY EDGE	
				Suffix 5	Suffix 6	Suffix M	Suffix N	Suffix J	Suffix Y	Suffix 3	Suffix Z	Suffix 4		
54	54	0	-	XX5454&@#	\$11,060	\$12,551	\$7139	\$6538	\$10,787	\$3915	\$4330	\$4444	\$4858	
54	72	2	-	XX5472&@#	\$12,442	\$14,120	\$8368	\$7714	\$12,945	\$4406	\$4870	\$4998	\$5465	
54	84	2	-	XX5484&@#	\$13,825	\$15,690	\$9598	\$8891	\$15,102	\$4895	\$5413	\$5554	\$6072	
54	96	2	-	XX5496&@#	\$13,825	\$15,690	\$12,315	\$11,453	\$17,574	\$4895	\$5413	\$5554	\$6072	
54	108	0	2pcs	XX54108&@#	\$16,621	\$18,719	\$13,713	\$12,792	\$19,771	\$5713	\$6265	\$6462	\$7013	
54	120	0	2pcs	XX54120&@#	\$18,254	\$20,583	\$15,111	\$14,130	\$21,967	\$6197	\$6796	\$7025	\$7626	
54	132	0	2pcs	XX54132&@#	\$19,884	\$22,448	\$16,510	\$15,468	\$24,164	\$6664	\$7303	\$7574	\$8214	
54	144	0	2pcs	XX54144&@#	\$21,516	\$24,312	\$17,908	\$16,808	\$26,361	\$7130	\$7808	\$8124	\$8802	
54	156	0	2pcs	XX54156&@#	\$23,146	\$26,176	\$19,306	\$18,146	\$28,558	\$7597	\$8315	\$8672	\$9390	
54	168	4	2pcs	XX54168&@#	\$24,778	\$28,040	\$20,704	\$19,485	\$30,754	\$8063	\$8822	\$9220	\$9977	
54	180	4	2pcs	XX54180&@#	\$26,409	\$29,904	\$22,103	\$20,823	\$32,952	\$8531	\$9328	\$9769	\$10,566	
54	192	4	2pcs	XX54192&@#	\$28,040	\$31,769	\$23,501	\$22,162	\$35,148	\$8998	\$9835	\$10,318	\$11,153	
54	204	0	3pcs	XX54204&@#	\$31,224	\$35,186	\$24,899	\$23,501	\$37,345	\$9833	\$10,711	\$11,240	\$12,118	
54	216	0	3pcs	XX54216&@#	\$32,856	\$37,051	\$24,958	\$24,840	\$39,542	\$10,300	\$11,218	\$11,788	\$12,707	
54	228	6	3pcs	XX54228&@#	\$34,487	\$38,914	\$27,695	\$26,178	\$41,739	\$10,766	\$11,724	\$12,338	\$13,296	
54	240	6	3pcs	XX54240&@#	\$34,953	\$40,778	\$29,093	\$27,517	\$43,935	\$11,234	\$12,231	\$12,887	\$13,884	

Conference Table Tops (60"D)

STEP 1

(XX) Top Shape Prefix List:

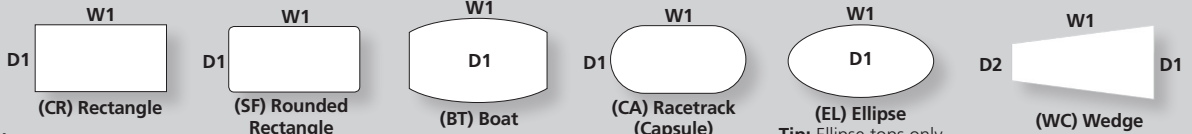

STEP 2

(&) Finish and Edge Suffix List:

- A Standard Laminate – 3mm Edge
- L Standard Laminate – PVC Edge w/ Ply look
- K Standard Laminate – Knife Edge
- T Contour Laminate – Taper Edge
- E Standard Laminate – 3mm Wood Edge
- F Standard Laminate – Taper Wood Edge
- G Standard Laminate – Knife Wood Edge
- H Standard Laminate – Bullnose Wood Edge
- P Standard Veneer – 3mm Wood Edge
- Q Standard Veneer – Taper Wood Edge
- R Standard Veneer – Knife Wood Edge
- U Standard Veneer – Bullnose Wood Edge
- V Standard Veneer – Ultra Wood Edge
- B Back-Painted Glass on 1-1/8" Knife Edge MDF
- D Back-Painted Glass (frosted) on 1-1/8" Knife Edge MDF
- 5 KrystalCast® on MDF - Knife Edge
- 6 KrystalCast® on Ply - Flat Ply Edge
- M Designer White Solid Surface (Wilsonart) - 2 1/8" Flat Edge
- N Designer White Solid Surface (Wilsonart) - 1-1/4" Knife Edge
- J **Quartz (Cambria) on MDF - 3mm Edge
- Y Statement Laminate Top - 2 1/8" Flat Ply Edge
- 3 Statement Laminate Top - Knife Ply Edge
- Z Statement Veneer Top - 2 1/8" Flat Ply Edge
- 4 Statement Veneer Top - Knife Ply Edge

** 30% Upcharge for Luxury Cambria Quartz Colors: Brittanica, Ella, Oakmoor, Roxwell, and Whitecliff.

STEP 3

(@) Cable Management Suffix List:

- N No Cable Management No charge
- G Grommet (one, center) +\$18
- K One Pwr/Data Cut-out, Centered (all size tops) +\$36
- C Two Pwr/Data Cut-outs, Between Bases (2-pc tops) +\$72
- D Two Pwr/Data Cut-outs, Between Outer Bases (3-pc tops) +\$72
- E Three Pwr/Data Cut-outs, Between Bases (3-pc tops) +\$108
- F Foundation Trough Door Kit Cut Out (n/a Designer Finishes) +\$99
- X Other TBD

STEP 4 - Laminate, Veneer, and Statement Ply Only

(#) Laminate Suffix List:

- A Wilsonart Kensington Maple (10776-60)
- B Wilsonart Monticello Maple (7925-38)
- C Wilsonart Wild Cherry (7054-60)
- E Wilsonart Fashion Grey (D381-60)
- F Wilsonart White Tigris (4783-60)
- G Wilsonart Cafelle (7933K-07)
- M Wilsonart Frosty White (1573-60)
- P Wilsonart Slate Grey (D91-60)
- R Wilsonart Black (1595-60)
- U Wilsonart Brazilwood (7946-38)
- V Wilsonart River Cherry (7937-38)
- W Wilsonart Designer White (D354-60)
- 3 Formica Neutral Twill (8826-58)
- 4 Formica Bleached Legno (8845-58)
- 5 Formica Prestige Walnut (6209-43)
- 7 Formica Select Cherry (7759-43)
- X *Wilsonart Non-Premium laminates (-38, -60). +10%
Orders of 100+ units have no upcharge.
- Y *Formica Non-Premium (58, 43, MC, SP and NT finishes) +19%
and Wilsonart Premium (-01, -07, -12, -18, -52, -78) laminates.
- Z *Pionier Non-Premium, Nevamar Non-Premium, Formica +25%
Premium (WR, 42, 77, 46, RD Finishes), and whiteboard laminates.

*Add \$350 list fee for Special Laminate orders of less than 10 units. See page 21 for edge selection.

(#) Contour Laminate Suffix List: (n/a on Statement Ply)

- G Natural Maple
- R Hayward Cherry
- S Studio White Matrix
- V River Cherry
- W Designer White
- Y Urban Walnut

(#) Veneer Suffix List:

- D Maple (stained similar to Kensington Maple laminate)
- J Cherry (stained similar to Wild Cherry laminate)
- N Walnut (stained similar to Cafelle laminate)
- 8 Walnut (stained similar to Prestige Walnut laminate)
- 9 Cherry (stained similar to Select Cherry laminate)
- X Stain Match (add a one-time \$700 list Stain Match fee) +10%

Laminate & Veneer

STANDARD LAMINATE			CONTOUR LAMINATE	
3MM EDGE	PVC PLY EDGE	KNIFE EDGE	TAPER EDGE	
Suffix A	Suffix L	Suffix K	Suffix T	

D1	W1	BRACES INCLD.		Part Number	Suffix A	Suffix L	Suffix K	Suffix T
60	60	2	-	XX6060&@#	\$778	\$894	\$1011	n/a
60	72	2	-	XX6072&@#	\$886	\$1018	\$1151	n/a
60	84	2	-	XX6084&@#	\$1088	\$1251	\$1414	n/a
60	96	2	-	XX6096&@#	\$1088	\$1251	\$1414	n/a
60	108	0	2 pcs	XX60108&@#	\$1549	\$1781	\$2013	n/a
60	120	0	2 pcs	XX60120&@#	\$1577	\$1813	\$2050	n/a
60	132	0	2 pcs	XX60132&@#	\$1738	\$1998	\$2259	n/a
60	144	0	2 pcs	XX60144&@#	\$1796	\$2065	\$2334	n/a
60	156	0	2 pcs	XX60156&@#	\$2071	\$2381	\$2692	n/a
60	168	4	2 pcs	XX60168&@#	\$2122	\$2440	\$2758	n/a
60	180	4	2 pcs	XX60180&@#	\$2312	\$2658	\$3005	n/a
60	192	4	2 pcs	XX60192&@#	\$2320	\$2668	\$3016	n/a
60	204	0	3 pcs	XX60204&@#	\$2854	\$3282	\$3710	n/a
60	216	0	3 pcs	XX60216&@#	\$2863	\$3292	\$3721	n/a
60	228	6	3 pcs	XX60228&@#	\$3495	\$4019	\$4543	n/a
60	240	6	3 pcs	XX60240&@#	\$3504	\$4029	\$4555	n/a

Designer Finishes

WHITE BACK-PAINTED GLASS ON MDF	WHITE BACK-PAINTED GLASS (FROSTED) ON MDF
---------------------------------	---

For other color options, see page 31.



D1	W1	BRACES INCLD.		Part Number	Suffix B	Suffix D
60	60	2	-	XX6060&@	\$10,427	\$12,323
60	72	2	-	XX6072&@	\$11,586	\$13,693
60	84	2	-	XX6084&@	\$9269	\$10,954
60	96	2	-	XX6096&@	\$11,586	\$13,693
60	108	0	2 pcs	XX60108&@	\$13,304	\$15,674
60	120	0	2 pcs	XX60120&@	\$14,411	\$17,045
60	132	0	2 pcs	XX60132&@	\$16,190	\$19,087
60	144	0	2 pcs	XX60144&@	\$17,297	\$20,457
60	156	0	2 pcs	XX60156&@	\$18,974	\$22,398
60	168	4	2 pcs	XX60168&@	\$20,083	\$23,769
60	180	4	2 pcs	XX60180&@	\$21,188	\$25,139
60	192	4	2 pcs	XX60192&@	\$22,295	\$26,509
60	204	0	3 pcs	XX60204&@	\$25,125	\$29,602
60	216	0	3 pcs	XX60216&@	\$26,231	\$30,971
60	228	6	3 pcs	XX60228&@	\$27,338	\$32,341
60	240	6	3 pcs	XX60240&@	\$28,446	\$33,713

Product Specifications:

- > Edge profile is the same on all sides.
- > D2 is 12" less than D1 on Boat tops.
- > For wedge tops, 72-96"W D2 is 12" less than D1; 108-192"W D2 is 18" less than D1; 204-240"W D2 is 24" less than D1.
- > Multi-piece tops come with alignment hardware.
- > See page 31 for Designer Finish specifications.
- > Laminate knife wood edge (G) is 1.9" wide. Veneer knife wood edge (R) is 0.12" wide (3mm).

Ordering Information:

- > **BRACES ARE INCLUDED WITH TABLE TOPS IF REQUIRED. See below for quantities.** (Stealth, Concurrence, and Foundation Trough Kit bases do not need braces). Maximum span between legs is 72".
- > Tops for Grid, XTB, and freestanding height-adjustable table bases can be found on pages 316-324.
- > **A freight fee of \$100 net is assessed on orders less than \$1000 net. See page 13.**

TOPS	TABLES STEP 1 - TOPS
BASES	
POWER DATA	
SUPPORT FURNITURE	
ACCESSORIES	

D1	W1	BRACES INCLD.	Part Number	STANDARD LAMINATE WOOD EDGE				STANDARD VENEER					
				Suffix E	Suffix F	Suffix G	Suffix H	Suffix P	Suffix Q	Suffix R	Suffix U	Suffix V	
60	60	2	-	XX6060&@#	\$2717	\$3503	\$3591	\$3153	\$3180	\$4131	\$3333	\$3783	\$4131
60	72	2	-	XX6072&@#	\$3058	\$3941	\$4040	\$3547	\$3577	\$4648	\$3749	\$4255	\$4648
60	84	2	-	XX6084&@#	\$3397	\$4379	\$4489	\$3942	\$3975	\$5165	\$4166	\$4730	\$5165
60	96	2	-	XX6096&@#	\$3397	\$4379	\$4489	\$3942	\$3975	\$5165	\$4166	\$4730	\$5165
60	108	0	2 pcs	XX60108&@#	\$4308	\$5445	\$5571	\$4939	\$5037	\$6411	\$5345	\$5906	\$6411
60	120	0	2 pcs	XX60120&@#	\$4312	\$5448	\$5574	\$4942	\$5041	\$6415	\$5348	\$5909	\$6415
60	132	0	2 pcs	XX60132&@#	\$4692	\$5903	\$6037	\$5364	\$5492	\$6956	\$5806	\$6418	\$6956
60	144	0	2 pcs	XX60144&@#	\$5068	\$6355	\$6497	\$5784	\$5942	\$7496	\$6263	\$6924	\$7496
60	156	0	2 pcs	XX60156&@#	\$5448	\$6808	\$6959	\$6204	\$6390	\$8034	\$6720	\$7431	\$8034
60	168	4	2 pcs	XX60168&@#	\$6154	\$7587	\$7746	\$6950	\$7166	\$8901	\$7501	\$8263	\$8901
60	180	4	2 pcs	XX60180&@#	\$6678	\$8651	\$9011	\$7934	\$7662	\$9577	\$8021	\$8873	\$9577
60	192	4	2 pcs	XX60192&@#	\$7080	\$9152	\$9529	\$8400	\$8130	\$10,141	\$8494	\$9402	\$10,141
60	204	0	3 pcs	XX60204&@#	\$7819	\$9995	\$10,392	\$9205	\$8937	\$11,045	\$9418	\$10,269	\$11,045
60	216	0	3 pcs	XX60216&@#	\$8221	\$10,497	\$10,910	\$9669	\$9406	\$11,605	\$9894	\$10,795	\$11,605
60	228	6	3 pcs	XX60228&@#	\$8663	\$11,035	\$11,469	\$10,172	\$9912	\$12,210	\$10,408	\$11,363	\$12,210
60	240	6	3 pcs	XX60240&@#	\$9067	\$11,538	\$11,988	\$10,639	\$10,381	\$12,773	\$10,885	\$11,894	\$12,773

D1	W1	BRACES INCLD.	Part Number	KRYSTALCAST® ON MDF		KRYSTALCAST® ON PLY		DESIGNER WHITE SOLID SURFACE (WILSONART)		**QUARTZ (CAMBRIA)	STATEMENT LAMINATE TOP W/ BIRCH PLY EDGE		STATEMENT VENEER TOP W/ BIRCH PLY EDGE	
				KNIFE EDGE	FLAT PLY EDGE	2-1/8" FLAT EDGE	1 1/4" KNIFE EDGE	FLAT EDGE	2-1/8" FLAT EDGE	1-1/4" KNIFE EDGE	2-1/8" FLAT EDGE	1-1/4" KNIFE EDGE		
Suffix 5	Suffix 6	Suffix M	Suffix N	Suffix J	Suffix Y	Suffix 3	Suffix Z	Suffix 4						
60	60	2	-	XX6060&@#	\$11,060	\$12,551	\$7139	\$6538	\$10,787	\$3915	\$4330	\$4444	\$4858	
60	72	2	-	XX6072&@#	\$12,442	\$14,120	\$8368	\$7714	\$12,945	\$4406	\$4870	\$4998	\$5465	
60	84	2	-	XX6084&@#	\$13,825	\$15,690	\$9598	\$8891	\$15,102	\$4895	\$5413	\$5554	\$6072	
60	96	2	-	XX6096&@#	\$13,825	\$15,690	\$12,315	\$11,453	\$17,574	\$4895	\$5413	\$5554	\$6072	
60	108	0	2 pcs	XX60108&@#	\$16,621	\$18,719	\$13,713	\$12,792	\$19,771	\$5713	\$6265	\$6462	\$7013	
60	120	0	2 pcs	XX60120&@#	\$18,254	\$20,583	\$15,111	\$14,130	\$21,967	\$6197	\$6796	\$7025	\$7626	
60	132	0	2 pcs	XX60132&@#	\$19,884	\$22,448	\$16,510	\$15,468	\$24,164	\$6664	\$7303	\$7574	\$8214	
60	144	0	2 pcs	XX60144&@#	\$21,516	\$24,312	\$17,908	\$16,808	\$26,361	\$7130	\$7808	\$8124	\$8802	
60	156	0	2 pcs	XX60156&@#	\$23,146	\$26,176	\$19,306	\$18,146	\$28,558	\$7597	\$8315	\$8672	\$9390	
60	168	4	2 pcs	XX60168&@#	\$24,778	\$28,040	\$20,704	\$19,485	\$30,754	\$8063	\$8822	\$9220	\$9977	
60	180	4	2 pcs	XX60180&@#	\$26,409	\$29,904	\$22,103	\$20,823	\$32,952	\$8531	\$9328	\$9769	\$10,566	
60	192	4	2 pcs	XX60192&@#	\$28,040	\$31,769	\$23,501	\$22,162	\$35,148	\$8998	\$9835	\$10,318	\$11,153	
60	204	0	3 pcs	XX60204&@#	\$31,224	\$35,186	\$24,899	\$23,501	\$37,345	\$9833	\$10,711	\$11,240	\$12,118	
60	216	0	3 pcs	XX60216&@#	\$32,856	\$37,051	\$24,958	\$24,840	\$39,542	\$10,300	\$11,218	\$11,788	\$12,707	
60	228	6	3 pcs	XX60228&@#	\$34,487	\$38,914	\$27,695	\$26,178	\$41,739	\$10,766	\$11,724	\$12,338	\$13,296	
60	240	6	3 pcs	XX60240&@#	\$34,953	\$40,778	\$29,093	\$27,517	\$43,935	\$11,234	\$12,231	\$12,887	\$13,884	

Round Table Tops

STEP 1

(&) Finish and Edge Suffix List:

- A Standard Laminate – 3mm Edge
- L Standard Laminate – PVC Edge w/ Ply look
- K Standard Laminate – Knife Edge
- T Contour Laminate – Taper Edge
- E Standard Laminate – 3mm Wood Edge
- F Standard Laminate – Taper Wood Edge
- G Standard Laminate – Knife Wood Edge
- H Standard Laminate – Bullnose Wood Edge
- P Standard Veneer – 3mm Wood Edge
- Q Standard Veneer – Taper Wood Edge
- R Standard Veneer – Knife Wood Edge
- U Standard Veneer – Bullnose Wood Edge
- V Standard Veneer – Ultra Wood Edge
- B Back-Painted Glass on 1-1/8" Knife Edge MDF
- D Back-Painted Glass (frosted) on 1-1/8" Knife Edge MDF
- 5 KrystalCast® on MDF - Knife Edge
- 6 KrystalCast® on Ply - Flat Ply Edge
- 7 KrystalCast® Solid - 1" Flat Edge
- M Designer White Solid Surface (Wilsonart) - 2 1/8" Flat Edge
- N Designer White Solid Surface (Wilsonart) - 1-1/4" Knife Edge
- J **Quartz (Cambria) on MDF - 3mm Edge
- Y Statement Laminate Top - 2 1/8" Flat Ply Edge
- 3 Statement Laminate Top - Knife Ply Edge
- Z Statement Veneer Top - 2 1/8" Flat Ply Edge
- 4 Statement Veneer Top - Knife Ply Edge

** 30% Upcharge for Luxury Cambria Quartz Colors: Brittanica, Ella, Oakmoor, Roxwell, and Whitecliff.

STEP 2

(@) Cable Management Suffix List:

- N No Cable Management No charge
- G Grommet (one, center) +\$18
- K One Pwr/Data Cut-out, Centered +\$36
- X Other TBD

STEP 3 - Laminate, Veneer, and Statement Ply Only

(#) Laminate Suffix List:

- A Wilsonart Kensington Maple (10776-60)
- B Wilsonart Monticello Maple (7925-38)
- C Wilsonart Wild Cherry (7054-60)
- E Wilsonart Fashion Grey (D381-60)
- F Wilsonart White Tigris (4783-60)
- G Wilsonart Cafelle (7933K-07)
- M Wilsonart Frosty White (1573-60)
- P Wilsonart Slate Grey (D91-60)
- R Wilsonart Black (1595-60)
- U Wilsonart Brazilwood (7946-38)
- V Wilsonart River Cherry (7937-38)
- W Wilsonart Designer White (D354-60)
- 3 Formica Neutral Twill (8826-58)
- 4 Formica Bleached Legno (8845-58)
- 5 Formica Prestige Walnut (6209-43)
- 7 Formica Select Cherry (7759-43)
- X *Wilsonart Non-Premium laminates (-38, -60). +10%
Orders of 100+ units have no upcharge.
- Y *Formica Non-Premium (58, 43, MC, SP and NT finishes) +19%
and Wilsonart Premium (-01, -07, -12, -18, -52, -78) laminates.
- Z *Pionite Non-Premium, Nevamar Non-Premium, Formica +25%
Premium (WR, 42, 77, 46, RD Finishes), and whiteboard laminates.

*Add \$350 list fee for Special Laminate orders of less than 10 units. See page 21 for edge selection.

(#) Contour Laminate Suffix List: (n/a on Statement Ply)

- G Natural Maple
- R Hayward Cherry
- S Studio White Matrix
- V River Cherry
- W Designer White
- Y Urban Walnut

(#) Veneer Suffix List:

- D Maple (stained similar to Kensington Maple laminate)
- J Cherry (stained similar to Wild Cherry laminate)
- N Walnut (stained similar to Cafelle laminate)
- 8 Walnut (stained similar to Prestige Walnut laminate)
- 9 Cherry (stained similar to Select Cherry laminate)
- X Stain Match (add a one-time \$700 list Stain Match fee) +10%

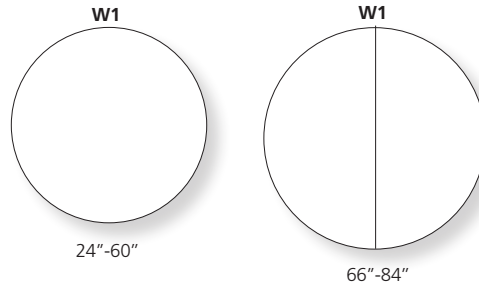

Laminate & Veneer



D1	W1	BRACES INCLD.	Part Number	SUFFIX A	SUFFIX L	SUFFIX K	SUFFIX T
-	24	-	R24&@#	\$218	\$250	\$283	\$289
-	30	-	R30&@#	\$269	\$309	\$349	\$358
-	36	-	R36&@#	\$350	\$402	\$455	\$475
-	42	-	R42&@#	\$431	\$495	\$560	\$574
-	48	-	R48&@#	\$491	\$564	\$638	\$672
-	54	-	R54&@#	\$642	\$738	\$834	n/a
-	60	-	R60&@#	\$642	\$738	\$834	n/a
-	66	2	2 pcs R66&@#	\$1338	\$1538	\$1739	n/a
-	72	2	2 pcs R72&@#	\$1338	\$1538	\$1739	n/a
-	84	2	2 pcs R84&@#	\$1783	\$2050	\$2317	n/a

Designer Finishes

WHITE BACK-PAINTED GLASS ON MDF | WHITE BACK-PAINTED GLASS (FROSTED) ON MDF

For other color options, see page 31.



D1	W1	BRACES INCLD.	Part Number	SUFFIX B	SUFFIX D
-	24	-	R24&@	\$1332	\$1507
-	30	-	R30&@	\$2047	\$2321
-	36	-	R36&@	\$2847	\$3242
-	42	-	R42&@	\$3859	\$4397
-	48	-	R48&@	\$4854	\$5555
-	54	-	R54&@	\$6151	\$7038
-	60	-	R60&@	\$7550	\$8648
-	66	2	2 pcs R66&@	\$9773	\$11,101
-	72	2	2 pcs R72&@	\$11,054	\$12,635
-	84	2	2 pcs R84&@	\$14,168	\$16,316

Product Specifications:

- > Multi-piece tops come with alignment hardware.
- > See page 31 for Designer Finish specifications.
- > Laminate knife wood edge (G) is 1.9" wide. Veneer knife wood edge (R) is 0.12" wide (3mm).

Ordering Information:

- > **BRACES ARE INCLUDED WITH TABLE TOPS IF REQUIRED. See below for quantities.** (Stealth, Concurrence, and Foundation Trough Kit bases do not need braces). Maximum span between legs is 72".
- > **A freight fee of \$100 net is assessed on orders less than \$1000 net. See page 13.**

TOPS	TABLES STEP 1 - TOPS
BASES	
POWER DATA	
SUPPORT FURNITURE	
ACCESSORIES	

D1	W1	BRACES INCLD.	Part Number	STANDARD LAMINATE WOOD EDGE		VENEER		STANDARD		3MM WOOD EDGE	TAPER WOOD EDGE	KNIFE WOOD EDGE	BULLNOSE WOOD EDGE	ULTRA WOOD EDGE
				Suffix E	Suffix F	Suffix G	Suffix H	Suffix P	Suffix Q					
-	24	-	R24&@#	\$399	\$637	\$663	\$532	\$423	\$748	\$585	\$644	\$748		
-	30	-	R30&@#	\$585	\$882	\$915	\$750	\$678	\$1039	\$808	\$907	\$1039		
-	36	-	R36&@#	\$799	\$1153	\$1193	\$997	\$908	\$1363	\$1067	\$1205	\$1363		
-	42	-	R42&@#	\$1049	\$1462	\$1507	\$1278	\$1229	\$1727	\$1368	\$1545	\$1727		
-	48	-	R48&@#	\$1333	\$1802	\$1855	\$1594	\$1565	\$2135	\$1709	\$1924	\$2135		
-	54	-	R54&@#	\$1651	\$2179	\$2238	\$1944	\$1942	\$2583	\$2092	\$2348	\$2583		
-	60	-	R60&@#	\$1997	\$2580	\$2646	\$2321	\$2357	\$3063	\$2509	\$2803	\$3063		
-	66	2	R66&@#	\$3090	\$3941	\$4095	\$3632	\$3337	\$4158	\$3616	\$3855	\$4158		
-	72	2	R72&@#	\$3544	\$4471	\$4638	\$4134	\$3865	\$4760	\$4149	\$4430	\$4760		
-	84	2	R84&@#	n/a	n/a	n/a	n/a	n/a	n/a	n/a	n/a	n/a		

D1	W1	BRACES INCLD.	Part Number	KRYSTALCAST®			DESIGNER WHITE SOLID SURFACE (WILSONART)		**QUARTZ (CAMBRIA)	STATEMENT LAMINATE TOP W/ BIRCH PLY EDGE		STATEMENT VENEER TOP W/ BIRCH PLY EDGE	
				ON MDF	ON PLY	1" THICK	2-1/8" FLAT EDGE	1 1/4" KNIFE EDGE	FLAT EDGE	2-1/8" FLAT EDGE	1-1/4" KNIFE EDGE	2-1/8" FLAT EDGE	1-1/4" KNIFE EDGE
Suffix 5	Suffix 6	Suffix 7	Suffix M	Suffix N	Suffix J	Suffix Y	Suffix 3	Suffix Z	Suffix 4				
-	24	-	R24&@#	\$1305	\$1491	\$1763	\$1874	\$1547	\$1757	\$1357	\$1671	\$1426	\$1742
-	30	-	R30&@#	\$2042	\$2330	\$2601	\$2617	\$2231	\$2746	\$1593	\$1992	\$1702	\$2099
-	36	-	R36&@#	\$2935	\$3355	\$3626	\$3479	\$3034	\$3954	\$1866	\$2337	\$2019	\$2488
-	42	-	R42&@#	\$3999	\$4567	\$4838	\$4462	\$3956	\$5381	\$2180	\$2730	\$2385	\$2934
-	48	-	R48&@#	\$5219	\$5965	\$6236	\$5562	\$4996	\$7029	\$2534	\$3160	\$2802	\$3428
-	54	-	R54&@#	\$7192	\$8131	\$8676	\$6781	\$6157	\$8897	\$2929	\$3633	\$3265	\$3972
-	60	-	R60&@#	\$8739	\$9902	\$10,447	\$8121	\$7436	\$10,983	\$3361	\$4140	\$3775	\$4553
-	66	2	R66&@#	\$11,620	\$13,025	\$13,569	\$9579	\$8835	\$13,291	\$4201	\$5058	\$4708	\$5567
-	72	2	R72&@#	\$13,491	\$15,170	\$15,712	\$11,427	\$10,614	\$16,256	\$4719	\$5653	\$5323	\$6257
-	84	2	R84&@#	\$17,733	\$20,016	\$20,560	\$14,666	\$13,743	\$21,528	\$5874	\$6960	\$6690	\$7775

Half-Round, Half-Elliptical, Half-Media Conference Table Tops

STEP 1

(&) Finish and Edge Suffix List:

- A Standard Laminate – 3mm Edge (all sides)
- L Standard Laminate – PVC Edge w/ Ply look (all sides)
- K Standard Laminate – Knife Edge (all sides)
- T Contour Laminate – Taper Edge (all sides)
- E Standard Laminate – 3mm Wood Edge (all sides)
- P Standard Veneer – 3mm Wood Edge (all sides)

STEP 2

(#) Laminate Suffix List:

- A Wilsonart Kensington Maple (10776-60)
- B Wilsonart Monticello Maple (7925-38)
- C Wilsonart Wild Cherry (7054-60)
- E Wilsonart Fashion Grey (D381-60)
- F Wilsonart White Tigris (4783-60)
- G Wilsonart Cafelle (7933K-07)
- M Wilsonart Frosty White (1573-60)
- P Wilsonart Slate Grey (D91-60)
- R Wilsonart Black (1595-60)
- U Wilsonart Brazilwood (7946-38)
- V Wilsonart River Cherry (7937-38)
- W Wilsonart Designer White (D354-60)
- 3 Formica Neutral Twill (8826-58)
- 4 Formica Bleached Legno (8845-58)
- 5 Formica Prestige Walnut (6209-43)
- 7 Formica Select Cherry (7759-43)
- X *Wilsonart Non-Premium laminates (-38, -60). +10% Orders of 100+ units have no upcharge.
- Y *Formica Non-Premium Standard (58, 43, +19% MC, SP and NT finishes) and Wilsonart Premium (-01, -07, -12, -18, -52, -78) laminates.
- Z *Pionite Non-Premium, Nevamar Non-Premium, Formica Premium (WR, 42, 77, 46, RD Finishes), and whiteboard laminate. +25%

*Add \$350 list for Special Laminate orders of less than 10 units. See page 21 for edge selection.

(#) Contour Laminate Suffix List:

- G Natural Maple
- R Hayward Cherry
- S Studio White Matrix
- V River Cherry
- W Designer White
- Y Urban Walnut

(#) Veneer Suffix List:

- D Maple (stained similar to Kensington Maple laminate)
- J Cherry (stained similar to Wild Cherry laminate)
- N Walnut (stained similar to Cafelle laminate)
- 8 Walnut (stained similar to Prestige Walnut laminate)
- 9 Cherry (stained similar to Select Cherry laminate)
- X Stain Match (add a one-time \$700 list +10% Stain Match fee)

Ordering Information:

- > For Half-Round tops used in flip applications, downsize the base one size (e.g. 24"x48" Half-Round would use an 18"D base).
- > W1 is always 3mm edge.
- > Braces not included. Add braces for spans of 54" or longer according to rules on page 23.
- > A freight fee of \$100 net is assessed on orders less than \$1000 net. See page 13.



Laminate & Veneer

D1	W1	BRACES INCLD.	Part Number	STANDARD LAMINATE		CONTOUR LAMINATE	STANDARD LAMINATE	STANDARD VENEER	
				Suffix A	Suffix L	Suffix K	Suffix T	Suffix E	Suffix P
Half-Round				3MM EDGE	PVC PLY EDGE	KNIFE EDGE	TAPER EDGE	3MM WOOD EDGE	3MM WOOD EDGE
24	48	-	HR2448&#	\$325	\$373	\$422	\$446	\$717	\$838
30	60	-	HR3060&#	\$466	\$535	\$605	\$637	\$1063	\$1246
36	72	-	HR3672&#	\$662	\$737	\$809	\$1074	\$1449	\$1665
Half-Elliptical									
48	48	-	HRE48&#	\$511	\$587	\$664	\$1283	\$1407	\$1645
60	60	-	HRE60&#	\$677	\$778	\$880	n/a	\$1995	\$2356
Half-Media									
48	48	-	HRM48&#	\$511	\$587	\$664	\$1283	\$1407	\$1645
60	60	-	HRM60&#	\$677	\$778	\$880	n/a	\$1995	\$2356

TOPS	TABLES STEP 1 - TOPS
BASES	
POWER DATA	
SUPPORT FURNITURE	
ACCESSORIES	

Notes

D-Top Table Tops

STEP 1

(&) Finish and Edge Suffix List:

- A Standard Laminate – 3mm Edge (all sides)
- L Standard Laminate – PVC Edge w/ Ply look (all sides)
- K Standard Laminate – Knife Edge (all sides)
- T Contour Laminate – Taper Edge (all sides)

STEP 2

(&) Cable Management Suffix List:

- N No Cable Management No charge
- G Grommet (one, center) +\$18
- K One Power/Data Cut-out, Centered +\$36
- C Two Power/Data Cut-outs +\$72
- X Other TBD

Ordering Information:

- > For applications which require Taper Edge to be handed, call customer service for quote.
- > This worksurface is not available for XTB Flexible Height Benching.
- > D1 is always 3mm edge.
- > **A freight fee of \$100 net is assessed on orders less than \$1000 net. See page 13.**

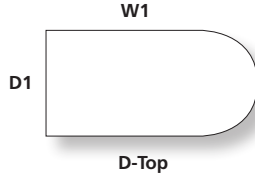

STEP 3

(&) Laminate Suffix List:

- A Wilsonart Kensington Maple (10776-60)
- B Wilsonart Monticello Maple (7925-38)
- C Wilsonart Wild Cherry (7054-60)
- E Wilsonart Fashion Grey (D381-60)
- F Wilsonart White Tigris (4783-60)
- G Wilsonart Cafelle (7933K-07)
- M Wilsonart Frosty White (1573-60)
- P Wilsonart Slate Grey (D91-60)
- R Wilsonart Black (1595-60)
- U Wilsonart Brazilwood (7946-38)
- V Wilsonart River Cherry (7937-38)
- W Wilsonart Designer White (D354-60)
- 3 Formica Neutral Twill (8826-58)
- 4 Formica Bleached Legno (8845-58)
- 5 Formica Prestige Walnut (6209-43)
- 7 Formica Select Cherry (7759-43)
- X *Wilsonart Non-Premium laminates (-38, -60). +10%
Orders of 100+ units have no upcharge.
- Y *Formica Non-Premium Standard (58, 43, MC, SP and NT finishes) and Wilsonart Premium (-01, -07, -12, -18, -52, -78) laminates. +19%
- Z *Pionite Non-Premium, Nevamar Non-Premium, Formica Premium (WR, 42, 77, 46, RD Finishes), and whiteboard laminate. +25%

*Add \$350 list for Special Laminate orders of less than 10 units. See page 21 for edge selection.

(&) Contour Laminate Suffix List:

- G Natural Maple
- R Hayward Cherry
- S Studio White Matrix
- V River Cherry
- W Designer White
- Y Urban Walnut

Laminate

D1	W1	BRACES INCLD.	Part Number	STANDARD LAMINATE			CONTOUR LAMINATE
				3MM EDGE Suffix A	PVC PLY EDGE Suffix L	KNIFE EDGE Suffix K	TAPER EDGE Suffix T
D-Top							
24	48	-	P2448&@#	\$320	\$368	\$416	\$427
24	60	1	P2460&@#	\$383	\$440	\$497	\$515
24	66	1	P2466&@#	\$401	\$461	\$521	\$533
24	72	1	P2472&@#	\$416	\$478	\$540	\$554
30	48	-	P3048&@#	\$456	\$524	\$592	\$624
30	60	1	P3060&@#	\$491	\$564	\$638	\$670
30	66	1	P3066&@#	\$522	\$600	\$678	\$715
30	72	2	P3072&@#	\$540	\$621	\$702	\$738
30	84	2	P3084&@#	\$673	\$773	\$874	\$1134
30	96	2	P3096&@#	\$721	\$806	\$937	\$1197
36	60	1	P3660&@#	\$701	\$806	\$911	\$1535
36	66	1	P3666&@#	\$771	\$886	\$1002	\$1663
36	72	2	P3672&@#	\$771	\$886	\$1002	\$1238
36	78	2	P3678&@#	\$931	\$1070	\$1210	\$1913
36	84	2	P3684&@#	\$931	\$1070	\$1210	\$1454
36	96	2	P3696&@#	\$931	\$1070	\$1210	\$1454
42	60	1	P4260&@#	\$755	\$868	\$981	\$1697
42	66	1	P4266&@#	\$832	\$956	\$1081	\$1836
42	72	2	P4272&@#	\$832	\$956	\$1081	\$1974
42	78	2	P4278&@#	\$943	\$1084	\$1225	\$2115
42	84	2	P4284&@#	\$943	\$1084	\$1225	\$2254
42	96	2	P4296&@#	\$998	\$1147	\$1297	\$2527
48	60	1	P4860&@#	\$755	\$868	\$981	\$1885
48	66	1	P4866&@#	\$832	\$956	\$1081	\$2041
48	72	2	P4872&@#	\$832	\$956	\$1081	\$2196
48	78	2	P4878&@#	\$943	\$1084	\$1225	\$2355
48	84	2	P4884&@#	\$943	\$1084	\$1225	\$2509
48	96	2	P4896&@#	\$998	\$1147	\$1297	\$2818
54	60	1	P5460&@#	\$886	\$1018	\$1151	n/a
54	66	1	P5466&@#	\$886	\$1018	\$1151	n/a
54	72	2	P5472&@#	\$886	\$1018	\$1151	n/a
54	78	2	P5478&@#	\$1088	\$1251	\$1414	n/a
54	84	2	P5484&@#	\$1088	\$1251	\$1414	n/a
54	96	2	P5496&@#	\$1088	\$1251	\$1414	n/a
60	60	1	P6060&@#	\$778	\$894	\$1011	n/a
60	66	1	P6066&@#	\$886	\$1018	\$1151	n/a
60	72	2	P6072&@#	\$886	\$1018	\$1151	n/a
60	78	2	P6078&@#	\$1088	\$1251	\$1414	n/a
60	84	2	P6084&@#	\$1088	\$1251	\$1414	n/a
60	96	2	P6096&@#	\$1088	\$1251	\$1414	n/a

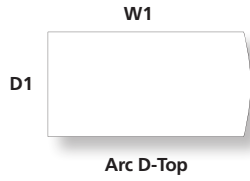

TOPS	TABLES STEP 1 - TOPS
BASES	
POWER DATA	
SUPPORT FURNITURE	
ACCESSORIES	

Laminate

D1	W1	BRACES INCLD.	Part Number	STANDARD LAMINATE			CONTOUR LAMINATE
				3MM EDGE Suffix A	PVC PLY EDGE Suffix L	KNIFE EDGE Suffix K	TAPER EDGE Suffix T
Arc D-Top							
30	60	1	PAB3060&@#	\$491	\$564	\$638	\$670
30	66	1	PAB3066&@#	\$522	\$600	\$678	\$715
30	72	2	PAB3072&@#	\$540	\$621	\$702	\$738
30	84	2	PAB3084&@#	\$673	\$673	\$874	\$1134
30	96	2	PAB3096&@#	\$721	\$701	\$937	\$1197
36	72	2	PAB3672&@#	\$771	\$886	\$1002	\$1238
36	84	2	PAB3684&@#	\$931	\$1070	\$1210	\$1454
36	96	2	PAB3696&@#	\$931	\$1070	\$1210	n/a

Conference Quarter-Round Table Tops

STEP 1

(#) Finish and Edge Suffix List:

- A Standard Laminate – 3mm Edge (all sides)
- L Standard Laminate – PVC Edge w/ Ply look (all sides)
- K Standard Laminate – Knife Edge (all sides)
- T Contour Laminate – Taper Edge (all sides)
- E Standard Laminate – 3mm Wood Edge (all sides)
- P Standard Veneer – 3mm Wood Edge (all sides)

STEP 2

(@) Cable Management Suffix List:

- N No Cable Management No charge
- G Grommet (one, center) +\$18
- K One Power/Data Cut-out, Centered +\$36
- X Other TBD

STEP 3

(#) Laminate Suffix List:

- A Wilsonart Kensington Maple (10776-60)
- B Wilsonart Monticello Maple (7925-38)
- C Wilsonart Wild Cherry (7054-60)
- E Wilsonart Fashion Grey (D381-60)
- F Wilsonart White Tigris (4783-60)
- G Wilsonart Cafelle (7933K-07)
- M Wilsonart Frosty White (1573-60)
- P Wilsonart Slate Grey (D91-60)
- R Wilsonart Black (1595-60)
- U Wilsonart Brazilwood (7946-38)
- V Wilsonart River Cherry (7937-38)
- W Wilsonart Designer White (D354-60)
- 3 Formica Neutral Twill (8826-58)
- 4 Formica Bleached Legno (8845-58)
- 5 Formica Prestige Walnut (6209-43)
- 7 Formica Select Cherry (7759-43)
- X *Wilsonart Non-Premium laminates (-38, -60). +10%
Orders of 100+ units have no upcharge.
- Y *Formica Non-Premium Standard (58, 43, MC, SP and NT finishes) and Wilsonart Premium (-01, -07, -12, -18, -52, -78) laminates. +19%
- Z *Pionite Non-Premium, Nevamar Non-Premium, Formica Premium (VWR, 42, 77, 46, RD Finishes), and whiteboard laminate. +25%

*Add \$350 list for Special Laminate orders of less than 10 units. See page 21 for edge selection.

(#) Contour Laminate Suffix List:

- G Natural Maple
- R Hayward Cherry
- S Studio White Matrix
- V River Cherry
- W Designer White
- Y Urban Walnut

(#) Veneer Suffix List:

- D Maple (stained similar to Kensington Maple laminate)
- J Cherry (stained similar to Wild Cherry laminate)
- N Walnut (stained similar to Cafelle laminate)
- 8 Walnut (stained similar to Prestige Walnut laminate)
- 9 Cherry (stained similar to Select Cherry laminate)
- X Stain Match (add a one-time \$700 list Stain Match fee) +10%

Ordering Information:

- > Support recommendation is 3 straight legs.
- > D1 is always a 3mm edge.
- > **A freight fee of \$100 net is assessed on orders less than \$1000 net. See page 13.**

Laminate & Veneer

D1	W1	BRACES INCLD.	Part Number	STANDARD LAMINATE				CONTOUR LAMINATE
				3MM EDGE Suffix A	PVC PLY EDGE Suffix L	KNIFE EDGE Suffix K	TAPER EDGE Suffix T	
24	24	-	-	QR2424&@#	\$229	\$263	\$297	\$305
30	30	-	-	QR3030&@#	\$289	\$332	\$375	\$389

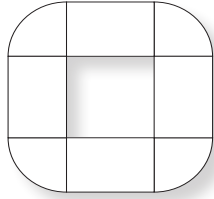
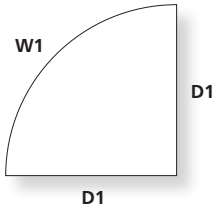

Tip: Order conference rectangle worksurfaces on pages 34-37 for this application.

TOPS	TABLES STEP 1 - TOPS
BASES	
POWER DATA	
SUPPORT FURNITURE	
ACCESSORIES	

STANDARD LAMINATE	STANDARD VENEER
3MM WOOD EDGE	3MM WOOD EDGE

D1	W1	BRACES INCLD.	Part Number	Suffix E	Suffix P
24	24	-	QR2424&@#	\$359	\$418
30	30	-	QR3030&@#	\$531	\$623

Teleconference Table Tops

STEP 1

(&) Finish and Edge Suffix List:

- A Standard Laminate – 3mm Edge (all sides)
- L Standard Laminate – PVC Edge w/ Ply look (all sides)
- E Standard Laminate – 3mm Wood Edge (all sides)
- P Standard Veneer – 3mm Wood Edge (all sides)

STEP 2

(@) Cable Management Suffix List:

- N No Cable Management No charge
- G Grommet (one, center) +\$18
- K One Power/Data Cut-out, Centered +\$36
- X Other TBD

STEP 3

(#) Laminate Suffix List:

- A Wilsonart Kensington Maple (10776-60)
- B Wilsonart Monticello Maple (7925-38)
- C Wilsonart Wild Cherry (7054-60)
- E Wilsonart Fashion Grey (D381-60)
- F Wilsonart White Tigris (4783-60)
- G Wilsonart Cafelle (7933K-07)
- M Wilsonart Frosty White (1573-60)
- P Wilsonart Slate Grey (D91-60)
- R Wilsonart Black (1595-60)
- U Wilsonart Brazilwood (7946-38)
- V Wilsonart River Cherry (7937-38)
- W Wilsonart Designer White (D354-60)
- 3 Formica Neutral Twill (8826-58)
- 4 Formica Bleached Legno (8845-58)
- 5 Formica Prestige Walnut (6209-43)
- 7 Formica Select Cherry (7759-43)
- X *Wilsonart Non-Premium laminates (-38, -60). +10%
Orders of 100+ units have no upcharge.
- Y *Formica Non-Premium Standard (58, 43, +19%
MC, SP and NT finishes) and Wilsonart Premium
(-01, -07, -12, -18, -52, -78) laminates.
- Z *Pionite Non-Premium, Nevamar Non- +25%
Premium, Formica Premium (WR, 42, 77,
46, RD Finishes), and whiteboard laminate.

*Add \$350 list for Special Laminate orders of less than 10 units. See page 21 for edge selection.

(#) Contour Laminate Suffix List:

- G Natural Maple
- R Hayward Cherry
- S Studio White Matrix
- V River Cherry
- W Designer White
- Y Urban Walnut

(#) Veneer Suffix List:

- D Maple (stained similar to Kensington +10%
Maple laminate)
- J Cherry (stained similar to Wild Cherry laminate)
- N Walnut (stained similar to Cafelle laminate)
- 8 Walnut (stained similar to Prestige Walnut laminate)
- 9 Cherry (stained similar to Select Cherry laminate)
- X Stain Match (add a one-time \$700 list +10%
Stain Match fee)

Product Specifications:

- > 24" Teleconference Tops: D2 = 24"
- > 30" Teleconference Tops: D2 = 30"

Ordering Information:

- > A freight fee of \$100 net is assessed on orders less than \$1000 net. See page 13.

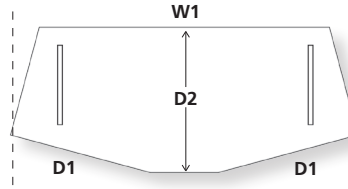

Tip: Leg orientation (legs purchased separately)

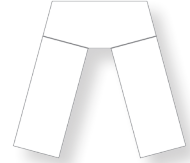

Tip: Order conference rectangle worksurfaces on pages 34-37 for this application.

Laminate & Veneer

D1	W1	BRACES INCLD.	Part Number	STANDARD LAMINATE			STANDARD VENEER
				3MM EDGE Suffix A	PVC PLY EDGE Suffix L	WOOD EDGE Suffix E	3MM WOOD EDGE Suffix P
24	72	-	ST242472&@#	\$479	\$550	\$1210	\$1435
30	72	-	ST303072&@#	\$571	\$656	\$1434	\$1706

TOPS	TABLES STEP 1 - TOPS
BASES	
POWER DATA	
SUPPORT FURNITURE	
ACCESSORIES	

Notes

Credenza and File Tops

STEP 1

(&) Finish and Edge Suffix List:

- A Standard Laminate - 3mm Edge
- B Back-Painted Glass
- D Back-Painted Glass (frosted)
- 6 KrystalCast® on Ply - Flat Ply Edge
- M Designer White Solid Surface (Wilsonart) - 1" Flat Edge
- J Quartz (Cambria) on MDF - 3mm Edge
- Y Statement Laminate Top - 1" Flat Ply Edge
- Z Statement Veneer Top - 1" Flat Ply Edge

Tip: 30% Upcharge for Luxury Cambria Quartz Colors: Brittanica, Ella, Oakmoor, Roxwell, and Whitecliff.

STEP 2

(@) Cable Management Suffix List:

- N No Cable Management No charge
- G Grommet (one, center) +\$18
- K One Power/Data Cut-out, Centered (all size tops) +\$36
- X Other TBD

STEP 3 - For Statement Ply Tops Only

(#) Laminate Suffix List:

- A Wilsonart Kensington Maple (10776-60)
- B Wilsonart Monticello Maple (7925-38)
- C Wilsonart Wild Cherry (7054-60)
- E Wilsonart Fashion Grey (D381-60)
- F Wilsonart White Tigris (4783-60)
- G Wilsonart Cafelle (7933K-07)
- M Wilsonart Frosty White (1573-60)
- P Wilsonart Slate Grey (D91-60)
- R Wilsonart Black (1595-60)
- U Wilsonart Brazilwood (7946-38)
- V Wilsonart River Cherry (7937-38)
- W Wilsonart Designer White (D354-60)
- 3 Formica Neutral Twill (8826-58)
- 4 Formica Bleached Legno (8845-58)
- 5 Formica Prestige Walnut (6209-43)
- 7 Formica Select Cherry (7759-43)
- X *Wilsonart Non-Premium laminates (-38, -60). +10%
Orders of 100+ units have no upcharge.
- Y *Formica Non-Premium Standard (58, 43, +19%
MC, SP and NT finishes) and Wilsonart Premium
(-01, -07, -12, -18, -52, -78) laminates.
- Z *Pionite Non-Premium, Nevamar Non- +25%
Premium, Formica Premium (WR, 42, 77,
46, RD Finishes), and whiteboard laminate.

*Add \$350 list for Special Laminate orders of less than 10 units. See page 21 for edge selection.

(#) Veneer Suffix List:

- D Maple (stained similar to Wilsonart Kensington Maple laminate)
- J Cherry (stained similar to Wilsonart Wild Cherry laminate)
- N Walnut (stained similar to Wilsonart Cafelle laminate)
- 8 Walnut (stained similar to Prestige Walnut laminate)
- 9 Cherry (stained similar to Select Cherry laminate)
- X Stain Match (add a one-time \$700 list +10%
Stain Match fee)

Product Specifications:

- > (see page 61)

Ordering Information:

- > **BRACES ARE INCLUDED WITH TABLE TOPS IF REQUIRED.**
- > There is a 30% upcharge for Luxury Cambria Quartz colors: Brittanica, Ella, Oakmoor, Roxwell, and Whitecliff.
- > **A freight fee of \$100 net is assessed on orders less than \$1000 net. See page 13.**

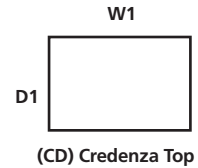

Laminate & Designer Finishes

STANDARD LAMINATE



3MM EDGE Suffix A

WHITE BACK-PAINTED GLASS

For other color options, see page 31.



FLAT EDGE Suffix B

WHITE BACK-PAINTED GLASS (FROSTED)

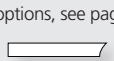

FLAT EDGE Suffix D

D1	W1	Part Number	3MM EDGE Suffix A	FLAT EDGE Suffix B	FLAT EDGE Suffix D
Credenza Tops*					
12.75	51.75**	- CD1351&@	\$199	\$1253	\$1420
20	36	- CD2036&@	\$241	\$1250	\$1426
20	48	- CD2048&@	\$283	\$1623	\$1857
20	60	- CD2060&@	\$420	\$2039	\$2331
20	72	- CD2072&@	\$452	\$2501	\$2852
24	60	- CD2460&@	\$420	\$2501	\$2852
24	72	- CD2472&@	\$452	\$2896	\$3318
24	84	- CD2484&@	\$575	\$3211	\$3643
24	96	- CD2496&@	\$604	\$3211	\$3643





**Tip: Used on Concurrency Monitor Wall.

*Tip: MDF substraight for glass tops not needed (and therefore not included) with Credenza Tops.

Product Specifications:

- > 2-1/8" thick Designer Finish options become 1" thick on Credenza Tops.
- > MDF substraigh for glass tops not needed (and therefore not included) with Credenza Tops.
- > **Back-Painted Glass** – 3/8" thick, annealed, flat-polished low iron. 1-1/8" knife edge MDF substrate painted to match. Bright white as standard. Any Benjamin Moore color available upon request. \$2000 list custom color fee applies for orders of less than 250 sq. ft. There is also a 20% upcharge to each top's list price for custom colors. Actual depth of 60"D tops is 59" due to yield.
- > **KrystalCast®** – Acrylic on MDF or birch ply is available in any Benjamin Moore color. Super White is by far the most popular. See www.KrystalCast.com for technical specs and care instructions.
- > **Solid Surface (Wilsonart)** – Designer White as standard. See <http://wilsonart.com/commercial/solid-surfaces/designs> for additional finish/color choices. Price varies by finish/color, contact quotes@enwork.com with your preferred selection.
- > **Quartz (Cambria)** – See www.cambriausa.com for finish/color choices. 13/16" thick. Undersized 1-1/8" knife edge substrate painted black. Due to sheet size availability, 60"D (only) tops come in twice the quantity of pieces. (For example, a top that normally comes in 3 pieces will come in 6 pieces.
- > **Birch Ply Edges** – Edge is clear coated when specified with laminate and stained-to-match when sold with veneer. Actual width of 96"W is 95". Actual width of 192"W is 190" due to yield.

TOPS	TABLES STEP 1 - TOPS
BASES	
POWER DATA	
SUPPORT FURNITURE	
ACCESSORIES	

D1	W1	Part Number	KRYSTALCAST® ON PLY  FLAT PLY EDGE Suffix 6	DESIGNER WHITE SOLID SURFACE (WILSONART)  1" FLAT EDGE Suffix M	QUARTZ (CAMBRIA)  FLAT EDGE Suffix J	STATEMENT LAMINATE TOP W/ BIRCH PLY EDGE  1" FLAT EDGE* Suffix Y	STATEMENT VENEER TOP W/ BIRCH PLY EDGE  1" FLAT EDGE* Suffix Z
Credenza Tops*							
12.75	51.75**	- CD1351&@#	\$1863	\$2193	\$1988	\$603	\$709
20	36	- CD2036&@#	\$1863	\$2250	\$2196	\$629	\$741
20	48	- CD2048&@#	\$2492	\$2855	\$2928	\$812	\$956
20	60	- CD2060&@#	\$3106	\$3459	\$3660	\$997	\$1172
20	72	- CD2072&@#	\$3728	\$4065	\$4393	\$1180	\$1389
24	60	- CD2460&@#	\$3728	\$3927	\$4393	\$1173	\$1383
24	72	- CD2472&@#	\$4474	\$4611	\$5271	\$1394	\$1640
24	84	- CD2484&@#	\$4763	\$4909	\$5976	\$1811	\$2053
24	96	- CD2496&@#	\$4763	\$4909	\$5976	\$1811	\$2053

**Tip: Used on Concurrence Monitor Wall.

*Tip: MDF substraigh for glass tops not needed (and therefore not included) with Credenza Tops.

Luminesse™ LED Rectangle Conference Table Tops Patent Pending

STEP 1

(@) Cable Management Suffix List:

N	No Cable Management	No charge
K	One Power/Data Cut-out, Centered (all size tops)	+\$36
X	Other	TBD

*Additional Cut-outs may be available. Contact quotes@enwork.com for specific applications and pricing.

STEP 2

(#) Laminate Suffix List:

A	Wilsonart Kensington Maple (10776-60)	
B	Wilsonart Monticello Maple (7925-38)	
C	Wilsonart Wild Cherry (7054-60)	
E	Wilsonart Fashion Grey (D381-60)	
F	Wilsonart White Tigris (4783-60)	
G	Wilsonart Cafelle (7933K-07)	
M	Wilsonart Frosty White (1573-60)	
P	Wilsonart Slate Grey (D91-60)	
R	Wilsonart Black (1595-60)	
U	Wilsonart Brazilwood (7946-38)	
V	Wilsonart River Cherry (7937-38)	
W	Wilsonart Designer White (D354-60)	
3	Formica Neutral Twill (8826-58)	
4	Formica Bleached Legno (8845-58)	
5	Formica Prestige Walnut (6209-43)	
7	Formica Select Cherry (7759-43)	
X	*Wilsonart Non-Premium laminates (-38, -60). Orders of 100+ units have no upcharge.	10%
Y	*Formica Non-Premium Standard (58, 43, MC, SP and NT finishes) and Wilsonart Premium (-01, -07, -12, -18, -52, -78) laminates.	19%
Z	*Pionite Non-Premium, Nevamar Non- Premium, Formica Premium (WR, 42, 77, 46, RD Finishes), and whiteboard laminate.	25%

*Add \$350 list for Special Laminate orders of less than 10 units. See page 21 for edge selection.

Product Specifications:

- > Available as rectangle conference table tops only.
- > Includes one battery operated remote wall switch.
- > Currently available as white LED only. Additional colors in development.
- > 3.3-7.8 amps, depending on top size.
- > Top is 1.5" thick. LED portion is 0.5" of the total thickness.
- > Back-painted glass tops available as a special. Contact quotes@enwork.com.
- > Each section of top comes fully assembled with its own power supply. Power supply is mounted in the field.
- > Multi-piece tops have matching seam in light channel.
- > LED lights are accessible for future maintenance.

Ordering Information:

- > Contact quotes@enwork.com if multiple power/data cut-outs are required.
- > If ordered with Stealth Luminesse LED base, fewer power supplies are required and provided.
- > **A freight fee of \$100 net is assessed on orders less than \$1000 net. See page 13.**

LAMINATE

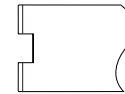

D1	W1	BRACES INCLD.		Part Number	Suffix 8
42	72	2	-	CRL4272@#	\$4617
42	84	2	-	CRL4284@#	\$4640
42	96	2	-	CRL4296@#	\$5013
42	108	0	2pcs	CRL42108@#	\$6578
42	120	0	2pcs	CRL42120@#	\$6601
42	132	0	2pcs	CRL42132@#	\$6651
42	144	0	2pcs	CRL42144@#	\$6674
42	156	0	2pcs	CRL42156@#	\$6855
42	168	4	2pcs	CRL42168@#	\$6878
42	180	4	2pcs	CRL42180@#	\$6928
42	192	4	2pcs	CRL42192@#	\$7142
42	204	0	3pcs	CRL42204@#	\$8733
42	216	0	3pcs	CRL42216@#	\$8912
42	228	6	3pcs	CRL42228@#	\$8936
42	240	6	3pcs	CRL42240@#	\$8960
48	72	2	-	CRL4872@#	\$4989
48	84	2	-	CRL4884@#	\$5013
48	96	2	-	CRL4896@#	\$5037
48	108	0	2pcs	CRL48108@#	\$6601
48	120	0	2pcs	CRL48120@#	\$6625
48	132	0	2pcs	CRL48132@#	\$6674
48	144	0	2pcs	CRL48144@#	\$6698
48	156	0	2pcs	CRL48156@#	\$6878
48	168	4	2pcs	CRL48168@#	\$6901
48	180	4	2pcs	CRL48180@#	\$6951
48	192	4	2pcs	CRL48192@#	\$7165
48	204	0	3pcs	CRL48204@#	\$8912
48	216	0	3pcs	CRL48216@#	\$8936
48	228	6	3pcs	CRL48228@#	\$8960
48	240	6	3pcs	CRL48240@#	\$8983

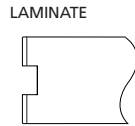
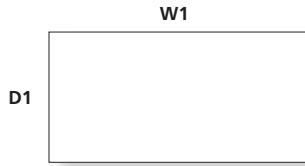

D1	W1	BRACES INCLD.		Part Number	Suffix 8
54	72	2	-	CRL5472@#	\$5003
54	84	2	-	CRL5484@#	\$5026
54	96	2	-	CRL5496@#	\$5049
54	108	0	2pcs	CRL54108@#	\$6627
54	120	0	2pcs	CRL54120@#	\$6650
54	132	0	2pcs	CRL54132@#	\$6700
54	144	0	2pcs	CRL54144@#	\$6880
54	156	0	2pcs	CRL54156@#	\$6903
54	168	4	2pcs	CRL54168@#	\$6927
54	180	4	2pcs	CRL54180@#	\$7167
54	192	4	2pcs	CRL54192@#	\$7192
54	204	0	3pcs	CRL54204@#	\$8951
54	216	0	3pcs	CRL54216@#	\$8975
54	228	6	3pcs	CRL54228@#	\$8998
54	240	6	3pcs	CRL54240@#	\$9021
60	72	2	-	CRL6072@#	\$5026
60	84	2	-	CRL6084@#	\$5049
60	96	2	-	CRL6096@#	\$5073
60	108	0	2pcs	CRL60108@#	\$6650
60	120	0	2pcs	CRL60120@#	\$6673
60	132	0	2pcs	CRL60132@#	\$6724
60	144	0	2pcs	CRL60144@#	\$6747
60	156	0	2pcs	CRL60156@#	\$5998
60	168	4	2pcs	CRL60168@#	\$6434
60	180	4	2pcs	CRL60180@#	\$7192
60	192	4	2pcs	CRL60192@#	\$7215
60	204	0	3pcs	CRL60204@#	\$8975
60	216	0	3pcs	CRL60216@#	\$8998
60	228	6	3pcs	CRL60228@#	\$9021
60	240	6	3pcs	CRL60240@#	\$9236

TOPS	
BASES	TABLES STEP 1 - TOPS
POWER DATA	
SUPPORT FURNITURE	
ACCESSORIES	

PowerEdge™ Rectangle Conference Table Tops Patent Pending

STEP 1

(^) Paint Suffix List

S Silver
G Slate Grey
R Black
T Medium Tone
W Arctic White
Z Other

Tip: Some Steelcase, Herman Miller, Knoll, Haworth, and Allsteel paints are available for \$350 list fee per order. Call/email for availability of specific colors. Additional custom paints (e.g. Tiger Dry Lac) must be quoted through quotes@enwork.com.

STEP 2

(#) Laminate Suffix List:

A Wilsonart Kensington Maple (10776-60)
B Wilsonart Monticello Maple (7925-38)
C Wilsonart Wild Cherry (7054-60)
E Wilsonart Fashion Grey (D381-60)
F Wilsonart White Tigris (4783-60)
G Wilsonart Cafelle (7933K-07)
M Wilsonart Frosty White (1573-60)
P Wilsonart Slate Grey (D91-60)
R Wilsonart Black (1595-60)
U Wilsonart Brazilwood (7946-38)
V Wilsonart River Cherry (7937-38)
W Wilsonart Designer White (D354-60)
3 Formica Neutral Twill (8826-58)
4 Formica Bleached Legno (8845-58)
5 Formica Prestige Walnut (6209-43)
7 Formica Select Cherry (7759-43)
X *Wilsonart Non-Premium laminates (-38, -60). +\$240
Orders of 100+ units have no upcharge.
Y *Formica Non-Premium Standard (58, 43, MC, SP and NT finishes) and Wilsonart Premium (-01, -07, -12, -18, -52, -78) laminates. +\$280
Z *Pionite Non-Premium, Nevamar Non-Premium, Formica Premium (WR, 42, 77, 46, RD Finishes), and whiteboard laminate. +\$302

*Add \$350 list for Special Laminate orders of less than 10 units. See page 21 for edge selection.

Product Specifications:

- > Available as rectangle conference table tops only.
- > Top is .75" thick on user edge and 1.5" thick on PowerEdge.
- > PowerEdge is recessed 2" from front edge of table.
- > **Power Data Units Specified Separately.** Quantity varies by size. See chart on page 65.
- > All tops have one power data unit on each end with 1, 2, or 3 openings on each side, depending on the size.
- > 2-circuit, 15 amp power system. 20 amp available as special and requires hardwire.
- > Back-painted glass tops available as a special. Contact quotes@enwork.com.
- > Each section of top comes fully assembled.
- > Access doors are provided for cable routing.

Ordering Information:

- > For Lugano bases, PowerEdge tops only available in 48", 54", and 60"D (not 42").
- > Contact quotes@enwork.com if power/data cut-outs are required.
- > **A freight fee of \$100 net is assessed on orders less than \$1000 net. See page 13.**

LAMINATE - 3MM EDGE

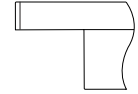

D1	W1	BRACES INCLD.		Part Number	List Price (US\$)
42	72	2	-	CRP4272^#	\$2926
42	84	2	-	CRP4284^#	\$3119
42	96	2	-	CRP4296^#	\$3191
42	108	0	2pcs	CRP42108^#	\$4677
42	120	0	2pcs	CRP42120^#	\$4756
42	132	0	2pcs	CRP42132^#	\$4931
42	144	0	2pcs	CRP42144^#	\$5025
42	156	0	2pcs	CRP42156^#	\$5148
42	168	4	2pcs	CRP42168^#	\$5522
42	180	4	2pcs	CRP42180^#	\$5796
42	192	4	2pcs	CRP42192^#	\$5844
42	204	0	3pcs	CRP42204^#	\$7246
42	216	0	3pcs	CRP42216^#	\$7299
42	228	6	3pcs	CRP42228^#	\$7886
42	240	6	3pcs	CRP42240^#	\$8413
48	72	2	-	CRP4872^#	\$2926
48	84	2	-	CRP4884^#	\$3119
48	96	2	-	CRP4896^#	\$3191
48	108	0	2pcs	CRP48108^#	\$4677
48	120	0	2pcs	CRP48120^#	\$4756
48	132	0	2pcs	CRP48132^#	\$4931
48	144	0	2pcs	CRP48144^#	\$5025
48	156	0	2pcs	CRP48156^#	\$5148
48	168	4	2pcs	CRP48168^#	\$5522
48	180	4	2pcs	CRP48180^#	\$5796
48	192	4	2pcs	CRP48192^#	\$5844
48	204	0	3pcs	CRP48204^#	\$7246
48	216	0	3pcs	CRP48216^#	\$7299
48	228	6	3pcs	CRP48228^#	\$7311
48	240	6	3pcs	CRP48240^#	\$8413

Part Number Description List Price (US\$)

Base Power-Ins

A8BP72	Base Power-In for Hardwire, 72"	\$168
A8BP120	Base Power-In for Hardwire, 120"	\$203
A1BP72	Base Power-In for RA Plug Circuit 1 (only), 72"	\$239

Tip: Use hardwire in feeds if UL listed (not recognized) is required.

Tip: Infeeds have a 20 amp plug end which requires a 20 amp wall receptacle. A plug adapter is required if using a standard 15 amp receptacle. The adapter is not included and must be purchased separately. Conntek 30129 15-Amp to 20-Amp Plug Adapters and similar are available through amazon.com and at many electrical supply houses.



15 amp Receptacle



20 amp Receptacle

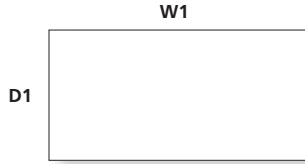

TOPS	TABLES STEP 1 - TOPS
BASES	
POWER DATA	
SUPPORT FURNITURE	
ACCESSORIES	

LAMINATE - 3MM EDGE



D1	W1	BRACES INCLD.		Part Number	List Price (US\$)
54	72	2	-	CRP5472^#	\$3065
54	84	2	-	CRP5484^#	\$3290
54	96	2	-	CRP5496^#	\$3360
54	108	0	2pcs	CRP54108^#	\$4882
54	120	0	2pcs	CRP54120^#	\$5016
54	132	0	2pcs	CRP54132^#	\$5217
54	144	0	2pcs	CRP54144^#	\$5324
54	156	0	2pcs	CRP54156^#	\$5475
54	168	4	2pcs	CRP54168^#	\$5860
54	180	4	2pcs	CRP54180^#	\$6162
54	192	4	2pcs	CRP54192^#	\$6212
54	204	0	3pcs	CRP54204^#	\$7601
54	216	0	3pcs	CRP54216^#	\$7647
54	228	6	3pcs	CRP54228^#	\$8631
54	240	6	3pcs	CRP54240^#	\$8688
60	72	2	-	CRP6072^#	\$3065
60	84	2	-	CRP6084^#	\$3290
60	96	2	-	CRP6096^#	\$3360
60	108	0	2pcs	CRP60108^#	\$4882
60	120	0	2pcs	CRP60120^#	\$5016
60	132	0	2pcs	CRP60132^#	\$5217
60	144	0	2pcs	CRP60144^#	\$5324
60	156	0	2pcs	CRP60156^#	\$5475
60	168	4	2pcs	CRP60168^#	\$5860
60	180	4	2pcs	CRP60180^#	\$6162
60	192	4	2pcs	CRP60192^#	\$6212
60	204	0	3pcs	CRP60204^#	\$7601
60	216	0	3pcs	CRP60216^#	\$7647
60	228	6	3pcs	CRP60228^#	\$8631
60	240	6	3pcs	CRP60240^#	\$8688

Part Number	Description	List Price (US\$)
PowerEdge Power & Data Units*		
CRPPW	Power Data Unit w/ 2 Power, White	\$250
CRPUW	Power Data Unit w/ 1 Power/2 USB, White	\$385
CRPDW	Power Data Unit w/ 1 Power/1 Data Opening, White	\$304
CRPPG	Power Data Unit w/ 2 Power, Grey	\$250
CRPUG	Power Data Unit w/ 1 Power/2 USB, Grey	\$385
CRPDG	Power Data Unit w/ 1 Power/1 Data Opening, Grey	\$304
CRPPR	Power Data Unit w/ 2 Power, Black	\$250
CRPUR	Power Data Unit w/ 1 Power/2 USB, Black	\$385
CRPDR	Power Data Unit w/ 1 Power/1 Data Opening, Black	\$304

Tip: All power data units are circuit 1. Circuit 2 units available as a special.
Tip: Will not accommodate VGA connections.
Tip: When data units are specified, data adapter tree is included.

*Number of power units to order by table size:	
Top Width	Power Unit Openings
72	4
84	4
96	4
108	6
120	6
132	6
144	6
156	6
168	6
180	6
192	6
204	8
216	8
228	8
240	8

Apron Tables (Complete Tables)

STEP 1

(@) Cable Management Suffix List:

N	No Cable Management	No charge
G	Grommet (one, center rear)	+\$18
P	Two Grommets (one left rear, one right rear)	+\$36
U	Power/Data Cut-out (one, center rear)	+\$36
K	Power/Data Cut-out (one, center of table)	+\$36
X	Other	TBD

STEP 2

(^) Paint Suffix List

S	Silver	no charge
G	Slate Grey	+\$200
R	Black	+\$200
T	Medium Tone	+\$200
W	Arctic White	+\$200
Z	Other	TBD

Tip: Some Steelcase, Herman Miller, Knoll, Haworth, and Allsteel paints are available for \$350 list fee per order. Call/email for availability of specific colors. Additional custom paints (e.g. Tiger Dry Lac) must be quoted through quotes@enwork.com.

STEP 3

(#) Laminate Suffix List:

A	Wilsonart Kensington Maple (10776-60)	
B	Wilsonart Monticello Maple (7925-38)	
C	Wilsonart Wild Cherry (7054-60)	
E	Wilsonart Fashion Grey (D381-60)	
F	Wilsonart White Tigris (4783-60)	
G	Wilsonart Cafelle (7933K-07)	
M	Wilsonart Frosty White (1573-60)	
P	Wilsonart Slate Grey (D91-60)	
R	Wilsonart Black (1595-60)	
U	Wilsonart Brazilwood (7946-38)	
V	Wilsonart River Cherry (7937-38)	
W	Wilsonart Designer White (D354-60)	
3	Formica Neutral Twill (8826-58)	
4	Formica Bleached Legno (8845-58)	
5	Formica Prestige Walnut (6209-43)	
7	Formica Select Cherry (7759-43)	
X	*Wilsonart Non-Premium laminates (-38, -60). Orders of 100+ units have no upcharge.	+\$36
Y	*Formica Non-Premium Standard (58, 43, MC, SP and NT finishes) and Wilsonart Premium (-01, -07, -12, -18, -52, -78) laminates.	+\$50
Z	*Pionite Non-Premium, Nevamar Non-Premium, Formica Premium (WR, 42, 77, 46, RD Finishes), and whiteboard laminate.	+\$72

*Add \$350 list for Special Laminate orders of less than 10 units. See page 21 for edge selection.

Ordering Information:

- > Includes 3/4" top with 3mm edge, apron structure, legs, and fasteners.
- > Top is shipped pre-assembled with apron. Field assembly requires 1-bolt per leg.
- > **A freight fee of \$100 net is assessed on orders less than \$1000 net. See page 13.**



Part Number	Description	List Price (US\$)
-------------	-------------	-------------------

24"D Apron Table w/ 3mm Edge

MB2430@^#	24"D Table, Laminate, 30"W	\$440
MB2436@^#	24"D Table, Laminate, 36"W	\$472
MB2442@^#	24"D Table, Laminate, 42"W	\$507
MB2448@^#	24"D Table, Laminate, 48"W	\$511
MB2460@^#	24"D Table, Laminate, 60"W	\$558
MB2466@^#	24"D Table, Laminate, 66"W	\$665
MB2472@^#	24"D Table, Laminate, 72"W	\$669

30"D Apron Table w/ 3mm Edge

MB3030@^#	30"D Table, Laminate, 30"W	\$472
MB3036@^#	30"D Table, Laminate, 36"W	\$510
MB3042@^#	30"D Table, Laminate, 42"W	\$551
MB3048@^#	30"D Table, Laminate, 48"W	\$556
MB3060@^#	30"D Table, Laminate, 60"W	\$612
MB3066@^#	30"D Table, Laminate, 66"W	\$715
MB3072@^#	30"D Table, Laminate, 72"W	\$721

36"D Apron Table w/ 3mm Edge

MB3660@^#	36"D Table, Laminate, 60"W	\$885
MB3672@^#	36"D Table, Laminate, 72"W	\$1051

42"D Apron Table w/ 3mm Edge

MB4260@^#	42"D Table, Laminate, 60"W	\$896
MB4272@^#	42"D Table, Laminate, 72"W	\$1063

48"D Apron Table w/ 3mm Edge

MB4860@^#	48"D Table, Laminate, 60"W	\$903
MB4872@^#	48"D Table, Laminate, 72"W	\$1070

TOPS	TABLES STEP 2 - APRON
BASES	
POWER DATA	
SUPPORT FURNITURE	
ACCESSORIES	

Notes

Concurrence™ - Conference Base Assemblies (36" D - 48" D Top)

STEP 1

(@) Segmentation Suffix List:

N Non-Segmented Bases	No Charge
S Segmented Bases	+\$312

Tip: Laminate or Veneer filler panels can be Non-Segmented or Segmented. Segmented panels have grooves with aluminum trim.

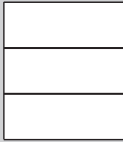

Segmented
Panel Option



Non-Segmented
Panel Option

STEP 2

(#) Laminate Suffix List:

A	Wilsonart Kensington Maple (10776-60)	
B	Wilsonart Monticello Maple (7925-38)	
C	Wilsonart Wild Cherry (7054-60)	
E	Wilsonart Fashion Grey (D381-60)	
F	Wilsonart White Tigris (4783-60)	
G	Wilsonart Cafelle (7933K-07)	
M	Wilsonart Frosty White (1573-60)	
P	Wilsonart Slate Grey (D91-60)	
R	Wilsonart Black (1595-60)	
U	Wilsonart Brazilwood (7946-38)	
V	Wilsonart River Cherry (7937-38)	
W	Wilsonart Designer White (D354-60)	
3	Formica Neutral Twill (8826-58)	
4	Formica Bleached Legno (8845-58)	
5	Formica Prestige Walnut (6209-43)	
7	Formica Select Cherry (7759-43)	
X	*Wilsonart Non-Premium laminates (-38, -60). Orders of 100+ units have no upcharge.	+\$240
Y	*Formica Non-Premium (includes 58, 43, MC, SP, and NT finishes) and Wilsonart Premium (-01, -07, -12, -18, -52, -78) laminates.	\$280
Z	*Pionite Non-Premium, Nevamar Non-Premium, Formica Premium (WR, 42, 77, 46, RD finishes), and whiteboard laminate.	+\$302

*Add \$350 list for Special Laminate orders of less than 10 units. See page 21 for edge selection.

(#) Veneer Suffix List:

D	Maple (stained similar to Kensington Maple laminate)	
J	Cherry (stained similar to Wild Cherry laminate)	
N	Walnut (stained similar to Cafelle laminate)	
8	Walnut (stained similar to Prestige Walnut laminate)	
9	Cherry (stained similar to Select Cherry laminate)	
X	Stain Match (add a one-time \$700 list Stain Match fee)	+10%

Product Specifications:

- > Individual bases are 4.75" wide.
- > Base trim is clear anodized aluminum.

Ordering Information:

- > Bases include PDGR cable management.
- > Product is base and aluminum structural beam kit only. Table top and trough covers are specified separately
- > Trough covers are available to conceal equipment and hide wiring & cabling. See chart on page 71.
- > Tops are ordered separately.
- > Concurrence bases ship partially assembled.
- > **A freight fee of \$100 net is assessed on orders less than \$1000 net. See page 13.**

Part Number Description List Price (US\$)

Laminate Concurrence Base and Beam Assemblies for 36"/42"D Tables

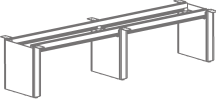
	LZTLA72@#	Lam. Base Assembly for 36"/42"D x 72"W top	\$3553
	LZTLA84@#	Lam. Base Assembly for 36"/42"D x 84"W top	\$3775
	LZTLA96@#	Lam. Base Assembly for 36"/42"D x 96"W top	\$3775
	LZTLA108@#	Lam. Base Assembly for 36"/42"D x 108"W top	\$3909
	LZTLA120@#	Lam. Base Assembly for 36"/42"D x 120"W top	\$4351
	LZTLA132@#	Lam. Base Assembly for 36"/42"D x 132"W top	\$4351
	LZTLA144@#	Lam. Base Assembly for 36"/42"D x 144"W top	\$4351
	LZTLA156@#	Lam. Base Assembly for 36"/42"D x 156"W top	\$4351
	LZTLA168@#	Lam. Base Assembly for 36"/42"D x 168"W top	\$4351
	LZTLA180@#	Lam. Base Assembly for 36"/42"D x 180"W top	\$6158
	LZTLA192@#	Lam. Base Assembly for 36"/42"D x 192"W top	\$7041
	LZTLA204@#	Lam. Base Assembly for 36"/42"D x 204"W top	\$7041
	LZTLA216@#	Lam. Base Assembly for 36"/42"D x 216"W top	\$7041
	LZTLA228@#	Lam. Base Assembly for 36"/42"D x 228"W top	\$7041
	LZTLA240@#	Lam. Base Assembly for 36"/42"D x 240"W top	\$7041

Laminate Concurrence Base and Beam Assemblies for 48"D Tables

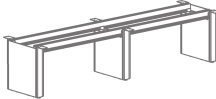
	LZTLB72@#	Lam. Base Assembly for 48"D x 72"W top	\$3689
	LZTLB84@#	Lam. Base Assembly for 48"D x 84"W top	\$3909
	LZTLB96@#	Lam. Base Assembly for 48"D x 96"W top	\$3909
	LZTLB108@#	Lam. Base Assembly for 48"D x 108"W top	\$3909
	LZTLB120@#	Lam. Base Assembly for 48"D x 120"W top	\$4351
	LZTLB132@#	Lam. Base Assembly for 48"D x 132"W top	\$4351
	LZTLB144@#	Lam. Base Assembly for 48"D x 144"W top	\$4351
	LZTLB156@#	Lam. Base Assembly for 48"D x 156"W top	\$4351
	LZTLB168@#	Lam. Base Assembly for 48"D x 168"W top	\$4351
	LZTLB180@#	Lam. Base Assembly for 48"D x 180"W top	\$6158
	LZTLB192@#	Lam. Base Assembly for 48"D x 192"W top	\$7041
	LZTLB204@#	Lam. Base Assembly for 48"D x 204"W top	\$7041
	LZTLB216@#	Lam. Base Assembly for 48"D x 216"W top	\$7041
	LZTLB228@#	Lam. Base Assembly for 48"D x 228"W top	\$7041
	LZTLB240@#	Lam. Base Assembly for 48"D x 240"W top	\$7041

TROUGH COVERS

Trough covers are available on page 71.

TOPS

BASES

POWER
DATASUPPORT
FURNITURE

ACCESSORIES

TABLES STEP 2 - CONCURRENCE

Part Number	Description	List Price (US\$)
-------------	-------------	-------------------

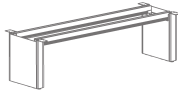
Veneer Concurrence Base and Beam Assemblies for 36\"/>

LZTVA72@#	Veneer Base Assembly for 36\"/>
LZTVA84@#	Veneer Base Assembly for 36\"/>
LZTVA96@#	Veneer Base Assembly for 36\"/>
LZTVA108@#	Veneer Base Assembly for 36\"/>
LZTVA120@#	Veneer Base Assembly for 36\"/>
LZTVA132@#	Veneer Base Assembly for 36\"/>
LZTVA144@#	Veneer Base Assembly for 36\"/>
LZTVA156@#	Veneer Base Assembly for 36\"/>
LZTVA168@#	Veneer Base Assembly for 36\"/>

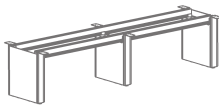

LZTVA180@#	Veneer Base Assembly for 36\"/>
LZTVA192@#	Veneer Base Assembly for 36\"/>
LZTVA204@#	Veneer Base Assembly for 36\"/>
LZTVA216@#	Veneer Base Assembly for 36\"/>
LZTVA228@#	Veneer Base Assembly for 36\"/>
LZTVA240@#	Veneer Base Assembly for 36\"/>

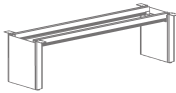
Veneer Concurrence Base and Beam Assemblies for 48\"/>

LZTVB72@#	Veneer Base Assembly for 48\"/>
LZTVB84@#	Veneer Base Assembly for 48\"/>
LZTVB96@#	Veneer Base Assembly for 48\"/>
LZTVB108@#	Veneer Base Assembly for 48\"/>
LZTVB120@#	Veneer Base Assembly for 48\"/>
LZTVB132@#	Veneer Base Assembly for 48\"/>
LZTVB144@#	Veneer Base Assembly for 48\"/>
LZTVB156@#	Veneer Base Assembly for 48\"/>
LZTVB168@#	Veneer Base Assembly for 48\"/>

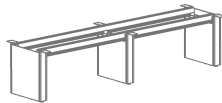

LZTVB180@#	Veneer Base Assembly for 48\"/>
LZTVB192@#	Veneer Base Assembly for 48\"/>
LZTVB204@#	Veneer Base Assembly for 48\"/>
LZTVB216@#	Veneer Base Assembly for 48\"/>
LZTVB228@#	Veneer Base Assembly for 48\"/>
LZTVB240@#	Veneer Base Assembly for 48\"/>

Concurrence - Conference Base Assemblies (54" D - 60" D Tops)

STEP 1

(@) Segmentation Suffix List:

N Non-Segmented Bases	No Charge
S Segmented Bases	+\$312

Tip: Laminate or Veneer filler panels can be Non-Segmented or Segmented. Segmented panels have grooves with aluminum trim.

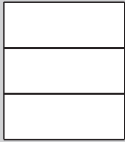

Segmented
Panel Option



Non-Segmented
Panel Option

STEP 2

(#) Laminate Suffix List:

A Wilsonart Kensington Maple (10776-60)	
B Wilsonart Monticello Maple (7925-38)	
C Wilsonart Wild Cherry (7054-60)	
E Wilsonart Fashion Grey (D381-60)	
F Wilsonart White Tigris (4783-60)	
G Wilsonart Cafelle (7933K-07)	
M Wilsonart Frosty White (1573-60)	
P Wilsonart Slate Grey (D91-60)	
R Wilsonart Black (1595-60)	
U Wilsonart Brazilwood (7946-38)	
V Wilsonart River Cherry (7937-38)	
W Wilsonart Designer White (D354-60)	
3 Formica Neutral Twill (8826-58)	
4 Formica Bleached Legno (8845-58)	
5 Formica Prestige Walnut (6209-43)	
7 Formica Select Cherry (7759-43)	
X *Wilsonart Non-Premium laminates (-38, -60). Orders of 100+ units have no upcharge.	+\$240
Y *Formica Non-Premium (includes 58, 43, MC, SP, and NT finishes) and Wilsonart Premium (-01, -07, -12, -18, -52, -78) laminates.	\$280
Z *Pionite Non-Premium, Nevamar Non-Premium, Formica Premium (WR, 42, 77, 46, RD finishes), and whiteboard laminate.	+\$302

*Add \$350 list for Special Laminate orders of less than 10 units. See page 21 for edge selection.

(#) Veneer Suffix List:

D Maple (stained similar to Kensington Maple laminate)	
J Cherry (stained similar to Wild Cherry laminate)	
N Walnut (stained similar to Cafelle laminate)	
8 Walnut (stained similar to Prestige Walnut laminate)	
9 Cherry (stained similar to Select Cherry laminate)	
X Stain Match (add a one-time \$700 list Stain Match fee)	+10%

Product Specifications:

- > Individual bases are 4.75" wide.
- > Base trim is clear anodized aluminum.

Ordering Information:

- > Bases include PDGR cable management.
- > Product is base and aluminum structural beam kit only. Table top and trough covers are specified separately
- > Trough covers are available to conceal equipment and hide wiring & cabling. See chart on page 71.
- > Tops are ordered separately.
- > Concurrence bases ship partially assembled.
- > **A freight fee of \$100 net is assessed on orders less than \$1000 net. See page 13.**

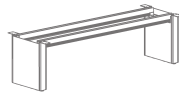

Part Number Description

List Price (US\$)

Laminate Concurrence Base and Beam Assemblies for 54"D Tables

LZTLD72@#	Lam. Base Assembly for 54"D x 72"W top	\$4716
LZTLD84@#	Lam. Base Assembly for 54"D x 84"W top	\$4935
LZTLD96@#	Lam. Base Assembly for 54"D x 96"W top	\$4935
LZTLD108@#	Lam. Base Assembly for 54"D x 108"W top	\$4935
LZTLD120@#	Lam. Base Assembly for 54"D x 120"W top	\$5377
LZTLD132@#	Lam. Base Assembly for 54"D x 132"W top	\$5377
LZTLD144@#	Lam. Base Assembly for 54"D x 144"W top	\$5377
LZTLD156@#	Lam. Base Assembly for 54"D x 156"W top	\$5377
LZTLD168@#	Lam. Base Assembly for 54"D x 168"W top	\$5377

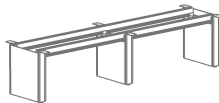

LZTLD180@#	Lam. Base Assembly for 54"D x 180"W top	\$7699
LZTLD192@#	Lam. Base Assembly for 54"D x 192"W top	\$8582
LZTLD204@#	Lam. Base Assembly for 54"D x 204"W top	\$8582
LZTLD216@#	Lam. Base Assembly for 54"D x 216"W top	\$8582
LZTLD228@#	Lam. Base Assembly for 54"D x 228"W top	\$8582
LZTLD240@#	Lam. Base Assembly for 54"D x 240"W top	\$8582

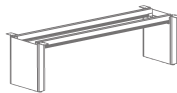

Laminate Concurrence Base and Beam Assemblies for 60"D Tables

LZTLC72@#	Lam. Base Assembly for 60"D x 72"W top	\$4716
LZTLC84@#	Lam. Base Assembly for 60"D x 84"W top	\$4935
LZTLC96@#	Lam. Base Assembly for 60"D x 96"W top	\$4935
LZTLC108@#	Lam. Base Assembly for 60"D x 108"W top	\$4935
LZTLC120@#	Lam. Base Assembly for 60"D x 120"W top	\$5377
LZTLC132@#	Lam. Base Assembly for 60"D x 132"W top	\$5377
LZTLC144@#	Lam. Base Assembly for 60"D x 144"W top	\$5377
LZTLC156@#	Lam. Base Assembly for 60"D x 156"W top	\$5377
LZTLC168@#	Lam. Base Assembly for 60"D x 168"W top	\$5377

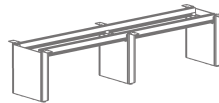

LZTLC180@#	Lam. Base Assembly for 60"D x 180"W top	\$7699
LZTLC192@#	Lam. Base Assembly for 60"D x 192"W top	\$8582
LZTLC204@#	Lam. Base Assembly for 60"D x 204"W top	\$8582
LZTLC216@#	Lam. Base Assembly for 60"D x 216"W top	\$8582
LZTLC228@#	Lam. Base Assembly for 60"D x 228"W top	\$8582
LZTLC240@#	Lam. Base Assembly for 60"D x 240"W top	\$8582

Part Number Description List Price (US\$)

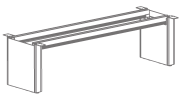

Veneer Concurrence Base and Beam Assemblies for 54"D Tables

LZTVD72@#	Veneer Base Assembly for 54"D x 72"W top	\$7003
LZTVD84@#	Veneer Base Assembly for 54"D x 84"W top	\$7223
LZTVD96@#	Veneer Base Assembly for 54"D x 96"W top	\$7223
LZTVD108@#	Veneer Base Assembly for 54"D x 108"W top	\$7223
LZTVD120@#	Veneer Base Assembly for 54"D x 120"W top	\$7665
LZTVD132@#	Veneer Base Assembly for 54"D x 132"W top	\$7665
LZTVD144@#	Veneer Base Assembly for 54"D x 144"W top	\$7665
LZTVD156@#	Veneer Base Assembly for 54"D x 156"W top	\$7665
LZTVD168@#	Veneer Base Assembly for 54"D x 168"W top	\$7665

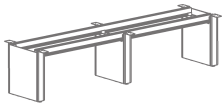

LZTVD180@#	Veneer Base Assembly for 54"D x 180"W top	\$10,673
LZTVD192@#	Veneer Base Assembly for 54"D x 192"W top	\$11,556
LZTVD204@#	Veneer Base Assembly for 54"D x 204"W top	\$11,556
LZTVD216@#	Veneer Base Assembly for 54"D x 216"W top	\$11,556
LZTVD228@#	Veneer Base Assembly for 54"D x 228"W top	\$11,556
LZTVD240@#	Veneer Base Assembly for 54"D x 240"W top	\$11,556



Veneer Concurrence Base and Beam Assemblies for 60"D Tables

LZTVC72@#	Veneer Base Assembly for 60"D x 72"W top	\$7003
LZTVC84@#	Veneer Base Assembly for 60"D x 84"W top	\$7223
LZTVC96@#	Veneer Base Assembly for 60"D x 96"W top	\$7223
LZTVC108@#	Veneer Base Assembly for 60"D x 108"W top	\$7223
LZTVC120@#	Veneer Base Assembly for 60"D x 120"W top	\$7665
LZTVC132@#	Veneer Base Assembly for 60"D x 132"W top	\$7665
LZTVC144@#	Veneer Base Assembly for 60"D x 144"W top	\$7665
LZTVC156@#	Veneer Base Assembly for 60"D x 156"W top	\$7665
LZTVC168@#	Veneer Base Assembly for 60"D x 168"W top	\$7665

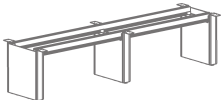

LZTVC180@#	Veneer Base Assembly for 60"D x 180"W top	\$10,673
LZTVC192@#	Veneer Base Assembly for 60"D x 192"W top	\$11,556
LZTVC204@#	Veneer Base Assembly for 60"D x 204"W top	\$11,556
LZTVC216@#	Veneer Base Assembly for 60"D x 216"W top	\$11,556
LZTVC228@#	Veneer Base Assembly for 60"D x 228"W top	\$11,556
LZTVC240@#	Veneer Base Assembly for 60"D x 240"W top	\$11,556

Concurrence Sliding Trough Covers* (See chart for maximum ordering quantities)

LZLACP18	One trough cover for use with bases for 36"/42"D tables, silver	\$82
LZLACP24	One trough cover for use with bases for 48"D tables, silver	\$89
LZLACP30	One trough cover for use with bases for 54"D tables, silver	\$106
LZLACP36	One trough cover for use with bases for 60"D tables, silver	\$122

*Concurrence Sliding Trough covers for concealing Power/Data under Concurrence conference tables:

Top Width	Max # of Trough Covers
72	0
84	1
96	1
108	2
120	3
132	3
144	4
156	4
168	5
180	6
192	6
204	6
216	6
228	8
240	8

(Trough covers are 20"W)

Concurrence "Build-Your-Own" Conference Table Bases & Beam Kits

STEP 1

(@) Segmentation Suffix List:

N Non-Segmented Bases	No Charge
S Segmented Bases	+\$156

Tip: Laminate or Veneer filler panels can be Non-Segmented or Segmented. Segmented panels have grooves with aluminum trim.

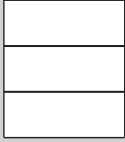

Segmented
Panel Option



Non-Segmented
Panel Option

STEP 2

(#) Laminate Suffix List:

A	Wilsonart Kensington Maple (10776-60)	
B	Wilsonart Monticello Maple (7925-38)	
C	Wilsonart Wild Cherry (7054-60)	
E	Wilsonart Fashion Grey (D381-60)	
F	Wilsonart White Tigris (4783-60)	
G	Wilsonart Cafelle (7933K-07)	
M	Wilsonart Frosty White (1573-60)	
P	Wilsonart Slate Grey (D91-60)	
R	Wilsonart Black (1595-60)	
U	Wilsonart Brazilwood (7946-38)	
V	Wilsonart River Cherry (7937-38)	
W	Wilsonart Designer White (D354-60)	
3	Formica Neutral Twill (8826-58)	
4	Formica Bleached Legno (8845-58)	
5	Formica Prestige Walnut (6209-43)	
7	Formica Select Cherry (7759-43)	
X	*Wilsonart Non-Premium laminates (-38, -60). Orders of 100+ units have no upcharge.	+\$240
Y	*Formica Non-Premium (includes 58, 43, MC, SP, and NT finishes) and Wilsonart Premium (-01, -07, -12, -18, -52, -78) laminates.	\$280
Z	*Pionite Non-Premium, Nevamar Non-Premium, Formica Premium (WR, 42, 77, 46, RD finishes), and whiteboard laminate.	+\$302

*Add \$350 list for Special Laminate orders of less than 10 units. See page 21 for edge selection.

(#) Veneer Suffix List:

D	Maple (stained similar to Kensington Maple laminate)	
J	Cherry (stained similar to Wild Cherry laminate)	
N	Walnut (stained similar to Cafelle laminate)	
8	Walnut (stained similar to Prestige Walnut laminate)	
9	Cherry (stained similar to Select Cherry laminate)	
X	Stain Match (add a one-time \$700 list Stain Match fee)	+10%

Ordering Information:

- > Bases must be connected with structural beams, ordered separately (page 73).
- > End Application bases should be inset 24" from end of table top.
- > Bases must be same depth (18", 24", 30", or 36"). 5"W and 12"W can be used under the same table.
- > Use 12" base when power/data in table top is directly over the base.
- > Two bases required for tables up to 168". Three bases required for tables 180"-240".
- > Where required, the third "center application" base must be centered (+/- 12") under the table.
- > Optional bases can be added for cable management (e.g. when a power/data unit or the floor power monument is in the center of a two base table).
- > Trough covers are available to conceal equipment and hide wiring & cabling. See chart on page 71.
- > Tops are ordered separately.
- > Concurrence bases ship assembled.
- > **A freight fee of \$100 net is assessed on orders less than \$1000 net. See page 13.**

Part Number	Description	List Price (US\$)
-------------	-------------	-------------------

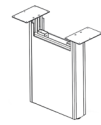

5" Laminate Concurrence Conference Bases w/ Levelers - End Application

LZBE518@#	Laminate Base, 18" x 5", for 36/42"D table	\$1443
LZBE524@#	Laminate Base, 24" x 5", for 48"D table	\$1550
LZBE530@#	Laminate Base, 30" x 5", for 54"D table	\$2058
LZBE536@#	Laminate Base, 36" x 5", for 60"D table	\$2058

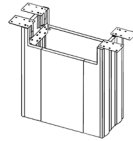

12" Laminate Concurrence Conference Base w/ Access Door & Levelers - End Application

LZBED1218@#	Laminate Base, 18" x 12", for 36/42"D table	\$1978
LZBED1224@#	Laminate Base, 24" x 12", for 48"D table	\$2116
LZBED1230@#	Laminate Base, 30" x 12", for 54"D table	\$2645
LZBED1236@#	Laminate Base, 36" x 12", for 60"D table	\$2645

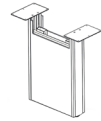

5" Laminate Concurrence Conference Base w/ Levelers - Middle Application

LZBM518@#	Laminate Base, 18" x 5", for 36/42"D table	\$1443
LZBM524@#	Laminate Base, 24" x 5", for 48"D table	\$1550
LZBM530@#	Laminate Base, 30" x 5", for 54"D table	\$2058
LZBM536@#	Laminate Base, 36" x 5", for 60"D table	\$2058

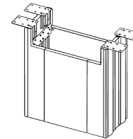

12" Laminate Concurrence Conference Base w/ Access Door & Levelers - Middle Application

LZBMD1218@#	Laminate Base, 18" x 12", for 36/42"D table	\$1978
LZBMD1224@#	Laminate Base, 24" x 12", for 48"D table	\$2116
LZBMD1230@#	Laminate Base, 30" x 12", for 54"D table	\$2645
LZBMD1236@#	Laminate Base, 36" x 12", for 60"D table	\$2645

Part Number Description List Price (US\$)

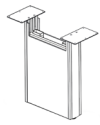

5" Veneer Concurrence Conference Base w/ Levelers - End Application

LZVBE518@#	Veneer Base, 18" x 5", for 36/42"D table	\$2250
LZVBE524@#	Veneer Base, 24" x 5", for 48"D table	\$2699
LZVBE530@#	Veneer Base, 30" x 5", for 54"D table	\$3194
LZVBE536@#	Veneer Base, 36" x 5", for 60"D table	\$3194

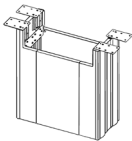

12" Veneer Concurrence Conference Base w/ Access Door & Levelers - End Application

LZVBED1218@#	Veneer Base, 18" x 12", for 36/42"D table	\$2892
LZVBED1224@#	Veneer Base, 24" x 12", for 48"D table	\$3341
LZVBED1230@#	Veneer Base, 30" x 12", for 54"D table	\$3835
LZVBED1236@#	Veneer Base, 36" x 12", for 60"D table	\$3835

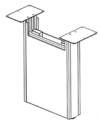

5" Veneer Concurrence Conference Base w/ Levelers - Middle Application

LZVBM518@#	Veneer Base, 18" x 5", for 36/42"D table	\$2250
LZVBM524@#	Veneer Base, 24" x 5", for 48"D table	\$2699
LZVBM530@#	Veneer Base, 30" x 5", for 54"D table	\$3194
LZVBM536@#	Veneer Base, 36" x 5", for 60"D table	\$3194

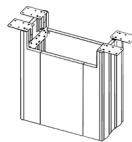

12" Veneer Concurrence Conference Base w/ Access Door & Levelers - Middle Application

LZVBMD1218@#	Veneer Base, 18" x 12", for 36/42"D table	\$2892
LZVBMD1224@#	Veneer Base, 24" x 12", for 48"D table	\$3341
LZVBMD1230@#	Veneer Base, 30" x 12", for 54"D table	\$3835
LZVBMD1236@#	Veneer Base, 36" x 12", for 60"D table	\$3835



Structural Aluminum Beams for use w/ Concurrence Conference Bases

LZBK72	Beam Kit for 72"W table (includes two beams)	\$694
LZBK84	Beam Kit for 84"W table (includes two beams)	\$908
LZBK96	Beam Kit for 96"W table (includes two beams)	\$908
LZBK108	Beam Kit for 108"W table (includes two beams)	\$908
LZBK120	Beam Kit for 120"W table (includes two beams)	\$1283
LZBK132	Beam Kit for 132"W table (includes two beams)	\$1283
LZBK144	Beam Kit for 144"W table (includes two beams)	\$1283
LZBK156	Beam Kit for 156"W table (includes two beams)	\$1283
LZBK168	Beam Kit for 168"W table (includes two beams)	\$1283
LZBK180	Beam Kit for 180"W table (includes four beams)	\$1603
LZBK192	Beam Kit for 192"W table (includes four beams)	\$2437
LZBK204	Beam Kit for 204"W table (includes four beams)	\$2437
LZBK216	Beam Kit for 216"W table (includes four beams)	\$2437
LZBK228	Beam Kit for 228"W table (includes four beams)	\$2437
LZBK240	Beam Kit for 240"W table (includes four beams)	\$2437

Concurrence VS (Video Sharing) Tables

STEP 1

(^) Shape Suffix List:

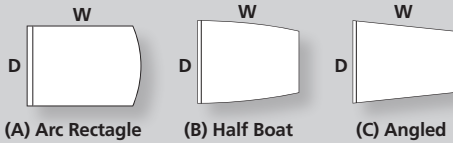

(A) Arc Rectangle

(B) Half Boat

(C) Angled

STEP 2

(&) Finish and Edge Suffix List:

- A Standard Laminate - 3mm Edge
- K Standard Laminate - Knife Edge
- P Standard Veneer - 3mm Wood Edge
- R Standard Veneer - Knife Wood Edge

STEP 3

(@) Cut-Out Suffix List:

- N No Cut-out
- A Cut-out for PDEVC222 (2 user, single sided), Over Panel Base
- B Cut-out for PDEVC314 (4 user, single sided), Over Panel Base
- C Cut-out for PDEVC444, PDEVD444 (4 user, double sided), Centered
- D Cut-out for PDEVC666, PDEVD666 (6 user, double sided), Centered
- E Cut-out for PDEVC444, PDEVD444 (4 user, double sided), Over Panel Base
- F Cut-out for PDEVC666, PDEVD666 (6 user, double sided), Over Panel Base
- X Other

Tip: Technology sold separately. See page 77.

STEP 4

(#) Laminate Suffix List:

- A Wilsonart Kensington Maple (10776-60)
- B Wilsonart Monticello Maple (7925-38)
- C Wilsonart Wild Cherry (7054-60)
- E Wilsonart Fashion Grey (D381-60)
- F Wilsonart White Tigris (4783-60)
- G Wilsonart Cafelle (7933K-07)
- M Wilsonart Frosty White (1573-60)
- P Wilsonart Slate Grey (D91-60)
- R Wilsonart Black (1595-60)
- U Wilsonart Brazilwood (7946-38)
- V Wilsonart River Cherry (7937-38)
- W Wilsonart Designer White (D354-60)
- 3 Formica Neutral Twill (8826-58)
- 4 Formica Bleached Legno (8845-58)
- 5 Formica Prestige Walnut (6209-43)
- 7 Formica Select Cherry (7759-43)
- X *Wilsonart Non-Premium laminates (-38, -60). +10%
Orders of 100+ units have no upcharge.
- Y *Formica Non-Premium Standard (58, 43, MC, SP and NT finishes) and Wilsonart Premium (-01, -07, -12, -18, -52, -78) laminates. +19%
- Z *Pionite Non-Premium, Nevamar Non-Premium, Formica Premium (VWR, 42, 77, 46, RD Finishes), and whiteboard laminate. +25%

*Add \$350 list for Special Laminate orders of less than 10 units. See page 21 for edge selection.

(#) Veneer Suffix List:

- D Maple (stained similar to Kensington Maple laminate)
- J Cherry (stained similar to Wild Cherry laminate)
- N Walnut (stained similar to Cafelle laminate)
- 8 Walnut (stained similar to Prestige Walnut laminate)
- 9 Cherry (stained similar to Select Cherry laminate)
- X Stain Match (add a one-time \$700 list Stain Match fee) +10%

Ordering Information:

- > Includes one monitor mount for monitors up to 55". Two monitors up to 40" may be mounted by ordering an alternate mount kit on page 78.
- > Sliding trough covers conceal technology components, cables and wiring under worksurface. Mast includes access holes for monitor cables.
- > Includes worksurface.
- > **Ellora VS (video sharing) technology unit ordered separately. See page 77.**
- > **A freight fee of \$100 net is assessed on orders less than \$1000 net. See page 13.**

W D H Part Number Description

Concurrence VS (Video Sharing) Tables - Seated Height (29")

W	D	H	Part Number	Description
60	54	72	LZAN2960^&@#	VS Table, Seated, 60"W
72	54	72	LZAN2972^&@#	VS Table, Seated, 72"W
84	54	72	LZAN2984^&@#	VS Table, Seated, 84"W
96	54	72	LZAN2996^&@#	VS Table, Seated, 96"W
120	54	72	LZAN29120^&@#	VS Table, Seated, 120"W
144	54	72	LZAN29144^&@#	VS Table, Seated, 144"W

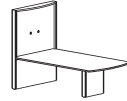

Concurrence VS (Video Sharing) Tables - Seated Height (29")

W	D	H	Part Number	Description
60	54	72	LZAS2960^&@#	VS Table, Seated, Segmented, 60"W
72	54	72	LZAS2972^&@#	VS Table, Seated, Segmented, 72"W
84	54	72	LZAS2984^&@#	VS Table, Seated, Segmented, 84"W
96	54	72	LZAS2996^&@#	VS Table, Seated, Segmented, 96"W
120	54	72	LZAS29120^&@#	VS Table, Seated, Segmented, 120"W
144	54	72	LZAS29144^&@#	VS Table, Seated, Segmented, 144"W

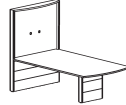

Concurrence VS (Video Sharing) Tables - Standing Height (42")

W	D	H	Part Number	Description
60	54	72	LZAN4260^&@#	VS Table, Standing, 60"W
72	54	72	LZAN4272^&@#	VS Table, Standing, 72"W
84	54	72	LZAN4284^&@#	VS Table, Standing, 84"W
96	54	72	LZAN4296^&@#	VS Table, Standing, 96"W
120	54	72	LZAN42120^&@#	VS Table, Standing, 120"W

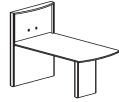

Concurrence VS (Video Sharing) Tables - Standing Height (42")

W	D	H	Part Number	Description
60	54	72	LZAS4260^&@#	VS Table, Standing, Segmented, 60"W
72	54	72	LZAS4272^&@#	VS Table, Standing, Segmented, 72"W
84	54	72	LZAS4284^&@#	VS Table, Standing, Segmented, 84"W
96	54	72	LZAS4296^&@#	VS Table, Standing, Segmented, 96"W
120	54	72	LZAS42120^&@#	VS Table, Standing, Segmented, 120"W

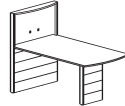

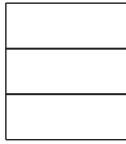

Segmented
Panel Option



Non-Segmented
Panel Option

Ordering Information: Panels below the worksurface on mast and on both sides of the panel base are segmented. Panels above the worksurface on the mast and the entire back side of the mast are not segmented.

COORDINATING FURNITURE

Cabinets for VS Tables are available on page 76.

Pixley Soft Seating and Lounge VS Tables available on pages 364-365.

TOPS

BASES

POWER DATA

SUPPORT FURNITURE

ACCESSORIES

TABLES STEP 2 - CONCURRENCE

STANDARD LAMINATE



3MM EDGE
Suffix A



KNIFE EDGE
Suffix K

STANDARD VENEER



3MM WOOD
Suffix P



KNIFE WOOD
Suffix R

\$8957	\$9277	\$13,513	\$13,834
\$9105	\$9426	\$14,054	\$14,374
\$9423	\$9743	\$15,135	\$15,456
\$10,081	\$10,402	\$16,820	\$17,141
\$10,844	\$11,378	\$17,918	\$18,452
\$11,195	\$11,730	\$19,536	\$20,070
\$9290	\$9611	\$13,847	\$14,167
\$9439	\$9760	\$14,388	\$14,708
\$9757	\$10,077	\$15,468	\$15,790
\$10,415	\$10,735	\$17,153	\$17,475
\$11,177	\$11,712	\$18,252	\$18,786
\$11,529	\$12,064	\$19,869	\$20,403
\$9401	\$9722	\$13,958	\$14,279
\$9550	\$9871	\$14,499	\$14,820
\$9867	\$10,188	\$15,473	\$15,794
\$10,526	\$10,847	\$17,265	\$17,586
\$11,289	\$11,824	\$18,363	\$18,898
\$9846	\$10,167	\$14,402	\$14,724
\$9995	\$10,315	\$14,943	\$15,265
\$10,312	\$10,632	\$15,918	\$16,238
\$10,970	\$11,292	\$17,710	\$18,030
\$11,733	\$12,268	\$18,808	\$19,343

Concurrence VS (Video Sharing) Cabinets

STEP 1

(#) Laminate Suffix List:

A	Wilsonart Kensington Maple (10776-60)	no charge
B	Wilsonart Monticello Maple (7925-38)	no charge
C	Wilsonart Wild Cherry (7054-60)	no charge
E	Wilsonart Fashion Grey (D381-60)	no charge
G	Wilsonart Cafelle (7933K-07)	no charge
M	Wilsonart Frosty White (1573-60)	no charge
P	Wilsonart Slate Grey (D91-60)	no charge
R	Wilsonart Black (1595-60)	no charge
U	Wilsonart Brazilwood (7946-38)	no charge
V	Wilsonart River Cherry (7937-38)	no charge
W	Wilsonart Designer White (D354-60)	no charge
3	Formica Neutral Twill (8826-58)	no charge
4	Formica Bleached Legno (8845-58)	no charge
5	Formica Prestige Walnut (6209-43)	no charge
7	Formica Select Cherry (7759-43)	no charge
X	*Wilsonart Non-Premium laminates (-38, -60)	+35%
Y	*Formica Non-Premium (includes 58, 43, MC, SP, and NT finishes), Formica Premium (WR, 42, 77, 46, RD finishes), Pionite Non-Premium, Nevamar Non-Premium, Wilsonart Premium (-01, -07, -12, -18, -52, -78), and whiteboard laminate.	+45%

*Add \$350 list for Special Laminate orders of less than 10 units. See page 21 for edge selection.

(#) Veneer Suffix List:

D	Maple (stained similar to Kensington Maple laminate)
J	Cherry (stained similar to Wild Cherry laminate)
N	Walnut (stained similar to Cafelle laminate)
8	Walnut (stained similar to Prestige Walnut laminate)
9	Cherry (stained similar to Select Cherry laminate)
X	Stain Match (add a one-time \$700 list Stain Match fee) +10%

STEP 2

(*) Pull Suffix List:



(A) Arc



(B) Bar

Cabinet Ordering Information:

- > VS Table Cabinets have a finished top and fit under VS table tops against monitor mast.
- > Includes lock and levelers.
- > Cabinets include adjustable shelves.
- > **A freight fee of \$100 is assessed on orders less than \$1000 net. See page 13.**

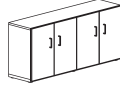

Part Number	Description	List Price (US\$)
-------------	-------------	-------------------

4-Door Cabinets for VS (Video Sharing) Tables – Seated Height

LZACAL#*	Laminate, 54"W x 23"H x 13"D	\$2510
LZACAV#*	Veneer, 54"W x 23"H x 13"D	\$7071



4-Door Cabinets for VS (Video Sharing) Tables – Standing Height

LZACBL#*	Laminate, 54"W x 36"H x 13"D	\$3184
LZACBV#*	Veneer, 54"W x 36"H x 13"D	\$8082

Concurrence VS (Video Sharing) Power Data Units

Video Sharing Power Data Ordering Information:

- > Ellora VS (Video Sharing) Technology provides collaboration and interaction by allowing users to “take control” of flat screen displays by pressing a button on the “show me” HDMI cord.
- > Two monitor applications come with 2 control boxes. “Show Me” cables are dedicated to one of two monitors. Half the “Show Me” cables will display on one monitor while the other half will display on the second monitor.
- > **A freight fee of \$100 net is assessed on orders less than \$1000 net. See page 13.**

Part #	# Users	Cut-Out Size	Description	List Price (US\$)
Ellora Single Sided VS (Video Share) Technology for 1 Monitor - HDMI, 6' power cord				
PDEVC222A	2	5" x 11"	2 power/2 data openings/2 Video Sharing HDMI cords, Clear Anodized Alum.	\$5496
PDEVC222R	2	5" x 11"	2 power/2 data openings/2 Video Sharing HDMI cords, Black Anodized Alum.	\$5711
PDEVC314A	4	5" x 14"	3 power/1 data opening/4 Video Sharing HDMI cords, Clear Anodized Alum.	\$8152
PDEVC314R	4	5" x 14"	3 power/1 data opening/4 Video Sharing HDMI cords, Black Anodized Alum.	\$8474
Ellora Double-Sided VS (Video Share) Technology for 1 Monitor - HDMI, two 6' power cords				
PDEVC444A	4	9.81" x 11"	4 power/4 data openings/4 Video Sharing HDMI cords, Clear Anodized Alum.	\$8348
PDEVC444R	4	9.81" x 11"	4 power/4 data openings/4 Video Sharing HDMI cords, Black Anodized Alum.	\$8730
PDEVC666A	6	9.81" x 14"	6 power/6 data openings/6 Video Sharing HDMI cords, Clear Anodized Alum.	\$13,121
PDEVC666R	6	9.81" x 14"	6 power/6 data openings/6 Video Sharing HDMI cords, Black Anodized Alum.	\$13,553
Ellora Double-Sided VS (Video Share) Technology for 2 Monitors - HDMI, two 6' power cords				
PDEVD444A	4	9.81" x 11"	4 power/4 data openings/4 Video Sharing HDMI cords, Clear Anodized Alum.	\$10,333
PDEVD444R	4	9.81" x 11"	4 power/4 data openings/4 Video Sharing HDMI cords, Black Anodized Alum.	\$10,697
PDEVD666A	6	9.81" x 14"	6 power/6 data openings/6 Video Sharing HDMI cords, Clear Anodized Alum.	\$13,333
PDEVD666R	6	9.81" x 14"	6 power/6 data openings/6 Video Sharing HDMI cords, Black Anodized Alum.	\$13,744

Tip: VS Technology for 2 monitors contains 2 control boxes. Half the “Show Me” cables will control one monitor and the other half control another.

TOPS

BASES

POWER
DATASUPPORT
FURNITURE

ACCESSORIES

TABLES STEP 2 - CONCURRENCE

Concurrence Monitor Walls & Monitors

STEP 1

(* Pull Suffix List:



(A) Arc



(B) Bar

STEP 2

(#) Laminate Suffix List:

A	Wilsonart Kensington Maple (10776-60)	no charge
B	Wilsonart Monticello Maple (7925-38)	no charge
C	Wilsonart Wild Cherry (7054-60)	no charge
E	Wilsonart Fashion Grey (D381-60)	no charge
G	Wilsonart Cafelle (7933K-07)	no charge
M	Wilsonart Frosty White (1573-60)	no charge
P	Wilsonart Slate Grey (D91-60)	no charge
R	Wilsonart Black (1595-60)	no charge
U	Wilsonart Brazilwood (7946-38)	no charge
V	Wilsonart River Cherry (7937-38)	no charge
W	Wilsonart Designer White (D354-60)	no charge
3	Formica Neutral Twill (8826-58)	no charge
4	Formica Bleached Legno (8845-58)	no charge
5	Formica Prestige Walnut (6209-43)	no charge
7	Formica Select Cherry (7759-43)	no charge
X	*Wilsonart Non-Premium laminates (-38, -60)	+35%
Y	*Formica Non-Premium (includes 58, 43, MC, SP, and NT finishes), Formica Premium (WR, 42, 77, 46, RD finishes), Pionite Non-Premium, Nevamar Non-Premium, Wilsonart Premium (-01, -07, -12, -18, -52, -78), and whiteboard laminate.	+45%

*Add \$350 list for Special Laminate orders of less than 10 units. See page 21 for edge selection.

(#) Veneer Suffix List:

D	Maple (stained similar to Kensington Maple laminate)	
J	Cherry (stained similar to Wild Cherry laminate)	
N	Walnut (stained similar to Cafelle laminate)	
8	Walnut (stained similar to Prestige Walnut laminate)	
9	Cherry (stained similar to Select Cherry laminate)	
X	Stain Match (add a one-time \$700 list Stain Match fee)	+10%

Ordering Information:

- > Includes one monitor mount for most monitors up to 55". Two monitors up to 40" may be mounted by ordering an alternate mount kit below.
- > Includes lock and levelers.
- > Monitors ordered separately.
- > 4-door cabinets include adjustable shelves.
- > **A freight fee of \$100 net is assessed on orders less than \$1000 net. See page 13.**



Part Number Description

List Price (US\$)

Concurrence Monitor Walls - Wall Mount with 4-Drawer Cabinet 54"W x 41"H x 15.5"D

LZMLN5441*#	Laminate Monitor Wall - Wall Mount w/4-Drawer Cabinet	\$5553
LZMVN5441*#	Veneer Monitor Wall - Wall Mount w/4-Drawer Cabinet	\$11,108

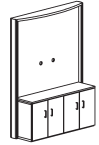

Concurrence Monitor Wall - Wall Mount with 4-Door Cabinet, 54"W x 72"H x 15.5"D

LZMLC5472*#	Laminate Monitor Wall - Wall Mount with 4-Door Cabinet	\$6762
LZMVC5472*#	Veneer Monitor Wall - Wall Mount with 4-Door Cabinet	\$13,525

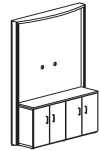

Concurrence Monitor Wall - Freestanding On Levelers w/ 4-Door Cabinet, 54"W x 72"H x 15.5"D

LZMLD5472*#	Laminate Monitor Wall - Freestanding	\$6762
LZMVD5472*#	Veneer Monitor Wall - Freestanding	\$13,525

Tip: Freestanding Monitor Wall must be positioned with back against wall.

Monitor Mounting Bracket for two Monitors on VS Tables and Monitor Wall

LZMMB	Bracket for two monitor application	\$480
-------	-------------------------------------	-------

Tip: Holds up to two 40" monitors.

TOPS	TABLES STEP 2 - CONCURRENCE
BASES	
POWER DATA	
SUPPORT FURNITURE	
ACCESSORIES	

Notes

Disc and Square Bases

STEP 1

(^) Paint Suffix List

G	Slate Grey	
R	Black	
S	Silver	
T	Medium Tone	
U	Chrome (LDFA, LDFB, LDGA, LDFAF, LDFBF, LDGAF)*	+\$495
V	Chrome (LDFC, LDGB, LDFCF, LDGBF)*	+\$725
W	Arctic White	
Z	Other	

***Tip:** Chrome is not available on Square bases, LDFDF, LDFD, and Disc Bases with power data top plate.

Tip: Some Steelcase, Herman Miller, Knoll, Haworth, and Allsteel paints are available for \$350 list fee per order. Call/email for availability of specific colors. Additional custom paints (e.g. Tiger Dry Lac) must be quoted through quotes@enwork.com.

Product Specifications:

> For Square bases, vertical column is square.

Ordering Information:

> For shorter heights put "X" in front of the part number and add \$54 list. For taller heights, put "XX" in front of the part number and add \$68 list.

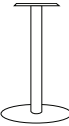
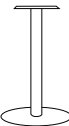
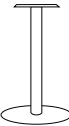
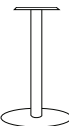
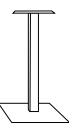

> **A freight fee of \$100 net is assessed on orders less than \$1000 net. See page 13.**

Part Number	Description	List Price (US\$)
Low Profile Disc Bases, No Levelers – Desk/Dining Height (27.75" Tall)		
 LDFAF^	Disc Base (17" diameter), for 24"-36" round or 24"-30" square top	\$520
LDFBF^	Disc Base (23" diameter), for 42" round or 36" square top	\$592
LDFCF^	Disc Base (27" diameter), for 48" round or 42" square top	\$713
LDFDF^	Disc Base (32" diameter), for 54"-60" round or 48" square top	\$1608
Low Profile Disc Bases, No Levelers – Bar Height (40.75" Tall)		
 LDGAF^	Disc Base, (23" diameter), Bar Height, for 24"-36" round or 24"-30" square top	\$675
LDGBF^	Disc Base (27" diameter), Bar Height, for 42" round or 36" square top	\$817
Steel Disc Bases with Levelers – Desk/Dining Height (28.25" Tall)		
 LDFA^	Disc Base (17" diameter) for 24"-36" round or 24"-30" square top	\$632
LDFB^	Disc Base (23" diameter) for 42" round or 36" square top	\$686
LDFC^	Disc Base (27" diameter) for 48" round or 42" square top	\$823
LDFD^	Disc Base (32" diameter) for 54"-60" round or 48" square top	\$1709
Steel Disc Bases with Levelers – Bar Height (41.25" Tall)		
 LDGA^	Disc Base (23" diameter), Bar Height, for 24"-36" round or 24"-30" square top	\$769
LDGB^	Disc Base (27" diameter), Bar Height, for 42" round or 36" square top	\$905
Low Profile Square Bases with Levelers - Desk/Dining Height (27.75" Tall)		
 LDSQ1A^	Flat Steel Square Base (17") for 24"-36" round or 24"-30" square top	\$721
LDSQ1B^	Flat Steel Square Base (22") for 42" round or 36" square top	\$773
LDSQ1C^	Flat Steel Square Base (27") for 48" round or 42" square top	\$1009
Low Profile Square Bases with Levelers - Bar Height (40.75" Tall)		
LDSQ2A^	Flat Steel Square Base (17"), Bar Height, for 24"-36" round or 24"-30" square tops	\$858
LDSQ2B^	Flat Steel Square Base (22"), Bar Height, for 42" round or 36"-42" square tops	\$1057

Disc Bases w/ Power Data Top Plate

Ordering Information:

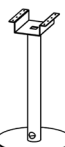
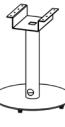
- > Special Top Plate allows room for Power/Data in center of top.
- > Top plate can accommodate the Flip-n-Go, Villa, Cove, and Single-Sided Ellora power data units.
- > Bases with Power/Data Top Plate include hole in side of leg near the bottom for cable management.
- > Disc bases with Power/Data Top Plate not available in chrome.
- > **A freight fee of \$100 net is assessed on orders less than \$1000 net. See page 13.**

Part Number	Description	List Price (US\$)
	Flat Steel Disc Bases, No Levelers, with Power/Data Top Plate – Desk/Dining Height (27.75" Tall)	
LD3FAF^	Disc Base (17" diameter), P/D Top Plate, for 24" - 36" round or 24" - 30" square top	\$651
LD3FBF^	Disc Base (23" diameter), P/D Top Plate, for 42" round or 36" square top	\$723
LD3FCF^	Disc Base (27" diameter), P/D Top Plate, for 48" round or 42" square top	\$844
LD3FDF^	Disc Base (32" diameter), P/D Top Plate, for 54"-60" round or 48" square top	\$2449
	Tip: Flip-n-Go Power/Data units and Ellora Double-sided units with 6 power or 8 power will not fit the 32" diameter Disc Base.	
	Flat Steel Disc Bases, No Levelers, with Power/Data Top Plate – Bar Height (40.75" Tall)	
LD3GAF^	Disc Base (23" diameter), P/D Top Plate, for 24"-36" round or 24"-30" square top	\$806
LD3GBF^	Disc Base (27" diameter), P/D Top Plate, for 42" round or 36" square top	\$947
	Steel Disc Bases, with Levelers and Power/Data Top Plate – Desk/Dining Height (28.25" Tall)	
LD3FA^	Disc Base (17" diameter), P/D Top Plate, for 24" - 36" round or 24" - 30" square top	\$764
LD3FB^	Disc Base (23" diameter), P/D Top Plate, for 42" round or 36" square top	\$817
LD3FC^	Disc Base (27" diameter), P/D Top Plate, for 48" round or 42" square top	\$955
LD3FD^	Disc Base (32" diameter), P/D Top Plate, for 54"-60" round or 48" square top	\$2523
	Tip: Flip-n-Go Power/Data units and Ellora Double-sided units with 6 power or 8 power will not fit the 32" diameter Disc Base.	
	Steel Disc Bases, with Levelers and Power/Data Top Plate – Bar Height (41.25" Tall)	
LD3GA^	Disc Base (23" diameter), P/D Top Plate, for 24"-36" round or 24"-30" square top	\$899
LD3GB^	Disc Base (27" diameter), P/D Top Plate, for 42" round or 36" square top	\$1036

TOPS

BASES

POWER
DATASUPPORT
FURNITURE

ACCESSORIES

TABLES STEP 2 - DISC & SQUARE

eBench™ Tables (Complete Tables)

STEP 1

(@) Cable Management Suffix List

N	No Cable Management	No charge
G	Grommet (one, centered)	+\$18
K	One Power/Data Cut-out (centered)	+\$36
C	Two Power/Data Cut-outs	+\$72
E	Three Power/Data Cut-outs	+\$108
X	Other	TBD

STEP 2

(^) Paint Suffix List

S	Silver	no charge
G	Slate Grey	+\$300
R	Black	+\$300
T	Medium Tone	+\$300
W	Arctic White	+\$300
Z	Other	TBD

Tip: Some Steelcase, Herman Miller, Knoll, Haworth, and Allsteel paints are available for \$350 list fee per order. Call/email for availability of specific colors. Additional custom paints (e.g. Tiger Dry Lac) must be quoted through quotes@enwork.com.

STEP 3

(#) Laminate Suffix List:

A	Wilsonart Kensington Maple (10776-60)	
B	Wilsonart Monticello Maple (7925-38)	
C	Wilsonart Wild Cherry (7054-60)	
E	Wilsonart Fashion Grey (D381-60)	
F	Wilsonart White Tigris (4783-60)	
G	Wilsonart Cafelle (7933K-07)	
M	Wilsonart Frosty White (1573-60)	
P	Wilsonart Slate Grey (D91-60)	
R	Wilsonart Black (1595-60)	
U	Wilsonart Brazilwood (7946-38)	
V	Wilsonart River Cherry (7937-38)	
W	Wilsonart Designer White (D354-60)	
3	Formica Neutral Twill (8826-58)	
4	Formica Bleached Legno (8845-58)	
5	Formica Prestige Walnut (6209-43)	
7	Formica Select Cherry (7759-43)	
X	*Wilsonart Non-Premium laminates (-38, -60). Orders of 100+ units have no upcharge.	+\$36
Y	*Formica Non-Premium Standard (58, 43, MC, SP and NT finishes) and Wilsonart Premium (-01, -07, -12, -18, -52, -78) laminates.	+\$50
Z	*Pionite Non-Premium, Nevamar Non-Premium, Formica Premium (WR, 42, 77, 46, RD Finishes), and whiteboard laminate.	+\$72

*Add \$350 list for Special Laminate orders of less than 10 units. See page 21 for edge selection.

Ordering Information:

- > Includes 3/4" floating laminate top with 3mm edge, structure, legs, and fasteners
- > Ships unassembled
- > Standard in silver paint, other standard paints available for an upcharge.
- > 96"-240"W tables include one magnetic vertical cable manager for concealed routing.
- > For 48" and 72"W tables with power, a PDVCR, ordered separately, is recommended for vertical cable management.
- > **A freight fee of \$100 net is assessed on orders less than \$1000 net. See page 13.**



Part Number	Description	List Price (US\$)
48"D eBench Table, 3mm Edge		
EBZ4848@^#	Complete Table 48"W	\$1612
EBZ4872@^#	Complete Table 72"W	\$1768
EBZ4896@^#	Complete Table 96"W	\$2958
EBZ48120@^#	Complete Table 120"W	\$3140
EBZ481442@^#	Complete Table 144"W, for use w/ none or two PD cutouts	\$3498
EBZ481443@^#	Complete Table 144"W, for use w/ one or three PD cutouts	\$4419
EBZ48156@^#	Complete Table 156"W	\$4509
EBZ48168@^#	Complete Table 168"W	\$4601
EBZ48180@^#	Complete Table 180"W	\$4692
EBZ48192@^#	Complete Table 192"W	\$4871
EBZ48204@^#	Complete Table 204"W	\$5050
EBZ48216@^#	Complete Table 216"W	\$5229
EBZ482404@^#	Complete Table 240"W, for use w/ none or two PD cutouts	\$6243
EBZ482405@^#	Complete Table 240"W, for use w/ one or three PD cutouts	\$6941
60"D eBench Tables, 3mm Edge		
EBZ6060@^#	Complete Table 60"W	\$1750
EBZ6072@^#	Complete Table 72"W	\$1902
EBZ6096@^#	Complete Table 96"W	\$3184
EBZ60120@^#	Complete Table 120"W	\$3457
EBZ601442@^#	Complete Table 144"W, for use w/ none or two PD cutouts	\$3763
EBZ601443@^#	Complete Table 144"W, for use w/ one or three PD cutouts	\$4563
EBZ60156@^#	Complete Table 156"W	\$4891
EBZ60168@^#	Complete Table 168"W	\$5023
EBZ60180@^#	Complete Table 180"W	\$5164
EBZ60192@^#	Complete Table 192"W	\$5317
EBZ60204@^#	Complete Table 204"W	\$5470
EBZ60216@^#	Complete Table 216"W	\$5623
EBZ602404@^#	Complete Table 240"W, for use w/ none or two PD cutouts	\$6872
EBZ602405@^#	Complete Table 240"W, for use w/ one or three PD cutouts	\$7393

TOPS
BASES
POWER DATA
SUPPORT FURNITURE
ACCESSORIES

TABLES STEP 2 - EBENCH

Notes

Equilibrium™ Conference Bases Patent Pending

STEP 1

(^) Paint Suffix List

S Silver (textured)	no charge
G Slate Grey (textured)	no charge
R Black (textured)	no charge
T Medium Tone (textured)	no charge
W Arctic White (textured)	no charge
Z Other (textured)	+\$TBD

Tip: Some Steelcase, Herman Miller, Knoll, Haworth, and Allsteel paints are available for \$350 list fee per order. Call/email for availability of specific colors. Additional custom paints (e.g. Tiger Dry Lac) must be quoted through quotes@enwork.com.

STEP 2 - Triangle Bases Only

(@) Cover Option Suffix List

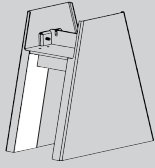
I Inner Covers  no charge

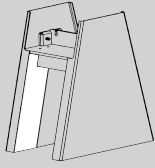

E End Covers  no charge

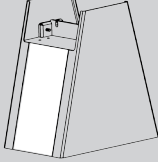

Product Specification:

- > Bases support conference tops 36"-60"D.

Ordering Information:

- > Bases are ordered in multiple pieces for design flexibility.
- > Base must bolt to a 4" concrete floor. Fasteners provided.
- > Power data units are housed between cantilever supports. Ordered separately.
- > Cantilever support trough covers provided to conceal power and cable routing.
Exception: Positioning for some power/data assemblies (e.g. Oasis) is limited due to base structure.
- > Trough covers not included with Truss design cantilever supports.
- > **A freight fee of \$100 net is assessed on orders less than \$1000 net. See page 13.**

Part Number	Description	List Price (US\$)
-------------	-------------	-------------------



Seated Height Equilibrium Inverse V Base, 29"H

EQV296^	Inverse V Base, for 84-144"W tops w/ Centered Cantilever Supports	\$9213
EQV298^	Inverse V Base, for 156-240"W tops w/ Centered Cantilever Supports and 120-192"W tops w/ Offset Cantilever Supports	\$9435

Tip: Inverse V bases include magnetic inner cable management covers. Two of 4 inner covers have a mousehole for cord pass thru.



Standing Height Equilibrium Inverse V Base, 42"H

EQV426^	Inverse V Base, for 84-144"W tops w/ Centered Cantilever Supports	\$10,200
EQV428^	Inverse V Base, for 156-240"W tops w/ Centered Cantilever Supports and 120-192"W tops w/ Offset Cantilever Supports	\$10,440

Tip: Inverse V bases include magnetic inner cable management covers. Two of 4 inner covers have a mousehole for cord pass thru.



Seated Height Equilibrium Triangle Base, 29"H

EQT296^@	Triangle Base, for 84-144"W tops w/ Centered Cantilever Supports	\$9435
EQT298^@	Triangle Base, for 156-240"W tops w/ Centered Cantilever Supports and 120-192"W tops w/ Offset Cantilever Supports	\$9657

Tip: Triangle base includes one set of magnetic inner cable management covers. See step 2 to select inner or end covers.

Tip: Inner covers enclose each leg and provide concealed power and cable routing. Base is open in the middle.

End covers fully enclose the base, concealing hardware, technology, and floor monument.

Disclaimer

Equilibrium tables must be installed directly onto a four inch minimum thickness concrete floor using factory provided hardware.

Warning

- Failure to install on four inch thick concrete floor or failure to follow instruction may cause table to function improperly and could lead to personal injury and or structural damage.
- Equilibrium assembled can weigh between 350 and 1,700 pounds depending on configuration and is supported in a three and a half square foot area. It is the responsibility of the dealer and or end user to determine if the installation location for Equilibrium is suitable.
- Enwork is not responsible for any structure failures or personal injuries due to improper installation or improper use of product.

Note

Installation requires at least two people.

Part Number Description List Price (US\$)

Centered Equilibrium Cantilever Top Supports, Solid Design

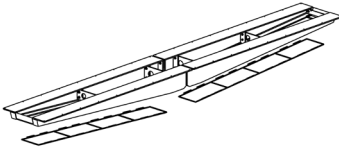

EQW1C84^	Centered Top Supports, Qty. 4, Solid Design for 84" top	\$8000
EQW1C96^	Centered Top Supports, Qty. 4, Solid Design for 96" top	\$8000
EQW1C108^	Centered Top Supports, Qty. 4, Solid Design for 108" top	\$8880
EQW1C120^	Centered Top Supports, Qty. 4, Solid Design for 120" top	\$10,000
EQW1C132^	Centered Top Supports, Qty. 4, Solid Design for 132" top	\$10,000
EQW1C144^	Centered Top Supports, Qty. 4, Solid Design for 144" top	\$10,800
EQW1C156^	Centered Top Supports, Qty. 4, Solid Design for 156" top	\$11,580
EQW1C168^	Centered Top Supports, Qty. 4, Solid Design for 168" top	\$12,000
EQW1C180^	Centered Top Supports, Qty. 4, Solid Design for 180" top	\$12,200
EQW1C192^	Centered Top Supports, Qty. 4, Solid Design for 192" top	\$12,700
EQW1C204^	Centered Top Supports, Qty. 4, Solid Design for 204" top	\$13,300
EQW1C216^	Centered Top Supports, Qty. 4, Solid Design for 216" top	\$13,500
EQW1C228^	Centered Top Supports, Qty. 4, Solid Design for 228" top	\$14,000
EQW1C240^	Centered Top Supports, Qty. 4, Solid Design for 240" top	\$14,000

Offset Equilibrium Cantilever Top Supports, Solid Design

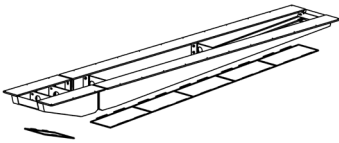

EQW1FF120^	Offset Top Supports, Qty. 4, Solid Design for 120" top	\$10,000
EQW1FF132^	Offset Top Supports, Qty. 4, Solid Design for 132" top	\$10,500
EQW1FF144^	Offset Top Supports, Qty. 4, Solid Design for 144" top	\$10,800
EQW1FF156^	Offset Top Supports, Qty. 4, Solid Design for 156" top	\$11,580
EQW1FF168^	Offset Top Supports, Qty. 4, Solid Design for 168" top	\$12,000
EQW1FF180^	Offset Top Supports, Qty. 4, Solid Design for 180" top	\$12,200
EQW1FF192^	Offset Top Supports, Qty. 4, Solid Design for 192" top	\$12,700

Centered Equilibrium Cantilever Top Supports, Truss Design

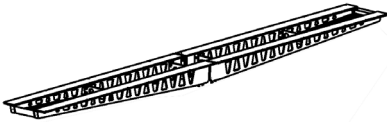

EQW2C84^	Centered Top Supports, Qty. 4, Truss Design for 84" top	\$9200
EQW2C96^	Centered Top Supports, Qty. 4, Truss Design for 96" top	\$9440
EQW2C108^	Centered Top Supports, Qty. 4, Truss Design for 108" top	\$10,000
EQW2C120^	Centered Top Supports, Qty. 4, Truss Design for 120" top	\$12,000
EQW2C132^	Centered Top Supports, Qty. 4, Truss Design for 132" top	\$12,000
EQW2C144^	Centered Top Supports, Qty. 4, Truss Design for 144" top	\$13,000
EQW2C156^	Centered Top Supports, Qty. 4, Truss Design for 156" top	\$13,000
EQW2C168^	Centered Top Supports, Qty. 4, Truss Design for 168" top	\$13,500
EQW2C180^	Centered Top Supports, Qty. 4, Truss Design for 180" top	\$14,500
EQW2C192^	Centered Top Supports, Qty. 4, Truss Design for 192" top	\$15,000
EQW2C204^	Centered Top Supports, Qty. 4, Truss Design for 204" top	\$16,000
EQW2C216^	Centered Top Supports, Qty. 4, Truss Design for 216" top	\$16,600
EQW2C228^	Centered Top Supports, Qty. 4, Truss Design for 228" top	\$16,800
EQW2C240^	Centered Top Supports, Qty. 4, Truss Design for 240" top	\$17,000

Tip: Cantilever trough covers not included with truss design.

Offset Equilibrium Cantilever Top Supports, Truss Design

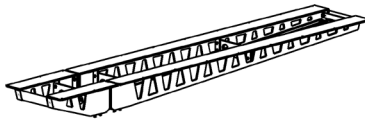

EQW2FF120^	Offset Top Supports, Qty. 4, Truss Design for 120" top	\$12,000
EQW2FF132^	Offset Top Supports, Qty. 4, Truss Design for 132" top	\$12,000
EQW2FF144^	Offset Top Supports, Qty. 4, Truss Design for 144" top	\$13,000
EQW2FF156^	Offset Top Supports, Qty. 4, Truss Design for 156" top	\$13,000
EQW2FF168^	Offset Top Supports, Qty. 4, Truss Design for 168" top	\$13,500
EQW2FF180^	Offset Top Supports, Qty. 4, Truss Design for 180" top	\$14,500
EQW2FF192^	Offset Top Supports, Qty. 4, Truss Design for 192" top	\$15,000

Tip: Cantilever trough covers not included with truss design.

Foundation™ - Base Assemblies for 48" D Boat/Capsule/Ellipse Tops

STEP 1

(#) Laminate Suffix List:

A	Wilsonart Kensington Maple (10776-60)	no charge
B	Wilsonart Monticello Maple (7925-38)	no charge
C	Wilsonart Wild Cherry (7054-60)	no charge
E	Wilsonart Fashion Grey (D381-60)	no charge
G	Wilsonart Cafelle (7933K-07)	no charge
M	Wilsonart Frosty White (1573-60)	no charge
P	Wilsonart Slate Grey (D91-60)	no charge
R	Wilsonart Black (1595-60)	no charge
U	Wilsonart Brazilwood (7946-38)	no charge
V	Wilsonart River Cherry (7937-38)	no charge
W	Wilsonart Designer White (D354-60)	no charge
3	Formica Neutral Twill (8826-58)	no charge
4	Formica Bleached Legno (8845-58)	no charge
5	Formica Prestige Walnut (6209-43)	no charge
7	Formica Select Cherry (7759-43)	no charge
X	*Wilsonart Non-Premium laminates (-38, -60)	+35%
Y	*Formica Non-Premium (includes 58, 43, MC, SP, and NT finishes), Formica Premium (WR, 42, 77, 46, RD finishes), Pionite Non-Premium, Nevamar Non-Premium, Wilsonart Premium (-01, -07, -12, -18, -52, -78), and whiteboard laminate.	+45%

*Add \$350 list for Special Laminate orders of less than 10 units. See page 21 for edge selection.

(#) Veneer Suffix List:

D	Maple (stained similar to Kensington Maple laminate)	
J	Cherry (stained similar to Wild Cherry laminate)	
N	Walnut (stained similar to Cafelle laminate)	
8	Walnut (stained similar to Prestige Walnut laminate)	
9	Cherry (stained similar to Select Cherry laminate)	
X	Stain Match (add a one-time \$700 list Stain Match fee)	+10%

Product Specifications:



- > Base is 6"W and 27.75"H.
- > Trough is 8"H x 10.5"D (interior).

Ordering Information:

- > All Bases in Base Kit include 1 removable door and levelers.
- > Trough includes cable grippers for cable retention.
- > Trough includes removable bottom panel.
- > Braces are not required on tables with the Panel Base Kit.
- > Door kits for top access to trough are located on page 100.
- > 15" Oasis Power does not fit on 72"W table kits. 30" Oasis only fits on 96"W, 180"W, and 192"W kits.
- > **A freight fee of \$100 net is assessed on orders less than \$1000 net. See page 13.**

Part Number	Description	List Price (US\$)
-------------	-------------	-------------------

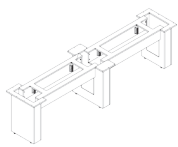
Laminate Foundation Panel Base and Trough Assemblies for 48"D Boat/Capsule Tables

	LPTLN4872#	Lam. Base Assembly for 48" x 72" Bt./Cap. Top	\$1550
	LPTLN4884#	Lam. Base Assembly for 48" x 84" Bt./Cap. Top	\$1550
	LPTLN4896#	Lam. Base Assembly for 48" x 96" Bt./Cap. Top	\$1550
	LPTLN48108#	Lam. Base Assembly for 48" x 108" Bt./Cap. Top	\$2689
	LPTLN48120#	Lam. Base Assembly for 48" x 120" Bt./Cap. Top	\$2689
	LPTLN48132#	Lam. Base Assembly for 48" x 132" Bt./Cap. Top	\$2689
	LPTLN48144#	Lam. Base Assembly for 48" x 144" Bt./Cap. Top	\$2689
	LPTLN48156#	Lam. Base Assembly for 48" x 156" Bt./Cap. Top	\$2689
	LPTLN48168#	Lam. Base Assembly for 48" x 168" Bt./Cap. Top	\$2689
	LPTLN48180#	Lam. Base Assembly for 48" x 180" Bt./Cap. Top	\$2689
	LPTLN48192#	Lam. Base Assembly for 48" x 192" Bt./Cap. Top	\$2689
	LPTLN48204#	Lam. Base Assembly for 48" x 204" Bt./Cap. Top	\$3818
	LPTLN48216#	Lam. Base Assembly for 48" x 216" Bt./Cap. Top	\$3818
	LPTLN48228#	Lam. Base Assembly for 48" x 228" Bt./Cap. Top	\$3818
	LPTLN48240#	Lam. Base Assembly for 48" x 240" Bt./Cap. Top	\$3818

Laminate Foundation Panel Base and Trough Assemblies with Aluminum Trim for 48"D Boat/Capsule Tables

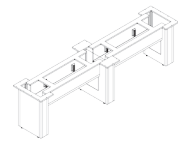
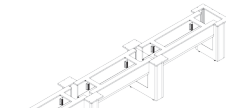
	LPTLA4872#	Lam. Base Assembly, Alum. for 48" x 72" Bt./Cap. Top	\$2125
	LPTLA4884#	Lam. Base Assembly, Alum. for 48" x 84" Bt./Cap. Top	\$2125
	LPTLA4896#	Lam. Base Assembly, Alum. for 48" x 96" Bt./Cap. Top	\$2125
	LPTLA48108#	Lam. Base Assembly, Alum. for 48" x 108" Bt./Cap. Top	\$3638
	LPTLA48120#	Lam. Base Assembly, Alum. for 48" x 120" Bt./Cap. Top	\$3638
	LPTLA48132#	Lam. Base Assembly, Alum. for 48" x 132" Bt./Cap. Top	\$3638
	LPTLA48144#	Lam. Base Assembly, Alum. for 48" x 144" Bt./Cap. Top	\$3638
	LPTLA48156#	Lam. Base Assembly, Alum. for 48" x 156" Bt./Cap. Top	\$3638
	LPTLA48168#	Lam. Base Assembly, Alum. for 48" x 168" Bt./Cap. Top	\$3638
	LPTLA48180#	Lam. Base Assembly, Alum. for 48" x 180" Bt./Cap. Top	\$3638
	LPTLA48192#	Lam. Base Assembly, Alum. for 48" x 192" Bt./Cap. Top	\$3638
	LPTLA48204#	Lam. Base Assembly, Alum. for 48" x 204" Bt./Cap. Top	\$5868
	LPTLA48216#	Lam. Base Assembly, Alum. for 48" x 216" Bt./Cap. Top	\$5868
	LPTLA48228#	Lam. Base Assembly, Alum. for 48" x 228" Bt./Cap. Top	\$5868
	LPTLA48240#	Lam. Base Assembly, Alum. for 48" x 240" Bt./Cap. Top	\$5868



COORDINATING FURNITURE

See pages 178-180
for coordinating
Foundation furniture.

TOPS	TABLES STEP 2 - FOUNDATION
BASES	
POWER DATA	
SUPPORT FURNITURE	
ACCESSORIES	

Part Number Description List Price (US\$)

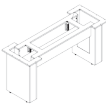
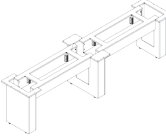
Veneer Foundation Panel Base and Trough Assemblies for 48"D Boat/Capsule Tables

	LPTVN4872#	Veneer Base Assembly for 48" x 72" Bt./Cap. Top	\$3987
	LPTVN4884#	Veneer Base Assembly for 48" x 84" Bt./Cap. Top	\$4292
	LPTVN4896#	Veneer Base Assembly for 48" x 96" Bt./Cap. Top	\$4601
	LPTVN48108#	Veneer Base Assembly for 48" x 108" Bt./Cap. Top	\$6647
	LPTVN48120#	Veneer Base Assembly for 48" x 120" Bt./Cap. Top	\$6953
	LPTVN48132#	Veneer Base Assembly for 48" x 132" Bt./Cap. Top	\$7256
	LPTVN48144#	Veneer Base Assembly for 48" x 144" Bt./Cap. Top	\$7571
	LPTVN48156#	Veneer Base Assembly for 48" x 156" Bt./Cap. Top	\$7874
	LPTVN48168#	Veneer Base Assembly for 48" x 168" Bt./Cap. Top	\$8188
	LPTVN48180#	Veneer Base Assembly for 48" x 180" Bt./Cap. Top	\$8494
	LPTVN48192#	Veneer Base Assembly for 48" x 192" Bt./Cap. Top	\$8795
	LPTVN48204#	Veneer Base Assembly for 48" x 204" Bt./Cap. Top	\$10,996
	LPTVN48216#	Veneer Base Assembly for 48" x 216" Bt./Cap. Top	\$11,300
	LPTVN48228#	Veneer Base Assembly for 48" x 228" Bt./Cap. Top	\$11,619
	LPTVN48240#	Veneer Base Assembly for 48" x 240" Bt./Cap. Top	\$11,924

Veneer Foundation Panel Base and Trough Assemblies with Aluminum Trim for 48"D Boat/Capsule Tables

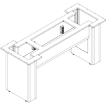
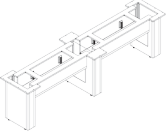
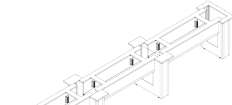
	LPTVA4872#	Veneer Base Assembly, Alum. for 48" x 72" Bt./Cap. Top	\$4161
	LPTVA4884#	Veneer Base Assembly, Alum. for 48" x 84" Bt./Cap. Top	\$4446
	LPTVA4896#	Veneer Base Assembly, Alum. for 48" x 96" Bt./Cap. Top	\$4730
	LPTVA48108#	Veneer Base Assembly, Alum. for 48" x 108" Bt./Cap. Top	\$6906
	LPTVA48120#	Veneer Base Assembly, Alum. for 48" x 120" Bt./Cap. Top	\$7193
	LPTVA48132#	Veneer Base Assembly, Alum. for 48" x 132" Bt./Cap. Top	\$7477
	LPTVA48144#	Veneer Base Assembly, Alum. for 48" x 144" Bt./Cap. Top	\$7761
	LPTVA48156#	Veneer Base Assembly, Alum. for 48" x 156" Bt./Cap. Top	\$8050
	LPTVA48168#	Veneer Base Assembly, Alum. for 48" x 168" Bt./Cap. Top	\$8337
	LPTVA48180#	Veneer Base Assembly, Alum. for 48" x 180" Bt./Cap. Top	\$8624
	LPTVA48192#	Veneer Base Assembly, Alum. for 48" x 192" Bt./Cap. Top	\$8908
	LPTVA48204#	Veneer Base Assembly, Alum. for 48" x 204" Bt./Cap. Top	\$11,226
	LPTVA48216#	Veneer Base Assembly, Alum. for 48" x 216" Bt./Cap. Top	\$11,511
	LPTVA48228#	Veneer Base Assembly, Alum. for 48" x 228" Bt./Cap. Top	\$11,799
	LPTVA48240#	Veneer Base Assembly, Alum. for 48" x 240" Bt./Cap. Top	\$12,084

Foundation - Base Assemblies for 54" D Boat/Capsule/Ellipse Tops

STEP 1

(#) Laminate Suffix List:

A	Wilsonart Kensington Maple (10776-60)	no charge
B	Wilsonart Monticello Maple (7925-38)	no charge
C	Wilsonart Wild Cherry (7054-60)	no charge
E	Wilsonart Fashion Grey (D381-60)	no charge
G	Wilsonart Cafelle (7933K-07)	no charge
M	Wilsonart Frosty White (1573-60)	no charge
P	Wilsonart Slate Grey (D91-60)	no charge
R	Wilsonart Black (1595-60)	no charge
U	Wilsonart Brazilwood (7946-38)	no charge
V	Wilsonart River Cherry (7937-38)	no charge
W	Wilsonart Designer White (D354-60)	no charge
3	Formica Neutral Twill (8826-58)	no charge
4	Formica Bleached Legno (8845-58)	no charge
5	Formica Prestige Walnut (6209-43)	no charge
7	Formica Select Cherry (7759-43)	no charge
X	*Wilsonart Non-Premium laminates (-38, -60)	+35%
Y	*Formica Non-Premium (includes 58, 43, MC, SP, and NT finishes), Formica Premium (WR, 42, 77, 46, RD finishes), Pionite Non-Premium, Nevamar Non-Premium, Wilsonart Premium (-01, -07, -12, -18, -52, -78), and whiteboard laminate.	+45%

*Add \$350 list for Special Laminate orders of less than 10 units. See page 21 for edge selection.

(#) Veneer Suffix List:

D	Maple (stained similar to Kensington Maple laminate)	
J	Cherry (stained similar to Wild Cherry laminate)	
N	Walnut (stained similar to Cafelle laminate)	
8	Walnut (stained similar to Prestige Walnut laminate)	
9	Cherry (stained similar to Select Cherry laminate)	
X	Stain Match (add a one-time \$700 list Stain Match fee)	+10%

Product Specifications:

- > Base is 6"W and 27.75"H.
- > Trough is 8"H x 10.5"D (interior).

Ordering Information:

- > All Bases in Base Kit include 1 removable door and levelers.
- > Trough includes cable grippers for cable retention.
- > Trough includes removable bottom panel.
- > Braces are not required on tables with the Panel Base Kit.
- > Door kits for top access to trough are located on page 100.
- > 15" Oasis Power does not fit on 72"W table kits. 30" Oasis only fits on 96"W, 180"W, and 192"W kits.
- > **A freight fee of \$100 net is assessed on orders less than \$1000 net. See page 13.**

Part Number	Description	List Price (US\$)
-------------	-------------	-------------------

Laminate Foundation Panel Base and Trough Assemblies for 54"D Boat/Capsule Tables

LPTLN5472#	Lam. Base Assembly for 54" x 72" Bt./Cap. Top	\$1719
LPTLN5484#	Lam. Base Assembly for 54" x 84" Bt./Cap. Top	\$1719
LPTLN5496#	Lam. Base Assembly for 54" x 96" Bt./Cap. Top	\$1719
LPTLN54108#	Lam. Base Assembly for 54" x 108" Bt./Cap. Top	\$3149
LPTLN54120#	Lam. Base Assembly for 54" x 120" Bt./Cap. Top	\$3149
LPTLN54132#	Lam. Base Assembly for 54" x 132" Bt./Cap. Top	\$3149
LPTLN54144#	Lam. Base Assembly for 54" x 144" Bt./Cap. Top	\$3149
LPTLN54156#	Lam. Base Assembly for 54" x 156" Bt./Cap. Top	\$3149
LPTLN54168#	Lam. Base Assembly for 54" x 168" Bt./Cap. Top	\$3149
LPTLN54180#	Lam. Base Assembly for 54" x 180" Bt./Cap. Top	\$3149
LPTLN54192#	Lam. Base Assembly for 54" x 192" Bt./Cap. Top	\$3149
LPTLN54204#	Lam. Base Assembly for 54" x 204" Bt./Cap. Top	\$4562
LPTLN54216#	Lam. Base Assembly for 54" x 216" Bt./Cap. Top	\$4562
LPTLN54228#	Lam. Base Assembly for 54" x 228" Bt./Cap. Top	\$4562
LPTLN54240#	Lam. Base Assembly for 54" x 240" Bt./Cap. Top	\$4562

Laminate Foundation Panel Base and Trough Assemblies with Aluminum Trim for 54"D Boat/Capsule Tables

LPTLA5472#	Lam. Base Assembly, Alum. for 54" x 72" Bt./Cap. Top	\$2292
LPTLA5484#	Lam. Base Assembly, Alum. for 54" x 84" Bt./Cap. Top	\$2292
LPTLA5496#	Lam. Base Assembly, Alum. for 54" x 96" Bt./Cap. Top	\$2292
LPTLA54108#	Lam. Base Assembly, Alum. for 54" x 108" Bt./Cap. Top	\$4089
LPTLA54120#	Lam. Base Assembly, Alum. for 54" x 120" Bt./Cap. Top	\$4089
LPTLA54132#	Lam. Base Assembly, Alum. for 54" x 132" Bt./Cap. Top	\$4089
LPTLA54144#	Lam. Base Assembly, Alum. for 54" x 144" Bt./Cap. Top	\$4089
LPTLA54156#	Lam. Base Assembly, Alum. for 54" x 156" Bt./Cap. Top	\$4089
LPTLA54168#	Lam. Base Assembly, Alum. for 54" x 168" Bt./Cap. Top	\$4089
LPTLA54180#	Lam. Base Assembly, Alum. for 54" x 180" Bt./Cap. Top	\$4089
LPTLA54192#	Lam. Base Assembly, Alum. for 54" x 192" Bt./Cap. Top	\$4089
LPTLA54204#	Lam. Base Assembly, Alum. for 54" x 204" Bt./Cap. Top	\$5868
LPTLA54216#	Lam. Base Assembly, Alum. for 54" x 216" Bt./Cap. Top	\$5868
LPTLA54228#	Lam. Base Assembly, Alum. for 54" x 228" Bt./Cap. Top	\$5868
LPTLA54240#	Lam. Base Assembly, Alum. for 54" x 240" Bt./Cap. Top	\$5868

COORDINATING FURNITURE

See pages 178-180
for coordinating
Foundation furniture.

TOPS

BASES

POWER
DATA

SUPPORT
FURNITURE

ACCESSORIES

TABLES STEP 2 - FOUNDATION

Part Number Description List Price (US\$)

Veneer Foundation Panel Base and Trough Assemblies for 54"D Boat/Capsule Tables

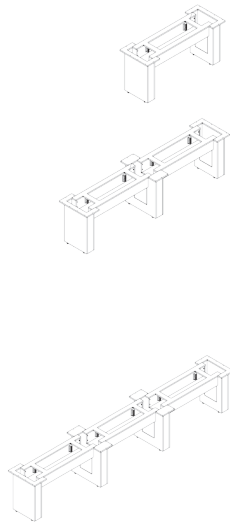

LPTVN5472#	Veneer Base Assembly for 54" x 72" Bt./Cap. Top	\$4452
LPTVN5484#	Veneer Base Assembly for 54" x 84" Bt./Cap. Top	\$4757
LPTVN5496#	Veneer Base Assembly for 54" x 96" Bt./Cap. Top	\$5066
LPTVN54108#	Veneer Base Assembly for 54" x 108" Bt./Cap. Top	\$7526
LPTVN54120#	Veneer Base Assembly for 54" x 120" Bt./Cap. Top	\$7830
LPTVN54132#	Veneer Base Assembly for 54" x 132" Bt./Cap. Top	\$8134
LPTVN54144#	Veneer Base Assembly for 54" x 144" Bt./Cap. Top	\$8447
LPTVN54156#	Veneer Base Assembly for 54" x 156" Bt./Cap. Top	\$8753
LPTVN54168#	Veneer Base Assembly for 54" x 168" Bt./Cap. Top	\$9067
LPTVN54180#	Veneer Base Assembly for 54" x 180" Bt./Cap. Top	\$9372
LPTVN54192#	Veneer Base Assembly for 54" x 192" Bt./Cap. Top	\$9667
LPTVN54204#	Veneer Base Assembly for 54" x 204" Bt./Cap. Top	\$12,288
LPTVN54216#	Veneer Base Assembly for 54" x 216" Bt./Cap. Top	\$12,591
LPTVN54228#	Veneer Base Assembly for 54" x 228" Bt./Cap. Top	\$12,910
LPTVN54240#	Veneer Base Assembly for 54" x 240" Bt./Cap. Top	\$13,214

Veneer Foundation Panel Base and Trough Assemblies with Aluminum Trim for 54"D Boat/Capsule Tables

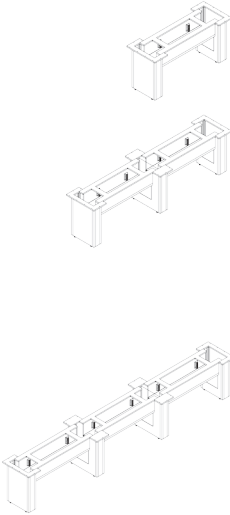

LPTVA5472#	Veneer Base Assembly, Alum. for 54" x 72" Bt./Cap. Top	\$4560
LPTVA5484#	Veneer Base Assembly, Alum. for 54" x 84" Bt./Cap. Top	\$4847
LPTVA5496#	Veneer Base Assembly, Alum. for 54" x 96" Bt./Cap. Top	\$5131
LPTVA54108#	Veneer Base Assembly, Alum. for 54" x 108" Bt./Cap. Top	\$7717
LPTVA54120#	Veneer Base Assembly, Alum. for 54" x 120" Bt./Cap. Top	\$8003
LPTVA54132#	Veneer Base Assembly, Alum. for 54" x 132" Bt./Cap. Top	\$8288
LPTVA54144#	Veneer Base Assembly, Alum. for 54" x 144" Bt./Cap. Top	\$8572
LPTVA54156#	Veneer Base Assembly, Alum. for 54" x 156" Bt./Cap. Top	\$8862
LPTVA54168#	Veneer Base Assembly, Alum. for 54" x 168" Bt./Cap. Top	\$9150
LPTVA54180#	Veneer Base Assembly, Alum. for 54" x 180" Bt./Cap. Top	\$9435
LPTVA54192#	Veneer Base Assembly, Alum. for 54" x 192" Bt./Cap. Top	\$9718
LPTVA54204#	Veneer Base Assembly, Alum. for 54" x 204" Bt./Cap. Top	\$12,449
LPTVA54216#	Veneer Base Assembly, Alum. for 54" x 216" Bt./Cap. Top	\$12,734
LPTVA54228#	Veneer Base Assembly, Alum. for 54" x 228" Bt./Cap. Top	\$13,021
LPTVA54240#	Veneer Base Assembly, Alum. for 54" x 240" Bt./Cap. Top	\$13,306

Foundation - Base Assemblies for 60" D Boat/Capsule/Ellipse Tops

STEP 1

(#) Laminate Suffix List:

A	Wilsonart Kensington Maple (10776-60)	no charge
B	Wilsonart Monticello Maple (7925-38)	no charge
C	Wilsonart Wild Cherry (7054-60)	no charge
E	Wilsonart Fashion Grey (D381-60)	no charge
G	Wilsonart Cafelle (7933K-07)	no charge
M	Wilsonart Frosty White (1573-60)	no charge
P	Wilsonart Slate Grey (D91-60)	no charge
R	Wilsonart Black (1595-60)	no charge
U	Wilsonart Brazilwood (7946-38)	no charge
V	Wilsonart River Cherry (7937-38)	no charge
W	Wilsonart Designer White (D354-60)	no charge
3	Formica Neutral Twill (8826-58)	no charge
4	Formica Bleached Legno (8845-58)	no charge
5	Formica Prestige Walnut (6209-43)	no charge
7	Formica Select Cherry (7759-43)	no charge
X	*Wilsonart Non-Premium laminates (-38, -60)	+35%
Y	*Formica Non-Premium (includes 58, 43, MC, SP, and NT finishes), Formica Premium (WR, 42, 77, 46, RD finishes), Pionite Non-Premium, Nevamar Non-Premium, Wilsonart Premium (-01, -07, -12, -18, -52, -78), and whiteboard laminate.	+45%

*Add \$350 list for Special Laminate orders of less than 10 units. See page 21 for edge selection.

(#) Veneer Suffix List:

D	Maple (stained similar to Kensington Maple laminate)	
J	Cherry (stained similar to Wild Cherry laminate)	
N	Walnut (stained similar to Cafelle laminate)	
8	Walnut (stained similar to Prestige Walnut laminate)	
9	Cherry (stained similar to Select Cherry laminate)	
X	Stain Match (add a one-time \$700 list Stain Match fee)	+10%

Product Specifications:

- > Base is 6"W and 27.75"H.
- > Trough is 8"H x 10.5"D (interior).

Ordering Information:

- > All Bases in Base Kit include 1 removable door and levelers.
- > Trough includes cable grippers for cable retention.
- > Trough includes removable bottom panel.
- > Braces are not required on tables with the Panel Base Kit.
- > Door kits for top access to trough are located on page 100.
- > 15" Oasis Power does not fit on 72"W table kits. 30" Oasis only fits on 96"W, 180"W, and 192"W kits.
- > **A freight fee of \$100 net is assessed on orders less than \$1000 net. See page 13.**

Part Number	Description	List Price (US\$)
-------------	-------------	-------------------

Laminate Foundation Panel Base and Trough Assemblies for 60"D Boat/Capsule Tables

LPTLN6072#	Lam. Base Assembly for 60" x 72" Bt./Cap. Top	\$1719
LPTLN6084#	Lam. Base Assembly for 60" x 84" Bt./Cap. Top	\$1719
LPTLN6096#	Lam. Base Assembly for 60" x 96" Bt./Cap. Top	\$1719
LPTLN60108#	Lam. Base Assembly for 60" x 108" Bt./Cap. Top	\$3149
LPTLN60120#	Lam. Base Assembly for 60" x 120" Bt./Cap. Top	\$3149
LPTLN60132#	Lam. Base Assembly for 60" x 132" Bt./Cap. Top	\$3149
LPTLN60144#	Lam. Base Assembly for 60" x 144" Bt./Cap. Top	\$3149
LPTLN60156#	Lam. Base Assembly for 60" x 156" Bt./Cap. Top	\$3149
LPTLN60168#	Lam. Base Assembly for 60" x 168" Bt./Cap. Top	\$3149
LPTLN60180#	Lam. Base Assembly for 60" x 180" Bt./Cap. Top	\$3149
LPTLN60192#	Lam. Base Assembly for 60" x 192" Bt./Cap. Top	\$3149
LPTLN60204#	Lam. Base Assembly for 60" x 204" Bt./Cap. Top	\$4562
LPTLN60216#	Lam. Base Assembly for 60" x 216" Bt./Cap. Top	\$4562
LPTLN60228#	Lam. Base Assembly for 60" x 228" Bt./Cap. Top	\$4562
LPTLN60240#	Lam. Base Assembly for 60" x 240" Bt./Cap. Top	\$4562

Laminate Foundation Panel Base and Trough Assemblies with Aluminum Trim for 60"D Boat/Capsule Tables

LPTLA6072#	Lam. Base Assembly, Alum. for 60" x 72" Bt./Cap. Top	\$2292
LPTLA6084#	Lam. Base Assembly, Alum. for 60" x 84" Bt./Cap. Top	\$2292
LPTLA6096#	Lam. Base Assembly, Alum. for 60" x 96" Bt./Cap. Top	\$2292
LPTLA60108#	Lam. Base Assembly, Alum. for 60" x 108" Bt./Cap. Top	\$4089
LPTLA60120#	Lam. Base Assembly, Alum. for 60" x 120" Bt./Cap. Top	\$4089
LPTLA60132#	Lam. Base Assembly, Alum. for 60" x 132" Bt./Cap. Top	\$4089
LPTLA60144#	Lam. Base Assembly, Alum. for 60" x 144" Bt./Cap. Top	\$4089
LPTLA60156#	Lam. Base Assembly, Alum. for 60" x 156" Bt./Cap. Top	\$4089
LPTLA60168#	Lam. Base Assembly, Alum. for 60" x 168" Bt./Cap. Top	\$4089
LPTLA60180#	Lam. Base Assembly, Alum. for 60" x 180" Bt./Cap. Top	\$4089
LPTLA60192#	Lam. Base Assembly, Alum. for 60" x 192" Bt./Cap. Top	\$4089
LPTLA60204#	Lam. Base Assembly, Alum. for 60" x 204" Bt./Cap. Top	\$5868
LPTLA60216#	Lam. Base Assembly, Alum. for 60" x 216" Bt./Cap. Top	\$5868
LPTLA60228#	Lam. Base Assembly, Alum. for 60" x 228" Bt./Cap. Top	\$5868
LPTLA60240#	Lam. Base Assembly, Alum. for 60" x 240" Bt./Cap. Top	\$5868

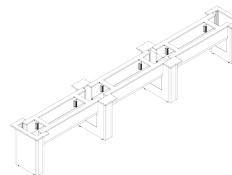
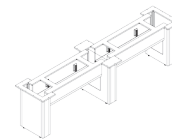
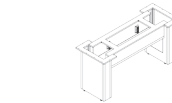
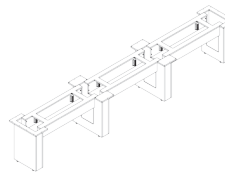
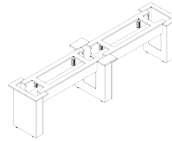
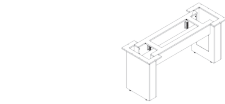

COORDINATING FURNITURE

See pages 178-180
for coordinating
Foundation furniture.

TOPS	TABLES STEP 2 - FOUNDATION
BASES	
POWER DATA	
SUPPORT FURNITURE	
ACCESSORIES	

Part Number Description List Price (US\$)

Veneer Foundation Panel Base and Trough Assemblies for 60"D Boat/Capsule Tables

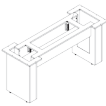
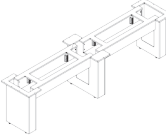
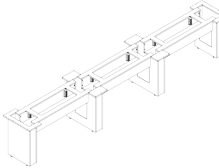
	LPTVN6072#	Veneer Base Assembly for 60" x 72" Bt./Cap. Top	\$4452
	LPTVN6084#	Veneer Base Assembly for 60" x 84" Bt./Cap. Top	\$4757
	LPTVN6096#	Veneer Base Assembly for 60" x 96" Bt./Cap. Top	\$5066
	LPTVN60108#	Veneer Base Assembly for 60" x 108" Bt./Cap. Top	\$7526
	LPTVN60120#	Veneer Base Assembly for 60" x 120" Bt./Cap. Top	\$7830
	LPTVN60132#	Veneer Base Assembly for 60" x 132" Bt./Cap. Top	\$8134
	LPTVN60144#	Veneer Base Assembly for 60" x 144" Bt./Cap. Top	\$8447
	LPTVN60156#	Veneer Base Assembly for 60" x 156" Bt./Cap. Top	\$8753
	LPTVN60168#	Veneer Base Assembly for 60" x 168" Bt./Cap. Top	\$9067
	LPTVN60180#	Veneer Base Assembly for 60" x 180" Bt./Cap. Top	\$9372
	LPTVN60192#	Veneer Base Assembly for 60" x 192" Bt./Cap. Top	\$9667
	LPTVN60204#	Veneer Base Assembly for 60" x 204" Bt./Cap. Top	\$12,288
	LPTVN60216#	Veneer Base Assembly for 60" x 216" Bt./Cap. Top	\$12,591
	LPTVN60228#	Veneer Base Assembly for 60" x 228" Bt./Cap. Top	\$12,910
	LPTVN60240#	Veneer Base Assembly for 60" x 240" Bt./Cap. Top	\$13,214

Veneer Foundation Panel Base and Trough Assemblies with Aluminum Trim for 60"D Boat/Capsule Tables

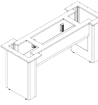
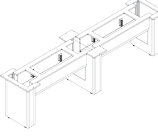
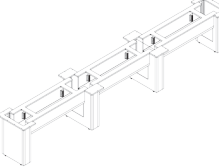
	LPTVA6072#	Veneer Base Assembly, Alum. for 60" x 72" Bt./Cap. Top	\$4560
	LPTVA6084#	Veneer Base Assembly, Alum. for 60" x 84" Bt./Cap. Top	\$4847
	LPTVA6096#	Veneer Base Assembly, Alum. for 60" x 96" Bt./Cap. Top	\$5131
	LPTVA60108#	Veneer Base Assembly, Alum. for 60" x 108" Bt./Cap. Top	\$7717
	LPTVA60120#	Veneer Base Assembly, Alum. for 60" x 120" Bt./Cap. Top	\$8003
	LPTVA60132#	Veneer Base Assembly, Alum. for 60" x 132" Bt./Cap. Top	\$8288
	LPTVA60144#	Veneer Base Assembly, Alum. for 60" x 144" Bt./Cap. Top	\$8572
	LPTVA60156#	Veneer Base Assembly, Alum. for 60" x 156" Bt./Cap. Top	\$8862
	LPTVA60168#	Veneer Base Assembly, Alum. for 60" x 168" Bt./Cap. Top	\$9150
	LPTVA60180#	Veneer Base Assembly, Alum. for 60" x 180" Bt./Cap. Top	\$9435
	LPTVA60192#	Veneer Base Assembly, Alum. for 60" x 192" Bt./Cap. Top	\$9718
	LPTVA60204#	Veneer Base Assembly, Alum. for 60" x 204" Bt./Cap. Top	\$12,449
	LPTVA60216#	Veneer Base Assembly, Alum. for 60" x 216" Bt./Cap. Top	\$12,734
	LPTVA60228#	Veneer Base Assembly, Alum. for 60" x 228" Bt./Cap. Top	\$13,021
	LPTVA60240#	Veneer Base Assembly, Alum. for 60" x 240" Bt./Cap. Top	\$13,306

Foundation - Base Assemblies for 36/42" D Rectangle Tops

STEP 1

(#) Laminate Suffix List:

A	Wilsonart Kensington Maple (10776-60)	no charge
B	Wilsonart Monticello Maple (7925-38)	no charge
C	Wilsonart Wild Cherry (7054-60)	no charge
E	Wilsonart Fashion Grey (D381-60)	no charge
G	Wilsonart Cafelle (7933K-07)	no charge
M	Wilsonart Frosty White (1573-60)	no charge
P	Wilsonart Slate Grey (D91-60)	no charge
R	Wilsonart Black (1595-60)	no charge
U	Wilsonart Brazilwood (7946-38)	no charge
V	Wilsonart River Cherry (7937-38)	no charge
W	Wilsonart Designer White (D354-60)	no charge
3	Formica Neutral Twill (8826-58)	no charge
4	Formica Bleached Legno (8845-58)	no charge
5	Formica Prestige Walnut (6209-43)	no charge
7	Formica Select Cherry (7759-43)	no charge
X	*Wilsonart Non-Premium laminates (-38, -60)	+35%
Y	*Formica Non-Premium (includes 58, 43, MC, SP, and NT finishes), Formica Premium (WR, 42, 77, 46, RD finishes), Pionite Non-Premium, Nevamar Non-Premium, Wilsonart Premium (-01, -07, -12, -18, -52, -78), and whiteboard laminate.	+45%

*Add \$350 list for Special Laminate orders of less than 10 units. See page 21 for edge selection.

(#) Veneer Suffix List:

D	Maple (stained similar to Kensington Maple laminate)	
J	Cherry (stained similar to Wild Cherry laminate)	
N	Walnut (stained similar to Cafelle laminate)	
8	Walnut (stained similar to Prestige Walnut laminate)	
9	Cherry (stained similar to Select Cherry laminate)	
X	Stain Match (add a one-time \$700 list Stain Match fee)	+10%

Product Specifications:

- > Base is 6"W and 27.75"H.
- > Trough is 8"H x 10.5"D (interior).

Ordering Information:

- > All Bases in Base Kit include 1 removable door and levelers.
- > Trough includes cable grippers for cable retention.
- > Trough includes removable bottom panel.
- > Braces are not required on tables with the Panel Base Kit.
- > Door kits for top access to trough are located on page 100.
- > 15" Oasis Power does not fit on 72"W table kits. 30" Oasis only fits on 96"W, 180"W, and 192"W kits.
- > **A freight fee of \$100 net is assessed on orders less than \$1000 net. See page 13.**

Part Number	Description	List Price (US\$)
-------------	-------------	-------------------

Laminate Foundation Panel Base and Trough Assemblies for 36/42"D Rectangle Tables

	LPULN3672# Lam. Base Assembly for 36/42"x 72" Rectangle Top	\$1719
	LPULN3684# Lam. Base Assembly for 36/42"x 84" Rectangle Top	\$1719
	LPULN3696# Lam. Base Assembly for 36/42"x 96" Rectangle Top	\$1719
	LPULN36108# Lam. Base Assembly for 36/42"x 108" Rectangle Top	\$2857
	LPULN36120# Lam. Base Assembly for 36/42"x 120" Rectangle Top	\$2857
	LPULN36132# Lam. Base Assembly for 36/42"x 132" Rectangle Top	\$2857
	LPULN36144# Lam. Base Assembly for 36/42"x 144" Rectangle Top	\$2857
	LPULN36156# Lam. Base Assembly for 36/42"x 156" Rectangle Top	\$2857
	LPULN36168# Lam. Base Assembly for 36/42"x 168" Rectangle Top	\$2857
	LPULN36180# Lam. Base Assembly for 36/42"x 180" Rectangle Top	\$2857
	LPULN36192# Lam. Base Assembly for 36/42"x 192" Rectangle Top	\$2857
	LPULN36204# Lam. Base Assembly for 36/42"x 204" Rectangle Top	\$3987
	LPULN36216# Lam. Base Assembly for 36/42"x 216" Rectangle Top	\$3987
	LPULN36228# Lam. Base Assembly for 36/42"x 228" Rectangle Top	\$3987
	LPULN36240# Lam. Base Assembly for 36/42"x 240" Rectangle Top	\$3987

Laminate Foundation Panel Base and Trough Assemblies with Aluminum Trim for 36/42"D Rectangle Tables

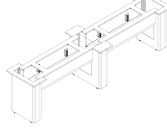
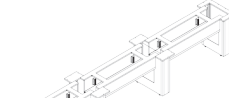
	LPULA3672# Lam. Base Assembly, Alum. for 36/42"x 72" Rectangle Top	\$2292
	LPULA3684# Lam. Base Assembly, Alum. for 36/42"x 84" Rectangle Top	\$2292
	LPULA3696# Lam. Base Assembly, Alum. for 36/42"x 96" Rectangle Top	\$2292
	LPULA36108# Lam. Base Assembly, Alum. for 36/42"x 108" Rectangle Top	\$4089
	LPULA36120# Lam. Base Assembly, Alum. for 36/42"x 120" Rectangle Top	\$4089
	LPULA36132# Lam. Base Assembly, Alum. for 36/42"x 132" Rectangle Top	\$4089
	LPULA36144# Lam. Base Assembly, Alum. for 36/42"x 144" Rectangle Top	\$4089
	LPULA36156# Lam. Base Assembly, Alum. for 36/42"x 156" Rectangle Top	\$4089
	LPULA36168# Lam. Base Assembly, Alum. for 36/42"x 168" Rectangle Top	\$4089
	LPULA36180# Lam. Base Assembly, Alum. for 36/42"x 180" Rectangle Top	\$4089
	LPULA36192# Lam. Base Assembly, Alum. for 36/42"x 192" Rectangle Top	\$4089
	LPULA36204# Lam. Base Assembly, Alum. for 36/42"x 204" Rectangle Top	\$5868
	LPULA36216# Lam. Base Assembly, Alum. for 36/42"x 216" Rectangle Top	\$5868
	LPULA36228# Lam. Base Assembly, Alum. for 36/42"x 228" Rectangle Top	\$5868
	LPULA36240# Lam. Base Assembly, Alum. for 36/42"x 240" Rectangle Top	\$5868

COORDINATING FURNITURE

See pages 178-180
for coordinating
Foundation furniture.

TOPS	TABLES STEP 2 - FOUNDATION
BASES	
POWER DATA	
SUPPORT FURNITURE	
ACCESSORIES	

Part Number Description List Price (US\$)

Veneer Foundation Panel Base and Trough Assemblies for 36/42"D Rectangle Tables

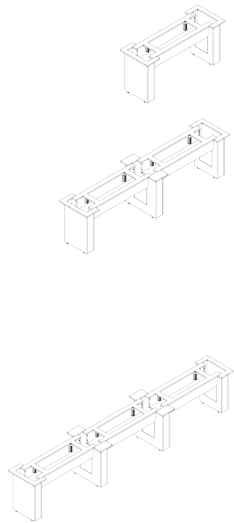

LPUVN3672#	Veneer Base Assembly for 36/42" x 72" Rectangle Top	\$4452
LPUVN3684#	Veneer Base Assembly for 36/42" x 84" Rectangle Top	\$4757
LPUVN3696#	Veneer Base Assembly for 36/42" x 96" Rectangle Top	\$5066
LPUVN36108#	Veneer Base Assembly for 36/42" x 108" Rectangle Top	\$7113
LPUVN36120#	Veneer Base Assembly for 36/42" x 120" Rectangle Top	\$7417
LPUVN36132#	Veneer Base Assembly for 36/42" x 132" Rectangle Top	\$7722
LPUVN36144#	Veneer Base Assembly for 36/42" x 144" Rectangle Top	\$8035
LPUVN36156#	Veneer Base Assembly for 36/42" x 156" Rectangle Top	\$8339
LPUVN36168#	Veneer Base Assembly for 36/42" x 168" Rectangle Top	\$8653
LPUVN36180#	Veneer Base Assembly for 36/42" x 180" Rectangle Top	\$8959
LPUVN36192#	Veneer Base Assembly for 36/42" x 192" Rectangle Top	\$9262
LPUVN36204#	Veneer Base Assembly for 36/42" x 204" Rectangle Top	\$11,461
LPUVN36216#	Veneer Base Assembly for 36/42" x 216" Rectangle Top	\$11,766
LPUVN36228#	Veneer Base Assembly for 36/42" x 228" Rectangle Top	\$12,084
LPUVN36240#	Veneer Base Assembly for 36/42" x 240" Rectangle Top	\$12,387

Veneer Foundation Panel Base and Trough Assemblies with Aluminum Trim for 36/42"D Rectangle Tables

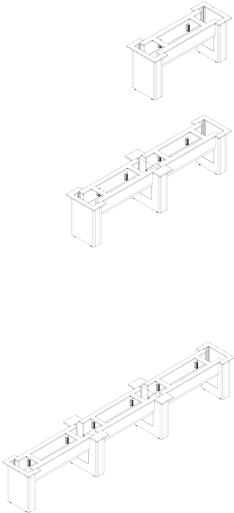

LPUVA3672#	Veneer Base Assembly, Alum. for 36/42" x 72" Rectangle Top	\$4560
LPUVA3684#	Veneer Base Assembly, Alum. for 36/42" x 84" Rectangle Top	\$4847
LPUVA3696#	Veneer Base Assembly, Alum. for 36/42" x 96" Rectangle Top	\$5131
LPUVA36108#	Veneer Base Assembly, Alum. for 36/42" x 108" Rectangle Top	\$7305
LPUVA36120#	Veneer Base Assembly, Alum. for 36/42" x 120" Rectangle Top	\$7593
LPUVA36132#	Veneer Base Assembly, Alum. for 36/42" x 132" Rectangle Top	\$7879
LPUVA36144#	Veneer Base Assembly, Alum. for 36/42" x 144" Rectangle Top	\$8161
LPUVA36156#	Veneer Base Assembly, Alum. for 36/42" x 156" Rectangle Top	\$8449
LPUVA36168#	Veneer Base Assembly, Alum. for 36/42" x 168" Rectangle Top	\$8737
LPUVA36180#	Veneer Base Assembly, Alum. for 36/42" x 180" Rectangle Top	\$9024
LPUVA36192#	Veneer Base Assembly, Alum. for 36/42" x 192" Rectangle Top	\$9307
LPUVA36204#	Veneer Base Assembly, Alum. for 36/42" x 204" Rectangle Top	\$11,626
LPUVA36216#	Veneer Base Assembly, Alum. for 36/42" x 216" Rectangle Top	\$11,910
LPUVA36228#	Veneer Base Assembly, Alum. for 36/42" x 228" Rectangle Top	\$12,200
LPUVA36240#	Veneer Base Assembly, Alum. for 36/42" x 240" Rectangle Top	\$12,483

Foundation - Base Assemblies for 48" D Rectangle Tops

STEP 1

(#) Laminate Suffix List:

A	Wilsonart Kensington Maple (10776-60)	no charge
B	Wilsonart Monticello Maple (7925-38)	no charge
C	Wilsonart Wild Cherry (7054-60)	no charge
E	Wilsonart Fashion Grey (D381-60)	no charge
G	Wilsonart Cafelle (7933K-07)	no charge
M	Wilsonart Frosty White (1573-60)	no charge
P	Wilsonart Slate Grey (D91-60)	no charge
R	Wilsonart Black (1595-60)	no charge
U	Wilsonart Brazilwood (7946-38)	no charge
V	Wilsonart River Cherry (7937-38)	no charge
W	Wilsonart Designer White (D354-60)	no charge
3	Formica Neutral Twill (8826-58)	no charge
4	Formica Bleached Legno (8845-58)	no charge
5	Formica Prestige Walnut (6209-43)	no charge
7	Formica Select Cherry (7759-43)	no charge
X	*Wilsonart Non-Premium laminates (-38, -60)	+35%
Y	*Formica Non-Premium (includes 58, 43, MC, SP, and NT finishes), Formica Premium (WR, 42, 77, 46, RD finishes), Pionite Non-Premium, Nevamar Non-Premium, Wilsonart Premium (-01, -07, -12, -18, -52, -78), and whiteboard laminate.	+45%

*Add \$350 list for Special Laminate orders of less than 10 units. See page 21 for edge selection.

(#) Veneer Suffix List:

D	Maple (stained similar to Kensington Maple laminate)	
J	Cherry (stained similar to Wild Cherry laminate)	
N	Walnut (stained similar to Cafelle laminate)	
8	Walnut (stained similar to Prestige Walnut laminate)	
9	Cherry (stained similar to Select Cherry laminate)	
X	Stain Match (add a one-time \$700 list Stain Match fee)	+10%

Product Specifications:



- > Base is 6"W and 27.75"H.
- > Trough is 8"H x 10.5"D (interior).

Ordering Information:

- > All Bases in Base Kit include 1 removable door and levelers.
- > Trough includes cable grippers for cable retention.
- > Trough includes removable bottom panel.
- > Braces are not required on tables with the Panel Base Kit.
- > Door kits for top access to trough are located on page 100.
- > 15" Oasis Power does not fit on 72"W table kits. 30" Oasis only fits on 96"W, 180"W, and 192"W kits.
- > **A freight fee of \$100 net is assessed on orders less than \$1000 net. See page 13.**

Part Number	Description	List Price (US\$)
-------------	-------------	-------------------

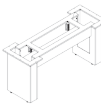
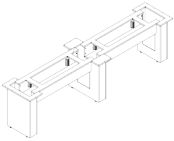
Laminate Foundation Panel Base and Trough Assemblies for 48"D Rectangle Tables

	LPULN4872# Lam. Base Assembly for 48" x 72" Rectangle Top	\$1719
	LPULN4884# Lam. Base Assembly for 48" x 84" Rectangle Top	\$1719
	LPULN4896# Lam. Base Assembly for 48" x 96" Rectangle Top	\$1719
	LPULN48108# Lam. Base Assembly for 48" x 108" Rectangle Top	\$2857
	LPULN48120# Lam. Base Assembly for 48" x 120" Rectangle Top	\$2857
	LPULN48132# Lam. Base Assembly for 48" x 132" Rectangle Top	\$2857
	LPULN48144# Lam. Base Assembly for 48" x 144" Rectangle Top	\$2857
	LPULN48156# Lam. Base Assembly for 48" x 156" Rectangle Top	\$2857
	LPULN48168# Lam. Base Assembly for 48" x 168" Rectangle Top	\$2857
	LPULN48180# Lam. Base Assembly for 48" x 180" Rectangle Top	\$2857
	LPULN48192# Lam. Base Assembly for 48" x 192" Rectangle Top	\$2857
	LPULN48204# Lam. Base Assembly for 48" x 204" Rectangle Top	\$3987
	LPULN48216# Lam. Base Assembly for 48" x 216" Rectangle Top	\$3987
	LPULN48228# Lam. Base Assembly for 48" x 228" Rectangle Top	\$3987
	LPULN48240# Lam. Base Assembly for 48" x 240" Rectangle Top	\$3987

Laminate Foundation Panel Base and Trough Assemblies with Aluminum Trim for 48"D Rectangle Tables

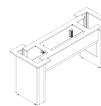
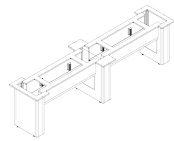
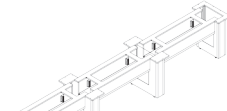
	LPULA4872# Lam. Base Assembly, Alum. for 48" x 72" Rectangle Top	\$2292
	LPULA4884# Lam. Base Assembly, Alum. for 48" x 84" Rectangle Top	\$2292
	LPULA4896# Lam. Base Assembly, Alum. for 48" x 96" Rectangle Top	\$2292
	LPULA48108# Lam. Base Assembly, Alum. for 48" x 108" Rectangle Top	\$4089
	LPULA48120# Lam. Base Assembly, Alum. for 48" x 120" Rectangle Top	\$4089
	LPULA48132# Lam. Base Assembly, Alum. for 48" x 132" Rectangle Top	\$4089
	LPULA48144# Lam. Base Assembly, Alum. for 48" x 144" Rectangle Top	\$4089
	LPULA48156# Lam. Base Assembly, Alum. for 48" x 156" Rectangle Top	\$4089
	LPULA48168# Lam. Base Assembly, Alum. for 48" x 168" Rectangle Top	\$4089
	LPULA48180# Lam. Base Assembly, Alum. for 48" x 180" Rectangle Top	\$4089
	LPULA48192# Lam. Base Assembly, Alum. for 48" x 192" Rectangle Top	\$4089
	LPULA48204# Lam. Base Assembly, Alum. for 48" x 204" Rectangle Top	\$5868
	LPULA48216# Lam. Base Assembly, Alum. for 48" x 216" Rectangle Top	\$5868
	LPULA48228# Lam. Base Assembly, Alum. for 48" x 228" Rectangle Top	\$5868
	LPULA48240# Lam. Base Assembly, Alum. for 48" x 240" Rectangle Top	\$5868

COORDINATING FURNITURE

See pages 178-180
for coordinating
Foundation furniture.

TOPS	TABLES STEP 2 - FOUNDATION
BASES	
POWER DATA	
SUPPORT FURNITURE	
ACCESSORIES	

Part Number Description List Price (US\$)

Veneer Foundation Panel Base and Trough Assemblies for 48"D Rectangle Tables

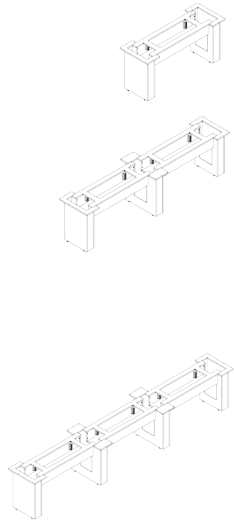

LPUVN4872#	Veneer Base Assembly for 48" x 72" Rectangle Top	\$4452
LPUVN4884#	Veneer Base Assembly for 48" x 84" Rectangle Top	\$4757
LPUVN4896#	Veneer Base Assembly for 48" x 96" Rectangle Top	\$5066
LPUVN48108#	Veneer Base Assembly for 48" x 108" Rectangle Top	\$7113
LPUVN48120#	Veneer Base Assembly for 48" x 120" Rectangle Top	\$7417
LPUVN48132#	Veneer Base Assembly for 48" x 132" Rectangle Top	\$7722
LPUVN48144#	Veneer Base Assembly for 48" x 144" Rectangle Top	\$8035
LPUVN48156#	Veneer Base Assembly for 48" x 156" Rectangle Top	\$8339
LPUVN48168#	Veneer Base Assembly for 48" x 168" Rectangle Top	\$8653
LPUVN48180#	Veneer Base Assembly for 48" x 180" Rectangle Top	\$8959
LPUVN48192#	Veneer Base Assembly for 48" x 192" Rectangle Top	\$9262
LPUVN48204#	Veneer Base Assembly for 48" x 204" Rectangle Top	\$11,461
LPUVN48216#	Veneer Base Assembly for 48" x 216" Rectangle Top	\$11,766
LPUVN48228#	Veneer Base Assembly for 48" x 228" Rectangle Top	\$12,084
LPUVN48240#	Veneer Base Assembly for 48" x 240" Rectangle Top	\$12,387

Veneer Foundation Panel Base and Trough Assemblies with Aluminum Trim for 48"D Rectangle Tables

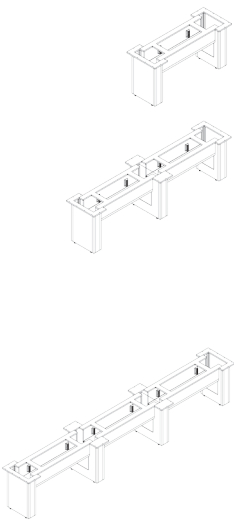

LPUVA4872#	Veneer Base Assembly, Alum. for 48" x 72" Rectangle Top	\$4560
LPUVA4884#	Veneer Base Assembly, Alum. for 48" x 84" Rectangle Top	\$4847
LPUVA4896#	Veneer Base Assembly, Alum. for 48" x 96" Rectangle Top	\$5131
LPUVA48108#	Veneer Base Assembly, Alum. for 48" x 108" Rectangle Top	\$7305
LPUVA48120#	Veneer Base Assembly, Alum. for 48" x 120" Rectangle Top	\$7593
LPUVA48132#	Veneer Base Assembly, Alum. for 48" x 132" Rectangle Top	\$7879
LPUVA48144#	Veneer Base Assembly, Alum. for 48" x 144" Rectangle Top	\$8161
LPUVA48156#	Veneer Base Assembly, Alum. for 48" x 156" Rectangle Top	\$8449
LPUVA48168#	Veneer Base Assembly, Alum. for 48" x 168" Rectangle Top	\$8737
LPUVA48180#	Veneer Base Assembly, Alum. for 48" x 180" Rectangle Top	\$9024
LPUVA48192#	Veneer Base Assembly, Alum. for 48" x 192" Rectangle Top	\$9307
LPUVA48204#	Veneer Base Assembly, Alum. for 48" x 204" Rectangle Top	\$11,626
LPUVA48216#	Veneer Base Assembly, Alum. for 48" x 216" Rectangle Top	\$11,910
LPUVA48228#	Veneer Base Assembly, Alum. for 48" x 228" Rectangle Top	\$12,200
LPUVA48240#	Veneer Base Assembly, Alum. for 48" x 240" Rectangle Top	\$12,483

Foundation - Base Assemblies for 54" D Rectangle Tops

STEP 1

(#) Laminate Suffix List:

A	Wilsonart Kensington Maple (10776-60)	no charge
B	Wilsonart Monticello Maple (7925-38)	no charge
C	Wilsonart Wild Cherry (7054-60)	no charge
E	Wilsonart Fashion Grey (D381-60)	no charge
G	Wilsonart Cafelle (7933K-07)	no charge
M	Wilsonart Frosty White (1573-60)	no charge
P	Wilsonart Slate Grey (D91-60)	no charge
R	Wilsonart Black (1595-60)	no charge
U	Wilsonart Brazilwood (7946-38)	no charge
V	Wilsonart River Cherry (7937-38)	no charge
W	Wilsonart Designer White (D354-60)	no charge
3	Formica Neutral Twill (8826-58)	no charge
4	Formica Bleached Legno (8845-58)	no charge
5	Formica Prestige Walnut (6209-43)	no charge
7	Formica Select Cherry (7759-43)	no charge
X	*Wilsonart Non-Premium laminates (-38, -60)	+35%
Y	*Formica Non-Premium (includes 58, 43, MC, SP, and NT finishes), Formica Premium (WR, 42, 77, 46, RD finishes), Pionite Non-Premium, Nevamar Non-Premium, Wilsonart Premium (-01, -07, -12, -18, -52, -78), and whiteboard laminate.	+45%

*Add \$350 list for Special Laminate orders of less than 10 units. See page 21 for edge selection.

(#) Veneer Suffix List:

D	Maple (stained similar to Kensington Maple laminate)	
J	Cherry (stained similar to Wild Cherry laminate)	
N	Walnut (stained similar to Cafelle laminate)	
8	Walnut (stained similar to Prestige Walnut laminate)	
9	Cherry (stained similar to Select Cherry laminate)	
X	Stain Match (add a one-time \$700 list Stain Match fee)	+10%

Product Specifications:

- > Base is 6"W and 27.75"H.
- > Trough is 8"H x 10.5"D (interior).

Ordering Information:

- > All Bases in Base Kit include 1 removable door and levelers.
- > Trough includes cable grippers for cable retention.
- > Trough includes removable bottom panel.
- > Braces are not required on tables with the Panel Base Kit.
- > Door kits for top access to trough are located on page 100.
- > 15" Oasis Power does not fit on 72"W table kits. 30" Oasis only fits on 96"W, 180"W, and 192"W kits.
- > **A freight fee of \$100 net is assessed on orders less than \$1000 net. See page 13.**

Part Number	Description	List Price (US\$)
-------------	-------------	-------------------

Laminate Foundation Panel Base and Trough Assemblies for 54"D Rectangle Tables

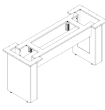
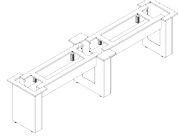
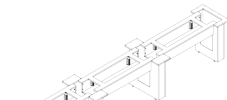
	LPULN5472# Lam. Base Assembly for 54" x 72" Rectangle Top	\$2303
	LPULN5484# Lam. Base Assembly for 54" x 84" Rectangle Top	\$2303
	LPULN5496# Lam. Base Assembly for 54" x 96" Rectangle Top	\$2303
	LPULN54108# Lam. Base Assembly for 54" x 108" Rectangle Top	\$3734
	LPULN54120# Lam. Base Assembly for 54" x 120" Rectangle Top	\$3734
	LPULN54132# Lam. Base Assembly for 54" x 132" Rectangle Top	\$3734
	LPULN54144# Lam. Base Assembly for 54" x 144" Rectangle Top	\$3734
	LPULN54156# Lam. Base Assembly for 54" x 156" Rectangle Top	\$3734
	LPULN54168# Lam. Base Assembly for 54" x 168" Rectangle Top	\$3734
	LPULN54180# Lam. Base Assembly for 54" x 180" Rectangle Top	\$3734
	LPULN54192# Lam. Base Assembly for 54" x 192" Rectangle Top	\$3734
	LPULN54204# Lam. Base Assembly for 54" x 204" Rectangle Top	\$5143
	LPULN54216# Lam. Base Assembly for 54" x 216" Rectangle Top	\$5143
	LPULN54228# Lam. Base Assembly for 54" x 228" Rectangle Top	\$5143
	LPULN54240# Lam. Base Assembly for 54" x 240" Rectangle Top	\$5143

Laminate Foundation Panel Base and Trough Assemblies with Aluminum Trim for 54"D Rectangle Tables

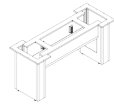
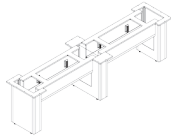
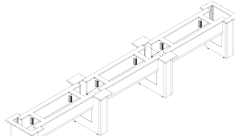
	LPULA5472# Lam. Base Assembly, Alum. for 54" x 72" Rectangle Top	\$2861
	LPULA5484# Lam. Base Assembly, Alum. for 54" x 84" Rectangle Top	\$2861
	LPULA5496# Lam. Base Assembly, Alum. for 54" x 96" Rectangle Top	\$2861
	LPULA54108# Lam. Base Assembly, Alum. for 54" x 108" Rectangle Top	\$4658
	LPULA54120# Lam. Base Assembly, Alum. for 54" x 120" Rectangle Top	\$4658
	LPULA54132# Lam. Base Assembly, Alum. for 54" x 132" Rectangle Top	\$4658
	LPULA54144# Lam. Base Assembly, Alum. for 54" x 144" Rectangle Top	\$4658
	LPULA54156# Lam. Base Assembly, Alum. for 54" x 156" Rectangle Top	\$4658
	LPULA54168# Lam. Base Assembly, Alum. for 54" x 168" Rectangle Top	\$4658
	LPULA54180# Lam. Base Assembly, Alum. for 54" x 180" Rectangle Top	\$4658
	LPULA54192# Lam. Base Assembly, Alum. for 54" x 192" Rectangle Top	\$4658
	LPULA54204# Lam. Base Assembly, Alum. for 54" x 204" Rectangle Top	\$6439
	LPULA54216# Lam. Base Assembly, Alum. for 54" x 216" Rectangle Top	\$6439
	LPULA54228# Lam. Base Assembly, Alum. for 54" x 228" Rectangle Top	\$6439
	LPULA54240# Lam. Base Assembly, Alum. for 54" x 240" Rectangle Top	\$6439

COORDINATING FURNITURE

See pages 178-180
for coordinating
Foundation furniture.

TOPS	TABLES STEP 2 - FOUNDATION
BASES	
POWER DATA	
SUPPORT FURNITURE	
ACCESSORIES	

Part Number Description List Price (US\$)

Veneer Foundation Panel Base and Trough Assemblies for 54"D Rectangle Tables

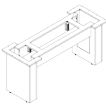
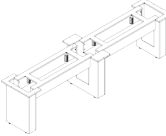
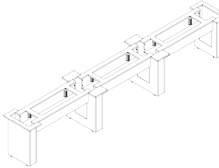
	LPUVN5472# Veneer Base Assembly for 54" x 72" Rectangle Top	\$5316
	LPUVN5484# Veneer Base Assembly for 54" x 84" Rectangle Top	\$5929
	LPUVN5496# Veneer Base Assembly for 54" x 96" Rectangle Top	\$5929
	LPUVN54108# Veneer Base Assembly for 54" x 108" Rectangle Top	\$8389
	LPUVN54120# Veneer Base Assembly for 54" x 120" Rectangle Top	\$8692
	LPUVN54132# Veneer Base Assembly for 54" x 132" Rectangle Top	\$8996
	LPUVN54144# Veneer Base Assembly for 54" x 144" Rectangle Top	\$9311
	LPUVN54156# Veneer Base Assembly for 54" x 156" Rectangle Top	\$9615
	LPUVN54168# Veneer Base Assembly for 54" x 168" Rectangle Top	\$9929
	LPUVN54180# Veneer Base Assembly for 54" x 180" Rectangle Top	\$10,234
	LPUVN54192# Veneer Base Assembly for 54" x 192" Rectangle Top	\$10,537
	LPUVN54204# Veneer Base Assembly for 54" x 204" Rectangle Top	\$13,150
	LPUVN54216# Veneer Base Assembly for 54" x 216" Rectangle Top	\$13,454
	LPUVN54228# Veneer Base Assembly for 54" x 228" Rectangle Top	\$13,774
	LPUVN54240# Veneer Base Assembly for 54" x 240" Rectangle Top	\$14,075

Veneer Foundation Panel Base and Trough Assemblies with Aluminum Trim for 54"D Rectangle Tables

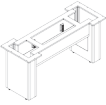
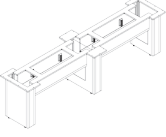
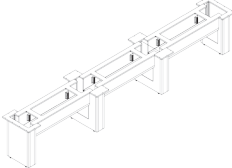
	LPUVA5472# Veneer Base Assembly, Alum. for 54" x 72" Rectangle Top	\$5419
	LPUVA5484# Veneer Base Assembly, Alum. for 54" x 84" Rectangle Top	\$5706
	LPUVA5496# Veneer Base Assembly, Alum. for 54" x 96" Rectangle Top	\$5993
	LPUVA54108# Veneer Base Assembly, Alum. for 54" x 108" Rectangle Top	\$8577
	LPUVA54120# Veneer Base Assembly, Alum. for 54" x 120" Rectangle Top	\$8863
	LPUVA54132# Veneer Base Assembly, Alum. for 54" x 132" Rectangle Top	\$9149
	LPUVA54144# Veneer Base Assembly, Alum. for 54" x 144" Rectangle Top	\$9432
	LPUVA54156# Veneer Base Assembly, Alum. for 54" x 156" Rectangle Top	\$9720
	LPUVA54168# Veneer Base Assembly, Alum. for 54" x 168" Rectangle Top	\$10,009
	LPUVA54180# Veneer Base Assembly, Alum. for 54" x 180" Rectangle Top	\$10,295
	LPUVA54192# Veneer Base Assembly, Alum. for 54" x 192" Rectangle Top	\$10,580
	LPUVA54204# Veneer Base Assembly, Alum. for 54" x 204" Rectangle Top	\$13,309
	LPUVA54216# Veneer Base Assembly, Alum. for 54" x 216" Rectangle Top	\$13,594
	LPUVA54228# Veneer Base Assembly, Alum. for 54" x 228" Rectangle Top	\$13,881
	LPUVA54240# Veneer Base Assembly, Alum. for 54" x 240" Rectangle Top	\$14,166

Foundation - Base Assemblies for 60" D Rectangle Tops

STEP 1

(#) Laminate Suffix List:

A	Wilsonart Kensington Maple (10776-60)	no charge
B	Wilsonart Monticello Maple (7925-38)	no charge
C	Wilsonart Wild Cherry (7054-60)	no charge
E	Wilsonart Fashion Grey (D381-60)	no charge
G	Wilsonart Cafelle (7933K-07)	no charge
M	Wilsonart Frosty White (1573-60)	no charge
P	Wilsonart Slate Grey (D91-60)	no charge
R	Wilsonart Black (1595-60)	no charge
U	Wilsonart Brazilwood (7946-38)	no charge
V	Wilsonart River Cherry (7937-38)	no charge
W	Wilsonart Designer White (D354-60)	no charge
3	Formica Neutral Twill (8826-58)	no charge
4	Formica Bleached Legno (8845-58)	no charge
5	Formica Prestige Walnut (6209-43)	no charge
7	Formica Select Cherry (7759-43)	no charge
X	*Wilsonart Non-Premium laminates (-38, -60)	+35%
Y	*Formica Non-Premium (includes 58, 43, MC, SP, and NT finishes), Formica Premium (WR, 42, 77, 46, RD finishes), Pionite Non-Premium, Nevamar Non-Premium, Wilsonart Premium (-01, -07, -12, -18, -52, -78), and whiteboard laminate.	+45%

*Add \$350 list for Special Laminate orders of less than 10 units. See page 21 for edge selection.

(#) Veneer Suffix List:

D	Maple (stained similar to Kensington Maple laminate)	
J	Cherry (stained similar to Wild Cherry laminate)	
N	Walnut (stained similar to Cafelle laminate)	
8	Walnut (stained similar to Prestige Walnut laminate)	
9	Cherry (stained similar to Select Cherry laminate)	
X	Stain Match (add a one-time \$700 list Stain Match fee)	+10%

Product Specifications:

- > Base is 6"W and 27.75"H.
- > Trough is 8"H x 10.5"D (interior).

Ordering Information:

- > All Bases in Base Kit include 1 removable door and levelers.
- > Trough includes cable grippers for cable retention.
- > Trough includes removable bottom panel.
- > Braces are not required on tables with the Panel Base Kit.
- > Door kits for top access to trough are located on page 100.
- > 15" Oasis Power does not fit on 72"W table kits. 30" Oasis only fits on 96"W, 180"W, and 192"W kits.
- > **A freight fee of \$100 net is assessed on orders less than \$1000 net. See page 13.**

Part Number	Description	List Price (US\$)
-------------	-------------	-------------------

Laminate Foundation Panel Base and Trough Assemblies for 60"D Rectangle Tables

LPULN6072#	Lam. Base Assembly for 60" x 72" Rectangle Top	\$2303
LPULN6084#	Lam. Base Assembly for 60" x 84" Rectangle Top	\$2303
LPULN6096#	Lam. Base Assembly for 60" x 96" Rectangle Top	\$2303
LPULN60108#	Lam. Base Assembly for 60" x 108" Rectangle Top	\$3734
LPULN60120#	Lam. Base Assembly for 60" x 120" Rectangle Top	\$3734
LPULN60132#	Lam. Base Assembly for 60" x 132" Rectangle Top	\$3734
LPULN60144#	Lam. Base Assembly for 60" x 144" Rectangle Top	\$3734
LPULN60156#	Lam. Base Assembly for 60" x 156" Rectangle Top	\$3734
LPULN60168#	Lam. Base Assembly for 60" x 168" Rectangle Top	\$3734
LPULN60180#	Lam. Base Assembly for 60" x 180" Rectangle Top	\$3734
LPULN60192#	Lam. Base Assembly for 60" x 192" Rectangle Top	\$3734
LPULN60204#	Lam. Base Assembly for 60" x 204" Rectangle Top	\$5143
LPULN60216#	Lam. Base Assembly for 60" x 216" Rectangle Top	\$5143
LPULN60228#	Lam. Base Assembly for 60" x 228" Rectangle Top	\$5143
LPULN60240#	Lam. Base Assembly for 60" x 240" Rectangle Top	\$5143

Laminate Foundation Panel Base and Trough Assemblies with Aluminum Trim for 60"D Rectangle Tables

LPULA6072#	Lam. Base Assembly, Alum. for 60" x 72" Rectangle Top	\$2861
LPULA6084#	Lam. Base Assembly, Alum. for 60" x 84" Rectangle Top	\$2861
LPULA6096#	Lam. Base Assembly, Alum. for 60" x 96" Rectangle Top	\$2861
LPULA60108#	Lam. Base Assembly, Alum. for 60" x 108" Rectangle Top	\$4658
LPULA60120#	Lam. Base Assembly, Alum. for 60" x 120" Rectangle Top	\$4658
LPULA60132#	Lam. Base Assembly, Alum. for 60" x 132" Rectangle Top	\$4658
LPULA60144#	Lam. Base Assembly, Alum. for 60" x 144" Rectangle Top	\$4658
LPULA60156#	Lam. Base Assembly, Alum. for 60" x 156" Rectangle Top	\$4658
LPULA60168#	Lam. Base Assembly, Alum. for 60" x 168" Rectangle Top	\$4658
LPULA60180#	Lam. Base Assembly, Alum. for 60" x 180" Rectangle Top	\$4658
LPULA60192#	Lam. Base Assembly, Alum. for 60" x 192" Rectangle Top	\$4658
LPULA60204#	Lam. Base Assembly, Alum. for 60" x 204" Rectangle Top	\$6439
LPULA60216#	Lam. Base Assembly, Alum. for 60" x 216" Rectangle Top	\$6439
LPULA60228#	Lam. Base Assembly, Alum. for 60" x 228" Rectangle Top	\$6439
LPULA60240#	Lam. Base Assembly, Alum. for 60" x 240" Rectangle Top	\$6439

COORDINATING FURNITURE

See pages 178-180
for coordinating
Foundation furniture.

TOPS	TABLES STEP 2 - FOUNDATION
BASES	
POWER DATA	
SUPPORT FURNITURE	
ACCESSORIES	

Part Number Description List Price (US\$)

Veneer Foundation Panel Base and Trough Assemblies for 60"D Rectangle Tables

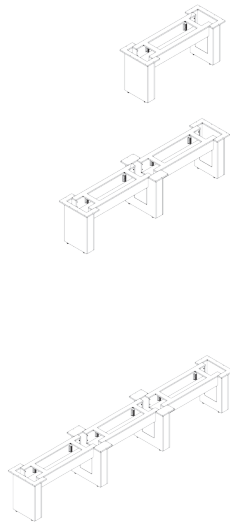

LPUVN6072#	Veneer Base Assembly for 60" x 72" Rectangle Top	\$5316
LPUVN6084#	Veneer Base Assembly for 60" x 84" Rectangle Top	\$5619
LPUVN6096#	Veneer Base Assembly for 60" x 96" Rectangle Top	\$5929
LPUVN60108#	Veneer Base Assembly for 60" x 108" Rectangle Top	\$8389
LPUVN60120#	Veneer Base Assembly for 60" x 120" Rectangle Top	\$8692
LPUVN60132#	Veneer Base Assembly for 60" x 132" Rectangle Top	\$8996
LPUVN60144#	Veneer Base Assembly for 60" x 144" Rectangle Top	\$9311
LPUVN60156#	Veneer Base Assembly for 60" x 156" Rectangle Top	\$9615
LPUVN60168#	Veneer Base Assembly for 60" x 168" Rectangle Top	\$9929
LPUVN60180#	Veneer Base Assembly for 60" x 180" Rectangle Top	\$10,234
LPUVN60192#	Veneer Base Assembly for 60" x 192" Rectangle Top	\$10,537
LPUVN60204#	Veneer Base Assembly for 60" x 204" Rectangle Top	\$13,150
LPUVN60216#	Veneer Base Assembly for 60" x 216" Rectangle Top	\$13,454
LPUVN60228#	Veneer Base Assembly for 60" x 228" Rectangle Top	\$13,774
LPUVN60240#	Veneer Base Assembly for 60" x 240" Rectangle Top	\$14,075

Veneer Foundation Panel Base and Trough Assemblies with Aluminum Trim for 60"D Rectangle Tables

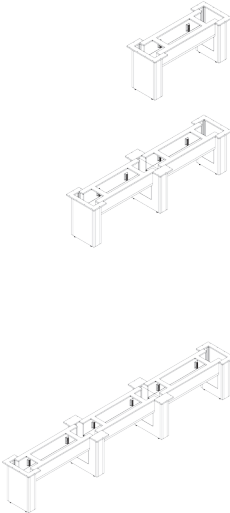

LPUVA6072#	Veneer Base Assembly, Alum. for 60" x 72" Rectangle Top	\$5419
LPUVA6084#	Veneer Base Assembly, Alum. for 60" x 84" Rectangle Top	\$5706
LPUVA6096#	Veneer Base Assembly, Alum. for 60" x 96" Rectangle Top	\$5993
LPUVA60108#	Veneer Base Assembly, Alum. for 60" x 108" Rectangle Top	\$8577
LPUVA60120#	Veneer Base Assembly, Alum. for 60" x 120" Rectangle Top	\$8863
LPUVA60132#	Veneer Base Assembly, Alum. for 60" x 132" Rectangle Top	\$9149
LPUVA60144#	Veneer Base Assembly, Alum. for 60" x 144" Rectangle Top	\$9432
LPUVA60156#	Veneer Base Assembly, Alum. for 60" x 156" Rectangle Top	\$9720
LPUVA60168#	Veneer Base Assembly, Alum. for 60" x 168" Rectangle Top	\$10,009
LPUVA60180#	Veneer Base Assembly, Alum. for 60" x 180" Rectangle Top	\$10,295
LPUVA60192#	Veneer Base Assembly, Alum. for 60" x 192" Rectangle Top	\$10,580
LPUVA60204#	Veneer Base Assembly, Alum. for 60" x 204" Rectangle Top	\$13,309
LPUVA60216#	Veneer Base Assembly, Alum. for 60" x 216" Rectangle Top	\$13,594
LPUVA60228#	Veneer Base Assembly, Alum. for 60" x 228" Rectangle Top	\$13,881
LPUVA60240#	Veneer Base Assembly, Alum. for 60" x 240" Rectangle Top	\$14,166

Foundation Trough Top-Access Door Kits

STEP 1 - Laminate Door Kits

(#) Laminate Suffix List:

- A Wilsonart Kensington Maple (10776-60)
- B Wilsonart Monticello Maple (7925-38)
- C Wilsonart Wild Cherry (7054-60)
- E Wilsonart Fashion Grey (D381-60)
- F Wilsonart White Tigris (4783-60)
- G Wilsonart Cafelle (7933K-07)
- M Wilsonart Frosty White (1573-60)
- P Wilsonart Slate Grey (D91-60)
- R Wilsonart Black (1595-60)
- U Wilsonart Brazilwood (7946-38)
- V Wilsonart River Cherry (7937-38)
- W Wilsonart Designer White (D354-60)
- 3 Formica Neutral Twill (8826-58)
- 4 Formica Bleached Legno (8845-58)
- 5 Formica Prestige Walnut (6209-43)
- 7 Formica Select Cherry (7759-43)
- X *Wilsonart Non-Premium laminates +10%
(-38, -60). Orders of 100+ units have no upcharge.
- Y *Formica Non-Premium Standard (58, +19%
43, MC, SP and NT finishes) and Wilsonart Premium (-01, -07, -12, -18, -52, -78) laminates.
- Z *Pionite Non-Premium, Nevamar Non- +25%
Premium, Formica Premium (WR, 42, 77, 46, RD Finishes), and whiteboard laminate.

*Add \$350 list for Special Laminate orders of less than 10 units. See page 21 for edge selection.

STEP 1 - Veneer Door Kits

(#) Veneer Suffix List:

- D Maple (stained similar to Kensington Maple laminate)
- J Cherry (stained similar to Wild Cherry laminate)
- N Walnut (stained similar to Cafelle laminate)
- 8 Walnut (stained similar to Prestige Walnut laminate)
- 9 Cherry (stained similar to Select Cherry laminate)
- X Stain Match (add a one-time \$700 list +10%
Stain Match fee)

Product Specifications:

- > Individual doors are 5.25" x 24".
- > Interior dimension of Trough is 10.5"D x 8"H

Ordering Information:

- > Door kits require that the door kit cut-out is selected when ordering the table top.
- > Field installed.
- > Door is hinged and lays flat on tabletop when open. When closed there is a 1" gap for cord access.
- > **A freight fee of \$100 net is assessed on orders less than \$1000 net. See page 13.**

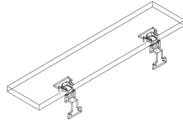

Part Number	Description	List Price (US\$)
-------------	-------------	-------------------

Laminate Door Kits for Foundation Tables with Trough

LPTD2L#	Laminate Door Kit for 72 or 84"W Table (includes 2 doors)	\$376
LPTD4L#	Laminate Door Kit for 96 or 108"W Table (includes 4 doors)	\$756
LPTD6L#	Laminate Door Kit for 120 or 132"W Table (includes 6 doors)	\$1131
LPTD8L#	Laminate Door Kit for 144 or 156"W Table (includes 8 doors)	\$1510
LPTD10L#	Laminate Door Kit for 168 or 180"W Table (includes 10 doors)	\$1886
LPTD12L#	Laminate Door Kit for 192 or 204"W Table (includes 12 doors)	\$2264
LPTD14L#	Laminate Door Kit for 216 or 228"W Table (includes 14 doors)	\$2642
LPTD16L#	Laminate Door Kit for 240"W Table (includes 16 doors)	\$3019

Veneer Door Kits for Foundation Tables with Trough

LPTD2V#	Veneer Door Kit for 72 or 84"W Table (includes 2 doors)	\$774
LPTD4V#	Veneer Door Kit for 96 or 108"W Table (includes 4 doors)	\$1548
LPTD6V#	Veneer Door Kit for 120 or 132"W Table (includes 6 doors)	\$2323
LPTD8V#	Veneer Door Kit for 144 or 156"W Table (includes 8 doors)	\$3097
LPTD10V#	Veneer Door Kit for 168 or 180"W Table (includes 10 doors)	\$3873
LPTD12V#	Veneer Door Kit for 192 or 204"W Table (includes 12 doors)	\$4648
LPTD14V#	Veneer Door Kit for 216 or 228"W Table (includes 14 doors)	\$5422
LPTD16V#	Veneer Door Kit for 240"W Table (includes 16 doors)	\$6198

Aluminum Door Kits for Foundation Tables with Trough

LPTD2AL	Aluminum Door Kit for 72 or 84"W Table (includes 2 doors)	\$376
LPTD4AL	Aluminum Door Kit for 96 or 108"W Table (includes 4 doors)	\$756
LPTD6AL	Aluminum Door Kit for 120 or 132"W Table (includes 6 doors)	\$1131
LPTD8AL	Aluminum Door Kit for 144 or 156"W Table (includes 8 doors)	\$1510
LPTD10AL	Aluminum Door Kit for 168 or 180"W Table (includes 10 doors)	\$1886
LPTD12AL	Aluminum Door Kit for 192 or 204"W Table (includes 12 doors)	\$2264
LPTD14AL	Aluminum Door Kit for 216 or 228"W Table (includes 14 doors)	\$2642
LPTD16AL	Aluminum Door Kit for 240"W Table (includes 16 doors)	\$3019

Foundation Trough Power Kits

TOPS	TABLES STEP 2 - FOUNDATION
BASES	
POWER DATA	
SUPPORT FURNITURE	
ACCESSORIES	

Part Number	Description	List Price (US\$)
Power Kits for Foundation Tables with Trough		
LPTD2PWR	Power Kit for 72" table (includes 3 receptacles and 1 telecom plate opening)	\$655
LPTD3PWR	Power Kit for 84" table (includes 6 receptacles and 2 telecom plate openings)	\$1256
LPTD4PWR	Power Kit for 96" table (includes 6 receptacles and 3 telecom plate openings)	\$1256
LPTD5PWR	Power Kit for 108" table (includes 6 receptacles and 2 telecom plate openings)	\$1911
LPTD6PWR	Power Kit for 120" or 132" table (includes 12 receptacles and 4 telecom plate openings)	\$1911
LPTD8PWR	Power Kit for 144" or 156" table (includes 12 receptacles and 6 telecom plate openings)	\$2646
LPTD10PWR	Power Kit for 168" or 180" table (includes 18 receptacles and 6 telecom plate openings)	\$3300
LPTD12PWR	Power Kit for 192" table (includes 24 receptacles and 8 telecom plate openings)	\$4036
LPTD14PWR	Power Kit for 204" table (includes 18 receptacles and 9 telecom plate openings)	\$4689
LPTD16PWR	Power Kit for 216", 228" or 240" table (includes 27 receptacles and 9 telecom plate openings)	\$5424

Tip: Half of Power Kit is circuit 1 and half is circuit 2. Jumpers included.

Tip: Power kit is 2.5"H x 5"W.

Tip: Telecom plates ordered separately. See page 174.

Base Power-Ins

LPTD72	Infeed for Foundation Trough Power Kit, 72", hardwired	\$273
LPTD120	Infeed for Foundation Trough Power Kit, 120", hardwired	\$352

Tip: Includes 3-way splitter and extra jumper. Used when power infeed comes in through center base location.

Foundation Panel and Drum Individual Bases

STEP 1

(#) Laminate Suffix List:

A	Wilsonart Kensington Maple (10776-60)	no charge
B	Wilsonart Monticello Maple (7925-38)	no charge
C	Wilsonart Wild Cherry (7054-60)	no charge
E	Wilsonart Fashion Grey (D381-60)	no charge
G	Wilsonart Cafelle (7933K-07)	no charge
M	Wilsonart Frosty White (1573-60)	no charge
P	Wilsonart Slate Grey (D91-60)	no charge
R	Wilsonart Black (1595-60)	no charge
U	Wilsonart Brazilwood (7946-38)	no charge
V	Wilsonart River Cherry (7937-38)	no charge
W	Wilsonart Designer White (D354-60)	no charge
3	Formica Neutral Twill (8826-58)	no charge
4	Formica Bleached Legno (8845-58)	no charge
5	Formica Prestige Walnut (6209-43)	no charge
7	Formica Select Cherry (7759-43)	no charge
X	*Wilsonart Non-Premium laminates (-38, -60)	+35%
Y	*Formica Non-Premium (includes 58, 43, MC, SP, and NT finishes), Formica Premium (WR, 42, 77, 46, RD finishes), Pionite Non-Premium, Nevamar Non-Premium, Wilsonart Premium (-01, -07, -12, -18, -52, -78), and whiteboard laminate.	+45%

*Add \$350 list for Special Laminate orders of less than 10 units. See page 21 for edge selection.

(#) Veneer Suffix List:

D	Maple (stained similar to Kensington Maple laminate)	
J	Cherry (stained similar to Wild Cherry laminate)	
N	Walnut (stained similar to Cafelle laminate)	
8	Walnut (stained similar to Prestige Walnut laminate)	
9	Cherry (stained similar to Select Cherry laminate)	
X	Stain Match (add a one-time \$700 list Stain Match fee)	+10%

Product Specifications:

- > Base height is 27.75"
- > Bases include Levelers.

Ordering Information:

- > Top and bottom of base are open for cable management. Panel Bases have a cable management cutout on both sides at the top.
- > Boat Tables require smaller (less deep) bases on ends than middle. See page 26 for recommendations.
- > **A freight fee of \$100 net is assessed on orders less than \$1000 net. See page 13.**

D1 W1 Part Number

List Price (US\$)

Laminate Foundation Conference Table Panel Bases

18	6	LPB618#	Lam. Base, 18" x 6", for 36/42"D table	\$518
18	10	LPB1018#	Lam. Base, 18" x 10", for 36/42"D table	\$562
24	6	LPB624#	Lam. Base, 24" x 6", for 48"D table	\$546
24	10	LPB1024#	Lam. Base, 24" x 10", for 48"D table	\$586
30	6	LPB630#	Lam. Base, 30" x 6", for 54"D table	\$739
30	10	LPB1030#	Lam. Base, 30" x 10", for 54"D table	\$763
36	6	LPB636#	Lam. Base, 36" x 6", for 60"D table	\$795
36	10	LPB1036#	Lam. Base, 36" x 10", for 60"D table	\$828



Laminate Foundation Conference Table Panel Bases with Access Door

18	6	LPBD618#	Lam. Base w/ Access Door, 18" x 6", for 36/42"D table	\$681
18	10	LPBD1018#	Lam. Base w/ Access Door, 18" x 10", for 36/42"D table	\$832
24	6	LPBD624#	Lam. Base w/ Access Door, 24" x 6", for 48"D table	\$702
24	10	LPBD1024#	Lam. Base w/ Access Door, 24" x 10", for 48"D table	\$852
30	6	LPBD630#	Lam. Base w/ Access Door, 30" x 6", for 54"D table	\$956
30	10	LPBD1030#	Lam. Base w/ Access Door, 30" x 10", for 54"D table	\$1012
36	6	LPBD636#	Lam. Base w/ Access Door, 36" x 6", for 60"D table	\$978
36	10	LPBD1036#	Lam. Base w/ Access Door, 36" x 10", for 60"D table	\$1036



Laminate Foundation Conference Table Panel Bases with Aluminum Trim

18	6	LPBA618#	Lam. Base w/ Alum. Trim, 18" x 6", for 36/42" D table	\$700
18	10	LPBA1018#	Lam. Base w/ Alum. Trim, 18" x 10", for 36/42" D table	\$738
24	6	LPBA624#	Lam. Base w/ Alum. Trim, 24" x 6", for 48" D table	\$708
24	10	LPBA1024#	Lam. Base w/ Alum. Trim, 24" x 10", for 48" D table	\$765
30	6	LPBA630#	Lam. Base w/ Alum. Trim, 30" x 6", for 54" D table	\$944
30	10	LPBA1030#	Lam. Base w/ Alum. Trim, 30" x 10", for 54" D table	\$957
36	6	LPBA636#	Lam. Base w/ Alum. Trim, 36" x 6", for 60" D table	\$963
36	10	LPBA1036#	Lam. Base w/ Alum. Trim, 36" x 10", for 60" D table	\$978

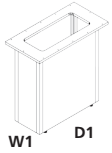

Laminate Foundation Conference Table Panel Bases with Aluminum Trim and Access Door

18	6	LPBAD618#	Lam. Base w/ Al. Trim, Access Door, 18" x 6", for 36/42"D table	\$793
18	10	LPBAD1018#	Lam. Base w/ Al. Trim, Access Door, 18" x 10", for 36/42"D table	\$876
24	6	LPBAD624#	Lam. Base w/ Al. Trim, Access Door, 24" x 6", for 48"D table	\$820
24	10	LPBAD1024#	Lam. Base w/ Al. Trim, Access Door, 24" x 10", for 48"D table	\$902
30	6	LPBAD630#	Lam. Base w/ Al. Trim, Access Door, 30" x 6", for 54"D table	\$995
30	10	LPBAD1030#	Lam. Base w/ Al. Trim, Access Door, 30" x 10", for 54"D table	\$1101
36	6	LPBAD636#	Lam. Base w/ Al. Trim, Access Door, 36" x 6", for 60"D table	\$1068
36	10	LPBAD1036#	Lam. Base w/ Al. Trim, Access Door, 36" x 10", for 60"D table	\$1152



Tip: Boat Tables require smaller (less deep) bases on ends than middle. See page 26 for recommendations.

Laminate Foundation Conference Table Drum Base

20	-	LLDR20#	Lam. Base, 20" diameter, for 48"D table	\$1466
24	-	LLDR24#	Lam. Base, 24" diameter, for 60"D table	\$1697

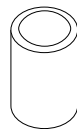

Tip: Ballast weight included.

Tip: Top and bottom (not sides) of bases are open for cable management.

Laminate Foundation Conference Table Drum Base with Access Door

20	-	LLDR20B#	Lam. Base w/ Access Door, 20" diameter, for 48"D table	\$2290
24	-	LLDR24B#	Lam. Base w/ Access Door, 24" diameter, for 60"D table	\$2354

Tip: Ballast weight included.

COORDINATING FURNITURE
See pages 178-180
for coordinating
Foundation furniture.

TOPS	TABLES STEP 2 - FOUNDATION
BASES	
POWER DATA	
SUPPORT FURNITURE	
ACCESSORIES	

D1 W1 Part Number List Price (US\$)

Veneer Foundation Conference Table Panel Bases



18	6	LVPB618#	Veneer Base, 18" x 6", for 36/42"D table	\$1209
18	10	LVPB1018#	Veneer Base, 18" x 10", for 36/42"D table	\$1266
24	6	LVPB624#	Veneer Base, 24" x 6", for 48"D table	\$1414
24	10	LVPB1024#	Veneer Base, 24" x 10", for 48"D table	\$1567
30	6	LVPB630#	Veneer Base, 30" x 6", for 54"D table	\$1618
30	10	LVPB1030#	Veneer Base, 30" x 10", for 54"D table	\$1777
36	6	LVPB636#	Veneer Base, 36" x 6", for 60"D table	\$1823
36	10	LVPB1036#	Veneer Base, 36" x 10", for 60"D table	\$1986

Veneer Foundation Conference Table Panel Bases with Access Door



18	6	LVPBD618#	Veneer Base w/ Access Door, 18" x 6", for 36/42"D table	\$1438
18	10	LVPBD1018#	Veneer Base w/ Access Door, 18" x 10", for 36/42"D table	\$1519
24	6	LVPBD624#	Veneer Base w/ Access Door, 24" x 6", for 48"D table	\$1614
24	10	LVPBD1024#	Veneer Base w/ Access Door, 24" x 10", for 48"D table	\$1766
30	6	LVPBD630#	Veneer Base w/ Access Door, 30" x 6", for 54"D table	\$1848
30	10	LVPBD1030#	Veneer Base w/ Access Door, 30" x 10", for 54"D table	\$2007
36	6	LVPBD636#	Veneer Base w/ Access Door, 36" x 6", for 60"D table	\$2085
36	10	LVPBD1036#	Veneer Base w/ Access Door, 36" x 10", for 60"D table	\$2247

Veneer Foundation Conference Table Panel Bases with Aluminum Trim

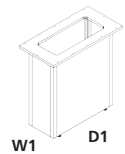

18	6	LVPBA618#	Veneer Base w/ Alum. Trim, 18" x 6", for 36/42" D table	\$1359
18	10	LVPBA1018#	Veneer Base w/ Alum. Trim, 18" x 10", for 36/42" D table	\$1450
24	6	LVPBA624#	Veneer Base w/ Alum. Trim, 24" x 6", for 48" D table	\$1563
24	10	LVPBA1024#	Veneer Base w/ Alum. Trim, 24" x 10", for 48" D table	\$1716
30	6	LVPBA630#	Veneer Base w/ Alum. Trim, 30" x 6", for 54" D table	\$1768
30	10	LVPBA1030#	Veneer Base w/ Alum. Trim, 30" x 10", for 54" D table	\$1926
36	6	LVPBA636#	Veneer Base w/ Alum. Trim, 36" x 6", for 60" D table	\$1938
36	10	LVPBA1036#	Veneer Base w/ Alum. Trim, 36" x 10", for 60" D table	\$2136

Veneer Foundation Conference Table Panel Bases with Aluminum Trim and Access Door

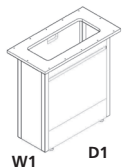

18	6	LVPBAD618#	Veneer Base w/ Alum. Trim, Access Door, 18" x 6", for 36/42"D table	\$1562
18	10	LVPBAD1018#	Veneer Base w/ Alum. Trim, Access Door, 18" x 10", for 36/42"D table	\$1643
24	6	LVPBAD624#	Veneer Base w/ Alum. Trim, Access Door, 24" x 6", for 48"D table	\$1738
24	10	LVPBAD1024#	Veneer Base w/ Alum. Trim, Access Door, 24" x 10", for 48"D table	\$1890
30	6	LVPBAD630#	Veneer Base w/ Alum. Trim, Access Door, 30" x 6", for 54"D table	\$1972
30	10	LVPBAD1030#	Veneer Base w/ Alum. Trim, Access Door, 30" x 10", for 54"D table	\$2130
36	6	LVPBAD636#	Veneer Base w/ Alum. Trim, Access Door, 36" x 6", for 60"D table	\$2208
36	10	LVPBAD1036#	Veneer Base w/ Alum. Trim, Access Door, 36" x 10", for 60"D table	\$2370

Tip: Boat Tables require smaller (less deep) bases on ends than middle.
See page 26 for recommendations.

Veneer Foundation Conference Table Drum Base

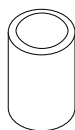

20		LLVDR20#	Veneer Base, 20" diameter, for 48"D table	\$2412
24		LLVDR24#	Veneer Base, 24" diameter, for 60"D table	\$2643

Tip: Ballast weight included.
Tip: Top and bottom (not sides) of bases are open for cable management.

Veneer Foundation Conference Table Drum Base with Access Door

20		LLVDR20B#	Veneer Base w/ Access Door, 20" diameter, for 48"D table	\$2737
24		LLVDR24B#	Veneer Base w/ Access Door, 24" diameter, for 60"D table	\$2905

Tip: Ballast weight included.

Gyration™ 2.0 Flip Bases

STEP 1

(^) Leg Finishes List:

A Silver with Black Caster	no charge
B Silver with White Caster	+\$44
W Alternative color with Black Caster	+\$60
X Alternative color with White Caster	+\$104

Tip: Some Steelcase, Herman Miller, Knoll, Haworth, and Allsteel paints are available for \$350 list fee per order. Call/email for availability of specific colors. Additional custom paints (e.g. Tiger Dry Lac) must be quoted through quotes@enwork.com.

Ordering Information:

- > Gyration bases do not allow for cable management holes.
- > Angled and Tubular legs nest in-line. Straight legs nest off-set.
- > **A freight fee of \$100 net is assessed on orders less than \$1000 net. See page 13.**



Part Number	Description	List Price (US\$)
Gyration 2.0 Flip (No Beam) Base on Casters - Blade (Straight) Legs, Package of Two		
LG2NB18^	18"D Flip Base, Blade (Straight) Legs	\$1184
LG2NB24^	24"D Flip Base, Blade (Straight) Legs	\$1194
LG2NB30^	30"D Flip Base, Blade (Straight) Legs	\$1230

Tip: Cannot use "no beam" bases on tops larger than 72"W.



Gyration 2.0 Flip (No Beam) Base on Casters - Blade (Angled) Legs, Package of Two		
LG2NJ24^	24"D Flip Base, Blade (Angled) Legs	\$1270
LG2NJ30^	30"D Flip Base, Blade (Angled) Legs	\$1306

Tip: Cannot use "no beam" bases on tops larger than 72"W.



Gyration 2.0 Flip (No Beam) Base on Casters - Tubular Legs, Package of Two		
LG2NT18^	18"D Flip Base, Tubular Legs	\$1009
LG2NT24^	24"D Flip Base, Tubular Legs	\$1026
LG2NT30^	30"D Flip Base, Tubular Legs	\$1038

Tip: Cannot use "no beam" bases on tops larger than 72"W.

TOPS

BASES

POWER
DATASUPPORT
FURNITURE

ACCESSORIES

TABLES STEP 2 - GYRATION 2.0

Part Number	Description	List Price (US\$)
-------------	-------------	-------------------

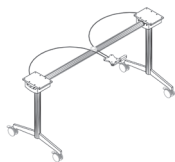

Gyration 2.0 Flip Base Assembly with Beam - 18\"D Blade (Straight) Legs (qty 2) - on casters		
LG2YB1848^	18\"D Flip Base with Beam, Blade (Straight) Legs for 48\"W table	\$1357
LG2YB1860^	18\"D Flip Base with Beam, Blade (Straight) Legs for 60\"W table	\$1378
LG2YB1872^	18\"D Flip Base with Beam, Blade (Straight) Legs for 72\"W table	\$1418
LG2YB1896^	18\"D Flip Base with Beam, Blade (Straight) Legs for 96\"W table	\$1509

Gyration 2.0 Flip Base Assembly with Beam - 24\"D Blade (Straight) Legs (qty 2) - on casters		
LG2YB2448^	24\"D Flip Base with Beam, Blade (Straight) Legs for 48\"W table	\$1367
LG2YB2460^	24\"D Flip Base with Beam, Blade (Straight) Legs for 60\"W table	\$1389
LG2YB2472^	24\"D Flip Base with Beam, Blade (Straight) Legs for 72\"W table	\$1429
LG2YB2496^	24\"D Flip Base with Beam, Blade (Straight) Legs for 96\"W table	\$1520

Gyration 2.0 Flip Base Assembly with Beam - 30\"D Blade (Straight) Legs (qty 2) - on casters		
LG2YB3048^	30\"D Flip Base with Beam, Blade (Straight) Legs for 48\"W table	\$1404
LG2YB3060^	30\"D Flip Base with Beam, Blade (Straight) Legs for 60\"W table	\$1425
LG2YB3072^	30\"D Flip Base with Beam, Blade (Straight) Legs for 72\"W table	\$1468
LG2YB3096^	30\"D Flip Base with Beam, Blade (Straight) Legs for 96\"W table	\$1557

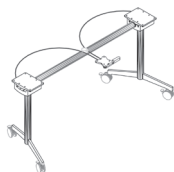

Gyration 2.0 Flip Base Assembly with Beam - 24\"D Blade (Angled) Legs (qty 2) - on casters		
LG2YJ2460^	24\"D Flip Base with Beam, Blade (Angled) Legs for 60\"W table	\$1449
LG2YJ2472^	24\"D Flip Base with Beam, Blade (Angled) Legs for 72\"W table	\$1490

Gyration 2.0 Flip Base Assembly with Beam - 30\"D Blade (Angled) Legs (qty 2) - on casters		
LG2YJ3060^	30\"D Flip Base with Beam, Blade (Angled) Legs for 60\"W table	\$1485
LG2YJ3072^	30\"D Flip Base with Beam, Blade (Angled) Legs for 72\"W table	\$1527

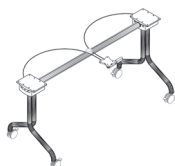

Gyration 2.0 Flip Base Assembly with Beam - 18\"D Tubular Legs (qty 2) - on casters		
LG2YT1848^	18\"D Flip Base with Beam, Tubular Legs for 48\"W table	\$1176
LG2YT1860^	18\"D Flip Base with Beam, Tubular Legs for 60\"W table	\$1193
LG2YT1872^	18\"D Flip Base with Beam, Tubular Legs for 72\"W table	\$1232
LG2YT1896^	18\"D Flip Base with Beam, Tubular Legs for 96\"W table	\$1317

Gyration 2.0 Flip Base Assembly with Beam - 24\"D Tubular Legs (qty 2) - on casters		
LG2YT2448^	24\"D Flip Base with Beam, Tubular Legs for 48\"W table	\$1213
LG2YT2460^	24\"D Flip Base with Beam, Tubular Legs for 60\"W table	\$1232
LG2YT2472^	24\"D Flip Base with Beam, Tubular Legs for 72\"W table	\$1271
LG2YT2496^	24\"D Flip Base with Beam, Tubular Legs for 96\"W table	\$1355

Gyration 2.0 Flip Base Assembly with Beam - 30\"D Tubular Legs (qty 2) - on casters		
LG2YT3048^	30\"D Flip Base with Beam, Tubular Legs for 48\"W table	\$1265
LG2YT3060^	30\"D Flip Base with Beam, Tubular Legs for 60\"W table	\$1272
LG2YT3072^	30\"D Flip Base with Beam, Tubular Legs for 72\"W table	\$1323
LG2YT3096^	30\"D Flip Base with Beam, Tubular Legs for 96\"W table	\$1443

Gyration 2.0 Flip Base Assembly with Beam - 36\"D Tubular Legs (qty 2) - on casters		
LG2YT3648^	36\"D Flip Base with Beam, Tubular Legs for 48\"W table	\$1321
LG2YT3660^	36\"D Flip Base with Beam, Tubular Legs for 60\"W table	\$1329
LG2YT3672^	36\"D Flip Base with Beam, Tubular Legs for 72\"W table	\$1380

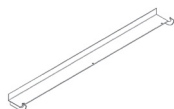

Gyration 2.0 Cable Trough Attachment for Beam		
LG2TRA^	Trough Attachment for (straight) 48\"W table or (angled) 60\"W table with Beam	\$109
LG2TRB^	Trough Attachment for (straight) 60\"W table or (angled) 72\"W table with Beam	\$118
LG2TRC^	Trough Attachment for (straight) 72\"W table with Beam	\$146

Tip: Modesty panels are located on pages 195-196.

Impression™ T-Legs

STEP 1

(?) Routing Holes Suffix List

N	No routing holes in leg	no charge
Y	Routing hole in one leg	+\$62
Z	Routing holes in two legs	+\$124

STEP 2 - Legs w/ Casters Only

(@) Caster Color Suffix List:

B	Black	no charge
G	Grey	+\$40

STEP 3

(^) Paint Suffix List

G	Slate Grey
R	Black
S	Silver
T	Medium Tone
W	Arctic White
Z	Other

Tip: Some Steelcase, Herman Miller, Knoll, Haworth, and Allsteel paints are available for \$350 list fee per order. Call/email for availability of specific colors. Additional custom paints (e.g. Tiger Dry Lac) must be quoted through quotes@enwork.com.

Ordering Information:

- > Standard height is 27.75". For shorter heights put "X" in front of the part number and add \$54 list. For taller, put "XX" in front and add \$68 list. Maximum worksurface height is 42"
- > **A freight fee of \$100 net is assessed on orders less than \$1000 net. See page 13.**

Part No.	Description	List Price (US\$)
	Impression T-Legs with Levelers, package of two	
LTP182?^	T-Legs, levelers, for 18"D table (16" spread)	\$558
LTP242?^	T-Legs, levelers, for 24"D table (22" spread)	\$567
LTP302?^	T-Legs, levelers, for 30-36"D table (26" spread)	\$606

	Impression T-Legs on Casters, package of two	
LTPC182?@^	T-Legs, casters, for 18"D table (16" spread)	\$634
LTPC242?@^	T-Legs, casters, for 24"D table (22" spread)	\$662
LTPC302?@^	T-Legs, casters, for 30-36"D table (26" spread)	\$689

Impression T-Leg Folding with Levelers, package of two

LTPF182^	T-Legs Folding, levelers, for 18"D table (16" spread)	\$958
LTPF242^	T-Legs Folding, levelers, for 24"D table (22" spread)	\$967
LTPF302^	T-Legs Folding, levelers, for 30-36"D table (26" spread)	\$973

Tip: Designed for tables 60" wide and wider.
Email quotes@enwork.com for other options.

Impression T-Leg Folding with Casters, package of two

LTPFC182^@	T-Legs Folding, casters, for 18"D table (16" spread)	\$980
LTPFC242^@	T-Legs Folding, casters, for 24"D table (22" spread)	\$986
LTPFC302^@	T-Legs Folding, casters, for 30-36"D table (26" spread)	\$993

Tip: Designed for tables 60" wide and wider.
Email quotes@enwork.com for other options.



Leg Cable Management Covers

LPCM^	Cable Management Cover for Leg with Leveler	\$57
LPCMC^	Cable Management Cover for Leg with Caster	\$57
LPCMA^	Cable Management Cover for Flip Table with Casters	\$57

Tip: Not applicable to Set Screw Adjustable legs.

Impression T-Leg Flip Base Assemblies

Ordering Information:

- > Angled legs nest in-line. Straight legs nest off-set.
- > Products on this page have been updated. If trying to match Impression T-Leg Flip bases ordered between 2008 and 2015, contact quotes@enwork.com.
- > A freight fee of \$100 net is assessed on orders less than \$1000 net. See page 13.

Part Number	Description	List Price (US\$)
Impression T-Leg (Straight) Flip Base Assembly with Crossbeam and Casters for 18"D Tables		
LTUB1848?@^	T-leg (straight) Flip Base w/ Beam for 18"D x 48"W top	\$1209
LTUB1860?@^	T-leg (straight) Flip Base w/ Beam for 18"D x 60"W top	\$1226
LTUB1872?@^	T-leg (straight) Flip Base w/ Beam for 18"D x 72"W top	\$1262
LTUB1896?@^	T-leg (straight) Flip Base w/ Beam for 18"D x 96"W top	\$1457
Impression T-Leg (Straight) Flip Base Assembly with Crossbeam and Casters for 24"D Tables		
LTUB2448?@^	T-leg (straight) Flip Base w/ Beam for 24"D x 48"W top	\$1246
LTUB2460?@^	T-leg (straight) Flip Base w/ Beam for 24"D x 60"W top	\$1262
LTUB2472?@^	T-leg (straight) Flip Base w/ Beam for 24"D x 72"W top	\$1299
LTUB2496?@^	T-leg (straight) Flip Base w/ Beam for 24"D x 96"W top	\$1497
Impression T-Leg (Straight) Flip Base Assembly with Crossbeam and Casters for 30"D Tables		
LTUB3048?@^	T-leg (straight) Flip Base w/ Beam for 30"D x 48"W top	\$1294
LTUB3060?@^	T-leg (straight) Flip Base w/ Beam for 30"D x 60"W top	\$1300
LTUB3072?@^	T-leg (straight) Flip Base w/ Beam for 30"D x 72"W top	\$1349
LTUB3096?@^	T-leg (straight) Flip Base w/ Beam for 30"D x 96"W top	\$1588
Impression T-Leg (Angled) Flip Base Assembly with Crossbeam and Casters for 24"D Tables		
LTUA2460?@^	T-Leg (angled) Flip Base w/ Beam 24"D x 60"W top	\$1321
LTUA2472?@^	T-Leg (angled) Flip Base w/ Beam 24"D x 72"W top	\$1357
Impression T-Leg (Angled) Flip Base Assembly with Crossbeam and Casters for 30"D Tables		
LTUA3060?@^	T-Leg (angled) Flip Base w/ Beam 30"D x 60"W top	\$1358
LTUA3072?@^	T-Leg (angled) Flip Base w/ Beam 30"D x 72"W top	\$1406
Impression T-Leg (Straight) Flip Base Assembly with Casters, package of two		
LT2NK18?@^	T-Leg (straight) Flip Base, Casters, for 18"D table	\$1033
LT2NK24?@^	T-Leg (straight) Flip Base, Casters, for 24"D table	\$1066
LT2NK30?@^	T-Leg (straight) Flip Base, Casters, for 30"D table	\$1069
Impression T-Leg (Angled) Flip Base Assembly with Casters, package of two		
LT2NL24?@^	T-Leg (angled) Flip Base, Casters, for 24"D table	\$1114
LT2NL30?@^	T-Leg (angled) Flip Base, Casters, for 30"D table	\$1127

TOPS

BASES

POWER
DATASUPPORT
FURNITURE

ACCESSORIES

TABLES STEP 2 - IMPRESSION

Impression TT-Legs - Conference

STEP 1

(?) Routing Holes Suffix List

N	No routing holes in column	no charge
Y	Routing hole in one column	+\$62
Z	Routing holes in two columns	+\$124

STEP 2

(^) Paint Suffix List

G	Slate Grey
R	Black
S	Silver
T	Medium Tone
W	Arctic White
Z	Other

Tip: Some Steelcase, Herman Miller, Knoll, Haworth, and Allsteel paints are available for \$350 list fee per order. Call/email for availability of specific colors. Additional custom paints (e.g. Tiger Dry Lac) must be quoted through quotes@enwork.com.

STEP 3 - TT-Leg Filler Only

(#) Laminate Suffix List:

A	Wilsonart Kensington Maple (10776-60)	no charge
B	Wilsonart Monticello Maple (7925-38)	no charge
C	Wilsonart Wild Cherry (7054-60)	no charge
E	Wilsonart Fashion Grey (D381-60)	no charge
G	Wilsonart Cafelle (7933K-07)	no charge
M	Wilsonart Frosty White (1573-60)	no charge
P	Wilsonart Slate Grey (D91-60)	no charge
R	Wilsonart Black (1595-60)	no charge
U	Wilsonart Brazilwood (7946-38)	no charge
V	Wilsonart River Cherry (7937-38)	no charge
W	Wilsonart Designer White (D354-60)	no charge
3	Formica Neutral Twill (8826-58)	no charge
4	Formica Bleached Legno (8845-58)	no charge
5	Formica Prestige Walnut (6209-43)	no charge
7	Formica Select Cherry (7759-43)	no charge
X	*Wilsonart Non-Premium laminates (-38, -60)	+\$60
Y	*Formica Non-Premium (includes 58, 43, MC, SP, and NT finishes), Formica Premium (WR, 42, 77, 46, RD finishes), Pionite Non-Premium, Nevamar Non-Premium, Wilsonart Premium (-01, -07, -12, -18, -52, -78), and whiteboard laminate.	+\$90

*Add \$350 list for Special Laminate orders of less than 10 units. See page 21 for edge selection.

(#) Veneer Suffix List:

D	Maple (stained similar to Kensington Maple laminate)	
J	Cherry (stained similar to Wild Cherry laminate)	
N	Walnut (stained similar to Cafelle laminate)	
8	Walnut (stained similar to Prestige Walnut laminate)	
9	Cherry (stained similar to Select Cherry laminate)	
X	Stain Match (add a one-time \$700 list Stain Match fee)	+10%

Ordering Information:

- > Standard height is 27.75". For shorter heights put "X" in front of the part number and add \$54 list. For taller, put "XX" in front and add \$68 list. Non-standard heights not available on height-adjustable legs. Maximum worksurface height is 42".
- > Installation hardware is included.
- > **A freight fee of \$100 net is assessed on orders less than \$1000 net. See page 13.**

COORDINATING FURNITURE

See pages 182-187 for coordinating Impression furniture.

Part Number	Description	List Price (US\$)
	Impression TT-Leg with Levelers, package of one	
LTP48?^	TT-Leg, levelers for 42"D and 48"D table (34" spread)	\$694
LTP60?^	TT-Leg, levelers for 60"D table (40" spread)	\$730
	Tip: The 48" leg top plates are 4" apart and therefore cannot receive power/data units between them.	

	Impression TT-Leg with Levelers and Laminate Filler, package of one	
LTPL48?^#	TT-Leg, levelers, laminate filler, for 42"D and 48"D table (34" spread)	\$805
LTPL60?^#	TT-Leg, levelers, laminate filler, for 60"D table (40" spread)	\$845
	Tip: A center power/data location on a 2-piece table is not possible due to interference with the laminate filler panel on the leg (a leg is typically shared at the seam of the 2 pieces).	
	Tip: TT-Leg with filler cannot accept the cable management cover.	

	Impression TT-Leg with Levelers and Veneer Filler, package of one	
LTPV48?^#	TT-Leg, levelers, veneer filler, for 42"D and 48"D table (34" spread)	\$997
LTPV60?^#	TT-Leg, levelers, veneer filler, for 60"D table (40" spread)	\$1039
	Tip: A center power/data location on a 2-piece table is not possible due to interference with the veneer filler panel on the leg (a leg is typically shared at the seam of the 2 pieces).	
	Tip: TT-Leg with filler cannot accept the cable management cover.	

TOPS	TABLES STEP 2 - IMPRESSION
BASES	
POWER DATA	
SUPPORT FURNITURE	
ACCESSORIES	

Notes

Impression C-Legs

STEP 1

(?) Routing Holes Suffix List

N	No routing holes in leg	no charge
Y	Routing hole in one leg	+\$62
Z	Routing holes in two legs	+\$124

STEP 2 - Legs w/ Casters Only

(@) Caster Color Suffix List:

B	Black	no charge
G	Grey	+\$40

STEP 3

(^) Paint Suffix List

G	Slate Grey
R	Black
S	Silver
T	Medium Tone
W	Arctic White
Z	Other

Tip: Some Steelcase, Herman Miller, Knoll, Haworth, and Allsteel paints are available for \$350 list fee per order. Call/email for availability of specific colors. Additional custom paints (e.g. Tiger Dry Lac) must be quoted through quotes@enwork.com.

Ordering Information:

- > Standard height is 27.75". For shorter heights put "X" in front of the part number and add \$54 list. For taller, put "XX" in front and add \$68 list. Non-standard heights not available on height-adjustable legs. Maximum worksurface height is 42".
- > Installation hardware is included.
- > **A freight fee of \$100 net is assessed on orders less than \$1000 net. See page 13.**

Part Number	Description	List Price (US\$)
	Impression C-Leg with Levelers, package of two	
LCP182?^	C-Leg, levelers, for 18"D table (16" spread)	\$558
LCP242?^	C-Leg, levelers, for 24"D table (22" spread)	\$567
LCP302?^	C-Leg, levelers, for 30"D table (26" spread)	\$606

	Impression C-Leg with Casters, package of two	
LCPC182?@^	C-Leg, casters, for 18"D table (16" spread)	\$634
LCPC242?@^	C-Leg, casters, for 24"D table (22" spread)	\$662
LCPC302?@^	C-Leg, casters, for 30"D table (26" spread)	\$689

TOPS

BASES

POWER
DATASUPPORT
FURNITURE

ACCESSORIES

TABLES STEP 2 - IMPRESSION

Part Number	Description	List Price (US\$)
-------------	-------------	-------------------

Impression Set-Screw Adjustable C-Leg Base Assembly with Crossbeam and levelers for 18"D tables

LACP1848?^	Set-Screw C-Leg base with Beam, levelers, for 18"D x 48"W top	\$950
LACP1860?^	Set-Screw C-Leg base with Beam, levelers, for 18"D x 60"W top	\$950
LACP1872?^	Set-Screw C-Leg base with Beam, levelers, for 18"D x 72"W top	\$950

Tip: Height range is 29"-43" with 1.5" increments (including top).

Tip: Set-Screw Adjustable legs cannot accept the cable management cover.

Impression Set-Screw Adjustable C-Leg Base Assembly with Crossbeam and levelers for 24"D tables

LACP2448?^	Set-Screw C-Leg base with Beam, levelers, for 24"D x 48"W top	\$978
LACP2460?^	Set-Screw C-Leg base with Beam, levelers, for 24"D x 60"W top	\$978
LACP2472?^	Set-Screw C-Leg base with Beam, levelers, for 24"D x 72"W top	\$978

Tip: Height range is 29"-43" with 1.5" increments (including top).

Tip: Set-Screw Adjustable legs cannot accept the cable management cover.

Impression Set-Screw Adjustable C-Leg Base Assembly with Crossbeam and levelers for 30"D tables

LACP3048?^	Set-Screw C-Leg base with Beam, levelers, for 30"D x 48"W top	\$1008
LACP3060?^	Set-Screw C-Leg base with Beam, levelers, for 30"D x 60"W top	\$1008
LACP3072?^	Set-Screw C-Leg base with Beam, levelers, for 30"D x 72"W top	\$1008

Tip: Height range is 29"-43" with 1.5" increments (including top).

Tip: Set-Screw Adjustable legs cannot accept the cable management cover.

Impression Set-Screw Adjustable C-Leg Base Assembly with Crossbeam and Casters for 18"D tables

LACPC1848?^@	Set-Screw C-Leg base with Beam, casters, for 18" x 48" top	\$1008
LACPC1860?^@	Set-Screw C-Leg base with Beam, casters, for 18" x 60" top	\$1008
LACPC1872?^@	Set-Screw C-Leg base with Beam, casters, for 18" x 72" top	\$1008

Impression Set-Screw Adjustable C-Leg Base Assembly with Crossbeam and Casters for 24"D tables

LACPC2448?^@	Set-Screw C-Leg base with Beam, casters, for 24" x 48" top	\$1033
LACPC2460?^@	Set-Screw C-Leg base with Beam, casters, for 24" x 60" top	\$1033
LACPC2472?^@	Set-Screw C-Leg base with Beam, casters, for 24" x 72" top	\$1033

Impression Set-Screw Adjustable C-Leg Base Assembly with Crossbeam and Casters for 30"D tables

LACPC3048?^@	Set-Screw C-Leg base with Beam, casters, for 30" x 48" top	\$1062
LACPC3060?^@	Set-Screw C-Leg base with Beam, casters, for 30" x 60" top	\$1062
LACPC3072?^@	Set-Screw C-Leg base with Beam, casters, for 30" x 72" top	\$1062

Tip: Height range is 29"-43" with 1.5" increments (including top).

Tip: Set-Screw Adjustable legs cannot accept the cable management cover.

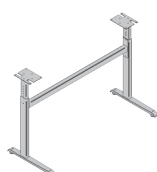
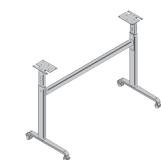

Impression C-Legs with Powerlex Modesty

STEP 1

(^) Paint Suffix List

G Slate Grey
R Black
S Silver
T Medium Tone
W Arctic White
Z Other

Tip: Some Steelcase, Herman Miller, Knoll, Haworth, and Allsteel paints are available for \$350 list fee per order. Call/email for availability of specific colors. Additional custom paints (e.g. Tiger Dry Lac) must be quoted through quotes@enwork.com.

Product Specifications:

- > Powerlex Modesty includes 4-wire power system, 2 duplex receptacles, 4 data openings and jumpers.
- > See page 21 for Powerlex Grommet option, which can be specified in table top.

Ordering Information:

- > For a non-powered version (just modesty with trough and legs) subtract \$300 from the list price and put a "Z" in front of the part number.
- > Installation hardware is included.
- > Base Power-In must be specified with base.
- > **A freight fee of \$100 net is assessed on orders less than \$1000 net. See page 13.**



Part Number	Description	List Price (US\$)
Impression C-Leg Base Assembly with Powerlex Modesty and Levelers, for 24"D tables		
LCP24481^	C-Leg base with Powerlex Modesty, levelers, for 24" x 48" top, Circuit 1	\$1204
LCP24601^	C-Leg base with Powerlex Modesty, levelers, for 24" x 60" top, Circuit 1	\$1353
LCP24721^	C-Leg base with Powerlex Modesty, levelers, for 24" x 72" top, Circuit 1	\$1502
LCP24482^	C-Leg base with Powerlex Modesty, levelers, for 24" x 48" top, Circuit 2	\$1204
LCP24602^	C-Leg base with Powerlex Modesty, levelers, for 24" x 60" top, Circuit 2	\$1353
LCP24722^	C-Leg base with Powerlex Modesty, levelers, for 24" x 72" top, Circuit 2	\$1502

Tip: Powerlex Modesty includes 4-wire power system, 2 duplex receptacles, 4 data openings and jumpers.

Tip: See page 21 for Powerlex Grommet option, which can be specified in table top (strongly recommended).

Tip: If you would like to order a non-powered version (just modesty with trough and legs) subtract \$300 from the list price and put a "Z" in front of the part number.

Tip: Specify Base Power-In (see below).

Impression C-Leg Base Assembly with Powerlex Modesty and Levelers, for 30"D tables

LCP30481^	C-Leg base with Powerlex Modesty, levelers, for 30" x 48" top, Circuit 1	\$1230
LCP30601^	C-Leg base with Powerlex Modesty, levelers, for 30" x 60" top, Circuit 1	\$1380
LCP30721^	C-Leg base with Powerlex Modesty, levelers, for 30" x 72" top, Circuit 1	\$1530
LCP30482^	C-Leg base with Powerlex Modesty, levelers, for 30" x 48" top, Circuit 2	\$1230
LCP30602^	C-Leg base with Powerlex Modesty, levelers, for 30" x 60" top, Circuit 2	\$1380
LCP30722^	C-Leg base with Powerlex Modesty, levelers, for 30" x 72" top, Circuit 2	\$1530

Tip: Powerlex Modesty includes 4-wire power system, 2 duplex receptacles, 4 data openings and jumpers.

Tip: See page 21 for Powerlex Grommet option, which can be specified in table top (strongly recommended).

Tip: If you would like to order a non-powered version (just modesty with trough and legs) subtract \$300 from the list price and put a "Z" in front of the part number.

Tip: Specify Base Power-In (see below).

Base Power-Ins

A8BP72	Base Power-In for Hardwire, 72"	\$168
A8BP120	Base Power-In for Hardwire, 120"	\$203
A1BP72	Base Power-In for RA Plug Circuit 1 (only), 72"	\$239

Tip: Use hardwire in feeds if UL listed (not recognized) is required.

Tip: Infeeds have a 20 amp plug end which requires a 20 amp wall receptacle. A plug adapter is required if using a standard 15 amp receptacle. The adapter is not included and must be purchased separately. Conntek 30129 15-Amp to 20-Amp Plug Adapters and similar are available through amazon.com and at many electrical supply houses.



15 amp Receptacle 20 amp Receptacle

Routing Hole Covers

WCVRB	Routing Hole Cover, Black	\$46
WCVRS	Routing Hole Cover, Silver	\$46
WCVRT	Routing Hole Cover, Medium Tone	\$46

Tip: Powerlex tables have routing holes on the inside of each foot as well as on the outside of each column where power is run from table to table. Routing hole covers can be ordered to cover any unused holes in the foot or at the end of a run.

TOPS

BASES

POWER
DATASUPPORT
FURNITURE

ACCESSORIES

TABLES STEP 2 - IMPRESSION

Notes

Impression Straight Legs and Conference O-Bases

STEP 1

(?) Routing Holes Suffix List

N	No routing holes in leg	no charge
Y	Routing hole in one leg	+\$62

STEP 2 - Legs w/ Casters Only

(@) Caster Color Suffix List:

B	Black	no charge
G	Grey	+\$40

STEP 3 - Steel Legs Only

(^) Paint Suffix List

G	Slate Grey
R	Black
S	Silver
T	Medium Tone
W	Arctic White
Z	Other

Tip: Some Steelcase, Herman Miller, Knoll, Haworth, and Allsteel paints are available for \$350 list fee per order. Call/email for availability of specific colors. Additional custom paints (e.g. Tiger Dry Lac) must be quoted through quotes@enwork.com.

Product Specifications:

- > Straight legs are 3"x1.5". Installation hardware is included.
- > Rectangular aluminum legs have two passageways 5/8" x 1-5/16" per leg. For steel legs there is a single passageway 1-5/16" x 2-3/4".

Ordering Information:

- > Standard height is 27.75". For shorter heights put "X" in front of the part number and add \$54 list. For taller steel legs, put "XX" in front and add \$68 list. Taller height anodized aluminum legs not available. Non-standard heights not available on height-adjustable legs. Maximum worksurface height is 42".
- > **A freight fee of \$100 net is assessed on orders less than \$1000 net. See page 13.**

Part Number	Description	List Price (US\$)
Impression Straight Legs with Levelers		
LPP?^	Straight Leg, Levelers, painted steel	\$193
LPP2?^	Straight Leg, Levelers, painted steel, package of two	\$387
LPPAL?	Straight Leg, Levelers, clear anodized aluminum	\$177
LPPAL2?	Straight Leg, Levelers, clear anodized aluminum, package of two	\$353
Impression Straight Legs with Levelers - Bar Height (42")		
LPPBH?^	Straight Leg, bar height, painted steel	\$261
LPPBH2?^	Straight Leg, bar height, painted steel, package of two	\$523
Impression Straight Legs with Casters		
LPPC^@	Straight Leg, Casters, painted steel	\$212
LPPC2^@	Straight Leg, Casters, painted steel, package of two	\$443
LPPALC@	Straight Leg, Casters, clear anodized aluminum	\$200
LPPALC2@	Straight Leg, Casters, clear anodized aluminum, package of two	\$400
Tip: Routing holes in steel legs are available. Add "Z" prior to part number and add \$18 to list price per leg.		
Impression Set-Screw Adjustable Straight Legs with Levelers		
LPPA^	Set-Screw Straight Leg, levelers, painted steel	\$310
LPPA2^	Set-Screw Straight Leg, levelers, painted steel, package of two	\$622
Tip: Height range is 29"-43" with 1 1/2" inch increments (including top).		
Tip: Set-Screw Adjustable legs cannot accept the cable management cover.		
Impression Set-Screw Adjustable Straight Legs with casters		
LPPAC^@	Set-Screw Straight Leg, casters, painted steel	\$383
LPPAC2^@	Set-Screw Straight Leg, casters, painted steel, package of two	\$766
Tip: Height range is 29"-43" with 1.5" inch increments (including top).		
Tip: Set-Screw Adjustable legs cannot accept the cable management cover.		

COORDINATING FURNITURE

See pages 182-187
for coordinating
Impression furniture.

TOPS

BASES

POWER
DATASUPPORT
FURNITURE

ACCESSORIES

TABLES STEP 2 - IMPRESSION

Part Number **Description** **List Price (US\$)**

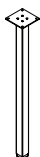
**Impression Square Straight Legs, 1.5" x 1.5", with levelers**

LPPSQ^	Square Straight Leg, painted steel	\$193
LPPSQ2^	Square Straight Leg, painted steel, package of two	\$387
LPPSQAL	Square Straight Leg, clear anodized aluminum	\$175
LPPSQAL2	Square Straight Leg, clear anodized aluminum, package of two	\$349

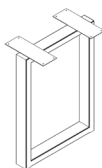
**Impression Conference O-Legs with Levelers, package of one**

LSQCONF18^	Conference O-Leg 36/42"D top	\$292
LSQCONF24^	Conference O-Leg for 48"D top	\$299
LSQCONF30^	Conference O-Leg for 54"D top	\$320
LSQCONF36^	Conference O-Leg for 60"D top	\$344

Tip: For cable manager use the LPCMC cover below.

Tip: For O-Legs for worksurfaces, see page 310.

**Impression Cable Management Covers**

LPCM^	Cable Management Cover for Leg with Leveler	\$57
LPCMC^	Cable Management Cover for Leg with Caster	\$57
LPCMA^	Cable Management Cover for Flip Table with Casters	\$57

Tip: Does not fit LPPSQAL and LPPSQ square legs.

Tip: Creates a 3/8" gap for cable routing.

Impression X-Bases

STEP 1 - 4-Post X-Base Only

(?) Routing Holes Suffix List

- N No routing holes in leg no charge
- Y Routing hole in one leg +\$62

STEP 2 - Steel Legs Only

(^) Paint Suffix List

- G Slate Grey
- R Black
- S Silver
- T Medium Tone
- W Arctic White
- Z Other

Tip: Some Steelcase, Herman Miller, Knoll, Haworth, and Allsteel paints are available for \$350 list fee per order. Call/email for availability of specific colors. Additional custom paints (e.g. Tiger Dry Lac) must be quoted through quotes@enwork.com.

STEP 3 - Legs w/ Casters Only

(@) Caster Color Suffix List:

- B Black no charge
- G Grey +\$40

STEP 1 - Infill Only

(#) Laminate Suffix List:

- A Wilsonart Kensington Maple (10776-60) no charge
- B Wilsonart Monticello Maple (7925-38) no charge
- C Wilsonart Wild Cherry (7054-60) no charge
- E Wilsonart Fashion Grey (D381-60) no charge
- G Wilsonart Cafelle (7933K-07) no charge
- M Wilsonart Frosty White (1573-60) no charge
- P Wilsonart Slate Grey (D91-60) no charge
- R Wilsonart Black (1595-60) no charge
- U Wilsonart Brazilwood (7946-38) no charge
- V Wilsonart River Cherry (7937-38) no charge
- W Wilsonart Designer White (D354-60) no charge
- 3 Formica Neutral Twill (8826-58) no charge
- 4 Formica Bleached Legno (8845-58) no charge
- 5 Formica Prestige Walnut (6209-43) no charge
- 7 Formica Select Cherry (7759-43) no charge
- X *Wilsonart Non-Premium laminates (-38, -60) +\$60
- Y *Formica Non-Premium (includes 58, 43, -07, -12, -18, -52, -78), and whiteboard laminate. +\$90

*Add \$350 list for Special Laminate orders of less than 10 units. See page 21 for edge selection.

Ordering Information:

- > Standard height is 27.75". For shorter heights put "X" in front of the part number and add \$54 list (\$108 for a 4-post x-base). For taller steel legs, put "XX" in front and add \$68 list (\$136 for a 4-post x-base). Non-standard heights not available on height-adjustable legs. Maximum worksurface height is 42".
- > A freight fee of \$100 net is assessed on orders less than \$1000 net. See page 13.



Part Number	Description	List Price (US\$)
-------------	-------------	-------------------

Impression X-Bases with Levelers

LXPA^	X-base, levelers, for 24" round top (spread 22" x 22")	\$653
LXPB^	X-base, levelers, for 30-36" round or 24"-30" sq top (26" x 26" spread)	\$668
LXPC^	X-base, levelers for 42" round or 36" sq top (32" x 32" spread)	\$681
LXPD^	X-base, levelers for 48" round or 42" sq top (38" x 38" spread)	\$695

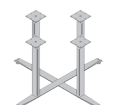

Impression 4-Post X-Base with Levelers

LXPE?^	4-Post X-base, levelers, for 54"-84" round top (spread 48" x 48")	\$1676
LXPEF#	Laminate Infill (no door) for LXPE	\$1043
LXPENFD#	Laminate Infill (with door) for LXPE	\$1217

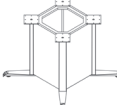

Impression X-Bases with Levelers - Bar Height

LXPBBA^	X-base, bar height, levelers, for 24" round top (22" x 22" spread)	\$708
LXPBBB^	X-base, bar height, levelers, for 30-36" round or 24" - 30" sq top (26" x 26" spread)	\$700
LXPBBC^	X-base, bar height, levelers, for 42" round or 36" sq top (32" x 32" spread)	\$735
LXPBBD^	X-base, bar height, levelers, for 48" round or 42" sq top (38" x 38" spread)	\$749

Impression 4-Post X-Base with Levelers - Bar Height

LXPBE?^	4-Post X-base, bar height, levelers, for 54"-72" round top (48" x 48" spread)	\$1775
LXPBEF#	Laminate Infill (no door) for LXPBE (bar height)	\$1313
LXPBENFD#	Laminate Infill (with door) for LXPBE (bar height)	\$1530



Impression X-Bases on Casters

LXPAC^@	X-base, casters, for 24" round top (22" x 22" spread)	\$763
LXPBC^@	X-base, casters, for 30-36" round or 24"-30" sq top (26" x 26" spread)	\$778
LXPCC^@	X-base, casters, for 42" round or 36" sq top (32" x 32" spread)	\$791
LXPDC^@	X-base, casters, for 48" round or 42" sq top (38" x 38" spread)	\$806



Impression 4-Post X-Base with Casters

LXPEC?^@	4-Post X-base, casters, for 54"-84" round top (48" x 48" spread)	\$1667
----------	--	--------

COORDINATING FURNITURE

See pages 182-187
for coordinating
Impression furniture.

TOPS

BASES

POWER
DATASUPPORT
FURNITURE

ACCESSORIES

TABLES STEP 2 - IMPRESSION

Part Number Description List Price (US\$)

**Impression X-Bases with Power/Data Top Plate and Levelers**

LX3PA^	X-base w/ P/D Top Plate, levelers, for 24" round top (22" x 22" spread)	\$761
LX3PB^	X-base w/ P/D Top Plate, levelers, for 30-36" round or 24-30" sq top (26" x 26" spread)	\$776
LX3PC^	X-base w/ P/D Top Plate, levelers, for 42" round or 36" sq top (32" x 32" spread)	\$790
LX3PD^	X-base w/ P/D Top Plate, levelers, for 48" round or 42" sq top (38" x 38" spread)	\$801

Tip: Includes hole in bottom of leg for cable management and special top plate that allows room for power/data in center of top.

Tip: Top plate can accommodate the Flip-n-Go, Villa, Cove, and Single-Sided Ellora power data units.

Impression X-Bases with Power/Data Top Plate and Levelers - Bar Height

LX3PBBA^	X-base w/ P/D Top Plate, bar height, levelers, for 24" round top (22" x 22" spread)	\$817
LX3PBBB^	X-base w/ P/D Top Plate, bar height, levelers, for 30-36" round or 24"-30" sq top (26" x 26" spread)	\$840
LX3PBBC^	X-base w/ P/D Top Plate, bar height, levelers, for 42" round or 36" sq top (32" x 32" spread)	\$845
LX3PBBD^	X-base w/ P/D Top Plate, bar height, levelers, for 48" round or 42" sq top (38" x 38" spread)	\$856

Tip: Includes hole in bottom of leg for cable management and special top plate that allows room for power/data in center of top.

Tip: Top plate can accommodate the Flip-n-Go, Villa, Cove, and Single-Sided Ellora power data units.

**Impression X-Bases with Power/Data Top Plate and Casters**

LX3PAC^@	X-base w/ P/D Top Plate, casters, for 24" round top (22" x 22" spread)	\$869
LX3PBC^@	X-base w/ P/D Top Plate, casters, for 30-36" round or 24-30" sq top (26" x 26" spread)	\$885
LX3PCC^@	X-base w/ P/D Top Plate, casters, for 42" round or 36" sq top (32" x 32" spread)	\$897
LX3PDC^@	X-base w/ P/D Top Plate, casters, for 48" round or 42" sq top (38" x 38" spread)	\$910

Tip: Includes hole in bottom of leg for cable management and special top plate that allows room for power/data in center of top.

Tip: Top plate can accommodate the Flip-n-Go, Villa, Cove, and Single-Sided Ellora power data units.

**Impression Flip X-Bases on Casters**

LXPAAC^@	Flip X-base, casters, for 24" round top (22" x 22" spread)	\$1094
LXPABC^@	Flip X-base, casters, for 30-36" round or 24-30" sq top (26" x 26" spread)	\$1108
LXPACC^@	Flip X-base, casters, for 42" round or 36" sq top (32" x 32" spread)	\$1122
LXPADC^@	Flip X-base, casters, for 48" round or 42" sq top (38" x 38" spread)	\$1092

Impression Crank Bases

STEP 1

(^) Paint Suffix List

G Slate Grey
R Black
S Silver
T Medium Tone
W Arctic White
Z Other

Tip: Some Steelcase, Herman Miller, Knoll, Haworth, and Allsteel paints are available for \$350 list fee per order. Call/email for availability of specific colors. Additional custom paints (e.g. Tiger Dry Lac) must be quoted through quotes@enwork.com.

Ordering Information:

- > Tops ordered separately.
- > Ships unassembled.
- > Installation hardware is included.
- > Use Solano Fast Crank height-adjustable bases, with Sit/Stand height range of 26"-44" (with top), as a less expensive alternative.
- > **A freight fee of \$100 net is assessed on orders less than \$1000 net. See page 13.**



Part Number	Description	List Price (US\$)
-------------	-------------	-------------------

Impression Crank Adjustment C-Leg Base Assemblies with Levelers for Rectangular Tables

LF4AER24^	Crank C-Leg Base for 24"x 48"-72"W Table (foot depth is 22")	\$1769
LF4AER30^	Crank C-Leg Base for 30"x 48"-72"W Table (foot depth is 26")	\$1795

Tip: Adjustment range is 27" to 45" (including top).

Tip: For shorter widths (36"-42") put a "W" in front of the part number. For longer widths (78"-96") put a "Z" in front of the part number.



Impression Crank Adjustment C-Leg Base Assemblies with Casters for Rectangular Tables

LF4AERC24^	Crank C-Leg Base for 24"x 48"-72"W Table (foot depth is 22")	\$1849
LF4AERC30^	Crank C-Leg Base for 30"x 48"-72"W Table (foot depth is 26")	\$1876

Tip: Adjustment range is 27" to 45" (including top).

Tip: For shorter widths (36"-42") put a "W" in front of the part number. For longer widths (78"-96") put a "Z" in front of the part number.

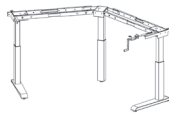

Impression Crank Adjustment 2-Legged C-Leg Base Assembly with Levelers for Corner Tables

LF4AEC24^	Crank 2-Leg, C-Leg Base for 24"D corner table (foot depth is 22")	\$1742
-----------	---	--------

Impression Crank Adjustment 3-Legged C-Leg Base Assembly with Levelers for 120-Degree Tables

LF4AET24^	Crank 3-Leg, C-Leg Base for 24"x 24"x 48"x 48" top (foot depth is 22")	\$2877
-----------	--	--------

Tip: Adjustment range is 28.5" to 46.5" (including top).

Five and a half cranks per inch.

Impression Crank Adjustment 3-Legged C-Leg Base Assembly with Levelers for L-Workstations

LF4AEL24^	Crank 3-Leg, C-Leg Base for 24"x 24"x 72"x 72" 90 degree top (foot depth is 22")	\$2804
-----------	--	--------

Tip: Adjustment range is 28.5" to 46.5" (including top).

Five and a half cranks per inch.

TOPS

BASES

POWER
DATASUPPORT
FURNITURE

ACCESSORIES

TABLES STEP 2 - IMPRESSION

Notes

Impression XT-Series ANSI/BIFMA Electric Adjustable Bases

STEP 1

(^) Paint Suffix List

G Slate Grey
R Black
S Silver
T Medium Tone
W Arctic White
Z Other

Tip: Some Steelcase, Herman Miller, Knoll, Haworth, and Allsteel paints are available for \$350 list fee per order. Call/email for availability of specific colors. Additional custom paints (e.g. Tiger Dry Lac) must be quoted through quotes@enwork.com.

Product Specifications:

- > 250 pound load capacity.
- > Bosch Electric motor present in each leg.
- > Adjusts up to 1.6 inch/second.
- > Adjusts via included up/down controller (no display).
- > Height adjustment range of 22.6" - 48.3" high (with top). Meets ANSI/BIFMA specifications.
- > Bases are 2-stage (3-tube).

Ordering Information:

- > Installation hardware is included.
- > Tops sold separately.
- > Ships unassembled.
- > Available as a 2-leg and 3-leg model as standard (4-leg as special).
- > Optional programmable digital display available on next page.
- > Use Solano VT Electric height-adjustable bases, with Sit/Stand height range of 24" - 49.5" (with top), as a less expensive alternative.
- > **A freight fee of \$100 net is assessed on orders less than \$1000 net. See page 13.**

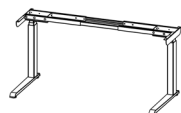

Part Number	Description	List Price (US\$)
-------------	-------------	-------------------

Impression XT-Series 2-Legged, 2-Stage (3-tube) Electric Adjustment C-leg Base Assemblies for Rectangle Tables

LFAER24^	XT 2-Leg, 2-stage (3-tube) Electric Base, Levelers, for 24"D rectangle table	\$2385
LFAER30^	XT 2-Leg, 2-stage (3-tube) Electric Base, Levelers, for 30"D rectangle table	\$2411
LFAERC24^	XT 2-Leg, 2-stage (3-tube) Electric Base, Casters, for 24"D rectangle table	\$2535
LFAERC30^	XT 2-Leg, 2-stage (3-tube) Electric Base, Casters, for 30"D rectangle table	\$2510

Tip: For use on 48" - 72" wide rectangle tops (adjustable cross bar).

Tip: For shorter widths (36"-42") put a "W" in front of the part number. For longer widths (78"-96") put a "Z" in front of the part number.

Tip: On bases with casters, the height range changes to 24.1" - 49.8", not ANSI/BIFMA.

Impression XT-Series 2-Legged, 2-Stage (3-tube) Electric Adjustment C-Leg Base Assembly with Levelers for Corner Tables

LFAEC24^	XT 2-Leg, 2-stage (3-tube) Electric Base for 24"D corner table	\$2405
----------	--	--------

Tip: For use on 24"D tops, 42" - 48" wide corners only (adjustable cross bar).

Impression XT-Series 2-Legged, 2-Stage (3-tube) Electric Adjustment C-Leg Base Assembly with Angled Feet and Levelers for 120-Degree Tables

LFAEJ24^	XT 2-Leg, 2-stage (3-tube) Electric Base, angled feet, for 120-Degree table	\$2687
----------	---	--------

Tip: For use on 24"D tops, 36" - 48" wide per side (adjustable cross bar).

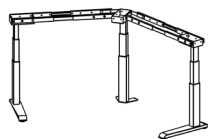

Impression XT-Series 3-Legged, 2-Stage (3-tube) Electric Adjustment C-Leg Base Assembly with Levelers for 120-Degree Tables

LFAET24^	XT 3-Leg, 2-stage (3-tube) Electric Base, for 120-Degree table	\$3811
----------	--	--------

Tip: For use on 24"D tops, 36" - 48" wide per side (adjustable cross bar).

Tip: For shorter or longer widths on 3-legged bases, contact quotes@enwork.com.

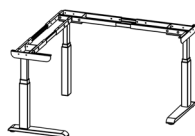

Impression XT-Series 3-Legged, 2-Stage (3-tube) Electric Adjustment C-Leg Base Assembly with Levelers for L-Workstations

LFAEL24^	XT 3-Leg, 2-stage (3-tube) Electric Base, for L-Workstation	\$3739
----------	---	--------

Tip: For use on 24"D tops, 48" - 72" wide (adjustable cross bar).

Tip: For shorter or longer widths on 3-legged bases, contact quotes@enwork.com.

Impression XT-Series Sit/Stand Electric Adjustable Bases

Product Specifications:

- > Adjusts via included up/down controller (no display).
- > 250 pound load capacity.
- > Adjustment range is 26" - 45" (including top).
- > Bases are 1-stage (2-tube).

Ordering Information:

- > Installation hardware is included.
- > Tops sold separately.
- > Ships unassembled.
- > Optional programmable digital display available.
- > For shorter widths (36"-42") put a "W" in front of the part number. For longer widths (78"-96") put a "Z" in front of the part number.
- > **A freight fee of \$100 net is assessed on orders less than \$1000 net. See page 13.**

TOPS

BASES

POWER
DATASUPPORT
FURNITURE

ACCESSORIES

TABLES STEP 2 - IMPRESSION

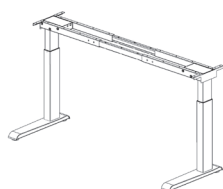

Part Number	Description	List Price (US\$)
-------------	-------------	-------------------

Impression XT-Series 2-Legged, 1-Stage (2-tube) Electric Adjustment C-Leg Base Assemblies for Rectangle Tables

LF2AER24^	XT 2-Leg, 1-stage (2-tube) Electric Base, Levelers, for 24"D rectangle table	\$2198
LF2AER30^	XT 2-Leg, 1-stage (2-tube) Electric Base, Levelers, for 30"D rectangle table	\$2223
LF2AERC24^	XT 2-Leg, 1-stage (2-tube) Electric Base, Casters, for 24"D rectangle table	\$2275
LF2AERC30^	XT 2-Leg, 1-stage (2-tube) Electric Base, Casters, for 30"D rectangle table	\$2308

Tip: For use on 48" - 72" wide rectangle tops (adjustable cross bar).

Tip: For shorter widths (36"-42") put a "W" in front of the part number. For longer widths (78"-96") put a "Z" in front of the part number.

Tip: On bases with casters, the height range changes to 27.5"-46.5".

Impression XT-Series 2-Legged, 1-Stage (2-tube) Electric Adjustment C-Leg Base Assembly for Corner Tables

LF2AEC24^	XT 2-Leg, 1-stage (2-tube) Electric Base for 24"D corner table	\$2173
-----------	--	--------

Tip: For use on 24"D tops, 42" - 48" wide corners only (adjustable cross bar).

Impression XT-Series 2-Legged, 1-Stage (2-tube) Electric Adjustment C-Leg Base Assembly w/ Angled Feet & Levelers for 120-Degree Tables

LF2AEJ24^	XT 2-Leg, 1-stage (2-tube) Electric Base, angled feet, for 120-Degree table	\$2480
-----------	---	--------

Tip: For use on 24"D tops, 36" - 48" wide per side (adjustable cross bar).

Impression XT-Series 3-Leg, 1-Stage (2-tube) Electric Adjustment C-Leg Base Assembly for 120-Degree Tables

LF2AET24^	XT 3-Leg, 1-stage (2-tube) Electric Base, for 120-Degree table	\$3459
-----------	--	--------

Tip: For use on 24"D tops, 36" - 48" wide per side (adjustable cross bar).

Tip: For shorter or longer widths on 3-legged bases, contact quotes@enwork.com.

Impression XT-Series 3-Legged, 1-Stage (2-tube) Electric Adjustment C-Leg Base Assembly for L-Workstations

LF2AEL24^	XT 3-Leg, 1-stage (2-tube) Electric Electric Base, for L-Workstation	\$3387
-----------	--	--------

Tip: For use on 24"D tops, 48" - 72" wide (adjustable cross bar).

Tip: For shorter or longer widths on 3-legged bases, contact quotes@enwork.com.

XT-Series Programmable Controller with Digital Read-Out Display (Optional)

LFADD2	Programmable Controller, Digital Display, for XT-Series bases, black	\$145
--------	--	-------

Tip: Digital display allows five preset programmable stops.

Impression Classroom Tables (Complete Tables) & Power Kits

STEP 1

(^) Paint Suffix List

G Slate Grey
R Black
S Silver
T Medium Tone
W Arctic White
Z Other

Tip: Some Steelcase, Herman Miller, Knoll, Haworth, and Allsteel paints are available for \$350 list fee per order. Call/email for availability of specific colors. Additional custom paints (e.g. Tiger Dry Lac) must be quoted through quotes@enwork.com.

STEP 2

(#) Laminate Suffix List:

A Wilsonart Kensington Maple (10776-60)
B Wilsonart Monticello Maple (7925-38)
C Wilsonart Wild Cherry (7054-60)
E Wilsonart Fashion Grey (D381-60)
F Wilsonart White Tigris (4783-60)
G Wilsonart Cafelle (7933K-07)
M Wilsonart Frosty White (1573-60)
P Wilsonart Slate Grey (D91-60)
R Wilsonart Black (1595-60)
U Wilsonart Brazilwood (7946-38)
V Wilsonart River Cherry (7937-38)
W Wilsonart Designer White (D354-60)
3 Formica Neutral Twill (8826-58)
4 Formica Bleached Legno (8845-58)
5 Formica Prestige Walnut (6209-43)
7 Formica Select Cherry (7759-43)
X *Wilsonart Non-Premium laminates (-38, +\$36 -60). Orders of 100+ units have no upcharge.
Y *Formica Non-Premium Standard (58, 43, +\$50 MC, SP and NT finishes) and Wilsonart Premium (-01, -07, -12, -18, -52, -78) laminates.
Z *Pionite Non-Premium, Nevamar Non-Premium, Formica Premium (WR, 42, 77, 46, RD Finishes), and whiteboard laminate.

*Add \$350 list for Special Laminate orders of less than 10 units. See page 21 for edge selection.

Product Specifications:

- > Inner and outer back panels are steel
- > Monitor lifts accept monitors that adhere to the VESA Mounting Standard
- > Contains storage for keyboards and mouse with monitor. Monitor storage is released by pushing down on top.
- > Includes a cable trough in the bottom for plug strips or hardwire power.
- > Includes cable management kit.

Ordering Information:

- > Worksurface included.
- > Ships assembled.
- > See maximum monitor sizes (diagonal measurement) below. For larger sizes email quotes@enwork.com.
- > Powerlex Modesty includes 4-wire power system and 2 duplex receptacles. In a Classroom Table, the receptacles are concealed within the modesty (not user accessible). For user access, specify a cut-out in Step 1. Use Villa, Axil-X, or Cove. For other power/data solutions, contact quotes@enwork.com. Power/data units are ordered separately.
- > **A freight fee of \$100 net is assessed on orders less than \$1000 net. See page 13.**

Part Number	Description	List Price (US\$)
-------------	-------------	-------------------

Impression Classroom Tables with Levelers

L2CP3030^#	Classroom Table, 30"D x 30"W	\$1789
------------	------------------------------	--------

Tip: Minimal room underneath table for CPU holder - affects kneespace.

L2CP3036^#	Classroom Table, 30"D x 36"W	\$1885
------------	------------------------------	--------

Tip: Room exists underneath table for two CPU holders. (ordered separately)

L2CP3060^#	Classroom Table, 30"D x 60"W	\$2572
------------	------------------------------	--------

Tip: Minimal room underneath table for CPU holder - affects kneespace.

L2CP3072^#	Classroom Table, 30"D x 72"W	\$3185
------------	------------------------------	--------

Tip: Room exists underneath table for two CPU holders. (ordered separately)

Impression Classroom Tables with Monitor Lift(s) and Levelers

L2CM3030^#	Classroom Table with Single Monitor Lift, 30"D x 30"W	\$3221
------------	---	--------

Tip: Works with most flat screens, 23" diagonal monitor or smaller. Maximum monitor weight is 20 lbs.

Tip: Minimal room underneath table for CPU holder - affects kneespace.

L2CM3036^#	Classroom Table with Single Monitor Lift, 30"D x 36"W	\$3357
------------	---	--------

Tip: Works with most flat screens, 25" diagonal monitor or smaller. Maximum monitor weight is 20 lbs.

Tip: Room exists underneath table for two CPU holders. (ordered separately)

L2CM3060^#	Classroom Table with Double Monitor Lift, 30"D x 60"W	\$5777
------------	---	--------

Tip: Works with most flat screens, 23" diagonal monitor or smaller. Maximum monitor weight is 20 lbs.

Tip: Minimal room underneath table for CPU holder - affects kneespace.

L2CM3072^#	Classroom Table with Double Monitor Lift, 30"D x 72"W	\$5935
------------	---	--------

Tip: Works with most flat screens, 25" diagonal monitor or smaller. Maximum monitor weight is 20 lbs.

Tip: Room exists underneath table for two CPU holders. (ordered separately)

COORDINATING FURNITURE

See pages 184-187
for coordinating Command
Centers and Lecterns.

TOPS

BASES

POWER
DATASUPPORT
FURNITURE

ACCESSORIES

TABLES STEP 2 - IMPRESSION

Part Number	Description	List Price (US\$)
Classroom Table Power Kits (Optional)		
L2CMP130	Kit for 30"W Classroom Table, 2 duplex receptacles, no data, two jumpers, Circuit 1	\$261
L2CMP136	Kit for 36"W Classroom Table, 2 duplex receptacles, no data, two jumpers, Circuit 1	\$265
L2CMP160	Kit for 60"W Classroom Table, 2 duplex receptacles, no data, two jumpers, Circuit 1	\$287
L2CMP172	Kit for 72"W Classroom Table, 2 duplex receptacles, no data, two jumpers, Circuit 1	\$302
L2CMP230	Kit for 30"W Classroom Table, 2 duplex receptacles, no data, two jumpers, Circuit 2	\$261
L2CMP236	Kit for 36"W Classroom Table, 2 duplex receptacles, no data, two jumpers, Circuit 2	\$265
L2CMP260	Kit for 60"W Classroom Table, 2 duplex receptacles, no data, two jumpers, Circuit 2	\$287
L2CMP272	Kit for 72"W Classroom Table, 2 duplex receptacles, no data, two jumpers, Circuit 2	\$302

Base Power Infeeds

A8BP72	Base Power Infeed for Hardwire, 72"	\$168
A8BP120	Base Power Infeed for Hardwire, 120"	\$203
A1BP72	Base Power Infeed for RA Plug Circuit 1 (only), 72"	\$239

Tip: Use hardwire infeeds if UL listed (not recognized) is required.

Tip: Infeeds have a 20 amp plug end which requires a 20 amp wall receptacle. A plug adapter is required if using a standard 15 amp receptacle. The adapter is not included and must be purchased separately. Conntek 30129 15-Amp to 20-Amp Plug Adapters and similar are available through amazon.com and at many electrical supply houses.



15 amp Receptacle 20 amp Receptacle

Routing Hole Cover

WCVRB	Routing Hole Cover, Black	\$46
WCVRS	Routing Hole Cover, Silver	\$46
WCVRT	Routing Hole Cover, Medium Tone	\$46

Tip: Classroom tables have routing holes on the inside of each foot as well as on the outside of each column where power is run from table to table. Routing hole covers can be ordered to cover any unused holes in the foot or at the end of a run.

Landing™ Team Tables (Complete Tables)

STEP 1

(#) Cable Management Suffix List:

N	No Cable Management	No charge
G	Grommet (one, center)	+\$18
K	One Power/Data Cut-out, Centered	+\$36
C	Two Power/Data Cut-outs	+\$72
X	Other	TBD

STEP 2

(@) Laminate Suffix List:

A	Wilsonart Kensington Maple (10776-60)	no charge
B	Wilsonart Monticello Maple (7925-38)	no charge
C	Wilsonart Wild Cherry (7054-60)	no charge
E	Wilsonart Fashion Grey (D381-60)	no charge
G	Wilsonart Cafelle (7933K-07)	no charge
M	Wilsonart Frosty White (1573-60)	no charge
P	Wilsonart Slate Grey (D91-60)	no charge
R	Wilsonart Black (1595-60)	no charge
U	Wilsonart Brazilwood (7946-38)	no charge
V	Wilsonart River Cherry (7937-38)	no charge
W	Wilsonart Designer White (D354-60)	no charge
3	Formica Neutral Twill (8826-58)	no charge
4	Formica Bleached Legno (8845-58)	no charge
5	Formica Prestige Walnut (6209-43)	no charge
7	Formica Select Cherry (7759-43)	no charge
X	*Wilsonart Non-Premium laminates (-38, -60)	+35%
Y	*Formica Non-Premium (includes 58, 43, MC, SP, and NT finishes), Formica Premium (WR, 42, 77, 46, RD finishes), Pionite Non-Premium, Nevamar Non-Premium, Wilsonart Premium (-01, -07, -12, -18, -52, -78), and whiteboard laminate.	+45%

*Add \$350 list for Special Laminate orders of less than 10 units. See page 21 for edge selection.

Product Specifications:

> Double support panels (12"H) run the entire length of the top to hide power data units and cables.

Ordering Information:

> Part number includes entire table (ie. top, sides, and structure).

> Tables 108" and longer have a center panel.

> Assembly required.

> **A freight fee of \$100 net is assessed on orders less than \$1000 net. See page 13.**

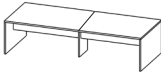
Part Number	Description	List Price (US\$)
Laminate Landing Team Tables - 29" Seated Height		
	NEL293672#@ Team Table, seated, 36"D x 72"W	\$1216
	NEL293684#@ Team Table, seated, 36"D x 84"W	\$1450
	NEL293696#@ Team Table, seated, 36"D x 96"W	\$1450
	NEL294272#@ Team Table, seated, 42"D x 72"W	\$1450
	NEL294284#@ Team Table, seated, 42"D x 84"W	\$1716
	NEL294296#@ Team Table, seated, 42"D x 96"W	\$1716
	NEL294872#@ Team Table, seated, 48"D x 72"W	\$1450
	NEL294884#@ Team Table, seated, 48"D x 84"W	\$1716
	NEL294896#@ Team Table, seated, 48"D x 96"W	\$1716
	NEL296096#@ Team Table, seated, 60"D x 96"W	\$2136
	NEL2948108#@ Team Table, seated, 48"D x 108"W (2 piece top)	\$2961
	NEL2948120#@ Team Table, seated, 48"D x 120"W (2 piece top)	\$2961
	NEL2948132#@ Team Table, seated, 48"D x 132"W (2 piece top)	\$3138
	NEL2948144#@ Team Table, seated, 48"D x 144"W (2 piece top)	\$3138
	NEL2960108#@ Team Table, seated, 60"D x 108"W (2 piece top)	\$3131
	NEL2960120#@ Team Table, seated, 60"D x 120"W (2 piece top)	\$3131
	NEL2960132#@ Team Table, seated, 60"D x 132"W (2 piece top)	\$3432
	NEL2960144#@ Team Table, seated, 60"D x 144"W (2 piece top)	\$3432



Laminate Wire Chases for 29"H Seated Height Landing Team Tables, Package of two (one for each end)

NELPM29@	Laminate Wire Chases for Landing Team Table, seated	\$515
----------	---	-------

TOPS

BASES

POWER
DATASUPPORT
FURNITURE

ACCESSORIES

TABLES STEP 2 - LANDING

Part Number	Description	List Price (US\$)
-------------	-------------	-------------------

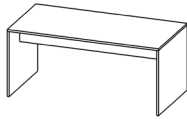
Laminate Landing Team Tables - 42" Standing Height

NEL423672#@	Team Table, standing, 36"D x 72"W	\$1569
NEL423684#@	Team Table, standing, 36"D x 84"W	\$1805
NEL423696#@	Team Table, standing, 36"D x 96"W	\$1805
NEL424272#@	Team Table, standing, 42"D x 72"W	\$1716
NEL424284#@	Team Table, standing, 42"D x 84"W	\$1981
NEL424296#@	Team Table, standing, 42"D x 96"W	\$1981
NEL424872#@	Team Table, standing, 48"D x 72"W	\$1716
NEL424884#@	Team Table, standing, 48"D x 84"W	\$1981
NEL424896#@	Team Table, standing, 48"D x 96"W	\$1981
NEL426096#@	Team Table, standing, 60"D x 96"W	\$2460

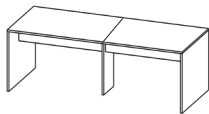

NEL4248108#@	Team Table, standing, 48"D x 108"W (2 piece top)	\$3049
NEL4248120#@	Team Table, standing, 48"D x 120"W (2 piece top)	\$3049
NEL4248132#@	Team Table, standing, 48"D x 132"W (2 piece top)	\$3226
NEL4248144#@	Team Table, standing, 48"D x 144"W (2 piece top)	\$3226
NEL4260108#@	Team Table, standing, 60"D x 108"W (2 piece top)	\$3455
NEL4260120#@	Team Table, standing, 60"D x 120"W (2 piece top)	\$3455
NEL4260132#@	Team Table, standing, 60"D x 132"W (2 piece top)	\$3757
NEL4260144#@	Team Table, standing, 60"D x 144"W (2 piece top)	\$3757

**Laminate Wire Chases for 42"H Standing Height Landing Team Tables,
Package of two (one for each end)**

NELPM42@	Laminate Wire Chases for Landing Team Table, standing	\$565
----------	---	-------

Lugano™ Fixed Height & Height-Adjustable Conference Bases

STEP 1

(#) Laminate Suffix List:

A	Wilsonart Kensington Maple (10776-60)	no charge
B	Wilsonart Monticello Maple (7925-38)	no charge
C	Wilsonart Wild Cherry (7054-60)	no charge
E	Wilsonart Fashion Grey (D381-60)	no charge
G	Wilsonart Cafelle (7933K-07)	no charge
M	Wilsonart Frosty White (1573-60)	no charge
P	Wilsonart Slate Grey (D91-60)	no charge
R	Wilsonart Black (1595-60)	no charge
U	Wilsonart Brazilwood (7946-38)	no charge
V	Wilsonart River Cherry (7937-38)	no charge
W	Wilsonart Designer White (D354-60)	no charge
3	Formica Neutral Twill (8826-58)	no charge
4	Formica Bleached Legno (8845-58)	no charge
5	Formica Prestige Walnut (6209-43)	no charge
7	Formica Select Cherry (7759-43)	no charge
X	*Wilsonart Non-Premium laminates (-38, -60)	+\$360
Y	*Formica Non-Premium (includes 58, 43, MC, SP, and NT finishes), and Formica Premium (WR, 42, 77, 46, RD finishes) laminate.	+\$684
Z	* Pionite Non-Premium, Nevamar Non-Premium, Wilsonart Premium (-01, -07, -12, -18, -52, -78), and whiteboard laminate.	+\$900

*Add \$350 list for Special Laminate orders of less than 10 units. See page 21 for edge selection.

STEP 2

(^) Paint Suffix List

G	Slate Grey
R	Black
S	Silver
T	Medium Tone
W	Arctic White
Z	Other

Tip: Some Steelcase, Herman Miller, Knoll, Haworth, and Allsteel paints are available for \$350 list fee per order. Call/email for availability of specific colors. Additional custom paints (e.g. Tiger Dry Lac) must be quoted through quotes@enwork.com.

Product Specifications:

- > Post-form laminate base cabinet
- > 11 and 14 gauge steel mitered top structure to support extended top oversails
- > 11 and 14 gauge steel mitered, tapered plinth
- > Internal wire and cable routing passage
- > Each base includes one removable access door for positioning technology and routing cables

Ordering Information:

- > Tapered plinth and top structure painted to match
- > Power Data assemblies can be positioned directly over the center of bases. For other P/D positions, contact quotes@enwork.com.
- > Only Alexander, Ellora (excluding PDE8), Flip-n-Go, Cove, and Villa power data assemblies fit over Lugano bases. For other P/D assemblies, contact Quotes@enwork.com.
- > Bases on this page can be used with Conference Rectangle, Boat and Capsule tops.
- > Tops are ordered separately.
- > Lugano bases shipped assembled. Bases are heavy and bulky, which may require disassembly in the field during installation.
- > **A freight fee of \$100 net is assessed on orders less than \$1000 net. See page 13.**

Part Number	Description	List Price (US\$)
-------------	-------------	-------------------



Lugano Square Conference Base, Seated Height (30")

LU1S2942A#^	Square, Seated Base for 42"-48" top	\$6616
LU1S2954B#^	Square, Seated Base for 54" top	\$6792
LU1S2960C#^	Square, Seated Base for 60" top	\$7207



Lugano Rectangle Conference Base, Seated Height (30")

LU12942A#^	Rectangle, Seated Base for 42"-48"D x 72"-84"W top	\$6868
LU12942B#^	Rectangle, Seated Base for 42"-48"D x 96"-108"W top	\$8226
LU12942C#^	Rectangle, Seated Base for 42"-48"D x 120"-132"W top	\$9700
LU12942D#^	Rectangle, Seated Base for 42"-48"D x 144"W top	\$10,896

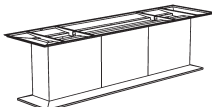

LU12954A#^	Rectangle, Seated Base for 54"D x 72"-84"W top	\$7123
LU12954B#^	Rectangle, Seated Base for 54"D x 96"-108"W top	\$8631
LU12954C#^	Rectangle, Seated Base for 54"D x 120"-132"W top	\$10,062
LU12954D#^	Rectangle, Seated Base for 54"D x 144"W top	\$11,222
LU12960A#^	Rectangle, Seated Base for 60"D x 72"-84"W top	\$7999
LU12960B#^	Rectangle, Seated Base for 60"D x 96"-108"W top	\$9358
LU12960C#^	Rectangle, Seated Base for 60"D x 120"-132"W top	\$10,649
LU12960D#^	Rectangle, Seated Base for 60"D x 144"W top	\$11,917

Product Specifications:

- > Post-form laminate base cabinet
- > 11 and 14 gauge steel mitered top structure to support extended top oversails
- > 11 and 14 gauge steel mitered, tapered plinth
- > Internal wire and cable routing passage
- > Each base includes one removable access door for positioning technology and routing cables
- > Electric height-adjustable base adjustment range 30" – 49.5"
- > Electric height-adjustable base supports 200 lbs. load
- > Adjusts up to .75 inch/second. Adjustment speed may be slower with Back-painted Glass, Luminesse, and KrystalCast® tops.
- > Lugano bases on this page can be used with Laminate, Veneer, Back-painted Glass, KrystalCast®, Statement and Luminesse tops. Cambria Quartz and Solid Surface tops cannot be paired with a Lugano height-adjustable base, specify a fixed-height Lugano base instead.

Ordering Information:

- > Tapered plinth and top structure painted to match
- > Power Data assemblies can be positioned directly over the center of bases. For other P/D positions, contact quotes@enwork.com.
- > Only Alexander, Ellora (excluding PDE8), Flip-n-Go, Cove, and Villa power data assemblies fit over Lugano bases. For other P/D assemblies, contact Quotes@enwork.com.
- > Bases on this page can be used with Conference Rectangle, Boat and Capsule tops.
- > Tops are ordered separately.
- > Lugano bases shipped assembled. Bases are heavy and bulky, which may require disassembly in the field during installation.
- > **A freight fee of \$100 net is assessed on orders less than \$1000 net. See page 13.**

TOPS

BASES

POWER
DATASUPPORT
FURNITURE

ACCESSORIES

TABLES STEP 2 - LUGANO

Part Number	Description	List Price (US\$)
-------------	-------------	-------------------

**Lugano Rectangle Conference Base, Electric Height-Adjustable Tables**

LU1HA42A#^	Rectangle Base, Electric HA, for 42-48"D x 72"-84"W top	\$12,431
LU1HA42B#^	Rectangle Base, Electric HA, for 42-48"D x 96"-108"W top	\$14,251
LU1HA42C#^	Rectangle Base, Electric HA, for 42-48"D x 120"-132"W top	\$16,532
LU1HA42D#^	Rectangle Base, Electric HA, for 42-48"D x 144"W top	\$17,937

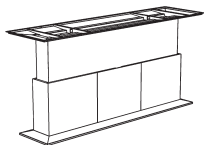
Tip: Back-painted glass tops not available.

LU1HA54A#^	Rectangle Base, Electric HA, for 54"D x 72"-84"W top	\$12,714
LU1HA54B#^	Rectangle Base, Electric HA, for 54"D x 96"-108"W top	\$14,667
LU1HA54C#^	Rectangle Base, Electric HA, for 54"D x 120"-132"W top	\$16,973

Tip: Back-painted glass tops not available.

LU1HA54D#^	Rectangle Base, Electric HA, for 54"D x 144"W top	\$18,472
------------	---	----------

Tip: Back-painted glass tops not available.

LU1HA60A#^	Rectangle Base, Electric HA, for 60"D x 72"-84"W top	\$13,445
LU1HA60B#^	Rectangle Base, Electric HA, for 60"D x 96"-108"W top	\$15,398
LU1HA60C#^	Rectangle Base, Electric HA, for 60"D x 120"-132"W top	\$17,130

Tip: Back-painted glass tops not available.

LU1HA60D#^	Rectangle Base, Electric HA, for 60"D x 144"W top	\$19,001
------------	---	----------

Tip: Back-painted glass tops not available.

Sawhorse Table Legs & Bases

STEP 1 - Conference Bases Only

(?) Routing Holes Suffix List

N	No routing holes in leg	no charge
Y	Routing hole in one leg	+\$62
Z	Routing holes in two legs	+\$124

STEP 2

(^) Paint Suffix List:

G	Slate Grey
R	Black
S	Silver
T	Medium Tone
W	Arctic White
Z	Other



Tip: Some Steelcase, Herman Miller, Knoll, Haworth, and Allsteel paints are available for \$350 list fee per order. Call/email for availability of specific colors. Additional custom paints (e.g. Tiger Dry Lac) must be quoted through quotes@enwork.com.

Product Specifications:

- > Standard height is 27.75"
- > Square tubes are 1.5" x 1.5". Rectangle tubes are 1.5" x 3".

Ordering Information:

- > Installation hardware included
- > Cable routing holes available on conference table bases. No cable routing hole in training table legs.
- > **A freight fee of \$100 net is assessed on orders less than \$1000 net. See page 13.**

Part Number	Description	List Price (US\$)
		
Sawhorse Training Table Legs (square tube) with Levelers, package of two		
LQT182^	Training Table Legs, levelers, for 18"D Table	\$505
LQT242^	Training Table Legs, levelers, for 24"D Table	\$537
LQT302^	Training Table Legs, levelers, for 30"/36"D Table	\$553
Tip: Each package of 2 legs supports a complete training table.		
		
Sawhorse Training Table Legs (square tube) with Black Casters, package of two		
LQT182C^	Training Table Legs, casters, for 18"D Table	\$520
LQT242C^	Training Table Legs, casters, for 24"D Table	\$551
LQT302C^	Training Table Legs, casters, for 30"/36"D Table	\$568
Tip: Each package of 2 legs supports a complete training table.		
		
Sawhorse Conference Table Base (rectangle tube) with levelers, package of two individual legs		
LQTCT?^	Conference Table Legs for 36"-60"D Table	\$430
LQRRBH?^	Conference Table Legs for 36"-60"D Tables, Bar Height (42"H)	\$498
Tip: Bases are designed to be inset 20-24" from conference table ends for tables greater than 96"W.		
Tip: Each package of 2 individual legs supports one side of a conference table.		

TOPS
BASES
POWER DATA
SUPPORT FURNITURE
ACCESSORIES

TABLES STEP 2 - SAWHORSE

Notes

Sensation™ T-Legs & T-Leg Flip Bases

STEP 1

(?) Routing Holes Suffix List

N	No routing holes in leg	no charge
Y	Routing hole in one leg	+\$62
Z	Routing holes in two legs	+\$124

STEP 2 - Legs with Casters Only

(@) Caster Color Suffix List:

B	Black	no charge
G	White with Grey Trim	+\$40

STEP 3

(^) Paint Suffix List:

G	Slate Grey
R	Black
S	Silver
T	Medium Tone
W	Arctic White
Z	Other

Tip: Polished aluminum feet (not columns) are available at no charge. This creates a two-tone color scheme. Free form "Polished Feet" on your order and put a "Z" in front of the part number.

Tip: Some Steelcase, Herman Miller, Knoll, Haworth, and Allsteel paints are available for \$350 list fee per order. Call/email for availability of specific colors. Additional custom paints (e.g. Tiger Dry Lac) must be quoted through quotes@enwork.com.

Ordering Information:

- > Standard height is 27.75". For shorter heights put "X" in front of the part number and add \$118 list. For taller, put "XX" in front and add \$118 list. Non-standard heights not available on height-adjustable legs. Maximum worksurface height is 42".
- > Installation hardware is included.
- > Polished aluminum feet with painted steel vertical columns are available. See Step 3.
- > A special 7"H hinged modesty panel, or a narrower width, are recommended for use with 30"D Sensation flip bases to avoid potential paint scratches on the feet. Contact quotes@enwork.com for more details.
- > **A freight fee of \$100 net is assessed on orders less than \$1000 net. See page 13.**



Part Number	Description	List Price (US\$)
-------------	-------------	-------------------

Sensation T-Legs with Levelers, package of two

LMT182?^	T-Leg, levelers, for 18"D table (14" spread)	\$542
LMT242?^	T-Leg, levelers, for 24"D table (20" spread)	\$547
LMT302?^	T-Leg, levelers, for 30-36"D table (26" spread)	\$573

Sensation T-Legs with Casters, package of two

LMT182?@^	T-Leg, casters, for 18"D table (14" spread)	\$596
LMT242?@^	T-Leg, casters, for 24"D table (20" spread)	\$629
LMT302?@^	T-Leg, casters, for 30-36"D table (26" spread)	\$651

Sensation Pin Adjustable T-Leg Base Assembly with Levelers, package of two

LMTA182^	Pin Adjust T-Leg base, levelers, for 18"D table (14" spread)	\$807
LMTA242^	Pin Adjust T-Leg base, levelers, for 24"D table (20" spread)	\$821
LMTA302^	Pin Adjust T-Leg base, levelers, for 30"D table (26" spread)	\$847

Tip: Adjustment range is 26"-35" with one inch increments (including top).

Sensation Pin Adjustable T-Leg Base Assembly with Casters, package of two

LMTAC182@^	Pin Adjust T-Leg base, casters, for 18"D table (14" spread)	\$862
LMTAC242@^	Pin Adjust T-Leg base, casters, for 24"D table (20" spread)	\$875
LMTAC302@^	Pin Adjust T-Leg base, casters, for 30"D table (26" spread)	\$903

Tip: Adjustment range is 26"-35" with one inch increments (including top).

Sensation Folding T-Leg Base Assembly with Levelers, package of two

LMTF182^	Folding T-Leg, levelers, for 18"D table (14" spread)	\$982
LMTF242^	Folding T-Leg, levelers, for 24"D table (20" spread)	\$1044
LMTF302^	Folding T-Leg, levelers, for 30-36"D table (26" spread)	\$1058

Tip: Folding T-Legs can be mounted on tables as short as 60"W

Sensation Folding T-Leg Base Assembly with Casters, package of two

LMTFC182@^	Folding T-Leg, casters, for 18"D table (14" spread)	\$1043
LMTFC242@^	Folding T-Leg, casters, for 24"D table (20" spread)	\$1106
LMTFC302@^	Folding T-Leg, casters, for 30-36"D table (26" spread)	\$1119

Tip: Folding T-Legs can be mounted on tables as short as 60"W



Sensation TT-Leg with Levelers, package of one

LMT48?^	TT-Leg, levelers for 42"D and 48"D table (39" spread)	\$543
LMT60?^	TT-Leg, levelers for 60"D table (46" spread)	\$596

Tip: Split-Y Leg is another option, see page 136.

Sensation Straight Legs, X-Bases, C-Legs, & C-Leg Flip Bases

STEP 1

(?) Routing Holes Suffix List

N	No routing holes in leg	no charge
Y	Routing hole in one leg	+\$62
Z	Routing holes in two legs	+\$124

STEP 2 - Legs with Casters Only

(@) Caster Color Suffix List:

B	Black	no charge
G	White with Grey Trim	+\$40

STEP 3

(^) Paint Suffix List

G	Slate Grey
R	Black
S	Silver
T	Medium Tone
W	Arctic White
Z	Other

Tip: Polished aluminum feet (not columns) are available at no charge. This creates a two-tone color scheme. Free form "Polished Feet" on your order and put a "Z" in front of the part number.

Tip: Some Steelcase, Herman Miller, Knoll, Haworth, and Allsteel paints are available for \$350 list fee per order. Call/email for availability of specific colors. Additional custom paints (e.g. Tiger Dry Lac) must be quoted through quotes@enwork.com.

Ordering Information:

- > Standard height is 27.75". For shorter heights put "X" in front of the part number and add \$118 list. For taller, put "XX" in front and add \$118 list. Double for 4-Post "X" Base. Non-standard heights not available on height-adjustable legs. Maximum worksurface height is 42".
- > Installation hardware is included.
- > Polished aluminum feet with painted steel vertical columns are available. See Step 3.
- > **A freight fee of \$100 net is assessed on orders less than \$1000 net. See page 13.**

Part Number	Description	List Price (US\$)
-------------	-------------	-------------------



Sensation Straight Legs (2.3" diameter) with levelers

LMA?^	Straight Leg, leveler	\$153
LMA2?^	Straight Leg, leveler, package of two	\$306



Sensation Straight Legs with locking casters

LMAC?@^	Straight Leg, caster	\$169
LMAC2?@^	Straight Leg, caster, package of two	\$341



Sensation X-Bases with Levelers

LMXA?^	X-Base, levelers, for 24" round table (22" x 22" spread)	\$594
LMXB?^	X-Base, levelers, for 30-36" round or 24-30" square table (26" x 26" spread)	\$618
LMXC?^	X-Base, levelers, for 42" round or 36" square table (32" x 32" spread)	\$630

Tip: 48" Round and 42" Square tops use two Y-legs (LMY302^@)



Sensation X-Bases with Levelers and Flared Column Casting for Power/Data Unit

LMXAP^	X-Base, for P/D, for 24" round table	\$714
LMXBP^	X-Base, for P/D, for 30-36" round or 24-30" square table	\$726
LMXCP^	X-Base, for P/D, for 42" round or 36" square table	\$753

Tip: Designed to accommodate Node Power/Data Unit.

Tip: Cables exit through the bottom of the column.

Sensation X-Bases with levelers - Bar Height

LMXBBA?^	X-Base, bar height, levelers, for 24" round table (22" x 22" spread)	\$648
LMXB BB?^	X-Base, bar height, levelers, for 30-36" round or 24-30" square table (26" x 26" spread)	\$671
LMXB BC?^	X-Base, bar height, levelers, for 42" round or 36" square table (32" x 32" spread)	\$683

Sensation X-Bases with Levelers and Flared Column Casting for Power/Data Unit - Bar Height

LMXB BAP^	X-Base, Bar Height, for P/D, for 24" round table	\$780
LMXB B BP^	X-Base, Bar Height, for P/D, for 30-36" round or 24-30" square table	\$790
LMXB B CP^	X-Base, Bar Height, for P/D, for 42" round or 36" square table	\$819

Tip: Designed to accommodate Node Power/Data Unit.

Tip: Cables exit through the bottom of the column.



Sensation X-Bases on Casters

LMXAC?@^	X-Base, casters, for 24" round table (22" x 22" spread)	\$633
LMXBC?@^	X-Base, casters, for 30-36" round or 24-30" square table (26" x 26" spread)	\$653
LMXCC?@^	X-Base, casters, for 42" round or 36" square table (32" x 32" spread)	\$667

Sensation Flip X-Bases on Casters

LMXAAC@^	Flip X-Base, casters for 24" round table (22" x 22" spread)	\$913
LMXABC@^	Flip X-Base, casters for 30-36" round table (26" x 26" spread)	\$929



Sensation 4-Post X-Bases with Levelers

LMXE?^	4-Post X-Base, levelers, for 60" round or 48" square table (38" x 38" spread)	\$1055
LMXF?^	4-Post X-Base, levelers, for 72"-84" 2-piece round table (46" x 46" spread)	\$1201

COORDINATING FURNITURE
See pages 188-189
for coordinating
Sensation furniture.

TOPS
BASES
POWER DATA
SUPPORT FURNITURE
ACCESSORIES



Part Number	Description	List Price (US\$)
Sensation C-Legs with Levelers, package of two		
LMC182?^	C-Leg, leveler, for 18"D table (17" spread)	\$542
LMC242?^	C-Leg, leveler, for 24"D table (20" spread)	\$547
LMC302?^	C-Leg, leveler, for 30"D table (27" spread)	\$573
Sensation C-Legs with Casters, package of two		
LMCC182?@^	C-Leg, caster, for 18"D table (17" spread)	\$596
LMCC242?@^	C-Leg, caster, for 24"D table (20" spread)	\$629
LMCC302?@^	C-Leg, caster, for 30"D table (27" spread)	\$651

Sensation Pin Adjustable C-Leg Base Assembly with Levelers, package of two		
LMCA182^	Pin Adjust. C-Leg base, levelers, for 18"D table (17" spread)	\$835
LMCA242^	Pin Adjust. C-Leg base, levelers, for 24"D table (20" spread)	\$841
LMCA302^	Pin Adjust. C-Leg base, levelers, for 30"D table (27" spread)	\$875

Tip: Adjustment range is 26"-35" with one inch increments (including top).

Sensation Pin Adjustable C-Leg Base Assembly with Casters, package of two		
LMCAC182@^	Pin Adjust. C-Leg base, casters, for 18"D table (17" spread)	\$888
LMCAC242@^	Pin Adjust. C-Leg base, casters, for 24"D table (20" spread)	\$895
LMCAC302@^	Pin Adjust. C-Leg base, casters, for 30"D table (27" spread)	\$929

Tip: Adjustment range is 26"-35" with one inch increments (including top).



Sensation C-Leg (straight) Flip Base Assembly with Crossbeam and casters for 24"D tables		
LMCU2448?@^	C-Legs (straight) Flip Base w/ Beam, casters, for 48"W table	\$1191
LMCU2460?@^	C-Legs (straight) Flip Base w/ Beam, casters, for 60"W table	\$1207
LMCU2472?@^	C-Legs (straight) Flip Base w/ Beam, casters, for 72"W table	\$1244

Tip: Available on tables up to 72"W only. For Sensation flip bases that accommodate larger widths, see page 131.

Sensation C-Leg (straight) Flip Base Assembly with Crossbeam and casters for 30"D tables		
LMCU3048?@^	C-Legs (straight) Flip Base w/ Beam, casters, for 48"W table	\$1239
LMCU3060?@^	C-Legs (straight) Flip Base w/ Beam, casters, for 60"W table	\$1245
LMCU3072?@^	C-Legs (straight) Flip Base w/ Beam, casters, for 72"W table	\$1294

Tip: Available on tables up to 72"W only. For Sensation flip bases that accommodate larger widths, see page 131.



Sensation C-Leg (straight) Flip Base Assembly on Casters, package of two		
LG2NC24?@^	C-Leg (straight) Flip Base, casters, for 24"D table	\$1013
LG2NC30?@^	C-Leg (straight) Flip Base, casters, for 30"D table	\$1027

Tip: Available on tables up to 72"W only. For Sensation flip bases that accommodate larger widths, see page 131.

Sensation Straight Y-Legs

STEP 1

(?) Routing Holes Suffix List

N	No routing holes in leg	no charge
Y	Routing hole in one leg	+\$62
Z	Routing holes in two legs	+\$124

STEP 2 - Legs with Casters Only

(@) Caster Color Suffix List:

B	Black	no charge
G	White with Grey Trim	+\$40

STEP 3

(^) Paint Suffix List

G	Slate Grey
R	Black
S	Silver
T	Medium Tone
W	Arctic White
Z	Other

Tip: Polished aluminum feet (not columns) are available at no charge. This creates a two-tone color scheme. Free form "Polished Feet" on your order and put a "Z" in front of the part number.

Tip: Some Steelcase, Herman Miller, Knoll, Haworth, and Allsteel paints are available for \$350 list fee per order. Call/email for availability of specific colors. Additional custom paints (e.g. Tiger Dry Lac) must be quoted through quotes@enwork.com.

Product Specifications:

- > Flip Tables do not nest in-line.

Ordering Information:

- > Standard height is 27.75". For shorter heights put "X" in front of the part number and add \$118 list. For taller, put "XX" in front and add \$118 list. Non-standard heights not available on height-adjustable legs. Maximum worksurface height is 42".
- > Installation hardware is included.
- > Polished aluminum feet with painted steel vertical columns are available. See Step 3.
- > To avoid paint scratches on legs, Modesty Panels are not recommended for 30"D Sensation Flip Bases.
- > **A freight fee of \$100 net is assessed on orders less than \$1000 net. See page 13.**



Part Number	Description	List Price (US\$)
-------------	-------------	-------------------

Sensation Y-Legs with Levelers, package of two

LMY182?^	Y-Leg, levelers, for 18"D table (15" spread)	\$561
LMY242?^	Y-Leg, levelers, for 24"D table (21" spread)	\$564
LMY302?^	Y-Leg, levelers, for 30"D table (25" spread)	\$586

Sensation Y-Legs with Casters, package of two

LMYC182?@^	Y-Leg, casters, for 18"D table (15" spread)	\$608
LMYC242?@^	Y-Leg, casters, for 24"D table (21" spread)	\$641
LMYC302?@^	Y-Leg, casters, for 30"D table (25" spread)	\$663

Sensation Pin Adjustable Y-Legs with Levelers, package of two

LMYA182^	Pin Adjustable Y-Leg, levelers, for 18"D table (15" spread)	\$841
LMYA242^	Pin Adjustable Y-Leg, levelers, for 24"D table (21" spread)	\$875
LMYA302^	Pin Adjustable Y-Leg, levelers, for 30"D table (25" spread)	\$926

Tip: Height Adjustment range is 26"-35" (including top) with one inch increments.

Sensation Pin Adjustable Y-Legs with Casters, package of two

LMYAC182@^	Pin Adjustable Y-Leg, casters, for 18"D table (15" spread)	\$895
LMYAC242@^	Pin Adjustable Y-Leg, casters, for 24"D table (21" spread)	\$929
LMYAC302@^	Pin Adjustable Y-Leg, casters, for 30"D table (25" spread)	\$981

Tip: Height Adjustment range is 26"-35" (including top) with one inch increments.

COORDINATING FURNITURE

See pages 188-189
for coordinating
Sensation furniture.

TOPS

BASES

POWER
DATA

SUPPORT
FURNITURE

ACCESSORIES

TABLES STEP 2 - SENSATION



Part Number	Description	List Price (US\$)
Sensation Y-Leg Flip Base Assembly with Crossbeam and Casters for 18\"D tables		
LMWY1860?@^	Y-Leg Flip Base w/ Beam, casters, for 60\"W table	\$1190
LMWY1872?@^	Y-Leg Flip Base w/ Beam, casters, for 72\"W table	\$1226
Sensation Y-Leg Flip Base Assembly with Crossbeam and Casters for 24\"D tables		
LMWY2460?@^	Y-Leg Flip Base w/ Beam, casters, for 60\"W table	\$1226
LMWY2472?@^	Y-Leg Flip Base w/ Beam, casters, for 72\"W table	\$1262
Sensation Y-Leg Flip Base Assembly with Crossbeam and Casters for 30\"D tables		
LMWY3060?@^	Y-Leg Flip Base w/ Beam, casters, for 60\"W table	\$1263
LMWY3072?@^	Y-Leg Flip Base w/ Beam, casters, for 72\"W table	\$1311



Sensation Y-Leg Flip Base Assembly on Casters		
LG2NR18?@^	Y-Leg Flip Base Assembly, casters, for 18\"D Table	\$1016
LG2NR24?@^	Y-Leg Flip Base Assembly, casters, for 24\"D Table	\$1029
LG2NR30?@^	Y-Leg Flip Base Assembly, casters, for 30\"D Table	\$1043

Tip: Cannot use "no beam" bases on tables larger than 72\"W.

Sensation Conference Y-Bases

STEP 1

(?) Routing Holes Suffix List

N	No routing holes in base	no charge
Y	Routing hole in one column	+\$62
Z	Routing holes in two columns	+\$124

STEP 2

(^) Paint Suffix List

G	Slate Grey
R	Black
S	Silver
T	Medium Tone
W	Arctic White
Z	Other

Tip: Polished aluminum feet (not columns or footer bar) are available at no charge. This creates a two-tone color scheme. Free form "Polished Feet" on your order and put a "Z" in front of the part number.

Tip: Some Steelcase, Herman Miller, Knoll, Haworth, and Allsteel paints are available for \$350 list fee per order. Call/email for availability of specific colors. Additional custom paints (e.g. Tiger Dry Lac) must be quoted through quotes@enwork.com.

Ordering Information:

- > Standard height is 27.75". For shorter heights put "X" in front of the part number and add \$118 list. For taller, put "XX" in front and add \$118 list. Maximum worksurface height is 42".
- > Installation hardware is included.
- > Polished aluminum feet with painted steel vertical columns and painted steel footer bars are available. See Step 2.
- > Routing holes are positioned in the center base. For routing holes in an end base, contact quotes@enwork.com.
- > **A freight fee of \$100 net is assessed on orders less than \$1000 net. See page 13.**

COORDINATING FURNITURE

See pages 188-189
for coordinating
Sensation furniture.

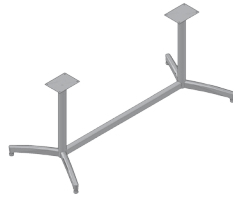

Part Number Description List Price (US\$)

Sensation Y-leg base with Footer Bar and Levelers, for 36"D tables - base spread 20.75"

LMYB3672?^	Y-Legs (includes two) w/ Footer Bar, levelers, for 36" x 72" top	\$1054
LMYB3684?^	Y-Legs (includes two) w/ Footer Bar, levelers, for 36" x 84" top	\$1083
LMYB3696?^	Y-Legs (includes two) w/ Footer Bar, levelers, for 36" x 96" top	\$1116

Sensation Y-leg base with Footer Bar and Levelers, for 42"D tables - base spread 26"

LMYB4272?^	Y-Legs (includes two) w/ Footer Bar, levelers, for 42" x 72" top	\$1093
LMYB4284?^	Y-Legs (includes two) w/ Footer Bar, levelers, for 42" x 84" top	\$1124
LMYB4296?^	Y-Legs (includes two) w/ Footer Bar, levelers, for 42" x 96" top	\$1154

Sensation Y-leg base with Footer Bar and Levelers, for 48"D tables - base spread 26"

LMYB4872?^	Y-Legs (includes two) w/ Footer Bar, levelers, for 48" x 72" top	\$1093
LMYB4884?^	Y-Legs (includes two) w/ Footer Bar, levelers, for 48" x 84" top	\$1124
LMYB4896?^	Y-Legs (includes two) w/ Footer Bar, levelers, for 48" x 96" top	\$1154

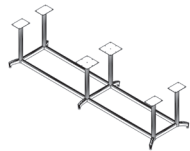

Sensation Split Y-Leg Bases with Rectangle Footer Bar and Levelers 48-60"D Tables

LMYD108?^	Split Y-Leg w/ Rect. Footer Bar, levelers, for 48"-60"D x 108"W top	\$2801
LMYD120?^	Split Y-Leg w/ Rect. Footer Bar, levelers, for 48"-60"D x 120"W top	\$2801
LMYD132?^	Split Y-Leg w/ Rect. Footer Bar, levelers, for 48"-60"D x 132"W top	\$2895
LMYD144?^	Split Y-Leg w/ Rect. Footer Bar, levelers, for 48"-60"D x 144"W top	\$2965
LMYD156?^	Split Y-Leg w/ Rect. Footer Bar, levelers, for 48"-60"D x 156"W top	\$3093
LMYD168?^	Split Y-Leg w/ Rect. Footer Bar, levelers, for 48"-60"D x 168"W top	\$3093

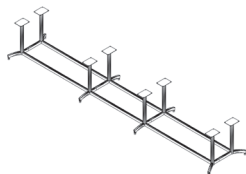

LMYD180?^	Split Y-Leg w/ Rect. Footer Bar, levelers, for 48"-60"D x 180"W top	\$4035
LMYD192?^	Split Y-Leg w/ Rect. Footer Bar, levelers, for 48"-60"D x 192"W top	\$4139
LMYD204?^	Split Y-Leg w/ Rect. Footer Bar, levelers, for 48"-60"D x 204"W top	\$4139
LMYD216?^	Split Y-Leg w/ Rect. Footer Bar, levelers, for 48"-60"D x 216"W top	\$4267
LMYD228?^	Split Y-Leg w/ Rect. Footer Bar, levelers, for 48"-60"D x 228"W top	\$4331
LMYD240?^	Split Y-Leg w/ Rect. Footer Bar, levelers, for 48"-60"D x 240"W top	\$4331

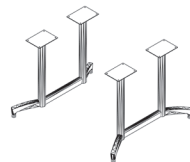

Sensation Split Y-Leg Bases, package of two

LMYE482?^	Split Y-Leg for 48"D table	\$1222
LMYE602?^	Split Y-Leg for 60"D table	\$1284

Tip: Two and three-piece tables also require a double T-Leg at the seams.

TOPS

BASES

POWER
DATASUPPORT
FURNITURE

ACCESSORIES

TABLES STEP 2 - SENSATION

Notes

Solano™ T-Legs *(formerly Captiva)*

STEP 1

(?) Routing Holes Suffix List

N	No routing holes in leg	no charge
Y	Routing hole in one leg	+\$62
Z	Routing holes in two legs	+\$124

STEP 2 - Legs w/ Casters Only

(@) Caster Color Suffix List:

B	Black	no charge
G	Grey	+\$40

STEP 3





(^) Paint Suffix List

G	Slate Grey
R	Black
S	Silver
T	Medium Tone
W	Arctic White
Z	Other

Tip: Some Steelcase, Herman Miller, Knoll, Haworth, and Allsteel paints are available for \$350 list fee per order. Call/email for availability of specific colors. Additional custom paints (e.g. Tiger Dry Lac) must be quoted through quotes@enwork.com.

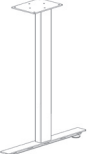
Ordering Information:

- > Standard height is 27.75". For shorter heights put "X" in front of the part number and add \$54 list. For taller, put "XX" in front and add \$68 list. Maximum worksurface height is 42"
- > **A freight fee of \$100 net is assessed on orders less than \$1000 net. See page 13.**

Part Number	Description	List Price (US\$)
	Solano T-Legs with Levelers, package of two	
LCATP182?^	T-Leg, levelers for 18"D table (16" spread)	\$558
LCATP242?^	T-Leg, levelers for 24"D table (22" spread)	\$567
LCATP302?^	T-Leg, levelers for 30-36"D table (26" spread)	\$606
	Solano T-Legs on Casters, package of two	
LCATPC182?@^	T-Leg, casters for 18"D table (16" spread)	\$634
LCATPC242?@^	T-Leg, casters for 24"D table (22" spread)	\$662
LCATPC302?@^	T-Leg, casters for 30-36"D table (26" spread)	\$689
	Solano T-Leg Folding with Levelers, package of two	
LCATPF182^	T-Leg Folding, levelers, for 18"D table	\$972
LCATPF242^	T-Leg Folding, levelers, for 24"D table	\$981
LCATPF302^	T-Leg Folding, levelers, for 30"D table	\$987
	Tip: Designed for tables 60" wide and wider. Email quotes@enwork.com for other options.	
	Solano T-Leg Folding with Casters, package of two	
LCATPFC182@^	T-Leg Folding, casters, for 18"D table	\$994
LCATPFC242@^	T-Leg Folding, casters, for 24"D table	\$1001
LCATPFC302@^	T-Leg Folding, casters, for 30"D table	\$1008
	Tip: Designed for tables 60" wide and wider. Email quotes@enwork.com for other options.	
	Leg Cable Management Covers	
LPCM^	Cable Management Cover for Leg with Leveler	\$57
LPCMC^	Cable Management Cover for Leg with Caster	\$57
LPCMA^	Cable Management Cover for Flip Table with Casters	\$57

Solano T-Leg Flip Base Assemblies *(formerly Captiva)*

Ordering Information:

- > Angled legs nest in-line. Straight legs nest off-set.
- > A freight fee of \$100 net is assessed on orders less than \$1000 net. See page 13.

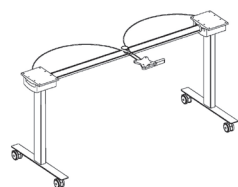

Part Number	Description	List Price (US\$)
Solano T-Leg (Straight) Flip Base Assembly with Crossbeam and Casters for 18"D Tables		
LCATQ1848?@^	T-Leg (straight) Flip Base w/ Beam for 18"D x 48"W top	\$1209
LCATQ1860?@^	T-Leg (straight) Flip Base w/ Beam for 18"D x 60"W top	\$1226
LCATQ1872?@^	T-Leg (straight) Flip Base w/ Beam for 18"D x 72"W top	\$1262
LCATQ1896?@^	T-Leg (straight) Flip Base w/ Beam for 18"D x 96"W top	\$1343

Solano T-Leg (Straight) Flip Base Assembly with Crossbeam and Casters for 24"D Tables		
LCATQ2448?@^	T-Leg (straight) Flip Base w/ Beam for 24"D x 48"W top	\$1246
LCATQ2460?@^	T-Leg (straight) Flip Base w/ Beam for 24"D x 60"W top	\$1262
LCATQ2472?@^	T-Leg (straight) Flip Base w/ Beam for 24"D x 72"W top	\$1299
LCATQ2496?@^	T-Leg (straight) Flip Base w/ Beam for 24"D x 96"W top	\$1380

Solano T-Leg (Straight) Flip Base Assembly with Crossbeam and Casters for 30"D Tables		
LCATQ3048?@^	T-Leg (straight) Flip Base w/ Beam for 30"D x 48"W top	\$1294
LCATQ3060?@^	T-Leg (straight) Flip Base w/ Beam for 30"D x 60"W top	\$1300
LCATQ3072?@^	T-Leg (straight) Flip Base w/ Beam for 30"D x 72"W top	\$1349
LCATQ3096?@^	T-Leg (straight) Flip Base w/ Beam for 30"D x 96"W top	\$1463

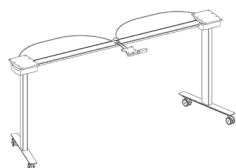

Solano T-Leg (Angled) Flip Base Assembly with Crossbeam and Casters for 24"D Tables		
LCATUA2460?@^	T-Leg (angled) Flip Base w/ Beam 24"D x 60"W top	\$1321
LCATUA2472?@^	T-Leg (angled) Flip Base w/ Beam 24"D x 72"W top	\$1357

Solano T-Leg (Angled) Flip Base Assembly with Crossbeam and Casters for 30"D Tables		
LCATUA3060?@^	T-Leg (angled) Flip Base w/ Beam 30"D x 60"W top	\$1358
LCATUA3072?@^	T-Leg (angled) Flip Base w/ Beam 30"D x 72"W top	\$1406

Solano T-Leg (Straight) Flip Base Assembly with Casters, package of two		
LCAT2NK18?@^	T-Leg (straight) Flip Base, Casters, for 18"D table	\$1043
LCAT2NK24?@^	T-Leg (straight) Flip Base, Casters, for 24"D table	\$1066
LCAT2NK30?@^	T-Leg (straight) Flip Base, Casters, for 30"D table	\$1069

Solano T-Leg (Angled) Flip Base Assembly with Casters, package of two		
LCAT2NL24?@^	T-Leg (angled) Flip Base, Casters, for 24"D table	\$1114
LCAT2NL30?@^	T-Leg (angled) Flip Base, Casters, for 30"D table	\$1127

TOPS

BASES

POWER
DATASUPPORT
FURNITURE

ACCESSORIES

TABLES STEP 2 - SOLANO

Solano TT-Legs - Conference *(formerly Captiva)*

STEP 1

(?) Routing Holes Suffix List

N	No routing holes in column	no charge
Y	Routing hole in one column	+\$62
Z	Routing holes in two columns	+\$124

STEP 2

(^) Paint Suffix List

G	Slate Grey
R	Black
S	Silver
T	Medium Tone
W	Arctic White
Z	Other

Tip: Some Steelcase, Herman Miller, Knoll, Haworth, and Allsteel paints are available for \$350 list fee per order. Call/email for availability of specific colors. Additional custom paints (e.g. Tiger Dry Lac) must be quoted through quotes@enwork.com.

STEP 3 - TT-Leg Filler Only

(#) Laminate Suffix List:

A	Wilsonart Kensington Maple (10776-60)	no charge
B	Wilsonart Monticello Maple (7925-38)	no charge
C	Wilsonart Wild Cherry (7054-60)	no charge
E	Wilsonart Fashion Grey (D381-60)	no charge
G	Wilsonart Cafelle (7933K-07)	no charge
M	Wilsonart Frosty White (1573-60)	no charge
P	Wilsonart Slate Grey (D91-60)	no charge
R	Wilsonart Black (1595-60)	no charge
U	Wilsonart Brazilwood (7946-38)	no charge
V	Wilsonart River Cherry (7937-38)	no charge
W	Wilsonart Designer White (D354-60)	no charge
3	Formica Neutral Twill (8826-58)	no charge
4	Formica Bleached Legno (8845-58)	no charge
5	Formica Prestige Walnut (6209-43)	no charge
7	Formica Select Cherry (7759-43)	no charge
X	*Wilsonart Non-Premium laminates (-38, -60)	+\$60
Y	*Formica Non-Premium (includes 58, 43, MC, SP, and NT finishes), Formica Premium (WR, 42, 77, 46, RD finishes), Pionite Non-Premium, Nevamar Non-Premium, Wilsonart Premium (-01, -07, -12, -18, -52, -78), and whiteboard laminate.	+\$90

*Add \$350 list for Special Laminate orders of less than 10 units. See page 21 for edge selection.

(#) Veneer Suffix List:

D	Maple (stained similar to Kensington Maple laminate)	
J	Cherry (stained similar to Wild Cherry laminate)	
N	Walnut (stained similar to Cafelle laminate)	
8	Walnut (stained similar to Prestige Walnut laminate)	
9	Cherry (stained similar to Select Cherry laminate)	
X	Stain Match (add a one-time \$700 list Stain Match fee)	+10%

Ordering Information:

- > Standard height is 27.75". For shorter heights put "X" in front of the part number and add \$54 list. For taller, put "XX" in front and add \$68 list. Maximum worksurface height is 42".
- > Installation hardware is included.
- > **A freight fee of \$100 net is assessed on orders less than \$1000 net. See page 13.**

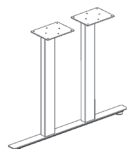

Part Number	Description	List Price (US\$)
-------------	-------------	-------------------

Solano TT-Leg with Levelers, package of one

LCATP48?^	TT-Leg, levelers for 42"D or 48"D table (34" spread)	\$694
LCATP60?^	TT-Leg, levelers for 60"D table (40" spread)	\$730

Tip: The 48" leg top plates are 4" apart and therefore cannot receive power/data units between them.

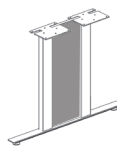

Solano TT-Leg with Levelers and Laminate Filler, package of one

LCATPL48?^#	TT-Leg, levelers, laminate filler for 42"D or 48"D table (34" spread)	\$828
LCATPL60?^#	TT-Leg, levelers, laminate filler for 60"D table (40" spread)	\$870

Tip: A center power/data location on a 2-piece table is not possible due to interference with the laminate filler panel on the leg (a leg is typically shared at the seam of the 2 pieces).

Tip: TT-Leg with filler cannot accept the cable management cover.

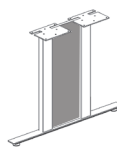

Solano TT-Leg with Levelers and Veneer Filler, package of one

LCATPV48?^#	TT-Leg, levelers, veneer filler for 42"D or 48"D table (34" spread)	\$1026
LCATPV60?^#	TT-Leg, levelers, veneer filler for 60"D table (40" spread)	\$1069

Tip: A center power/data location on a 2-piece table is not possible due to interference with the laminate filler panel on the leg (a leg is typically shared at the seam of the 2 pieces).

Tip: TT-Leg with filler cannot accept the cable management cover.

TOPS

BASES

POWER
DATASUPPORT
FURNITURE

ACCESSORIES

TABLES STEP 2 - SOLANO

Notes

Solano C-Legs *(formerly Captiva)*

STEP 1

(?) Routing Holes Suffix List

N	No routing holes in leg	no charge
Y	Routing hole in one leg	+\$62
Z	Routing holes in two legs	+\$124

STEP 2 - Legs w/ Casters Only

(@) Caster Color Suffix List:

B	Black	no charge
G	Grey	+\$40

STEP 3

(^) Paint Suffix List

G	Slate Grey
R	Black
S	Silver
T	Medium Tone
W	Arctic White
Z	Other

Tip: Some Steelcase, Herman Miller, Knoll, Haworth, and Allsteel paints are available for \$350 list fee per order. Call/email for availability of specific colors. Additional custom paints (e.g. Tiger Dry Lac) must be quoted through quotes@enwork.com.

Ordering Information:

- > Standard height is 27.75". For shorter heights put "X" in front of the part number and add \$54 list. For taller, put "XX" in front and add \$68 list. Non-standard heights not available on height-adjustable legs. Maximum worksurface height is 42".
- > Installation hardware is included.
- > **A freight fee of \$100 net is assessed on orders less than \$1000 net. See page 13.**

Part Number	Description	List Price (US\$)
Solano C-Leg with Levelers, package of two		
LCACP182?^	C-Leg, levelers, for 18"D table (16" spread)	\$558
LCACP242?^	C-Leg, levelers, for 24"D table (22" spread)	\$567
LCACP302?^	C-Leg, levelers, for 30"D table (26" spread)	\$606
Solano C-Leg with Casters, package of two		
LCACPC182?@^	C-Leg, casters, for 18"D table (16" spread)	\$634
LCACPC242?@^	C-Leg, casters, for 24"D table (22" spread)	\$662
LCACPC302?@^	C-Leg, casters, for 30"D table (26" spread)	\$689
Solano Set-Screw Adjustable C-Leg Base Assembly with Levelers for 18"D Tables (16" spread)		
LCAACP1848?^	Set-Screw C-Leg base assembly, levelers, for 18"D x 48"W top	\$950
LCAACP1860?^	Set-Screw C-Leg base assembly, levelers, for 18"D x 60"W top	\$950
LCAACP1872?^	Set-Screw C-Leg base assembly, levelers, for 18"D x 72"W top	\$950
Tip: Height range is 29"-43" with 1.5" increments (including top).		
Tip: Set-Screw Adjustable legs cannot accept the cable management cover.		
Solano Set-Screw Adjustable C-Leg Base Assembly with Levelers for 24"D Tables (22" spread)		
LCAACP2448?^	Set-Screw C-Leg base assembly, levelers, for 24"D x 48"W top	\$978
LCAACP2460?^	Set-Screw C-Leg base assembly, levelers, for 24"D x 60"W top	\$978
LCAACP2472?^	Set-Screw C-Leg base assembly, levelers, for 24"D x 72"W top	\$978
Tip: Height range is 29"-43" with 1.5" increments (including top).		
Tip: Set-Screw Adjustable legs cannot accept the cable management cover.		
Solano Set-Screw Adjustable C-Leg Base Assembly with Levelers for 30"D Tables (26" spread)		
LCAACP3048?^	Set-Screw C-Leg base assembly, levelers, for 30"D x 48"W top	\$1008
LCAACP3060?^	Set-Screw C-Leg base assembly, levelers, for 30"D x 60"W top	\$1008
LCAACP3072?^	Set-Screw C-Leg base assembly, levelers, for 30"D x 72"W top	\$1008
Tip: Height range is 29"-43" with 1.5" increments (including top).		
Tip: Set-Screw Adjustable legs cannot accept the cable management cover.		

TOPS

BASES

POWER
DATASUPPORT
FURNITURE

ACCESSORIES

TABLES STEP 2 - SOLANO

Part Number	Description	List Price (US\$)
-------------	-------------	-------------------

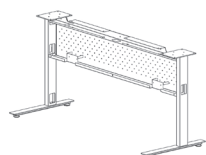
Solano C-Leg Base Assembly with Powerlex Modesty and Levelers, for 24"D tables (22" spread)

LCACP24481^	C-Leg Base with Powerlex Modesty, Levelers for 24"D x 48"W top, Circuit 1	\$1204
LCACP24601^	C-Leg Base with Powerlex Modesty, Levelers for 24"D x 60"W top, Circuit 1	\$1353
LCACP24721^	C-Leg Base with Powerlex Modesty, Levelers for 24"D x 72"W top, Circuit 1	\$1502
LCACP24482^	C-Leg Base with Powerlex Modesty, Levelers for 24"D x 48"W top, Circuit 2	\$1204
LCACP24602^	C-Leg Base with Powerlex Modesty, Levelers for 24"D x 60"W top, Circuit 2	\$1353
LCACP24722^	C-Leg Base with Powerlex Modesty, Levelers for 24"D x 72"W top, Circuit 2	\$1502

Tip: Powerlex Modesty includes 4-wire power system, 2 duplex receptacles, 4 data openings and jumpers.

Tip: See page 21 for Powerlex Grommet option, which can be specified in table top (strongly recommended).

Tip: If you would like to order a non-powered version (just modesty with trough and legs) subtract \$300 from the list price and put a "Z" in front of the part number.

Tip: Specify Base Power-In (see below).

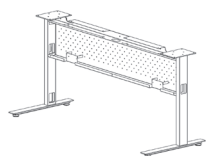
Solano C-Leg Base Assembly with Powerlex Modesty and Levelers, for 30"D tables

LCACP30481^	C-Leg Base with Powerlex Modesty, Levelers for 30"D x 48"W top, Circuit 1	\$1230
LCACP30601^	C-Leg Base with Powerlex Modesty, Levelers for 30"D x 60"W top, Circuit 1	\$1380
LCACP30721^	C-Leg Base with Powerlex Modesty, Levelers for 30"D x 72"W top, Circuit 1	\$1530
LCACP30482^	C-Leg Base with Powerlex Modesty, Levelers for 30"D x 48"W top, Circuit 2	\$1230
LCACP30602^	C-Leg Base with Powerlex Modesty, Levelers for 30"D x 60"W top, Circuit 2	\$1380
LCACP30722^	C-Leg Base with Powerlex Modesty, Levelers for 30"D x 72"W top, Circuit 2	\$1530

Tip: Powerlex Modesty includes 4-wire power system, 2 duplex receptacles, 4 data openings and jumpers.

Tip: See page 21 for Powerlex Grommet option, which can be specified in table top (strongly recommended).

Tip: If you would like to order a non-powered version (just modesty with trough and legs) subtract \$300 from the list price and put a "Z" in front of the part number.

Tip: Specify Base Power-In (see below).

Base Power-Ins

A8BP72	Base Power-In for Hardwire, 72"	\$168
A8BP120	Base Power-In for Hardwire, 120"	\$203
A1BP72	Base Power-In for RA Plug Circuit 1 (only), 72"	\$239

Tip: Use hardwire in feeds if UL listed (not recognized) is required.

Tip: Infeeds have a 20 amp plug end which requires a 20 amp wall receptacle. A plug adapter is required if using a standard 15 amp receptacle. The adapter is not included and must be purchased separately. Conntek 30129 15-Amp to 20-Amp Plug Adapters and similar are available through amazon.com and at many electrical supply houses.



15 amp Receptacle



20 amp Receptacle

Routing Hole Covers

WCVRB	Routing Hole Cover, Black	\$46
WCVRS	Routing Hole Cover, Silver	\$46
WCVRT	Routing Hole Cover, Medium Tone	\$46

Tip: Powerlex tables have routing holes on the inside of each foot as well as on the outside of each column where power is run from table to table. Routing hole covers can be ordered to cover any unused holes in the foot or at the end of a run.

Solano X-Bases *(formerly Captiva)*

STEP 1 - 4-Post X-Base Only

(?) Routing Holes Suffix List

N	No routing holes in leg	no charge
Y	Routing hole in one leg	+\$62
Z	Routing holes in two legs	+\$124

STEP 2

(^) Paint Suffix List

G	Slate Grey
R	Black
S	Silver
T	Medium Tone
W	Arctic White
Z	Other

Tip: Some Steelcase, Herman Miller, Knoll, Haworth, and Allsteel paints are available for \$350 list fee per order. Call/email for availability of specific colors. Additional custom paints (e.g. Tiger Dry Lac) must be quoted through quotes@enwork.com.

STEP 3 - Legs w/ Casters Only

(@) Caster Color Suffix List:

B	Black	no charge
G	Grey	+\$40

STEP 1 - Infill Only

(#) Laminate Suffix List:

A	Wilsonart Kensington Maple (10776-60)	no charge
B	Wilsonart Monticello Maple (7925-38)	no charge
C	Wilsonart Wild Cherry (7054-60)	no charge
E	Wilsonart Fashion Grey (D381-60)	no charge
G	Wilsonart Cafelle (7933K-07)	no charge
M	Wilsonart Frosty White (1573-60)	no charge
P	Wilsonart Slate Grey (D91-60)	no charge
R	Wilsonart Black (1595-60)	no charge
U	Wilsonart Brazilwood (7946-38)	no charge
V	Wilsonart River Cherry (7937-38)	no charge
W	Wilsonart Designer White (D354-60)	no charge
3	Formica Neutral Twill (8826-58)	no charge
4	Formica Bleached Legno (8845-58)	no charge
5	Formica Prestige Walnut (6209-43)	no charge
7	Formica Select Cherry (7759-43)	no charge
X	*Wilsonart Non-Premium laminates (-38, -60)	+\$60
Y	*Formica Non-Premium (includes 58, 43, MC, SP, and NT finishes), Formica Premium (WR, 42, 77, 46, RD finishes), Pionite Non-Premium, Nevamar Non-Premium, Wilsonart Premium (-01, -07, -12, -18, -52, -78), and whiteboard laminate.	+\$90

*Add \$350 list for Special Laminate orders of less than 10 units. See page 21 for edge selection.

Ordering Information:

- > Standard height is 27.75". For shorter heights put "X" in front of the part number and add \$54 list (\$108 for a 4-post x-base). For taller steel legs, put "XX" in front and add \$68 list (\$136 for a 4-post x-base). Non-standard heights not available on height-adjustable legs. Maximum worksurface height is 42".
- > **A freight fee of \$100 net is assessed on orders less than \$1000 net. See page 13.**

Part Number	Description	List Price (US\$)
-------------	-------------	-------------------

Solano X-Bases with Levelers

LCAXPA^	X-base, levelers, for 24" round top (22"x 22" spread)	\$660
LCAXPB^	X-base, levelers, for 30-36" round or 24"-30" sq top (26"x 26" spread)	\$674
LCAXPC^	X-base, levelers, for 42" round or 36" sq top (32"x 32" spread)	\$688
LCAXPD^	X-base, levelers, for 48" round or 42" sq top (38"x 38" spread)	\$702



Solano 4-Post X-Base with Levelers

LCAXPE?^	4-Post X-Base, levelers, for 54"-84" Round Top	\$1693
LXPEF#	Laminate Infill (no door) for LCAXPE	\$1043
LXPENFD#	Laminate Infill (with door) for LCAXPE	\$1217

Solano X-Bases with Levelers - Bar Height

LCAXPBBA^	X-base, bar height, levelers, for 24" round top (22" x 22" spread)	\$715
LCAXPBBA^	X-base, bar height, levelers, for 30-36" round or 24" - 30" sq top (26" x 26" spread)	\$707
LCAXPBBC^	X-base, bar height, levelers, for 42" round or 36" sq top (32" x 32" spread)	\$742
LCAXPBBD^	X-base, bar height, levelers, for 48" round or 42" sq top (38" x 38" spread)	\$757

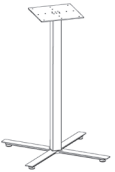

Solano 4-Post X-Base with Levelers - Bar Height

LCAXPBE?^	4-Post X-base, bar height, levelers, for 54"-72" round top (48" x 48" spread)	\$1793
LCAXPBEF#	Laminate Infill (no door) for LCAXPBE (bar height)	\$1313
LCAXPBENFD#	Laminate Infill (with door) for LCAXPBE (bar height)	\$1530

Solano X-Bases with Casters

LCAXPAC^@	X-base, casters, for 24" round top (22"x 22" spread)	\$771
LCAXPBC^@	X-base, casters, for 30-36" round or 24"-30" sq top (26"x 26" spread)	\$785
LCAXPCC^@	X-base, casters, for 42" round or 36" sq top (32"x 32" spread)	\$799
LCAXPDC^@	X-base, casters, for 48" round or 42" sq top (38"x 38" spread)	\$814



Solano 4-Post X-Base with Casters

LCAXPEC?^@	4-Post X-Base, casters, for 54"-84" Round Top	\$1684
------------	---	--------

TOPS

BASES

POWER
DATASUPPORT
FURNITURE

ACCESSORIES

TABLES STEP 2 - SOLANO

Part Number	Description	List Price (US\$)
-------------	-------------	-------------------



Solano X-Bases with Power/Data Top Plate and Levelers

LCAX3PA^	X-Base w/ P/D Top Plate, Levelers, for 24" round top (22"x 22" spread)	\$769
LCAX3PB^	X-Base w/ P/D Top Plate, Levelers, for 30"-36" round or 24"-30" sq top (26"x 26" spread)	\$783
LCAX3PC^	X-Base w/ P/D Top Plate, Levelers, for 42" round or 36" sq top (32"x 32" spread)	\$798
LCAX3PD^	X-Base w/ P/D Top Plate, Levelers, for 48" round or 42" sq top (38"x 38" spread)	\$809

Tip: Includes hole in bottom of leg for cable management and special top plate that allows room for power/data in center of top.

Tip: Top plate can accommodate the Flip-n-Go, Villa, Cove, and Single-Sided Ellora power data units.



Solano X-Bases with Power/Data Top Plate and Levelers - Bar Height

LCAX3PBBA^	X-base w/ P/D Top Plate, bar height, levelers, for 24" round top (22"x 22" spread)	\$825
LCAX3PBBB^	X-base w/ P/D Top Plate, bar height, levelers, for 30"-36" round or 24"-30" sq top (26"x 26" spread)	\$848
LCAX3PBBC^	X-base w/ P/D Top Plate, bar height, levelers, for 42" round or 36" sq top (32"x 32" spread)	\$853
LCAX3PBBD^	X-base w/ P/D Top Plate, bar height, levelers, for 48" round or 42" sq top (38" x 38" spread)	\$865

Tip: Includes hole in bottom of leg for cable management and special top plate that allows room for power/data in center of top.

Tip: Top plate can accommodate the Flip-n-Go, Villa, Cove, and Single-Sided Ellora power data units.



Solano X-Bases with Power/Data Top Plate and Casters

LCAX3PAC^@	X-Base with P/D Top Plate, casters, for 24" round top (22"x 22" spread)	\$877
LCAX3PBC^@	X-Base with P/D Top Plate, casters, for 30"-36" round or 24"-30" sq top (26"x 26" spread)	\$894
LCAX3PCC^@	X-Base with P/D Top Plate, casters, for 42" round or 36" sq top (32"x 32" spread)	\$906
LCAX3PDC^@	X-Base with P/D Top Plate, casters, for 48" round or 42" sq top (38"x 38" spread)	\$919

Tip: Includes hole in bottom of leg for cable management and special top plate that allows room for power/data in center of top.

Tip: Top plate can accommodate the Flip-n-Go, Villa, Cove, and Single-Sided Ellora power data units.

Solano Fast Crank & Crank Height-Adjustable Bases *(formerly Captiva)*

STEP 1 - Fast Crank Only

(^) Paint Suffix List

S Silver
R Black
W Arctic White

Tip: Other colors available with longer lead times. Contact quotes@enwork.com for details.

STEP 1 - Crank Only

(^) Paint Suffix List

G Slate Grey
R Black
S Silver
T Medium Tone
W Arctic White
Z Other





Tip: Some Steelcase, Herman Miller, Knoll, Haworth, and Allsteel paints are available for \$350 list fee per order. Call/email for availability of specific colors. Additional custom paints (e.g. Tiger Dry Lac) must be quoted through quotes@enwork.com.

Fast Crank Product Specifications:

- > Height adjustment range of 26" - 44" high (with top).
- > Adjusts 2 turns per inch.
- > 110 lbs load capacity when moving, 210 lbs when static. (Load capacity includes weight of worksurface.)

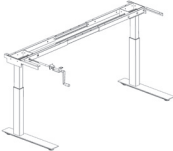
Ordering Information:

- > Installation hardware is included.
- > Tops ordered separately.
- > Ships unassembled.
- > **A freight fee of \$100 net is assessed on orders less than \$1000 net. See page 13.**

Part Number	Description	List Price (US\$)
	Solano 2-Legged Fast Crank Adjustment C-Leg Base Assemblies for Rectangle Tables LVTCRR^ 2-Leg Fast Crank Base, Levelers, for 24"/30"D rectangle table	\$1060
	Tip: For use on 54" - 72" wide rectangle tops (adjustable cross bar).	
	LVTC Caster Kit, 4 casters, 1.5"H	\$58
	Tip: On bases with casters, the height adjustment range changes to 27.5" - 45.5".	
	Solano Crank Adjustment C-Leg Base Assemblies with Levelers for Rectangular Tables LCA4ER24^ Crank C-Leg Base for 24" x 48"-72"W Table (foot depth is 22")	\$1769
	LCA4ER30^ Crank C-Leg Base for 30" x 48"-72"W Table (foot depth is 26")	\$1795
	Tip: Adjustment range is 27" to 45" (including top). Five and a half cranks per inch.	
	Tip: For shorter widths (36"-42") put a "W" in front of the part number. For longer widths (78"-96") put a "Z" in front of the part number.	
	Solano Crank Adjustment C-Leg Base Assemblies with Casters for Rectangular Tables LCA4ERC24^ Crank C-Leg Base for 24" x 48"-72"W Table (foot depth is 22")	\$1849
	LCA4ERC30^ Crank C-Leg Base for 30" x 48"-72"W Table (foot depth is 26")	\$1876
	Tip: Adjustment range is 27" to 45" (including top). Five and a half cranks per inch.	
	Tip: For shorter widths (36"-42") put a "W" in front of the part number. For longer widths (78"-96") put a "Z" in front of the part number.	
	Solano Crank Adjustment 2-Legged C-Leg Base Assembly with Levelers for Corner Tables LCA4EC24^ Crank 2-Leg, C-Leg Base for 24"D corner table (foot depth is 22")	\$1742
	Tip: Five and a half cranks per inch.	
	Solano Crank Adjustment 3-Legged C-Leg Base Assembly with Levelers for 120-Degree Tables LCA4ET24^ Crank 3-Leg, C-Leg Base for 24"x 24"x 48"x 48" top (foot depth is 22")	\$2877
	Tip: Adjustment range is 28.5" to 46.5" (including top). Five and a half cranks per inch.	
	Solano Crank Adjustment 3-Legged C-Leg Base Assembly with Levelers for L-Workstations LCA4EL24^ Crank 3-Leg, C-Leg Base for 24"x 24"x 72"x 72" 90 degree top (foot depth is 22")	\$2804
	Tip: Adjustment range is 28.5" to 46.5" (including top). Five and a half cranks per inch.	

TOPS

BASES

POWER
DATASUPPORT
FURNITURE

ACCESSORIES

TABLES STEP 2 - SOLANO

Notes

Solano™ VT-Series Extended Range Electric Adjustable Bases

STEP 1 - VT Bases Only

(^) Paint Suffix List

S Silver
R Black
W Arctic White

Tip: Other colors available with longer lead times. Contact quotes@enwork.com for details.

STEP 1 - XT Bases Only

(^) Paint Suffix List

G Slate Grey
R Black
S Silver
T Medium Tone
W Arctic White
Z Other

Tip: Some Steelcase, Herman Miller, Knoll, Haworth, and Allsteel paints are available for \$350 list fee per order. Call/email for availability of specific colors. Additional custom paints (e.g. Tiger Dry Lac) must be quoted through quotes@enwork.com.

Product Specifications:

- > 220 lbs load capacity for 2-legged base. 240 lbs load capacity for 3-legged base. (Load capacity includes weight of worksurface.)
- > Bosch® electric motor present in each leg.
- > Adjusts 1.4 inch/second.
- > Includes programmable handset with 3 preset buttons and Logic Data controller with range limiting capability.
- > Height adjustment range of 24" - 49.5" high (with top).
- > Passes ANSI/BIFMA testing.

Ordering Information:

- > Installation hardware is included.
- > Tops sold separately.
- > Ships unassembled.
- > Some products may be available for quick ship. Contact info@enwork.com.
- > **Silver, black, and arctic white paint available in standard lead time. Additional colors available in 7-8 weeks.**
- > **A freight fee of \$100 net is assessed on orders less than \$1000 net. See page 13.**

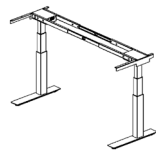

Part Number	Description	List Price (US\$)
-------------	-------------	-------------------

Solano VT-Series 2-Legged, 2-Stage (3-tube) Electric Adjustment C-Leg Base Assemblies for Rectangle Tables

LVTER^	VT 2-Leg, 2-stage (3-tube) Electric Base, Levelers, for 24"/30"D rectangle table	\$1555
--------	--	--------

Tip: For use on 48" - 72" wide rectangle tops (adjustable cross bar).

LVTC	Caster Kit, 4 casters, 1.5"H	\$58
------	------------------------------	------

Tip: On bases with casters, the height adjustment range changes to 25.5" - 51".

LVTLB	Cross Bar Kit for 84" - 96"W Tables	\$72
-------	-------------------------------------	------

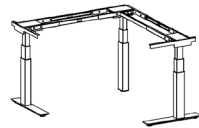

Solano VT-Series 3-Legged, 2-Stage (3-tube) Electric Adjustment C-Leg Base Assemblies for L-Workstations

LVTEL^	VT 3-Leg, 2-stage (3-tube) Electric Base, for 24"/30"D L-Workstation table	\$2660
--------	--	--------

Tip: For use on tops 60" - 78" wide (adjustable cross bar).

Tip: For shorter or longer widths on 3-legged bases, contact quotes@enwork.com.

Solano VT-Series 120-Degree Table Bracket

LVTETR	120-Degree Bracket	\$125
--------	--------------------	-------

Tip: For use with tops 48"x48" or 60"x60" wide.

Tip: Bracket converts 3-Legged C-Leg base for L-workstations (ordered above) to 120 degree applications.

Solano XT-Series ANSI/BIFMA Electric Height-Adjustable Bases

Product Specifications:

- > 250 pound load capacity.
- > Bosch electric motor present in each leg.
- > Adjusts up to 1.6 inch/second.
- > Adjusts via included up/down controller (no display).
- > Height adjustment range of 22.6"- 48.3" high (with top). Meets ANSI/BIFMA specifications.
- > Bases are 2-stage (3-tube).

Ordering Information:

- > Installation hardware is included.
- > Tops sold separately.
- > Ships unassembled.
- > Available as a 2-leg and 3-leg model as standard (4-leg as special).
- > Optional programmable digital display available on next page.
- > **A freight fee of \$100 net is assessed on orders less than \$1000 net. See page 13.**

TOPS

BASES

POWER
DATASUPPORT
FURNITURE

ACCESSORIES

TABLES STEP 2 - SOLANO

Part Number	Description	List Price (US\$)
-------------	-------------	-------------------

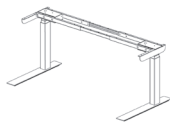

Solano XT-Series 2-Legged, 2-Stage (3-tube) Electric Adjustment C-Leg Base Assemblies for Rectangle Tables

LCAER24^	XT 2-Leg, 2-stage (3-tube) Electric Base, Levelers, for 24"D rectangle table	\$2431
LCAER30^	XT 2-Leg, 2-stage (3-tube) Electric Base, Levelers, for 30"D rectangle table	\$2458
LCAERC24^	XT 2-Leg, 2-stage (3-tube) Electric Base, Casters, for 24"D rectangle table	\$2510
LCAERC30^	XT 2-Leg, 2-stage (3-tube) Electric Base, Casters, for 30"D rectangle table	\$2535

Tip: For use on 48" - 72" wide rectangle tops (adjustable cross bar).

Tip: For shorter widths (36"-42") put a "W" in front of the part number.

For longer widths (78"-96") put a "Z" in front of the part number.

Tip: On bases with casters, the height range changes to 24.1"-49.8", not ANSI/BIFMA.

Solano XT-Series 2-Legged, 2-Stage (3-tube) Electric Adjustment C-Leg Base Assemblies for Corner Tables

LCAEC24^	XT 2-Leg, 2-stage (3-tube) Electric Base for 24"D corner table	\$2405
----------	--	--------

Tip: For use on 24"D tops, 42" - 48" wide corners only (adjustable cross bar).

Solano XT-Series 2-Legged, 2-Stage (3-tube) Electric Adjustment C-Leg Base Assembly w/ Angled Feet & Levelers for 120-Degree Tables

LCAEJ24^	XT 2-Leg, 2-stage (3-tube) Electric Base, angled feet, for 120-Degree table	\$2687
----------	---	--------

Tip: For use on 24"D tops, 36" - 48" wide per side (adjustable cross bar).

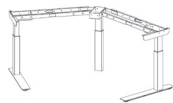

Solano XT-Series 3-Legged, 2-Stage (3-tube) Electric Adjustment C-Leg Base Assemblies for 120-Degree Tables

LCAET24^	XT 3-Leg, 2-stage (3-tube) Electric Base, for 120-Degree table	\$3811
----------	--	--------

Tip: For use on 24"D tops, 36" - 48" wide per side (adjustable cross bar).

Tip: For shorter or longer widths on 3-legged bases, contact quotes@enwork.com.

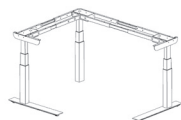

Solano XT-Series 3-Legged, 2-Stage (3-tube) Electric Adjustment C-Leg Base Assemblies for L-Workstations

LCAEL24^	XT 3-Leg, 2-stage (3-tube) Electric Electric Base, for L-Workstation	\$3739
----------	--	--------

Tip: For use on 24"D tops, 48" - 72" wide (adjustable cross bar).

Tip: For shorter or longer widths on 3-legged bases, contact quotes@enwork.com.

Solano XT-Series Sit/Stand Electric Height-Adjustable Bases

STEP 1

(^) Paint Suffix List

G Slate Grey
R Black
S Silver
T Medium Tone
W Arctic White
Z Other

Tip: Some Steelcase, Herman Miller, Knoll, Haworth, and Allsteel paints are available for \$350 list fee per order. Call/email for availability of specific colors. Additional custom paints (e.g. Tiger Dry Lac) must be quoted through quotes@enwork.com.

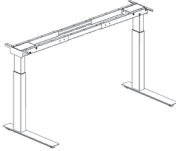

Product Specifications:

- > 250 pound load capacity.
- > Adjusts via included up/down controller (no display).
- > Adjustment range is 26" - 45" (including top).
- > Bases are 1-stage (2-tube).

Ordering Information:

- > Installation hardware is included.
- > Tops sold separately.
- > Ships unassembled.
- > Optional programmable digital display available.
- > **A freight fee of \$100 net is assessed on orders less than \$1000 net. See page 13.**

Part Number	Description	List Price (US\$)
Solano XT-Series 2-Legged, 1-Stage (2-tube) Electric Adjustment C-Leg Base Assemblies for Rectangle Tables		
LCA2ER24^	XT 2-Leg, 1-Stage (2-tube) Electric Base, Levelers, for 24"D rectangle table	\$2431
LCA2ER30^	XT 2-Leg, 1-Stage (2-tube) Electric Base, Levelers, for 30"D rectangle table	\$2458
LCA2ERC24^	XT 2-Leg, 1-Stage (2-tube) Electric Base, Casters, for 24"D rectangle table	\$2510
LCA2ERC30^	XT 2-Leg, 1-Stage (2-tube) Electric Base, Casters, for 30"D rectangle table	\$2535

Tip: For use on 48" - 72" wide rectangle tops (adjustable cross bar).

Tip: For shorter widths (36"-42") put a "W" in front of the part number. For longer widths (78"-96") put a "Z" in front of the part number.

Tip: On bases with casters, the height range changes to 27.5"-46.5".

Solano XT-Series 2-Legged, 1-Stage (2-tube) Electric Adjustment C-Leg Base Assembly for Corner Tables

LCA2EC24^	XT 2-Leg, 1-Stage (2-tube) Electric Base for 24"D corner table	\$2405
-----------	--	--------

Tip: For use on 24"D tops, 42" - 48" wide corners only (adjustable cross bar).

Solano XT-Series 2-Legged, 1-Stage (2-tube) Electric Adjustment C-Leg Base Assembly with Angled Feet & Levelers for 120-Degree Tables

LCA2EJ24^	XT 2-Leg, 1-Stage (2-tube) Electric Base, angled feet, for 120-Degree table	\$2687
-----------	---	--------

Tip: For use on 24"D tops, 36" - 48" wide per side (adjustable cross bar).

Solano XT-Series 3-Legged, 1-Stage (2-tube) Electric Adjustment C-Leg Base Assembly for 120-Degree Tables

LCA2ET24^	XT 3-Leg, 1-Stage (2-tube) Electric Base, for 120-Degree table	\$3811
-----------	--	--------

Tip: For use on 24"D tops, 36" - 48" wide per side (adjustable cross bar).

Tip: For shorter or longer widths on 3-legged bases, contact quotes@enwork.com.

Solano XT-Series 3-Legged, 1-Stage (2-tube) Electric Adjustment C-Leg Base Assembly for L-Workstations

LCA2EL24^	XT 3-Leg, 1-Stage (2-tube) Electric Electric Base, for L-Workstation	\$3739
-----------	--	--------

Tip: For use on 24"D tops, 48" - 72" wide (adjustable cross bar).

Tip: For shorter or longer widths on 3-legged bases, contact quotes@enwork.com.

XT-Series Programmable Controller with Digital Read-Out Display (Optional)

LFADD2	Programmable Controller, Digital Display, for XT-Series bases, black	\$145
--------	--	-------

Tip: Digital display allows five preset programmable stops.

TOPS
BASES
POWER DATA
SUPPORT FURNITURE
ACCESSORIES

TABLES STEP 2 - SOLANO

Notes

Solano Classroom Tables (Complete Tables) & Power Kits

STEP 1

(^) Paint Suffix List

- G Slate Grey
- R Black
- S Silver
- T Medium Tone
- W Arctic White
- Z Other

Tip: Some Steelcase, Herman Miller, Knoll, Haworth, and Allsteel paints are available for \$350 list fee per order. Call/email for availability of specific colors. Additional custom paints (e.g. Tiger Dry Lac) must be quoted through quotes@enwork.com.

STEP 3

(#) Laminate Suffix List:

- A Wilsonart Kensington Maple (10776-60)
- B Wilsonart Monticello Maple (7925-38)
- C Wilsonart Wild Cherry (7054-60)
- E Wilsonart Fashion Grey (D381-60)
- F Wilsonart White Tigris (4783-60)
- G Wilsonart Cafelle (7933K-07)
- M Wilsonart Frosty White (1573-60)
- P Wilsonart Slate Grey (D91-60)
- R Wilsonart Black (1595-60)
- U Wilsonart Brazilwood (7946-38)
- V Wilsonart River Cherry (7937-38)
- W Wilsonart Designer White (D354-60)
- 3 Formica Neutral Twill (8826-58)
- 4 Formica Bleached Legno (8845-58)
- 5 Formica Prestige Walnut (6209-43)
- 7 Formica Select Cherry (7759-43)
- X *Wilsonart Non-Premium Laminates (-38, -60). Orders of 100+ units have no upcharge. +\$36
- Y *Formica Non-Premium (includes 58, 43, MC, SP, and NT finishes) and Wilsonart Premium (-01, -07, -12, -18, -52, -78) laminates. +\$50
- Z *Pionite Non-Premium, Nevamar Non-Premium, Formica Premium (WR, 42, 77, 46, RD finishes), and whiteboard laminate. +\$72

*Add \$350 list for Special Laminate orders of less than 10 units. See page 21 for edge selection.

Product Specifications:

- > Inner and outer back panels are steel
- > Tops are Laminate with a 3mm edge
- > Monitor lifts accept monitors that adhere to the VESA Mounting Standard
- > Contains storage for keyboards and mouse with monitor. Monitor storage is released by pushing down on top.
- > Includes a cable trough in the bottom for plug strips or hardwire power.
- > Includes cable management kit.

Ordering Information:

- > Worksurface included.
- > Ships assembled.
- > See maximum monitor sizes (diagonal measurement) below. For larger sizes email quotes@enwork.com.
- > **A freight fee of \$100 net is assessed on orders less than \$1000 net. See page 13.**

Part Number	Description	List Price (US\$)
-------------	-------------	-------------------

Solano Classroom Tables with Levelers



LCA2CP3030^#	Classroom Table, 30" D x 30" W	\$1789
--------------	--------------------------------	--------

Tip: Minimal room underneath table for CPU holder - affects kneespace.

LCA2CP3036^#	Classroom Table, 30" D x 36" W	\$1885
--------------	--------------------------------	--------

Tip: Room exists underneath table for two CPU holders. (ordered separately)

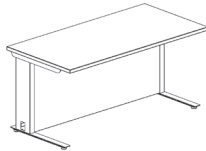

LCA2CP3060^#	Classroom Table, 30" D x 60" W	\$2572
--------------	--------------------------------	--------

Tip: Minimal room underneath table for CPU holder - affects kneespace.

LCA2CP3072^#	Classroom Table, 30" D x 72" W	\$3185
--------------	--------------------------------	--------

Tip: Room exists underneath table for two CPU holders. (ordered separately)

Solano Classroom Tables with Monitor Lift(s) and Levelers

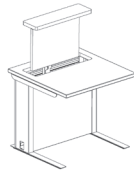

LCA2CM3030^#	Classroom Table with Single Monitor Lift, 30" D x 30" W	\$3221
--------------	---	--------

Tip: Works with most flat screens, 23" diagonal monitor or smaller. Maximum monitor weight is 20 lbs.

Tip: Minimal room underneath table for CPU holder - affects kneespace.

LCA2CM3036^#	Classroom Table with Single Monitor Lift, 30" D x 36" W	\$3357
--------------	---	--------

Tip: Works with most flat screens, 25" diagonal monitor or smaller. Maximum monitor weight is 20 lbs.

Tip: Room exists underneath table for two CPU holders. (ordered separately)

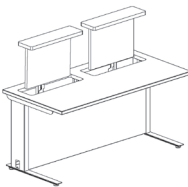

LCA2CM3060^#	Classroom Table with Double Monitor Lift, 30" D x 60" W	\$5777
--------------	---	--------

Tip: Works with most flat screens, 23" diagonal monitor or smaller. Maximum monitor weight is 20 lbs.

Tip: Minimal room underneath table for CPU holder - affects kneespace.

LCA2CM3072^#	Classroom Table with Double Monitor Lift, 30" D x 72" W	\$5935
--------------	---	--------

Tip: Works with most flat screens, 25" diagonal monitor or smaller. Maximum monitor weight is 20 lbs.

Tip: Room exists underneath table for two CPU holders. (ordered separately)

TOPS

BASES

POWER
DATASUPPORT
FURNITURE

ACCESSORIES

TABLES STEP 2 - SOLANO

Part Number	Description	List Price (US\$)
Classroom Table Power Kits (Optional)		
L2CMP130	Kit for 30"W Classroom Table, 2 duplex receptacles, no data, two jumpers, circuit 1	\$261
L2CMP136	Kit for 36"W Classroom Table, 2 duplex receptacles, no data, two jumpers, circuit 1	\$265
L2CMP160	Kit for 60"W Classroom Table, 2 duplex receptacles, no data, two jumpers, circuit 1	\$287
L2CMP172	Kit for 72"W Classroom Table, 2 duplex receptacles, no data, two jumpers, circuit 1	\$302
L2CMP230	Kit for 30"W Classroom Table, 2 duplex receptacles, no data, two jumpers, circuit 2	\$261
L2CMP236	Kit for 36"W Classroom Table, 2 duplex receptacles, no data, two jumpers, circuit 2	\$265
L2CMP260	Kit for 60"W Classroom Table, 2 duplex receptacles, no data, two jumpers, circuit 2	\$287
L2CMP272	Kit for 72"W Classroom Table, 2 duplex receptacles, no data, two jumpers, circuit 2	\$302

Solano Classroom Tables with Single Laptop Storage and Powerlex Modesty

LCALAP301^#	Classroom Table w/ Powerlex, Single Laptop Storage, for 24"D x 30"W Tables, Circuit 1	\$2663
LCALAP302^#	Classroom Table w/ Powerlex, Single Laptop Storage, for 24"D x 30"W Tables, Circuit 2	\$2663

Tip: If you would like to order a non-powered version (just modesty with trough and legs) subtract \$300 from the list price and put a "Z" in front of the part number.

Solano Classroom Tables with Double Laptop Storage and Powerlex Modesty

LCALAP721^#	Classroom Table w/ Powerlex, Double Laptop Storage, for 24"D x 72"W Tables, Circuit 1	\$3716
LCALAP722^#	Classroom Table w/ Powerlex, Double Laptop Storage, for 24"D x 72"W Tables, Circuit 2	\$3716

Tip: If you would like to order a non-powered version (just modesty with trough and legs) subtract \$300 from the list price and put a "Z" in front of the part number.

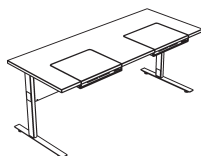
**Base Power-Ins**

A8BP72	Base Power-In for Hardwire, 72"	\$168
A8BP120	Base Power-In for Hardwire, 120"	\$203
A1BP72	Base Power-In for RA Plug Circuit 1 (only), 72"	\$239

Tip: Use hardwire in feeds if UL listed (not recognized) is required.

Tip: Infeeds have a 20 amp plug end which requires a 20 amp wall receptacle. A plug adapter is required if using a standard 15 amp receptacle. The adapter is not included and must be purchased separately. Conntek 30129 15-Amp to 20-Amp Plug Adapters and similar are available through amazon.com and at many electrical supply houses.



15 amp Receptacle



20 amp Receptacle

Routing Hole Covers

WCVRB	Routing Hole Cover, Black	\$46
WCVRS	Routing Hole Cover, Silver	\$46
WCVRT	Routing Hole Cover, Medium Tone	\$46

Tip: Classroom tables have routing holes on the inside of each foot as well as on the outside of each column where power is run from table to table. Routing hole covers can be ordered to cover any unused holes in the foot or at the end of a run.

Statement™ Table Bases

STEP 1

(@) Filler Suffix List:

A	Open (No Filler)	No Charge
B	Acrylic Filler	+\$310
C	Glass Filler, acid-etched w/ pattern	+\$720

STEP 2

(#) Laminate Suffix List:

A	Wilsonart Kensington Maple (10776-60)
B	Wilsonart Monticello Maple (7925-38)
C	Wilsonart Wild Cherry (7054-60)
E	Wilsonart Fashion Grey (D381-60)
F	Wilsonart White Tigris (4783-60)
G	Wilsonart Cafelle (7933K-07)
M	Wilsonart Frosty White (1573-60)
P	Wilsonart Slate Grey (D91-60)
R	Wilsonart Black (1595-60)
U	Wilsonart Brazilwood (7946-38)
V	Wilsonart River Cherry (7937-38)
W	Wilsonart Designer White (D354-60)
3	Formica Neutral Twill (8826-58)
4	Formica Bleached Legno (8845-58)
5	Formica Prestige Walnut (6209-43)
7	Formica Select Cherry (7759-43)
X	*Wilsonart Non-Premium laminates (-38, +\$36 -60). Orders of 100+ units have no upcharge.
Y	*Formica Non-Premium Standard (58, 43, +\$50 MC, SP and NT finishes) and Wilsonart Premium (-01, -07, -12, -18, -52, -78) laminates.
Z	*Pionite Non-Premium, Nevamar Non-Premium, Formica Premium (WR, 42, 77, 46, RD Finishes), and whiteboard laminate. +\$72

*Add \$350 list for Special Laminate orders of less than 10 units. See page 21 for edge selection.

(#) Veneer Suffix List:

D	Maple (stained similar to Kensington Maple Laminate)
J	Cherry (stained similar to Wild Cherry Laminate)
N	Walnut (stained similar to Cafelle Laminate)
8	Walnut (stained similar to Prestige Walnut laminate)
9	Cherry (stained similar to Select Cherry laminate)
X	Stain Match (add a one-time \$700 list +10% Stain Match fee)

Product Specifications:

> Thickness of Birch ply on base is 2.75".

Ordering Information:

> Bases include steel tube interior structure for cable management within the base.

> Statement tops ordered separately. See pages 40-49.

> **A freight fee of \$100 net is assessed on orders less than \$1000 net. See page 13.**



D1 W1 Part Number Description List Price (US\$)

Laminate Statement Conference Table Bases with Exposed Plyed Core and levelers (package of one)

18	6	LK18LP@#	18" Base, Exposed Plyed Core, for use on 36"/42"D table	\$1594
24	6	LK24LP@#	24" Base, Exposed Plyed Core, for use on 48"D table	\$1654
30	6	LK30LP@#	30" Base, Exposed Plyed Core, for use on 54"D table	\$1715
36	6	LK36LP@#	36" Base, Exposed Plyed Core, for use on 60"D table	\$1775

Laminate (all sides) Statement Conference Table Bases with levelers (package of one)

18	6	LK18LA@#	18" Base, Laminate all sides, for use on 36"/42"D table	\$1612
24	6	LK24LA@#	24" Base, Laminate all sides, for use on 48"D table	\$1676
30	6	LK30LA@#	30" Base, Laminate all sides, for use on 54"D table	\$1741
36	6	LK36LA@#	36" Base, Laminate all sides, for use on 60"D table	\$1807



Veneer Statement Conference Table Bases with Exposed Plyed Core and levelers (package of one)

18	6	LK18VP@#	18" Base, Veneer w/ Exposed Plyed Core, for use on 36"/42"D table	\$2191
24	6	LK24VP@#	24" Base, Veneer w/ Exposed Plyed Core, for use on 48"D table	\$2280
30	6	LK30VP@#	30" Base, Veneer w/ Exposed Plyed Core, for use on 54"D table	\$2369
36	6	LK36VP@#	36" Base, Veneer w/ Exposed Plyed Core, for use on 60"D table	\$2457

Veneer (all sides) Statement Conference Table Bases with levelers (package of one)

18	6	LK18VA@#	18" Base, Veneer all sides, for use on 36"/42"D table	\$2323
24	6	LK24VA@#	24" Base, Veneer all sides, for use on 48"D table	\$2422
30	6	LK30VA@#	30" Base, Veneer all sides, for use on 54"D table	\$2520
36	6	LK36VA@#	36" Base, Veneer all sides, for use on 60"D table	\$2620

TOPS
BASES
POWER DATA
SUPPORT FURNITURE
ACCESSORIES

TABLES STEP 2 - STATEMENT

Notes

Stealth™ Conference Base & Beam Assemblies

STEP 1

(@) Filler List:

- A Flat Filler - Standard Laminate
- B Flat Filler - Standard Veneer
- L Flat Filler - Standard Laminate with Luminesse LED option (for use w/ Non-Luminesse Top)
- M Flat Filler - Standard Laminate with Luminesse LED option (for use w/ Luminesse Top)

Tip: Fillers are aesthetic treatments on the front and back of panel bases.

Product Specifications:

- > Trim is clear anodized aluminum.
- > Panel Bases are 5-3/16"W
- > Luminesse LED lighting option only available on seated height bases.
- > Two power supplies are provided with bases up to 156"W. 168"W and larger come with three power supplies.
- > Luminesse option uses UL Certified electrical components.

Ordering Information:

- > Product is base and beam kit only. Table top specified separately.
- > Bases include cable management and cable grippers.
- > Trough covers are available to conceal equipment and hide wiring & cabling. See chart on page 158.
- > Kit includes aluminum mitered structural cross beams.
- > Base and Beam kits ship partially assembled.
- > If ordered with Luminesse LED top, fewer power supplies are required and provided.
- > **A freight fee of \$100 net is assessed on orders less than \$1000 net. See page 13.**

STEP 2

(#) Laminate Suffix List: (Filler A Only)

- A Wilsonart Kensington Maple (10776-60)
- B Wilsonart Monticello Maple (7925-38)
- C Wilsonart Wild Cherry (7054-60)
- E Wilsonart Fashion Grey (D381-60)
- F Wilsonart White Tigris (4783-60)
- G Wilsonart Cafelle (7933K-07)
- M Wilsonart Frosty White (1573-60)
- P Wilsonart Slate Grey (D91-60)
- R Wilsonart Black (1595-60)
- U Wilsonart Brazilwood (7946-38)
- V Wilsonart River Cherry (7937-38)
- W Wilsonart Designer White (D354-60)
- 3 Formica Neutral Twill (8826-58)
- 4 Formica Bleached Legno (8845-58)
- 5 Formica Prestige Walnut (6209-43)
- 7 Formica Select Cherry (7759-43)
- X *Wilsonart Non-Premium laminates +\$240 (-38, -60). Orders of 100+ units have no upcharge.
- Y *Formica Non-Premium Standard (58, +\$280 43, MC, SP and NT finishes) and Wilsonart Premium (-01, -07, -12, -18, -52, -78) laminates.
- Z *Pionite Non-Premium, Nevamar +\$302 Non-Premium, Formica Premium (WR, 42, 77, 46, RD Finishes), and whiteboard laminate.

*Add \$350 list for Special Laminate orders of less than 10 units. See page 21 for edge selection.

(#) Veneer Suffix List: (Filler B Only)

- D Maple (stained similar to Kensington Maple laminate)
- J Cherry (stained similar to Wild Cherry laminate)
- N Walnut (stained similar to Cafelle laminate)
- 8 Walnut (stained similar to Prestige Walnut laminate)
- 9 Cherry (stained similar to Select Cherry laminate)
- X Stain Match (add a one-time \$700 list +10% Stain Match fee)

FLAT FILLER STANDARD LAMINATE FLAT FILLER STANDARD VENEER

Part Number Description

Suffix A Suffix B

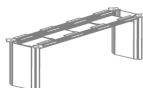

Stealth Base and Beam Assemblies for 36"/42"D Tables - Seated Height (29"H)

LY36AA@#	Seated Base Assembly for 36/42"D x 72" - 84"W table	\$4347	\$5872
LY36BA@#	Seated Base Assembly for 36/42"D x 96"-108"W table	\$4617	\$6142
LY36CA@#	Seated Base Assembly for 36/42"D x 120"W table	\$5321	\$7429
LY36DA@#	Seated Base Assembly for 36/42"D x 132"W table	\$5321	\$7429
LY36EA@#	Seated Base Assembly for 36/42"D x 144"W table	\$5321	\$7429
LY36FA@#	Seated Base Assembly for 36/42"D x 156"W table	\$5321	\$7429

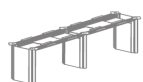

LY36GA@#	Seated Base Assembly for 36/42"D x 168/180/192"W table	\$8038	\$10,527
LY36HA@#	Seated Base Assembly for 36/42"D x 204"-216"W table	\$8531	\$11,016
LY36IA@#	Seated Base Assembly for 36/42"D x 228"-240"W table	\$8531	\$11,016



Stealth Base and Beam Assemblies for 48"D Tables - Seated Height (29"H)

LY48AA@#	Seated Base Assembly for 48"D x 72"-84"W table	\$4617	\$6796
LY48BA@#	Seated Base Assembly for 48"D x 96-108"W table	\$4781	\$6961
LY48CA@#	Seated Base Assembly for 48"D x 120"W table	\$5321	\$7429
LY48DA@#	Seated Base Assembly for 48"D x 132"W table	\$5321	\$7429
LY48EA@#	Seated Base Assembly for 48"D x 144"W table	\$5321	\$7429
LY48FA@#	Seated Base Assembly for 48"D x 156"W table	\$5321	\$7429

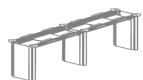

LY48GA@#	Seated Base Assembly for 48"D x 168/180/192"W	\$8038	\$10,527
LY48HA@#	Seated Base Assembly for 48"D x 204-216"W table	\$8531	\$11,016
LY48IA@#	Seated Base Assembly for 48"D x 228-240"W table	\$8531	\$11,016

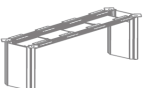

Stealth Base and Beam Assemblies for 54"D Tables - Seated Height (29"H)

LY54AA@#	Seated Base Assembly for 54"D x 72"-84"W table	\$5876	\$7980
LY54BA@#	Seated Base Assembly for 54"D x 96-108"W table	\$6036	\$8138
LY54CA@#	Seated Base Assembly for 54"D x 120"W table	\$6577	\$8674
LY54DA@#	Seated Base Assembly for 54"D x 132"W table	\$6577	\$8674
LY54EA@#	Seated Base Assembly for 54"D x 144"W table	\$6577	\$8674
LY54FA@#	Seated Base Assembly for 54"D x 156"W table	\$6577	\$8674



LY54GA@#	Seated Base Assembly for 54"D x 168/180/192"W table	\$9884	\$12,542
LY54HA@#	Seated Base Assembly for 54"D x 204-216"W table	\$10,298	\$12,951
LY54IA@#	Seated Base Assembly for 54"D x 228-240"W table	\$10,298	\$12,951

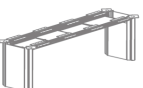

Stealth Base and Beam Assemblies for 60"D Tables - Seated Height (29"H)

LY60AA@#	Seated Base Assembly for 60"D x 72"-84"W table	\$5876	\$7980
LY60BA@#	Seated Base Assembly for 60"D x 96-108"W table	\$6036	\$8138
LY60CA@#	Seated Base Assembly for 60"D x 120"W table	\$6577	\$8674
LY60DA@#	Seated Base Assembly for 60"D x 132"W table	\$6577	\$8674
LY60EA@#	Seated Base Assembly for 60"D x 144"W table	\$6577	\$8674
LY60FA@#	Seated Base Assembly for 60"D x 156"W table	\$6577	\$8674



LY60GA@#	Seated Base Assembly for 60"D x 168/180/192"W table	\$9884	\$12,542
LY60HA@#	Seated Base Assembly for 60"D x 204-216"W table	\$10,298	\$12,951
LY60IA@#	Seated Base Assembly for 60"D x 228-240"W table	\$10,298	\$12,951

COORDINATING FURNITURE
 See page 190 for
 coordinating Stealth Credenzas.
 See pages 62-63 for
 Luminesse LED Top option.

TOPS

BASES

POWER
DATASUPPORT
FURNITURE

ACCESSORIES

TABLES STEP 2 - STEALTH

Part Number	Suffix L	Suffix M
	LAMINATE FILLER W/ LUMINESSE LED LIGHTING (FOR USE w/ NON-LUMINESSE TOP)	LAMINATE FILLER W/ LUMINESSE LED LIGHTING (FOR USE w/ LUMINESSE TOP) SEE PG. 62 FOR TOPS
LY36AA@#	\$6265	\$5841
LY36BA@#	\$6535	\$6111
LY36CA@#	\$7171	\$6815
LY36DA@#	\$7171	\$6815
LY36EA@#	\$7171	\$6815
LY36FA@#	\$7171	\$6815
LY36GA@#	\$9844	\$9428
LY36HA@#	\$10,748	\$10,332
LY36IA@#	\$10,748	\$10,332
LY48AA@#	\$6535	\$6111
LY48BA@#	\$6700	\$6276
LY48CA@#	\$7171	\$6815
LY48DA@#	\$7171	\$6815
LY48EA@#	\$7171	\$6815
LY48FA@#	\$7171	\$6815
LY48GA@#	\$9844	\$9428
LY48HA@#	\$10,748	\$10,332
LY48IA@#	\$10,748	\$10,332
LY54AA@#	\$7721	\$7301
LY54BA@#	\$7880	\$7460
LY54CA@#	\$8415	\$7995
LY54DA@#	\$8415	\$7995
LY54EA@#	\$8415	\$7995
LY54FA@#	\$8415	\$7995
LY54GA@#	\$11,766	\$11,350
LY54HA@#	\$12,596	\$12,180
LY54IA@#	\$12,475	\$12,180
LY60AA@#	\$7721	\$7301
LY60BA@#	\$7880	\$7460
LY60CA@#	\$8415	\$7995
LY60DA@#	\$8415	\$7995
LY60EA@#	\$8415	\$7995
LY60FA@#	\$8415	\$7995
LY60GA@#	\$11,766	\$11,350
LY60HA@#	\$12,475	\$12,180
LY60IA@#	\$12,475	\$12,180

Stealth Conference Base & Beam Assemblies

STEP 1

(@) Filler List:

- A Flat Filler - Standard Laminate
- B Flat Filler - Standard Veneer

Tip: Fillers are aesthetic treatments on the front and back of panel bases.

STEP 2

(#) Laminate Suffix List: (Step 1: Filler A Only)

- A Wilsonart Kensington Maple (10776-60)
- B Wilsonart Monticello Maple (7925-38)
- C Wilsonart Wild Cherry (7054-60)
- E Wilsonart Fashion Grey (D381-60)
- F Wilsonart White Tigris (4783-60)
- G Wilsonart Cafelle (7933K-07)
- M Wilsonart Frosty White (1573-60)
- P Wilsonart Slate Grey (D91-60)
- R Wilsonart Black (1595-60)
- U Wilsonart Brazilwood (7946-38)
- V Wilsonart River Cherry (7937-38)
- W Wilsonart Designer White (D354-60)
- 3 Formica Neutral Twill (8826-58)
- 4 Formica Bleached Legno (8845-58)
- 5 Formica Prestige Walnut (6209-43)
- 7 Formica Select Cherry (7759-43)
- X *Wilsonart Non-Premium laminates (-38, -60). Orders of 100+ units have no upcharge. +\$240
- Y *Formica Non-Premium Standard (58, 43, MC, SP and NT finishes) and Wilsonart Premium (-01, -07, -12, -18, -52, -78) laminates. +\$280
- Z *Pionite Non-Premium, Nevamar (WR, 42, 77, 46, RD Finishes), and whiteboard laminate. +\$302

*Add \$350 list for Special Laminate orders of less than 10 units. See page 21 for edge selection.

(#) Veneer Suffix List: (Step 1: Filler B Only)

- D Maple (stained similar to Wilsonart Kensington Maple laminate)
- J Cherry (stained similar to Wilsonart Wild Cherry laminate)
- N Walnut (stained similar to Wilsonart Cafelle laminate)
- 8 Walnut (stained similar to Prestige Walnut laminate)
- 9 Cherry (stained similar to Select Cherry laminate)
- X Stain Match (add a one-time \$700 list +10% Stain Match fee)

Product Specifications:

- > Trim is clear anodized aluminum.
- > Panel Bases are 5 3/16"W

Ordering Information:

- > Product is base and Beam kit only. Table top specified separately.
- > Bases include cable management – inner panel that slides up/down and cable grippers.
- > Kit includes aluminum mitered structural cross beams.
- > Base and Beam kits ship partially assembled.
- > **A freight fee of \$100 net is assessed on orders less than \$1000 net. See page 13.**

COORDINATING FURNITURE

See page 190 for coordinating Stealth Credenzas.

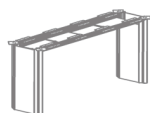
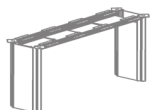

Part Number Description

Stealth Base and Beam Assemblies for 48"D Tables - Standing Height (42"H)

Part Number	Description	FLAT FILLER STANDARD LAMINATE Suffix A	FLAT FILLER STANDARD VENEER Suffix B
LY48AB@#	Standing Base Assembly for 48"D x 72"-84"W table	\$5316	\$7640
LY48BB@#	Standing Base Assembly for 48"D x 96-108"W table	\$5481	\$7803
LY48CB@#	Standing Base Assembly for 48"D x 120"W table	\$6020	\$8338
LY48DB@#	Standing Base Assembly for 48"D x 132"W table	\$6020	\$8338
LY48EB@#	Standing Base Assembly for 48"D x 144"W table	\$6020	\$8338

Stealth Base and Beam Assemblies for 60"D Tables - Standing Height (42"H)

LY60AB@#	Standing Base Assembly for 60"D x 72"-84"W table	\$6576	\$8889
LY60BB@#	Standing Base Assembly for 60"D x 96-108"W table	\$6736	\$8961
LY60CB@#	Standing Base Assembly for 60"D x 120"W table	\$7208	\$9492
LY60DB@#	Standing Base Assembly for 60"D x 132"W table	\$7208	\$9492
LY60EB@#	Standing Base Assembly for 60"D x 144"W table	\$7208	\$9492

Stealth Sliding Trough Covers* (See chart for maximum ordering quantities)

LYTCV18	One trough cover for use with bases for 36"/42"D tables, silver	\$86
---------	---	------

Tip: Trough covers for 36"/42"D tables are compatible with select power data units. For details, contact quotes@enwork.com.

LYTCV24	One trough cover for use with bases for 48"D tables, silver	\$94
LYTCV30	One trough cover for use with bases for 54"D tables, silver	\$112
LYTCV36	One trough cover for use with bases for 60"D tables, silver	\$129

*Stealth Sliding Trough covers for concealing Power/Data under Stealth conference tables:

Top Width	Max # of Trough Covers
72	1 or 2^
84	2
96	2 or 3^
108	2 or 3^
120	3
132	4
144	4
156	5^
168	5
180	6^
192	6
204	6 or 7^
216	7^
228	7^
240	8^

(Trough covers are 24"W)

^ Covers will overlap to completely cover gaps.

TOPS

BASES

POWER
DATASUPPORT
FURNITURE

ACCESSORIES

TABLES STEP 2 - STEALTH

Notes

Stealth Team Tables (Complete Tables)

STEP 1 - Tables on This Page Only

(@) Cable Management Suffix List:

N	No Cable Management	No charge
G	Grommet (one, center)	+\$18
K	One Power/Data Cut-out, Centered	+\$36
C	Two Power/Data Cut-outs	+\$72
X	Other	TBD

STEP 2

(#) Laminate Suffix List:

A	Wilsonart Kensington Maple (10776-60)	
B	Wilsonart Monticello Maple (7925-38)	
C	Wilsonart Wild Cherry (7054-60)	
E	Wilsonart Fashion Grey (D381-60)	
F	Wilsonart White Tigris (4783-60)	
G	Wilsonart Cafelle (7933K-07)	
M	Wilsonart Frosty White (1573-60)	
P	Wilsonart Slate Grey (D91-60)	
R	Wilsonart Black (1595-60)	
U	Wilsonart Brazilwood (7946-38)	
V	Wilsonart River Cherry (7937-38)	
W	Wilsonart Designer White (D354-60)	
3	Formica Neutral Twill (8826-58)	
4	Formica Bleached Legno (8845-58)	
5	Formica Prestige Walnut (6209-43)	
7	Formica Select Cherry (7759-43)	
X	*Wilsonart Non-Premium laminates (-38, -60). Orders of 100+ units have no upcharge.	+\$240
Y	*Formica Non-Premium Standard (58, 43, MC, SP and NT finishes) and Wilsonart Premium (-01, -07, -12, -18, -52, -78) laminates.	+\$280
Z	*Pionite Non-Premium, Nevamar Non-Premium, and Formica Premium (WR, 42, 77, 46, RD Finishes).	+\$302

*Add \$350 list for Special Laminate orders of less than 10 units. See page 21 for edge selection.

Tip: Whiteboard laminate is not available on Stealth Team Tables.

(#) Veneer Suffix List:

D	Maple (stained similar to Kensington Maple laminate)	
J	Cherry (stained similar to Wild Cherry laminate)	
N	Walnut (stained similar to Cafelle laminate)	
8	Walnut (stained similar to Prestige Walnut laminate)	
9	Cherry (stained similar to Select Cherry laminate)	
X	Stain Match (add a one-time \$700 list Stain Match fee)	+10%

Product Specifications:

- > Trim is clear anodized aluminum.
- > Acrylic dividers are 11"H.

Ordering Information:

- > Product numbers include entire table (e.g.: top, sides, structure).
- > Table Ships assembled. Power data unit and acrylic screens field installed.
- > Whiteboard laminate is not available on Stealth Team Tables.
- > **A freight fee of \$100 net is assessed on orders less than \$1000 net. See page 13.**

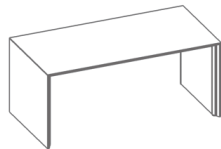

Part Number	Description	List Price (US\$)
Laminate Stealth Team Tables - 29" Seated Height		
LYTL3672A@#	Laminate Team Table, seated, 36"D x 72"W	\$5448
LYTL3684A@#	Laminate Team Table, seated, 36"D x 84"W	\$5779
LYTL3696A@#	Laminate Team Table, seated, 36"D x 96"W	\$5779
LYTL4272A@#	Laminate Team Table, seated, 42"D x 72"W	\$6111
LYTL4284A@#	Laminate Team Table, seated, 42"D x 84"W	\$6441
LYTL4296A@#	Laminate Team Table, seated, 42"D x 96"W	\$6441
LYTL4872A@#	Laminate Team Table, seated, 48"D x 72"W	\$6111
LYTL4884A@#	Laminate Team Table, seated, 48"D x 84"W	\$6441
LYTL4896A@#	Laminate Team Table, seated, 48"D x 96"W	\$6441
Veneer Stealth Team Tables - 29" Seated Height		
LYTV3672A@#	Veneer Team Table, seated, 36"D x 72"W	\$9217
LYTV3684A@#	Veneer Team Table, seated, 36"D x 84"W	\$9667
LYTV3696A@#	Veneer Team Table, seated, 36"D x 96"W	\$9667
LYTV4272A@#	Veneer Team Table, seated, 42"D x 72"W	\$10,118
LYTV4284A@#	Veneer Team Table, seated, 42"D x 84"W	\$10,792
LYTV4296A@#	Veneer Team Table, seated, 42"D x 96"W	\$10,792
LYTV4872A@#	Veneer Team Table, seated, 48"D x 72"W	\$10,118
LYTV4884A@#	Veneer Team Table, seated, 48"D x 84"W	\$10,792
LYTV4896A@#	Veneer Team Table, seated, 48"D x 96"W	\$10,792
Laminate Stealth Team Tables - 42" Standing Height		
LYTL3672B@#	Laminate Team Table, standing, 36"D x 72"W	\$5999
LYTL3684B@#	Laminate Team Table, standing, 36"D x 84"W	\$6331
LYTL3696B@#	Laminate Team Table, standing, 36"D x 96"W	\$6331
LYTL4272B@#	Laminate Team Table, standing, 42"D x 72"W	\$6662
LYTL4284B@#	Laminate Team Table, standing, 42"D x 84"W	\$6994
LYTL4296B@#	Laminate Team Table, standing, 42"D x 96"W	\$6994
LYTL4872B@#	Laminate Team Table, standing, 48"D x 72"W	\$6662
LYTL4884B@#	Laminate Team Table, standing, 48"D x 84"W	\$6994
LYTL4896B@#	Laminate Team Table, standing, 48"D x 96"W	\$6994
Veneer Stealth Team Tables - 42" Standing Height		
LYTV3672B@#	Veneer Team Table, standing, 36"D x 72"W	\$9780
LYTV3684B@#	Veneer Team Table, standing, 36"D x 84"W	\$10,231
LYTV3696B@#	Veneer Team Table, standing, 36"D x 96"W	\$10,231
LYTV4272B@#	Veneer Team Table, standing, 42"D x 72"W	\$10,680
LYTV4284B@#	Veneer Team Table, standing, 42"D x 84"W	\$11,356
LYTV4296B@#	Veneer Team Table, standing, 42"D x 96"W	\$11,356
LYTV4872B@#	Veneer Team Table, standing, 48"D x 72"W	\$10,680
LYTV4884B@#	Veneer Team Table, standing, 48"D x 84"W	\$11,356
LYTV4896B@#	Veneer Team Table, standing, 48"D x 96"W	\$11,356

COORDINATING FURNITURE
See page 190 for coordinating Stealth Credenzas.

TOPS
BASES
POWER DATA
SUPPORT FURNITURE
ACCESSORIES

TABLES STEP 2 - STEALTH

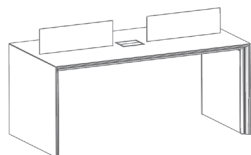

Part Number Description List Price (US\$)

Laminate Stealth Team Tables with Double-Sided Ellora Power/Data Assembly and Acrylic Dividers - 29" Seated Height

LYTL4872AP#	Laminate Team Table, seated, 48"D x 72"W, with 4 power/4 data and Dividers	\$7674
LYTL4884AP#	Laminate Team Table, seated 48"D x 84"W, with 4 power/4 data and Dividers	\$8005
LYTL4896AP#	Laminate Team Table, seated 48"D x 96"W, with 4 power/4 data and Dividers	\$8005

Veneer Stealth Team Tables with Double-Sided Ellora Power/Data Assembly and Acrylic Dividers - 29" Seated Height

LYTV4872AP#	Veneer Team Table, seated, 48"D x 72"W, with 4 power/4 data and Dividers	\$11,711
LYTV4884AP#	Veneer Team Table, seated 48"D x 84"W, with 4 power/4 data and Dividers	\$12,387
LYTV4896AP#	Veneer Team Table, seated 48"D x 96"W, with 4 power/4 data and Dividers	\$12,387

Tip: Ellora is Clear Aluminum with Black Interior. For additional details, see page 169.

Laminate Stealth Team Tables with Double-Sided Ellora Power/Data Assembly and Acrylic Dividers - 42" Standing Height

LYTL4872BP#	Laminate Team Table, standing, 48"D x 72"W, with 4 power/4 data and Dividers	\$8226
LYTL4884BP#	Laminate Team Table, standing 48"D x 84"W, with 4 power/4 data and Dividers	\$8558
LYTL4896BP#	Laminate Team Table, standing 48"D x 96"W, with 4 power/4 data and Dividers	\$8558

Veneer Stealth Team Tables with Double-Sided Ellora Power/Data Assembly and Acrylic Dividers - 42" Standing Height

LYTV4872BP#	Veneer Team Table, standing, 48"D x 72"W, with 4 power/4 data and Dividers	\$12,274
LYTV4884BP#	Veneer Team Table, standing 48"D x 84"W, with 4 power/4 data and Dividers	\$12,951
LYTV4896BP#	Veneer Team Table, standing 48"D x 96"W, with 4 power/4 data and Dividers	\$12,951

Tip: Ellora is Clear Aluminum with Black Interior. For additional details, see page 169.

Value Legs

STEP 1







(^) Paint Suffix List

G Slate Grey	no charge
R Black	no charge
S Silver	no charge
T Medium Tone	no charge
U Chrome (not available on H-legs)	+\$198
W Arctic White	no charge
Z Other	

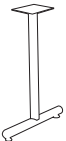
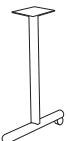
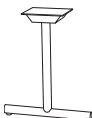
Tip: Some Steelcase, Herman Miller, Knoll, Haworth, and Allsteel paints are available for \$350 list fee per order. Call/email for availability of specific colors. Additional custom paints (e.g. Tiger Dry Lac) must be quoted through quotes@enwork.com.

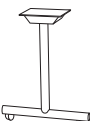
Ordering Information:

- > Standard height is 27.75". For shorter heights put "X" in front of the part number and add \$54 list. For taller, put "XX" in front and add \$68 list. Double for 4-Post "X" Base. Non-standard heights not available on height-adjustable legs. Maximum worksurface height is 42".
- > Installation hardware included
- > All Value Legs are available in chrome except H Legs. See Step 1.
- > All value legs with casters use 2" casters.
- > **A freight fee of \$100 net is assessed on orders less than \$1000 net. See page 13.**

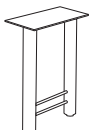
	Part Number	Description	List Price (US\$)
	Value T-Legs with Levelers, package of two		
	LTS182^	T-Leg, levelers, for 18"D table (16" spread)	\$484
	LTS242^	T-Leg, levelers, for 24"D table (22" spread)	\$490
	LTS302^	T-Leg, levelers, for 30"D or 36"D table (26" spread)	\$510
	Value T-Legs on Casters, package of two		
	LTSC182^	T-Leg, casters, for 18"D table (16" spread)	\$549
	LTSC242^	T-Leg, casters, for 24"D table (22" spread)	\$556
	LTSC302^	T-Leg, casters, for 30"D or 36"D table (26" spread)	\$574
	Value Folding T-Leg Base Assembly with Levelers, package of two		
	LTSF182^	Folding T-Leg, levelers, for 18"D table (16" spread)	\$843
	LTSF242^	Folding T-Leg, levelers, for 24"D table (22" spread)	\$904
	LTSF302^	Folding T-Leg, levelers, for 30"D or 36"D table (26" spread)	\$917
Tip: Folding T-Legs can be mounted on tables as short as 60" W.			
	Value Folding T-Leg Base Assembly with Casters, package of two		
	LTSFC182^	Folding T-Leg, casters, for 18"D table (16" spread)	\$903
	LTSFC242^	Folding T-Leg, casters, for 24"D table (22" spread)	\$966
	LTSFC302^	Folding T-Leg, casters, for 30"D or 36"D table (26" spread)	\$979
Tip: Folding T-Legs can be mounted on tables as short as 60" W.			
	Value T-Leg Flip Base Assembly with Casters and Single Release Handle, package of two		
	LTSACD182^	Flip T-Leg, casters, for 18"D table (16" spread)	\$1043
	LTSACD242^	Flip T-Leg, casters, for 24"D table (22" spread)	\$1051
	LTSACD302^	Flip T-Leg, casters, for 30"D table (26" spread)	\$1068
Tip: For 36"D T-Leg Flip Base assembly, see page 131.			
	Value C-Legs with Levelers, package of two		
	LCV182^	C-Leg, levelers, for 18"D table	\$492
	LCV242^	C-Leg, levelers, for 24"D table	\$498
	LCV302^	C-Leg, levelers, for 30"D table	\$509
	Value C-Legs with Casters, package of two		
	LCVC182^	C-Leg, casters, for 18"D table	\$558
	LCVC242^	C-Leg, casters, for 24"D table	\$565
	LCVC302^	C-Leg, casters, for 30"D table	\$576
	Value TT-Legs with Levelers, package of one		
LTSD^	TT-Leg, levelers, for table up to 60"W (36" spread)	\$436	
	Value H-Legs, package of one		
	LHA^	H-leg (14" spread) for 18-24"D table with 2" dia. Columns	\$282
	LHB^	H-Leg (20" spread) for 30-36"D table with 3" dia. Columns	\$303
	LHC^	H-Leg (24" spread) for 42-48"D table with 3" dia. Columns	\$412
	LHD^	H-Leg (30" spread) for 54-60"D table with 4" dia. Columns	\$833









TOPS

BASES

POWER
DATASUPPORT
FURNITURE

ACCESSORIES

TABLES STEP 2 - VALUE

	Part Number	Description	List Price (US\$)
		Value Column Legs for Peninsula, D-Top, Spanner and Jetty Worksurfaces - 3" diameter, package of one	
	LCLMP^	Column Leg	\$148
		Value Straight Legs - 2" diameter	
	LPLE^	Straight Leg, leveler	\$118
	LPLE2^	Straight Leg, leveler, package of two	\$212
	LPLEC^	Straight Leg, caster	\$129
	LPLEC2^	Straight Leg, caster, package of two	\$232
		Value Folding Straight Legs, package of two	
	LPLEF2^	Folding Straight Leg, leveler	\$471
	LPLECF2^	Folding Straight Leg, caster	\$489
		Tip: For use on maximum table size of 30"x60" or 48"x48". For larger tables specify heavy duty mechanism. Put "X" in front of the part number and add \$300 to list price (package of 2).	
		Value Pin Adjustable Straight Legs	
	LAPL^	Pin Adjustable Straight Leg, leveler	\$311
	LAPL2^	Pin Adjustable Straight Leg, leveler, package of two	\$590
	LAPLC^	PinAdjustable Straight Leg, caster	\$322
	LAPLC2^	PinAdjustable Straight Leg, caster, package of two	\$603
		Tip: Adjusts 26" - 35" with one inch increments (including top).	
		Value X-Bases with Levelers	
	LXBA^	X-Base, levelers, for 24" round or 24" square table	\$432
	LXBB^	X-Base, levelers, for 30"-36" round or 30" square table	\$445
	LXBC^	X-Base, levelers, for 42" round or 36" square table	\$528
	LXBD^	X-Base, levelers, for 48" round or 42" square table	\$585
		Value X-Bases with Casters	
	LXBCA^	X-Base, casters, for 24" round or 24" square table	\$435
	LXBCB^	X-Base, casters, for 30"-36" round or 30" square table	\$446
	LXBCC^	X-Base, casters, for 42" round or 36" square table	\$553
	LXB CD^	X-Base, casters, for 48" round or 42" square table	\$581
		Value Flip X-Bases on Casters	
	LXFAC^	Flip X-Base, casters, for 24" round table	\$802
	LXFBC^	Flip X-Base, casters, for 30"-36" round or 24"-30" square table	\$818
	LXFCC^	Flip X-Base, casters, for 42" round or 36" square table	\$912
	LXFDC^	Flip X-Base, casters, for 48" round or 42" square table	\$948
		Value 4-Post X-Base with Levelers	
	LXBE^	4-Post X-Base, levelers, for 54"-60" round or 48" square table	\$1072
	LXBF^	4-Post X-Base, levelers, for 66"-84" round table	\$1145

Choosing Power, Data, & Telecom Solutions

We make it easy to choose the right Power/Data assembly, assuring you have a highly functional yet cost effective solution. With a little bit of planning, empowering a table or a large training room can be simple – usually without the added complexity and expense of a technology integrator. Listed below are planning tips to help assure an impressive, productive installation.

Step 1 – Determine the number of power outlets needed.

Based on the size of the table and type of space, determine how many users might need power.

Tip: If the table will be used continuously for long periods of time, users will need to plug in their laptops. If so, a higher number of outlets may be needed.

Step 2 – Determine the number and type of datacom connections needed.

Which systems require physical connections? If the room or facility has a wireless network, fewer will be needed.

Step 3 – Determine which Power/Data unit best fits your requirements.

Use the Conference and Training/Teaming charts as well as the detailed assembly descriptions in this Price List to compare capabilities and features. Be sure to review the datacom options available for each assembly.

Data Options - Each unit is marked with an ▲ or ● to identify the category of datacom options available. Both types can meet most needs, but if you have diverse or unusual needs, assemblies with a ● have a wider variety of options available.



▲ : Power/Data units in this category come standard with data openings and a Voice/Data Adapter kit. Adapters from the kit are used to install jacks or couplers (ordered separately from Enwork or supplied by the customer) into the data openings of the power/data unit. Voice/data options are punch down. Audio/video options are inline.



● : Power/Data units in this category come standard with datacom plate openings. Datacom plates must be ordered from Enwork or openings can be left empty. Datacom plates can be configured to include multiple voice, data, audio and video solutions. Voice/data options are punch down. Audio/video options are inline.

Tip: Two or more smaller units can provide better user access on longer conference tables. When using multiple units, it is often easier and more convenient if power cords can be combined. Some assemblies can be daisy-chained together under the table. In other cases a UL listed power strip under the top or hidden in a base becomes the consolidation point, reducing the number of cords that need to be routed to the floor.

Tip: Some units are one-sided, others are two-sided. For the same number of outlets, a single two-sided unit will be lower cost than two one-sided units.

Tip: Be sure you understand how power and cabling will be routed from the building into the space and to the table(s).

Tip: To select an appropriate in-feed, determine if power will be coming from an outlet or hard-wired to the building. Hardwiring also allows the possibility of multi-circuit power within a table or series of interconnected tables. Note that only some units can be hardwired.

Tip: If power needs to run from one table to the next, look for units that can be daisy-chained. If connected tables will be re-configured into alternate set-ups, then units with non-sequential daisy-chaining are often the best solution.

TOPS	TABLES STEP 3 - POWER / DATA
BASES	
POWER DATA	
SUPPORT FURNITURE	
ACCESSORIES	

Step 4 – Determine the location and orientation of the Power/Data units in the table top.

The position of units in a table is important because it affects both access from different seating positions as well as the ease with which power and data can be routed from the building into the table.

Tip: For smaller tables, a single unit in the center is the most common solution. For tables longer than 96", multiple and/or two-sided units provide more convenient user access.

Tip: One-sided units typically open towards the end of a table. Two-sided units typically open towards the long sides of a table.

Tip: Multiple units are often spaced equally along the length of the table or positioned near the ends of the table, typically 20-24" in from the edge.

Tip: Positioning one or more units just next to legs or bases usually makes it easier to keep everything hidden. Placing assemblies directly over legs or bases requires special attention to assure there is no physical interference - contact quotes@enwork.com.

Tip: Refer to the Conference Table Power/Data Standard Cut-outs page in this Price List to see different positioning options.

Step 5 – Don't forget to order accessories

Cable Grippers, Cable Managers, and other accessories help keep all the wires and cables organized and out of sight. See page 176 for available options.

Choosing Power, Data, & Telecom Solutions

Training, Teaming, and Workstation Applications

	Product*	Door/Case Material	# Power Outlets	Daisy-Chaining Available	Hardwire Option	# Datacom Ports	Datacom Options	USB Charging Available	Key Features and Descriptions
Clamp-on	Axil X	Aluminum	2	N	Special	1 or 2	▲	Y	Clamp on convenience and flexible 6' power cord, longer
NEW	Cove	Aluminum	2	Y	Special	0	NA	Y	Surface mounted power and charging USB perfect for retrofit projects. cords available.
	Ellora, Single-Sided	Aluminum	2	Special	Special	2	▲	Y	Great aesthetics. Flush fit door with cable drop space. Available with pre-wired dual charging USBs in one or more Datacom ports.
Best Seller	Flip-n-Go	Steel	2	Y	Special	1 Multi-option Plate	●	N	Popular choice for multiple mobile table applications. Flush-fit doors with cable drop space. Convenience Outlet on bottom. 6' or 9' power cord. Includes 15A 125V circuit breaker for overload protection.
NEW	Node	Die-Cast Zinc	1 or 2	N	N	0	▲ (Specials Only)	Y	Clean, flush mount design. Fits 1.25"-1.5" tops. 2 amp stacked USB charging available. 6' 15 amp power cord.
Specialty	Powerlex	Impression Modesty Panel	4	Y	Y	4	▲	N	Power integration below the work surface. Non-sequential Daisy Chaining.
New Undersurface Mount	Satellite	Steel	1 or 2		Y	1 or 2	▲	Y	Ideal for day 2 updates to existing tables. Available with angled or rounded aesthetic.
Best Seller	Villa, Corded	Steel	2	Y	Special	0 or 2	RJ-45 CAT6	Y	Popular low cost choice for multiple mobile table applications. Convenience Outlet on bottom. Only data option is two RJ-45 CAT6 only punch-downs.
Specialty	CHI, NYC, SF	See Price List or contact quotes@enwork.com							

* Go to www.enwork.com for additional information

TOPS

BASES

POWER
DATASUPPORT
FURNITURE

ACCESSORIES

TABLES STEP 3 - POWER / DATA

Conference Applications

	Product*	Door/Case Material	# Power Outlets	Daisy-Chaining Available	Hardwire Option	# Datacom Ports	Datacom Options	USB Charging Available	Key Features and Descriptions
	Alexander Linear, Double-Sided	Aluminum	4, 6 or 8	N	Special	4 or 6	▲	Special	Modern long rectangular shape aesthetics with pop-up doors. Two 10' cords.
Best Seller	Ellora, Double-Sided	Aluminum	4, 6 or 8	Y	Special	4 or 6	▲	Y	Aesthetics. Flush fit door with cable drop space. Available with pre-wired dual charging USBs in one or more Datacom ports. Sequential Daisy-Chaining is optional.
	Flip-n-Go	Steel	2	Y	Y	1 Multi-option Plate	●	N	Popular choice for multiple mobile table applications. Flush-fit doors with cable drop space. Convenience Outlet on bottom. 6' or 9' power cord. Includes 15A 125V circuit breaker for overload protection.
Specialty	Foundation Trough Kit	Veneer, Laminate or Aluminum	3-27	Y	Y	1-9 Multi-option Plate @	●	N	Doors lay flat when open. Power Data varies by table size.
New	PowerEdge	Steel	4-16*	NA	Y	0-8*	▲	Y	Complete top with integrated power data recessed 2" from edge. Choices include power, stacked USB charging, and data. *Depending on table size and option choices
	Oasis 30"	Steel	12	Y	Y	4 Multi-option Plates	●	Special	The most substantial solution for conference applications. Retracting doors.
Best Seller	Oasis 15"	Steel	6	Y	Y	2 Multi-option Plates	●	Y	Great flexibility. Retracting doors flush with surface. 9' power cord.
New Undersurface Mount	Satellite	Steel	1 or 2		Y	1 or 2	▲	Y	Ideal for day 2 updates to existing tables. Available with angled or rounded aesthetic.
Specialty	CHI, NYC, SF,	See Price List or contact quotes@enwork.com							

Power & Data

Ordering Information:

- > For product features and capability comparison, see page 166-167.
- > For details and pricing of features listed under the "Additional Specials" section of a product, email quotes@enwork.com.
- > Data options for ▲ and ● can be found on page 174-175.
- > **A freight fee of \$100 net is assessed on orders less than \$1000 net. See page 13.**

Part Number **Cut-Out Size** **List Price (US\$)**



Alexander™

Data Options: ▲

Features: 15 amp capability, modern aesthetic

Material: Anodized aluminum

Cord/Hardware: 10' power cord

Additional Specials: Hardwired power, Longer cords, additional openings

Alexander Linear Double-Sided Power/Data Assembly with two 10' power cords

PDL22A	Alexander Linear, 4 power/4 data openings, Clear Anodized Aluminum	4.0" x 16.19"	\$1236
PDL22R	Alexander Linear, 4 power/4 data openings, Black Anodized Aluminum	4.0" x 16.19"	\$1608
PDL33A	Alexander Linear, 6 power/6 data openings, Clear Anodized Aluminum	4.0" x 22.19"	\$1353
PDL33R	Alexander Linear, 6 power/6 data openings, Black Anodized Aluminum	4.0" x 22.19"	\$2276
PDL44A	Alexander Linear, 8 power/2 circuit breakers/6 data openings, Clear Anodized Aluminum	4.0" x 28.19"	\$1675
PDL44R	Alexander Linear, 8 power/2 circuit breakers/6 data openings, Black Anodized Aluminum	4.0" x 28.19"	\$2167



Axil-X™

Data Options: ▲

Features: Clamps to any worksurface, 15amp

Material: Anodized aluminum

Cord/Hardware: 6' power cord

Additional Specials: Longer cords, different number of openings

Axil-X Clamp-On Power/Data Assembly with 6' power cord

PDAX22R	Axil-X Clamp-on, 2 power/2 data openings, Black		\$479
PDAX22S	Axil-X Clamp-on, 2 power/2 data openings, Silver		\$365
PDAX22W	Axil-X Clamp-on, 2 power/2 data openings, White		\$365
PDAX21UR	Axil-X Clamp-on, 2 power/1 data opening/2 charging USB (stacked), Black		\$604
PDAX21US	Axil-X Clamp-on, 2 power/1 data opening/2 charging USB (stacked), Silver		\$489
PDAX21UW	Axil-X Clamp-on, 2 power/1 data opening/2 charging USB (stacked), White		\$489



Cove™

Data Options: N/A

Features: Spill resistant receptacles, 15amp

Material: Anodized aluminum

Cord/Hardware: 9' power cord

Additional Specials: Longer cords, different number of openings

Cove Surface-Mount Power/Data Assembly with 9' power cord

PDCOVR	Cove, Corded, 2 pwr, 9' pwr cord, extra plug on bottom, Black w/ Black Receptacles	2.0" x 5.25"	\$459
PDCOVW	Cove, Corded, 2 pwr, 9' pwr cord, extra plug on bottom, Gloss White w/ White Receptacles	2.0" x 5.25"	\$459
PDCOVV	Cove, Corded, 2 pwr, 9' pwr cord, extra plug on bottom, Silver w/ Black Receptacles	2.0" x 5.25"	\$459
PDCO2R	Cove, Corded, 2 pwr/2 charging USB, 9' pwr cord, 2 extra plugs on bottom, Black w/ Black Receptacles	2.0" x 7.25"	\$786
PDCO2W	Cove, Corded, 2 pwr/2 charging USB, 9' pwr cord, 2 extra plugs on bottom, Gloss White w/ White Receptacles	2.0" x 7.25"	\$786
PDCO2S	Cove, Corded, 2 pwr/2 charging USB, 9' pwr cord, 2 extra plugs on bottom, Silver w/ Black Receptacles	2.0" x 7.25"	\$786



Part Number **Cut-Out Size** **List Price**

Ellora™

Data Options: ▲

Features: Flush fit doors with cable drop space

Material: Anodized aluminum

Cord: 6' (Single), 10' (Double)

Additional Specials: Pre-installed voice/data, different configurations

Ellora Single-Sided Power/Data Assemblies with 6' power cord

PDE22AW	Ellora Single, 2 pwr/2 data openings, Clear Aluminum w/ White Interior	5.0" x 8.0"	\$636
PDE22AR	Ellora Single, 2 pwr/2 data openings, Clear Aluminum w/ Black Interior	5.0" x 8.0"	\$636
PDE22RR	Ellora Single, 2 pwr/2 data openings, Black Aluminum w/ Black Interior	5.0" x 8.0"	\$827
PDE212AW	Ellora Single, 2 pwr/1 data opening/2 charging USB, Clear Aluminum w/ White Interior	5.0" x 8.0"	\$768
PDE212AR	Ellora Single, 2 pwr/1 data opening/2 charging USB, Clear Aluminum w/ Black Interior	5.0" x 8.0"	\$768
PDE212RR	Ellora Single, 2 pwr/1 data opening/2 charging USB, Black Aluminum w/ Black Interior	5.0" x 8.0"	\$959

Ellora Double-Sided Power/Data Assemblies with two 10' power cords

PDE44AW	Ellora Double, 4 pwr/4 data openings, Clear Aluminum w/ White Interior	9.81" x 8.0"	\$1140
PDE44AR	Ellora Double, 4 pwr/4 data openings, Clear Aluminum w/ Black Interior	9.81" x 8.0"	\$1140
PDE44RR	Ellora Double, 4 pwr/4 data openings, Black Aluminum w/ Black Interior	9.81" x 8.0"	\$1473
PDE424AW	Ellora Double, 4 pwr/2 data openings/4 charging USB, Clear Aluminum w/ White Interior	9.81" x 8.0"	\$1406
PDE424AR	Ellora Double, 4 pwr/2 data openings/4 charging USB, Clear Aluminum w/ Black Interior	9.81" x 8.0"	\$1406
PDE424RR	Ellora Double, 4 pwr/2 data openings/4 charging USB, Black Aluminum w/ Black Interior	9.81" x 8.0"	\$1615
PDE66AW	Ellora Double, 6 pwr/6 data openings, Clear Aluminum w/ White Interior	9.81" x 11.0"	\$1271
PDE66AR	Ellora Double, 6 pwr/6 data openings, Clear Aluminum w/ Black Interior	9.81" x 11.0"	\$1271
PDE66RR	Ellora Double, 6 pwr/6 data openings, Black Aluminum w/ Black Interior	9.81" x 11.0"	\$1643
PDE644AW	Ellora Double, 6 pwr/4 data openings/4 charging USB, Clear Aluminum w/ White Interior	9.81" x 11.0"	\$1519
PDE644AR	Ellora Double, 6 pwr/4 data openings/4 charging USB, Clear Aluminum w/ Black Interior	9.81" x 11.0"	\$1519
PDE644RR	Ellora Double, 6 pwr/4 data openings/4 charging USB, Black Aluminum w/ Black Interior	9.81" x 11.0"	\$2276
PDE88AW	Ellora Double, 8 pwr/2 circuit breakers/6 data openings, Clear Aluminum w/ White Interior	9.81" x 14.0"	\$1588
PDE88AR	Ellora Double, 8 pwr/2 circuit breakers/6 data openings, Clear Aluminum w/ Black Interior	9.81" x 14.0"	\$1588
PDE88RR	Ellora Double, 8 pwr/2 circuit breakers/6 data openings, Black Aluminum w/ Black Interior	9.81" x 14.0"	\$2052
PDE834AW	Ellora Double, 8 pwr/2 circuit breakers/4 data openings/4 charging USB, Clear Aluminum w/ White Interior	9.81" x 14.0"	\$1850
PDE834AR	Ellora Double, 8 pwr/2 circuit breakers/4 data openings/4 charging USB, Clear Aluminum w/ Black Interior	9.81" x 14.0"	\$1850
PDE834RR	Ellora Double, 8 pwr/2 circuit breakers/4 data openings/4 charging USB, Black Aluminum w/ Black Interior	9.81" x 14.0"	\$2284

Power & Data

Ordering Information:

- > For product features and capability comparison, see page 166-167.
- > For details and pricing of features listed under the "Additional Specials" section of a product, email quotes@enwork.com.
- > Data options for ▲ and ● can be found on page 174-175.
- > **A freight fee of \$100 net is assessed on orders less than \$1000 net. See page 13.**

Part Number	Cut-Out Size	List Price (US\$)
-------------	--------------	-------------------

Ellora™

Data Options: ▲

Features: Flush fit doors with cable drop space

Material: Anodized aluminum

Cord: 10' (Double)

Additional Specials: Pre-installed voice/data, different configurations

Ellora Daisy Chain Double-sided Power/Data Assemblies with two 12" Harnesses and "H" Block, Clear Aluminum w/ Black Interior

Circuit 1

PDE44ARDC1	Ellora Daisy Chain, Circuit 1, 4 power/4 data openings	9.81" x 8.0"	\$1201
PDE424ARDC1	Ellora Daisy Chain, Circuit 1, 4 power/2 data openings/4 charging USB	9.81" x 8.0"	\$1465
PDE66ARDC1	Ellora Daisy Chain, Circuit 1, 6 power/6 data openings	9.81" x 11.0"	\$1332
PDE644ARDC1	Ellora Daisy Chain, Circuit 1, 6 power/4 data openings/4 charging USB	9.81" x 11.0"	\$1597

Circuit 2

PDE44ARDC2	Ellora Daisy Chain, Circuit 2, 4 power/4 data openings	9.81" x 8.0"	\$1201
PDE424ARDC2	Ellora Daisy Chain, Circuit 2, 4 power/2 data openings/4 charging USB	9.81" x 8.0"	\$1465
PDE66ARDC2	Ellora Daisy Chain, Circuit 2, 6 power/6 data openings	9.81" x 11.0"	\$1332
PDE644ARDC2	Ellora Daisy Chain, Circuit 2, 6 power/4 data openings/4 charging USB	9.81" x 11.0"	\$1597

Jumpers (used to connect Ellora Daisy Chain units)

PDEJUMPXX	Jumper for connecting 2 Ellora Units, package of one		\$137
-----------	--	--	-------

Infeeds

A8BP72	Base Power-In for Hardwire, 72"	\$168
A8BP120	Base Power-In for Hardwire, 120"	\$203
A1BP72	Base Power-In for RA Plug Circuit 1 (only), 72"	\$239

Tip: Use hardwire infeeds if UL listed (not recognized) is required.

Tip: Infeeds have a 20 amp plug end which requires a 20 amp wall receptacle. A plug adapter is required if using a standard 15 amp receptacle. The adapter is not included and must be purchased separately. Conntek 30129 15-Amp to 20-Amp Plug Adapters and similar are available through amazon.com and at many electrical supply houses.



15 amp Receptacle



20 amp Receptacle



Flip-n-Go™

Data Options: ●

Features: Convenience outlet, flush fit doors with cable drop space, 15A 125V circuit breaker

Material: Painted steel

Cord/Hardwire: 6' or 9' power cord

Additional Specials: Hardwired power

Flip-n-Go Power/Data Assemblies, 9"x5.5", with additional convenience power outlet on bottom

PDNSS	Flip-n-Go Grommet, 2 power/1 telecom plate cutout, 6' power cord, Silver	4.75" x 8.38"	\$505
PDNSR	Flip-n-Go Grommet, 2 power/1 telecom plate cutout, 6' power cord, Black	4.75" x 8.38"	\$505
PDNS9S	Flip-n-Go Grommet, 2 power/1 telecom plate cutout, 9' power cord, Silver	4.75" x 8.38"	\$533
PDNS9R	Flip-n-Go Grommet, 2 power/1 telecom plate cutout, 9' power cord, Black	4.75" x 8.38"	\$533



Part Number		Cut-Out Size	List Price
Node™			
	Data Options: ▲ (Specials Only)	Cord/Hardware: 6' Power Cord	
	Features: Simple flush mount design, 15 amp, 2 amp	Additional Specials: Longer cords, Data openings charging USB duplex available	
	Material: Painted die-cast Zinc		
PDF20S	Node Power Unit, 2 Outlets, Silver	3" Diameter	\$256
PDF20R	Node Power Unit, 2 Outlets, Black	3" Diameter	\$256
PDF20W	Node Power Unit, 2 Outlets, Parchment White	3" Diameter	\$256
PDF12S	Node Power Unit, 1 Outlet/2 charging USB, Silver	3" Diameter	\$367
PDF12R	Node Power Unit, 1 Outlet/2 charging USB, Black	3" Diameter	\$367
PDF12W	Node Power Unit, 1 Outlet/2 charging USB, Parchment White	3" Diameter	\$367

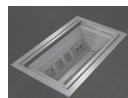

Oasis™ Power/Data Assemblies, 12 amp power cords			
	Data Options: ●	Cord/Hardware: 9' cords or Daisy Chaining hardware	
	Features: Flush with worksurface, Integral lid, Flexibility		
	Material: Painted steel		

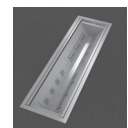

Oasis Power/Data Assemblies, Plug-In			
PDOASIS15S	Oasis, 6 power/2 telecom plate cutouts, two 108" power cords, 9"x15", Silver	8.25" x 14.25"	\$2422
PDOASIS15R	Oasis, 6 power/2 telecom plate cutouts, two 108" power cords, 9"x15", Black	8.25" x 14.25"	\$2422
PDOAUU15S	Oasis, 6 power/1 telecom plate cutout/2 charging USB, two 108" power cords, 9"x15", Silver	8.25" x 14.25"	\$2652
PDOAUU15R	Oasis, 6 power/1 telecom plate cutout/2 charging USB, two 108" power cords, 9"x15", Black	8.25" x 14.25"	\$2652
PDOASIS30S	Oasis, 12 power/4 telecom plate cutouts, four 108" power cords, 9"x30", Silver	8.25" x 29.25"	\$4167
PDOASIS30R	Oasis, 12 power/4 telecom plate cutouts, four 108" power cords, 9"x30", Black	8.25" x 29.25"	\$4167

Tip: Telecom plates ordered separately.

Oasis Daisy Chain Power/Data Assemblies, hardware interface, 20 Amp, Circuit 1

PDOASIS15D1S	Oasis Daisy Chain, Circuit 1, 6 power/2 telecom plate cutouts, 9" x 15", Silver	8.25" x 14.25"	\$2493
PDOASIS15D1R	Oasis Daisy Chain, Circuit 1, 6 power/2 telecom plate cutouts, 9" x 15", Black	8.25" x 14.25"	\$2493
PDOAUU15D1S	Oasis Daisy Chain, Circuit 1, 6 power/1 telecom plate cutout/2 charging USB, 9" x 15", Silver	8.25" x 14.25"	\$2792
PDOAUU15D1R	Oasis Daisy Chain, Circuit 1, 6 power/1 telecom plate cutout/2 charging USB, 9" x 15", Black	8.25" x 14.25"	\$2792
PDOASIS30D1S	Oasis Daisy Chain, Circuit 1, 12 power/4 telecom plate cutouts, 9" x 30", Silver	8.25" x 29.25"	\$4288
PDOASIS30D1R	Oasis Daisy Chain, Circuit 1, 12 power/4 telecom plate cutouts, 9" x 30", Black	8.25" x 29.25"	\$4288

Oasis Daisy Chain Power/Data Assemblies, hardware interface, 20 Amp, Circuit 2

PDOASIS15D2S	Oasis Daisy Chain, Circuit 2, 6 power/2 telecom plate cutouts, 9" x 15", Silver	8.25" x 14.25"	\$2493
PDOASIS15D2R	Oasis Daisy Chain, Circuit 2, 6 power/2 telecom plate cutouts, 9" x 15", Black	8.25" x 14.25"	\$2493
PDOAUU15D2S	Oasis Daisy Chain, Circuit 2, 6 power/1 telecom plate cutout/2 charging USB, 9" x 15", Silver	8.25" x 14.25"	\$2792
PDOAUU15D2R	Oasis Daisy Chain, Circuit 2, 6 power/1 telecom plate cutout/2 charging USB, 9" x 15", Black	8.25" x 14.25"	\$2792
PDOASIS30D2S	Oasis Daisy Chain, Circuit 2, 12 power/4 telecom plate cutouts, 9" x 30", Silver	8.25" x 29.25"	\$4288
PDOASIS30D2R	Oasis Daisy Chain, Circuit 2, 12 power/4 telecom plate cutouts, 9" x 30", Black	8.25" x 29.25"	\$4288

Oasis Power-In and Jumpers

PDVP72	Hardwire Power-In, 72"		\$180
PDVP144	Hardwire Power-In, 144"		\$229
PDV72AP	Base Power-In, 72" (for Plug Circuit 1 only)		\$279
PDJUMPXX	Jumpers for connecting 2 Oasis Daisy Chain Units, package of two		\$404

Power & Data

Ordering Information:

- > For product features and capability comparison, see page 166-167.
- > For details and pricing of features listed under the "Additional Specials" section of a product, email quotes@enwork.com.
- > Data options for ▲ and ● can be found on page 174-175.
- > **A freight fee of \$100 net is assessed on orders less than \$1000 net. See page 13.**

Satellite™





Data Options: ▲

Features: Only 1.5"H, mounts under worksurface, 15 amp capability, strain relief on cord

Material: Painted steel with matching plastic outlets

Cord/Hardware: 10' Power Cord with 15 amp plug

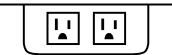
Additional Specials: Hardwire

	Part Number	Description	List Price (US\$)
	Angled Undermount Satellite Power/Data Units, 2 Power		
	PDPAAPW	Angled Power Data Unit w/ 10' cord, 2 Power, White w/ White	\$290
	PDPAAPS	Angled Power Data Unit w/ 10' cord, 2 Power, Silver w/ Grey	\$290
	PDPAAPR	Angled Power Data Unit w/ 10' cord, 2 Power, Black w/ Black	\$290
	Angled Undermount Satellite Power/Data Units, 1 Power/2 Stacked USB		
	PDPAAUW	Angled Power Data Unit w/ 10' cord, 1 Power/2 Stacked USB, White w/ White	\$435
	PDPA AUS	Angled Power Data Unit w/ 10' cord, 1 Power/2 Stacked USB, Silver w/ Grey	\$435
	PDPA AUR	Angled Power Data Unit w/ 10' cord, 1 Power/2 Stacked USB, Black w/ Black	\$435
	Angled Undermount Satellite Power/Data Units, 1 Power/1 Data Opening		
	PDPAADW	Angled Power Data Unit w/ 10' cord, 1 Power/1 Data Opening, White w/ White	\$356
	PDPAADS	Angled Power Data Unit w/ 10' cord, 1 Power/1 Data Opening, Silver w/ Grey	\$356
	PDPAADR	Angled Power Data Unit w/ 10' cord, 1 Power/1 Data Opening, Black w/ Black	\$356
		Tip: Data knockout adapter tree included.	
		Tip: Will not accommodate VGA connections.	
		Tip: Order a plug strip to consolidate multiple Satellite units under a single top.	
	Rounded Undermount Satellite Power/Data Units, 2 Power		
	PDP88PW	Rounded Power Data Unit w/ 10' cord, 2 Power, White w/ White	\$290
	PDP88PS	Rounded Power Data Unit w/ 10' cord, 2 Power, Silver w/ Grey	\$290
	PDP88PR	Rounded Power Data Unit w/ 10' cord, 2 Power, Black w/ Black	\$290
	Rounded Undermount Satellite Power/Data Units, 1 Power/2 Stacked USB		
	PDP88UW	Rounded Power Data Unit w/ 10' cord, 1 Power/2 Stacked USB, White w/ White	\$435
	PDP88US	Rounded Power Data Unit w/ 10' cord, 1 Power/2 Stacked USB, Silver w/ Grey	\$435
	PDP88UR	Rounded Power Data Unit w/ 10' cord, 1 Power/2 Stacked USB, Black w/ Black	\$435
	Rounded Undermount Satellite Power/Data Units, 1 Power/1 Data Opening		
	PDP88DW	Rounded Power Data Unit w/ 10' cord, 1 Power/1 Data Opening, White w/ White	\$356
	PDP88DS	Rounded Power Data Unit w/ 10' cord, 1 Power/1 Data Opening, Silver w/ Grey	\$356
	PDP88DR	Rounded Power Data Unit w/ 10' cord, 1 Power/1 Data Opening, Black w/ Black	\$356
		Tip: Data knockout adapter tree included.	
		Tip: Will not accommodate VGA connections.	
		Tip: Order a plug strip to consolidate multiple Satellite units under a single top.	



Part Number		Cut-Out Size	List Price
Villa™	<p>Data Options: N/A</p> <p>Features: Convenience outlet, Circuit breaker, Low cost solution</p> <p>Material: Painted steel</p>		
	<p>Cord/Hardware: 6' or 9' power cord</p> <p>Additional Specials: Hardwire (quotes@enwork.com)</p>		
Villa Power/Data Assemblies, 3.5"x5.5", with additional convenience power outlet on bottom			
PDVCS	Villa, 2 power/2 data openings, 6' power cord, Silver	3.06" x 5.31"	\$451
PDVCR	Villa, 2 power/2 data openings, 6' power cord, Black	3.06" x 5.31"	\$451
PDVC9S	Villa, 2 power/2 data openings, 9' power cord, Silver	3.06" x 5.31"	\$451
PDVC9R	Villa, 2 power/2 data openings, 9' power cord, Black	3.06" x 5.31"	\$451
PDVCUSS	Villa, 2 power/2 data openings/2 charging USB, 6' power cord, Silver	3.06" x 5.31"	\$649
PDVCUSR	Villa, 2 power/2 data openings/2 charging USB, 6' power cord, Black	3.06" x 5.31"	\$649
PDVCUS9S	Villa, 2 power/2 data openings/2 charging USB, 9' power cord, Silver	3.06" x 5.31"	\$649
PDVCUS9R	Villa, 2 power/2 data openings/2 charging USB, 9' power cord, Black	3.06" x 5.31"	\$649
	Tip: Data openings are for keystone data jacks only.		
PDVD2S	Villa, 2 power/2 RJ-45 CAT6 punch-downs, 6' power cord, Silver	3.06" x 5.31"	\$633
PDVD2R	Villa, 2 power/2 RJ-45 CAT6 punch-downs, 6' power cord, Black	3.06" x 5.31"	\$633
PDVD29S	Villa, 2 power/2 RJ-45 CAT6 punch-downs, 9' power cord, Silver	3.06" x 5.31"	\$633
PDVD29R	Villa, 2 power/2 RJ-45 CAT6 punch-downs, 9' power cord, Black	3.06" x 5.31"	\$633
Plug Strip with Surge Protection, Rotating Plug and 8' cord			
CPPSI	Belkin 6-outlet plug strip, Black		\$118

TOPS

BASES

POWER
DATASUPPORT
FURNITURE

ACCESSORIES

TABLES STEP 3 - POWER / DATA

Power & Data

Ordering Information:























- > Items on this page work with Power Data units marked with a circle ●.
- > See Tables Power and Data section of the Enwork website to see detailed pictures of standard Telecom plates.
- > Other combinations available, contact quotes@enwork.com.
- > **A freight fee of \$100 net is assessed on orders less than \$1000 net. See page 13.**



Part Number

List Price (US\$)

Telecom Plates (for Flip-N-Go, Oasis and Foundation Trough Kits)

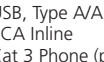
	A-BL	● Blank cover to fill Hole in Power/Data unit	\$19
	A-BL-73-73	● RJ45 category 5 Data Inline (Qty. 2)	\$199
	A-BL-B	● RJ45 category 6 Data (Qty. 1)	\$103
	A-BL-B-B	● RJ45 category 6 Data (Qty. 2)	\$199
	A-BL-A-B-B	● RJ11 category 3 Phone (Qty. 1) and RJ45 category 6 Data (Qty. 2)	\$245
	A-BL-B-B-B	● RJ45 category 6 Data (Qty. 4)	\$376
	A-BL-B-B-C51	● RJ45 category 6 Data (Qty. 2) and 15 pin HDVGA (Qty. 1)	\$382
	A-BL-L-C51	● Mini-stereo (Qty. 1) and 15 pin HDVGA (Qty. 1)	\$228
	A-BL-B-B-L-C51	● RJ45 category 6 Data (Qty. 2), Mini-stereo (Qty. 1) and 15 pin HDVGA	\$415
	A-BL-13-13	● 3 pin XLR Female (Qty. 2)	\$383
	A-BL-CRDMINDER	● Cordminder Plate (Qty. 1)	\$64
	A-BL-102-C51	● 15 pin HDVGA (Qty. 1) and USB (Qty. 1)	\$257
	A-BL-A-102-C51	● RJ11 category 3 Phone (Qty. 1), 15 pin HDVGA (Qty. 1) and USB (Qty. 1)	\$308
	A-BL-C51-77-78-79	● 15 pin HDVGA (Qty. 1), and RCA Red, White and Yellow (Qty. 1)	\$286
	A-BL-Z	● DVI (Qty. 1)	\$312
	A-BL-C45-L-C51	● HDMI (Qty. 1), Mini-stereo (Qty. 1), and 15 pin HDVGA	\$458
	A-BL-C45-B-B	● HDMI (Qty. 1) and RJ45 category 6 Data (Qty. 2)	\$378
	A-BL-C45	● HDMI (Qty. 1)	\$206
	A-BL-C45-C51	● HDMI (Qty. 1) and 15 pin HDVGA	\$353
	A-BL-C45-C51-B-B	● HDMI (Qty. 1), 15 pin HDVGA (Qty. 1), and RJ45 category 6 Data (Qty. 2)	\$522
	A-BL-C45-A-A	● HDMI (Qty. 1) and RJ11 category 3 Phone (Qty. 2)	\$417
	A-BL-L-C51-Z	● Mini-stereo (Qty. 1), 15 pin HDVGA (Qty. 1), and DVI (Qty.1)	\$489
	A-BL-102-102	● USB (Qty. 2)	\$170
	A-BL-102-C45	● HDMI (Qty. 1) and USB (Qty. 1)	\$288

DATACOM KEY

73	Cat 5E Data Inline
13	XLR Female
102	USB, Type A/A with 72" patch cord
77/78/79	RCA Inline
A (suffix)	Cat 3 Phone (punch down)
B	Cat 6 Data (punch down)
C45	HDMI with 36" patch cord
C51	15 pin HDVGA with 72" patch cord
L	Mini-stereo Inline
Z	DV1 Inline

Tip:

- > Phone/Data jacks are punch-down unless otherwise indicated (e.g. "Inline")
- > Video RCA, mini-stereo, and DVI are Inline (Inline allows connection to the back of the connector without any wiring)
- > XLR connector is solder
- > VGA includes 72" ultra thin patch cord
- > HDMI includes 36" ultra thin patch cord
- > USB is type A/A, 72" patch cord

Ordering Information:

- > Items on this page work with Power Data units marked with a triangle ▲.
- > These Power Data units come with an Adapter Kit that allows the solutions below to be snapped into the unit's data openings.
- > **A freight fee of \$100 net is assessed on orders less than \$1000 net. See page 13.**



	Part Number		List Price (US\$)
	PDBHDR	▲ HDMI Corded Coupler, 18" Length, Black	\$109
	PDBHDW	▲ HDMI Corded Coupler, 18" Length, White	\$109
	PDBVGA	▲ VGA 15-pin Cord, M/F, 10' Length	\$137
	PDBCAT6	▲ RJ45 CAT 6 Data Cord, Siemen, M/F, 10' Length	\$117
	PDBCAT5EA	▲ RJ45 Cat 5E Data Cord, Amp, M/F, 9' Length	\$71
	PDBCAT5EB	▲ RJ45 Cat 5E Data Cord, Panduit, M/F, 9' Length	\$97
	PDBCAT5EC	▲ RJ45 Cat 5E/6 Data Jack, Punch Down	\$34
	PDBMINIR	▲ Mini-Stereo, M/F, 10' length, Black	\$28
	PDBMINIW	▲ Mini-Stereo, M/F, 10' length, White	\$28
	PDUSBAR	▲ USB-A Data Transfer (not charging), 6' length, Black	\$68
	PDUSBAW	▲ USB-A Data Transfer (not charging), 6' length, White	\$68
	URDATA	▲ Data Adapter Tree, Grey	\$21
	PDDTR	▲ Data Adapter Tree, Black	\$21
	PDDTW	▲ Data Adapter Tree, White	\$21

Tip: Service part. Comes standard with ▲ power data units. Order for reconfiguration.

TOPS

BASES

POWER
DATASUPPORT
FURNITURE

ACCESSORIES

TABLES STEP 3 - POWER / DATA

Power & Data - Cable Management

STEP 1 - Monitor Risers Only



(^) Paint Suffix List

G Slate Grey
R Black
S Silver
T Medium Tone
W Arctic White
Z Other

Tip: Some Steelcase, Herman Miller, Knoll, Haworth, and Allsteel paints are available for \$350 list fee per order. Call/email for availability of specific colors. Additional custom paints (e.g. Tiger Dry Lac) must be quoted through quotes@enwork.com.

Ordering Information:

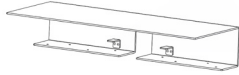
> A freight fee of \$100 net is assessed on orders less than \$1000 net. See page 13.

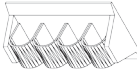
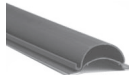
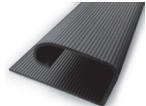
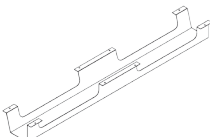
	Part Number		List Price (US\$)
	Monitor Riser, Steel, 11"D		
	URISER28^	Monitor Riser for Single Monitor, 28"W	\$339
	URISER39^	Monitor Riser for Double Monitors, 39"W	\$427
	Vertical Cable Managers with weighted base		
	PDVCMR	Vertical Cable Manager, flexible spine, 30", worksurface attached, Black	\$198
	PDVCMS	Vertical Cable Manager, flexible spine, 30", worksurface attached, Silver	\$198
	ULCM	Vertical Cable Manager, flexible spine, 1.5" diameter, Black	\$163
	Cable Managers and Grippers		
	PDGR	Universal Cable Gripper, 5 openings, Black	\$27
	PDUCMR	Universal Cable Manager, extruded plastic, double-sided tape, 22", Black	\$59
	PDUCMS	Universal Cable Manager, extruded plastic, double-sided tape, 22", Silver	\$59
	Tip: Can be mounted vertically to legs or horizontally under a worksurface		
	PDJTR24	Universal Cable Manager extruded black plastic J-channel, 24" (22" actual)	\$40
	PDJTR30	Universal Cable Manager extruded black plastic J-channel, 30" (28" actual)	\$43
	PDJTR36	Universal Cable Manager extruded black plastic J-channel, 36" (34" actual)	\$43
	PDJTR42	Universal Cable Manager extruded black plastic J-channel, 42" (40" actual)	\$51
	PDJTR48	Universal Cable Manager extruded black plastic J-channel, 48" (46" actual)	\$51
	PDJTR54	Universal Cable Manager extruded black plastic J-channel, 54" (52" actual)	\$60
	PDJTR60	Universal Cable Manager extruded black plastic J-channel, 60" (58" actual)	\$60
	PDJTR66	Universal Cable Manager extruded black plastic J-channel, 66" (64" actual)	\$60
	PDJTR72	Universal Cable Manager extruded black plastic J-channel, 72" (70" actual)	\$60
	Tip: If installing between legs, order next smallest size.		
	Tip: Channel is 1"H x 1.5"W		
	Steel Cable Troughs		
	PDK48	Steel Cable Trough for Tables, Black 48"W	\$121

TOPS

BASES

POWER
DATASUPPORT
FURNITURE

ACCESSORIES

TABLES STEP 3 - POWER / DATA

Notes

Foundation Credenzas

STEP 1 - Not Available on Credenzas w/ Aluminum Trim

(&) Credenza Case Options Suffix List

- A Standard no charge
- B Includes 4 Vents (rear) +\$370
- C Includes oversized opening (far right) with Rear Access Door (includes 2 vents and brush strip for cable management). Oversized opening can be used for AV Rack or Refrigerator (ordered separately). Remaining doors have adjustable shelf behind them. This option available on 24" deep only credenzas. Height changes to 39" on buffet credenza, 4-door is unchanged. +\$637
- D Includes pull-out Waste Receptacle (far left door). Remaining doors have an adjustable shelf behind them. +\$1111
- E Includes pull-out Waste Receptacle (far left door) and oversized opening (far right) with Rear Access Door (includes 2 vents and brush strip for cable management). Oversized opening can be used for AV Rack or Refrigerator (ordered separately). Remaining doors have an adjustable shelf behind them. This option available on 24" deep only credenzas. Height changes to 39" on buffet credenza, 4-door is unchanged. +\$1740

Tip: When Waste Receptacle is ordered, door handle will be mounted horizontally in center of door.

Tip: Oversized opening for refrigerator and AV Rack is 19.5"W x 28.5"H.

STEP 2 - Not Available on Credenzas w/ Aluminum Trim

(*) Credenza Top Suffix List

- A Standard Credenza top
- B Specialty Top ordered separately (includes back-painted glass, quartz, ply, solid surface or KyrstalCast®) on pages 60-61.

STEP 3

(@) Pull Suffix List:



(A) Arc (B) Bar

STEP 4

(#) Laminate Suffix List:

- A Wilsonart Kensington Maple (10776-60) no charge
- B Wilsonart Monticello Maple (7925-38) no charge
- C Wilsonart Wild Cherry (7054-60) no charge
- E Wilsonart Fashion Grey (D381-60) no charge
- G Wilsonart Cafelle (7933K-07) no charge
- M Wilsonart Frosty White (1573-60) no charge
- P Wilsonart Slate Grey (D91-60) no charge
- R Wilsonart Black (1595-60) no charge
- U Wilsonart Brazilwood (7946-38) no charge
- V Wilsonart River Cherry (7937-38) no charge
- W Wilsonart Designer White (D354-60) no charge
- 3 Formica Neutral Twill (8826-58) no charge
- 4 Formica Bleached Legno (8845-58) no charge
- 5 Formica Prestige Walnut (6209-43) no charge
- 7 Formica Select Cherry (7759-43) no charge
- X *Wilsonart Non-Premium Laminates (-38, -60) +35%
- Y *Formica Non-Premium (includes 58, 43, MC, SP, and NT finishes), Formica Premium (WR, 42, 77, 46, RD finishes), Pionite Non-Premium, Nevamar Non-Premium, Wilsonart Premium (-01, -07, -12, -18, -52, -78), and whiteboard laminate. +45%

*Add \$350 list for Special Laminate orders of less than 10 units. See page 21 for edge selection.

(#) Veneer Suffix List:

- D Maple (stained similar to Kensington Maple laminate)
- J Cherry (stained similar to Wild Cherry laminate)
- N Walnut (stained similar to Cafelle laminate)
- 8 Walnut (stained similar to Prestige Walnut laminate)
- 9 Cherry (stained similar to Select Cherry laminate)
- X Stain Match (add a one-time \$700 list Stain Match fee) +10%

Product Specifications:

- > 110-degree hinges

Ordering Information:

- > Includes locks and levelers
- > Ships assembled
- > Includes adjustable shelf
- > **A freight fee of \$100 net is assessed on orders less than \$1000 net. See page 13.**

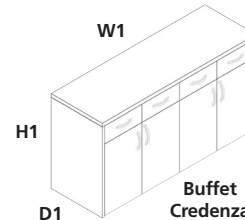
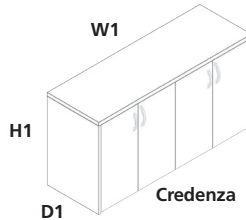

D1	W1	H1	Part Number	Description	List Price (US\$)
----	----	----	-------------	-------------	-------------------

Laminate Foundation Credenzas, 31"H

20	36	31	TDL2036&*@#	Laminate Credenza, 2 doors, 20 x 36	\$2307
20	48	31	TDL2048&*@#	Laminate Credenza, 4 doors, 20 x 48	\$2789
20	60	31	TDL2060&*@#	Laminate Credenza, 4 doors, 20 x 60	\$3305
20	72	31	TDL2072&*@#	Laminate Credenza, 4 doors, 20 x 72	\$3821
24	60	31	TDL2460&*@#	Laminate Credenza, 4 doors, 24 x 60	\$3739
24	72	31	TDL2472&*@#	Laminate Credenza, 4 doors, 24 x 72	\$4280
24	84	31	TDL2484&*@#	Laminate Credenza, 4 doors, 24 x 84	\$5680
24	96	31	TDL2496&*@#	Laminate Credenza, 6 doors, 24 x 96	\$5680

Laminate Foundation Buffet Credenzas, 36"H

24	60	36	TDLB2460&*@#	Laminate Buffet Credenza, 4 doors/4 drawers, 24 x 60	\$4255
24	72	36	TDLB2472&*@#	Laminate Buffet Credenza, 4 doors/4 drawers, 24 x 72	\$4973
24	84	36	TDLB2484&*@#	Laminate Buffet Credenza, 4 doors/4 drawers, 24 x 84	\$6534
24	96	36	TDLB2496&*@#	Laminate Buffet Credenza, 6 doors/6 drawers, 24 x 96	\$6534

Veneer Foundation Credenzas, 31"H

20	36	31	TDV2036&*@#	Veneer Credenza, 2 doors, 20 x 36	\$5354
20	48	31	TDV2048&*@#	Veneer Credenza, 4 doors, 20 x 48	\$7337
20	60	31	TDV2060&*@#	Veneer Credenza, 4 doors, 20 x 60	\$8280
20	72	31	TDV2072&*@#	Veneer Credenza, 4 doors, 20 x 72	\$9182
24	60	31	TDV2460&*@#	Veneer Credenza, 4 doors, 24 x 60	\$8924
24	72	31	TDV2472&*@#	Veneer Credenza, 4 doors, 24 x 72	\$9971

Veneer Foundation Buffet Credenzas, 36"H

24	60	36	TDVB2460&*@#	Veneer Buffet Credenza, 4 doors/4 drawers, 24 x 60	\$12,434
24	72	36	TDVB2472&*@#	Veneer Buffet Credenza, 4 doors/4 drawers, 24 x 72	\$13,835

Refrigerator and AV Rack

CPR1	Refrigerator, Black	\$1351
------	---------------------	--------

Tip: Enwork warranty does not apply. Refrigerator manufacturer warranty applies.

CPAVR1624	Freestanding AV Rack (16"D x 19.25"W x 23.75"H), Middle Atlantic CFR-14-18	\$1250
-----------	--	--------

COORDINATING FURNITURE
See pages 86-103 for
Foundation Conference Tables.

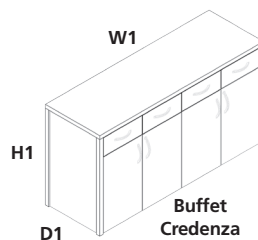
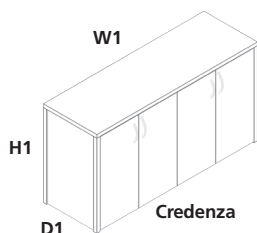

TOPS	TABLES STEP 4 - SUPPORT FURNITURE
BASES	
POWER DATA	
SUPPORT FURNITURE	
ACCESSORIES	

D1	W1	H1	Part Number	Description	List Price (US\$)
Laminate Foundation Credenzas with Aluminum Trim, 31"H					
20	36	31	TEL2036@#	Laminate Credenza, 2 doors, Aluminum Trim, 20 x 36	\$2419
20	48	31	TEL2048@#	Laminate Credenza, 4 doors, Aluminum Trim, 20 x 48	\$2975
20	60	31	TEL2060@#	Laminate Credenza, 4 doors, Aluminum Trim, 20 x 60	\$3492
20	72	31	TEL2072@#	Laminate Credenza, 4 doors, Aluminum Trim, 20 x 72	\$4008
24	60	31	TEL2460@#	Laminate Credenza, 4 doors, Aluminum Trim, 24 x 60	\$3926
24	72	31	TEL2472@#	Laminate Credenza, 4 doors, Aluminum Trim, 24 x 72	\$4466
Laminate Buffet Foundation Credenzas with Aluminum Trim, 36"H					
24	60	36	TELB2460@#	Laminate Buffet Credenza, 4 doors/4 drawers, Aluminum Trim, 24 x 60	\$4441
24	72	36	TELB2472@#	Laminate Buffet Credenza, 4 doors/4 drawers, Aluminum Trim, 24 x 72	\$5160
Veneer Foundation Credenzas with Aluminum Trim, 31"H					
20	36	31	TEV2036@#	Veneer Credenza, 2 doors, Aluminum Trim, 20 x 36	\$5573
20	48	31	TEV2048@#	Veneer Credenza, 4 doors, Aluminum Trim, 20 x 48	\$7624
20	60	31	TEV2060@#	Veneer Credenza, 4 doors, Aluminum Trim, 20 x 60	\$8505
20	72	31	TEV2072@#	Veneer Credenza, 4 doors, Aluminum Trim, 20 x 72	\$9565
24	60	31	TEV2460@#	Veneer Credenza, 4 doors, Aluminum Trim, 24 x 60	\$9155
24	72	31	TEV2472@#	Veneer Credenza, 4 doors, Aluminum Trim, 24 x 72	\$10,300
Veneer Buffet Foundation Credenzas with Aluminum Trim, 36"H					
24	60	36	TEVB2460@#	Veneer Buffet Credenza, 4 doors/4 drawers, Aluminum Trim, 24 x 60	\$12,948
24	72	36	TEVB2472@#	Veneer Buffet Credenza, 4 doors/4 drawers, Aluminum Trim, 24 x 72	\$14,392

Foundation Lecterns

STEP 1

(@) Pull Suffix List:



(A) Arc



(B) Bar

STEP 2

(#) Laminate Suffix List:

A	Wilsonart Kensington Maple (10776-60)	no charge
B	Wilsonart Monticello Maple (7925-38)	no charge
C	Wilsonart Wild Cherry (7054-60)	no charge
E	Wilsonart Fashion Grey (D381-60)	no charge
G	Wilsonart Cafelle (7933K-07)	no charge
M	Wilsonart Frosty White (1573-60)	no charge
P	Wilsonart Slate Grey (D91-60)	no charge
R	Wilsonart Black (1595-60)	no charge
U	Wilsonart Brazilwood (7946-38)	no charge
V	Wilsonart River Cherry (7937-38)	no charge
W	Wilsonart Designer White (D354-60)	no charge
3	Formica Neutral Twill (8826-58)	no charge
4	Formica Bleached Legno (8845-58)	no charge
5	Formica Prestige Walnut (6209-43)	no charge
7	Formica Select Cherry (7759-43)	no charge
X	*Wilsonart Non-Premium laminates (-38, -60)	+35%
Y	*Formica Non-Premium (includes 58, 43, MC, SP, and NT finishes), Formica Premium (WR, 42, 77, 46, RD finishes), Pionite Non-Premium, Nevamar Non-Premium, Wilsonart Premium (-01, -07, -12, -18, -52, -78), and whiteboard laminate.	+45%

*Add \$350 list for Special Laminate orders of less than 10 units. See page 21 for edge selection.

(#) Veneer Suffix List:

D	Maple (stained similar to Kensington Maple laminate)	
J	Cherry (stained similar to Wild Cherry laminate)	
N	Walnut (stained similar to Cafelle laminate)	
8	Walnut (stained similar to Prestige Walnut laminate)	
9	Cherry (stained similar to Select Cherry laminate)	
X	Stain Match (add a one-time \$700 list Stain Match fee)	+10%

Product Specifications:

- > 110-degree hinges

Ordering Information:

- > Ships assembled
- > **A freight fee of \$100 net is assessed on orders less than \$1000 net. See page 13.**

COORDINATING FURNITURE

See pages 86-103 for Foundation Conference Tables.

D1	W1	H1	Part Number	Description	List Price (US\$)
----	----	----	-------------	-------------	-------------------



Laminate Foundation Lecterns with 2 door, Non-Locking Cabinet

24	27	49	LPWLECTA@#	Laminate Lectern, levelers	\$2488
24	27	49	LPWLECTAC@#	Laminate Lectern, casters	\$2507

Veneer Foundation Lecterns with 2 door, Non-Locking Cabinet

24	27	49	LPWLECTV@#	Veneer Lectern, levelers	\$6675
24	27	49	LPWLECTVC@#	Veneer Lectern, casters	\$6675

TOPS

BASES

POWER
DATASUPPORT
FURNITURE

ACCESSORIES

TABLES STEP 4 - SUPPORT FURNITURE

Notes

Impression Credenzas

STEP 1

(@) Pull Suffix List:



(A) Arc



(B) Bar

STEP 2

(#) Laminate Suffix List:

A	Wilsonart Kensington Maple (10776-60)	no charge
B	Wilsonart Monticello Maple (7925-38)	no charge
C	Wilsonart Wild Cherry (7054-60)	no charge
E	Wilsonart Fashion Grey (D381-60)	no charge
G	Wilsonart Cafelle (7933K-07)	no charge
M	Wilsonart Frosty White (1573-60)	no charge
P	Wilsonart Slate Grey (D91-60)	no charge
R	Wilsonart Black (1595-60)	no charge
U	Wilsonart Brazilwood (7946-38)	no charge
V	Wilsonart River Cherry (7937-38)	no charge
W	Wilsonart Designer White (D354-60)	no charge
3	Formica Neutral Twill (8826-58)	no charge
4	Formica Bleached Legno (8845-58)	no charge
5	Formica Prestige Walnut (6209-43)	no charge
7	Formica Select Cherry (7759-43)	no charge
X	*Wilsonart Non-Premium laminates (-38, -60)	+35%
Y	*Formica Non-Premium (includes 58, 43, MC, SP, and NT finishes), Formica Premium (WR, 42, 77, 46, RD finishes), Pionite Non-Premium, Nevamar Non-Premium, Wilsonart Premium (-01, -07, -12, -18, -52, -78), and whiteboard laminate.	+45%

*Add \$350 list for Special Laminate orders of less than 10 units. See page 21 for edge selection.

(#) Veneer Suffix List:

D	Maple (stained similar to Kensington Maple laminate)	
J	Cherry (stained similar to Wild Cherry laminate)	
N	Walnut (stained similar to Cafelle laminate)	
8	Walnut (stained similar to Prestige Walnut laminate)	
9	Cherry (stained similar to Select Cherry laminate)	
X	Stain Match (add a one-time \$700 list Stain Match fee)	+10%

Product Specifications:

- > Includes locks
- > 4" Impression Foot
- > 110-degree hinges
- > Includes adjustable shelf

Ordering Information:

- > Ships assembled (except for feet)
- > **A freight fee of \$100 net is assessed on orders less than \$1000 net. See page 13.**

COORDINATING FURNITURE
See page 108 for Impression Conference Tables.

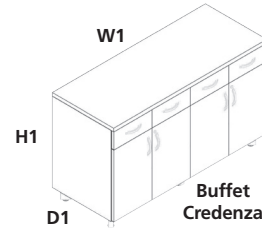
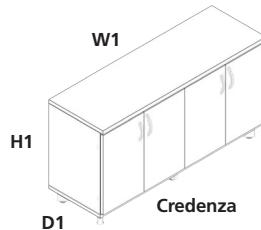

D1	W1	H1	Part Number	Description	List Price (US\$)
Laminate Impression Credenzas, 31"H					
20	36	31	TCL2036@#	Laminate Impression Credenza, 2 doors, 20 x 36	\$1892
20	48	31	TCL2048@#	Laminate Impression Credenza, 4 doors, 20 x 48	\$2535
20	60	31	TCL2060@#	Laminate Impression Credenza, 4 doors, 20 x 60	\$3007
20	72	31	TCL2072@#	Laminate Impression Credenza, 4 doors, 20 x 72	\$3478
24	60	31	TCL2460@#	Laminate Impression Credenza, 4 doors, 24 x 60	\$3400
24	72	31	TCL2472@#	Laminate Impression Credenza, 4 doors, 24 x 72	\$3935
Laminate Impression Buffet Credenzas, 36"H					
24	60	36	TCLB2460@#	Laminate Impression Buffet Credenza, 4 doors/4 drawers, 24 x 60	\$4112
24	72	36	TCLB2472@#	Laminate Impression Buffet Credenza, 4 doors/4 drawers, 24 x 72	\$4811
Veneer Impression Credenzas, 31"H					
20	36	31	TCV2036@#	Veneer Impression Credenza, 2 doors, 20 x 36	\$5662
20	48	31	TCV2048@#	Veneer Impression Credenza, 4 doors, 20 x 48	\$7820
20	60	31	TCV2060@#	Veneer Impression Credenza, 4 doors, 20 x 60	\$8728
20	72	31	TCV2072@#	Veneer Impression Credenza, 4 doors, 20 x 72	\$9724
24	60	31	TCV2460@#	Veneer Impression Credenza, 4 doors, 24 x 60	\$9480
24	72	31	TCV2472@#	Veneer Impression Credenza, 4 doors, 24 x 72	\$10,578
Veneer Impression Buffet Credenzas, 36"H					
24	60	36	TCVB2460@#	Veneer Impression Buffet Credenza, 4 doors/4 drawers, 24 x 60	\$12,156
24	72	36	TCVB2472@#	Veneer Impression Buffet Credenza, 4 doors/4 drawers, 24 x 72	\$13,486

TOPS

BASES

POWER
DATASUPPORT
FURNITURE

ACCESSORIES

TABLES STEP 4 - SUPPORT FURNITURE

Notes

Impression Lecterns

STEP 1 - if Applicable

(@) Pull Suffix List:



(A) Arc



(B) Bar

STEP 2

(^) Paint Suffix List

- G Slate Grey with black casters
- R Black with black casters
- S Silver with white casters
- T Medium Tone with black casters
- W Arctic White with white casters
- Z Other

Tip: Some Steelcase, Herman Miller, Knoll, Haworth, and Allsteel paints are available for \$350 list fee per order. Call/email for availability of specific colors. Additional custom paints (e.g. Tiger Dry Lac) must be quoted through quotes@enwork.com.

STEP 3 - if applicable

(#) Laminate Suffix List:

- | | | |
|---|--|-----------|
| A | Wilsonart Kensington Maple (10776-60) | no charge |
| B | Wilsonart Monticello Maple (7925-38) | no charge |
| C | Wilsonart Wild Cherry (7054-60) | no charge |
| E | Wilsonart Fashion Grey (D381-60) | no charge |
| G | Wilsonart Cafelle (7933K-07) | no charge |
| M | Wilsonart Frosty White (1573-60) | no charge |
| P | Wilsonart Slate Grey (D91-60) | no charge |
| R | Wilsonart Black (1595-60) | no charge |
| U | Wilsonart Brazilwood (7946-38) | no charge |
| V | Wilsonart River Cherry (7937-38) | no charge |
| W | Wilsonart Designer White (D354-60) | no charge |
| 3 | Formica Neutral Twill (8826-58) | no charge |
| 4 | Formica Bleached Legno (8845-58) | no charge |
| 5 | Formica Prestige Walnut (6209-43) | no charge |
| 7 | Formica Select Cherry (7759-43) | no charge |
| X | *Wilsonart Non-Premium laminates (-38, -60) | +\$500 |
| Y | *Formica Non-Premium (includes 58, 43, MC, SP, and NT finishes), Formica Premium (WR, 42, 77, 46, RD finishes), Pionite Non-Premium, Nevamar Non-Premium, Wilsonart Premium (-01, -07, -12, -18, -52, -78), and whiteboard laminate. | +\$650 |

*Add \$350 list for Special Laminate orders of less than 10 units. See page 21 for edge selection.

Product Specifications:

- > Articulating Lectern top has 2 positions: flat and inclined. Top articulates between positions.
- > Fixed units are 42"H. Adjustable units are 34" - 46"H.
- > Cabinet on fixed height unit is 20"W x 36"H x 20"D. Includes one non-locking door and one drawer.
- > Cabinet on adjustable height unit is 20"W x 25"H x 20"D. Includes one non-locking door.
- > Basic cabinet includes adjustable shelf.
- > Tech cabinet includes rack rails (13 RU on adjustable height units, 16 RU on fixed height units), rear locking access door, and vent holes.

Ordering Information:

- > Ships assembled.
- > **A freight fee of \$100 net is assessed on orders less than \$1000 net. See page 13.**

Part Number	Description	List Price (US\$)
-------------	-------------	-------------------

Articulating Lecterns with Basic Cabinet, with Casters

LCL1FC@^#	Articulating Lectern, Basic Cabinet, 28"D x 24"W, Fixed Height	\$3477
-----------	--	--------

LCL1AC@^#	Articulating Lectern, Basic Cabinet, 28"D x 24"W, Pin Adjustable	\$3503
-----------	--	--------

LCL1PC@^#	Articulating Lectern, Basic Cabinet, 28"D x 24"W, Pneumatic Adjustable	\$5009
-----------	--	--------

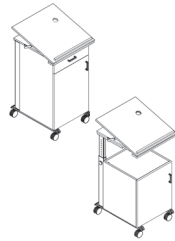

Articulating Lecterns with Tech Cabinet, with Casters

LCL2FC@^#	Articulating Lectern, Tech Cabinet, 28"D x 24"W, Fixed Height	\$3719
-----------	---	--------

LCL2AC@^#	Articulating Lectern, Tech Cabinet, 28"D x 24"W, Pin Adjustable	\$3745
-----------	---	--------

LCL2PC@^#	Articulating Lectern, Tech Cabinet, 28"D x 24"W, Pneumatic Adjustable	\$5253
-----------	---	--------



Articulating Lectern with Back Panel (no cabinet), with Casters

LCL3FC^#	Articulating Lectern, 28"D x 24"W, fixed height	\$2119
----------	---	--------

LCL3AC^#	Articulating Lectern, 28"D x 24"W, Pin Adjustable	\$2358
----------	---	--------

LCL3PC^#	Articulating Lectern, 28"D x 24"W, Pneumatic Adjustable	\$3867
----------	---	--------

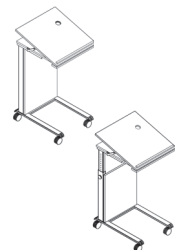

Traditional Impression Lectern, 49"H

LMLECTB@#	Lectern, double doors, 4"H feet, 24"D x 27"W	\$2598
-----------	--	--------

Tip: Fixed Top.



Impression 34"W Command Centers

Product Specifications:

- > Fixed units are 42"H. Adjustable units are 34"- 46"H.
- > Cabinet on fixed height unit is 30"W x 36"H x 20"D. Includes one non-locking door and one drawer.
- > Cabinet on adjustable height unit is 30"W x 25"H x 20"D. Includes one non-locking door.
- > Top is flat. Does not articulate.
- > Basic cabinet includes adjustable shelf.
- > Tech cabinet includes rack rails (13 RU on adjustable height units, 16 RU on fixed height units), rear locking access door, and extra vent holes.

Ordering Information:

- > Ships assembled.
- > **A freight fee of \$100 net is assessed on orders less than \$1000 net. See page 13.**

COORDINATING FURNITURE
See page 108 for coordinating Impression Tables.

TOPS	TABLES STEP 4 - SUPPORT FURNITURE
BASES	
POWER DATA	
SUPPORT FURNITURE	
ACCESSORIES	

	Part Number	Description	List Price (US\$)
	34" Command Center with Basic Cabinet, with Casters		
	LCL4FC@^#	Command Center with Basic Cabinet, 28"D x 34"W, Fixed Height	\$3492
	LCL4AC@^#	Command Center with Basic Cabinet, 28"D x 34"W, Pin Adjustable	\$3464
	LCL4PC@^#	Command Center with Basic Cabinet, 28"D x 34"W, Pneumatic Adjustable	\$4957
	34" Command Center with Tech Cabinet, with Casters		
	LCL5FC@^#	Command Center with Tech Cabinet, 28"D x 34"W, Fixed Height	\$3774
	LCL5AC@^#	Command Center with Tech Cabinet, 28"D x 34"W, Pin Adjustable	\$3741
	LCL5PC@^#	Command Center with Tech Cabinet, 28"D x 34"W, Pneumatic Adjustable	\$5235

Impression 66"W Command Centers

STEP 1 - if Applicable

(@) Pull Suffix List:



(A) Arc



(B) Bar

STEP 2

(^) Paint Suffix List

- G Slate Grey with black casters
- R Black with black casters
- S Silver with white casters
- T Medium Tone with black casters
- W Arctic White with white casters
- Z Other

Tip: Some Steelcase, Herman Miller, Knoll, Hawthorn, and Allsteel paints are available for \$350 list fee per order. Call/email for availability of specific colors. Additional custom paints (e.g. Tiger Dry Lac) must be quoted through quotes@enwork.com.

STEP 3 - if applicable

(#) Laminate Suffix List:

- A Wilsonart Kensington Maple (10776-60) no charge
- B Wilsonart Monticello Maple (7925-38) no charge
- C Wilsonart Wild Cherry (7054-60) no charge
- E Wilsonart Fashion Grey (D381-60) no charge
- G Wilsonart Cafelle (7933K-07) no charge
- M Wilsonart Frosty White (1573-60) no charge
- P Wilsonart Slate Grey (D91-60) no charge
- R Wilsonart Black (1595-60) no charge
- U Wilsonart Brazilwood (7946-38) no charge
- V Wilsonart River Cherry (7937-38) no charge
- W Wilsonart Designer White (D354-60) no charge
- 3 Formica Neutral Twill (8826-58) no charge
- 4 Formica Bleached Legno (8845-58) no charge
- 5 Formica Prestige Walnut (6209-43) no charge
- 7 Formica Select Cherry (7759-43) no charge
- X *Wilsonart Non-Premium laminates (-38, -60) +\$500
- Y *Formica Non-Premium (includes 58, 43, +\$650 MC, SP, and NT finishes), Formica Premium (WR, 42, 77, 46, RD finishes), Pionite Non-Premium, Nevamar Non-Premium, Wilsonart Premium (-01, -07, -12, -18, -52, -78), and whiteboard laminate.





*Add \$350 list for Special Laminate orders of less than 10 units. See page 21 for edge selection.

Product Specifications:

- > Fixed units are 42"H. Adjustable units are 34" - 46"H.
- > Cabinet on fixed height unit is 20"W x 36"H x 20"D. Includes one non-locking door and one drawer.
- > Cabinet on adjustable height unit is 20"W x 25"H x 20"D. Includes one non-locking door.
- > Top is flat. Does not articulate.
- > Basic cabinet includes adjustable shelf.
- > Tech cabinet includes rack rails (13 RU on adjustable height units, 16 RU on fixed height units), rear locking access door, and extra vent holes.

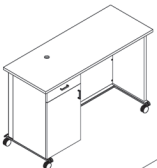
Ordering Information:

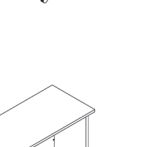
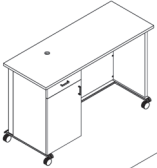
- > Ships assembled.
- > **A freight fee of \$100 net is assessed on orders less than \$1000 net. See page 13.**

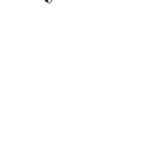
	<u>Part Number</u>	<u>Description</u>	<u>List Price (US\$)</u>
	66" Command Center with One 20"W Basic Cabinet, with Casters LCL6FC@^#	Command Center with 20W Basic Cabinet, 28"D x 66"W, Fixed Height	\$4080
	LCL6AC@^#	Command Center with 20"W Basic Cabinet, 28"D x 66"W, Pin Adjustable	\$3976
	LCL6PC@^#	Command Center with 20"W Basic Cabinet, 28"D x 66"W, Pneumatic Adjustable	\$5281
	66" Command Center with One 20"W Tech Cabinet, with Casters LCL7FC@^#	Command Center with 20"W Tech Cabinet, 28"D x 66"W, Fixed Height	\$4322
	LCL7AC@^#	Command Center with 20"W Tech Cabinet, 28"D x 66"W, Pin Adjustable	\$4219
	LCL7PC@^#	Command Center with 20"W Tech Cabinet, 28"D x 66"W, Pneumatic Adjustable	\$5523

COORDINATING FURNITURE
See page 108 for coordinating
Impression Tables.

TOPS	TABLES STEP 4 - SUPPORT FURNITURE
BASES	
POWER DATA	
SUPPORT FURNITURE	
ACCESSORIES	



Part Number Description List Price (US\$)

66" Command Center with One 20"W Basic Cabinet plus One 10"W Basic Cabinet, with Casters
LCL8FC@^# Command Center with 20"W and 10"W Basic Cabinets, 28"D x 66"W, Fixed Height \$5126

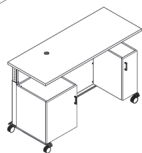

LCL8AC@^# Command Center with 20"W and 10"W Basic Cabinets, 28"D x 66"W, Pin Adjustable \$4603
LCL8PC@^# Command Center with 20"W and 10"W Basic Cabinets, 28"D x 66"W, Pneumatic Adjustable \$5906



66" Command Center with One 20"W Tech Cabinet plus One 10"W Basic Cabinet, with Casters
LCL9FC@^# Command Center with 20"W Tech Cabinet, 10"W Basic Cabinet, 28"D x 66"W, Fixed Height \$5368

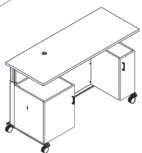

LCL9AC@^# Command Center with 20"W Tech Cabinet, 10"W Basic Cabinet, 28"D x 66"W, Pin Adjustable \$4844
LCL9PC@^# Command Center with 20"W Tech Cabinet, 10"W Basic Cabinet, 28"D x 66"W, Pneumatic Adjustable \$6150

Sensation Credenzas & Lecterns

STEP 1

(@) Pull Suffix List:



(A) Arc



(B) Bar

STEP 2

(#) Laminate Suffix List:

A	Wilsonart Kensington Maple (10776-60)	no charge
B	Wilsonart Monticello Maple (7925-38)	no charge
C	Wilsonart Wild Cherry (7054-60)	no charge
E	Wilsonart Fashion Grey (D381-60)	no charge
G	Wilsonart Cafelle (7933K-07)	no charge
M	Wilsonart Frosty White (1573-60)	no charge
P	Wilsonart Slate Grey (D91-60)	no charge
R	Wilsonart Black (1595-60)	no charge
U	Wilsonart Brazilwood (7946-38)	no charge
V	Wilsonart River Cherry (7937-38)	no charge
W	Wilsonart Designer White (D354-60)	no charge
3	Formica Neutral Twill (8826-58)	no charge
4	Formica Bleached Legno (8845-58)	no charge
5	Formica Prestige Walnut (6209-43)	no charge
7	Formica Select Cherry (7759-43)	no charge
X	*Wilsonart Non-Premium laminates (-38, -60)	+35%
Y	*Formica Non-Premium (includes 58, 43, MC, SP, and NT finishes), Formica Premium (WR, 42, 77, 46, RD finishes), Pionite Non-Premium, Nevamar Non-Premium, Wilsonart Premium (-01, -07, -12, -18, -52, -78), and whiteboard laminate.	+45%

*Add \$350 list for Special Laminate orders of less than 10 units. See page 21 for edge selection.

(#) Veneer Suffix List:

D	Maple (stained similar to Wilsonart Kensington Maple laminate)	
J	Cherry (stained similar to Wilsonart Wild Cherry laminate)	
N	Walnut (stained similar to Wilsonart Cafelle laminate)	
8	Walnut (stained similar to Prestige Walnut laminate)	
9	Cherry (stained similar to Select Cherry laminate)	
X	Stain Match (add a one-time \$700 list Stain Match fee)	+10%

STEP 3 - Credenza w/ Base Only

(^) Paint Suffix List

G	Slate Grey
R	Black
S	Silver
T	Medium Tone
W	Arctic White
Z	Other

Tip: Polished aluminum feet are available at no charge. Free form "Polished Feet" on your order and put a "Z" in front of the part number.

Tip: Some Steelcase, Herman Miller, Knoll, Haworth, and Allsteel paints are available for \$350 list fee per order. Call/email for availability of specific colors. Additional custom paints (e.g. Tiger Dry Lac) must be quoted through quotes@enwork.com.

STEP 2 - Sensation Mobile Lectern Base Only

(&) Caster Color Suffix List:

B	Black	no charge
G	White with Grey Trim	+\$40

Product Specifications:

- > Includes locks
- > Sensation Foot Credenzas include 4" H straight round feet. Base Credenzas include Sensation aluminum die-cast feet.
- > 110-degree hinges
- > Includes adjustable shelf

Ordering Information:

- > Ships assembled (except for feet/base)
- > **A freight fee of \$100 net is assessed on orders less than \$1000 net. See page 13.**

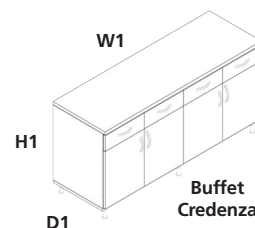
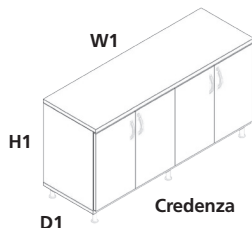

D1	W1	H1	Part Number	Description	List Price (US\$)
----	----	----	-------------	-------------	-------------------

Laminate Sensation Credenzas with Foot, 31"H

20	36	31	TFL2036@#	Laminate Sensation Foot Credenza, 2 doors, 20 x 36	\$1892
20	48	31	TFL2048@#	Laminate Sensation Foot Credenza, 4 doors, 20 x 48	\$2535
20	60	31	TFL2060@#	Laminate Sensation Foot Credenza, 4 doors, 20 x 60	\$3007
20	72	31	TFL2072@#	Laminate Sensation Foot Credenza, 4 doors, 20 x 72	\$3478
24	60	31	TFL2460@#	Laminate Sensation Foot Credenza, 4 doors, 24 x 60	\$3400
24	72	31	TFL2472@#	Laminate Sensation Foot Credenza, 4 doors, 24 x 72	\$3935

Laminate Sensation Buffet Credenzas with Foot, 36"H

24	60	36	TFLB2460@#	Laminate Sensation Foot Buffet Credenza, 4 doors/4 drawers, 24 x 60	\$4112
24	72	36	TFLB2472@#	Laminate Sensation Foot Buffet Credenza, 4 doors/4 drawers, 24 x 72	\$4811

Veneer Sensation Credenzas with Foot, 31"H

20	36	31	TFV2036@#	Veneer Sensation Foot Credenza, 2 doors, 20 x 36	\$5635
20	48	31	TFV2048@#	Veneer Sensation Foot Credenza, 4 doors, 20 x 48	\$7782
20	60	31	TFV2060@#	Veneer Sensation Foot Credenza, 4 doors, 20 x 60	\$8685
20	72	31	TFV2072@#	Veneer Sensation Foot Credenza, 4 doors, 20 x 72	\$9677
24	60	31	TFV2460@#	Veneer Sensation Foot Credenza, 4 doors, 24 x 60	\$9433
24	72	31	TFV2472@#	Veneer Sensation Foot Credenza, 4 doors, 24 x 72	\$10,526

Veneer Sensation Buffet Credenzas with Foot, 36"H

24	60	36	TFVB2460@#	Veneer Sensation Foot Buffet Credenza, 4 doors/4 drawers, 24 x 60	\$12,097
24	72	36	TFVB2472@#	Veneer Sensation Foot Buffet Credenza, 4 doors/4 drawers, 24 x 72	\$13,420

COORDINATING FURNITURE
See pages 130 & 136 for
coordinating Sensation Tables.

TOPS
BASES
POWER
DATA
SUPPORT
FURNITURE
ACCESSORIES
TABLES STEP 4 - SUPPORT FURNITURE

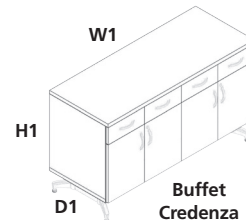
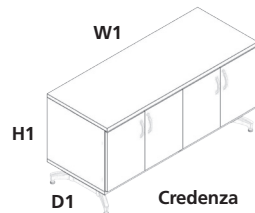

D1	W1	H1	Part Number	Description	List Price (US\$)
Laminate Sensation Credenzas with Base, 31"H					
20	36	31	TGL2036@#^	Laminate Sensation Base Credenza, 2 doors, 20 x 36	\$3348
20	48	31	TGL2048@#^	Laminate Sensation Base Credenza, 4 doors, 20 x 48	\$3665
20	60	31	TGL2060@#^	Laminate Sensation Base Credenza, 4 doors, 20 x 60	\$4171
20	72	31	TGL2072@#^	Laminate Sensation Base Credenza, 4 doors, 20 x 72	\$4675
24	60	31	TGL2460@#^	Laminate Sensation Base Credenza, 4 doors, 24 x 60	\$4334
24	72	31	TGL2472@#^	Laminate Sensation Base Credenza, 4 doors, 24 x 72	\$4853
Laminate Sensation Buffet Credenzas with Base, 36"H					
24	60	36	TGLB2460@#^	Laminate Sensation Base Buffet Credenza, 4 doors/4 drawers, 24 x 60	\$4957
24	72	36	TGLB2472@#^	Laminate Sensation Base Buffet Credenza, 4 doors/4 drawers, 24 x 72	\$5478
Veneer Sensation Credenzas with Base, 31"H					
20	36	31	TGV2036@#^	Veneer Sensation Base Credenza, 2 doors, 20 x 36	\$6885
20	48	31	TGV2048@#^	Veneer Sensation Base Credenza, 4 doors, 20 x 48	\$8436
20	60	31	TGV2060@#^	Veneer Sensation Base Credenza, 4 doors, 20 x 60	\$9480
20	72	31	TGV2072@#^	Veneer Sensation Base Credenza, 4 doors, 20 x 72	\$10,526
24	60	31	TGV2460@#^	Veneer Sensation Base Credenza, 4 doors, 24 x 60	\$10,243
24	72	31	TGV2472@#^	Veneer Sensation Base Credenza, 4 doors, 24 x 72	\$11,397
Veneer Sensation Buffet Credenzas with Base, 36"H					
24	60	36	TGVB2460@#^	Veneer Sensation Base Buffet Credenza, 4 doors/4 drawers, 24 x 60	\$12,666
24	72	36	TGVB2472@#^	Veneer Sensation Base Buffet Credenza, 4 doors/4 drawers, 24 x 72	\$12,930
Laminate Sensation Base Lectern with Aluminum Die-Cast Feet and Levelers, 49"H					
24	27	49	LMLECTA@#^	Sensation Lectern, 24D x 27W, Laminate Tip: Includes adjustable shelf.	\$2949
Sensation Mobile Lectern Base with Laminate Modesty Back Panel, 20"H x 28"D x 35.5"H					
			LME#&	Lectern Base with Laminate Panel, Silver Tip: For 24"x30" or 24"x36" Rectangle and Rounded Rectangle top, ordered separately.	\$1575



Stealth Credenzas

STEP 1

(@) Pull Suffix List:



(A) Arc



(B) Bar

STEP 2

(#) Laminate Suffix List:

A	Wilsonart Kensington Maple (10776-60)	no charge
B	Wilsonart Monticello Maple (7925-38)	no charge
C	Wilsonart Wild Cherry (7054-60)	no charge
E	Wilsonart Fashion Grey (D381-60)	no charge
G	Wilsonart Cafelle (7933K-07)	no charge
M	Wilsonart Frosty White (1573-60)	no charge
P	Wilsonart Slate Grey (D91-60)	no charge
R	Wilsonart Black (1595-60)	no charge
U	Wilsonart Brazilwood (7946-38)	no charge
V	Wilsonart River Cherry (7937-38)	no charge
W	Wilsonart Designer White (D354-60)	no charge
3	Formica Neutral Twill (8826-58)	no charge
4	Formica Bleached Legno (8845-58)	no charge
5	Formica Prestige Walnut (6209-43)	no charge
7	Formica Select Cherry (7759-43)	no charge
X	*Wilsonart Non-Premium laminates (-38, -60)	+35%
Y	*Formica Non-Premium (includes 58, 43, MC, SP, and NT finishes), Formica Premium (WR, 42, 77, 46, RD finishes), Pionite Non-Premium, Nevamar Non-Premium, Wilsonart Premium (-01, -07, -12, -18, -52, -78), and whiteboard laminate.	+45%

*Add \$350 list for Special Laminate orders of less than 10 units. See page 21 for edge selection.

(#) Veneer Suffix List:

D	Maple (stained similar to Kensington Maple laminate)	
J	Cherry (stained similar to Wild Cherry laminate)	
N	Walnut (stained similar to Cafelle laminate)	
8	Walnut (stained similar to Prestige Walnut laminate)	
9	Cherry (stained similar to Select Cherry laminate)	
X	Stain Match (add a one-time \$700 list Stain Match fee)	+10%

Product Specifications:

> Actual case is 22.9"D 27.9"H x 56.9/68.9"W.

Ordering Information:

- > Credenzas are designed to have back against a wall. Case depth must be altered if used in middle of a space. Email quotes@enwork.com.
- > Aluminum Trim compliments Stealth Conference Bases
- > **A freight fee of \$100 net is assessed on orders less than \$1000 net. See page 13.**

Part Number	Description	List Price (US\$)
-------------	-------------	-------------------



Laminate Stealth Credenzas, 4 doors, 29"H

LYCL2460@#	Laminate Stealth Credenza, 24"D x 60"W	\$5700
LYCL2472@#	Laminate Stealth Credenza, 24"D x 72"W	\$6221



Laminate Stealth Buffet Credenzas, 4 doors/4 drawers, 36"H

LYCLB2460@#	Laminate Stealth Buffet Credenza, 24"D x 60"W	\$6708
LYCLB2472@#	Laminate Stealth Buffet Credenza, 24"D x 72"W	\$7428



Veneer Stealth Credenzas, 4 doors, 29"H

LYCV2460@#	Veneer Stealth Credenza, 24"D x 60"W	\$11,030
LYCV2472@#	Veneer Stealth Credenza, 24"D x 72"W	\$11,936



Veneer Stealth Buffet Credenzas, 4 doors/4 drawers, 36"H

LYCVB2460@#	Veneer Stealth Buffet Credenza, 24"D x 60"W	\$15,212
LYCVB2472@#	Veneer Stealth Buffet Credenza, 24"D x 72"W	\$16,642

TOPS
BASES
POWER DATA
SUPPORT FURNITURE
ACCESSORIES

TABLES STEP 4 - SUPPORT FURNITURE

Notes

Occasional Tables (Complete Tables)

STEP 1

(^) Base Finishes List:

- A Clear Anodized Alum. (Impression only)
- G Slate Grey
- R Black
- S Silver
- T Medium Tone
- W Arctic White
- Z Other

Tip: Some alternative paint finishes are available. A \$350 list set-up fee is charged on orders less than 20 units.

Tip: Polished aluminum feet (not columns) are available on Sensation at no charge. This creates a two-tone color scheme. Free form "Polished Feet" on your order and put a "Z" in front of the part number.

STEP 2

(#) Laminate Suffix List:

- A Wilsonart Kensington Maple (10776-60)
- B Wilsonart Monticello Maple (7925-38)
- C Wilsonart Wild Cherry (7054-60)
- E Wilsonart Fashion Grey (D381-60)
- F Wilsonart White Tigris (4783-60)
- G Wilsonart Cafelle (7933K-07)
- M Wilsonart Frosty White (1573-60)
- P Wilsonart Slate Grey (D91-60)
- R Wilsonart Black (1595-60)
- U Wilsonart Brazilwood (7946-38)
- V Wilsonart River Cherry (7937-38)
- W Wilsonart Designer White (D354-60)
- 3 Formica Neutral Twill (8826-58)
- 4 Formica Bleached Legno (8845-58)
- 5 Formica Prestige Walnut (6209-43)
- 7 Formica Select Cherry (7759-43)
- X *Wilsonart Non-Premium laminates (-38, -60). +\$36
Orders of 100+ units have no upcharge.
- Y *Formica Non-Premium Standard (58, 43, +\$50
MC, SP and NT finishes) and Wilsonart Premium
(-01, -07, -12, -18, -52, -78) laminates.
- Z *Pionite Non-Premium, Nevamar Non-
Premium, Formica Premium (WR, 42, 77,
46, RD Finishes), and whiteboard laminate.

*Add \$350 list for Special Laminate orders of less than 10 units. See page 21 for edge selection.

(#) Veneer Suffix List:

- D Maple (stained similar to Kensington Maple laminate)
- J Cherry (stained similar to Wild Cherry laminate)
- N Walnut (stained similar to Cafelle laminate)
- 8 Walnut (stained similar to Prestige Walnut laminate)
- 9 Cherry (stained similar to Select Cherry laminate)
- X Stain Match (add a one-time \$700 list +10%
Stain Match fee)

Ordering Information:

- > Occasional Tables include base, top and hardware. Assembled in field.
- > Table edges are 3mm. Additional edge choices available by contacting quotes@enwork.com.
- > **A freight fee of \$100 net is assessed on orders less than \$1000 net. See page 13.**

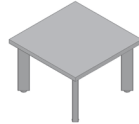

Part Number	Description	List Price (US\$)
Laminate Impression Tables		
LPLSC36^#	Impression Laminate Square Coffee Table, 36"D x 36"W x 16"H	\$1148
LPLRC2460^#	Impression Laminate Rectangle Coffee Table, 24"D x 60"W x 16"H	\$1148
LPLRC3060^#	Impression Laminate Rectangle Coffee Table, 30"D x 60"W x 16"H	\$1215
LPLDE2424^#	Impression Laminate Square End Table, 24"D x 24"W x 20"H	\$1015

Tip: Tables include Impression straight legs.

Veneer Impression Tables

LPVSC36^#	Impression Veneer Square Coffee Table, 36"D x 36"W x 16"H	\$1787
LPVRC2460^#	Impression Veneer Rectangle Coffee Table, 24"D x 60"W x 16"H	\$2114
LPVRC3060^#	Impression Veneer Rectangle Coffee Table, 30"D x 60"W x 16"H	\$2150
LPVDE2424^#	Impression Veneer Square End Table, 24"D x 24"W x 20"H	\$1340

Tip: Tables include Impression straight legs.



Laminate Sensation Tables

LMLAC36^#	Sensation Laminate Round Coffee Table, 36" diameter, 16"H	\$895
LMLBC3060^#	Sensation Laminate Elliptical Coffee Table, 30"D x 60"W x 16"H	\$1417
LMLDE2424^#	Sensation Laminate Round End Table, 24" dia., 20"H	\$757
LMLLE2418^#	Sensation Laminate Elliptical End Table, 24"D x 18"W x 20"H	\$757

Tip: End Tables and Round Coffee Table include X-bases. Elliptical Coffee Table includes Y-base with foot bar.



Veneer Sensation Tables

LMVAC36^#	Sensation Veneer Round Coffee Table, 36" diameter, 16"H	\$1516
LMVBC3060^#	Sensation Veneer Elliptical Coffee Table, 30"D x 60"W x 16"H	\$2354
LMVDE2424^#	Sensation Veneer Round End Table, 24" dia., 20"H	\$1025
LMVEE2418^#	Sensation Veneer Elliptical End Table, 24"D x 18"W x 20"H	\$1025

Tip: End Tables and Round Coffee Table include X-bases. Elliptical Coffee Table includes Y-base with foot bar.

Universal Support Furniture

Ordering Information:

- > Ships assembled.
- > A freight fee of \$100 net is assessed on orders less than \$1000 net. See page 13.

Part Number	Description	List Price (US\$)
-------------	-------------	-------------------

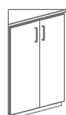

Universal Triangle Corner Cabinets with Adjustable Shelf, 29"H

TDAL318@#	Laminate Triangle Corner Cabinet, 18"D x 18"W	\$1463
TDAL324@#	Laminate Triangle Corner Cabinet, 24"D x 24"W	\$1632
TDAV318@#	Veneer Triangle Corner Cabinet, 18"D x 18"W	\$3658
TDAV324@#	Veneer Triangle Corner Cabinet, 24"D x 24"W	\$4081

Tip: Corner Cabinet is freestanding.

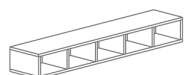

Universal Wall Mount Cubby Shelves with 11"W cubbies, 12"D

THL36#	Laminate Cubby Shelf with three cubbies, 36"W x 6"H	\$875
THL48#	Laminate Cubby Shelf, with four cubbies, 48"W x 6"H	\$973
THL60#	Laminate Cubby Shelf, with five cubbies, 60"W x 6"H	\$1083
THL72#	Laminate Cubby Shelf, with six cubbies, 72"W x 6"H	\$1226
THV36#	Veneer Cubby Shelf with three cubbies, 36"W x 6"H	\$2191
THV48#	Veneer Cubby Shelf, with four cubbies, 48"W x 6"H	\$2432
THV60#	Veneer Cubby Shelf, with five cubbies, 60"W x 6"H	\$2707
THV72#	Veneer Cubby Shelf, with six cubbies, 72"W x 6"H	\$3068

Tip: Includes mounting cleats

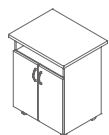

Universal Beverage Carts on Casters, 24"D x 30"W x 38"H

LPWCARTA@#	Laminate Universal Beverage Cart	\$1857
LPWCARTV@#	Veneer Universal Beverage Cart	\$4739



Presentation Cabinets, 48" x 48" with Whiteboard

PCL4848@#^	Laminate Presentation Cabinet	\$2884
PCV4848@#^	Veneer Presentation Cabinet	\$5633

Tip: Presentation Cabinet Includes: Porcelain Magnetic Whiteboard, Tackboards on doors, flip chart hooks. Mounted by screwing to wall. Attachment hardware not provided.

STEP 1 - if applicable

(@) Pull Suffix List:



(A) Arc



(B) Bar

TOPS

BASES

POWER
DATASUPPORT
FURNITURE

ACCESSORIES

TABLES STEP 4 - SUPPORT FURNITURE

STEP 2

(#) Laminate Suffix List:

A	Wilsonart Kensington Maple (10776-60)	no charge
B	Wilsonart Monticello Maple (7925-38)	no charge
C	Wilsonart Wild Cherry (7054-60)	no charge
E	Wilsonart Fashion Grey (D381-60)	no charge
G	Wilsonart Cafelle (7933K-07)	no charge
M	Wilsonart Frosty White (1573-60)	no charge
P	Wilsonart Slate Grey (D91-60)	no charge
R	Wilsonart Black (1595-60)	no charge
U	Wilsonart Brazilwood (7946-38)	no charge
V	Wilsonart River Cherry (7937-38)	no charge
W	Wilsonart Designer White (D354-60)	no charge
3	Formica Neutral Twill (8826-58)	no charge
4	Formica Bleached Legno (8845-58)	no charge
5	Formica Prestige Walnut (6209-43)	no charge
7	Formica Select Cherry (7759-43)	no charge
X	*Wilsonart Non-Premium laminates (-38, -60)	+35%
Y	*Formica Non-Premium (includes 58, 43, MC, SP, and NT finishes), Formica Premium (WR, 42, 77, 46, RD finishes), Pionite Non-Premium, Nevamar Non-Premium, Wilsonart Premium (-01, -07, -12, -18, -52, -78), and whiteboard laminate.	+45%

*Add \$350 list for Special Laminate orders of less than 10 units. See page 21 for edge selection.

(#) Veneer Suffix List:

D	Maple (stained similar to Kensington Maple laminate)	
J	Cherry (stained similar to Wild Cherry laminate)	
N	Walnut (stained similar to Cafelle laminate)	
8	Walnut (stained similar to Prestige Walnut laminate)	
9	Cherry (stained similar to Select Cherry laminate)	
X	Stain Match (add a one-time \$700 list Stain Match fee)	+10%

STEP 3 - Presentation Cabinet Only

(^) Fabric Suffix List:

- > Free form fabric selection. Choose from Camira Mill L2 or Lucia fabrics.

Tip: To view fabric colors or to order samples go to www.camirafabrics.com/us.

Tip: For COM yardage see page 16.

Privacy Screens/Modesty Panels

STEP 1 - Laminate Pac-Man, All-in-One Privacy/Modesty, and Clamp Screen Only

(#) Laminate Suffix List:

A	Wilsonart Kensington Maple (10776-60)	no charge
B	Wilsonart Monticello Maple (7925-38)	no charge
C	Wilsonart Wild Cherry (7054-60)	no charge
E	Wilsonart Fashion Grey (D381-60)	no charge
G	Wilsonart Cafelle (7933K-07)	no charge
M	Wilsonart Frosty White (1573-60)	no charge
P	Wilsonart Slate Grey (D91-60)	no charge
R	Wilsonart Black (1595-60)	no charge
U	Wilsonart Brazilwood (7946-38)	no charge
V	Wilsonart River Cherry (7937-38)	no charge
W	Wilsonart Designer White (D354-60)	no charge
3	Formica Neutral Twill (8826-58)	no charge
4	Formica Bleached Legno (8845-58)	no charge
5	Formica Prestige Walnut (6209-43)	no charge
7	Formica Select Cherry (7759-43)	no charge
X	*Wilsonart Non-Premium laminates (-38, -60)	+35%
Y	*Formica Non-Premium (includes 58, 43, MC, SP, and NT finishes), Formica Premium (WR, 42, 77, 46, RD finishes), Pionite Non-Premium, Nevamar Non-Premium, Wilsonart Premium (-01, -07, -12, -18, -52, -78), and whiteboard laminate.	+45%

*Add \$350 list for Special Laminate orders of less than 10 units. See page 21 for edge selection.

STEP 1 - Tackable Fabrics

(?) Fabric Suffix List:

Free form fabric selection. Choose from Camira Mill L2 or Lucia fabrics.

Tip: To view fabric colors or to order samples go to www.camirafabrics.com/us.

Tip: For COM yardage, see page 16.

Product Specifications

- > Clamp Privacy Screens and Modesty Panels 48"W and smaller include two clamps, 54"W and wider include three clamps.

Ordering Information:

- > Clamp privacy screens 36"-72"W and Modesty Panels are screwed to the underside of the worksurface.
- > Clamp screens 24"-30"W are designed for side-to-side privacy and screw to the underside of the worksurface front edge (only). Knob attachment is available, email quotes@enwork.com
- > For COM yardage, see page 16.
- > **A freight fee of \$100 net is assessed on orders less than \$1000 net. See page 13.**



Part Number	Description	List Price (US\$)
-------------	-------------	-------------------

Clamp Frosted Acrylic Privacy Screen, 13"H x .25" thick

FLPA24	Frosted Acrylic Clamp Privacy Screen, 24"W	\$247
FLPA30	Frosted Acrylic Clamp Privacy Screen, 30"W	\$260
FLPA36	Frosted Acrylic Clamp Privacy Screen, 36"W	\$293
FLPA42	Frosted Acrylic Clamp Privacy Screen, 42"W	\$305
FLPA48	Frosted Acrylic Clamp Privacy Screen, 48"W	\$396
FLPA54	Frosted Acrylic Clamp Privacy Screen, 54"W	\$409
FLPA60	Frosted Acrylic Clamp Privacy Screen, 60"W	\$422
FLPA66	Frosted Acrylic Clamp Privacy Screen, 66"W	\$435
FLPA72	Frosted Acrylic Clamp Privacy Screen, 72"W	\$448

Clamp Laminate Privacy Screen, 13"H x .25" thick

FLPL24#	Laminate Clamp Privacy Screen, 24"W	\$308
FLPL30#	Laminate Clamp Privacy Screen, 30"W	\$325
FLPL36#	Laminate Clamp Privacy Screen, 36"W	\$361
FLPL42#	Laminate Clamp Privacy Screen, 42"W	\$388
FLPL48#	Laminate Clamp Privacy Screen, 48"W	\$463
FLPL54#	Laminate Clamp Privacy Screen, 54"W	\$504
FLPL60#	Laminate Clamp Privacy Screen, 60"W	\$504
FLPL66#	Laminate Clamp Privacy Screen, 66"W	\$531
FLPL72#	Laminate Clamp Privacy Screen, 72"W	\$531

Clamp Whiteboard Privacy Screen, 13"H x .25" thick

FLPW24	Whiteboard Clamp Privacy Screen, 24"W	\$329
FLPW30	Whiteboard Clamp Privacy Screen, 30"W	\$352
FLPW36	Whiteboard Clamp Privacy Screen, 36"W	\$394
FLPW42	Whiteboard Clamp Privacy Screen, 42"W	\$431
FLPW48	Whiteboard Clamp Privacy Screen, 48"W	\$507
FLPW54	Whiteboard Clamp Privacy Screen, 54"W	\$558
FLPW60	Whiteboard Clamp Privacy Screen, 60"W	\$558
FLPW66	Whiteboard Clamp Privacy Screen, 66"W	\$595
FLPW72	Whiteboard Clamp Privacy Screen, 72"W	\$595

Clamp Tackable Fabric Privacy Screen, 13"H x .5" thick

FLPF24?	Tackable Fabric Clamp Privacy Screen, 24"W	\$335
FLPF30?	Tackable Fabric Clamp Privacy Screen, 30"W	\$361
FLPF36?	Tackable Fabric Clamp Privacy Screen, 36"W	\$394
FLPF42?	Tackable Fabric Clamp Privacy Screen, 42"W	\$406
FLPF48?	Tackable Fabric Clamp Privacy Screen, 48"W	\$496
FLPF54?	Tackable Fabric Clamp Privacy Screen, 54"W	\$542
FLPF60?	Tackable Fabric Clamp Privacy Screen, 60"W	\$556
FLPF66?	Tackable Fabric Clamp Privacy Screen, 66"W	\$568
FLPF72?	Tackable Fabric Clamp Privacy Screen, 72"W	\$581

Pac-Man Universal Privacy Screens, Brackets included, 19"H x 30"D

UPM#	Laminate Pac-Man Privacy Screen	\$374
UPM2	Frosted Acrylic Pac-Man Privacy Screen	\$384

Tip: 30"D Divider covers 22" of worksurface and hangs 8" off. 13" of screen is above worksurface, 4.75" below worksurface.

Tip: Fits all 1.125" - 1.25" thick worksurfaces



Part Number	Description	List Price (US\$)
-------------	-------------	-------------------

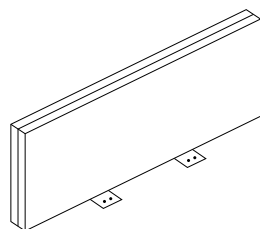

Universal Privacy Screens – 2-Sided Tackable Fabric, 17" H x 1" thick

AAF24?	Privacy Screen, Tackable Fabric, 24"W	\$328
AAF30?	Privacy Screen, Tackable Fabric, 30"W	\$380
AAF36?	Privacy Screen, Tackable Fabric, 36"W	\$391
AAF42?	Privacy Screen, Tackable Fabric, 42"W	\$422
AAF48?	Privacy Screen, Tackable Fabric, 48"W	\$435
AAF54?	Privacy Screen, Tackable Fabric, 54"W	\$562
AAF60?	Privacy Screen, Tackable Fabric, 60"W	\$574
AAF66?	Privacy Screen, Tackable Fabric, 66"W	\$587
AAF72?	Privacy Screen, Tackable Fabric, 72"W	\$598

Tip: Includes L-brackets, hardware and tackable screen (tackable fabric on both sides).

Tip: Must be used in application where L-brackets can attach to the underside of worksurface.

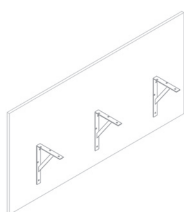
Tip: 13"H version available in Grid section of Price List.

All-In-One Privacy/Modesty Screen, Double-Sided Laminate, .75" thick

UG48#	Desk Mounted Privacy/Modesty Screen, 48"W	\$371
UG60#	Desk Mounted Privacy/Modesty Screen, 60"W	\$456
UG72#	Desk Mounted Privacy/Modesty Screen, 72"W	\$533

Tip: Screen attaches to bottom of worksurface and sits behind surface. Screen is 13" above surface and 16" below surface.

Tackboards for Laminate All-in-One Privacy/Modesty Screens

UG48T?	Tackboard for use with UG48 Screen	\$199
UG60T?	Tackboard for use with UG60 Screen	\$233
UG72T?	Tackboard for use with UG72 Screen	\$277

Tip: Sits above worksurface and faces user.

Tip: Tackboard is .75" thick.

Tip: Not intended for use on Frosted Acrylic All-in-One Privacy/Modesty Screen.

All-in-One Privacy/Modesty Screen, Frosted Acrylic

UGAC48	Frosted Acrylic Desk Mounted Privacy/Modesty 48"W	\$584
UGAC60	Frosted Acrylic Desk Mounted Privacy/Modesty 60"W	\$669
UGAC72	Frosted Acrylic Desk Mounted Privacy/Modesty 72"W	\$754

Clamp Modesty Panel, Frosted Acrylic, 13"H x .25" thick

FDMA48	Frosted Acrylic Clamp Modesty Panel, 48"W	\$336
FDMA54	Frosted Acrylic Clamp Modesty Panel, 54"W	\$350
FDMA60	Frosted Acrylic Clamp Modesty Panel, 60"W	\$362
FDMA66	Frosted Acrylic Clamp Modesty Panel, 66"W	\$376
FDMA72	Frosted Acrylic Clamp Modesty Panel, 72"W	\$388

Clamp Modesty Panel, Laminate, 13"H x .25" thick

FDML48#	Laminate Clamp Modesty Panel, 48"W	\$422
FDML54#	Laminate Clamp Modesty Panel, 54"W	\$462
FDML60#	Laminate Clamp Modesty Panel, 60"W	\$462
FDML66#	Laminate Clamp Modesty Panel, 66"W	\$489
FDML72#	Laminate Clamp Modesty Panel, 72"W	\$489

Clamp Modesty Panel, Fabric, 13"H x .5" thick

FDMF48?	Fabric Clamp Modesty Panel, 48"W	\$436
FDMF54?	Fabric Clamp Modesty Panel, 54"W	\$484
FDMF60?	Fabric Clamp Modesty Panel, 60"W	\$497
FDMF66?	Fabric Clamp Modesty Panel, 66"W	\$509
FDMF72?	Fabric Clamp Modesty Panel, 72"W	\$522

TOPS

BASES

POWER
DATASUPPORT
FURNITURE

ACCESSORIES

TABLES STEP 5 - ACCESSORIES

Modesty Panels and Accessories

STEP 1 - Steel Modesty

(^) Paint Suffix List

- G Slate Grey
- R Black
- S Silver
- T Medium Tone
- W Arctic White
- Z Other

Tip: Some Steelcase, Herman Miller, Knoll, Haworth, and Allsteel paints are available for \$350 list fee per order. Call/email for availability of specific colors. Additional custom paints (e.g. Tiger Dry Lac) must be quoted through quotes@enwork.com.

STEP 1 - Laminate Modesty

(#) Laminate Suffix List:

- A Wilsonart Kensington Maple (10776-60)
- B Wilsonart Monticello Maple (7925-38)
- C Wilsonart Wild Cherry (7054-60)
- E Wilsonart Fashion Grey (D381-60)
- F Wilsonart White Tigris (4783-60)
- G Wilsonart Cafelle (7933K-07)
- M Wilsonart Frosty White (1573-60)
- P Wilsonart Slate Grey (D91-60)
- R Wilsonart Black (1595-60)
- U Wilsonart Brazilwood (7946-38)
- V Wilsonart River Cherry (7937-38)
- W Wilsonart Designer White (D354-60)
- 3 Formica Neutral Twill (8826-58)
- 4 Formica Bleached Legno (8845-58)
- 5 Formica Prestige Walnut (6209-43)
- 7 Formica Select Cherry (7759-43)
- X *Wilsonart Non-Premium laminates +10% (-38, -60). Orders of 100+ units have no upcharge.
- Y *Formica Non-Premium Standard (58, +19% 43, MC, SP and NT finishes) and Wilsonart Premium (-01, -07, -12, -18, -52, -78) laminates.
- Z *Pionite Non-Premium, Nevamar Non-Premium, Formica Premium (WR, 42, 77, 46, RD Finishes), and whiteboard laminate.

*Add \$350 list for Special Laminate orders of less than 10 units. See page 21 for edge selection.

Ordering Information:

- > Replacement casters are sold 1 per package.
- > **A freight fee of \$100 net is assessed on orders less than \$1000 net. See page 13.**

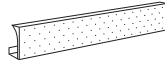

Part Number	Description	List Price (US\$)
Fixed Modesty Panels - Perforated Metal with Trough, 9.5" H		
AMPT30^	Perforated Modesty Panel, 30" W	\$235
AMPT36^	Perforated Modesty Panel, 36" W	\$238
AMPT42^	Perforated Modesty Panel, 42" W	\$253
AMPT48^	Perforated Modesty Panel, 48" W	\$257
AMPT54^	Perforated Modesty Panel, 54" W	\$282
AMPT60^	Perforated Modesty Panel, 60" W	\$289
AMPT66^	Perforated Modesty Panel, 66" W	\$295
AMPT72^	Perforated Modesty Panel, 72" W	\$304

Tip: Dimensions are actual. If installing between two legs, then purchase a 12" smaller size. If installing behind two legs, then purchase size to match worksurface.

Tip: Freestanding Straights have radiused (2.5") corners. Plan accordingly.



Universal Pivoting Modesty Panel - Mesh, with Wire Management Pocket, 10" H, black		
AMPM36	Mesh Modesty Panel, 36"W	\$288
AMPM48	Mesh Modesty Panel, 48"W	\$304
AMPM60	Mesh Modesty Panel, 60"W	\$316
AMPM66	Mesh Modesty Panel, 66"W	\$348
AMPM72	Mesh Modesty Panel, 72"W	\$348

Tip: For use on Flip or Fixed tables.

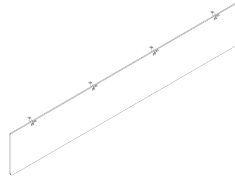

Universal Pivoting Modesty Panels - Frosted Acrylic, 9.5"H		
LGBMB48	Acrylic Modesty Panel, 48"W	\$403
LGBMB60	Acrylic Modesty Panel, 60"W	\$417
LGBMB66	Acrylic Modesty Panel, 66"W	\$427
LGBMB72	Acrylic Modesty Panel, 72"W	\$427
LGBMB96	Acrylic Modesty Panel, 96"W	\$625

Tip: For use on Flip or Fixed tables.

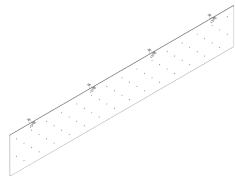

Universal Pivoting Modesty Panels - Perforated Steel, 9.5"H		
LGBMC48^	Perforated Modesty Panel, 48"W	\$347
LGBMC60^	Perforated Modesty Panel, 60"W	\$358
LGBMC66^	Perforated Modesty Panel, 66"W	\$370
LGBMC72^	Perforated Modesty Panel, 72"W	\$370

Tip: For use on Flip or Fixed tables.

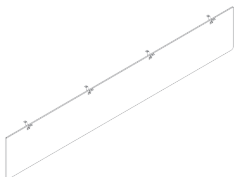

Universal Pivoting Modesty Panels - Laminate, 9.5"H		
AMPL48#	Laminate Modesty Panel, 48"W	\$273
AMPL60#	Laminate Modesty Panel, 60"W	\$288
AMPL66#	Laminate Modesty Panel, 66"W	\$299
AMPL72#	Laminate Modesty Panel, 72"W	\$329
AMPL96#	Laminate Modesty Panel, 96"W	\$424

Tip: For use on Flip or Fixed tables.



TOPS

BASES

POWER
DATASUPPORT
FURNITURE

ACCESSORIES

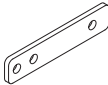
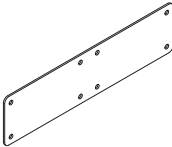
TABLES STEP 5 - ACCESSORIES

	Part Number	Description	List Price (US\$)
	Carts		
	CART60	Cart for 60" Round Tables, 61"W x 31.25" D x 42.5 H	\$1877
	CART	Cart for Rectangle Tables, 49"W x 31.25"D x 32.25"H	\$1845
		Tip: Carts hold 5 Enwork folding tables. Includes 4" heavy duty casters and frame. Portions of the steel frame are covered by Neoprene rubber to help protect tables.	
	Tie Plates		
	UTE	1/2" x 2.5" Tie plates - package of 5	\$32
	Support Plates		
	USPT	2" x 7.5" Support plate - package of 1	\$23
	Grommets, 2.36" Diameter with Covers, Package of five		
	GRMB	Grommets, Black	\$61
	GRMG	Grommets, Grey	\$61
	GRMT	Grommets, Medium Tone	\$61
	GRMA	Grommets, Almond	\$61
	GRMP	Grommets, Pearl	\$61
	Edging		
	GREDG1	1mm Edging, price per foot	\$7
	GREDG3	3mm Edging, price per foot	\$8
		Tip: Freeform color selection. Standard Enwork edge colors only.	
	Ganging Bracket Packages		
	GBT2	Ganging brackets for tables with 3mm edge – package of 2, black only	\$50
		Tip: GBT2 Ganging Package includes 2 ganging mechanisms (4 ganging parts). Use both ganging mechanisms (one package) to connect two 24-36"D tables. Tables 18" deep only require one ganging mechanism (1/2 package) per pair.	
		Tip: Will not work on tables that have knife edge on all 4 sides.	
	Replacement Casters for Legs and Bases, Package of one		
	CSTSW	3" White twin wheel locking Caster for Sensation and Gyration 2.0	\$20
	CSTSB	3" Black twin wheel locking Caster for Sensation and Gyration 2.0	\$20
	CSTMG	2-1/2" Grey locking Caster for Impression (except Command Centers and Lecterns) and Sawhorse	\$20
	CSTMB	2-1/2" Black locking Caster for Impression (except Command Centers and Lecterns) and Sawhorse	\$20
	CSTCCW	3" White locking Casters for Impression Command Centers and Lecterns	\$20
	CSTCCB	3" Black locking Casters for Impression Command Centers and Lecterns	\$20
	CSTVB	2" Black twin wheel locking Caster for Value legs (except Value Flip)	\$20
	CSTVFB	2-1/2" Black twin wheel locking Caster for Value Flip	\$20

Perimeter™ Porcelain & Glass Wall-Mount Whiteboards

Product Specifications:

> Wall-Mounted Glass Whiteboards are 3/16" tempered, low iron glass back-painted Super White.

Ordering Information:

> A freight fee of \$100 net is assessed on orders less than \$1000 net. See page 13.



Part Number	Description	List Price (US\$)
-------------	-------------	-------------------

Perimeter Wall-Mounted Rectangle Glass Whiteboards, 48"H

DYD4848	Glass Whiteboard for Walls, 48"W	\$2172
DYD4860	Glass Whiteboard for Walls, 60"W	\$2699
DYD4872	Glass Whiteboard for Walls, 72"W	\$3258
DYD4896	Glass Whiteboard for Walls, 96"W	\$4345

Perimeter Wall-Mounted Rectangle Glass Whiteboards with 15" Marker Tray, 48"H

DYG4848	Glass Whiteboard for Walls, 15" Marker Tray, 48"W	\$2299
DYG4860	Glass Whiteboard for Walls, 15" Marker Tray, 60"W	\$2827
DYG4872	Glass Whiteboard for Walls, 15" Marker Tray, 72"W	\$3386
DYG4896	Glass Whiteboard for Walls, 15" Marker Tray, 96"W	\$4472

Tip: Includes mounting cleat and hardware. No standoffs.

Tip: Two-sided tape included to attach tray to whiteboard.

Perimeter Wall-Mounted Rectangle Glass Magnetic Whiteboards, 48"H

DYE4848	Glass Magnetic Whiteboard for Walls, 48"W	\$2884
DYE4860	Glass Magnetic Whiteboard for Walls, 60"W	\$3589
DYE4872	Glass Magnetic Whiteboard for Walls, 72"W	\$4326
DYE4896	Glass Magnetic Whiteboard for Walls, 96"W	\$5769

Perimeter Wall-Mounted Rectangle Glass Magnetic Whiteboards with 15" Marker Tray, 48"H

DYH4848	Glass Magnetic Whiteboard for Walls, 15" Marker Tray, 48"W	\$3011
DYH4860	Glass Magnetic Whiteboard for Walls, 15" Marker Tray, 60"W	\$3716
DYH4872	Glass Magnetic Whiteboard for Walls, 15" Marker Tray, 72"W	\$4453
DYH4896	Glass Magnetic Whiteboard for Walls, 15" Marker Tray, 96"W	\$5895

Tip: Includes mounting cleat and hardware. No standoffs.

Tip: Requires rare earth magnets.

Tip: Two-sided tape included to attach tray to whiteboard.



Rare Earth Magnets, Package of Five

DYMAGB	Rare Earth Magnets, Black	\$154
DYMAGR	Rare Earth Magnets, Red	\$154
DYMAGW	Rare Earth Magnets, White	\$154

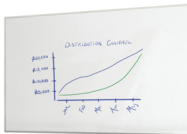

Perimeter Wall-Mounted Porcelain Magnetic Whiteboards with Aluminum Frame and Full Width Marker Tray, 48"H

DYF4848	Porcelain Whiteboard with Frame for Walls, Marker Tray, 48"W	\$987
DYF4860	Porcelain Whiteboard with Frame for Walls, Marker Tray, 60"W	\$1125
DYF4872	Porcelain Whiteboard with Frame for Walls, Marker Tray, 72"W	\$1268
DYF4896	Porcelain Whiteboard with Frame for Walls, Marker Tray, 96"W	\$1496

Tip: Includes mounting hardware.

Mobile Whiteboards

TOPS

BASES

POWER
DATASUPPORT
FURNITURE

ACCESSORIES

TABLES STEP 5 - ACCESSORIES



Part Number Description List Price (US\$)

Sensation 2-Sided Mobile Laminate Whiteboard with Trays, 45"W x 75.5"H, Silver
LMD@ 2-Sided Mobile Laminate Whiteboard \$2680



Perimeter 2-Sided Full Mobile Whiteboards, 73.5"H, Silver

TPMF3673	Full Porcelain Magnetic Mobile Whiteboard, 36"W	\$2803
TPMF4873	Full Porcelain Magnetic Mobile Whiteboard, 48"W	\$2940
TPMG3673	Full White Glass Mobile Whiteboard, 36"W	\$2964
TPMG4273	Full White Glass Mobile Whiteboard, 42"W	\$3156



Perimeter 2-sided Segmented Mobile Whiteboard with Accessory Steel Core Bottom, 73.5"H, Silver

TPMS3673	Segmented Porcelain Magnetic Mobile Whiteboard, 36"W	\$2776
TPMS4873	Segmented Porcelain Magnetic Mobile Whiteboard, 48"W	\$2881
TPMH3673	Segmented White Glass Mobile Whiteboard, 36"W	\$2948
TPMH4873	Segmented White Glass Mobile Whiteboard, 48"W	\$3456

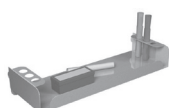

Perimeter Segmented Mobile Whiteboard Accessories, Silver

TTR	Tool Tray	\$127
LTR	Literature Tray	\$179
LTH	Letter Tray	\$94
PTH	Pencil Box	\$72

STEP 1 - Sensation Mobile Whiteboard Only

(@) Caster Color Suffix List:

B Black	no charge
G White with Grey Trim	+\$40



Apex™

Revisions

P203 03/17 Cabinet & Bookcase Shelf capacity 140 lbs

Notes

Apex™ Specifications

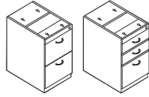
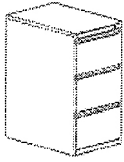

Verticals and Pedestals have the following characteristics:

- > 18 gauge – front reinforcements, back reinforcements, bottom panels
- > 20 gauge – top, drawer heads, front filler on ped, case back/sides on mobile ped
- > 22 gauge – case back/sides on fixed peds/verticals, rear slide mounts
- > 22 gauge – double wall drawer body (excluding head)
- > Lock included
- > Levelers included (3/4" adjustment)
- > Vertical files come with counterweights
- > Mobile peds have counterweight included
- > Full extension drawer slides on file drawers and box drawers
- > Interlock rated at 100 pounds distributed load
- > Pedestals and Verticals have removable drawer fronts
- > Verticals have 16 gauge interlock channels
- > Mobile peds have 2 locking and 2 non-locking casters
- > Pedestals accommodate letter filing front to back. Additional bars must be ordered to accommodate legal filing.

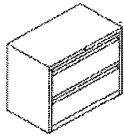

Laterals and Combination Cabinets have the following characteristics:

- > 18 gauge – top, bottom shelves, door supports
- > 20 gauge – back, sides, doors, and drawers
- > Lock included
- > Levelers included (1" adjustment)
- > Laterals and Combination Cabinets must be ganged together or bolted to the wall or floor. Counterweights are available as an option (field installed)
- > Heavy duty full extension drawer slides with interlock rated at 175 pounds of distributed load.
- > Laterals come with side-to-side hanging bars for legal and letter side-to-side filing

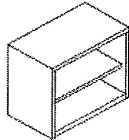
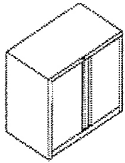

Double Door Cabinets and Heavy Duty Bookcases have the following characteristics:

- > 18" deep for Double Door Cabinets
- > 14" deep for Heavy Duty Bookcases
- > 18 gauge – top, bottom, shelves, door supports
- > 20 gauge – back, sides, and doors
- > Lock included
- > Levelers included (1" adjustment)
- > Lock rod material: steel for 4-hi and 5-hi – 16 gauge steel lock cam on 2-hi and 3-hi
- > 11.75" clearance between shelves – more space available at top and bottom
- > Shelves adjustable 1.5" up/down (in 1/2" increments)
- > Shelf capacity approximately 140 lbs
- > Doors have self-close hinges
- > Cabinets and Heavy Duty Bookcases taller than 50" must be ganged or bolted to the wall/floor.

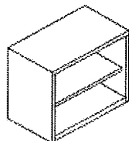

Bookcases (non heavy duty) have the following characteristics:

- > 13" or 16" deep
- > 18 gauge – bottom plate, top, and shelves
- > 20 gauge – Case (side/back)
- > Shelves adjustable on 1/2" increments
- > Shelf capacity approximately 140 lbs
- > Levelers included
- > Bookcases taller than 50" must be ganged or bolted to the wall/floor.
- > Back panels have exposed welds and brackets

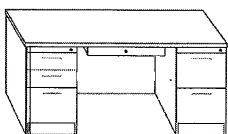

Apex steel desk products have the following characteristics:

- > 18 gauge double sided construction end panels with levelers (3/4" adjustment)
- > 7 gauge reinforcing corner brackets
- > 18 gauge back panels
- > High pressure laminate worksurface with backer and particleboard core (1-3/16" thick)
- > MDF core is available as a special
- > Center drawers are locking with 22 gauge drawers and 18 gauge brackets
- > Center drawers and peds are keyed alike within a single desk

Apex Steel Storage - Combo Cabinets, File Centers, Vertical Files

STEP 1

(^) Paint Suffix List

- G Slate Grey
- R Black
- S Silver
- T Medium Tone
- W Arctic White
- Z Other

Tip: Some Steelcase, Herman Miller, Knoll, Haworth, and Allsteel paints are available for \$350 list fee per order. Call/email for availability of specific colors. Additional custom paints (e.g. Tiger Dry Lac) must be quoted through quotes@enwork.com.

STEP 2

(#) Pull Suffix Style List:



(A) Arc



(I) Integral

Product Specifications:

- > See page 203 for detailed product characteristics
- > Combination Cabinets have a finished metal top. File Centers do not.

Ordering Information:

- > Default Keying is random. See page 17 for Keyed-alike (no charge).
- > Lock cores are LL Series. UM Series lock cores are available upon request.
- > If ordering an additional laminate top for these products, contact quotes@enwork.com.
- > **Laterals and Combination Cabinets must be ganged together or bolted to the wall or floor. Counterweights are available as an alternative. See next page for part numbers. Vertical Files come with required counterweights.**
- > Design modifications have been made on this product. If adding on to a previous order, contact customer service with original order information. Enwork cannot guarantee that the original product can be matched.
- > **A freight fee of \$100 net is assessed on orders less than \$1000 net. See page 13.**

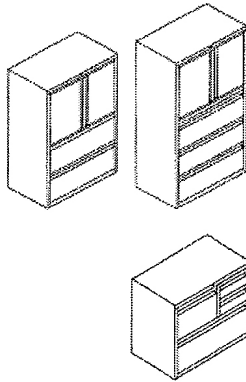

D1	W1	H1	Part Number	Description	List Price (US\$)
----	----	----	-------------	-------------	-------------------

Combination Cabinets

18	36	51.5	A2CC183651^#	Combo Cabinet, 51.5"H	\$2563
18	36	68	A2CC183667^#	Combo Cabinet, 67.4"H	\$2940

File Centers Without Top for Under Worksurface Applications

18	30	28	A2FC1830^#	File Center, 30"W without top	\$1378
----	----	----	------------	-------------------------------	--------

Tip: Metal tops can be added (as shown). Contact quotes@enwork.com.

Vertical Files – Letter

28	15	27.5	A2VF2^#	Vertical File, 2 Drawer	\$731
28	15	39.5	A2VF3^#	Vertical File, 3 Drawer	\$1041
28	15	51.5	A2VF4^#	Vertical File, 4 Drawer	\$1237
28	15	63.5	A2VF5^#	Vertical File, 5 Drawer	\$1464

Tip: Vertical Files come standard with front-to-back file bars.

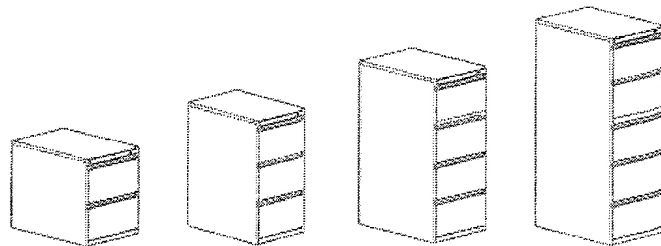

Apex Steel Storage - Lateral Files

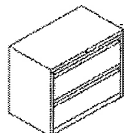

D1	W1	H1	Part Number	Description	List Price (US\$)
Lateral Files – 2 High					
18	30	27.5	A2Z230^#	Lateral File, 2 Drawer, 30"W	\$1096
18	36	27.5	A2Z236^#	Lateral File, 2 Drawer, 36"W	\$1168
18	42	27.5	A2Z242^#	Lateral File, 2 Drawer, 42"W	\$1286

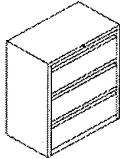

Lateral Files – 3 High					
18	30	39.5	A2Z330^#	Lateral File, 3 Drawer, 30"W	\$1485
18	36	39.5	A2Z336^#	Lateral File, 3 Drawer, 36"W	\$1580
18	42	39.5	A2Z342^#	Lateral File, 3 Drawer, 42"W	\$1739

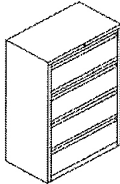

Lateral Files – 4 High					
18	30	51.5	A2Z430^#	Lateral File, 4 Drawer, 30"W	\$1827
18	36	51.5	A2Z436^#	Lateral File, 4 Drawer, 36"W	\$1946
18	42	51.5	A2Z442^#	Lateral File, 4 Drawer, 42"W	\$2140

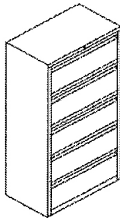

Lateral Files – 5 High (4 Drawers and Fixed Shelf with Door)					
18	30	67.4	A2Z530^#	Lateral File, 5 high, 30"W	\$2287
18	36	67.4	A2Z536^#	Lateral File, 5 high, 36"W	\$2438
18	42	67.4	A2Z542^#	Lateral File, 5 high, 42"W	\$2681

Tip: Top opening is a fixed shelf.

Tip: Door opens over cabinet.

Counterweights for Lateral Files and Combination Cabinets

A2ZCW23	Counterweight for 2 High / 3 High Cabinet	\$211
A2ZCW45	Counterweight for 4 High / 5 High Cabinet	\$159

File Bar Kits for Lateral Files

A2ZBF	Front-to-Back File Bars for ONE drawer	\$35
-------	--	------

Apex Steel Storage - Bookcases

STEP 1

(^) Paint Suffix List

G Slate Grey
R Black
S Silver
T Medium Tone
W Arctic White
Z Other





Tip: Some Steelcase, Herman Miller, Knoll, Haworth, and Allsteel paints are available for \$350 list fee per order. Call/email for availability of specific colors. Additional custom paints (e.g. Tiger Dry Lac) must be quoted through quotes@enwork.com.



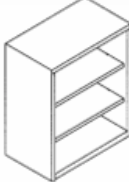

Product Specifications:

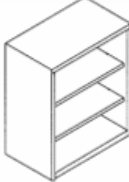
- > Bookcases and Heavy Duty Bookcases have levelers.
- > Heavy Duty Bookcases have reinforced corners.
- > Bookcases on this page have back panels with exposed welds and brackets.
- > See page 203 for detailed product characteristics.

Ordering Information:

- > **All bookcases over 50"H must be ganged or bolted to the floor/wall.**
- > Design modifications have been made on this product. If adding on to a previous order, contact customer service with original order information. Enwork cannot guarantee that the original product can be matched.
- > If ordering an additional laminate top for these products, contact quotes@enwork.com.
- > **A freight fee of \$100 net is assessed on orders less than \$1000 net. See page 13.**

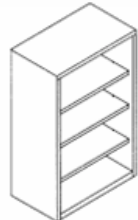
D1	W1	H1	Part Number	Description	List Price (US\$)
					
Bookcases - 2 High, 13"D					
13	30	31	A2B21230^	Bookcase, 2 high, 13"D x 30"W	\$592
13	36	31	A2B21236^	Bookcase, 2 high, 13"D x 36"W	\$608
13	42	31	A2B21242^	Bookcase, 2 high, 13"D x 42"W	\$651
					
Bookcases - 3 High, 13"D					
13	30	42	A2B31230^	Bookcase, 3 high, 13"D x 30"W	\$736
13	36	42	A2B31236^	Bookcase, 3 high, 13"D x 36"W	\$778
13	42	42	A2B31242^	Bookcase, 3 high, 13"D x 42"W	\$849
					
Bookcases - 2 High, 16"D					
16	30	31	A2B21530^	Bookcase, 2 high, 16"D x 30"W	\$658
16	36	31	A2B21536^	Bookcase, 2 high, 16"D x 36"W	\$677
16	42	31	A2B21542^	Bookcase, 2 high, 16"D x 42"W	\$709
					
Bookcases - 3 High, 16"D					
16	30	42	A2B31530^	Bookcase, 3 high, 16"D x 30"W	\$826
16	36	42	A2B31536^	Bookcase, 3 high, 16"D x 36"W	\$869
16	42	42	A2B31542^	Bookcase, 3 high, 16"D x 42"W	\$914
Dividers (Bookcase only)					
13	-	-	A2BDIV	Divider, package of 3	\$101
					
Extra Shelf, 13"D					
13	30	-	A2B1230^	Shelf, 13"D x 30"W	\$101
13	36	-	A2B1236^	Shelf, 13"D x 36"W	\$101
13	42	-	A2B1242^	Shelf, 13"D x 42"W	\$101
Extra Shelf 16"D					
16	30	-	A2B1530^	Shelf, 16"D x 30"W	\$101
16	36	-	A2B1536^	Shelf, 16"D x 36"W	\$101
16	42	-	A2B1542^	Shelf, 16"D x 42"W	\$101

D1	W1	H1	Part Number	Description	List Price (US\$)	
Heavy Duty Bookcases - 2 High, 14"D						
	14	30	27.5	A2BHD230^	Heavy Duty Bookcase, 2 high, 30"W	\$788
	14	36	27.5	A2BHD236^	Heavy Duty Bookcase, 2 high, 36"W	\$829
	14	42	27.5	A2BHD242^	Heavy Duty Bookcase, 2 high, 42"W	\$868
Heavy Duty Bookcases - 3 High, 14"D						
	14	30	39.5	A2BHD330^	Heavy Duty Bookcase, 3 high, 30"W	\$881
	14	36	39.5	A2BHD336^	Heavy Duty Bookcase, 3 high, 36"W	\$920
	14	42	39.5	A2BHD342^	Heavy Duty Bookcase, 3 high, 42"W	\$960
Heavy Duty Bookcases - 4 High, 14"D						
	14	30	51.5	A2BHD430^	Heavy Duty Bookcase, 4 high, 30"W	\$980
	14	36	51.5	A2BHD436^	Heavy Duty Bookcase, 4 high, 36"W	\$1020
	14	42	51.5	A2BHD442^	Heavy Duty Bookcase, 4 high, 42"W	\$1059
Heavy Duty Bookcases - 5 High, 14"D						
	14	30	68	A2BHD530^	Heavy Duty Bookcase, 5 high, 30"W	\$1085
	14	36	68	A2BHD536^	Heavy Duty Bookcase, 5 high, 36"W	\$1124
	14	42	68	A2BHD542^	Heavy Duty Bookcase, 5 high, 42"W	\$1163
Extra Shelves for Heavy Duty Bookcases						
	14	30		A2SH30^	Shelf, 30"W	\$101
	14	36		A2SH36^	Shelf, 36"W	\$101
	14	42		A2SH42^	Shelf, 42"W	\$101

Apex Steel Storage - Double Door Cabinets

STEP 1

(^) Paint Suffix List

G Slate Grey
R Black
S Silver
T Medium Tone
W Arctic White
Z Other

Tip: Some Steelcase, Herman Miller, Knoll, Haworth, and Allsteel paints are available for \$350 list fee per order. Call/email for availability of specific colors. Additional custom paints (e.g. Tiger Dry Lac) must be quoted through quotes@enwork.com.

STEP 2

(#) Pull Suffix Style List:



(A) Arc



(I) Integral

Ordering Information:

- > Default Keying is random. See page 17 for Keyed-alike (no charge).
- > Lock cores are LL Series. UM Series lock cores are available upon request.
- > **All cabinets over 50"H must be ganged or bolted to the floor/wall.**
- > See page 203 for detailed product characteristics.
- > Design modifications have been made on this product. If adding on to a previous order, contact customer service with original order information. Enwork cannot guarantee that the original product can be matched.
- > If ordering an additional laminate top for these products, contact quotes@enwork.com.
- > **A freight fee of \$100 net is assessed on orders less than \$1000 net. See page 13.**

D1	W1	H1	Part Number	Description	List Price (US\$)
----	----	----	-------------	-------------	-------------------

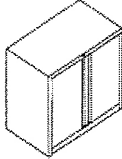

Double Door Cabinets - 2 High with One Adjustable Shelf

18	30	27.5	A2SC230^#	Double Door Cabinet, 2 high w/ 1 adjustable shelf, 30"W	\$1183
18	36	27.5	A2SC236^#	Double Door Cabinet, 2 high w/ 1 adjustable shelf, 36"W	\$1203
18	42	27.5	A2SC242^#	Double Door Cabinet, 2 high w/ 1 adjustable shelf, 42"W	\$1324

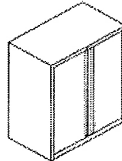

Double Door Cabinets - 3 High with Two Adjustable Shelves

18	30	39.5	A2SC330^#	Double Door Cabinet, 3 high w/ 2 adjustable shelves, 30"W	\$1376
18	36	39.5	A2SC336^#	Double Door Cabinet, 3 high w/ 2 adjustable shelves, 36"W	\$1424
18	42	39.5	A2SC342^#	Double Door Cabinet, 3 high w/ 2 adjustable shelves, 42"W	\$1526

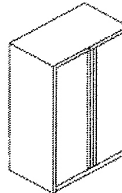

Double Door Cabinets - 4 High with Three Adjustable Shelves

18	30	51.5	A2SC430^#	Double Door Cabinet, 4 high w/ 3 adjustable shelves, 30"W	\$1663
18	36	51.5	A2SC436^#	Double Door Cabinet, 4 high w/ 3 adjustable shelves, 36"W	\$1715
18	42	51.5	A2SC442^#	Double Door Cabinet, 4 high w/ 3 adjustable shelves, 42"W	\$1845

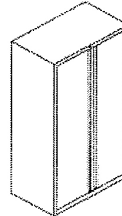

Double Door Cabinets - 5 High with Four Adjustable Shelves

18	30	67.4	A2SC530^#	Double Door Cabinet, 5 high w/ 4 adjustable shelves, 30"W	\$1944
18	36	67.4	A2SC536^#	Double Door Cabinet, 5 high w/ 4 adjustable shelves, 36"W	\$2163
18	42	67.4	A2SC542^#	Double Door Cabinet, 5 high w/ 4 adjustable shelves, 42"W	\$2163

Notes

Apex Steel Storage - Towers

STEP 1

(^) Paint Suffix List

- G Slate Grey
- R Black
- S Silver
- T Medium Tone
- W Arctic White
- Z Other

Tip: Some Steelcase, Herman Miller, Knoll, Haworth, and Allsteel paints are available for \$350 list fee per order. Call/email for availability of specific colors. Additional custom paints (e.g. Tiger Dry Lac) must be quoted through quotes@enwork.com.

STEP 2 - Towers and Open Top Peds Only

(#) Pull Suffix List:



STEP 2 - for Mobile Peds, Steel Top Only

(#) Pull Suffix List:

- A Arc, Aluminum no charge
- J Arc, Aluminum w/ add. Arc pull on lock cover +\$36
- K Arc, Aluminum w/ Tote pull +\$180
- B Bar no charge
- L Bar w/ additional Bar pull on lock cover +\$36
- M Bar w/ Tote pull +\$180
- R Rod no charge
- P Rod w/ additional Rod pull on lock cover +\$36
- Q Rod w/ Tote pull +\$180
- I Integral no charge
- T Integral w/ additional Arc pull on lock cover +\$36
- U Integral w/ Tote pull +\$180

STEP 3 - for Peds with Laminate Fronts Only

(@) Laminate Suffix List:

- A Wilsonart Kensington Maple (10776-60) +\$206
- B Wilsonart Monticello Maple (7925-38) +\$206
- C Wilsonart Wild Cherry (7054-60) +\$206
- E Wilsonart Fashion Grey (D381-60) +\$206
- G Wilsonart Cafelle (7933K-07) +\$206
- M Wilsonart Frosty White (1573-60) +\$206
- P Wilsonart Slate Grey (D91-60) +\$206
- R Wilsonart Black (1595-60) +\$206
- U Wilsonart Brazilwood (7946-38) +\$206
- V Wilsonart River Cherry (7937-38) +\$206
- W Wilsonart Designer White (D354-60) +\$206
- 3 Formica Neutral Twill (8826-58) +\$206
- 4 Formica Bleached Legno (8845-58) +\$206
- 5 Formica Prestige Walnut (6209-43) +\$206
- 7 Formica Select Cherry (7759-43) +\$206
- X *Wilsonart Non-Premium laminates (-38, -60) +\$225
- Y *Formica Non-Premium (includes 58, 43, MC, SP, and NT finishes), Formica Premium (WR, 42, 77, 46, RD finishes), Pionite Non-Premium, Nevamar Non-Premium, Wilsonart Premium (-01, -07, -12, -18, -52, -78), and whiteboard laminate. +\$250

*Add \$350 list for Special Laminate orders of less than 10 units. See page 21 for edge selection.

Tip: For laminate fronts on peds, you must add a "Z" in front of the part number.

Product Specifications:

- > Box drawers and file drawers have full extension slides.

Ordering Information:

- > Default Keying is random. See page 17 for Keyed-alike (no charge).
- > Lock cores are LL Series. UM Series lock cores are available upon request.
- > Design modifications have been made on this product. If adding on to a previous order, contact customer service with original order information. Enwork cannot guarantee that the original product can be matched.
- > If ordering an additional laminate top for these products, contact quotes@enwork.com.
- > **A freight fee of \$100 net is assessed on orders less than \$1000 net. See page 13.**

D1	W1	H1	Part Number	Description	List Price (US\$)
----	----	----	-------------	-------------	-------------------

Side-Access Storage Towers, 51"H

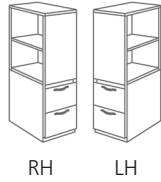

24	15	51.5	A2NWT51L^#	Side-Access Tower, F/F, LH	\$1571
24	15	51.5	A2NWT51R^#	Side-Access Tower, F/F, RH	\$1571
24	15	51.5	A2NWD51L^#	Side-Access Tower, B/B/F, LH	\$1625
24	15	51.5	A2NWD51R^#	Side-Access Tower, B/B/F, RH	\$1625

Tip: Storage unit includes one adjustable shelf.
Tip: Tower has 1 lock

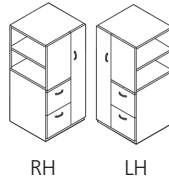

Side-Access Storage Towers with Wardrobe, 51"H

24	24	51.5	A2BT51L^#	Side-Access Tower, Wardrobe, F/F, LH	\$2378
24	24	51.5	A2BT51R^#	Side-Access Tower, Wardrobe, F/F, RH	\$2378
24	24	51.5	A2BTB51L^#	Side-Access Tower, Wardrobe, B/B/F, LH	\$2463
24	24	51.5	A2BTB51R^#	Side-Access Tower, Wardrobe, B/B/F, RH	\$2463

Tip: Display unit includes one adjustable shelf.
Tip: Wardrobe and Pedestals are locking.
Tip: Tower has 2 locks

Apex Steel Storage - Pedestals

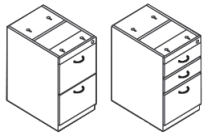

D1	W1	H1	Part Number	Description	List Price (US\$)
Pedestals - Open Top					
18	15	27.5	A2P18FF^#@	18" D F/F Ped - full ext. files	\$591
18	15	27.5	A2P18BBFE^#@	18" D B/B/F Ped - full ext. boxes, full ext. file	\$612
22	15	27.5	A2P24FF^#@	24" D F/F Ped - full ext. slide	\$601
22	15	27.5	A2P24BBFE^#@	24" D B/B/F Ped - full ext. boxes, full ext. file	\$624
28	15	27.5	A2P30FF^#@	30" D F/F Ped - full ext. slide	\$747
28	15	27.5	A2P30BBFE^#@	30" D B/B/F Ped - full ext. boxes, full ext. file	\$809

Tip: Box drawers do not include dividers.

Tip: Laminate fronts are available as an option (lock bar is painted). Add a "Z" to the front of the part number and see Step 3 to specify laminate.

Tip: 18" D peds do not support legal filing.

Tip: As of March 2015, 24" D pedestals fit under 24" Apex shells. 30" D pedestals fit under 30" Apex shells.



Mobile Pedestals - Steel Top					
18	15	22.3	A2MP18BBFE^#@	18" D B/F Mobile Ped - full ext. box, full ext. file	\$595
18	15	27.2	A2MP18BBFE^#@	18" D B/B/F Mobile Ped - full ext. box, full ext. file	\$705
18	15	27.2	A2MP18FF^#@	18" D F/F Mobile Ped - full ext. slide	\$658
22	15	22.3	A2MP24BBFE^#@	24" D B/F Mobile Ped - full ext. box, full ext. file	\$605
22	15	27.2	A2MP24BBFE^#@	24" D B/B/F Mobile Ped - full ext. box, full ext. file	\$727
22	15	27.2	A2MP24FF^#@	24" D F/F Mobile Ped - full ext. slide	\$679

Tip: Casters require field installation. Counterweight included.

Tip: Box drawers do not include dividers.

Tip: Laminate fronts are available as an option (lock bar is painted). Add a "Z" to the front of the part number and see Step 3 to specify laminate.

Tip: Box Box File and File File will hit NWBRACE if NWBRACE is supporting top.

Tip: Additional lock bar pull or tote pull available on mobile peds. See Step 2.

Tote Pull



Pull on
Lock Bar

Pulling Options

Seat Cushions for Apex Pedestals, Magnet Installation - 2"x15"x18"

A2CUSH18	Apex Ped Cushion, 18", Camira Era or the Mill Collection Fabrics, Specify Pattern & Color	\$200
A2CUSHCOM18	Apex Ped Cushion, 18", COM Fabric	\$200

Seat Cushions for Apex Pedestals, Magnet Installation - 2"x15"x22"

A2CUSH24	Apex Ped Cushion, 22", Camira Era or the Mill Collection Fabrics, Specify Pattern & Color	\$222
A2CUSHCOM24	Apex Ped Cushion, 22", COM Fabric	\$222

Tip: To view Camira fabrics or to order samples, go to www.camirafabrics.com/us.

Tip: For COM yardage, see page 16.

Apex Steel Storage - Desk Mount Hutch & Lighting

STEP 1

(^) Paint Suffix List

G Slate Grey
R Black
S Silver
T Medium Tone
W Arctic White
Z Other

Tip: Some Steelcase, Herman Miller, Knoll, Haworth, and Allsteel paints are available for \$350 list fee per order. Call/email for availability of specific colors. Additional custom paints (e.g. Tiger Dry Lac) must be quoted through quotes@enwork.com.

STEP 2 - If Applicable

(#) Fabric Suffix List:

Free form fabric selection. Choose from Camira Mill L2 or Lucia fabrics.

Tip: To view fabric colors or to order samples go to www.camirafabrics.com/us.

Tip: For COM yardage, see page 16.

Product Specifications:

- > Height is 37"
- > Doors recede into cabinet.
- > Lock cores are LL Series.

Ordering Information:

- > Default Keying is random. See page 17 for Keyed-alike (no charge).
- > For COM yardage see page 16.
- > Design modifications have been made on this product. If adding on to a previous order, contact customer service with original order information. Enwork cannot guarantee that the original product can be matched.
- > **A freight fee of \$100 net is assessed on orders less than \$1000 net. See page 13.**

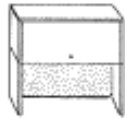

D1	W1	H1	Part Number	Description	List Price (US\$)
Desk Mount Hutches - Single Door with Tackboard					
-	36	-	A2CT36^#	Hutch, 36"	\$1646
-	42	-	A2CT42^#	Hutch, 42"	\$1696
-	48	-	A2CT48^#	Hutch, 48"	\$1729

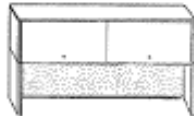

Desk Mount Hutches - Double Door with Tackboard					
-	60	-	A2CT60^#	Hutch, 60"	\$1970
-	66	-	A2CT66^#	Hutch, 66"	\$2002
-	72	-	A2CT72^#	Hutch, 72"	\$2065

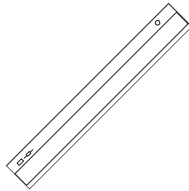

Task Light with Electronic Ballast, Colored Paint

-	18	-	TLEC^	Task Light for use on 24" overhead storage, 18"	\$361
-	24	-	TLEA^	Task Light for use on 30" - 36" overhead storage, 24"	\$361
-	36	-	TLEB^	Task Light for use on 42" - 48" overhead storage, 36"	\$385
-	48	-	TLED^	Task Light for use on 54" - 60" overhead storage, 48"	\$416
-	58	-	TLEE^	Task Light for use on 60+" overhead storage, 58"	\$462

Tip: Attachment hardware and T-8 bulb included.

Apex Steel Storage - Overhead Storage, Tackboards, & Wall Tracks

Ordering Information:

- > Product ships KD.
- > Default keying option is random. See page 17 for ordering keyed-alike (no charge).
- > Lock cores are LL (nickel only).
- > Installation hardware is included.
- > Tackboard Installation hardware included.
- > **A freight fee of \$100 net is assessed on orders less than \$1000 net. See page 13.**



D1	W1	H1	Part Number	Description	List Price (US\$)
Overhead Storage Cabinet – Flat Door					
14	24	16.5	SBBMA24*^	Overhead Storage Cabinet, 24"	\$628
14	30	16.5	SBBMA30*^	Overhead Storage Cabinet, 30"	\$630
14	36	16.5	SBBMA36*^	Overhead Storage Cabinet, 36"	\$654
14	42	16.5	SBBMA42*^	Overhead Storage Cabinet, 42"	\$685
14	48	16.5	SBBMA48*^	Overhead Storage Cabinet, 48"	\$723
14	60	16.5	SBBMA60*^	Overhead Storage Cabinet, 60"	\$907

Tip: Door opens over cabinet.



D1	W1	H1	Part Number	Description	List Price (US\$)
Half Height Shelves for Enwork Wall Tracks Only					
12.75	24	7	SHHSMA24A^	Half Height Shelf, 24"	\$270
12.75	30	7	SHHSMA30A^	Half Height Shelf, 30"	\$284
12.75	36	7	SHHSMA36A^	Half Height Shelf, 36"	\$296
12.75	42	7	SHHSMA42A^	Half Height Shelf, 42"	\$307
12.75	48	7	SHHSMA48A^	Half Height Shelf, 48"	\$320
12.75	60	7	SHHSMA60A^	Half Height Shelf, 60"	\$370



D1	W1	H1	Part Number	Description	List Price (US\$)
Tackboards for Enwork Wall Tracks or Wall Mount Cabinets, 19"H					
-	24	19	WTKB1924*#	Tackboard, 24"	\$255
-	30	19	WTKB1930*#	Tackboard, 30"	\$261
-	36	19	WTKB1936*#	Tackboard, 36"	\$278
-	42	19	WTKB1942*#	Tackboard, 42"	\$286
-	48	19	WTKB1948*#	Tackboard, 48"	\$290
-	60	19	WTKB1960*#	Tackboard, 60"	\$322

Tip: Pick from Camira Mill L2 or Lucia fabrics and free form color.

Tip: Product will come with brackets if wall tracks are specified, velcro if wall mount is specified.

Tip: For COM yardage see page 16.



D1	W1	H1	Part Number	Description	List Price (US\$)
Wall Tracks for Enwork Tackboards, Package of Two, Black					
-	-	35	WTR352	Wall Track, 35"	\$69
-	-	60	WTR602	Wall Track, 60"	\$112

Tip: Attachment hardware is NOT included. 3/8" toggle bolts are recommended.

STEP 1

(*) Mounting Suffix List:

- A Enwork Wall Tracks
- B Wall Mount (Overhead Storage Cabinet only)

STEP 2 - Overhead Storage Cabinets Only

(^) Paint Suffix List

- G Slate Grey
- R Black
- S Silver
- T Medium Tone
- W Arctic White
- Z Other

Tip: Some Steelcase, Herman Miller, Knoll, Haworth, and Allsteel paints are available for \$350 list fee per order. Call/email for availability of specific colors. Additional custom paints (e.g. Tiger Dry Lac) must be quoted through quotes@enwork.com.

STEP 2 - Tackboards Only

(#) Fabric Suffix List:

Free form fabric selection. Choose from Camira Mill L2 or Lucia fabrics.

Tip: To view fabric colors or to order samples go to www.camirafabrics.com/us.

Tip: For COM yardage, see page 16.

Apex Ped Supported Desks

STEP 1

(&) Laminate Edge and Drawer Front Suffix List:

- A Standard Laminate (3mm Edge) no charge w/ standard steel drawer fronts
- F Standard Laminate (3mm edge) +\$200 w/ laminate drawer fronts (single ped)
- G Standard Laminate (3mm edge) +\$400 w/ laminate drawer fronts (double ped)

Tip: Laminate drawer fronts require Arc pulls in step 3.

STEP 2

(*) Cable Management Option List:

- N None no charge
- C Grommet (center, rear) +\$18
- L Grommet (left, rear) +\$18
- R Grommet (right, rear) +\$18
- D Grommets (left and right, rear) +\$36

Tip: A grommet cannot be specified over a pedestal.

STEP 3 - If Applicable

(@) Pull Suffix List:

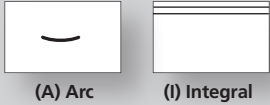

STEP 4

(^) Paint Suffix List

- G Slate Grey
- R Black
- S Silver
- T Medium Tone
- W Arctic White
- Z Other

Tip: Some Steelcase, Herman Miller, Knoll, Haworth, and Allsteel paints are available for \$350 list fee per order. Call/email for availability of specific colors. Additional custom paints (e.g. Tiger Dry Lac) must be quoted through quotes@enwork.com.

STEP 5

(#) Laminate Suffix List:

- A Wilsonart Kensington Maple (10776-60)
- B Wilsonart Monticello Maple (7925-38)
- C Wilsonart Wild Cherry (7054-60)
- E Wilsonart Fashion Grey (D381-60)
- F Wilsonart White Tigris (4783-60)
- G Wilsonart Cafelle (7933K-07)
- M Wilsonart Frosty White (1573-60)
- P Wilsonart Slate Grey (D91-60)
- R Wilsonart Black (1595-60)
- U Wilsonart Brazilwood (7946-38)
- V Wilsonart River Cherry (7937-38)
- W Wilsonart Designer White (D354-60)
- 3 Formica Neutral Twill (8826-58)
- 4 Formica Bleached Legno (8845-58)
- 5 Formica Prestige Walnut (6209-43)
- 7 Formica Select Cherry (7759-43)
- X *Wilsonart Non-Premium laminates +\$36 (-38, -60). Orders of 100+ units have no upcharge.
- Y *Formica Non-Premium Standard +\$50 (58, 43, MC, SP and NT finishes) and Wilsonart Premium (-01, -07, -12, -18, -52, -78) laminates.
- Z *Pionite Non-Premium, Nevamar +\$72 Non-Premium, Formica Premium (WR, 42, 77, 46, RD Finishes), and whiteboard laminate.

*Add \$350 list for Special Laminate orders of less than 10 units. See page 21 for edge selection.

Product Specifications:

- > Desks are steel with laminate worksurface and full-height back panels.
- > Lock cores are LL Series.
- > Height is 29".

Ordering Information:

- > 1/2 height back panels are available (no charge). Add "Y" in front of part number. 3/4 height back panels are also available (no charge). Add "Z" in front of part number.
- > Peds can have either steel or laminate fronts. See Step 1.
- > A grommet cannot be specified over a pedestal.
- > Peds and Center Drawers are Keyed alike.
- > Ships assembled.
- > **A freight fee of \$100 net is assessed on orders less than \$1000 net. See page 13.**

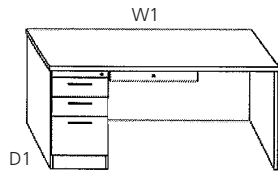

Left hand unit shown

D1	W1	O	Part Number	Description	List Price (US\$)
----	----	---	-------------	-------------	-------------------

Single Pedestal Desks - Ped Supported, B/B/F, with Center Drawer, LH

24	72	LH	A2PL2472&*@^#	Single Ped Desk, LH, 24"x72"	\$2151
30	48	LH	A2PL3048&*@^#	Single Ped Desk, LH, 30"x48"	\$2107
30	60	LH	A2PL3060&*@^#	Single Ped Desk, LH, 30"x60"	\$2257
30	66	LH	A2PL3066&*@^#	Single Ped Desk, LH, 30"x66"	\$2293
30	72	LH	A2PL3072&*@^#	Single Ped Desk, LH, 30"x72"	\$2318
36	72	LH	A2PL3672&*@^#	Single Ped Desk, LH, with 6" overhang, 36"x72"	\$2378

Single Pedestal Desks - Ped Supported, B/B/F, with Center Drawer, RH

24	72	RH	A2PR2472&*@^#	Single Ped Desk, RH, 24"x72"	\$2151
30	48	RH	A2PR3048&*@^#	Single Ped Desk, RH, 30"x48"	\$2107
30	60	RH	A2PR3060&*@^#	Single Ped Desk, RH, 30"x60"	\$2257
30	66	RH	A2PR3066&*@^#	Single Ped Desk, RH, 30"x66"	\$2293
30	72	RH	A2PR3072&*@^#	Single Ped Desk, RH, 30"x72"	\$2318
36	72	RH	A2PR3672&*@^#	Single Ped Desk, RH, with 6" overhang, 36"x72"	\$2378

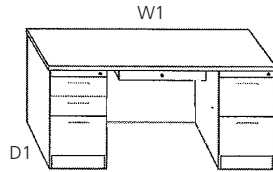

Double Pedestal Desks - Ped Supported, B/B/F and F/F, with Center Drawer

30	60	-	A2PD3060&*@^#	Double Ped Desk, 30"x60"	\$2531
30	66	-	A2PD3066&*@^#	Double Ped Desk, 30"x66"	\$2568
30	72	-	A2PD3072&*@^#	Double Ped Desk, 30"x72"	\$2594
36	72	-	A2PD3672&*@^#	Double Ped Desk, with 6" overhang, 36"x72"	\$2731

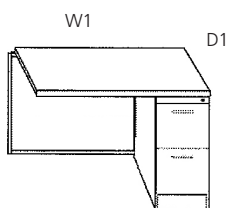

Right hand unit shown

D1	W1	O	Part Number	Description	List Price (US\$)
Single Pedestal Returns - Ped Supported, F/F, 24"D, LH					
24	36	LH	A2FL2436&*ℤ	Single Ped Returns, LH, 36"	\$1397
24	42	LH	A2FL2442&*ℤ	Single Ped Returns, LH, 42"	\$1397
24	48	LH	A2FL2448&*ℤ	Single Ped Returns, LH, 48"	\$1429
Single Pedestal Returns - Ped Supported, F/F, 24"D, RH					
24	36	RH	A2FR2436&*ℤ	Single Ped Returns, RH, 36"	\$1397
24	42	RH	A2FR2442&*ℤ	Single Ped Returns, RH, 42"	\$1397
24	48	RH	A2FR2448&*ℤ	Single Ped Returns, RH, 48"	\$1429

Tip: Returns are intended to be used with 66" and 72" desks. Center drawers will be partially covered by return worksurface on 60" and smaller desk widths.

Tip: As of March 2015, dimensions of the Desk Shells, Return Shells, Bridges, and D-tops have changed. Previous versions will not mix.

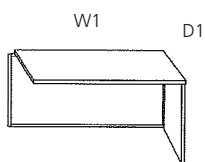

Right hand unit shown

D1	W1	O	Part Number	Description	List Price (US\$)
Return Shells, 24"D					
24	36	LH	A2HL2436&*ℤ	Return Shells, LH, 36"	\$912
24	42	LH	A2HL2442&*ℤ	Return Shells, LH, 42"	\$912
24	48	LH	A2HL2448&*ℤ	Return Shells, LH, 48"	\$939
24	36	RH	A2HR2436&*ℤ	Return Shells, RH, 36"	\$912
24	42	RH	A2HR2442&*ℤ	Return Shells, RH, 42"	\$912
24	48	RH	A2HR2448&*ℤ	Return Shells, RH, 48"	\$939

Tip: Returns are intended to be used with 66" and 72" desks. Center drawers will be partially covered by return worksurface on 60" and smaller desk widths.

Tip: As of March 2015, dimensions of the Desk Shells, Return Shells, Bridges, and D-tops have changed. Previous versions will not mix.

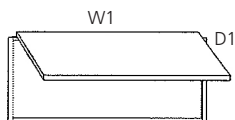

D1	W1	O	Part Number	Description	List Price (US\$)
Bridges, 24"D					
24	42	-	A2BR2442&*ℤ	Bridge, 42"	\$740
24	48	-	A2BR2448&*ℤ	Bridge, 48"	\$780

Tip: Bridge cannot connect to ped, only end panel.

Tip: As of March 2015, dimensions of the Desk Shells, Return Shells, Bridges, and D-tops have changed. Previous versions will not mix.

Apex Ped Supported Credenzas

STEP 1

(&) Laminate Edge and Drawer Front Suffix List:

- A Standard Laminate (3mm Edge) no charge w/ standard steel drawer fronts
 F Standard Laminate (3mm edge) +\$200 w/ laminate drawer fronts (single ped)
 G Standard Laminate (3mm edge) +\$400 w/ laminate drawer fronts (double ped)

Tip: Laminate drawer fronts require Arc pulls in step 3.

STEP 2

(*) Cable Management Option List:

- N None no charge
 C Grommet (center, rear) +\$18
 L Grommet (left, rear) +\$18
 R Grommet (right, rear) +\$18
 D Grommets (left and right, rear) +\$36

Tip: A grommet cannot be specified over a pedestal.

STEP 3 - If Applicable

(@) Pull Suffix List:



(A) Arc



(I) Integral

STEP 4

(^) Paint Suffix List

- G Slate Grey
 R Black
 S Silver
 T Medium Tone
 W Arctic White
 Z Other

Tip: Some Steelcase, Herman Miller, Knoll, Haworth, and Allsteel paints are available for \$350 list fee per order. Call/email for availability of specific colors. Additional custom paints (e.g. Tiger Dry Lac) must be quoted through quotes@enwork.com.

STEP 5

(#) Laminate Suffix List:

- A Wilsonart Kensington Maple (10776-60)
 B Wilsonart Monticello Maple (7925-38)
 C Wilsonart Wild Cherry (7054-60)
 E Wilsonart Fashion Grey (D381-60)
 F Wilsonart White Tigris (4783-60)
 G Wilsonart Cafelle (7933K-07)
 M Wilsonart Frosty White (1573-60)
 P Wilsonart Slate Grey (D91-60)
 R Wilsonart Black (1595-60)
 U Wilsonart Brazilwood (7946-38)
 V Wilsonart River Cherry (7937-38)
 W Wilsonart Designer White (D354-60)
 3 Formica Neutral Twill (8826-58)
 4 Formica Bleached Legno (8845-58)
 5 Formica Prestige Walnut (6209-43)
 7 Formica Select Cherry (7759-43)
 X *Wilsonart Non-Premium laminates (-38, -60). Orders of 100+ units have no upcharge. +\$36
 Y *Formica Non-Premium Standard (58, 43, MC, SP and NT finishes) and Wilsonart Premium (-01, -07, -12, -18, -52, -78) laminates. +\$50
 Z *Pionite Non-Premium, Nevamar Non-Premium, Formica Premium (WR, 42, 77, 46, RD Finishes), and whiteboard laminate. +\$72

*Add \$350 list for Special Laminate orders of less than 10 units. See page 21 for edge selection.

Product Specifications:

- > Desks are steel with laminate worksurface and full-height back panels.
- > Lock cores are LL Series.
- > Height is 29"

Ordering Information:

- > 1/2 height back panels are available (no charge). Add "Y" in front of part number. 3/4 height back panels are also available (no charge). Add "Z" in front of part number.
- > Peds can have either steel or laminate fronts. See Step 1.
- > A grommet cannot be specified over a pedestal.
- > Peds and Center Drawers are Keyed alike.
- > Ships assembled
- > **A freight fee of \$100 net is assessed on orders less than \$1000 net. See page 13.**

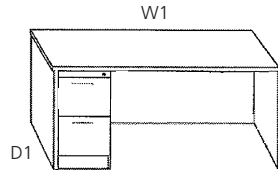

Left hand unit shown

D1	W1	O	Part Number	Description	List Price (US\$)
----	----	---	-------------	-------------	-------------------

Single Pedestal Credenzas - Ped Supported, F/F, 24"D, LH

24	60	LH	A2ML2460&*@^#	Credenza, Single ped, LH, 60"	\$1614
24	66	LH	A2ML2466&*@^#	Credenza, Single ped, LH, 66"	\$1738
24	72	LH	A2ML2472&*@^#	Credenza, Single ped, LH, 72"	\$1806

Single Pedestal Credenzas - Ped Supported, F/F, 24"D, RH

24	60	RH	A2MR2460&*@^#	Credenza, Single ped, RH, 60"	\$1614
24	66	RH	A2MR2466&*@^#	Credenza, Single ped, RH, 66"	\$1738
24	72	RH	A2MR2472&*@^#	Credenza, Single ped, RH, 72"	\$1806

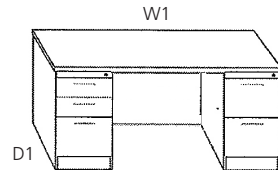

Double Pedestal Credenzas - Ped Supported, B/B/F and F/F, 24"D

24	60	-	A2MD2460&*@^#	Credenza, Double ped, 60"	\$1853
24	66	-	A2MD2466&*@^#	Credenza, Double ped, 66"	\$1898
24	72	-	A2MD2472&*@^#	Credenza, Double ped, 72"	\$2026

Apex Center Drawer & Accessories

Ordering Information:

> A freight fee of \$100 net is assessed on orders less than \$1000 net. See page 13.



D1	W1	Part Number	Description	List Price (US\$)
Metal Center Drawer, locking, 19.2"W x 17.2"D				
17.2	19.2	A2MCD^	Metal Center Drawer	\$265
Drawer Accessories				
-	-	A2PHFB	Side-to-Side File Bars for ONE File drawer (qty. 2 bars)	\$66
-	-	CTRAY-CA	Coin Tray	\$18
-	-	A2PBXD	Box Drawer Divider, Black	\$19

STEP 1

(^) Paint Suffix List

G Slate Grey
R Black
S Silver
T Medium Tone
W Arctic White
Z Other

Tip: Some Steelcase, Herman Miller, Knoll, Haworth, and Allsteel paints are available for \$350 list fee per order. Call/email for availability of specific colors. Additional custom paints (e.g. Tiger Dry Lac) must be quoted through quotes@enwork.com.

Apex Desk Shells

STEP 1

(&) Laminate Edge and Drawer Front Suffix List:

A	Standard Laminate (3mm Edge) w/ standard steel drawer fronts	no charge
F	Standard Laminate (3mm edge) w/ laminate drawer fronts (single ped)	+\$200
G	Standard Laminate (3mm edge) w/ laminate drawer fronts (double ped)	+\$400

Tip: Laminate drawer fronts require Arc pulls in step 3.

STEP 2

(*) Cable Management Option List:

N	None	no charge
C	Grommet (center, rear)	+\$18
L	Grommet (left, rear)	+\$18
R	Grommet (right, rear)	+\$18
D	Grommets (left and right, rear)	+\$36

Tip: A grommet cannot be specified over a pedestal.

STEP 3 - If Applicable

(@) Pull Suffix List:



(A) Arc

(I) Integral

STEP 4

(^) Paint Suffix List

G	Slate Grey
R	Black
S	Silver
T	Medium Tone
W	Arctic White
Z	Other

Tip: Some Steelcase, Herman Miller, Knoll, Haworth, and Allsteel paints are available for \$350 list fee per order. Call/email for availability of specific colors. Additional custom paints (e.g. Tiger Dry Lac) must be quoted through quotes@enwork.com.

STEP 5

(#) Laminate Suffix List:

A	Wilsonart Kensington Maple (10776-60)	
B	Wilsonart Monticello Maple (7925-38)	
C	Wilsonart Wild Cherry (7054-60)	
E	Wilsonart Fashion Grey (D381-60)	
F	Wilsonart White Tigris (4783-60)	
G	Wilsonart Cafelle (7933K-07)	
M	Wilsonart Frosty White (1573-60)	
P	Wilsonart Slate Grey (D91-60)	
R	Wilsonart Black (1595-60)	
U	Wilsonart Brazilwood (7946-38)	
V	Wilsonart River Cherry (7937-38)	
W	Wilsonart Designer White (D354-60)	
3	Formica Neutral Twill (8826-58)	
4	Formica Bleached Legno (8845-58)	
5	Formica Prestige Walnut (6209-43)	
7	Formica Select Cherry (7759-43)	
X	*Wilsonart Non-Premium laminates (-38, -60). Orders of 100+ units have no upcharge.	+\$36
Y	*Formica Non-Premium Standard (58, 43, MC, SP and NT finishes) and Wilsonart Premium (-01, -07, -12, -18, -52, -78) laminates.	+\$50
Z	*Pionite Non-Premium, Nevamar Non-Premium, Formica Premium (WR, 42, 77, 46, RD Finishes), and whiteboard laminate.	+\$72

*Add \$350 list for Special Laminate orders of less than 10 units. See page 21 for edge selection.

Product Specifications:

- > Desks are steel with laminate worksurface and full-height back panels.
- > Lock cores are LL Series.
- > Height is 29"

Ordering Information:

- > Peds and Center Drawers are Keyed alike.
- > Peds can have either steel or laminate fronts. See Step 1.
- > Ships assembled.
- > Desk Shells always have end panels. They also have one piece back panels. 1/2 and 3/4 height are also available at no charge. Put "Y" in front of part number for 1/2 height and "Z" for 3/4 height.
- > **A freight fee of \$100 net is assessed on orders less than \$1000 net. See page 13.**

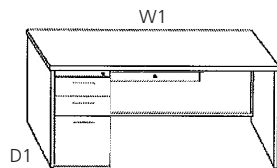

Left hand unit shown

D1 W1 O Part Number Description List Price (US\$)

Desk Shell with B/B/F Pedestal and Center Drawer, LH

24	72	LH	A2DL2472&*@^#	Desk Shell, 18"D ped, LH, 24"x72"	\$2256
30	48	LH	A2DL3048&*@^#	Desk Shell, 24"D ped, LH, 30"x48"	\$2060
30	60	LH	A2DL3060&*@^#	Desk Shell, 24"D ped, LH, 30"x60"	\$2210
30	66	LH	A2DL3066&*@^#	Desk Shell, 24"D ped, LH, 30"x66"	\$2248
30	72	LH	A2DL3072&*@^#	Desk Shell, 24"D ped, LH, 30"x72"	\$2306
36	72	LH	A2DL3672&*@^#	Desk Shell with 6" overhang, 24"D ped, LH, 36"x72"	\$2386

Desk Shell with B/B/F Pedestal and Center Drawer, RH

24	72	RH	A2DR2472&*@^#	Desk Shell, 18"D ped, RH, 24"x72"	\$2256
30	48	RH	A2DR3048&*@^#	Desk Shell, 24"D ped, RH, 30"x48"	\$2060
30	60	RH	A2DR3060&*@^#	Desk Shell, 24"D ped, RH, 30"x60"	\$2210
30	66	RH	A2DR3066&*@^#	Desk Shell, 24"D ped, RH, 30"x66"	\$2248
30	72	RH	A2DR3072&*@^#	Desk Shell, 24"D ped, RH, 30"x72"	\$2306
36	72	RH	A2DR3672&*@^#	Desk Shell with 6" overhang, 24"D ped, RH, 36"x72"	\$2386

Tip: Lower priced Ped Supported Desks are found earlier in this section. The desks on this page have end panels and full width back panels.

Tip: As of March 2015, dimensions of the Desk Shells, Return Shells, Bridges, and D-tops have changed. Previous versions will not mix.

Tip: If you want full depth peds, shells and peds must be ordered separately.

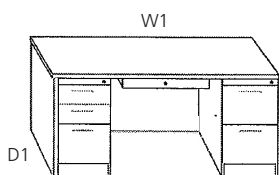

D1	W1	O	Part Number	Description	List Price (US\$)
----	----	---	-------------	-------------	-------------------

Desk Shell with 24"D B/B/F Pedestal, 24"D F/F Pedestal, and Center Drawer

30	60	-	A2E3060&*&^#	Desk Shell, Double Ped, 30"x60"	\$2733
30	66	-	A2E3066&*&^#	Desk Shell, Double Ped, 30"x66"	\$2770
30	72	-	A2E3072&*&^#	Desk Shell, Double Ped, 30"x72"	\$2832
36	72	-	A2E3672&*&^#	Desk Shell with 6" overhang ,Double Ped, 36"x72"	\$2910

Tip: As of March 2015, dimensions of the Desk Shells, Return Shells, Bridges, and D-tops have changed. Previous versions will not mix.

Tip: If you want full depth peds, shells and peds must be ordered separately.

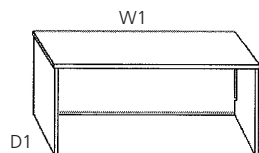
Desk Shell (no drawer), 24"D and 30"D

24	48	-	A2T2448&*&^#	Desk Shell, 24"x48"	\$1072
24	60	-	A2T2460&*&^#	Desk Shell, 24"x60"	\$1175
24	66	-	A2T2466&*&^#	Desk Shell, 24"x66"	\$1234
24	72	-	A2T2472&*&^#	Desk Shell, 24"x72"	\$1323
30	48	-	A2T3048&*&^#	Desk Shell, 30"x48"	\$1157
30	60	-	A2T3060&*&^#	Desk Shell, 30"x60"	\$1306
30	66	-	A2T3066&*&^#	Desk Shell, 30"x66"	\$1341
30	72	-	A2T3072&*&^#	Desk Shell, 30"x72"	\$1401
36	72	-	A2T3672&*&^#	Desk Shell with 6" overhang, 36"x72"	\$1481

Tip: Lower priced Ped Supported Desks are found earlier in this section.

Tip: The desks on this page have end panels and full width back panels.

Tip: As of March 2015, dimensions of the Desk Shells, Return Shells, Bridges, and D-tops have changed. Previous versions will not mix.

Apex Desk Shells

STEP 1

(&) Laminate Edge and Drawer Front Suffix List:

- A Standard Laminate (3mm Edge) no charge w/ standard steel drawer fronts
 F Standard Laminate (3mm edge) +\$200 w/ laminate drawer fronts (single ped)
 G Standard Laminate (3mm edge) +\$400 w/ laminate drawer fronts (double ped)

Tip: Laminate drawer fronts require Arc pulls in step 3.

STEP 2

(*) Cable Management Option List:

- N None no charge
 C Grommet (center, rear) +\$18
 L Grommet (left, rear) +\$18
 R Grommet (right, rear) +\$18
 D Grommets (left and right, rear) +\$36

Tip: A grommet cannot be specified over a pedestal.

STEP 3 - If Applicable

(@) Pull Suffix List:



(A) Arc



(I) Integral

STEP 4

(^) Paint Suffix List

- G Slate Grey
 R Black
 S Silver
 T Medium Tone
 W Arctic White
 Z Other

Tip: Some Steelcase, Herman Miller, Knoll, Haworth, and Allsteel paints are available for \$350 list fee per order. Call/email for availability of specific colors. Additional custom paints (e.g. Tiger Dry Lac) must be quoted through quotes@enwork.com.

STEP 5

(#) Laminate Suffix List:

- A Wilsonart Kensington Maple (10776-60)
 B Wilsonart Monticello Maple (7925-38)
 C Wilsonart Wild Cherry (7054-60)
 E Wilsonart Fashion Grey (D381-60)
 F Wilsonart White Tigris (4783-60)
 G Wilsonart Cafelle (7933K-07)
 M Wilsonart Frosty White (1573-60)
 P Wilsonart Slate Grey (D91-60)
 R Wilsonart Black (1595-60)
 U Wilsonart Brazilwood (7946-38)
 V Wilsonart River Cherry (7937-38)
 W Wilsonart Designer White (D354-60)
 3 Formica Neutral Twill (8826-58)
 4 Formica Bleached Legno (8845-58)
 5 Formica Prestige Walnut (6209-43)
 7 Formica Select Cherry (7759-43)
 X *Wilsonart Non-Premium laminates (-38, -60). Orders of 100+ units have no upcharge. +\$36
 Y *Formica Non-Premium Standard (58, 43, MC, SP and NT finishes) and Wilsonart Premium (-01, -07, -12, -18, -52, -78) laminates. +\$50
 Z *Pionite Non-Premium, Nevamar Non-Premium, Formica Premium (WR, 42, 77, 46, RD Finishes), and whiteboard laminate. +\$72

*Add \$350 list for Special Laminate orders of less than 10 units. See page 21 for edge selection.

Product Specifications:

- > Desks are steel with laminate worksurface and full-height back panels.
- > Lock cores are LL Series.
- > Height is 29"

Ordering Information:

- > 1/2 height back panels are available (no charge). Add "Y" in front of part number. 3/4 height back panels are also available (no charge). Add "Z" in front of part number.
- > Peds can have either steel or laminate fronts. See Step 1.
- > Peds and Center Drawers are Keyed alike.
- > Ships assembled.
- > **When ordering peds for shells drop down a size (e.g. put 18"D peds into 24"D shells).**
- > **A freight fee of \$100 net is assessed on orders less than \$1000 net. See page 13.**

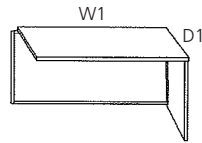

Right hand unit shown

D1	W1	O	Part Number	Description	List Price (US\$)
----	----	---	-------------	-------------	-------------------

Return Shells, 24"D

24	36	LH	A2HL2436&*^#	Return Shell LH, 36"	\$912
24	42	LH	A2HL2442&*^#	Return Shell LH, 42"	\$912
24	48	LH	A2HL2448&*^#	Return Shell LH, 48"	\$939
24	36	RH	A2HR2436&*^#	Return Shell, RH, 36"	\$912
24	42	RH	A2HR2442&*^#	Return Shell, RH, 42"	\$912
24	48	RH	A2HR2448&*^#	Return Shell, RH, 48"	\$939

Tip: Returns are intended to be used with 66" and 72" desks. Center drawers will be partially covered by return worksurface on 60" and smaller desk widths.

Tip: As of March 2015, dimensions of the Desk Shells, Return Shells, Bridges, and D-tops have changed. Previous versions will not mix.

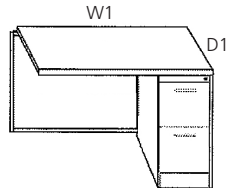

Right hand unit shown

Return Shells, 24"D with 18"D F/F Pedestal

24	36	LH	A2KL2436&*@^#	Return Shell with ped, LH, 36"	\$1438
24	42	LH	A2KL2442&*@^#	Return Shell with ped, LH, 42"	\$1438
24	48	LH	A2KL2448&*@^#	Return Shell with ped, LH, 48"	\$1465
24	36	RH	A2KR2436&*@^#	Return Shell with ped, RH, 36"	\$1438
24	42	RH	A2KR2442&*@^#	Return Shell with ped, RH, 42"	\$1438
24	48	RH	A2KR2448&*@^#	Return Shell with ped, RH, 48"	\$1465

Tip: Returns are intended to be used with 66" and 72" desks. Center drawers will be partially covered by return worksurface on 60" and smaller desk widths.

Tip: As of March 2015, dimensions of the Desk Shells, Return Shells, Bridges, and D-tops have changed. Previous versions will not mix.

Tip: If you want full depth peds, shells and peds must be ordered separately.

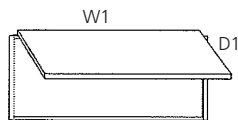

Bridges, 24"D

24	42	-	A2BR2442&*^#	Bridge, 42"	\$740
24	48	-	A2BR2448&*^#	Bridge, 48"	\$780

Tip: Grommet specified in Step 2.

Tip: Bridge cannot connect to ped, only end panel.

Tip: As of March 2015, dimensions of the Desk Shells, Return Shells, Bridges, and D-tops have changed. Previous versions will not mix.

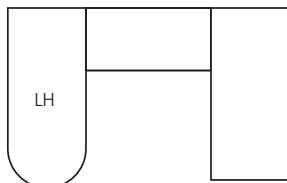

D-Top Left-Handed Application

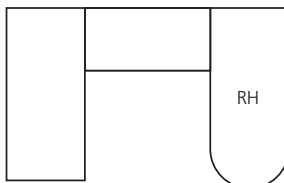

D-Top Right-Handed Application

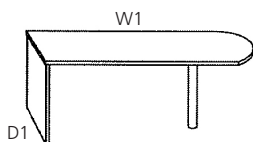

D1	W1	O	Part Number	Description	List Price (US\$)
----	----	---	-------------	-------------	-------------------

D-Top Desks, 30"D

30	48	-	A2L3048&*&#	D-Top Desk, 48"	\$1241
30	60	-	A2L3060&*&#	D-Top Desk, 60"	\$1314
30	66	-	A2L3066&*&#	D-Top Desk, 66"	\$1366
30	72	-	A2L3072&*&#	D-Top Desk, 72"	\$1476

Tip: Attaches to return or bridge to form a "U" station

Tip: As of March 2015, dimensions of the Desk Shells, Return Shells, Bridges, and D-tops have changed. Previous versions will not mix.

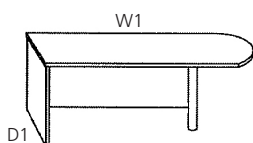
**D-Top Desks with 3/4 Modesty, 30"D**

30	48	-	A2JR3048&*&#	D-Top Desk with 3/4 modesty, RH, 48"	\$1319
30	60	-	A2JR3060&*&#	D-Top Desk with 3/4 modesty, RH, 60"	\$1405
30	66	-	A2JR3066&*&#	D-Top Desk with 3/4 modesty, RH, 66"	\$1474
30	72	-	A2JR3072&*&#	D-Top Desk with 3/4 modesty, RH, 72"	\$1599
30	48	-	A2JL3048&*&#	D-Top Desk with 3/4 modesty, LH, 48"	\$1319
30	60	-	A2JL3060&*&#	D-Top Desk with 3/4 modesty, LH, 60"	\$1405
30	66	-	A2JL3066&*&#	D-Top Desk with 3/4 modesty, LH, 66"	\$1474
30	72	-	A2JL3072&*&#	D-Top Desk with 3/4 modesty, LH, 72"	\$1599

Tip: Attaches to return or bridge to form a "U" station

Tip: Can be reconfigured between LH and RH in field.

Tip: As of March 2015, dimensions of the Desk Shells, Return Shells, Bridges, and D-tops have changed. Previous versions will not mix.

Full-Height Back Panels (Component Part)

-	60	-	A2ZBP260^	Back Panel for use on 2 Ped Desks, 60"W	\$161
-	66	-	A2ZBP266^	Back Panel for use on 2 Ped Desks, 66"W	\$189
-	72	-	A2ZBP272^	Back Panel for use on 2 Ped Desks, 72"W	\$210
-	60	-	A2ZBP160^	Back Panel for use on 1 Ped Desk, 60"W	\$223
-	66	-	A2ZBP166^	Back Panel for use on 1 Ped Desk, 66"W	\$250
-	72	-	A2ZBP172^	Back Panel for use on 1 Ped Desk, 72"W	\$277
-	36	-	A2ZRP136^	Back Panel for use on 1 Ped Return, 36"W	\$142
-	42	-	A2ZRP142^	Back Panel for use on 1 Ped Return, 42"W	\$161
-	48	-	A2ZRP148^	Back Panel for use on 1 Ped Return, 48"W	\$182

Tip: 1/2 height back panels are available (no charge). Add "Y" in front of part number. 3/4 height back panels are also available (no charge). Add "Z" in front of part number.

End Panel (Component Part)

24	-	-	A2ZEP24^	Apex End Panel, 24"D	\$184
30	-	-	A2ZEP30^	Apex End Panel, 30"D	\$216



A large, stylized graphic of a leaf or petal, rendered in a lighter shade of olive green, occupies the left and bottom portions of the page. It has a smooth, organic shape with a pointed tip and a rounded base.

Affinity™

Affinity™ Overview

Full Desks

Rectangular

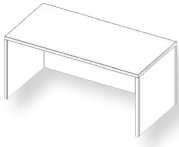

Bow



Wave

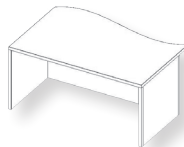

Return Shells

Rectangle

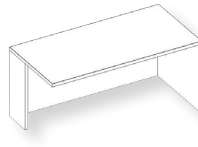

Transition



Visitor



Conference Shells

Jetty

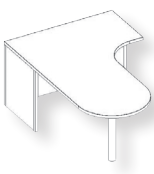

"P"

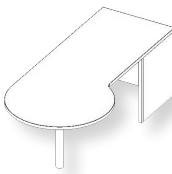

Angled

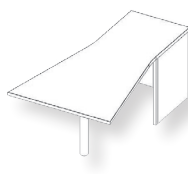

"D-Top"



Crowned Rectangle

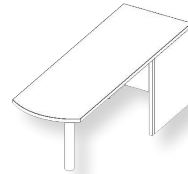

Straight Base Desk Shell

Bridge Shell A

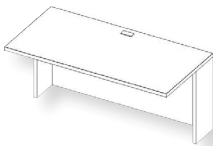

Bridge Shell B

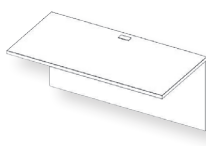

Corner Shells

Curved Corner

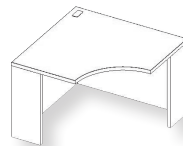

Extended Curved Corner

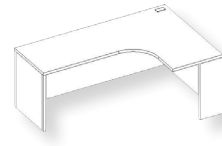

Reception Shells

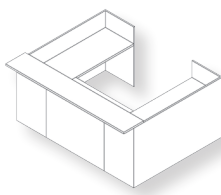
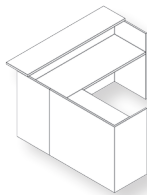
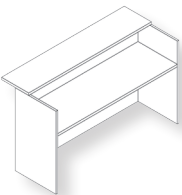

Other Supports

L Panel

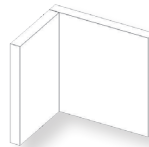

T Panel

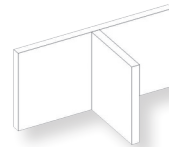

Designer Series Hutches

Rectangular Doors

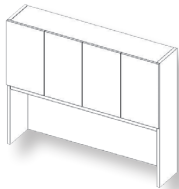

Cubby Hutch

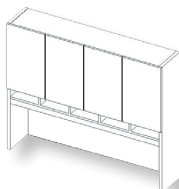

Aluminum with Frosted Glass

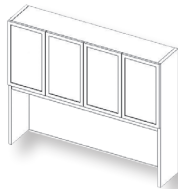

Other Hutch Components

Wall Mount

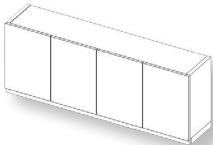

Product Specifications:

- Corners and bridge shells come standard with oval-shaped grommets. Additional grommets can be requested for a charge of \$36 list per grommet.
- Hutches offer cable management between the hutch back panel and the worksurface.
- Full depth, full extension ball bearing sides
- High quality cam lock and dowel construction
- 110 degree hinges included on overhead storage
- Adjustable door hinges
- Keyed alike
- 3mm edge/1mm on some parts

Pedestals

File-File



Box-Box-File



Mobile-Box-File



Double Door Cabinets

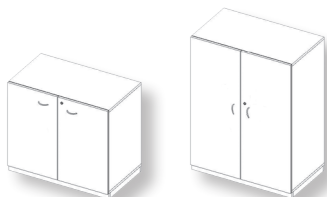

Laterals



Combination Cabinets

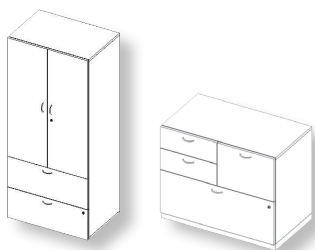

Towers

Wardrobe Tower with Storage Door

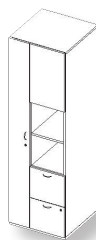

Wardrobe Tower with Side-Access

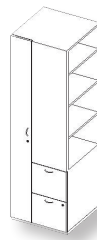

Vertical Tower

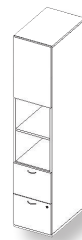

Corner Cabinets

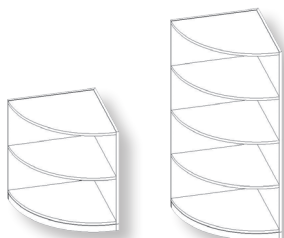

Bookcases

2-High



3-High



4-High



5-High

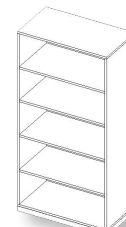

6-High

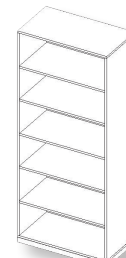

Affinity Modular Desk Shells

STEP 1

(&) Back Panel Suffix List:

- F Full Height Back Panel
- T Three-Quarter Height Back Panel
- E Short Back Panel (for outlet access)

STEP 2

(*) Cable Management Option List:

- N None no charge
- C Grommet (center, rear) +\$18
- L Grommet (left, rear) +\$18
- R Grommet (right, rear) +\$18

Tip: A grommet cannot be specified over a pedestal.

STEP 3

(#) Worksurface Laminate Suffix List:

- A Wilsonart Kensington Maple (10776-60)
- B Wilsonart Monticello Maple (7925-38)
- C Wilsonart Wild Cherry (7054-60)
- E Wilsonart Fashion Grey (D381-60)
- F Wilsonart White Tigris (4783-60)
- G Wilsonart Cafelle (7933K-07)
- M Wilsonart Frosty White (1573-60)
- P Wilsonart Slate Grey (D91-60)
- R Wilsonart Black (1595-60)
- U Wilsonart Brazilwood (7946-38)
- V Wilsonart River Cherry (7937-38)
- W Wilsonart Designer White (D354-60)
- 3 Formica Neutral Twill (8826-58)
- 4 Formica Bleached Legno (8845-58)
- 5 Formica Prestige Walnut (6209-43)
- 7 Formica Select Cherry (7759-43)
- X *Wilsonart Non-Premium laminates (-38, -60).
- Y *Formica Non-Premium (includes 58, 43, MC, SP, and NT finishes), Formica Premium (WR, 42, 77, 46, RD finishes), Pionite Non-Premium, Nevamar Non-Premium, Wilsonart Premium (-01, -07, -12, -18, -52, -78), and whiteboard laminate.

*Add \$350 list for Special Laminate orders of less than 10 units. See page 21 for edge selection.

STEP 4

(@) Casegood (Shell) Laminate Suffix List:

- A Wilsonart Kensington Maple (10776-60) no charge
- B Wilsonart Monticello Maple (7925-38) no charge
- C Wilsonart Wild Cherry (7054-60) no charge
- E Wilsonart Fashion Grey (D381-60) no charge
- G Wilsonart Cafelle (7933K-07) no charge
- M Wilsonart Frosty White (1573-60) no charge
- P Wilsonart Slate Grey (D91-60) no charge
- R Wilsonart Black (1595-60) no charge
- U Wilsonart Brazilwood (7946-38) no charge
- V Wilsonart River Cherry (7937-38) no charge
- W Wilsonart Designer White (D354-60) no charge
- 3 Formica Neutral Twill (8826-58) no charge
- 4 Formica Bleached Legno (8845-58) no charge
- 5 Formica Prestige Walnut (6209-43) no charge
- 7 Formica Select Cherry (7759-43) no charge
- X *Wilsonart Non-Premium laminates (-38, -60) +35%
- Y *Formica Non-Premium (includes 58, 43, 58, 43, MC, SP, and NT finishes), Formica Premium (WR, 42, 77, 46, RD finishes), Pionite Non-Premium, Nevamar Non-Premium, Wilsonart Premium (-01, -07, -12, -18, -52, -78), and whiteboard laminate. +45%

*Add \$350 list for Special Laminate orders of less than 10 units. See page 21 for edge selection.

Product Specifications:

- > 3mm Edge
- > Height is 29"

Ordering Information:

- > Ships KD
- > A freight fee of \$100 is assessed on orders less than \$1000 net. See page 13.

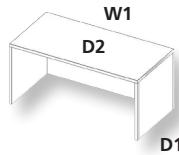

Rectangular

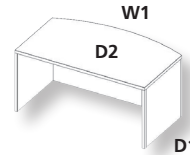

Bow

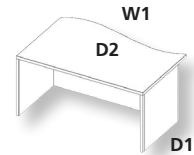

Wave

D1	D2	W1	Part Number	Description	List Price (US\$)
----	----	----	-------------	-------------	-------------------

Rectangle Desk Shells, 24"D

24	24	48	DAA2448&*#@	Rectangle Desk Shell, 24"x48"	\$957
24	24	60	DAA2460&*#@	Rectangle Desk Shell, 24"x60"	\$1033
24	24	66	DAA2466&*#@	Rectangle Desk Shell, 24"x66"	\$1113
24	24	72	DAA2472&*#@	Rectangle Desk Shell, 24"x72"	\$1113
24	24	84	DAA2484&*#@	Rectangle Desk Shell, 24"x84"	\$1443
24	24	96	DAA2496&*#@	Rectangle Desk Shell, 24"x96"	\$1443

Rectangle Desk Shells, 30"D

30	30	48	DAA3048&*#@	Rectangle Desk Shell, 30"x48"	\$1064
30	30	60	DAA3060&*#@	Rectangle Desk Shell, 30"x60"	\$1154
30	30	66	DAA3066&*#@	Rectangle Desk Shell, 30"x66"	\$1244
30	30	72	DAA3072&*#@	Rectangle Desk Shell, 30"x72"	\$1244
30	30	84	DAA3084&*#@	Rectangle Desk Shell, 30"x84"	\$1488
30	30	96	DAA3096&*#@	Rectangle Desk Shell, 30"x96"	\$1488

Rectangle Desk Shells, 36"D

30	36	48	DAA3648&*#@	Rectangle Desk Shell, 30"x48" shell w/ 6" overhang, 36"x48"	\$1200
30	36	60	DAA3660&*#@	Rectangle Desk Shell, 30"x60" shell w/ 6" overhang, 36"x60"	\$1297
30	36	66	DAA3666&*#@	Rectangle Desk Shell, 30"x66" shell w/ 6" overhang, 36"x66"	\$1400
30	36	72	DAA3672&*#@	Rectangle Desk Shell, 30"x72" shell w/ 6" overhang, 36"x72"	\$1400

Bow Front Desk Shells, 24"D

24	30	48	DAB2448&*#@	Bow Front Desk Shell, 24"x48" shell w/ 6" overhang, 30"x48"	\$1146
24	30	60	DAB2460&*#@	Bow Front Desk Shell, 24"x60" shell w/ 6" overhang, 30"x60"	\$1248
24	30	72	DAB2472&*#@	Bow Front Desk Shell, 24"x72" shell w/ 6" overhang, 30"x72"	\$1356

Bow Front Desk Shells, 30"D

30	36	48	DAB3048&*#@	Bow Front Desk Shell, 30"x48" shell w/ 6" overhang, 36"x48"	\$1262
30	36	60	DAB3060&*#@	Bow Front Desk Shell, 30"x60" shell w/ 6" overhang, 36"x60"	\$1423
30	36	72	DAB3072&*#@	Bow Front Desk Shell, 30"x72" shell w/ 6" overhang, 36"x72"	\$1535

Wave Front Desk Shells, 36"D

30	36	60	DAC3060&*#@	Wave Front Desk Shell, 30"x60" shell w/ 6" overhang, 36"x60"	\$1423
30	36	72	DAC3072&*#@	Wave Front Desk Shell, 30"x72" shell w/ 6" overhang, 36"x72"	\$1535

Affinity Return Shells

Product Specifications:

- > 3mm Edge
- > Height is 29"

Ordering Information:

- > Extended Curved Corner Shells include a corner grommet. Select grommets for Rectangle and Transition Shells in Step 4.
- > Standard grain direction runs left to right. To specify front to back (matching) grain direction on return or bridge shells contact quotes@enwork.com.
- > A freight fee of \$100 is assessed on orders less than \$1000 net. See page 13.

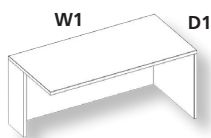

Rectangle

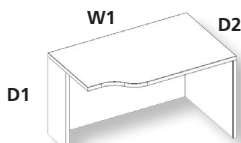

Transition RH
(LH opposite)

D1	D2	W1	O	Part Number	Description	List Price (US\$)
Rectangle Return Shells, 24"D, RH						
24	-	30	RH	DCAR2430&#amp;#@*	Rectangle Return Shell, RH, 24"x30"	\$722
24	-	36	RH	DCAR2436&#amp;#@*	Rectangle Return Shell, RH, 24"x36"	\$765
24	-	42	RH	DCAR2442&#amp;#@*	Rectangle Return Shell, RH, 24"x42"	\$824
24	-	48	RH	DCAR2448&#amp;#@*	Rectangle Return Shell, RH, 24"x48"	\$859
24	-	60	RH	DCAR2460&#amp;#@*	Rectangle Return Shell, RH, 24"x60"	\$944
Rectangle Return Shells, 30"D, RH						
30	-	30	RH	DCAR3030&#amp;#@*	Rectangle Return Shell, RH, 30"x30"	\$795
30	-	36	RH	DCAR3036&#amp;#@*	Rectangle Return Shell, RH, 30"x36"	\$829
30	-	42	RH	DCAR3042&#amp;#@*	Rectangle Return Shell, RH, 30"x42"	\$896
30	-	48	RH	DCAR3048&#amp;#@*	Rectangle Return Shell, RH, 30"x48"	\$938
30	-	60	RH	DCAR3060&#amp;#@*	Rectangle Return Shell, RH, 30"x60"	\$1029
Rectangle Return Shells, 24"D, LH						
24	-	30	LH	DCAL2430&#amp;#@*	Rectangle Return Shell, LH, 24"x30"	\$722
24	-	36	LH	DCAL2436&#amp;#@*	Rectangle Return Shell, LH, 24"x36"	\$765
24	-	42	LH	DCAL2442&#amp;#@*	Rectangle Return Shell, LH, 24"x42"	\$824
24	-	48	LH	DCAL2448&#amp;#@*	Rectangle Return Shell, LH, 24"x48"	\$859
24	-	60	LH	DCAL2460&#amp;#@*	Rectangle Return Shell, LH, 24"x60"	\$944
Rectangle Return Shells, 30"D, LH						
30	-	30	LH	DCAL3030&#amp;#@*	Rectangle Return Shell, LH, 30"x30"	\$795
30	-	36	LH	DCAL3036&#amp;#@*	Rectangle Return Shell, LH, 30"x36"	\$829
30	-	42	LH	DCAL3042&#amp;#@*	Rectangle Return Shell, LH, 30"x42"	\$896
30	-	48	LH	DCAL3048&#amp;#@*	Rectangle Return Shell, LH, 30"x48"	\$938
30	-	60	LH	DCAL3060&#amp;#@*	Rectangle Return Shell, LH, 30"x60"	\$1029
Transition Return Shells, RH						
24	30	30	RH	DCB2430&#amp;#@*	Transition Return Shell, RH, 24"x30"x30"	\$722
24	30	36	RH	DCB2436&#amp;#@*	Transition Return Shell, RH, 24"x30"x36"	\$765
24	30	42	RH	DCB2442&#amp;#@*	Transition Return Shell, RH, 24"x30"x42"	\$824
24	30	48	RH	DCB2448&#amp;#@*	Transition Return Shell, RH, 24"x30"x48"	\$859
24	30	60	RH	DCB2460&#amp;#@*	Transition Return Shell, RH, 24"x30"x60"	\$944
Transition Return Shells, LH						
30	24	30	LH	DCB3030&#amp;#@*	Transition Return Shell, LH, 30"x24"x30"	\$722
30	24	36	LH	DCB3036&#amp;#@*	Transition Return Shell, LH, 30"x24"x36"	\$765
30	24	42	LH	DCB3042&#amp;#@*	Transition Return Shell, LH, 30"x24"x42"	\$824
30	24	48	LH	DCB3048&#amp;#@*	Transition Return Shell, LH, 30"x24"x48"	\$859
30	24	60	LH	DCB3060&#amp;#@*	Transition Return Shell, LH, 30"x24"x60"	\$944

STEP 1

(&) Back Panel Suffix List:

- F Full Height Back Panel
- T Three-Quarter Height Back Panel
- E Short Back Panel (for outlet access)

STEP 2

(#) Worksurface Laminate Suffix List:

- A Wilsonart Kensington Maple (10776-60)
- B Wilsonart Monticello Maple (7925-38)
- C Wilsonart Wild Cherry (7054-60)
- E Wilsonart Fashion Grey (D381-60)
- F Wilsonart White Tigris (4783-60)
- G Wilsonart Cafelle (7933K-07)
- M Wilsonart Frosty White (1573-60)
- P Wilsonart Slate Grey (D91-60)
- R Wilsonart Black (1595-60)
- U Wilsonart Brazilwood (7946-38)
- V Wilsonart River Cherry (7937-38)
- W Wilsonart Designer White (D354-60)
- 3 Formica Neutral Twill (8826-58)
- 4 Formica Bleached Legno (8845-58)
- 5 Formica Prestige Walnut (6209-43)
- 7 Formica Select Cherry (7759-43)
- X *Wilsonart Non-Premium laminates (-38, -60).
- Y *Formica Non-Premium (includes 58, 43, MC, SP, and NT finishes), Formica Premium (WR, 42, 77, 46, RD finishes), Pionite Non-Premium, Nevamar Non-Premium, Wilsonart Premium (-01, -07, -12, -18, -52, -78), and whiteboard laminate.

*Add \$350 list for Special Laminate orders of less than 10 units. See page 21 for edge selection.

STEP 3

(@) Casegood (Shell) Laminate Suffix List:

- A Wilsonart Kensington Maple (10776-60) no charge
- B Wilsonart Monticello Maple (7925-38) no charge
- C Wilsonart Wild Cherry (7054-60) no charge
- E Wilsonart Fashion Grey (D381-60) no charge
- G Wilsonart Cafelle (7933K-07) no charge
- M Wilsonart Frosty White (1573-60) no charge
- P Wilsonart Slate Grey (D91-60) no charge
- R Wilsonart Black (1595-60) no charge
- U Wilsonart Brazilwood (7946-38) no charge
- V Wilsonart River Cherry (7937-38) no charge
- W Wilsonart Designer White (D354-60) no charge
- 3 Formica Neutral Twill (8826-58) no charge
- 4 Formica Bleached Legno (8845-58) no charge
- 5 Formica Prestige Walnut (6209-43) no charge
- 7 Formica Select Cherry (7759-43) no charge
- X *Wilsonart Non-Premium laminates (-38, -60) +35%
- Y *Formica Non-Premium (includes 58, 43, MC, SP, and NT finishes), Formica Premium (WR, 42, 77, 46, RD finishes), Pionite Non-Premium, Nevamar Non-Premium, Wilsonart Premium (-01, -07, -12, -18, -52, -78), and whiteboard laminate

*Add \$350 list for Special Laminate orders of less than 10 units. See page 21 for edge selection.

STEP 4

(*) Cable Management Option List:

- N None no charge
- C Grommet (center, rear) +\$18
- L Grommet (left, rear) +\$18
- R Grommet (right, rear) +\$18

Tip: A grommet cannot be specified over a pedestal.

Affinity Modular Desk Shells

STEP 1

(&) Back Panel Suffix List:

- F Full Height Back Panel
- T Three-Quarter Height Back Panel
- E Short Back Panel (for outlet access)

STEP 2

(#) Worksurface Laminate Suffix List:

- A Wilsonart Kensington Maple (10776-60)
- B Wilsonart Monticello Maple (7925-38)
- C Wilsonart Wild Cherry (7054-60)
- E Wilsonart Fashion Grey (D381-60)
- F Wilsonart White Tigris (4783-60)
- G Wilsonart Cafelle (7933K-07)
- M Wilsonart Frosty White (1573-60)
- P Wilsonart Slate Grey (D91-60)
- R Wilsonart Black (1595-60)
- U Wilsonart Brazilwood (7946-38)
- V Wilsonart River Cherry (7937-38)
- W Wilsonart Designer White (D354-60)
- 3 Formica Neutral Twill (8826-58)
- 4 Formica Bleached Legno (8845-58)
- 5 Formica Prestige Walnut (6209-43)
- 7 Formica Select Cherry (7759-43)
- X *Wilsonart Non-Premium laminates (-38, -60).
- Y *Formica Non-Premium (includes 58, 43, MC, SP, and NT finishes), Formica Premium (WR, 42, 77, 46, RD finishes), Pionite Non-Premium, Nevamar Non-Premium, Wilsonart Premium (-01, -07, -12, -18, -52, -78), and whiteboard laminate.

*Add \$350 list for Special Laminate orders of less than 10 units. See page 21 for edge selection.

STEP 3

(@) Casegood (Shell) Laminate Suffix List:

- A Wilsonart Kensington Maple (10776-60) no charge
- B Wilsonart Monticello Maple (7925-38) no charge
- C Wilsonart Wild Cherry (7054-60) no charge
- E Wilsonart Fashion Grey (D381-60) no charge
- G Wilsonart Cafelle (7933K-07) no charge
- M Wilsonart Frosty White (1573-60) no charge
- P Wilsonart Slate Grey (D91-60) no charge
- R Wilsonart Black (1595-60) no charge
- U Wilsonart Brazilwood (7946-38) no charge
- V Wilsonart River Cherry (7937-38) no charge
- W Wilsonart Designer White (D354-60) no charge
- 3 Formica Neutral Twill (8826-58) no charge
- 4 Formica Bleached Legno (8845-58) no charge
- 5 Formica Prestige Walnut (6209-43) no charge
- 7 Formica Select Cherry (7759-43) no charge
- X *Wilsonart Non-Premium laminates (-38, -60) +35%
- Y *Formica Non-Premium (includes 58, 43, MC, SP, and NT finishes), Formica Premium (WR, 42, 77, 46, RD finishes), Pionite Non-Premium, Nevamar Non-Premium, Wilsonart Premium (-01, -07, -12, -18, -52, -78), and whiteboard laminate

*Add \$350 list for Special Laminate orders of less than 10 units. See page 21 for edge selection.

STEP 4 - Jetty Only

(^*) Leg Finish Suffix List:

- G Slate Grey
- R Black
- S Silver
- T Medium Tone
- W Arctic White
- Z Other

Tip: Some Steelcase, Herman Miller, Knoll, Haworth, and Allsteel paints are available for \$350 list fee per order. Call/email for availability of specific colors. Additional custom paints (e.g. Tiger Dry Lac) must be quoted through quotes@enwork.com.

Product Specifications:

- > 3mm Edge
- > Height is 29"

Ordering Information:

- > Ships KD
- > A freight fee of \$100 is assessed on orders less than \$1000 net. See page 13.

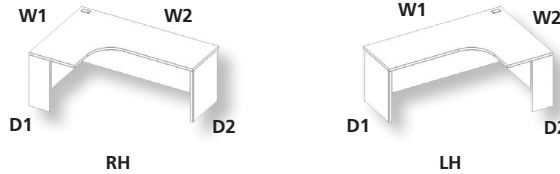

D1	D2	W1	W2	O	Part Number	Description	List Price (US\$)
----	----	----	----	---	-------------	-------------	-------------------

Extended Curved Corner Desk Shells, 36"x 60", RH

24	24	36	60	RH	DDA223660&#@	Ext. Curved Corner Shell, RH, 24"x24"x36"x60"	\$1304
24	30	36	60	RH	DDA233660&#@	Ext. Curved Corner Shell, RH, 24"x30"x36"x60"	\$1339
30	24	36	60	RH	DDA323660&#@	Ext. Curved Corner Shell, RH, 30"x24"x36"x60"	\$1304
30	30	36	60	RH	DDA333660&#@	Ext. Curved Corner Shell, RH, 30"x30"x36"x60"	\$1339

Extended Curved Corner Desk Shells, 36"x 72", RH

24	24	36	72	RH	DDA223672&#@	Ext. Curved Corner Shell, RH, 24"x24"x36"x72"	\$1411
24	30	36	72	RH	DDA233672&#@	Ext. Curved Corner Shell, RH, 24"x30"x36"x72"	\$1441
30	24	36	72	RH	DDA323672&#@	Ext. Curved Corner Shell, RH, 30"x24"x36"x72"	\$1411
30	30	36	72	RH	DDA333672&#@	Ext. Curved Corner Shell, RH, 30"x30"x36"x72"	\$1441

Extended Curved Corner Desk Shells, 48"x 60", RH

24	24	48	60	RH	DDA224860&#@	Ext. Curved Corner Shell, RH, 24"x24"x48"x60"	\$1453
24	30	48	60	RH	DDA234860&#@	Ext. Curved Corner Shell, RH, 24"x30"x48"x60"	\$1488
30	24	48	60	RH	DDA324860&#@	Ext. Curved Corner Shell, RH, 30"x24"x48"x60"	\$1453
30	30	48	60	RH	DDA334860&#@	Ext. Curved Corner Shell, RH, 30"x30"x48"x60"	\$1488

Extended Curved Corner Desk Shells, 48"x 72", RH

24	24	48	72	RH	DDA224872&#@	Ext. Curved Corner Shell, RH, 24"x24"x48"x72"	\$1579
24	30	48	72	RH	DDA234872&#@	Ext. Curved Corner Shell, RH, 24"x30"x48"x72"	\$1615
30	24	48	72	RH	DDA324872&#@	Ext. Curved Corner Shell, RH, 30"x24"x48"x72"	\$1579
30	30	48	72	RH	DDA334872&#@	Ext. Curved Corner Shell, RH, 30"x30"x48"x72"	\$1615

Extended Curved Corner Desk Shells, 60"x36", LH

24	24	60	36	LH	DDA226036&#@	Ext. Curved Corner Shell, LH, 24"x24"x60"x36"	\$1304
24	30	60	36	LH	DDA236036&#@	Ext. Curved Corner Shell, LH, 24"x30"x60"x36"	\$1339
30	24	60	36	LH	DDA326036&#@	Ext. Curved Corner Shell, LH, 30"x24"x60"x36"	\$1304
30	30	60	36	LH	DDA336036&#@	Ext. Curved Corner Shell, LH, 30"x30"x60"x36"	\$1339

Extended Curved Corner Desk Shells, 72"x36", LH

24	24	72	36	LH	DDA227236&#@	Ext. Curved Corner Shell, LH, 24"x24"x72"x36"	\$1411
24	30	72	36	LH	DDA237236&#@	Ext. Curved Corner Shell, LH, 24"x30"x72"x36"	\$1441
30	24	72	36	LH	DDA327236&#@	Ext. Curved Corner Shell, LH, 30"x24"x72"x36"	\$1411
30	30	72	36	LH	DDA337236&#@	Ext. Curved Corner Shell, LH, 30"x30"x72"x36"	\$1441

Extended Curved Corner Desk Shells, 60"x48", LH

24	24	60	48	LH	DDA226048&#@	Ext. Curved Corner Shell, LH, 24"x24"x60"x48"	\$1453
24	30	60	48	LH	DDA236048&#@	Ext. Curved Corner Shell, LH, 24"x30"x60"x48"	\$1488
30	24	60	48	LH	DDA326048&#@	Ext. Curved Corner Shell, LH, 30"x24"x60"x48"	\$1453
30	30	60	48	LH	DDA336048&#@	Ext. Curved Corner Shell, LH, 30"x30"x60"x48"	\$1488

Extended Curved Corner Desk Shells, 72"x48", LH

24	24	72	48	LH	DDA227248&#@	Ext. Curved Corner Shell, LH, 24"x24"x72"x48"	\$1579
24	30	72	48	LH	DDA237248&#@	Ext. Curved Corner Shell, LH, 24"x30"x72"x48"	\$1615
30	24	72	48	LH	DDA327248&#@	Ext. Curved Corner Shell, LH, 30"x24"x72"x48"	\$1579
30	30	72	48	LH	DDA337248&#@	Ext. Curved Corner Shell, LH, 30"x30"x72"x48"	\$1615

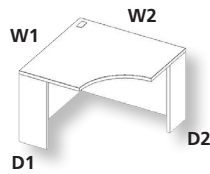

Curved

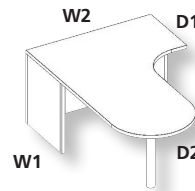
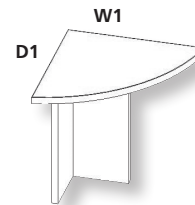
Jetty LH
(RH opposite)

Visitor

D1	D2	W1	W2	O	Part Number	Description	List Price (US\$)
Curved Corner Desk Shells							
24	24	36	36	-	DBA223636&#@	Curved Corner Desk Shell, 24"x24"x36"x36"	\$1029
24	30	36	36	-	DBA233636&#@	Curved Corner Desk Shell, 24"x30"x36"x36"	\$1029
30	24	36	36	-	DBA323636&#@	Curved Corner Desk Shell, 30"x24"x36"x36"	\$1029
24	24	42	42	-	DBA224242&#@	Curved Corner Desk Shell, 24"x24"x42"x42"	\$1124
24	30	42	42	-	DBA234242&#@	Curved Corner Desk Shell, 24"x30"x42"x42"	\$1124
30	24	42	42	-	DBA324242&#@	Curved Corner Desk Shell, 30"x24"x42"x42"	\$1124
30	30	42	42	-	DBA334242&#@	Curved Corner Desk Shell, 30"x30"x42"x42"	\$1124
24	24	48	48	-	DBA224848&#@	Curved Corner Desk Shell, 24"x24"x48"x48"	\$1237
24	30	48	48	-	DBA234848&#@	Curved Corner Desk Shell, 24"x30"x48"x48"	\$1237
30	24	48	48	-	DBA324848&#@	Curved Corner Desk Shell, 30"x24"x48"x48"	\$1237
30	30	48	48	-	DBA334848&#@	Curved Corner Desk Shell, 30"x30"x48"x48"	\$1237
Jetty Conference Shells							
24	30	48	72	RH	DEA234872&#@^	Jetty Conference Shell, RH 24"x30"x48"x72"	\$1279
30	30	48	72	RH	DEA334872&#@^	Jetty Conference Shell, RH 30"x30"x48"x72"	\$1352
24	30	72	48	LH	DEA327248&#@^	Jetty Conference Shell, LH 30"x24"x72"x48"	\$1279
30	30	72	48	LH	DEA337248&#@^	Jetty Conference Shell, LH 30"x30"x72"x48"	\$1352
120 Visitor Shell							
24	-	24	-	-	DJB2424&#@	120 Visitor Shell, 24"x24"	\$442

Affinity Modular Conference Shells

STEP 1

(&) Back Panel Suffix List:

- F *Full Height Back Panel
- T Three-Quarter Height Back Panel
- E Short Back Panel (for outlet access)

* D-Top only available with Full Height Back Panel.

STEP 2

(#) Worksurface Laminate Suffix List:

- A Wilsonart Kensington Maple (10776-60)
- B Wilsonart Monticello Maple (7925-38)
- C Wilsonart Wild Cherry (7054-60)
- E Wilsonart Fashion Grey (D381-60)
- F Wilsonart White Tigris (4783-60)
- G Wilsonart Cafelle (7933K-07)
- M Wilsonart Frosty White (1573-60)
- P Wilsonart Slate Grey (D91-60)
- R Wilsonart Black (1595-60)
- U Wilsonart Brazilwood (7946-38)
- V Wilsonart River Cherry (7937-38)
- W Wilsonart Designer White (D354-60)
- 3 Formica Neutral Twill (8826-58)
- 4 Formica Bleached Legno (8845-58)
- 5 Formica Prestige Walnut (6209-43)
- 7 Formica Select Cherry (7759-43)
- X *Wilsonart Non-Premium laminates (-38, -60).
- Y *Formica Non-Premium (includes 58, 43, MC, SP, and NT finishes), Formica Premium (WR, 42, 77, 46, RD finishes), Pionite Non-Premium, Nevamar Non-Premium, Wilsonart Premium (-01, -07, -12, -18, -52, -78), and whiteboard laminate.

*Add \$350 list for Special Laminate orders of less than 10 units. See page 21 for edge selection.

STEP 3

(@) Casegood (Shell) Laminate Suffix List:

- A Wilsonart Kensington Maple (10776-60) no charge
- B Wilsonart Monticello Maple (7925-38) no charge
- C Wilsonart Wild Cherry (7054-60) no charge
- E Wilsonart Fashion Grey (D381-60) no charge
- G Wilsonart Cafelle (7933K-07) no charge
- M Wilsonart Frosty White (1573-60) no charge
- P Wilsonart Slate Grey (D91-60) no charge
- R Wilsonart Black (1595-60) no charge
- U Wilsonart Brazilwood (7946-38) no charge
- V Wilsonart River Cherry (7937-38) no charge
- W Wilsonart Designer White (D354-60) no charge
- 3 Formica Neutral Twill (8826-58) no charge
- 4 Formica Bleached Legno (8845-58) no charge
- 5 Formica Prestige Walnut (6209-43) no charge
- 7 Formica Select Cherry (7759-43) no charge
- X *Wilsonart Non-Premium laminates (-38, -60) +35%
- Y *Formica Non-Premium (includes 58, 43, MC, SP, and NT finishes), Formica Premium (WR, 42, 77, 46, RD finishes), Pionite Non-Premium, Nevamar Non-Premium, Wilsonart Premium (-01, -07, -12, -18, -52, -78), and whiteboard laminate. +45%

*Add \$350 list for Special Laminate orders of less than 10 units. See page 21 for edge selection.

STEP 4

(^) Leg Finish Suffix List:

- G Slate Grey
- R Black
- S Silver
- T Medium Tone
- W Arctic White
- Z Other

Tip: Some Steelcase, Herman Miller, Knoll, Haworth, and Allsteel paints are available for \$350 list fee per order. Call/email for availability of specific colors. Additional custom paints (e.g. Tiger Dry Lac) must be quoted through quotes@enwork.com.

Product Specifications:

- > 3mm Edge
- > Height is 29"

Ordering Information:

- > No Grommet
- > Includes Support Leg
- > Ships KD
- > Modesty Screen specified separately. See pages 195-196.
- > **A freight fee of \$100 net is assessed on orders less than \$1000 net. See page 13.**

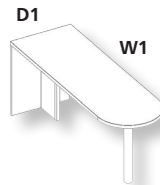

"D-Top"

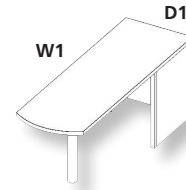

Crowned Rectangle RH
(LH opposite)

D1	D2	W1	O	Part Number	Description	List Price (US\$)
"D-Top" with T-Support and Column, 30"						
30	-	48	-	D5D3048#@^	Affinity D-Top, 30"x48"	\$843
30	-	60	-	D5D3060#@^	Affinity D-Top, 30"x60"	\$897
30	-	66	-	D5D3066#@^	Affinity D-Top, 30"x66"	\$972
30	-	72	-	D5D3072#@^	Affinity D-Top, 30"x72"	\$972
30	-	84	-	D5D3084#@^	Affinity D-Top, 30"x84"	\$1082
30	-	96	-	D5D3096#@^	Affinity D-Top, 30"x96"	\$1082

Tip: Only available with a full height back panel (see Step 1).

Crowned Rectangle Conference Shells, RH

24	-	72	RH	DKJR2472&#@^	Crowned Rectangle Conference Shell, RH, 24"x72"	\$920
30	-	72	RH	DKJR3072&#@^	Crowned Rectangle Conference Shell, RH, 30"x72"	\$1000

Crowned Rectangle Conference Shells, LH

24	-	72	LH	DKJL2472&#@^	Crowned Rectangle Conference Shell, LH, 24"x72"	\$920
30	-	72	LH	DKJL3072&#@^	Crowned Rectangle Conference Shell, LH, 30"x72"	\$1000

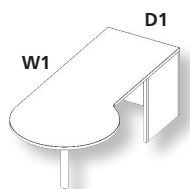

"P" RH

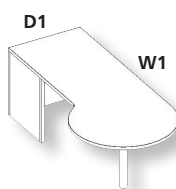

"P" LH

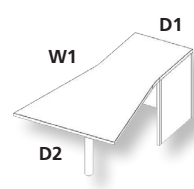
Angled RH
(LH opposite)

D1	D2	W1	O	Part Number	Description	List Price (US\$)
"P" Conference Shells, RH						
24	-	72	RH	DKD2472&#amp;#@^	"P" Conference Shell, RH, 24"x72"	\$980
30	-	72	RH	DKD3072&#amp;#@^	"P" Conference Shell, RH, 30"x72"	\$1090
"P" Conference Shells, LH						
24	-	72	LH	DKK2472&#amp;#@^	"P" Conference Shell, LH, 24"x72"	\$980
30	-	72	LH	DKK3072&#amp;#@^	"P" Conference Shell, LH, 30"x72"	\$1090
Angled Conference Shells, RH						
24	36	72	RH	DKFR243672&#amp;#@^	Angled Conference Shell, RH, 24"x36"x72"	\$1073
30	42	72	RH	DKFR304272&#amp;#@^	Angled Conference Shell, RH, 30"x42"x72"	\$1212
Angled Conference Shells, LH						
24	36	72	LH	DKFL243672&#amp;#@^	Angled Conference Shell, LH, 24"x36"x72"	\$1073
30	42	72	LH	DKFL304272&#amp;#@^	Angled Conference Shell, LH, 30"x42"x72"	\$1212

Affinity Modular Bridge Shells

STEP 1

(&) Back Panel Suffix List:

- F Full Height Back Panel
- T Three-Quarter Height Back Panel
- E Short Back Panel (for outlet access)

Tip: Three-Quarter Height and Short Back Panels are available on Bridge Shell A only.

STEP 2

(#) Worksurface Laminate Suffix List:

- A Wilsonart Kensington Maple (10776-60)
- B Wilsonart Monticello Maple (7925-38)
- C Wilsonart Wild Cherry (7054-60)
- E Wilsonart Fashion Grey (D381-60)
- F Wilsonart White Tigris (4783-60)
- G Wilsonart Cafelle (7933K-07)
- M Wilsonart Frosty White (1573-60)
- P Wilsonart Slate Grey (D91-60)
- R Wilsonart Black (1595-60)
- U Wilsonart Brazilwood (7946-38)
- V Wilsonart River Cherry (7937-38)
- W Wilsonart Designer White (D354-60)
- 3 Formica Neutral Twill (8826-58)
- 4 Formica Bleached Legno (8845-58)
- 5 Formica Prestige Walnut (6209-43)
- 7 Formica Select Cherry (7759-43)
- X *Wilsonart Non-Premium laminates (-38, -60).
- Y *Formica Non-Premium (includes 58, 43, MC, SP, and NT finishes), Formica Premium (WR, 42, 77, 46, RD finishes), Pionite Non-Premium, Nevamar Non-Premium, Wilsonart Premium (-01, -07, -12, -18, -52, -78), and whiteboard laminate.

*Add \$350 list for Special Laminate orders of less than 10 units. See page 21 for edge selection.

STEP 3

(@) Casegood (Shell) Laminate Suffix List:

- A Wilsonart Kensington Maple (10776-60) no charge
- B Wilsonart Monticello Maple (7925-38) no charge
- C Wilsonart Wild Cherry (7054-60) no charge
- E Wilsonart Fashion Grey (D381-60) no charge
- G Wilsonart Cafelle (7933K-07) no charge
- M Wilsonart Frosty White (1573-60) no charge
- P Wilsonart Slate Grey (D91-60) no charge
- R Wilsonart Black (1595-60) no charge
- U Wilsonart Brazilwood (7946-38) no charge
- V Wilsonart River Cherry (7937-38) no charge
- W Wilsonart Designer White (D354-60) no charge
- 3 Formica Neutral Twill (8826-58) no charge
- 4 Formica Bleached Legno (8845-58) no charge
- 5 Formica Prestige Walnut (6209-43) no charge
- 7 Formica Select Cherry (7759-43) no charge
- X *Wilsonart Non-Premium laminates (-38, -60) +35%
- Y *Formica Non-Premium (includes 58, 43, MC, SP, and NT finishes), Formica Premium (WR, 42, 77, 46, RD finishes), Pionite Non-Premium, Nevamar Non-Premium, Wilsonart Premium (-01, -07, -12, -18, -52, -78), and whiteboard laminate. +45%

*Add \$350 list for Special Laminate orders of less than 10 units.. See page 21 for edge selection.

Product Specifications:

- > 3mm Edge
- > Height is 29"

Ordering Information:

- > Includes Grommet
- > Ships KD
- > Hardware included
- > Standard grain direction runs left to right. To specify front to back (matching) grain direction on return or bridge shells, contact quotes@enwork.com.
- > **A freight fee of \$100 net is assessed on orders less than \$1000 net. See page 13.**

Bridge Shell A works with all conference shells except D-Top.
 Bridge Shell B spans two full desk shells or a desk shell and a D-Top to make a "U."

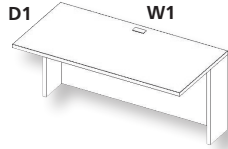

Bridge Shell A

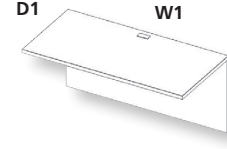

Bridge Shell B

D1	W1	Part Number	Description	List Price (US\$)
----	----	-------------	-------------	-------------------

Bridge Shell A, 24"D

24	24	DLA2424&#amp;#amp;	Rectangular Bridge Shell A, 24"x24"	\$650
24	30	DLA2430&#amp;#amp;	Rectangular Bridge Shell A, 24"x30"	\$695
24	36	DLA2436&#amp;#amp;	Rectangular Bridge Shell A, 24"x36"	\$730
24	42	DLA2442&#amp;#amp;	Rectangular Bridge Shell A, 24"x42"	\$795
24	48	DLA2448&#amp;#amp;	Rectangular Bridge Shell A, 24"x48"	\$829

Bridge Shell A, 30"D

30	30	DLA3030&#amp;#amp;	Rectangular Bridge Shell A, 30"x30"	\$735
30	36	DLA3036&#amp;#amp;	Rectangular Bridge Shell A, 30"x36"	\$765
30	42	DLA3042&#amp;#amp;	Rectangular Bridge Shell A, 30"x42"	\$829
30	48	DLA3048&#amp;#amp;	Rectangular Bridge Shell A, 30"x48"	\$874

Bridge Shell B, 24"D

24	24	DLB2424&#amp;#amp;	Rectangular Bridge Shell B, 24"x24"	\$382
24	30	DLB2430&#amp;#amp;	Rectangular Bridge Shell B, 24"x30"	\$424
24	36	DLB2436&#amp;#amp;	Rectangular Bridge Shell B, 24"x36"	\$466
24	42	DLB2442&#amp;#amp;	Rectangular Bridge Shell B, 24"x42"	\$525
24	48	DLB2448&#amp;#amp;	Rectangular Bridge Shell B, 24"x48"	\$567

Bridge Shell B, 30"D

30	30	DLB3030&#amp;#amp;	Rectangular Bridge Shell B, 30"x30"	\$466
30	36	DLB3036&#amp;#amp;	Rectangular Bridge Shell B, 30"x36"	\$495
30	42	DLB3042&#amp;#amp;	Rectangular Bridge Shell B, 30"x42"	\$562
30	48	DLB3048&#amp;#amp;	Rectangular Bridge Shell B, 30"x48"	\$610

Affinity Miscellaneous Supports

Ordering Information:

- > Ships KD
- > Attachment hardware included
- > Tie plate included
- > **A freight fee of \$100 net is assessed on orders less than \$1000 net. See page 13.**

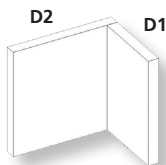

L Support

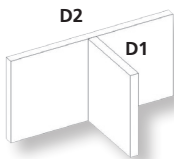

T Support

D1	D2	Part Number	Description	List Price (US\$)
L Supports				
9	9	LEND9@	LEND 9"x9"	\$275
9	24	LEND24@	LEND 9"x24"	\$379
9	30	LEND30@	LEND 9"x30"	\$440
T Supports				
9	24	TEND24@	TEND 9"x24"	\$390
9	30	TEND30@	TEND 9"x30"	\$440

STEP 1

(@) Casegood (Shell) Laminate Suffix List:

A	Wilsonart Kensington Maple (10776-60)	no charge
B	Wilsonart Monticello Maple (7925-38)	no charge
C	Wilsonart Wild Cherry (7054-60)	no charge
E	Wilsonart Fashion Grey (D381-60)	no charge
G	Wilsonart Cafelle (7933K-07)	no charge
M	Wilsonart Frosty White (1573-60)	no charge
P	Wilsonart Slate Grey (D91-60)	no charge
R	Wilsonart Black (1595-60)	no charge
U	Wilsonart Brazilwood (7946-38)	no charge
V	Wilsonart River Cherry (7937-38)	no charge
W	Wilsonart Designer White (D354-60)	no charge
3	Formica Neutral Twill (8826-58)	no charge
4	Formica Bleached Legno (8845-58)	no charge
5	Formica Prestige Walnut (6209-43)	no charge
7	Formica Select Cherry (7759-43)	no charge
X	*Other (Non-premium Wilsonart) (-38, -60)	+35%
Y	*Other (Non-premium Formica/Pionite/Nevamar)	+45%

*Add \$350 list for Special Laminate orders of less than 10 units. See page 21 for edge selection.

Affinity Reception Desk Shells

STEP 1

(#) Worksurface Laminate Suffix List:

- A Wilsonart Kensington Maple (10776-60)
- B Wilsonart Monticello Maple (7925-38)
- C Wilsonart Wild Cherry (7054-60)
- E Wilsonart Fashion Grey (D381-60)
- F Wilsonart White Tigris (4783-60)
- G Wilsonart Cafelle (7933K-07)
- M Wilsonart Frosty White (1573-60)
- P Wilsonart Slate Grey (D91-60)
- R Wilsonart Black (1595-60)
- U Wilsonart Brazilwood (7946-38)
- V Wilsonart River Cherry (7937-38)
- W Wilsonart Designer White (D354-60)
- 3 Formica Neutral Twill (8826-58)
- 4 Formica Bleached Legno (8845-58)
- 5 Formica Prestige Walnut (6209-43)
- 7 Formica Select Cherry (7759-43)
- X *Wilsonart Non-Premium Laminates (-38, -60)
- Y *Formica Non-Premium (includes 58, 43, MC, SP, and NT finishes), Formica Premium (WR, 42, 77, 46, RD finishes), Pionite Non-Premium, Nevamar Non-Premium, Wilsonart Premium (-01, -07, -12, -18, -52, -78), and whiteboard laminate.

*Add \$350 list for Special Laminate orders of less than 10 units. See page 21 for edge selection.

STEP 2

(@) Casegood (Shell) Laminate Suffix List:

- A Wilsonart Kensington Maple (10776-60) no charge
- B Wilsonart Monticello Maple (7925-38) no charge
- C Wilsonart Wild Cherry (7054-60) no charge
- E Wilsonart Fashion Grey (D381-60) no charge
- G Wilsonart Cafelle (7933K-07) no charge
- M Wilsonart Frosty White (1573-60) no charge
- P Wilsonart Slate Grey (D91-60) no charge
- R Wilsonart Black (1595-60) no charge
- U Wilsonart Brazilwood (7946-38) no charge
- V Wilsonart River Cherry (7937-38) no charge
- W Wilsonart Designer White (D354-60) no charge
- 3 Formica Neutral Twill (8826-58) no charge
- 4 Formica Bleached Legno (8845-58) no charge
- 5 Formica Prestige Walnut (6209-43) no charge
- 7 Formica Select Cherry (7759-43) no charge
- X *Wilsonart Non-Premium laminates (-38, -60) +35%
- Y *Formica Non-Premium (includes 58, 43, MC, SP, and NT finishes), Formica Premium (WR, 42, 77, 46, RD finishes), Pionite Non-Premium, Nevamar Non-Premium, Wilsonart Premium (-01, -07, -12, -18, -52, -78), and whiteboard laminate. +45%

*Add \$350 list for Special Laminate orders of less than 10 units. See page 21 for edge selection.

Product Specifications:

- > 3mm Edge / 1mm Edge

Ordering Information:

- > Storage sold separately
- > **A freight fee of \$100 net is assessed on orders less than \$1000 net. See page 13.**

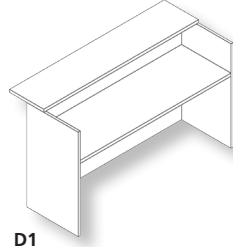

D1

Rectangle Reception Shell

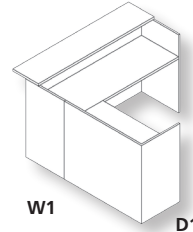

W1

D1

"L" Reception Shell
LH Return
(RH Opposite)

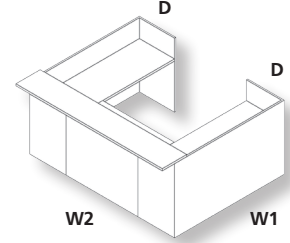

W2

W1

"U" Reception Shell

D1	D2	W1	W2	H	Part Number	Description	List Price (US\$)
Rectangle Reception Shells							
30	30	72	-	42	DRSI3072#@	Rectangle Reception Shell, 30"x72"	\$2180
"L" Reception Shells - RH Return							
24	24	60	60	42	DRSLR6060#@	"L" Reception Shell, RH Return, 60"x60"	\$2657
24	24	72	72	42	DRSLR7272#@	"L" Reception Shell, RH Return, 72"x72"	\$3720
24	24	84	84	42	DRSLR8484#@	"L" Reception Shell, RH Return, 84"x84"	\$5589
24	24	96	96	42	DRSLR9696#@	"L" Reception Shell, RH Return, 96"x96"	\$6830
"L" Reception Shells - LH Return							
24	24	60	60	42	DRSLL6060#@	"L" Reception Shell, LH Return, 60"x60"	\$2657
24	24	72	72	42	DRSLL7272#@	"L" Reception Shell, LH Return, 72"x72"	\$3720
24	24	84	84	42	DRSLL8484#@	"L" Reception Shell, LH Return, 84"x84"	\$5589
24	24	96	96	42	DRSLL9696#@	"L" Reception Shell, LH Return, 96"x96"	\$6830
"U" Reception Shells							
24	24	72	96	42	DRSU7296#@	"U" Reception Shell, 24"x24"x72"x96"	\$6210
24	24	96	96	42	DRSU9696#@	"U" Reception Shell, 24"x24"x96"x96"	\$7450

Notes

Affinity Above Worksurface Storage

STEP 1

(&) Door Option Suffix List:

B	Standard Rectangle Doors	no charge
C	Standard Rectangle Doors (2-Doors on a 4-Door Hutch)	-\$134
H	Aluminum Doors with Frosted Glass - (4-Doors)	+\$2090
J	Aluminum Doors with Frosted Glass - (2-Doors)	+\$1102

*For 6-Door options, contact quotes@enwork.com.

STEP 2

(@) Casework (Shell) Laminate Suffix List:

A	Wilsonart Kensington Maple (10776-60)	no charge
B	Wilsonart Monticello Maple (7925-38)	no charge
C	Wilsonart Wild Cherry (7054-60)	no charge
E	Wilsonart Fashion Grey (D381-60)	no charge
G	Wilsonart Cafelle (7933K-07)	no charge
M	Wilsonart Frosty White (1573-60)	no charge
P	Wilsonart Slate Grey (D91-60)	no charge
R	Wilsonart Black (1595-60)	no charge
U	Wilsonart Brazilwood (7946-38)	no charge
V	Wilsonart River Cherry (7937-38)	no charge
W	Wilsonart Designer White (D354-60)	no charge
3	Formica Neutral Twill (8826-58)	no charge
4	Formica Bleached Legno (8845-58)	no charge
5	Formica Prestige Walnut (6209-43)	no charge
7	Formica Select Cherry (7759-43)	no charge
X	*Wilsonart Non-Premium laminates (-38, -60)	+35%
Y	*Formica Non-Premium (includes 58, 43, MC, SP, and NT finishes), Formica Premium (WR, 42, 77, 46, RD finishes), Pionite Non-Premium, Nevamar Non-Premium, Wilsonart Premium (-01, -07, -12, -18, -52, -78), and whiteboard laminate.	+45%

*Add \$350 list for Special Laminate orders of less than 10 units. See page 21 for edge selection.

STEP 3

(#) Door Laminate Suffix List: (Matches Shell Laminate)

A	Standard Door Front	no charge
B	HPL Door Upgrade	+\$50

Product Specifications:

- > Non-locking
- > 2" Valance to hide lighting
- > 13" Depth
- > Adjustable Laminate shelves

Ordering Information:

- > Ships assembled
- > No pulls required
- > Wire management for lights behind tackboards.
- > Cable management 1.5" Gap on bottom of hutch for cords.
- > For lighting see page 212.
- > **A freight fee of \$100 net is assessed on orders less than \$1000 net. See page 13.**

Designer Series Hutches



Rectangular Doors

Aluminum with Frosted Glass

Cubby Hutch

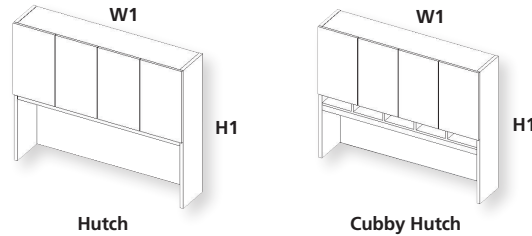

Hutch

Cubby Hutch

W1	H1	Part Number	Description	List Price (US\$)
----	----	-------------	-------------	-------------------

Hutch Assemblies - 66"H installed

36	36.5	DHTV36&@#	Hutch Assembly, 2 doors, 36"	\$1383
42	36.5	DHTV42&@#	Hutch Assembly, 2 doors, 42"	\$1473
48	36.5	DHTV48&@#	Hutch Assembly, 4 doors, 48"	\$1561
60	36.5	DHTV60&@#	Hutch Assembly, 4 doors, 60"	\$1786
66	36.5	DHTV66&@#	Hutch Assembly, 4 doors, 66"	\$1967
72	36.5	DHTV72&@#	Hutch Assembly, 4 doors, 72"	\$1907
84	36.5	DHTV84&@#	Hutch Assembly, 4 doors, 84"	\$2333
96	36.5	DHTV96&@#	Hutch Assembly, 6 doors, 96"	\$2464

Hutch Assemblies - 78"H installed

36	49.1	DHT36&@#	Hutch Assembly, 2 doors, 36"	\$1907
42	49.1	DHT42&@#	Hutch Assembly, 2 doors, 42"	\$1998
48	49.1	DHT48&@#	Hutch Assembly, 4 doors, 48"	\$2117
60	49.1	DHT60&@#	Hutch Assembly, 4 doors, 60"	\$2217
66	49.1	DHT66&@#	Hutch Assembly, 4 doors, 66"	\$2347
72	49.1	DHT72&@#	Hutch Assembly, 4 doors, 72"	\$2347
84	49.1	DHT84&@#	Hutch Assembly, 4 doors, 84"	\$3147
96	49.1	DHT96&@#	Hutch Assembly, 6 doors, 96"	\$3279

Cubby Hutch Assemblies - 78"H installed

36	49.1	DH236&@#	Cubby Hutch Assembly, 2 doors, 36"	\$2251
42	49.1	DH242&@#	Cubby Hutch Assembly, 2 doors, 42"	\$2347
48	49.1	DH248&@#	Cubby Hutch Assembly, 4 doors, 48"	\$2347
60	49.1	DH260&@#	Cubby Hutch Assembly, 4 doors, 60"	\$2447
66	49.1	DH266&@#	Cubby Hutch Assembly, 4 doors, 66"	\$2578
72	49.1	DH272&@#	Cubby Hutch Assembly, 4 doors, 72"	\$2578

Affinity Tackboards

Ordering Information:

- > Tackboards are velcro installed and include "V" channels to route lighting cables.
- > For full width tackboards to use with wall mount cabinets, see page 213.
- > For COM yardage see page 16.
- > **A freight fee of \$100 net is assessed on orders less than \$1000 net. See page 13.**

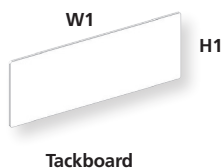

W1	H1	Part Number	Description	List Price (US\$)
Tackboards for 36.5"H Hutch or Wall Cabinets				
34.25	19.8	VTKB36?	Tackboard, 36"	\$374
40.25	19.8	VTKB42?	Tackboard, 42"	\$435
46.25	19.8	VTKB48?	Tackboard, 48"	\$435
58.25	19.8	VTKB60?	Tackboard, 60"	\$516
64.25	19.8	VTKB66?	Tackboard, 66"	\$534
70.25	19.8	VTKB72?	Tackboard, 72"	\$605
Tackboards for 49.1"H Hutch or Wall Mount Cabinets				
34.25	21	DTKB36?	Tackboard, 36"	\$374
40.25	21	DTKB42?	Tackboard, 42"	\$435
46.25	21	DTKB48?	Tackboard, 48"	\$435
58.25	21	DTKB60?	Tackboard, 60"	\$516
64.25	21	DTKB66?	Tackboard, 66"	\$534
70.25	21	DTKB72?	Tackboard, 72"	\$605
Tackboards for 49.1"H Cubby Hutch				
34.25	18	DTKC36?	Tackboard, 36"	\$374
40.25	18	DTKC42?	Tackboard, 42"	\$435
46.25	18	DTKC48?	Tackboard, 48"	\$435
58.25	18	DTKC60?	Tackboard, 60"	\$516
64.25	18	DTKC66?	Tackboard, 66"	\$534
70.25	18	DTKC72?	Tackboard, 72"	\$605

STEP 1 - Tackboards Only

(?) Fabric Suffix List:

Free form fabric selection. Choose from Camira Mill L2 or Lucia fabrics.

Tip: To view fabric colors or to order samples go to www.camirafabrics.com/us.

Tip: For COM yardage, see page 16.

Affinity Above Worksurface Storage

STEP 1

(&) Door Option Suffix List:

B	Standard Rectangle Doors	No Charge
C	Standard Rectangle Doors (2-Doors on a 4-Door Hutch)	-\$134
H	Aluminum Doors with Frosted Glass - (4-Doors)	+\$2090
J	Aluminum Doors with Frosted Glass - (2-Doors)	+\$1102

STEP 2

(@) Casegood (Shell) Laminate Suffix List:

A	Wilsonart Kensington Maple (10776-60)	no charge
B	Wilsonart Monticello Maple (7925-38)	no charge
C	Wilsonart Wild Cherry (7054-60)	no charge
E	Wilsonart Fashion Grey (D381-60)	no charge
G	Wilsonart Cafelle (7933K-07)	no charge
M	Wilsonart Frosty White (1573-60)	no charge
P	Wilsonart Slate Grey (D91-60)	no charge
R	Wilsonart Black (1595-60)	no charge
U	Wilsonart Brazilwood (7946-38)	no charge
V	Wilsonart River Cherry (7937-38)	no charge
W	Wilsonart Designer White (D354-60)	no charge
3	Formica Neutral Twill (8826-58)	no charge
4	Formica Bleached Legno (8845-58)	no charge
5	Formica Prestige Walnut (6209-43)	no charge
7	Formica Select Cherry (7759-43)	no charge
X	*Wilsonart Non-Premium laminates (-38, -60)	+35%
Y	*Formica Non-Premium (includes 58, 43, MC, SP, and NT finishes), Formica Premium (WR, 42, 77, 46, RD finishes), Pionite Non-Premium, Nevamar Non-Premium, Wilsonart Premium (-01, -07, -12, -18, -52, -78), and whiteboard laminate.	+45%

*Add \$350 list for Special Laminate orders of less than 10 units. See page 21 for edge selection.

STEP 3 - If Applicable

(#) Door Laminate Suffix List: (Matches Shell Laminate)

A	Standard Door Front	no charge
B	HPL Door Upgrade	+\$50

Tip: If aluminum doors were specified in Step 1, skip this step.

Product Specifications:

- > Non-locking
- > No pulls
- > 2" Valance to hide lighting.
- > 13" depth

Ordering Information:

- > Ships assembled
- > For lighting see page 212.
- > Wall Mount Cabinets come with mounting cleats and hardware to mount cleat to cabinet. Hardware to mount cleat to wall is to be supplied by dealer.
- > **A freight fee of \$100 net is assessed on orders less than \$1000 net. See page 13.**

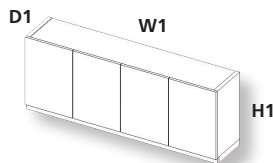

Wall Mount

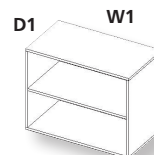

Bookcase (on credenza)

D1	W1	H1	Part Number	Description	List Price (US\$)
Wall Mount Overhead Cabinets - 66"H installed					
13	36	16.8	DH136&@#	Wall Mount Cabinet, 2 doors, 36"	\$1323
13	42	16.8	DH142&@#	Wall Mount Cabinet, 2 doors, 42"	\$1467
13	48	16.8	DH148&@#	Wall Mount Cabinet, 4 doors, 48"	\$1517
13	60	16.8	DH160&@#	Wall Mount Cabinet, 4 doors, 60"	\$1651
13	66	16.8	DH166&@#	Wall Mount Cabinet, 4 doors, 66"	\$1720
13	72	16.8	DH172&@#	Wall Mount Cabinet, 4 doors, 72"	\$1839

Wall Mount Overhead Cabinets - 78" installed

13	36	28	DHW36&@#	Wall Mount Cabinet, 2 doors, 36"	\$1549
13	42	28	DHW42&@#	Wall Mount Cabinet, 2 doors, 42"	\$1761
13	48	28	DHW48&@#	Wall Mount Cabinet, 4 doors, 48"	\$1913
13	60	28	DHW60&@#	Wall Mount Cabinet, 4 doors, 60"	\$1976
13	66	28	DHW66&@#	Wall Mount Cabinet, 4 doors, 66"	\$2071
13	72	28	DHW72&@#	Wall Mount Cabinet, 4 doors, 72"	\$2224

Bookcases for Placement on Credenzas

-	30	37	D6A30@	Bookcase for Credenza, 30"W, 37"H	\$744
-	36	37	D6A36@	Bookcase for Credenza, 36"W, 37"H	\$763
-	30	49	D6B30@	Bookcase for Credenza, 30"W, 49"H	\$832
-	36	49	D6B36@	Bookcase for Credenza, 36"W, 49"H	\$863

Affinity Below Worksurface Storage

Product Specifications:

- > Height is 27.75"
- > Locking

Ordering Information:

- > Storage on this page goes under a desk shell.
- > 24"D storage will not work in 24" Desk Shells. Use 20"D.
- > Use 24"D storage with 30"D desk shells.
- > 20"D pedestals do not support legal filing. Use 24"D.
- > Ships assembled.
- > A freight fee of \$100 net is assessed on orders less than \$1000 net. See page 13.

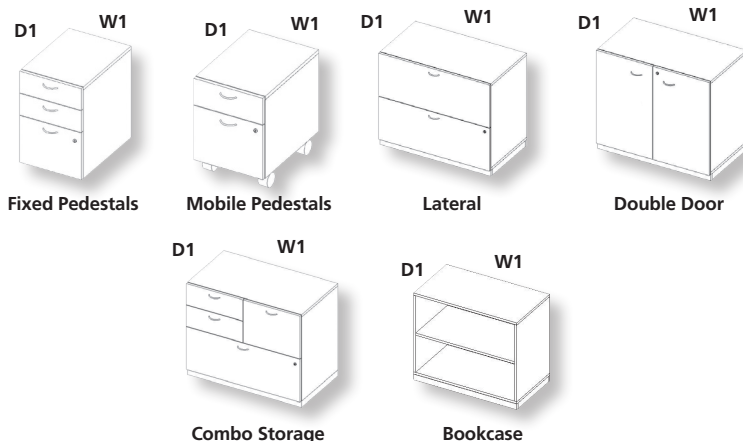

D1	W1	Part Number	Description	List Price (US\$)
Fixed Pedestals, B/B/F, Laminate				
20	16	DSA20BBF*@^	Ped, B/B/F, 20"	\$1152
24	16	DSA24BBF*@^	Ped, B/B/F, 24"	\$1281
Fixed Pedestals, F/F, Laminate				
20	16	DSC20FF*@^	Ped, F/F, 20"	\$1053
24	16	DSC24FF*@^	Ped, F/F, 24"	\$1193
Mobile Pedestals, B/F, Laminate				
20	16	DSD20BF*@^	Mobile Ped, B/F, 20"	\$1134
24	16	DSD24BF*@^	Mobile Ped, B/F, 24"	\$1242
Tip: Casters are field installed.				
Laterals, 2 High, Laminate				
20	30	DSH3028*@^	Lateral, 20"x30"x28"	\$1631
20	36	DSH3628*@^	Lateral, 20"x36"x28"	\$1674
Double Door Cabinets, 2 High with One Adjustable Shelf, Laminate				
20	30	DSJ203028*@^	Double Door Cabinet, 20"x30"x28"	\$952
20	36	DSJ203628*@^	Double Door Cabinet, 20"x36"x28"	\$1084
24	30	DSJ243028*@^	Double Door Cabinet, 24"x30"x28"	\$991
24	36	DSJ243628*@^	Double Door Cabinet, 24"x36"x28"	\$1180
Combo Storage, B/B/F/Lat, Laminate				
20	32	DSZ2032*@^	Combo B/B/F/Lat, 20"x32"	\$1893
24	32	DSZ2432*@^	Combo B/B/F/Lat, 24"x32"	\$1987
Bookcase, Laminate				
13	30	DSL1330@	Bookcase, 13"x30"	\$576
13	36	DSL1336@	Bookcase, 13"x36"	\$717

STEP 1

(*) Storage Pull Suffix List:



(A) Arc

(B) Bar

STEP 2

(@) Casegood (Shell) Laminate Suffix List:

A	Wilsonart Kensington Maple (10776-60)	no charge
B	Wilsonart Monticello Maple (7925-38)	no charge
C	Wilsonart Wild Cherry (7054-60)	no charge
E	Wilsonart Fashion Grey (D381-60)	no charge
G	Wilsonart Cafelle (7933K-07)	no charge
M	Wilsonart Frosty White (1573-60)	no charge
P	Wilsonart Slate Grey (D91-60)	no charge
R	Wilsonart Black (1595-60)	no charge
U	Wilsonart Brazilwood (7946-38)	no charge
V	Wilsonart River Cherry (7937-38)	no charge
W	Wilsonart Designer White (D354-60)	no charge
3	Formica Neutral Twill (8826-58)	no charge
4	Formica Bleached Legno (8845-58)	no charge
5	Formica Prestige Walnut (6209-43)	no charge
7	Formica Select Cherry (7759-43)	no charge
X	*Wilsonart Non-Premium laminates (-38, -60)	+35%
Y	*Formica Non-Premium (includes 58, 43, MC, SP, and NT finishes), Formica Premium (WR, 42, 77, 46, RD finishes), Pionite Non-Premium, Nevamar Non-Premium, Wilsonart Premium (-01, -07, -12, -18, -52, -78), and whiteboard laminate.	+45%

*Add \$350 list for Special Laminate orders of less than 10 units. See page 21 for edge selection.

STEP 3

(^) Storage Drawer Front Laminate Suffix List: (Matches Shell Laminate)

A	Standard Door/Drawer Front	no charge
B	HPL Door Upgrade	+\$50

Affinity Freestanding Storage

STEP 1

(* Storage Pull Suffix List:



(A) Arc



(B) Bar

STEP 2

(@) Casegood (Shell) Laminate Suffix List:

A	Wilsonart Kensington Maple (10776-60)	no charge
B	Wilsonart Monticello Maple (7925-38)	no charge
C	Wilsonart Wild Cherry (7054-60)	no charge
E	Wilsonart Fashion Grey (D381-60)	no charge
G	Wilsonart Cafelle (7933K-07)	no charge
M	Wilsonart Frosty White (1573-60)	no charge
P	Wilsonart Slate Grey (D91-60)	no charge
R	Wilsonart Black (1595-60)	no charge
U	Wilsonart Brazilwood (7946-38)	no charge
V	Wilsonart River Cherry (7937-38)	no charge
W	Wilsonart Designer White (D354-60)	no charge
3	Formica Neutral Twill (8826-58)	no charge
4	Formica Bleached Legno (8845-58)	no charge
5	Formica Prestige Walnut (6209-43)	no charge
7	Formica Select Cherry (7759-43)	no charge
X	*Wilsonart Non-Premium laminates (-38, -60)	+35%
Y	*Formica Non-Premium (includes 58, 43, MC, SP, and NT finishes), Formica Premium (WR, 42, 77, 46, RD finishes), Pionite Non-Premium, Nevamar Non-Premium, Wilsonart Premium (-01, -07, -12, -18, -52, -78), and whiteboard laminate.	+45%

*Add \$350 list for Special Laminate orders of less than 10 units. See page 21 for edge selection.

STEP 3

(^) Storage Drawer Laminate Suffix List: (Matches Shell Laminate)

A	Standard Door Front	no charge
B	HPL Door Upgrade	+\$50

Product Specifications:

- > Includes lock
- > Front to Back file bars included with Laterals.
- > Double Door Cabinets have adjustable shelves.
- > For below-worksurface Laterals and 2-High Double Door Cabinets, see page 239.

Ordering Information:

- > Ships assembled
- > **A freight fee of \$100 net is assessed on orders less than \$1000 net. See page 13.**



Laterals

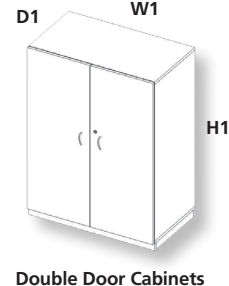

Double Door Cabinets

D1	W1	H1	Part Number	Description	List Price (US\$)
Laterals, 2 High with Worksurface					
20	30	29	DSM203029*@^	Lateral, 2-high with worksurface, 20"x30"x29"	\$1791
20	36	29	DSM203629*@^	Lateral, 2-high with worksurface, 20"x36"x29"	\$1833
Laterals, 3 High					
20	30	41	DSM203041*@^	Lateral, 3 high, Lam. 20"x30"x41"	\$2337
20	36	41	DSM203641*@^	Lateral, 3 high, Lam. 20"x36"x41"	\$2450
Laterals, 4 High					
20	30	53	DSM203053*@^	Lateral, 4 high, Lam. 20"x30"x53"	\$2906
20	36	53	DSM203653*@^	Lateral, 4 high, Lam. 20"x36"x53"	\$3362
Double Door Cabinets, 2 High with Worksurface					
20	30	29	DSJ203029*@^	Double Door Cabinet, 2 high w/ worksurface, 20"x30"x29"	\$1098
20	36	29	DSJ203629*@^	Double Door Cabinet, 2 high w/ worksurface, 20"x36"x29"	\$1227
20	42	29	DSJ204229*@^	Double Door Cabinet, 2 high w/ worksurface, 20"x42"x29"	\$1712
Double Door Cabinets, 3 High					
20	30	41	DSJ203041*@^	Double Door Cabinet, 3 high, 20"x30"x41"	\$1209
20	36	41	DSJ203641*@^	Double Door Cabinet, 3 high, 20"x36"x41"	\$1380
20	42	41	DSJ204241*@^	Double Door Cabinet, 3 high, 20"x42"x41"	\$1985
Double Door Cabinets, 4 High					
20	30	53	DSJ203053*@^	Double Door Cabinet, 4 high, 20"x30"x53"	\$1503
20	36	53	DSJ203653*@^	Double Door Cabinet, 4 high, 20"x36"x53"	\$1627
20	42	53	DSJ204253*@^	Double Door Cabinet, 4 high, 20"x42"x53"	\$2223
Double Door Cabinets, 5 High					
20	30	66	DSJ203066*@^	Double Door Cabinet, 5 high, 20"x30"x66"	\$1764
20	36	66	DSJ203666*@^	Double Door Cabinet, 5 high, 20"x36"x66"	\$1917
20	42	66	DSJ204266*@^	Double Door Cabinet, 5 high, 20"x42"x66"	\$2792
Double Door Cabinets, 6 High					
20	30	78	DSJ203078*@^	Double Door Cabinet, 6 high, 20"x30"x78"	\$2027
20	36	78	DSJ203678*@^	Double Door Cabinet, 6 high, 20"x36"x78"	\$2205
20	42	78	DSJ204278*@^	Double Door Cabinet, 6 high, 20"x42"x78"	\$3222

Notes

Affinity Freestanding Storage

STEP 1

(* Storage Pull Suffix List:



(A) Arc

(B) Bar

STEP 2

(& Door Option Suffix List:

A	No Door Above Files	-\$107
B	Standard Rectangle Door Above Files	no charge
F	Angle Door - Above Files	no charge
H	Aluminum Door with Frosted Glass - Above Files and Wardrobe Door	+\$1486

STEP 3

(@ Casegood (Shell) Laminate Suffix List:

A	Wilsonart Kensington Maple (10776-60)	no charge
B	Wilsonart Monticello Maple (7925-38)	no charge
C	Wilsonart Wild Cherry (7054-60)	no charge
E	Wilsonart Fashion Grey (D381-60)	no charge
G	Wilsonart Cafelle (7933K-07)	no charge
M	Wilsonart Frosty White (1573-60)	no charge
P	Wilsonart Slate Grey (D91-60)	no charge
R	Wilsonart Black (1595-60)	no charge
U	Wilsonart Brazilwood (7946-38)	no charge
V	Wilsonart River Cherry (7937-38)	no charge
W	Wilsonart Designer White (D354-60)	no charge
3	Formica Neutral Twill (8826-58)	no charge
4	Formica Bleached Legno (8845-58)	no charge
5	Formica Prestige Walnut (6209-43)	no charge
7	Formica Select Cherry (7759-43)	no charge
X	*Wilsonart Non-Premium laminates (-38, -60)	+35%
Y	*Formica Non-Premium (includes 58, 43, MC, SP, and NT finishes), Formica Premium (WR, 42, 77, 46, RD finishes), Pionite Non-Premium, Nevamar Non-Premium, Wilsonart Premium (-01, -07, -12, -18, -52, -78), and whiteboard laminate.	+45%

*Add \$350 list for Special Laminate orders of less than 10 units. See page 21 for edge selection.

STEP 4

(^ Storage Drawer Door Laminate Suffix List: (Matches Shell Laminate)

A	Standard Door/Drawer Front	no charge
B	HPL Door Upgrade	+\$50

Tip: If aluminum doors were specified in Step 2, skip this step.

Product Specifications:

- > Includes lock on wardrobe and drawers
- > Adjustable shelves

Ordering Information:

- > Ships assembled
- > Multiple Storage door aesthetic options exist to match Hutches
- > **A freight fee of \$100 net is assessed on orders less than \$1000 net. See page 13.**

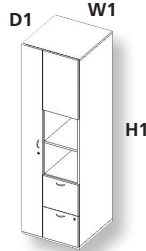

Left-Hand Shown

Wardrobe Tower with Storage Door and File-File-Ped (other combinations available)

D1	W1	H1	O	Part Number	Description	List Price (US\$)
----	----	----	---	-------------	-------------	-------------------

Wardrobe Towers with Storage Door, File/File, 24", LH

24	24	53	LH	DSTA* & @ ^	Wardrobe Tower, F/F, LH, 24"x24"x53"	\$2754
24	24	66	LH	DSTB* & @ ^	Wardrobe Tower, F/F, LH, 24"x24"x66"	\$2996
24	24	78	LH	DSTC* & @ ^	Wardrobe Tower, F/F, LH, 24"x24"x78"	\$3265

Wardrobe Towers with Storage Door, File/File, 24", RH

24	24	53	RH	DSTK* & @ ^	Wardrobe Tower, F/F, RH, 24"x24"x53"	\$2754
24	24	66	RH	DSTL* & @ ^	Wardrobe Tower, F/F, RH, 24"x24"x66"	\$2996
24	24	78	RH	DSTM* & @ ^	Wardrobe Tower, F/F, RH, 24"x24"x78"	\$3265

Affinity Freestanding Storage

Product Specifications:

- > Includes lock on wardrobe and drawers
- > Adjustable shelves

Ordering Information:

- > Ships assembled
- > Multiple Storage door aesthetic options exist to match Hutches
- > **A freight fee of \$100 net is assessed on orders less than \$1000 net. See page 13.**

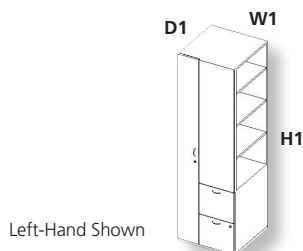

Wardrobe Tower with Side-Access and
File-File-Ped (other combinations available)

D1	W1	H1	O	Part Number	Description	List Price (US\$)
----	----	----	---	-------------	-------------	-------------------

Wardrobe Towers with Side-Access, File/File, 24", LH

24	24	53	LH	DSTU* [@] ^	Wardrobe Tower, Side-Access, F/F, LH, 24"x24"x53"	\$2620
24	24	66	LH	DSTV* [@] ^	Wardrobe Tower, Side-Access, F/F, LH, 24"x24"x66"	\$2871
24	24	78	LH	DSTW* [@] ^	Wardrobe Tower, Side-Access, F/F, LH, 24"x24"x78"	\$3121

Wardrobe Towers with Side-Access, File/File, 24", RH

24	24	53	RH	DST2* [@] ^	Wardrobe Tower, Side-Access, F/F, RH, 24"x24"x53"	\$2620
24	24	66	RH	DST3* [@] ^	Wardrobe Tower, Side-Access, F/F, RH, 24"x24"x66"	\$2871
24	24	78	RH	DST4* [@] ^	Wardrobe Tower, Side-Access, F/F, RH, 24"x24"x78"	\$3121

STEP 1

(*) Storage Pull Suffix List:



(A) Arc

(B) Bar

STEP 2

(@) Casegood (Shell) Laminate Suffix List:

A	Wilsonart Kensington Maple (10776-60)	no charge
B	Wilsonart Monticello Maple (7925-38)	no charge
C	Wilsonart Wild Cherry (7054-60)	no charge
E	Wilsonart Fashion Grey (D381-60)	no charge
G	Wilsonart Cafelle (7933K-07)	no charge
M	Wilsonart Frosty White (1573-60)	no charge
P	Wilsonart Slate Grey (D91-60)	no charge
R	Wilsonart Black (1595-60)	no charge
U	Wilsonart Brazilwood (7946-38)	no charge
V	Wilsonart River Cherry (7937-38)	no charge
W	Wilsonart Designer White (D354-60)	no charge
3	Formica Neutral Twill (8826-58)	no charge
4	Formica Bleached Legno (8845-58)	no charge
5	Formica Prestige Walnut (6209-43)	no charge
7	Formica Select Cherry (7759-43)	no charge
X	*Wilsonart Non-Premium laminates (-38, -60)	+35%
Y	*Formica Non-Premium (includes 58, 43, MC, SP, and NT finishes), Formica Premium (WR, 42, 77, 46, RD finishes), Pionite Non-Premium, Nevamar Non-Premium, Wilsonart Premium (-01, -07, -12, -18, -52, -78), and whiteboard laminate.	+45%

*Add \$350 list for Special Laminate orders of less than 10 units. See page 21 for edge selection.

STEP 3

(^) Storage Drawer Door Laminate Suffix List:

(Matches Shell Laminate)

A	Standard Door Front	no charge
B	HPL Door Upgrade	+\$50

Affinity Freestanding Storage

STEP 1

(*) Storage Pull Suffix List:



(A) Arc

(B) Bar

STEP 2

(&) Door Option Suffix List:

B	Standard Rectangle Door Above Files	no charge
H	Aluminum Door(s) with Frosted Glass	+\$1486

STEP 3

(@) Casegood (Shell) Laminate Suffix List:

A	Wilsonart Kensington Maple (10776-60)	no charge
B	Wilsonart Monticello Maple (7925-38)	no charge
C	Wilsonart Wild Cherry (7054-60)	no charge
E	Wilsonart Fashion Grey (D381-60)	no charge
G	Wilsonart Cafelle (7933K-07)	no charge
M	Wilsonart Frosty White (1573-60)	no charge
P	Wilsonart Slate Grey (D91-60)	no charge
R	Wilsonart Black (1595-60)	no charge
U	Wilsonart Brazilwood (7946-38)	no charge
V	Wilsonart River Cherry (7937-38)	no charge
W	Wilsonart Designer White (D354-60)	no charge
3	Formica Neutral Twill (8826-58)	no charge
4	Formica Bleached Legno (8845-58)	no charge
5	Formica Prestige Walnut (6209-43)	no charge
7	Formica Select Cherry (7759-43)	no charge
X	*Wilsonart Non-Premium laminates (-38, -60)	+35%
Y	*Formica Non-Premium (includes 58, 43, MC, SP, and NT finishes), Formica Premium (WR, 42, 77, 46, RD finishes), Pionite Non-Premium, Nevamar Non-Premium, Wilsonart Premium (-01, -07, -12, -18, -52, -78), and whiteboard laminate.	+45%

*Add \$350 list for Special Laminate orders of less than 10 units. See page 21 for edge selection.

STEP 4

(^) Storage Drawer Door Front Laminate Suffix List: (Matches Shell Laminate)

A	Standard Door Front	no charge
B	HPL Door Upgrade	+\$50

Product Specifications:

- > Includes lock
- > Adjustable shelves

Ordering Information:

- > Ships assembled.
- > A freight fee of \$100 net is assessed on orders less than \$1000 net. See page 13.

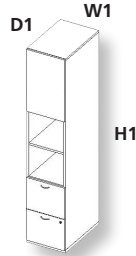

Vertical Tower

D1	W1	H1	O	Part Number	Description	List Price (US\$)
Vertical Towers – LH Hinge on Storage Door, 24"D						
24	16	53	LH	DST8A* & @ ^	Vertical Tower, F/F, LH 24" x 16" x 53"	\$2219
24	16	66	LH	DST8B* & @ ^	Vertical Tower, F/F, LH 24" x 16" x 66"	\$2424
24	16	78	LH	DST8C* & @ ^	Vertical Tower, F/F, LH 24" x 16" x 78"	\$2641

Vertical Towers – RH Hinge on Storage Door, 24"D						
24	16	53	RH	DST9A* & @ ^	Vertical Tower, F/F, RH 24" x 16" x 53"	\$2219
24	16	66	RH	DST9B* & @ ^	Vertical Tower, F/F, RH 24" x 16" x 66"	\$2424
24	16	78	RH	DST9C* & @ ^	Vertical Tower, F/F, RH 24" x 16" x 78"	\$2641

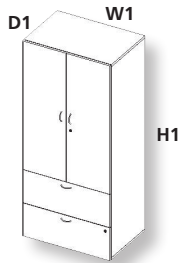

Combination Cabinet

Combination Cabinets, 20"D						
20	30	53	-	DSRA* & @ ^	Combination Cabinet, 20" x 30" x 53"	\$2602
20	36	53	-	DSRB* & @ ^	Combination Cabinet, 20" x 36" x 53"	\$2745
20	30	66	-	DSRC* & @ ^	Combination Cabinet, 20" x 30" x 66"	\$2864
20	36	66	-	DSRD* & @ ^	Combination Cabinet, 20" x 36" x 66"	\$3033
20	30	78	-	DSRE* & @ ^	Combination Cabinet, 20" x 30" x 78"	\$3141
20	36	78	-	DSRF* & @ ^	Combination Cabinet, 20" x 36" x 78"	\$3337

Affinity Freestanding Storage

Product Specifications:

- > Adjustable shelves on bookcases

Ordering Information:

- > Ships assembled.
- > Stability Requirements: 78" Bookcase must be bolted to a wall.
- > For below-worksurface storage see page 239.
- > **A freight fee of \$100 net is assessed on orders less than \$1000 net. See page 13.**



Open Corner Cabinet

D1	W1	H1	Part Number	Description	List Price (US\$)
Open Corner Cabinets, 5 High					
20	20	66	DSP2066@	Open Corner Cabinet, 5 high, 20"x20"x66"	\$1543
24	24	66	DSP2466@	Open Corner Cabinet, 5 high, 24"x24"x66"	\$1829
30	30	66	DSP3066@	Open Corner Cabinet, 5 high, 30"x30"x66"	\$2256
Open Corner Cabinets, 6 High					
20	20	78	DSP2078@	Open Corner Cabinet, 6 high, 20"x20"x78"	\$1838
24	24	78	DSP2478@	Open Corner Cabinet, 6 high, 24"x24"x78"	\$2182
30	30	78	DSP3078@	Open Corner Cabinet, 6 high, 30"x30"x78"	\$2697

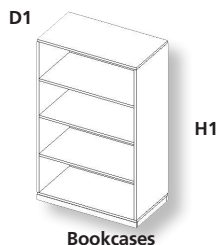

Bookcases

Bookcases, 2 High with Worksurface					
13	30	29	DSQ3029@	Bookcase, 2 high with worksurface, 30" x 29"	\$749
13	36	29	DSQ3629@	Bookcase, 2 high with worksurface, 36" x 29"	\$912
13	42	29	DSQ4229@	Bookcase, 2 high with worksurface, 42" x 29"	\$1209
Bookcases, 3 High					
13	30	41	DSQ3041@	Bookcase, 3 high, 30" x 41"	\$694
13	36	41	DSQ3641@	Bookcase, 3 high, 36" x 41"	\$835
13	42	41	DSQ4241@	Bookcase, 3 high, 42" x 41"	\$1212
Bookcases, 4 High					
13	30	53	DSQ3053@	Bookcase, 4 high, 30" x 53"	\$835
13	36	53	DSQ3653@	Bookcase, 4 high, 36" x 53"	\$969
13	42	53	DSQ4253@	Bookcase, 4 high, 42" x 53"	\$1415
Bookcases, 5 High					
13	30	66	DSQ3066@	Bookcase, 5 high, 30" x 66"	\$969
13	36	66	DSQ3666@	Bookcase, 5 high, 36" x 66"	\$1111
13	42	66	DSQ4266@	Bookcase, 5 high, 42" x 66"	\$1627
Bookcases, 6 High					
13	30	78	DSQ3078@	Bookcase, 6 high, 30" x 78"	\$1124
13	36	78	DSQ3678@	Bookcase, 6 high, 36" x 78"	\$1261
13	42	78	DSQ4278@	Bookcase, 6 high, 42" x 78"	\$1850

STEP 1

(@) Casegood (Shell) Laminate Suffix List:

A	Wilsonart Kensington Maple (10776-60)	no charge
B	Wilsonart Monticello Maple (7925-38)	no charge
C	Wilsonart Wild Cherry (7054-60)	no charge
E	Wilsonart Fashion Grey (D381-60)	no charge
G	Wilsonart Cafelle (7933K-07)	no charge
M	Wilsonart Frosty White (1573-60)	no charge
P	Wilsonart Slate Grey (D91-60)	no charge
R	Wilsonart Black (1595-60)	no charge
U	Wilsonart Brazilwood (7946-38)	no charge
V	Wilsonart River Cherry (7937-38)	no charge
W	Wilsonart Designer White (D354-60)	no charge
3	Formica Neutral Twill (8826-58)	no charge
4	Formica Bleached Legno (8845-58)	no charge
5	Formica Prestige Walnut (6209-43)	no charge
7	Formica Select Cherry (7759-43)	no charge
X	*Wilsonart Non-Premium laminates (-38, -60)	+35%
Y	*Formica Non-Premium (includes 58, 43, MC, SP, and NT finishes), Formica Premium (WR, 42, 77, 46, RD finishes), Pionite Non-Premium, Nevamar Non-Premium, Wilsonart Premium (-01, -07, -12, -18, -52, -78), and whiteboard laminate.	+45%

*Add \$350 list for Special Laminate orders of less than 10 units. See page 21 for edge selection.



Benching

Revisions

P314	03/17	Removed UTITLE24; consolidated 8-wire 4-circuit Added 8-wire 4-circuit w/ controlled stamp
-------------	-------	---

What is Avant?

Avant is the future of integrated, height-adjustable benching environments. An entirely new design concept, it restores the function and convenience of traditional workstations within the dense footprint of modern benching. Ergonomic, electric height-adjustable technology tops keep active documents right at your fingertips while providing the health benefits of a sit/stand environment.

Avant's anchored storage bases express a substantial, contemporary statement. The clean aesthetic fully conceals the moving leg mechanisms, power system components, and cabling of modern workspaces. Proprietary technology includes an industry leading collision detection system on both legs with an external sensor.

Avant linked bench configurations are available in two finish options, Contour Laminate or Laminate. Dimension and style of the tops vary between the two.

SINGLE-SIDED 4" STORAGE TOP End View

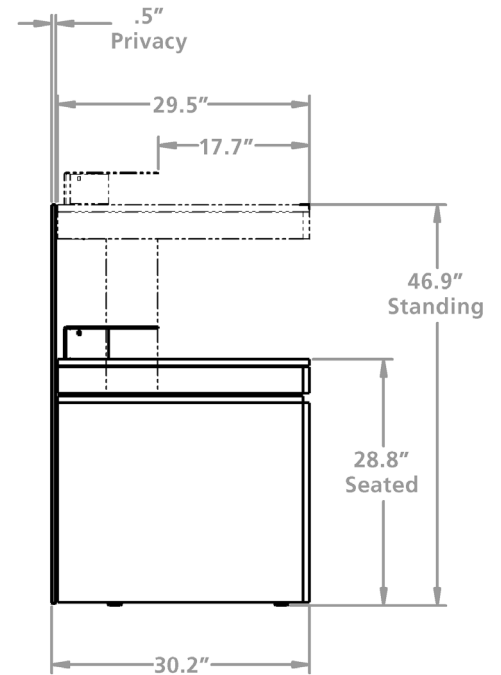

DOUBLE-SIDED 4" STORAGE TOP End View

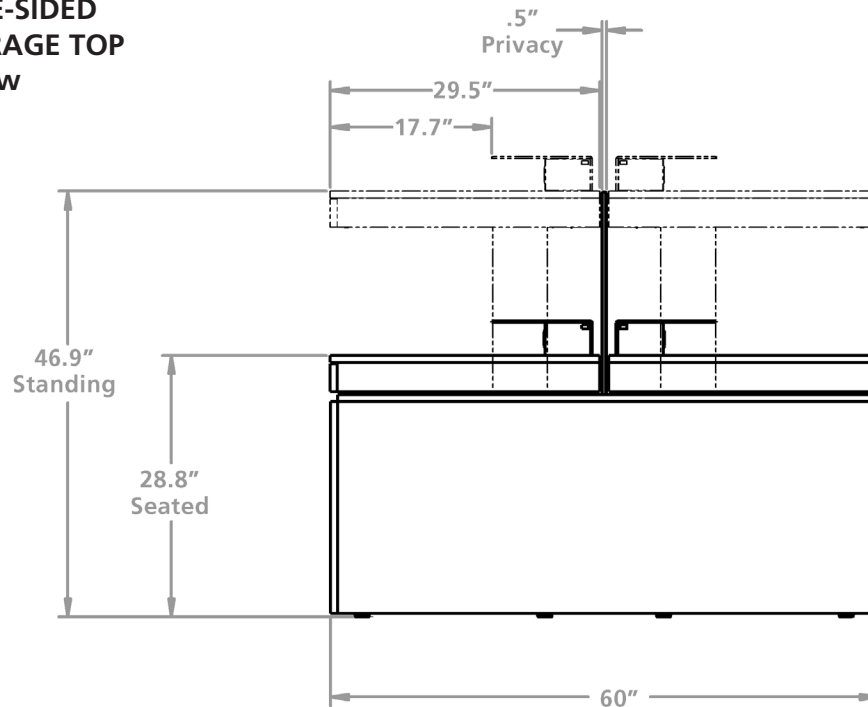

4" STORAGE TOP Elevation View

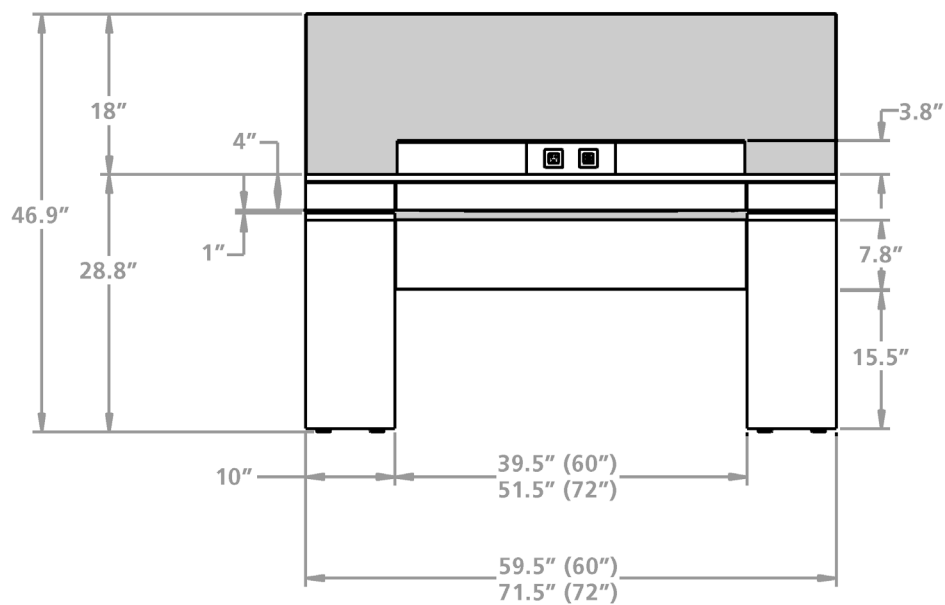

1-1/4" LAMINATE TOP Elevation View

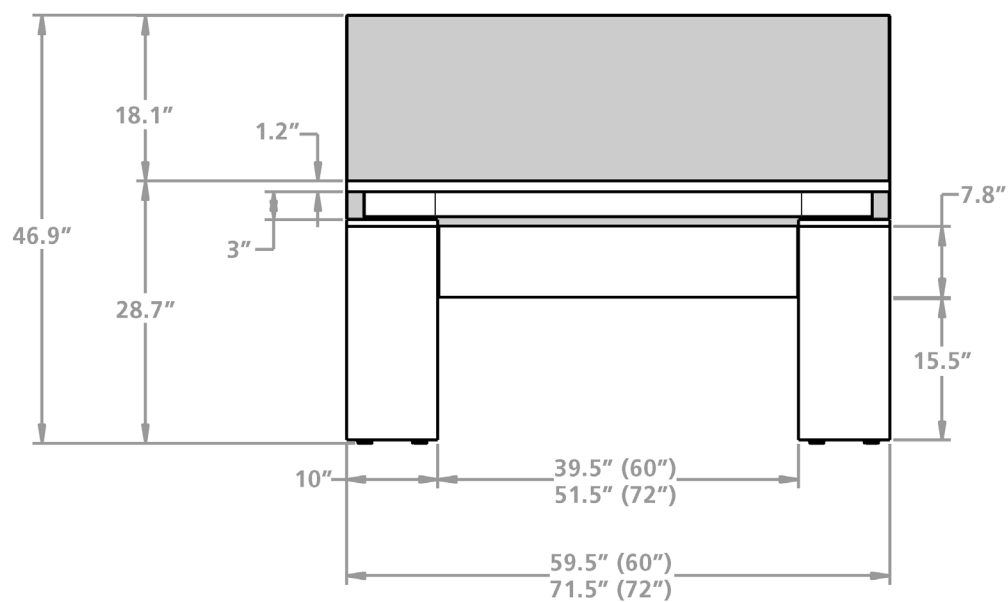

Power and Data

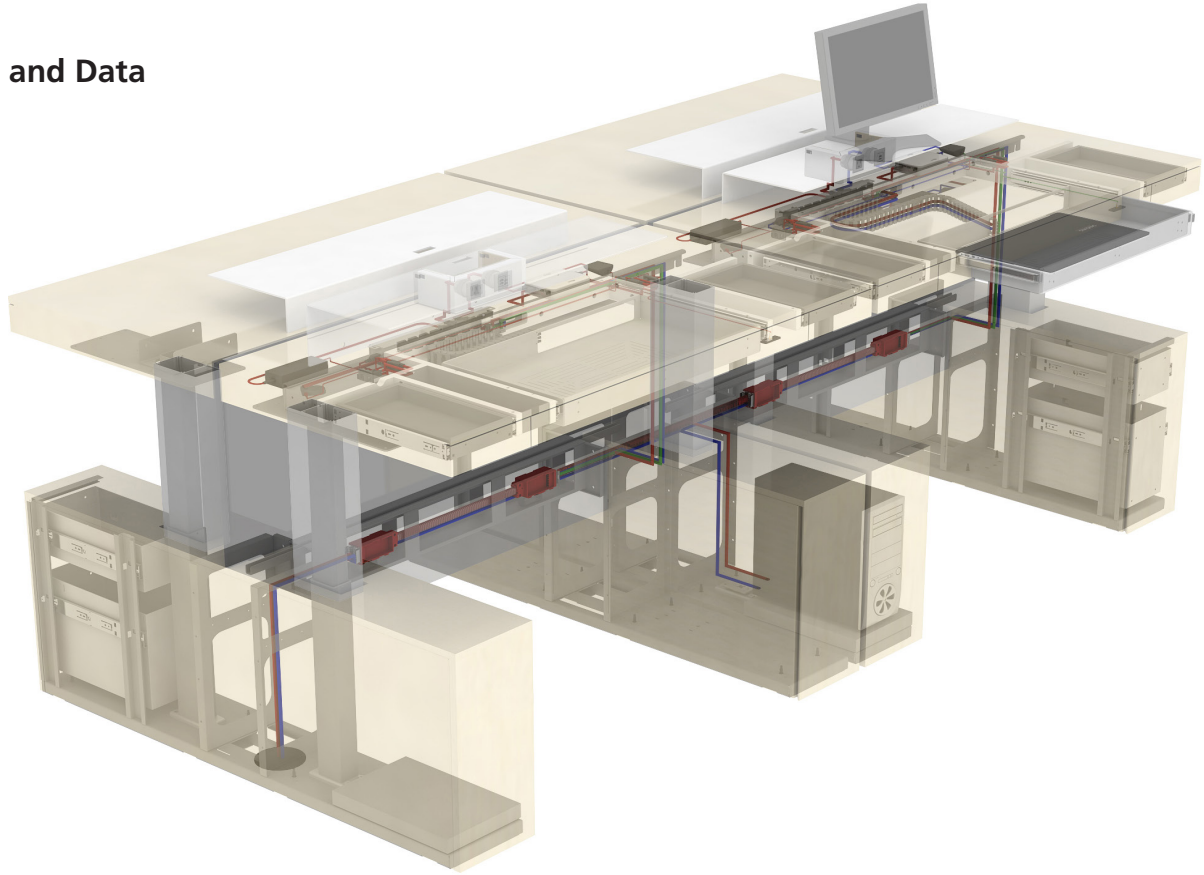

8 Wire Power with Dedicated Circuit

Avant's 8-wire power system with a Dedicated Circuit (3+1 or 2+2) comes installed. Receptacles must be specified separately.

Note: All 8-wire modular wiring comes standard with metallic conduit.

System Features:

8-wires, 4 circuits, 20 amps each
 13 - duplex receptacles per circuit,
 26 - 15 amp duplex receptacles per power infeed maximum

UL Listed as a Manufactured Wiring System.

8-Trac - 4 Circuit Separate Neutral, 8 Wires (3+1)

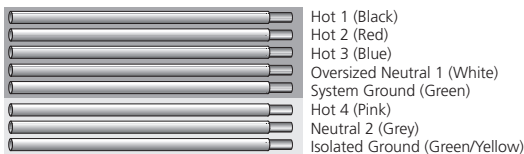

8-Trac - 4 Circuit Separate Neutral, 8 Wires (2+2)

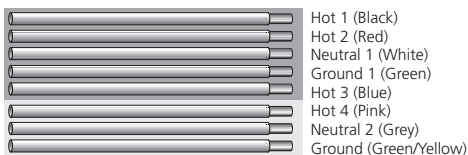

San Francisco Power or Municipalities with Metallic Conduit Requirements

For San Francisco and any other municipalities whose electrical code requires metallic conduit on all modular wiring, 8-Trac comes standard with metallic conduit and is fully San Francisco compliant.

Chicago Power

J-boxes are available for Chicago installations as a special. Contact quotes@enwork.com before ordering.

New York City Power

New York City electrical code requires metallic conduit on all modular wiring. All of the modular wiring harnesses for Avant come standard with metallic conduit. In some cases, modular wiring components must also be field installed.

Avant Functionality

Tops

4" Storage Top

- Contour Laminate. Many standard Contour Laminates have comparable durability to High-performance Laminate (HPL). Others have performance characteristics more similar to LPL.
- Includes steel Monitor Riser 39"W x 11"D, which raises monitors approx. 4" to a more ergonomic position, maximizing worksurface area. Includes power block with user receptacle and USB charging.
- Includes three drawers.
- Center drawer is steel with bottom venting and cord carriers designed for laptop docking stations and two "secret" pull-out cubbies. Center drawer size is 15"D x 27.5"W.
- Plug strip included in back, provides 6 outlets of concealed power accessible for installation and maintenance
- Top portion is removable during installation for access to technology and power components.

1-1/4" Standard Top with Cable Trough

- High-performance Laminate with 3mm edge
- Includes grommet, center rear
- Steel cable trough comes standard to route and conceal wires
- Available with optional steel monitor riser.

Bases

- Bases are made of laminate, with Laminate or Contour Laminate door fronts and top caps.
- Monolithic architectural design with minimal seams for visual harmony.
- Available 30"D x 60"W or 72"W
- Electric height-adjustable with a range of 28" - 47".
Available in fixed height as a special.
- Left hand storage is available for storage of small CPU's. Interior space is 16"D x 8-3/8"W x 18-1/2"H. An optional power strip is available for this area.
- Right hand storage is a box/file configuration. The hanging file drawer is sized to store letter size files.
- All power and cabling is concealed, but accessible for installation and maintenance.
- The spine linking bases together has a removable magnetic cover for easy installation and maintenance. Additionally, it serves as a built-in modesty. There is an access door in each base.
- Each spine has 2 duplex receptacles for plugging in the leg mechanism, accessible to installers.
- Leg column vertical cover includes a wire management channel for concealed power and cable routing.

Accessories

- 1/2" thick dark acrylic privacy screen
 - 46.9"H on Single- and Double-sided bases
- Screen extends to the floor on Single-sided bases

Collision Detection & Power Data

- A state-of-the-art Collision Detection System is included at every workstation. There is an external sensor on both legs in addition to a sensor inside of the leg mechanism.
- Receptacles ordered separately. See page 257.
- Additional power data options are available at the worksurface. Contact quotes@enwork.com for more information.

Planning Workstations

Space Planning

- Double-sided Avant workstations are true dimensions - no creep - for space planning. The width of each workstation in an X-pack is a true 60" or 72". The depth is a true 60".
- Single-sided Avant workstation widths are true dimensions, 60" or 72". The true depth is 30.25".
- Worksurfaces are slightly undersized.
- X-packs cannot be connected to other X-packs.
- Each X-pack uses a separate base power infeed.

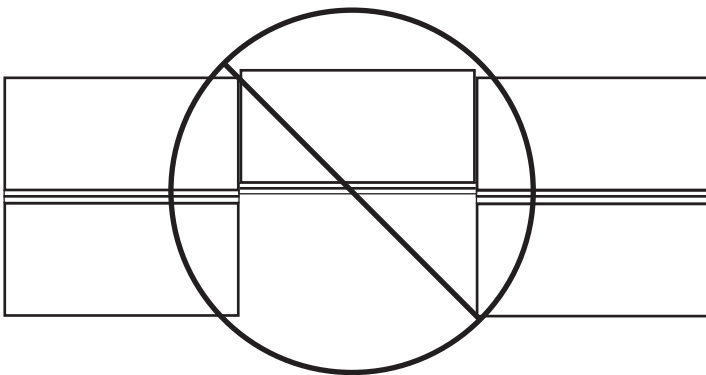
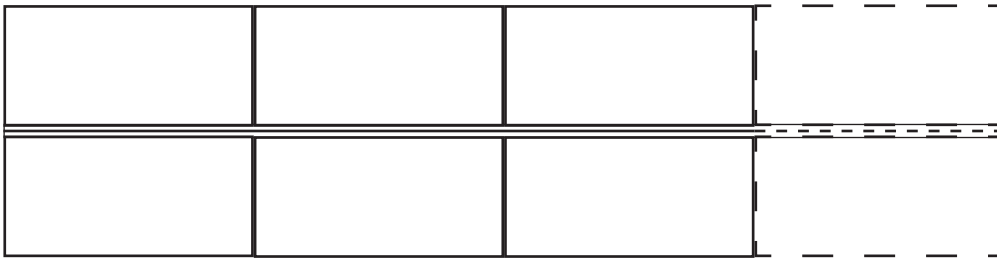
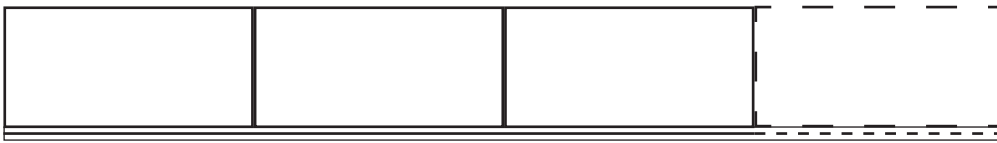

Single-sided Workstations

- Single-sided workstations match the style and aesthetics of Double-sided workstations except the acrylic divider extends to the floor to provide privacy and modesty.

Specifying Avant Workstations

- Step 1** Choose 4" contour laminate storage tops or 1-1/4" laminate tops
- Step 2** Select Double- or Single-sided bases and the appropriate pack size
- Step 3** Add optional monitor riser (standard with 4" storage top)
- Step 4** Choose receptacles

Avant with 4" Storage Top

STEP 1 - Paint Selection

(^) Paint Suffix List

- G Slate Grey
- R Black
- S Silver
- T Medium Tone
- W Arctic White
- Z Other

Tip: Some Steelcase, Herman Miller, Knoll, Haworth, and Allsteel paints are available for \$350 list fee per order. Call/email for availability of specific colors. Additional custom paints (e.g. Tiger Dry Lac) must be quoted through quotes@enwork.com.

STEP 2 - Ped Top Cap

(@) Contour Laminate Suffix List:

- A Freedom Red +\$TBD
- B Addison Mahogany +\$TBD
- C Carbon Fibers Silver +\$TBD
- D Venus Silver +\$TBD
- E Steel Diecast +\$TBD
- * G Natural Maple no charge
- V River Cherry no charge
- W Designer White no charge
- Y Urban Walnut no charge
- * F High Gloss Aluma Grey +\$TBD
- * K High Gloss Fire +\$TBD
- * H Aluminum Brushed +\$TBD
- * J Milk Chocolate +\$TBD

* Indicates durability closer to LPL laminate.

STEP 3 - Ped Door Fronts & Storage Top

(#) Contour Laminate Suffix List:

- A Freedom Red +\$TBD
- B Addison Mahogany +\$TBD
- C Carbon Fibers Silver +\$TBD
- D Venus Silver +\$TBD
- E Steel Diecast +\$TBD
- * G Natural Maple no charge
- V River Cherry no charge
- W Designer White no charge
- Y Urban Walnut no charge
- * F High Gloss Aluma Grey +\$TBD
- * K High Gloss Fire +\$TBD
- * H Aluminum Brushed +\$TBD
- * J Milk Chocolate +\$TBD

* Indicates durability closer to LPL laminate.

STEP 4 - Storage Case

(&) Laminate Suffix List:

- A Wilsonart Kensington Maple (10776-60) no charge
- B Wilsonart Monticello Maple (7925-38) no charge
- C Wilsonart Wild Cherry (7054-60) no charge
- E Wilsonart Fashion Grey (D381-60) no charge
- G Wilsonart Cafelle (7933K-07) no charge
- M Wilsonart Frosty White (1573-60) no charge
- P Wilsonart Slate Grey (D91-60) no charge
- R Wilsonart Black (1595-60) no charge
- U Wilsonart Brazilwood (7946-38) no charge
- V Wilsonart River Cherry (7937-38) no charge
- W Wilsonart Designer White (D354-60) no charge
- 3 Formica Neutral Twill (8826-58) no charge
- 4 Formica Bleached Legno (8845-58) no charge
- 5 Formica Prestige Walnut (6209-43) no charge
- 7 Formica Select Cherry (7759-43) no charge
- X *Wilsonart Non-Premium laminates (-38, -60) +\$3600
- Y *Formica Non-Premium (includes 58, 43, MC, SP, and NT finishes), Formica Premium (WR, 42, 77, 46, RD finishes), Pionite Non-Premium, Nevamar Non-Premium, Wilsonart Premium (-01, -07, -12, -18, -52, -78), and whiteboard laminate +\$4600

*Add \$350 list for Special Laminate orders of less than 10 units.

Product Specifications:

- > 1/2" thick acrylic screen is dark grey.
- > Single-sided screen extends to the floor.
- > Monitor Riser with worksurface power block is included. Power block has user plug and stacked USB charging.
- > Edge profile is flat.
- > Includes 8-wire power system. Receptacles ordered separately.
- > Includes 72" power infeed.
- > 4" Top includes three drawers. Center drawer is steel with bottom venting and cord carriers designed for laptop docking stations. Center drawer front covers two "secret" pull-out cubbies.
- > Plug strip included in back of top, provides 6 outlets of concealed power accessible for installation and maintenance.
- > Ped bases are high pressure laminate. Storage top, door fronts, and ped top caps are contour laminate.
- > Bases include door (LH), box and file Drawer (RH).
- > Most contour laminates are high performance, with comparable durability to HPL laminate. * Indicates durability closer to LPL laminate.

Ordering Information:

- > Spine includes two data and four receptacle openings per user (receptacles ordered separately).
- > **A freight fee of \$100 net is assessed on orders less than \$1000 net. See page 13.**

Part Number	Description	List Price (US\$)
-------------	-------------	-------------------

Double-sided Base with 4" Storage Top

- | | | |
|--------------|---|--|
| AV2F602^@##& | Double-Sided, Contour Laminate, 60"W, 2-Pack | |
| AV2F604^@##& | Double-Sided, Contour Laminate, 60"W, 4-Pack | |
| AV2F606^@##& | Double-Sided, Contour Laminate, 60"W, 6-Pack | |
| AV2F608^@##& | Double-Sided, Contour Laminate, 60"W, 8-Pack | |
| AV2F610^@##& | Double-Sided, Contour Laminate, 60"W, 10-Pack | |
| AV2F612^@##& | Double-Sided, Contour Laminate, 60"W, 12-Pack | |

- | | | |
|---------------|---|--|
| AV2F722^@##& | Double-Sided, Contour Laminate, 72"W, 2-Pack | |
| AV2F724^@##& | Double-Sided, Contour Laminate, 72"W, 4-Pack | |
| AV2F726^@##& | Double-Sided, Contour Laminate, 72"W, 6-Pack | |
| AV2F728^@##& | Double-Sided, Contour Laminate, 72"W, 8-Pack | |
| AV2F7210^@##& | Double-Sided, Contour Laminate, 72"W, 10-Pack | |
| AV2F7212^@##& | Double-Sided, Contour Laminate, 72"W, 12-Pack | |

Single-sided Base with 4" Storage Top

- | | | |
|--------------|--|--|
| AV1F601^@##& | Single-Sided, Contour Laminate, 60"W, 1-Pack | |
| AV1F602^@##& | Single-Sided, Contour Laminate, 60"W, 2-Pack | |
| AV1F603^@##& | Single-Sided, Contour Laminate, 60"W, 3-Pack | |
| AV1F604^@##& | Single-Sided, Contour Laminate, 60"W, 4-Pack | |
| AV1F605^@##& | Single-Sided, Contour Laminate, 60"W, 5-Pack | |
| AV1F606^@##& | Single-Sided, Contour Laminate, 60"W, 6-Pack | |

- | | | |
|--------------|--|--|
| AV1F721^@##& | Single-Sided, Contour Laminate, 72"W, 1-Pack | |
| AV1F722^@##& | Single-Sided, Contour Laminate, 72"W, 2-Pack | |
| AV1F723^@##& | Single-Sided, Contour Laminate, 72"W, 3-Pack | |
| AV1F724^@##& | Single-Sided, Contour Laminate, 72"W, 4-Pack | |
| AV1F725^@##& | Single-Sided, Contour Laminate, 72"W, 5-Pack | |
| AV1F726^@##& | Single-Sided, Contour Laminate, 72"W, 6-Pack | |

For current pricing, see PDF version of V12 Price List at enwork.com or contact quotes@enwork.com.

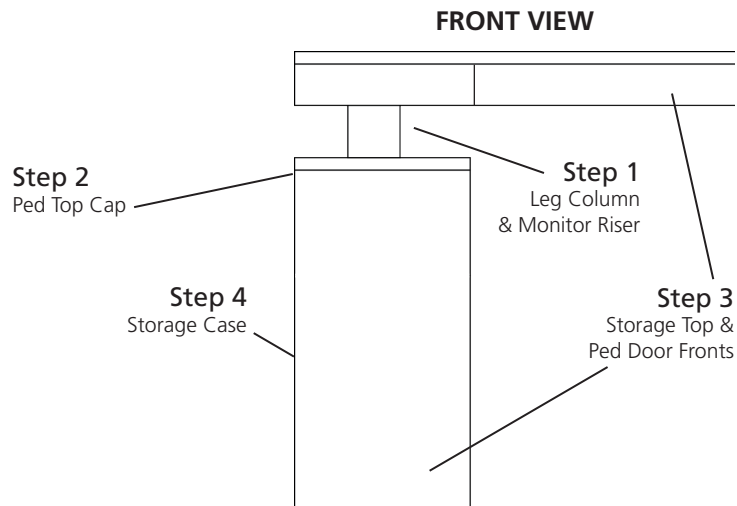

Avant with 1-1/4" Laminate Top

Product Specifications:

- > Edge profile is 3mm.
- > Top Includes metal cable trough to conceal power and cabling.
- > 1/2" thick acrylic screen is dark grey.
- > Single-sided screen extends to the floor.
- > Includes 8-wire power system. Receptacles ordered separately.
- > Includes 72" power infeed.
- > Includes grommet, center rear.
- > Top depth is undersized 3/4".
- > Ped bases are laminate. Top, fronts, and ped top cap are laminate.
- > Bases include door (LH), box and file Drawer (RH).

Ordering Information:

- > Spine includes two data and four receptacle openings per user (receptacles ordered separately).
- > Monitor riser is optional and ordered separately.
- > **A freight fee of \$100 net is assessed on orders less than \$1000 net. See page 13.**

Part Number	Description	List Price (US\$)
-------------	-------------	-------------------

Double-sided Base with 1-1/4" Laminate Top

AV2L602^#&	Double-Sided, Laminate, 60"W, 2-Pack	
AV2L604^#&	Double-Sided, Laminate, 60"W, 4-Pack	
AV2L606^#&	Double-Sided, Laminate, 60"W, 6-Pack	
AV2L608^#&	Double-Sided, Laminate, 60"W, 8-Pack	
AV2L6010^#&	Double-Sided, Laminate, 60"W, 10-Pack	
AV2L6012^#&	Double-Sided, Laminate, 60"W, 12-Pack	

AV2L722^#&	Double-Sided, Laminate, 72"W, 2-Pack	
AV2L724^#&	Double-Sided, Laminate, 72"W, 4-Pack	
AV2L726^#&	Double-Sided, Laminate, 72"W, 6-Pack	
AV2L728^#&	Double-Sided, Laminate, 72"W, 8-Pack	
AV2L7210^#&	Double-Sided, Laminate, 72"W, 10-Pack	
AV2L7212^#&	Double-Sided, Laminate, 72"W, 12-Pack	

Single-sided Base with 1-1/4" Laminate Top

AV1L601^#&	Single-Sided, Laminate, 60"W, 1-Pack	
AV1L602^#&	Single-Sided, Laminate, 60"W, 2-Pack	
AV1L603^#&	Single-Sided, Laminate, 60"W, 3-Pack	
AV1L604^#&	Single-Sided, Laminate, 60"W, 4-Pack	
AV1L605^#&	Single-Sided, Laminate, 60"W, 5-Pack	
AV1L606^#&	Single-Sided, Laminate, 60"W, 6-Pack	

AV1L721^#&	Single-Sided, Laminate, 72"W, 1-Pack	
AV1L722^#&	Single-Sided, Laminate, 72"W, 2-Pack	
AV1L723^#&	Single-Sided, Laminate, 72"W, 3-Pack	
AV1L724^#&	Single-Sided, Laminate, 72"W, 4-Pack	
AV1L725^#&	Single-Sided, Laminate, 72"W, 5-Pack	
AV1L726^#&	Single-Sided, Laminate, 72"W, 6-Pack	

For current pricing, see PDF version of V12 Price List at enwork.com or contact quotes@enwork.com.

Step 2

Top, Ped Top Cap
Ped Door Fronts

FRONT VIEW

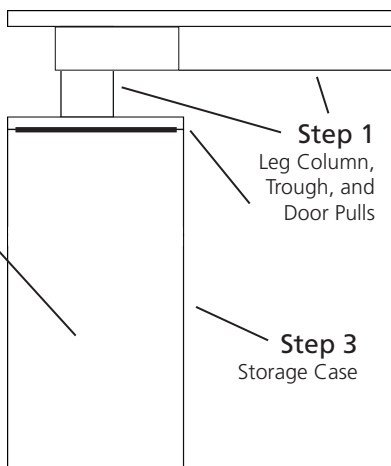

STEP 1 - Paint Selection

(^) Paint Suffix List

- G Slate Grey
- R Black
- S Silver
- T Medium Tone
- W Arctic White
- Z Other

Tip: Some Steelcase, Herman Miller, Knoll, Haworth, and Allsteel paints are available for \$350 list fee per order. Call/email for availability of specific colors. Additional custom paints (e.g. Tiger Dry Lac) must be quoted through quotes@enwork.com.

STEP 2 - Laminate Selection (Top, Fronts, and Ped Cap)

(#) Laminate Suffix List:

A	Wilsonart Kensington Maple (10776-60)	no charge
B	Wilsonart Monticello Maple (7925-38)	no charge
C	Wilsonart Wild Cherry (7054-60)	no charge
E	Wilsonart Fashion Grey (D381-60)	no charge
G	Wilsonart Cafelle (7933K-07)	no charge
M	Wilsonart Frosty White (1573-60)	no charge
P	Wilsonart Slate Grey (D91-60)	no charge
R	Wilsonart Black (1595-60)	no charge
U	Wilsonart Brazilwood (7946-38)	no charge
V	Wilsonart River Cherry (7937-38)	no charge
W	Wilsonart Designer White (D354-60)	no charge
3	Formica Neutral Twill (8826-58)	no charge
4	Formica Bleached Legno (8845-58)	no charge
5	Formica Prestige Walnut (6209-43)	no charge
7	Formica Select Cherry (7759-43)	no charge
X	*Wilsonart Non-Premium laminates (-38, -60)	+\$600
Y	*Formica Non-Premium (includes 58, 43, MC, SP, and NT finishes), Formica Premium (WR, 42, 77, 46, RD finishes), Pionite Non-Premium, Nevamar Non-Premium, Wilsonart Premium (-01, -07, -12, -18, -52, -78), and whiteboard laminate	+\$900

*Add \$350 list for Special Laminate orders of less than 10 units.

STEP 3 - Storage Case

(&) Laminate Suffix List:

A	Wilsonart Kensington Maple (10776-60)	no charge
B	Wilsonart Monticello Maple (7925-38)	no charge
C	Wilsonart Wild Cherry (7054-60)	no charge
E	Wilsonart Fashion Grey (D381-60)	no charge
G	Wilsonart Cafelle (7933K-07)	no charge
M	Wilsonart Frosty White (1573-60)	no charge
P	Wilsonart Slate Grey (D91-60)	no charge
R	Wilsonart Black (1595-60)	no charge
U	Wilsonart Brazilwood (7946-38)	no charge
V	Wilsonart River Cherry (7937-38)	no charge
W	Wilsonart Designer White (D354-60)	no charge
3	Formica Neutral Twill (8826-58)	no charge
4	Formica Bleached Legno (8845-58)	no charge
5	Formica Prestige Walnut (6209-43)	no charge
7	Formica Select Cherry (7759-43)	no charge
X	*Wilsonart Non-Premium laminates (-38, -60)	+\$3600
Y	*Formica Non-Premium (includes 58, 43, MC, SP, and NT finishes), Formica Premium (WR, 42, 77, 46, RD finishes), Pionite Non-Premium, Nevamar Non-Premium, Wilsonart Premium (-01, -07, -12, -18, -52, -78), and whiteboard laminate	+\$4600

*Add \$350 list for Special Laminate orders of less than 10 units.

BENCHING ENVIRONMENTS
AVANT

STEP 1 - Monitor Riser

(^) Paint Suffix List

G Slate Grey
 R Black
 S Silver
 T Medium Tone
 W Arctic White
 Z Other

Tip: Some Steelcase, Herman Miller, Knoll, Haworth, and Allsteel paints are available for \$350 list fee per order. Call/email for availability of specific colors. Additional custom paints (e.g. Tiger Dry Lac) must be quoted through quotes@enwork.com.

Ordering Information:

> A freight fee of \$100 net is assessed on orders less than \$1000 net. See page 13.

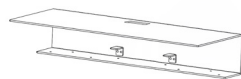

Part Number	Description	List Price (US\$)
-------------	-------------	-------------------

Monitor Riser for 1-1/4" Tops, Steel, 11"D

URISER28A^	Monitor Riser for Single Monitor on Avant, 28"W	\$330
URISER39A^	Monitor Riser for Double Monitors on Avant, 39"W	\$415

Tip: Monitor Riser does not include above worksurface power block.

**Enwork Monitor Arm, with USB, Silver**

EBMA11S	Monitor Arm, Single Mount with dual USB ports, Silver	\$384
---------	---	-------

Tip: Monitor Arm not compatible with 4" Storage top.

Tip: Off-center installation recommended.

EBMA22S	Monitor Arm, Dual Mount with dual USB ports, Silver	\$TBD
---------	---	-------

Tip: Still in development. See enwork.com or call for availability.

Avant Electrical Components

Ordering Information:

- > 8-wire, 4-circuit powerway comes standard.
- > Bases include 72" power infeed.
- > Receptacles ordered separately, below.
- > **A freight fee of \$100 net is assessed on orders less than \$1000 net. See page 13.**

Part Number	Description	List Price (US\$)
Receptacles for Grid 8-Wire, 4-Circuit Powerway		
For 3+1 Wiring Schematic, 15-Amp, Grey		
UREC8W15G311	15-amp Receptacle for 4-circuit (3+1) Powerway, Circuit 1	\$36
UREC8W15G312	15-amp Receptacle for 4-circuit (3+1) Powerway, Circuit 2	\$36
UREC8W15G313	15-amp Receptacle for 4-circuit (3+1) Powerway, Circuit 3	\$36
UREC8W15G314	15-amp Receptacle for 4-circuit (3+1) Powerway, Circuit 4 (Dedicated)	\$36
For 3+1 Wiring Schematic, 20-Amp, Grey		
UREC8W20G311	20-amp Receptacle for 4-circuit (3+1) Powerway, Circuit 1	\$41
UREC8W20G312	20-amp Receptacle for 4-circuit (3+1) Powerway, Circuit 2	\$41
UREC8W20G313	20-amp Receptacle for 4-circuit (3+1) Powerway, Circuit 3	\$41
UREC8W20G314	20-amp Receptacle for 4-circuit (3+1) Powerway, Circuit 4 (Dedicated)	\$41
For 2+2 Wiring Schematic, 15-Amp, Grey		
UREC8W15G221	15-amp Receptacle for 4-circuit (2+2) Powerway, Circuit 1	\$36
UREC8W15G222	15-amp Receptacle for 4-circuit (2+2) Powerway, Circuit 2	\$36
UREC8W15G223	15-amp Receptacle for 4-circuit (2+2) Powerway, Circuit 3 (Dedicated)	\$36
UREC8W15G224	15-amp Receptacle for 4-circuit (2+2) Powerway, Circuit 4 (Dedicated)	\$36
For 2+2 Wiring Schematic, 20-Amp, Grey		
UREC8W20G221	20-amp Receptacle for 4-circuit (2+2) Powerway, Circuit 1	\$41
UREC8W20G222	20-amp Receptacle for 4-circuit (2+2) Powerway, Circuit 2	\$41
UREC8W20G223	20-amp Receptacle for 4-circuit (2+2) Powerway, Circuit 3 (Dedicated)	\$41
UREC8W20G224	20-amp Receptacle for 4-circuit (2+2) Powerway, Circuit 4 (Dedicated)	\$41



Power Poles, Two Chamber, Clear Anodized Aluminum, 2.3"W x 2.3"D

UPHPP10	Power Pole, 10'H	\$1287
UPHPP12	Power Pole, 12'H	\$1465
UPHPP15	Power Pole, 15'H	\$1710

Tip: Power Pole has a cable routing hole on side of pole at the bottom. Infeed passes through the hole, across the floor, and into hole at the bottom of the infeed leg.

Additional hole(s) can be field cut to allow routing directly into the power system.

Tip: Includes mounting hardware and ceiling trim plate.

Tip: Power infeed not included. Order 240" base power infeed separately.

What is eBench?

eBench workstations pack style, function, and technology integration into a simple, uncluttered package. Engineered in Germany, its highly tooled steel structure assures a long-lasting, sturdy foundation. Inset shared legs create ample knee space with plenty of room for storage components.

3/4" sliding tops provide pocket access to the fully concealed power outlets, data ports, and cable troughs in the center raceway. The standard 4-circuit power system includes 2 duplexes and 2 data openings per user. For frequent user access, surface- and edge-mount power and data options assure connections are always close at hand.

eBench is available for Double- and Single-sided rectangular applications 48", 60", or 72"W with 24" or 30"D worksurfaces. Use topper screens and end panels to add privacy and modesty, also creating options for aesthetic customization. Add a 12" Skinny™ box-file mobile ped for high density applications, or choose Landscape or Apex storage components.

SINGLE-SIDED End View

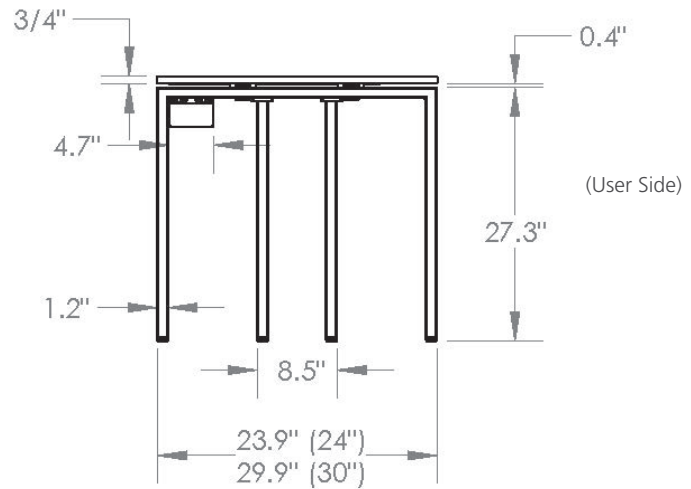

DOUBLE-SIDED End View

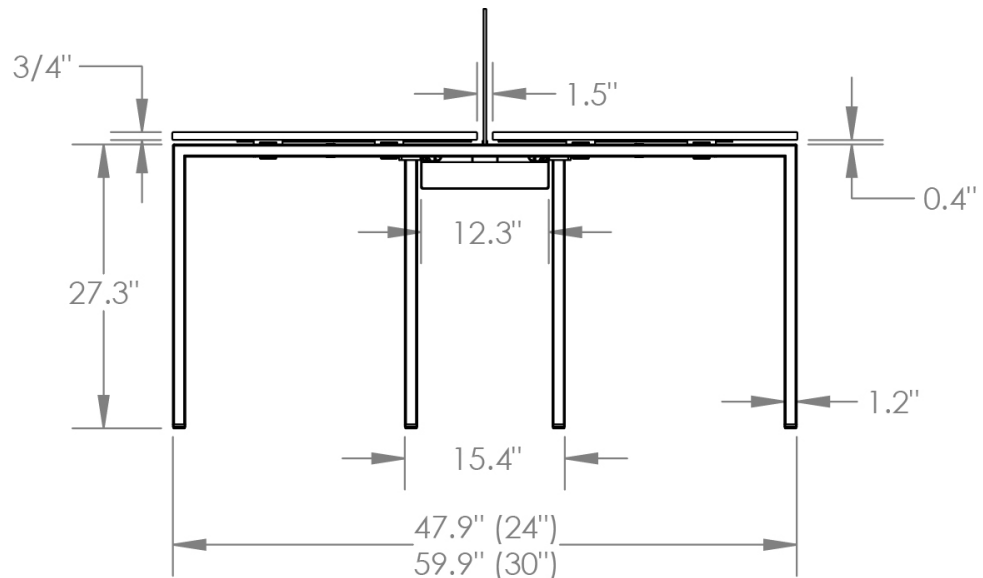

**SINGLE-SIDED
Elevation View**

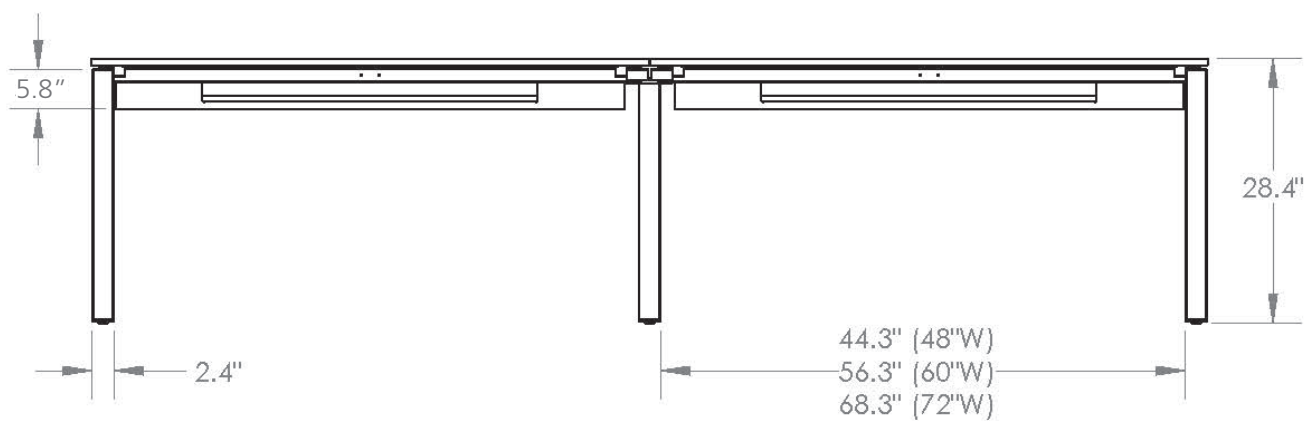

**DOUBLE-SIDED
Elevation View**

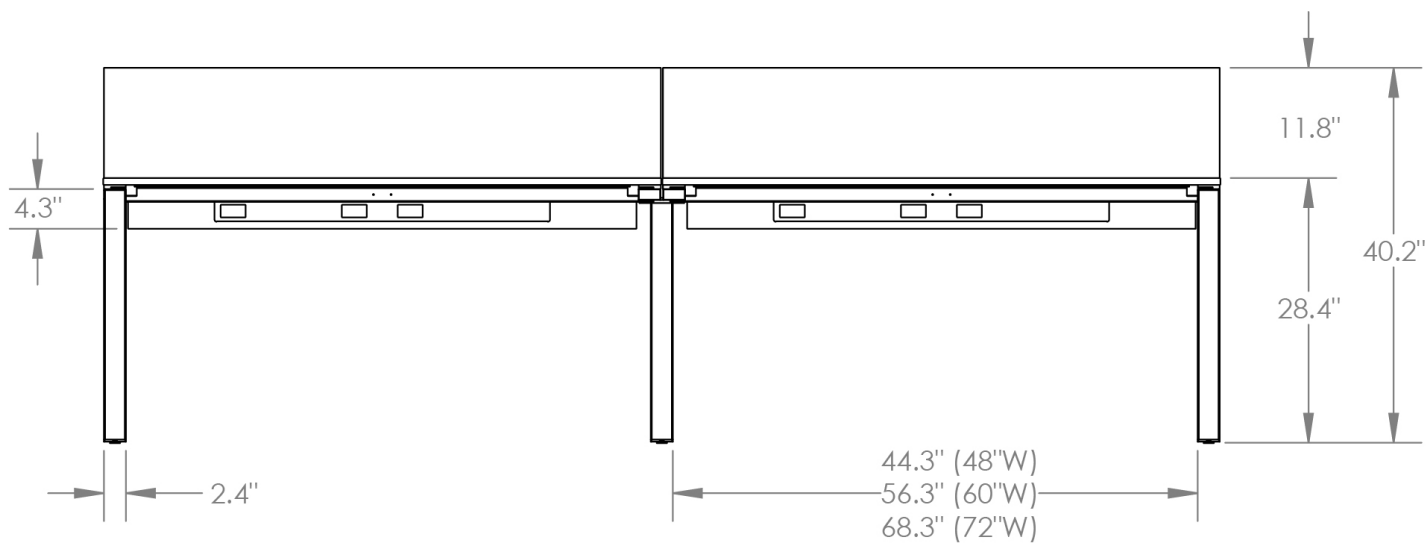

Power and Data

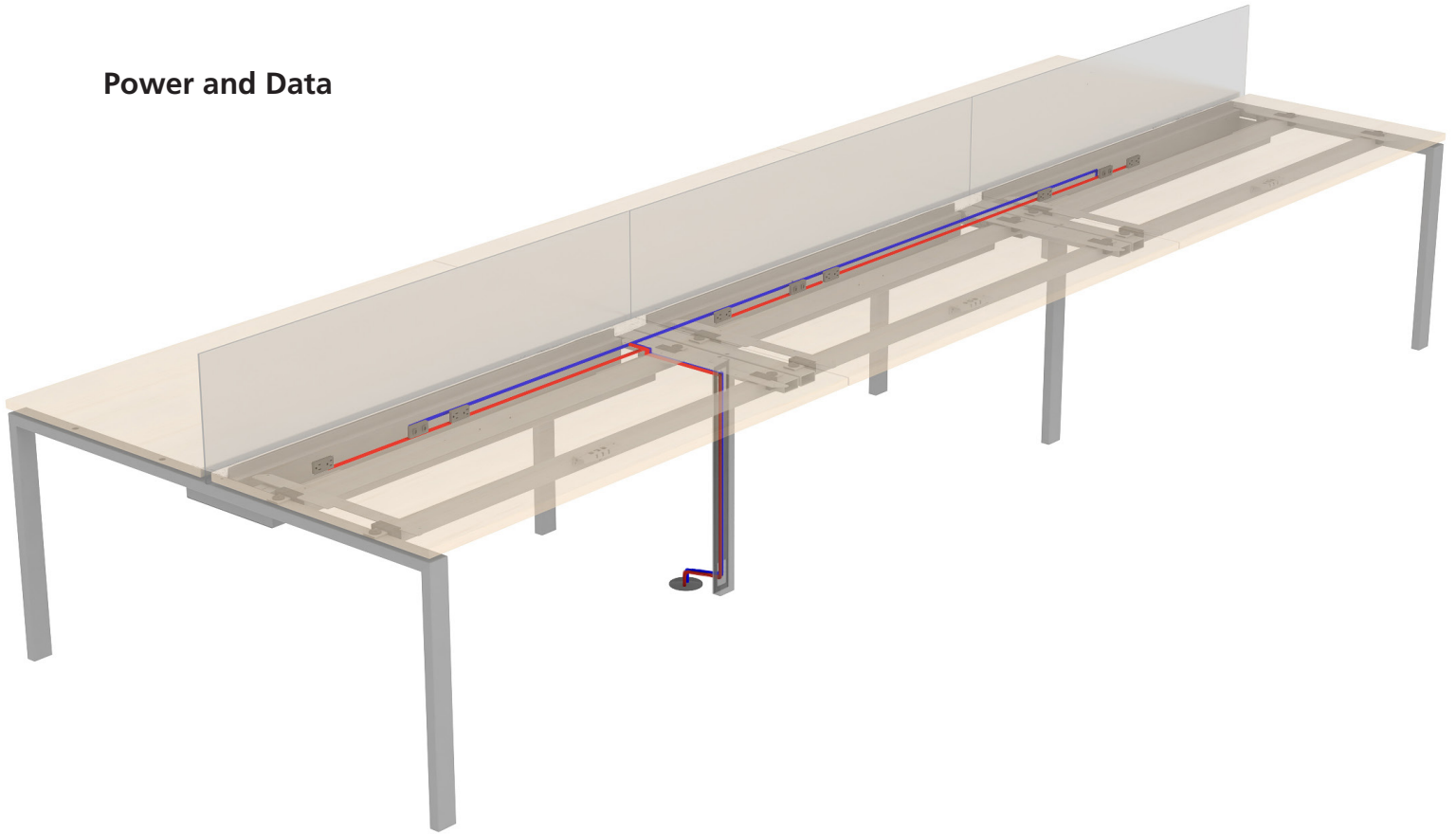

8 Wire Power with Dedicated Circuit

eBench's 8-wire power system with a Dedicated Circuit (3+1 or 2+2) comes installed. Receptacles must be specified separately.

Note: All 8-wire modular wiring comes standard with metallic conduit.

System Features:

8-wires, 4 circuits, 20 amps each
 13 - duplex receptacles per circuit,
 26 - 15 amp duplex receptacles per power infeed maximum

UL Listed as a Manufactured Wiring System.

8-Trac - 4 Circuit Separate Neutral, 8 Wires (3+1)

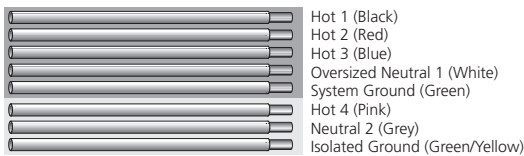

8-Trac - 4 Circuit Separate Neutral, 8 Wires (2+2)

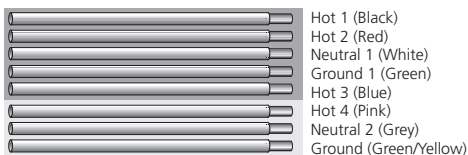

San Francisco Power or Municipalities with Metallic Conduit Requirements

For San Francisco and any other municipalities whose electrical code requires metallic conduit on all modular wiring, 8-Trac comes standard with metallic conduit and is fully San Francisco compliant.

Chicago Power

J-boxes are available for Chicago installations as a special. Contact quotes@enwork.com before ordering.

New York City Power

New York City electrical code requires metallic conduit on all modular wiring. All of the modular wiring harnesses for eBench come standard with metallic conduit. eBench Base Power Infeeds UPHASE5NY or UPHASE8NY must be used. Modular wiring components must be field installed.

eBench Functionality

Structure

- Legs, support bars, and center technology raceway are made of powder coated steel.
- Available Double- or Single-sided, in 1- to 12-packs for 24" or 30"D and 48", 60", or 72"W worksurfaces.
- Structure includes legs, support bars, sliding top mechanisms, connectors, top latches, magnetic removable cable management leg cover, and center technology raceway.
- Shared legs are inset to provide extra room for storage components and additional knee space.
- Center technology raceway includes integral topper screen mount, cable troughs, data cut-outs, and a 4-circuit power system. Receptacles are ordered separately.

Accessories

- Frosted acrylic, fabric (non-tackable), frosted glass, and etched (frosted) glass topper screens available 12" or 22"H.
- Multiple surface- and edge-mount power and data options are available for easy user access.
- CPU holder fits towers up to 8"W x 20"H.
- Laminate end panels fill the inside of the leg structure for enhanced privacy and additional aesthetic customization.
- eBench 12" Skinny™ mobile box-file ped is ideal for high density applications. eBench 15" mobile box-file peds, Apex™, Grid™, and Landscape storage options are also available as coordinating storage.

Tops

- ¾" thick with high pressure laminate and a 3mm edge.
- Actual dimensions are nominally undersized for clearance.
- Tops are pre-drilled for easy installation.

Power Data

- Power data spine has two duplexes and a one data cover (with two data openings) for each user.
- Standard 8-wire modular wiring system comes with metal conduit.
- Power data spine metal covers are removable for installation and cable routing.
- Receptacles are ordered separately.

Power Data Routing Planning Tips

- Power/data is routed from the floor through a magnetic removable inset leg cover, under the structure, and into the center technology raceway.
- Double-sided 2-packs and Single-sided 1-pack include a vertical cable routing vertebrae.
- Double-sided 4- and 6-packs and Single-sided 2-, 3-, and 4-packs include one removable leg cover.
- Double-sided 8-, 10-, and 12-packs, and Single-sided 5- and 6-packs include two removable leg covers.
- Power Poles (10', 12', 15') are available.
- Base power infeeds ordered separately.

Planning Workstations

Space Planning

- Double-sided and single-sided eBench workstations are true dimensions – no creep – for space planning. The width of each workstation in an X-pack is a true 48", 60" or 72". The depth of each X-pack is a true 24" or 30", or 48" or 60".
- Worksurfaces are slightly undersized and specific to double- or single-sided applications.
- X-Packs cannot be connected to other X-packs.
- Each X-Pack uses a separate BPI.

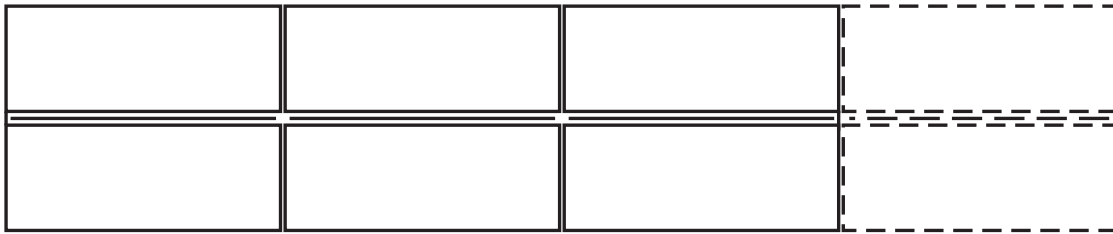

Single-sided Workstations

- Cable troughs on single-sided workstations drop down for easy access.
- A combination privacy screen/modesty panel is available. Single-sided workstations do not accommodate a topper screen.

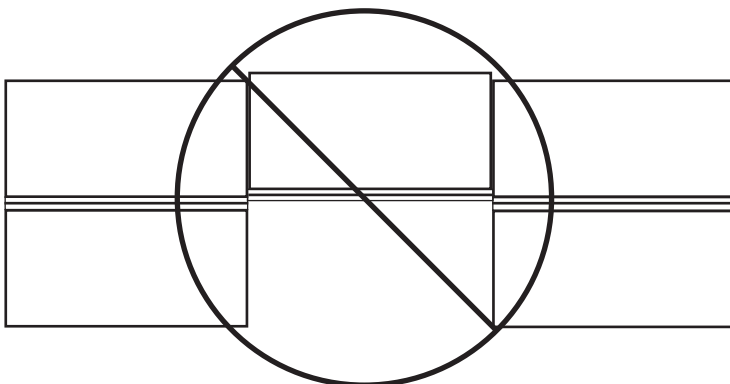

Specifying eBench Workstations

- Step 1** Select Double- or Single-sided structures and the appropriate pack size
- Step 2** Specify corresponding worksurfaces
- Step 3** Choose base power infeed and receptacles
- Step 4** Add optional surface or edge mount power accessories and CPU holder
- Step 5** Choose topper screens for Double-sided privacy, combo privacy/modesty panel for Single-sided
- Step 6** Add optional end panels
- Step 7** Add storage

STEP 1**(^) Paint Suffix List**

S Silver	no charge
G Slate Grey	+\$500
R Black	+\$500
T Medium Tone	+\$500
W Arctic White	+\$500
Z Other	TBD

Tip: Some Steelcase, Herman Miller, Knoll, Haworth, and Allsteel paints are available for \$350 list fee per order. Call/email for availability of specific colors. Additional custom paints (e.g. Tiger Dry Lac) must be quoted through quotes@enwork.com.

Product Specifications:

- > Center raceway comes with installed 8-wire power system.
- > Includes two duplex receptacle openings and two data openings per user.
- > Data knockout adapter tree included.

Ordering Information:

- > Includes legs, power system, power data routing removable magnetic leg cover, support bars, center technology raceway, and sliding top mechanisms with latches.
- > Tops, infeeds, receptacles, and privacy screens ordered separately.
- > Accessories ordered separately.
- > **A freight fee of \$100 net is assessed on orders less than \$1000 net. See page 13.**

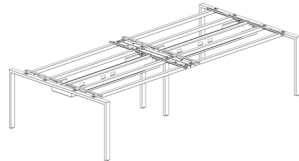

Part Number	Description	List Price (US\$)
-------------	-------------	-------------------

Double-sided Structures for 24"D Tops

EBD22448^	Double-Sided, w/ 24"D top, 48"W, 2-pack	\$2032
EBD42448^	Double-Sided, w/ 24"D top, 48"W, 4-pack	\$3992
EBD62448^	Double-Sided, w/ 24"D top, 48"W, 6-pack	\$5954
EBD82448^	Double-Sided, w/ 24"D top, 48"W, 8-pack	\$7915
EBDA2448^	Double-Sided, w/ 24"D top, 48"W, 10-pack	\$9876
EBDB2448^	Double-Sided, w/ 24"D top, 48"W, 12-pack	\$11,838
EBD22460^	Double-Sided, w/ 24"D top, 60"W, 2-pack	\$2067
EBD42460^	Double-Sided, w/ 24"D top, 60"W, 4-pack	\$4086
EBD62460^	Double-Sided, w/ 24"D top, 60"W, 6-pack	\$6105
EBD82460^	Double-Sided, w/ 24"D top, 60"W, 8-pack	\$8125
EBDA2460^	Double-Sided, w/ 24"D top, 60"W, 10-pack	\$10,144
EBDB2460^	Double-Sided, w/ 24"D top, 60"W, 12-pack	\$12,163
EBD22472^	Double-Sided, w/ 24"D top, 72"W, 2-pack	\$2147
EBD42472^	Double-Sided, w/ 24"D top, 72"W, 4-pack	\$4262
EBD62472^	Double-Sided, w/ 24"D top, 72"W, 6-pack	\$6378
EBD82472^	Double-Sided, w/ 24"D top, 72"W, 8-pack	\$8493
EBDA2472^	Double-Sided, w/ 24"D top, 72"W, 10-pack	\$10,609
EBDB2472^	Double-Sided, w/ 24"D top, 72"W, 12-pack	\$12,724

Double-sided Structures for 30"D Tops

EBD23048^	Double-Sided, w/ 30"D top, 48"W, 2-pack	\$2066
EBD43048^	Double-Sided, w/ 30"D top, 48"W, 4-pack	\$4029
EBD63048^	Double-Sided, w/ 30"D top, 48"W, 6-pack	\$5992
EBD83048^	Double-Sided, w/ 30"D top, 48"W, 8-pack	\$7995
EBDA3048^	Double-Sided, w/ 30"D top, 48"W, 10-pack	\$9917
EBDB3048^	Double-Sided, w/ 30"D top, 48"W, 12-pack	\$11,880
EBD23060^	Double-Sided, w/ 30"D top, 60"W, 2-pack	\$2102
EBD43060^	Double-Sided, w/ 30"D top, 60"W, 4-pack	\$4123
EBD63060^	Double-Sided, w/ 30"D top, 60"W, 6-pack	\$6143
EBD83060^	Double-Sided, w/ 30"D top, 60"W, 8-pack	\$8164
EBDA3060^	Double-Sided, w/ 30"D top, 60"W, 10-pack	\$10,185
EBDB3060^	Double-Sided, w/ 30"D top, 60"W, 12-pack	\$12,205
EBD23072^	Double-Sided, w/ 30"D top, 72"W, 2-pack	\$2181
EBD43072^	Double-Sided, w/ 30"D top, 72"W, 4-pack	\$4298
EBD63072^	Double-Sided, w/ 30"D top, 72"W, 6-pack	\$6416
EBD83072^	Double-Sided, w/ 30"D top, 72"W, 8-pack	\$8533
EBDA3072^	Double-Sided, w/ 30"D top, 72"W, 10-pack	\$10,649
EBDB3072^	Double-Sided, w/ 30"D top, 72"W, 12-pack	\$12,767

COORDINATING FURNITURE

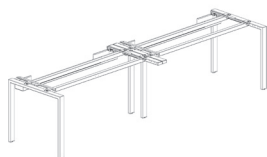
See page 82 for
coordinating eBench Tables.

Part Number	Description	List Price (US\$)
-------------	-------------	-------------------

Single-sided Structures for 24"D Tops

EBN12448^	Single-Sided, w/ 24"D top, 48"W, 1-pack	\$1315
EBN22448^	Single-Sided, w/ 24"D top, 48"W, 2-pack	\$2703
EBN32448^	Single-Sided, w/ 24"D top, 48"W, 3-pack	\$4091
EBN42448^	Single-Sided, w/ 24"D top, 48"W, 4-pack	\$5479
EBN52448^	Single-Sided, w/ 24"D top, 48"W, 5-pack	\$6824
EBN62448^	Single-Sided, w/ 24"D top, 48"W, 6-pack	\$8212
EBN12460^	Single-Sided, w/ 24"D top, 60"W, 1-pack	\$1290
EBN22460^	Single-Sided, w/ 24"D top, 60"W, 2-pack	\$2718
EBN32460^	Single-Sided, w/ 24"D top, 60"W, 3-pack	\$4146
EBN42460^	Single-Sided, w/ 24"D top, 60"W, 4-pack	\$5574
EBN52460^	Single-Sided, w/ 24"D top, 60"W, 5-pack	\$7002
EBN62460^	Single-Sided, w/ 24"D top, 60"W, 6-pack	\$8430
EBN12472^	Single-Sided, w/ 24"D top, 72"W, 1-pack	\$1336
EBN22472^	Single-Sided, w/ 24"D top, 72"W, 2-pack	\$2814
EBN32472^	Single-Sided, w/ 24"D top, 72"W, 3-pack	\$4299
EBN42472^	Single-Sided, w/ 24"D top, 72"W, 4-pack	\$5784
EBN52472^	Single-Sided, w/ 24"D top, 72"W, 5-pack	\$7268
EBN62472^	Single-Sided, w/ 24"D top, 72"W, 6-pack	\$8753

Single-sided Structures for 30"D Tops

EBN13048^	Single-Sided, w/ 30"D top, 48"W, 1-pack	\$1377
EBN23048^	Single-Sided, w/ 30"D top, 48"W, 2-pack	\$2777
EBN33048^	Single-Sided, w/ 30"D top, 48"W, 3-pack	\$4177
EBN43048^	Single-Sided, w/ 30"D top, 48"W, 4-pack	\$5577
EBN53048^	Single-Sided, w/ 30"D top, 48"W, 5-pack	\$6977
EBN63048^	Single-Sided, w/ 30"D top, 48"W, 6-pack	\$8340
EBN13060^	Single-Sided, w/ 30"D top, 60"W, 1-pack	\$1395
EBN23060^	Single-Sided, w/ 30"D top, 60"W, 2-pack	\$2835
EBN33060^	Single-Sided, w/ 30"D top, 60"W, 3-pack	\$4275
EBN43060^	Single-Sided, w/ 30"D top, 60"W, 4-pack	\$5679
EBN53060^	Single-Sided, w/ 30"D top, 60"W, 5-pack	\$7156
EBN63060^	Single-Sided, w/ 30"D top, 60"W, 6-pack	\$8594
EBN13072^	Single-Sided, w/ 30"D top, 72"W, 1-pack	\$1435
EBN23072^	Single-Sided, w/ 30"D top, 72"W, 2-pack	\$2931
EBN33072^	Single-Sided, w/ 30"D top, 72"W, 3-pack	\$4428
EBN43072^	Single-Sided, w/ 30"D top, 72"W, 4-pack	\$4925
EBN53072^	Single-Sided, w/ 30"D top, 72"W, 5-pack	\$7421
EBN63072^	Single-Sided, w/ 30"D top, 72"W, 6-pack	\$8917

STEP 1

(*) Worksurface Application Suffix List

- 2 eBench Double-sided no charge
- 1 eBench Single-sided no charge

STEP 2

(@) Cable Management Suffix List

- N No Cut-out no charge
- Y Cut-out for Convenience +\$18
Power or USB
- X Other Cut-out +\$36

STEP 3

(#) Laminate Suffix List:

- A Wilsonart Kensington Maple (10776-60)
- B Wilsonart Monticello Maple (7925-38)
- C Wilsonart Wild Cherry (7054-60)
- E Wilsonart Fashion Grey (D381-60)
- F Wilsonart White Tigris (4783-60)
- G Wilsonart Cafelle (7933K-07)
- M Wilsonart Frosty White (1573-60)
- P Wilsonart Slate Grey (D91-60)
- R Wilsonart Black (1595-60)
- U Wilsonart Brazilwood (7946-38)
- V Wilsonart River Cherry (7937-38)
- W Wilsonart Designer White (D354-60)
- 3 Formica Neutral Twill (8826-58)
- 4 Formica Bleached Legno (8845-58)
- 5 Formica Prestige Walnut (6209-43)
- 7 Formica Select Cherry (7759-43)
- X *Wilsonart Non-Premium laminates (-38, -60). +10%
Orders of 100+ units have no upcharge.
- Y *Formica Non-Premium Standard (58, 43, +19%
MC, SP and NT finishes) and Wilsonart Premium
(-01, -07, -12, -18, -52, -78) laminates.
- Z *Pionite Non-Premium, Nevamar Non- +25%
Premium, Formica Premium (WR, 42, 77,
46, RD Finishes), and whiteboard laminate.

*Add \$350 list for Special Laminate orders of less than 10 units. See page 21.

Product Specifications:

- > Edge of worksurface is 3mm.
- > eBench worksurfaces are 3/4" thick. 1-1/4" worksurfaces are available as a special.
- > Single-sided top depth is exact. Double-sided top depth is 3/4" less than nominal.
Actual top width is 1/8" less than nominal.

Ordering Information:

- > A freight fee of \$100 net is assessed on orders less than \$1000 net. See page 13.

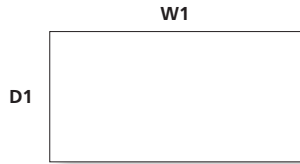

Part Number	Description	List Price (US\$)
24"D eBench Worksurface, 3/4" Laminate w/ 3mm edge		
EBTOP2448A*#@#	Worksurface, Laminate, 48"W	\$232
EBTOP2460A*#@#	Worksurface, Laminate, 60"W	\$293
EBTOP2472A*#@#	Worksurface, Laminate, 72"W	\$332
30"D eBench Worksurface, 3/4" Laminate w/ 3mm edge		
EBTOP3048A*#@#	Worksurface, Laminate, 48"W	\$299
EBTOP3060A*#@#	Worksurface, Laminate, 60"W	\$345
EBTOP3072A*#@#	Worksurface, Laminate, 72"W	\$395

Tip: Surface mount convenience outlets specified separately. See page 268.

Part Number	Description	List Price (US\$)
Base Power Infeed for eBench 8-Wire, 4-Circuit Powerways, Metallic		
UPHASE728W	8-Wire Power Infeed for Hardwire, 72"	\$187
UPHASE1208W	8-Wire Power Infeed, Black, for Hardwire, 120"	\$248
UPHASE2408W	8-Wire Power Infeed, Black, for Hardwire, 240" (use with Power Poles)	\$436
NYC Power Entry Kit, Bolt Mount, 72" Length		
UPHASE5NY	5-Wire Power Entry Kit, NYC, Bolt Mount, 15.59"	\$310
UPHASE8NY	8-Wire Power Entry Kit, NYC, Bolt Mount, 15.59"	\$310
Power Poles, Two Chamber, Clear Anodized Aluminum, 2.3"W x 2.3"D		
UPHPP10	Power Pole, 10'H	\$1287
UPHPP12	Power Pole, 12'H	\$1465
UPHPP15	Power Pole, 15'H	\$1710
<p>Tip: Power Pole has a cable routing hole on side of pole at the bottom. Infeed passes through the hole, across the floor, and into hole at the bottom of the infeed leg. Additional hole(s) can be field cut to allow routing directly into the power system.</p> <p>Tip: Includes mounting hardware and ceiling trim plate.</p> <p>Tip: Power infeed not included. Order 240" base power infeed separately.</p>		
Receptacles for eBench 8-Wire, 4-Circuit Powerway		
For 3+1 Wiring Schematic, 15-Amp, Grey		
UREC8W15G311	15-amp Receptacle for 4-circuit (3+1) Powerway, Circuit 1	\$36
UREC8W15G312	15-amp Receptacle for 4-circuit (3+1) Powerway, Circuit 2	\$36
UREC8W15G313	15-amp Receptacle for 4-circuit (3+1) Powerway, Circuit 3	\$36
UREC8W15G314	15-amp Receptacle for 4-circuit (3+1) Powerway, Circuit 4 (Dedicated)	\$36
For 3+1 Wiring Schematic, 20-Amp, Grey		
UREC8W20G311	20-amp Receptacle for 4-circuit (3+1) Powerway, Circuit 1	\$41
UREC8W20G312	20-amp Receptacle for 4-circuit (3+1) Powerway, Circuit 2	\$41
UREC8W20G313	20-amp Receptacle for 4-circuit (3+1) Powerway, Circuit 3	\$41
UREC8W20G314	20-amp Receptacle for 4-circuit (3+1) Powerway, Circuit 4 (Dedicated)	\$41
For 2+2 Wiring Schematic, 15-Amp, Grey		
UREC8W15G221	15-amp Receptacle for 4-circuit (2+2) Powerway, Circuit 1	\$36
UREC8W15G222	15-amp Receptacle for 4-circuit (2+2) Powerway, Circuit 2	\$36
UREC8W15G223	15-amp Receptacle for 4-circuit (2+2) Powerway, Circuit 3 (Dedicated)	\$36
UREC8W15G224	15-amp Receptacle for 4-circuit (2+2) Powerway, Circuit 4 (Dedicated)	\$36
For 2+2 Wiring Schematic, 20-Amp, Grey		
UREC8W20G221	20-amp Receptacle for 4-circuit (2+2) Powerway, Circuit 1	\$41
UREC8W20G222	20-amp Receptacle for 4-circuit (2+2) Powerway, Circuit 2	\$41
UREC8W20G223	20-amp Receptacle for 4-circuit (2+2) Powerway, Circuit 3 (Dedicated)	\$41
UREC8W20G224	20-amp Receptacle for 4-circuit (2+2) Powerway, Circuit 4 (Dedicated)	\$41
Building Automation Receptacle Sticker, Package of 40		
UTITLE24	Building Automation Receptacle sticker for California Title 24	\$23



STEP 1 - CPU Holder

(^) Paint Suffix List

S Silver	no charge
G Slate Grey	+\$29
R Black	+\$29
T Medium Tone	+\$29
W Arctic White	+\$29
Z Other	TBD

Tip: Some Steelcase, Herman Miller, Knoll, Haworth, and Allsteel paints are available for \$350 list fee per order. Call/email for availability of specific colors. Additional custom paints (e.g. Tiger Dry Lac) must be quoted through quotes@enwork.com.

Ordering Information:

> A freight fee of \$100 net is assessed on orders less than \$1000 net. See page 13.



Part Number	Description	List Price (US\$)
-------------	-------------	-------------------

Surface Mount Convenience Outlet

Cord/Hardwire: 6' power cord (longer cords available)

Features: Spill proof technology

Material: Molded plastic

Surface Mount Convenience Outlet

PDTSW	Simplex Power Outlet, White	\$103
PDTSG	Simplex Power Outlet, Grey	\$103
PDTSR	Simplex Power Outlet, Black	\$103
PDTPW	Stacked Charging USB Outlet, White	\$309
PDTPG	Stacked Charging USB Outlet, Grey	\$309
PDTPB	Stacked Charging USB Outlet, Black	\$309

Tip: Surface Mount Convenience Outlet is located 1-1/2" from back edge and 14" from right side of worksurface. See diagram below.



Tip: Each convenience outlet uses one power outlet in the raceway spine.



Axil-X

Data Options: ▲

Cord/Hardwire: 6' power cord

Features: Clamps to any worksurface, 15amp

Additional Specials: Longer cords, different number of openings

Material: Anodized aluminum

Axil-X Clamp-On Power/Data Assembly with 6' power cord

PDAX22R	Axil-X Clamp-on, 2 pwr/2 data openings, Black	\$479
PDAX22S	Axil-X Clamp-on, 2 pwr/2 data openings, Silver	\$365
PDAX22W	Axil-X Clamp-on, 2 pwr/2 data openings, White	\$365
PDAX21UR	Axil-X Clamp-on, 2 pwr/1 data opening/2 charging USB (stacked), Black	\$604
PDAX21US	Axil-X Clamp-on, 2 pwr/1 data opening/2 charging USB (stacked), Silver	\$489
PDAX21UW	Axil-X Clamp-on, 2 pwr/1 data opening/2 charging USB (stacked), White	\$489



CPU Holder

EBCPU^	CPU Holder	\$153
--------	------------	-------

Tip: For use with eBench structures only. Fits CPU towers up to 8"W x 20"H.

Tip: Must attach to interior crossrail when using End Panel.



Enwork Monitor Arm, with USB, Silver

EBMA11S	Monitor Arm, Single Mount with dual USB ports, Silver	\$384
---------	---	-------

Tip: Off-center installation recommended.

EBMA22S	Monitor Arm, Dual Mount with dual USB ports, Silver	\$TBD
---------	---	-------

Tip: Still in development. See enwork.com or call for availability.

Product Specifications:

- > Glass and acrylic topper screens are 1/4" thick.
- > eBench Topper screens only available for Double-sided workstations.
- > End panels nest within the eBench frame with no external hardware.
- > Privacy Screen/Modesty Panel for Single-sided eBench is 24.5" tall and 3/4" thick. Height aligns with 12"H Double-sided eBench topper screen.

Ordering Information:

- > A freight fee of \$100 net is assessed on orders less than \$1000 net. See page 13.

STEP 1 - Privacy/Modesty Combo and End Panel

(#) Laminate Suffix List:

- A Wilsonart Kensington Maple (10776-60)
- B Wilsonart Monticello Maple (7925-38)
- C Wilsonart Wild Cherry (7054-60)
- E Wilsonart Fashion Grey (D381-60)
- F Wilsonart White Tigris (4783-60)
- G Wilsonart Cafelle (7933K-07)
- M Wilsonart Frosty White (1573-60)
- P Wilsonart Slate Grey (D91-60)
- R Wilsonart Black (1595-60)
- U Wilsonart Brazilwood (7946-38)
- V Wilsonart River Cherry (7937-38)
- W Wilsonart Designer White (D354-60)
- 3 Formica Neutral Twill (8826-58)
- 4 Formica Bleached Legno (8845-58)
- 5 Formica Prestige Walnut (6209-43)
- 7 Formica Select Cherry (7759-43)
- X *Wilsonart Non-Premium laminates (-38, -60). +10% Orders of 100+ units have no upcharge.
- Y *Formica Non-Premium Standard (58, 43, +19% MC, SP and NT finishes) and Wilsonart Premium (-01, -07, -12, -18, -52, -78) laminates.
- Z *Pionite Non-Premium, Nevamar Non-Premium, Formica Premium (WR, 42, 77, 46, RD Finishes), and whiteboard laminate. +25%

*Add \$350 list for Special Laminate orders of less than 10 units. See page 21.

STEP 1 - Non-Tackable Fabric Screen

(?) Fabric Suffix List:

Free form fabric selection. Choose from Camira Mill L2 or Lucia fabrics.

Tip: To view fabric colors or to order samples go to www.camirafabrics.com/us.

Tip: For COM yardage, see page 16.

Part Number	Description	List Price (US\$)
Frosted Acrylic Topper Screen for Double-sided eBench, 12"H		
EBTA1248	Frosted Acrylic Topper Screen, 48"W	\$167
EBTA1260	Frosted Acrylic Topper Screen, 60"W	\$198
EBTA1272	Frosted Acrylic Topper Screen, 72"W	\$236
Frosted Acrylic Topper Screen for Double-sided eBench, 22"H		
EBTA2248	Frosted Acrylic Topper Screen, 48"W	\$268
EBTA2260	Frosted Acrylic Topper Screen, 60"W	\$324
EBTA2272	Frosted Acrylic Topper Screen, 72"W	\$386
Non-Tackable Fabric Topper Screen for Double-sided eBench, 12"H		
EBTN1248?	Non-Tackable Fabric Topper Screen, 48"W	\$451
EBTN1260?	Non-Tackable Fabric Topper Screen, 60"W	\$536
EBTN1272?	Non-Tackable Fabric Topper Screen, 72"W	\$675
Frosted Glass Topper Screen for Double-sided eBench, 12"H		
EBTG1248	Frosted Glass Topper Screen, 48"W	\$541
EBTG1260	Frosted Glass Topper Screen, 60"W	\$634
EBTG1272	Frosted Glass Topper Screen, 72"W	\$767
Frosted Glass Topper Screen for Double-sided eBench, 22"H		
EBTG2248	Frosted Glass Topper Screen, 48"W	\$831
EBTG2260	Frosted Glass Topper Screen, 60"W	\$1008
EBTG2272	Frosted Glass Topper Screen, 72"W	\$1184
Etched, (Frosted) Glass Topper Screen w/ Large Knots Design for Double-sided eBench, 12"H		
EBTH1248	Large Knots Pattern Etched Glass Topper Screen, 48"W	\$667
EBTH1260	Large Knots Pattern Etched Glass Topper Screen, 60"W	\$806
EBTH1272	Large Knots Pattern Etched Glass Topper Screen, 72"W	\$938
Etched, (Frosted) Glass Topper Screen w/ Large Knots Design for Double-sided eBench, 22"H		
EBTH2248	Large Knots Pattern Etched Glass Topper Screen, 48"W	\$1058
EBTH2260	Large Knots Pattern Etched Glass Topper Screen, 60"W	\$1291
EBTH2272	Large Knots Pattern Etched Glass Topper Screen, 72"W	\$1525
Privacy Screen/Modesty Panel Combo for Single-sided eBench, Laminate		
EBUG48#	Privacy/Modesty Panel, Laminate, 48"W	\$469
EBUG60#	Privacy/Modesty Panel, Laminate, 60"W	\$627
EBUG72#	Privacy/Modesty Panel, Laminate, 72"W	\$691
End Panel for eBench Workstations, Laminate		
EBEND48#	End Panel, for 24"D Double-sided units	\$414
EBEND60#	End Panel, for 30"D Double-sided units	\$472
EBEND24#	End Panel, for 24"D Single-sided units	\$286
EBEND30#	End Panel, for 30"D Single-sided units	\$300

STEP 1

(^) Paint Suffix List

S Silver

W Arctic White

Product Specifications:

> Ped is 19-1/2" tall (including casters).

Ordering Information:

> eBench mobile peds available in silver or arctic white paint only.

> **A freight fee of \$100 net is assessed on orders less than \$1000 net. See page 13.****COORDINATING STORAGE**

See pages 334-337
for coordinating Apex, Grid,
and Landscape storage.



Part Number	Description	List Price (US\$)
-------------	-------------	-------------------

eBench Mobile Box/File Ped w/ side pull drawers, 22"D

EBPED12^	Skinny™ Mobile Box-File Ped, 12"W	\$440
EBPED15^	Mobile Box-File Ped, 15"W	\$475

Tip: eBench pedestals available in silver or arctic white paint only.**Tip:** Apex pedestals, Landscape Storage, and Grid Storage also available. See page 334-337.**Seat Cushions for eBench 12" Skinny™ Mobile Pedestal, Magnet Installation**

EBCUSH12	Ped Cushion, 12"W Skinny Ped, Camira Era or the Mill Collection Fabrics, Specify Pattern & Color	\$170
----------	---	-------

EBCUSHCOM12	Ped Cushion, 12"W Skinny Ped, COM Fabric	\$170
-------------	--	-------

Seat Cushions for eBench 15" Mobile Pedestal, Magnet Installation

EBCUSH15	Ped Cushion, 15"W Ped, Camira Era or the Mill Collection Fabrics, Specify Pattern & Color	\$182
----------	--	-------

EBCUSHCOM15	Ped Cushion, 15"W Ped, COM Fabric	\$182
-------------	-----------------------------------	-------

Tip: To view Camira Era or the Mill Collection fabrics, visit www.camirafabrics.com/us.**Tip:** For COM yardage, see page 16.

Notes

Grid™ Overview - Frames & Workstations

Frame Sizes

Mini 7.9"H - no tile



Standard 15.9"H - tile



Mega 20.6"H - tall tile

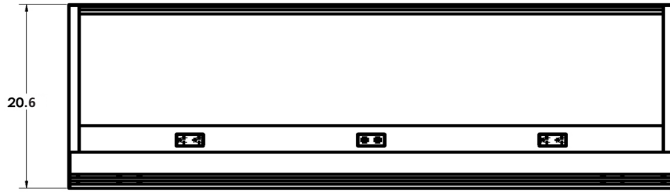

Frame Profiles

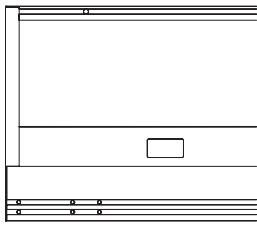

Rail Profile (original design)

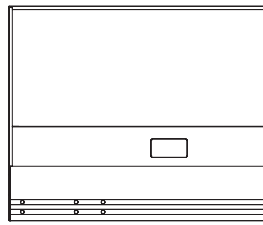

Thin Top Profile (no top rail)

Standard Frame - Workstations

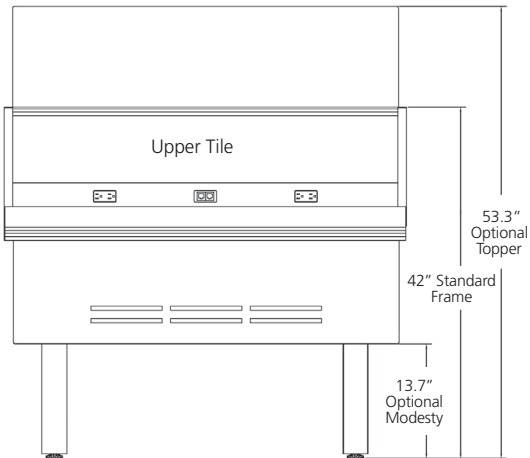

Beltway (Power/Data) Above Worksurface

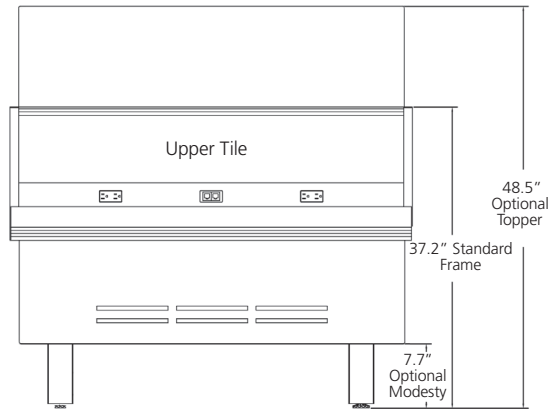

Beltway (Power/Data) Below Worksurface

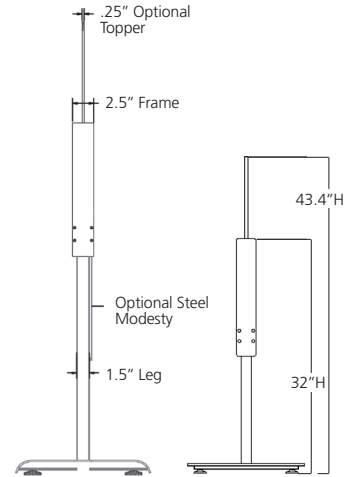

Side View

Low Beltway

Grid Overview - Workstations

Mini Frame - Workstations

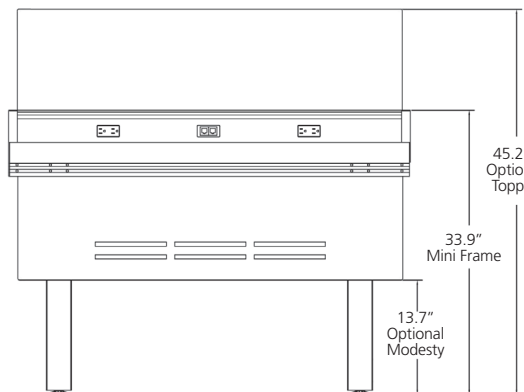

**Mini Frame with Beltway
(Power/Data) Above Worksurface**

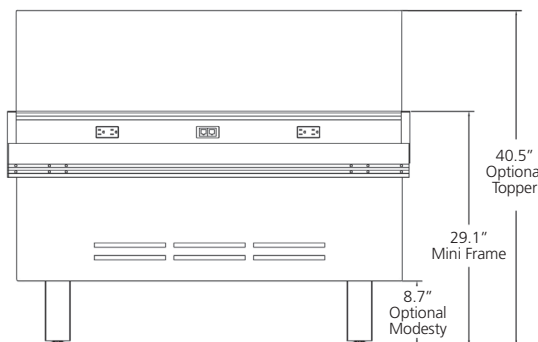

**Mini Frame with Beltway
(Power/Data) Below Worksurface**

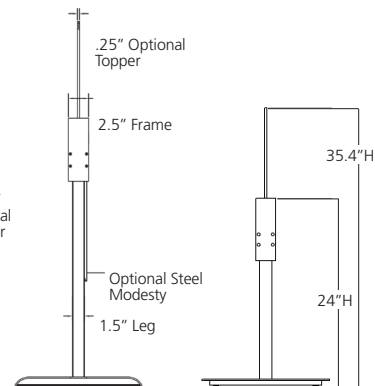

Side View

Low Beltway

Mega Frame - Workstations

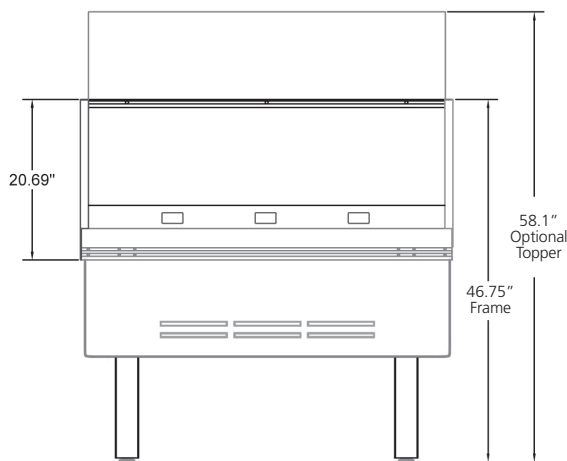

Beltway (Power/Data) Above Worksurface

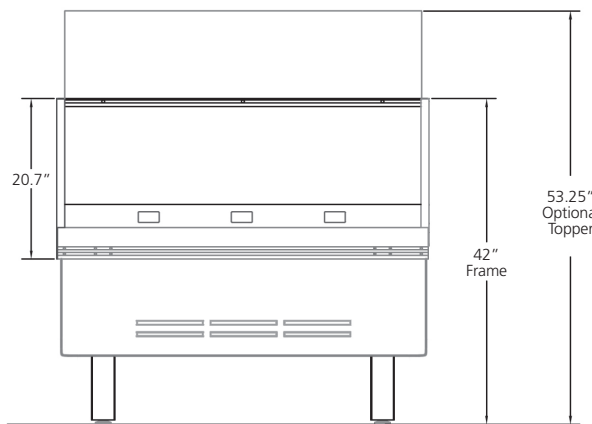

Beltway (Power/Data) Below Worksurface

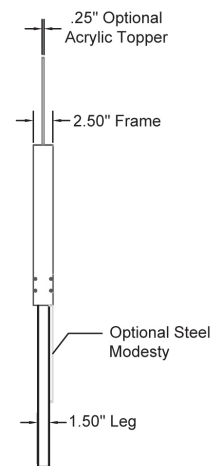

BENCHING ENVIRONMENTS
GRID

Grid XTB Overview

Standard Frame - XTB

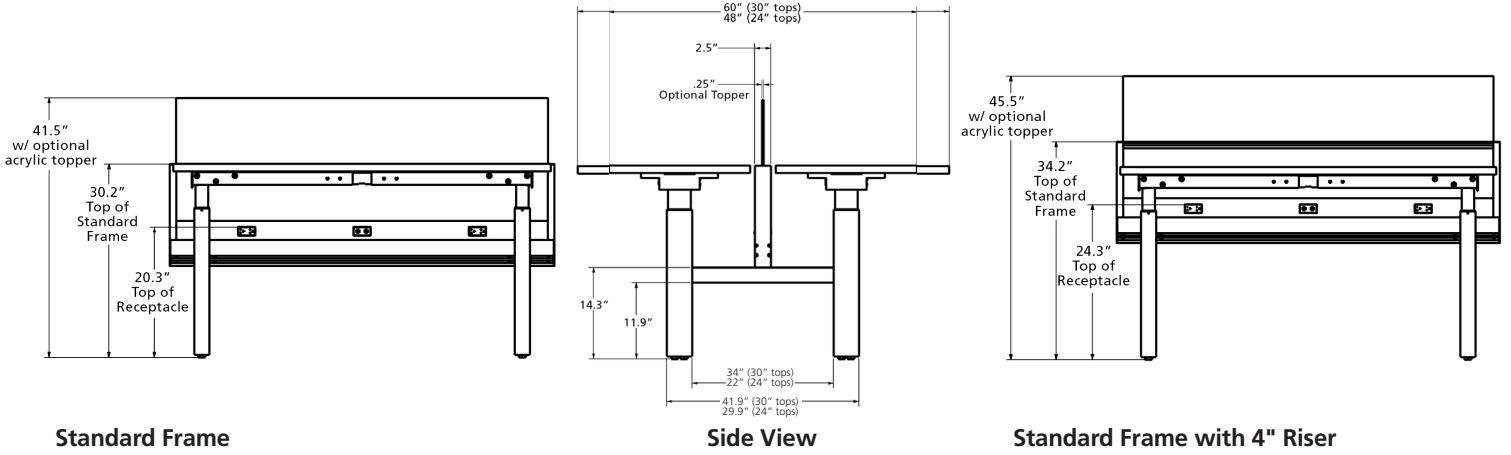

Mini Frame - XTB

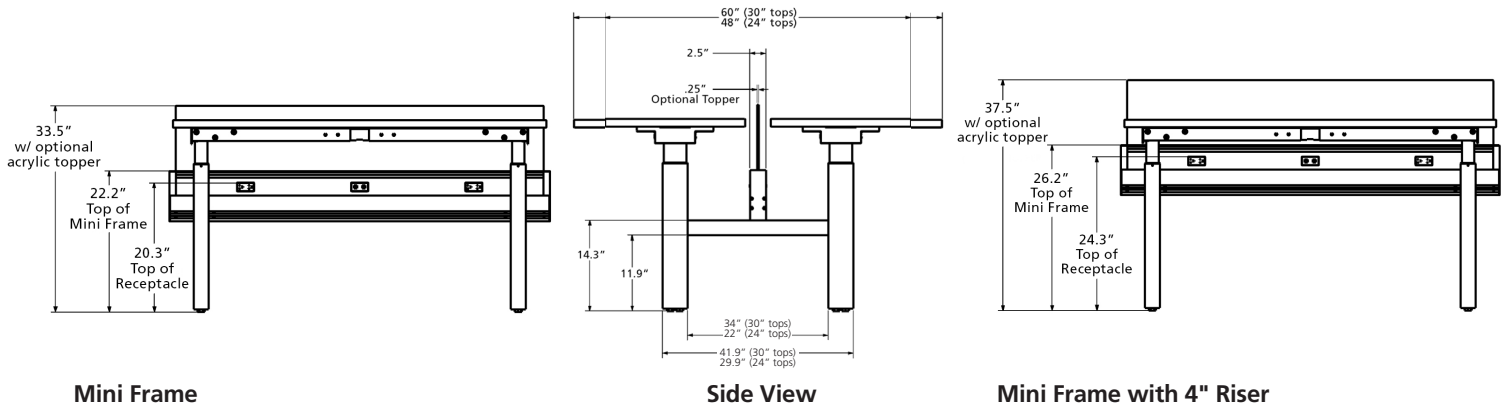

Mega Frame - XTB

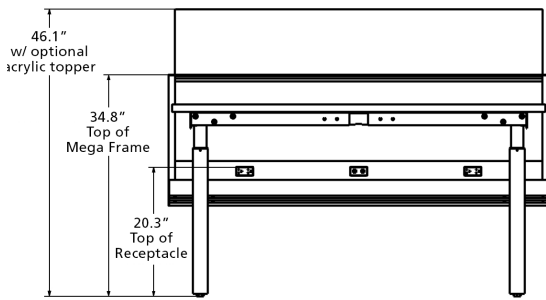

Mega Frame

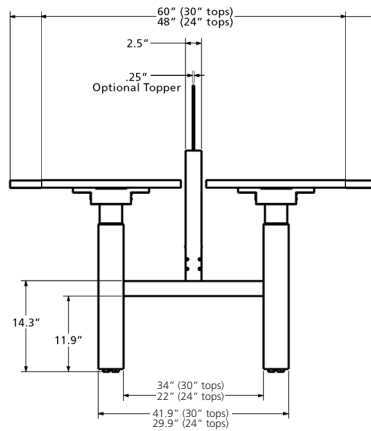

Side View

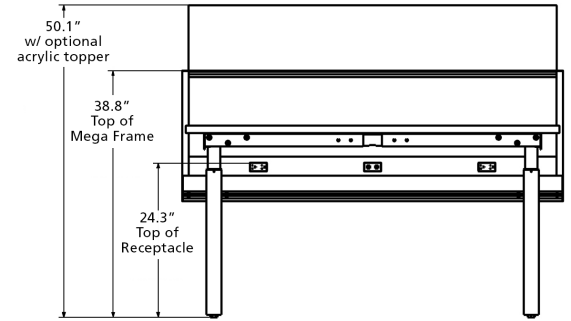

Mega Frame with 4" Riser

Grid Frame Type by Position

Frame Type by Position

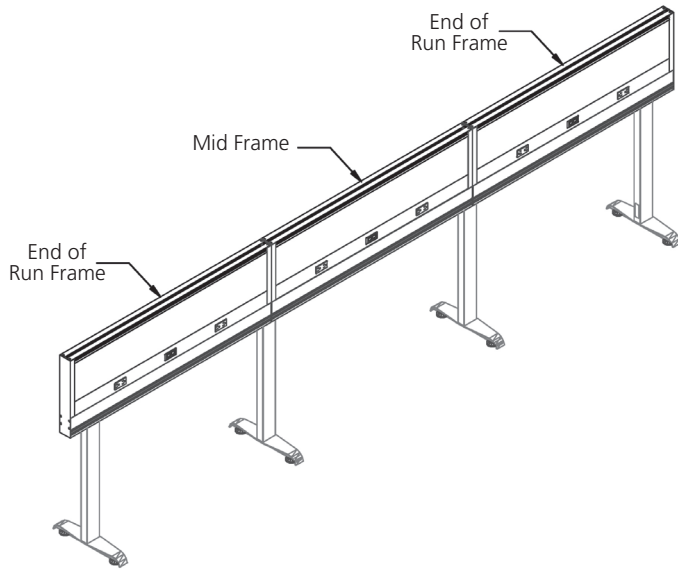

Tip: Spine Wall with no tethering requires T-Legs

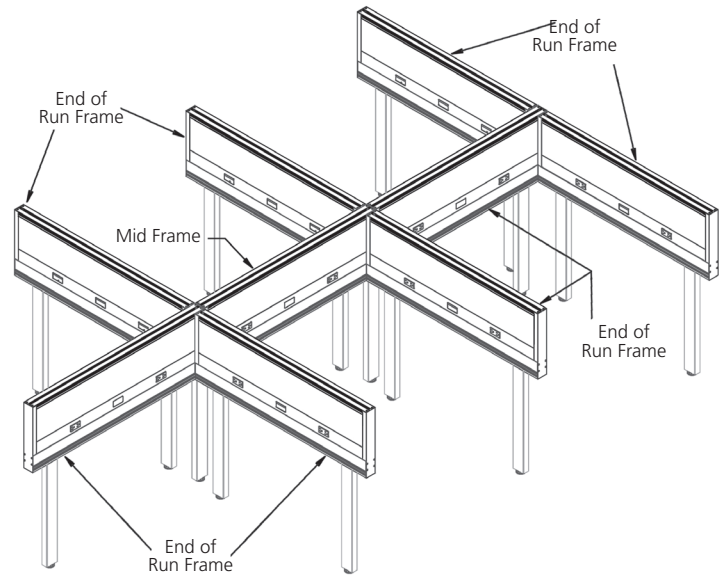

Tip: Spine Wall with tethering can use T-Leg or Straight Leg

End of Run Frame

- One end of Frame is closed and the opposite end is open for lay-in power/data cable routing and Frame-to-Frame attachment.
- Frame, Receptacles, Jumpers and Beltway are included and ship assembled. Tiles and Legs ship separately.
- Not handed.

Mid Frame

- Both ends of Frame are open for lay-in power/data cable routing and Frame-to-Frame attachment.
- Frame, Receptacles, Jumpers, and Beltway are included and ship assembled. Tiles and Legs ship separately.

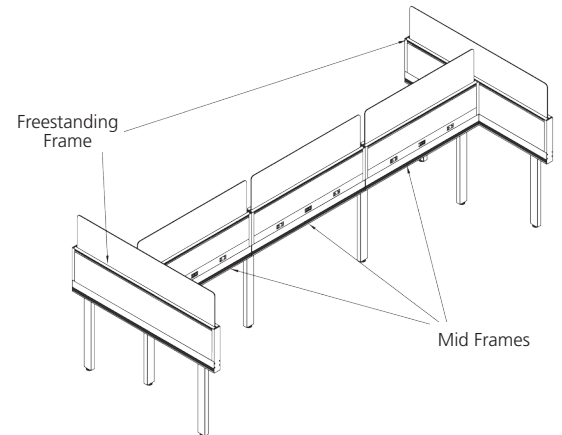

Tip: All Frames are clear anodized aluminum

Freestanding Frame

- Both ends of Frame are closed.
- Intended for single Frame applications or end of Spines (see diagram). No openings exist for Frame-to-Frame attachment on end of Frame.
- Frame, Receptacles, Jumpers and Beltway are included and ship assembled. Tiles and Legs ship separately.

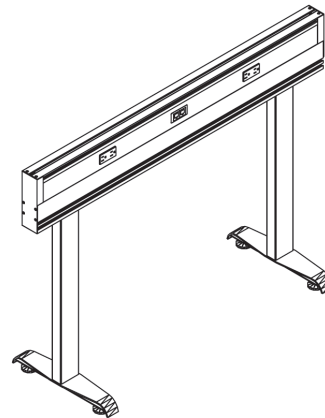
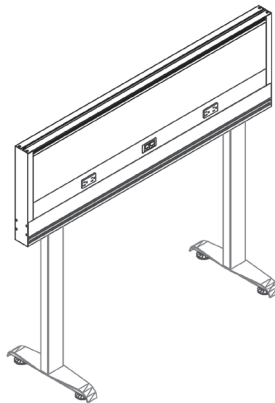

Grid Frame Functionality & Power Data

Frame Functionality

Top Rail Top Slot

- Utilized for optional Topper Screen.

Top Rail Side Slot (1 each side) Rail Profile (original design) only

- Utilized for work tools.
- Utilized for Frame-to-Frame 90 degree connections.
- Not included with Thin Profile Frames

Bottom Rail Side Slots (2 each side)

- Utilized for optional worksurface tether brackets (connects worksurfaces to Frames).
- Utilized for leg attachment.
- Utilized for 90 and 120 degree attachment.
- Utilized for optional Cable Tray.

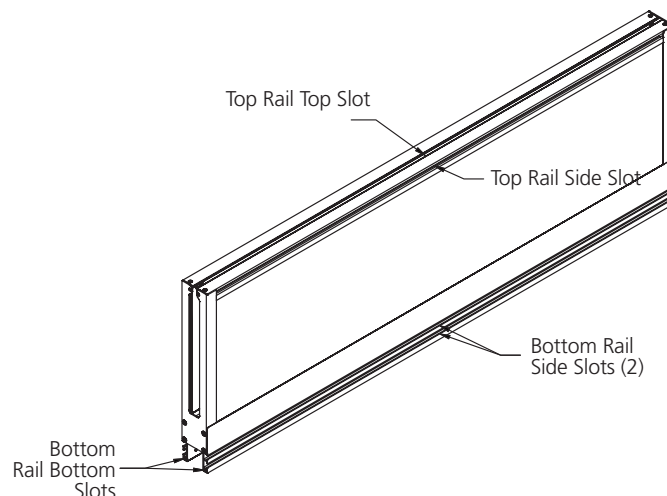

Bottom Rail Bottom Slots (1 each side)

- Utilized for modesty panels.

Power and Data

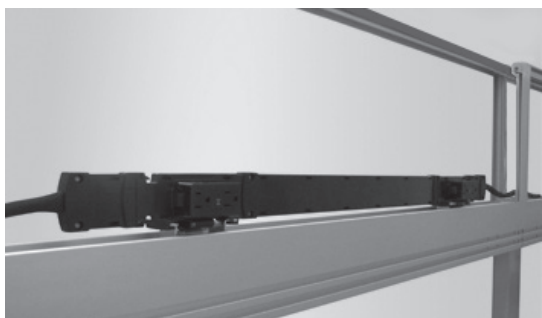

Overview

- Power is typically ordered as part of Frame and **comes installed**.
- Grid frames offer **lay-in** installation of power and data across multiple frames.
- Utilizes the Byrne Phase 3, 5-wire, three 15 amp circuit double (or single) sided power system. Phase 3 contains 3 hot wires, common neutral and common ground.
- Phase 3 is UL 1286 Listed.
- In situations requiring dedicated circuits the Byrne 8-Trac System (4 circuits) may be seamlessly substituted for an upcharge.
- Receptacles are part of the Frame Power option for 5-wire. When 8-Trac is specified, receptacles must be specified separately.

Phase 3 - 3 Circuit Shared Neutral, 5 Wires



- Hot 1 (Black)
- Hot 2 (Red)
- Hot 3 (Blue)
- Oversized Neutral (White)
- System Ground (Green or Bare)

8-Trac - 4 Circuit Separate Neutral, 8 Wires (3+1)



- Hot 1 (Black)
- Hot 2 (Red)
- Hot 3 (Blue)
- Oversized Neutral 1 (White)
- System Ground (Green)
- Hot 4 (Pink)
- Neutral 2 (Grey)
- Isolated Ground (Green/Yellow)

8-Trac - 4 Circuit Separate Neutral, 8 Wires (2+2)



- Hot 1 (Black)
- Hot 2 (Red)
- Neutral 1 (White)
- Ground 1 (Green)
- Hot 3 (Blue)
- Hot 4 (Pink)
- Neutral 2 (Grey)
- Ground (Green/Yellow)

Grid Power Data



Non-Powered Frames

- Includes no power or data.
- If Beltways are desired to maintain aesthetic continuity with Powered Frames they are ordered separately.
- Power and Data may be added at a later date.

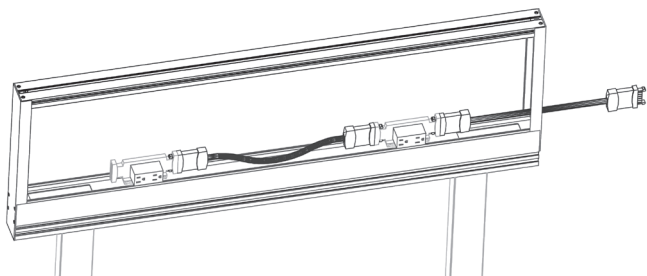

1-Sided Power Frames

- Includes two 15 amp duplex receptacles on ONE side of Frame. Choose from Circuit 1, 2 or 3 for the ENTIRE Frame.
- Includes 1 data cover (with 2 data openings) on ONE side of Frame (Exception: 30"W frames have no data cover).
- Includes a jumper to connect the 2 duplex receptacles within the Frame.
- Includes a jumper to connect the Frame to the next Frame in line. NOTE: this jumper will be discarded in the field if the next Frame is a pass-thru Frame or if this Frame is the last in line.
- Includes 1 Beltway cover (with 3 cutouts). Left and Right cutouts are for duplex receptacles. Middle cutout is for the data plate.
- Non-powered side of panel does not include a beltway.

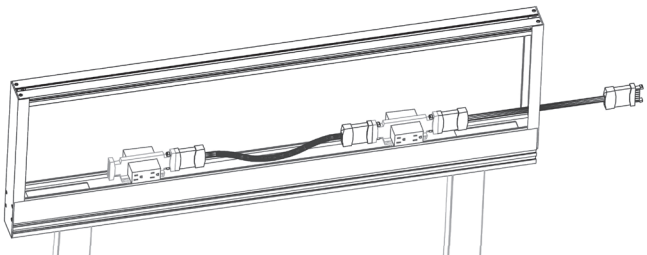

2-Sided Power Frames

- Includes two 15 amp duplex receptacles on EACH side of Frame. Choose from Circuit 1, 2 or 3 for the ENTIRE Frame.
- Includes 1 data cover (with 2 data openings) on EACH side of Frame (Exception: 30"W frames have no data cover).
- Includes a jumper to connect the 2 duplex receptacles in the Frame.
- Includes a jumper to connect the Frame to the next Frame in line. NOTE: this jumper will be discarded in the field if the next Frame is a pass-thru Frame or if this Frame is the last in line.
- Includes 2 Beltway covers (with 3 cutouts each). Left and Right cutouts are for duplex receptacles. Middle cutout is for data plate.

San Francisco Power or Municipalities with Metallic Conduit Requirements

For San Francisco and any other municipalities whose electrical code requires metallic conduit on all modular wiring, the Grid Base Power Ins must be specified in the metallic option for the 5-wire system. 8-Trac is fully San Francisco compliant. Note: All of the modular wiring harness for Grid Frames come standard with metallic conduit (5-wire, 3-circuit).

Chicago Power

For Circuit Choice (#), Select "9 - With empty j-boxes for Chicago Power".

New York City Power

New York City electrical code requires metallic conduit on all modular wiring. All of the modular wiring harnesses for Grid Frames come standard with metallic conduit (5-wire, 3-circuit). Grid Base Power Infeeds UPHASE5NY or UPHASE8NY must be used. Modular wiring components must be field installed. To order the Grid Frames with this option, for circuit choice (#) select "Field Installed" power option.

8 Wire Power with Dedicated Circuit

If an 8-wire power system with a Dedicated Circuit (3+1 or 2+2) is required, select the "4-circuit Powerway" option. Unlike the standard 5-wiring system, receptacles for the 4-circuit system must be specified separately.

Note: All 8-wire modular wiring comes standard with metallic conduit.

Note: Splitter (UYCONN) not needed.

Power/Data Routing Planning Tips

- Power/Data is routed from the floor through the interior of the leg and into the Frame via base in-feeds.
- U-channel on open Frame ends provides lay-in installation of power and data across multiple frames.
- Separate power and data chambers exist within the Frame to keep wires somewhat separated if desired.
- 90 and 120-degree power connections require the purchase of a 90 or 120-degree Power Kit.
- Power Poles (10', 12', 15') are available.
- T-Legs and Straight Legs hold 12 CAT6 cables.

Grid Tile Types & Workstation Leg Types

Tile Types



Full Tile Options

- Tackable Fabric
- Non-tackable Fabric
- Acrylic, Frosted
- Laminate
- Veneer
- Whiteboard
- Magnetic Whiteboard

Full Tile Tips

- > Used where power is not present.
- > Specified and shipped separately from Frames. Requires 2 per frame.
- > Field Assembled
- > Thin and Rail (original design) profiles require different tile sizes

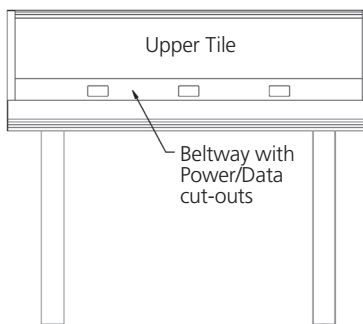

Upper Tile Options

- Tackable Fabric
- Non-tackable Fabric
- Acrylic, Frosted
- Laminate
- Veneer
- Whiteboard
- Magnetic Whiteboard

Upper Tile Tips

- > Requires presence of a beltway.
- > Specified and shipped separately from Frames. Requires 2 per frame.
- > Field Assembled.
- > Thin and Rail (original design) profiles require different tile sizes

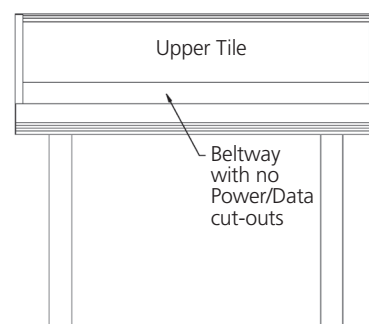

Beltway Options

- Beltway with power and data cutouts
- Beltway with no power and data cutouts

Beltway Tips

- > Can be specified with Frames or separately. If specified with Frames comes installed.
- > Beltways with cutouts have 3 openings – one for dataplate in center (2 openings) and two for power (2 duplex receptacles on the left and right, inset 12" from sides of frame).

Leg Types for Workstations

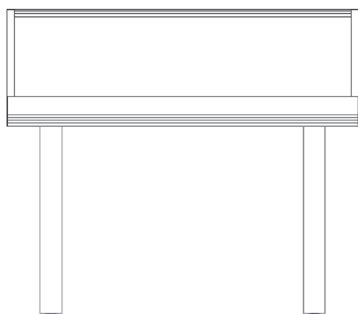

Grid Straight Legs - Rectangular or Square

- Used in applications where 90 degree connections and/or tethered worksurface can supply stability.
- Legs are ordered separate from Frames.
- Legs are clear anodized alum or painted steel.
- Rectangular for Grid Frame and worksurface support
- Square only for worksurface support

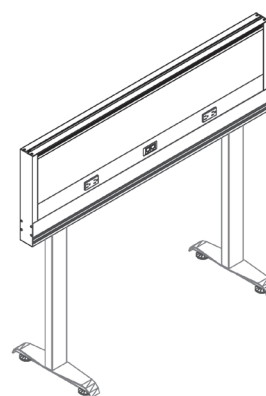

Grid T-Legs

- Used in straight line "Spine Wall" applications where the spine is not attached to the worksurface and there are no 90 degree connections.
- Legs are ordered separate from Frames.
- Legs are painted steel (only).
- Used where overheads are present if there is no Double-Sided 90 degree connection.

Grid XTB Bases

Bases for XTB Linked Benching

Height-Adjustable Options

- 5 types of height-adjustable mechanisms are available.
 - Bases with different height-adjustable mechanisms can be intermixed within the same XTB Bench Pack.
- Note:** Images below show two Double-Sided Bases with a Double-Sided 2-pack connector package.

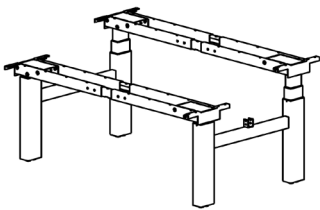

Ansi/BIFMA Electric

- Worksurface adjustable between 22" - 48" (including top)
- 250 lbs load capacity.
- Optional programmable controller
- Includes anti-collision
- Triple tube legs

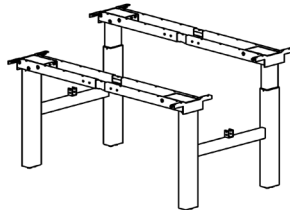

Sit-Stand Electric

- Worksurface adjustable between 27" - 46" (including top)
- 250 lbs load capacity.
- Optional programmable controller
- Includes anti-collision
- Dual tube legs

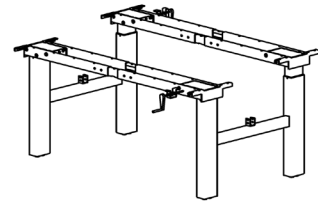

Crank

- Worksurface adjustable between 27" - 46" (including top)
- Approximately five and a half cranks per inch adjustment
- Dual tube legs

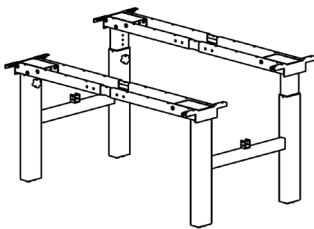

Knob

- Worksurface adjustable between 27" - 42" (including top) in 1" increments
- Dual tube legs

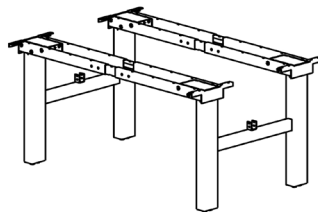

Fixed Height

- Worksurface at 29" high
- Single tube legs

Applications

- Bases are specific for the application:
 - Double-Sided:
 - 24" or 30"D rectangle worksurface (two straight legs)
 - 24" or 30"D extended corner worksurface (three straight legs)
 - Single-Sided:
 - 24"D rectangle worksurface (T-legs)
 - 30"D rectangle worksurface (T-legs)
 - 120 planning:
 - 24"D worksurface (three straight legs)
- Bases for Double-Sided and Single-Sided applications include adjustable top support cross bars for use with 60" or 72"W Frames and worksurfaces
- Bases for 120 applications are for use with 48"W Frames and worksurfaces.
- Bases support any size Frame (Mini, Standard, or Mega).
- Bases ordered separate from Frames and worksurfaces
- Bases are painted steel (only) with levelers.

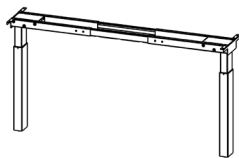

Double-Sided Rectangle

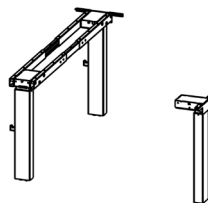

Double-Sided Extended Corner

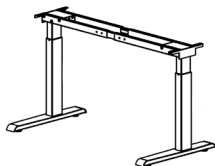

Single-Sided Rectangle

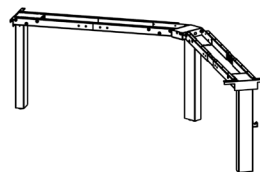

120 Planning

Planning - Grid Workstations

Frame Connections – Understanding Spine-Based Planning for Workstations

Step 1

- Always identify and specify the “Spine” first. The Spine is the dominant panel run that others are based on.
- Spines consist of 2 end of Run Frames and an unknown number of Mid Frames.

90 Degree Connections

- Requires Rail Profile Frames
- Connections are off modular and can be at any location on the Spine.
- A 90 Degree Connector package is specified separately from Frames.
- No Junctions (L,T,X) are utilized with Grid.

Connections are always off the spine and thus will affect worksurface specification requirements.

Tip: A 90 degree connection cannot span an in line connection on Rail Profile (original design) Frames



In-Line Connections

- The top of the Frames are connected via bolt on the inside top of the Frame. The bottom of the Frames are connected via shared legs.
- **In-Line connection hardware is included with every Frame.**
- No dimensional creep occurs at in-line connections.

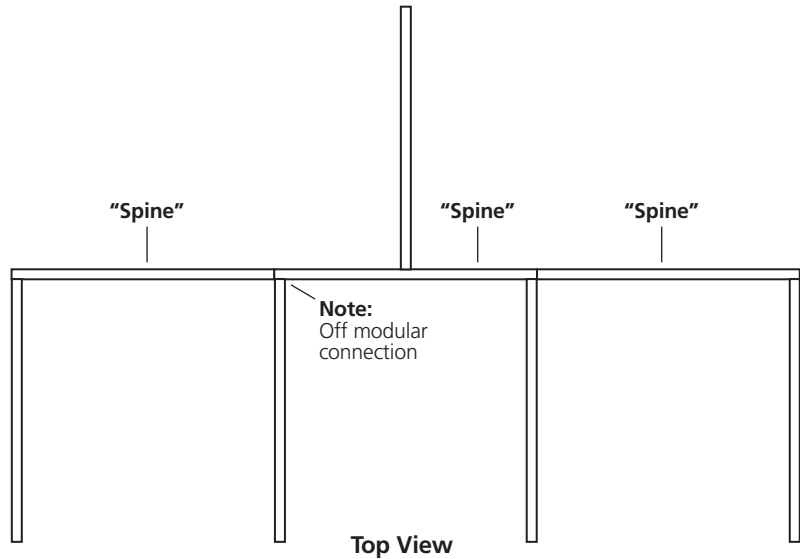

120 Degree Connections

- Three Frame and Two Frame 120 degree connections are allowed (Exception: There are no 2-frame connections for Mega Frames).
- 120 connector package is specified separately from Frames.



120 Degree 2-Way Junction

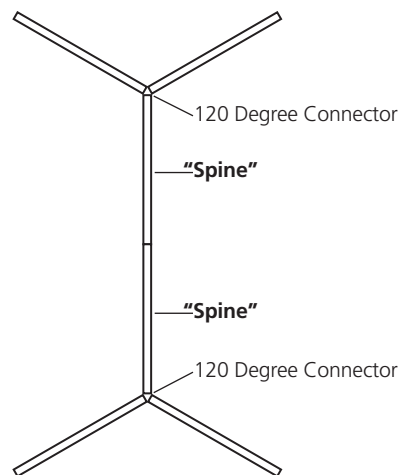

Frame Stability for Workstations

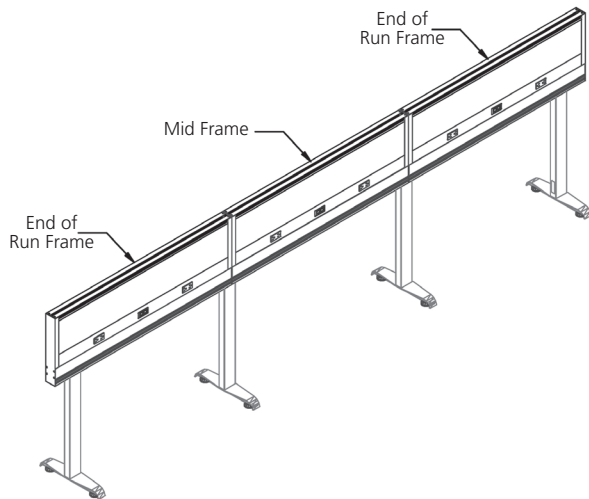

Tip: Spine wall with no tethering requires T-Legs

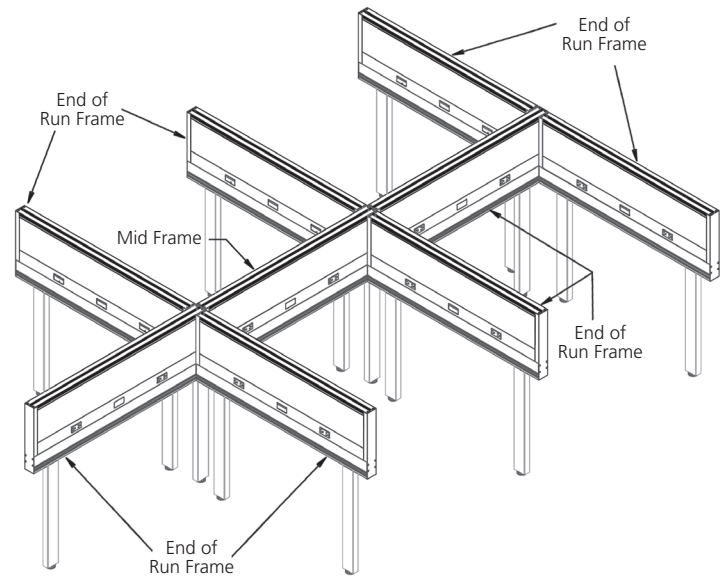

Tip: Spine Wall with tethering can use T-Legs or Straight Legs

Overview

- Spine wall applications with no 90 degree connections and no worksurface tethering must utilize T-Legs.
- If utilizing T-Legs the panels are stable for indefinite lengths. (See local codes for fire/ADA requirements.)
- If utilizing straight legs, no more than 2 Frames may be connected without either a 90 degree Frame connection, worksurface tether brackets or T-legs for stability.

Leg Planning for Frames in Workstations

Planning

- Legs are ordered separately from Frames.
- Always start leg planning with the Spine first.
- A T-, C-, or rectangle leg is required at the end of each run. Legs at this location are inset from the end of the Frame by 6".
- A T-, C- or rectangle leg is shared when there is an In-line Frame-to-Frame connection.
- A T-, C- or rectangle leg is required at the start of any 90 degree connection point.
- If there are NO 90 degree connections or worksurface tether applications then "T" legs must be used. This is typically a single Frame or a Spine Wall application.

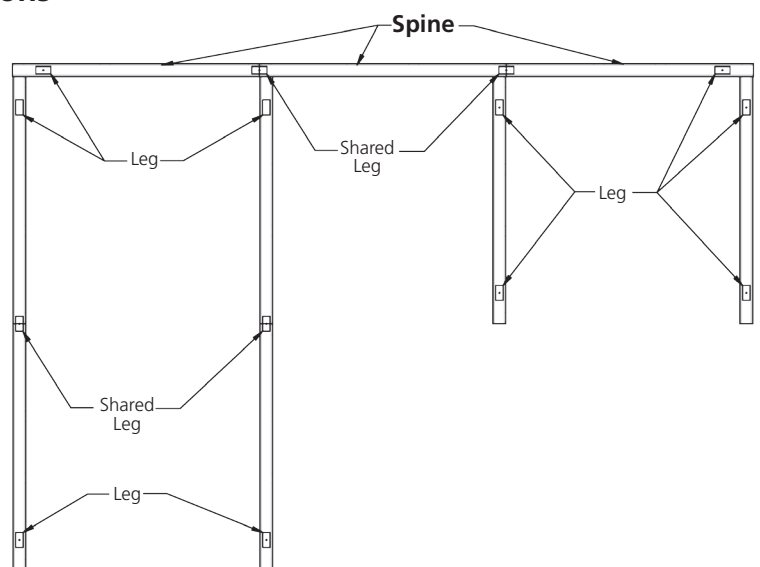

Top View

Planning - Grid Workstations

Worksurface Planning in Workstations

Freestanding vs. Tether Brackets

- Freestanding worksurfaces give optimum reconfigurability and mobility.
- Tether brackets eliminate legs and lower cost.

Tether Bracket Rules

- Tether brackets connect the back of the worksurface to the Frame. The front of the worksurface must be held up by a leg. A tether bracket is NOT THE SAME AS A CANTILEVER.
- As a general rule, two tether brackets are required to hold up the back of a rectangle surface. See diagram T1. Four tether brackets are required on a corner worksurface (two on each side).
- Braces are required on 60" wide and wider rectangle worksurfaces. Spans longer than 72" require additional mid-run floor support such as a leg or storage unit. (Braces are ordered separately.)
- If two worksurfaces are adjoining tether brackets may be shared. In this case surfaces 48" and less require one tether bracket plus a shared. Surfaces 54"+ require two tether brackets plus a shared. See diagram T2 and T3.
- A support plate and brace are required for 90 degree application. See diagram T4 and T5.

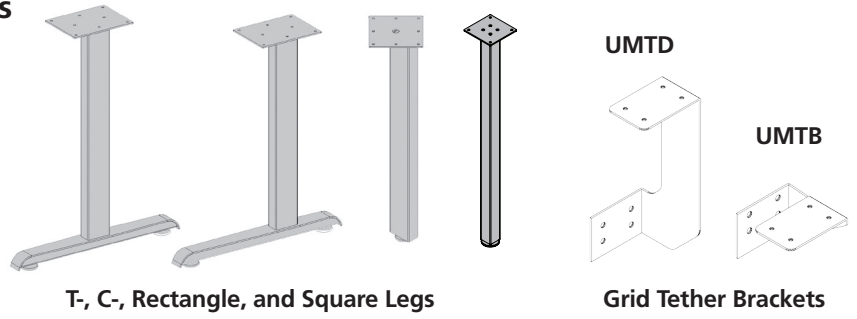

T-, C-, Rectangle, and Square Legs

Grid Tether Brackets

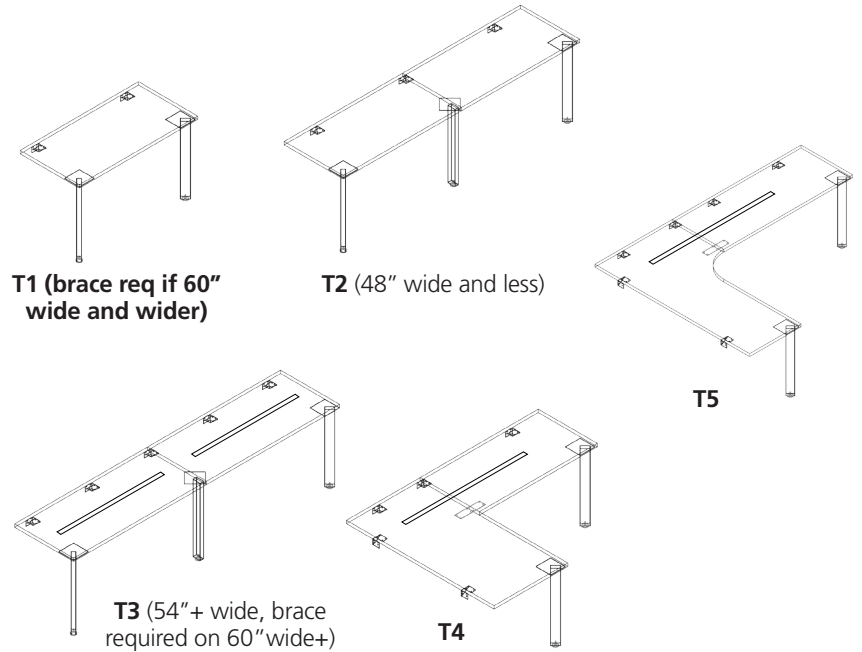

T1 (brace req if 60" wide and wider)

T2 (48" wide and less)

T5

T3 (54" + wide, brace required on 60" wide+)

T4

Worksurface Sizing Tips

- For Spine Wall only applications worksurface dimensions are true.
- In 90 degree applications worksurfaces are designed to be "loose fitting". The worksurface dimension depends on the number of 90 degree connections and WHERE THEY ARE LOCATED. Remember, Frame thickness is 2.5".
- **Rule:** available space for worksurface equals Frame length less 2.5" per 90 degree attachment.

Cable Management

- Worksurface may be specified with either no gap, 1/2" gap or 1" gap to Frame.
- Grommets and Full Scallops are recommended in no gap situations.
- Scallops are recommended in 1/2" gap situations.
- Full Scallops or 1" gap recommended for monitor arms
- Grid cable troughs are also available.

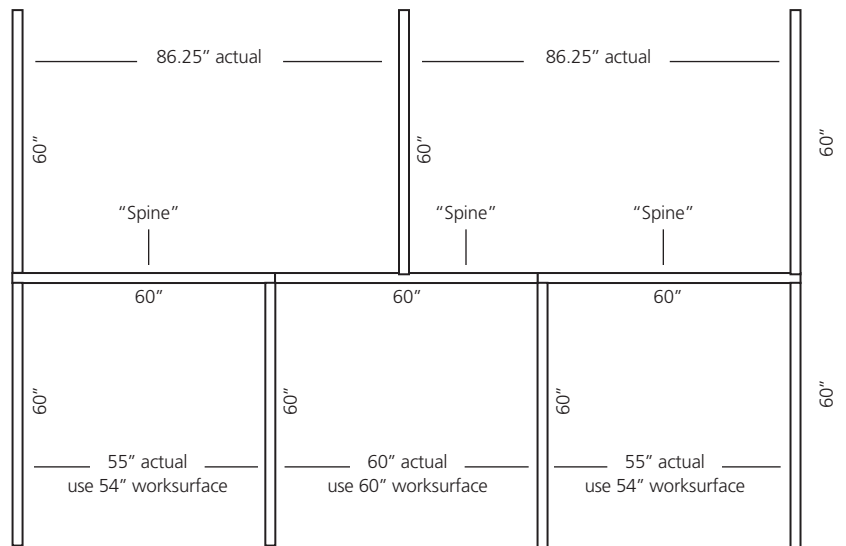

Top View

(All Frames are 60" wide x 2.5" thick in this example)

Planning - Grid XTB Flexible Benching

Bases and Connector Packages

- Five types of height-adjustable bases are available for rectilinear, extended corner, and 120 planning.
- Bases with different adjustable mechanisms can be intermixed within the same XTB Bench Pack.
- Connector packages link bases together and are ordered separately.
- Connector packages are available to create Bench Packs of 1-12 workstations.
- Connector packages include links, cross links, and all necessary hardware.
- Connectors are different for Single-Sided, Double-Sided, and 120 planning applications. If creating different configurations within a space, be sure to order the correct connector package for each XTB Bench Pack.
- Double-Sided and 120 planning bases must be connected to other bases for stability.
- Single-Sided bases require extra infeed legs for stability.

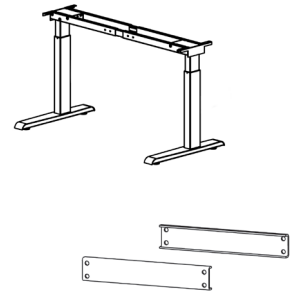

Frames

- Use 60" W or 72" W Frames with Double- and Single-Sided Bases.
- Use 48" W Frames with 120 Bases.
- Must be the same size - Mini, Standard, or Mega - within an XTB Bench Pack.

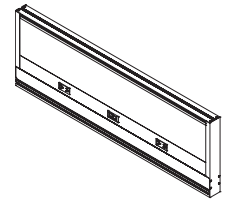

Worksurfaces

- Double-Sided rectangle bases fit tops 24" or 30" D and 60" or 72" W.
- Double-Sided extended corner bases fit tops 24" or 30" D and 60" or 72" W x 48" W.
- Single-Sided bases are different for 24" D and 30" D tops. Both bases fit tops 60" or 72" W.
- Straight worksurfaces fit Double- and Single-Sided rectangle bases.
- 120 Bases fit tops 24" D 24" D 48" W 48" W.
- Worksurfaces are undersized in width and depth for cable management and safety (to minimize pinch-points).
- Worksurfaces for XTB Benches must be specified with "A" in Step 2.
- Full scallops (Step 3) are recommended.

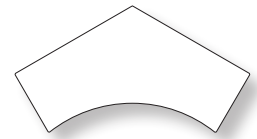

Power/Data and Cable Management

- Power/data access is provided by Grid Frame. In general, the same power/data information and requirements outlined for Grid workstations apply to Grid XTB Benches.
- Electric bases plug into one outlet in the Grid frame.
- Above worksurface power/data access can be provided with an Axil-X clamp-on power/data unit.
- High capacity cable troughs are available to keep wires and cabling neatly contained (paired with ULCM Cable Manager/vertebrae is recommended).

Tip: For XTB applications, order Cable Trough one size smaller. (ie: UMHCP60 for 72" Frame).

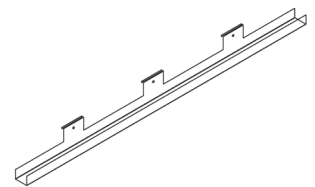

Privacy

- See pages 200-201 for the Dimensional Overview of XTB Frame and privacy options.
- Choosing Standard or Mega frame increases visual privacy.
- Topper screens add another 11" of visual separation.
- 4" riser increases Frame mounting height for added privacy.
- *TIP: 4" Riser is generally not recommended for use with Ansi/BIFMA electric bases due to potential worksurface interference with plugs/cords. If use of the 4" riser is necessary within a Grid Bench pack with Ansi/BIFMA electric bases, a flat plug powerstrip can be laid in the high capacity trough for power access. Implications on data connections are application specific and need to be resolved in planning. If there will be storage below every Ansi/BIFMA base worksurface, it may stop downward travel such that special accommodations may not be necessary.*
- Multiple types of Privacy Screens are available for side-to-side privacy.
- End panels and modesty panels can be specified for additional privacy below the worksurface.

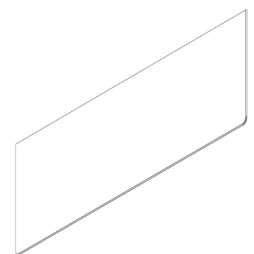

Planning - Grid XTB Flexible Benching

Overview

- XTB flexible benching is spine-based planning.

Bases, Connector Packages, and Frames

- Bases with five different types of height-adjustable mechanisms are available.
- Bases and Connectors are different for Double-Sided, Single-Sided and 120 applications. Be sure to order the correct connector package for each XTB Bench Pack.
- Double-Sided extended corner bases are also available..
- Double-Sided rectangle and extended corner bases can be intermixed.
- 60"W and 72"W Frames and worksurfaces can be intermixed.
- Frames cannot be connected 90 degrees to the spine within XTB Bench Packs.

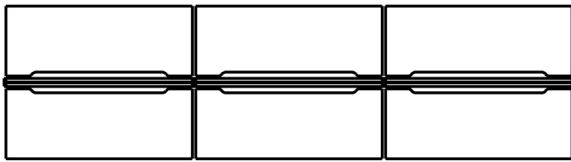

6 Double-Sided Rectangle bases, Straight tops,
Double-Sided 6-pack Connector Package

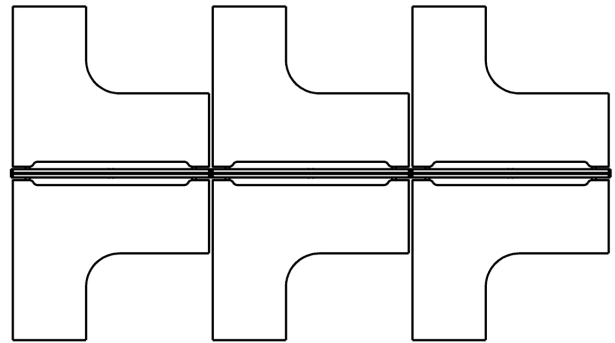

6 Extended Corner bases, Extended Corner tops,
Double-Sided 6-pack Connector Package

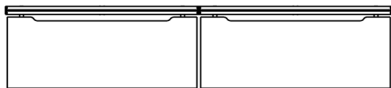

2 Single-Sided bases, Straight tops,
Single-Sided 2-pack Connector Package.

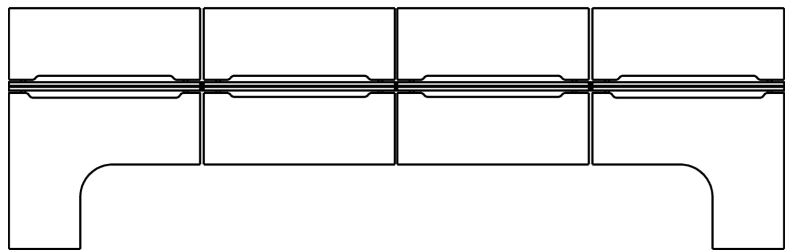

6 Double-Sided Rectangle bases, 2 Extended Corner bases, 6 Straight
and 2 Extended Corner tops, Double-Sided 8-pack Connector Package

Planning Around Poles and Obstacles

Bases and connector packages can be easily combined to create odd-numbered Double-Sided XTB Bench Packs.

- Order the number of Double-Sided bases needed (e.g., 6) and the corresponding Double-Sided connector pack.
- Order the number of Single-Sided bases needed (e.g., 1) and the same number of 1-pack Single-Sided connector packages (UMCON11^).

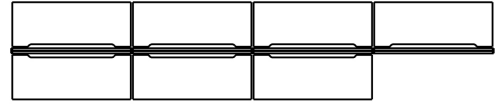

120 Degree Planning

- Bases with five different types of height-adjustable mechanisms are available
- 120 Connector packages are available to create 3-packs and 6-pack boomerang.
- 120 bases fit 48" Frames with 24"x24"x48"x48" worksurfaces
- Connector packages are unique for 120 applications. If using different configurations, be sure to order the correct connector package for each XTB Bench Pack.
- The 36"W cable troughs are designed for use with 48"W Frames in 120 applications.

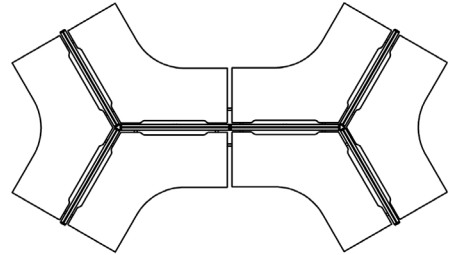

Planning - Options to Complete your Applications

Planning - Privacy

Frame Topper Screen

- May be placed into any Frame top slot at any time.
- 11.3"H above Frame.
- Actual width is 2" less than Frame nominal dimension.
- Styles: Frosted Acrylic, Designer Acid-Etched Large Knots Pattern Frosted Glass, Back Painted Glass Two-sided Markerboards. 3Form options are available, contact quotes@enwork.com for more information.

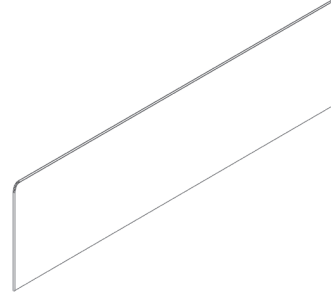

Modesty Panel

- Steel construction.
- Attached utilizing the Bottom Rail Bottom Slot. There are modesty slots on both sides of the Frame. Two modesty's on each Frame are possible but not necessary (see Grid Dimensional Overviews for more information).
- The modesty slides into Frame on the end and thus is labor intensive to install after furniture is already assembled. Requires disassembly to add-on.
- 12"H.
- Actual width is 1" less than Frame nominal dimension.
- Legs sit on inside of modesty.
- Does not fit XTB Bases.

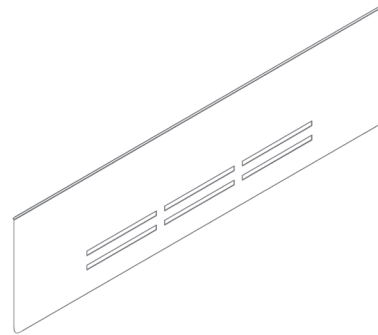

Planning - Accessories

Monitor Arms

- Holds a Single monitor
- Clamps to worksurface, through a grommet, or through-worksurface mount (3/16" - 2-3/4" hole)
- 85° upward and 15° downward tilt range
- +/- 90° swivel angle
- Landscape or portrait orientation



CPU Holder

- Width adjustment 5-1/2" to 9-1/4", height adjustment is 13.4" to 20-1/2"
- Very small CPUs may not fit.



Cable Management Options

- Numerous vertebrae and cable grippers available. See page 176.

Worktools

- Attaches utilizing the slot on the side of the Top Rail on Rail Profile (original design) Frames.

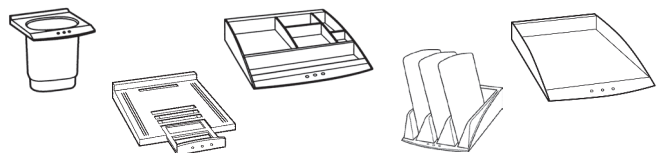

Planning - Accessories

High-Capacity Cable Trough

- Recommended for Grid XTB.
- Trough is 4" H x 2.5" D.

Tip: For XTB applications, order Cable Trough one size smaller. (ie: UMHCP60 for 72" Frame).

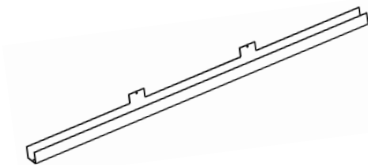

Planning - Storage

Landscape Storage

- 4-types available: Steel Box/Files, Bookcases, Personal Cabinets on levelers or casters, and Personal Towers
- Comes with Laminate Tops
- 20" H x 18" D
- Cushions available
- Plinth available for worksurface support
- Page 335



Gird Steel Storage

- Box Laterals and Bookcases
- 21.5" H x 18" D
- Page 336

Mobile Peds & Apex Metal Storage

- Apex Steel Mobile Peds, Fixed Peds, Laterals, Cabinets, etc. are found on pages 204-211.
- eBench Mobile peds, including Skinny (12" mobile peds) with side drawer pulls are found on page 270.



Affinity Laminate Storage & Mobile Peds

- Laminate Mobile Peds, Fixed Peds, Laterals, Cabinets, etc. are found on pages 239-245.

Specifying Grid Workstations

Specifying Grid Workstations

Step 1 – Pick your Frame size and Power

- Mini, Standard or Mega Frame
- Rail (original) or Thin Profile
- 30", 48", 60", 72", or 84"W
- Standard 5 Wire 3 circuit, Optional 8 Wire, or Hard wired

Step 2 – Specify Frame Supports and Connectors

- Supports determine power/data access above or below worksurface

Step 3 – Choose Tiles for Frames

- Tile size depends on the chosen Frame size, profile, and power/data access.
- Fabric, acrylic, laminate, veneer, or whiteboards

Step 4 – Select Worksurfaces

- Gaps, scallops, and a full scallop available for power/data access
- Rectangular, Corners and Extended Corners, Spanner,
- Multiple edge options
- Worksurface width typically matches Frame width

Step 5 – Specify Worksurface Supports

- Rectangular and square straight Legs, O-legs, Tether Brackets, Plinths
- Fixed peds and Landscape storage
- Worksurface braces required for tops 60"W and wider. Must be ordered separately.

Step 6 – Add Base Power-Ins and Power Infeed Legs

- Needed for every workstation pack
- **Tip:** Don't forget to order a UYCONN splitter if your 5-Wire infeed is not at the end of the typical.

Step 7 – Incorporate Privacy components

- Topper Screens, Privacy Screens, Modesty Panels, and End Panels
- Numerous attachment and material options including acrylic, whiteboard, magnetic whiteboard, fabric.

Step 8 – Add Cable Management Accessories and Work Tools

- Enwork offers fully articulating single Monitor Arms
- Cable Troughs, Cable Managers, and CPU holders

Step 9 – Finish with Storage Components

- Mobile Peds, Fixed Peds, Laterals, Bookcases, and Towers.

Specifying Grid XTB Flexible, Height-Adjustable Benches

Specifying Grid XTB Flexible, Height-adjustable Benches

Step 1 – Pick your Base Configuration

- Mix or match from five Height-Adjustable options
- Different bases are used for Double-sided, Single-Sided, and 120 planning
- Double-Sided and Single-Sided XTB bases include expanding worksurface supports to fit 60" and 72" Frames
- 120 XTB bases fit 48" Frames
- Extended corner bases fit worksurfaces 60" or 72"W x 48"W

Step 2 – Add Connector Packages and Optional Riser

- Connector packages create 2-packs to 12-packs.
- Connector packages are different for Double-Sided, Single-Sided, and 120 planning
- 4" Riser available for added privacy.

Step 3 – Specify Frame size and Power

- Mini, Standard or Mega Frame
- Rail (original) or Thin Profile
- 60" W or 72" W Frames for Double and Single-Sided applications
- 48" W Frames for 120 degree applications
- Standard 5 Wire 3 circuit, Optional 8 Wire, or Hard wired

Step 4 – Choose Tiles for Frames

- Fabric, Laminate, Veneer, Acrylic, Whiteboard, Magnetic Whiteboard
- Tile size depends on the chosen frame size, profile, and power/data access.

Step 5 – Add Base Power-Ins and Power Infeed Legs

- Needed for every XTB pack
- **Tip:** Don't forget to order a UYCONN splitter if your 5-wire infeed is not at the end of the typical.
- **Tip:** For Double-Sided and 120 degree applications only one power infeed leg is required. For stability, additional power infeed legs must be ordered for Single-Sided Grid XTB applications. Two legs, one on each end, plus a leg in the middle (3 legs total) are required for each 2 Pack or 3 Pack. An additional leg (4 total) is required for 4 Pack and 5 Pack Single-Sided applications.

	Single-Sided Applications			
	2 Pack	3 Pack	4 Pack	5 Pack
 # Infeed Legs	3	3	4	4

Step 6 – Select Worksurfaces

- Straight worksurfaces fit Double- and Single-Sided rectangle bases.
- 24"D 24"D 48"W 48"W tops fit 120 Bases.
- Worksurfaces are undersized in width and depth for cable management and safety (to minimize pinch-points).
- Worksurfaces for XTB Benches must be specified with "A" in Step 2.
- Full scallops (Step 3) are recommended.

Step 7 – Incorporate Privacy components

- Topper Screens, Privacy Screens, Modesty Panels, and End Panels
- Numerous attachment and material options including acrylic, whiteboard, magnetic whiteboard, fabric.

Step 8 – Add Cable Management Accessories and Work Tools

- Enwork offers fully articulating single Monitor Arms
- Cable Troughs, Cable Managers, and CPU holders

Step 9 – Finish with Storage Components

- Mobile Peds, Fixed Peds, Laterals, Bookcases, and Towers.

Grid Standard Frames - End of Run & Mid

STEP 1

(@) Frame and Top Cap Choice:

T Thin Profile

R Rail Profile (original design)

STEP 2 - If Applicable

(#) Circuit Choice:

1	3-circuit powerway w/ Circuit 1 grey receptacles	+\$0
2	3-circuit powerway w/ Circuit 2 grey receptacles	+\$0
3	3-circuit powerway w/ Circuit 3 grey receptacles	+\$0
4	FIELD INSTALLED 3-circuit powerway w/ Circuit 1 grey receptacles	+\$0
5	FIELD INSTALLED 3-circuit powerway w/ Circuit 2 grey receptacles	+\$0
6	FIELD INSTALLED 3-circuit powerway w/ Circuit 3 grey receptacles	+\$0
7	4-circuit powerway, RECEPTACLES (3+1 or 2+2) SPECIFIED SEPARATELY	+\$150
8	FIELD INSTALLED 4-circuit powerway, SPECIFIED SEPARATELY (See page 314). RECEPTACLES (3+1 or 2+2)	+\$150
9	With empty j-boxes for Chicago Power	+\$0

Tip: Contact quotes@enwork.com if using heavier duty Category 6 cables, which require the 2-sided data openings to be offset from each other via a special beltway.

Product Specifications:

- > Finish is clear anodized aluminum (exception: Beltway is silver).
- > End of Run Frame includes one finished end and one end with open "U" channel for lay-in power and cabling.
- > Mid Frame has an open "U" channel at both ends for lay-in power and cabling.
- > See page 283 for product details.

Ordering Information:

- > Frame, Jumpers and Beltway are included and ship assembled.
- > Legs and Tiles are specified and ship separately.
- > Order Full Tiles for sides without Beltways. Order Upper Tiles for sides with Beltways.
- > 90 and 120-degree connector kits are on page 309.
- > Receptacles are included with some power systems and not included with others. See Step 2.
- > For more specific information on power systems in Step 2 below, see pages 277-278.
- > Some products may be available for quick ship. Contact info@enwork.com.
- > **A freight fee of \$100 net is assessed on orders less than \$1000 net. See page 13.**

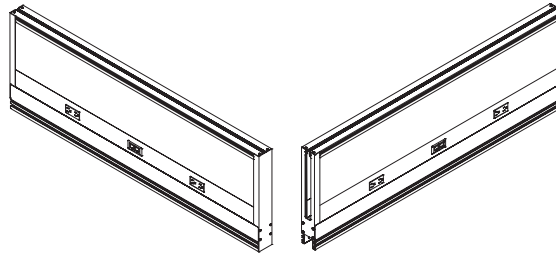

D	W	H	Part Number	Description	List Price (US\$)
Standard Frames, End of Run					
2.5	30	16	U30E0@0	Standard Frame, End, 30"W, No Power, No Beltway	\$645
2.5	30	16	U30E1@#	Standard Frame, End, 30"W, 1 Sided Power with 1 Beltway	\$950
2.5	30	16	U30E2@#	Standard Frame, End, 30"W, 2 Sided Power with 2 Beltways	\$1051
Tip: Data openings are omitted on 30" frames due to space constraints.					
2.5	48	16	U48E0@0	Standard Frame, End, 48"W, No Power, No Beltway	\$682
2.5	48	16	U48E1@#	Standard Frame, End, 48"W, 1 Sided Power with 1 Beltway	\$988
2.5	48	16	U48E2@#	Standard Frame, End, 48"W, 2 Sided Power with 2 Beltways	\$1088
2.5	60	16	U60E0@0	Standard Frame, End, 60"W, No Power, No Beltway	\$759
2.5	60	16	U60E1@#	Standard Frame, End, 60"W, 1 Sided Power with 1 Beltway	\$1144
2.5	60	16	U60E2@#	Standard Frame, End, 60"W, 2 Sided Power with 2 Beltways	\$1252
2.5	72	16	U72E0@0	Standard Frame, End, 72"W, No Power, No Beltway	\$808
2.5	72	16	U72E1@#	Standard Frame, End, 72"W, 1 Sided Power with 1 Beltway	\$1213
2.5	72	16	U72E2@#	Standard Frame, End, 72"W, 2 Sided Power with 2 Beltways	\$1329
2.5	84	16	U84E0@0	Standard Frame, End, 84"W, No Power, No Beltway	\$956
2.5	84	16	U84E1@#	Standard Frame, End, 84"W, 1 Sided Power with 1 Beltway	\$1363
2.5	84	16	U84E2@#	Standard Frame, End, 84"W, 2 Sided Power with 2 Beltways	\$1476

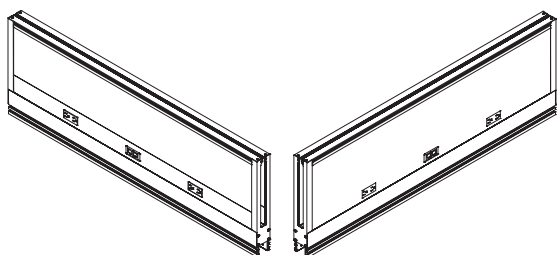

D	W	H	Part Number	Description	List Price (US\$)
Standard Frames, Middle of Run					
2.5	30	16	U30M0@0	Standard Frame, Mid, 30"W, No Power, No Beltway	\$619
2.5	30	16	U30M1@#	Standard Frame, Mid, 30"W, 1 Sided Power with 1 Beltway	\$924
2.5	30	16	U30M2@#	Standard Frame, Mid, 30"W, 2 Sided Power with 2 Beltways	\$1024
Tip: Data openings are omitted on 30" frames due to space constraints.					
2.5	48	16	U48M0@0	Standard Frame, Mid, 48"W, No Power, No Beltway	\$656
2.5	48	16	U48M1@#	Standard Frame, Mid, 48"W, 1 Sided Power with 1 Beltway	\$960
2.5	48	16	U48M2@#	Standard Frame, Mid, 48"W, 2 Sided Power with 2 Beltways	\$1059
2.5	60	16	U60M0@0	Standard Frame, Mid, 60"W, No Power, No Beltway	\$731
2.5	60	16	U60M1@#	Standard Frame, Mid, 60"W, 1 Sided Power with 1 Beltway	\$1116
2.5	60	16	U60M2@#	Standard Frame, Mid, 60"W, 2 Sided Power with 2 Beltways	\$1227
2.5	72	16	U72M0@0	Standard Frame, Mid, 72"W, No Power, No Beltway	\$781
2.5	72	16	U72M1@#	Standard Frame, Mid, 72"W, 1 Sided Power with 1 Beltway	\$1186
2.5	72	16	U72M2@#	Standard Frame, Mid, 72"W, 2 Sided Power with 2 Beltways	\$1296
2.5	84	16	U84M0@0	Standard Frame, Mid, 84"W, No Power, No Beltway	\$915
2.5	84	16	U84M1@#	Standard Frame, Mid, 84"W, 1 Sided Power with 1 Beltway	\$1329
2.5	84	16	U84M2@#	Standard Frame, Mid, 84"W, 2 Sided Power with 2 Beltways	\$1442

Grid Standard Frames - Freestanding

STEP 1

(@) Frame and Top Cap Choice:

T Thin Profile

R Rail Profile (original design)

STEP 2 - If Applicable

(#) Circuit Choice:

1	3-circuit powerway w/ Circuit 1 grey receptacles	+\$0
2	3-circuit powerway w/ Circuit 2 grey receptacles	+\$0
3	3-circuit powerway w/ Circuit 3 grey receptacles	+\$0
4	FIELD INSTALLED 3-circuit powerway w/ Circuit 1 grey receptacles	+\$0
5	FIELD INSTALLED 3-circuit powerway w/ Circuit 2 grey receptacles	+\$0
6	FIELD INSTALLED 3-circuit powerway w/ Circuit 3 grey receptacles	+\$0
7	4-circuit powerway, RECEPTACLES (3+1 or 2+2) SPECIFIED SEPARATELY	+\$150
8	FIELD INSTALLED 4-circuit powerway, RECEPTACLES (3+1 or 2+2) SPECIFIED SEPARATELY (See page 314).	+\$150
9	With empty j-boxes for Chicago Power	+\$0

Tip: Contact quotes@enwork.com if using heavier duty Category 6 cables, which require the 2-sided data openings to be offset from each other via a special beltway.

Product Specifications:

- > Finish is clear anodized aluminum (exception: Beltway is silver).
- > Includes two finished ends.
- > See page 283 for product details.

Ordering Information:

- > Frame, Receptacles, Jumpers and Beltway are included and ship assembled.
- > Legs and Tiles are specified and ship separately.
- > Order Full Tiles for sides without Beltways. Order Upper Tiles for sides with Beltways.
- > 90 and 120-degree connector kits are on page 309.
- > Receptacles are included with some power systems and not included with others. See Step 2.
- > For more specific information on power systems in Step 2 below, see pages 277-278.
- > Some products may be available for quick ship. Contact info@enwork.com.
- > **A freight fee of \$100 net is assessed on orders less than \$1000 net. See page 13.**

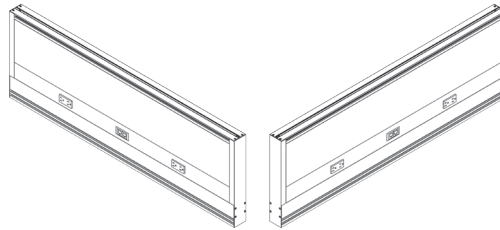

D	W	H	Part Number	Description	List Price (US\$)
Standard Frame, Freestanding					
2.5	30	16	U30F0@0	Standard Frame, Freestanding, 30"W, No Power, No Beltway	\$672
2.5	30	16	U30F1@#	Standard Frame, Freestanding, 30"W, 1 Sided Power, 1 Beltway	\$978
2.5	30	16	U30F2@#	Standard Frame, Freestanding, 30"W, 2 Sided Power with 2 Beltways	\$1076
Tip: Data openings are omitted on 30" frames due to space constraints.					
2.5	48	16	U48F0@0	Standard Frame, Freestanding, 48"W, No Power, No Beltway	\$708
2.5	48	16	U48F1@#	Standard Frame, Freestanding, 48"W, 1 Sided Power, 1 Beltway	\$1014
2.5	48	16	U48F2@#	Standard Frame, Freestanding, 48"W, 2 Sided Power with 2 Beltways	\$1112
2.5	60	16	U60F0@0	Standard Frame, Freestanding, 60"W, No Power, No Beltway	\$785
2.5	60	16	U60F1@#	Standard Frame, Freestanding, 60"W, 1 Sided Power, 1 Beltway	\$1171
2.5	60	16	U60F2@#	Standard Frame, Freestanding, 60"W, 2 Sided Power with 2 Beltways	\$1278
2.5	72	16	U72F0@0	Standard Frame, Freestanding, 72"W, No Power, No Beltway	\$835
2.5	72	16	U72F1@#	Standard Frame, Freestanding, 72"W, 1 Sided Power, 1 Beltway	\$1239
2.5	72	16	U72F2@#	Standard Frame, Freestanding, 72"W, 2 Sided Power with 2 Beltways	\$1301
2.5	84	16	U84F0@0	Standard Frame, Freestanding, 84"W, No Power, No Beltway	\$977
2.5	84	16	U84F1@#	Standard Frame, Freestanding, 84"W, 1 Sided Power, 1 Beltway	\$1382
2.5	84	16	U84F2@#	Standard Frame, Freestanding, 84"W, 2 Sided Power with 2 Beltways	\$1443

Notes

Grid Mega Frames - End of Run & Mid

STEP 1 - If Applicable

(#) Circuit Choice:

1	3-circuit powerway w/ Circuit 1 grey receptacles	+\$0
2	3-circuit powerway w/ Circuit 2 grey receptacles	+\$0
3	3-circuit powerway w/ Circuit 3 grey receptacles	+\$0
4	FIELD INSTALLED 3-circuit powerway w/ Circuit 1 grey receptacles	+\$0
5	FIELD INSTALLED 3-circuit powerway w/ Circuit 2 grey receptacles	+\$0
6	FIELD INSTALLED 3-circuit powerway w/ Circuit 3 grey receptacles	+\$0
7	4-circuit powerway, RECEPTACLES (3+1 or 2+2) SPECIFIED SEPARATELY	+\$150
8	FIELD INSTALLED 4-circuit powerway, SPECIFIED SEPARATELY (See page 314). RECEPTACLES (3+1 or 2+2)	+\$150
9	With empty j-boxes for Chicago Power	+\$0

Tip: Contact quotes@enwork.com if using heavier duty Category 6 cables, which require the 2-sided data openings to be offset from each other via a special beltway.

Product Specifications:

- > Finish is clear anodized aluminum (exception: Beltway is silver).
- > End of Run Frame includes one finished end and one end with open "U" channel for lay-in power and cabling.
- > Mid Frame has an open "U" channel at both ends for lay-in power and cabling.
- > Thin Profile not available on Mega Frames.
- > See page 283 for product details.

Ordering Information:

- > Frame, Jumpers and Beltway are included and ship assembled.
- > Legs and Tiles are specified and ship separately.
- > Order Full Tiles for sides without Beltways. Order Upper Tiles for sides with Beltways.
- > 90 and 120-degree connector kits are on page 309.
- > Receptacles are included with some power systems and not included with others. See Step 2.
- > For more specific information on power systems in Step 2 below, see pages 277-278.
- > Some products may be available for quick ship. Contact info@enwork.com.
- > **A freight fee of \$100 net is assessed on orders less than \$1000 net. See page 13.**

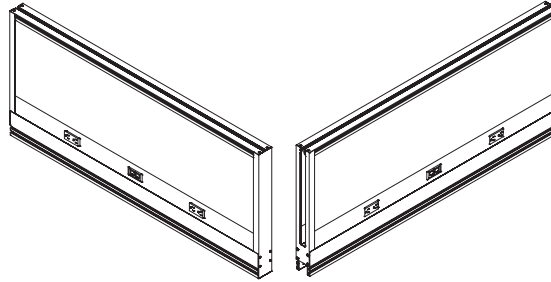

D	W	H	Part Number	Description	List Price (US\$)
Mega Frame, End of Run					
2.5	30	20.7	U30EB0R0	Mega Frame, End, 30"W, No Power, No Beltway	\$668
2.5	30	20.7	U30EB1R#	Mega Frame, End, 30"W, 1 Sided Power, 1 Beltway	\$974
2.5	30	20.7	U30EB2R#	Mega Frame, End, 30"W, 2 Sided Power with 2 Beltways	\$1074
Tip: Data openings are omitted on 30" frames due to space constraints.					
2.5	48	20.7	U48EB0R0	Mega Frame, End, 48"W, No Power, No Beltway	\$705
2.5	48	20.7	U48EB1R#	Mega Frame, End, 48"W, 1 Sided Power, 1 Beltway	\$1009
2.5	48	20.7	U48EB2R#	Mega Frame, End, 48"W, 2 Sided Power with 2 Beltways	\$1110
2.5	60	20.7	U60EB0R0	Mega Frame, End, 60"W, No Power, No Beltway	\$781
2.5	60	20.7	U60EB1R#	Mega Frame, End, 60"W, 1 Sided Power, 1 Beltway	\$1167
2.5	60	20.7	U60EB2R#	Mega Frame, End, 60"W, 2 Sided Power with 2 Beltways	\$1275
2.5	72	20.7	U72EB0R0	Mega Frame, End, 72"W, No Power, No Beltway	\$830
2.5	72	20.7	U72EB1R#	Mega Frame, End, 72"W, 1 Sided Power, 1 Beltway	\$1236
2.5	72	20.7	U72EB2R#	Mega Frame, End, 72"W, 2 Sided Power with 2 Beltways	\$1349
2.5	84	20.7	U84EB0R0	Mega Frame, End, 84"W, No Power, No Beltway	\$979
2.5	84	20.7	U84EB1R#	Mega Frame, End, 84"W, 1 Sided Power, 1 Beltway	\$1384
2.5	84	20.7	U84EB2R#	Mega Frame, End, 84"W, 2 Sided Power with 2 Beltways	\$1499

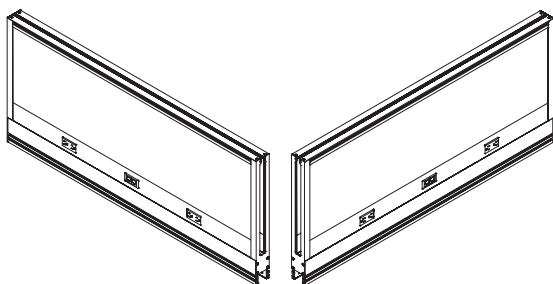

D	W	H	Part Number	Description	List Price (US\$)
Mega Frame, Middle of Run					
2.5	30	20.7	U30MB0R0	Mega Frame, Mid, 30"W, No Power, No Beltway	\$642
2.5	30	20.7	U30MB1R#	Mega Frame, Mid, 30"W, 1 Sided Power, 1 Beltway	\$947
2.5	30	20.7	U30MB2R#	Mega Frame, Mid, 30"W, 2 Sided Power, 2 Beltways	\$1046
Tip: Data openings are omitted on 30" frames due to space constraints.					
2.5	48	20.7	U48MB0R0	Mega Frame, Mid, 48"W, No Power, No Beltway	\$679
2.5	48	20.7	U48MB1R#	Mega Frame, Mid, 48"W, 1 Sided Power, 1 Beltway	\$983
2.5	48	20.7	U48MB2R#	Mega Frame, Mid, 48"W, 2 Sided Power, 2 Beltways	\$1081
2.5	60	20.7	U60MB0R0	Mega Frame, Mid, 60"W, No Power, No Beltway	\$755
2.5	60	20.7	U60MB1R#	Mega Frame, Mid, 60"W, 1 Sided Power, 1 Beltway	\$1140
2.5	60	20.7	U60MB2R#	Mega Frame, Mid, 60"W, 2 Sided Power, 2 Beltways	\$1249
2.5	72	20.7	U72MB0R0	Mega Frame, Mid, 72"W, No Power, No Beltway	\$804
2.5	72	20.7	U72MB1R#	Mega Frame, Mid, 72"W, 1 Sided Power, 1 Beltway	\$1210
2.5	72	20.7	U72MB2R#	Mega Frame, Mid, 72"W, 2 Sided Power, 2 Beltways	\$1318
2.5	84	20.7	U84MB0R0	Mega Frame, Mid, 84"W, No Power, No Beltway	\$939
2.5	84	20.7	U84MB1R#	Mega Frame, Mid, 84"W, 1 Sided Power, 1 Beltway	\$1349
2.5	84	20.7	U84MB2R#	Mega Frame, Mid, 84"W, 2 Sided Power, 2 Beltways	\$1465

Grid Mega Frames - Freestanding

STEP 1 - If Applicable

(#) Circuit Choice:

1	3-circuit powerway w/ Circuit 1 grey receptacles	+\$0
2	3-circuit powerway w/ Circuit 2 grey receptacles	+\$0
3	3-circuit powerway w/ Circuit 3 grey receptacles	+\$0
4	FIELD INSTALLED 3-circuit powerway w/ Circuit 1 grey receptacles	+\$0
5	FIELD INSTALLED 3-circuit powerway w/ Circuit 2 grey receptacles	+\$0
6	FIELD INSTALLED 3-circuit powerway w/ Circuit 3 grey receptacles	+\$0
7	4-circuit powerway, RECEPTACLES (3+1 or 2+2) SPECIFIED SEPARATELY	+\$150
8	FIELD INSTALLED 4-circuit powerway, SPECIFIED SEPARATELY (See page 314). RECEPTACLES (3+1 or 2+2)	+\$150
9	With empty j-boxes for Chicago Power	+\$0

Tip: Contact quotes@enwork.com if using heavier duty Category 6 cables, which require the 2-sided data openings to be offset from each other via a special beltway.

Product Specifications:

- > Finish is clear anodized aluminum (exception: Beltway is silver).
- > Includes two finished ends.
- > Thin Profile not available on Mega Frames.
- > See page 283 for product details.

Ordering Information:

- > Frame, Receptacles, Jumpers and Beltway are included and ship assembled.
- > Legs and Tiles are specified and ship separately.
- > Order Full Tiles for sides without Beltways. Order Upper Tiles for sides with Beltways.
- > 90 and 120-degree connector kits are on page 309.
- > Receptacles are included with some power systems and not included with others. See Step 2.
- > For more specific information on power systems in Step 2 below, see pages 277-278.
- > **A freight fee of \$100 net is assessed on orders less than \$1000 net. See page 13.**

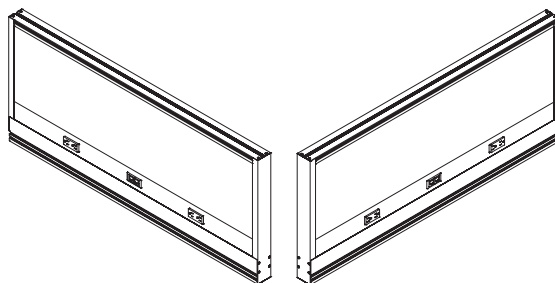

D	W	H	Part Number	Description	List Price (US\$)
Mega Frame, Freestanding					
2.5	30	20.7	U30FB0R0	Mega Frame, Freestanding, 30"W, No Power, No Beltway	\$694
2.5	30	20.7	U30FB1R#	Mega Frame, Freestanding, 30"W, 1 Sided Power, 1 Beltway	\$1001
2.5	30	20.7	U30FB2R#	Mega Frame, Freestanding, 30"W, 2 Sided Power, 2 Beltways	\$1100
Tip: Data openings are omitted on 30" frames due to space constraints.					
2.5	48	20.7	U48FB0R0	Mega Frame, Freestanding, 48"W, No Power, No Beltway	\$730
2.5	48	20.7	U48FB1R#	Mega Frame, Freestanding, 48"W, 1 Sided Power, 1 Beltway	\$1036
2.5	48	20.7	U48FB2R#	Mega Frame, Freestanding, 48"W, 2 Sided Power, 2 Beltways	\$1136
2.5	60	20.7	U60FB0R0	Mega Frame, Freestanding, 60"W, No Power, No Beltway	\$808
2.5	60	20.7	U60FB1R#	Mega Frame, Freestanding, 60"W, 1 Sided Power, 1 Beltway	\$1193
2.5	60	20.7	U60FB2R#	Mega Frame, Freestanding, 60"W, 2 Sided Power, 2 Beltways	\$1302
2.5	72	20.7	U72FB0R0	Mega Frame, Freestanding, 72"W, No Power, No Beltway	\$856
2.5	72	20.7	U72FB1R#	Mega Frame, Freestanding, 72"W, 1 Sided Power, 1 Beltway	\$1263
2.5	72	20.7	U72FB2R#	Mega Frame, Freestanding, 72"W, 2 Sided Power, 2 Beltways	\$1324
2.5	84	20.7	U84FB0R0	Mega Frame, Freestanding, 84"W, No Power, No Beltway	\$1000
2.5	84	20.7	U84FB1R#	Mega Frame, Freestanding, 84"W, 1 Sided Power, 1 Beltway	\$1406
2.5	84	20.7	U84FB2R#	Mega Frame, Freestanding, 84"W, 2 Sided Power, 2 Beltways	\$1466

Grid Mini Frames - End of Run

Product Specifications:

- > Finish is clear anodized aluminum (exception: Beltway is silver).
- > Includes one finished end and one end with open "U" channel for lay-in power and cabling.
- > A total of 44 Cat5 cables (UTP Solid 24AWG/4PRS) fit within a Mini Frame, 28 above the receptacles and 16 below.
- > Rail Profile not available on Mini Frames.
- > See page 283 for product details.

Ordering Information:

- > Frame, Receptacles, Jumpers and Beltway are included and ship assembled.
- > Legs are specified and ship separately..
- > Mini Frames do not allow for tiles.
- > 90 and 120-degree connector kits are on page 309.
- > Receptacles are included with some power systems and not included with others. See Step 2.
- > For more specific information on power systems in Step 2 below, see pages 277-278.
- > **A freight fee of \$100 net is assessed on orders less than \$1000 net. See page 13.**

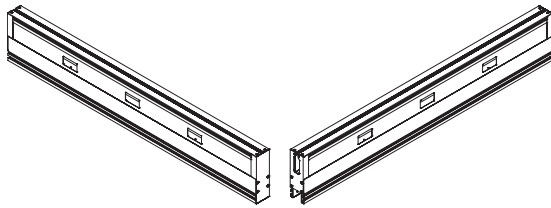

STEP 1 - If Applicable

(#) Circuit Choice:

1	3-circuit powerway w/ Circuit 1 grey receptacles	+\$0
2	3-circuit powerway w/ Circuit 2 grey receptacles	+\$0
3	3-circuit powerway w/ Circuit 3 grey receptacles	+\$0
4	FIELD INSTALLED 3-circuit powerway w/ Circuit 1 grey receptacles	+\$0
5	FIELD INSTALLED 3-circuit powerway w/ Circuit 2 grey receptacles	+\$0
6	FIELD INSTALLED 3-circuit powerway w/ Circuit 3 grey receptacles	+\$0
7	4-circuit powerway, RECEPTACLES (3+1 or 2+2) SPECIFIED SEPARATELY	+\$150
8	FIELD INSTALLED 4-circuit powerway, SPECIFIED SEPARATELY (See page 314). RECEPTACLES (3+1 or 2+2)	+\$150
9	With empty j-boxes for Chicago Power	+\$0

Tip: Contact quotes@enwork.com if using heavier duty Category 6 cables, which require the 2-sided data openings to be offset from each other via a special beltway.

D	W	H	Part Number	Description	List Price (US\$)
Mini Frame, End of Run					
2.5	30	8	U30EM0T0	Mini Frame, End, 30"W, No Power, 2 Beltways	\$621
2.5	30	8	U30EM1T#	Mini Frame, End, 30"W, 1 Sided Power, 2 Beltways	\$926
2.5	30	8	U30EM2T#	Mini Frame, End, 30"W, 2 Sided Power, 2 Beltways	\$1027
Tip: Data openings are omitted on 30" frames due to space constraints.					
2.5	48	8	U48EM0T0	Mini Frame, End, 48"W, No Power, 2 Beltways	\$658
2.5	48	8	U48EM1T#	Mini Frame, End, 48"W, 1 Sided Power, 2 Beltways	\$964
2.5	48	8	U48EM2T#	Mini Frame, End, 48"W, 2 Sided Power, 2 Beltways	\$1064
2.5	60	8	U60EM0T0	Mini Frame, End, 60"W, No Power, 2 Beltways	\$733
2.5	60	8	U60EM1T#	Mini Frame, End, 60"W, 1 Sided Power, 2 Beltways	\$1119
2.5	60	8	U60EM2T#	Mini Frame, End, 60"W, 2 Sided Power, 2 Beltways	\$1229
2.5	72	8	U72EM0T0	Mini Frame, End, 72"W, No Power, 2 Beltways	\$784
2.5	72	8	U72EM1T#	Mini Frame, End, 72"W, 1 Sided Power, 2 Beltways	\$1189
2.5	72	8	U72EM2T#	Mini Frame, End, 72"W, 2 Sided Power, 2 Beltways	\$1303
2.5	84	8	U84EM0T0	Mini Frame, End, 84"W, No Power, 2 Beltways	\$926
2.5	84	8	U84EM1T#	Mini Frame, End, 84"W, 1 Sided Power, 2 Beltways	\$1333
2.5	84	8	U84EM2T#	Mini Frame, End, 84"W, 2 Sided Power, 2 Beltways	\$1445

Grid Mini Frames - Mid & Freestanding

STEP 1 - If Applicable

(#) Circuit Choice:		
1	3-circuit powerway w/ Circuit 1 grey receptacles	+\$0
2	3-circuit powerway w/ Circuit 2 grey receptacles	+\$0
3	3-circuit powerway w/ Circuit 3 grey receptacles	+\$0
4	FIELD INSTALLED 3-circuit powerway w/ Circuit 1 grey receptacles	+\$0
5	FIELD INSTALLED 3-circuit powerway w/ Circuit 2 grey receptacles	+\$0
6	FIELD INSTALLED 3-circuit powerway w/ Circuit 3 grey receptacles	+\$0
7	4-circuit powerway, RECEPTACLES (3+1 or 2+2) SPECIFIED SEPARATELY	+\$150
8	FIELD INSTALLED 4-circuit powerway, SPECIFIED SEPARATELY (See page 314). RECEPTACLES (3+1 or 2+2)	+\$150
9	With empty j-boxes for Chicago Power	+\$0

Tip: Contact quotes@enwork.com if using heavier duty Category 6 cables, which require the 2-sided data openings to be offset from each other via a special beltway.

Product Specifications:

- > Finish is clear anodized aluminum (exception: Beltway is silver).
- > Mid Frame has an open "U" channel at both ends for lay-in power and cabling.
- > Freestanding Frame includes two finished ends.
- > A total of 44 Cat5 cables (UTP Solid 24AWG/4PRS) fit within a Mini Frame, 28 above the receptacles and 16 below.
- > Rail Profile not available on Mini Frames.
- > See page 283 for product details.

Ordering Information:

- > Frame, Receptacles, Jumpers and Beltway are included and ship assembled.
- > Legs are specified and ship separately.
- > Mini Frames do not allow for tiles.
- > 90 and 120-degree connector kits are on page 309.
- > Receptacles are included with some power systems and not included with others. See Step 2.
- > For more specific information on power systems in Step 2 below, see pages 277-278.
- > **A freight fee of \$100 net is assessed on orders less than \$1000 net. See page 13.**

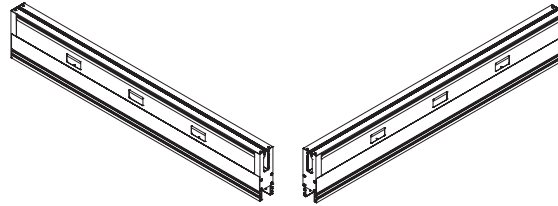

D	W	H	Part Number	Description	List Price (US\$)
Mini Frame, Middle of Run					
2.5	30	8	U30MM0T0	Mini Frame, Mid, 30"W, No Power, 2 Beltways	\$595
2.5	30	8	U30MM1T#	Mini Frame, Mid, 30"W, 1 Sided Power, 2 Beltways	\$901
2.5	30	8	U30MM2T#	Mini Frame, Mid, 30"W, 2 Sided Power, 2 Beltways	\$1000
Tip: Data openings are omitted on 30" frames due to space constraints.					
2.5	48	8	U48MM0T0	Mini Frame, Mid, 48"W, No Power, 2 Beltways	\$632
2.5	48	8	U48MM1T#	Mini Frame, Mid, 48"W, 1 Sided Power, 2 Beltways	\$938
2.5	48	8	U48MM2T#	Mini Frame, Mid, 48"W, 2 Sided Power, 2 Beltways	\$1035
2.5	60	8	U60MM0T0	Mini Frame, Mid, 60"W, No Power, 2 Beltways	\$708
2.5	60	8	U60MM1T#	Mini Frame, Mid, 60"W, 1 Sided Power, 2 Beltways	\$1094
2.5	60	8	U60MM2T#	Mini Frame, Mid, 60"W, 2 Sided Power, 2 Beltways	\$1203
2.5	72	8	U72MM0T0	Mini Frame, Mid, 72"W, No Power, 2 Beltways	\$758
2.5	72	8	U72MM1T#	Mini Frame, Mid, 72"W, 1 Sided Power, 2 Beltways	\$1163
2.5	72	8	U72MM2T#	Mini Frame, Mid, 72"W, 2 Sided Power, 2 Beltways	\$1271
2.5	84	8	U84MM0T0	Mini Frame, Mid, 84"W, No Power, 2 Beltways	\$901
2.5	84	8	U84MM1T#	Mini Frame, Mid, 84"W, 1 Sided Power, 2 Beltways	\$1306
2.5	84	8	U84MM2T#	Mini Frame, Mid, 84"W, 2 Sided Power, 2 Beltways	\$1414

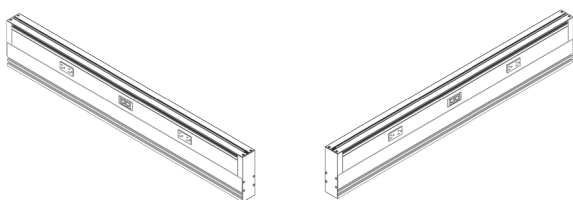

D	W	H	Part Number	Description	List Price (US\$)
Mini Frame, Freestanding					
2.5	30	8	U30FM0T0	Mini Frame, Freestanding, 30"W, No Power, 2 Beltways	\$659
2.5	30	8	U30FM1T#	Mini Frame, Freestanding, 30"W, 1 Sided Power, 2 Beltways	\$954
2.5	30	8	U30FM2T#	Mini Frame, Freestanding, 30"W, 2 Sided Power, 2 Beltways	\$1052
Tip: Data openings are omitted on 30" frames due to space constraints.					
2.5	48	8	U48FM0T0	Mini Frame, Freestanding, 48"W, No Power, 2 Beltways	\$683
2.5	48	8	U48FM1T#	Mini Frame, Freestanding, 48"W, 1 Sided Power, 2 Beltways	\$990
2.5	48	8	U48FM2T#	Mini Frame, Freestanding, 48"W, 2 Sided Power, 2 Beltways	\$1089
2.5	60	8	U60FM0T0	Mini Frame, Freestanding, 60"W, No Power, 2 Beltways	\$761
2.5	60	8	U60FM1T#	Mini Frame, Freestanding, 60"W, 1 Sided Power, 2 Beltways	\$1146
2.5	60	8	U60FM2T#	Mini Frame, Freestanding, 60"W, 2 Sided Power, 2 Beltways	\$1254
2.5	72	8	U72FM0T0	Mini Frame, Freestanding, 72"W, No Power, 2 Beltways	\$810
2.5	72	8	U72FM1T#	Mini Frame, Freestanding, 72"W, 1 Sided Power, 2 Beltways	\$1214
2.5	72	8	U72FM2T#	Mini Frame, Freestanding, 72"W, 2 Sided Power, 2 Beltways	\$1276
2.5	84	8	U84FM0T0	Mini Frame, Freestanding, 84"W, No Power, 2 Beltways	\$952
2.5	84	8	U84FM1T#	Mini Frame, Freestanding, 84"W, 1 Sided Power, 2 Beltways	\$1359
2.5	84	8	U84FM2T#	Mini Frame, Freestanding, 84"W, 2 Sided Power, 2 Beltways	\$1418

Grid Upper Tiles for Thin Profile Standard Frames

STEP 1 - If Applicable

(?) Fabric Suffix List:

- > Free form fabric selection. Choose from Camira Mill L2 or Lucia fabrics.

Tip: To view fabric colors or to order samples go to www.camirafabrics.com/us.

Tip: For COM yardage, see page 16.

(#) Laminate Suffix List:

- A Wilsonart Kensington Maple (10776-60)
 B Wilsonart Monticello Maple (7925-38)
 C Wilsonart Wild Cherry (7054-60)
 E Wilsonart Fashion Grey (D381-60)
 F Wilsonart White Tigris (4783-60)
 G Wilsonart Cafelle (7933K-07)
 M Wilsonart Frosty White (1573-60)
 P Wilsonart Slate Grey (D91-60)
 R Wilsonart Black (1595-60)
 U Wilsonart Brazilwood (7946-38)
 V Wilsonart River Cherry (7937-38)
 W Wilsonart Designer White (D354-60)
 3 Formica Neutral Twill (8826-58)
 4 Formica Bleached Legno (8845-58)
 5 Formica Prestige Walnut (6209-43)
 7 Formica Select Cherry (7759-43)
 X *Wilsonart Non-Premium laminates (-38, +10%
 -60). Orders of 100+ units have no upcharge.
 Y *Formica Non-Premium Standard (58, 43, +19%
 MC, SP and NT finishes) and Wilsonart
 Premium (-01, -07, -12, -18, -52, -78) laminates.
 Z *Pionite Non-Premium, Nevamar Non-
 Premium, Formica Premium (WR, 42, 77, 46,
 RD Finishes), and whiteboard laminate.

*Add \$350 list for Special Laminate orders of less than 10 units. See page 21 for edge selection.

(@) Veneer Suffix List:

- D Maple (stained similar to
 Kensington Maple laminate)
 J Cherry (stained similar to Wild Cherry laminate)
 N Walnut (stained similar to Cafelle laminate)
 8 Walnut (stained similar to Prestige Walnut laminate)
 9 Cherry (stained similar to Select Cherry laminate)
 X Stain Match (add a one-time \$700 list +10%
 Stain Match fee)

Product Specifications:

- > See page 279 for product details.

Ordering Information:

- > Each frame requires 2 tiles.
 > Upper Tiles must be used with a beltway. Full Tiles for Standard Frames are found on pages 304-305.
 > For COM yardage see page 16.
 > Some products may be available for quick ship. Contact info@enwork.com.
 > **A freight fee of \$100 net is assessed on orders less than \$1000 net. See page 13.**

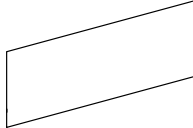

Part Number Description

List Price (US\$)

Tackable Fabric Upper Tiles for Thin Profile Standard Frames - (8"H)

Part Number	Description	List Price (US\$)
USUFT30?	Tackable Fabric Upper Tile, Thin Standard, 30"W	\$238
USUFT48?	Tackable Fabric Upper Tile, Thin Standard, 48"W	\$250
USUFT60?	Tackable Fabric Upper Tile, Thin Standard, 60"W	\$258
USUFT72?	Tackable Fabric Upper Tile, Thin Standard, 72"W	\$319
USUFT84?	Tackable Fabric Upper Tile, Thin Standard, 84"W	\$329

Non-tackable Fabric Upper Tiles for Thin Profile Standard Frames - (8"H)

Part Number	Description	List Price (US\$)
USUGT30?	Non-tackable Fabric Upper Tile, Thin Standard, 30"W	\$161
USUGT48?	Non-tackable Fabric Upper Tile, Thin Standard, 48"W	\$166
USUGT60?	Non-tackable Fabric Upper Tile, Thin Standard, 60"W	\$200
USUGT72?	Non-tackable Fabric Upper Tile, Thin Standard, 72"W	\$219
USUGT84?	Non-tackable Fabric Upper Tile, Thin Standard, 84"W	\$236

Frosted Acrylic Upper Tiles for Thin Profile Standard Frame - (8"H)

Part Number	Description	List Price (US\$)
USUAT30	Frosted Acrylic Upper Tile, Thin Standard, 30"W	\$151
USUAT48	Frosted Acrylic Upper Tile, Thin Standard, 48"W	\$162
USUAT60	Frosted Acrylic Upper Tile, Thin Standard, 60"W	\$194
USUAT72	Frosted Acrylic Upper Tile, Thin Standard, 72"W	\$225
USUAT84	Frosted Acrylic Upper Tile, Thin Standard, 84"W	\$257

Laminate Upper Tiles for Thin Profile Standard Frame - (8"H)

Part Number	Description	List Price (US\$)
USULT30#	Laminate Upper Tile, Thin Standard, 30"W	\$81
USULT48#	Laminate Upper Tile, Thin Standard, 48"W	\$86
USULT60#	Laminate Upper Tile, Thin Standard, 60"W	\$103
USULT72#	Laminate Upper Tile, Thin Standard, 72"W	\$120
USULT84#	Laminate Upper Tile, Thin Standard, 84"W	\$165

Veneer Upper Tiles for Thin Profile Standard Frame - (8"H)

Part Number	Description	List Price (US\$)
USUVT30@	Veneer Upper Tile, Thin Standard, 30"W	\$319
USUVT48@	Veneer Upper Tile, Thin Standard, 48"W	\$341
USUVT60@	Veneer Upper Tile, Thin Standard, 60"W	\$427
USUVT72@	Veneer Upper Tile, Thin Standard, 72"W	\$509
USUVT84@	Veneer Upper Tile, Thin Standard 84"W	\$592

Whiteboard Upper Tiles for Thin Profile Standard Frame - (8"H)

Part Number	Description	List Price (US\$)
USUWT30	Whiteboard Upper Tile, Thin Standard, 30"W	\$113
USUWT48	Whiteboard Upper Tile, Thin Standard, 48"W	\$121
USUWT60	Whiteboard Upper Tile, Thin Standard, 60"W	\$227
USUWT72	Whiteboard Upper Tile, Thin Standard, 72"W	\$262
USUWT84	Whiteboard Upper Tile, Thin Standard, 84"W	\$313

Tip: Laminate Whiteboard construction.

Magnetic Whiteboard Upper Tiles for Thin Profile Standard Frame - (8"H)

Part Number	Description	List Price (US\$)
USUYT30	Magnetic Whiteboard Upper Tile, Thin Standard, 30"W	\$257
USUYT48	Magnetic Whiteboard Upper Tile, Thin Standard, 48"W	\$277
USUYT60	Magnetic Whiteboard Upper Tile, Thin Standard, 60"W	\$309
USUYT72	Magnetic Whiteboard Upper Tile, Thin Standard, 72"W	\$328
USUYT84	Magnetic Whiteboard Upper Tile, Thin Standard, 84"W	\$373

Tip: Porcelain on steel core.

Grid Upper Tiles for Rail Profile Standard Frames

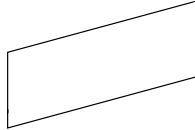

Part Number	Description	List Price (US\$)
Tackable Fabric Upper Tiles for Rail Profile Standard Frames - (8"H)		
USUF30?	Tackable Fabric Upper Tile, Rail Standard, 30"W	\$238
USUF48?	Tackable Fabric Upper Tile, Rail Standard, 48"W	\$250
USUF60?	Tackable Fabric Upper Tile, Rail Standard, 60"W	\$295
USUF72?	Tackable Fabric Upper Tile, Rail Standard, 72"W	\$319
USUF84?	Tackable Fabric Upper Tile, Rail Standard, 84"W	\$329
Non-tackable Fabric Upper Tiles for Rail Profile Standard Frames - (8"H)		
USUG30?	Non-tackable Fabric Upper Tile, Rail Standard, 30"W	\$161
USUG48?	Non-tackable Fabric Upper Tile, Rail Standard, 48"W	\$166
USUG60?	Non-tackable Fabric Upper Tile, Rail Standard, 60"W	\$200
USUG72?	Non-tackable Fabric Upper Tile, Rail Standard, 72"W	\$219
USUG84?	Non-tackable Fabric Upper Tile, Rail Standard, 84"W	\$236
Frosted Acrylic Upper Tiles for Rail Profile Standard Frame - (8"H)		
USUA30	Frosted Acrylic Upper Tile, Rail Standard, 30"W	\$151
USUA48	Frosted Acrylic Upper Tile, Rail Standard, 48"W	\$162
USUA60	Frosted Acrylic Upper Tile, Rail Standard, 60"W	\$194
USUA72	Frosted Acrylic Upper Tile, Rail Standard, 72"W	\$225
USUA84	Frosted Acrylic Upper Tile, Rail Standard, 84"W	\$257
Laminate Upper Tiles for Rail Profile Standard Frame - (8"H)		
USUL30#	Laminate Upper Tile, Rail Standard, 30"W	\$81
USUL48#	Laminate Upper Tile, Rail Standard, 48"W	\$86
USUL60#	Laminate Upper Tile, Rail Standard, 60"W	\$103
USUL72#	Laminate Upper Tile, Rail Standard, 72"W	\$120
USUL84#	Laminate Upper Tile, Rail Standard, 84"W	\$165
Veneer Upper Tiles for Rail Profile Standard Frame - (8"H)		
USUV30@	Veneer Upper Tile, Rail Standard, 30"W	\$319
USUV48@	Veneer Upper Tile, Rail Standard, 48"W	\$341
USUV60@	Veneer Upper Tile, Rail Standard, 60"W	\$427
USUV72@	Veneer Upper Tile, Rail Standard, 72"W	\$509
USUV84@	Veneer Upper Tile, Rail Standard, 84"W	\$592
Whiteboard Upper Tiles for Rail Profile Standard Frame - (8"H)		
USUW30	Whiteboard Upper Tile, Rail Standard, 30"W	\$113
USUW48	Whiteboard Upper Tile, Rail Standard, 48"W	\$121
USUW60	Whiteboard Upper Tile, Rail Standard, 60"W	\$227
USUW72	Whiteboard Upper Tile, Rail Standard, 72"W	\$262
USUW84	Whiteboard Upper Tile, Rail Standard, 84"W	\$313
	Tip: Laminate Whiteboard construction.	
Magnetic Whiteboard Upper Tiles for Rail Profile Standard Frame - (8"H)		
USUY30	Magnetic Whiteboard Upper Tile, Rail Standard, 30"W	\$257
USUY48	Magnetic Whiteboard Upper Tile, Rail Standard, 48"W	\$277
USUY60	Magnetic Whiteboard Upper Tile, Rail Standard, 60"W	\$309
USUY72	Magnetic Whiteboard Upper Tile, Rail Standard, 72"W	\$328
USUY84	Magnetic Whiteboard Upper Tile, Rail Standard, 84"W	\$373
	Tip: Porcelain on steel core.	

Grid Full Tiles for Thin Profile Standard Frames

STEP 1 - If Applicable

(?) Fabric Suffix List:

- > Free form fabric selection. Choose from Camira Mill L2 or Lucia fabrics.

Tip: To view fabric colors or to order samples go to www.camirafabrics.com/us.

Tip: For COM yardage, see page 16.

(#) Laminate Suffix List:

- A Wilsonart Kensington Maple (10776-60)
- B Wilsonart Monticello Maple (7925-38)
- C Wilsonart Wild Cherry (7054-60)
- E Wilsonart Fashion Grey (D381-60)
- F Wilsonart White Tigris (4783-60)
- G Wilsonart Cafelle (7933K-07)
- M Wilsonart Frosty White (1573-60)
- P Wilsonart Slate Grey (D91-60)
- R Wilsonart Black (1595-60)
- U Wilsonart Brazilwood (7946-38)
- V Wilsonart River Cherry (7937-38)
- W Wilsonart Designer White (D354-60)
- 3 Formica Neutral Twill (8826-58)
- 4 Formica Bleached Legno (8845-58)
- 5 Formica Prestige Walnut (6209-43)
- 7 Formica Select Cherry (7759-43)
- X *Wilsonart Non-Premium laminates (-38, +10% -60). Orders of 100+ units have no upcharge.
- Y *Formica Non-Premium Standard (58, +19% 43, MC, SP and NT finishes) and Wilsonart Premium (-01, -07, -12, -18, -52, -78) laminates.
- Z *Pionite Non-Premium, Nevamar Non-Premium, Formica Premium (WR, 42, 77, 46, RD Finishes), and whiteboard laminate.

*Add \$350 list for Special Laminate orders of less than 10 units. See page 21 for edge selection.

(@) Veneer Suffix List:

- D Maple (stained similar to Kensington Maple laminate)
- J Cherry (stained similar to Wild Cherry laminate)
- N Walnut (stained similar to Cafelle laminate)
- 8 Walnut (stained similar to Prestige Walnut laminate)
- 9 Cherry (stained similar to Select Cherry laminate)
- X Stain Match (add a one-time \$700 list +10% Stain Match fee)

Product Specifications:

- > See page 279 for product details

Ordering Information:

- > Each frame requires 2 tiles
- > Full Tiles are only used in non-powered instances. Upper Tiles for Standard Frames, used with a beltway, are found on pages 302-303.
- > For COM yardage see page 16.
- > Some products may be available for quick ship. Contact info@enwork.com.
- > **A freight fee of \$100 net is assessed on orders less than \$1000 net. See page 13.**

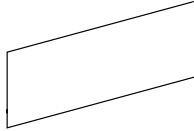

Part Number	Description	List Price (US\$)
Tackable Fabric Full Tiles for Thin Profile Standard Frames - (11"H)		
USFFT30?	Tackable Fabric Full Tile, Thin Standard, 30"W	\$332
USFFT48?	Tackable Fabric Full Tile, Thin Standard, 48"W	\$342
USFFT60?	Tackable Fabric Full Tile, Thin Standard, 60"W	\$357
USFFT72?	Tackable Fabric Full Tile, Thin Standard, 72"W	\$431
USFFT84?	Tackable Fabric Full Tile, Thin Standard, 84"W	\$454
Non-Tackable Fabric Full Tiles for Thin Profile Standard Frames - (11"H)		
USFGT30?	Non-tackable Fabric Full Tile, Thin Standard, 30"W	\$187
USFGT48?	Non-tackable Fabric Full Tile, Thin Standard, 48"W	\$201
USFGT60?	Non-tackable Fabric Full Tile, Thin Standard, 60"W	\$230
USFGT72?	Non-tackable Fabric Full Tile, Thin Standard, 72"W	\$258
USFGT84?	Non-tackable Fabric Full Tile, Thin Standard, 84"W	\$283
Frosted Acrylic Full Tiles for Thin Profile Standard Frames - (11"H)		
USFAT30	Acrylic Full Tile, Thin Standard, 30"W	\$153
USFAT48	Acrylic Full Tile, Thin Standard, 48"W	\$163
USFAT60	Acrylic Full Tile, Thin Standard, 60"W	\$196
USFAT72	Acrylic Full Tile, Thin Standard, 72"W	\$228
USFAT84	Acrylic Full Tile, Thin Standard, 84"W	\$260
Laminate Full Tiles for Thin Profile Standard Frames - (11"H)		
USFLT30#	Laminate Full Tile, Thin Standard, 30"W	\$96
USFLT48#	Laminate Full Tile, Thin Standard, 48"W	\$101
USFLT60#	Laminate Full Tile, Thin Standard, 60"W	\$120
USFLT72#	Laminate Full Tile, Thin Standard, 72"W	\$139
USFLT84#	Laminate Full Tile, Thin Standard, 84"W	\$180
Veneer Full Tiles for Thin Profile Standard Frames - (11"H)		
USFVT30@	Veneer Full Tile, Thin Standard, 30"W	\$386
USFVT48@	Veneer Full Tile, Thin Standard, 48"W	\$396
USFVT60@	Veneer Full Tile, Thin Standard, 60"W	\$493
USFVT72@	Veneer Full Tile, Thin Standard, 72"W	\$590
USFVT84@	Veneer Full Tile, Thin Standard, 84"W	\$663
Whiteboard Full Tiles for Thin Profile Standard Frames - (11"H)		
USFWT30	Whiteboard Full Tile, Thin Standard, 30"W	\$131
USFWT48	Whiteboard Full Tile, Thin Standard, 48"W	\$139
USFWT60	Whiteboard Full Tile, Thin Standard, 60"W	\$243
USFWT72	Whiteboard Full Tile, Thin Standard, 72"W	\$277
USFWT84	Whiteboard Full Tile, Thin Standard, 84"W	\$326
	Tip: Laminate Whiteboard construction.	
Magnetic Whiteboard Full Tiles for Thin Profile Standard Frames - (11"H)		
USFYT30	Magnetic Whiteboard Full Tile, Thin Standard, 30"W	\$291
USFYT48	Magnetic Whiteboard Full Tile, Thin Standard, 48"W	\$316
USFYT60	Magnetic Whiteboard Full Tile, Thin Standard, 60"W	\$339
USFYT72	Magnetic Whiteboard Full Tile, Thin Standard, 72"W	\$382
USFYT84	Magnetic Whiteboard Full Tile, Thin Standard, 84"W	\$440
	Tip: Porcelain on steel core.	

Grid Full Tiles for Rail Profile Standard Frames

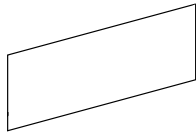

Part Number	Description	List Price (US\$)
Tackable Fabric Full Tiles for Rail Profile Standard Frames - (11"H)		
USFF30?	Tackable Fabric Full Tile, Rail Standard, 30"W	\$332
USFF48?	Tackable Fabric Full Tile, Rail Standard, 48"W	\$342
USFF60?	Tackable Fabric Full Tile, Rail Standard, 60"W	\$357
USFF72?	Tackable Fabric Full Tile, Rail Standard, 72"W	\$431
USFF84?	Tackable Fabric Full Tile, Rail Standard, 84"W	\$454
Non-Tackable Fabric Full Tiles for Rail Profile Standard Frames - (11"H)		
USFG30?	Non-tackable Fabric Full Tile, Rail Standard, 30"W	\$187
USFG48?	Non-tackable Fabric Full Tile, Rail Standard, 48"W	\$201
USFG60?	Non-tackable Fabric Full Tile, Rail Standard, 60"W	\$230
USFG72?	Non-tackable Fabric Full Tile, Rail Standard, 72"W	\$258
USFG84?	Non-tackable Fabric Full Tile, Rail Standard, 84"W	\$283
Frosted Acrylic Full Tiles for Rail Profile Standard Frames - (11"H)		
USFA30	Acrylic Full Tile, Rail Standard, 30"W	\$152
USFA48	Acrylic Full Tile, Rail Standard, 48"W	\$163
USFA60	Acrylic Full Tile, Rail Standard, 60"W	\$195
USFA72	Acrylic Full Tile, Rail Standard, 72"W	\$227
USFA84	Acrylic Full Tile, Rail Standard, 84"W	\$260
Laminate Full Tiles for Rail Profile Standard Frames - (11"H)		
USFL30#	Laminate Full Tile, Rail Standard, 30"W	\$96
USFL48#	Laminate Full Tile, Rail Standard, 48"W	\$101
USFL60#	Laminate Full Tile, Rail Standard, 60"W	\$120
USFL72#	Laminate Full Tile, Rail Standard, 72"W	\$139
USFL84#	Laminate Full Tile, Rail Standard, 84"W	\$180
Veneer Full Tiles for Rail Profile Standard Frames - (11"H)		
USFV30@	Veneer Full Tile, Rail Standard, 30"W	\$386
USFV48@	Veneer Full Tile, Rail Standard, 48"W	\$396
USFV60@	Veneer Full Tile, Rail Standard, 60"W	\$493
USFV72@	Veneer Full Tile, Rail Standard, 72"W	\$590
USFV84@	Veneer Full Tile, Rail Standard, 84"W	\$663
Whiteboard Full Tiles for Rail Profile Standard Frames - (11"H)		
USFW30	Whiteboard Full Tile, Rail Standard, 30"W	\$131
USFW48	Whiteboard Full Tile, Rail Standard, 48"W	\$139
USFW60	Whiteboard Full Tile, Rail Standard, 60"W	\$243
USFW72	Whiteboard Full Tile, Rail Standard, 72"W	\$277
USFW84	Whiteboard Full Tile, Rail Standard, 84"W	\$326
	Tip: Laminate Whiteboard construction.	
Magnetic Whiteboard Full Tiles for Rail Profile Standard Frames - (11"H)		
USFY30	Magnetic Whiteboard Full Tile, Rail Standard, 30"W	\$291
USFY48	Magnetic Whiteboard Full Tile, Rail Standard, 48"W	\$316
USFY60	Magnetic Whiteboard Full Tile, Rail Standard, 60"W	\$339
USFY72	Magnetic Whiteboard Full Tile, Rail Standard, 72"W	\$382
USFY84	Magnetic Whiteboard Full Tile, Rail Standard, 84"W	\$440
	Tip: Porcelain on steel core.	

Grid Upper & Full Tiles for Rail Profile Mega Frames

STEP 1 - If Applicable

(?) Fabric Suffix List:

- > Free form fabric selection. Choose from Camira Mill L2 or Lucia fabrics.

Tip: To view fabric colors or to order samples go to www.camirafabrics.com/us.

Tip: For COM yardage, see page 16.

(#) Laminate Suffix List:

- A Wilsonart Kensington Maple (10776-60)
- B Wilsonart Monticello Maple (7925-38)
- C Wilsonart Wild Cherry (7054-60)
- E Wilsonart Fashion Grey (D381-60)
- F Wilsonart White Tigris (4783-60)
- G Wilsonart Cafelle (7933K-07)
- M Wilsonart Frosty White (1573-60)
- P Wilsonart Slate Grey (D91-60)
- R Wilsonart Black (1595-60)
- U Wilsonart Brazilwood (7946-38)
- V Wilsonart River Cherry (7937-38)
- W Wilsonart Designer White (D354-60)
- 3 Formica Neutral Twill (8826-58)
- 4 Formica Bleached Legno (8845-58)
- 5 Formica Prestige Walnut (6209-43)
- 7 Formica Select Cherry (7759-43)
- X *Wilsonart Non-Premium laminates (-38, +10% -60). Orders of 100+ units have no upcharge.
- Y *Formica Non-Premium Standard (58, +19% 43, MC, SP and NT finishes) and Wilsonart Premium (-01, -07, -12, -18, -52, -78) laminates.
- Z *Pionite Non-Premium, Nevamar Non-Premium, Formica Premium (WR, 42, 77, 46, RD Finishes), and whiteboard laminate.

*Add \$350 list for Special Laminate orders of less than 10 units. See page 21 for edge selection.

(@) Veneer Suffix List:

- D Maple (stained similar to Kensington Maple laminate)
- J Cherry (stained similar to Wild Cherry laminate)
- N Walnut (stained similar to Cafelle laminate)
- 8 Walnut (stained similar to Prestige Walnut laminate)
- 9 Cherry (stained similar to Select Cherry laminate)
- X Stain Match (add a one-time \$700 list +10% Stain Match fee)

Product Specifications:

- > See page 279 for product details

Ordering Information:

- > Each frame requires 2 tiles
- > Upper Tiles must be used with a beltway. Full Tiles are only used in non-powered instances.
- > For COM yardage see page 16.
- > Some products may be available for quick ship. Contact info@enwork.com.
- > **A freight fee of \$100 net is assessed on orders less than \$1000 net. See page 13.**

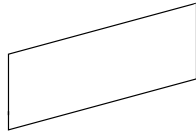

Part Number Description

List Price (US\$)

Tackable Fabric Upper Tiles for Rail Profile Mega Frames - (12"H)

USUFB30?	Tackable Fabric Upper Tile, Mega, 30"W	\$257
USUFB48?	Tackable Fabric Upper Tile, Mega, 48"W	\$270
USUFB60?	Tackable Fabric Upper Tile, Mega, 60"W	\$333
USUFB72?	Tackable Fabric Upper Tile, Mega, 72"W	\$360
USUFB84?	Tackable Fabric Upper Tile, Mega, 84"W	\$387

Non-Tackable Fabric Upper Tiles for Rail Profile Mega Frames - (12"H)

USUGB30?	Non-tackable Fabric Upper Tile, Mega, 30"W	\$172
USUGB48?	Non-tackable Fabric Upper Tile, Mega, 48"W	\$180
USUGB60?	Non-tackable Fabric Upper Tile, Mega, 60"W	\$238
USUGB72?	Non-tackable Fabric Upper Tile, Mega, 72"W	\$244
USUGB84?	Non-tackable Fabric Upper Tile, Mega, 84"W	\$267

Frosted Acrylic Upper Tiles for Rail Profile Mega Frames - (12"H)

USUAB30	Acrylic Upper Tile, Mega, 30"W	\$180
USUAB48	Acrylic Upper Tile, Mega, 48"W	\$206
USUAB60	Acrylic Upper Tile, Mega, 60"W	\$252
USUAB72	Acrylic Upper Tile, Mega, 72"W	\$294
USUAB84	Acrylic Upper Tile, Mega, 84"W	\$326

Laminate Upper Tiles for Rail Profile Mega Frames - (12"H)

USULB30#	Laminate Upper Tile, Mega, 30"W	\$102
USULB48#	Laminate Upper Tile, Mega, 48"W	\$122
USULB60#	Laminate Upper Tile, Mega, 60"W	\$147
USULB72#	Laminate Upper Tile, Mega, 72"W	\$163
USULB84#	Laminate Upper Tile, Mega, 84"W	\$196

Veneer Upper Tiles for Rail Profile Mega Frames - (12"H)

USUVB30@	Veneer Upper Tile, Mega, 30"W	\$342
USUVB48@	Veneer Upper Tile, Mega, 48"W	\$438
USUVB60@	Veneer Upper Tile, Mega, 60"W	\$545
USUVB72@	Veneer Upper Tile, Mega, 72"W	\$654
USUVB84@	Veneer Upper Tile, Mega, 84"W	\$723

Whiteboard Upper Tiles for Rail Profile Mega Frames - (12"H)

USUWB30	Whiteboard Upper Tile, Mega, 30"W	\$134
USUWB48	Whiteboard Upper Tile, Mega, 48"W	\$190
USUWB60	Whiteboard Upper Tile, Mega, 60"W	\$298
USUWB72	Whiteboard Upper Tile, Mega, 72"W	\$346
USUWB84	Whiteboard Upper Tile, Mega, 84"W	\$389

Tip: Laminate Whiteboard Construction.

Magnetic Whiteboard Upper Tiles for Rail Profile Mega Frames - (12"H)

USUYB30	Magnetic Whiteboard Upper Tile, Mega, 30"W	\$296
USUYB48	Magnetic Whiteboard Upper Tile, Mega, 48"W	\$347
USUYB60	Magnetic Whiteboard Upper Tile, Mega, 60"W	\$401
USUYB72	Magnetic Whiteboard Upper Tile, Mega, 72"W	\$432
USUYB84	Magnetic Whiteboard Upper Tile, Mega, 84"W	\$471

Tip: Porcelain on steel core.

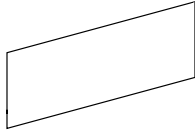

Part Number	Description	List Price (US\$)
Tackable Fabric Full Tiles for Rail Profile Mega Frames - (15"H)		
USFFB30?	Tackable Fabric Full Tile, Mega, 30"W	\$355
USFFB48?	Tackable Fabric Full Tile, Mega, 48"W	\$366
USFFB60?	Tackable Fabric Full Tile, Mega, 60"W	\$395
USFFB72?	Tackable Fabric Full Tile, Mega, 72"W	\$473
USFFB84?	Tackable Fabric Full Tile, Mega, 84"W	\$490
Non-Tackable Fabric Full Tiles for Rail Profile Mega Frames - (15"H)		
USFGB30?	Non-tackable Fabric Full Tile, Mega, 30"W	\$196
USFGB48?	Non-tackable Fabric Full Tile, Mega, 48"W	\$213
USFGB60?	Non-tackable Fabric Full Tile, Mega, 60"W	\$262
USFGB72?	Non-tackable Fabric Full Tile, Mega, 72"W	\$295
USFGB84?	Non-tackable Fabric Full Tile, Mega, 84"W	\$315
Frosted Acrylic Full Tiles for Rail Profile Mega Frames - (15"H)		
USFAB30	Acrylic Full Tile, Mega, 30"W	\$183
USFAB48	Acrylic Full Tile, Mega, 48"W	\$209
USFAB60	Acrylic Full Tile, Mega, 60"W	\$254
USFAB72	Acrylic Full Tile, Mega, 72"W	\$296
USFAB84	Acrylic Full Tile, Mega, 84"W	\$328
Laminate Full Tiles for Rail Profile Mega Frames - (15"H)		
USFLB30#	Laminate Full Tile, Mega, 30"W	\$112
USFLB48#	Laminate Full Tile, Mega, 48"W	\$143
USFLB60#	Laminate Full Tile, Mega, 60"W	\$163
USFLB72#	Laminate Full Tile, Mega, 72"W	\$195
USFLB84#	Laminate Full Tile, Mega, 84"W	\$222
Veneer Full Tiles for Rail Profile Mega Frames - (15"H)		
USFVB30@	Veneer Full Tile, Mega, 30"W	\$410
USFVB48@	Veneer Full Tile, Mega, 48"W	\$519
USFVB60@	Veneer Full Tile, Mega, 60"W	\$641
USFVB72@	Veneer Full Tile, Mega, 72"W	\$774
USFVB84@	Veneer Full Tile, Mega, 84"W	\$805
Whiteboard Full Tiles for Rail Profile Mega Frames - (15"H)		
USFWB30	Whiteboard Full Tile, Mega, 30"W	\$169
USFWB48	Whiteboard Full Tile, Mega, 48"W	\$210
USFWB60	Whiteboard Full Tile, Mega, 60"W	\$322
USFWB72	Whiteboard Full Tile, Mega, 72"W	\$374
USFWB84	Whiteboard Full Tile, Mega, 84"W	\$404
	Tip: Laminate Whiteboard Construction.	
Magnetic Whiteboard Full Tiles for Rail Profile Mega Frames - (15"H)		
USFYB30	Magnetic Whiteboard Full Tile, Mega, 30"W	\$301
USFYB48	Magnetic Whiteboard Full Tile, Mega, 48"W	\$360
USFYB60	Magnetic Whiteboard Full Tile, Mega, 60"W	\$403
USFYB72	Magnetic Whiteboard Full Tile, Mega, 72"W	\$449
USFYB84	Magnetic Whiteboard Full Tile, Mega, 84"W	\$487
	Tip: Porcelain on steel core.	

Grid Frame Supports & Connectors for Workstations

STEP 1 - Steel Legs Only





(^) Paint Suffix List





G	Slate Grey
R	Black
S	Silver
T	Medium Tone
W	Arctic White
Z	Other

Tip: Some Steelcase, Herman Miller, Knoll, Haworth, and Allsteel paints are available for \$350 list fee per order. Call/email for availability of specific colors. Additional custom paints (e.g. Tiger Dry Lac) must be quoted through quotes@enwork.com.

Ordering Information:

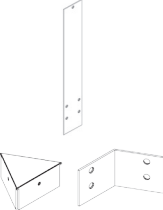
- > Frame Support aluminum legs have two passageways 5/8" x 1-5/16" per leg. For steel legs there is a single passageway 1-5/16" x 2-3/4".
- > Some products may be available for quick ship. Contact info@enwork.com.
- > **A freight fee of \$100 net is assessed on orders less than \$1000 net. See page 13.**

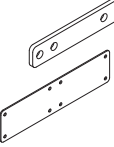
	Part Numbers	Description	List Price (US\$)
	T-Leg Frame Supports, Painted Steel		
	UTLEG36^	Impression Foot Steel T-Leg for Beltway Below Worksurface	\$243
	UTLEG42^	Impression Foot Steel T-Leg for Beltway Above Worksurface	\$266
	UCATLEG32^	Solano Foot Steel T-Leg for Low Beltway	\$243
	Tip: Low beltway foot puts bottom of frame at 16.1", top of Mini Frame at 24.0, top of Standard Frame at 32.0", and top of Mega Frame at 36.7".		
	UCATLEG36^	Solano Foot Steel T-Leg for Beltway Below Worksurface	\$243
	UCATLEG42^	Solano Foot Steel T-Leg for Beltway Above Worksurface	\$266
	T-Leg Frame Supports with Power Infeed Hole, Painted Steel		
	UTLEG36H^	Impression Foot Steel T-Leg, Infeed Hole, for Beltway Below Worksurface	\$248
	UTLEG42H^	Impression Foot Steel T-Leg, Infeed Hole, for Beltway Above Worksurface	\$272
	UCATLEG32H^	Solano Foot Steel T-Leg, Infeed Hole, for Low Beltway	\$248
	Tip: Low beltway foot puts bottom of frame at 16.1", top of Mini Frame at 24.0, top of Standard Frame at 32.0", and top of Mega Frame at 36.7".		
	UCATLEG36H^	Solano Foot Steel T-Leg, Infeed Hole, for Beltway Below Worksurface	\$248
	UCATLEG42H^	Solano Foot Steel T-Leg, Infeed Hole, for Beltway Above Worksurface	\$272
	Straight Leg Frame Supports		
	USLEGAL36	Aluminum Straight Leg for Beltway Below Worksurface	\$201
	USLEGAL42	Aluminum Straight Leg for Beltway Above Worksurface	\$216
	USLEG36^	Steel Straight Leg for Beltway Below Worksurface	\$238
	USLEG42^	Steel Straight Leg for Beltway Above Worksurface	\$252
	Straight Leg Frame Supports with Power Infeed Hole		
	USLEGAL36H	Aluminum Straight Leg, Infeed Hole, for Beltway Below Worksurface	\$210
	USLEGAL42H	Aluminum Straight Leg, Infeed Hole, for Beltway Above Worksurface	\$223
	USLEG36H^	Steel Straight Leg, Infeed Hole, for Beltway Below Worksurface	\$244
	USLEG42H^	Steel Straight Leg, Infeed Hole, for Beltway Above Worksurface	\$258
	Tip: Infeed hole is 1" x 3".		
	Tip: Infeed Legs for Grid XTB found on page 313.		
	UHC^	Grid Leg Infeed Hole Cover	\$45

	Part Numbers	Description	List Price (US\$)
	90 Degree Connector Packages - Rail Profile		
	UC90	90 Degree Connector Package, for Rail Profile Frame, No Power	\$36
	UPP90	90 Degree Connector Package, for Rail Profile Frame, with 3-circuit Power Tip: Includes Brackets, Splitter and Jumper for one 90 degree Frame connection off a Spine Wall When doing an X junction with two 90 degree Frames off a Spine wall then two UPP90 packages are required.	\$203
	UPP908W	90 Degree Connector Package, for Rail Profile Frame, with 4-circuit Power Tip: For applications requiring 90-Degree Connectors, Rail Profile Frames are required for structural reasons.	\$203
	120 Degree Connector Packages - Thin and Rail Profiles		
	UJ2	2-Way 120 Degree Connector Package, No Power Tip: Only works on Standard Frames (not Mega Frames or Mini Frames)	\$197
	UC120	3-Way 120 Degree Connector Package, No Power	\$101
	UJP2	2-Way 120 Degree Connector Package, with 3-circuit Power Tip: Only works on Standard Frames (not Mega Frames or Mini Frames) Tip: Includes Brackets, Splitter and Jumper.	\$369
	UPP120	3-Way 120 Degree Connector Package, with 3-circuit Power Tip: Includes Brackets, Splitter and Jumper.	\$284
	UJP28W	2-Way 120 Degree Connector Package, with 4-circuit Power Tip: Only works on Standard Frames (not Mega Frames or Mini Frames)	\$369
	UPP1208W	3-Way 120 Degree Connector Package, with 4-circuit Power	\$284
	Worksurface Tether Brackets, Silver		
	UMTD	Tether Brackets for power beltway below worksurface applications, Silver	\$26
	UMTB	Tether Brackets for power beltway above worksurface applications, Silver	\$20
	Worksurface Tie and Support Plates		
	UTE	1/2" x 2.5" Tie plates - package of 5	\$32
	USPT	2" x 7.5" Support plate	\$23
	End Cap Conversion Kits (for reconfiguring Frames) - Rail Profile		
	UZSE	Standard Frame Conversion Kit for Rail Profile, End of Run (no opening)	\$76
	UZME	Standard Frame Conversion Kit for Rail Profile, Middle of Run (opening)	\$67
	UZSME	Mini Frame Conversion Kit for Rail Profile, End of Run (no opening)	\$76
	UZMME	Mini Frame Conversion Kit for Rail Profile, Middle of Run (opening)	\$67
	UZSBE	Mega Frame Conversion Kit for Rail Profile, End of Run (no opening)	\$76
	UZMBE	Mega Frame Conversion Kit for Rail Profile, Middle of Run (opening)	\$67
	End Cap Conversion Kits (for reconfiguring Frames) - Thin Profile		
	UZSTE	Standard Frame Conversion Kit for Thin Profile, End of Run (no opening)	\$76
	UZMTE	Standard Frame Conversion Kit for Thin Profile, Middle of Run (opening)	\$67
	UZSMTE	Mini Frame Conversion Kit for Thin Profile, End of Run (no opening)	\$76
	UZMMTE	Mini Frame Conversion Kit for Thin Profile, Middle of Run (opening)	\$67

Grid Worksurface Supports for Workstations

STEP 1 - Steel Legs Only

(^) Paint Suffix List

G Slate Grey
R Black
S Silver
T Medium Tone
W Arctic White
Z Other

Tip: Some Steelcase, Herman Miller, Knoll, Haworth, and Allsteel paints are available for \$350 list fee per order. Call/email for availability of specific colors. Additional custom paints (e.g. Tiger Dry Lac) must be quoted through quotes@enwork.com.

STEP 2 - Steel Legs w/ Casters

(@) Caster Color Suffix List:

B Black no charge
G Grey +\$40

Ordering Information:

- > Legs and Panels on these pages do NOT support Grid Frames, only worksurfaces.
- > Taller height anodized aluminum legs not available.
- > Some products may be available for quick ship. Contact info@enwork.com.
- > **A freight fee of \$100 net is assessed on orders less than \$1000 net. See page 13.**

Part Number	Description	List Price (US\$)
T-Legs, Painted Steel with Levelers, package of two		
LTP182^	Impression Foot T-Leg, Levelers, for 18"D worksurface (16" spread)	\$558
LTP242^	Impression Foot T-Leg, Levelers, for 24"D worksurface (22" spread)	\$567
LTP302^	Impression Foot T-Leg, Levelers, for 30-36"D worksurface (26" spread)	\$606
Tip: For Solano Foot T-Leg, see page 138.		
C-Legs, Painted Steel with Levelers, package of two		
LCP182^	Impression Foot C-Leg, Levelers, for 18"D worksurface (16" spread)	\$558
LCP242^	Impression Foot C-Leg, Levelers, for 24"D worksurface (22" spread)	\$567
LCP302^	Impression Foot C-Leg, Levelers, for 30"D worksurface (26" spread)	\$606
Tip: For Solano Foot C-Leg, see page 142.		
Rectangle Straight Legs, with Levelers		
LPP?^	Straight Leg, Levelers, Painted Steel	\$193
LPP2?^	Straight Leg, Levelers, Painted Steel, Package of Two	\$387
LPPAL?	Straight Leg, Levelers, Clear Anodized Aluminum	\$177
LPPAL2?	Straight Leg, Levelers, Clear Anodized Aluminum, Package of Two	\$353
Square Straight Leg, 1.5" x 1.5"		
LPPSQ^	Square Straight Leg, Painted Steel	\$193
LPPSQ2^	Square Straight Leg, Painted Steel, Package of Two	\$387
LPPSQAL	Square Straight Leg, Clear Anodized Aluminum	\$175
LPPSQAL2	Square Straight Leg, Clear Anodized Aluminum, Package of Two	\$349
Rectangle Straight Legs, with Casters		
LPPC^@	Straight Leg, Caster, Painted Steel	\$212
LPPC2^@	Straight Leg, Caster, Painted Steel, Package of Two	\$433
LPPALC	Straight Leg, Caster, Clear Anodized Aluminum	\$200
LPPALC2	Straight Leg, Caster, Clear Anodized Aluminum, Package of Two	\$400
Plinth Worksurface Supports, Clear Anodized Aluminum		
UULP	Square Plinth, 3.5"H, used between Landscape Storage and underside of worksurface	\$42
Tip: Landscape Storage can be found on pages 334-335.		
Tip: Contact quotes@enwork.com when using Grid Steel Storage.		
O-Legs for Worksurfaces, with Levelers, package of one		
LSQ18^	O-Leg for 18"D worksurfaces (actual size 16")	\$276
LSQ24^	O-Leg for 24"D worksurfaces (actual size 22")	\$283
LSQ30^	O-Leg for 30"D worksurfaces (actual size 28")	\$302
LSQ36^	O-Leg for 36"D worksurfaces (actual size 34")	\$325
Tip: For cable manager, order LPCMC.		
Tip: For O-Legs for conference applications, see page 115.		
Tip: Standard height is 27.75". For shorter heights put "X" in front of the part number and add \$54 list. For taller heights put "XX" in front and add \$68 list. Maximum worksurface height is 42".		

Grid End Panels & Worksurface Supports

End Panel Product Specifications:

- > Edge: 3mm
- > 27.75" High x 1.25" thick

Ordering Information:

- > End Panels include levelers, brackets, and hardware.
- > **A freight fee of \$100 net is assessed on orders less than \$1000 net. See page 13.**

Part Number	Description	List Price (US\$)
-------------	-------------	-------------------



End Panel for Double-Sided Grid Workstations, Laminate

UEPDA24#	End panel for two 24"D 3mm Tops	\$509
UEPDA30#	End panel for two 30"D 3mm Tops	\$550
UEPDK24#	End panel for two 24"D Knife Tops	\$447
UEPDK30#	End panel for two 30"D Knife Tops	\$509

Tip: For use with Grid frames when power is above worksurface.



End Panel for Grid XTB with 3mm Edge Tops, Laminate, 29"H

UMEP483^#	XTB End Panel, for 24"D Double-Sided units	\$637
UMEP603^#	XTB End Panel, for 30"D Double-Sided units	\$676
UMEP243^#	XTB End Panel, for 24"D Single-Sided units	\$431
UMEP303^#	XTB End Panel, for 30"D Single-Sided units	\$462

End Panels for Worksurfaces, Laminate with Levelers



EP1827A*#	End Panel for 18"D Worksurface	\$254
EP2427A*#	End Panel for 24"D Worksurface	\$286
EP3027A*#	End Panel for 30"D Worksurface	\$300
EP3627A*#	End Panel for 36"D Worksurface	\$339

Tip: Intended for cosmetic purposes beside storage. If no storage is present order CABRACE below.

Tip: End panel does not attach to the panel system.



Mid Worksurface Support Panel, Laminate with Levelers

EP1027A#	Mid panel with levelers, 10"D	\$214
----------	-------------------------------	-------

End Panel Support Brace for Workstations

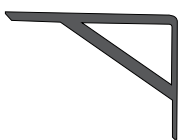

CABRACE	End Panel Support, Heavy Duty 11.5"D x 8"H	\$32
---------	--	------

Tip: Used when end panel has no storage nearby for support. Connects end panel to worksurface. One required per end panel.

Worksurface Support Braces, Black



NWBRACE	Brace for worksurfaces w/ 54" or more of unsupported knee space, 52"W	\$76
---------	---	------

Tip: Two braces are required per table for depths of 36" or greater.

NZBRACE60	Recessed brace for worksurfaces w/ 60" or more of unsupported knee space, 54"W	\$155
-----------	--	-------

NZBRACE72	Recessed brace for worksurfaces w/ 72" or more of unsupported knee space, 66"W	\$172
-----------	--	-------

Tip: NZBRACE60 and NZBRACE72 are designed to be recessed into the underside of the worksurface.

Tip: Price includes routing of worksurface.

STEP 1 - End Panels for Worksurfaces Only

(*) Worksurface Application Suffix List:

- A Grid XTB Workstations (actual top depth 2" less than nominal and width 1-1/8" less than nominal)
- B Enwork Height-adjustable freestanding Tables (actual top depth and width 1-1/8" less than nominal)
- C Grid with no gap between worksurface and Frame (actual top depth matches nominal).
- D Grid with 1/2" gap between worksurface and Frame (actual top depth 1/2" less than nominal).
- V Grid with 1" gap between worksurface and Frame (actual top depth 1" less than nominal).

STEP 1 - Grid XTB End Panels Only

(^) Paint Suffix List

- G Slate Grey
- R Black
- S Silver
- T Medium Tone
- W Arctic White
- Z Other

Tip: Some Steelcase, Herman Miller, Knoll, Haworth, and Allsteel paints are available for \$350 list fee per order. Call/email for availability of specific colors. Additional custom paints (e.g. Tiger Dry Lac) must be quoted through quotes@enwork.com.

STEP 2 - Mid and End Panels

(#) Laminate Suffix List:

- A Wilsonart Kensington Maple (10776-60)
- B Wilsonart Monticello Maple (7925-38)
- C Wilsonart Wild Cherry (7054-60)
- E Wilsonart Fashion Grey (D381-60)
- F Wilsonart White Tigris (4783-60)
- G Wilsonart Cafelle (7933K-07)
- M Wilsonart Frosty White (1573-60)
- P Wilsonart Slate Grey (D91-60)
- R Wilsonart Black (1595-60)
- U Wilsonart Brazilwood (7946-38)
- V Wilsonart River Cherry (7937-38)
- W Wilsonart Designer White (D354-60)
- 3 Formica Neutral Twill (8826-58)
- 4 Formica Bleached Legno (8845-58)
- 5 Formica Prestige Walnut (6209-43)
- 7 Formica Select Cherry (7759-43)
- X *Wilsonart Non-Premium laminates +10%
(-38, -60). Orders of 100+ units have no upcharge.
- Y *Formica Non-Premium Standard (58, +19%
43, MC, SP and NT finishes) and
Wilsonart Premium (-01, -07, -12, -18,
-52, -78) laminates.
- Z *Pionite Non-Premium, Nevamar +25%
Non-Premium, Formica Premium (WR,
42, 77, 46, RD Finishes), and whiteboard
laminate.

*Add \$350 list for Special Laminate orders of less than 10 units. See page 21 for edge selection.

Grid XTB Bases & Connector Packages

STEP 1

(^) Paint Suffix List

G Slate Grey
R Black
S Silver
T Medium Tone
W Arctic White
Z Other

Tip: Some Steelcase, Herman Miller, Knoll, Haworth, and Allsteel paints are available for \$350 list fee per order. Call/email for availability of specific colors. Additional custom paints (e.g. Tiger Dry Lac) must be quoted through quotes@enwork.com.

Product Specifications:

- > Bases with different height-adjustable mechanisms are interchangeable for reconfiguration.
- > Bases fit any size Frame (Mega, Standard, or Mini).
- > Rectangle and extended corner bases have adjustable cross bars to fit 60" or 72"W tops and Frames.
- > Double-Sided bases fit either 24" or 30"D tops. Single-Sided bases are unique for 24" and 30"D.
- > Rectangle bases fit Straight top shapes.
- > Extended corner Double-Sided bases fit 60"W or 72"W x 48"W tops.
- > 120 bases fit 24"D, 24"D, 48"W, 48"W tops.

Ordering Information:

- > (see page 313)

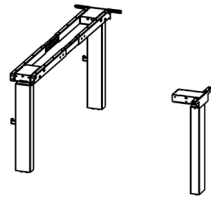
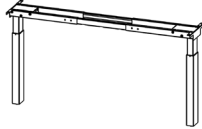

Part Number	Description	List Price (US\$)
-------------	-------------	-------------------

XTB Bases for 24" or 30"D Rectangle Tops - Double-Sided Benching

UMMF2R^	XTB Fixed Base, for Double-Sided	\$733
UMMK2R^	XTB Knob Adjustable Base, for Double-Sided	\$951
UMMC2R^	XTB Crank Base, for Double-Sided	\$1477
UMME12R^	XTB Electric Base, for Double-Sided	\$2107
UMME22R^	XTB BIFMA Electric Base, for Double-Sided	\$2486

XTB Bases for Extended Corner Tops - Double-Sided Benching

UMMF2E^	XTB Extended Corner Fixed Base, for Double-Sided	\$1126
UMMK2E^	XTB Extended Corner Knob Adjustable Base, for Double-Sided	\$1419
UMME12E^	XTB Extended Corner Electric Base, for Double-Sided	\$2938
UMME22E^	XTB Extended Corner BIFMA Electric Base, for Double-Sided	\$3712

XTB Connector Packages - Double-Sided Benching with 24"D Tops

UMCON22^	XTB Double-Sided w/ 24"D Tops Connector Pkg 2-Pack	\$333
UMCON24^	XTB Double-Sided w/ 24"D Tops Connector Pkg 4-Pack	\$812
UMCON26^	XTB Double-Sided w/ 24"D Tops Connector Pkg 6-Pack	\$1291
UMCON28^	XTB Double-Sided w/ 24"D Tops Connector Pkg 8-Pack	\$1770
UMCON210^	XTB Double-Sided w/ 24"D Tops Connector Pkg 10-Pack	\$2249
UMCON212^	XTB Double-Sided w/ 24"D Tops Connector Pkg 12-Pack	\$2727

XTB Connector Packages - Double-Sided Benching with 30"D Tops

UMCOP22^	XTB Double-Sided w/ 30"D Tops Connector Pkg 2-Pack	\$333
UMCOP24^	XTB Double-Sided w/ 30"D Tops Connector Pkg 4-Pack	\$812
UMCOP26^	XTB Double-Sided w/ 30"D Tops Connector Pkg 6-Pack	\$1291
UMCOP28^	XTB Double-Sided w/ 30"D Tops Connector Pkg 8-Pack	\$1770
UMCOP210^	XTB Double-Sided w/ 30"D Tops Connector Pkg 10-Pack	\$2249
UMCOP212^	XTB Double-Sided w/ 30"D Tops Connector Pkg 12-Pack	\$2727

XTB Bases for Rectangle Tops - Single-Sided Benching

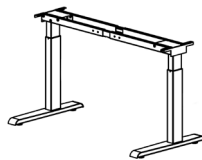

UMMF1R24^	XTB Fixed Base, for Single-Sided with 24"D Top	\$1129
UMMF1R30^	XTB Fixed Base, for Single-Sided with 30"D Top	\$1190
UMMK1R24^	XTB Knob Adjustable Base, for Single-Sided with 24"D Top	\$1353
UMMK1R30^	XTB Knob Adjustable Base, for Single-Sided with 30"D Top	\$1416
UMMC1R24^	XTB Crank Base, for Single-Sided with 24"D Top	\$1798
UMMC1R30^	XTB Crank Base, for Single-Sided with 30"D Top	\$1861
UMME11R24^	XTB Electric Base, for Single-Sided with 24"D Top	\$2239
UMME11R30^	XTB Electric Base, for Single-Sided with 30"D Top	\$2301
UMME21R24^	XTB BIFMA Electric Base, for Single-Sided with 24"D Top	\$2887
UMME21R30^	XTB BIFMA Electric Base, for Single-Sided with 30"D Top	\$2948

Adjustment Ranges (including top):

- > Knob 27" - 42" > Electric 27" - 46", 250 pound load capacity
- > Crank 27" - 46" > BIFMA Electric 22" - 48", 250 pound load capacity

Ordering Information:

- > Bases must be assembled with Connector Packages, ordered separately.
- > Tops ordered separately.
- > Electric Bases adjust via up/down controller (no display). Optional programmable digital display available below.
- > **A freight fee of \$100 net is assessed on orders less than \$1000 net. See page 13.**

COORDINATING FURNITURE

See pages 118-121, and 146-150 for coordinating freestanding bases

Part Number	Description	List Price (US\$)
XTB Connector Packages - Single-Sided Benching with 24"D Tops		
UMCON11^	XTB Single-Sided w/ 24"D Tops Connector Package 1-Pack	\$623
UMCON12^	XTB Single-Sided w/ 24"D Tops Connector Package 2-Pack	\$924
UMCON13^	XTB Single-Sided w/ 24"D Tops Connector Package 3-Pack	\$1447
UMCON14^	XTB Single-Sided w/ 24"D Tops Connector Package 4-Pack	\$1970
UMCON15^	XTB Single-Sided w/ 24"D Tops Connector Package 5-Pack	\$2493
XTB Connector Packages - Single-Sided Benching with 30"D Tops		
UMCOP11^	XTB Single-Sided w/ 30"D Tops Connector Package 1-Pack	\$623
UMCOP12^	XTB Single-Sided w/ 30"D Tops Connector Package 2-Pack	\$924
UMCOP13^	XTB Single-Sided w/ 30"D Tops Connector Package 3-Pack	\$1447
UMCOP14^	XTB Single-Sided w/ 30"D Tops Connector Package 4-Pack	\$1970
UMCOP15^	XTB Single-Sided w/ 30"D Tops Connector Package 5-Pack	\$2493

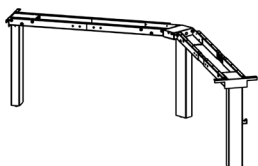
**XTB Bases for 120 Degree Corner Tops**

UMMF3120^	XTB Fixed Base, for 120 Degree	\$1126
UMMK3120^	XTB Knob Adjustable Base, for 120 Degree	\$1419
UMMC3120^	XTB Crank Base, for 120 Degree	\$2141
UMME13120^	XTB Electric Base, for 120 Degree	\$3026
UMME23120^	XTB BIFMA Electric Base, for 120 Degree	\$3712

XTB Connector Packages - 120 Degree Bases with 48"W Tops, 24"D

UMCON33^	XTB 3-Pack 120 Degree w/ 24"D Tops Connector Package	\$1645
UMCON66^	XTB 6-Pack (boomerang) 120 Degree w/ 24"D Tops Connector Package	\$3467

XTB Connector Packages - 120 Degree Bases with 48"W Tops, 30"D

UMCOP33^	XTB 3-Pack 120 Degree w/ 30"D Tops Connector Package	\$1645
UMCOP66^	XTB 6-Pack (boomerang) 120 Degree w/ 30"D Tops Connector Package	\$3467

XTB Riser Bracket - package of two (one for each end of Grid Frame)

UMRISER4^	Riser Bracket, 4"H	\$94
-----------	--------------------	------

Tip: Not recommended with BIFMA Electric bases. See page 285 for planning information.

**XTB Infeed Legs**

UMLEG16H^	XTB Infeed Leg	\$158
UMLEG20H^	XTB Infeed Leg for use with 4" Riser Bracket	\$158

Tip: Infeed Legs for Grid workstations found on page 308.

XTB Programmable Controller for Electric Bases with Digital Read-Out Display and 4 Stored Positions

UTWA	Programmable Controller, Digital Display, for Electric XTB, Black w/ Silver Buttons	\$184
------	---	-------

Tip: Optional for Single-Sided, Double-Sided, and 120 XTB Electric Bases.

Grid Electrical Components

Ordering Information:

- > 90-degree and 120 degree power connector packages are on page 309.
- > 5-wire, 3 circuit power systems come with receptacles. Receptacles for other power systems are listed below.
- > Some products may be available for quick ship. Contact info@enwork.com.
- > **A freight fee of \$100 net is assessed on orders less than \$1000 net. See page 13.**

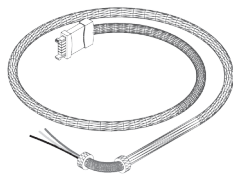

Part Number	Description	List Price (US\$)
-------------	-------------	-------------------

Base Power Infeed for Grid 5-Wire, 3-Circuit (standard) Powerways, Black

UPHASE72	5-Wire Power Infeed, Black, for Hardwire, 72"	\$148
UPHASE120	5-Wire Power Infeed, Black, for Hardwire, 120"	\$224
UPHASE240	5-Wire Power Infeed, Black, for Hardwire, 240" (Power Poles)	\$368

Tip: If Base Power-In is coming into the middle of a spine wall application then a splitter is required.

Tip: Not required in 8-wire applications.

Base Power Infeed for Grid 5-Wire, 3-Circuit (standard) Powerways, Metallic

UPHASE72M	5-Wire Power Infeed, Metallic, for Hardwire, 72"	\$193
UPHASE120M	5-Wire Power Infeed, Metallic, for Hardwire, 120"	\$284
UPHASE240M	5-Wire Power Infeed, Metallic, for Hardwire, 240" (use with Power Poles)	\$428

Tip: If Base Power-In is coming into the middle of a spine wall application then a Splitter must be ordered (see below).

UYCONN	3-Way Base Power Infeed Splitter	\$25
--------	----------------------------------	------

Tip: If Base Power-In is coming into the middle of a spine wall application then a splitter is required.

Tip: Not required in 8-wire applications.

Base Power Infeed for Grid 8-Wire, 4-Circuit (optional) Powerways, Metallic

UPHASE728W	8-Wire Power Infeed, Metallic, for Hardwire, 72"	\$187
UPHASE1208W	8-Wire Power Infeed, Metallic, for Hardwire, 120"	\$248
UPHASE2408W	8-Wire Power Infeed, Metallic, for Hardwire, 240" (use with Power Poles)	\$436

NYC Power Entry Kit, Bolt Mount, 72" Length

UPHASE5NY	5-Wire Power Entry Kit, NYC, Bolt Mount, 15.59"	\$310
UPHASE8NY	8-Wire Power Entry Kit, NYC, Bolt Mount, 15.59"	\$310

Power Poles, Two Chamber, Clear Anodized Aluminum, 2.3"W x 2.3"D

UPHPP10	Power Pole, 10'H	\$1287
UPHPP12	Power Pole, 12'H	\$1465
UPHPP15	Power Pole, 15'H	\$1710

Tip: Power Pole has a cable routing hole on side of pole at the bottom. Infeed passes through the hole, across the floor, and into hole at the bottom of the infeed leg. Additional hole(s) can be field cut to allow routing directly into the power system.

Tip: Includes mounting hardware and ceiling trim plate.

Tip: Power infeed not included. Order 240" Base Power Infeed separately.

Receptacles for Grid 8-Wire, 4-Circuit Powerway (optional)

15-Amp, Grey

UREC8W15G311	15-amp Receptacle for 4-circuit Powerway, Circuit 1	\$36
UREC8W15G312	15-amp Receptacle for 4-circuit Powerway, Circuit 2	\$36
UREC8W15G313	15-amp Receptacle for 4-circuit Powerway, Circuit 3	\$36
UREC8W15G223	15-amp Receptacle for 4-circuit Powerway, Circuit 3 (Dedicated)	\$36
UREC8W15G314	15-amp Receptacle for 4-circuit Powerway, Circuit 4 (Dedicated)	\$36

20-Amp, Grey

UREC8W20G311	20-amp Receptacle for 4-circuit Powerway, Circuit 1	\$41
UREC8W20G312	20-amp Receptacle for 4-circuit Powerway, Circuit 2	\$41
UREC8W20G313	20-amp Receptacle for 4-circuit Powerway, Circuit 3	\$41
UREC8W20G223	20-amp Receptacle for 4-circuit Powerway, Circuit 3 (Dedicated)	\$41
UREC8W20G314	20-amp Receptacle for 4-circuit Powerway, Circuit 4 (Dedicated)	\$41



15-Amp, Grey w/ Controlled Stamp for California Title 24

UREC8W15G1C	15-amp Receptacle for 4-circuit Powerway, Circuit 1, Controlled Stamp	\$38
UREC8W15G2C	15-amp Receptacle for 4-circuit Powerway, Circuit 2, Controlled Stamp	\$38
UREC8W15G3C	15-amp Receptacle for 4-circuit Powerway, Circuit 3, Controlled Stamp	\$38
UREC8W15G6C	15-amp Receptacle for 4-circuit Powerway, Circuit 3 (Dedicated), Controlled Stamp	\$38
UREC8W15G4C	15-amp Receptacle for 4-circuit Powerway, Circuit 4 (Dedicated), Controlled Stamp	\$38

20-Amp, Grey w/ Controlled Stamp for California Title 24

UREC8W20G1C	20-amp Receptacle for 4-circuit Powerway, Circuit 1, Controlled Stamp	\$43
UREC8W20G2C	20-amp Receptacle for 4-circuit Powerway, Circuit 2, Controlled Stamp	\$43
UREC8W20G3C	20-amp Receptacle for 4-circuit Powerway, Circuit 3, Controlled Stamp	\$43
UREC8W20G6C	20-amp Receptacle for 4-circuit Powerway, Circuit 3 (Dedicated), Controlled Stamp	\$43
UREC8W20G4C	20-amp Receptacle for 4-circuit Powerway, Circuit 4 (Dedicated), Controlled Stamp	\$43

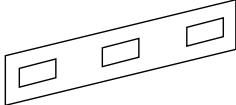
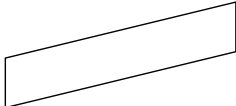
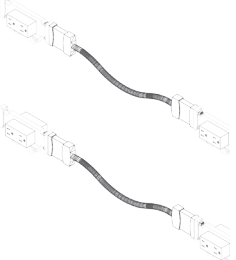
Grid Electrical Retro-Fit Components

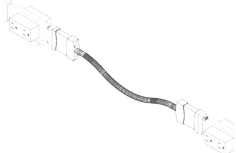
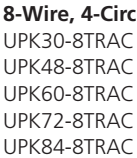
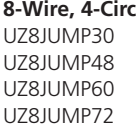
	Part Number	Description	List Price (US\$)
	Beltway Tiles with Power/Data Cutouts, Silver (usually ordered with Frame)		
	UESP30	Beltway Tile for Standard or Mega Frame, P/D cutouts, 30"W	\$45
	UESP48	Beltway Tile for Standard or Mega Frame, P/D cutouts, 48"W	\$49
	UESP60	Beltway Tile for Standard or Mega Frame, P/D cutouts, 60"W	\$62
	UESP72	Beltway Tile for Standard or Mega Frame, P/D cutouts, 72"W	\$68
	UESPM30	Beltway Tile for Mini Frame, P/D cutouts, 30"W	\$45
	UESPM48	Beltway Tile for Mini Frame, P/D cutouts, 48"W	\$49
	UESPM60	Beltway Tile for Mini Frame, P/D cutouts, 60"W	\$62
	UESPM72	Beltway Tile for Mini Frame, P/D cutouts, 72"W	\$68
		Beltway Tiles with No Power/Data Cutouts, Silver (usually ordered with Frame)	
UESN30		Beltway Tile for Standard or Mega Frame, no P/D cutouts, 30"W	\$49
UESN48		Beltway Tile for Standard or Mega Frame, no P/D cutouts, 48"W	\$54
UESN60		Beltway Tile for Standard or Mega Frame, no P/D cutouts, 60"W	\$65
UESN72		Beltway Tile for Standard or Mega Frame, no P/D cutouts, 72"W	\$72
UESNM30		Beltway Tile for Mini Frame, no P/D cutouts, 30"W	\$49
UESNM48		Beltway Tile for Mini Frame, no P/D cutouts, 48"W	\$54
UESNM60		Beltway Tile for Mini Frame, no P/D cutouts, 60"W	\$65
UESNM72		Beltway Tile for Mini Frame, no P/D cutouts, 72"W	\$72
		5-Wire, 3-Circuit Electrical Add-on Power Kit (usually ordered with Frame)	
	UPK301	Power Kit for 30" Frame, 1-sided power	\$250
	UPK481	Power Kit for 48" Frame, 1-sided power	\$263
	UPK601	Power Kit for 60" Frame, 1-sided power	\$336
	UPK721	Power Kit for 72" Frame, 1-sided power	\$350
	UPK302	Power Kit for 30" Frame, 2-sided power	\$308
	UPK482	Power Kit for 48" Frame, 2-sided power	\$321
	UPK602	Power Kit for 60" Frame, 2-sided power	\$394
	UPK722	Power Kit for 72" Frame, 2-sided power	\$407
		5-Wire, 3-Circuit Receptacles - 15 amp, Grey (usually ordered as part of Frame)	
UREC1		Circuit 1 Receptacle, 15 amp	\$38
UREC2		Circuit 2 Receptacle, 15 amp	\$38
UREC3		Circuit 3 Receptacle, 15 amp	\$38
URDATA		Data Adapter Tree for beltway, Grey	\$21
PDDTR		Data Adapter Tree for beltway, Black	\$21
PDDTW		Data Adapter Tree for beltway, White	\$21
URDATA2		Data Adapter Plates, Grey	\$21
URBL		Blank Cover for unused Power/Data cutouts on Beltway, Grey	\$20
			Tip: For black, contact quotes@enwork.com
	5-Wire, 3-Circuit Jumpers for Pass-Thru (Usually ordered as part of Frame)		
	UZJUMP30	Jumper for 30" Frame (48" actual)	\$103
	UZJUMP48	Jumper for 48" Frame (66" actual)	\$139
	UZJUMP60	Jumper for 60" Frame (78" actual)	\$178
	UZJUMP72	Jumper for 72" Frame (90" actual)	\$189
	8-Wire, 4-Circuit Electrical Add-on Power Kit (To Power Non-Powered Frames)		
	UPK30-8TRAC	Power Kit for 30" Frame	\$250
	UPK48-8TRAC	Power Kit for 48" Frame	\$263
	UPK60-8TRAC	Power Kit for 60" Frame	\$336
	UPK72-8TRAC	Power Kit for 72" Frame	\$350
	UPK84-8TRAC	Power Kit for 84" Frame	\$386
	8-Wire, 4-Circuit Jumpers for Pass-Thru (Usually ordered as part of Frame)		
	UZ8JUMP30	Jumper for 30" Frame (48" actual)	\$135
	UZ8JUMP48	Jumper for 48" Frame (66" actual)	\$161
	UZ8JUMP60	Jumper for 60" Frame (78" actual)	\$185
	UZ8JUMP72	Jumper for 72" Frame (90" actual)	\$210

Grid Straight Worksurfaces

STEP 1

(&) Finish and Edge Suffix List:

- A Standard Laminate – 3mm Edge
- L Standard Laminate – PVC Edge with Ply Look
- K Standard Laminate – Knife Edge
- T Contour Laminate – Taper Edge

STEP 2

(*) Worksurface Application Suffix List:

- A Grid XTB Workstations (actual top depth 2" less than nominal and width 1-1/8" less than nominal) Full Scallop is recommended in Step 3.
- B Enwork Height-adjustable freestanding Tables (actual top depth and width 1-1/8" less than nominal)
- C Grid with no gap between worksurface and Frame (actual top depth matches nominal).
- D Grid with 1/2" gap between worksurface and Frame (actual top depth 1/2" less than nominal).
- V Grid with 1" gap between worksurface and Frame (actual top depth 1" less than nominal).

STEP 3

(@) Cable Management Suffix List:

- N No cable management No charge
- G Grommet (one, center rear) +\$18
- S Scallop (one, center rear) +\$22
- T Full Scallop 1"D (one, center rear) +\$22
- A Full Scallop 3"D (one, center rear)* +\$22
- K Power/Data Cut-out for Node (one, center rear) +\$36

* For use on crank/electric height-adjustable tops with freestanding Grid Frames.

Tip: Grommet and edge color are pre-defined to match laminate color. See page 21.

STEP 4

(#) Laminate Suffix List:

- A Wilsonart Kensington Maple (10776-60)
- B Wilsonart Monticello Maple (7925-38)
- C Wilsonart Wild Cherry (7054-60)
- E Wilsonart Fashion Grey (D381-60)
- F Wilsonart White Tigris (4783-60)
- G Wilsonart Cafelle (7933K-07)
- M Wilsonart Frosty White (1573-60)
- P Wilsonart Slate Grey (D91-60)
- R Wilsonart Black (1595-60)
- U Wilsonart Brazilwood (7946-38)
- V Wilsonart River Cherry (7937-38)
- W Wilsonart Designer White (D354-60)
- 3 Formica Neutral Twill (8826-58)
- 4 Formica Bleached Legno (8845-58)
- 5 Formica Prestige Walnut (6209-43)
- 7 Formica Select Cherry (7759-43)
- X *Wilsonart Non-Premium laminates (-38, -60). Orders of 100+ units have no upcharge. +10%
- Y *Formica Non-Premium Standard (58, 43, MC, SP and NT finishes) and Wilsonart Premium (-01, -07, -12, -18, -52, -78) laminates. +19%
- Z *Pionite Non-Premium, Nevamar Non-Premium, Formica Premium (WR, 42, 77, 46, RD Finishes), and whiteboard laminate. +25%

*Add \$350 list for Special Laminate orders of less than 10 units. See page 21 for edge selection.

(#) Contour Laminate Suffix List:

- G Natural Maple
- R Hayward Cherry
- S Studio White Matrix
- V River Cherry
- W Designer White
- Y Urban Walnut

Product Specifications:

- > Side and Back Edges are Flat

Ordering Information:

- > Bracing requirements are outlined on page 23. Braces are listed on page 311.
- > Some products may be available for quick ship. Contact info@enwork.com.
- > **A freight fee of \$100 net is assessed on orders less than \$1000 net. See page 13.**

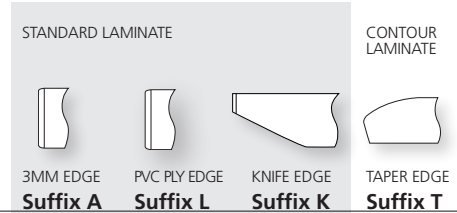

D1	D2	W1	W2	Part Number	Suffix A	Suffix L	Suffix K	Suffix T	
18	-	24	-	S1824&*@#	\$190	\$218	\$247	\$236	
18	-	30	-	S1830&*@#	\$200	\$230	\$260	\$249	
18	-	36	-	S1836&*@#	\$213	\$244	\$276	\$265	
18	-	42	-	S1842&*@#	\$266	\$305	\$345	\$329	
18	-	48	-	S1848&*@#	\$268	\$308	\$348	\$333	
18	-	54	-	S1854&*@#	\$330	\$379	\$429	\$407	
18	-	60	-	S1860&*@#	\$346	\$397	\$449	\$428	
18	-	66	-	S1866&*@#	\$372	\$427	\$483	\$460	
18	-	72	-	S1872&*@#	\$384	\$441	\$499	\$474	
18	-	78	-	S1878&*@#	\$457	\$525	\$594	\$566	
18	-	84	-	S1884&*@#	\$472	\$542	\$613	\$596	
18	-	90	-	S1890&*@#	\$489	\$562	\$635	\$621	
18	-	96	-	S1896&*@#	\$504	\$579	\$655	\$639	
24	-	24	-	S2424&*@#	\$194	\$223	\$252	\$245	
24	-	30	-	S2430&*@#	\$210	\$241	\$273	\$260	
24	-	36	-	S2436&*@#	\$226	\$259	\$293	\$280	
24	-	42	-	S2442&*@#	\$268	\$308	\$348	\$333	
24	-	48	-	S2448&*@#	\$278	\$319	\$361	\$346	
24	-	54	-	S2454&*@#	\$340	\$391	\$442	\$421	
XTB	24	-	60	-	S2460&*@#	\$351	\$403	\$456	\$435
	24	-	66	-	S2466&*@#	\$376	\$432	\$488	\$465
XTB	24	-	72	-	S2472&*@#	\$398	\$457	\$517	\$492
	24	-	78	-	S2478&*@#	\$468	\$538	\$608	\$580
	24	-	84	-	S2484&*@#	\$484	\$556	\$629	\$615
	24	-	90	-	S2490&*@#	\$500	\$575	\$650	\$634
	24	-	96	-	S2496&*@#	\$516	\$593	\$670	\$655

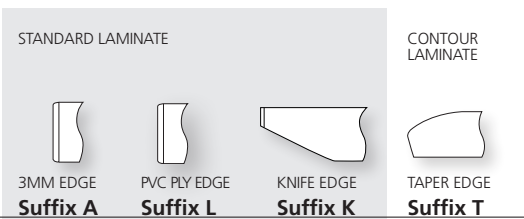
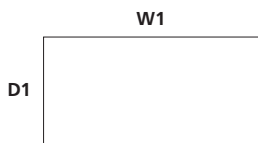

D1	D2	W1	W2	Part Number	STANDARD LAMINATE			CONTOUR LAMINATE	
					Suffix A	Suffix L	Suffix K	Suffix T	
30	-	24	-	S3024&*@#	\$236	\$271	\$306	\$537	
30	-	30	-	S3030&*@#	\$266	\$305	\$345	\$576	
30	-	36	-	S3036&*@#	\$298	\$342	\$387	\$615	
30	-	42	-	S3042&*@#	\$338	\$388	\$439	\$650	
30	-	48	-	S3048&*@#	\$358	\$411	\$465	\$691	
30	-	54	-	S3054&*@#	\$404	\$464	\$525	\$750	
XTB	30	-	60	-	S3060&*@#	\$414	\$476	\$538	\$762
	30	-	66	-	S3066&*@#	\$453	\$520	\$588	\$813
XTB	30	-	72	-	S3072&*@#	\$474	\$545	\$616	\$837
	30	-	78	-	S3078&*@#	\$543	\$624	\$705	\$927
	30	-	84	-	S3084&*@#	\$559	\$642	\$726	\$945
	30	-	90	-	S3090&*@#	\$600	\$690	\$780	\$997
	30	-	96	-	S3096&*@#	\$612	\$703	\$795	\$1013
	36	-	24	-	S3624&*@#	\$288	\$331	\$374	\$539
	36	-	30	-	S3630&*@#	\$303	\$348	\$393	\$577
	36	-	36	-	S3636&*@#	\$336	\$386	\$436	\$616
	36	-	42	-	S3642&*@#	\$376	\$432	\$488	\$651
	36	-	48	-	S3648&*@#	\$380	\$437	\$494	\$692
	36	-	54	-	S3654&*@#	\$508	\$584	\$660	\$816
	36	-	60	-	S3660&*@#	\$508	\$584	\$660	\$816
	36	-	66	-	S3666&*@#	\$508	\$584	\$660	\$816
	36	-	72	-	S3672&*@#	\$570	\$655	\$741	\$842
	36	-	78	-	S3678&*@#	\$710	\$816	\$923	\$1018
	36	-	84	-	S3684&*@#	\$710	\$816	\$923	\$1018
	36	-	90	-	S3690&*@#	\$710	\$816	\$923	\$1018
	36	-	96	-	S3696&*@#	\$710	\$816	\$923	\$1018

Grid Curved Corner Worksurfaces

STEP 1

(&) Finish and Edge Suffix List:

- A Standard Laminate – 3mm Edge
- L Standard Laminate – PVC Edge with Ply Look
- K Standard Laminate – Knife Edge
- T Contour Laminate – Taper Edge

STEP 2

(*) Worksurface Application Suffix List:

- C Grid with no gap between worksurface and Frame (actual top depth matches nominal).
- D Grid with 1/2" gap between worksurface and Frame (actual top depth 1/2" less than nominal).
- V Grid with 1" gap between worksurface and Frame (actual top depth 1" less than nominal).

STEP 3

(@) Cable Management Suffix List:

- N No cable management No charge
- G Grommet (one, center rear) +\$18
- S Scallop (two, 8" from corner) +\$44
- B Full Scallop 3"D (left)* +\$22
- C Full Scallop 3"D (right)* +\$22
- D Full Scallop 3"D (left and right)* +\$44
- K Power/Data Cut-out for Node (one, center rear) +\$36

* For use on crank/electric height-adjustable tops with freestanding Grid Frames.

Tip: Grommet and edge color are pre-defined to match laminate color. See page 21.

STEP 4

(#) Laminate Suffix List:

- A Wilsonart Kensington Maple (10776-60)
- B Wilsonart Monticello Maple (7925-38)
- C Wilsonart Wild Cherry (7054-60)
- E Wilsonart Fashion Grey (D381-60)
- F Wilsonart White Tigris (4783-60)
- G Wilsonart Cafelle (7933K-07)
- M Wilsonart Frosty White (1573-60)
- P Wilsonart Slate Grey (D91-60)
- R Wilsonart Black (1595-60)
- U Wilsonart Brazilwood (7946-38)
- V Wilsonart River Cherry (7937-38)
- W Wilsonart Designer White (D354-60)
- 3 Formica Neutral Twill (8826-58)
- 4 Formica Bleached Legno (8845-58)
- 5 Formica Prestige Walnut (6209-43)
- 7 Formica Select Cherry (7759-43)
- X *Wilsonart Non-Premium laminates (-38, +10% -60). Orders of 100+ units have no upcharge.
- Y *Formica Non-Premium Standard (58, +19% 43, MC, SP and NT finishes) and Wilsonart Premium (-01, -07, -12, -18, -52, -78) laminates.
- Z *Pionite Non-Premium, Nevamar Non-Premium, Formica Premium (WR, 42, 77, 46, RD Finishes), and whiteboard laminate.

*Add \$350 list for Special Laminate orders of less than 10 units. See page 21 for edge selection.

(#) Contour Laminate Suffix List:

- G Natural Maple
- R Hayward Cherry
- S Studio White Matrix
- V River Cherry
- W Designer White
- Y Urban Walnut





Product Specifications:

- > Side and Back Edges are Flat

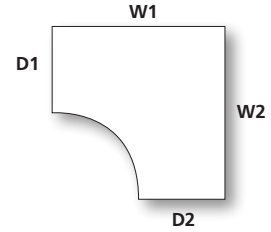
Ordering Information:

- > This worksurface is not available for XTB Flexible Height Benching.
- > Rear corner supports are not included.
- > **A freight fee of \$100 net is assessed on orders less than \$1000 net.**
See page 13.



				STANDARD LAMINATE			CONTOUR LAMINATE	
								
				3MM EDGE	PVC PLY EDGE	KNIFE EDGE	TAPER EDGE	
D1	D2	W1	W2	Part Number	Suffix A	Suffix L	Suffix K	Suffix T
18	18	36	36	CC1836&*@#	\$361	\$415	\$469	\$487
18	18	42	42	CC1842&*@#	\$469	\$539	\$609	\$567
18	18	48	48	CC1848&*@#	\$475	\$546	\$617	\$572
24	24	36	36	CC2436&*@#	\$361	\$415	\$469	\$487
24	24	42	42	CC2442&*@#	\$475	\$546	\$617	\$572
24	24	48	48	CC2448&*@#	\$484	\$556	\$629	\$586
24	24	60	60	CC2460&*@#	\$625	\$718	\$812	n/a
30	30	42	42	CC3042&*@#	\$488	\$561	\$634	\$615
30	30	48	48	CC3048&*@#	\$512	\$588	\$665	\$647
30	30	60	60	CC3060&*@#	\$629	\$723	\$817	n/a

Notes

Grid Extended Curved Corner Worksurfaces

STEP 1

(&) Finish and Edge Suffix List:

- A Standard Laminate – 3mm Edge
- L Standard Laminate – PVC Edge with Ply Look
- K Standard Laminate – Knife Edge
- T Contour Laminate – Taper Edge

STEP 2

(*) Worksurface Application Suffix List:

- A Grid XTB Workstations (actual top depth 2" less than nominal and width 1-1/8" less than nominal) Full Scallop is recommended in Step 3.
- B Enwork Height-adjustable freestanding Tables (actual top depth and width 1-1/8" less than nominal)
- C Grid with no gap between worksurface and Frame (actual top depth matches nominal).
- D Grid with 1/2" gap between worksurface and Frame (actual top depth 1/2" less than nominal).
- V Grid with 1" gap between worksurface and Frame (actual top depth 1" less than nominal).

STEP 3

(@) Cable Management Suffix List:

- N No cable management No charge
- G Grommet (one, corner) +\$18
- S Scallop (two, 8" from corner) +\$44
- U Full Scallop 1"D (left) +\$22
- V Full Scallop 1"D (right) +\$22
- W Full Scallop 1"D (left and right) +\$44
- B Full Scallop 3"D (left)* +\$22
- C Full Scallop 3"D (right)* +\$22
- D Full Scallop 3"D (left and right)* +\$44
- K Power/Data Cut-out for Node (one, center rear) +\$36

* For use on crank/electric height-adjustable tops with freestanding Grid Frames.

Tip: Grommet and edge color are pre-defined to match laminate color. See page 21.

STEP 4

(#) Laminate Suffix List:

- A Wilsonart Kensington Maple (10776-60)
- B Wilsonart Monticello Maple (7925-38)
- C Wilsonart Wild Cherry (7054-60)
- E Wilsonart Fashion Grey (D381-60)
- F Wilsonart White Tigris (4783-60)
- G Wilsonart Cafelle (7933K-07)
- M Wilsonart Frosty White (1573-60)
- P Wilsonart Slate Grey (D91-60)
- R Wilsonart Black (1595-60)
- U Wilsonart Brazilwood (7946-38)
- V Wilsonart River Cherry (7937-38)
- W Wilsonart Designer White (D354-60)
- 3 Formica Neutral Twill (8826-58)
- 4 Formica Bleached Legno (8845-58)
- 5 Formica Prestige Walnut (6209-43)
- 7 Formica Select Cherry (7759-43)
- X *Wilsonart Non-Premium laminates (-38, -60). Orders of 100+ units have no upcharge. +10%
- Y *Formica Non-Premium Standard (58, 43, MC, SP and NT finishes) and Wilsonart Premium (-01, -07, -12, -18, -52, -78) laminates. +19%
- Z *Pionite Non-Premium, Nevamar Non-Premium, Formica Premium (WR, 42, 77, 46, RD Finishes), and whiteboard laminate. +25%

*Add \$350 list for Special Laminate orders of less than 10 units. See page 21 for edge selection.

(#) Contour Laminate Suffix List:

- G Natural Maple
- R Hayward Cherry
- S Studio White Matrix
- V River Cherry
- W Designer White
- Y Urban Walnut

Product Specifications:

- > Side and Back Edges are Flat

Ordering Information:

- > Rear corner supports are not included.
- > Bracing requirements are outlined on page 23. Braces are listed on page 311.
- > **A freight fee of \$100 net is assessed on orders less than \$1000 net. See page 13.**

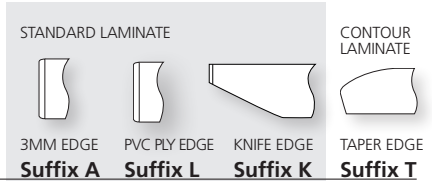

D1	D2	W1	W2	O	Part Number	3MM EDGE Suffix A	PVC PLY EDGE Suffix L	KNIFE EDGE Suffix K	TAPER EDGE Suffix T	
24	24	60	36	LH	EC226036&*@#	\$551	\$633	\$716	\$668	
24	24	66	36	LH	EC226636&*@#	\$616	\$708	\$800	\$751	
24	24	72	36	LH	EC227236&*@#	\$676	\$777	\$878	\$823	
24	24	60	42	LH	EC226042&*@#	\$558	\$641	\$725	\$679	
24	24	66	42	LH	EC226642&*@#	\$616	\$708	\$800	\$751	
24	24	72	42	LH	EC227242&*@#	\$676	\$777	\$878	\$823	
XTB	24	24	60	48	LH	EC226048&*@#	\$588	\$676	\$764	\$715
24	24	66	48	LH	EC226648&*@#	\$647	\$744	\$841	\$787	
XTB	24	24	72	48	LH	EC227248&*@#	\$705	\$810	\$916	\$858
24	24	36	60	RH	EC223660&*@#	\$551	\$633	\$716	\$668	
24	24	36	66	RH	EC223666&*@#	\$616	\$708	\$800	\$751	
24	24	36	72	RH	EC223672&*@#	\$676	\$777	\$878	\$823	
24	24	42	60	RH	EC224260&*@#	\$558	\$641	\$725	\$679	
24	24	42	66	RH	EC224266&*@#	\$616	\$708	\$800	\$751	
24	24	42	72	RH	EC224272&*@#	\$676	\$777	\$878	\$823	
24	24	48	60	RH	EC224860&*@#	\$588	\$676	\$764	\$715	
24	24	48	66	RH	EC224866&*@#	\$647	\$744	\$841	\$787	
24	24	48	72	RH	EC224872&*@#	\$705	\$810	\$916	\$858	
XTB	30	30	60	48	LH	EC336048&*@#	\$644	\$740	\$837	\$784
30	30	66	48	LH	EC336648&*@#	\$702	\$807	\$912	\$854	
XTB	30	30	72	48	LH	EC337248&*@#	\$760	\$874	\$988	\$927
30	30	48	60	RH	EC334860&*@#	\$644	\$740	\$837	\$784	
30	30	48	66	RH	EC334866&*@#	\$702	\$807	\$912	\$854	
30	30	48	72	RH	EC334872&*@#	\$760	\$874	\$988	\$927	



		STANDARD LAMINATE				CONTOUR LAMINATE				
		3MM EDGE		PVC PLY EDGE		KNIFE EDGE		TAPER EDGE		
D1	D2	W1	W2	O	Part Number	Suffix A	Suffix L	Suffix K	Suffix T	
	24	30	60	36	LH	EC236036&*@#	\$582	\$669	\$756	\$707
	24	30	66	36	LH	EC236636&*@#	\$647	\$744	\$841	\$787
	24	30	72	36	LH	EC237236&*@#	\$705	\$810	\$916	\$858
XTB	24	30	60	48	LH	EC236048&*@#	\$616	\$708	\$800	\$751
	24	30	66	48	LH	EC236648&*@#	\$676	\$777	\$878	\$823
XTB	24	30	72	48	LH	EC237248&*@#	\$735	\$845	\$955	\$893
	24	30	36	60	RH	EC233660&*@#	\$582	\$669	\$756	\$707
	24	30	36	66	RH	EC233666&*@#	\$647	\$744	\$841	\$787
	24	30	36	72	RH	EC233672&*@#	\$705	\$810	\$916	\$858
	24	30	48	60	RH	EC234860&*@#	\$616	\$708	\$800	\$751
	24	30	48	66	RH	EC234866&*@#	\$676	\$777	\$878	\$823
	24	30	48	72	RH	EC234872&*@#	\$735	\$845	\$955	\$893
	30	24	60	36	LH	EC326036&*@#	\$582	\$669	\$756	\$707
	30	24	66	36	LH	EC326636&*@#	\$647	\$744	\$841	\$787
	30	24	72	36	LH	EC327236&*@#	\$705	\$810	\$916	\$858
XTB	30	24	60	48	LH	EC326048&*@#	\$616	\$708	\$800	\$751
	30	24	66	48	LH	EC326648&*@#	\$676	\$777	\$878	\$823
XTB	30	24	72	48	LH	EC327248&*@#	\$735	\$845	\$955	\$893
	30	24	36	60	RH	EC323660&*@#	\$582	\$669	\$756	\$707
	30	24	36	66	RH	EC323666&*@#	\$647	\$744	\$841	\$787
	30	24	36	72	RH	EC323672&*@#	\$705	\$810	\$916	\$858
	30	24	48	60	RH	EC324860&*@#	\$616	\$708	\$800	\$751
	30	24	48	66	RH	EC324866&*@#	\$676	\$777	\$878	\$823
	30	24	48	72	RH	EC324872&*@#	\$735	\$845	\$955	\$893

Grid 120 Corner Worksurfaces

STEP 1

(&) Finish and Edge Suffix List:

- A Standard Laminate – 3mm Edge
- L Standard Laminate – PVC Edge with Ply Look
- K Standard Laminate – Knife Edge
- T Contour Laminate – Taper Edge

STEP 2

(*) Worksurface Application Suffix List:

- A **Grid XTB Workstations (actual top depth 2" less than nominal and width 1-1/8" less than nominal) Full Scallop is recommended in Step 3.
- B Enwork Height-adjustable freestanding Tables (actual top depth and width 1-1/8" less than nominal)
- C Grid with no gap between worksurface and Frame (actual top depth matches nominal).
- D Grid with 1/2" gap between worksurface and Frame (actual top depth 1/2" less than nominal).
- V Grid with 1" gap between worksurface and Frame (actual top depth 1" less than nominal).

STEP 3

(@) Cable Management Suffix List:

- N No cable management No charge
- G Grommet (one, center rear) +\$18
- S Scallop (two, 8" from corner) +\$44
- U Full Scallop 1"D (left) +\$22
- V Full Scallop 1"D (right) +\$22
- W Full Scallop 1"D (left and right) +\$44
- B Full Scallop 3"D (left)* +\$22
- C Full Scallop 3"D (right)* +\$22
- D Full Scallop 3"D (left and right)* +\$44
- K Power/Data Cut-out for Node (one, center rear) +\$36

* For use on crank/electric height-adjustable tops with freestanding Grid Frames.

Tip: Grommet and edge color are pre-defined to match laminate color. See page 21.

STEP 4

(#) Laminate Suffix List:

- A Wilsonart Kensington Maple (10776-60)
- B Wilsonart Monticello Maple (7925-38)
- C Wilsonart Wild Cherry (7054-60)
- E Wilsonart Fashion Grey (D381-60)
- F Wilsonart White Tigris (4783-60)
- G Wilsonart Cafelle (7933K-07)
- M Wilsonart Frosty White (1573-60)
- P Wilsonart Slate Grey (D91-60)
- R Wilsonart Black (1595-60)
- U Wilsonart Brazilwood (7946-38)
- V Wilsonart River Cherry (7937-38)
- W Wilsonart Designer White (D354-60)
- 3 Formica Neutral Twill (8826-58)
- 4 Formica Bleached Legno (8845-58)
- 5 Formica Prestige Walnut (6209-43)
- 7 Formica Select Cherry (7759-43)
- X *Wilsonart Non-Premium laminates (-38, -60). Orders of 100+ units have no upcharge. +10%
- Y *Formica Non-Premium Standard (58, 43, MC, SP and NT finishes) and Wilsonart Premium (-01, -07, -12, -18, -52, -78) laminates. +19%
- Z *Pionite Non-Premium, Nevamar Non-Premium, Formica Premium (WR, 42, 77, 46, RD Finishes), and whiteboard laminate. +25%

*Add \$350 list for Special Laminate orders of less than 10 units. See page 21 for edge selection.

(#) Contour Laminate Suffix List:

- G Natural Maple
- R Hayward Cherry
- S Studio White Matrix
- V River Cherry
- W Designer White
- Y Urban Walnut

Product Specifications:

- > Side and Back Edges are Flat

Ordering Information:

- > Rear corner supports are not included with 120 corner worksurfaces.
- > The corner dimension for TC224848 is deeper when Worksurface Application Suffix "A" is specified in Step 2. See diagram.
- > **A freight fee of \$100 net is assessed on orders less than \$1000 net. See page 13.**

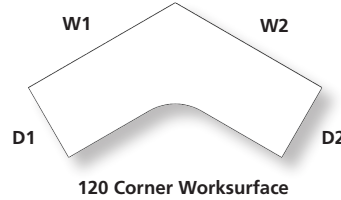

				STANDARD LAMINATE			CONTOUR LAMINATE		
				3MM EDGE	PVC PLY EDGE	KNIFE EDGE	TAPER EDGE		
D1	D2	W1	W2	Part Number	Suffix A	Suffix L	Suffix K	Suffix T	
24	24	36	36	TC223636&*@#	\$755	\$868	\$981	\$961	
24	24	42	42	TC224242&*@#	\$940	\$1081	\$1222	\$1195	
**XTB	24	24	48	48	TC224848&*@#	\$940	\$1081	\$1222	\$1195
	24	24	60	60	TC226060&*@#	\$1388	\$1596	\$1804	n/a
30	30	36	36	TC333636&*@#	\$755	\$868	\$981	\$961	
30	30	42	42	TC334242&*@#	\$940	\$1081	\$1222	\$1195	
30	30	48	48	TC334848&*@#	\$940	\$1081	\$1222	n/a	

Tip: Laminate grain direction is non-standard on the 24x24x60x60 corner (runs along W2). See page 20 for defaults.

****Tip:** The corner dimension for TC224848 is deeper when Worksurface Application Suffix "A" is specified in Step 2. See diagram.

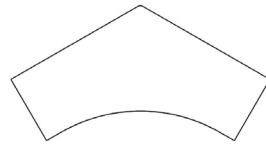

TC224848 worksurface shape when "A" is selected in Step 2

Grid Spanner Worksurfaces

Product Specifications:

> Back Edge is Flat

Ordering Information:

> Column support is ordered separately for spanner worksurfaces. See page 163.

> **A freight fee of \$100 net is assessed on orders less than \$1000 net. See page 13.**

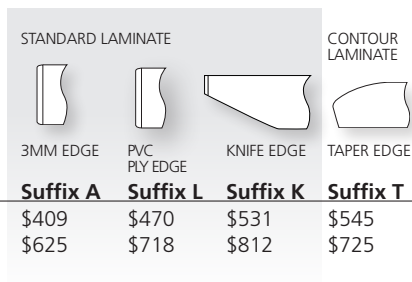
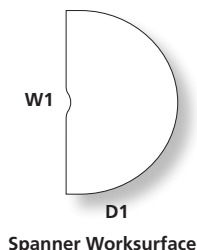

D1	D2	W1	W2	Part Number	Suffix A	Suffix L	Suffix K	Suffix T
27	-	51	-	SP51&E#	\$409	\$470	\$531	\$545
33	-	63	-	SP63&E#	\$625	\$718	\$812	\$725

STEP 1

(&) Finish and Edge Suffix List:

- A Standard Laminate – 3mm Edge
- L Standard Laminate – PVC Edge with Ply Look
- K Standard Laminate – Knife Edge
- T Contour Laminate – Taper Edge

STEP 2

(#) Laminate Suffix List:

- A Wilsonart Kensington Maple (10776-60)
- B Wilsonart Monticello Maple (7925-38)
- C Wilsonart Wild Cherry (7054-60)
- E Wilsonart Fashion Grey (D381-60)
- F Wilsonart White Tigris (4783-60)
- G Wilsonart Cafelle (7933K-07)
- M Wilsonart Frosty White (1573-60)
- P Wilsonart Slate Grey (D91-60)
- R Wilsonart Black (1595-60)
- U Wilsonart Brazilwood (7946-38)
- V Wilsonart River Cherry (7937-38)
- W Wilsonart Designer White (D354-60)
- 3 Formica Neutral Twill (8826-58)
- 4 Formica Bleached Legno (8845-58)
- 5 Formica Prestige Walnut (6209-43)
- 7 Formica Select Cherry (7759-43)
- X *Wilsonart Non-Premium laminates (-38, +10% -60). Orders of 100+ units have no upcharge.
- Y *Formica Non-Premium Standard (58, +19% 43, MC, SP and NT finishes) and Wilsonart Premium (-01, -07, -12, -18, -52, -78) laminates.
- Z *Pionite Non-Premium, Nevamar Non- +25% Premium, Formica Premium (WR, 42, 77, 46, RD Finishes), and whiteboard laminate.

*Add \$350 list for Special Laminate orders of less than 10 units. See page 21 for edge selection.

(#) Contour Laminate Suffix List:

- G Natural Maple
- R Hayward Cherry
- S Studio White Matrix
- V River Cherry
- W Designer White
- Y Urban Walnut

Grid Transaction Worksurfaces

STEP 1

(&) Finish and Edge Suffix List:

- A Standard Laminate – 3mm Edge
- L Standard Laminate – PVC Edge with Ply Look
- K Standard Laminate – Knife Edge
- T Contour Laminate – Taper Edge

STEP 2

(#) Laminate Suffix List:

- A Wilsonart Kensington Maple (10776-60)
- B Wilsonart Monticello Maple (7925-38)
- C Wilsonart Wild Cherry (7054-60)
- E Wilsonart Fashion Grey (D381-60)
- F Wilsonart White Tigris (4783-60)
- G Wilsonart Cafelle (7933K-07)
- M Wilsonart Frosty White (1573-60)
- P Wilsonart Slate Grey (D91-60)
- R Wilsonart Black (1595-60)
- U Wilsonart Brazilwood (7946-38)
- V Wilsonart River Cherry (7937-38)
- W Wilsonart Designer White (D354-60)
- 3 Formica Neutral Twill (8826-58)
- 4 Formica Bleached Legno (8845-58)
- 5 Formica Prestige Walnut (6209-43)
- 7 Formica Select Cherry (7759-43)
- X *Wilsonart Non-Premium laminates (-38, +10% -60). Orders of 100+ units have no upcharge.
- Y *Formica Non-Premium Standard (58, +19% 43, MC, SP and NT finishes) and Wilsonart Premium (-01, -07, -12, -18, -52, -78) laminates.
- Z *Pionite Non-Premium, Nevamar Non-Premium, Formica Premium (WR, 42, 77, 46, RD Finishes), and whiteboard laminate.

*Add \$350 list for Special Laminate orders of less than 10 units. See page 21 for edge selection.

(#) Contour Laminate Suffix List:

- G Natural Maple
- R Hayward Cherry
- S Studio White Matrix
- V River Cherry
- W Designer White
- Y Urban Walnut

Product Specifications:

- > Side Edges are Flat

Ordering Information:

- > This worksurface is not available for XTB Flexible Height Benching.
- > **A freight fee of \$100 net is assessed on orders less than \$1000 net. See page 13.**

W1

D1

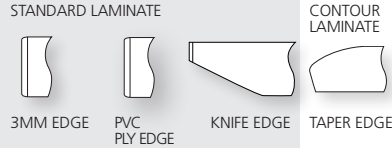

D1	D2	W1	W2	Part Number	Suffix A	Suffix L	Suffix K	Suffix T
16	-	24	-	S1624&CN#	\$217	\$249	\$282	\$231
16	-	30	-	S1630&CN#	\$231	\$265	\$300	\$250
16	-	36	-	S1636&CN#	\$244	\$280	\$317	\$266
16	-	42	-	S1642&CN#	\$266	\$305	\$345	\$283
16	-	48	-	S1648&CN#	\$280	\$322	\$364	\$310
16	-	54	-	S1654&CN#	\$339	\$389	\$440	\$375
16	-	60	-	S1660&CN#	\$349	\$401	\$453	\$402
16	-	66	-	S1666&CN#	\$387	\$445	\$503	\$438
16	-	72	-	S1672&CN#	\$411	\$472	\$534	\$466
16	-	78	-	S1678&CN#	\$456	\$524	\$592	\$561
16	-	84	-	S1684&CN#	\$471	\$541	\$612	\$594
16	-	90	-	S1690&CN#	\$473	\$543	\$614	\$597
16	-	96	-	S1696&CN#	\$492	\$565	\$639	\$620

Enwork Grid Mounting Hardware for Transaction Worksurfaces

S16HDW Grid mounting hardware (4 pc.), silver \$170

Tip: Knife edge transaction tops must be 18”D to work with this hardware. Contact quotes@enwork.com.

Tip: Use only with 42” Standard Grid Frame (positioned for power above worksurface).

Notes

Grid Topper Screens

STEP 1 - If Applicable

(?) Fabric Suffix List:

Free form fabric selection. Choose from Camira Mill L2 or Lucia fabrics.

Tip: To view fabric colors or to order samples go to www.camirafabrics.com/us.

Tip: For COM yardage, see page 16.

Ordering Information:

- > 3Form products are available for use as Grid topper Screens. Contact quotes@enwork.com for more information.
- > Some products may be available for quick ship. Contact info@enwork.com.
- > **A freight fee of \$100 net is assessed on orders less than \$1000 net. See page 13.**

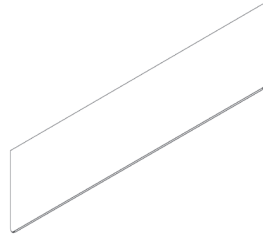

Part Numbers	Description	List Price (US\$)
--------------	-------------	-------------------

Acrylic Topper Screens for Frames, 11.25"H

UMTP30	Acrylic Topper Screen, 30"W	\$152
UMTP48	Acrylic Topper Screen, 48"W	\$173
UMTP60	Acrylic Topper Screen, 60"W	\$198
UMTP72	Acrylic Topper Screen, 72"W	\$254
UMTP84	Acrylic Topper Screen, 84"W	\$290

Non-Tackable Fabric Topper Screens for Frames, 11.25"H

UMTPN30?	Non-Tackable Fabric Topper Screen, 30"W	\$319
UMTPN48?	Non-Tackable Fabric Topper Screen, 48"W	\$435
UMTPN60?	Non-Tackable Fabric Topper Screen, 60"W	\$529
UMTPN72?	Non-Tackable Fabric Topper Screen, 72"W	\$659
UMTPN84?	Non-Tackable Fabric Topper Screen, 84"W	\$738

Tackable Fabric Topper Screens for Frames, 11.25"H

UMTPF30?	Tackable Fabric Topper Screen, 30"W	\$402
UMTPF48?	Tackable Fabric Topper Screen, 48"W	\$488
UMTPF60?	Tackable Fabric Topper Screen, 60"W	\$635
UMTPF72?	Tackable Fabric Topper Screen, 72"W	\$713
UMTPF84?	Tackable Fabric Topper Screen, 84"W	\$741

Markerboard Glass Topper Screens for Frames, 11.25"H

UMTPG30	Markerboard Glass Topper Screen, 30"W	\$268
UMTPG48	Markerboard Glass Topper Screen, 48"W	\$426
UMTPG60	Markerboard Glass Topper Screen, 60"W	\$551
UMTPG72	Markerboard Glass Topper Screen, 72"W	\$652

Tip: Product consists of two 1/8" pieces of tempered back-painted glass (white) bonded together

Frosted Glass Topper Screens for Frames, 11.25"H

UMTPY30	Frosted Glass Topper Screen, 30"W	\$324
UMTPY48	Frosted Glass Topper Screen, 48"W	\$526
UMTPY60	Frosted Glass Topper Screen, 60"W	\$665
UMTPY72	Frosted Glass Topper Screen, 72"W	\$805

Acid-Etched (Frosted) Glass Topper Screen with Large Knots Design for Frames, 11.25"H

UMTPW30	Large Knots Pattern Etched Glass Topper Screen, 30"W	\$359
UMTPW48	Large Knots Pattern Etched Glass Topper Screen, 48"W	\$562
UMTPW60	Large Knots Pattern Etched Glass Topper Screen, 60"W	\$703
UMTPW72	Large Knots Pattern Etched Glass Topper Screen, 72"W	\$844

Tip: Product consists of one 1/4" piece of tempered glass with Large Knots design laser-etched on one side.

Notes

Privacy Screens and Modesty Panels

STEP 1 - If Applicable

(#) Laminate Suffix List:

A	Wilsonart Kensington Maple (10776-60)	no charge
B	Wilsonart Monticello Maple (7925-38)	no charge
C	Wilsonart Wild Cherry (7054-60)	no charge
E	Wilsonart Fashion Grey (D381-60)	no charge
G	Wilsonart Cafelle (7933K-07)	no charge
M	Wilsonart Frosty White (1573-60)	no charge
P	Wilsonart Slate Grey (D91-60)	no charge
R	Wilsonart Black (1595-60)	no charge
U	Wilsonart Brazilwood (7946-38)	no charge
V	Wilsonart River Cherry (7937-38)	no charge
W	Wilsonart Designer White (D354-60)	no charge
3	Formica Neutral Twill (8826-58)	no charge
4	Formica Bleached Legno (8845-58)	no charge
5	Formica Prestige Walnut (6209-43)	no charge
7	Formica Select Cherry (7759-43)	no charge
X	*Wilsonart Non-Premium laminates (-38, -60)	+35%
Y	*Formica Non-Premium (includes 58, 43, MC, SP, and NT finishes), Formica Premium (WR, 42, 77, 46, RD finishes), Pionite Non-Premium, Nevamar Non-Premium, Wilsonart Premium (-01, -07, -12, -18, -52, -78), and whiteboard laminate.	+45%

*Add \$350 list for Special Laminate orders of less than 10 units. See page 21 for edge selection.

STEP 1 - If Applicable

(?) Fabric Suffix List:

Free form fabric selection. Choose from Camira Mill L2 or Lucia fabrics.

Tip: To view fabric colors or to order samples go to www.camirafabrics.com/us.

Tip: For COM yardage, see page 16.

Product Specifications

- > Clamp Privacy Screens and Modesty Panels 48"W and smaller include two clamps, 54"W and wider include three clamps.

Ordering Information:

- > Clamp privacy screens 36"-72"W and Modesty Panels are screwed to the underside of the worksurface.
- > Clamp screens 24"-30"W are designed for side-to-side privacy and screw to the underside of the worksurface front edge (only). Knob attachment is available, email quotes@enwork.com
- > For COM yardage, see page 16.
- > **A freight fee of \$100 net is assessed on orders less than \$1000 net. See page 13.**



Part Number Description List Price (US\$)

Clamp Frosted Acrylic Privacy Screen, 13"H x .25" thick

FLPA24	Frosted Acrylic Clamp Privacy Screen, 24"W	\$247
FLPA30	Frosted Acrylic Clamp Privacy Screen, 30"W	\$260
FLPA36	Frosted Acrylic Clamp Privacy Screen, 36"W	\$293
FLPA42	Frosted Acrylic Clamp Privacy Screen, 42"W	\$305
FLPA48	Frosted Acrylic Clamp Privacy Screen, 48"W	\$396
FLPA54	Frosted Acrylic Clamp Privacy Screen, 54"W	\$409
FLPA60	Frosted Acrylic Clamp Privacy Screen, 60"W	\$422
FLPA66	Frosted Acrylic Clamp Privacy Screen, 66"W	\$435
FLPA72	Frosted Acrylic Clamp Privacy Screen, 72"W	\$448

Clamp Laminate Privacy Screen, 13"H x .25" thick

FLPL24#	Laminate Clamp Privacy Screen, 24"W	\$308
FLPL30#	Laminate Clamp Privacy Screen, 30"W	\$325
FLPL36#	Laminate Clamp Privacy Screen, 36"W	\$361
FLPL42#	Laminate Clamp Privacy Screen, 42"W	\$388
FLPL48#	Laminate Clamp Privacy Screen, 48"W	\$463
FLPL54#	Laminate Clamp Privacy Screen, 54"W	\$504
FLPL60#	Laminate Clamp Privacy Screen, 60"W	\$504
FLPL66#	Laminate Clamp Privacy Screen, 66"W	\$531
FLPL72#	Laminate Clamp Privacy Screen, 72"W	\$531

Clamp Whiteboard Privacy Screen, 13"H x .25" thick

FLPW24	Whiteboard Clamp Privacy Screen, 24"W	\$329
FLPW30	Whiteboard Clamp Privacy Screen, 30"W	\$352
FLPW36	Whiteboard Clamp Privacy Screen, 36"W	\$394
FLPW42	Whiteboard Clamp Privacy Screen, 42"W	\$431
FLPW48	Whiteboard Clamp Privacy Screen, 48"W	\$507
FLPW54	Whiteboard Clamp Privacy Screen, 54"W	\$558
FLPW60	Whiteboard Clamp Privacy Screen, 60"W	\$558
FLPW66	Whiteboard Clamp Privacy Screen, 66"W	\$595
FLPW72	Whiteboard Clamp Privacy Screen, 72"W	\$595

Clamp Tackable Fabric Privacy Screen, 13"H x .5" thick

FLPF24?	Tackable Fabric Clamp Privacy Screen, 24"W	\$335
FLPF30?	Tackable Fabric Clamp Privacy Screen, 30"W	\$361
FLPF36?	Tackable Fabric Clamp Privacy Screen, 36"W	\$394
FLPF42?	Tackable Fabric Clamp Privacy Screen, 42"W	\$406
FLPF48?	Tackable Fabric Clamp Privacy Screen, 48"W	\$496
FLPF54?	Tackable Fabric Clamp Privacy Screen, 54"W	\$542
FLPF60?	Tackable Fabric Clamp Privacy Screen, 60"W	\$556
FLPF66?	Tackable Fabric Clamp Privacy Screen, 66"W	\$568
FLPF72?	Tackable Fabric Clamp Privacy Screen, 72"W	\$581

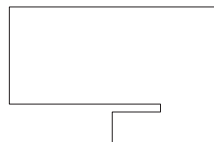

Pac-Man Universal Privacy Screens, Brackets included, 19"H x 30"D

UPM#	Laminate Pac-Man Privacy Screen	\$374
UPM2	Frosted Acrylic Pac-Man Privacy Screen	\$384

Tip: 30"D Divider covers 22" of worksurface and hangs 8" off. 13" of screen is above worksurface, 4.75" below worksurface.

Tip: Fits all 1.125" - 1.25" thick worksurfaces

Part Number	Description	List Price (US\$)
Universal 2-Sided Tackable Fabric Privacy Screen - 1" Thick, 13"H		
AAG24?	Tackable Fabric Privacy Screen, 1" Thick, 24"W	\$329
AAG30?	Tackable Fabric Privacy Screen, 1" Thick, 30"W	\$379
AAG36?	Tackable Fabric Privacy Screen, 1" Thick, 36"W	\$391
AAG42?	Tackable Fabric Privacy Screen, 1" Thick, 42"W	\$422
AAG48?	Tackable Fabric Privacy Screen, 1" Thick, 48"W	\$435
AAG54?	Tackable Fabric Privacy Screen, 1" Thick, 54"W	\$562
AAG60?	Tackable Fabric Privacy Screen, 1" Thick, 60"W	\$574
AAG66?	Tackable Fabric Privacy Screen, 1" Thick, 66"W	\$587
AAG72?	Tackable Fabric Privacy Screen, 1" Thick, 72"W	\$598
<p>Tip: Includes L-brackets, hardware and tackable screen (tackable fabric on both sides).</p> <p>Tip: Must be used in application where L-brackets can attach to the underside of worksurface.</p> <p>Tip: Two panels in 90-degree orientation will not work. Requires a special width.</p>		
Universal 2-Sided Tackable Fabric Privacy Screen, Aluminum Frame - 13"H		
AAUH24?	Tackable Fabric Privacy Screen, 24"W	\$489
AAUH30?	Tackable Fabric Privacy Screen, 30"W	\$540
<p>Tip: Attached with industrial strength double-face tape.</p> <p>Optional Grid attachment bracket available, see AAUABRKT.</p>		
Universal Frosted Acrylic Privacy Screen, Aluminum Frame - 13"H		
AAUA24	Acrylic Privacy Screen, 24"W	\$375
AAUA30	Acrylic Privacy Screen, 30"W	\$402
<p>Tip: Attached with industrial strength double-face tape.</p> <p>Optional Grid attachment bracket available, see AAUABRKT.</p>		
AAUABRKT	Bracket to attach 1 upper corner of AAUA or AAUH to top of Grid Frame	\$38
<p>Tip: Works on standard Grid Frame (not Mini or Mega) with Rail Profile (original design) only. Frame must be in 42"H (power above) position.</p>		
All-In-One Privacy/Modesty Screen, Double-Sided Laminate, .75" thick		
UG48#	Desk Mounted Privacy/Modesty Screen, 48"W	\$371
UG60#	Desk Mounted Privacy/Modesty Screen, 60"W	\$456
UG72#	Desk Mounted Privacy/Modesty Screen, 72"W	\$533
<p>Tip: Screen attaches to bottom of worksurface and sits behind surface. Screen is 13" above surface and 16" below surface.</p>		
Tackboards for Laminate All-in-One Privacy/Modesty Screens		
UG48T?	Tackboard for use with UG48 Screen	\$199
UG60T?	Tackboard for use with UG60 Screen	\$233
UG72T?	Tackboard for use with UG72 Screen	\$277
<p>Tip: Sits above worksurface and faces user.</p> <p>Tip: Tackboard is .75" thick.</p>		
All-in-One Privacy/Modesty Screen, Frosted Acrylic		
UGAC48	Frosted Acrylic Desk Mounted Privacy/Modesty 48"W	\$584
UGAC60	Frosted Acrylic Desk Mounted Privacy/Modesty 60"W	\$669
UGAC72	Frosted Acrylic Desk Mounted Privacy/Modesty 72"W	\$754

Grid Modesty Panels

STEP 1 - Slotted Modesty Panels

(^) Paint Suffix List

G Slate Grey
 R Black
 S Silver
 T Medium Tone
 W Arctic White
 Z Other

Tip: Some Steelcase, Herman Miller, Knoll, Haworth, and Allsteel paints are available for \$350 list fee per order. Call/email for availability of specific colors. Additional custom paints (e.g. Tiger Dry Lac) must be quoted through quotes@enwork.com.

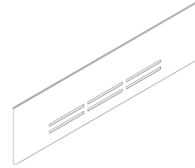

Ordering Information:

> A freight fee of \$100 net is assessed on orders less than \$1000 net. See page 13.

Part Number	Description	List Price (US\$)
Slotted Modesty Panels for Frames, Painted Steel, 12"H		
UMP30^	Slotted Modesty Panel, 30"W	\$156
UMP48^	Slotted Modesty Panel, 48"W	\$164
UMP60^	Slotted Modesty Panel, 60"W	\$216
UMP72^	Slotted Modesty Panel, 72"W	\$225
UMP84^	Slotted Modesty Panel, 84"W	\$259

Notes

Grid Accessories

STEP 1





(^) Paint Suffix List

G Slate Grey
R Black
S Silver
T Medium Tone
W Arctic White
Z Other

Tip: Some Steelcase, Herman Miller, Knoll, Haworth, and Allsteel paints are available for \$350 list fee per order. Call/email for availability of specific colors. Additional custom paints (e.g. Tiger Dry Lac) must be quoted through quotes@enwork.com.

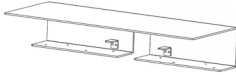
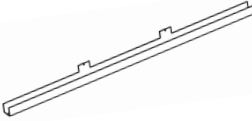
Ordering Information:

> A freight fee of \$100 net is assessed on orders less than \$1000 net. See page 13.

	Part Number	Description	List Price (US\$)
	Monitor Riser, Steel, 11"D		
	URISER28^	Monitor Riser for Single Monitor, 28"W	\$339
	URISER39^	Monitor Riser for Double Monitors, 39"W	\$427
	High Capacity Cable Trough for Grid Frames, 2.25" Trough Depth, 4"H x 2.5"D		
	UMHCP36^	36" High Capacity Trough	\$74
	UMHCP48^	High Capacity Trough for 48" Frame	\$77
	UMHCP60^	High Capacity Trough for 60" Frame	\$117
	UMHCP72^	High Capacity Trough for 72" Frame	\$120
	Tip: For XTB applications, order Cable Trough one size smaller. (ie: UMHCP60 for 72" Frame).		
	Tip: Use 36" trough for XTB 120 planning.		
	Tip: Specify worksurface suffix D or V or Full Scallops to receive gap between Frame and top for access to trough.		
	Enwork Monitor Arm, with USB, Silver		
	EBMA11S	Monitor Arm, Single Mount with dual USB ports, Silver Tip: Off-center installation recommended.	\$384
	EBMA22S	Monitor Arm, Dual Mount with dual USB ports, Silver Tip: Dual mount still in development. See enwork.com or call for availability.	\$TBD
	Vertical Cable Managers with weighted base		
	PDVCMR	Vertical Cable Manager, flexible spine, 30", worksurface attached, Black	\$198
	PDVCMS	Vertical Cable Manager, flexible spine, 30", worksurface attached, Silver	\$198
	ULCM	Vertical Cable Manager, flexible spine, 1.5" diameter, Black	\$163
	Center Drawers - Non-Locking, Black Plastic		
	CDRAWER	Center Drawer, Non-Locking, 13"W x 17"D x 1.75"H Tip: Metal center drawer is found in Apex.	\$126
	CPU Holders, black		
	CPHF	CPU Holder, Fixed	\$273
	CPHS	CPU Holder, Swivel	\$468
	Tip: Width adjustment is 5.5-9.25", height adjustment is 13.4-20.5", Very small CPUs may not fit.		



Grid Worktools for Rail Profile Frames

Product Specifications:

> Work tools attach to Top Rail side slot in Grid Rail Profile Frames.

Ordering Information:

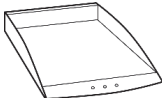
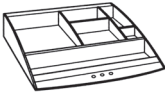
> A freight fee of \$100 net is assessed on orders less than \$1000 net. See page 13.

	Part Number	Description	List Price (US\$)
Grid Accessories for Rail Profile Frames, Clear Plastic			
	TPE	Pencil Holder	\$21
	TTP	Paper Tray	\$49
	TAT	Accessory Tray	\$36
	TPH	Phone Holder	\$40
	TFT	Folder Tray	\$59

Landscape Storage

STEP 1

(^) Paint Suffix List

G Slate Grey
R Black
S Silver
T Medium Tone
W Arctic White
Z Other

Tip: Some Steelcase, Herman Miller, Knoll, Haworth, and Allsteel paints are available for \$350 list fee per order. Call/email for availability of specific colors. Additional custom paints (e.g. Tiger Dry Lac) must be quoted through quotes@enwork.com.

STEP 2

(#) Pull Suffix List:



Tip: Rod pull is 6.5" long on Personal Cabinet. Rod pull is 20.5" long on Personal Tower and Box-Lateral.

STEP 3

(@) Laminate Suffix List:

A Wilsonart Kensington Maple (10776-60)
B Wilsonart Monticello Maple (7925-38)
C Wilsonart Wild Cherry (7054-60)
E Wilsonart Fashion Grey (D381-60)
F Wilsonart White Tigris (4783-60)
G Wilsonart Cafelle (7933K-07)
M Wilsonart Frosty White (1573-60)
P Wilsonart Slate Grey (D91-60)
R Wilsonart Black (1595-60)
U Wilsonart Brazilwood (7946-38)
V Wilsonart River Cherry (7937-38)
W Wilsonart Designer White (D354-60)
3 Formica Neutral Twill (8826-58)
4 Formica Bleached Legno (8845-58)
5 Formica Prestige Walnut (6209-43)
7 Formica Select Cherry (7759-43)
X *Wilsonart Non-Premium laminates +\$36 (-38, -60). Orders of 100+ units have no upcharge.
Y *Formica Non-Premium Standard +\$50 (58, 43, MC, SP and NT finishes) and Wilsonart Premium (-01, -07, -12, -18, -52, -78) laminates.
Z *Pionite Non-Premium, Nevamar +\$72 Non-Premium, Formica Premium (WR, 42, 77, 46, RD Finishes), and whiteboard laminate.







*Add \$350 list for Special Laminate orders of less than 10 units. See page 21 for edge selection.

Product Specifications:

- > Steel Storage with laminate tops
- > Lock cores are LL Series. UM Series lock cores are available upon request.
- > Bookcase adjustable shelf has room for cord management behind shelf.
- > Landscape Storage feet are 3-1/8" high square clear anodized aluminum.
- > Four feet or four casters included with each component. Six feet included with combination units since center feet are shared.
- > Tops are 3/4" thick, high pressure laminate, 3mm edge

Ordering Information:

- > (see page 335)

	D	W	H	Part Number	Description	List Price (US\$)
	Landscape Box-Lateral Files					
	18	30	24	UUBFLAT30^#@	Box-Lateral, 30"W	\$1478
	18	36	24	UUBFLAT36^#@	Box-Lateral, 36"W	\$1545
	Landscape Bookcases with Adjustable Shelf					
	18	18	24	UUBK18^@	Bookcase, 18"W	\$1114
	18	24	24	UUBK24^@	Bookcase, 24"W	\$1134
	18	30	24	UUBK30^@	Bookcase, 30"W	\$1152
	18	36	24	UUBK36^@	Bookcase, 36"W	\$1218
	Landscape Bookcases with Sliding Acrylic Doors					
	18	30	24	UUBKA30^@	Bookcase, w/ Sliding Acrylic Doors, 30"W	\$1492
	18	36	24	UUBKA36^@	Bookcase, w/ Sliding Acrylic Doors, 36"W	\$1576
	18	30	24	UUBKG30^@	Bookcase, w/ Sliding Designer Acid-Etched Glass Doors, 30"W	\$1994
	18	36	24	UUBKG36^@	Bookcase, w/ Sliding Designer Acid-Etched Glass Doors, 36"W	\$2123
	Landscape Personal Cabinets with Single Door and Adjustable Shelf					
	18	12	24	UUPAF24R^#@	Cabinet w/ RH Door, on Feet, 12"W	\$1106
	18	12	24	UUPAF24L^#@	Cabinet w/ LH Door, on Feet, 12"W	\$1106
	18	12	24	UUPAC24R^#@	Cabinet w/ Single RH Door, on Black Casters, 12"W	\$980
	18	12	24	UUPAC24L^#@	Cabinet w/ Single LH Door, on Black Casters, 12"W	\$980
	Landscape Personal Towers with Single Door and Adjustable Shelves					
	18	12	42	UUPA42R^#@	Tower w/ RH Door, 12"W	\$1534
	18	12	42	UUPA42L^#@	Tower w/ LH Door, 12"W	\$1534
	Landscape Personal Towers with Single Door and Adjustable Shelves					
	18	12	42	UUPC42R^#@	Tower w/ RH Door, Coat Rod, 12"W	\$1484
	18	12	42	UUPC42L^#@	Tower w/ LH Door, Coat Rod, 12"W	\$1484

Tip: Must be ganged (using provided shared feet) with another piece of Landscape storage.









Tip: Must be ganged (using provided shared feet) with another piece of Landscape storage.

Ordering Information:

- > All doors and drawers are locking except sliding doors on bookcases. Default Keying is random. See page 17 for Keyed-alike (no charge).
- > Counterweights included on Box-Laterals.
- > Tops and Landscape Storage feet are field installed. Casters ship installed.
- > Combinations feature shared (fewer) legs and a common top. No case bolting required.
- > Additional Combinations are available. Contact quotes@enwork.com.
- > **A freight fee of \$100 net is assessed on orders less than \$1000 net. See page 13.**

STEEL STORAGE OPTIONS

For lower cost Grid steel storage see page 336.

	D	W	H	Part Number	Description	List Price (US\$)
Combination Box-Lateral and Bookcase (no doors) with Common Top and Shared Feet						
	18	48	24	UU48AR^#@	30" Box Lateral (right) and 18" Bookcase (left), 48" top	\$2397
	18	54	24	UU54AR^#@	30" Box Lateral (right) and 24" Bookcase (left), 54" top	\$2481
	18	60	24	UU60AR^#@	30" Box Lateral (right) and 30" Bookcase (left), 60" top	\$2500
	18	72	24	UU72AR^#@	36" Box Lateral (right) and 36" Bookcase (left), 72" top	\$2634
	18	48	24	UU48AL^#@	30" Box Lateral (left) and 18" Bookcase (right), 48" top	\$2397
	18	54	24	UU54AL^#@	30" Box Lateral (left) and 24" Bookcase (right), 54" top	\$2481
	18	60	24	UU60AL^#@	30" Box Lateral (left) and 30" Bookcase (right), 60" top	\$2500
	18	72	24	UU72AL^#@	36" Box Lateral (left) and 36" Bookcase (right), 72" top	\$2634
Combination Box-Lateral and Bookcase with Sliding Acrylic Doors, Common Top, and Shared Feet						
	18	60	24	UU60CR^#@	30" Box Lateral (right) and 30" Bookcase (left) w/ Sliding Acrylic Doors and 60" top	\$2839
	18	72	24	UU72CR^#@	36" Box Lateral (right) and 36" Bookcase (left) w/ Sliding Acrylic Doors and 72" top	\$2992
	18	60	24	UU60CL^#@	30" Box Lateral (left) and 30" Bookcase (right) w/ Sliding Acrylic Doors and 60" top	\$2839
	18	72	24	UU72CL^#@	36" Box Lateral (left) and 36" Bookcase (right) w/ Sliding Acrylic Doors and 72" top	\$2992
Combination Personal Cabinet and Bookcase (no doors) with Common Top and Shared Feet						
	18	42	24	UU42DR^#@	12" Personal Cabinet (right) and 30" Bookcase (left) w/ 42" top	\$2091
	18	48	24	UU48DR^#@	12" Personal Cabinet (right) and 36" Bookcase (left) w/ 48" top	\$2158
	18	42	24	UU42DL^#@	12" Personal Cabinet (left) and 30" Bookcase (right) w/ 42" top	\$2091
	18	48	24	UU48DL^#@	12" Personal Cabinet (left) and 36" Bookcase (right) w/ 48" top	\$2158
Combination Personal Cabinet and Bookcase with Sliding Acrylic Doors, Common Top, and Shared Feet						
	18	42	24	UU42ER^#@	12" Personal Cabinet (right) and 30" Bookcase (left) w/ Sliding Acrylic Doors and 42" top	\$2431
	18	48	24	UU48ER^#@	12" Personal Cabinet (right) and 36" Bookcase (left) w/ Sliding Acrylic Doors and 48" top	\$2515
	18	42	24	UU42EL^#@	12" Personal Cabinet (left) and 30" Bookcase (right) w/ Sliding Acrylic Doors and 42" top	\$2431
	18	48	24	UU48EL^#@	12" Personal Cabinet (left) and 36" Bookcase (right) w/ Sliding Acrylic Doors and 48" top	\$2515
				UULP	Square Plinth, 3.5"H, used between Landscape Storage and bottom of worksurface	\$42

Landscape Storage & Grid Steel Storage

STEP 1 - Seat Cushions for Landscape Storage

(^) Fabric Suffix List:

> Free form fabric selection. Choose from Camira Era or the Mill Collection fabrics.

Tip: To view fabric colors or to order samples go to www.camirafabrics.com/us.

Tip: For COM yardage, see page 16.

STEP 1 - Grid Steel Storage

(^) Paint Suffix List

G Slate Grey
R Black
S Silver
T Medium Tone
W Arctic White
Z Other

Tip: Some Steelcase, Herman Miller, Knoll, Haworth, and Allsteel paints are available for \$350 list fee per order. Call/email for availability of specific colors. Additional custom paints (e.g. Tiger Dry Lac) must be quoted through quotes@enwork.com.

STEP 2 - Grid Steel Storage

(@) Pull Suffix List:



(A) Arc

(B) Bar

(R) Rod

Ordering Information:

> Grid Steel Storage has Steel top and levelers

> **A freight fee of \$100 net is assessed on orders less than \$1000 net. See page 13.**

D1	W1	H1	Part Number	Description	List Price (US\$)
Seat Cushions for Landscape Storage					
18	12	2	U9CUSH12^	Seat Cushion, 12"W	\$190
18	18	2	U9CUSH18^	Seat Cushion, 18"W	\$220
18	24	2	U9CUSH24^	Seat Cushion, 24"W	\$246
18	30	2	U9CUSH30^	Seat Cushion, 30"W	\$277
18	36	2	U9CUSH36^	Seat Cushion, 36"W	\$331
18	42	2	U9CUSH42^	Seat Cushion, 42"W	\$352
18	48	2	U9CUSH48^	Seat Cushion, 48"W	\$379
18	54	2	U9CUSH54^	Seat Cushion, 54"W	\$463
18	60	2	U9CUSH60^	Seat Cushion, 60"W	\$509
18	66	2	U9CUSH66^	Seat Cushion, 66"W	\$531
18	72	2	U9CUSH72^	Seat Cushion, 72"W	\$583

Tip: Free form your fabric selection. Choose from Camira Era or the Mill Collection fabrics. See www.camirafabrics.com/us for more information.

Tip: For COM yardage, see page 16.

Tip: Includes velcro installation.

D	W	H	Part Number	Description	List Price (US\$)
Grid Steel Box-Lateral Files					
18	30	21.5	UABL30^@	Steel Box Lateral File, 30"W	\$1147
18	36	21.5	UABL36^@	Steel Box Lateral File, 36"W	\$1220
18	42	21.5	UABL42^@	Steel Box Lateral File, 42"W	\$1336

Tip: Counterweight is included in Box-Lateral Storage.

Grid Steel Bookcases with Adjustable Shelf

18	18	21.5	UABK18^	Steel Bookcase, 18"W	\$735
18	24	21.5	UABK24^	Steel Bookcase, 24"W	\$788
18	30	21.5	UABK30^	Steel Bookcase, 30"W	\$815
18	36	21.5	UABK36^	Steel Bookcase, 36"W	\$867
18	42	21.5	UABK42^	Steel Bookcase, 42"W	\$932

Apex Steel Storage - Pedestals

Ordering Information:

- > Default Keying is random. See page 17 for Keyed-alike (no charge).
- > Lock cores are LL Series. UM Series lock cores are available upon request.
- > If ordering an additional laminate top for these products, contact quotes@enwork.com.
- > **A freight fee of \$100 net is assessed on orders less than \$1000 net. See page 13.**

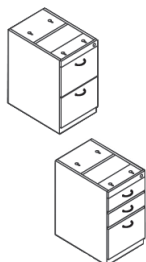

D1	W1	H1	Part Number	Description	List Price (US\$)
Pedestals - Open Top					
18	15	27.5	A2P18FF^#@	18"D F/F Ped - full ext. files	\$591
18	15	27.5	A2P18BBFE^#@	18"D B/B/F Ped - full ext. boxes, full ext. file	\$612
22	15	27.5	A2P24FF^#@	24"D F/F Ped - full ext. slide	\$601
22	15	27.5	A2P24BBFE^#@	24"D B/B/F Ped - full ext. boxes, full ext. file	\$624
28	15	27.5	A2P30FF^#@	30"D F/F Ped - full ext. slide	\$747
28	15	27.5	A2P30BBFE^#@	30"D B/B/F Ped - full ext. boxes, full ext. file	\$809

Tip: Box drawers do not include dividers.
Tip: Laminate fronts are available as an option (lock bar is painted). Add a "Z" to the front of the part number and see Step 3 to specify laminate.
Tip: 18" D peds do not support legal filing.
Tip: As of March 2015, 24"D pedestals fit under 24" Apex shells. 30"D pedestals fit under 30" Apex shells.

Mobile Pedestals - Steel Top



18	15	22.3	A2MP18BFE^#@	18"D B/F Mobile Ped - full ext. box, full ext. file	\$585
18	15	27.2	A2MP18BBFE^#@	18"D B/B/F Mobile Ped - full ext. box, full ext. file	\$714
18	15	27.2	A2MP18FF^#@	18"D F/F Mobile Ped - full ext. slide	\$658
22	15	22.3	A2MP24BFE^#@	24"D B/F Mobile Ped - full ext. box, full ext. file	\$605
22	15	27.2	A2MP24BBFE^#@	24"D B/B/F Mobile Ped - full ext. box, full ext. file	\$738
22	15	27.2	A2MP24FF^#@	24"D F/F Mobile Ped - full ext. slide	\$679

Tip: Casters require field installation. Counterweight included.
Tip: Box drawers do not include dividers.
Tip: Laminate fronts are available as an option (lock bar is painted). Add a "Z" to the front of the part number and see Step 3 to specify laminate.
Tip: Box Box File and File File will hit NWBRACE if NWBRACE is supporting top.
Tip: Additional lock bar pull or tote pull available on mobile peds. See Step 2.

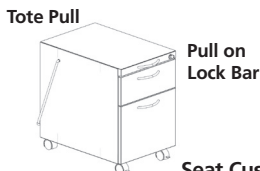

Pulling Options

Seat Cushions for Apex Pedestals, Magnet Installation - 2"x15"x18"

A2CUSH18	Apex Ped Cushion, 18", Camira Era or the Mill Collection Fabrics, specify pattern & color	\$200
A2CUSHCOM18	Apex Ped Cushion, 18", COM Fabric	\$200

Seat Cushions for Apex Pedestals, Magnet Installation - 2"x15"x22"

A2CUSH24	Apex Ped Cushion, 22", Camira Era or the Mill Collection Fabrics, specify pattern & color	\$222
A2CUSHCOM24	Apex Ped Cushion, 22", COM Fabric	\$222

Tip: To view Camira fabrics or to order samples, go to www.camirafabrics.com/us.
Tip: For COM yardage, see page 16.

STEP 1

(^) Paint Suffix List

- G Slate Grey
- R Black
- S Silver
- T Medium Tone
- W Arctic White
- Z Other

Tip: Some Steelcase, Herman Miller, Knoll, Haworth, and Allsteel paints are available for \$350 list fee per order. Call/email for availability of specific colors. Additional custom paints (e.g. Tiger Dry Lac) must be quoted through quotes@enwork.com.

STEP 2 - for Open Top Peds Only

(#) Pull Suffix List:



(A) Arc (B) Bar (R) Rod (I) Integral

STEP 2 - for Mobile Peds, Steel Top Only

(#) Pull Suffix List:

A	Arc, Aluminum	no charge
J	Arc, Aluminum w/ add. Arc pull on lock cover	+\$36
K	Arc, Aluminum w/ Tote pull	+\$180
B	Bar	no charge
L	Bar w/ additional Bar pull on lock cover	+\$36
M	Bar w/ Tote pull	+\$180
R	Rod	no charge
P	Rod w/ additional Rod pull on lock cover	+\$36
Q	Rod w/ Tote pull	+\$180
I	Integral	no charge
T	Integral w/ additional Arc pull on lock cover	+\$36
U	Integral w/ Tote pull	+\$180

STEP 3 - for Peds with Laminate Fronts Only

(@) Laminate Suffix List:

A	Wilsonart Kensington Maple (10776-60)	+\$206
B	Wilsonart Monticello Maple (7925-38)	+\$206
C	Wilsonart Wild Cherry (7054-60)	+\$206
E	Wilsonart Fashion Grey (D381-60)	+\$206
G	Wilsonart Cafelle (7933K-07)	+\$206
M	Wilsonart Frosty White (1573-60)	+\$206
P	Wilsonart Slate Grey (D91-60)	+\$206
R	Wilsonart Black (1595-60)	+\$206
U	Wilsonart Brazilwood (7946-38)	+\$206
V	Wilsonart River Cherry (7937-38)	+\$206
W	Wilsonart Designer White (D354-60)	+\$206
3	Formica Neutral Twill (8826-58)	+\$206
4	Formica Bleached Legno (8845-58)	+\$206
5	Formica Prestige Walnut (6209-43)	+\$206
7	Formica Select Cherry (7759-43)	+\$206
X	*Wilsonart Non-Premium laminates (-38, -60)	+\$225
Y	*Formica Non-Premium (includes 58, 43, MC, SP, and NT finishes), Formica Premium (WR, 42, 77, 46, RD finishes), Pronite Non-Premium, Nevamar Non-Premium, Wilsonart Premium (-01, -07, -12, -18, -52, -78), and whiteboard laminate.	+\$250

*Add \$350 list for Special Laminate orders of less than 10 units. See page 21 for edge selection.

Tip: For laminate fronts on peds, you must add a "Z" in front of the part number.

BENCHING ENVIRONMENTS GRID



Seating

Revisions

P358, 359 03/17 Removed Available through Dec. 2017 note

Task



Capri Task
P. 348



Me! Simple Task
P. 350



Me! Task
P. 351



Me! Intensive Task
P. 353



Me! High Back Task
P. 352

Conference



Ardi Conference
Black
P. 346



Ardi Conference
White
P. 346



Reko Chair
P. 366



Zeppa Simple Task
P. 368



Me! Simple Task
P. 350

Multi-purpose



Me! Guest
P. 357



Me! Flip Seat
Nesting
P. 356



Monaco Stacking
P. 360



Monaco Stacking
w/ Upholstered Seat
P. 361



Monaco Guest
P. 362

Lounge



Pixley Bench
P. 364



Pixley Bench
w/ Back
P. 364



Pixley Bench
w/ Back & Stadium Shelf
P. 364



Me! Stool
P. 354



Zeppa Simple Task
P. 368



Zeppa Task
P.369



Milan Intensive Task
P. 359



Milan Simple Task
P. 358



Monaco Flip Seat
Nesting
P. 363



Monaco Dolly
P. 360

Ardi



Ardi Conference
Black
P. 346



Ardi Conference
White
P. 346

Capri



Capri Task
P. 348

Me!



Me! Simple Task
P. 350



Me! Task
P. 351



Me! Intensive Task
P. 353



Me! High Back Task
P. 352



Me! Stool
P. 354



Me! Guest
P. 357



Me! Flip Seat
Nesting
P. 356

Milan



Milan Intensive Task
P. 359



Milan Simple Task
P. 358

Monaco



Monaco Flip Seat
Nesting
P. 363



Monaco Dolly
P. 360



Monaco Stacking
P. 360



Monaco Stacking
w/ Upholstered Seat
P. 361



Monaco Guest
P. 362

Pixley



Pixley Bench
P. 364



Pixley Bench
w/ Back
P. 364



Pixley Bench
w/ Back & Stadium Shelf
P. 364

Reko



Reko Chair
P. 366

Zeppa



Zeppa Task
P. 369



Zeppa Simple Task
P. 368

Notes

Chair Adjustments Guide

FEATURE/ ADJUSTMENT	Mid Back Conference Chair Mid Back Task Chair Mid Back Simple Task Chair Mid Back Task Chair High Back Task Chair Mid Back Intensive Use Task Chair Mid Back Intensive Use Task Chair Flip Seat Stool Flip Seat Nesting Chair Stackable Guest Chair Mid Back Simple Task Chair Mid Back Intensive Use Task Chair Stacking Chair, Poly Seat Upholstered Seat Flip Seat Nesting Chair Stackable Guest Chair Single Shell Swivel Tilt Chair Simple Task Chair Task Chair										Ardi		Capri	Me!					Milan		Monaco				Reko	Zeppa	
	Synchro-Tilt	x	x	x	x	x						x												x	x		
Multi-Function												x															
Swivel																											
Swivel Tilt																											
Tilt Tension	x	x	x	x	x	x					x	x									x		x	x			
Forward Tilt												x															
Tilt Lock	x	x	x	x	x	x					x	x											x	x			
Back Height		x	x	x		x	x	x			x	x															
Back Angle												x															
Seat Angle												x															
Seat Height	x	x	x	x	x	x	x				x	x									x		x	x			
Seat Slider				x	x	x						x												x			
Independent Lumbar Support						x																		x			
Stackable																x	x				x						
Nesting																											

Product Specifications:

- > Black or white EcoLeather upholstery
- > 2 to 1 synchro tilt mechanism
- > 3 Position tilt lock
- > Tilt tension control
- > Pneumatic seat height adjustment
- > Fixed loop style chrome arms with non-marring black nylon tops
- > 27" diameter chromed aluminum 5-star base
- > 50mm dual wheel nylon casters
- > Complies with CAL TB 117-2013
- > Meets or exceeds ANSI/BIFMA standards

Ordering Information:

- > Typically ships in 1-3 business days.
- > **A \$30 freight fee per chair applies to chair orders of 1-3 units. For orders of 4 or more chairs, a freight fee of \$100 net is applied to orders less than \$1000 net. See page 13.**

Part Number	Description	List Price (US\$)
Ardi Mid Back Conference Chair		
MARDM-BLACK	Ardi Mid Back Conference Chair, Black EcoLeather	\$821
MARDM-WHITE	Ardi Mid Back Conference Chair, White EcoLeather	\$821

Dimensions

Overall	39-3/4 to 43"H x 24-7/16"W x 23-5/8"D
Seat height	18" to 21-1/4"
Seat depth	18-1/2"
Seat width	19-3/4"
Back height from seat	22"
Distance between arms	20"
Arm height from seat	8-1/2"
Cartoned chair weight	44.6 lbs
Carton size	25-1/2" x 27" x 14-1/4"



Notes

Capri™ Mid Back Task Chair

Product Specifications:

- > Black mesh back with ratchet height adjustment
- > Extra thick molded foam contoured seat with black upholstery
- > 1 paddle synchro tilt mechanism
- > Tilt tension control
- > Tilt lock
- > Pneumatic seat height adjustment
- > Height and width adjustable arms with telescoping arm pads
- > 26" diameter black nylon 5-star base
- > 50mm nylon dual wheel casters
- > Complies with CAL TB 117-2013
- > Meets or exceeds ANSI/BIFMA standards

Ordering Information:

- > Typically ships in 1-3 business days.
- > **A \$30 freight fee per chair applies to chair orders of 1-3 units. For orders of 4 or more chairs, a freight fee of \$100 net is applied to orders less than \$1000 net. See page 13.**

Part Number	Description	List Price (US\$)
-------------	-------------	-------------------

Capri Mid Back Task Chair, Black

MM1133M-V2	Capri Mid Back Task Chair, Black Seat Upholstery, Black Mesh Back	\$482
------------	---	-------

Dimensions

Overall	37-3/4 to 42" H x 27-1/5" W x 25" D
Seat height	18-3/4" to 22-1/4"
Seat depth	19-3/4"
Seat width	19-1/2"
Back height from seat	18" to 21"
Distance between arms	19-1/2"
Arm height from seat	6-1/2" to 9-1/4"
Cartoned chair weight	46 lbs
Carton size	25-1/4" x 26-1/2" x 14-1/4"



Notes

350 **Me!™ Mid Back Simple Task Chair**

Additional Back Mesh Options

10-12 week lead time — 50 unit minimum



Charcoal Grass Magenta



Red Sea Blue Tangerine

Freeform the back mesh color you'd like.

Example:
MEST-COLOR GRASS

Product Specifications:

- > Black mesh back with ratchet height adjustment
- > Molded foam waterfall style seat with (black) Camira Era: Forward upholstery
- > 2 to 1 synchro tilt mechanism
- > Tilt tension control
- > Tilt lock
- > Pneumatic seat height adjustment
- > Height and width adjustable arms with telescoping arm pads
- > 27" diameter black nylon base
- > 60mm polyurethane dual wheel casters
- > Complies with CAL TB 117-2013
- > Meets or exceeds ANSI/BIFMA standards
- > Can be assembled without arms

Ordering Information:

- > Typically ships in 1-3 business days.
- > Additional options are available with various lead times. See left for additional information.
- > **A \$30 freight fee per chair applies to chair orders of 1-3 units. For orders of 4 or more chairs, a freight fee of \$100 net is applied to orders less than \$1000 net. See page 13.**

Part Number	Description	List Price (US\$)
Me! Mid Back Simple Task Chair		
MEST	Me! Mid Back Simple Task Chair, Black Upholstered Seat, Black Mesh Back	\$638
MEST-COLOR	Me! Mid Back Simple Task Chair, Black Upholstered Seat, Colored Mesh Back Tip: Extended 10-12 week lead time.	\$688

Dimensions

Overall	37-1/2 to 43" H x 26" W x 26" D
Seat height	18-1/2" to 22-1/4"
Seat depth	19-1/2" to 21"
Seat width	20-1/2"
Back height from seat	20-1/2" to 23-1/2"
Distance between arms	18" to 20"
Arm height from seat	6-1/2" to 9"
Cartoned chair weight	50 lbs
Carton size	25-1/4" x 26-1/2" x 15"



Me! Mid Back Task Chair

Product Specifications:

- > Black mesh back with ratchet height adjustment
- > Molded foam waterfall style seat with (black) Camira Era: Forward upholstery
- > 2 to 1 synchro tilt mechanism
- > Tilt tension control
- > 3 position tilt lock control
- > Pneumatic seat height adjustment
- > Height and width adjustable arms with telescoping arm pads
- > Seat slider
- > 27" diameter black nylon base
- > 60mm dual wheel, dual surface polyurethane casters
- > Complies with CAL TB 117-2013
- > Meets or exceeds ANSI/BIFMA standards
- > Can be assembled without arms

Ordering Information:

- > Typically ships in 1-3 business days.
- > Additional options are available with various lead times. See right for additional information.
- > **A \$30 freight fee per chair applies to chair orders of 1-3 units. For orders of 4 or more chairs, a freight fee of \$100 net is applied to orders less than \$1000 net. See page 13.**

Additional Back Mesh Options

10-12 week lead time — 50 unit minimum

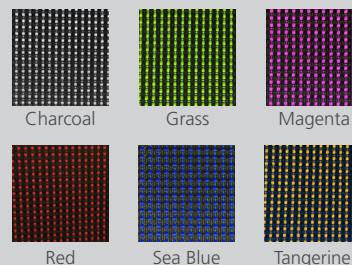

Freeform the back mesh color you'd like.

Example:
MEST-COLOR GRASS

Part Number	Description	List Price (US\$)
Me! Mid Back Task Chair		
MEM3	Me! Mid Back Task Chair, Black Upholstered Seat, Black Mesh Back	\$681
MEM3-COLOR	Me! Mid Back Task Chair, Black Upholstered Seat, Colored Mesh Back Tip: Extended 10-12 week lead time.	\$731



Dimensions

Overall	37-1/2 to 43" H x 26" W x 26" D
Seat height	18-1/2" to 22-1/4"
Seat depth	19-1/2" to 21"
Seat width	20-1/2"
Back height from seat	20-1/2" to 23-1/2"
Distance between arms	18" to 20"
Arm height from seat	6-1/2" to 9"
Cartoned chair weight	54 lbs
Carton size	25-1/4" x 26-1/2" x 15-1/2"



Me! High Back Task Chair

Additional Back Mesh Options

10-12 week lead time — 50 unit minimum

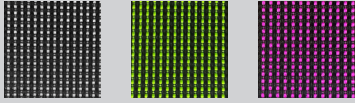

Charcoal

Grass

Magenta



Red

Sea Blue

Tangerine

Freeform the back mesh color you'd like.

Example:

MEST-COLOR GRASS

Product Specifications:

- > Black mesh back
- > Molded foam waterfall style seat with (black) Camira Era: Forward upholstery
- > 2 to 1 synchro tilt mechanism
- > Tilt tension control
- > 3 position tilt lock control
- > Pneumatic seat height adjustment
- > Height and width adjustable arms with telescoping arm pads
- > Independent lumbar support
- > Seat slider
- > 27" diameter black nylon 5-star base
- > 60mm polyurethane dual wheel casters
- > Complies with CAL TB 117-2013
- > Meets or exceeds ANSI/BIFMA standards
- > Can be assembled without arms

Ordering Information:

- > Typically ships in 1-3 business days.
- > Additional options are available with various lead times. See left for additional information.
- > **A \$30 freight fee per chair applies to chair orders of 1-3 units. For orders of 4 or more chairs, a freight fee of \$100 net is applied to orders less than \$1000 net. See page 13.**

Part Number	Description	List Price (US\$)
Me! High Back Task Chair		
MEHB3	Me! High Back Task Chair, Black Upholstered Seat, Black Mesh Back	\$725
MEHB3-COLOR	Me! High Back Task Chair, Black Upholstered Seat, Colored Mesh Back Tip: Extended 10-12 week lead time.	\$775

Dimensions

Overall	38-1/4 to 44" H x 26" W x 26" D
Seat height	18-1/2" to 22-1/4"
Seat depth	19-1/2" to 21"
Seat width	20-1/2"
Back height from seat	23-1/2"
Distance between arms	18" to 20"
Arm height from seat	6-1/2" to 9"
Cartoned chair weight	55.2 lbs
Carton size	25-1/4" x 29-1/4" x 15"



Me! Mid Back Intensive Use Task Chair

Product Specifications:

- > Black mesh back with ratchet height adjustment
- > Molded foam waterfall style seat with (black) Camira Era: Forward upholstery
- > Tilt tension control
- > Forward tilt with lock out
- > Pneumatic seat height adjustment
- > Back and seat angle adjustment
- > Height and width adjustable arms with telescoping arm pads
- > Seat slider
- > 27" diameter black nylon 5-star base
- > 60mm polyurethane dual wheel casters
- > Complies with CAL TB 117-2013
- > Meets or exceeds ANSI/BIFMA standards
- > Can be assembled without arms

Ordering Information:

- > Typically ships in 1-3 business days.
- > Additional options are available with various lead times. See right for additional information.
- > **A \$30 freight fee per chair applies to chair orders of 1-3 units. For orders of 4 or more chairs, a freight fee of \$100 net is applied to orders less than \$1000 net. See page 13.**

Additional Back Mesh Options

10-12 week lead time — 50 unit minimum

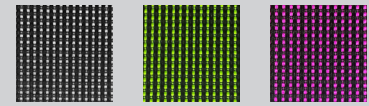

Charcoal Grass Magenta

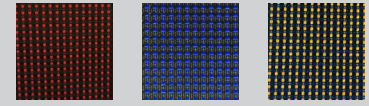

Red Sea Blue Tangerine

Freeform the back mesh color you'd like.

Example:

MEST-COLOR GRASS

Part Number	Description	List Price (US\$)
Me! Mid Back Intensive Use Task Chair		
MEM5	Me! Mid Back Intensive Use Task Chair, Black Upholstered Seat, Black Mesh Back	\$699
MEM5-COLOR	Me! Mid Back Intensive Use Task Chair, Black Upholstered Seat, Colored Mesh Back Tip: Extended 10-12 week lead time.	\$749



Dimensions

Overall	37-1/2 to 43" H x 26" W x 26" D
Seat height	18-1/2" to 22-1/4"
Seat depth	19-1/2" to 21"
Seat width	20-1/2"
Back height from seat	20-1/2" to 23-1/2"
Distance between arms	18" to 20"
Arm height from seat	6-1/2" to 9"
Cartoned chair weight	60 lbs
Carton size	25-1/4" x 26-1/2" x 16"



Me! Mid Back Stool

Additional Back Mesh Options

10-12 week lead time — 50 unit minimum

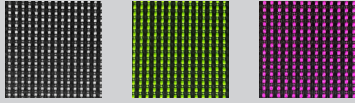

Charcoal

Grass

Magenta

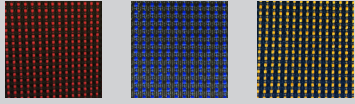

Red

Sea Blue

Tangerine

Freeform the back mesh color you'd like.

Example:
MEST-COLOR GRASS

Product Specifications:

- > Black mesh back with ratchet height adjustment
- > Molded foam waterfall style seat with (black) Camira Era: Forward upholstery
- > 1-Paddle swivel mechanism
- > Pneumatic seat height adjustment approx. 24-33"
- > Height and width adjustable arms with telescoping arm pads
- > 21" foot ring with black powder coated finish
- > 27" diameter black nylon 5-star base
- > 50mm polyurethane dual wheel, dual surface casters
- > Complies with CAL TB 117-2013
- > Meets or exceeds ANSI/BIFMA standards
- > Can be assembled without arms

Ordering Information:

- > Typically ships in 1-3 business days.
- > Additional options are available with various lead times. See left for additional information.
- > **A \$30 freight fee per chair applies to chair orders of 1-3 units. For orders of 4 or more chairs, a freight fee of \$100 net is applied to orders less than \$1000 net. See page 13.**

Part Number	Description	List Price (US\$)
Me! Mid Back Stool		
MESTOOL	Me! Mid Back Stool, Black Upholstered Seat, Black Mesh Back	\$703
MESTOOL-COLOR	Me! Mid Back Stool, Black Upholstered Seat, Colored Mesh Back Tip: Extended 10-12 week lead time.	\$753

Dimensions

Overall	41-5/8 to 49" H x 26-1/2" W x 23-1/2" D
Seat height	24" to 29"
Seat depth	19"
Seat width	21"
Back height from seat	19-1/4" to 22"
Distance between arms	19" to 20-1/4"
Arm height from seat	6-1/4" to 8-1/2"
Cartoned chair weight	57-1/2 lbs
Carton size	26" x 26-1/2" x 15"



Notes

Me! Flip Seat Nesting Chair

Additional Back Mesh Options

10-12 week lead time — 50 unit minimum

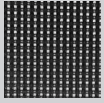

Charcoal

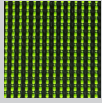

Grass



Magenta

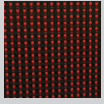

Red



Sea Blue



Tangerine

Freeform the back mesh color you'd like.

Example:

MEST-COLOR GRASS

Product Specifications:

- > Black mesh back with ratchet height adjustment
- > Molded foam waterfall style seat with (black) Camira Era: Forward upholstery
- > Flip-up seat for easy nesting
- > Black steel frame with powder coat finish
- > 50mm nylon dual surface, dual wheel casters
- > Complies with CAL TB 117-2013
- > Meets or exceeds ANSI/BIFMA standards

Ordering Information:

- > Typically ships in 1-3 business days.
- > Packaged 2 chairs to a box
- > Additional options are available with various lead times. See left for additional information.
- > **A \$30 freight fee per box applies to chair orders of 1-3 units. For orders of 4 or more chairs, a freight fee of \$100 net is applied to orders less than \$1000 net. See page 13.**

Part Number	Description	List Price (US\$)
-------------	-------------	-------------------

Me! Flip Seat Nesting Chair

MENEST	Me! Flip Seat Nesting Chair, Black Upholstered Seat, Black Mesh Back	\$486
--------	--	-------

MENEST-COLOR	Me! Flip Seat Nesting Chair, Black Upholstered Seat, Colored Mesh Back	\$536
--------------	--	-------

Tip: Extended 10-12 week lead time.

Tip: Packaged 2 chairs to a box.

Dimensions

Overall	38"H x 23-3/4"W x 24"D
Seat height	19"
Seat depth	19"
Seat width	18-1/4"
Back height from seat	21"
Distance between arms	20"
Cartoned chair weight	63 lbs (2 chairs)
Carton size	27-3/4" x 27-3/4" x 26-1/2"
Nested, back of chair 1 to front of chair 2	28"



Me! Stackable Guest Chair

Product Specifications:

- > Black mesh back
- > Molded foam waterfall style seat with (black) Camira Era: Forward upholstery
- > Stacks 4-high
- > Black steel frame with powder coated finish
- > Non-marring nylon floor glides
- > Complies with CAL TB 117-2013
- > Meets or exceeds ANSVBIFMA standards

Ordering Information:

- > Typically ships in 1-3 business days.
- > Packaged 2 chairs to a box
- > Additional options are available with various lead times. See right for additional information.
- > **A \$30 freight fee per box applies to chair orders of 1-3 units. For orders of 4 or more chairs, a freight fee of \$100 net is applied to orders less than \$1000 net. See page 13.**

Additional Back Mesh Options

10-12 week lead time — 50 unit minimum

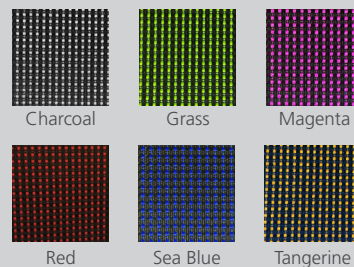

Freeform the back mesh color you'd like.

Example:
MEST-COLOR GRASS

Part Number	Description	List Price (US\$)
Me! Stackable Guest Chair		
MEGG	Me! Stackable Guest Chair, Black Upholstered Seat, Black Mesh Back	\$376
MEGG-COLOR	Me! Stackable Guest Chair, Black Upholstered Seat, Colored Mesh Back Tip: Extended 10-12 week lead time. Tip: Packaged 2 chairs to a box.	\$426



Dimensions

Overall	37-1/2" H x 24" W x 24" D
Seat height	19"
Seat depth	18"
Seat width	18-1/4"
Back height from seat	20"
Distance between arms	20"
Cartoned chair weight	45 lbs
Carton size	24-1/2" x 35-1/2" x 14"

Milan™ Mid Back Simple Task Chair

Product Specifications:

- > Black mesh back with ratchet height adjustment
- > Extra thick molded foam contoured seat with black upholstery
- > 2 to 1 synchro tilt
- > Multi-tilt and tilt tension control
- > Pneumatic seat height adjustment
- > Height and width adjustable arms with telescoping arm pads
- > 27" diameter black nylon 5-star base
- > 50mm polyurethane dual surface, dual wheel casters
- > Complies with CAL TB 117-2013
- > Meets or exceeds ANSI/BIFMA standards
- > Can be assembled without arms

Ordering Information:

- > Typically ships in 1-3 business days.
- > **A \$30 freight fee per chair applies to chair orders of 1-3 units. For orders of 4 or more chairs, a freight fee of \$100 net is applied to orders less than \$1000 net. See page 13.**

Part Number	Description	List Price (US\$)
Milan Mid Back Simple Task Chair, Black		
MM4333M	Milan Mid Back Simple Task Chair, Black Upholstered Seat, Black Mesh Back	\$535

Dimensions

Overall	35-5/8 to 42"H x 26-1/2"W x 23-1/2"D
Seat height	18-1/4" to 22-1/8"
Seat depth	19" to 20-7/8"
Seat width	21"
Back height from seat	19-1/4" to 22"
Distance between arms	19" to 20-1/4"
Arm height from seat	6-1/4" to 8-1/2"
Cartoned chair weight	46 lbs
Carton size	25" x 24-3/4" x 15"

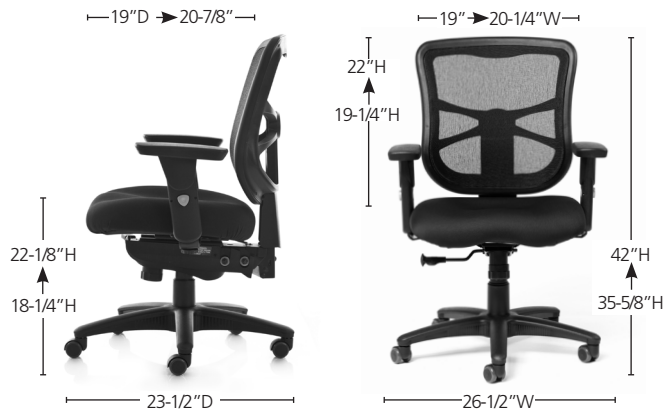

Milan Mid Back Intensive Use Task Chair

Product Specifications:

- > Black mesh back with ratchet height adjustment
- > Extra thick molded foam contoured seat with black upholstery
- > Intensive ergonomic 5-paddle mechanism
- > Multi-tilt and tilt tension control
- > Forward tilt with lockout
- > Height and width adjustable arms with telescoping arm pads
- > Back and seat angle adjustment
- > Pneumatic seat height adjustment
- > Seat slider
- > 27" diameter black nylon 5-star base
- > 50mm dual surface, dual wheel polyurethane casters
- > Complies with CAL TB 117-2013
- > Meets or exceeds ANSI/BIFMA standards
- > Can be assembled without arms

Ordering Information:

- > Typically ships in 1-3 business days.
- > **A \$30 freight fee per chair applies to chair orders of 1-3 units. For orders of 4 or more chairs, a freight fee of \$100 net is applied to orders less than \$1000 net. See page 13.**

Part Number	Description	List Price (US\$)
MM4533M	Milan Mid Back Intensive Use Task Chair, Black Upholstered Seat, Black Mesh Back	\$660

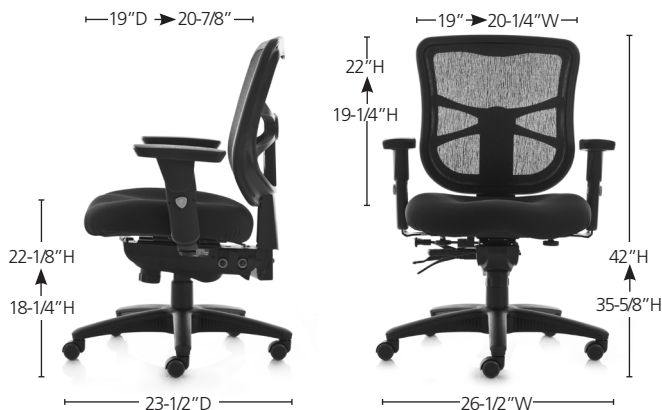

Dimensions

Overall	35-5/8 to 42" H x 26-1/2" W x 23-1/2" D
Seat height	18-1/4" to 22-1/8"
Seat depth	19" to 20-7/8"
Seat width	21"
Back height from seat	19-1/4" to 22"
Distance between arms	19" to 20-1/4"
Arm height from seat	6-1/4" to 8-1/2"
Cartoned chair weight	56 lbs
Carton size	25" x 26-1/4" x 15-3/4"



360 Monaco™ Poly Seat Stacking Chairs

Additional Options

10-12 week lead time — 60 unit minimum

Poly colors available

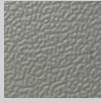

Beige

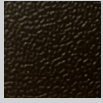

Dark Brown

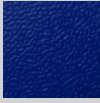

Deep Blue

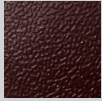

Maroon



Navy Blue

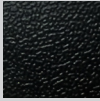

Noir

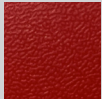

Red

Also available in Stool height

Freeform the Poly color you'd like.

Example:
V5000SF-COLOR NAVY BLUE

Product Specifications:

- > Perforated black contoured poly back and black poly seat
- > Silver steel frame with powder coat finish
- > Non-marring ganging device glides
- > Meets or exceeds ANSI/BIFMA standards
- > Stacks 16 high
- > Dolly: Tubular steel frame
Heavy duty casters
Stores approximately 16 stacking chairs

Ordering Information:

- > Typically ships in 1-3 business days.
- > Additional options are available with various lead times. See left for additional information.
- > Packaged 4 chairs to a box
- > 4-wheel storage dolly available
- > **A \$30 freight fee per box applies to chair orders of 1-3 units. For orders of 4 or more chairs, a freight fee of \$100 net is applied to orders less than \$1000 net. See page 13.**

Part Number	Description	List Price (US\$)
Monaco Sled Base Stacking Chair, Poly Seat, Black V5000S	Monaco Stacking Chair, Black Poly Seat and Back	\$156
V5000S-COLOR	Monaco Stacking Chair, Colored Poly Seat and Back Tip: Extended 10-12 week lead time. Tip: Packaged 4 chairs to a box.	\$156
Monaco Stacking Chair Storage Dolly 8050	Monaco Stacking Chair Storage Dolly, Black	\$321

Dimensions

Overall	33-7/8" H x 21" W x 22-1/2" D
Seat height	18"
Seat depth	18-5/8"
Seat width	18-1/8"
Back height from seat	17-1/2"
Cartoned chair weight	61 lbs (4 chairs)
Carton size	22-1/4" x 25-3/4" x 25-1/4"



Dimensions

Cartoned weight	14 lbs
Carton size	32" x 25" x 13"

Monaco Upholstered Seat Stacking Chairs

Product Specifications:

- > Perforated black contoured poly back
- > Molded foam black upholstered seat
- > Silver steel frame with powder coat finish
- > Non-marring ganging device glides
- > Complies with CAL TB 117-2013
- > Meets or exceeds ANSI/BIFMA standards
- > Stacks 10 high

Ordering Information:

- > Typically ships in 1-3 business days.
- > Additional options are available with various lead times. See right for additional information.
- > Packaged 4 chairs to a box
- > 4-wheel storage dolly available, see page 360.
- > **A \$30 freight fee per box applies to chair orders of 1-3 units. For orders of 4 or more chairs, a freight fee of \$100 net is applied to orders less than \$1000 net. See page 13.**

Additional Options

10-12 week lead time — 60 unit minimum

Back poly colors available



Also available in Stool height

Freeform the back Poly color you'd like.

Example:
V5000SF-COLOR NAVY BLUE

Part Number	Description	List Price (US\$)
Monaco Upholstered Seat Sled Base Stacking Chair V5000SF	Monaco Stacking Chair, Black Upholstered Seat, Black Poly Back	\$178
V5000SF-COLOR	Monaco Stacking Chair, Black Upholstered Seat, Colored Poly Back Tip: Extended 10-12 week lead time. Tip: Packaged 4 chairs to a box.	\$178



Dimensions

Overall	33-7/8" H x 21" W x 22-1/2" D
Seat height	18"
Seat depth	18-5/8"
Seat width	17-1/4"
Back height from seat	17-1/2"
Cartoned chair weight	61 lbs (4 chairs)
Carton size	21-3/4" x 27" x 29-1/4"



Monaco Guest Chair

Additional Options

10-12 week lead time — 60 unit minimum

Back poly colors available



Beige

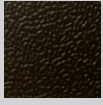

Dark Brown

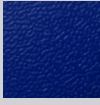

Deep Blue

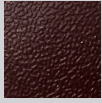

Maroon

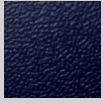

Navy Blue

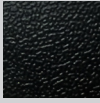

Noir

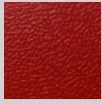

Red

Freeform the Poly color you'd like.

Example:
V5000SF-COLOR NAVY BLUE

Product Specifications:

- > Perforated black contoured poly back
- > Molded foam black upholstered seat
- > Stacks 4 high
- > Silver steel frame with powder coat finish
- > Ships with glides and 50mm nylon dual wheel casters (seat height remains the same)
- > Complies with CAL TB 117-2013
- > Meets or exceeds ANSI/BIFMA standards

Ordering Information:

- > Typically ships in 1-3 business days.
- > Additional options are available with various lead times. See left for additional information.
- > Packaged 2 chairs to a box
- > **A \$30 freight fee per box applies to chair orders of 1-3 units. For orders of 4 or more chairs, a freight fee of \$100 net is applied to orders less than \$1000 net. See page 13.**

Part Number	Description	List Price (US\$)
Monaco Guest Chair V5031HG-R	Monaco Guest Chair, Black Upholstered Seat, Black Poly Back	\$257
V5031HG-R-COLOR	Monaco Guest Chair, Black Upholstered Seat, Colored Poly Back Tip: Extended 10-12 week lead time. Tip: Packaged 2 chairs to a box.	\$257

Dimensions

Overall	33-7/8"H x 21"W x 22-1/2"D
Seat height	18"
Seat depth	18-5/8"
Seat width	17-1/4"
Back height from seat	17-1/2"
Cartoned chair weight	39 lbs (2 chairs)
Carton size	22" x 34" x 15"



Monaco Flip Seat Nesting Chair

Product Specifications:

- > Perforated black contoured poly back
- > Molded foam black upholstered seat
- > Flip-up seat for easy nesting
- > Silver steel frame with powder coat finish
- > 50mm nylon dual wheel casters
- > Complies with CAL TB 117-2013
- > Meets or exceeds ANSV/BIFMA standards

Ordering Information:

- > Typically ships in 1-3 business days.
- > Additional options are available with various lead times. See right for additional information.
- > Packaged 2 chairs to a box
- > **A \$30 freight fee per box applies to chair orders of 1-3 units. For orders of 4 or more chairs, a freight fee of \$100 net is applied to orders less than \$1000 net. See page 13.**

Additional Options

10-12 week lead time — 60 unit minimum

Back poly colors available

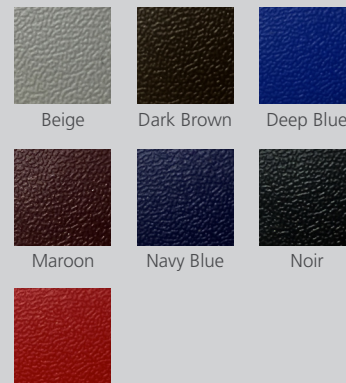

Red

Freeform the back Poly color you'd like.

Example:
V5000SF-COLOR NAVY BLUE

Part Number	Description	List Price (US\$)
Monaco Flip Seat Nesting Chair		
PL2031HR	Monaco Flip Seat Nesting Chair, Black Upholstered Seat, Black Poly Back	\$332
PL2031HR-COLOR	Monaco Flip Seat Nesting Chair, Black Upholstered Seat, Colored Poly Back Tip: Extended 10-12 week lead time.	\$332
	Tip: Packaged 2 chairs to a box.	



Dimensions

Overall	33-7/8" H x 21" W x 22-1/2" D
Seat height	18"
Seat depth	18-5/8"
Seat width	17-1/4" (Fabric)
Back height from seat	17-1/2"
Cartoned chair weight	51 lbs (2 chairs)
Carton size	23-3/4" x 25-3/4" x 25-3/4" (Fabric)
Nested, back of chair 1 to front of chair 2	28"

Pixley™ Upholstered Bench

STEP 1

(?) Fabric Suffix List:

Standard fabrics:

Tier 1 - CF Stinson: Ace, Bryant Park, Hive, Inside Track, Polka, and Sprint.

Tier 2 - CF Stinson: Nova. Camira: Blazer.

Tier 2 fabrics **add \$350 List per zone.**

To view standard fabrics, go to Enwork.com/products/Pixley

COM fabrics require 4-1/4 yards and a \$350 List fee per fabric for testing. Contact Customer Service if using a COM.

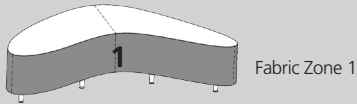

Fabric Zone 1

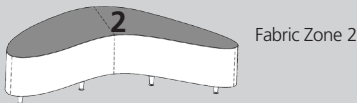

Fabric Zone 2

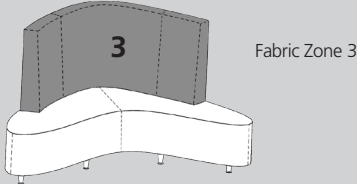

Fabric Zone 3

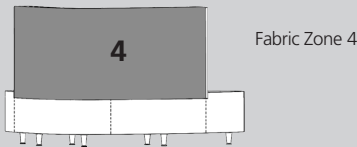

Fabric Zone 4

Seam locations as shown are typical. Since fabrics have different characteristics, seams within zones may vary from illustrations and images.

STEP 2 - Stadium Shelf Only

(#) Laminate Suffix List:

- A Wilsonart Kensington Maple (10776-60)
- B Wilsonart Monticello Maple (7925-38)
- C Wilsonart Wild Cherry (7054-60)
- E Wilsonart Fashion Grey (D381-60)
- F Wilsonart White Tigris (4783-60)
- G Wilsonart Cafelle (7933K-07)
- M Wilsonart Frosty White (1573-60)
- P Wilsonart Slate Grey (D91-60)
- R Wilsonart Black (1595-60)
- U Wilsonart Brazilwood (7946-38)
- V Wilsonart River Cherry (7937-38)
- W Wilsonart Designer White (D354-60)
- 3 Formica Neutral Twill (8826-58)
- 4 Formica Bleached Legno (8845-58)
- 5 Formica Prestige Walnut (6209-43)
- 7 Formica Select Cherry (7759-43)
- X *Wilsonart Non-Premium laminates (-38, -60).Orders of 100+ units have no upcharge. +\$36
- Y *Formica Non-Premium Standard (58, 43, MC, SP and NT finishes) and Wilsonart Premium (-01, -07, -12, -18, -52, -78) laminates. +\$50
- Z *Pionite Non-Premium, Nevamar Non-Premium, Formica Premium (WR, 42, 77, 46, RD Finishes), and whiteboard laminate. +\$72

*Add \$350 list for Special Laminate orders of less than 10 units. See page 21 for edge selection.

Product Specifications:

- > Sized to seat 3 average sized adults comfortably.
- > Total weight capacity is 900 lbs.
- > Seat is 20"H. Maximum seat depth is 33.8" without back and 26.5" with back. Back is 49"H.
- > Stadium Shelf is 12"D and at 42"H from floor with 3mm edge.
- > 6"H aluminum feet, with a leveler adjustment of 1.25".
- > Power option includes 1 receptacle and 2 USB charging outlets per receptacle.

Ordering Information:

- > Four separate fabric zones for customization.
- > Standard fabrics: Tier 1 - CF Stinson: Ace, Bryant Park, Hive, Inside Track, Polka, Sprint. Tier 2 - CF Stinson: Nova, and Camira: Blazer. Tier 2 fabrics add \$350 List per zone.
- > To view standard fabrics, go to Enwork.com/products/Pixley
- > COM Fabric Usage: Zone 1 = 7.25 yds, Zone 2 = 4.5 yds, Zone 3 = 5.25 yds, Zone 4 = 3 yds.
- > **A freight fee of \$100 net is assessed on orders less than \$1000 net. See page 13.**

Part Number	Description	List Price (US\$)
-------------	-------------	-------------------

Pixley Bench

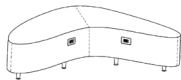

PYBE??	Bench	\$3524
PYBEP??	Bench with Power	\$4468

Tip: Bench with power includes two receptacles and four USB on the front inside curve of the base.

Pixley Bench with Back

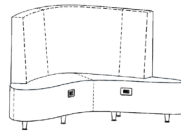

PYBEB????	Bench with Back	\$5454
PYBEBP????	Bench with Back and Power	\$6399

Tip: Bench with Power includes two receptacles and four USB on the front inside curve of the base.

Pixley Bench with Back and Stadium Shelf

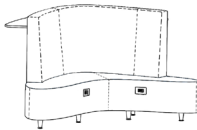

PYBEBW????#	Bench with Back and Shelf	\$6290
PYBEBWP????#	Bench with Back and Shelf and Power	\$8179

Tip: Bench with Stadium Shelf and Power includes two receptacles and four USB on the front inside curve of the bases and two receptacles and four USB under the Stadium Shelf.

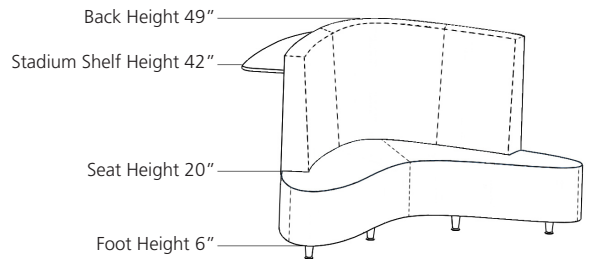
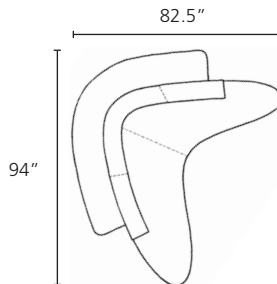

Pixley Tables (Complete Tables)

Product Specifications:

- > Table tops are laminate with 3mm edge, designed to coordinate with Pixley Upholstered Seating. Additional material and edge choices including Designer Finishes are available by contacting quotes@enwork.com
- > Painted legs with levelers.
- > Video Sharing table includes 5" x 11" cut-out for PDEVC222, ordered separately.

Ordering Information:

- > A freight fee of \$100 net is assessed on orders less than \$1000 net. See page 13.

STEP 1

(^) Paint Suffix List

- G Slate Grey
- R Black
- S Silver
- T Medium Tone
- W Arctic White
- Z Other

Tip: Some Steelcase, Herman Miller, Knoll, Haworth, and Allsteel paints are available for \$350 list fee per order. Call/email for availability of specific colors. Additional custom paints (e.g. Tiger Dry Lac) must be quoted through quotes@enwork.com.

STEP 2

(#) Laminate Suffix List:

- A Wilsonart Kensington Maple (10776-60)
- B Wilsonart Monticello Maple (7925-38)
- C Wilsonart Wild Cherry (7054-60)
- E Wilsonart Fashion Grey (D381-60)
- F Wilsonart White Tigris (4783-60)
- G Wilsonart Cafelle (7933K-07)
- M Wilsonart Frosty White (1573-60)
- P Wilsonart Slate Grey (D91-60)
- R Wilsonart Black (1595-60)
- U Wilsonart Brazilwood (7946-38)
- V Wilsonart River Cherry (7937-38)
- W Wilsonart Designer White (D354-60)
- 3 Formica Neutral Twill (8826-58)
- 4 Formica Bleached Legno (8845-58)
- 5 Formica Prestige Walnut (6209-43)
- 7 Formica Select Cherry (7759-43)
- X *Wilsonart Non-Premium laminates (-38, +\$36 -60). Orders of 100+ units have no upcharge.
- Y *Formica Non-Premium Standard (58, +\$50 43, MC, SP and NT finishes) and Wilsonart Premium (-01, -07, -12, -18, -52, -78) laminates.
- Z *Pionite Non-Premium, Nevamar Non-Premium, Formica Premium (WR, 42, 77, 46, RD Finishes), and whiteboard laminate.

*Add \$350 list for Special Laminate orders of less than 10 units. See page 21 for edge selection.

Part Number	Description	List Price (US\$)
-------------	-------------	-------------------



Pixley Occasional Table, 38"D x 32"W

PYT16^#	Occasional Table, 16"H	\$920
PYT22^#	Occasional Table, 22"H	\$926

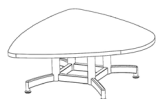

Pixley Meeting Table, 50"D x 42"W

PYCT16^#	Meeting Table, 16"H	\$1717
PYCT22^#	Meeting Table, 22"H	\$1717



Pixley Video Sharing (VS) Table with Steel Technology Infill and Cut-out, 50"D x 42"W

PYVS16^#	VS Table, 16"H	\$2037
PYVS22^#	VS Table, 22"H	\$2037

Tip: Steel infill painted to match legs.
See Step 1 for paint options.

Part Number	# of Users	Cut-Out Size	Description	List Price (US\$)
-------------	------------	--------------	-------------	-------------------

Ellora Single-Sided VS (Video Sharing) Technology for 1 Monitor - HDMI, 6' power cord

PDEVC222A	2	5" x 11"	2 power/2 data openings/2 Video Sharing HDMI cords, Clear Anodized Alum.	\$5285
PDEVC222R	2	5" x 11"	2 power/2 data openings/2 Video Sharing HDMI cords, Black Anodized Alum.	\$5492

Reko™ Chair

Seat Fabric Program

Typically ships in 10 days — no unit minimum

Enwork has partnered with Camira Fabrics to provide the full Era and Mill Collections at one easy upcharge. Freeform the seat color you'd like.

Example:
MEST-SEAT ERA PRIME

Contact customer service at info@enwork.com if you would like to use a COM.

Product Specifications:

- > Single shell design with black mesh back
- > Comfortable foam upholstered seat
- > Tilt tension adjustment
- > Tilt-lock
- > Swivel Tilt
- > Pneumatic seat height adjustment
- > Fixed loop arm
- > 26" diameter black nylon 5-star base
- > 50mm nylon dual wheel casters
- > Complies with CAL TB 117-2013
- > Meets or exceeds ANSI/BIFMA standards

Ordering Information:

- > Typically ships in 1-3 business days.
- > Available with Camira Era or Mill Collection, or COM seat fabric options. Freeform as shown left.
- > Seat COM Fabric Usage: 1 yds
- > **A \$30 freight fee per chair applies to chair orders of 1-3 units. For orders of 4 or more chairs, a freight fee of \$100 net is applied to orders less than \$1000 net. See page 13.**

Part Number	Description	List Price (US\$)
Reko Chair		
MFOW	Reko Chair, Black Mesh Back, Black Upholstered Seat	\$528
MFOW-SEAT	Reko Chair, Black Mesh Back, Camira Era or Mill Collection Fabric Upholstered Seat Tip: Available May 2017 Tip: Extended 10 day lead time.	\$628
MFOW-COM	Reko Chair, Black Mesh Back, COM Upholstered Seat Tip: Available May 2017 Tip: Lead time based on COM availability.	\$628

Dimensions

Overall	35-13/16 to 38-7/8"H x 23-5/8"W x 22"D
Seat height	15-1/4" to 18-7/8"
Seat depth	19-1/4"
Seat width	19-1/4"
Back height from seat	21-5/8"
Distance between arms	20"
Arm height from seat	6-11/16"
Cartoned chair weight	30 lbs
Carton size	25-1/4" x 12-3/4" x 25"



Notes

Seat Fabric Program

Typically ships in 10 days — no unit minimum

Enwork has partnered with Camira Fabrics to provide the full Era and Mill Collections at one easy upcharge. Freeform the seat color you'd like.

Example:
MEST-SEAT ERA PRIME

Contact customer service at info@enwork.com if you would like to use a COM.

Additional Options

Contact customer service at info@enwork.com for information and availability of additional options.

Product Specifications:

- > 300 lbs capacity
- > Charcoal mesh back
- > Upholstered seat with Camira fabric in Era: Forward (Black)
- > 1-Paddle 2 to 1 synchro tilt mechanism
- > Tilt tension control
- > Pneumatic height-adjustment
- > Height and width adjustable arms with polyurethane arm pads
- > Steel frame with black powder coat finish
- > 27" diameter black nylon 5-star base
- > 60mm polyurethane dual surface, dual wheel casters
- > Complies with CAL TB 117-2013
- > Meets or exceeds ANSI/BIFMA standards

Ordering Information:

- > Typically ships in 1-3 business days.
- > Available with Camira Era or Mill Collection, or COM seat fabric options. Freeform as shown left.
- > Seat COM Fabric Usage: 1 yds
- > Additional options are available with various lead times. See left for additional information.
- > **A \$30 freight fee per chair applies to chair orders of 1-3 units. For orders of 4 or more chairs, a freight fee of \$100 net is applied to orders less than \$1000 net. See page 13.**

Part Number	Description	List Price (US\$)
Zeppa Simple Task Chair		
MZ11	Zeppa Simple Task Chair, Charcoal Mesh Back, Black Upholstered Seat	\$605
MZ11-SEAT	Zeppa Simple Task Chair, Charcoal Mesh Back, Camira Era or Mill Collection Fabric Upholstered Seat Tip: Available May 2017 Tip: Extended 10 day lead time.	\$705
MZ11-COM	Zeppa Simple Task Chair, Charcoal Mesh Back, COM Upholstered Seat Tip: Available May 2017 Tip: Lead time based on COM availability.	\$705

Dimensions

Overall	38 to 42-1/2" H x 25-1/2 to 27-3/4"W x 22-1/4 to 24-1/2" D
Seat height	16-1/4" to 20-1/2"
Seat depth	19"
Seat width	19-1/4"
Back height from seat	22-1/4"
Distance between arms	17-5/8" to 20-3/8"
Arm height from seat	7" to 9-3/4"
Cartoned chair weight	42 lbs
Carton size	27" x 19" x 26"



Zeppa Task Chair Protected by US patent D774,814

Product Specifications:

- > 300 lbs capacity
- > Charcoal mesh back
- > Upholstered seat with Camira fabric in Era: Forward (Black)
- > 3-Paddle 2 to 1 Synchro tilt mechanism
- > Tilt tension control
- > Multi-position tilt lock
- > Pneumatic height-adjustment
- > Height and width adjustable arms with polyurethane arm pads
- > Steel frame with silver powder coat finish
- > Adjustable lumbar support
- > Seat Slider
- > 27" diameter silver powder coated aluminum 5-star base
- > 60mm polyurethane dual surface, dual wheel casters
- > Complies with CAL TB 117-2013
- > Meets or exceeds ANSI/BIFMA standards

Ordering Information:

- > Typically ships in 1-3 business days.
- > Available with Camira Era or Mill Collection, or COM seat fabric options. Freeform as shown right.
- > Seat COM Fabric Usage: 1 yds
- > Additional options are available with various lead times. See right for additional information.
- > **A \$30 freight fee per chair applies to chair orders of 1-3 units. For orders of 4 or more chairs, a freight fee of \$100 net is applied to orders less than \$1000 net. See page 13.**

Part Number	Description	List Price (US\$)
Zeppa Task Chair, Black		
MZ33	Zeppa Task Chair, Charcoal Mesh Back, Black Upholstered Seat	\$706
MZ33-SEAT	Zeppa Task Chair, Charcoal Mesh Back, Camira Era or Mill Collection Fabric Upholstered Seat Tip: Available May 2017 Tip: Extended 10 day lead time.	\$806
MZ33-COM	Zeppa Task Chair, Charcoal Mesh Back, COM Upholstered Seat Tip: Available May 2017 Tip: Lead time based on COM availability.	\$806



Dimensions

Overall	38 to 42-1/2" H x 25-1/2 to 27-3/4" W x 22-1/4 to 25" D
Seat height	16-1/4" to 20-1/2"
Seat depth	19" to 21"
Seat width	19-1/4"
Back height from seat	22-1/4"
Distance between arms	17-5/8" to 20-3/8"
Arm height from seat	7" to 9-3/4"
Cartoned chair weight	48 lbs
Carton size	27" x 18-1/2" x 25"



Seat Fabric Program

Typically ships in 10 days — no unit minimum

Enwork has partnered with Camira Fabrics to provide the full Era and Mill Collections at one easy upcharge. Freeform the seat color you'd like.

Example:
MEST-SEAT ERA PRIME

Contact customer service at info@enwork.com if you would like to use a COM.

Additional Options

Contact customer service at info@enwork.com for information and availability of additional options.

Index – Part Numbers

Part No.	Page	Part No.	Page	Part No.	Page	Part No.	Page
8050	360	CART...	197	EBM...	256/268/332	LG2NL...	131
A-BL...	174	CC...	318	EBN...	265	LG2NR...	135
A1BP72...	112/123/143 153/170	CD...	60-61	EBPED...	270	LG2NT...	104
A2B[#]...	206	CDRAWER	332	EBT...	269	LG2TR...	105/131
A2BHD...	207	CPAVR...	178	EBTOP...	266	LG2Y...	105
A2BR...	215/220	CPH...	332	EBUG...	269	LGBM...	196
A2BT...	210	CPP...	173	EBZ...	82	LH...	162
A2CC...	204	CPR...	178	EC...	320-321	LK...	154
A2CT...	212	CR[#]...	32-49	EL[#]...	38-49	LLDR...	102
A2CUSH...	211/337	CRL...	62-63	EP...	311	LLVDR...	103
A2D...	218	CRP...	64-65	EQ...	84-85	LMA...	132
A2E...	219	CST...	197	FDM...	195	LMC...	133
A2F...	204/215	CTRAY...	217	FLP...	194/328	LMD...	199
A2H...	215/220	D5D...	230	GBT2	197	LME...	189
A2J...	221	D6...	238	GR...	197	LML...	184/189/192
A2K...	220	DA...	226	HR...	52	LMT...	130
A2L...	221	DBA...	229	L2C...	122/153	LMV...	192
A2MC...	217	DC...	227	LACP...	111	LMWU...	131
A2MD...	216	DDA...	228	LAPL...	163	LMWW...	131
A2ML...	216	DEA...	229	LCA2...	150/152	LMWY...	135
A2MP...	211/337	DH...	236/238	LCA4E...	146	LMX...	132
A2MR...	216	DJB...	229	LCAA...	142	LMY...	134/136
A2NW...	210	DK...	230-231	LCAC...	142-143	LPB...	102
A2P...	211/214/217/337	DL...	232	LCAE...	149	LPCM...	106/115/138
A2SC...	208	DRS...	234	LCAL...	153	LPL...	163/192
A2SH...	207	DSA/C/D/H...	239	LCAT...	138-140	LPP...	114/115/310
A2T...	219	DSJ...	239/240	LCAX...	144-145	LPTD...	100-101
A2VF...	204	DSL...	239	LCL...	163/184-187	LPTLA...	86/88/90
A2Z...	205/221	DSM...	240	LCP...	110/112/310	LPTLN...	86/88/90
A8BP...	112/123/143 153/170	DSP...	245	LCV...	162	LPTVA...	87/89/91
AAF...	195	DSQ...	245	LD...	80-81	LPTVN...	87/89/91
AAG...	329	DSR...	244	LEND	233	LPULA...	92/94/96/98
AAU...	329	DST...	242-244	LF2AE...	121	LPULN...	92/94/96/98
AMP...	196	DSZ...	239	LF4AE...	118	LPUVA...	93/95/97/99
AV...	254-255	DTK...	237	LFAE...	120	LPUVN...	93/95/97/99
BT[#]...	38-49	DY...	198	LFADD...	121/150	LPV...	192
CA[#]...	38-49	EBCPU	268	LG2NB...	104	LPW...	180/193
CABRACE	311	EBCUSH...	270	LG2NC...	133	LQ...	128
		EBD...	264	LG2NJ...	104	LSQ...	115/310
		EBEND...	269	LG2NK...	131	LT2N...	107

Part No.	Page	Part No.	Page	Part No.	Page	Part No.	Page
LTH	199	PDB...	175	TLE...	212	USF...	304-305/307
LTP...	106/108/310	PDC...	168	TPE	333	USLEG...	308
LTR	199	PDD...	175/315	TPH...	333	USPT	197/309
LTS...	162	PDE... 77/169/170/365		TPM...	199	USU...	302-303/306
LTU...	107	PDF...	171	TTP	333	UTE	197/309
LU1...	126-127	PDGR...	176	TTR	199	UTITLE	267/314
LVPB...	103	PDJ...	171/176	U9CUSH	336	UTLEG...	308
LVT...	146/148	PDK...	176	U30 TO 84E	292	UTWA	313
LX3P...	117	PDL...	168	U30 TO 84EB	296	UU...	310/334-335
LXB...	163	PDN...	170	U30 TO 84EM	299	UYCONN...	314
LXF...	163	PDO...	171	U30 TO 84F	294	UZ...	309/315
LXP...	116/117/144	PDP...	172	U30 TO 84FB	298	V500...	360-361
LY...	156-158 160-161/190	PDT...	268	U30 TO 84FM	301	V503...	362
LZA...	74-76	PDU...	175-176	U30 TO 84M	293	VTK...	237
LZB...	72/73	PDV... 171/173/176/332		U30 TO 84MM	297	WCVR...112/123/143/153	
LZL...	71	PL2...	363	U30 TO 84MM	300	WL[#]...	44-49
LZM...	78	PTH	199	UAB...	336	WT...	213
LZT...	68-71	PY...	365	UC...	309	XX...	32-49
LZV...	73	PYBE...	364	UCATLEG...	308		
MARDM...	346	QR...	56	UEPD...	311		
MB...	66	R...	50	UES...	315		
MEGG...	357	S[#]... 316-317/324		UG...	195/329		
MEHB...	352	SBB...	213	UHC...	308		
MEM3...	351	SF[#]... 32-49		UJ...	309		
MEM5...	353	SHH...	213	ULCM...	176/332		
MENEST...	356	SP...	323	UMCO...	312-313		
MEST...	350	ST...	58	UMEP...	311		
MESTOOL...	354	TAT...	333	UMH...	332		
MFOW...	366	TC... 182/322		UMLEG...	313		
MM1...	348	TDA...	193	UMM...	312-313		
MM4...	358-359	TDL...	178	UMP...	330		
MZ...	368-369	TDV...	178	UMRISER...	313		
NEL...	124-125	TEL...	179	UMT...	309/326		
NWBRACE	311	TEND...	233	UPH...	257/267/314		
NZBRACE	311	TEV...	179	UPK...	315		
P[#]...	54	TFL...	188	UPM...	194/328		
PAB...	55	TFT	333	UPP...	309		
PC...	193	TFV...	188	UR...	175/315		
PDAX...	168/268	TG...	189	UREC...257/267/314-315			
		TH...	193	URISER... 176/256/332			



12900 Christopher Drive • Lowell, Michigan 49331
800.815.7251 • www.enwork.com

Specifications subject to change without prior notice.
Visit enwork.com/product-pricing/ for most current version of the Price List.

Comments? Questions? Your feedback helps us make improvements, so tell us what you think!
Please send your thoughts to communications@enwork.com