

January 3, 2011
Updated January 2, 2017
800-424-2432



Genesis® Desking	
General information	2
<hr/>	
Genesis® Specifications	4
<hr/>	
Genesis® Worksurfaces	
Basic Rectangular	6
Tripod Corner Fixed Height	18
Tripod Corner Pin and Crank Height Adjustable	20
Tripod Corner Electric Height Adjustable	24
Reduction Tripod Corner Fixed Height	28
Reduction Tripod Corner Fixed Height Dual	32
Reduction Tripod Corner Pin Height Adjustable	36
Reduction Tripod Corner Crank Height Adjustable	38
Reduction Tripod Corner Crank Height Dual	40
Reduction Tripod Corner Electric Height Adjustable	44
Reduction Tripod Corner Electric Height Adjustable Dual	48
Square Shoe Fixed Height	52
Square Shoe Fixed Height Dual	56
Square Shoe Pin Height Adjustable	60
Square Shoe Crank Height Adjustable	62
Square Shoe Crank Height Dual	64
Square Shoe Electric Height Adjustable	68
Square Shoe Electric Height Adjustable Dual	72
Reduction Square Shoe Fixed Height	76
Reduction Square Shoe Fixed Height Dual	80
Reduction Square Shoe Pin Height Adjustable	84
Reduction Square Shoe Crank Height Adjustable	86
Reduction Square Shoe Crank Height Dual	88
Reduction Square Shoe Electric Height Adjustable	92
Reduction Square Shoe Electric Height Adjustable Dual	96
"P" Shaped Peninsula	100
Arcade Peninsula	104
Two-Legged Croner	108
<hr/>	
Balance® Storage Accessories	
Overhead Storage	114
<hr/>	
Balance® Storage and Accessories	
Balance® Task Lights	116
<hr/>	
Universal Storage Accessories	
Overhead Storage	118
<hr/>	
Universal Storage and Accessories	
Universal Task Lights	120
Overhead Shelf/Tool Rail Kits	122
<hr/>	
Storage Accessories	
Paper Management	124
<hr/>	
Accessories	
Privacy Screens	128
Electrical	138
	144
<hr/>	
Accessories Worksurfaces	146
<hr/>	
Index	152

Genesis® Desking

General information



Freestanding Design

Features

Rectangular worksurface	•
Corner worksurface	•
Peninsula worksurface	•
Fixed-height base	•
Pin-adjustable base	•
Crank-adjustable base	•
Electric-adjustable base	•
Wire management	•
Modesty panel	



Fixed Height

Pin Adjustable

Crank Adjustable

Electric Adjustable

Mini Cable Tray

Wire Management
Trough

Modesty Panel



INFORMATION

Warranty

Refer to KI Terms & Conditions document or visit ki.com

ANSI Requirements

All fixed and adjustable tables meet or exceed ANSI/BIFMA 1998 requirements for desk products. The adjustable tables meet the ANSI/HFS 100-1988 standard for adjustability and knee clearance.

ADA Requirements

The tables meet the ADA specification for wheelchair access and height of surfaces.

Genesis® Specifications

Genesis® tables are available in fixed height as well as adjustable. All fixed and adjustable tables meet or exceed ANSI/BIFMA 1998 requirements for desk products. The adjustable tables meet the ANSI/HFS 100-1988 standard for adjustability and knee clearance. The tables meet the ADA specifications for wheelchair access and height of surfaces. The metal components of Genesis® tables are powder coated for appearance and durability. All plastic components are color matched in accordance with the KI color program.

TABLE BASE SPECIFICATIONS

Fixed-Height Tables

Each leg assembly is comprised of a 2" x 3" x 14-gauge steel tube that is welded to a steel foot, and on the other end, to worksurface support. The 14-gauge, draw-formed foot provides strength and room for carpet levelers in a low profile, sculpted component. The worksurface support is an 11-gauge steel, draw-formed component that provides high strength to support large, cantilevered loads. Extruded aluminum covers are attached to the front and back of the upright tubing. Leg assemblies are modified in the factory so that finished heights with glides is 29".

Pin-Adjustable Tables

Each leg assembly is comprised of 1-3/8" x 2-3/4" x 16-gauge steel tube that telescopes inside a 2" x 3" x 14-gauge steel outer leg tube. Nylon bushings ensure a smooth, telescoping action between the tubes. A 14-gauge, draw-formed foot is welded to the outer leg tube, and provides strength and room for carpet levelers in a low profile, sculpted component. An 11-gauge steel, draw-formed worksurface support is welded to the inner tube, and provides strength to support large, cantilevered loads. Extruded aluminum covers are attached to the front and back of the upright tubing for visual appeal. A spring steel button, protruding through holes in both tubes, allows for adjustment in one-inch increments from 24" to 31".

Crank-Adjustable Tables

Each leg assembly is comprised of 1-3/8" x 2-3/4" x 16-gauge steel tube that telescopes inside a 2" x 3" x 14-gauge steel outer leg tube. Nylon bushings ensure a smooth, telescoping action between the tubes. A 14-gauge, draw-formed foot is welded to the outer leg tube, and provides strength and room for carpet levelers in a low profile, sculpted component. An 11-gauge steel, draw-formed worksurface support is welded to the inner tube, and provides strength to support large, cantilevered loads on the worksurface. Extruded aluminum covers are attached to the front and back of the upright tubing for visual appeal. The table is manually adjustable from 22" to 33" or 27" to 43" by turning a crank. The crank raises or lowers the table at a rate of 1 inch per 10 revolutions. A lifting mechanism inside of each leg provides a uniform lifting force to

the worksurface, regardless of the loading condition. Each mechanism is comprised of a steel acme-threaded rod turning through a delrin lead nut. The delrin nut provides a silent operation, low friction, and excellent wear characteristics. The acme rods deliver a lifting force to the underside of the surface supports. Precision needle roller bearings provide a smooth, quiet interface between the rotating acme rods and the surface supports. The lifting mechanisms are synchronized via a 1/4" pitch roller chain that spans the distance between the table legs. The chain engages each acme-threaded rod through a delrin sprocket that is attached to the rod.

Electric-Adjustable Tables

Each leg assembly is comprised of a triple telescoping steel tube with an overall dimension of 4.3" x 2.28". Extruded aluminum covers are attached to the back of the upright tubing for visual appeal. The table is electrically adjustable from 24" to 51" by pressing a button. Motors raise or lower the table at a rate of 1.7 inches per second. The motors drive a lifting mechanism inside of each leg to provide a uniform lifting force to the worksurface, regardless of the loading condition. The parallel connectors synchronize the motors electronically. The controller keeps track of each motor revolution, and ensures that the motors remain in perfect synchronization. The user interface occurs at the switch. The basic controller includes up/down buttons and three memory presets. The deluxe also includes a digital display indicating the height of the worksurface. A keyboard mechanism is available on most electrically adjustable tables. The mechanism allows the keyboard surface to be easily adjusted 5" above or below the primary worksurface. The mechanism also provides +/- 15° of tilt.

WORKSURFACE SPECIFICATIONS

74P, EP and KN Worksurfaces

74P, elliptical-postform (EP) and Knife-edge (KN) worksurfaces are constructed of 1-1/8" thick, 45-pound density particleboard. A .030" minimum thickness laminate provides a durable writing surface. The backer is a .030" minimum thickness melamine sheet. This provides a balanced construction that gives greater strength and prevents warping. All mounting holes are pre-drilled for easier table assembly and maximum holding power. A steel channel is provided for extra structure on tables with unsupported spans over 51". The 74P and KN surfaces are available in curvilinear or traditional shapes. The elliptical-postform surfaces are available in traditional shapes.

MP Worksurfaces

Membrane pressed worksurfaces are constructed of 1-1/8" thick, high-density fiberboard. A .021" thick vinyl foil sheet is applied to the core under heat and pressure. The vinyl foil includes a .005" thick urethane topcoat for surface protection. All mounting holes are pre-drilled for easier table

assembly and maximum holding power. A steel channel is provided for extra structure on tables with unsupported spans over 51". Membrane pressed worksurfaces are available in curvilinear or transitional shapes. Peninsula and square shoe shapes are not available.

Powder-Coated Finish

Epoxy powder coating is electrostatically applied. The dry coating is then fused and cured in a baking oven to form a smooth, continuous film. Finish is chemical-resistant, hard, tough and mar-resistant.

Wire Management Trough

Troughs are formed from 16-gauge CRS and powder coated to match the table base. Trough is 5" tall; width on the bottom of the trough is 3.9" and opens up to 6.4" at the top. On fixed-height tables, the wire management trough is attached to the back of the legs with 4 thread-forming screws.

Modesty Panel

Modesty panels are constructed of textured CRS, 18-gauge to 16-gauge in thickness. The 8" modesty panels are suspended from the worksurface via 11-gauge steel brackets. There is a 1" gap between the panels and the worksurface in order to pass wires, and the panels are inset from the back edge by 1". Modesty panels can be used on all types of Genesis® Desking, regardless of adjustability. However, the modesty panel will conflict with a wire trough on adjustable tables and the two accessories should not be specified together. All corner tables and square shoes use two modesty panels along the back edges. Peninsula tables use one panel along the 48" back edge only so as not to interfere with conferencing capabilities.

Universal and Balance® Overhead-Note different stanchion for overhead support

Balance® Overhead Storage

The overhead storage unit shall have door(s) that are mechanically assisted in such a way as to keep the door(s) balanced throughout its operation such that the action of both opening and closing is automatically controlled such that the door doesn't spring open or slam closed. The overhead storage unit structure and mechanical assist mechanism shall have a Lifetime warranty. The overhead storage unit shall comply with the Americans with Disabilities Act ADA 4.2.5 and 4.2.6 whereby a user shall not reach higher than 48" from the floor to the front of the unit or no higher than 54" to the side. The overhead storage unit shall comply with the Americans with Disabilities Act ADA 4.27.4 whereby the door shall be operable with one hand and shall not require tight grasping, pinching, or twisting of the wrist. The force required to operate the door (open and close) shall be no greater than five foot pounds. The door of the overhead storage unit shall open to the outside of the cabinet to help prevent the storage of unsightly papers on the top of the cabinet, yet there shall

be a narrow space at the rear of the cabinet to allow plants or other small items to be displayed. The overhead storage unit shall accommodate standard American size three ring binders as well as A4 and Folscep sized binders, up to 13-3/4" high. The overhead storage unit shall be available with an upper door that can be upholstered in fabric as well as offered in solid colored, translucent, and high-pressure laminate.

Universal Overhead Cabinet

The product shall be offered in widths of 24", 30", 36", 42", 48", 54" and 60". The overall dimensions of the end panels shall be 16-1/2" high and 14-1/2" deep. The shelf depth shall be 13-1/4". Each cabinet shall include separate brackets, which allow for either on or off-module mounting. Off-module cabinet shall mount into slots in vertical posts. Cabinet must be same width as the panel to which it is mounted. Off-module cabinet shall mount into the integral track in the horizontal rail, allowing cabinet to slide along track. Door fronts shall be offered in steel, fabric, and laminate versions with a dual-durometer extruded handle. The door front will operate on a rack and pinion gear system and will utilize a center lock mechanism. The door front will store recessed inside the cabinet with the handle exposed. The steel door front shall be of honeycomb core constructions with a powder coat finish. The construction of the fabric door front shall be identical to the steel door front except that the outer surface of the door front is covered with fabric. The laminate door front shall be high-pressure laminate covering a particleboard core. The overhead stanchions mount to the under surface of any fixed desk with overhead grommets.

Shelf Dividers

Shelf dividers shall be offered in the same color trim as the panels. The shelf dividers shall be powder coated steel. Installation and removal shall be accomplished without the use of tools or fasteners.

Accessories

Task lights shall be available which suspend from the shelf and overhead cabinet. The task light shall mount flush with the underside of the shelf and overhead cabinet. Task lights shall be offered in standard panel trim colors. The task light shall have a 9" cord. Task lights will be available in three versions: standard high-power factor ballast, variable (high/low) high-power factor ballast and electronic ballast. All three options include a cool white lamp. Cords can be concealed by tucking between the reveal along tiles.

Privacy Screens

Privacy screens shall be available to provide sit down privacy or standup privacy within Genesis® workstations. Screens shall be 3/4" thick, 18" through 38" high and available to fit all worksurfaces. Screens shall attach to the back of the legs providing a stationary height for the screen even when attached to an adjustable height desk. Screens are mounted 1" to 1-1/2" from the worksurface



edge. Privacy screens shall be designed for straight-line applications. They shall include mounting brackets for attachment. Screens shall be available for straight applications in 24", 30", 36", 42", 48", 54", 60", 66" and 72" widths. The 66" and 72" widths shall consist of a pair of screens (1) 30" screen plus (1) 36" screen for the 66" application and (2) 36" screens with splice for 72" applications. Screens may be used to serve two worksurfaces placed back-to-back. Privacy screens shall be useable on worksurfaces with overhead storage units to close the opening between the worksurface and the bottom shelf. Privacy screens will consist of two different aluminum extrusion profiles, each with die-cast corner connectors to create a rectangular frame. The frames will be either upholstered or painted, depending on the options. Between the two assembled frames, different core materials can be inserted. The screen material shall be made of 1/2" or 3/4" thick tackable core light or a 10 mm thick non-tackable translucent plastic. The extruded aluminum frame shall be .060" thick. The attachment bracket shall be made of 7 gauge steel. End-of-run privacy screens shall be available in 24" and 30" widths to match the depth of the fixed height worksurface that it will be used on. End-of-run privacy screens attach to the underside of the worksurface. End-of-run privacy screens shall have the same height and finishes as the regular privacy screens.

10-Wire Electrical Distribution System

The 10-wire system is available in two configurations (6-2-2 and 4-4-2). The UL label is green for 6-2-2 and blue for 4-4-2 applications. These numbers refer to the quantity of hot, neutral and ground wires configured in each system. Both 6-2-2 and 4-4-2 systems may be brought into the system from the ceiling, the wall or the floor, through the use of top feeds and base feeds. Genesis[®] 10-wire electrical will be able to integrate with KI's WireWorks[®] panel system with the addition of the appropriate connectors. The 10-wire electrical distribution system will consist of a 10-wire harness, table-to-table connectors and a 10-wire infeed kit. The 2.16" wide double-sided rigid 10-wire harness shall mount inside the wire management trough and shall be available in widths to span the worksurface. The 30" to 66" wide worksurface harness kit shall accommodate (2) 15 amp duplex receptacles and the 72" wide worksurface harness kit shall accommodate up to (4) 15 amp duplex receptacles. Receptacles shall be available to access the up to 6 circuits within the harness and must be ordered separately. Both 10-wire circuits are rated at 120 VAC@ 20 amps. All receptacles are rated at 15 amps. The specifics of each wiring configuration are detailed below.

Note: The two 10-wire systems (4-4-2 and 6-2-2) cannot be mixed together. The wiring systems must be separate. There are different receptacles for each system, and different connectors specific to each

system. Keyed connectors will not allow the 2 systems to be mixed.

6-2-2 Configuration

The 6-2-2 configuration of the 10-wire system will have three "convenience" circuits (1, 2 and 3) which will each have their own hot wire, will share an oversized neutral wire and will share the building ground wire. Circuits 4, 5 and 6 are "isolated ground" circuits that will each have their own hot wire, will share an oversized neutral wire, and will share an isolated ground wire. The advantage of this system is that it will be able to have 6 circuits coming in via one top feed or base feed. This will cut down on the number of feed points on an installation. The number 4, 5 and 6 receptacles will be colored orange to designate that they are on the isolated ground while the number 1, 2 and 3 receptacles come in standard trim colors.

4-4-2 Configuration

The 4-4-2 configuration of the 10-wire system will have two "convenience" circuits (1 and 2), which will each have their own hot wire, their own neutral wire and will share the building ground wire. Circuits 3 and 4 receptacles are the "isolated ground" which will each have their own hot wire, their own neutral wire, and will share an isolated ground wire. The advantage of this system is that all of the circuits will have their own neutral wires and it has two circuits (3 and 4) that use an isolated ground. The number 3 and 4 receptacles will be colored orange to designate that they are on the isolated ground, while the number 1 and 2 receptacles come in standard trim colors.

10-Wire Power Infeed Kit

The 10-wire power infeed kit shall provide power from fixed floor or wall sources to the 10-wire harness. It shall include 6' of plastic covered flexible conduit. To connect the hardwire end of a 10-wire top feed or base feed to your building, use a 3/4" Romex connector on the conduit.

10-Wire Power Table-to-Table Connector

10-wire table-to-table connector shall consist of a sleeved flexible harness, which provides power connections from adjoining desks. The jumper shall have a length of 27".

Fabric

Fabric will be applied as swatched by the fabric manufacturer. Fabric that is required to be applied differently than is swatched will need a Special Cost Request written specifying the direction the fabric is to be applied. The posted standard lead time will apply to the Special Cost Request.



Genesis® Worksurfaces

Basic Rectangular

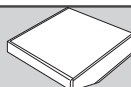
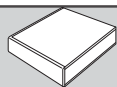

74P Edge
(74P)

Elliptical Postformed Edge
(EP)

Knife Edge
(KN)

Membrane Edge
(MP)

Modesty
Panel
add to list
price

Wire
Trough
add to list
price

\$ 884	\$ 918	\$ 935	\$ 935	\$ 117	\$ 364
911	940	980	980	123	401
951	983	995	995	132	416
957	986	999	999	141	473
999	1030	1157	1157	147	491
1008	1035	1171	1171	174	505
1051	1077	1261	1261	179	679
1059	1084	1262	1262	199	700
887	927	939	939	117	364
912	955	983	983	123	401
956	979	998	998	132	416
959	986	1002	1002	141	473
1002	1050	1136	1136	147	491
1012	1060	1141	1141	174	505
1056	1104	1261	1261	179	679
1061	1107	1262	1262	199	700
\$ 1858	\$ 1893	\$ 1901	\$ 1901	\$ 132	\$ 416
1865	1896	1904	1904	141	473
1864	1880	1903	1903	132	416
1868	1893	1907	1907	141	473

FINISH INFORMATION

Additional Laminate Offering

Additional laminates beyond KI standard offering, are available with two weeks extended leadtime. To specify additional laminates, use these designators followed by the supplier's color/pattern code:

Formica - LF/supplier's color pattern code
Nevamar - LN/supplier's color pattern code
Wilsonart - LW/supplier's color pattern code

KI's standard finish is the supplier's recommended finish for that color/pattern. Note: Nonstandard laminates from these suppliers (example: textured laminates), require an upcharge and additional leadtime. Contact KI.

SPECIAL SERVICES

Special Carton Marking

With specially marked information N/C

Shipping

Shipped k.d. freight prepaid f.o.b. Manitowoc, Wisconsin 54220 factory.
Freight class #100.

Specifications and prices are subject to change without prior notice.

Genesis® Worksurfaces

Basic Rectangular

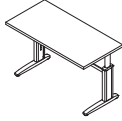
MODEL	D x W	MODEL NUMBER							
		Basic Model	Edge Style	Module Location	Modesty Panel	Wire Trough	Base Finish	Edge Color	Surface Finish
 <p>GSTR</p> <p>Pin Height Adjustable</p> <ul style="list-style-type: none"> Rectangular surface with straight front Height adjusts from 24"-31" in 1" increments Adjustable glides Wire trough and modesty panel should not be ordered together on adjustable tables 	24 x 30"	GSTR2430S/P	<input type="checkbox"/>	<input type="checkbox"/>	<input type="checkbox"/>	<input type="checkbox"/>			
	24 x 36"	GSTR2436S/P	<input type="checkbox"/>	<input type="checkbox"/>	<input type="checkbox"/>	<input type="checkbox"/>			
	24 x 42"	GSTR2442S/P	<input type="checkbox"/>	<input type="checkbox"/>	<input type="checkbox"/>	<input type="checkbox"/>			
	24 x 48"	GSTR2448S/P	<input type="checkbox"/>	<input type="checkbox"/>	<input type="checkbox"/>	<input type="checkbox"/>			
	24 x 54"	GSTR2454S/P	<input type="checkbox"/>	<input type="checkbox"/>	<input type="checkbox"/>	<input type="checkbox"/>			
	24 x 60"	GSTR2460S/P	<input type="checkbox"/>	<input type="checkbox"/>	<input type="checkbox"/>	<input type="checkbox"/>			
	24 x 66"	GSTR2466S/P	<input type="checkbox"/>	<input type="checkbox"/>	<input type="checkbox"/>	<input type="checkbox"/>			
	24 x 72"	GSTR2472S/P	<input type="checkbox"/>	<input type="checkbox"/>	<input type="checkbox"/>	<input type="checkbox"/>			
	30 x 30"	GSTR3030S/P	<input type="checkbox"/>	<input type="checkbox"/>	<input type="checkbox"/>	<input type="checkbox"/>			
	30 x 36"	GSTR3036S/P	<input type="checkbox"/>	<input type="checkbox"/>	<input type="checkbox"/>	<input type="checkbox"/>			
	30 x 42"	GSTR3042S/P	<input type="checkbox"/>	<input type="checkbox"/>	<input type="checkbox"/>	<input type="checkbox"/>			
	30 x 48"	GSTR3048S/P	<input type="checkbox"/>	<input type="checkbox"/>	<input type="checkbox"/>	<input type="checkbox"/>			
	30 x 54"	GSTR3054S/P	<input type="checkbox"/>	<input type="checkbox"/>	<input type="checkbox"/>	<input type="checkbox"/>			
	30 x 60"	GSTR3060S/P	<input type="checkbox"/>	<input type="checkbox"/>	<input type="checkbox"/>	<input type="checkbox"/>			
	30 x 66"	GSTR3066S/P	<input type="checkbox"/>	<input type="checkbox"/>	<input type="checkbox"/>	<input type="checkbox"/>			
	30 x 72"	GSTR3072S/P	<input type="checkbox"/>	<input type="checkbox"/>	<input type="checkbox"/>	<input type="checkbox"/>			

A

B

C

D

E

F

G

H

HOW TO ORDER

Indicate the following information on order form:

- Quantity of each item.
- Model number, including options. See "How To Build a Model Number".
- Any special service required.

Note: • The indicates that a choice is required.

- The absence of the indicates that no choice is required.
- Alpha-numeric characters in place of indicate that no other alternatives are available.

HOW TO BUILD A MODEL NUMBER

A Select basic model.

B Select edge style.

- | | |
|------------|------------------------------|
| 74P | - 74P edge |
| EP | - Elliptical postformed edge |
| KN | - Knife edge |
| MP | - Membrane edge |

C Select PowerUp module location.

Select only one from the following and add the appropriate upcharge to the base price.

- | | |
|------------|--|
| PUN | - No data |
| PUL | - Left module; add \$108 |
| PUR | - Right module; add \$108 |
| PUC | - Center module; add \$108 |
| PUB | - Both left and right modules; add \$218 |

PUL and PUR option only available on worksurfaces 42" wide or greater. PUB option only available on 60", 66" and 72" wide only.

D Select modesty panel option.

NM - No modesty panel

WM - With modesty panel
Add upcharge to unit price for "WM" option.

E Select wire trough and power option.

NW - No wire trough

WW - Wire trough
Add upcharge to unit price for "WW" option.

F Select base finish.

Refer to color addendum at ki.com or KI Fabrics & Finishes binder.

G Select edge/PowerUp module color.

Refer to color addendum at ki.com or KI Fabrics & Finishes binder.
Edge color offerings are based on edge style selections.

H Select surface finish.

Refer to color addendum at ki.com or KI Fabrics & Finishes binder.
Surface finish offerings are based on edge

style selections. Laminate finishes are only available on (74P) 74P edge, (EP) elliptical postformed edge and (KN) knife edge worksurfaces. The membrane color selections are only available on the (MP) membrane edge worksurfaces.



Genesis® Worksurfaces

Basic Rectangular

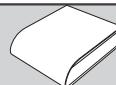
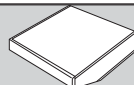
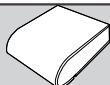
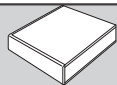

Approx. Packaged Weight	74P Edge (74P)	Elliptical Postformed Edge (EP)	Knife Edge (KN)	Membrane Edge (MP)	Modesty Panel add to list price	Wire Trough add to list price
66.0#	\$ 1006	\$ 1037	\$ 1060	\$ 1060	\$ 117	\$ 364
72.0#	1031	1062	1101	1101	123	401
78.0#	1072	1104	1115	1115	132	416
84.0#	1075	1107	1121	1121	141	473
92.0#	1136	1166	1294	1294	147	491
98.0#	1144	1174	1306	1306	174	505
104.0#	1189	1217	1401	1401	179	679
115.0#	1193	1224	1403	1403	199	700
75.0#	1009	1050	1061	1061	117	364
82.0#	1032	1073	1104	1104	123	401
90.0#	1074	1096	1120	1120	132	416
97.0#	1080	1121	1123	1123	141	473
106.0#	1138	1187	1274	1274	147	491
114.0#	1148	1195	1280	1280	174	505
122.0#	1191	1241	1403	1403	179	679
134.0#	1196	1246	1404	1404	199	700

FINISH INFORMATION

Additional Laminate Offering

Additional laminates beyond KI standard offering, are available with two weeks extended leadtime. To specify additional laminates, use these designators followed by the supplier's color/pattern code:

Formica - LF/supplier's color pattern code
 Nevamar - LN/supplier's color pattern code
 Wilsonart - LW/supplier's color pattern code

KI's standard finish is the supplier's recommended finish for that color/pattern. Note: Nonstandard laminates from these suppliers (example: textured laminates), require an upcharge and additional leadtime. Contact KI.

SPECIAL SERVICES

Special Carton Marking

With specially marked information N/C

Shipping

Shipped k.d. freight prepaid f.o.b. Manitowoc, Wisconsin 54220 factory. Freight class #100.

Specifications and prices are subject to change without prior notice.

Genesis® Worksurfaces

Basic Rectangular

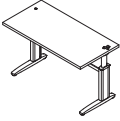
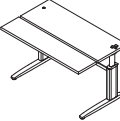
		MODEL NUMBER									
MODEL	D x W	Basic Model	Edge Style	Module Location	Modesty Panel	Wire Trough	Base Finish	Edge Color	Surface Finish		
 <p>GSTR</p> <p>Crank Height Adjustable</p> <ul style="list-style-type: none"> Rectangular surface with straight front Height adjusts from 22"-33" Adjustable glides Worksurfaces are undersized by 1/4" from side-to-side and 1/4" from back-to-front from the stated dimensions Wire trough and modesty panel should not be ordered together on adjustable tables 	24 x 30"	GSTR2430S/CR	<input type="checkbox"/>	<input type="checkbox"/>	<input type="checkbox"/>	<input type="checkbox"/>	<input type="checkbox"/>	<input type="checkbox"/>	<input type="checkbox"/>		
	24 x 36"	GSTR2436S/CR	<input type="checkbox"/>	<input type="checkbox"/>	<input type="checkbox"/>	<input type="checkbox"/>	<input type="checkbox"/>	<input type="checkbox"/>	<input type="checkbox"/>		
	24 x 42"	GSTR2442S/CR	<input type="checkbox"/>	<input type="checkbox"/>	<input type="checkbox"/>	<input type="checkbox"/>	<input type="checkbox"/>	<input type="checkbox"/>	<input type="checkbox"/>		
	24 x 48"	GSTR2448S/CR	<input type="checkbox"/>	<input type="checkbox"/>	<input type="checkbox"/>	<input type="checkbox"/>	<input type="checkbox"/>	<input type="checkbox"/>	<input type="checkbox"/>		
	24 x 54"	GSTR2454S/CR	<input type="checkbox"/>	<input type="checkbox"/>	<input type="checkbox"/>	<input type="checkbox"/>	<input type="checkbox"/>	<input type="checkbox"/>	<input type="checkbox"/>		
	24 x 60"	GSTR2460S/CR	<input type="checkbox"/>	<input type="checkbox"/>	<input type="checkbox"/>	<input type="checkbox"/>	<input type="checkbox"/>	<input type="checkbox"/>	<input type="checkbox"/>		
	24 x 66"	GSTR2466S/CR	<input type="checkbox"/>	<input type="checkbox"/>	<input type="checkbox"/>	<input type="checkbox"/>	<input type="checkbox"/>	<input type="checkbox"/>	<input type="checkbox"/>		
	24 x 72"	GSTR2472S/CR	<input type="checkbox"/>	<input type="checkbox"/>	<input type="checkbox"/>	<input type="checkbox"/>	<input type="checkbox"/>	<input type="checkbox"/>	<input type="checkbox"/>		
	30 x 30"	GSTR3030S/CR	<input type="checkbox"/>	<input type="checkbox"/>	<input type="checkbox"/>	<input type="checkbox"/>	<input type="checkbox"/>	<input type="checkbox"/>	<input type="checkbox"/>		
	30 x 36"	GSTR3036S/CR	<input type="checkbox"/>	<input type="checkbox"/>	<input type="checkbox"/>	<input type="checkbox"/>	<input type="checkbox"/>	<input type="checkbox"/>	<input type="checkbox"/>		
	30 x 42"	GSTR3042S/CR	<input type="checkbox"/>	<input type="checkbox"/>	<input type="checkbox"/>	<input type="checkbox"/>	<input type="checkbox"/>	<input type="checkbox"/>	<input type="checkbox"/>		
	30 x 48"	GSTR3048S/CR	<input type="checkbox"/>	<input type="checkbox"/>	<input type="checkbox"/>	<input type="checkbox"/>	<input type="checkbox"/>	<input type="checkbox"/>	<input type="checkbox"/>		
	30 x 54"	GSTR3054S/CR	<input type="checkbox"/>	<input type="checkbox"/>	<input type="checkbox"/>	<input type="checkbox"/>	<input type="checkbox"/>	<input type="checkbox"/>	<input type="checkbox"/>		
	30 x 60"	GSTR3060S/CR	<input type="checkbox"/>	<input type="checkbox"/>	<input type="checkbox"/>	<input type="checkbox"/>	<input type="checkbox"/>	<input type="checkbox"/>	<input type="checkbox"/>		
	30 x 66"	GSTR3066S/CR	<input type="checkbox"/>	<input type="checkbox"/>	<input type="checkbox"/>	<input type="checkbox"/>	<input type="checkbox"/>	<input type="checkbox"/>	<input type="checkbox"/>		
30 x 72"	GSTR3072S/CR	<input type="checkbox"/>	<input type="checkbox"/>	<input type="checkbox"/>	<input type="checkbox"/>	<input type="checkbox"/>	<input type="checkbox"/>	<input type="checkbox"/>			
 <p>GSTR</p> <p>Crank Height Dual</p> <ul style="list-style-type: none"> Rectangular surface with straight front Height adjusts from 22"-33" Adjustable glides Keyboard surface adjusts 5" above/below primary surface. Keyboard surface tilts +/-15° Worksurfaces are undersized by 1/4" from side-to-side and 1/4" from back-to-front from the stated dimensions Wire trough and modesty panel should not be ordered together on adjustable tables 	30 x 42"	GSTR3042D/CR	<input type="checkbox"/>	<input type="checkbox"/>	<input type="checkbox"/>	<input type="checkbox"/>	<input type="checkbox"/>	<input type="checkbox"/>			
	30 x 48"	GSTR3048D/CR	<input type="checkbox"/>	<input type="checkbox"/>	<input type="checkbox"/>	<input type="checkbox"/>	<input type="checkbox"/>	<input type="checkbox"/>	<input type="checkbox"/>		
			A	B	C	D	E	F	G	H	

HOW TO ORDER

Indicate the following information on order form:

- Quantity of each item.
- Model number, including options. See "How To Build a Model Number".
- Any special service required.

Note:

- The indicates that a choice is required.
- The absence of the indicates that no choice is required.
- Alpha-numeric characters in place of indicate that no other alternatives are available.

HOW TO BUILD A MODEL NUMBER

- A** Select basic model.
- B** Select edge style.

74P	- 74P edge
EP	- Elliptical postformed edge
KN	- Knife edge
MP	- Membrane edge
- C** Select PowerUp module location. Select only one from the following and add the appropriate upcharge to the base price.

PUN	- No data
PUL	- Left module; add \$108
PUR	- Right module; add \$108
PUC	- Center module; add \$108
PUB	- Both left and right modules; add \$218

PUL and PUR option only available on worksurfaces 42" wide or greater. PUB option only available on 60", 66" and 72" wide only.
- D** Select modesty panel option.

- NM** - No modesty panel
- WM** - With modesty panel
Add upcharge to unit price for "WM" option.
- E** Select wire trough and power option.

NW	- No wire trough
WW	- Wire trough

Add upcharge to unit price for "WW" option.
- F** Select base finish.
Refer to color addendum at ki.com or KI Fabrics & Finishes binder.
- G** Select edge/PowerUp module color.
Refer to color addendum at ki.com or KI Fabrics & Finishes binder.
Edge color offerings are based on edge style selections.
- H** Select surface finish.
Refer to color addendum at ki.com or KI Fabrics & Finishes binder.
Surface finish offerings are based on edge

style selections. Laminate finishes are only available on (74P) 74P edge, (EP) elliptical postformed edge and (KN) knife edge worksurfaces. The membrane color selections are only available on the (MP) membrane edge worksurfaces.

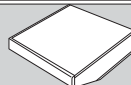
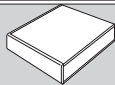

Approx. Packaged Weight	74P Edge (74P)	Elliptical Postformed Edge (EP)	Knife Edge (KN)	Membrane Edge (MP)	Modesty Panel add to list price	Wire Trough add to list price
69.0#	\$ 1249	\$ 1284	\$ 1301	\$ 1301	\$ 117	\$ 364
76.0#	1275	1305	1344	1344	123	401
82.0#	1317	1347	1360	1360	132	416
89.0#	1320	1353	1366	1366	141	473
96.0#	1366	1396	1523	1523	147	491
103.0#	1373	1405	1534	1534	174	505
109.0#	1415	1446	1627	1627	179	679
121.0#	1420	1449	1628	1628	199	700
78.0#	1251	1293	1303	1303	117	364
86.0#	1277	1318	1347	1347	123	401
94.0#	1319	1338	1365	1365	132	416
102.0#	1327	1350	1368	1368	141	473
111.0#	1368	1414	1501	1501	147	491
119.0#	1376	1422	1508	1508	174	505
127.0#	1417	1470	1628	1628	179	679
140.0#	1423	1473	1630	1630	199	700
114.0#	\$ 2229	\$ 2257	\$ 2272	\$ 2272	\$ 132	\$ 416
122.0#	2232	2266	2276	2276	141	473

FINISH INFORMATION

Additional Laminate Offering

Additional laminates beyond KI standard offering, are available with two weeks extended leadtime. To specify additional laminates, use these designators followed by the supplier's color/pattern code:

Formica - LF/supplier's color pattern code
 Nevamar - LN/supplier's color pattern code
 Wilsonart - LW/supplier's color pattern code

KI's standard finish is the supplier's recommended finish for that color/pattern. Note: Nonstandard laminates from these suppliers (example: textured laminates), require an upcharge and additional leadtime. Contact KI.

SPECIAL SERVICES

Special Carton Marking

With specially marked information N/C

Shipping

Shipped k.d. freight prepaid f.o.b. Manitowoc, Wisconsin 54220 factory. Freight class #100.

Specifications and prices are subject to change without prior notice.

Genesis® Worksurfaces

Basic Rectangular

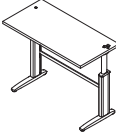
MODEL	D x W	MODEL NUMBER							
		Basic Model	Edge Style	Module Location	Modesty Panel	Wire Trough	Base Finish	Edge Color	Surface Finish
 <p>GSTR</p> <p>Crank Sit/Stand Height Adjustable</p> <ul style="list-style-type: none"> Rectangular surface with straight front Height adjusts from 27"-43" Adjustable glides Worksurfaces are undersized by 1/4" from side-to-side Wire trough and modesty panel should not be ordered together on adjustable tables 	24 x 30"	GSTR2430SS/CR	<input type="checkbox"/>	<input type="checkbox"/>	<input type="checkbox"/>	<input type="checkbox"/>	<input type="checkbox"/>	<input type="checkbox"/>	
	24 x 36"	GSTR2436SS/CR	<input type="checkbox"/>	<input type="checkbox"/>	<input type="checkbox"/>	<input type="checkbox"/>	<input type="checkbox"/>	<input type="checkbox"/>	
	24 x 42"	GSTR2442SS/CR	<input type="checkbox"/>	<input type="checkbox"/>	<input type="checkbox"/>	<input type="checkbox"/>	<input type="checkbox"/>	<input type="checkbox"/>	
	24 x 48"	GSTR2448SS/CR	<input type="checkbox"/>	<input type="checkbox"/>	<input type="checkbox"/>	<input type="checkbox"/>	<input type="checkbox"/>	<input type="checkbox"/>	
	24 x 54"	GSTR2454SS/CR	<input type="checkbox"/>	<input type="checkbox"/>	<input type="checkbox"/>	<input type="checkbox"/>	<input type="checkbox"/>	<input type="checkbox"/>	
	24 x 60"	GSTR2460SS/CR	<input type="checkbox"/>	<input type="checkbox"/>	<input type="checkbox"/>	<input type="checkbox"/>	<input type="checkbox"/>	<input type="checkbox"/>	
	24 x 66"	GSTR2466SS/CR	<input type="checkbox"/>	<input type="checkbox"/>	<input type="checkbox"/>	<input type="checkbox"/>	<input type="checkbox"/>	<input type="checkbox"/>	
	24 x 72"	GSTR2472SS/CR	<input type="checkbox"/>	<input type="checkbox"/>	<input type="checkbox"/>	<input type="checkbox"/>	<input type="checkbox"/>	<input type="checkbox"/>	
	30 x 30"	GSTR3030SS/CR	<input type="checkbox"/>	<input type="checkbox"/>	<input type="checkbox"/>	<input type="checkbox"/>	<input type="checkbox"/>	<input type="checkbox"/>	
	30 x 36"	GSTR3036SS/CR	<input type="checkbox"/>	<input type="checkbox"/>	<input type="checkbox"/>	<input type="checkbox"/>	<input type="checkbox"/>	<input type="checkbox"/>	
	30 x 42"	GSTR3042SS/CR	<input type="checkbox"/>	<input type="checkbox"/>	<input type="checkbox"/>	<input type="checkbox"/>	<input type="checkbox"/>	<input type="checkbox"/>	
	30 x 48"	GSTR3048SS/CR	<input type="checkbox"/>	<input type="checkbox"/>	<input type="checkbox"/>	<input type="checkbox"/>	<input type="checkbox"/>	<input type="checkbox"/>	
	30 x 54"	GSTR3054SS/CR	<input type="checkbox"/>	<input type="checkbox"/>	<input type="checkbox"/>	<input type="checkbox"/>	<input type="checkbox"/>	<input type="checkbox"/>	
	30 x 60"	GSTR3060SS/CR	<input type="checkbox"/>	<input type="checkbox"/>	<input type="checkbox"/>	<input type="checkbox"/>	<input type="checkbox"/>	<input type="checkbox"/>	
	30 x 66"	GSTR3066SS/CR	<input type="checkbox"/>	<input type="checkbox"/>	<input type="checkbox"/>	<input type="checkbox"/>	<input type="checkbox"/>	<input type="checkbox"/>	
	30 x 72"	GSTR3072SS/CR	<input type="checkbox"/>	<input type="checkbox"/>	<input type="checkbox"/>	<input type="checkbox"/>	<input type="checkbox"/>	<input type="checkbox"/>	

A

B

C

D

E

F

G

H

HOW TO ORDER

Indicate the following information on order form:

- Quantity of each item.
- Model number, including options. See "How To Build a Model Number".
- Any special service required.

Note: • The indicates that a choice is required.

- The absence of the indicates that no choice is required.
- Alpha-numeric characters in place of indicate that no other alternatives are available.

HOW TO BUILD A MODEL NUMBER

A Select basic model.

B Select edge style.

- | | |
|------------|------------------------------|
| 74P | - 74P edge |
| EP | - Elliptical postformed edge |
| KN | - Knife edge |
| MP | - Membrane edge |

C Select PowerUp module location.

Select only one from the following and add the appropriate upcharge to the base price.

- | | |
|------------|--|
| PUN | - No data |
| PUL | - Left module; add \$108 |
| PUR | - Right module; add \$108 |
| PUC | - Center module; add \$108 |
| PUB | - Both left and right modules; add \$218 |

PUL and PUR option only available on worksurfaces 42" wide or greater. PUB option only available on 60", 66" and 72" wide only.

D Select modesty panel option.

NM - No modesty panel

WM - With modesty panel

Add upcharge to unit price for "WM" option.

E Select wire trough and power option.

NW - No wire trough

WW - Wire trough

Add upcharge to unit price for "WW" option.

F Select base finish.

Refer to color addendum at ki.com or KI Fabrics & Finishes binder.

G Select edge/PowerUp module color.

Refer to color addendum at ki.com or KI Fabrics & Finishes binder.

Edge color offerings are based on edge style selections.

H Select surface finish.

Refer to color addendum at ki.com or KI Fabrics & Finishes binder.

Surface finish offerings are based on edge

style selections. Laminate finishes are only available on (74P) 74P edge, (EP) elliptical postformed edge and (KN) knife edge worksurfaces. The membrane color selections are only available on the (MP) membrane edge worksurfaces.



Genesis® Worksurfaces

Basic Rectangular

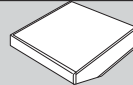
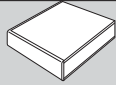

Approx. Packaged Weight	74P Edge (74P)	Elliptical Postformed Edge (EP)	Knife Edge (KN)	Membrane Edge (MP)	Modesty Panel add to list price	Wire Trough add to list price
74.0#	\$ 1408	\$ 1440	\$ 1458	\$ 1458	\$ 117	\$ 364
81.0#	1429	1462	1501	1501	123	401
87.0#	1473	1505	1517	1517	132	416
94.0#	1478	1509	1522	1522	141	473
101.0#	1522	1552	1679	1679	147	491
108.0#	1531	1559	1690	1690	174	505
114.0#	1572	1600	1782	1782	179	679
126.0#	1580	1604	1783	1783	199	700
83.0#	1410	1449	1460	1460	117	364
91.0#	1431	1474	1505	1505	123	401
99.0#	1475	1498	1520	1520	132	416
107.0#	1480	1513	1524	1524	141	473
116.0#	1524	1570	1657	1657	147	491
124.0#	1533	1582	1664	1664	174	505
132.0#	1576	1626	1783	1783	179	679
144.0#	1583	1630	1787	1787	199	700

FINISH INFORMATION

Additional Laminate Offering

Additional laminates beyond KI standard offering, are available with two weeks extended leadtime. To specify additional laminates, use these designators followed by the supplier's color/pattern code:

Formica - LF/supplier's color pattern code
 Nevamar - LN/supplier's color pattern code
 Wilsonart - LW/supplier's color pattern code

KI's standard finish is the supplier's recommended finish for that color/pattern. Note: Nonstandard laminates from these suppliers (example: textured laminates), require an upcharge and additional leadtime. Contact KI.

SPECIAL SERVICES

Special Carton Marking

With specially marked information N/C

Shipping

Shipped k.d. freight prepaid f.o.b. Manitowoc, Wisconsin 54220 factory. Freight class #100.

Specifications and prices are subject to change without prior notice.

Genesis® Worksurfaces

Basic Rectangular

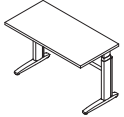
MODEL	D x W	MODEL NUMBER								
		Basic Model	Edge Style	Electrical Control	Module Location	Modesty Panel	Wire Trough	Base Finish	Edge Color	Surface Finish
 <p>GSRE</p> <p>Electric Height Adjustable Single</p> <ul style="list-style-type: none"> Rectangular surface with straight front Height adjusts from 24"-51" Standard or deluxe up/down switch Adjustable glides Worksurfaces are undersized by 1-1/4" from side-to-side and 1/2" from back-to-front from the stated dimensions Wire trough and modesty panel should not be ordered together on adjustable tables 	24 x 36"	GSRE2436S	<input type="checkbox"/> <input type="checkbox"/> <input type="checkbox"/>	<input type="checkbox"/>	<input type="checkbox"/> <input type="checkbox"/> <input type="checkbox"/>	<input type="checkbox"/> <input type="checkbox"/>	<input type="checkbox"/> <input type="checkbox"/>	<input type="checkbox"/> <input type="checkbox"/>	<input type="checkbox"/> <input type="checkbox"/> <input type="checkbox"/>	<input type="checkbox"/> <input type="checkbox"/> <input type="checkbox"/>
	24 x 42"	GSRE2442S	<input type="checkbox"/> <input type="checkbox"/> <input type="checkbox"/>	<input type="checkbox"/>	<input type="checkbox"/> <input type="checkbox"/> <input type="checkbox"/>	<input type="checkbox"/> <input type="checkbox"/>	<input type="checkbox"/> <input type="checkbox"/>	<input type="checkbox"/> <input type="checkbox"/>	<input type="checkbox"/> <input type="checkbox"/> <input type="checkbox"/>	<input type="checkbox"/> <input type="checkbox"/> <input type="checkbox"/>
	24 x 48"	GSRE2448S	<input type="checkbox"/> <input type="checkbox"/> <input type="checkbox"/>	<input type="checkbox"/>	<input type="checkbox"/> <input type="checkbox"/> <input type="checkbox"/>	<input type="checkbox"/> <input type="checkbox"/>	<input type="checkbox"/> <input type="checkbox"/>	<input type="checkbox"/> <input type="checkbox"/>	<input type="checkbox"/> <input type="checkbox"/> <input type="checkbox"/>	<input type="checkbox"/> <input type="checkbox"/> <input type="checkbox"/>
	24 x 54"	GSRE2454S	<input type="checkbox"/> <input type="checkbox"/> <input type="checkbox"/>	<input type="checkbox"/>	<input type="checkbox"/> <input type="checkbox"/> <input type="checkbox"/>	<input type="checkbox"/> <input type="checkbox"/>	<input type="checkbox"/> <input type="checkbox"/>	<input type="checkbox"/> <input type="checkbox"/>	<input type="checkbox"/> <input type="checkbox"/> <input type="checkbox"/>	<input type="checkbox"/> <input type="checkbox"/> <input type="checkbox"/>
	24 x 60"	GSRE2460S	<input type="checkbox"/> <input type="checkbox"/> <input type="checkbox"/>	<input type="checkbox"/>	<input type="checkbox"/> <input type="checkbox"/> <input type="checkbox"/>	<input type="checkbox"/> <input type="checkbox"/>	<input type="checkbox"/> <input type="checkbox"/>	<input type="checkbox"/> <input type="checkbox"/>	<input type="checkbox"/> <input type="checkbox"/> <input type="checkbox"/>	<input type="checkbox"/> <input type="checkbox"/> <input type="checkbox"/>
	30 x 36"	GSRE3036S	<input type="checkbox"/> <input type="checkbox"/> <input type="checkbox"/>	<input type="checkbox"/>	<input type="checkbox"/> <input type="checkbox"/> <input type="checkbox"/>	<input type="checkbox"/> <input type="checkbox"/>	<input type="checkbox"/> <input type="checkbox"/>	<input type="checkbox"/> <input type="checkbox"/>	<input type="checkbox"/> <input type="checkbox"/> <input type="checkbox"/>	<input type="checkbox"/> <input type="checkbox"/> <input type="checkbox"/>
	30 x 42"	GSRE3042S	<input type="checkbox"/> <input type="checkbox"/> <input type="checkbox"/>	<input type="checkbox"/>	<input type="checkbox"/> <input type="checkbox"/> <input type="checkbox"/>	<input type="checkbox"/> <input type="checkbox"/>	<input type="checkbox"/> <input type="checkbox"/>	<input type="checkbox"/> <input type="checkbox"/>	<input type="checkbox"/> <input type="checkbox"/> <input type="checkbox"/>	<input type="checkbox"/> <input type="checkbox"/> <input type="checkbox"/>
	30 x 48"	GSRE3048S	<input type="checkbox"/> <input type="checkbox"/> <input type="checkbox"/>	<input type="checkbox"/>	<input type="checkbox"/> <input type="checkbox"/> <input type="checkbox"/>	<input type="checkbox"/> <input type="checkbox"/>	<input type="checkbox"/> <input type="checkbox"/>	<input type="checkbox"/> <input type="checkbox"/>	<input type="checkbox"/> <input type="checkbox"/> <input type="checkbox"/>	<input type="checkbox"/> <input type="checkbox"/> <input type="checkbox"/>
	30 x 54"	GSRE3054S	<input type="checkbox"/> <input type="checkbox"/> <input type="checkbox"/>	<input type="checkbox"/>	<input type="checkbox"/> <input type="checkbox"/> <input type="checkbox"/>	<input type="checkbox"/> <input type="checkbox"/>	<input type="checkbox"/> <input type="checkbox"/>	<input type="checkbox"/> <input type="checkbox"/>	<input type="checkbox"/> <input type="checkbox"/> <input type="checkbox"/>	<input type="checkbox"/> <input type="checkbox"/> <input type="checkbox"/>
	30 x 60"	GSRE3060S	<input type="checkbox"/> <input type="checkbox"/> <input type="checkbox"/>	<input type="checkbox"/>	<input type="checkbox"/> <input type="checkbox"/> <input type="checkbox"/>	<input type="checkbox"/> <input type="checkbox"/>	<input type="checkbox"/> <input type="checkbox"/>	<input type="checkbox"/> <input type="checkbox"/>	<input type="checkbox"/> <input type="checkbox"/> <input type="checkbox"/>	<input type="checkbox"/> <input type="checkbox"/> <input type="checkbox"/>

A

B

C

D

E

F

G

H

I

HOW TO ORDER

Indicate the following information on order form:

- Quantity of each item.
- Model number, including options. See "How To Build a Model Number".
- Any special service required.

Note: • The indicates that a choice is required.

- The absence of the indicates that no choice is required.
- Alpha-numeric characters in place of indicate that no other alternatives are available.

HOW TO BUILD A MODEL NUMBER

A Select basic model.

B Select edge style.

- 74P** - 74P edge
EP - Elliptical postformed edge
KN - Knife edge
MP - Membrane edge

C Select control style

- S** - Standard up/down switch
D - Deluxe up/down switch; add \$112

D Select PowerUp module location.

Select only one from the following and add the appropriate upcharge to the base price.

- PUN** - No data
PUL - Left module; add \$108
PUR - Right module; add \$108
PUC - Center module; add \$108
PUB - Both left and right modules; add \$218
 PUL and PUR option only available on

worksurfaces 42" wide or greater. PUB option only available on 60", 66" and 72" wide only.

E Select modesty panel option.

- NM** - No modesty panel
WM - With modesty panel
 Add upcharge to unit price for "WM" option.

F Select wire trough and power option.

- NW** - No wire trough
WW - Wire trough
 Add upcharge to unit price for "WW" option.

G Select base finish.

Refer to color addendum at ki.com or KI Fabrics & Finishes binder.

H Select edge/PowerUp module color.

Refer to color addendum at ki.com or KI Fabrics & Finishes binder.
 Edge color offerings are based on edge style selections.

I Select surface finish.

Refer to color addendum at ki.com or KI Fabrics & Finishes binder.
 Surface finish offerings are based on edge style selections. Laminate finishes are only available on (74P) 74P edge, (EP) elliptical postformed edge and (KN) knife edge worksurfaces. The membrane color selections are only available on the (MP) membrane edge worksurfaces.



Genesis® Worksurfaces

Basic Rectangular

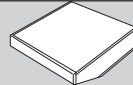
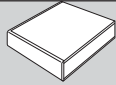

Approx. Packaged Weight	74P Edge (74P)	Elliptical Postformed Edge (EP)	Knife Edge (KN)	Membrane Edge (MP)	Modesty Panel add to list price	Wire Trough add to list price
97.0#	\$ 2397	\$ 2430	\$ 2470	\$ 2470	\$ 123	\$ 401
104.0#	2456	2485	2499	2499	132	416
110.0#	2476	2511	2518	2518	141	473
117.0#	2544	2576	2688	2688	147	491
123.0#	2560	2588	2693	2693	174	505
108.0#	2399	2442	2472	2472	123	401
116.0#	2460	2486	2503	2503	132	416
123.0#	2480	2516	2520	2520	141	473
132.0#	2546	2597	2700	2700	147	491
140.0#	2562	2608	2719	2719	174	505

FINISH INFORMATION

Additional Laminate Offering

Additional laminates beyond KI standard offering, are available with two weeks extended leadtime. To specify additional laminates, use these designators followed by the supplier's color/pattern code:

Formica - LF/supplier's color pattern code
 Nevamar - LN/supplier's color pattern code
 Wilsonart - LW/supplier's color pattern code

KI's standard finish is the supplier's recommended finish for that color/pattern. Note: Nonstandard laminates from these suppliers (example: textured laminates), require an upcharge and additional leadtime. Contact KI.

SPECIAL SERVICES

Special Carton Marking

With specially marked information N/C

Shipping

Shipped k.d. freight prepaid f.o.b. Manitowoc, Wisconsin 54220 factory.
 Freight class #100.

Specifications and prices are subject to change without prior notice.

Genesis® Worksurfaces

Basic Rectangular

MODEL	D x W	MODEL NUMBER								
		Basic Model	Edge Style	Electrical Control	Module Location	Modesty Panel	Wire Trough	Base Finish	Edge Color	Surface Finish
 <p>GSRE</p> <p>Electric Height Adjustable Dual</p> <ul style="list-style-type: none"> • Rectangular surface with straight front • Height adjusts from 24"-51" • Keyboard surface adjusts 5" above/below primary surface. • Keyboard surface tilts +/-15° • Standard or deluxe up/down switch • Adjustable glides • Worksurfaces are undersized by 1-1/4" from side-to-side and 1/2" from back-to-front from the stated dimensions • Wire trough and modesty panel should not be ordered together on adjustable tables 	30 x 48"	GSRE3048D	<input type="checkbox"/> <input type="checkbox"/> <input type="checkbox"/>	<input type="checkbox"/>	<input type="checkbox"/> <input type="checkbox"/> <input type="checkbox"/>	<input type="checkbox"/> <input type="checkbox"/>	<input type="checkbox"/> <input type="checkbox"/>	<input type="checkbox"/> <input type="checkbox"/> <input type="checkbox"/>	<input type="checkbox"/> <input type="checkbox"/> <input type="checkbox"/>	

A B C D E F G H I

HOW TO ORDER

Indicate the following information on order form:

1. Quantity of each item.
2. Model number, including options. See "How To Build a Model Number".
3. Any special service required.

- Note:
- The indicates that a choice is required.
 - The absence of the indicates that no choice is required.
 - Alpha-numeric characters in place of indicate that no other alternatives are available.

HOW TO BUILD A MODEL NUMBER





- A** Select basic model.
- B** Select edge style.
 - 74P** - 74P edge
 - EP** - Elliptical postformed edge
 - KN** - Knife edge
 - MP** - Membrane edge
- C** Select control style
 - S** - Standard up/down switch
 - D** - Deluxe up/down switch; add \$112
- D** Select PowerUp module location. Select only one from the following and add the appropriate upcharge to the base price.
 - PUN** - No data
 - PUL** - Left module; add \$108
 - PUR** - Right module; add \$108
 - PUC** - Center module; add \$108
 - PUB** - Both left and right modules; add \$218
 PUL and PUR option only available on

worksurfaces 42" wide or greater. PUB option only available on 60", 66" and 72" wide only.

- E** Select modesty panel option.
 - NM** - No modesty panel
 - WM** - With modesty panel
 Add upcharge to unit price for "WM" option.
- F** Select wire trough and power option.
 - NW** - No wire trough
 - WW** - Wire trough
 Add upcharge to unit price for "WW" option.
- G** Select base finish. Refer to color addendum at ki.com or KI Fabrics & Finishes binder.
- H** Select edge/PowerUp module color. Refer to color addendum at ki.com or KI Fabrics & Finishes binder. Edge color offerings are based on edge style selections.

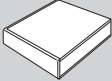
- I** Select surface finish. Refer to color addendum at ki.com or KI Fabrics & Finishes binder. Surface finish offerings are based on edge style selections. Laminate finishes are only available on (74P) 74P edge, (EP) elliptical postformed edge and (KN) knife edge worksurfaces. The membrane color selections are only available on the (MP) membrane edge worksurfaces.

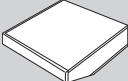

						
Approx. Packaged Weight	74P Edge (74P)	Elliptical Postformed Edge (EP)	Knife Edge (KN)	Membrane Edge (MP)	Modesty Panel add to list price	Wire Trough add to list price
144.0#	\$ 3390	\$ 3407	\$ 3430	\$ 3430	\$ 141	\$ 473

FINISH INFORMATION

Additional Laminate Offering

Additional laminates beyond KI standard offering, are available with two weeks extended leadtime. To specify additional laminates, use these designators followed by the supplier's color/pattern code:

- Formica - LF/supplier's color pattern code
- Nevamar - LN/supplier's color pattern code
- Wilsonart - LW/supplier's color pattern code

KI's standard finish is the supplier's recommended finish for that color/pattern. Note: Nonstandard laminates from these suppliers (example: textured laminates), require an upcharge and additional leadtime. Contact KI.

SPECIAL SERVICES

Special Carton Marking



With specially marked information N/C

Shipping

Shipped **k.d. freight prepaid f.o.b. Manitowoc, Wisconsin 54220** factory. Freight class #100.

Specifications and prices are subject to change without prior notice.

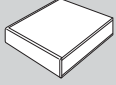
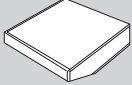

Approx. Packaged Weight				LH Modesty Panel add to list price	RH Modesty Panel add to list price	Both Modesty Panels add to list price	Left Wire Trough add to list price	Right Wire Trough add to list price	Both Wire Troughs add to list price
	74P Edge (74P)	Knife Edge (KN)	Membrane Edge (MP)						
88.0#	\$ 1274	\$ 1375	\$ 1375	\$ 172	\$ 172	\$ 344	\$ 397	\$ 397	\$ 796
103.0#	1338	1443	1443	178	178	358	430	430	860
119.0#	1406	1508	1508	185	185	374	483	483	964
136.0#	1553	1643	N/A	197	197	392	500	500	1002
109.0#	1338	1491	1491	178	178	358	430	430	860
127.0#	1406	1556	1556	185	185	374	483	483	964
145.0#	1553	1669	N/A	197	197	392	500	500	1002
139.0#	\$ 2311	\$ 2415	\$ 2415	\$ 185	\$ 185	\$ 374	\$ 483	\$ 483	\$ 964
156.0#	2461	2549	2549	197	197	392	500	500	1002
147.0#	2311	2466	2466	185	185	374	483	483	964
165.0#	2461	2575	2575	197	197	392	500	500	1002

FINISH INFORMATION

Additional Laminate Offering

Additional laminates beyond KI standard offering, are available with two weeks extended leadtime. To specify additional laminates, use these designators followed by the supplier's color/pattern code:

Formica - LF/supplier's color pattern code
 Nevamar - LN/supplier's color pattern code
 Wilsonart - LW/supplier's color pattern code

KI's standard finish is the supplier's recommended finish for that color/pattern. Note: Nonstandard laminates from these suppliers (example: textured laminates), require an upcharge and additional leadtime. Contact KI.

SPECIAL SERVICES

Special Carton Marking

With specially marked information N/C

Shipping

Shipped k.d. freight prepaid f.o.b. Manitowoc, Wisconsin 54220 factory. Freight class #100.

Specifications and prices are subject to change without prior notice.

Genesis® Worksurfaces

Tripod Corner Pin and Crank Height Adjustable

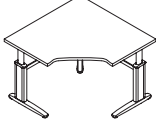
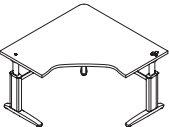
	D x W x W x D	MODEL NUMBER								Approx. Packaged Weight
		Basic Model	Edge Style	Module Location	Modesty Panel	Wire Trough	Base Finish	Edge Color	Surface Finish	
 <p>GCCT Tripod Corner Pin Height Adjustable</p> <ul style="list-style-type: none"> • Corner surface with cockpit front • Three-legged table base • Height adjusts from 24"-31" in 1" increments • Adjustable glides • Wire trough and modesty panel should not be ordered together on adjustable tables 	24 x 42 x 42 x 24"	GCCT24424224S/P	<input type="checkbox"/> <input type="checkbox"/> <input type="checkbox"/>	<input type="checkbox"/> <input type="checkbox"/> <input type="checkbox"/>	<input type="checkbox"/>	<input type="checkbox"/>	<input type="checkbox"/>	<input type="checkbox"/> <input type="checkbox"/> <input type="checkbox"/>	<input type="checkbox"/> <input type="checkbox"/> <input type="checkbox"/>	108.0#
	24 x 48 x 48 x 24"	GCCT24484824S/P	<input type="checkbox"/> <input type="checkbox"/> <input type="checkbox"/>	<input type="checkbox"/> <input type="checkbox"/> <input type="checkbox"/>	<input type="checkbox"/>	<input type="checkbox"/>	<input type="checkbox"/>	<input type="checkbox"/> <input type="checkbox"/> <input type="checkbox"/>	<input type="checkbox"/> <input type="checkbox"/> <input type="checkbox"/>	125.0#
	24 x 54 x 54 x 24"	GCCT24545424S/P	<input type="checkbox"/> <input type="checkbox"/> <input type="checkbox"/>	<input type="checkbox"/> <input type="checkbox"/> <input type="checkbox"/>	<input type="checkbox"/>	<input type="checkbox"/>	<input type="checkbox"/>	<input type="checkbox"/> <input type="checkbox"/> <input type="checkbox"/>	<input type="checkbox"/> <input type="checkbox"/> <input type="checkbox"/>	143.0#
	30 x 42 x 42 x 30"	GCCT30424230S/P	<input type="checkbox"/> <input type="checkbox"/> <input type="checkbox"/>	<input type="checkbox"/> <input type="checkbox"/> <input type="checkbox"/>	<input type="checkbox"/>	<input type="checkbox"/>	<input type="checkbox"/>	<input type="checkbox"/> <input type="checkbox"/> <input type="checkbox"/>	<input type="checkbox"/> <input type="checkbox"/> <input type="checkbox"/>	114.0#
	30 x 48 x 48 x 30"	GCCT30484830S/P	<input type="checkbox"/> <input type="checkbox"/> <input type="checkbox"/>	<input type="checkbox"/> <input type="checkbox"/> <input type="checkbox"/>	<input type="checkbox"/>	<input type="checkbox"/>	<input type="checkbox"/>	<input type="checkbox"/> <input type="checkbox"/> <input type="checkbox"/>	<input type="checkbox"/> <input type="checkbox"/> <input type="checkbox"/>	133.0#
	30 x 54 x 54 x 30"	GCCT30545430S/P	<input type="checkbox"/> <input type="checkbox"/> <input type="checkbox"/>	<input type="checkbox"/> <input type="checkbox"/> <input type="checkbox"/>	<input type="checkbox"/>	<input type="checkbox"/>	<input type="checkbox"/>	<input type="checkbox"/> <input type="checkbox"/> <input type="checkbox"/>	<input type="checkbox"/> <input type="checkbox"/> <input type="checkbox"/>	152.0#
 <p>GCCT Tripod Corner Crank Height Adjustable</p> <ul style="list-style-type: none"> • Corner surface with cockpit front • Three-legged table base • Height adjusts from 22"-33" • Adjustable glides • Worksurfaces are undersized by 1/4" from side-to-side and 1/4" from back-to-front from the stated dimensions • Wire trough and modesty panel should not be ordered together on adjustable tables 	24 x 42 x 42 x 24"	GCCT24424224S/CR	<input type="checkbox"/> <input type="checkbox"/> <input type="checkbox"/>	<input type="checkbox"/> <input type="checkbox"/> <input type="checkbox"/>	<input type="checkbox"/>	<input type="checkbox"/>	<input type="checkbox"/>	<input type="checkbox"/> <input type="checkbox"/> <input type="checkbox"/>	<input type="checkbox"/> <input type="checkbox"/> <input type="checkbox"/>	115.0#
	24 x 48 x 48 x 24"	GCCT24484824S/CR	<input type="checkbox"/> <input type="checkbox"/> <input type="checkbox"/>	<input type="checkbox"/> <input type="checkbox"/> <input type="checkbox"/>	<input type="checkbox"/>	<input type="checkbox"/>	<input type="checkbox"/>	<input type="checkbox"/> <input type="checkbox"/> <input type="checkbox"/>	<input type="checkbox"/> <input type="checkbox"/> <input type="checkbox"/>	132.0#
	24 x 54 x 54 x 24"	GCCT24545424S/CR	<input type="checkbox"/> <input type="checkbox"/> <input type="checkbox"/>	<input type="checkbox"/> <input type="checkbox"/> <input type="checkbox"/>	<input type="checkbox"/>	<input type="checkbox"/>	<input type="checkbox"/>	<input type="checkbox"/> <input type="checkbox"/> <input type="checkbox"/>	<input type="checkbox"/> <input type="checkbox"/> <input type="checkbox"/>	150.0#
	30 x 42 x 42 x 30"	GCCT30424230S/CR	<input type="checkbox"/> <input type="checkbox"/> <input type="checkbox"/>	<input type="checkbox"/> <input type="checkbox"/> <input type="checkbox"/>	<input type="checkbox"/>	<input type="checkbox"/>	<input type="checkbox"/>	<input type="checkbox"/> <input type="checkbox"/> <input type="checkbox"/>	<input type="checkbox"/> <input type="checkbox"/> <input type="checkbox"/>	121.0#
	30 x 48 x 48 x 30"	GCCT30484830S/CR	<input type="checkbox"/> <input type="checkbox"/> <input type="checkbox"/>	<input type="checkbox"/> <input type="checkbox"/> <input type="checkbox"/>	<input type="checkbox"/>	<input type="checkbox"/>	<input type="checkbox"/>	<input type="checkbox"/> <input type="checkbox"/> <input type="checkbox"/>	<input type="checkbox"/> <input type="checkbox"/> <input type="checkbox"/>	140.0#
	30 x 54 x 54 x 30"	GCCT30545430S/CR	<input type="checkbox"/> <input type="checkbox"/> <input type="checkbox"/>	<input type="checkbox"/> <input type="checkbox"/> <input type="checkbox"/>	<input type="checkbox"/>	<input type="checkbox"/>	<input type="checkbox"/>	<input type="checkbox"/> <input type="checkbox"/> <input type="checkbox"/>	<input type="checkbox"/> <input type="checkbox"/> <input type="checkbox"/>	160.0#

A **B** **C** **D** **E** **F** **G** **H**

HOW TO ORDER

Indicate the following information on order form:

1. Quantity of each item.
2. Model number, including options. See "How To Build a Model Number".
3. Any special service required.

Note: • The indicates that a choice is required.

- The absence of the indicates that no choice is required.
- Alpha-numeric characters in place of indicate that no other alternatives are available.

HOW TO BUILD A MODEL NUMBER

- A** Select basic model.

<u>74P</u>	- 74P edge
<u>KN</u>	- Knife edge
<u>MP</u>	- Membrane edge
- B** Select edge style.

<u>74P</u>	- 74P edge
<u>KN</u>	- Knife edge
<u>MP</u>	- Membrane edge
- C** Select PowerUp module location. Select only one from the following and add the appropriate upcharge to the base price.

<u>PUN</u>	- No data
<u>PUL</u>	- Left module; add \$108
<u>PUR</u>	- Right module; add \$108
<u>PUB</u>	- Both left and right modules; add \$218
- D** Select modesty panel option.

<u>NM</u>	- No modesty panel
<u>LM</u>	- LH modesty only
<u>RM</u>	- RH modesty only
<u>WM</u>	- Both modesty panels

Add upcharge to unit price for "LM", "RM" and "WM" options.

- E** Select wire trough and power option.

<u>NW</u>	- No wire trough
<u>WL</u>	- Wire trough LH only
<u>WR</u>	- Wire trough RH only
<u>WW</u>	- Wire trough Both

Add upcharge to unit price for "WL", "WR" and "WW" options.

- F** Select base finish. Refer to color addendum at ki.com or KI Fabrics & Finishes binder.

- G** Select edge/PowerUp/crank grommet color. Refer to color addendum at ki.com or KI Fabrics & Finishes binder. Edge color offerings are based on edge style selections. The color selection will apply to the trim, edge, PowerUp module and crank grommet. Trim color doesn't apply to the membrane edge selection.

- H** Select surface finish. Refer to color addendum at ki.com or KI

Fabrics & Finishes binder. Surface finish offerings are based on edge style selections. Laminate finishes are only available on (74P) 74P edge and (KN) knife edge worksurfaces. The membrane color selections are only available on the (MP) membrane edge worksurfaces.



Genesis® Worksurfaces

Tripod Corner Pin and Crank Height Adjustable

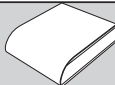
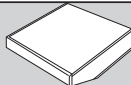
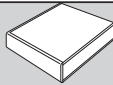

74P Edge
(74P)

Knife Edge
(KN)

Membrane Edge
(MP)

LH
Modesty
Panel
add to list
price

RH
Modesty
Panel
add to list
price

Both
Modesty
Panels
add to list
price

Left
Wire
Trough
add to list
price

Right
Wire
Trough
add to list
price

Both
Wire
Troughs
add to list
price

\$ 1536	\$ 1640	\$ 1640	\$ 178	\$ 178	\$ 358	\$ 430	\$ 430	\$ 860
1602	1706	1706	185	185	374	483	483	964
1753	1843	N/A	197	197	392	500	500	1002
1536	1689	1689	178	178	358	430	430	860
1602	1755	1755	185	185	374	483	483	964
1753	1894	N/A	197	197	392	500	500	1002

\$ 1908	\$ 2014	\$ 2014	\$ 178	\$ 178	\$ 358	\$ 430	\$ 430	\$ 860
1979	2080	2080	185	185	374	483	483	964
2127	2216	N/A	197	197	392	500	500	1002
1908	2063	2063	178	178	358	430	430	860
1979	2129	2129	185	185	374	483	483	964
2127	2263	N/A	197	197	392	500	500	1002

FINISH INFORMATION

Additional Laminate Offering

Additional laminates beyond KI standard offering, are available with two weeks extended leadtime. To specify additional laminates, use these designators followed by the supplier's color/pattern code:

- Formica - LF/supplier's color pattern code
- Nevamar - LN/supplier's color pattern code
- Wilsonart - LW/supplier's color pattern code

KI's standard finish is the supplier's recommended finish for that color/pattern. Note: Nonstandard laminates from these suppliers (example: textured laminates), require an upcharge and additional leadtime. Contact KI.

SPECIAL SERVICES

Special Carton Marking

With specially marked information N/C

Shipping

Shipped k.d. freight prepaid f.o.b. Manitowoc, Wisconsin 54220 factory. Freight class #100.

Specifications and prices are subject to change without prior notice.

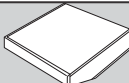
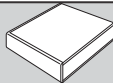

74P Edge
(74P)

Knife Edge
(KN)

Membrane Edge
(MP)

LH
Modesty
Panel
add to list
price

RH
Modesty
Panel
add to list
price

Both
Modesty
Panels
add to list
price

Left
Wire
Trough
add to list
price

Right
Wire
Trough
add to list
price

Both
Wire
Troughs
add to list
price

\$ 2883	\$ 2989	\$ 2989	\$ 185	\$ 185	\$ 374	\$ 483	\$ 483	\$ 964
3034	3123	3123	197	197	392	500	500	1002
2883	3036	3036	185	185	374	483	483	964
3034	3173	3173	197	197	392	500	500	1002

FINISH INFORMATION

Additional Laminate Offering

Additional laminates beyond KI standard offering, are available with two weeks extended leadtime. To specify additional laminates, use these designators followed by the supplier's color/pattern code:

- Formica - LF/supplier's color pattern code
- Nevamar - LN/supplier's color pattern code
- Wilsonart - LW/supplier's color pattern code

KI's standard finish is the supplier's recommended finish for that color/pattern. Note: Nonstandard laminates from these suppliers (example: textured laminates), require an upcharge and additional leadtime. Contact KI.

SPECIAL SERVICES

Special Carton Marking

With specially marked information N/C

Shipping

Shipped k.d. freight prepaid f.o.b. Manitowoc, Wisconsin 54220 factory. Freight class #100.

Specifications and prices are subject to change without prior notice.

Genesis® Worksurfaces

Tripod Corner Electric Height Adjustable

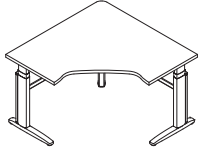

GCTE

Tripod Corner Electric Height Adjustable Single

- Corner surface with cockpit front
- Three-legged table base
- Height adjusts from 24"-51"
- Standard or deluxe up/down switch
- Adjustable glides
- Worksurfaces are undersized by 1-1/4" from side-to-side and 1/2" from back-to-front from the stated dimensions
- Wire trough and modesty panel should not be ordered together on adjustable tables

D x W x W x D	MODEL NUMBER										Approx. Packaged Weight
	Basic Model	Edge Style	Electrical Control	Module Location	Modesty Panel	Wire Trough	Base Finish	Edge Color	Surface Finish		
24 x 42 x 42 x 24"	GCTE24424224S	<input type="checkbox"/> <input type="checkbox"/> <input type="checkbox"/>	<input type="checkbox"/>	<input type="checkbox"/> <input type="checkbox"/> <input type="checkbox"/>	<input type="checkbox"/> <input type="checkbox"/>	<input type="checkbox"/> <input type="checkbox"/>	<input type="checkbox"/> <input type="checkbox"/>	<input type="checkbox"/> <input type="checkbox"/> <input type="checkbox"/>	<input type="checkbox"/> <input type="checkbox"/> <input type="checkbox"/>	<input type="checkbox"/> <input type="checkbox"/>	136.0#
24 x 48 x 48 x 24"	GCTE24484824S	<input type="checkbox"/> <input type="checkbox"/> <input type="checkbox"/>	<input type="checkbox"/>	<input type="checkbox"/> <input type="checkbox"/> <input type="checkbox"/>	<input type="checkbox"/> <input type="checkbox"/>	<input type="checkbox"/> <input type="checkbox"/>	<input type="checkbox"/> <input type="checkbox"/>	<input type="checkbox"/> <input type="checkbox"/> <input type="checkbox"/>	<input type="checkbox"/> <input type="checkbox"/> <input type="checkbox"/>	<input type="checkbox"/> <input type="checkbox"/>	153.0#
24 x 54 x 54 x 24"	GCTE24545424S	<input type="checkbox"/> <input type="checkbox"/> <input type="checkbox"/>	<input type="checkbox"/>	<input type="checkbox"/> <input type="checkbox"/> <input type="checkbox"/>	<input type="checkbox"/> <input type="checkbox"/>	<input type="checkbox"/> <input type="checkbox"/>	<input type="checkbox"/> <input type="checkbox"/>	<input type="checkbox"/> <input type="checkbox"/> <input type="checkbox"/>	<input type="checkbox"/> <input type="checkbox"/> <input type="checkbox"/>	<input type="checkbox"/> <input type="checkbox"/>	171.0#
30 x 42 x 42 x 30"	GCTE30424230S	<input type="checkbox"/> <input type="checkbox"/> <input type="checkbox"/>	<input type="checkbox"/>	<input type="checkbox"/> <input type="checkbox"/> <input type="checkbox"/>	<input type="checkbox"/> <input type="checkbox"/>	<input type="checkbox"/> <input type="checkbox"/>	<input type="checkbox"/> <input type="checkbox"/>	<input type="checkbox"/> <input type="checkbox"/> <input type="checkbox"/>	<input type="checkbox"/> <input type="checkbox"/> <input type="checkbox"/>	<input type="checkbox"/> <input type="checkbox"/>	143.0#
30 x 48 x 48 x 30"	GCTE30484830S	<input type="checkbox"/> <input type="checkbox"/> <input type="checkbox"/>	<input type="checkbox"/>	<input type="checkbox"/> <input type="checkbox"/> <input type="checkbox"/>	<input type="checkbox"/> <input type="checkbox"/>	<input type="checkbox"/> <input type="checkbox"/>	<input type="checkbox"/> <input type="checkbox"/>	<input type="checkbox"/> <input type="checkbox"/> <input type="checkbox"/>	<input type="checkbox"/> <input type="checkbox"/> <input type="checkbox"/>	<input type="checkbox"/> <input type="checkbox"/>	161.0#
30 x 54 x 54 x 30"	GCTE30545430S	<input type="checkbox"/> <input type="checkbox"/> <input type="checkbox"/>	<input type="checkbox"/>	<input type="checkbox"/> <input type="checkbox"/> <input type="checkbox"/>	<input type="checkbox"/> <input type="checkbox"/>	<input type="checkbox"/> <input type="checkbox"/>	<input type="checkbox"/> <input type="checkbox"/>	<input type="checkbox"/> <input type="checkbox"/> <input type="checkbox"/>	<input type="checkbox"/> <input type="checkbox"/> <input type="checkbox"/>	<input type="checkbox"/> <input type="checkbox"/>	180.0#

A **B** **C** **D** **E** **F** **G** **H** **I**

HOW TO ORDER

Indicate the following information on order form:

1. Quantity of each item.
2. Model number, including options. See "How To Build a Model Number".
3. Any special service required.

- Note:
- The indicates that a choice is required.
 - The absence of the indicates that no choice is required.
 - Alpha-numeric characters in place of indicate that no other alternatives are available.

HOW TO BUILD A MODEL NUMBER

- A** Select basic model.
- B** Select edge style.
 - 74P - 74P edge
 - KN - Knife edge
 - MP - Membrane edge
- C** Select electric control style.
 - S - Standard up/down switch
 - D - Deluxe up/down switch; add \$112
- D** Select PowerUp module location. Select only one from the following and add the appropriate upcharge to the base price.
 - PUN - No data
 - PUL - Left module; add \$108
 - PUR - Right module; add \$108
 - PUB - Both left and right modules; add \$218
- E** Select modesty panel option.
 - NM - No modesty panel

- LM - LH modesty only
 - RM - RH modesty only
 - WM - Both modesty panels
- Add upcharge to unit price for "LM", "RM" and "WM" options.
- F** Select wire trough and power option.
 - NW - No wire trough
 - WL - Wire trough LH only
 - WR - Wire trough RH only
 - WW - Wire trough Both
 Add upcharge to unit price for "WL", "WR" and "WW" options.

- G** Select base finish. Refer to color addendum at ki.com or KI Fabrics & Finishes binder.
- H** Select edge/PowerUp color. Refer to color addendum at ki.com or KI Fabrics & Finishes binder. Edge color offerings are based on edge style selections. The color selection will apply to the trim, edge and PowerUp module. Trim color doesn't apply to the
- I** Select surface finish. Refer to color addendum at ki.com or KI Fabrics & Finishes binder. Surface finish offerings are based on edge style selections. Laminate finishes are only available on (74P) 74P edge and (KN) knife edge worksurfaces. The membrane color selections are only available on the (MP) membrane edge worksurfaces.

membrane edge selection.



Genesis® Worksurfaces

Tripod Corner Electric Height Adjustable

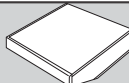
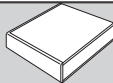

74P Edge
(74P)

Knife Edge
(KN)

Membrane Edge
(MP)

LH
Modesty
Panel
add to list
price

RH
Modesty
Panel
add to list
price

Both
Modesty
Panels
add to list
price

Left
Wire
Trough
add to list
price

Right
Wire
Trough
add to list
price

Both
Wire
Troughs
add to list
price

\$ 3822	\$ 3891	\$ 3891	\$ 178	\$ 178	\$ 358	\$ 430	\$ 430	\$ 860
3854	3957	3957	185	185	374	483	483	964
3777	3980	N/A	197	197	392	500	500	1002
3757	3942	3942	178	178	358	430	430	860
3789	4008	4008	185	185	374	483	483	964
3820	4021	N/A	197	197	392	500	500	1002

FINISH INFORMATION

Additional Laminate Offering

Additional laminates beyond KI standard offering, are available with two weeks extended leadtime. To specify additional laminates, use these designators followed by the supplier's color/pattern code:

- Formica - LF/supplier's color pattern code
- Nevamar - LN/supplier's color pattern code
- Wilsonart - LW/supplier's color pattern code

KI's standard finish is the supplier's recommended finish for that color/pattern. Note: Nonstandard laminates from these suppliers (example: textured laminates), require an upcharge and additional leadtime. Contact KI.

SPECIAL SERVICES

Special Carton Marking

With specially marked information N/C

Shipping

Shipped k.d. freight prepaid f.o.b. Manitowoc, Wisconsin 54220 factory. Freight class #100.

Specifications and prices are subject to change without prior notice.



Genesis® Worksurfaces

Tripod Corner Electric Height Adjustable

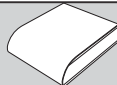
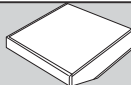
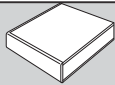

74P Edge
(74P)

Knife Edge
(KN)

Membrane Edge
(MP)

LH
Modesty
Panel
add to list
price

RH
Modesty
Panel
add to list
price

Both
Modesty
Panels
add to list
price

Left
Wire
Trough
add to list
price

Right
Wire
Trough
add to list
price

Both
Wire
Troughs
add to list
price

\$ 4763
4886
4810
4837

\$ 4868
4943
4916
4943

\$ 4868
4943
4916
4943

\$ 185
197
185
197

\$ 185
197
185
197

\$ 374
392
374
392

\$ 483
500
483
500

\$ 483
500
483
500

\$ 964
1002
964
1002

FINISH INFORMATION

Additional Laminate Offering

Additional laminates beyond KI standard offering, are available with two weeks extended leadtime. To specify additional laminates, use these designators followed by the supplier's color/pattern code:

- Formica - LF/supplier's color pattern code
- Nevamar - LN/supplier's color pattern code
- Wilsonart - LW/supplier's color pattern code

KI's standard finish is the supplier's recommended finish for that color/pattern. Note: Nonstandard laminates from these suppliers (example: textured laminates), require an upcharge and additional leadtime. Contact KI.

SPECIAL SERVICES

Special Carton Marking

With specially marked information N/C



Shipping

Shipped k.d. freight prepaid f.o.b. Manitowoc, Wisconsin 54220 factory. Freight class #100.

Specifications and prices are subject to change without prior notice.

Genesis® Worksurfaces

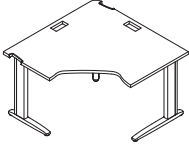
Reduction Tripod Corner Fixed Height

	D x W x W x D	MODEL NUMBER									
		Basic Model	Edge Style	Module Location	Modesty Panel	Wire Trough	Overhead Grommet	Trans. Legs	Base Finish	Edge Color	Surface Finish
 <p>GCCT Reduction Tripod Corner Fixed Height-Left</p> <ul style="list-style-type: none"> • Corner surface with cockpit front • Three-legged table base • Fixed height at 29" • Adjustable glides 	24 x 42 x 42 x 30"	GCCT24424230S/F	<input type="checkbox"/> <input type="checkbox"/> <input type="checkbox"/>	<input type="checkbox"/> <input type="checkbox"/> <input type="checkbox"/>	<input type="checkbox"/> <input type="checkbox"/>	<input type="checkbox"/> <input type="checkbox"/>	<input type="checkbox"/> <input type="checkbox"/> <input type="checkbox"/>	<input type="checkbox"/> <input type="checkbox"/>	<input type="checkbox"/> <input type="checkbox"/>	<input type="checkbox"/> <input type="checkbox"/> <input type="checkbox"/>	<input type="checkbox"/> <input type="checkbox"/>
	24 x 48 x 48 x 30"	GCCT24484830S/F	<input type="checkbox"/> <input type="checkbox"/> <input type="checkbox"/>	<input type="checkbox"/> <input type="checkbox"/> <input type="checkbox"/>	<input type="checkbox"/> <input type="checkbox"/>	<input type="checkbox"/> <input type="checkbox"/>	<input type="checkbox"/> <input type="checkbox"/> <input type="checkbox"/>	<input type="checkbox"/> <input type="checkbox"/>	<input type="checkbox"/> <input type="checkbox"/>	<input type="checkbox"/> <input type="checkbox"/> <input type="checkbox"/>	<input type="checkbox"/> <input type="checkbox"/>
	24 x 54 x 54 x 30"	GCCT24545430S/F	<input type="checkbox"/> <input type="checkbox"/> <input type="checkbox"/>	<input type="checkbox"/> <input type="checkbox"/> <input type="checkbox"/>	<input type="checkbox"/> <input type="checkbox"/>	<input type="checkbox"/> <input type="checkbox"/>	<input type="checkbox"/> <input type="checkbox"/> <input type="checkbox"/>	<input type="checkbox"/> <input type="checkbox"/>	<input type="checkbox"/> <input type="checkbox"/>	<input type="checkbox"/> <input type="checkbox"/> <input type="checkbox"/>	<input type="checkbox"/> <input type="checkbox"/>
 <p>OCR-OCL</p> <ul style="list-style-type: none"> • OCR = Overhead right • OCL = Overhead left 											

A **B** **C** **D** **E** **F** **G** **H** **I** **J**

HOW TO ORDER

Indicate the following information on order form:

1. Quantity of each item.
2. Model number, including options. See "How To Build a Model Number".
3. Any special service required.

Note:

- The indicates that a choice is required.
- The absence of the indicates that no choice is required.
- Alpha-numeric characters in place of indicate that no other alternatives are available.

HOW TO BUILD A MODEL NUMBER

- A** Select basic model.
 - 74P - 74P edge
 - KN - Knife edge
 - MP - Membrane edge
- B** Select edge style.
 - PUN - No data
 - PUL - Left module; add \$108
 - PUR - Right module; add \$108
 - PUB - Both left and right modules; add \$218
- C** Select PowerUp module location. Select only one from the following and add the appropriate upcharge to the base price.
 - PUN - No data
 - PUL - Left module; add \$108
 - PUR - Right module; add \$108
 - PUB - Both left and right modules; add \$218
- D** Select modesty panel option.
 - NM - No modesty panel
 - LM - LH modesty only
 - RM - RH modesty only
 - WM - Both modesty panels
 Add upcharge to unit price for "LM", "RM" and "WM" options.

- E** Select wire trough and power option.
 - NW - No wire trough
 - WL - Wire trough LH only
 - WR - Wire trough RH only
 - WW - Wire trough Both
 Add upcharge to unit price for "WL", "WR" and "WW" options.
- F** Select overhead grommet.
 - OGN - Overhead grommets no
 - OGL - Overhead grommets left
 - OGR - Overhead grommets right
- G** Select transition legs.
 - TS - No transition foot
 - TL - Left transition foot
 - TR - Right transition foot
 - TB - Both transition feet
 TR, TL and TB not allowed on 24" deep dual surfaces.
- H** Select base finish. Refer to color addendum at ki.com or KI Fabrics & Finishes binder.

- I** Select edge/PowerUp/crank grommet color. Refer to color addendum at ki.com or KI Fabrics & Finishes binder. Edge color offerings are based on edge style selections. The color selection will apply to the trim, edge, PowerUp module and crank grommet. Trim color doesn't apply to the membrane edge selection.
- J** Select surface finish. Refer to color addendum at ki.com or KI Fabrics & Finishes binder. Surface finish offerings are based on edge style selections. Laminate finishes are only available on (74P) 74P edge and (KN) knife edge worksurfaces. The membrane color selections are only available on the (MP) membrane edge worksurfaces.

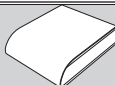
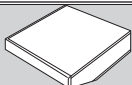
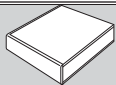

Approx. Packaged Weight	74P Edge (74P)	Knife Edge (KN)	Membrane Edge (MP)	LH Modesty Panel add to list price	RH Modesty Panel add to list price	Both Modesty Panels add to list price	Left Wire Trough add to list price	Right Wire Trough add to list price	Both Wire Troughs add to list price
106.0#	\$ 1338	\$ 1491	\$ 1491	\$ 178	\$ 178	\$ 358	\$ 430	\$ 430	\$ 860
123.0#	1406	1556	1556	185	185	374	483	483	964
141.0#	1553	1669	N/A	197	197	392	500	500	1002

FINISH INFORMATION

Additional Laminate Offering

Additional laminates beyond KI standard offering, are available with two weeks extended leadtime. To specify additional laminates, use these designators followed by the supplier's color/pattern code:

- Formica - LF/supplier's color pattern code
- Nevamar - LN/supplier's color pattern code
- Wilsonart - LW/supplier's color pattern code

KI's standard finish is the supplier's recommended finish for that color/pattern. Note: Nonstandard laminates from these suppliers (example: textured laminates), require an upcharge and additional leadtime. Contact KI.

SPECIAL SERVICES

Special Carton Marking

With specially marked information N/C

Shipping

Shipped k.d. freight prepaid f.o.b. Manitowoc, Wisconsin 54220 factory. Freight class #100.

Specifications and prices are subject to change without prior notice.

Genesis® Worksurfaces

Reduction Tripod Corner Fixed Height

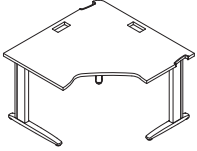
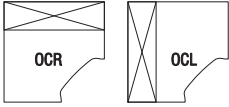
	D x W x W x D	MODEL NUMBER										
		Basic Model	Edge Style	Module Location	Modesty Panel	Wire Trough	Overhead Grommet	Trans. Legs	Base Finish	Edge Color	Surface Finish	
 <p>GCCT Reduction Tripod Corner Fixed Height-Right</p> <ul style="list-style-type: none"> • Corner surface with cockpit front • Three-legged table base • Fixed height at 29" • Adjustable glides 	30 x 42 x 42 x 24"	GCCT30424224S/F	<input type="checkbox"/> <input type="checkbox"/>	<input type="checkbox"/> <input type="checkbox"/>	<input type="checkbox"/>	<input type="checkbox"/>	<input type="checkbox"/> <input type="checkbox"/>	<input type="checkbox"/>	<input type="checkbox"/>	<input type="checkbox"/> <input type="checkbox"/>	<input type="checkbox"/> <input type="checkbox"/>	
	30 x 48 x 48 x 24"	GCCT30484824S/F	<input type="checkbox"/> <input type="checkbox"/>	<input type="checkbox"/> <input type="checkbox"/>	<input type="checkbox"/>	<input type="checkbox"/>	<input type="checkbox"/> <input type="checkbox"/>	<input type="checkbox"/>	<input type="checkbox"/>	<input type="checkbox"/> <input type="checkbox"/>	<input type="checkbox"/> <input type="checkbox"/>	
	30 x 54 x 54 x 24"	GCCT30545424S/F	<input type="checkbox"/> <input type="checkbox"/>	<input type="checkbox"/> <input type="checkbox"/>	<input type="checkbox"/>	<input type="checkbox"/>	<input type="checkbox"/> <input type="checkbox"/>	<input type="checkbox"/>	<input type="checkbox"/>	<input type="checkbox"/> <input type="checkbox"/>	<input type="checkbox"/> <input type="checkbox"/>	
 <p>OCR-OCL</p> <ul style="list-style-type: none"> • OCR = Overhead right • OCL = Overhead left 												
			A	B	C	D	E	F	G	H	I	J

HOW TO ORDER

Indicate the following information on order form:

- Quantity of each item.
- Model number, including options. See "How To Build a Model Number".
- Any special service required.

Note: • The indicates that a choice is required.
 • The absence of the indicates that no choice is required.
 • Alpha-numeric characters in place of indicate that no other alternatives are available.

HOW TO BUILD A MODEL NUMBER

- A** Select basic model.
- B** Select edge style.
 - 74P - 74P edge
 - KN - Knife edge
 - MP - Membrane edge
- C** Select PowerUp module location. Select only one from the following and add the appropriate upcharge to the base price.
 - PUN - No data
 - PUL - Left module; add \$108
 - PUR - Right module; add \$108
 - PUB - Both left and right modules; add \$218
- D** Select modesty panel option.
 - NM - No modesty panel
 - LM - LH modesty only
 - RM - RH modesty only
 - WM - Both modesty panels
 Add upcharge to unit price for "LM", "RM" and "WM" options.

- E** Select wire trough and power option.
 - NW - No wire trough
 - WL - Wire trough LH only
 - WR - Wire trough RH only
 - WW - Wire trough Both
 Add upcharge to unit price for "WL", "WR" and "WW" options.
- F** Select overhead grommet.
 - OGN - Overhead grommets no
 - OGL - Overhead grommets left
 - OGR - Overhead grommets right
- G** Select transition legs.
 - TS - No transition foot
 - TL - Left transition foot
 - TR - Right transition foot
 - TB - Both transition feet
 TR, TL and TB not allowed on 24" deep dual surfaces.
- H** Select base finish. Refer to color addendum at ki.com or KI Fabrics & Finishes binder.

- I** Select edge/PowerUp/crank grommet color. Refer to color addendum at ki.com or KI Fabrics & Finishes binder. Edge color offerings are based on edge style selections. The color selection will apply to the trim, edge, PowerUp module and crank grommet. Trim color doesn't apply to the membrane edge selection.
- J** Select surface finish. Refer to color addendum at ki.com or KI Fabrics & Finishes binder. Surface finish offerings are based on edge style selections. Laminate finishes are only available on (74P) 74P edge and (KN) knife edge worksurfaces. The membrane color selections are only available on the (MP) membrane edge worksurfaces.

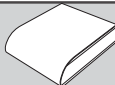
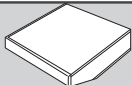
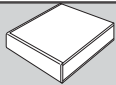

Approx. Packaged Weight	74P Edge (74P)	Knife Edge (KN)	Membrane Edge (MP)	LH Modesty Panel add to list price	RH Modesty Panel add to list price	Both Modesty Panels add to list price	Left Wire Trough add to list price	Right Wire Trough add to list price	Both Wire Troughs add to list price
106.0#	\$ 1338	\$ 1491	\$ 1491	\$ 178	\$ 178	\$ 358	\$ 430	\$ 430	\$ 860
123.0#	1406	1556	1556	185	185	374	483	483	964
141.0#	1553	1669	N/A	197	197	392	500	500	1002

FINISH INFORMATION

Additional Laminate Offering

Additional laminates beyond KI standard offering, are available with two weeks extended leadtime. To specify additional laminates, use these designators followed by the supplier's color/pattern code:

- Formica - LF/supplier's color pattern code
- Nevamar - LN/supplier's color pattern code
- Wilsonart - LW/supplier's color pattern code

KI's standard finish is the supplier's recommended finish for that color/pattern. Note: Nonstandard laminates from these suppliers (example: textured laminates), require an upcharge and additional leadtime. Contact KI.

SPECIAL SERVICES

Special Carton Marking

With specially marked information N/C

Shipping

Shipped k.d. freight prepaid f.o.b. Manitowoc, Wisconsin 54220 factory. Freight class #100.

Specifications and prices are subject to change without prior notice.

Genesis® Worksurfaces

Reduction Tripod Corner Fixed Height Dual

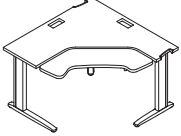
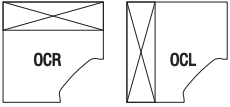
	D x W x W x D	MODEL NUMBER										
		Basic Model	Edge Style	Module Location	Modesty Panel	Wire Trough	Overhead Grommet	Trans. Legs	Base Finish	Edge Color	Surface Finish	
 <p>GCCT Reduction Tripod Corner Fixed Height Dual-Left</p> <ul style="list-style-type: none"> • Corner surface with cockpit front • Three-legged table base • Fixed height at 29" • Keyboard surface adjusts 5" above/below primary surface. • Keyboard surface tilts +/- 15° • Adjustable glides 	24 x 48 x 48 x 30"	GCCT24484830D/F	<input type="checkbox"/> <input type="checkbox"/> <input type="checkbox"/>	<input type="checkbox"/> <input type="checkbox"/> <input type="checkbox"/>	<input type="checkbox"/> <input type="checkbox"/>	<input type="checkbox"/> <input type="checkbox"/>	<input type="checkbox"/> <input type="checkbox"/> <input type="checkbox"/>	<input type="checkbox"/> <input type="checkbox"/>	<input type="checkbox"/> <input type="checkbox"/>	<input type="checkbox"/> <input type="checkbox"/> <input type="checkbox"/>	<input type="checkbox"/> <input type="checkbox"/>	
	24 x 54 x 54 x 30"	GCCT24545430D/F	<input type="checkbox"/> <input type="checkbox"/> <input type="checkbox"/>	<input type="checkbox"/> <input type="checkbox"/> <input type="checkbox"/>	<input type="checkbox"/> <input type="checkbox"/>	<input type="checkbox"/> <input type="checkbox"/>	<input type="checkbox"/> <input type="checkbox"/> <input type="checkbox"/>	<input type="checkbox"/> <input type="checkbox"/>	<input type="checkbox"/> <input type="checkbox"/>	<input type="checkbox"/> <input type="checkbox"/> <input type="checkbox"/>	<input type="checkbox"/> <input type="checkbox"/>	
 <p>OCR-OCL</p> <ul style="list-style-type: none"> • OCR = Overhead right • OCL = Overhead left 												
			A	B	C	D	E	F	G	H	I	J

HOW TO ORDER

Indicate the following information on order form:

- Quantity of each item.
- Model number, including options. See "How To Build a Model Number".
- Any special service required.

Note:

- The indicates that a choice is required.
- The absence of the indicates that no choice is required.
- Alpha-numeric characters in place of indicate that no other alternatives are available.

HOW TO BUILD A MODEL NUMBER

- A** Select basic model.
 - 74P - 74P edge
 - KN - Knife edge
 - MP - Membrane edge
- B** Select edge style.
 - PUN - No data
 - PUL - Left module; add \$108
 - PUR - Right module; add \$108
 - PUB - Both left and right modules; add \$218
- C** Select PowerUp module location. Select only one from the following and add the appropriate upcharge to the base price.
 - PUN - No data
 - PUL - Left module; add \$108
 - PUR - Right module; add \$108
 - PUB - Both left and right modules; add \$218
- D** Select modesty panel option.
 - NM - No modesty panel
 - LH - LH modesty only
 - RM - RH modesty only
 - WM - Both modesty panels

Add upcharge to unit price for "LM", "RM" and "WM" options.

- E** Select wire trough and power option.
 - NW - No wire trough
 - WL - Wire trough LH only
 - WR - Wire trough RH only
 - WW - Wire trough Both



Add upcharge to unit price for "WL", "WR" and "WW" options.
- F** Select overhead grommet.
 - OGN - Overhead grommets no
 - OGL - Overhead grommets left
 - OGR - Overhead grommets right
- G** Select transition legs.
 - TS - No transition foot
 - TR - Right transition foot

TR, TL and TB not allowed on 24" deep dual surfaces.
- H** Select base finish. Refer to color addendum at ki.com or KI Fabrics & Finishes binder.
- I** Select edge/PowerUp/crank grommet

color. Refer to color addendum at ki.com or KI Fabrics & Finishes binder. Edge color offerings are based on edge style selections. The color selection will apply to the trim, edge, PowerUp module and crank grommet. Trim color doesn't apply to the membrane edge selection.

J Select surface finish. Refer to color addendum at ki.com or KI Fabrics & Finishes binder. Surface finish offerings are based on edge style selections. Laminate finishes are only available on (74P) 74P edge and (KN) knife edge worksurfaces. The membrane color selections are only available on the (MP) membrane edge worksurfaces.

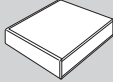
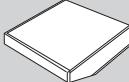

Approx. Packaged Weight	 74P Edge (74P)	 Knife Edge (KN)	 Membrane Edge (MP)	LH Modesty Panel add to list price	RH Modesty Panel add to list price	Both Modesty Panels add to list price	Left Wire Trough add to list price	Right Wire Trough add to list price	Both Wire Troughs add to list price
143.0#	\$ 2311	\$ 2466	\$ 2466	\$ 185	\$ 185	\$ 374	\$ 483	\$ 483	\$ 964
161.0#	2461	2575	2575	197	197	392	500	500	1002

FINISH INFORMATION

Additional Laminate Offering

Additional laminates beyond KI standard offering, are available with two weeks extended leadtime. To specify additional laminates, use these designators followed by the supplier's color/pattern code:

- Formica - LF/supplier's color pattern code
- Nevamar - LN/supplier's color pattern code
- Wilsonart - LW/supplier's color pattern code

KI's standard finish is the supplier's recommended finish for that color/pattern. Note: Nonstandard laminates from these suppliers (example: textured laminates), require an upcharge and additional leadtime. Contact KI.

SPECIAL SERVICES

Special Carton Marking

With specially marked information N/C

Shipping

Shipped **k.d. freight prepaid f.o.b. Manitowoc, Wisconsin 54220** factory. Freight class #100.

Specifications and prices are subject to change without prior notice.

Genesis® Worksurfaces

Reduction Tripod Corner Fixed Height Dual

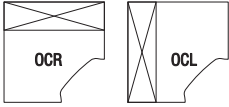
	D x W x W x D	MODEL NUMBER										
		Basic Model	Edge Style	Module Location	Modesty Panel	Wire Trough	Overhead Grommet	Trans. Legs	Base Finish	Edge Color	Surface Finish	
 <p>GCCT Reduction Tripod Corner Fixed Height Dual-Right</p> <ul style="list-style-type: none"> • Corner surface with cockpit front • Three-legged table base • Fixed height at 29" • Keyboard surface adjusts 5" above/below primary surface. • Keyboard surface tilts +/- 15° • Adjustable glides 	30 x 48 x 48 x 24"	GCCT30484824D/F	<input type="checkbox"/> <input type="checkbox"/>	<input type="checkbox"/> <input type="checkbox"/>	<input type="checkbox"/>	<input type="checkbox"/>	<input type="checkbox"/> <input type="checkbox"/>	<input type="checkbox"/>	<input type="checkbox"/>	<input type="checkbox"/> <input type="checkbox"/>	<input type="checkbox"/> <input type="checkbox"/>	
	30 x 54 x 54 x 24"	GCCT30545424D/F	<input type="checkbox"/> <input type="checkbox"/>	<input type="checkbox"/> <input type="checkbox"/>	<input type="checkbox"/>	<input type="checkbox"/>	<input type="checkbox"/> <input type="checkbox"/>	<input type="checkbox"/>	<input type="checkbox"/>	<input type="checkbox"/> <input type="checkbox"/>	<input type="checkbox"/> <input type="checkbox"/>	
 <p>OCR-OCL</p> <ul style="list-style-type: none"> • OCR = Overhead right • OCL = Overhead left 												
			A	B	C	D	E	F	G	H	I	J

HOW TO ORDER

Indicate the following information on order form:

- Quantity of each item.
- Model number, including options. See "How To Build a Model Number".
- Any special service required.

Note: • The indicates that a choice is required.
 • The absence of the indicates that no choice is required.
 • Alpha-numeric characters in place of indicate that no other alternatives are available.

HOW TO BUILD A MODEL NUMBER

- A** Select basic model.

74P - 74P edge
KN - Knife edge
MP - Membrane edge
- C** Select PowerUp module location.
 Select only one from the following and add the appropriate upcharge to the base price.
PUN - No data
PUL - Left module; add \$108
PUR - Right module; add \$108
PUB - Both left and right modules; add \$218
- D** Select modesty panel option.

NM - No modesty panel
LM - LH modesty only
RM - RH modesty only
WM - Both modesty panels
 Add upcharge to unit price for "LM", "RM" and "WM" options.

- E** Select wire trough and power option.

NW - No wire trough
WL - Wire trough LH only
WR - Wire trough RH only
WW - Wire trough Both
 Add upcharge to unit price for "WL", "WR" and "WW" options.
- F** Select overhead grommet.

OGN - Overhead grommets no
OGL - Overhead grommets left
OGR - Overhead grommets right
- G** Select transition legs.

TS - No transition foot
TL - Left transition foot
 TR, TL and TB not allowed on 24" deep dual surfaces.
- H** Select base finish.
 Refer to color addendum at ki.com or KI Fabrics & Finishes binder.
- I** Select edge/PowerUp/crank grommet

color.
 Refer to color addendum at ki.com or KI Fabrics & Finishes binder.
 Edge color offerings are based on edge style selections. The color selection will apply to the trim, edge, PowerUp module and crank grommet. Trim color doesn't apply to the membrane edge selection.

J Select surface finish.
 Refer to color addendum at ki.com or KI Fabrics & Finishes binder.
 Surface finish offerings are based on edge style selections. Laminate finishes are only available on (74P) 74P edge and (KN) knife edge worksurfaces. The membrane color selections are only available on the (MP) membrane edge worksurfaces.



Genesis® Worksurfaces

Reduction Tripod Corner Fixed Height Dual

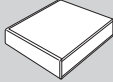
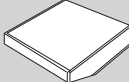
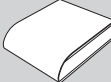
Approx. Packaged Weight	 74P Edge (74P)	 Knife Edge (KN)	 Membrane Edge (MP)	LH Modesty Panel add to list price	RH Modesty Panel add to list price	Both Modesty Panels add to list price	Left Wire Trough add to list price	Right Wire Trough add to list price	Both Wire Troughs add to list price
143.0#	\$ 2311	\$ 2466	\$ 2466	\$ 185	\$ 185	\$ 374	\$ 483	\$ 483	\$ 964
161.0#	2461	2575	2575	197	197	392	500	500	1002

FINISH INFORMATION

Additional Laminate Offering

Additional laminates beyond KI standard offering, are available with two weeks extended leadtime. To specify additional laminates, use these designators followed by the supplier's color/pattern code:

- Formica - LF/supplier's color pattern code
- Nevamar - LN/supplier's color pattern code
- Wilsonart - LW/supplier's color pattern code

KI's standard finish is the supplier's recommended finish for that color/pattern. Note: Nonstandard laminates from these suppliers (example: textured laminates), require an upcharge and additional leadtime. Contact KI.

SPECIAL SERVICES

Special Carton Marking

With specially marked information N/C

Shipping

Shipped k.d. freight prepaid f.o.b. Manitowoc, Wisconsin 54220 factory. Freight class #100.

Specifications and prices are subject to change without prior notice.

Genesis® Worksurfaces

Reduction Tripod Corner Pin Height Adjustable

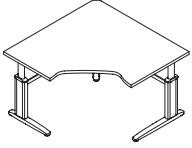
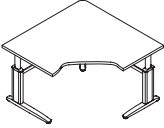
	D x W x W x D	MODEL NUMBER								Approx. Packaged Weight
		Basic Model	Edge Style	Module Location	Modesty Panel	Wire Trough	Base Finish	Edge Color	Surface Finish	
 <p>GCCT Reduction Tripod Corner Pin Height Adjustable-Left</p> <ul style="list-style-type: none"> • Corner surface with cockpit front • Three-legged table base • Height adjusts from 24"-31" in 1" increments • Adjustable glides • Wire trough and modesty panel should not be ordered together on adjustable tables 	24 x 42 x 42 x 30"	GCCT24424230S/P	<input type="checkbox"/>	<input type="checkbox"/>	<input type="checkbox"/>	<input type="checkbox"/>	112.0#			
	24 x 48 x 48 x 30"	GCCT24484830S/P	<input type="checkbox"/>	<input type="checkbox"/>	<input type="checkbox"/>	<input type="checkbox"/>	129.0#			
	24 x 54 x 54 x 30"	GCCT24545430S/P	<input type="checkbox"/>	<input type="checkbox"/>	<input type="checkbox"/>	<input type="checkbox"/>	148.0#			
 <p>GCCT Reduction Tripod Corner Pin Height Adjustable-Right</p> <ul style="list-style-type: none"> • Corner surface with cockpit front • Three-legged table base • Height adjusts from 24"-31" in 1" increments • Adjustable glides • Wire trough and modesty panel should not be ordered together on adjustable tables 	30 x 42 x 42 x 24"	GCCT30424224S/P	<input type="checkbox"/>	<input type="checkbox"/>	<input type="checkbox"/>	<input type="checkbox"/>	112.0#			
	30 x 48 x 48 x 24"	GCCT30484824S/P	<input type="checkbox"/>	<input type="checkbox"/>	<input type="checkbox"/>	<input type="checkbox"/>	129.0#			
	30 x 54 x 54 x 24"	GCCT30545424S/P	<input type="checkbox"/>	<input type="checkbox"/>	<input type="checkbox"/>	<input type="checkbox"/>	148.0#			

A **B** **C** **D** **E** **F** **G** **H**

HOW TO ORDER

Indicate the following information on order form:

1. Quantity of each item.
2. Model number, including options. See "How To Build a Model Number".
3. Any special service required.

Note: • The indicates that a choice is required.

- The absence of the indicates that no choice is required.
- Alpha-numeric characters in place of indicate that no other alternatives are available.

HOW TO BUILD A MODEL NUMBER

- A** Select basic model.
 - 74P - 74P edge
 - KN - Knife edge
 - MP - Membrane edge
- B** Select edge style.
 - 74P - 74P edge
 - KN - Knife edge
 - MP - Membrane edge
- C** Select PowerUp module location. Select only one from the following and add the appropriate upcharge to the base price.
 - PUN - No data
 - PUL - Left module; add \$108
 - PUR - Right module; add \$108
 - PUB - Both left and right modules; add \$218
- D** Select modesty panel option.
 - NM - No modesty panel
 - LM - LH modesty only
 - RM - RH modesty only
 - WM - Both modesty panels

Add upcharge to unit price for "LM", "RM" and "WM" options.

- E** Select wire trough and power option.
 - NW - No wire trough
 - WL - Wire trough LH only
 - WR - Wire trough RH only
 - WW - Wire trough Both

Add upcharge to unit price for "WL", "WR" and "WW" options.

- F** Select base finish. Refer to color addendum at ki.com or KI Fabrics & Finishes binder.

- G** Select edge/PowerUp/crank grommet color. Refer to color addendum at ki.com or KI Fabrics & Finishes binder. Edge color offerings are based on edge style selections. The color selection will apply to the trim, edge, PowerUp module and crank grommet. Trim color doesn't apply to the membrane edge selection.

- H** Select surface finish. Refer to color addendum at ki.com or KI

Fabrics & Finishes binder. Surface finish offerings are based on edge style selections. Laminate finishes are only available on (74P) 74P edge and (KN) knife edge worksurfaces. The membrane color selections are only available on the (MP) membrane edge worksurfaces.



Genesis® Worksurfaces
Reduction Tripod Corner Pin Height Adjustable

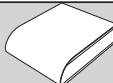
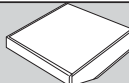
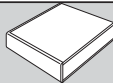

74P Edge
(74P)

Knife Edge
(KN)

Membrane Edge
(MP)

LH
Modesty
Panel
add to list
price

RH
Modesty
Panel
add to list
price

Both
Modesty
Panels
add to list
price

Left
Wire
Trough
add to list
price

Right
Wire
Trough
add to list
price

Both
Wire
Troughs
add to list
price

\$ 1536	\$ 1689	\$ 1689	\$ 178	\$ 178	\$ 358	\$ 430	\$ 430	\$ 860
1602	1755	1755	185	185	374	483	483	964
1753	1894	N/A	197	197	392	500	500	1002

\$ 1536	\$ 1689	\$ 1689	\$ 178	\$ 178	\$ 358	\$ 430	\$ 430	\$ 860
1602	1755	1755	185	185	374	483	483	964
1753	1894	N/A	197	197	392	500	500	1002

FINISH INFORMATION

Additional Laminate Offering

Additional laminates beyond KI standard offering, are available with two weeks extended leadtime. To specify additional laminates, use these designators followed by the supplier's color/pattern code:

- Formica - LF/supplier's color pattern code
- Nevamar - LN/supplier's color pattern code
- Wilsonart - LW/supplier's color pattern code

KI's standard finish is the supplier's recommended finish for that color/pattern. Note: Nonstandard laminates from these suppliers (example: textured laminates), require an upcharge and additional leadtime. Contact KI.

SPECIAL SERVICES

Special Carton Marking

With specially marked information N/C

Shipping

Shipped k.d. freight prepaid f.o.b. Manitowoc, Wisconsin 54220 factory. Freight class #100.

Specifications and prices are subject to change without prior notice.

Genesis® Worksurfaces

Reduction Tripod Corner Crank Height Adjustable

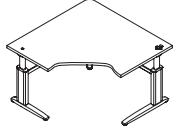
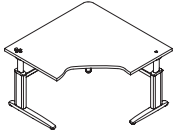
	D x W x W x D	MODEL NUMBER								Approx. Packaged Weight
		Basic Model	Edge Style	Module Location	Modesty Panel	Wire Trough	Base Finish	Edge Color	Surface Finish	
 <p>GCCT Reduction Tripod Corner Crank Height Adjustable-Left</p> <ul style="list-style-type: none"> • Corner surface with cockpit front • Three-legged table base • Height adjusts from 22"-33" • Adjustable glides • Worksurfaces are undersized by 1/4" from side-to-side and 1/4" from back-to-front from the stated dimensions • Wire trough and modesty panel should not be ordered together on adjustable tables 	24 x 48 x 48 x 30"	GCCT24484830S/CR	<input type="checkbox"/> <input type="checkbox"/> <input type="checkbox"/>	<input type="checkbox"/> <input type="checkbox"/> <input type="checkbox"/>	<input type="checkbox"/>	<input type="checkbox"/> <input type="checkbox"/>	<input type="checkbox"/>	<input type="checkbox"/> <input type="checkbox"/> <input type="checkbox"/>	<input type="checkbox"/> <input type="checkbox"/>	136.0#
	24 x 54 x 54 x 30"	GCCT24545430S/CR	<input type="checkbox"/> <input type="checkbox"/> <input type="checkbox"/>	<input type="checkbox"/> <input type="checkbox"/> <input type="checkbox"/>	<input type="checkbox"/>	<input type="checkbox"/> <input type="checkbox"/>	<input type="checkbox"/>	<input type="checkbox"/> <input type="checkbox"/> <input type="checkbox"/>	<input type="checkbox"/> <input type="checkbox"/>	155.0#
 <p>GCCT Reduction Tripod Corner Crank Height Adjustable-Right</p> <ul style="list-style-type: none"> • Corner surface with cockpit front • Three-legged table base • Height adjusts from 22"-33" • Adjustable glides • Worksurfaces are undersized by 1/4" from side-to-side and 1/4" from back-to-front from the stated dimensions • Wire trough and modesty panel should not be ordered together on adjustable tables 	30 x 48 x 48 x 24"	GCCT30484824S/CR	<input type="checkbox"/> <input type="checkbox"/> <input type="checkbox"/>	<input type="checkbox"/> <input type="checkbox"/> <input type="checkbox"/>	<input type="checkbox"/>	<input type="checkbox"/> <input type="checkbox"/>	<input type="checkbox"/>	<input type="checkbox"/> <input type="checkbox"/> <input type="checkbox"/>	<input type="checkbox"/> <input type="checkbox"/>	136.0#
	30 x 54 x 54 x 24"	GCCT30545424S/CR	<input type="checkbox"/> <input type="checkbox"/> <input type="checkbox"/>	<input type="checkbox"/> <input type="checkbox"/> <input type="checkbox"/>	<input type="checkbox"/>	<input type="checkbox"/> <input type="checkbox"/>	<input type="checkbox"/>	<input type="checkbox"/> <input type="checkbox"/> <input type="checkbox"/>	<input type="checkbox"/> <input type="checkbox"/>	155.0#

A B C D E F G H

HOW TO ORDER

Indicate the following information on order form:

- Quantity of each item.
- Model number, including options. See "How To Build a Model Number".
- Any special service required.

Note: • The indicates that a choice is required.

- The absence of the indicates that no choice is required.
- Alpha-numeric characters in place of indicate that no other alternatives are available.

HOW TO BUILD A MODEL NUMBER

- A** Select basic model.
 - 74P - 74P edge
 - KN - Knife edge
 - MP - Membrane edge
- B** Select edge style.
 - PUN - No data
 - PUL - Left module; add \$108
 - PUR - Right module; add \$108
 - PUB - Both left and right modules; add \$218
- C** Select PowerUp module location. Select only one from the following and add the appropriate upcharge to the base price.
 - NM - No modesty panel
 - LM - LH modesty only
 - RM - RH modesty only
 - WM - Both modesty panels
 Add upcharge to unit price for "LM", "RM" and "WM" options.
- D** Select modesty panel option.
 - NM - No modesty panel
 - LM - LH modesty only
 - RM - RH modesty only
 - WM - Both modesty panels
 Add upcharge to unit price for "LM", "RM" and "WM" options.

- E** Select wire trough and power option.
 - NW - No wire trough
 - WL - Wire trough LH only
 - WR - Wire trough RH only
 - WW - Wire trough Both
 Add upcharge to unit price for "WL", "WR" and "WW" options.

- F** Select base finish. Refer to color addendum at ki.com or KI Fabrics & Finishes binder.

- G** Select edge/PowerUp/crank grommet color. Refer to color addendum at ki.com or KI Fabrics & Finishes binder. Edge color offerings are based on edge style selections. The color selection will apply to the trim, edge, PowerUp module and crank grommet. Trim color doesn't apply to the membrane edge selection.

- H** Select surface finish. Refer to color addendum at ki.com or KI

Fabrics & Finishes binder. Surface finish offerings are based on edge style selections. Laminate finishes are only available on (74P) 74P edge and (KN) knife edge worksurfaces. The membrane color selections are only available on the (MP) membrane edge worksurfaces.



Genesis® Worksurfaces

Reduction Tripod Corner Crank Height Adjustable

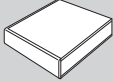
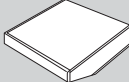
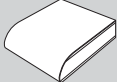
			LH Modesty Panel add to list price	RH Modesty Panel add to list price	Both Modesty Panels add to list price	Left Wire Trough add to list price	Right Wire Trough add to list price	Both Wire Troughs add to list price
\$ 1979 2127	\$ 2129 2263	\$ 2129 N/A	\$ 185 197	\$ 185 197	\$ 374 392	\$ 483 500	\$ 483 500	\$ 964 1002

\$ 1979 2127	\$ 2129 2263	\$ 2129 N/A	\$ 185 197	\$ 185 197	\$ 374 392	\$ 483 500	\$ 483 500	\$ 964 1002
-----------------	-----------------	----------------	---------------	---------------	---------------	---------------	---------------	----------------

FINISH INFORMATION

Additional Laminate Offering

Additional laminates beyond KI standard offering, are available with two weeks extended leadtime. To specify additional laminates, use these designators followed by the supplier's color/pattern code:

- Formica - LF/supplier's color pattern code
- Nevamar - LN/supplier's color pattern code
- Wilsonart - LW/supplier's color pattern code

KI's standard finish is the supplier's recommended finish for that color/pattern. Note: Nonstandard laminates from these suppliers (example: textured laminates), require an upcharge and additional leadtime. Contact KI.

SPECIAL SERVICES

Special Carton Marking

With specially marked information N/C

Shipping

Shipped **k.d. freight prepaid f.o.b. Manitowoc, Wisconsin 54220** factory. Freight class #100.

Specifications and prices are subject to change without prior notice.

Genesis® Worksurfaces

Reduction Tripod Corner Crank Height Dual

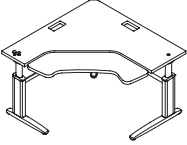
	D x W x W x D	MODEL NUMBER								Approx. Packaged Weight
		Basic Model	Edge Style	Module Location	Modesty Panel	Wire Trough	Base Finish	Edge Color	Surface Finish	
	24 x 48 x 48 x 30"	GCCT24484830D/CR	<input type="checkbox"/> <input type="checkbox"/> <input type="checkbox"/>	<input type="checkbox"/> <input type="checkbox"/> <input type="checkbox"/>	<input type="checkbox"/> <input type="checkbox"/>	<input type="checkbox"/> <input type="checkbox"/>	<input type="checkbox"/> <input type="checkbox"/>	<input type="checkbox"/> <input type="checkbox"/> <input type="checkbox"/>	<input type="checkbox"/> <input type="checkbox"/> <input type="checkbox"/>	156.0#
	24 x 54 x 54 x 30"	GCCT24545430D/CR	<input type="checkbox"/> <input type="checkbox"/> <input type="checkbox"/>	<input type="checkbox"/> <input type="checkbox"/> <input type="checkbox"/>	<input type="checkbox"/> <input type="checkbox"/>	<input type="checkbox"/> <input type="checkbox"/>	<input type="checkbox"/> <input type="checkbox"/>	<input type="checkbox"/> <input type="checkbox"/> <input type="checkbox"/>	<input type="checkbox"/> <input type="checkbox"/> <input type="checkbox"/>	175.0#
<p>GCCT</p> <p>Reduction Tripod Corner Crank Height Dual-Left</p> <ul style="list-style-type: none"> • Corner surface with cockpit front • Three-legged table base • Height adjusts from 22"-33" • Keyboard surface adjusts 5" above/below primary surface. • Keyboard surface tilts +/- 15° • Adjustable glides • Worksurfaces are undersized by 1/4" from side-to-side and 1/4" from back-to-front from the stated dimensions • Wire trough and modesty panel should not be ordered together on adjustable tables 										
<p>A B C D E F G H</p>										

HOW TO ORDER

Indicate the following information on order form:

1. Quantity of each item.
2. Model number, including options. See "How To Build a Model Number".
3. Any special service required.

Note:

- The indicates that a choice is required.
- The absence of the indicates that no choice is required.
- Alpha-numeric characters in place of indicate that no other alternatives are available.

HOW TO BUILD A MODEL NUMBER

- A** Select basic model.

<u>74P</u>	- 74P edge
<u>KN</u>	- Knife edge
<u>MP</u>	- Membrane edge
- B** Select edge style.

<u>74P</u>	- 74P edge
<u>KN</u>	- Knife edge
<u>MP</u>	- Membrane edge
- C** Select PowerUp module location. Select only one from the following and add the appropriate upcharge to the base price.

<u>PUN</u>	- No data
<u>PUL</u>	- Left module; add \$108
<u>PUR</u>	- Right module; add \$108
<u>PUB</u>	- Both left and right modules; add \$218
- D** Select modesty panel option.

<u>NM</u>	- No modesty panel
<u>LM</u>	- LH modesty only
<u>RM</u>	- RH modesty only
<u>WM</u>	- Both modesty panels

Add upcharge to unit price for "LM", "RM" and "WM" options.

- E** Select wire trough and power option.

<u>NW</u>	- No wire trough
<u>WL</u>	- Wire trough LH only
<u>WR</u>	- Wire trough RH only
<u>WW</u>	- Wire trough Both

Add upcharge to unit price for "WL", "WR" and "WW" options.
- F** Select base finish. Refer to color addendum at ki.com or KI Fabrics & Finishes binder.
- G** Select edge/PowerUp/crank grommet color. Refer to color addendum at ki.com or KI Fabrics & Finishes binder. Edge color offerings are based on edge style selections. The color selection will apply to the trim, edge, PowerUp module and crank grommet. Trim color doesn't apply to the membrane edge selection.
- H** Select surface finish. Refer to color addendum at ki.com or KI

Fabrics & Finishes binder. Surface finish offerings are based on edge style selections. Laminate finishes are only available on (74P) 74P edge and (KN) knife edge worksurfaces. The membrane color selections are only available on the (MP) membrane edge worksurfaces.



74P Edge (74P)	Knife Edge (KN)	Membrane Edge (MP)	LH Modesty Panel add to list price	RH Modesty Panel add to list price	Both Modesty Panels add to list price	Left Wire Trough add to list price	Right Wire Trough add to list price	Both Wire Troughs add to list price
\$ 2883	\$ 3036	\$ 3036	\$ 185	\$ 185	\$ 374	\$ 483	\$ 483	\$ 964
3034	3173	3173	197	197	392	500	500	1002

FINISH INFORMATION

Additional Laminate Offering

Additional laminates beyond KI standard offering, are available with two weeks extended leadtime. To specify additional laminates, use these designators followed by the supplier's color/pattern code:

- Formica - LF/supplier's color pattern code
- Nevamar - LN/supplier's color pattern code
- Wilsonart - LW/supplier's color pattern code

KI's standard finish is the supplier's recommended finish for that color/pattern. Note: Nonstandard laminates from these suppliers (example: textured laminates), require an upcharge and additional leadtime. Contact KI.

SPECIAL SERVICES

Special Carton Marking

With specially marked information N/C

Shipping

Shipped **k.d. freight prepaid f.o.b. Manitowoc, Wisconsin 54220** factory. Freight class #100.

Specifications and prices are subject to change without prior notice.



74P Edge (74P)	Knife Edge (KN)	Membrane Edge (MP)	LH Modesty Panel add to list price	RH Modesty Panel add to list price	Both Modesty Panels add to list price	Left Wire Trough add to list price	Right Wire Trough add to list price	Both Wire Troughs add to list price
\$ 2883	\$ 3036	\$ 3036	\$ 185	\$ 185	\$ 374	\$ 483	\$ 483	\$ 964
3034	3173	3173	197	197	392	500	500	1002

FINISH INFORMATION

Additional Laminate Offering

Additional laminates beyond KI standard offering, are available with two weeks extended leadtime. To specify additional laminates, use these designators followed by the supplier's color/pattern code:

- Formica - LF/supplier's color pattern code
- Nevamar - LN/supplier's color pattern code
- Wilsonart - LW/supplier's color pattern code

KI's standard finish is the supplier's recommended finish for that color/pattern. Note: Nonstandard laminates from these suppliers (example: textured laminates), require an upcharge and additional leadtime. Contact KI.

SPECIAL SERVICES

Special Carton Marking

With specially marked information N/C

Shipping

Shipped k.d. freight prepaid f.o.b. Manitowoc, Wisconsin 54220 factory. Freight class #100.

Specifications and prices are subject to change without prior notice.



Genesis® Worksurfaces

Reduction Tripod Corner Electric Height Adjustable

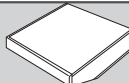
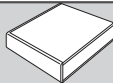

74P Edge
(74P)

Knife Edge
(KN)

Membrane Edge
(MP)

LH
Modesty
Panel
add to list
price

RH
Modesty
Panel
add to list
price

Both
Modesty
Panels
add to list
price

Left
Wire
Trough
add to list
price

Right
Wire
Trough
add to list
price

Both
Wire
Troughs
add to list
price

\$ 3822

\$ 3942

\$ 3942

\$ 178

\$ 178

\$ 358

\$ 430

\$ 430

\$ 860

3854

4008

4008

185

185

374

483

483

964

3884

4021

N/A

197

197

392

500

500

1002

FINISH INFORMATION

Additional Laminate Offering

Additional laminates beyond KI standard offering, are available with two weeks extended leadtime. To specify additional laminates, use these designators followed by the supplier's color/pattern code:

- Formica - LF/supplier's color pattern code
- Nevamar - LN/supplier's color pattern code
- Wilsonart - LW/supplier's color pattern code

KI's standard finish is the supplier's recommended finish for that color/pattern. Note: Nonstandard laminates from these suppliers (example: textured laminates), require an upcharge and additional leadtime. Contact KI.

SPECIAL SERVICES

Special Carton Marking

With specially marked information N/C

Shipping

Shipped k.d. freight prepaid f.o.b. Manitowoc, Wisconsin 54220 factory. Freight class #100.

Specifications and prices are subject to change without prior notice.



Genesis® Worksurfaces

Reduction Tripod Corner Electric Height Adjustable

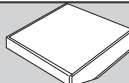
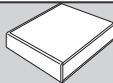

74P Edge
(74P)

Knife Edge
(KN)

Membrane Edge
(MP)

LH
Modesty
Panel
add to list
price

RH
Modesty
Panel
add to list
price

Both
Modesty
Panels
add to list
price

Left
Wire
Trough
add to list
price

Right
Wire
Trough
add to list
price

Both
Wire
Troughs
add to list
price

\$ 3822

\$ 3942

\$ 3942

\$ 178

\$ 178

\$ 358

\$ 430

\$ 430

\$ 860

3854

4008

4008

185

185

374

483

483

964

3884

4021

N/A

197

197

392

500

500

1002

FINISH INFORMATION

Additional Laminate Offering

Additional laminates beyond KI standard offering, are available with two weeks extended leadtime. To specify additional laminates, use these designators followed by the supplier's color/pattern code:

- Formica - LF/supplier's color pattern code
- Nevamar - LN/supplier's color pattern code
- Wilsonart - LW/supplier's color pattern code

KI's standard finish is the supplier's recommended finish for that color/pattern. Note: Nonstandard laminates from these suppliers (example: textured laminates), require an upcharge and additional leadtime. Contact KI.

SPECIAL SERVICES

Special Carton Marking

With specially marked information N/C

Shipping

Shipped k.d. freight prepaid f.o.b. Manitowoc, Wisconsin 54220 factory. Freight class #100.

Specifications and prices are subject to change without prior notice.



Genesis® Worksurfaces

Reduction Tripod Corner Electric Height Adjustable Dual

74P Edge (74P)	Knife Edge (KN)	Membrane Edge (MP)	LH Modesty Panel add to list price	RH Modesty Panel add to list price	Both Modesty Panels add to list price	Left Wire Trough add to list price	Right Wire Trough add to list price	Both Wire Troughs add to list price
\$ 4516	\$ 4676	\$ 4676	\$ 185	\$ 185	\$ 374	\$ 483	\$ 483	\$ 964
4687	4886	4886	197	197	392	500	500	1002

FINISH INFORMATION

Additional Laminate Offering

Additional laminates beyond KI standard offering, are available with two weeks extended leadtime. To specify additional laminates, use these designators followed by the supplier's color/pattern code:

- Formica - LF/supplier's color pattern code
- Nevamar - LN/supplier's color pattern code
- Wilsonart - LW/supplier's color pattern code

KI's standard finish is the supplier's recommended finish for that color/pattern. Note: Nonstandard laminates from these suppliers (example: textured laminates), require an upcharge and additional leadtime. Contact KI.

SPECIAL SERVICES

Special Carton Marking

With specially marked information N/C

Shipping

Shipped **k.d. freight prepaid f.o.b. Manitowoc, Wisconsin 54220** factory. Freight class #100.

Specifications and prices are subject to change without prior notice.



Genesis® Worksurfaces

Reduction Tripod Corner Electric Height Adjustable Dual

74P Edge (74P)	Knife Edge (KN)	Membrane Edge (MP)	LH Modesty Panel add to list price	RH Modesty Panel add to list price	Both Modesty Panels add to list price	Left Wire Trough add to list price	Right Wire Trough add to list price	Both Wire Troughs add to list price
\$ 4516	\$ 4676	\$ 4676	\$ 185	\$ 185	\$ 374	\$ 483	\$ 483	\$ 964
4687	4934	4934	197	197	392	500	500	1002

FINISH INFORMATION

Additional Laminate Offering

Additional laminates beyond KI standard offering, are available with two weeks extended leadtime. To specify additional laminates, use these designators followed by the supplier's color/pattern code:

- Formica - LF/supplier's color pattern code
- Nevamar - LN/supplier's color pattern code
- Wilsonart - LW/supplier's color pattern code

KI's standard finish is the supplier's recommended finish for that color/pattern. Note: Nonstandard laminates from these suppliers (example: textured laminates), require an upcharge and additional leadtime. Contact KI.

SPECIAL SERVICES

Special Carton Marking



With specially marked information N/C

Shipping

Shipped k.d. freight prepaid f.o.b. Manitowoc, Wisconsin 54220 factory. Freight class #100.

Specifications and prices are subject to change without prior notice.

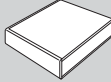
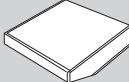

Approx. Packaged Weight				LH Modesty Panel add to list price	RH Modesty Panel add to list price	Both Modesty Panels add to list price	Left Wire Trough add to list price	Right Wire Trough add to list price	Both Wire Troughs add to list price
	74P Edge (74P)	Knife Edge (KN)	Membrane Edge (MP)						
125.0#	\$ 1471	\$ 1518	\$ 1518	\$ 198	\$ 185	\$ 385	\$ 500	\$ 483	\$ 983
132.0#	1474	1520	1520	205	185	392	517	483	998
138.0#	1509	1543	1543	213	185	399	637	483	1119
145.0#	1552	1594	1594	220	185	409	710	483	1191
158.0#	1622	1625	1625	249	185	435	715	483	1196
134.0#	1471	1518	1518	198	185	385	500	483	983
142.0#	1474	1520	1520	205	185	392	517	483	998
150.0#	1509	1543	1543	213	185	399	637	483	1119
158.0#	1552	1594	1594	220	185	409	710	483	1191
173.0#	1622	1625	1625	249	185	435	715	483	1196

FINISH INFORMATION

Additional Laminate Offering

Additional laminates beyond KI standard offering, are available with two weeks extended leadtime. To specify additional laminates, use these designators followed by the supplier's color/pattern code:

Formica - LF/supplier's color pattern code
 Nevamar - LN/supplier's color pattern code
 Wilsonart - LW/supplier's color pattern code

KI's standard finish is the supplier's recommended finish for that color/pattern. Note: Nonstandard laminates from these suppliers (example: textured laminates), require an upcharge and additional leadtime. Contact KI.

SPECIAL SERVICES

Special Carton Marking

With specially marked information N/C

Shipping

Shipped k.d. freight prepaid f.o.b. Manitowoc, Wisconsin 54220 factory. Freight class #100.

Specifications and prices are subject to change without prior notice.

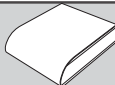
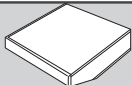
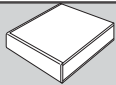

Approx. Packaged Weight	74P Edge (74P)	Knife Edge (KN)	Membrane Edge (MP)	LH Modesty Panel add to list price	RH Modesty Panel add to list price	Both Modesty Panels add to list price	Left Wire Trough add to list price	Right Wire Trough add to list price	Both Wire Troughs add to list price
125.0#	\$ 1471	\$ 1518	\$ 1518	\$ 185	\$ 198	\$ 385	\$ 483	\$ 500	\$ 983
132.0#	1474	1520	1520	185	205	392	483	517	998
138.0#	1509	1543	1543	185	213	399	483	637	1119
145.0#	1552	1594	1594	185	220	409	483	710	1191
158.0#	1622	1625	1625	185	249	435	483	715	1196
134.0#	1471	1518	1518	185	198	385	483	500	983
142.0#	1474	1520	1520	185	205	392	483	517	998
150.0#	1509	1543	1543	185	213	399	483	637	1119
158.0#	1552	1594	1594	185	220	409	483	710	1191
173.0#	1622	1625	1625	185	249	435	483	715	1196

FINISH INFORMATION

Additional Laminate Offering

Additional laminates beyond KI standard offering, are available with two weeks extended leadtime. To specify additional laminates, use these designators followed by the supplier's color/pattern code:

- Formica - LF/supplier's color pattern code
- Nevamar - LN/supplier's color pattern code
- Wilsonart - LW/supplier's color pattern code

KI's standard finish is the supplier's recommended finish for that color/pattern. Note: Nonstandard laminates from these suppliers (example: textured laminates), require an upcharge and additional leadtime. Contact KI.

SPECIAL SERVICES

Special Carton Marking

With specially marked information N/C

Shipping



Shipped k.d. freight prepaid f.o.b. Manitowoc, Wisconsin 54220 factory. Freight class #100.

Specifications and prices are subject to change without prior notice.

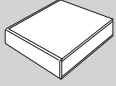
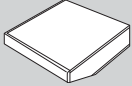

Genesis® Worksurfaces

Square Shoe Fixed Height Dual

Approx. Packaged Weight				LH Modesty Panel add to list price	RH Modesty Panel add to list price	Both Modesty Panels add to list price	Left Wire Trough add to list price	Right Wire Trough add to list price	Both Wire Troughs add to list price
	74P Edge (74P)	Knife Edge (KN)	Membrane Edge (MP)						
145.0#	\$ 2380	\$ 2426	\$ 2426	\$ 198	\$ 185	\$ 385	\$ 500	\$ 483	\$ 983
152.0#	2384	2429	2429	205	185	392	517	483	998
158.0#	2405	2450	2450	213	185	399	637	483	1119
165.0#	2460	2504	2504	220	185	409	710	483	1191
178.0#	2530	2534	2534	249	185	435	715	483	1196
154.0#	2380	2426	2426	198	185	385	500	483	983
162.0#	2384	2429	2429	205	185	392	517	483	998
170.0#	2405	2450	2450	213	185	399	637	483	1119
178.0#	2460	2504	2504	220	185	409	710	483	1191
193.0#	2530	2534	2534	249	185	435	715	483	1196

FINISH INFORMATION

Additional Laminate Offering

Additional laminates beyond KI standard offering, are available with two weeks extended leadtime. To specify additional laminates, use these designators followed by the supplier's color/pattern code:

Formica - LF/supplier's color pattern code
 Nevamar - LN/supplier's color pattern code
 Wilsonart - LW/supplier's color pattern code

KI's standard finish is the supplier's recommended finish for that color/pattern. Note: Nonstandard laminates from these suppliers (example: textured laminates), require an upcharge and additional leadtime. Contact KI.

SPECIAL SERVICES

Special Carton Marking

With specially marked information N/C

Shipping

Shipped k.d. freight prepaid f.o.b. Manitowoc, Wisconsin 54220 factory. Freight class #100.

Specifications and prices are subject to change without prior notice.

Genesis® Worksurfaces

Square Shoe Fixed Height Dual

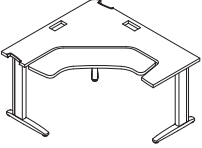
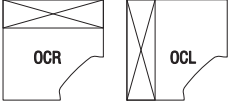
	D x L x W x D	MODEL NUMBER										
		Basic Model	Edge Style	Module Location	Modesty Panel	Wire Trough	Overhead Grommet	Trans. Legs	Base Finish	Edge Color	Surface Finish	
 <p>GSSH Basic Square Shoe Fixed Height Dual-Right</p> <ul style="list-style-type: none"> Extended corner surface Three-legged table base Fixed height at 29" Adjustable glides Keyboard surface adjusts 5" above/below primary surface. Keyboard surface tilts +/-15° 	24 x 48 x 54 x 24"	GSSH24485424D/F	<input type="checkbox"/>	<input type="checkbox"/>	<input type="checkbox"/>	<input type="checkbox"/>	<input type="checkbox"/>					
	24 x 48 x 60 x 24"	GSSH24486024D/F	<input type="checkbox"/>	<input type="checkbox"/>	<input type="checkbox"/>	<input type="checkbox"/>	<input type="checkbox"/>					
	24 x 48 x 66 x 24"	GSSH24486624D/F	<input type="checkbox"/>	<input type="checkbox"/>	<input type="checkbox"/>	<input type="checkbox"/>	<input type="checkbox"/>					
	24 x 48 x 72 x 24"	GSSH24487224D/F	<input type="checkbox"/>	<input type="checkbox"/>	<input type="checkbox"/>	<input type="checkbox"/>	<input type="checkbox"/>					
	24 x 48 x 84 x 24"	GSSH24488424D/F	<input type="checkbox"/>	<input type="checkbox"/>	<input type="checkbox"/>	<input type="checkbox"/>	<input type="checkbox"/>					
	30 x 48 x 54 x 30"	GSSH30485430D/F	<input type="checkbox"/>	<input type="checkbox"/>	<input type="checkbox"/>	<input type="checkbox"/>	<input type="checkbox"/>					
	30 x 48 x 60 x 30"	GSSH30486030D/F	<input type="checkbox"/>	<input type="checkbox"/>	<input type="checkbox"/>	<input type="checkbox"/>	<input type="checkbox"/>					
	30 x 48 x 66 x 30"	GSSH30486630D/F	<input type="checkbox"/>	<input type="checkbox"/>	<input type="checkbox"/>	<input type="checkbox"/>	<input type="checkbox"/>					
	30 x 48 x 72 x 30"	GSSH30487230D/F	<input type="checkbox"/>	<input type="checkbox"/>	<input type="checkbox"/>	<input type="checkbox"/>	<input type="checkbox"/>					
	30 x 48 x 84 x 30"	GSSH30488430D/F	<input type="checkbox"/>	<input type="checkbox"/>	<input type="checkbox"/>	<input type="checkbox"/>	<input type="checkbox"/>					
 <p>OCR-OCL</p> <ul style="list-style-type: none"> OCR = Overhead right OCL = Overhead left 												

A B C D E F G H I J

HOW TO ORDER

Indicate the following information on order form:

- Quantity of each item.
- Model number, including options. See "How To Build a Model Number".
- Any special service required.

Note:

- The indicates that a choice is required.
- The absence of the indicates that no choice is required.
- Alpha-numeric characters in place of indicate that no other alternatives are available.

HOW TO BUILD A MODEL NUMBER

- A** Select basic model.
 - 74P** - 74P edge
 - KN** - Knife edge
 - MP** - Membrane edge
- B** Select edge style.
 - PUN** - No data
 - PUL** - Left module; add \$108
 - PUR** - Right module; add \$108
 - PUB** - Both left and right modules; add \$218
- C** Select PowerUp module location. Select only one from the following and add the appropriate upcharge to the base price.
 - PUN** - No data
 - PUL** - Left module; add \$108
 - PUR** - Right module; add \$108
 - PUB** - Both left and right modules; add \$218
- D** Select modesty panel option.
 - NM** - No modesty panel
 - LM** - LH modesty only
 - RM** - RH modesty only
 - WM** - Both modesty panels

Add upcharge to unit price for "LM", "RM" and "WM" options.

- E** Select wire trough and power option.
 - NW** - No wire trough
 - WL** - Wire trough LH only
 - WR** - Wire trough RH only
 - WW** - Wire trough Both

Add upcharge to unit price for "WL", "WR" and "WW" options.
- F** Select overhead grommet.
 - OGN** - Overhead grommets no
 - OGL** - Overhead grommets left
 - OGR** - Overhead grommets right

OGR not available on 72" & 84" worksurfaces.
- G** Select transition legs.
 - TS** - No transition foot
 - TL** - Left transition foot
 - TR** - Right transition foot
 - TB** - Both transition feet

TR, TL and TB not allowed on 24" deep dual surfaces.
- H** Select base finish.

Refer to color addendum at ki.com or KI Fabrics & Finishes binder.

- I** Select edge/PowerUp color. Refer to color addendum at ki.com or KI Fabrics & Finishes binder. Edge color offerings are based on edge style selections. The color selection will apply to the trim, edge, PowerUp module and crank grommet. Trim color doesn't apply to the membrane edge selection.
- J** Select surface finish. Refer to color addendum at ki.com or KI Fabrics & Finishes binder. Surface finish offerings are based on edge style selections. Laminate finishes are only available on (74P) 74P edge and (KN) knife edge worksurfaces. The membrane color selections are only available on the (MP) membrane edge worksurfaces.



Genesis® Worksurfaces

Square Shoe Fixed Height Dual

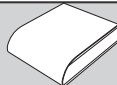
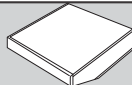
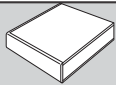

Approx. Packaged Weight	74P Edge (74P)	Knife Edge (KN)	Membrane Edge (MP)	LH Modesty Panel add to list price	RH Modesty Panel add to list price	Both Modesty Panels add to list price	Left Wire Trough add to list price	Right Wire Trough add to list price	Both Wire Troughs add to list price
145.0#	\$ 2380	\$ 2426	\$ 2426	\$ 185	\$ 198	\$ 385	\$ 483	\$ 500	\$ 983
152.0#	2384	2429	2429	185	205	392	483	517	998
158.0#	2405	2450	2450	185	213	399	483	637	1119
165.0#	2460	2504	2504	185	220	409	483	710	1191
178.0#	2530	2534	2534	185	249	435	483	715	1196
154.0#	2380	2426	2426	185	198	385	483	500	983
162.0#	2384	2429	2429	185	205	392	483	517	998
170.0#	2405	2450	2450	185	213	399	483	637	1119
178.0#	2460	2504	2504	185	220	409	483	710	1191
193.0#	2530	2534	2534	185	249	435	483	715	1196

FINISH INFORMATION

Additional Laminate Offering

Additional laminates beyond KI standard offering, are available with two weeks extended leadtime. To specify additional laminates, use these designators followed by the supplier's color/pattern code:

- Formica - LF/supplier's color pattern code
- Nevamar - LN/supplier's color pattern code
- Wilsonart - LW/supplier's color pattern code

KI's standard finish is the supplier's recommended finish for that color/pattern. Note: Nonstandard laminates from these suppliers (example: textured laminates), require an upcharge and additional leadtime. Contact KI.

SPECIAL SERVICES

Special Carton Marking

With specially marked information N/C

Shipping

Shipped k.d. freight prepaid f.o.b. Manitowoc, Wisconsin 54220 factory. Freight class #100.

Specifications and prices are subject to change without prior notice.

Genesis® Worksurfaces

Square Shoe Pin Height Adjustable

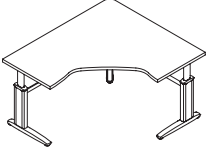
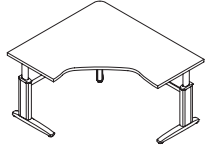
	D x L x W x D	MODEL NUMBER								Approx. Packaged Weight	
		Basic Model	Edge Style	Module Location	Modesty Panel	Wire Trough	Base Finish	Edge Color	Surface Finish		
 <p>GSSH Basic Square Shoe Pin Height Adjustable-Left</p> <ul style="list-style-type: none"> Extended corner surface Three-legged table base Height adjusts from 24"-31" in 1" increments Adjustable glides Wire trough and modesty panel should not be ordered together on adjustable tables 	24 x 54 x 48 x 24"	GSSH24544824S/P	<input type="checkbox"/>	<input type="checkbox"/>	<input type="checkbox"/>	<input type="checkbox"/>	<input type="checkbox"/>	<input type="checkbox"/>	<input type="checkbox"/>	132.0#	
	24 x 60 x 48 x 24"	GSSH24604824S/P	<input type="checkbox"/>	<input type="checkbox"/>	<input type="checkbox"/>	<input type="checkbox"/>	<input type="checkbox"/>	<input type="checkbox"/>	<input type="checkbox"/>	139.0#	
	24 x 66 x 48 x 24"	GSSH24664824S/P	<input type="checkbox"/>	<input type="checkbox"/>	<input type="checkbox"/>	<input type="checkbox"/>	<input type="checkbox"/>	<input type="checkbox"/>	<input type="checkbox"/>	146.0#	
	24 x 72 x 48 x 24"	GSSH24724824S/P	<input type="checkbox"/>	<input type="checkbox"/>	<input type="checkbox"/>	<input type="checkbox"/>	<input type="checkbox"/>	<input type="checkbox"/>	<input type="checkbox"/>	152.0#	
	24 x 84 x 48 x 24"	GSSH24844824S/P	<input type="checkbox"/>	<input type="checkbox"/>	<input type="checkbox"/>	<input type="checkbox"/>	<input type="checkbox"/>	<input type="checkbox"/>	<input type="checkbox"/>	166.0#	
	30 x 54 x 48 x 30"	GSSH30544830S/P	<input type="checkbox"/>	<input type="checkbox"/>	<input type="checkbox"/>	<input type="checkbox"/>	<input type="checkbox"/>	<input type="checkbox"/>	<input type="checkbox"/>	141.0#	
	30 x 60 x 48 x 30"	GSSH30604830S/P	<input type="checkbox"/>	<input type="checkbox"/>	<input type="checkbox"/>	<input type="checkbox"/>	<input type="checkbox"/>	<input type="checkbox"/>	<input type="checkbox"/>	149.0#	
	30 x 66 x 48 x 30"	GSSH30664830S/P	<input type="checkbox"/>	<input type="checkbox"/>	<input type="checkbox"/>	<input type="checkbox"/>	<input type="checkbox"/>	<input type="checkbox"/>	<input type="checkbox"/>	157.0#	
	30 x 72 x 48 x 30"	GSSH30724830S/P	<input type="checkbox"/>	<input type="checkbox"/>	<input type="checkbox"/>	<input type="checkbox"/>	<input type="checkbox"/>	<input type="checkbox"/>	<input type="checkbox"/>	165.0#	
	30 x 84 x 48 x 30"	GSSH30844830S/P	<input type="checkbox"/>	<input type="checkbox"/>	<input type="checkbox"/>	<input type="checkbox"/>	<input type="checkbox"/>	<input type="checkbox"/>	<input type="checkbox"/>	182.0#	
 <p>GSSH Basic Square Shoe Pin Height Adjustable-Right</p> <ul style="list-style-type: none"> Extended corner surface Three-legged table base Height adjusts from 24"-31" in 1" increments Adjustable glides Wire trough and modesty panel should not be ordered together on adjustable tables 	24 x 48 x 54 x 24"	GSSH24485424S/P	<input type="checkbox"/>	<input type="checkbox"/>	<input type="checkbox"/>	<input type="checkbox"/>	<input type="checkbox"/>	<input type="checkbox"/>	<input type="checkbox"/>	132.0#	
	24 x 48 x 60 x 24"	GSSH24486024S/P	<input type="checkbox"/>	<input type="checkbox"/>	<input type="checkbox"/>	<input type="checkbox"/>	<input type="checkbox"/>	<input type="checkbox"/>	<input type="checkbox"/>	139.0#	
	24 x 48 x 66 x 24"	GSSH24486624S/P	<input type="checkbox"/>	<input type="checkbox"/>	<input type="checkbox"/>	<input type="checkbox"/>	<input type="checkbox"/>	<input type="checkbox"/>	<input type="checkbox"/>	146.0#	
	24 x 48 x 72 x 24"	GSSH24487224S/P	<input type="checkbox"/>	<input type="checkbox"/>	<input type="checkbox"/>	<input type="checkbox"/>	<input type="checkbox"/>	<input type="checkbox"/>	<input type="checkbox"/>	152.0#	
	24 x 48 x 84 x 24"	GSSH24488424S/P	<input type="checkbox"/>	<input type="checkbox"/>	<input type="checkbox"/>	<input type="checkbox"/>	<input type="checkbox"/>	<input type="checkbox"/>	<input type="checkbox"/>	166.0#	
	30 x 48 x 54 x 30"	GSSH30485430S/P	<input type="checkbox"/>	<input type="checkbox"/>	<input type="checkbox"/>	<input type="checkbox"/>	<input type="checkbox"/>	<input type="checkbox"/>	<input type="checkbox"/>	141.0#	
	30 x 48 x 60 x 30"	GSSH30486030S/P	<input type="checkbox"/>	<input type="checkbox"/>	<input type="checkbox"/>	<input type="checkbox"/>	<input type="checkbox"/>	<input type="checkbox"/>	<input type="checkbox"/>	149.0#	
	30 x 48 x 66 x 30"	GSSH30486630S/P	<input type="checkbox"/>	<input type="checkbox"/>	<input type="checkbox"/>	<input type="checkbox"/>	<input type="checkbox"/>	<input type="checkbox"/>	<input type="checkbox"/>	157.0#	
	30 x 48 x 72 x 30"	GSSH30487230S/P	<input type="checkbox"/>	<input type="checkbox"/>	<input type="checkbox"/>	<input type="checkbox"/>	<input type="checkbox"/>	<input type="checkbox"/>	<input type="checkbox"/>	165.0#	
	30 x 48 x 84 x 30"	GSSH30488430S/P	<input type="checkbox"/>	<input type="checkbox"/>	<input type="checkbox"/>	<input type="checkbox"/>	<input type="checkbox"/>	<input type="checkbox"/>	<input type="checkbox"/>	182.0#	
			A	B	C	D	E	F	G	H	

HOW TO ORDER

Indicate the following information on order form:

- Quantity of each item.
- Model number, including options. See "How To Build a Model Number".
- Any special service required.

Note: • The indicates that a choice is required.

- The absence of the indicates that no choice is required.
- Alpha-numeric characters in place of indicate that no other alternatives are available.

HOW TO BUILD A MODEL NUMBER

A Select basic model.

B Select edge style.

- 74P** - 74P edge
KN - Knife edge
MP - Membrane edge

C Select PowerUp module location.

Select only one from the following and add the appropriate upcharge to the base price.

- PUN** - No data
PUL - Left module; add \$108
PUR - Right module; add \$108

D Select modesty panel option.

- NM** - No modesty panel
LM - LH modesty only
RM - RH modesty only
WM - Both modesty panels

Add upcharge to unit price for "LM", "RM" and "WM" options.

E Select wire trough and power option.

NW - No wire trough

WL - Wire trough LH only

WR - Wire trough RH only

WW - Wire trough Both

Add upcharge to unit price for "WL", "WR" and "WW" options.

F Select base finish.

Refer to color addendum at ki.com or KI Fabrics & Finishes binder.

G Select edge color.

Refer to color addendum at ki.com or KI Fabrics & Finishes binder.

Edge color offerings are based on edge style selections. The color selection will apply to the trim, edge, PowerUp module and crank grommet. Trim color doesn't apply to the membrane edge selection.

H Select surface finish.

Refer to color addendum at ki.com or KI Fabrics & Finishes binder.

Surface finish offerings are based on edge style selections. Laminate finishes are

only available on (74P) 74P edge and (KN) knife edge worksurfaces. The membrane color selections are only available on the (MP) membrane edge worksurfaces.



Genesis® Worksurfaces

Square Shoe Pin Height Adjustable

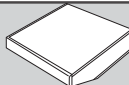
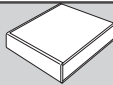

74P Edge
(74P)

Knife Edge
(KN)

Membrane Edge
(MP)

LH
Modesty
Panel
add to list
price

RH
Modesty
Panel
add to list
price

Both
Modesty
Panels
add to list
price

Left
Wire
Trough
add to list
price

Right
Wire
Trough
add to list
price

Both
Wire
Troughs
add to list
price

\$ 1677	\$ 1723	\$ 1723	\$ 198	\$ 185	\$ 385	\$ 500	\$ 483	\$ 983
1681	1725	1725	205	185	392	517	483	998
1703	1749	1749	213	185	399	637	483	1119
1775	1818	1818	220	185	409	710	483	1191
1800	1846	1846	249	185	435	715	483	1196
1677	1723	1723	198	185	385	500	483	983
1681	1725	1725	205	185	392	517	483	998
1703	1749	1749	213	185	399	637	483	1119
1775	1818	1818	220	185	409	710	483	1191
1800	1846	1846	249	185	435	715	483	1196

\$ 1677	\$ 1723	\$ 1723	\$ 185	\$ 198	\$ 385	\$ 483	\$ 500	\$ 983
1681	1725	1725	185	205	392	483	517	998
1703	1749	1749	185	213	399	483	637	1119
1775	1818	1818	185	220	409	483	710	1191
1800	1846	1846	185	249	435	483	715	1196
1677	1723	1723	185	198	385	483	500	983
1681	1725	1725	185	205	392	483	517	998
1703	1749	1749	185	213	399	483	637	1119
1775	1818	1818	185	220	409	483	710	1191
1800	1846	1846	185	249	435	483	715	1196

FINISH INFORMATION

Additional Laminate Offering

Additional laminates beyond KI standard offering, are available with two weeks extended leadtime. To specify additional laminates, use these designators followed by the supplier's color/pattern code:

- Formica - LF/supplier's color pattern code
- Nevamar - LN/supplier's color pattern code
- Wilsonart - LW/supplier's color pattern code

KI's standard finish is the supplier's recommended finish for that color/pattern. Note: Nonstandard laminates from these suppliers (example: textured laminates), require an upcharge and additional leadtime. Contact KI.

SPECIAL SERVICES

Special Carton Marking

With specially marked information N/C

Shipping

Shipped k.d. freight prepaid f.o.b. Manitowoc, Wisconsin 54220 factory. Freight class #100.

Specifications and prices are subject to change without prior notice.

Genesis® Worksurfaces

Square Shoe Crank Height Adjustable

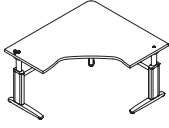
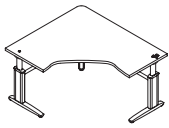
	D x L x W x D	MODEL NUMBER								Approx. Packaged Weight	
		Basic Model	Edge Style	Module Location	Modesty Panel	Wire Trough	Base Finish	Edge Color	Surface Finish		
 <p>GSSH</p> <p>Basic Square Shoe Crank Height Adjustable-Left</p> <ul style="list-style-type: none"> Extended corner surface Three-legged table base Height adjusts from 22"-33" Adjustable glides Worksurfaces are undersized by 1/4" from side-to-side and 1/4" from back-to-front from the stated dimensions Wire trough and modesty panel should not be ordered together on adjustable tables 	24 x 54 x 48 x 24"	GSSH24544824S/CR	<input type="checkbox"/>	<input type="checkbox"/>	<input type="checkbox"/>	<input type="checkbox"/>	139.0#				
	24 x 60 x 48 x 24"	GSSH24604824S/CR	<input type="checkbox"/>	<input type="checkbox"/>	<input type="checkbox"/>	<input type="checkbox"/>	146.0#				
	24 x 66 x 48 x 24"	GSSH24664824S/CR	<input type="checkbox"/>	<input type="checkbox"/>	<input type="checkbox"/>	<input type="checkbox"/>	153.0#				
	24 x 72 x 48 x 24"	GSSH24724824S/CR	<input type="checkbox"/>	<input type="checkbox"/>	<input type="checkbox"/>	<input type="checkbox"/>	161.0#				
	24 x 84 x 48 x 24"	GSSH24844824S/CR	<input type="checkbox"/>	<input type="checkbox"/>	<input type="checkbox"/>	<input type="checkbox"/>	175.0#				
	30 x 54 x 48 x 30"	GSSH30544830S/CR	<input type="checkbox"/>	<input type="checkbox"/>	<input type="checkbox"/>	<input type="checkbox"/>	148.0#				
	30 x 60 x 48 x 30"	GSSH30604830S/CR	<input type="checkbox"/>	<input type="checkbox"/>	<input type="checkbox"/>	<input type="checkbox"/>	157.0#				
	30 x 66 x 48 x 30"	GSSH30664830S/CR	<input type="checkbox"/>	<input type="checkbox"/>	<input type="checkbox"/>	<input type="checkbox"/>	165.0#				
	30 x 72 x 48 x 30"	GSSH30724830S/CR	<input type="checkbox"/>	<input type="checkbox"/>	<input type="checkbox"/>	<input type="checkbox"/>	173.0#				
	30 x 84 x 48 x 30"	GSSH30844830S/CR	<input type="checkbox"/>	<input type="checkbox"/>	<input type="checkbox"/>	<input type="checkbox"/>	190.0#				
 <p>GSSH</p> <p>Basic Square Shoe Crank Height Adjustable-Right</p> <ul style="list-style-type: none"> Extended corner surface Three-legged table base Height adjusts from 22"-33" Adjustable glides Worksurfaces are undersized by 1/4" from side-to-side and 1/4" from back-to-front from the stated dimensions Wire trough and modesty panel should not be ordered together on adjustable tables 	24 x 48 x 54 x 24"	GSSH24485424S/CR	<input type="checkbox"/>	<input type="checkbox"/>	<input type="checkbox"/>	<input type="checkbox"/>	139.0#				
	24 x 48 x 60 x 24"	GSSH24486024S/CR	<input type="checkbox"/>	<input type="checkbox"/>	<input type="checkbox"/>	<input type="checkbox"/>	146.0#				
	24 x 48 x 66 x 24"	GSSH24486624S/CR	<input type="checkbox"/>	<input type="checkbox"/>	<input type="checkbox"/>	<input type="checkbox"/>	153.0#				
	24 x 48 x 72 x 24"	GSSH24487224S/CR	<input type="checkbox"/>	<input type="checkbox"/>	<input type="checkbox"/>	<input type="checkbox"/>	161.0#				
	24 x 48 x 84 x 24"	GSSH24488424S/CR	<input type="checkbox"/>	<input type="checkbox"/>	<input type="checkbox"/>	<input type="checkbox"/>	175.0#				
	30 x 48 x 54 x 30"	GSSH30485430S/CR	<input type="checkbox"/>	<input type="checkbox"/>	<input type="checkbox"/>	<input type="checkbox"/>	148.0#				
	30 x 48 x 60 x 30"	GSSH30486030S/CR	<input type="checkbox"/>	<input type="checkbox"/>	<input type="checkbox"/>	<input type="checkbox"/>	157.0#				
	30 x 48 x 66 x 30"	GSSH30486630S/CR	<input type="checkbox"/>	<input type="checkbox"/>	<input type="checkbox"/>	<input type="checkbox"/>	165.0#				
	30 x 48 x 72 x 30"	GSSH30487230S/CR	<input type="checkbox"/>	<input type="checkbox"/>	<input type="checkbox"/>	<input type="checkbox"/>	173.0#				
	30 x 48 x 84 x 30"	GSSH30488430S/CR	<input type="checkbox"/>	<input type="checkbox"/>	<input type="checkbox"/>	<input type="checkbox"/>	190.0#				
			A	B	C	D	E	F	G	H	

HOW TO ORDER

Indicate the following information on order form:

- Quantity of each item.
- Model number, including options. See "How To Build a Model Number".
- Any special service required.

Note: • The indicates that a choice is required.

- The absence of the indicates that no choice is required.
- Alpha-numeric characters in place of indicate that no other alternatives are available.

HOW TO BUILD A MODEL NUMBER

A Select basic model.

B Select edge style.

- 74P** - 74P edge
KN - Knife edge
MP - Membrane edge

C Select PowerUp module location.

Select only one from the following and add the appropriate upcharge to the base price.

- PUN** - No data
PUL - Left module; add \$108
PUR - Right module; add \$108
PUB - Both left and right modules; add \$218

D Select modesty panel option.

- NM** - No modesty panel
LM - LH modesty only
RM - RH modesty only
WM - Both modesty panels

Add upcharge to unit price for "LM", "RM" and "WM" options.

E Select wire trough and power option.

- NW** - No wire trough
WL - Wire trough LH only
WR - Wire trough RH only
WW - Wire trough Both

Add upcharge to unit price for "WL", "WR" and "WW" options.

F Select base finish.

Refer to color addendum at ki.com or KI Fabrics & Finishes binder.

G Select edge/PowerUp color.

Refer to color addendum at ki.com or KI Fabrics & Finishes binder. Edge color offerings are based on edge style selections. The color selection will apply to the trim, edge, PowerUp module and crank grommet. Trim color doesn't apply to the membrane edge selection.

H Select surface finish.

Refer to color addendum at ki.com or KI Fabrics & Finishes binder.

Surface finish offerings are based on edge style selections. Laminate finishes are only available on (74P) 74P edge and (KN) knife edge worksurfaces. The membrane color selections are only available on the (MP) membrane edge worksurfaces.



Genesis® Worksurfaces

Square Shoe Crank Height Adjustable

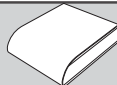
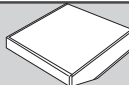
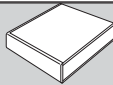

74P Edge (74P)	Knife Edge (KN)	Membrane Edge (MP)	LH Modesty Panel add to list price	RH Modesty Panel add to list price	Both Modesty Panels add to list price	Left Wire Trough add to list price	Right Wire Trough add to list price	Both Wire Troughs add to list price
\$ 2046	\$ 2087	\$ 2087	\$ 198	\$ 185	\$ 385	\$ 500	\$ 483	\$ 983
2049	2090	2090	205	185	392	517	483	998
2078	2114	2114	213	185	399	637	483	1119
2124	2167	2167	220	185	409	710	483	1191
2154	2199	2199	249	185	435	715	483	1196
2046	2087	2087	198	185	385	500	483	983
2049	2090	2090	205	185	392	517	483	998
2078	2114	2114	213	185	399	637	483	1119
2124	2167	2167	220	185	409	710	483	1191
2154	2199	2199	249	185	435	715	483	1196

\$ 2046	\$ 2087	\$ 2087	\$ 185	\$ 198	\$ 385	\$ 483	\$ 500	\$ 983
2049	2090	2090	185	205	392	483	517	998
2078	2114	2114	185	213	399	483	637	1119
2124	2167	2167	185	220	409	483	710	1191
2154	2199	2199	185	249	435	483	715	1196
2046	2087	2087	185	198	385	483	500	983
2049	2090	2090	185	205	392	483	517	998
2078	2114	2114	185	213	399	483	637	1119
2124	2167	2167	185	220	409	483	710	1191
2154	2199	2199	185	249	435	483	715	1196

FINISH INFORMATION

Additional Laminate Offering

Additional laminates beyond KI standard offering, are available with two weeks extended leadtime. To specify additional laminates, use these designators followed by the supplier's color/pattern code:

- Formica - LF/supplier's color pattern code
- Nevamar - LN/supplier's color pattern code
- Wilsonart - LW/supplier's color pattern code

KI's standard finish is the supplier's recommended finish for that color/pattern. Note: Nonstandard laminates from these suppliers (example: textured laminates), require an upcharge and additional leadtime. Contact KI.

SPECIAL SERVICES

Special Carton Marking

With specially marked information N/C

Shipping

Shipped k.d. freight prepaid f.o.b. Manitowoc, Wisconsin 54220 factory. Freight class #100.

Specifications and prices are subject to change without prior notice.

Genesis® Worksurfaces

Square Shoe Crank Height Dual

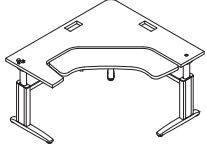

GSSH

Basic Square Shoe Crank Height Dual-Left

- Extended corner surface
- Three-legged table base
- Height adjusts from 22"-33"
- Adjustable glides
- Keyboard surface adjusts 5" above/below primary surface
- Keyboard surface tilts +/-15°
- Worksurfaces are undersized by 1/4" from side-to-side and 1/4" from back-to-front from the stated dimensions
- Wire trough and modesty panel should not be ordered together on adjustable tables

D x L x W x D	MODEL NUMBER								Approx. Packaged Weight
	Basic Model	Edge Style	Module Location	Modesty Panel	Wire Trough	Base Finish	Edge Color	Surface Finish	
24 x 54 x 48 x 24"	GSSH24544824D/CR	<input type="checkbox"/> <input type="checkbox"/> <input type="checkbox"/>	<input type="checkbox"/> <input type="checkbox"/> <input type="checkbox"/>	<input type="checkbox"/> <input type="checkbox"/> <input type="checkbox"/>	<input type="checkbox"/> <input type="checkbox"/> <input type="checkbox"/>	<input type="checkbox"/> <input type="checkbox"/> <input type="checkbox"/>	<input type="checkbox"/> <input type="checkbox"/> <input type="checkbox"/>	<input type="checkbox"/> <input type="checkbox"/> <input type="checkbox"/>	159.0#
24 x 60 x 48 x 24"	GSSH24604824D/CR	<input type="checkbox"/> <input type="checkbox"/> <input type="checkbox"/>	<input type="checkbox"/> <input type="checkbox"/> <input type="checkbox"/>	<input type="checkbox"/> <input type="checkbox"/> <input type="checkbox"/>	<input type="checkbox"/> <input type="checkbox"/> <input type="checkbox"/>	<input type="checkbox"/> <input type="checkbox"/> <input type="checkbox"/>	<input type="checkbox"/> <input type="checkbox"/> <input type="checkbox"/>	<input type="checkbox"/> <input type="checkbox"/> <input type="checkbox"/>	166.0#
24 x 66 x 48 x 24"	GSSH24664824D/CR	<input type="checkbox"/> <input type="checkbox"/> <input type="checkbox"/>	<input type="checkbox"/> <input type="checkbox"/> <input type="checkbox"/>	<input type="checkbox"/> <input type="checkbox"/> <input type="checkbox"/>	<input type="checkbox"/> <input type="checkbox"/> <input type="checkbox"/>	<input type="checkbox"/> <input type="checkbox"/> <input type="checkbox"/>	<input type="checkbox"/> <input type="checkbox"/> <input type="checkbox"/>	<input type="checkbox"/> <input type="checkbox"/> <input type="checkbox"/>	173.0#
24 x 72 x 48 x 24"	GSSH24724824D/CR	<input type="checkbox"/> <input type="checkbox"/> <input type="checkbox"/>	<input type="checkbox"/> <input type="checkbox"/> <input type="checkbox"/>	<input type="checkbox"/> <input type="checkbox"/> <input type="checkbox"/>	<input type="checkbox"/> <input type="checkbox"/> <input type="checkbox"/>	<input type="checkbox"/> <input type="checkbox"/> <input type="checkbox"/>	<input type="checkbox"/> <input type="checkbox"/> <input type="checkbox"/>	<input type="checkbox"/> <input type="checkbox"/> <input type="checkbox"/>	181.0#
24 x 84 x 48 x 24"	GSSH24844824D/CR	<input type="checkbox"/> <input type="checkbox"/> <input type="checkbox"/>	<input type="checkbox"/> <input type="checkbox"/> <input type="checkbox"/>	<input type="checkbox"/> <input type="checkbox"/> <input type="checkbox"/>	<input type="checkbox"/> <input type="checkbox"/> <input type="checkbox"/>	<input type="checkbox"/> <input type="checkbox"/> <input type="checkbox"/>	<input type="checkbox"/> <input type="checkbox"/> <input type="checkbox"/>	<input type="checkbox"/> <input type="checkbox"/> <input type="checkbox"/>	195.0#
30 x 54 x 48 x 30"	GSSH30544830D/CR	<input type="checkbox"/> <input type="checkbox"/> <input type="checkbox"/>	<input type="checkbox"/> <input type="checkbox"/> <input type="checkbox"/>	<input type="checkbox"/> <input type="checkbox"/> <input type="checkbox"/>	<input type="checkbox"/> <input type="checkbox"/> <input type="checkbox"/>	<input type="checkbox"/> <input type="checkbox"/> <input type="checkbox"/>	<input type="checkbox"/> <input type="checkbox"/> <input type="checkbox"/>	<input type="checkbox"/> <input type="checkbox"/> <input type="checkbox"/>	166.0#
30 x 60 x 48 x 30"	GSSH30604830D/CR	<input type="checkbox"/> <input type="checkbox"/> <input type="checkbox"/>	<input type="checkbox"/> <input type="checkbox"/> <input type="checkbox"/>	<input type="checkbox"/> <input type="checkbox"/> <input type="checkbox"/>	<input type="checkbox"/> <input type="checkbox"/> <input type="checkbox"/>	<input type="checkbox"/> <input type="checkbox"/> <input type="checkbox"/>	<input type="checkbox"/> <input type="checkbox"/> <input type="checkbox"/>	<input type="checkbox"/> <input type="checkbox"/> <input type="checkbox"/>	177.0#
30 x 66 x 48 x 30"	GSSH30664830D/CR	<input type="checkbox"/> <input type="checkbox"/> <input type="checkbox"/>	<input type="checkbox"/> <input type="checkbox"/> <input type="checkbox"/>	<input type="checkbox"/> <input type="checkbox"/> <input type="checkbox"/>	<input type="checkbox"/> <input type="checkbox"/> <input type="checkbox"/>	<input type="checkbox"/> <input type="checkbox"/> <input type="checkbox"/>	<input type="checkbox"/> <input type="checkbox"/> <input type="checkbox"/>	<input type="checkbox"/> <input type="checkbox"/> <input type="checkbox"/>	185.0#
30 x 72 x 48 x 30"	GSSH30724830D/CR	<input type="checkbox"/> <input type="checkbox"/> <input type="checkbox"/>	<input type="checkbox"/> <input type="checkbox"/> <input type="checkbox"/>	<input type="checkbox"/> <input type="checkbox"/> <input type="checkbox"/>	<input type="checkbox"/> <input type="checkbox"/> <input type="checkbox"/>	<input type="checkbox"/> <input type="checkbox"/> <input type="checkbox"/>	<input type="checkbox"/> <input type="checkbox"/> <input type="checkbox"/>	<input type="checkbox"/> <input type="checkbox"/> <input type="checkbox"/>	193.0#
30 x 84 x 48 x 30"	GSSH30844830D/CR	<input type="checkbox"/> <input type="checkbox"/> <input type="checkbox"/>	<input type="checkbox"/> <input type="checkbox"/> <input type="checkbox"/>	<input type="checkbox"/> <input type="checkbox"/> <input type="checkbox"/>	<input type="checkbox"/> <input type="checkbox"/> <input type="checkbox"/>	<input type="checkbox"/> <input type="checkbox"/> <input type="checkbox"/>	<input type="checkbox"/> <input type="checkbox"/> <input type="checkbox"/>	<input type="checkbox"/> <input type="checkbox"/> <input type="checkbox"/>	210.0#
		A	B	C	D	E	F	G	H

HOW TO ORDER

Indicate the following information on order form:

1. Quantity of each item.
2. Model number, including options. See "How To Build a Model Number".
3. Any special service required.

Note: • The indicates that a choice is required.

- The absence of the indicates that no choice is required.
- Alpha-numeric characters in place of indicate that no other alternatives are available.

HOW TO BUILD A MODEL NUMBER

A Select basic model.

B Select edge style.

74P - 74P edge
KN - Knife edge
MP - Membrane edge

C Select PowerUp module location.

Select only one from the following and add the appropriate upcharge to the base price.

PUN - No data
PUL - Left module; add \$108
PUR - Right module; add \$108
PUB - Both left and right modules; add \$218

D Select modesty panel option.

NM - No modesty panel
LM - LH modesty only
RM - RH modesty only
WM - Both modesty panels

Add upcharge to unit price for "LM", "RM" and "WM" options.

E Select wire trough and power option.

NW - No wire trough
WL - Wire trough LH only
WR - Wire trough RH only
WW - Wire trough Both

Add upcharge to unit price for "WL", "WR" and "WW" options.

F Select base finish.

Refer to color addendum at ki.com or KI Fabrics & Finishes binder.

G Select edge/PowerUp color.

Refer to color addendum at ki.com or KI Fabrics & Finishes binder. Edge color offerings are based on edge style selections. The color selection will apply to the trim, edge, PowerUp module and crank grommet. Trim color doesn't apply to the membrane edge selection.

H Select surface finish.

Refer to color addendum at ki.com or KI Fabrics & Finishes binder.

Surface finish offerings are based on edge style selections. Laminate finishes are only available on (74P) 74P edge and (KN) knife edge worksurfaces. The membrane color selections are only available on the (MP) membrane edge worksurfaces.



Genesis® Worksurfaces

Square Shoe Crank Height Dual

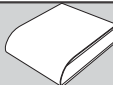
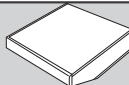
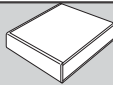

74P Edge
(74P)

Knife Edge
(KN)

Membrane Edge
(MP)

LH
Modesty
Panel
add to list
price

RH
Modesty
Panel
add to list
price

Both
Modesty
Panels
add to list
price

Left
Wire
Trough
add to list
price

Right
Wire
Trough
add to list
price

Both
Wire
Troughs
add to list
price

\$ 2954	\$ 2997	\$ 2997	\$ 198	\$ 185	\$ 385	\$ 500	\$ 483	\$ 983
2958	2999	2999	205	185	392	517	483	998
2979	3021	3021	213	185	399	637	483	1119
3032	3077	3077	220	185	409	710	483	1191
3061	3106	3106	249	185	435	715	483	1196
2954	2997	2997	198	185	385	500	483	983
2958	2999	2999	205	185	392	517	483	998
2979	3021	3021	213	185	399	637	483	1119
3032	3077	3077	220	185	409	710	483	1191
3061	3106	3106	249	185	435	715	483	1196

FINISH INFORMATION

Additional Laminate Offering

Additional laminates beyond KI standard offering, are available with two weeks extended leadtime. To specify additional laminates, use these designators followed by the supplier's color/pattern code:

- Formica - LF/supplier's color pattern code
- Nevamar - LN/supplier's color pattern code
- Wilsonart - LW/supplier's color pattern code

KI's standard finish is the supplier's recommended finish for that color/pattern. Note: Nonstandard laminates from these suppliers (example: textured laminates), require an upcharge and additional leadtime. Contact KI.

SPECIAL SERVICES

Special Carton Marking

With specially marked information N/C

Shipping

Shipped k.d. freight prepaid f.o.b. Manitowoc, Wisconsin 54220 factory. Freight class #100.

Specifications and prices are subject to change without prior notice.

Genesis® Worksurfaces

Square Shoe Crank Height Dual

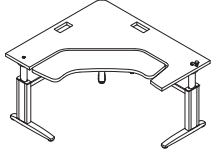

GSSH

Basic Square Shoe Crank Height Dual-Right

- Extended corner surface
- Three-legged table base
- Height adjusts from 22"-33"
- Adjustable glides
- Keyboard surface adjusts 5" above/below primary surface
- Keyboard surface tilts +/-15°
- Worksurfaces are undersized by 1/4" from side-to-side and 1/4" from back-to-front from the stated dimensions
- Wire trough and modesty panel should not be ordered together on adjustable tables

D x L x W x D	MODEL NUMBER								Approx. Packaged Weight
	Basic Model	Edge Style	Module Location	Modesty Panel	Wire Trough	Base Finish	Edge Color	Surface Finish	
24 x 48 x 54 x 24"	GSSH24485424D/CR	<input type="checkbox"/> <input type="checkbox"/> <input type="checkbox"/>	<input type="checkbox"/> <input type="checkbox"/> <input type="checkbox"/>	<input type="checkbox"/> <input type="checkbox"/> <input type="checkbox"/>	<input type="checkbox"/> <input type="checkbox"/> <input type="checkbox"/>	<input type="checkbox"/> <input type="checkbox"/> <input type="checkbox"/>	<input type="checkbox"/> <input type="checkbox"/> <input type="checkbox"/>	<input type="checkbox"/> <input type="checkbox"/> <input type="checkbox"/>	159.0#
24 x 48 x 60 x 24"	GSSH24486024D/CR	<input type="checkbox"/> <input type="checkbox"/> <input type="checkbox"/>	<input type="checkbox"/> <input type="checkbox"/> <input type="checkbox"/>	<input type="checkbox"/> <input type="checkbox"/> <input type="checkbox"/>	<input type="checkbox"/> <input type="checkbox"/> <input type="checkbox"/>	<input type="checkbox"/> <input type="checkbox"/> <input type="checkbox"/>	<input type="checkbox"/> <input type="checkbox"/> <input type="checkbox"/>	<input type="checkbox"/> <input type="checkbox"/> <input type="checkbox"/>	166.0#
24 x 48 x 66 x 24"	GSSH24486624D/CR	<input type="checkbox"/> <input type="checkbox"/> <input type="checkbox"/>	<input type="checkbox"/> <input type="checkbox"/> <input type="checkbox"/>	<input type="checkbox"/> <input type="checkbox"/> <input type="checkbox"/>	<input type="checkbox"/> <input type="checkbox"/> <input type="checkbox"/>	<input type="checkbox"/> <input type="checkbox"/> <input type="checkbox"/>	<input type="checkbox"/> <input type="checkbox"/> <input type="checkbox"/>	<input type="checkbox"/> <input type="checkbox"/> <input type="checkbox"/>	173.0#
24 x 48 x 72 x 24"	GSSH24487224D/CR	<input type="checkbox"/> <input type="checkbox"/> <input type="checkbox"/>	<input type="checkbox"/> <input type="checkbox"/> <input type="checkbox"/>	<input type="checkbox"/> <input type="checkbox"/> <input type="checkbox"/>	<input type="checkbox"/> <input type="checkbox"/> <input type="checkbox"/>	<input type="checkbox"/> <input type="checkbox"/> <input type="checkbox"/>	<input type="checkbox"/> <input type="checkbox"/> <input type="checkbox"/>	<input type="checkbox"/> <input type="checkbox"/> <input type="checkbox"/>	181.0#
24 x 48 x 84 x 24"	GSSH24488424D/CR	<input type="checkbox"/> <input type="checkbox"/> <input type="checkbox"/>	<input type="checkbox"/> <input type="checkbox"/> <input type="checkbox"/>	<input type="checkbox"/> <input type="checkbox"/> <input type="checkbox"/>	<input type="checkbox"/> <input type="checkbox"/> <input type="checkbox"/>	<input type="checkbox"/> <input type="checkbox"/> <input type="checkbox"/>	<input type="checkbox"/> <input type="checkbox"/> <input type="checkbox"/>	<input type="checkbox"/> <input type="checkbox"/> <input type="checkbox"/>	195.0#
30 x 48 x 54 x 30"	GSSH30485430D/CR	<input type="checkbox"/> <input type="checkbox"/> <input type="checkbox"/>	<input type="checkbox"/> <input type="checkbox"/> <input type="checkbox"/>	<input type="checkbox"/> <input type="checkbox"/> <input type="checkbox"/>	<input type="checkbox"/> <input type="checkbox"/> <input type="checkbox"/>	<input type="checkbox"/> <input type="checkbox"/> <input type="checkbox"/>	<input type="checkbox"/> <input type="checkbox"/> <input type="checkbox"/>	<input type="checkbox"/> <input type="checkbox"/> <input type="checkbox"/>	168.0#
30 x 48 x 60 x 30"	GSSH30486030D/CR	<input type="checkbox"/> <input type="checkbox"/> <input type="checkbox"/>	<input type="checkbox"/> <input type="checkbox"/> <input type="checkbox"/>	<input type="checkbox"/> <input type="checkbox"/> <input type="checkbox"/>	<input type="checkbox"/> <input type="checkbox"/> <input type="checkbox"/>	<input type="checkbox"/> <input type="checkbox"/> <input type="checkbox"/>	<input type="checkbox"/> <input type="checkbox"/> <input type="checkbox"/>	<input type="checkbox"/> <input type="checkbox"/> <input type="checkbox"/>	177.0#
30 x 48 x 66 x 30"	GSSH30486630D/CR	<input type="checkbox"/> <input type="checkbox"/> <input type="checkbox"/>	<input type="checkbox"/> <input type="checkbox"/> <input type="checkbox"/>	<input type="checkbox"/> <input type="checkbox"/> <input type="checkbox"/>	<input type="checkbox"/> <input type="checkbox"/> <input type="checkbox"/>	<input type="checkbox"/> <input type="checkbox"/> <input type="checkbox"/>	<input type="checkbox"/> <input type="checkbox"/> <input type="checkbox"/>	<input type="checkbox"/> <input type="checkbox"/> <input type="checkbox"/>	185.0#
30 x 48 x 72 x 30"	GSSH30487230D/CR	<input type="checkbox"/> <input type="checkbox"/> <input type="checkbox"/>	<input type="checkbox"/> <input type="checkbox"/> <input type="checkbox"/>	<input type="checkbox"/> <input type="checkbox"/> <input type="checkbox"/>	<input type="checkbox"/> <input type="checkbox"/> <input type="checkbox"/>	<input type="checkbox"/> <input type="checkbox"/> <input type="checkbox"/>	<input type="checkbox"/> <input type="checkbox"/> <input type="checkbox"/>	<input type="checkbox"/> <input type="checkbox"/> <input type="checkbox"/>	193.0#
30 x 48 x 84 x 30"	GSSH30488430D/CR	<input type="checkbox"/> <input type="checkbox"/> <input type="checkbox"/>	<input type="checkbox"/> <input type="checkbox"/> <input type="checkbox"/>	<input type="checkbox"/> <input type="checkbox"/> <input type="checkbox"/>	<input type="checkbox"/> <input type="checkbox"/> <input type="checkbox"/>	<input type="checkbox"/> <input type="checkbox"/> <input type="checkbox"/>	<input type="checkbox"/> <input type="checkbox"/> <input type="checkbox"/>	<input type="checkbox"/> <input type="checkbox"/> <input type="checkbox"/>	210.0#

A

B

C

D

E

F

G

H

HOW TO ORDER

Indicate the following information on order form:

1. Quantity of each item.
2. Model number, including options. See "How To Build a Model Number".
3. Any special service required.

Note: • The indicates that a choice is required.

- The absence of the indicates that no choice is required.
- Alpha-numeric characters in place of indicate that no other alternatives are available.

HOW TO BUILD A MODEL NUMBER

A Select basic model.

B Select edge style.

74P - 74P edge
KN - Knife edge
MP - Membrane edge

C Select PowerUp module location.

Select only one from the following and add the appropriate upcharge to the base price.

PUN - No data
PUL - Left module; add \$108
PUR - Right module; add \$108
PUB - Both left and right modules; add \$218

D Select modesty panel option.

NM - No modesty panel
LM - LH modesty only
RM - RH modesty only
WM - Both modesty panels

Add upcharge to unit price for "LM", "RM" and "WM" options.

E Select wire trough and power option.

NW - No wire trough
WL - Wire trough LH only
WR - Wire trough RH only
WW - Wire trough Both

Add upcharge to unit price for "WL", "WR" and "WW" options.

F Select base finish.

Refer to color addendum at ki.com or KI Fabrics & Finishes binder.

G Select edge/PowerUp color.

Refer to color addendum at ki.com or KI Fabrics & Finishes binder. Edge color offerings are based on edge style selections. The color selection will apply to the trim, edge, PowerUp module and crank grommet. Trim color doesn't apply to the membrane edge selection.

H Select surface finish.

Refer to color addendum at ki.com or KI Fabrics & Finishes binder.

Surface finish offerings are based on edge style selections. Laminate finishes are only available on (74P) 74P edge and (KN) knife edge worksurfaces. The membrane color selections are only available on the (MP) membrane edge worksurfaces.



Genesis® Worksurfaces

Square Shoe Crank Height Dual

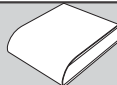
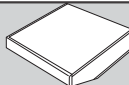
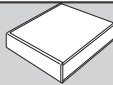

74P Edge
(74P)

Knife Edge
(KN)

Membrane Edge
(MP)

LH
Modesty
Panel
add to list
price

RH
Modesty
Panel
add to list
price

Both
Modesty
Panels
add to list
price

Left
Wire
Trough
add to list
price

Right
Wire
Trough
add to list
price

Both
Wire
Troughs
add to list
price

\$ 2954	\$ 2997	\$ 2997	\$ 185	\$ 198	\$ 385	\$ 483	\$ 500	\$ 983	
2958	2999	2999	185	205	392	483	517	998	
2979	3021	3021	185	213	399	483	637	1119	
3032	3077	3077	185	220	409	483	710	1191	
3061	3106	3106	185	249	435	483	715	1196	
2954	2997	2997	185	198	385	483	500	983	
2958	2999	2999	185	205	392	483	517	998	
2979	3021	3021	185	213	399	483	637	1119	
3032	3077	3077	185	220	409	483	710	1191	
3061	3106	3106	185	249	435	483	715	1196	

FINISH INFORMATION

Additional Laminate Offering

Additional laminates beyond KI standard offering, are available with two weeks extended leadtime. To specify additional laminates, use these designators followed by the supplier's color/pattern code:

- Formica - LF/supplier's color pattern code
- Nevamar - LN/supplier's color pattern code
- Wilsonart - LW/supplier's color pattern code

KI's standard finish is the supplier's recommended finish for that color/pattern. Note: Nonstandard laminates from these suppliers (example: textured laminates), require an upcharge and additional leadtime. Contact KI.

SPECIAL SERVICES

Special Carton Marking

With specially marked information N/C

Shipping

Shipped k.d. freight prepaid f.o.b. Manitowoc, Wisconsin 54220 factory. Freight class #100.

Specifications and prices are subject to change without prior notice.



Genesis® Worksurfaces

Square Shoe Electric Height Adjustable

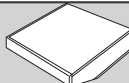
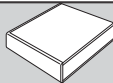

74P Edge
(74P)

Knife Edge
(KN)

Membrane Edge
(MP)

LH
Modesty
Panel
add to list
price

RH
Modesty
Panel
add to list
price

Both
Modesty
Panels
add to list
price

Left
Wire
Trough
add to list
price

Right
Wire
Trough
add to list
price

Both
Wire
Troughs
add to list
price

\$ 3953	\$ 3999	\$ 3999	\$ 198	\$ 185	\$ 385	\$ 500	\$ 483	\$ 983
3956	4002	4002	205	185	392	517	483	998
4009	4056	4056	213	185	399	637	483	1119
4065	4108	4108	220	185	409	710	483	1191
4121	4165	4165	249	185	435	715	483	1196
3953	3999	3999	198	185	385	500	483	983
3956	4002	4002	205	185	392	517	483	998
4009	4056	4056	213	185	399	637	483	1119
4065	4108	4108	220	185	409	710	483	1191
4121	4165	4165	249	185	435	715	483	1196

FINISH INFORMATION

Additional Laminate Offering

Additional laminates beyond KI standard offering, are available with two weeks extended leadtime. To specify additional laminates, use these designators followed by the supplier's color/pattern code:

- Formica - LF/supplier's color pattern code
- Nevamar - LN/supplier's color pattern code
- Wilsonart - LW/supplier's color pattern code

KI's standard finish is the supplier's recommended finish for that color/pattern. Note: Nonstandard laminates from these suppliers (example: textured laminates), require an upcharge and additional leadtime. Contact KI.

SPECIAL SERVICES

Special Carton Marking

With specially marked information N/C

Shipping

Shipped k.d. freight prepaid f.o.b. Manitowoc, Wisconsin 54220 factory. Freight class #100.

Specifications and prices are subject to change without prior notice.



Genesis® Worksurfaces

Square Shoe Electric Height Adjustable

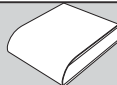
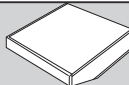
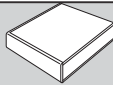

74P Edge
(74P)

Knife Edge
(KN)

Membrane Edge
(MP)

LH
Modesty
Panel
add to list
price

RH
Modesty
Panel
add to list
price

Both
Modesty
Panels
add to list
price

Left
Wire
Trough
add to list
price

Right
Wire
Trough
add to list
price

Both
Wire
Troughs
add to list
price

	\$	\$	\$	\$	\$	\$	\$	\$	\$
3953	3953	3999	3999	185	198	385	483	500	983
3956	3956	4002	4002	185	205	392	483	517	998
4009	4009	4056	4056	185	213	399	483	637	1119
4065	4065	4108	4108	185	220	409	483	710	1191
4121	4121	4165	4165	185	249	435	483	715	1196
3953	3953	3999	3999	185	198	385	483	500	983
3956	3956	4002	4002	185	205	392	483	517	998
4009	4009	4056	4056	185	213	399	483	637	1119
4065	4065	4108	4108	185	220	409	483	710	1191
4121	4121	4165	4165	185	249	435	483	715	1196

FINISH INFORMATION

Additional Laminate Offering

Additional laminates beyond KI standard offering, are available with two weeks extended leadtime. To specify additional laminates, use these designators followed by the supplier's color/pattern code:

- Formica - LF/supplier's color pattern code
- Nevamar - LN/supplier's color pattern code
- Wilsonart - LW/supplier's color pattern code

KI's standard finish is the supplier's recommended finish for that color/pattern. Note: Nonstandard laminates from these suppliers (example: textured laminates), require an upcharge and additional leadtime. Contact KI.

SPECIAL SERVICES

Special Carton Marking

With specially marked information N/C

Shipping

Shipped k.d. freight prepaid f.o.b. Manitowoc, Wisconsin 54220 factory. Freight class #100.

Specifications and prices are subject to change without prior notice.



Genesis® Worksurfaces

Square Shoe Electric Height Adjustable Dual

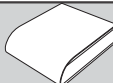
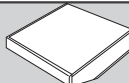
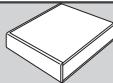

74P Edge
(74P)

Knife Edge
(KN)

Membrane Edge
(MP)

LH
Modesty
Panel
add to list
price

RH
Modesty
Panel
add to list
price

Both
Modesty
Panels
add to list
price

Left
Wire
Trough
add to list
price

Right
Wire
Trough
add to list
price

Both
Wire
Troughs
add to list
price

\$ 4862	\$ 4906	\$ 4906	\$ 198	\$ 185	\$ 385	\$ 500	\$ 483	\$ 983
4867	4908	4908	205	185	392	517	483	998
4920	4963	4963	213	185	399	637	483	1119
4974	5017	5017	220	185	409	710	483	1191
5060	5076	5076	249	185	435	715	483	1196
4862	4906	4906	198	185	385	500	483	983
4867	4908	4908	205	185	392	517	483	998
4920	4963	4963	213	185	399	637	483	1119
4974	5017	5017	220	185	409	710	483	1191
5060	5076	5076	249	185	435	715	483	1196

FINISH INFORMATION

Additional Laminate Offering

Additional laminates beyond KI standard offering, are available with two weeks extended leadtime. To specify additional laminates, use these designators followed by the supplier's color/pattern code:

- Formica - LF/supplier's color pattern code
- Nevamar - LN/supplier's color pattern code
- Wilsonart - LW/supplier's color pattern code

KI's standard finish is the supplier's recommended finish for that color/pattern. Note: Nonstandard laminates from these suppliers (example: textured laminates), require an upcharge and additional leadtime. Contact KI.

SPECIAL SERVICES

Special Carton Marking

With specially marked information N/C

Shipping

Shipped k.d. freight prepaid f.o.b. Manitowoc, Wisconsin 54220 factory. Freight class #100.

Specifications and prices are subject to change without prior notice.



Genesis® Worksurfaces

Square Shoe Electric Height Adjustable Dual

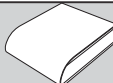
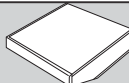
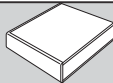

74P Edge (74P)	Knife Edge (KN)	Membrane Edge (MP)	LH Modesty Panel add to list price	RH Modesty Panel add to list price	Both Modesty Panels add to list price	Left Wire Trough add to list price	Right Wire Trough add to list price	Both Wire Troughs add to list price
\$ 4862	\$ 4906	\$ 4906	\$ 185	\$ 198	\$ 385	\$ 483	\$ 500	\$ 983
4867	4908	4908	185	205	392	483	517	998
4920	4963	4963	185	213	399	483	637	1119
4974	5017	5017	185	220	409	483	710	1191
5060	5076	5076	185	249	435	483	715	1196
4862	4906	4906	185	198	385	483	500	983
4867	5016	5016	185	205	392	483	517	998
4920	4963	4963	185	213	399	483	637	1119
4974	5017	5017	185	220	409	483	710	1191
5060	5076	5076	185	249	435	483	715	1196

FINISH INFORMATION

Additional Laminate Offering

Additional laminates beyond KI standard offering, are available with two weeks extended leadtime. To specify additional laminates, use these designators followed by the supplier's color/pattern code:

- Formica - LF/supplier's color pattern code
- Nevamar - LN/supplier's color pattern code
- Wilsonart - LW/supplier's color pattern code

KI's standard finish is the supplier's recommended finish for that color/pattern. Note: Nonstandard laminates from these suppliers (example: textured laminates), require an upcharge and additional leadtime. Contact KI.

SPECIAL SERVICES

Special Carton Marking

With specially marked information N/C

Shipping

Shipped k.d. freight prepaid f.o.b. Manitowoc, Wisconsin 54220 factory. Freight class #100.

Specifications and prices are subject to change without prior notice.

Genesis® Worksurfaces

Reduction Square Shoe Fixed Height

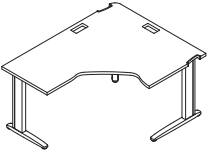
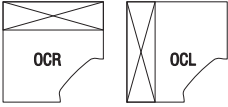
	D x L x W x D	MODEL NUMBER										
		Basic Model	Edge Style	Module Location	Modesty Panel	Wire Trough	Overhead Grommet	Trans. Legs	Base Finish	Edge Color	Surface Finish	
 <p>GSSH</p> <p>Reduction Basic Square Shoe Fixed Height-Left</p> <ul style="list-style-type: none"> Extended corner surface Three-legged table base Fixed height at 29" Adjustable glides 	24 x 54 x 48 x 30"	GSSH24544830S/F	<input type="checkbox"/> <input type="checkbox"/>	<input type="checkbox"/> <input type="checkbox"/>	<input type="checkbox"/>	<input type="checkbox"/>	<input type="checkbox"/> <input type="checkbox"/>	<input type="checkbox"/>	<input type="checkbox"/>	<input type="checkbox"/> <input type="checkbox"/>	<input type="checkbox"/> <input type="checkbox"/>	
	24 x 60 x 48 x 30"	GSSH24604830S/F	<input type="checkbox"/> <input type="checkbox"/>	<input type="checkbox"/> <input type="checkbox"/>	<input type="checkbox"/>	<input type="checkbox"/>	<input type="checkbox"/> <input type="checkbox"/>	<input type="checkbox"/>	<input type="checkbox"/>	<input type="checkbox"/> <input type="checkbox"/>	<input type="checkbox"/> <input type="checkbox"/>	
	24 x 66 x 48 x 30"	GSSH24664830S/F	<input type="checkbox"/> <input type="checkbox"/>	<input type="checkbox"/> <input type="checkbox"/>	<input type="checkbox"/>	<input type="checkbox"/>	<input type="checkbox"/> <input type="checkbox"/>	<input type="checkbox"/>	<input type="checkbox"/>	<input type="checkbox"/> <input type="checkbox"/>	<input type="checkbox"/> <input type="checkbox"/>	
	24 x 72 x 48 x 30"	GSSH24724830S/F	<input type="checkbox"/> <input type="checkbox"/>	<input type="checkbox"/> <input type="checkbox"/>	<input type="checkbox"/>	<input type="checkbox"/>	<input type="checkbox"/> <input type="checkbox"/>	<input type="checkbox"/>	<input type="checkbox"/>	<input type="checkbox"/> <input type="checkbox"/>	<input type="checkbox"/> <input type="checkbox"/>	
	24 x 84 x 48 x 30"	GSSH24844830S/F	<input type="checkbox"/> <input type="checkbox"/>	<input type="checkbox"/> <input type="checkbox"/>	<input type="checkbox"/>	<input type="checkbox"/>	<input type="checkbox"/> <input type="checkbox"/>	<input type="checkbox"/>	<input type="checkbox"/>	<input type="checkbox"/> <input type="checkbox"/>	<input type="checkbox"/> <input type="checkbox"/>	
	30 x 54 x 48 x 24"	GSSH30544824S/F	<input type="checkbox"/> <input type="checkbox"/>	<input type="checkbox"/> <input type="checkbox"/>	<input type="checkbox"/>	<input type="checkbox"/>	<input type="checkbox"/> <input type="checkbox"/>	<input type="checkbox"/>	<input type="checkbox"/>	<input type="checkbox"/> <input type="checkbox"/>	<input type="checkbox"/> <input type="checkbox"/>	
	30 x 60 x 48 x 24"	GSSH30604824S/F	<input type="checkbox"/> <input type="checkbox"/>	<input type="checkbox"/> <input type="checkbox"/>	<input type="checkbox"/>	<input type="checkbox"/>	<input type="checkbox"/> <input type="checkbox"/>	<input type="checkbox"/>	<input type="checkbox"/>	<input type="checkbox"/> <input type="checkbox"/>	<input type="checkbox"/> <input type="checkbox"/>	
	30 x 66 x 48 x 24"	GSSH30664824S/F	<input type="checkbox"/> <input type="checkbox"/>	<input type="checkbox"/> <input type="checkbox"/>	<input type="checkbox"/>	<input type="checkbox"/>	<input type="checkbox"/> <input type="checkbox"/>	<input type="checkbox"/>	<input type="checkbox"/>	<input type="checkbox"/> <input type="checkbox"/>	<input type="checkbox"/> <input type="checkbox"/>	
	30 x 72 x 48 x 24"	GSSH30724824S/F	<input type="checkbox"/> <input type="checkbox"/>	<input type="checkbox"/> <input type="checkbox"/>	<input type="checkbox"/>	<input type="checkbox"/>	<input type="checkbox"/> <input type="checkbox"/>	<input type="checkbox"/>	<input type="checkbox"/>	<input type="checkbox"/> <input type="checkbox"/>	<input type="checkbox"/> <input type="checkbox"/>	
	30 x 84 x 48 x 24"	GSSH30844824S/F	<input type="checkbox"/> <input type="checkbox"/>	<input type="checkbox"/> <input type="checkbox"/>	<input type="checkbox"/>	<input type="checkbox"/>	<input type="checkbox"/> <input type="checkbox"/>	<input type="checkbox"/>	<input type="checkbox"/>	<input type="checkbox"/> <input type="checkbox"/>	<input type="checkbox"/> <input type="checkbox"/>	
 <p>OCR-OCL</p> <ul style="list-style-type: none"> OCR = Overhead right OCL = Overhead left 												
			A	B	C	D	E	F	G	H	I	J

HOW TO ORDER

Indicate the following information on order form:

- Quantity of each item.
- Model number, including options. See "How To Build a Model Number".
- Any special service required.

Note: • The indicates that a choice is required.

- The absence of the indicates that no choice is required.
- Alpha-numeric characters in place of indicate that no other alternatives are available.

HOW TO BUILD A MODEL NUMBER

A Select basic model.

B Select edge style.

74P - 74P edge
KN - Knife edge
MP - Membrane edge

C Select PowerUp module location.

Select only one from the following and add the appropriate upcharge to the base price.

PUN - No data
PUL - Left module; add \$108
PUR - Right module; add \$108
PUB - Both left and right modules; add \$218

D Select modesty panel option.

NM - No modesty panel
LM - LH modesty only
RM - RH modesty only
WM - Both modesty panels

Add upcharge to unit price for "LM", "RM" and "WM" options.

E Select wire trough and power option.

NW - No wire trough
WL - Wire trough LH only
WR - Wire trough RH only
WW - Wire trough Both

Add upcharge to unit price for "WL", "WR" and "WW" options.

F Select overhead grommet.

OGN - Overhead grommets no
OGL - Overhead grommets left
OGR - Overhead grommets right

G Select transition legs.

TS - No transition foot
TL - Left transition foot
TR - Right transition foot
TB - Both transition feet

H Select base finish.

Refer to color addendum at ki.com or KI Fabrics & Finishes binder.

I Select edge/PowerUp color.

Refer to color addendum at ki.com or KI Fabrics & Finishes binder.

Edge color offerings are based on edge style selections. The color selection will apply to the trim, edge, PowerUp module and crank grommet. Trim color doesn't apply to the membrane edge selection.

J Select surface finish.

Refer to color addendum at ki.com or KI Fabrics & Finishes binder. Surface finish offerings are based on edge style selections. Laminate finishes are only available on (74P) 74P edge and (KN) knife edge worksurfaces. The membrane color selections are only available on the (MP) membrane edge worksurfaces.



Genesis® Worksurfaces

Reduction Square Shoe Fixed Height

Approx. Packaged Weight	Edge Type			LH Modesty Panel add to list price	RH Modesty Panel add to list price	Both Modesty Panels add to list price	Left Wire Trough add to list price	Right Wire Trough add to list price	Both Wire Troughs add to list price
	74P Edge (74P)	Knife Edge (KN)	Membrane Edge (MP)						
130.0#	\$ 1471	\$ 1518	\$ 1518	\$ 198	\$ 185	\$ 385	\$ 500	\$ 483	\$ 983
136.0#	1474	1520	1520	205	185	392	517	483	998
143.0#	1509	1543	1543	213	185	399	637	483	1119
149.0#	1552	1594	1594	220	185	409	710	483	1191
162.0#	1622	1625	1625	249	185	435	715	483	1196
131.0#	1471	1518	1518	198	185	385	500	483	983
139.0#	1474	1520	1520	205	185	392	517	483	998
146.0#	1509	1543	1543	213	185	399	637	483	1119
154.0#	1552	1594	1594	220	185	409	710	483	1191
170.0#	1622	1625	1625	249	185	435	715	483	1196

FINISH INFORMATION

Additional Laminate Offering

Additional laminates beyond KI standard offering, are available with two weeks extended leadtime. To specify additional laminates, use these designators followed by the supplier's color/pattern code:

Formica - LF/supplier's color pattern code
 Nevamar - LN/supplier's color pattern code
 Wilsonart - LW/supplier's color pattern code

KI's standard finish is the supplier's recommended finish for that color/pattern. Note: Nonstandard laminates from these suppliers (example: textured laminates), require an upcharge and additional leadtime. Contact KI.

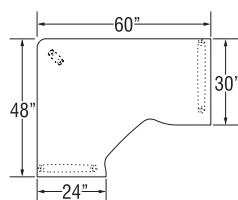

Basic Model:
GSSH24486030S/F

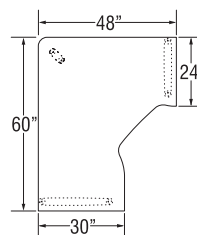

Basic Model:
GSSH30604824S/F

INFORMATION

Options are always specified left to right from the seated position

SPECIAL SERVICES

Special Carton Marking

With specially marked information N/C

Shipping

Shipped k.d. freight prepaid f.o.b. Manitowoc, Wisconsin 54220 factory. Freight class #100.

Specifications and prices are subject to change without prior notice.



Genesis® Worksurfaces

Reduction Square Shoe Fixed Height

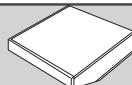
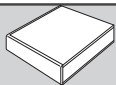

Approx. Packaged Weight	74P Edge (74P)	Knife Edge (KN)	Membrane Edge (MP)	LH Modesty Panel add to list price	RH Modesty Panel add to list price	Both Modesty Panels add to list price	Left Wire Trough add to list price	Right Wire Trough add to list price	Both Wire Troughs add to list price
131.0#	\$ 1471	\$ 1518	\$ 1518	\$ 185	\$ 198	\$ 385	\$ 483	\$ 500	\$ 983
139.0#	1474	1520	1520	185	205	392	483	517	998
146.0#	1509	1543	1543	185	213	399	483	637	1119
154.0#	1552	1594	1594	185	220	409	483	710	1191
170.0#	1622	1625	1625	185	249	435	483	715	1196
130.0#	1471	1518	1518	185	198	385	483	500	983
136.0#	1474	1520	1520	185	205	392	483	517	998
143.0#	1509	1543	1543	185	213	399	483	637	1119
149.0#	1552	1594	1594	185	220	409	483	710	1191
162.0#	1622	1625	1625	185	249	435	483	715	1196

FINISH INFORMATION

Additional Laminate Offering

Additional laminates beyond KI standard offering, are available with two weeks extended leadtime. To specify additional laminates, use these designators followed by the supplier's color/pattern code:

- Formica - LF/supplier's color pattern code
- Nevamar - LN/supplier's color pattern code
- Wilsonart - LW/supplier's color pattern code

KI's standard finish is the supplier's recommended finish for that color/pattern. Note: Nonstandard laminates from these suppliers (example: textured laminates), require an upcharge and additional leadtime. Contact KI.

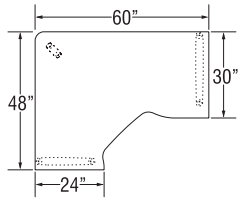

Basic Model:
GSSH24486030S/F

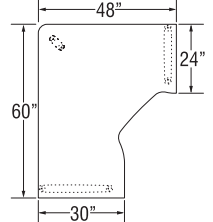

Basic Model:
GSSH30604824S/F

INFORMATION

Options are always specified left to right from the seated position

SPECIAL SERVICES

Special Carton Marking

With specially marked information N/C

Shipping

Shipped k.d. freight prepaid f.o.b. Manitowoc, Wisconsin 54220 factory. Freight class #100.

Specifications and prices are subject to change without prior notice.

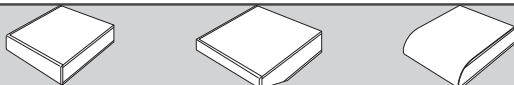

Approx. Packaged Weight	74P Edge (74P)	Knife Edge (KN)	Membrane Edge (MP)	LH Modesty Panel add to list price	RH Modesty Panel add to list price	Both Modesty Panels add to list price	Left Wire Trough add to list price	Right Wire Trough add to list price	Both Wire Troughs add to list price
150.0#	\$ 2380	\$ 2426	\$ 2426	\$ 198	\$ 185	\$ 385	\$ 500	\$ 483	\$ 983
156.0#	2384	2429	2429	205	185	392	517	483	998
163.0#	2405	2450	2450	213	185	399	637	483	1119
169.0#	2460	2504	2504	220	185	409	710	483	1191
182.0#	2530	2534	2534	249	185	435	715	483	1196
151.0#	2380	2426	2426	198	185	385	500	483	983
159.0#	2384	2429	2429	205	185	392	517	483	998
166.0#	2405	2450	2450	213	185	399	637	483	1119
174.0#	2460	2504	2504	220	185	409	710	483	1191
190.0#	2530	2534	2534	249	185	435	715	483	1196

FINISH INFORMATION

Additional Laminate Offering

Additional laminates beyond KI standard offering, are available with two weeks extended leadtime. To specify additional laminates, use these designators followed by the supplier's color/pattern code:

- Formica - LF/supplier's color pattern code
- Nevamar - LN/supplier's color pattern code
- Wilsonart - LW/supplier's color pattern code

KI's standard finish is the supplier's recommended finish for that color/pattern. Note: Nonstandard laminates from these suppliers (example: textured laminates), require an upcharge and additional leadtime. Contact KI.

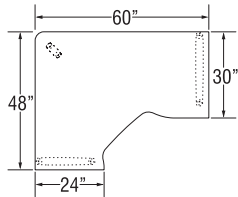

Basic Model: GSSH24486030S/F

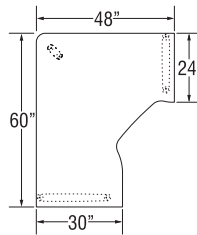

Basic Model: GSSH30604824S/F

INFORMATION

Options are always specified left to right from the seated position

SPECIAL SERVICES

Special Carton Marking

With specially marked information N/C

Shipping

Shipped k.d. freight prepaid f.o.b. Manitowoc, Wisconsin 54220 factory. Freight class #100.

Specifications and prices are subject to change without prior notice.

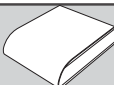
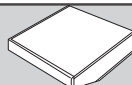
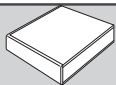

Approx. Packaged Weight	74P Edge (74P)	Knife Edge (KN)	Membrane Edge (MP)	LH Modesty Panel add to list price	RH Modesty Panel add to list price	Both Modesty Panels add to list price	Left Wire Trough add to list price	Right Wire Trough add to list price	Both Wire Troughs add to list price
151.0#	\$ 2380	\$ 2426	\$ 2426	\$ 185	\$ 198	\$ 385	\$ 483	\$ 500	\$ 983
159.0#	2384	2429	2429	185	205	392	483	517	998
166.0#	2405	2450	2450	185	213	399	483	637	1119
174.0#	2460	2504	2504	185	220	409	483	710	1191
190.0#	2530	2534	2534	185	249	435	483	715	1196
150.0#	2380	2426	2426	185	198	385	483	500	983
156.0#	2384	2429	2429	185	205	392	483	517	998
163.0#	2405	2450	2450	185	213	399	483	637	1119
169.0#	2460	2504	2504	185	220	409	483	710	1191
182.0#	2530	2534	2534	185	249	435	483	715	1196

FINISH INFORMATION

Additional Laminate Offering

Additional laminates beyond KI standard offering, are available with two weeks extended leadtime. To specify additional laminates, use these designators followed by the supplier's color/pattern code:

- Formica - LF/supplier's color pattern code
- Nevamar - LN/supplier's color pattern code
- Wilsonart - LW/supplier's color pattern code

KI's standard finish is the supplier's recommended finish for that color/pattern. Note: Nonstandard laminates from these suppliers (example: textured laminates), require an upcharge and additional leadtime. Contact KI.

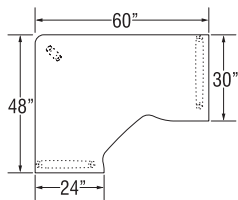

Basic Model:
GSSH24486030S/F

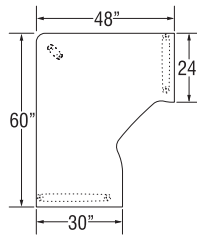

Basic Model:
GSSH30604824S/F

INFORMATION

Options are always specified left to right from the seated position

SPECIAL SERVICES

Special Carton Marking

With specially marked information N/C

Shipping

Shipped k.d. freight prepaid f.o.b. Manitowoc, Wisconsin 54220 factory. Freight class #100.

Specifications and prices are subject to change without prior notice.

Genesis® Worksurfaces

Reduction Square Shoe Pin Height Adjustable

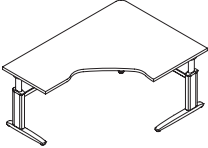
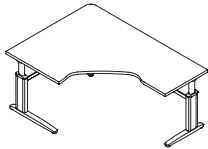
	D x L x W x D	MODEL NUMBER								Approx. Packaged Weight
		Basic Model	Edge Style	Module Location	Modesty Panel	Wire Trough	Base Finish	Edge Color	Surface Finish	
 <p>GSSH Reduction Square Shoe Pin Height Adjustable-Left</p> <ul style="list-style-type: none"> Extended corner surface Three-legged table base Height adjusts from 24"-31" in 1" increments Adjustable glides Wire trough and modesty panel should not be ordered together on adjustable tables 	24 x 54 x 48 x 30"	GSSH24544830S/P	□□□	□□□	□□	□□	□□	□□□	□□□	136.0#
	24 x 60 x 48 x 30"	GSSH24604830S/P	□□□	□□□	□□	□□	□□	□□□	□□□	143.0#
	24 x 66 x 48 x 30"	GSSH24664830S/P	□□□	□□□	□□	□□	□□	□□□	□□□	150.0#
	24 x 72 x 48 x 30"	GSSH24724830S/P	□□□	□□□	□□	□□	□□	□□□	□□□	157.0#
	24 x 84 x 48 x 30"	GSSH24844830S/P	□□□	□□□	□□	□□	□□	□□□	□□□	170.0#
	30 x 54 x 48 x 24"	GSSH30544824S/P	□□□	□□□	□□	□□	□□	□□□	□□□	137.0#
	30 x 60 x 48 x 24"	GSSH30604824S/P	□□□	□□□	□□	□□	□□	□□□	□□□	145.0#
	30 x 66 x 48 x 24"	GSSH30664824S/P	□□□	□□□	□□	□□	□□	□□□	□□□	153.0#
	30 x 72 x 48 x 24"	GSSH30724824S/P	□□□	□□□	□□	□□	□□	□□□	□□□	162.0#
	30 x 84 x 48 x 24"	GSSH30844824S/P	□□□	□□□	□□	□□	□□	□□□	□□□	178.0#
 <p>GSSH Reduction Square Shoe Pin Height Adjustable-Right</p> <ul style="list-style-type: none"> Extended corner surface Three-legged table base Height adjusts from 24"-31" in 1" increments Adjustable glides Wire trough and modesty panel should not be ordered together on adjustable tables 	24 x 48 x 54 x 30"	GSSH24485430S/P	□□□	□□□	□□	□□	□□	□□□	□□□	137.0#
	24 x 48 x 60 x 30"	GSSH24486030S/P	□□□	□□□	□□	□□	□□	□□□	□□□	145.0#
	24 x 48 x 66 x 30"	GSSH24486630S/P	□□□	□□□	□□	□□	□□	□□□	□□□	153.0#
	24 x 48 x 72 x 30"	GSSH24487230S/P	□□□	□□□	□□	□□	□□	□□□	□□□	162.0#
	24 x 48 x 84 x 30"	GSSH24488430S/P	□□□	□□□	□□	□□	□□	□□□	□□□	178.0#
	30 x 48 x 54 x 24"	GSSH30485424S/P	□□□	□□□	□□	□□	□□	□□□	□□□	136.0#
	30 x 48 x 60 x 24"	GSSH30486024S/P	□□□	□□□	□□	□□	□□	□□□	□□□	143.0#
	30 x 48 x 66 x 24"	GSSH30486624S/P	□□□	□□□	□□	□□	□□	□□□	□□□	150.0#
	30 x 48 x 72 x 24"	GSSH30487224S/P	□□□	□□□	□□	□□	□□	□□□	□□□	157.0#
	30 x 48 x 84 x 24"	GSSH30488424S/P	□□□	□□□	□□	□□	□□	□□□	□□□	170.0#

A **B** **C** **D** **E** **F** **G** **H**

HOW TO ORDER

Indicate the following information on order form:

- Quantity of each item.
- Model number, including options. See "How To Build a Model Number".
- Any special service required.

Note: • The □ indicates that a choice is required.

- The absence of the □ indicates that no choice is required.
- Alpha-numeric characters in place of □ indicate that no other alternatives are available.

HOW TO BUILD A MODEL NUMBER

- A** Select basic model.
 - 74P** - 74P edge
 - KN** - Knife edge
 - MP** - Membrane edge
- B** Select edge style.
 - 74P** - 74P edge
 - KN** - Knife edge
 - MP** - Membrane edge
- C** Select PowerUp module location. Select only one from the following and add the appropriate upcharge to the base price.
 - PUN** - No data
 - PUL** - Left module; add \$108
 - PUR** - Right module; add \$108
 - PUB** - Both left and right modules; add \$218
- D** Select modesty panel option.
 - NM** - No modesty panel
 - LM** - LH modesty only
 - RM** - RH modesty only
 - WM** - Both modesty panels
 Add upcharge to unit price for "LM", "RM" and "WM" options.

- E** Select wire trough and power option.
 - NW** - No wire trough
 - WL** - Wire trough LH only
 - WR** - Wire trough RH only
 - WW** - Wire trough Both
 Add upcharge to unit price for "WL", "WR" and "WW" options.

- F** Select base finish. Refer to color addendum at ki.com or KI Fabrics & Finishes binder.

- G** Select edge/PowerUp color. Refer to color addendum at ki.com or KI Fabrics & Finishes binder. Edge color offerings are based on edge style selections. The color selection will apply to the trim, edge, PowerUp module and crank grommet. Trim color doesn't apply to the membrane edge selection.

- H** Select surface finish. Refer to color addendum at ki.com or KI Fabrics & Finishes binder.

Surface finish offerings are based on edge style selections. Laminate finishes are only available on (74P) 74P edge and (KN) knife edge worksurfaces. The membrane color selections are only available on the (MP) membrane edge worksurfaces.

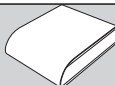
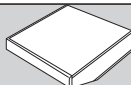
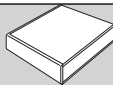

74P Edge
(74P)

Knife Edge
(KN)

Membrane Edge
(MP)

LH
Modesty
Panel
add to list
price

RH
Modesty
Panel
add to list
price

Both
Modesty
Panels
add to list
price

Left
Wire
Trough
add to list
price

Right
Wire
Trough
add to list
price

Both
Wire
Troughs
add to list
price

\$ 1677	\$ 1723	\$ 1723	\$ 198	\$ 185	\$ 385	\$ 500	\$ 483	\$ 983
1681	1725	1725	205	185	392	517	483	998
1703	1749	1749	213	185	399	637	483	1119
1775	1818	1818	220	185	409	710	483	1191
1800	1846	1846	249	185	435	715	483	1196
1677	1723	1723	198	185	385	500	483	983
1681	1725	1725	205	185	392	517	483	998
1703	1749	1749	213	185	399	637	483	1119
1775	1818	1818	220	185	409	710	483	1191
1800	1846	1846	249	185	435	715	483	1196

\$ 1677	\$ 1723	\$ 1723	\$ 185	\$ 198	\$ 385	\$ 483	\$ 500	\$ 983
1681	1725	1725	185	205	392	483	517	998
1703	1749	1749	185	213	399	483	637	1119
1775	1818	1818	185	220	409	483	710	1191
1800	1846	1846	185	249	435	483	715	1196
1677	1723	1723	185	198	385	483	500	983
1681	1725	1725	185	205	392	483	517	998
1703	1749	1749	185	213	399	483	637	1119
1775	1818	1818	185	220	409	483	710	1191
1800	1846	1846	185	249	435	483	715	1196

FINISH INFORMATION

Additional Laminate Offering

Additional laminates beyond KI standard offering, are available with two weeks extended leadtime. To specify additional laminates, use these designators followed by the supplier's color/pattern code:

Formica - LF/supplier's color pattern code
Nevamar - LN/supplier's color pattern code
Wilsonart - LW/supplier's color pattern code

KI's standard finish is the supplier's recommended finish for that color/pattern. Note: Nonstandard laminates from these suppliers (example: textured laminates), require an upcharge and additional leadtime. Contact KI.

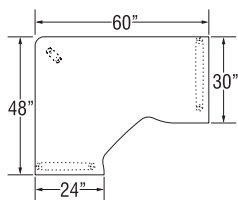

Basic Model:
GSSH24486030S/F

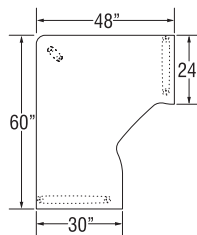

Basic Model:
GSSH30604824S/F

INFORMATION

Options are always specified left to right from the seated position

SPECIAL SERVICES

Special Carton Marking

With specially marked information N/C

Shipping

Shipped k.d. freight prepaid f.o.b. Manitowoc, Wisconsin 54220 factory. Freight class #100.

Specifications and prices are subject to change without prior notice.

Genesis® Worksurfaces

Reduction Square Shoe Crank Height Adjustable

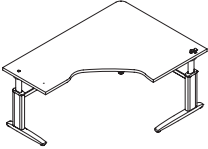
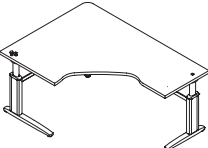
	D x L x W x D	MODEL NUMBER								Approx. Packaged Weight
		Basic Model	Edge Style	Module Location	Modesty Panel	Wire Trough	Base Finish	Edge Color	Surface Finish	
 <p>GSSH Reduction Basic Square Shoe Crank Height Adjustable-Left</p> <ul style="list-style-type: none"> Extended corner surface Three-legged table base Height adjusts from 22"-33" Adjustable glides Worksurfaces are undersized by 1/4" from side-to-side and 1/4" from back-to-front from the stated dimensions Wire trough and modesty panel should not be ordered together on adjustable tables 	24 x 54 x 48 x 30"	GSSH24544830S/CR	<input type="checkbox"/> <input type="checkbox"/> <input type="checkbox"/>	<input type="checkbox"/> <input type="checkbox"/> <input type="checkbox"/>	<input type="checkbox"/>	<input type="checkbox"/>	<input type="checkbox"/>	<input type="checkbox"/> <input type="checkbox"/> <input type="checkbox"/>	<input type="checkbox"/> <input type="checkbox"/> <input type="checkbox"/>	143.0#
	24 x 60 x 48 x 30"	GSSH24604830S/CR	<input type="checkbox"/> <input type="checkbox"/> <input type="checkbox"/>	<input type="checkbox"/> <input type="checkbox"/> <input type="checkbox"/>	<input type="checkbox"/>	<input type="checkbox"/>	<input type="checkbox"/>	<input type="checkbox"/> <input type="checkbox"/> <input type="checkbox"/>	<input type="checkbox"/> <input type="checkbox"/> <input type="checkbox"/>	150.0#
	24 x 66 x 48 x 30"	GSSH24664830S/CR	<input type="checkbox"/> <input type="checkbox"/> <input type="checkbox"/>	<input type="checkbox"/> <input type="checkbox"/> <input type="checkbox"/>	<input type="checkbox"/>	<input type="checkbox"/>	<input type="checkbox"/>	<input type="checkbox"/> <input type="checkbox"/> <input type="checkbox"/>	<input type="checkbox"/> <input type="checkbox"/> <input type="checkbox"/>	157.0#
	24 x 72 x 48 x 30"	GSSH24724830S/CR	<input type="checkbox"/> <input type="checkbox"/> <input type="checkbox"/>	<input type="checkbox"/> <input type="checkbox"/> <input type="checkbox"/>	<input type="checkbox"/>	<input type="checkbox"/>	<input type="checkbox"/>	<input type="checkbox"/> <input type="checkbox"/> <input type="checkbox"/>	<input type="checkbox"/> <input type="checkbox"/> <input type="checkbox"/>	165.0#
	24 x 84 x 48 x 30"	GSSH24844830S/CR	<input type="checkbox"/> <input type="checkbox"/> <input type="checkbox"/>	<input type="checkbox"/> <input type="checkbox"/> <input type="checkbox"/>	<input type="checkbox"/>	<input type="checkbox"/>	<input type="checkbox"/>	<input type="checkbox"/> <input type="checkbox"/> <input type="checkbox"/>	<input type="checkbox"/> <input type="checkbox"/> <input type="checkbox"/>	179.0#
	30 x 54 x 48 x 24"	GSSH30544824S/CR	<input type="checkbox"/> <input type="checkbox"/> <input type="checkbox"/>	<input type="checkbox"/> <input type="checkbox"/> <input type="checkbox"/>	<input type="checkbox"/>	<input type="checkbox"/>	<input type="checkbox"/>	<input type="checkbox"/> <input type="checkbox"/> <input type="checkbox"/>	<input type="checkbox"/> <input type="checkbox"/> <input type="checkbox"/>	146.0#
	30 x 60 x 48 x 24"	GSSH30604824S/CR	<input type="checkbox"/> <input type="checkbox"/> <input type="checkbox"/>	<input type="checkbox"/> <input type="checkbox"/> <input type="checkbox"/>	<input type="checkbox"/>	<input type="checkbox"/>	<input type="checkbox"/>	<input type="checkbox"/> <input type="checkbox"/> <input type="checkbox"/>	<input type="checkbox"/> <input type="checkbox"/> <input type="checkbox"/>	155.0#
	30 x 66 x 48 x 24"	GSSH30664824S/CR	<input type="checkbox"/> <input type="checkbox"/> <input type="checkbox"/>	<input type="checkbox"/> <input type="checkbox"/> <input type="checkbox"/>	<input type="checkbox"/>	<input type="checkbox"/>	<input type="checkbox"/>	<input type="checkbox"/> <input type="checkbox"/> <input type="checkbox"/>	<input type="checkbox"/> <input type="checkbox"/> <input type="checkbox"/>	163.0#
	30 x 72 x 48 x 24"	GSSH30724824S/CR	<input type="checkbox"/> <input type="checkbox"/> <input type="checkbox"/>	<input type="checkbox"/> <input type="checkbox"/> <input type="checkbox"/>	<input type="checkbox"/>	<input type="checkbox"/>	<input type="checkbox"/>	<input type="checkbox"/> <input type="checkbox"/> <input type="checkbox"/>	<input type="checkbox"/> <input type="checkbox"/> <input type="checkbox"/>	172.0#
	30 x 84 x 48 x 24"	GSSH30844824S/CR	<input type="checkbox"/> <input type="checkbox"/> <input type="checkbox"/>	<input type="checkbox"/> <input type="checkbox"/> <input type="checkbox"/>	<input type="checkbox"/>	<input type="checkbox"/>	<input type="checkbox"/>	<input type="checkbox"/> <input type="checkbox"/> <input type="checkbox"/>	<input type="checkbox"/> <input type="checkbox"/> <input type="checkbox"/>	189.0#
 <p>GSSH Reduction Basic Square Shoe Crank Height Adjustable-Right</p> <ul style="list-style-type: none"> Extended corner surface Three-legged table base Height adjusts from 22"-33" Adjustable glides Worksurfaces are undersized by 1/4" from side-to-side and 1/4" from back-to-front from the stated dimensions Wire trough and modesty panel should not be ordered together on adjustable tables 	24 x 48 x 54 x 30"	GSSH24485430S/CR	<input type="checkbox"/> <input type="checkbox"/> <input type="checkbox"/>	<input type="checkbox"/> <input type="checkbox"/> <input type="checkbox"/>	<input type="checkbox"/>	<input type="checkbox"/>	<input type="checkbox"/>	<input type="checkbox"/> <input type="checkbox"/> <input type="checkbox"/>	<input type="checkbox"/> <input type="checkbox"/> <input type="checkbox"/>	144.0#
	24 x 48 x 60 x 30"	GSSH24486030S/CR	<input type="checkbox"/> <input type="checkbox"/> <input type="checkbox"/>	<input type="checkbox"/> <input type="checkbox"/> <input type="checkbox"/>	<input type="checkbox"/>	<input type="checkbox"/>	<input type="checkbox"/>	<input type="checkbox"/> <input type="checkbox"/> <input type="checkbox"/>	<input type="checkbox"/> <input type="checkbox"/> <input type="checkbox"/>	153.0#
	24 x 48 x 66 x 30"	GSSH24486630S/CR	<input type="checkbox"/> <input type="checkbox"/> <input type="checkbox"/>	<input type="checkbox"/> <input type="checkbox"/> <input type="checkbox"/>	<input type="checkbox"/>	<input type="checkbox"/>	<input type="checkbox"/>	<input type="checkbox"/> <input type="checkbox"/> <input type="checkbox"/>	<input type="checkbox"/> <input type="checkbox"/> <input type="checkbox"/>	161.0#
	24 x 48 x 72 x 30"	GSSH24487230S/CR	<input type="checkbox"/> <input type="checkbox"/> <input type="checkbox"/>	<input type="checkbox"/> <input type="checkbox"/> <input type="checkbox"/>	<input type="checkbox"/>	<input type="checkbox"/>	<input type="checkbox"/>	<input type="checkbox"/> <input type="checkbox"/> <input type="checkbox"/>	<input type="checkbox"/> <input type="checkbox"/> <input type="checkbox"/>	170.0#
	24 x 48 x 84 x 30"	GSSH24488430S/CR	<input type="checkbox"/> <input type="checkbox"/> <input type="checkbox"/>	<input type="checkbox"/> <input type="checkbox"/> <input type="checkbox"/>	<input type="checkbox"/>	<input type="checkbox"/>	<input type="checkbox"/>	<input type="checkbox"/> <input type="checkbox"/> <input type="checkbox"/>	<input type="checkbox"/> <input type="checkbox"/> <input type="checkbox"/>	187.0#
	30 x 48 x 54 x 24"	GSSH30485424S/CR	<input type="checkbox"/> <input type="checkbox"/> <input type="checkbox"/>	<input type="checkbox"/> <input type="checkbox"/> <input type="checkbox"/>	<input type="checkbox"/>	<input type="checkbox"/>	<input type="checkbox"/>	<input type="checkbox"/> <input type="checkbox"/> <input type="checkbox"/>	<input type="checkbox"/> <input type="checkbox"/> <input type="checkbox"/>	145.0#
	30 x 48 x 60 x 24"	GSSH30486024S/CR	<input type="checkbox"/> <input type="checkbox"/> <input type="checkbox"/>	<input type="checkbox"/> <input type="checkbox"/> <input type="checkbox"/>	<input type="checkbox"/>	<input type="checkbox"/>	<input type="checkbox"/>	<input type="checkbox"/> <input type="checkbox"/> <input type="checkbox"/>	<input type="checkbox"/> <input type="checkbox"/> <input type="checkbox"/>	152.0#
	30 x 48 x 66 x 24"	GSSH30486624S/CR	<input type="checkbox"/> <input type="checkbox"/> <input type="checkbox"/>	<input type="checkbox"/> <input type="checkbox"/> <input type="checkbox"/>	<input type="checkbox"/>	<input type="checkbox"/>	<input type="checkbox"/>	<input type="checkbox"/> <input type="checkbox"/> <input type="checkbox"/>	<input type="checkbox"/> <input type="checkbox"/> <input type="checkbox"/>	159.0#
	30 x 48 x 72 x 24"	GSSH30487224S/CR	<input type="checkbox"/> <input type="checkbox"/> <input type="checkbox"/>	<input type="checkbox"/> <input type="checkbox"/> <input type="checkbox"/>	<input type="checkbox"/>	<input type="checkbox"/>	<input type="checkbox"/>	<input type="checkbox"/> <input type="checkbox"/> <input type="checkbox"/>	<input type="checkbox"/> <input type="checkbox"/> <input type="checkbox"/>	167.0#
	30 x 48 x 84 x 24"	GSSH30488424S/CR	<input type="checkbox"/> <input type="checkbox"/> <input type="checkbox"/>	<input type="checkbox"/> <input type="checkbox"/> <input type="checkbox"/>	<input type="checkbox"/>	<input type="checkbox"/>	<input type="checkbox"/>	<input type="checkbox"/> <input type="checkbox"/> <input type="checkbox"/>	<input type="checkbox"/> <input type="checkbox"/> <input type="checkbox"/>	181.0#
			A	B	C	D	E	F	G	H

HOW TO ORDER

Indicate the following information on order form:

- Quantity of each item.
- Model number, including options. See "How To Build a Model Number".
- Any special service required.

Note: • The indicates that a choice is required.

- The absence of the indicates that no choice is required.
- Alpha-numeric characters in place of indicate that no other alternatives are available.

HOW TO BUILD A MODEL NUMBER

A Select basic model.

B Select edge style.

- 74P** - 74P edge
- KN** - Knife edge
- MP** - Membrane edge

C Select PowerUp module location.

Select only one from the following and add the appropriate upcharge to the base price.

- PUN** - No data
- PUL** - Left module; add \$108
- PUR** - Right module; add \$108
- PUB** - Both left and right modules; add \$218

D Select modesty panel option.

- NM** - No modesty panel
- LM** - LH modesty only
- RM** - RH modesty only
- WM** - Both modesty panels

Add upcharge to unit price for "LM", "RM" and "WM" options.

E Select wire trough and power option.

- NW** - No wire trough
- WL** - Wire trough LH only
- WR** - Wire trough RH only
- WW** - Wire trough Both

Add upcharge to unit price for "WL", "WR" and "WW" options.

F Select base finish.

Refer to color addendum at ki.com or KI Fabrics & Finishes binder.

G Select edge/PowerUp color.

Refer to color addendum at ki.com or KI Fabrics & Finishes binder. Edge color offerings are based on edge style selections. The color selection will apply to the trim, edge, PowerUp module and crank grommet. Trim color doesn't apply to the membrane edge selection.

H Select surface finish.

Refer to color addendum at ki.com or KI Fabrics & Finishes binder.

Surface finish offerings are based on edge style selections. Laminated finishes are only available on (74P) 74P edge and (KN) knife edge worksurfaces. The membrane color selections are only available on the (MP) membrane edge worksurfaces.



Genesis® Worksurfaces

Reduction Square Shoe Crank Height Adjustable

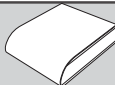
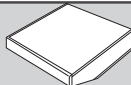
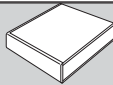

74P Edge
(74P)

Knife Edge
(KN)

Membrane Edge
(MP)

LH
Modesty
Panel
add to list
price

RH
Modesty
Panel
add to list
price

Both
Modesty
Panels
add to list
price

Left
Wire
Trough
add to list
price

Right
Wire
Trough
add to list
price

Both
Wire
Troughs
add to list
price

\$ 2046	\$ 2087	\$ 2087	\$ 198	\$ 185	\$ 385	\$ 500	\$ 483	\$ 983
2049	2090	2090	205	185	392	517	483	998
2078	2114	2114	213	185	399	637	483	1119
2124	2167	2167	220	185	409	710	483	1191
2154	2199	2199	249	185	435	715	483	1196
2046	2087	2087	198	185	385	500	483	983
2049	2090	2090	205	185	392	517	483	998
2078	2114	2114	213	185	399	637	483	1119
2124	2167	2167	220	185	409	710	483	1191
2154	2199	2199	249	185	435	715	483	1196

\$ 2046	\$ 2087	\$ 2087	\$ 185	\$ 198	\$ 385	\$ 483	\$ 500	\$ 983
2049	2090	2090	185	205	392	483	517	998
2078	2114	2114	185	213	399	483	637	1119
2124	2167	2167	185	220	409	483	710	1191
2154	2199	2199	185	249	435	483	715	1196
2046	2087	2087	185	198	385	483	500	983
2049	2090	2090	185	205	392	483	517	998
2078	2114	2114	185	213	399	483	637	1119
2124	2167	2167	185	220	409	483	710	1191
2154	2199	2199	185	249	435	483	715	1196

FINISH INFORMATION

Additional Laminate Offering

Additional laminates beyond KI standard offering, are available with two weeks extended leadtime. To specify additional laminates, use these designators followed by the supplier's color/pattern code:

- Formica - LF/supplier's color pattern code
- Nevamar - LN/supplier's color pattern code
- Wilsonart - LW/supplier's color pattern code

KI's standard finish is the supplier's recommended finish for that color/pattern. Note: Nonstandard laminates from these suppliers (example: textured laminates), require an upcharge and additional leadtime. Contact KI.

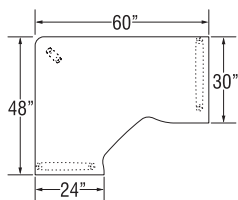

Basic Model:
GSSH24486030S/F

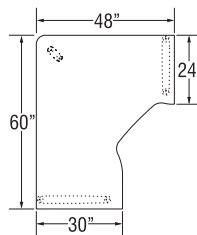

Basic Model:
GSSH30604824S/F

INFORMATION

Options are always specified left to right from the seated position

SPECIAL SERVICES

Special Carton Marking

With specially marked information N/C

Shipping

Shipped k.d. freight prepaid f.o.b. Manitowoc, Wisconsin 54220 factory. Freight class #100.

Specifications and prices are subject to change without prior notice.

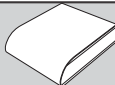
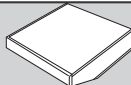
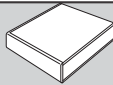

74P Edge
(74P)

Knife Edge
(KN)

Membrane Edge
(MP)

LH
Modesty
Panel
add to list
price

RH
Modesty
Panel
add to list
price

Both
Modesty
Panels
add to list
price

Left
Wire
Trough
add to list
price

Right
Wire
Trough
add to list
price

Both
Wire
Troughs
add to list
price

\$ 2954	\$ 2997	\$ 2997	\$ 198	\$ 185	\$ 385	\$ 500	\$ 483	\$ 983
2958	2999	2999	205	185	392	517	483	998
2979	3021	3021	213	185	399	637	483	1119
3032	3077	3077	220	185	409	710	483	1191
3061	3106	3106	249	185	435	715	483	1196
2954	2997	2997	198	185	385	500	483	983
2958	2999	2999	205	185	392	517	483	998
2979	3021	3021	213	185	399	637	483	1119
3032	3077	3077	220	185	409	710	483	1191
3061	3106	3106	249	185	435	715	483	1196

FINISH INFORMATION

Additional Laminate Offering

Additional laminates beyond KI standard offering, are available with two weeks extended leadtime. To specify additional laminates, use these designators followed by the supplier's color/pattern code:

Formica - LF/supplier's color pattern code
Nevamar - LN/supplier's color pattern code
Wilsonart - LW/supplier's color pattern code

KI's standard finish is the supplier's recommended finish for that color/pattern. Note: Nonstandard laminates from these suppliers (example: textured laminates), require an upcharge and additional leadtime. Contact KI.

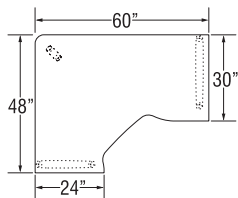

Basic Model:
GSSH24486030S/F

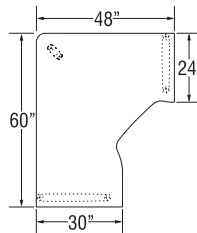

Basic Model:
GSSH30604824S/F

INFORMATION

Options are always specified left to right from the seated position

SPECIAL SERVICES

Special Carton Marking

With specially marked information N/C

Shipping

Shipped k.d. freight prepaid f.o.b. Manitowoc, Wisconsin 54220 factory. Freight class #100.

Specifications and prices are subject to change without prior notice.

Genesis® Worksurfaces

Reduction Square Shoe Crank Height Dual

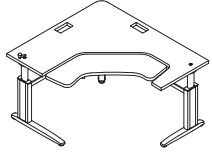

GSSH

Reduction Basic Square Shoe Crank Height Dual-Right

- Extended corner surface
- Three-legged table base
- Height adjusts from 22"-33"
- Adjustable glides
- Keyboard surface adjusts 5" above/below primary surface
- Keyboard surface tilts +/-15°
- Worksurfaces are undersized by 1/4" from side-to-side and 1/4" from back-to-front from the stated dimensions
- Wire trough and modesty panel should not be ordered together on adjustable tables

D x L x W x D	MODEL NUMBER								Approx. Packaged Weight
	Basic Model	Edge Style	Module Location	Modesty Panel	Wire Trough	Base Finish	Edge Color	Surface Finish	
24 x 48 x 54 x 30"	GSSH24485430D/CR	<input type="checkbox"/> <input type="checkbox"/> <input type="checkbox"/>	<input type="checkbox"/> <input type="checkbox"/> <input type="checkbox"/>	<input type="checkbox"/> <input type="checkbox"/> <input type="checkbox"/>	<input type="checkbox"/> <input type="checkbox"/> <input type="checkbox"/>	<input type="checkbox"/> <input type="checkbox"/> <input type="checkbox"/>	<input type="checkbox"/> <input type="checkbox"/> <input type="checkbox"/>	<input type="checkbox"/> <input type="checkbox"/> <input type="checkbox"/>	164.0#
24 x 48 x 60 x 30"	GSSH24486030D/CR	<input type="checkbox"/> <input type="checkbox"/> <input type="checkbox"/>	<input type="checkbox"/> <input type="checkbox"/> <input type="checkbox"/>	<input type="checkbox"/> <input type="checkbox"/> <input type="checkbox"/>	<input type="checkbox"/> <input type="checkbox"/> <input type="checkbox"/>	<input type="checkbox"/> <input type="checkbox"/> <input type="checkbox"/>	<input type="checkbox"/> <input type="checkbox"/> <input type="checkbox"/>	<input type="checkbox"/> <input type="checkbox"/> <input type="checkbox"/>	173.0#
24 x 48 x 66 x 30"	GSSH24486630D/CR	<input type="checkbox"/> <input type="checkbox"/> <input type="checkbox"/>	<input type="checkbox"/> <input type="checkbox"/> <input type="checkbox"/>	<input type="checkbox"/> <input type="checkbox"/> <input type="checkbox"/>	<input type="checkbox"/> <input type="checkbox"/> <input type="checkbox"/>	<input type="checkbox"/> <input type="checkbox"/> <input type="checkbox"/>	<input type="checkbox"/> <input type="checkbox"/> <input type="checkbox"/>	<input type="checkbox"/> <input type="checkbox"/> <input type="checkbox"/>	181.0#
24 x 48 x 72 x 30"	GSSH24487230D/CR	<input type="checkbox"/> <input type="checkbox"/> <input type="checkbox"/>	<input type="checkbox"/> <input type="checkbox"/> <input type="checkbox"/>	<input type="checkbox"/> <input type="checkbox"/> <input type="checkbox"/>	<input type="checkbox"/> <input type="checkbox"/> <input type="checkbox"/>	<input type="checkbox"/> <input type="checkbox"/> <input type="checkbox"/>	<input type="checkbox"/> <input type="checkbox"/> <input type="checkbox"/>	<input type="checkbox"/> <input type="checkbox"/> <input type="checkbox"/>	190.0#
24 x 48 x 84 x 30"	GSSH24488430D/CR	<input type="checkbox"/> <input type="checkbox"/> <input type="checkbox"/>	<input type="checkbox"/> <input type="checkbox"/> <input type="checkbox"/>	<input type="checkbox"/> <input type="checkbox"/> <input type="checkbox"/>	<input type="checkbox"/> <input type="checkbox"/> <input type="checkbox"/>	<input type="checkbox"/> <input type="checkbox"/> <input type="checkbox"/>	<input type="checkbox"/> <input type="checkbox"/> <input type="checkbox"/>	<input type="checkbox"/> <input type="checkbox"/> <input type="checkbox"/>	207.0#
30 x 48 x 54 x 24"	GSSH30485424D/CR	<input type="checkbox"/> <input type="checkbox"/> <input type="checkbox"/>	<input type="checkbox"/> <input type="checkbox"/> <input type="checkbox"/>	<input type="checkbox"/> <input type="checkbox"/> <input type="checkbox"/>	<input type="checkbox"/> <input type="checkbox"/> <input type="checkbox"/>	<input type="checkbox"/> <input type="checkbox"/> <input type="checkbox"/>	<input type="checkbox"/> <input type="checkbox"/> <input type="checkbox"/>	<input type="checkbox"/> <input type="checkbox"/> <input type="checkbox"/>	165.0#
30 x 48 x 60 x 24"	GSSH30486024D/CR	<input type="checkbox"/> <input type="checkbox"/> <input type="checkbox"/>	<input type="checkbox"/> <input type="checkbox"/> <input type="checkbox"/>	<input type="checkbox"/> <input type="checkbox"/> <input type="checkbox"/>	<input type="checkbox"/> <input type="checkbox"/> <input type="checkbox"/>	<input type="checkbox"/> <input type="checkbox"/> <input type="checkbox"/>	<input type="checkbox"/> <input type="checkbox"/> <input type="checkbox"/>	<input type="checkbox"/> <input type="checkbox"/> <input type="checkbox"/>	172.0#
30 x 48 x 66 x 24"	GSSH30486624D/CR	<input type="checkbox"/> <input type="checkbox"/> <input type="checkbox"/>	<input type="checkbox"/> <input type="checkbox"/> <input type="checkbox"/>	<input type="checkbox"/> <input type="checkbox"/> <input type="checkbox"/>	<input type="checkbox"/> <input type="checkbox"/> <input type="checkbox"/>	<input type="checkbox"/> <input type="checkbox"/> <input type="checkbox"/>	<input type="checkbox"/> <input type="checkbox"/> <input type="checkbox"/>	<input type="checkbox"/> <input type="checkbox"/> <input type="checkbox"/>	179.0#
30 x 48 x 72 x 24"	GSSH30487224D/CR	<input type="checkbox"/> <input type="checkbox"/> <input type="checkbox"/>	<input type="checkbox"/> <input type="checkbox"/> <input type="checkbox"/>	<input type="checkbox"/> <input type="checkbox"/> <input type="checkbox"/>	<input type="checkbox"/> <input type="checkbox"/> <input type="checkbox"/>	<input type="checkbox"/> <input type="checkbox"/> <input type="checkbox"/>	<input type="checkbox"/> <input type="checkbox"/> <input type="checkbox"/>	<input type="checkbox"/> <input type="checkbox"/> <input type="checkbox"/>	187.0#
30 x 48 x 84 x 24"	GSSH30488424D/CR	<input type="checkbox"/> <input type="checkbox"/> <input type="checkbox"/>	<input type="checkbox"/> <input type="checkbox"/> <input type="checkbox"/>	<input type="checkbox"/> <input type="checkbox"/> <input type="checkbox"/>	<input type="checkbox"/> <input type="checkbox"/> <input type="checkbox"/>	<input type="checkbox"/> <input type="checkbox"/> <input type="checkbox"/>	<input type="checkbox"/> <input type="checkbox"/> <input type="checkbox"/>	<input type="checkbox"/> <input type="checkbox"/> <input type="checkbox"/>	201.0#

A

B

C

D

E

F

G

H

HOW TO ORDER

Indicate the following information on order form:

1. Quantity of each item.
2. Model number, including options. See "How To Build a Model Number".
3. Any special service required.

Note: • The indicates that a choice is required.

- The absence of the indicates that no choice is required.
- Alpha-numeric characters in place of indicate that no other alternatives are available.

HOW TO BUILD A MODEL NUMBER

A Select basic model.

B Select edge style.

74P - 74P edge
KN - Knife edge
MP - Membrane edge

C Select PowerUp module location.

Select only one from the following and add the appropriate upcharge to the base price.

PUN - No data
PUL - Left module; add \$108
PUR - Right module; add \$108
PUB - Both left and right modules; add \$218

D Select modesty panel option.

NM - No modesty panel
LM - LH modesty only
RM - RH modesty only
WM - Both modesty panels

Add upcharge to unit price for "LM", "RM" and "WM" options.

E Select wire trough and power options.

NW - No wire trough
WL - Wire trough LH only
WR - Wire trough RH only
WW - Wire trough Both

Add upcharge to unit price for "WL", "WR" and "WW" option.

F Select base finish.

Refer to color addendum at ki.com or KI Fabrics & Finishes binder.

G Select edge/PowerUp color.

Refer to color addendum at ki.com or KI Fabrics & Finishes binder. Edge color offerings are based on edge style selections. The color selection will apply to the trim, edge, PowerUp module and crank grommet. Trim color doesn't apply to the membrane edge selection.

H Select surface finish.

Refer to color addendum at ki.com or KI Fabrics & Finishes binder.

Surface finish offerings are based on edge style selections. Laminate finishes are only available on (74P) 74P edge and (KN) knife edge worksurfaces. The membrane color selections are only available on the (MP) membrane edge worksurfaces.



Genesis® Worksurfaces

Reduction Square Shoe Crank Height Dual

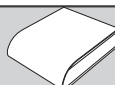
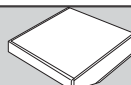
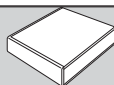

74P Edge
(74P)

Knife Edge
(KN)

Membrane Edge
(MP)

LH
Modesty
Panel
add to list
price

RH
Modesty
Panel
add to list
price

Both
Modesty
Panels
add to list
price

Left
Wire
Trough
add to list
price

Right
Wire
Trough
add to list
price

Both
Wire
Troughs
add to list
price

\$ 2954

\$ 2997

\$ 2997

\$ 185

\$ 198

\$ 385

\$ 483

\$ 500

\$ 983

2958

2999

2999

185

205

392

483

517

998

2979

3021

3021

185

213

399

483

637

1119

3032

3077

3077

185

220

409

483

710

1191

3061

3106

3106

185

249

435

483

715

1196

2954

2997

2997

185

198

385

483

500

983

2958

2999

2999

185

205

392

483

517

998

2979

3021

3021

185

213

399

483

637

1119

3032

3077

3077

185

220

409

483

710

1191

3061

3106

3106

185

249

435

483

715

1196

FINISH INFORMATION

Additional Laminate Offering

Additional laminates beyond KI standard offering, are available with two weeks extended leadtime. To specify additional laminates, use these designators followed by the supplier's color/pattern code:

Formica - LF/supplier's color pattern code
Nevamar - LN/supplier's color pattern code
Wilsonart - LW/supplier's color pattern code

KI's standard finish is the supplier's recommended finish for that color/pattern. Note: Nonstandard laminates from these suppliers (example: textured laminates), require an upcharge and additional leadtime. Contact KI.

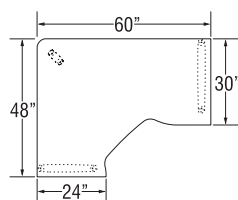

Basic Model:
GSSH24486030S/F

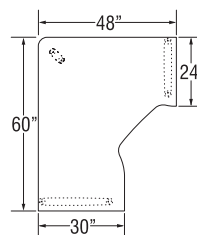

Basic Model:
GSSH30604824S/F

INFORMATION

Options are always specified left to right from the seated position

SPECIAL SERVICES

Special Carton Marking

With specially marked information N/C

Shipping

Shipped k.d. freight prepaid f.o.b. Manitowoc, Wisconsin 54220 factory. Freight class #100.

Specifications and prices are subject to change without prior notice.

Genesis® Worksurfaces

Reduction Square Shoe Electric Height Adjustable

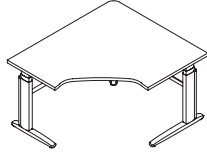

GSHE

Reduction Basic Square Shoe Electric Height Adjustable Single-Left

- Extended corner surface
- Three-legged table base
- Height adjusts from 24"-51"
- Standard or deluxe up/down switch
- Adjustable glides
- Worksurfaces are undersized by 1-1/4" from side-to-side and 1/2" from back-to-front from the stated dimensions
- Wire trough and modesty panel should not be ordered together on adjustable tables

D x L x W x D	MODEL NUMBER										Approx. Packaged Weight
	Basic Model	Edge Style	Electrical Control	Module Location	Modesty Panel	Wire Trough	Base Finish	Edge Color	Surface Finish		
24 x 54 x 48 x 30"	GSHE24544830S	<input type="checkbox"/> <input type="checkbox"/> <input type="checkbox"/>	<input type="checkbox"/>	<input type="checkbox"/> <input type="checkbox"/> <input type="checkbox"/>	<input type="checkbox"/> <input type="checkbox"/>	<input type="checkbox"/> <input type="checkbox"/>	<input type="checkbox"/> <input type="checkbox"/>	<input type="checkbox"/> <input type="checkbox"/> <input type="checkbox"/>	<input type="checkbox"/> <input type="checkbox"/> <input type="checkbox"/>	<input type="checkbox"/> <input type="checkbox"/> <input type="checkbox"/>	164.0#
24 x 60 x 48 x 30"	GSHE24604830S	<input type="checkbox"/> <input type="checkbox"/> <input type="checkbox"/>	<input type="checkbox"/>	<input type="checkbox"/> <input type="checkbox"/> <input type="checkbox"/>	<input type="checkbox"/> <input type="checkbox"/>	<input type="checkbox"/> <input type="checkbox"/>	<input type="checkbox"/> <input type="checkbox"/>	<input type="checkbox"/> <input type="checkbox"/> <input type="checkbox"/>	<input type="checkbox"/> <input type="checkbox"/> <input type="checkbox"/>	<input type="checkbox"/> <input type="checkbox"/> <input type="checkbox"/>	171.0#
24 x 66 x 48 x 30"	GSHE24664830S	<input type="checkbox"/> <input type="checkbox"/> <input type="checkbox"/>	<input type="checkbox"/>	<input type="checkbox"/> <input type="checkbox"/> <input type="checkbox"/>	<input type="checkbox"/> <input type="checkbox"/>	<input type="checkbox"/> <input type="checkbox"/>	<input type="checkbox"/> <input type="checkbox"/>	<input type="checkbox"/> <input type="checkbox"/> <input type="checkbox"/>	<input type="checkbox"/> <input type="checkbox"/> <input type="checkbox"/>	<input type="checkbox"/> <input type="checkbox"/> <input type="checkbox"/>	178.0#
24 x 72 x 48 x 30"	GSHE24724830S	<input type="checkbox"/> <input type="checkbox"/> <input type="checkbox"/>	<input type="checkbox"/>	<input type="checkbox"/> <input type="checkbox"/> <input type="checkbox"/>	<input type="checkbox"/> <input type="checkbox"/>	<input type="checkbox"/> <input type="checkbox"/>	<input type="checkbox"/> <input type="checkbox"/>	<input type="checkbox"/> <input type="checkbox"/> <input type="checkbox"/>	<input type="checkbox"/> <input type="checkbox"/> <input type="checkbox"/>	<input type="checkbox"/> <input type="checkbox"/> <input type="checkbox"/>	185.0#
24 x 84 x 48 x 30"	GSHE24844830S	<input type="checkbox"/> <input type="checkbox"/> <input type="checkbox"/>	<input type="checkbox"/>	<input type="checkbox"/> <input type="checkbox"/> <input type="checkbox"/>	<input type="checkbox"/> <input type="checkbox"/>	<input type="checkbox"/> <input type="checkbox"/>	<input type="checkbox"/> <input type="checkbox"/>	<input type="checkbox"/> <input type="checkbox"/> <input type="checkbox"/>	<input type="checkbox"/> <input type="checkbox"/> <input type="checkbox"/>	<input type="checkbox"/> <input type="checkbox"/> <input type="checkbox"/>	199.0#
30 x 54 x 48 x 24"	GSHE30544824S	<input type="checkbox"/> <input type="checkbox"/> <input type="checkbox"/>	<input type="checkbox"/>	<input type="checkbox"/> <input type="checkbox"/> <input type="checkbox"/>	<input type="checkbox"/> <input type="checkbox"/>	<input type="checkbox"/> <input type="checkbox"/>	<input type="checkbox"/> <input type="checkbox"/>	<input type="checkbox"/> <input type="checkbox"/> <input type="checkbox"/>	<input type="checkbox"/> <input type="checkbox"/> <input type="checkbox"/>	<input type="checkbox"/> <input type="checkbox"/> <input type="checkbox"/>	166.0#
30 x 60 x 48 x 24"	GSHE30604824S	<input type="checkbox"/> <input type="checkbox"/> <input type="checkbox"/>	<input type="checkbox"/>	<input type="checkbox"/> <input type="checkbox"/> <input type="checkbox"/>	<input type="checkbox"/> <input type="checkbox"/>	<input type="checkbox"/> <input type="checkbox"/>	<input type="checkbox"/> <input type="checkbox"/>	<input type="checkbox"/> <input type="checkbox"/> <input type="checkbox"/>	<input type="checkbox"/> <input type="checkbox"/> <input type="checkbox"/>	<input type="checkbox"/> <input type="checkbox"/> <input type="checkbox"/>	174.0#
30 x 66 x 48 x 24"	GSHE30664824S	<input type="checkbox"/> <input type="checkbox"/> <input type="checkbox"/>	<input type="checkbox"/>	<input type="checkbox"/> <input type="checkbox"/> <input type="checkbox"/>	<input type="checkbox"/> <input type="checkbox"/>	<input type="checkbox"/> <input type="checkbox"/>	<input type="checkbox"/> <input type="checkbox"/>	<input type="checkbox"/> <input type="checkbox"/> <input type="checkbox"/>	<input type="checkbox"/> <input type="checkbox"/> <input type="checkbox"/>	<input type="checkbox"/> <input type="checkbox"/> <input type="checkbox"/>	182.0#
30 x 72 x 48 x 24"	GSHE30724824S	<input type="checkbox"/> <input type="checkbox"/> <input type="checkbox"/>	<input type="checkbox"/>	<input type="checkbox"/> <input type="checkbox"/> <input type="checkbox"/>	<input type="checkbox"/> <input type="checkbox"/>	<input type="checkbox"/> <input type="checkbox"/>	<input type="checkbox"/> <input type="checkbox"/>	<input type="checkbox"/> <input type="checkbox"/> <input type="checkbox"/>	<input type="checkbox"/> <input type="checkbox"/> <input type="checkbox"/>	<input type="checkbox"/> <input type="checkbox"/> <input type="checkbox"/>	190.0#
30 x 84 x 48 x 24"	GSHE30844824S	<input type="checkbox"/> <input type="checkbox"/> <input type="checkbox"/>	<input type="checkbox"/>	<input type="checkbox"/> <input type="checkbox"/> <input type="checkbox"/>	<input type="checkbox"/> <input type="checkbox"/>	<input type="checkbox"/> <input type="checkbox"/>	<input type="checkbox"/> <input type="checkbox"/>	<input type="checkbox"/> <input type="checkbox"/> <input type="checkbox"/>	<input type="checkbox"/> <input type="checkbox"/> <input type="checkbox"/>	<input type="checkbox"/> <input type="checkbox"/> <input type="checkbox"/>	206.0#

A **B** **C** **D** **E** **F** **G** **H** **I**

HOW TO ORDER

Indicate the following information on order form:

1. Quantity of each item.
2. Model number, including options. See "How To Build a Model Number".
3. Any special service required.

- Note:
- The indicates that a choice is required.
 - The absence of the indicates that no choice is required.
 - Alpha-numeric characters in place of indicate that no other alternatives are available.

HOW TO BUILD A MODEL NUMBER

- A** Select basic model.
- B** Select edge style.
 - 74P** - 74P edge
 - KN** - Knife edge
 - MP** - Membrane edge
- C** Select electric control style.
 - S** - Standard up/down switch
 - D** - Deluxe up/down switch; add \$112
- D** Select PowerUp module location. Select only one from the following and add the appropriate upcharge to the base price.
 - PUN** - No data
 - PUL** - Left module; add \$108
 - PUR** - Right module; add \$108
 - PUB** - Both left and right modules; add \$218
- E** Select modesty panel option.
 - NM** - No modesty panel

- LM** - LH modesty only
 - RM** - RH modesty only
 - WM** - Both modesty panels
- Add upcharge to unit price for "LM", "RM" and "WM" options.
- F** Select wire trough and power option.
 - NW** - No wire trough
 - WL** - Wire trough LH only
 - WR** - Wire trough RH only
 - WW** - Wire trough Both
 Add upcharge to unit price for "WL", "WR" and "WW" options.

- G** Select base finish. Refer to color addendum at ki.com or KI Fabrics & Finishes binder.
- H** Select edge/PowerUp color. Refer to color addendum at ki.com or KI Fabrics & Finishes binder. Edge color offerings are based on edge style selections. The color selection will apply to the trim, edge, PowerUp module and crank grommet. Trim color doesn't apply to the membrane edge selection.
- I** Select surface finish. Refer to color addendum at ki.com or KI Fabrics & Finishes binder. Surface finish offerings are based on edge style selections. Laminate finishes are only available on (74P) 74P edge and (KN) knife edge worksurfaces. The membrane color selections are only available on the (MP) membrane edge worksurfaces.



Genesis® Worksurfaces

Reduction Square Shoe Electric Height Adjustable

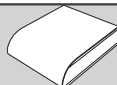
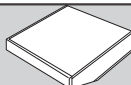
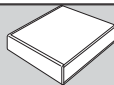

74P Edge
(74P)

Knife Edge
(KN)

Membrane Edge
(MP)

LH
Modesty
Panel
add to list
price

RH
Modesty
Panel
add to list
price

Both
Modesty
Panels
add to list
price

Left
Wire
Trough
add to list
price

Right
Wire
Trough
add to list
price

Both
Wire
Troughs
add to list
price

74P Edge (74P)	Knife Edge (KN)	Membrane Edge (MP)	LH Modesty Panel add to list price	RH Modesty Panel add to list price	Both Modesty Panels add to list price	Left Wire Trough add to list price	Right Wire Trough add to list price	Both Wire Troughs add to list price
\$ 3953	\$ 3999	\$ 3999	\$ 198	\$ 185	\$ 385	\$ 500	\$ 483	\$ 983
3956	4002	4002	205	185	392	517	483	998
4009	4056	4056	213	185	399	637	483	1119
4065	4108	4108	220	185	409	710	483	1191
4121	4165	4165	249	185	435	715	483	1196
3953	3999	3999	198	185	385	500	483	983
3956	4002	4002	205	185	392	517	483	998
4009	4056	4056	213	185	399	637	483	1119
4065	4108	4108	220	185	409	710	483	1191
4121	4165	4165	249	185	435	715	483	1196

FINISH INFORMATION

Additional Laminate Offering

Additional laminates beyond KI standard offering, are available with two weeks extended leadtime. To specify additional laminates, use these designators followed by the supplier's color/pattern code:

- Formica - LF/supplier's color pattern code
- Nevamar - LN/supplier's color pattern code
- Wilsonart - LW/supplier's color pattern code

KI's standard finish is the supplier's recommended finish for that color/pattern. Note: Nonstandard laminates from these suppliers (example: textured laminates), require an upcharge and additional leadtime. Contact KI.

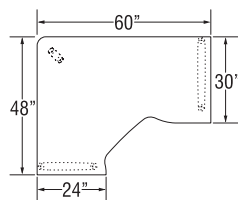

Basic Model:
GSSH24486030S/F

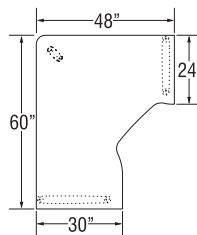

Basic Model:
GSSH30604824S/F

INFORMATION

Options are always specified left to right from the seated position

SPECIAL SERVICES

Special Carton Marking

With specially marked information N/C

Shipping

Shipped k.d. freight prepaid f.o.b. Manitowoc, Wisconsin 54220 factory. Freight class #100.

Specifications and prices are subject to change without prior notice.

Genesis® Worksurfaces

Reduction Square Shoe Electric Height Adjustable

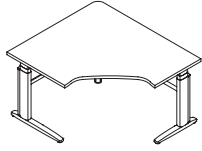

GSHE

Reduction Basic Square Shoe Electric Height Adjustable Single-Right

- Extended corner surface
- Three-legged table base
- Height adjusts from 24"-51"
- Standard or deluxe up/down switch
- Adjustable glides
- Worksurfaces are undersized by 1-1/4" from side-to-side and 1/2" from back-to-front from the stated dimensions
- Wire trough and modesty panel should not be ordered together on adjustable tables

D x L x W x D	MODEL NUMBER										Approx. Packaged Weight
	Basic Model	Edge Style	Electrical Control	Module Location	Modesty Panel	Wire Trough	Base Finish	Edge Color	Surface Finish		
24 x 48 x 54 x 30"	GSHE24485430S	<input type="checkbox"/> <input type="checkbox"/> <input type="checkbox"/>	<input type="checkbox"/>	<input type="checkbox"/> <input type="checkbox"/> <input type="checkbox"/>	<input type="checkbox"/> <input type="checkbox"/>	<input type="checkbox"/> <input type="checkbox"/>	<input type="checkbox"/> <input type="checkbox"/>	<input type="checkbox"/> <input type="checkbox"/> <input type="checkbox"/>	<input type="checkbox"/> <input type="checkbox"/> <input type="checkbox"/>	<input type="checkbox"/> <input type="checkbox"/> <input type="checkbox"/>	166.0#
24 x 48 x 60 x 30"	GSHE24486030S	<input type="checkbox"/> <input type="checkbox"/> <input type="checkbox"/>	<input type="checkbox"/>	<input type="checkbox"/> <input type="checkbox"/> <input type="checkbox"/>	<input type="checkbox"/> <input type="checkbox"/>	<input type="checkbox"/> <input type="checkbox"/>	<input type="checkbox"/> <input type="checkbox"/>	<input type="checkbox"/> <input type="checkbox"/> <input type="checkbox"/>	<input type="checkbox"/> <input type="checkbox"/> <input type="checkbox"/>	<input type="checkbox"/> <input type="checkbox"/> <input type="checkbox"/>	174.0#
24 x 48 x 66 x 30"	GSHE24486630S	<input type="checkbox"/> <input type="checkbox"/> <input type="checkbox"/>	<input type="checkbox"/>	<input type="checkbox"/> <input type="checkbox"/> <input type="checkbox"/>	<input type="checkbox"/> <input type="checkbox"/>	<input type="checkbox"/> <input type="checkbox"/>	<input type="checkbox"/> <input type="checkbox"/>	<input type="checkbox"/> <input type="checkbox"/> <input type="checkbox"/>	<input type="checkbox"/> <input type="checkbox"/> <input type="checkbox"/>	<input type="checkbox"/> <input type="checkbox"/> <input type="checkbox"/>	182.0#
24 x 48 x 72 x 30"	GSHE24487230S	<input type="checkbox"/> <input type="checkbox"/> <input type="checkbox"/>	<input type="checkbox"/>	<input type="checkbox"/> <input type="checkbox"/> <input type="checkbox"/>	<input type="checkbox"/> <input type="checkbox"/>	<input type="checkbox"/> <input type="checkbox"/>	<input type="checkbox"/> <input type="checkbox"/>	<input type="checkbox"/> <input type="checkbox"/> <input type="checkbox"/>	<input type="checkbox"/> <input type="checkbox"/> <input type="checkbox"/>	<input type="checkbox"/> <input type="checkbox"/> <input type="checkbox"/>	190.0#
24 x 48 x 84 x 30"	GSHE24488430S	<input type="checkbox"/> <input type="checkbox"/> <input type="checkbox"/>	<input type="checkbox"/>	<input type="checkbox"/> <input type="checkbox"/> <input type="checkbox"/>	<input type="checkbox"/> <input type="checkbox"/>	<input type="checkbox"/> <input type="checkbox"/>	<input type="checkbox"/> <input type="checkbox"/>	<input type="checkbox"/> <input type="checkbox"/> <input type="checkbox"/>	<input type="checkbox"/> <input type="checkbox"/> <input type="checkbox"/>	<input type="checkbox"/> <input type="checkbox"/> <input type="checkbox"/>	206.0#
30 x 48 x 54 x 24"	GSHE30485424S	<input type="checkbox"/> <input type="checkbox"/> <input type="checkbox"/>	<input type="checkbox"/>	<input type="checkbox"/> <input type="checkbox"/> <input type="checkbox"/>	<input type="checkbox"/> <input type="checkbox"/>	<input type="checkbox"/> <input type="checkbox"/>	<input type="checkbox"/> <input type="checkbox"/>	<input type="checkbox"/> <input type="checkbox"/> <input type="checkbox"/>	<input type="checkbox"/> <input type="checkbox"/> <input type="checkbox"/>	<input type="checkbox"/> <input type="checkbox"/> <input type="checkbox"/>	164.0#
30 x 48 x 60 x 24"	GSHE30486024S	<input type="checkbox"/> <input type="checkbox"/> <input type="checkbox"/>	<input type="checkbox"/>	<input type="checkbox"/> <input type="checkbox"/> <input type="checkbox"/>	<input type="checkbox"/> <input type="checkbox"/>	<input type="checkbox"/> <input type="checkbox"/>	<input type="checkbox"/> <input type="checkbox"/>	<input type="checkbox"/> <input type="checkbox"/> <input type="checkbox"/>	<input type="checkbox"/> <input type="checkbox"/> <input type="checkbox"/>	<input type="checkbox"/> <input type="checkbox"/> <input type="checkbox"/>	171.0#
30 x 48 x 66 x 24"	GSHE30486624S	<input type="checkbox"/> <input type="checkbox"/> <input type="checkbox"/>	<input type="checkbox"/>	<input type="checkbox"/> <input type="checkbox"/> <input type="checkbox"/>	<input type="checkbox"/> <input type="checkbox"/>	<input type="checkbox"/> <input type="checkbox"/>	<input type="checkbox"/> <input type="checkbox"/>	<input type="checkbox"/> <input type="checkbox"/> <input type="checkbox"/>	<input type="checkbox"/> <input type="checkbox"/> <input type="checkbox"/>	<input type="checkbox"/> <input type="checkbox"/> <input type="checkbox"/>	178.0#
30 x 48 x 72 x 24"	GSHE30487224S	<input type="checkbox"/> <input type="checkbox"/> <input type="checkbox"/>	<input type="checkbox"/>	<input type="checkbox"/> <input type="checkbox"/> <input type="checkbox"/>	<input type="checkbox"/> <input type="checkbox"/>	<input type="checkbox"/> <input type="checkbox"/>	<input type="checkbox"/> <input type="checkbox"/>	<input type="checkbox"/> <input type="checkbox"/> <input type="checkbox"/>	<input type="checkbox"/> <input type="checkbox"/> <input type="checkbox"/>	<input type="checkbox"/> <input type="checkbox"/> <input type="checkbox"/>	185.0#
30 x 48 x 84 x 24"	GSHE30488424S	<input type="checkbox"/> <input type="checkbox"/> <input type="checkbox"/>	<input type="checkbox"/>	<input type="checkbox"/> <input type="checkbox"/> <input type="checkbox"/>	<input type="checkbox"/> <input type="checkbox"/>	<input type="checkbox"/> <input type="checkbox"/>	<input type="checkbox"/> <input type="checkbox"/>	<input type="checkbox"/> <input type="checkbox"/> <input type="checkbox"/>	<input type="checkbox"/> <input type="checkbox"/> <input type="checkbox"/>	<input type="checkbox"/> <input type="checkbox"/> <input type="checkbox"/>	199.0#

A **B** **C** **D** **E** **F** **G** **H** **I**

HOW TO ORDER

Indicate the following information on order form:

1. Quantity of each item.
2. Model number, including options. See "How To Build a Model Number".
3. Any special service required.

- Note:
- The indicates that a choice is required.
 - The absence of the indicates that no choice is required.
 - Alpha-numeric characters in place of indicate that no other alternatives are available.

HOW TO BUILD A MODEL NUMBER

- A** Select basic model.
- B** Select edge style.
 - 74P - 74P edge
 - KN - Knife edge
 - MP - Membrane edge
- C** Select electric control style.
 - S - Standard up/down switch
 - D - Deluxe up/down switch; add \$112
- D** Select PowerUp module location. Select only one from the following and add the appropriate upcharge to the base price.
 - PUN - No data
 - PUL - Left module; add \$108
 - PUR - Right module; add \$108
 - PUB - Both left and right modules; add \$218
- E** Select modesty panel option.
 - NM - No modesty panel

- LM - LH modesty only
 - RM - RH modesty only
 - WM - Both modesty panels
- Add upcharge to unit price for "LM", "RM" and "WM" options.
- F** Select wire trough and power option.
 - NW - No wire trough
 - WL - Wire trough LH only
 - WR - Wire trough RH only
 - WW - Wire trough Both
 Add upcharge to unit price for "WL", "WR" and "WW" options.

- G** Select base finish. Refer to color addendum at ki.com or KI Fabrics & Finishes binder.
- H** Select edge/PowerUp color. Refer to color addendum at ki.com or KI Fabrics & Finishes binder. Edge color offerings are based on edge style selections. The color selection will apply to the trim, edge, PowerUp module and crank grommet. Trim color doesn't apply to the membrane edge selection.
- I** Select surface finish. Refer to color addendum at ki.com or KI Fabrics & Finishes binder. Surface finish offerings are based on edge style selections. Laminate finishes are only available on (74P) 74P edge and (KN) knife edge worksurfaces. The membrane color selections are only available on the (MP) membrane edge worksurfaces.



Genesis® Worksurfaces

Reduction Square Shoe Electric Height Adjustable

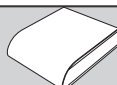
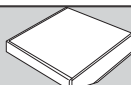
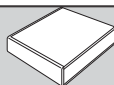
74P Edge
(74P)Knife Edge
(KN)Membrane Edge
(MP)LH
Modesty
Panel
add to list
priceRH
Modesty
Panel
add to list
priceBoth
Modesty
Panels
add to list
priceLeft
Wire
Trough
add to list
priceRight
Wire
Trough
add to list
priceBoth
Wire
Troughs
add to list
price

\$ 3953

\$ 3999

\$ 3999

\$ 185

\$ 198

\$ 385

\$ 483

\$ 500

\$ 983

3956

4002

4002

185

205

392

483

517

998

4009

4056

4056

185

213

399

483

637

1119

4065

4108

4108

185

220

409

483

710

1191

4121

4165

4165

185

249

435

483

715

1196

3953

3999

3999

185

198

385

483

500

983

3956

4002

4002

185

205

392

483

517

998

4009

4056

4056

185

213

399

483

637

1119

4065

4108

4108

185

220

409

483

710

1191

4121

4165

4165

185

249

435

483

715

1196

FINISH INFORMATION

Additional Laminate Offering

Additional laminates beyond KI standard offering, are available with two weeks extended leadtime. To specify additional laminates, use these designators followed by the supplier's color/pattern code:

Formica - LF/supplier's color pattern code
Nevamar - LN/supplier's color pattern code
Wilsonart - LW/supplier's color pattern code

KI's standard finish is the supplier's recommended finish for that color/pattern. Note: Nonstandard laminates from these suppliers (example: textured laminates), require an upcharge and additional leadtime. Contact KI.

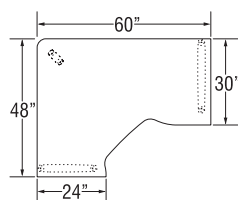

Basic Model:
GSSH24486030S/F

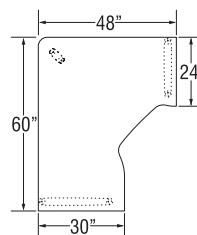

Basic Model:
GSSH30604824S/F

INFORMATION

Options are always specified left to right from the seated position

SPECIAL SERVICES

Special Carton Marking

With specially marked information N/C

Shipping

Shipped k.d. freight prepaid f.o.b. Manitowoc, Wisconsin 54220 factory. Freight class #100.

Specifications and prices are subject to change without prior notice.

Genesis® Worksurfaces

Reduction Square Shoe Electric Height Adjustable Dual

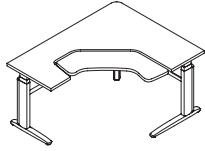

GSHE

Reduction Basic Square Shoe Electric Height Adjustable Dual-Left

- Extended corner surface
- Three-legged table base
- Height adjusts from 24"-51"
- Standard or deluxe up/down switch
- Keyboard surface adjusts 5" above/below primary surface
- Keyboard surface tilts +/-15°
- Adjustable glides
- Worksurfaces are undersized by 1-1/4" from side-to-side and 1/2" from back-to-front from the stated dimensions
- Wire trough and modesty panel should not be ordered together on adjustable tables

D x L x W x D	MODEL NUMBER										Approx. Packaged Weight
	Basic Model	Edge Style	Electrical Control	Module Location	Modesty Panel	Wire Trough	Base Finish	Edge Color	Surface Finish		
24 x 54 x 48 x 30"	GSHE24544830D	□□□	□	□□□	□□	□□	□□	□□	□□□	□□□	184.0#
24 x 60 x 48 x 30"	GSHE24604830D	□□□	□	□□□	□□	□□	□□	□□	□□□	□□□	191.0#
24 x 66 x 48 x 30"	GSHE24664830D	□□□	□	□□□	□□	□□	□□	□□	□□□	□□□	198.0#
24 x 72 x 48 x 30"	GSHE24724830D	□□□	□	□□□	□□	□□	□□	□□	□□□	□□□	205.0#
24 x 84 x 48 x 30"	GSHE24844830D	□□□	□	□□□	□□	□□	□□	□□	□□□	□□□	219.0#
30 x 54 x 48 x 24"	GSHE30544824D	□□□	□	□□□	□□	□□	□□	□□	□□□	□□□	186.0#
30 x 60 x 48 x 24"	GSHE30604824D	□□□	□	□□□	□□	□□	□□	□□	□□□	□□□	194.0#
30 x 66 x 48 x 24"	GSHE30664824D	□□□	□	□□□	□□	□□	□□	□□	□□□	□□□	202.0#
30 x 72 x 48 x 24"	GSHE30724824D	□□□	□	□□□	□□	□□	□□	□□	□□□	□□□	210.0#
30 x 84 x 48 x 24"	GSHE30844824D	□□□	□	□□□	□□	□□	□□	□□	□□□	□□□	226.0#

A B C D E F G H I

HOW TO ORDER

Indicate the following information on order form:

1. Quantity of each item.
2. Model number, including options. See "How To Build a Model Number".
3. Any special service required.

- Note:
- The □ indicates that a choice is required.
 - The absence of the □ indicates that no choice is required.
 - Alpha-numeric characters in place of □ indicate that no other alternatives are available.

HOW TO BUILD A MODEL NUMBER

- A** Select basic model.
- B** Select edge style.
 - 74P** - 74P edge
 - KN** - Knife edge
 - MP** - Membrane edge
- C** Select electric control style.
 - S** - Standard up/down switch
 - D** - Deluxe up/down switch; add \$112
- D** Select PowerUp module location. Select only one from the following and add the appropriate upcharge to the base price.
 - PUN** - No data
 - PUL** - Left module; add \$108
 - PUR** - Right module; add \$108
 - PUB** - Both left and right modules; add \$218
- E** Select modesty panel option.
 - NM** - No modesty panel

- LM** - LH modesty only
 - RM** - RH modesty only
 - WM** - Both modesty panels
- Add upcharge to unit price for "LM", "RM" and "WM" options.
- F** Select wire trough and power option.
 - NW** - No wire trough
 - WL** - Wire trough LH only
 - WR** - Wire trough RH only
 - WW** - Wire trough Both
- Add upcharge to unit price for "WL", "WR" and "WW" options.

- G** Select base finish. Refer to color addendum at ki.com or KI Fabrics & Finishes binder.
- H** Select edge/PowerUp color. Refer to color addendum at ki.com or KI Fabrics & Finishes binder. Edge color offerings are based on edge style selections. The color selection will apply to the trim, edge, PowerUp module and crank grommet. Trim color doesn't

apply to the membrane edge selection.

- I** Select surface finish. Refer to color addendum at ki.com or KI Fabrics & Finishes binder. Surface finish offerings are based on edge style selections. Laminate finishes are only available on (74P) 74P edge and (KN) knife edge worksurfaces. The membrane color selections are only available on the (MP) membrane edge worksurfaces.



Genesis® Worksurfaces

Reduction Square Shoe Electric Height Adjustable Dual

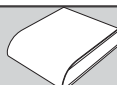
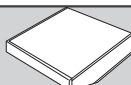
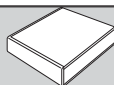

74P Edge
(74P)

Knife Edge
(KN)

Membrane Edge
(MP)

LH
Modesty
Panel
add to list
price

RH
Modesty
Panel
add to list
price

Both
Modesty
Panels
add to list
price

Left
Wire
Trough
add to list
price

Right
Wire
Trough
add to list
price

Both
Wire
Troughs
add to list
price

\$ 4862	\$ 4906	\$ 4906	\$ 198	\$ 185	\$ 385	\$ 500	\$ 483	\$ 983
4867	4908	4908	205	185	392	517	483	998
4920	4963	4963	213	185	399	637	483	1119
4974	5017	5017	220	185	409	710	483	1191
5060	5076	5076	249	185	435	715	483	1196
4862	4906	4906	198	185	385	500	483	983
4867	4908	4908	205	185	392	517	483	998
4920	4963	4963	213	185	399	637	483	1119
4974	5017	5017	220	185	409	710	483	1191
5060	5076	5076	249	185	435	715	483	1196

FINISH INFORMATION

Additional Laminate Offering

Additional laminates beyond KI standard offering, are available with two weeks extended leadtime. To specify additional laminates, use these designators followed by the supplier's color/pattern code:

Formica - LF/supplier's color pattern code
Nevamar - LN/supplier's color pattern code
Wilsonart - LW/supplier's color pattern code

KI's standard finish is the supplier's recommended finish for that color/pattern. Note: Nonstandard laminates from these suppliers (example: textured laminates), require an upcharge and additional leadtime. Contact KI.

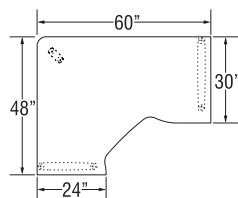

Basic Model:
GSSH24486030S/F

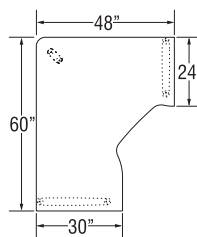

Basic Model:
GSSH30604824S/F

INFORMATION

Options are always specified left to right from the seated position

SPECIAL SERVICES

Special Carton Marking

With specially marked information N/C

Shipping

Shipped k.d. freight prepaid f.o.b. Manitowoc, Wisconsin 54220 factory. Freight class #100.

Specifications and prices are subject to change without prior notice.

Genesis® Worksurfaces

Reduction Square Shoe Electric Height Adjustable Dual

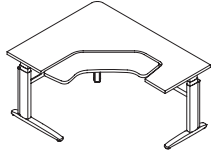

GSHE

Reduction Basic Square Shoe Electric Height Adjustable Dual-Right

- Extended corner surface
- Three-legged table base
- Height adjusts from 24"-51"
- Standard or deluxe up/down switch
- Keyboard surface adjusts 5" above/below primary surface
- Keyboard surface tilts +/-15°
- Adjustable glides
- Worksurfaces are undersized by 1-1/4" from side-to-side and 1/2" from back-to-front from the stated dimensions
- Wire trough and modesty panel should not be ordered together on adjustable tables

D x L x W x D	MODEL NUMBER										Approx. Packaged Weight
	Basic Model	Edge Style	Electrical Control	Module Location	Modesty Panel	Wire Trough	Base Finish	Edge Color	Surface Finish		
24 x 48 x 54 x 30"	GSHE24485430D	□□□	□	□□□	□□	□□	□□	□□	□□□	□□□	186.0#
24 x 48 x 60 x 30"	GSHE24486030D	□□□	□	□□□	□□	□□	□□	□□	□□□	□□□	194.0#
24 x 48 x 66 x 30"	GSHE24486630D	□□□	□	□□□	□□	□□	□□	□□	□□□	□□□	202.0#
24 x 48 x 72 x 30"	GSHE24487230D	□□□	□	□□□	□□	□□	□□	□□	□□□	□□□	210.0#
24 x 48 x 84 x 30"	GSHE24488430D	□□□	□	□□□	□□	□□	□□	□□	□□□	□□□	226.0#
30 x 48 x 54 x 24"	GSHE30485424D	□□□	□	□□□	□□	□□	□□	□□	□□□	□□□	184.0#
30 x 48 x 60 x 24"	GSHE30486024D	□□□	□	□□□	□□	□□	□□	□□	□□□	□□□	191.0#
30 x 48 x 66 x 24"	GSHE30486624D	□□□	□	□□□	□□	□□	□□	□□	□□□	□□□	198.0#
30 x 48 x 72 x 24"	GSHE30487224D	□□□	□	□□□	□□	□□	□□	□□	□□□	□□□	205.0#
30 x 48 x 84 x 24"	GSHE30488424D	□□□	□	□□□	□□	□□	□□	□□	□□□	□□□	219.0#

A **B** **C** **D** **E** **F** **G** **H** **I**

HOW TO ORDER

Indicate the following information on order form:

1. Quantity of each item.
2. Model number, including options. See "How To Build a Model Number".
3. Any special service required.

- Note:
- The □ indicates that a choice is required.
 - The absence of the □ indicates that no choice is required.
 - Alpha-numeric characters in place of □ indicate that no other alternatives are available.

HOW TO BUILD A MODEL NUMBER

- A** Select basic model.
- B** Select edge style.
 - 74P** - 74P edge
 - KN** - Knife edge
 - MP** - Membrane edge
- C** Select electric control style.
 - S** - Standard up/down switch
 - D** - Deluxe up/down switch; add \$112
- D** Select PowerUp module location. Select only one from the following and add the appropriate upcharge to the base price.
 - PUN** - No data
 - PUL** - Left module; add \$108
 - PUR** - Right module; add \$108
 - PUB** - Both left and right modules; add \$218
- E** Select modesty panel option.
 - NM** - No modesty panel

- LM** - LH modesty only
 - RM** - RH modesty only
 - WM** - Both modesty panels
- Add upcharge to unit price for "LM", "RM" and "WM" options.
- F** Select wire trough and power option.
 - NW** - No wire trough
 - WL** - Wire trough LH only
 - WR** - Wire trough RH only
 - WW** - Wire trough Both
- Add upcharge to unit price for "WL", "WR" and "WW" option.

- G** Select base finish. Refer to color addendum at ki.com or KI Fabrics & Finishes binder.
- H** Select edge/PowerUp color. Refer to color addendum at ki.com or KI Fabrics & Finishes binder. Edge color offerings are based on edge style selections. The color selection will apply to the trim, edge, PowerUp module and crank grommet. Trim color doesn't

apply to the membrane edge selection.

- I** Select surface finish. Refer to color addendum at ki.com or KI Fabrics & Finishes binder. Surface finish offerings are based on edge style selections. Laminate finishes are only available on (74P) 74P edge and (KN) knife edge worksurfaces. The membrane color selections are only available on the (MP) membrane edge worksurfaces.



Genesis® Worksurfaces

Reduction Square Shoe Electric Height Adjustable Dual

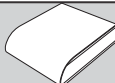
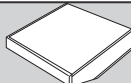
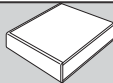

74P Edge
(74P)

Knife Edge
(KN)

Membrane Edge
(MP)

LH
Modesty
Panel
add to list
price

RH
Modesty
Panel
add to list
price

Both
Modesty
Panels
add to list
price

Left
Wire
Trough
add to list
price

Right
Wire
Trough
add to list
price

Both
Wire
Troughs
add to list
price

\$ 4862	\$ 4906	\$ 4906	\$ 185	\$ 198	\$ 385	\$ 483	\$ 500	\$ 983
4867	4908	4908	185	205	392	483	517	998
4920	4963	4963	185	213	399	483	637	1119
4974	5017	5017	185	220	409	483	710	1191
5060	5076	5076	185	249	435	483	715	1196
4862	4906	4906	185	198	385	483	500	983
4867	5016	5016	185	205	392	483	517	998
4920	4963	4963	185	213	399	483	637	1119
4974	5017	5017	185	220	409	483	710	1191
5060	5076	5076	185	249	435	483	715	1196

FINISH INFORMATION

Additional Laminate Offering

Additional laminates beyond KI standard offering, are available with two weeks extended leadtime. To specify additional laminates, use these designators followed by the supplier's color/pattern code:

Formica - LF/supplier's color pattern code
 Nevamar - LN/supplier's color pattern code
 Wilsonart - LW/supplier's color pattern code

KI's standard finish is the supplier's recommended finish for that color/pattern. Note: Nonstandard laminates from these suppliers (example: textured laminates), require an upcharge and additional leadtime. Contact KI.

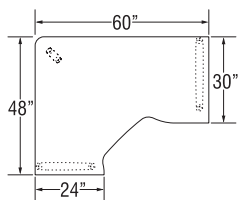

Basic Model:
GSSH24486030S/F

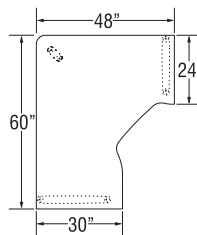

Basic Model:
GSSH30604824S/F

SPECIAL SERVICES

Special Carton Marking

With specially marked information N/C

Shipping

Shipped k.d. freight prepaid f.o.b. Manitowoc, Wisconsin 54220 factory. Freight class #100.

Specifications and prices are subject to change without prior notice.

INFORMATION

Options are always specified left to right from the seated position

Genesis® Worksurfaces

"P" Shaped Peninsula

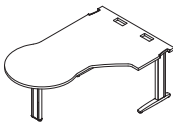
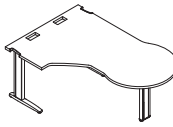
	D x W x L	MODEL NUMBER										
		Basic Model	Edge Style	Module Location	Modesty Panel	Wire Trough	Overhead Grommet	Trans. Legs	Base Finish	Edge Color	Surface Finish	
 <p>GSTP Fixed Height-Left</p> <ul style="list-style-type: none"> • Corner surface with conferencing end • Fixed height at 29" • Adjustable glides 	60 x 48 x 24"	GSTP604824S/F	<input type="checkbox"/>	<input type="checkbox"/>	<input type="checkbox"/>	<input type="checkbox"/>	<input type="checkbox"/>	<input type="checkbox"/>	<input type="checkbox"/>	<input type="checkbox"/>		
	66 x 48 x 24"	GSTP664824S/F	<input type="checkbox"/>	<input type="checkbox"/>	<input type="checkbox"/>	<input type="checkbox"/>	<input type="checkbox"/>	<input type="checkbox"/>	<input type="checkbox"/>	<input type="checkbox"/>		
	72 x 48 x 24"	GSTP724824S/F	<input type="checkbox"/>	<input type="checkbox"/>	<input type="checkbox"/>	<input type="checkbox"/>	<input type="checkbox"/>	<input type="checkbox"/>	<input type="checkbox"/>	<input type="checkbox"/>		
	84 x 48 x 24"	GSTP844824S/F	<input type="checkbox"/>	<input type="checkbox"/>	<input type="checkbox"/>	<input type="checkbox"/>	<input type="checkbox"/>	<input type="checkbox"/>	<input type="checkbox"/>	<input type="checkbox"/>		
	60 x 48 x 30"	GSTP604830S/F	<input type="checkbox"/>	<input type="checkbox"/>	<input type="checkbox"/>	<input type="checkbox"/>	<input type="checkbox"/>	<input type="checkbox"/>	<input type="checkbox"/>	<input type="checkbox"/>		
	66 x 48 x 30"	GSTP664830S/F	<input type="checkbox"/>	<input type="checkbox"/>	<input type="checkbox"/>	<input type="checkbox"/>	<input type="checkbox"/>	<input type="checkbox"/>	<input type="checkbox"/>	<input type="checkbox"/>		
	72 x 48 x 30"	GSTP724830S/F	<input type="checkbox"/>	<input type="checkbox"/>	<input type="checkbox"/>	<input type="checkbox"/>	<input type="checkbox"/>	<input type="checkbox"/>	<input type="checkbox"/>	<input type="checkbox"/>		
	84 x 48 x 30"	GSTP844830S/F	<input type="checkbox"/>	<input type="checkbox"/>	<input type="checkbox"/>	<input type="checkbox"/>	<input type="checkbox"/>	<input type="checkbox"/>	<input type="checkbox"/>	<input type="checkbox"/>		
 <p>GSTP Fixed Height-Right</p> <ul style="list-style-type: none"> • Corner surface with conferencing end • Fixed height at 29" • Adjustable glides 	24 x 48 x 60"	GSTP244860S/F	<input type="checkbox"/>	<input type="checkbox"/>	<input type="checkbox"/>	<input type="checkbox"/>	<input type="checkbox"/>	<input type="checkbox"/>	<input type="checkbox"/>			
	24 x 48 x 66"	GSTP244866S/F	<input type="checkbox"/>	<input type="checkbox"/>	<input type="checkbox"/>	<input type="checkbox"/>	<input type="checkbox"/>	<input type="checkbox"/>	<input type="checkbox"/>			
	24 x 48 x 72"	GSTP244872S/F	<input type="checkbox"/>	<input type="checkbox"/>	<input type="checkbox"/>	<input type="checkbox"/>	<input type="checkbox"/>	<input type="checkbox"/>	<input type="checkbox"/>			
	24 x 48 x 84"	GSTP244884S/F	<input type="checkbox"/>	<input type="checkbox"/>	<input type="checkbox"/>	<input type="checkbox"/>	<input type="checkbox"/>	<input type="checkbox"/>	<input type="checkbox"/>			
	30 x 48 x 60"	GSTP304860S/F	<input type="checkbox"/>	<input type="checkbox"/>	<input type="checkbox"/>	<input type="checkbox"/>	<input type="checkbox"/>	<input type="checkbox"/>	<input type="checkbox"/>			
	30 x 48 x 66"	GSTP304866S/F	<input type="checkbox"/>	<input type="checkbox"/>	<input type="checkbox"/>	<input type="checkbox"/>	<input type="checkbox"/>	<input type="checkbox"/>	<input type="checkbox"/>			
	30 x 48 x 72"	GSTP304872S/F	<input type="checkbox"/>	<input type="checkbox"/>	<input type="checkbox"/>	<input type="checkbox"/>	<input type="checkbox"/>	<input type="checkbox"/>	<input type="checkbox"/>			
	30 x 48 x 84"	GSTP304884S/F	<input type="checkbox"/>	<input type="checkbox"/>	<input type="checkbox"/>	<input type="checkbox"/>	<input type="checkbox"/>	<input type="checkbox"/>	<input type="checkbox"/>			
			A	B	C	D	E	F	G	H	I	J

HOW TO ORDER

Indicate the following information on order form:

- Quantity of each item.
- Model number, including options. See "How To Build a Model Number".
- Any special service required.

Note: • The indicates that a choice is required.

- The absence of the indicates that no choice is required.
- Alpha-numeric characters in place of indicate that no other alternatives are available.

HOW TO BUILD A MODEL NUMBER

- A** Select basic model.
- B** Select edge style.
74P - 74P edge
KN - Knife edge
- C** Select PowerUp module location.
 Select only one from the following and add the appropriate upcharge to the base price.
PUN - No data
PUL - Left module; add \$108
PUR - Right module; add \$108
PUB - Both left and right modules; add \$218
- D** Select modesty panel options.
NM - No modesty panel
LM - LH modesty only
RM - RH modesty only
WM - Both modesty panels
 Add upcharge to unit price for "LM", "RM" and "WM" option.

- E** Select wire trough and power option.
NW - No wire trough
WW - Wire trough
 Add upcharge to unit price for "WW" option.
- F** Select overhead grommet.
OGN - Overhead grommets no
OGY - Overhead grommets yes
 OGY not available for 24" deep dual rectangles wider than 60".
- G** Select transition legs.
TS - No transition foot
TL - Left transition foot
TR - Right transition foot
TB - Both transition feet
 TR, TL and TB not allowed on 24" deep dual surfaces.
- H** Select base finish.
 Refer to color addendum at ki.com or KI Fabrics & Finishes binder.
- I** Select edge color.

Refer to color addendum at ki.com or KI Fabrics & Finishes binder. Edge color offerings are based on edge style selections. The color selection will apply to the trim, edge and PowerUp module.

J Select surface finish.
 Refer to color addendum at ki.com or KI Fabrics & Finishes binder. Surface finish offerings are based on edge style selections. Laminate finishes are only available on (74P) 74P edge and (KN) knife edge worksurfaces.

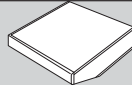
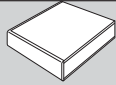

Approx. Packaged Weight	74P Edge (74P)	Knife Edge (KN)	LH Modesty Panel add to list price	RH Modesty Panel add to list price	Both Modesty Panels add to list price	Wire Trough add to list price
131.0#	\$ 1749	\$ 1891	\$ 190	\$ 141	\$ 330	\$ 473
139.0#	1816	1984	198	141	340	473
147.0#	1824	2017	205	141	346	473
155.0#	1895	2040	213	141	353	473
139.0#	1749	1891	190	141	330	473
147.0#	1816	1984	198	141	340	473
155.0#	1824	2017	205	141	346	473
162.0#	1895	2040	213	141	353	473
<hr/>						
131.0#	\$ 1749	\$ 1891	\$ 141	\$ 190	\$ 330	\$ 473
139.0#	1816	1984	141	198	340	473
147.0#	1824	2017	141	205	346	473
155.0#	1895	2040	141	213	353	473
139.0#	1749	1891	141	190	330	473
147.0#	1816	1984	141	198	340	473
155.0#	1824	2017	141	205	346	473
162.0#	1895	2040	141	213	353	473

FINISH INFORMATION

Additional Laminate Offering

Additional laminates beyond KI standard offering, are available with two weeks extended leadtime. To specify additional laminates, use these designators followed by the supplier's color/pattern code:

Formica - LF/supplier's color pattern code
 Nevamar - LN/supplier's color pattern code
 Wilsonart - LW/supplier's color pattern code

KI's standard finish is the supplier's recommended finish for that color/pattern. Note: Nonstandard laminates from these suppliers (example: textured laminates), require an upcharge and additional leadtime. Contact KI.

SPECIAL SERVICES

Special Carton Marking

With specially marked information N/C

Shipping

Shipped k.d. freight prepaid f.o.b. Manitowoc, Wisconsin 54220 factory. Freight class #100.

Specifications and prices are subject to change without prior notice.

Genesis® Worksurfaces

"P" Shaped Peninsula

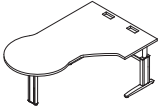
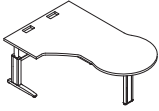
		MODEL NUMBER								
MODEL		D x W x L	Basic Model	Edge Style	Module Location	Modesty Panel	Wire Trough	Base Finish	Edge Color	Surface Finish
 <p>GSTP</p>	Pin Height Adjustable-Left	60 x 48 x 24"	GSTP604824S/P	<input type="checkbox"/>	<input type="checkbox"/>	<input type="checkbox"/>	<input type="checkbox"/>	<input type="checkbox"/>	<input type="checkbox"/>	
	• Corner surface with conferencing end	66 x 48 x 24"	GSTP664824S/P	<input type="checkbox"/>	<input type="checkbox"/>	<input type="checkbox"/>	<input type="checkbox"/>	<input type="checkbox"/>	<input type="checkbox"/>	
	• Height adjusts from 24"-31" in 1" increments	72 x 48 x 24"	GSTP724824S/P	<input type="checkbox"/>	<input type="checkbox"/>	<input type="checkbox"/>	<input type="checkbox"/>	<input type="checkbox"/>	<input type="checkbox"/>	
	• Adjustable glides	84 x 48 x 24"	GSTP844824S/P	<input type="checkbox"/>	<input type="checkbox"/>	<input type="checkbox"/>	<input type="checkbox"/>	<input type="checkbox"/>	<input type="checkbox"/>	
	• Wire trough and modesty panel should not be ordered together on adjustable tables	60 x 48 x 30"	GSTP604830S/P	<input type="checkbox"/>	<input type="checkbox"/>	<input type="checkbox"/>	<input type="checkbox"/>	<input type="checkbox"/>	<input type="checkbox"/>	
		66 x 48 x 30"	GSTP664830S/P	<input type="checkbox"/>	<input type="checkbox"/>	<input type="checkbox"/>	<input type="checkbox"/>	<input type="checkbox"/>	<input type="checkbox"/>	
		72 x 48 x 30"	GSTP724830S/P	<input type="checkbox"/>	<input type="checkbox"/>	<input type="checkbox"/>	<input type="checkbox"/>	<input type="checkbox"/>	<input type="checkbox"/>	
		84 x 48 x 30"	GSTP844830S/P	<input type="checkbox"/>	<input type="checkbox"/>	<input type="checkbox"/>	<input type="checkbox"/>	<input type="checkbox"/>	<input type="checkbox"/>	
 <p>GSTP</p>	Pin Height Adjustable-Right	24 x 48 x 60"	GSTP244860S/P	<input type="checkbox"/>	<input type="checkbox"/>	<input type="checkbox"/>	<input type="checkbox"/>	<input type="checkbox"/>	<input type="checkbox"/>	
	• Corner surface with conferencing end	24 x 48 x 66"	GSTP244866S/P	<input type="checkbox"/>	<input type="checkbox"/>	<input type="checkbox"/>	<input type="checkbox"/>	<input type="checkbox"/>	<input type="checkbox"/>	
	• Height adjusts from 24"-31" in 1" increments	24 x 48 x 72"	GSTP244872S/P	<input type="checkbox"/>	<input type="checkbox"/>	<input type="checkbox"/>	<input type="checkbox"/>	<input type="checkbox"/>	<input type="checkbox"/>	
	• Adjustable glides	24 x 48 x 84"	GSTP244884S/P	<input type="checkbox"/>	<input type="checkbox"/>	<input type="checkbox"/>	<input type="checkbox"/>	<input type="checkbox"/>	<input type="checkbox"/>	
	• Wire trough and modesty panel should not be ordered together on adjustable tables	30 x 48 x 60"	GSTP304860S/P	<input type="checkbox"/>	<input type="checkbox"/>	<input type="checkbox"/>	<input type="checkbox"/>	<input type="checkbox"/>	<input type="checkbox"/>	
		30 x 48 x 66"	GSTP304866S/P	<input type="checkbox"/>	<input type="checkbox"/>	<input type="checkbox"/>	<input type="checkbox"/>	<input type="checkbox"/>	<input type="checkbox"/>	
		30 x 48 x 72"	GSTP304872S/P	<input type="checkbox"/>	<input type="checkbox"/>	<input type="checkbox"/>	<input type="checkbox"/>	<input type="checkbox"/>	<input type="checkbox"/>	
		30 x 48 x 84"	GSTP304884S/P	<input type="checkbox"/>	<input type="checkbox"/>	<input type="checkbox"/>	<input type="checkbox"/>	<input type="checkbox"/>	<input type="checkbox"/>	

A **B** **C** **D** **E** **F** **G** **H**

HOW TO ORDER

Indicate the following information on order form:

- Quantity of each item.
- Model number, including options. See "How To Build a Model Number".
- Any special service required.

Note: • The indicates that a choice is required.

- The absence of the indicates that no choice is required.
- Alpha-numeric characters in place of indicate that no other alternatives are available.

HOW TO BUILD A MODEL NUMBER

- A** Select basic model.

- B** Select edge style.

- C** Select PowerUp module location.
Select only one from the following and add the appropriate upcharge to the base price.

PUN	- No data
PUL	- Left module; add \$108
PUR	- Right module; add \$108
PUB	- Both left and right modules; add \$218
- D** Select modesty panel.

NM	- No modesty panel
LM	- LH modesty only
RM	- RH modesty only
WM	- Both modesty panels

 Add upcharge to unit price for "LM", "RM" and "WM" options.

E Select wire trough and power option.

- | | |
|-----------|------------------|
| NW | - No wire trough |
| WW | - Wire trough |
- Add upcharge to unit price for "WW" option.

F Select base finish.

Refer to color addendum at ki.com or KI Fabrics & Finishes binder.

G Select edge color.

Refer to color addendum at ki.com or KI Fabrics & Finishes binder.
Edge color offerings are based on edge style selections. The color selection will apply to the trim, edge and PowerUp module.

H Select surface finish.

Refer to color addendum at ki.com or KI Fabrics & Finishes binder.
Surface finish offerings are based on edge style selections. Laminate finishes are only available on (74P) 74P edge and (KN) knife edge worksurfaces.

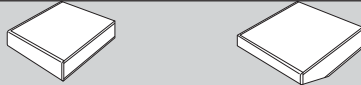

Approx. Packaged Weight	74P Edge (74P)	Knife Edge (KN)	LH Modesty Panel add to list price	RH Modesty Panel add to list price	Both Modesty Panels add to list price	Wire Trough add to list price
135.0#	\$ 1970	\$ 2112	\$ 190	\$ 141	\$ 330	\$ 473
143.0#	2039	2203	198	141	340	473
151.0#	2045	2237	205	141	346	473
159.0#	2115	2260	213	141	353	473
143.0#	1970	2112	190	141	330	473
151.0#	2039	2203	198	141	340	473
159.0#	2045	2237	205	141	346	473
166.0#	2115	2260	213	141	353	473
135.0#	\$ 1970	\$ 2112	\$ 141	\$ 190	\$ 330	\$ 473
143.0#	2039	2203	141	198	340	473
151.0#	2045	2237	141	205	346	473
159.0#	2115	2260	141	213	353	473
143.0#	1970	2112	141	190	330	473
151.0#	2039	2203	141	198	340	473
159.0#	2045	2237	141	205	346	473
166.0#	2115	2260	141	213	353	473

FINISH INFORMATION

Additional Laminate Offering

Additional laminates beyond KI standard offering, are available with two weeks extended leadtime. To specify additional laminates, use these designators followed by the supplier's color/pattern code:

Formica - LF/supplier's color pattern code
 Nevamar - LN/supplier's color pattern code
 Wilsonart - LW/supplier's color pattern code

KI's standard finish is the supplier's recommended finish for that color/pattern. Note: Nonstandard laminates from these suppliers (example: textured laminates), require an upcharge and additional leadtime. Contact KI.

SPECIAL SERVICES

Special Carton Marking

With specially marked information N/C

Shipping

Shipped k.d. freight prepaid f.o.b. Manitowoc, Wisconsin 54220 factory. Freight class #100.

Specifications and prices are subject to change without prior notice.

Genesis® Worksurfaces

Arcade Peninsula

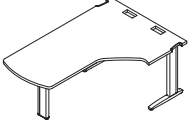
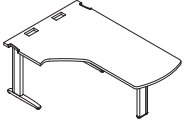
		MODEL NUMBER										
		D x W x L	Basic Model	Edge Style	Module Location	Modesty Panel	Wire Trough	Overhead Grommet	Trans. Legs	Base Finish	Edge Color	Surface Finish
 <p>GSAP Fixed Height-Left</p> <ul style="list-style-type: none"> • Corner surface with conferencing end • Fixed height at 29" • Adjustable glides 	60 x 48 x 24"	GSAP604824S/F	<input type="checkbox"/> <input type="checkbox"/> <input type="checkbox"/>	<input type="checkbox"/> <input type="checkbox"/> <input type="checkbox"/>	<input type="checkbox"/>	<input type="checkbox"/>	<input type="checkbox"/> <input type="checkbox"/> <input type="checkbox"/>	<input type="checkbox"/>	<input type="checkbox"/>	<input type="checkbox"/> <input type="checkbox"/> <input type="checkbox"/>	<input type="checkbox"/> <input type="checkbox"/> <input type="checkbox"/>	
	66 x 48 x 24"	GSAP664824S/F	<input type="checkbox"/> <input type="checkbox"/> <input type="checkbox"/>	<input type="checkbox"/> <input type="checkbox"/> <input type="checkbox"/>	<input type="checkbox"/>	<input type="checkbox"/>	<input type="checkbox"/> <input type="checkbox"/> <input type="checkbox"/>	<input type="checkbox"/>	<input type="checkbox"/>	<input type="checkbox"/> <input type="checkbox"/> <input type="checkbox"/>	<input type="checkbox"/> <input type="checkbox"/> <input type="checkbox"/>	
	72 x 48 x 24"	GSAP724824S/F	<input type="checkbox"/> <input type="checkbox"/> <input type="checkbox"/>	<input type="checkbox"/> <input type="checkbox"/> <input type="checkbox"/>	<input type="checkbox"/>	<input type="checkbox"/>	<input type="checkbox"/> <input type="checkbox"/> <input type="checkbox"/>	<input type="checkbox"/>	<input type="checkbox"/>	<input type="checkbox"/> <input type="checkbox"/> <input type="checkbox"/>	<input type="checkbox"/> <input type="checkbox"/> <input type="checkbox"/>	
	84 x 48 x 24"	GSAP844824S/F	<input type="checkbox"/> <input type="checkbox"/> <input type="checkbox"/>	<input type="checkbox"/> <input type="checkbox"/> <input type="checkbox"/>	<input type="checkbox"/>	<input type="checkbox"/>	<input type="checkbox"/> <input type="checkbox"/> <input type="checkbox"/>	<input type="checkbox"/>	<input type="checkbox"/>	<input type="checkbox"/> <input type="checkbox"/> <input type="checkbox"/>	<input type="checkbox"/> <input type="checkbox"/> <input type="checkbox"/>	
	60 x 48 x 30"	GSAP604830S/F	<input type="checkbox"/> <input type="checkbox"/> <input type="checkbox"/>	<input type="checkbox"/> <input type="checkbox"/> <input type="checkbox"/>	<input type="checkbox"/>	<input type="checkbox"/>	<input type="checkbox"/> <input type="checkbox"/> <input type="checkbox"/>	<input type="checkbox"/>	<input type="checkbox"/>	<input type="checkbox"/> <input type="checkbox"/> <input type="checkbox"/>	<input type="checkbox"/> <input type="checkbox"/> <input type="checkbox"/>	
	66 x 48 x 30"	GSAP664830S/F	<input type="checkbox"/> <input type="checkbox"/> <input type="checkbox"/>	<input type="checkbox"/> <input type="checkbox"/> <input type="checkbox"/>	<input type="checkbox"/>	<input type="checkbox"/>	<input type="checkbox"/> <input type="checkbox"/> <input type="checkbox"/>	<input type="checkbox"/>	<input type="checkbox"/>	<input type="checkbox"/> <input type="checkbox"/> <input type="checkbox"/>	<input type="checkbox"/> <input type="checkbox"/> <input type="checkbox"/>	
	72 x 48 x 30"	GSAP724830S/F	<input type="checkbox"/> <input type="checkbox"/> <input type="checkbox"/>	<input type="checkbox"/> <input type="checkbox"/> <input type="checkbox"/>	<input type="checkbox"/>	<input type="checkbox"/>	<input type="checkbox"/> <input type="checkbox"/> <input type="checkbox"/>	<input type="checkbox"/>	<input type="checkbox"/>	<input type="checkbox"/> <input type="checkbox"/> <input type="checkbox"/>	<input type="checkbox"/> <input type="checkbox"/> <input type="checkbox"/>	
	84 x 48 x 30"	GSAP844830S/F	<input type="checkbox"/> <input type="checkbox"/> <input type="checkbox"/>	<input type="checkbox"/> <input type="checkbox"/> <input type="checkbox"/>	<input type="checkbox"/>	<input type="checkbox"/>	<input type="checkbox"/> <input type="checkbox"/> <input type="checkbox"/>	<input type="checkbox"/>	<input type="checkbox"/>	<input type="checkbox"/> <input type="checkbox"/> <input type="checkbox"/>	<input type="checkbox"/> <input type="checkbox"/> <input type="checkbox"/>	
 <p>GSAP Fixed Height-Right</p> <ul style="list-style-type: none"> • Corner surface with conferencing end • Fixed height at 29" • Adjustable glides 	24 x 48 x 60"	GSAP244860S/F	<input type="checkbox"/> <input type="checkbox"/> <input type="checkbox"/>	<input type="checkbox"/> <input type="checkbox"/> <input type="checkbox"/>	<input type="checkbox"/>	<input type="checkbox"/>	<input type="checkbox"/> <input type="checkbox"/> <input type="checkbox"/>	<input type="checkbox"/>	<input type="checkbox"/>	<input type="checkbox"/> <input type="checkbox"/> <input type="checkbox"/>	<input type="checkbox"/> <input type="checkbox"/> <input type="checkbox"/>	
	24 x 48 x 66"	GSAP244866S/F	<input type="checkbox"/> <input type="checkbox"/> <input type="checkbox"/>	<input type="checkbox"/> <input type="checkbox"/> <input type="checkbox"/>	<input type="checkbox"/>	<input type="checkbox"/>	<input type="checkbox"/> <input type="checkbox"/> <input type="checkbox"/>	<input type="checkbox"/>	<input type="checkbox"/>	<input type="checkbox"/> <input type="checkbox"/> <input type="checkbox"/>	<input type="checkbox"/> <input type="checkbox"/> <input type="checkbox"/>	
	24 x 48 x 72"	GSAP244872S/F	<input type="checkbox"/> <input type="checkbox"/> <input type="checkbox"/>	<input type="checkbox"/> <input type="checkbox"/> <input type="checkbox"/>	<input type="checkbox"/>	<input type="checkbox"/>	<input type="checkbox"/> <input type="checkbox"/> <input type="checkbox"/>	<input type="checkbox"/>	<input type="checkbox"/>	<input type="checkbox"/> <input type="checkbox"/> <input type="checkbox"/>	<input type="checkbox"/> <input type="checkbox"/> <input type="checkbox"/>	
	24 x 48 x 84"	GSAP244884S/F	<input type="checkbox"/> <input type="checkbox"/> <input type="checkbox"/>	<input type="checkbox"/> <input type="checkbox"/> <input type="checkbox"/>	<input type="checkbox"/>	<input type="checkbox"/>	<input type="checkbox"/> <input type="checkbox"/> <input type="checkbox"/>	<input type="checkbox"/>	<input type="checkbox"/>	<input type="checkbox"/> <input type="checkbox"/> <input type="checkbox"/>	<input type="checkbox"/> <input type="checkbox"/> <input type="checkbox"/>	
	30 x 48 x 60"	GSAP304860S/F	<input type="checkbox"/> <input type="checkbox"/> <input type="checkbox"/>	<input type="checkbox"/> <input type="checkbox"/> <input type="checkbox"/>	<input type="checkbox"/>	<input type="checkbox"/>	<input type="checkbox"/> <input type="checkbox"/> <input type="checkbox"/>	<input type="checkbox"/>	<input type="checkbox"/>	<input type="checkbox"/> <input type="checkbox"/> <input type="checkbox"/>	<input type="checkbox"/> <input type="checkbox"/> <input type="checkbox"/>	
	30 x 48 x 66"	GSAP304866S/F	<input type="checkbox"/> <input type="checkbox"/> <input type="checkbox"/>	<input type="checkbox"/> <input type="checkbox"/> <input type="checkbox"/>	<input type="checkbox"/>	<input type="checkbox"/>	<input type="checkbox"/> <input type="checkbox"/> <input type="checkbox"/>	<input type="checkbox"/>	<input type="checkbox"/>	<input type="checkbox"/> <input type="checkbox"/> <input type="checkbox"/>	<input type="checkbox"/> <input type="checkbox"/> <input type="checkbox"/>	
	30 x 48 x 72"	GSAP304872S/F	<input type="checkbox"/> <input type="checkbox"/> <input type="checkbox"/>	<input type="checkbox"/> <input type="checkbox"/> <input type="checkbox"/>	<input type="checkbox"/>	<input type="checkbox"/>	<input type="checkbox"/> <input type="checkbox"/> <input type="checkbox"/>	<input type="checkbox"/>	<input type="checkbox"/>	<input type="checkbox"/> <input type="checkbox"/> <input type="checkbox"/>	<input type="checkbox"/> <input type="checkbox"/> <input type="checkbox"/>	
	30 x 48 x 84"	GSAP304884S/F	<input type="checkbox"/> <input type="checkbox"/> <input type="checkbox"/>	<input type="checkbox"/> <input type="checkbox"/> <input type="checkbox"/>	<input type="checkbox"/>	<input type="checkbox"/>	<input type="checkbox"/> <input type="checkbox"/> <input type="checkbox"/>	<input type="checkbox"/>	<input type="checkbox"/>	<input type="checkbox"/> <input type="checkbox"/> <input type="checkbox"/>	<input type="checkbox"/> <input type="checkbox"/> <input type="checkbox"/>	
			A	B	C	D	E	F	G	H	I	J

HOW TO ORDER

Indicate the following information on order form:

- Quantity of each item.
- Model number, including options. See "How To Build a Model Number".
- Any special service required.

Note: • The indicates that a choice is required.

- The absence of the indicates that no choice is required.
- Alpha-numeric characters in place of indicate that no other alternatives are available.

HOW TO BUILD A MODEL NUMBER

- A** Select basic model.
 - 74P - 74P edge
 - KN - Knife edge
 - MP - Membrane edge
- B** Select edge style.
 - 74P - 74P edge
 - KN - Knife edge
 - MP - Membrane edge
- C** Select PowerUp module location. Select only one from the following and add the appropriate upcharge to the base price.
 - PUN - No data
 - PUL - Left module; add \$108
 - PUR - Right module; add \$108
 - PUB - Both left and right modules; add \$218
- D** Select modesty panel.
 - NM - No modesty panel
 - LM - LH modesty only
 - RM - RH modesty only
 - WM - Both modesty panels
 Add upcharge to unit price for "LM", "RM" and "WM" options.

- E** Select wire trough and power option.
 - NW - No wire trough
 - WW - Wire trough
 Add upcharge to unit price for "WW" option.
- F** Select overhead grommet.
 - OGN - Overhead grommets no
 - OGY - Overhead grommets yes
- G** Select transition legs.
 - TS - No transition foot
 - TL - Left transition foot
 - TR - Right transition foot
 - TB - Both transition feet

- H** Select base finish. Refer to color addendum at ki.com or KI Fabrics & Finishes binder.

- I** Select edge color. Refer to color addendum at ki.com or KI Fabrics & Finishes binder. Edge color offerings are based on edge

style selections. The color selection will apply to the trim, edge and PowerUp module.

- J** Select surface finish. Refer to color addendum at ki.com or KI Fabrics & Finishes binder. Surface finish offerings are based on edge style selections. Laminate finishes are only available on (74P) 74P edge and (KN) knife edge worksurfaces.

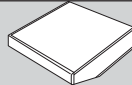
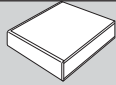

Approx. Packaged Weight	74P Edge (74P)	Knife Edge (KN)	Membrane Edge (MP)	LH Modesty Panel add to list price	RH Modesty Panel add to list price	Both Modesty Panels add to list price	Wire Trough add to list price
127.0#	\$ 1618	\$ 1691	\$ 1691	\$ 205	\$ 185	\$ 392	\$ 473
135.0#	1684	1782	1782	213	185	399	473
143.0#	1691	1818	1818	220	185	409	473
151.0#	1763	1842	1842	249	185	435	473
135.0#	1618	1691	1691	205	185	392	473
143.0#	1684	1782	1782	213	185	399	473
151.0#	1691	1818	1818	220	185	409	473
158.0#	1763	1842	1842	249	185	435	473
127.0#	\$ 1618	\$ 1691	\$ 1691	\$ 185	\$ 205	\$ 392	\$ 473
135.0#	1684	1782	1782	185	213	399	473
143.0#	1691	1818	1818	185	220	409	473
151.0#	1763	1842	1842	141	213	353	473
135.0#	1618	1691	1691	185	205	392	473
143.0#	1684	1782	1782	185	213	399	473
151.0#	1691	1818	1818	185	220	409	473
158.0#	1763	1842	1842	185	249	435	473

FINISH INFORMATION

Additional Laminate Offering

Additional laminates beyond KI standard offering, are available with two weeks extended leadtime. To specify additional laminates, use these designators followed by the supplier's color/pattern code:

- Formica - LF/supplier's color pattern code
- Nevamar - LN/supplier's color pattern code
- Wilsonart - LW/supplier's color pattern code

KI's standard finish is the supplier's recommended finish for that color/pattern. Note: Nonstandard laminates from these suppliers (example: textured laminates), require an upcharge and additional leadtime. Contact KI.

SPECIAL SERVICES

Special Carton Marking

With specially marked information N/C

Shipping

Shipped k.d. freight prepaid f.o.b. Manitowoc, Wisconsin 54220 factory. Freight class #100.

Specifications and prices are subject to change without prior notice.

Genesis® Worksurfaces

Arcade Peninsula

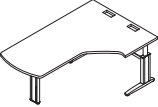
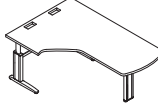
			MODEL NUMBER							
MODEL	D x W x L	Basic Model	Edge Style	Module Location	Modesty Panel	Wire Trough	Base Finish	Edge Color	Surface Finish	
 <p>GSAP</p> <p>Pin Height Adjustable-Left</p> <ul style="list-style-type: none"> • Corner surface with conferencing end • Height adjusts from 24"-31" in 1" increments • Adjustable glides • Wire trough and modesty panel should not be ordered together on adjustable tables 	60 x 48 x 24"	GSAP604824S/P	<input type="checkbox"/> <input type="checkbox"/>	<input type="checkbox"/> <input type="checkbox"/>	<input type="checkbox"/>	<input type="checkbox"/>	<input type="checkbox"/>	<input type="checkbox"/> <input type="checkbox"/>	<input type="checkbox"/> <input type="checkbox"/>	
	66 x 48 x 24"	GSAP664824S/P	<input type="checkbox"/> <input type="checkbox"/>	<input type="checkbox"/> <input type="checkbox"/>	<input type="checkbox"/>	<input type="checkbox"/>	<input type="checkbox"/>	<input type="checkbox"/> <input type="checkbox"/>	<input type="checkbox"/> <input type="checkbox"/>	
	72 x 48 x 24"	GSAP724824S/P	<input type="checkbox"/> <input type="checkbox"/>	<input type="checkbox"/> <input type="checkbox"/>	<input type="checkbox"/>	<input type="checkbox"/>	<input type="checkbox"/>	<input type="checkbox"/> <input type="checkbox"/>	<input type="checkbox"/> <input type="checkbox"/>	
	84 x 48 x 24"	GSAP844824S/P	<input type="checkbox"/> <input type="checkbox"/>	<input type="checkbox"/> <input type="checkbox"/>	<input type="checkbox"/>	<input type="checkbox"/>	<input type="checkbox"/>	<input type="checkbox"/> <input type="checkbox"/>	<input type="checkbox"/> <input type="checkbox"/>	
	60 x 48 x 30"	GSAP604830S/P	<input type="checkbox"/> <input type="checkbox"/>	<input type="checkbox"/> <input type="checkbox"/>	<input type="checkbox"/>	<input type="checkbox"/>	<input type="checkbox"/>	<input type="checkbox"/> <input type="checkbox"/>	<input type="checkbox"/> <input type="checkbox"/>	
	66 x 48 x 30"	GSAP664830S/P	<input type="checkbox"/> <input type="checkbox"/>	<input type="checkbox"/> <input type="checkbox"/>	<input type="checkbox"/>	<input type="checkbox"/>	<input type="checkbox"/>	<input type="checkbox"/> <input type="checkbox"/>	<input type="checkbox"/> <input type="checkbox"/>	
	72 x 48 x 30"	GSAP724830S/P	<input type="checkbox"/> <input type="checkbox"/>	<input type="checkbox"/> <input type="checkbox"/>	<input type="checkbox"/>	<input type="checkbox"/>	<input type="checkbox"/>	<input type="checkbox"/> <input type="checkbox"/>	<input type="checkbox"/> <input type="checkbox"/>	
	84 x 48 x 30"	GSAP844830S/P	<input type="checkbox"/> <input type="checkbox"/>	<input type="checkbox"/> <input type="checkbox"/>	<input type="checkbox"/>	<input type="checkbox"/>	<input type="checkbox"/>	<input type="checkbox"/> <input type="checkbox"/>	<input type="checkbox"/> <input type="checkbox"/>	
 <p>GSAP</p> <p>Pin Height Adjustable-Right</p> <ul style="list-style-type: none"> • Corner surface with conferencing end • Height adjusts from 24"-31" in 1" increments • Adjustable glides • Wire trough and modesty panel should not be ordered together on adjustable tables 	24 x 48 x 60"	GSAP244860S/P	<input type="checkbox"/> <input type="checkbox"/>	<input type="checkbox"/>	<input type="checkbox"/>	<input type="checkbox"/>	<input type="checkbox"/>	<input type="checkbox"/> <input type="checkbox"/>	<input type="checkbox"/> <input type="checkbox"/>	
	24 x 48 x 66"	GSAP244866S/P	<input type="checkbox"/> <input type="checkbox"/>	<input type="checkbox"/>	<input type="checkbox"/>	<input type="checkbox"/>	<input type="checkbox"/>	<input type="checkbox"/> <input type="checkbox"/>	<input type="checkbox"/> <input type="checkbox"/>	
	24 x 48 x 72"	GSAP244872S/P	<input type="checkbox"/> <input type="checkbox"/>	<input type="checkbox"/>	<input type="checkbox"/>	<input type="checkbox"/>	<input type="checkbox"/>	<input type="checkbox"/> <input type="checkbox"/>	<input type="checkbox"/> <input type="checkbox"/>	
	24 x 48 x 84"	GSAP244884S/P	<input type="checkbox"/> <input type="checkbox"/>	<input type="checkbox"/>	<input type="checkbox"/>	<input type="checkbox"/>	<input type="checkbox"/>	<input type="checkbox"/> <input type="checkbox"/>	<input type="checkbox"/> <input type="checkbox"/>	
	30 x 48 x 60"	GSAP304860S/P	<input type="checkbox"/> <input type="checkbox"/>	<input type="checkbox"/>	<input type="checkbox"/>	<input type="checkbox"/>	<input type="checkbox"/>	<input type="checkbox"/> <input type="checkbox"/>	<input type="checkbox"/> <input type="checkbox"/>	
	30 x 48 x 66"	GSAP304866S/P	<input type="checkbox"/> <input type="checkbox"/>	<input type="checkbox"/>	<input type="checkbox"/>	<input type="checkbox"/>	<input type="checkbox"/>	<input type="checkbox"/> <input type="checkbox"/>	<input type="checkbox"/> <input type="checkbox"/>	
	30 x 48 x 72"	GSAP304872S/P	<input type="checkbox"/> <input type="checkbox"/>	<input type="checkbox"/>	<input type="checkbox"/>	<input type="checkbox"/>	<input type="checkbox"/>	<input type="checkbox"/> <input type="checkbox"/>	<input type="checkbox"/> <input type="checkbox"/>	
	30 x 48 x 84"	GSAP304884S/P	<input type="checkbox"/> <input type="checkbox"/>	<input type="checkbox"/>	<input type="checkbox"/>	<input type="checkbox"/>	<input type="checkbox"/>	<input type="checkbox"/> <input type="checkbox"/>	<input type="checkbox"/> <input type="checkbox"/>	

A B C D E F G H

HOW TO ORDER

Indicate the following information on order form:

1. Quantity of each item.
2. Model number, including options. See "How To Build a Model Number".
3. Any special service required.

Note: • The indicates that a choice is required.

- The absence of the indicates that no choice is required.
- Alpha-numeric characters in place of indicate that no other alternatives are available.

HOW TO BUILD A MODEL NUMBER

- A** Select basic model.
 - 74P - 74P edge
 - KN - Knife edge
 - MP - Membrane edge
- B** Select edge style.
 - PUN - No data
 - PUL - Left module; add \$108
 - PUR - Right module; add \$108
 - PUB - Both left and right modules; add \$218
- C** Select PowerUp module location. Select only one from the following and add the appropriate upcharge to the base price.
 - LM - LH modesty only
 - RM - RH modesty only
 - WM - Both modesty panels
 Add upcharge to unit price for "LM", "RM" and "WM" options.
- D** Select modesty panel.
 - NM - No modesty panel
 - LM - LH modesty only
 - RM - RH modesty only
 - WM - Both modesty panels
 Add upcharge to unit price for "LM", "RM" and "WM" options.

- E** Select wire trough and power option.
 - NW - No wire trough
 - WW - Wire trough
 Add upcharge to unit price for "WW" option.
- F** Select base finish. Refer to color addendum at ki.com or KI Fabrics & Finishes binder.
- G** Select edge color. Refer to color addendum at ki.com or KI Fabrics & Finishes binder. Edge color offerings are based on edge style selections. The color selection will apply to the trim, edge and PowerUp module.
- H** Select surface finish. Refer to color addendum at ki.com or KI Fabrics & Finishes binder. Surface finish offerings are based on edge style selections. Laminate finishes are only available on (74P) 74P edge and (KN) knife edge worksurfaces.

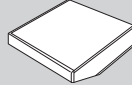
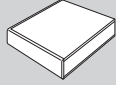

Approx. Packaged Weight	74P Edge (74P)	Knife Edge (KN)	Membrane Edge (MP)	LH Modesty Panel add to list price	RH Modesty Panel add to list price	Both Modesty Panels add to list price	Wire Trough add to list price
131.0#	\$ 1839	\$ 1910	\$ 1910	\$ 205	\$ 185	\$ 392	\$ 473
139.0#	1904	2005	2005	213	185	399	473
147.0#	1909	2040	2040	220	185	409	473
155.0#	1984	2060	2060	249	185	435	473
139.0#	1839	1910	1910	205	185	392	473
147.0#	1904	2005	2005	213	185	399	473
155.0#	1909	2040	2040	220	185	409	473
162.0#	1984	2060	2060	249	185	435	473
131.0#	\$ 1839	\$ 1910	\$ 1910	\$ 185	\$ 205	\$ 392	\$ 473
139.0#	1904	2005	2005	185	213	399	473
147.0#	1909	2040	2040	185	220	409	473
155.0#	1984	2060	2060	185	249	435	473
139.0#	1839	1910	1910	185	205	392	473
147.0#	1904	2005	2005	185	213	399	473
155.0#	1909	2040	2040	185	220	409	473
162.0#	1984	2060	2060	185	249	435	473

FINISH INFORMATION

Additional Laminate Offering

Additional laminates beyond KI standard offering, are available with two weeks extended leadtime. To specify additional laminates, use these designators followed by the supplier's color/pattern code:

Formica - LF/supplier's color pattern code
 Nevamar - LN/supplier's color pattern code
 Wilsonart - LW/supplier's color pattern code

KI's standard finish is the supplier's recommended finish for that color/pattern. Note: Nonstandard laminates from these suppliers (example: textured laminates), require an upcharge and additional leadtime. Contact KI.

SPECIAL SERVICES

Special Carton Marking

With specially marked information N/C

Shipping

Shipped k.d. freight prepaid f.o.b. Manitowoc, Wisconsin 54220 factory. Freight class #100.

Specifications and prices are subject to change without prior notice.

Genesis® Worksurfaces

Two-Legged Corner

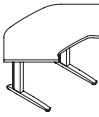
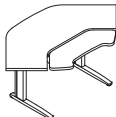
MODEL	W x H	MODEL NUMBER							Approx. Packaged Weight
		Basic Model	Edge Style	Module Location	Modesty Panel	Base Finish	Edge Color	Surface Finish	
 <p>Fixed Height</p> <ul style="list-style-type: none"> • Corner surface • Fixed height at 29" • Adjustable glides • For cross-brace specify GXBRxx (for rectangles) 	24 x 42"	GC2C2442S/F	<input type="checkbox"/>	<input type="checkbox"/>	<input type="checkbox"/>	<input type="checkbox"/>	<input type="checkbox"/>	278.0#	
	24 x 48"	GC2C2448S/F	<input type="checkbox"/>	<input type="checkbox"/>	<input type="checkbox"/>	<input type="checkbox"/>	<input type="checkbox"/>	290.0#	
	24 x 54"	GC2C2454S/F	<input type="checkbox"/>	<input type="checkbox"/>	<input type="checkbox"/>	<input type="checkbox"/>	<input type="checkbox"/>	304.0#	
	30 x 42"	GC2C3042S/F	<input type="checkbox"/>	<input type="checkbox"/>	<input type="checkbox"/>	<input type="checkbox"/>	<input type="checkbox"/>	278.0#	
	30 x 48"	GC2C3048S/F	<input type="checkbox"/>	<input type="checkbox"/>	<input type="checkbox"/>	<input type="checkbox"/>	<input type="checkbox"/>	290.0#	
	30 x 54"	GC2C3054S/F	<input type="checkbox"/>	<input type="checkbox"/>	<input type="checkbox"/>	<input type="checkbox"/>	<input type="checkbox"/>	304.0#	
 <p>Fixed Height Dual</p> <ul style="list-style-type: none"> • Corner surface • Fixed height at 29" • Adjustable glides • Keyboard surface adjusts 5" above/below primary surface. • Keyboard surface tilts +/- 15° • For cross-brace specify GXBRxx (for rectangles) 	30 x 48"	GC2C3048D/F	<input type="checkbox"/>	PUN	<input type="checkbox"/>	<input type="checkbox"/>	<input type="checkbox"/>	290.0#	
	30 x 54"	GC2C3054D/F	<input type="checkbox"/>	PUN	<input type="checkbox"/>	<input type="checkbox"/>	<input type="checkbox"/>	304.0#	

A **B** **C** **D** **E** **F** **G**

HOW TO ORDER

Indicate the following information on order form:

1. Quantity of each item.
2. Model number, including options. See "How To Build a Model Number".
3. Any special service required.

Note: • The indicates that a choice is required.
 • The absence of the indicates that no choice is required.
 • Alpha-numeric characters in place of indicate that no other alternatives are available.

HOW TO BUILD A MODEL NUMBER

- A** Select basic model.
- B** Select edge style.

74P	- 74P edge
KN	- Knife edge
MP	- Membrane edge
- C** Select PowerUp module location. Select only one from the following and add the appropriate upcharge to the base price.

PUN	- No data
PUL	- Left module; add \$108
PUR	- Right module; add \$108
PUB	- Both left and right modules; add \$218
- D** Select modesty panel.

NM	- No modesty panel
WM	- With modesty panel

 Add upcharge to unit price for "WM" option.
- E** Select base finish.

Refer to color addendum at ki.com or KI Fabrics & Finishes binder.

- F** Select edge color. Refer to color addendum at ki.com or KI Fabrics & Finishes binder. Edge color offerings are based on edge style selections. The color selection will apply to the trim, edge and PowerUp module.
- G** Select surface finish. Refer to color addendum at ki.com or KI Fabrics & Finishes binder. Surface finish offerings are based on edge style selections. Laminate finishes are only available on (74P) 74P edge and (KN) knife edge worksurfaces.

FINISH INFORMATION

Additional Laminate Offering

Additional laminates beyond KI standard offering, are available with two weeks extended leadtime. To specify additional laminates, use these designators followed by the supplier's color/pattern code:

Formica - LF/supplier's color pattern code
 Nevamar - LN/supplier's color pattern code
 Wilsonart - LW/supplier's color pattern code

KI's standard finish is the supplier's recommended finish for that color/pattern. Note: Nonstandard laminates from these suppliers (example: textured laminates), require an upcharge and additional leadtime. Contact KI.

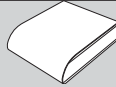
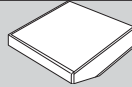
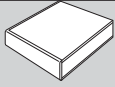

74P Edge (74P)	Knife Edge (KN)	Membrane Edge (MP)	Modesty Panel add to list price
\$ 1035	\$ 1160	\$ 1160	\$ 353
1102	1229	1229	369
1250	1343	1343	387
1077	1210	1210	353
1148	1278	1278	369
1290	1343	1343	387
\$ 2011	\$ 2185	\$ 2185	\$ 369
2162	2253	2253	387

SPECIAL SERVICES

Special Carton Marking

With specially marked information N/C

Shipping

Shipped **k.d. freight prepaid f.o.b. Manitowoc, Wisconsin 54220** factory.
Freight class #100.

Specifications and prices are subject to change without prior notice.

Genesis® Worksurfaces

Two-Legged Corner

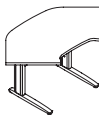
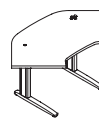
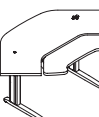
	MODEL	W x H	MODEL NUMBER							Approx. Packaged Weight
			Basic Model	Edge Style	Module Location	Modesty Panel	Base Finish	Edge Color	Surface Finish	
 <p>GC2C</p>	Pin Height Adjustable • Corner surface with conferencing end • Height adjusts from 24"-31" in 1" increments • Adjustable glides • Wire trough and modesty panel should not be ordered together on adjustable tables	24 x 42"	GC2C2442S/P	<input type="checkbox"/>	<input type="checkbox"/>	<input type="checkbox"/>	<input type="checkbox"/>	<input type="checkbox"/>	<input type="checkbox"/>	76.0#
		24 x 48"	GC2C2448S/P	<input type="checkbox"/>	<input type="checkbox"/>	<input type="checkbox"/>	<input type="checkbox"/>	<input type="checkbox"/>	<input type="checkbox"/>	97.0#
		24 x 54"	GC2C2454S/P	<input type="checkbox"/>	<input type="checkbox"/>	<input type="checkbox"/>	<input type="checkbox"/>	<input type="checkbox"/>	<input type="checkbox"/>	120.0#
		30 x 42"	GC2C3042S/P	<input type="checkbox"/>	<input type="checkbox"/>	<input type="checkbox"/>	<input type="checkbox"/>	<input type="checkbox"/>	<input type="checkbox"/>	81.0#
		30 x 48"	GC2C3048S/P	<input type="checkbox"/>	<input type="checkbox"/>	<input type="checkbox"/>	<input type="checkbox"/>	<input type="checkbox"/>	<input type="checkbox"/>	102.0#
		30 x 54"	GC2C3054S/P	<input type="checkbox"/>	<input type="checkbox"/>	<input type="checkbox"/>	<input type="checkbox"/>	<input type="checkbox"/>	<input type="checkbox"/>	125.0#
 <p>GC2C</p>	Crank Height Adjustable • Corner surface with conferencing end • Height adjusts from 22"-33" • Adjustable glides • Worksurfaces are undersized by 1/4" from side-to-side and 1/4" from back-to-front from the stated dimensions • Wire trough and modesty panel should not be ordered together on adjustable tables	24 x 42"	GC2C2442S/CR	<input type="checkbox"/>	<input type="checkbox"/>	<input type="checkbox"/>	<input type="checkbox"/>	<input type="checkbox"/>	<input type="checkbox"/>	80.0#
		24 x 48"	GC2C2448S/CR	<input type="checkbox"/>	<input type="checkbox"/>	<input type="checkbox"/>	<input type="checkbox"/>	<input type="checkbox"/>	<input type="checkbox"/>	101.0#
		24 x 54"	GC2C2454S/CR	<input type="checkbox"/>	<input type="checkbox"/>	<input type="checkbox"/>	<input type="checkbox"/>	<input type="checkbox"/>	<input type="checkbox"/>	124.0#
		30 x 42"	GC2C3042S/CR	<input type="checkbox"/>	<input type="checkbox"/>	<input type="checkbox"/>	<input type="checkbox"/>	<input type="checkbox"/>	<input type="checkbox"/>	85.0#
		30 x 48"	GC2C3048S/CR	<input type="checkbox"/>	<input type="checkbox"/>	<input type="checkbox"/>	<input type="checkbox"/>	<input type="checkbox"/>	<input type="checkbox"/>	106.0#
		30 x 54"	GC2C3054S/CR	<input type="checkbox"/>	<input type="checkbox"/>	<input type="checkbox"/>	<input type="checkbox"/>	<input type="checkbox"/>	<input type="checkbox"/>	129.0#
 <p>GC2C</p>	Crank Height Dual • Corner surface with conferencing end • Height adjusts from 22"-33" • Adjustable glides • Keyboard surface adjusts 5" above/below primary surface. • Keyboard surface tilts +/- 15° • Worksurfaces are undersized by 1/4" from side-to-side and 1/4" from back-to-front from the stated dimensions • Wire trough and modesty panel should not be ordered together on adjustable tables	30 x 48"	GC2C3048D/CR	<input type="checkbox"/>	PUN	<input type="checkbox"/>	<input type="checkbox"/>	<input type="checkbox"/>	<input type="checkbox"/>	126.0#
		30 x 54"	GC2C3054D/CR	<input type="checkbox"/>	PUN	<input type="checkbox"/>	<input type="checkbox"/>	<input type="checkbox"/>	<input type="checkbox"/>	149.0#

A **B** **C** **D** **E** **F** **G**

HOW TO ORDER

Indicate the following information on order form:

- Quantity of each item.
- Model number, including options. See "How To Build a Model Number".
- Any special service required.

Note: • The indicates that a choice is required.

- The absence of the indicates that no choice is required.
- Alpha-numeric characters in place of indicate that no other alternatives are available.

HOW TO BUILD A MODEL NUMBER

- A** Select basic model.
 - 74P - 74P edge
 - KN - Knife edge
 - MP - Membrane edge
- B** Select edge style.
 - PUN - No data
 - PUL - Left module; add \$108
 - PUR - Right module; add \$108
 - PUB - Both left and right modules; add \$218
- C** Select PowerUp module location. Select only one from the following and add the appropriate upcharge to the base price.
 - PUN - No data
 - PUL - Left module; add \$108
 - PUR - Right module; add \$108
 - PUB - Both left and right modules; add \$218
- D** Select modesty panel.
 - NM - No modesty panel
 - WM - With modesty panel
 Add upcharge to unit price "WM" option.
- E** Select base finish. Refer to color addendum at ki.com or KI

Fabrics & Finishes binder.

- F** Select edge color. Refer to color addendum at ki.com or KI Fabrics & Finishes binder. Edge color offerings are based on edge style selections. The color selection will apply to the trim, edge and PowerUp module.
- G** Select surface finish. Refer to color addendum at ki.com or KI Fabrics & Finishes binder. Surface finish offerings are based on edge style selections. Laminate finishes are only available on (74P) 74P edge and (KN) knife edge worksurfaces.

FINISH INFORMATION

Additional Laminate Offering

Additional laminates beyond KI standard offering, are available with two weeks extended leadtime. To specify additional laminates, use these designators followed by the supplier's color/pattern code:

Formica - LF/supplier's color pattern code
 Nevamar - LN/supplier's color pattern code
 Wilsonart - LW/supplier's color pattern code

KI's standard finish is the supplier's recommended finish for that color/pattern. Note: Nonstandard laminates from these suppliers (example: textured laminates), require an upcharge and additional leadtime. Contact KI.



Genesis® Worksurfaces

Two-Legged Corner

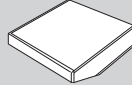
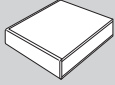

74P Edge (74P)	Knife Edge (KN)	Membrane Edge (MP)	Modesty Panel add to list price
\$ 1158	\$ 1282	\$ 1282	\$ 353
1226	1349	1349	369
1373	1465	1465	387
1203	1335	1335	353
1272	1403	1403	369
1377	1469	1469	387
\$ 1405	\$ 1529	\$ 1529	\$ 353
1469	1593	1593	369
1618	1707	1707	387
1448	1580	1580	353
1516	1645	1645	369
1622	1712	1712	387
\$ 2377	\$ 2551	\$ 2551	\$ 369
2527	2619	2619	387

SPECIAL SERVICES

Special Carton Marking

With specially marked information N/C



Shipping

Shipped **k.d. freight prepaid f.o.b. Manitowoc, Wisconsin 54220** factory.
Freight class #100.

Specifications and prices are subject to change without prior notice.

Genesis® Worksurfaces

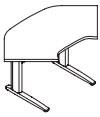
Two-Legged Corner

		MODEL NUMBER								
MODEL		W x H	Basic Model	Edge Style	Electrical Control	Module Location	Modesty Panel	Base Finish	Edge Color	Surface Finish
 <p>GC2E</p>	Electric Height Adjustable Single • Corner surface with conferencing end • Height adjusts from 24"-51" • Standard or deluxe up/down switch • Adjustable glides • Worksurfaces are undersized by 1-1/4" from side-to-side and 1/2" from back-to-front from the stated dimensions • Wire trough and modesty panel should not be ordered together on adjustable tables	24 x 42"	GC2E2442S	<input type="checkbox"/> <input type="checkbox"/> <input type="checkbox"/>	<input type="checkbox"/>	<input type="checkbox"/> <input type="checkbox"/> <input type="checkbox"/>	<input type="checkbox"/>	<input type="checkbox"/>	<input type="checkbox"/> <input type="checkbox"/> <input type="checkbox"/>	<input type="checkbox"/> <input type="checkbox"/> <input type="checkbox"/>
		24 x 48"	GC2E2448S	<input type="checkbox"/> <input type="checkbox"/> <input type="checkbox"/>	<input type="checkbox"/>	<input type="checkbox"/> <input type="checkbox"/> <input type="checkbox"/>	<input type="checkbox"/>	<input type="checkbox"/>	<input type="checkbox"/> <input type="checkbox"/> <input type="checkbox"/>	<input type="checkbox"/> <input type="checkbox"/> <input type="checkbox"/>
		24 x 54"	GC2E2454S	<input type="checkbox"/> <input type="checkbox"/> <input type="checkbox"/>	<input type="checkbox"/>	<input type="checkbox"/> <input type="checkbox"/> <input type="checkbox"/>	<input type="checkbox"/>	<input type="checkbox"/>	<input type="checkbox"/> <input type="checkbox"/> <input type="checkbox"/>	<input type="checkbox"/> <input type="checkbox"/> <input type="checkbox"/>
		30 x 48"	GC2E3048S	<input type="checkbox"/> <input type="checkbox"/> <input type="checkbox"/>	<input type="checkbox"/>	<input type="checkbox"/> <input type="checkbox"/> <input type="checkbox"/>	<input type="checkbox"/>	<input type="checkbox"/>	<input type="checkbox"/> <input type="checkbox"/> <input type="checkbox"/>	<input type="checkbox"/> <input type="checkbox"/> <input type="checkbox"/>
		30 x 54"	GC2E3054S	<input type="checkbox"/> <input type="checkbox"/> <input type="checkbox"/>	<input type="checkbox"/>	<input type="checkbox"/> <input type="checkbox"/> <input type="checkbox"/>	<input type="checkbox"/>	<input type="checkbox"/>	<input type="checkbox"/> <input type="checkbox"/> <input type="checkbox"/>	<input type="checkbox"/> <input type="checkbox"/> <input type="checkbox"/>
 <p>GC2E</p>	Electric Height Adjustable Dual • Corner surface with conferencing end • Height adjusts from 24"-51" • Standard or deluxe up/down switch • Keyboard surface adjusts 5" above/below primary surface. • Keyboard surface tilts +/- 15° • Adjustable glides • Worksurfaces are undersized by 1-1/4" from side-to-side and 1/2" from back-to-front from the stated dimensions • Wire trough and modesty panel should not be ordered together on adjustable tables	30 x 48"	GC2E3048D	<input type="checkbox"/> <input type="checkbox"/> <input type="checkbox"/>	<input type="checkbox"/>	PUN	<input type="checkbox"/>	<input type="checkbox"/>	<input type="checkbox"/> <input type="checkbox"/> <input type="checkbox"/>	
		30 x 54"	GC2E3054D	<input type="checkbox"/> <input type="checkbox"/> <input type="checkbox"/>	<input type="checkbox"/>	PUN	<input type="checkbox"/>	<input type="checkbox"/>	<input type="checkbox"/> <input type="checkbox"/> <input type="checkbox"/>	
			A	B	C	D	E	F	G	H

HOW TO ORDER

Indicate the following information on order form:

- Quantity of each item.
- Model number, including options. See "How To Build a Model Number".
- Any special service required.

Note: • The indicates that a choice is required.
 • The absence of the indicates that no choice is required.
 • Alpha-numeric characters in place of indicate that no other alternatives are available.

HOW TO BUILD A MODEL NUMBER

- A** Select basic model.
- B** Select edge style.
 74P - 74P edge
 KN - Knife edge
 MP - Membrane edge
- C** Select electric control style.
 S - Standard up/down switch
 D - Deluxe up/down switch; add \$112
- D** Select PowerUp module location.
 Select only one from the following and add the appropriate upcharge to the base price.
 PUN - No data
 PUL - Left module; add \$108
 PUR - Right module; add \$108
 PUB - Both left and right modules; add \$218
- E** Select modesty panel option.
 NM - No modesty panel

WM - With modesty panel
 Add upcharge to unit price for "WM" option.

- F** Select base finish.
 Refer to color addendum at ki.com or KI Fabrics & Finishes binder.
- G** Select edge color.
 Refer to color addendum at ki.com or KI Fabrics & Finishes binder.
 Edge color offerings are based on edge style selections. The color selection will apply to the trim, edge and PowerUp module.
- H** Select surface finish.
 Refer to color addendum at ki.com or KI Fabrics & Finishes binder.
 Surface finish offerings are based on edge style selections. Laminate finishes are only available on (74P) 74P edge and (KN) knife edge worksurfaces.

FINISH INFORMATION

Additional Laminate Offering

Additional laminates beyond KI standard offering, are available with two weeks extended leadtime. To specify additional laminates, use these designators followed by the supplier's color/pattern code:

Formica - LF/supplier's color pattern code
 Nevamar - LN/supplier's color pattern code
 Wilsonart - LW/supplier's color pattern code

KI's standard finish is the supplier's recommended finish for that color/pattern. Note: Nonstandard laminates from these suppliers (example: textured laminates), require an upcharge and additional leadtime. Contact KI.



Genesis® Worksurfaces

Two-Legged Corner

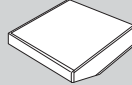
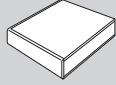

Approx. Packaged Weight	74P Edge (74P)	Knife Edge (KN)	Membrane Edge (MP)	Modesty Panel add to list price
102.0#	\$ 2555	\$ 2675	\$ 2675	\$ 353
123.0#	2621	2744	2744	369
146.0#	2653	2748	2748	387
123.0#	2621	2791	2791	369
146.0#	2789	2795	2795	387
143.0#	\$ 3529	\$ 3699	\$ 3699	\$ 369
166.0#	3537	3703	3703	387

SPECIAL SERVICES

Special Carton Marking

With specially marked information N/C

Shipping

Shipped k.d. freight prepaid f.o.b. Manitowoc, Wisconsin 54220 factory. Freight class #100.

Specifications and prices are subject to change without prior notice.

Balance® Storage Accessories

Overhead Storage

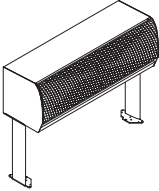
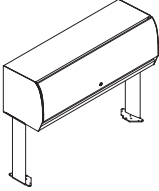
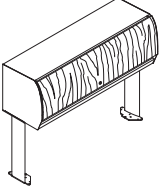
MODEL	W	MODEL NUMBER							
		Basic Model	Cabinet Paint Color	Fabric Color	Upper Door Solid Color	Upper Door Laminate	Laminate Door Edge Color	Lock Option	
 <p>Balance® Overhead Cabinet-Fabric Upper Door</p> <ul style="list-style-type: none"> Fabric covered upper door Painted cabinet and lower door Shelf dividers available separately Cabinet is fully assembled Door stores above top of cabinet 	30"	BLCF30/GB0	<input type="checkbox"/>	<input type="checkbox"/> <input type="checkbox"/> <input type="checkbox"/> <input type="checkbox"/>				<input type="checkbox"/> <input type="checkbox"/>	
	36"	BLCF36/GB0	<input type="checkbox"/>	<input type="checkbox"/> <input type="checkbox"/> <input type="checkbox"/> <input type="checkbox"/>				<input type="checkbox"/> <input type="checkbox"/>	
	42"	BLCF42/GB0	<input type="checkbox"/>	<input type="checkbox"/> <input type="checkbox"/> <input type="checkbox"/> <input type="checkbox"/>				<input type="checkbox"/> <input type="checkbox"/>	
	48"	BLCF48/GB0	<input type="checkbox"/>	<input type="checkbox"/> <input type="checkbox"/> <input type="checkbox"/> <input type="checkbox"/>				<input type="checkbox"/> <input type="checkbox"/>	
	54"	BLCF54/GB0	<input type="checkbox"/>	<input type="checkbox"/> <input type="checkbox"/> <input type="checkbox"/> <input type="checkbox"/>				<input type="checkbox"/> <input type="checkbox"/>	
	60"	BLCF60/GB0	<input type="checkbox"/>	<input type="checkbox"/> <input type="checkbox"/> <input type="checkbox"/> <input type="checkbox"/>				<input type="checkbox"/> <input type="checkbox"/>	
BOH									
 <p>Balance® Overhead Cabinet-Solid Color Upper Door</p> <ul style="list-style-type: none"> Colored or translucent extruded polypropylene door Painted cabinet and lower door Shelf dividers available separately Cabinet is fully assembled Door stores above top of cabinet 	30"	B LCS30/GB0	<input type="checkbox"/>		<input type="checkbox"/> <input type="checkbox"/>			<input type="checkbox"/> <input type="checkbox"/>	
	36"	B LCS36/GB0	<input type="checkbox"/>		<input type="checkbox"/> <input type="checkbox"/>			<input type="checkbox"/> <input type="checkbox"/>	
	42"	B LCS42/GB0	<input type="checkbox"/>		<input type="checkbox"/> <input type="checkbox"/>			<input type="checkbox"/> <input type="checkbox"/>	
	48"	B LCS48/GB0	<input type="checkbox"/>		<input type="checkbox"/> <input type="checkbox"/>			<input type="checkbox"/> <input type="checkbox"/>	
	54"	B LCS54/GB0	<input type="checkbox"/>		<input type="checkbox"/> <input type="checkbox"/>			<input type="checkbox"/> <input type="checkbox"/>	
	60"	B LCS60/GB0	<input type="checkbox"/>		<input type="checkbox"/> <input type="checkbox"/>			<input type="checkbox"/> <input type="checkbox"/>	
BOH									
 <p>Balance® Overhead Cabinet Laminated Upper Door</p> <ul style="list-style-type: none"> Laminate covered upper door Painted cabinet and lower door Shelf dividers available separately Cabinet is fully assembled Door stores above top of cabinet 	30"	B LCL30/GB0	<input type="checkbox"/>			<input type="checkbox"/> <input type="checkbox"/>	<input type="checkbox"/> <input type="checkbox"/>	<input type="checkbox"/> <input type="checkbox"/>	
	36"	B LCL36/GB0	<input type="checkbox"/>			<input type="checkbox"/> <input type="checkbox"/>	<input type="checkbox"/> <input type="checkbox"/>	<input type="checkbox"/> <input type="checkbox"/>	
	42"	B LCL42/GB0	<input type="checkbox"/>			<input type="checkbox"/> <input type="checkbox"/>	<input type="checkbox"/> <input type="checkbox"/>	<input type="checkbox"/> <input type="checkbox"/>	
	48"	B LCL48/GB0	<input type="checkbox"/>			<input type="checkbox"/> <input type="checkbox"/>	<input type="checkbox"/> <input type="checkbox"/>	<input type="checkbox"/> <input type="checkbox"/>	
	54"	B LCL54/GB0	<input type="checkbox"/>			<input type="checkbox"/> <input type="checkbox"/>	<input type="checkbox"/> <input type="checkbox"/>	<input type="checkbox"/> <input type="checkbox"/>	
	60"	B LCL60/GB0	<input type="checkbox"/>			<input type="checkbox"/> <input type="checkbox"/>	<input type="checkbox"/> <input type="checkbox"/>	<input type="checkbox"/> <input type="checkbox"/>	
BOH									
			A	B	C	D	E	F	G

HOW TO ORDER

Indicate the following information on order form:

- Quantity of each item.
- Model number, including options. See "How To Build a Model Number".
- Any special service required.

Note: • The indicates that a choice is required.

- The absence of the indicates that no choice is required.
- Alpha-numeric characters in place of indicate that no other alternatives are available.

HOW TO BUILD A MODEL NUMBER

- A** Select basic model.
- B** Select cabinet paint color.
Refer to color addendum at ki.com or KI Fabrics & Finishes binder.
- C** Select upper door fabric.
Refer to Vertical Fabric Pricing Addendum.
- D** Select upper door solid color.
Refer to color addendum at ki.com or KI Fabrics & Finishes binder.
- E** Select upper door laminate color.
Refer to color addendum at ki.com or KI Fabrics & Finishes binder.
- F** Select laminate door edge color.
Refer to color addendum at ki.com or KI Fabrics & Finishes binder.
- G** Select lock option.
KA - Key alike

- NLC** - No Lock Core
- KS** - Key standard



Balance® Storage Accessories

Overhead Storage

Approx. Packaged Weight	<attrib a="167" l="10" o="685181" p="875884" s="94" status="1"/>	Delivered Pricing Fabric Grade 1 & C.O.M.	Delivered Pricing Fabric Grade 2	Delivered Pricing Fabric Grade 3 & Pallas Vertical Fabric Grade PV	Delivered Pricing Pallas Vertical Fabric Grade PV1	Delivered Pricing Pallas Vertical Fabric Grade PV2
50.0#	N/A	\$ 1324	\$ 1334	\$ 1350	\$ 1372	\$ 1391
56.0#	N/A	1350	1359	1381	1402	1420
62.0#	N/A	1380	1388	1411	1430	1452
68.0#	N/A	1443	1454	1474	1498	1519
74.0#	N/A	1543	1553	1579	1600	1626
80.0#	N/A	1560	1570	1594	1621	1645

50.0#	\$ 1234
56.0#	1261
62.0#	1289
68.0#	1351
74.0#	1435
80.0#	1454

50.0#	\$ 1463
56.0#	1516
62.0#	1572
68.0#	1646
74.0#	1781
80.0#	1809

SPECIAL SERVICES

Special Carton Marking

With specially marked information N/C

Shipping

Shipped **assembled freight prepaid f.o.b. Manitowoc, Wisconsin 54220** factory. Freight class #77.5

Specifications and prices are subject to change without prior notice.

Balance® Storage and Accessories

Balance® Task Lights

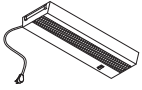
MODEL	W	MODEL NUMBER		Approx. Packaged Weight
			Basic Model	
 <p>Balance® Task Lights • Electronic ballast</p>	24"		BTLT5.24	3.9#
	36"		BTLT5.36	5.3#
	48"		BTLT5.48	6.7#

HRDPT

A

HOW TO ORDER

Indicate the following information on order form:

1. Quantity of each item.
2. Model number, including options. See "How To Build a Model Number".
3. Any special service required.

Note: • The indicates that a choice is required.

- The absence of the indicates that no choice is required.
- Alpha-numeric characters in place of indicate that no other alternatives are available.

HOW TO BUILD A MODEL NUMBER

A Select basic model.

INFORMATION

TASK LIGHT CABINET WIDTH

Cabinet Width	Light Width
24"	18"
30"	24"
36"	24"
42"	36"
48"	36"
54"	48"
60"	48"
66"	(2)24"
72"	(2)24"



Balance® Storage and Accessories

Balance® Task Lights

Delivered
Pricing

\$ 102

112

117

SPECIAL SERVICES

Special Carton Marking

With specially marked information N/C

Shipping

Shipped **assembled freight prepaid f.o.b. Manitowoc, Wisconsin 54220** factory.
Freight class #100.

Specifications and prices are subject to change without prior notice.

Universal Storage Accessories

Overhead Storage

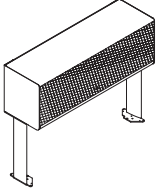
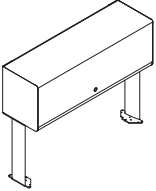
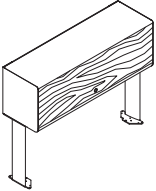
MODEL	W	MODEL NUMBER						Approx. Packaged Weight
		Basic Model	Assembly	Paint Color	Fabric Color	Laminate Color	Lock Option	
 <p>Universal - Fabric Door Overhead Cabinet</p> <ul style="list-style-type: none"> Steel end panels, bottom and top shelf with powder-coated finish Fabric-covered door 	30"	GUOF30	<input type="checkbox"/>	<input type="checkbox"/>	<input type="checkbox"/>		<input type="checkbox"/>	39.0#
	36"	GUOF36	<input type="checkbox"/>	<input type="checkbox"/>	<input type="checkbox"/>		<input type="checkbox"/>	45.0#
	42"	GUOF42	<input type="checkbox"/>		<input type="checkbox"/>		<input type="checkbox"/>	51.0#
	48"	GUOF48	<input type="checkbox"/>	<input type="checkbox"/>	<input type="checkbox"/>		<input type="checkbox"/>	57.0#
	54"	GUOF54	<input type="checkbox"/>	<input type="checkbox"/>	<input type="checkbox"/>		<input type="checkbox"/>	63.0#
	60"	GUOF60	<input type="checkbox"/>	<input type="checkbox"/>	<input type="checkbox"/>		<input type="checkbox"/>	69.0#
GUOF								
 <p>Universal - Steel Door Overhead Cabinet</p> <ul style="list-style-type: none"> Steel end panels, bottom, top shelf, and door with powder-coated finish 	30"	GUOS30	<input type="checkbox"/>	<input type="checkbox"/>			<input type="checkbox"/>	39.0#
	36"	GUOS36	<input type="checkbox"/>	<input type="checkbox"/>			<input type="checkbox"/>	45.0#
	42"	GUOS42	<input type="checkbox"/>	<input type="checkbox"/>			<input type="checkbox"/>	51.0#
	48"	GUOS48	<input type="checkbox"/>	<input type="checkbox"/>			<input type="checkbox"/>	57.0#
	54"	GUOS54	<input type="checkbox"/>	<input type="checkbox"/>			<input type="checkbox"/>	63.0#
	60"	GUOS60	<input type="checkbox"/>	<input type="checkbox"/>			<input type="checkbox"/>	69.0#
GUOS								
 <p>Universal - Laminate Door Overhead Cabinet</p> <ul style="list-style-type: none"> Steel end panels, bottom and top shelf with powder-coated finish High-pressure laminate on particleboard door 	30"	GUOL30	<input type="checkbox"/>	<input type="checkbox"/>		<input type="checkbox"/>	<input type="checkbox"/>	39.0#
	36"	GUOL36	<input type="checkbox"/>	<input type="checkbox"/>		<input type="checkbox"/>	<input type="checkbox"/>	45.0#
	42"	GUOL42	<input type="checkbox"/>	<input type="checkbox"/>		<input type="checkbox"/>	<input type="checkbox"/>	51.0#
	48"	GUOL48	<input type="checkbox"/>	<input type="checkbox"/>		<input type="checkbox"/>	<input type="checkbox"/>	57.0#
	54"	GUOL54	<input type="checkbox"/>	<input type="checkbox"/>		<input type="checkbox"/>	<input type="checkbox"/>	63.0#
	60"	GUOL60	<input type="checkbox"/>	<input type="checkbox"/>		<input type="checkbox"/>	<input type="checkbox"/>	69.0#
GUOL								
			A	B	C	D	E	F

HOW TO ORDER

Indicate the following information on order form:

- Quantity of each item.
- Model number, including options. See "How To Build a Model Number".
- Any special service required.

Note:

- The indicates that a choice is required.
- The absence of the indicates that no choice is required.
- Alpha-numeric characters in place of indicate that no other alternatives are available.

HOW TO BUILD A MODEL NUMBER

- A** Select basic model.
- B** Select assembly.

F	- Fully Assembled; add \$129
U	- Unassembled
- C** Select paint color. Refer to color addendum at ki.com or KI Fabrics & Finishes binder.
- D** Select fabric color. Refer to Vertical Fabric Pricing Addendum.
- E** Select laminate color. Refer to color addendum at ki.com or KI Fabrics & Finishes binder.
- F** Select lock option.

KA	- Key alike
NLC	- No Lock Core
KS	- Key standard



Universal Storage Accessories

Overhead Storage

Delivered Pricing	Delivered Pricing Fabric Grade 1 & C.O.M.	Delivered Pricing Fabric Grade 2	Delivered Pricing Fabric Grade 3 & Pallas Vertical Fabric Grade PV	Delivered Pricing Pallas Vertical Fabric Grade PV1	Delivered Pricing Pallas Vertical Fabric Grade PV2
N/A	\$ 889	\$ 897	\$ 919	\$ 934	\$ 953
N/A	918	925	942	961	981
N/A	935	946	964	983	1003
N/A	961	971	989	1010	1028
N/A	1074	1088	1106	1129	1152
N/A	1124	1133	1157	1179	1201
<hr/>					
\$ 828					
848					
874					
935					
992					
1040					
<hr/>					
\$ 882					
921					
957					
991					
1091					
1141					

SPECIAL SERVICES

Special Carton Marking

With specially marked information N/C

Shipping

Delivered. Shipped **k.d. freight prepaid f.o.b. Manitowoc, Wisconsin 54220** factory. Freight class #70.

Specifications and prices are subject to change without prior notice.

Universal Storage and Accessories

Universal Task Lights

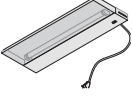
	MODEL	W	MODEL NUMBER	Approx. Packaged Weight
			Basic Model	
	Universal Task Lights • Electronic ballast	24"	TLT5.24	3.9#
		36"	TLT5.36	5.3#
		48"	TLT5.48	6.7#

HRDPT

A

HOW TO ORDER

Indicate the following information on order form:

1. Quantity of each item.
2. Model number, including options. See "How To Build a Model Number".
3. Any special service required.

Note:

- The indicates that a choice is required.
- The absence of the indicates that no choice is required.
- Alpha-numeric characters in place of indicate that no other alternatives are available.

HOW TO BUILD A MODEL NUMBER

A Select basic model.



Universal Storage and Accessories

Universal Task Lights

Delivered
Pricing

\$ 76
83
91

SPECIAL SERVICES

Special Carton Marking

With specially marked information N/C



Shipping

Shipped **k.d. freight prepaid f.o.b. Manitowoc, Wisconsin 54220** factory.
Freight class #100.

Specifications and prices are subject to change without prior notice.

Universal Storage and Accessories

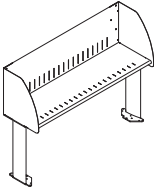
Overhead Shelf/Tool Rail Kits

	MODEL	W x H	MODEL NUMBER		Approx. Packaged Weight
			Basic Model	Paint Color	
 <p>GUSS</p>	Shelf Kits <ul style="list-style-type: none"> • Powder-coated steel end panels and bottom shelf • Accepts shelf dividers • Field installable to compatible Genesis® surfaces 	30"	GUSS30	<input type="checkbox"/>	23.0#
		36"	GUSS36	<input type="checkbox"/>	29.0#
		42"	GUSS42	<input type="checkbox"/>	35.0#
		48"	GUSS48	<input type="checkbox"/>	41.0#
		54"	GUSS54	<input type="checkbox"/>	47.0#
		60"	GUSS60	<input type="checkbox"/>	53.0#
 <p>GTBS</p>	Tool Rail Kits <ul style="list-style-type: none"> • Accommodates paper management components • Attaches between overhead uprights • Field installable 	30"	GTBS30	<input type="checkbox"/>	3.0#
		36"	GTBS36	<input type="checkbox"/>	4.0#
		42"	GTBS42	<input type="checkbox"/>	4.0#
		48"	GTBS48	<input type="checkbox"/>	5.0#
		54"	GTBS54	<input type="checkbox"/>	6.0#
		60"	GTBS60	<input type="checkbox"/>	6.0#
 <p>HRDPT</p>	Shelf Divider <ul style="list-style-type: none"> • Steel shelf dividers with powder-coated finish • Fits shelves and overheads 	7-1/4 x 11-1/2"	NSD	<input type="checkbox"/>	1.0#

A

B

HOW TO ORDER

Indicate the following information on order form:

1. Quantity of each item.
2. Model number, including options. See "How To Build a Model Number".
3. Any special service required.

Note: • The indicates that a choice is required.

- The absence of the indicates that no choice is required.
- Alpha-numeric characters in place of indicate that no other alternatives are available.

HOW TO BUILD A MODEL NUMBER

- A** Select basic model.
- B** Select paint color.
Refer to color addendum at ki.com or KI Fabrics & Finishes binder.



Universal Storage and Accessories

Overhead Shelf/Tool Rail Kits

Delivered
Pricing

\$ 584
595
607
617
646
663

\$ 117
123
129
137
156
174
\$ 26

SPECIAL SERVICES

Special Carton Marking

With specially marked information N/C

Shipping

Delivered. Shipped **k.d. freight prepaid**
f.o.b. Manitowoc, Wisconsin 54220
factory. Freight class #70.

Specifications and prices are subject to
change without prior notice.

Storage Accessories

Paper Management

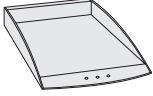
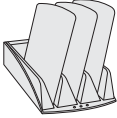
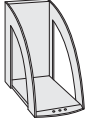
	MODEL	H x W x D	MODEL NUMBER		Approx. Packaged Weight
			Basic Model	Trim Color	
 HRDPT	Paper Tray <ul style="list-style-type: none"> • Plastic construction • Stores letter or legal size documents • Suspends from tool rail • Suitable for free-standing worksurface or overhead location 	2 x 9-1/2 x 14"	PLL	<input type="checkbox"/> <input type="checkbox"/>	1.0#
 HRDPT	Diagonal Storage <ul style="list-style-type: none"> • Plastic construction • Suspends only from tool rail • Suitable for free-standing Worksurface or overhead location • Three slanted partitions per unit • Dividers in black only 	2-1/2 x 7 x 12-1/2"	PDS	<input type="checkbox"/> <input type="checkbox"/>	4.0#
 HRDPT	Vertical Storage <ul style="list-style-type: none"> • Injection molded plastic construction • Suspends only from tool rail • Suitable for free-standing worksurface or overhead location • Stores binder, phone books or periodicals 	9 x 5 x 10-1/2"	PVS	<input type="checkbox"/> <input type="checkbox"/>	1.0#

A

B

HOW TO ORDER

Indicate the following information on order form:

1. Quantity of each item.
2. Model number, including options. See "How To Build a Model Number".
3. Any special service required.

- Note:
- The indicates that a choice is required.
 - The absence of the indicates that no choice is required.
 - Alpha-numeric characters in place of indicate that no other alternatives are available.

HOW TO BUILD A MODEL NUMBER

- A** Select basic model.
- B** Select trim color.
Refer to color addendum at ki.com or KI Fabrics & Finishes binder.



Delivered
Pricing

\$ 38

\$ 38

\$ 36

SPECIAL SERVICES

Special Carton Marking

With specially marked information N/C



Shipping

Delivered. Shipped **k.d. freight prepaid f.o.b. Manitowoc, Wisconsin 54220** factory. Freight class #70.

Specifications and prices are subject to change without prior notice.

Storage Accessories

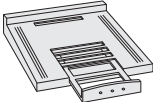
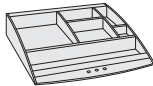
Paper Management

	MODEL	H x W x D	MODEL NUMBER		Approx. Packaged Weight
			Basic Model	Trim Color	
 HRDPT	Telephone Caddy • Plastic construction • Holds telephone up to 8-1/2" wide and 9-1/2" deep • Suspends from tool rail	2 x 8-1/2 x 9-1/2"	PTC	<input type="checkbox"/>	1.0#
 HRDPT	Accessory Tray • Injection molded plastic • Stores stamps, tape dispenser, post-it pads and paper clips • Suspends from tool rail	2 x 9-1/2 x 10"	PAT	<input type="checkbox"/>	6.0#
 HRDPT	Pencil Cup • Injection molded plastic • Suspends from tool rail	4 x 4 x 3-1/2"	PPC	<input type="checkbox"/>	1.0#

A

B

HOW TO ORDER

Indicate the following information on order form:

- Quantity of each item.
- Model number, including options. See "How To Build a Model Number".
- Any special service required.

Note: • The indicates that a choice is required.

- The absence of the indicates that no choice is required.
- Alpha-numeric characters in place of indicate that no other alternatives are available.

HOW TO BUILD A MODEL NUMBER

A Select basic model.

B Select trim color.
Refer to color addendum at ki.com or KI Fabrics & Finishes binder.



Delivered
Pricing

\$ 46

\$ 32

\$ 32

SPECIAL SERVICES

Special Carton Marking

With specially marked information N/C

Shipping

Delivered. Shipped **k.d. freight prepaid f.o.b. Manitowoc, Wisconsin 54220** factory. Freight class #70.

Specifications and prices are subject to change without prior notice.

Accessories

Privacy Screens

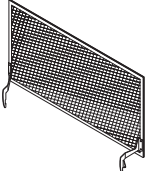
MODEL	Overall Height	W x H	MODEL NUMBER				Approx. Packaged Weight
			Basic Model	Usage	Paint Color	Upholstery Color	
 <p>GSCR</p> <p>Exposed Frame Fabric Screen</p> <ul style="list-style-type: none"> Upholstered screen with painted frame Screens attach to frame so height remains constant Overall height is from the floor Fabric within screens larger than 60" will be two pieces with a metal trim piece separating the two parts and trim will match frame CLH used for screens mounted on the left side of a corner or square shoe when sitting at the desk CRH used for screens mounted on the right side of a corner or square shoe when sitting at the desk 24 and 30" wide 'End of Run' screens are surface mounted and not frame mounted and are to be used on fixed 'non-adjustable' only 	42	24 x 25.3"	GSCR2442/EF	END	<input type="checkbox"/>	<input type="checkbox"/>	7.0#
	48	24 x 31.3"	GSCR2448/EF	END	<input type="checkbox"/>	<input type="checkbox"/>	9.0#
	51	24 x 34.1"	GSCR2451/EF	END	<input type="checkbox"/>	<input type="checkbox"/>	10.0#
	54	24 x 37.3"	GSCR2454/EF	END	<input type="checkbox"/>	<input type="checkbox"/>	11.0#
	42	30 x 25.3"	GSCR3042/EF	<input type="checkbox"/>	<input type="checkbox"/>	<input type="checkbox"/>	9.0#
	48	30 x 31.3"	GSCR3048/EF	<input type="checkbox"/>	<input type="checkbox"/>	<input type="checkbox"/>	11.0#
	51	30 x 34.1"	GSCR3051/EF	<input type="checkbox"/>	<input type="checkbox"/>	<input type="checkbox"/>	12.0#
	54	30 x 37.3"	GSCR3054/EF	<input type="checkbox"/>	<input type="checkbox"/>	<input type="checkbox"/>	14.0#
	42	36 x 25.3"	GSCR3642/EF	<input type="checkbox"/>	<input type="checkbox"/>	<input type="checkbox"/>	11.0#
	48	36 x 31.3"	GSCR3648/EF	<input type="checkbox"/>	<input type="checkbox"/>	<input type="checkbox"/>	14.0#
	51	36 x 34.1"	GSCR3651/EF	<input type="checkbox"/>	<input type="checkbox"/>	<input type="checkbox"/>	15.0#
	54	36 x 37.3"	GSCR3654/EF	<input type="checkbox"/>	<input type="checkbox"/>	<input type="checkbox"/>	16.0#
	42	42 x 25.3"	GSCR4242/EF	<input type="checkbox"/>	<input type="checkbox"/>	<input type="checkbox"/>	13.0#
	48	42 x 31.3"	GSCR4248/EF	<input type="checkbox"/>	<input type="checkbox"/>	<input type="checkbox"/>	16.0#
	51	42 x 34.1"	GSCR4251/EF	<input type="checkbox"/>	<input type="checkbox"/>	<input type="checkbox"/>	17.0#
	54	42 x 37.3"	GSCR4254/EF	<input type="checkbox"/>	<input type="checkbox"/>	<input type="checkbox"/>	19.0#
	42	48 x 25.3"	GSCR4842/EF	<input type="checkbox"/>	<input type="checkbox"/>	<input type="checkbox"/>	15.0#
	48	48 x 31.3"	GSCR4848/EF	<input type="checkbox"/>	<input type="checkbox"/>	<input type="checkbox"/>	18.0#
	51	48 x 34.1"	GSCR4851/EF	<input type="checkbox"/>	<input type="checkbox"/>	<input type="checkbox"/>	20.0#
	54	48 x 37.3"	GSCR4854/EF	<input type="checkbox"/>	<input type="checkbox"/>	<input type="checkbox"/>	22.0#
42	54 x 25.3"	GSCR5442/EF	<input type="checkbox"/>	<input type="checkbox"/>	<input type="checkbox"/>	17.0#	
48	54 x 31.3"	GSCR5448/EF	<input type="checkbox"/>	<input type="checkbox"/>	<input type="checkbox"/>	21.0#	
51	54 x 34.1"	GSCR5451/EF	<input type="checkbox"/>	<input type="checkbox"/>	<input type="checkbox"/>	22.0#	
54	54 x 37.3"	GSCR5454/EF	<input type="checkbox"/>	<input type="checkbox"/>	<input type="checkbox"/>	25.0#	

A **B** **C** **D**

HOW TO ORDER

Indicate the following information on order form:

- Quantity of each item.
- Model number, including options. See "How To Build a Model Number".
- Any special service required.

Note: • The indicates that a choice is required.

- The absence of the indicates that no choice is required.
- Alpha-numeric characters in place of indicate that no other alternatives are available.

HOW TO BUILD A MODEL NUMBER

- A** Select basic model.
- B** Select usage for screens.
 - CLH** - Corner or shoe (left handed)
 - CRH** - Corner or shoe (right handed)
 - END** - End of run
 - STR** - Rectangle or peninsula

'End of Run Screens' only available in 24" and 30" widths.
- C** Select paint color. Refer to color addendum at ki.com or KI Fabrics & Finishes binder.
- D** Select upholstery color. Refer to color addendum at ki.com or in KI Fabrics & Finishes binder.



Delivered Pricing Fabric Grade 1 & C.O.M.	Delivered Pricing Fabric Grade 2	Delivered Pricing Fabric Grade 3 & Pallas Vertical Fabric Grade PV	Delivered Pricing Pallas Vertical Fabric Grade PV1	Delivered Pricing Pallas Vertical Fabric Grade PV2
\$ 369	\$ 386	\$ 400	\$ 426	\$ 441
434	452	469	495	519
464	483	497	531	552
495	519	538	573	593
437	455	472	501	522
519	538	559	592	615
555	576	599	636	661
597	621	645	686	712
506	524	544	580	603
602	624	648	692	715
645	668	697	742	767
697	721	752	800	829
573	593	617	657	682
683	711	741	786	814
737	763	796	844	877
796	826	858	916	948
639	664	693	734	762
766	798	828	881	916
825	857	890	948	983
893	928	967	1027	1065
708	737	763	812	843
849	883	920	976	1014
917	952	987	1051	1092
992	1032	1072	1140	1183

SPECIAL SERVICES

Special Carton Marking

With specially marked information N/C

Shipping

Delivered. Shipped k.d. freight prepaid
f.o.b. Pembroke, Ontario K8A 0E1 factory.
Freight class #70.

Specifications and prices are subject to
change without prior notice.

Accessories

Privacy Screens

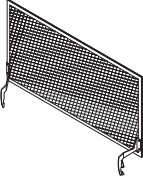
MODEL	Overall Height	W x H	MODEL NUMBER				Approx. Packaged Weight
			Basic Model	Usage	Paint Color	Upholstery Color	
 <p>GSCR</p> <p>Exposed Frame Fabric Screen</p> <ul style="list-style-type: none"> Upholstered screen with painted frame Screens attach to frame so height remains constant Overall height is from the floor Fabric within screens larger than 60" will be two pieces with a metal trim piece separating the two parts and trim will match frame CLH used for screens mounted on the left side of a corner or square shoe when sitting at the desk CRH used for screens mounted on the right side of a corner or square shoe when sitting at the desk 24 and 30" wide 'End of Run' screens are surface mounted and not frame mounted and are to be used on fixed 'non-adjustable' only 	42	60 x 25.3"	GSCR6042/EF	<input type="checkbox"/> <input type="checkbox"/> <input type="checkbox"/>	<input type="checkbox"/> <input type="checkbox"/>	<input type="checkbox"/> <input type="checkbox"/> <input type="checkbox"/> <input type="checkbox"/> <input type="checkbox"/> <input type="checkbox"/>	18.0#
	48	60 x 31.3"	GSCR6048/EF	<input type="checkbox"/> <input type="checkbox"/> <input type="checkbox"/>	<input type="checkbox"/> <input type="checkbox"/>	<input type="checkbox"/> <input type="checkbox"/> <input type="checkbox"/> <input type="checkbox"/> <input type="checkbox"/> <input type="checkbox"/>	23.0#
	51	60 x 34.1"	GSCR6051/EF	<input type="checkbox"/> <input type="checkbox"/> <input type="checkbox"/>	<input type="checkbox"/> <input type="checkbox"/>	<input type="checkbox"/> <input type="checkbox"/> <input type="checkbox"/> <input type="checkbox"/> <input type="checkbox"/> <input type="checkbox"/>	25.0#
	54	60 x 37.3"	GSCR6054/EF	<input type="checkbox"/> <input type="checkbox"/> <input type="checkbox"/>	<input type="checkbox"/> <input type="checkbox"/>	<input type="checkbox"/> <input type="checkbox"/> <input type="checkbox"/> <input type="checkbox"/> <input type="checkbox"/> <input type="checkbox"/>	27.0#
	42	66 x 25.3"	GSCR6642/EF	<input type="checkbox"/> <input type="checkbox"/> <input type="checkbox"/>	<input type="checkbox"/> <input type="checkbox"/>	<input type="checkbox"/> <input type="checkbox"/> <input type="checkbox"/> <input type="checkbox"/> <input type="checkbox"/> <input type="checkbox"/>	20.0#
	48	66 x 31.3"	GSCR6648/EF	<input type="checkbox"/> <input type="checkbox"/> <input type="checkbox"/>	<input type="checkbox"/> <input type="checkbox"/>	<input type="checkbox"/> <input type="checkbox"/> <input type="checkbox"/> <input type="checkbox"/> <input type="checkbox"/> <input type="checkbox"/>	25.0#
	51	66 x 34.1"	GSCR6651/EF	<input type="checkbox"/> <input type="checkbox"/> <input type="checkbox"/>	<input type="checkbox"/> <input type="checkbox"/>	<input type="checkbox"/> <input type="checkbox"/> <input type="checkbox"/> <input type="checkbox"/> <input type="checkbox"/> <input type="checkbox"/>	27.0#
	54	66 x 37.3"	GSCR6654/EF	<input type="checkbox"/> <input type="checkbox"/> <input type="checkbox"/>	<input type="checkbox"/> <input type="checkbox"/>	<input type="checkbox"/> <input type="checkbox"/> <input type="checkbox"/> <input type="checkbox"/> <input type="checkbox"/> <input type="checkbox"/>	30.0#
	42	72 x 25.3"	GSCR7242/EF	<input type="checkbox"/> <input type="checkbox"/> <input type="checkbox"/>	<input type="checkbox"/> <input type="checkbox"/>	<input type="checkbox"/> <input type="checkbox"/> <input type="checkbox"/> <input type="checkbox"/> <input type="checkbox"/> <input type="checkbox"/>	22.0#
	48	72 x 31.3"	GSCR7248/EF	<input type="checkbox"/> <input type="checkbox"/> <input type="checkbox"/>	<input type="checkbox"/> <input type="checkbox"/>	<input type="checkbox"/> <input type="checkbox"/> <input type="checkbox"/> <input type="checkbox"/> <input type="checkbox"/> <input type="checkbox"/>	27.0#
	51	72 x 34.1"	GSCR7251/EF	<input type="checkbox"/> <input type="checkbox"/> <input type="checkbox"/>	<input type="checkbox"/> <input type="checkbox"/>	<input type="checkbox"/> <input type="checkbox"/> <input type="checkbox"/> <input type="checkbox"/> <input type="checkbox"/> <input type="checkbox"/>	30.0#
	54	72 x 37.3"	GSCR7254/EF	<input type="checkbox"/> <input type="checkbox"/> <input type="checkbox"/>	<input type="checkbox"/> <input type="checkbox"/>	<input type="checkbox"/> <input type="checkbox"/> <input type="checkbox"/> <input type="checkbox"/> <input type="checkbox"/> <input type="checkbox"/>	33.0#
	42	84 x 25.3"	GSCR8442/EF	<input type="checkbox"/> <input type="checkbox"/> <input type="checkbox"/>	<input type="checkbox"/> <input type="checkbox"/>	<input type="checkbox"/> <input type="checkbox"/> <input type="checkbox"/> <input type="checkbox"/> <input type="checkbox"/> <input type="checkbox"/>	26.0#
	48	84 x 31.3"	GSCR8448/EF	<input type="checkbox"/> <input type="checkbox"/> <input type="checkbox"/>	<input type="checkbox"/> <input type="checkbox"/>	<input type="checkbox"/> <input type="checkbox"/> <input type="checkbox"/> <input type="checkbox"/> <input type="checkbox"/> <input type="checkbox"/>	32.0#
	51	84 x 34.1"	GSCR8451/EF	<input type="checkbox"/> <input type="checkbox"/> <input type="checkbox"/>	<input type="checkbox"/> <input type="checkbox"/>	<input type="checkbox"/> <input type="checkbox"/> <input type="checkbox"/> <input type="checkbox"/> <input type="checkbox"/> <input type="checkbox"/>	35.0#
	54	84 x 37.3"	GSCR8454/EF	<input type="checkbox"/> <input type="checkbox"/> <input type="checkbox"/>	<input type="checkbox"/> <input type="checkbox"/>	<input type="checkbox"/> <input type="checkbox"/> <input type="checkbox"/> <input type="checkbox"/> <input type="checkbox"/> <input type="checkbox"/>	38.0#

A

B

C

D

HOW TO ORDER

Indicate the following information on order form:

- Quantity of each item.
- Model number, including options. See "How To Build a Model Number".
- Any special service required.

Note: • The indicates that a choice is required.

- The absence of the indicates that no choice is required.
- Alpha-numeric characters in place of indicate that no other alternatives are available.

HOW TO BUILD A MODEL NUMBER

A Select basic model.

B Select usage for screens.

CLH - Corner or shoe (left handed)

CRH - Corner or shoe (right handed)

STR - Rectangle or peninsula

'End of Run Screens' only available in 24" and 30" widths.

C Select paint color.

Refer to color addendum at ki.com or KI Fabrics & Finishes binder.

D Select upholstery color.

Refer to color addendum at ki.com or in KI Fabrics & Finishes binder.



Delivered Pricing Fabric Grade 1 & C.O.M.	Delivered Pricing Fabric Grade 2	Delivered Pricing Fabric Grade 3 & Pallas Vertical Fabric Grade PV	Delivered Pricing Pallas Vertical Fabric Grade PV1	Delivered Pricing Pallas Vertical Fabric Grade PV2
\$ 773	\$ 803	\$ 835	\$ 888	\$ 923
930	969	1008	1070	1111
1005	1045	1088	1156	1199
1092	1134	1180	1252	1301
840	874	907	965	1003
1016	1058	1098	1166	1210
1096	1138	1186	1259	1306
1190	1237	1286	1368	1417
906	943	981	1044	1083
1098	1141	1188	1262	1310
1186	1234	1282	1364	1413
1288	1340	1394	1481	1537
1042	1083	1127	1196	1241
1263	1314	1367	1454	1508
1366	1418	1475	1570	1628
1488	1547	1608	1711	1773

SPECIAL SERVICES

Special Carton Marking

With specially marked information N/C

Shipping

Delivered. Shipped k.d. freight prepaid
f.o.b. Pembroke, Ontario K8A 0E1 factory.
Freight class #70.

Specifications and prices are subject to
change without prior notice.

Accessories

Privacy Screens

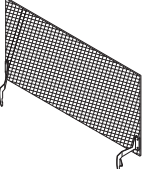
MODEL	Overall Height	W x H	MODEL NUMBER				Approx. Packaged Weight
			Basic Model	Usage	Paint Color	Upholstery Color	
 <p>Fully Upholstered Fabric Screen</p> <ul style="list-style-type: none"> Fully upholstered screen Screens attach to frame so height remains constant Overall height is from the floor CLH used for screens mounted on the left side of a corner or square shoe when sitting at the desk CRH used for screens mounted on the right side of a corner or square shoe when sitting at the desk 24 and 30" wide 'End of Run' screens are surface mounted and not frame mounted and are to be used on fixed 'non-adjustable' only 	42	24 x 25.3"	GSCR2442/UF	END	<input type="checkbox"/>	<input type="checkbox"/>	9.0#
	48	24 x 31.3"	GSCR2448/UF	END	<input type="checkbox"/>	<input type="checkbox"/>	10.0#
	51	24 x 34.1"	GSCR2451/UF	END	<input type="checkbox"/>	<input type="checkbox"/>	11.0#
	54	24 x 37.3"	GSCR2454/UF	END	<input type="checkbox"/>	<input type="checkbox"/>	13.0#
	42	30 x 25.3"	GSCR3042/UF	<input type="checkbox"/>	<input type="checkbox"/>	<input type="checkbox"/>	11.0#
	48	30 x 31.3"	GSCR3048/UF	<input type="checkbox"/>	<input type="checkbox"/>	<input type="checkbox"/>	13.0#
	51	30 x 34.1"	GSCR3051/UF	<input type="checkbox"/>	<input type="checkbox"/>	<input type="checkbox"/>	14.0#
	54	30 x 37.3"	GSCR3054/UF	<input type="checkbox"/>	<input type="checkbox"/>	<input type="checkbox"/>	16.0#
	42	36 x 25.3"	GSCR3642/UF	<input type="checkbox"/>	<input type="checkbox"/>	<input type="checkbox"/>	13.0#
	48	36 x 31.3"	GSCR3648/UF	<input type="checkbox"/>	<input type="checkbox"/>	<input type="checkbox"/>	16.0#
	51	36 x 34.1"	GSCR3651/UF	<input type="checkbox"/>	<input type="checkbox"/>	<input type="checkbox"/>	17.0#
	54	36 x 37.3"	GSCR3654/UF	<input type="checkbox"/>	<input type="checkbox"/>	<input type="checkbox"/>	19.0#
	42	42 x 25.3"	GSCR4242/UF	<input type="checkbox"/>	<input type="checkbox"/>	<input type="checkbox"/>	15.0#
	48	42 x 31.3"	GSCR4248/UF	<input type="checkbox"/>	<input type="checkbox"/>	<input type="checkbox"/>	18.0#
	51	42 x 34.1"	GSCR4251/UF	<input type="checkbox"/>	<input type="checkbox"/>	<input type="checkbox"/>	20.0#
	54	42 x 37.3"	GSCR4254/UF	<input type="checkbox"/>	<input type="checkbox"/>	<input type="checkbox"/>	22.0#
	42	48 x 25.3"	GSCR4842/UF	<input type="checkbox"/>	<input type="checkbox"/>	<input type="checkbox"/>	17.0#
	48	48 x 31.3"	GSCR4848/UF	<input type="checkbox"/>	<input type="checkbox"/>	<input type="checkbox"/>	21.0#
	51	48 x 34.1"	GSCR4851/UF	<input type="checkbox"/>	<input type="checkbox"/>	<input type="checkbox"/>	23.0#
	54	48 x 37.3"	GSCR4854/UF	<input type="checkbox"/>	<input type="checkbox"/>	<input type="checkbox"/>	25.0#
	42	54 x 25.3"	GSCR5442/UF	<input type="checkbox"/>	<input type="checkbox"/>	<input type="checkbox"/>	19.0#
	48	54 x 31.3"	GSCR5448/UF	<input type="checkbox"/>	<input type="checkbox"/>	<input type="checkbox"/>	24.0#
	51	54 x 34.1"	GSCR5451/UF	<input type="checkbox"/>	<input type="checkbox"/>	<input type="checkbox"/>	26.0#
	54	54 x 37.3"	GSCR5454/UF	<input type="checkbox"/>	<input type="checkbox"/>	<input type="checkbox"/>	28.0#
	42	60 x 25.3"	GSCR6042/UF	<input type="checkbox"/>	<input type="checkbox"/>	<input type="checkbox"/>	21.0#
	48	60 x 31.3"	GSCR6048/UF	<input type="checkbox"/>	<input type="checkbox"/>	<input type="checkbox"/>	26.0#
	51	60 x 34.1"	GSCR6051/UF	<input type="checkbox"/>	<input type="checkbox"/>	<input type="checkbox"/>	28.0#
	54	60 x 37.3"	GSCR6054/UF	<input type="checkbox"/>	<input type="checkbox"/>	<input type="checkbox"/>	31.0#

A **B** **C** **D**

HOW TO ORDER

Indicate the following information on order form:

- Quantity of each item.
- Model number, including options. See "How To Build a Model Number".
- Any special service required.

Note: • The indicates that a choice is required.

- The absence of the indicates that no choice is required.
- Alpha-numeric characters in place of indicate that no other alternatives are available.

HOW TO BUILD A MODEL NUMBER

- A** Select basic model.
- B** Select usage for screens.
 - CLH** - Corner or shoe (left handed)
 - CRH** - Corner or shoe (right handed)
 - END** - End of run
 - STR** - Rectangle or peninsula

'End of Run Screens' only available in 24" and 30" widths.
- C** Select paint color. Refer to color addendum at ki.com or KI Fabrics & Finishes binder.
- D** Select upholstery color. Refer to color addendum at ki.com or in KI Fabrics & Finishes binder.



Delivered Pricing Fabric Grade 1 & C.O.M.	Delivered Pricing Fabric Grade 2	Delivered Pricing Fabric Grade 3 & Pallas Vertical Fabric Grade PV	Delivered Pricing Pallas Vertical Fabric Grade PV1	Delivered Pricing Pallas Vertical Fabric Grade PV2
\$ 369	\$ 386	\$ 400	\$ 426	\$ 441
434	452	469	495	519
464	483	497	531	552
495	519	538	573	593
437	455	472	501	522
519	538	559	592	615
555	576	599	637	661
597	621	645	686	712
506	525	544	580	588
602	625	648	692	715
645	668	697	742	767
697	722	752	800	829
573	593	617	657	682
683	710	741	785	814
737	763	796	844	877
796	826	858	915	948
639	664	693	734	762
766	798	828	881	916
825	857	890	948	983
893	928	967	1027	1065
708	737	763	812	843
849	883	920	977	1014
917	952	987	1051	1092
992	1032	1072	1140	1186
773	803	835	888	923
930	969	1008	1070	1111
1005	1045	1088	1156	1198
1092	1134	1180	1252	1301

SPECIAL SERVICES

Special Carton Marking

With specially marked information N/C

Shipping

Delivered. Shipped k.d. freight prepaid
f.o.b. **Pembroke, Ontario K8A 0E1** factory.
Freight class #70.

Specifications and prices are subject to
change without prior notice.

Accessories

Privacy Screens

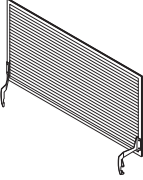
MODEL	Overall Height	W x H	MODEL NUMBER			Approx. Packaged Weight
			Basic Model	Usage	Paint Color	
 <p>GSCR</p> <p>Clear Fluted Plastic Core Screen</p> <ul style="list-style-type: none"> Painted metal frame with a fluted plastic core Screens attach to frame so height remains constant Overall height is from the floor CLH used for screens mounted on the left side of a corner or square shoe when sitting at the desk CRH used for screens mounted on the right side of a corner or square shoe when sitting at the desk 24 and 30" wide 'End of Run' screens are surface mounted and not frame mounted and are to be used on fixed 'non-adjustable' only 	42	24 x 25.3"	GSCR2442/TF	END	<input type="checkbox"/>	6.0#
	48	24 x 31.3"	GSCR2448/TF	END	<input type="checkbox"/>	8.0#
	51	24 x 34.1"	GSCR2451/TF	END	<input type="checkbox"/>	9.0#
	54	24 x 37.3"	GSCR2454/TF	END	<input type="checkbox"/>	10.0#
	42	30 x 25.3"	GSCR3042/TF	<input type="checkbox"/>	<input type="checkbox"/>	8.0#
	48	30 x 31.3"	GSCR3048/TF	<input type="checkbox"/>	<input type="checkbox"/>	10.0#
	51	30 x 34.1"	GSCR3051/TF	<input type="checkbox"/>	<input type="checkbox"/>	11.0#
	54	30 x 37.3"	GSCR3054/TF	<input type="checkbox"/>	<input type="checkbox"/>	12.0#
	42	36 x 25.3"	GSCR3642/TF	<input type="checkbox"/>	<input type="checkbox"/>	10.0#
	48	36 x 31.3"	GSCR3648/TF	<input type="checkbox"/>	<input type="checkbox"/>	12.0#
	51	36 x 34.1"	GSCR3651/TF	<input type="checkbox"/>	<input type="checkbox"/>	13.0#
	54	36 x 37.3"	GSCR3654/TF	<input type="checkbox"/>	<input type="checkbox"/>	14.0#
	42	42 x 25.3"	GSCR4242/TF	<input type="checkbox"/>	<input type="checkbox"/>	11.0#
	48	42 x 31.3"	GSCR4248/TF	<input type="checkbox"/>	<input type="checkbox"/>	14.0#
	51	42 x 34.1"	GSCR4251/TF	<input type="checkbox"/>	<input type="checkbox"/>	15.0#
	54	42 x 37.3"	GSCR4254/TF	<input type="checkbox"/>	<input type="checkbox"/>	16.0#
	42	48 x 25.3"	GSCR4842/TF	<input type="checkbox"/>	<input type="checkbox"/>	13.0#
	48	48 x 31.3"	GSCR4848/TF	<input type="checkbox"/>	<input type="checkbox"/>	16.0#
	51	48 x 34.1"	GSCR4851/TF	<input type="checkbox"/>	<input type="checkbox"/>	17.0#
	54	48 x 37.3"	GSCR4854/TF	<input type="checkbox"/>	<input type="checkbox"/>	19.0#
42	54 x 25.3"	GSCR5442/TF	<input type="checkbox"/>	<input type="checkbox"/>	14.0#	
48	54 x 31.3"	GSCR5448/TF	<input type="checkbox"/>	<input type="checkbox"/>	18.0#	
51	54 x 34.1"	GSCR5451/TF	<input type="checkbox"/>	<input type="checkbox"/>	19.0#	
54	54 x 37.3"	GSCR5454/TF	<input type="checkbox"/>	<input type="checkbox"/>	21.0#	

A **B** **C**

HOW TO ORDER

Indicate the following information on order form:

- Quantity of each item.
- Model number, including options. See "How To Build a Model Number".
- Any special service required.

Note: • The indicates that a choice is required.

- The absence of the indicates that no choice is required.
- Alpha-numeric characters in place of indicate that no other alternatives are available.

HOW TO BUILD A MODEL NUMBER

- A** Select basic model.
- B** Select usage for screens.
- | | |
|------------|---------------------------------|
| CLH | - Corner or shoe (left handed) |
| CRH | - Corner or shoe (right handed) |
| END | - End of run |
| STR | - Rectangle or peninsula |
- 'End of Run Screens' only available in 24" and 30" widths.
- C** Select paint color.
Refer to color addendum at ki.com or KI Fabrics & Finishes binder.



Delivered
Pricing

\$ 369
434
464
495
437
519
555
597
506
602
645
697
573
683
737
796
639
766
825
893
708
849
917
992

SPECIAL SERVICES

Special Carton Marking

With specially marked information N/C

Shipping

Delivered. Shipped k.d. freight prepaid
f.o.b. Pembroke, Ontario K8A 0E1 factory.
Freight class #70.

Specifications and prices are subject to
change without prior notice.

Accessories

Privacy Screens

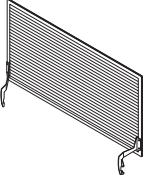
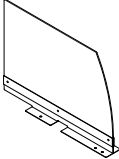
	MODEL	Overall Height	W x H	MODEL NUMBER			Approx. Packaged Weight
				Basic Model	Usage	Paint Color	
 <p>GSCR</p>	Clear Fluted Plastic Core Screen	42	60 x 25.3"	GSCR6042/TF	<input type="checkbox"/> <input type="checkbox"/> <input type="checkbox"/>	<input type="checkbox"/>	16.0#
	• Painted metal frame with a fluted plastic core	48	60 x 31.3"	GSCR6048/TF	<input type="checkbox"/> <input type="checkbox"/> <input type="checkbox"/>	<input type="checkbox"/>	20.0#
	• Screens attach to frame so height remains constant	51	60 x 34.1"	GSCR6051/TF	<input type="checkbox"/> <input type="checkbox"/> <input type="checkbox"/>	<input type="checkbox"/>	21.0#
	• CLH used for screens mounted on the left side of a corner or square shoe when sitting at the desk	54	60 x 37.3"	GSCR6054/TF	<input type="checkbox"/> <input type="checkbox"/> <input type="checkbox"/>	<input type="checkbox"/>	23.0#
	• Overall height is from the floor	42	66 x 25.3"	GSCR6642/TF	<input type="checkbox"/> <input type="checkbox"/> <input type="checkbox"/>	<input type="checkbox"/>	17.0#
	• CRH used for screens mounted on the right side of a corner or square shoe when sitting at the desk	48	66 x 31.3"	GSCR6648/TF	<input type="checkbox"/> <input type="checkbox"/> <input type="checkbox"/>	<input type="checkbox"/>	22.0#
	• CRH used for screens mounted on the right side of a corner or square shoe when sitting at the desk	51	66 x 34.1"	GSCR6651/TF	<input type="checkbox"/> <input type="checkbox"/> <input type="checkbox"/>	<input type="checkbox"/>	23.0#
	• 24 and 30" wide 'End of Run' screens are surface mounted and not frame mounted and are to be used on fixed 'non-adjustable' only	54	66 x 37.3"	GSCR6654/TF	<input type="checkbox"/> <input type="checkbox"/> <input type="checkbox"/>	<input type="checkbox"/>	26.0#
		42	72 x 25.3"	GSCR7242/TF	<input type="checkbox"/> <input type="checkbox"/> <input type="checkbox"/>	<input type="checkbox"/>	19.0#
		48	72 x 31.3"	GSCR7248/TF	<input type="checkbox"/> <input type="checkbox"/> <input type="checkbox"/>	<input type="checkbox"/>	24.0#
		51	72 x 34.1"	GSCR7251/TF	<input type="checkbox"/> <input type="checkbox"/> <input type="checkbox"/>	<input type="checkbox"/>	26.0#
		54	72 x 37.3"	GSCR7254/TF	<input type="checkbox"/> <input type="checkbox"/> <input type="checkbox"/>	<input type="checkbox"/>	28.0#
		42	84 x 25.3"	GSCR8442/TF	<input type="checkbox"/> <input type="checkbox"/> <input type="checkbox"/>	<input type="checkbox"/>	22.0#
		48	84 x 31.3"	GSCR8448/TF	<input type="checkbox"/> <input type="checkbox"/> <input type="checkbox"/>	<input type="checkbox"/>	27.0#
		51	84 x 34.1"	GSCR8451/TF	<input type="checkbox"/> <input type="checkbox"/> <input type="checkbox"/>	<input type="checkbox"/>	30.0#
		54	84 x 37.3"	GSCR8454/TF	<input type="checkbox"/> <input type="checkbox"/> <input type="checkbox"/>	<input type="checkbox"/>	33.0#
	 <p>GDVD</p>	Table Mounted Plastic Dividers	With overhead	24"	GDVD24/O		<input type="checkbox"/>
• Plastic dividers to divide a shared work-surface		Without overhead	24"	GDVD24/S		<input type="checkbox"/>	3.0#
• 16" high		With overhead	30"	GDVD30/O		<input type="checkbox"/>	3.0#
		Without overhead	30"	GDVD30/S		<input type="checkbox"/>	3.0#

A

B

C

HOW TO ORDER

Indicate the following information on order form:

- Quantity of each item.
- Model number, including options. See "How To Build a Model Number".
- Any special service required.

Note: • The indicates that a choice is required.

- The absence of the indicates that no choice is required.
- Alpha-numeric characters in place of indicate that no other alternatives are available.

HOW TO BUILD A MODEL NUMBER

A Select basic model.

B Select usage for screens.

CLH - Corner or shoe (left handed)

CRH - Corner or shoe (right handed)

STR - Rectangle or peninsula

'End of Run Screens' only available in 24" and 30" widths.

C Select paint color.

Refer to color addendum at ki.com or KI Fabrics & Finishes binder.



Delivered
Pricing

\$ 773
930
1005
1092
840
1016
1096
1190
906
1098
1186
1288
1042
1263
1366
1488
\$ 201
201
227
227

SPECIAL SERVICES

Special Carton Marking

With specially marked information N/C

Shipping

Delivered. Shipped k.d. freight prepaid f.o.b. **Pembroke, Ontario K8A 0E1** factory. Freight class #70.

Specifications and prices are subject to change without prior notice.

Accessories

Electrical

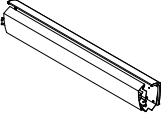
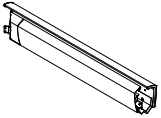
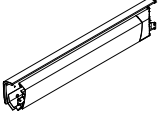
	MODEL	L	MODEL NUMBER			Approx. Packaged Weight
			Basic Model	Base Finish	Door Color	
 GWTR	Straight Wire Trough • To be used to house ridged wireway • Cannot be used with modesty panel on adjustable height surfaces	30"	GWTR30	<input type="checkbox"/>	<input type="checkbox"/>	10.0#
		36"	GWTR36	<input type="checkbox"/>	<input type="checkbox"/>	13.0#
		42"	GWTR42	<input type="checkbox"/>	<input type="checkbox"/>	15.0#
		48"	GWTR48	<input type="checkbox"/>	<input type="checkbox"/>	18.0#
		54"	GWTR54	<input type="checkbox"/>	<input type="checkbox"/>	21.0#
		60"	GWTR60	<input type="checkbox"/>	<input type="checkbox"/>	23.0#
		66"	GWTR66	<input type="checkbox"/>	<input type="checkbox"/>	26.0#
		72"	GWTR72	<input type="checkbox"/>	<input type="checkbox"/>	29.0#
 GWTC	Corner Wire Trough - Right • To be used to house ridged wireway • To be mounted on the right side of the corner/square shoe unit when sitting at the desk	36"	GWTC36R	<input type="checkbox"/>	<input type="checkbox"/>	12.0#
		42"	GWTC42R	<input type="checkbox"/>	<input type="checkbox"/>	15.0#
		48"	GWTC48R	<input type="checkbox"/>	<input type="checkbox"/>	18.0#
		54"	GWTC54R	<input type="checkbox"/>	<input type="checkbox"/>	21.0#
		60"	GWTC60R	<input type="checkbox"/>	<input type="checkbox"/>	23.0#
		66"	GWTC66R	<input type="checkbox"/>	<input type="checkbox"/>	26.0#
		72"	GWTC72R	<input type="checkbox"/>	<input type="checkbox"/>	29.0#
		84"	GWTC84R	<input type="checkbox"/>	<input type="checkbox"/>	34.0#
 GWTC	Corner Wire Trough - Left • To be used to house ridged wireway • To be mounted on the left side of the corner/square shoe unit when sitting at the desk	36"	GWTC36L	<input type="checkbox"/>	<input type="checkbox"/>	12.0#
		42"	GWTC42L	<input type="checkbox"/>	<input type="checkbox"/>	15.0#
		48"	GWTC48L	<input type="checkbox"/>	<input type="checkbox"/>	18.0#
		54"	GWTC54L	<input type="checkbox"/>	<input type="checkbox"/>	21.0#
		60"	GWTC60L	<input type="checkbox"/>	<input type="checkbox"/>	23.0#
		66"	GWTC66L	<input type="checkbox"/>	<input type="checkbox"/>	26.0#
		72"	GWTC72L	<input type="checkbox"/>	<input type="checkbox"/>	29.0#
		84"	GWTC84L	<input type="checkbox"/>	<input type="checkbox"/>	34.0#

A

B

C

HOW TO ORDER

Indicate the following information on order form:

1. Quantity of each item.
2. Model number, including options. See "How To Build a Model Number".
3. Any special service required.

Note: • The indicates that a choice is required.

- The absence of the indicates that no choice is required.
- Alpha-numeric characters in place of indicate that no other alternatives are available.

HOW TO BUILD A MODEL NUMBER

- A** Select basic model.
- B** Select base finish.
Refer to color addendum at ki.com or KI Fabrics & Finishes binder.
- C** Select door color.
Refer to color addendum at ki.com or KI Fabrics & Finishes binder.



Delivered Pricing
\$ 378
417
433
491
512
525
705
727
\$ 412
448
501
521
537
662
740
745
\$ 412
448
501
521
537
662
740
745

SPECIAL SERVICES

Special Carton Marking

With specially marked information N/C

Shipping

Shipped k.d. freight prepaid f.o.b. Manitowoc, Wisconsin 54220 factory. Freight class #100.

Specifications and prices are subject to change without prior notice.

Accessories

Electrical

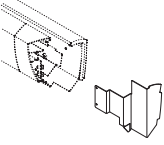
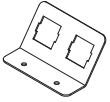
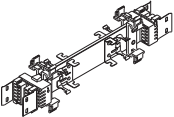
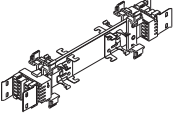
MODEL	Features	L	MODEL NUMBER		Approx. Packaged Weight
			Basic Model	Base Finish	
	LH end cap for corner condition		GWTECLH	<input type="checkbox"/>	1.0#
	RH end cap for corner condition		GWTECRH	<input type="checkbox"/>	1.0#
	LH end cap for table end		GWTELH	<input type="checkbox"/>	0.6#
	RH end cap for table end		GWTERH	<input type="checkbox"/>	0.6#
HRDPT					
	Wire Trough Data Face Plate • Data tree is included		GWTD	<input type="checkbox"/>	0.2#
HRDPT					
	Rigid Wireway • For use with 6-2-2 power	30"	G6DS30		4.0#
		36"	G6DS36		5.0#
		42"	G6DS42		5.0#
		48"	G6DS48		8.0#
		54"	G6DS54		8.0#
		60"	G6DS60		11.0#
		66"	G6DS66		11.0#
		72"	G6DS72		12.0#
84"	G6DS84		13.0#		
HRDPT					
	Rigid Wireway • For use with 4-2-2 power	30"	G4DS30		4.0#
		36"	G4DS36		5.0#
		42"	G4DS42		5.0#
		48"	G4DS48		8.0#
		54"	G4DS54		8.0#
		60"	G4DS60		11.0#
		66"	G4DS66		11.0#
		72"	G4DS72		12.0#
84"	G4DS84		13.0#		
HRDPT					

A

B

HOW TO ORDER

Indicate the following information on order form:

- Quantity of each item.
- Model number, including options. See "How To Build a Model Number".
- Any special service required.

Note: • The indicates that a choice is required.

- The absence of the indicates that no choice is required.
- Alpha-numeric characters in place of indicate that no other alternatives are available.

HOW TO BUILD A MODEL NUMBER

- A** Select basic model.
- B** Select base finish.
Refer to color addendum at ki.com or KI Fabrics & Finishes binder.



Delivered
Pricing

\$ 59
59
57
57

\$ 34

\$ 129
133
137
143
147
165
176
184
202

\$ 129
133
137
143
147
165
176
184
202

SPECIAL SERVICES

Special Carton Marking

With specially marked information N/C

Shipping

Shipped k.d. freight prepaid f.o.b. Manitowoc, Wisconsin 54220 factory.
Freight class #100.

Specifications and prices are subject to change without prior notice.

Accessories

Electrical

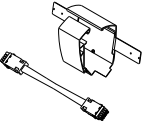
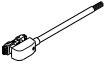
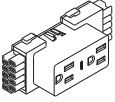
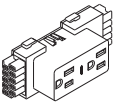
	MODEL	Features	L	MODEL NUMBER				Approx. Packaged Weight	
				Basic Model	Base Finish	Door Color	Receptacle Color		
 <p>GCJ</p>	Jumpers <ul style="list-style-type: none"> Fills gap at trough 21" use when screen is present 18" for adjacent table 	No power	18"	GCJ.18	<input type="checkbox"/> <input type="checkbox"/>	<input type="checkbox"/> <input type="checkbox"/> <input type="checkbox"/> <input type="checkbox"/>		4.0#	
		No power	21"	GCJ.21	<input type="checkbox"/> <input type="checkbox"/>	<input type="checkbox"/> <input type="checkbox"/> <input type="checkbox"/> <input type="checkbox"/>		4.0#	
		4-4-2	18"	GCJ.418	<input type="checkbox"/> <input type="checkbox"/>	<input type="checkbox"/> <input type="checkbox"/> <input type="checkbox"/> <input type="checkbox"/>		5.0#	
		4-4-2	21"	GCJ.421	<input type="checkbox"/> <input type="checkbox"/>	<input type="checkbox"/> <input type="checkbox"/> <input type="checkbox"/> <input type="checkbox"/>		5.0#	
		6-2-2	18"	GCJ.618	<input type="checkbox"/> <input type="checkbox"/>	<input type="checkbox"/> <input type="checkbox"/> <input type="checkbox"/> <input type="checkbox"/>		5.0#	
		6-2-2	21"	GCJ.621	<input type="checkbox"/> <input type="checkbox"/>	<input type="checkbox"/> <input type="checkbox"/> <input type="checkbox"/> <input type="checkbox"/>		5.0#	
 <p>HRDPT</p>	Infeeds <ul style="list-style-type: none"> Base infeed Specify 4-4-2 or 6-2-2 power 	4-4-2	72"	GEIFF442				4.0#	
		6-2-2	72"	GEIFF622				4.0#	
 <p>HRDPT</p>	Receptacles - Shared Ground 6-2-2 <ul style="list-style-type: none"> Includes the modular duplex 15 amp receptacle that snaps onto a rigid wireway Available in two 10-wire styles. Note: 10-wire styles must match on all electrical parts 	Circuit 1		GE.RECP6.1			<input type="checkbox"/> <input type="checkbox"/>	0.2#	
		Circuit 2		GE.RECP6.2			<input type="checkbox"/> <input type="checkbox"/>	0.2#	
		Circuit 3		GE.RECP6.3			<input type="checkbox"/> <input type="checkbox"/>	0.2#	
		Circuit 4		GE.RECP6.4I					0.2#
		Circuit 5		GE.RECP6.5I					0.2#
		Circuit 6		GE.RECP6.6I					0.2#
 <p>HRDPT</p>	Receptacles - Shared Ground 4-4-2 <ul style="list-style-type: none"> Includes the modular duplex 15 amp receptacle that snaps onto a rigid wireway Available in two 10-wire styles. Note: 10-wire styles must match all electrical parts 	Circuit 1		GE.RECP4.1			<input type="checkbox"/> <input type="checkbox"/>	0.2#	
		Circuit 2		GE.RECP4.2			<input type="checkbox"/> <input type="checkbox"/>	0.2#	
		Circuit 3		GE.RECP4.3			<input type="checkbox"/> <input type="checkbox"/>	0.2#	
		Circuit 3		GE.RECP4.3I					0.2#
		Circuit 4		GE.RECP4.4I					0.2#

A **B** **C** **D**

HOW TO ORDER

Indicate the following information on order form:

- Quantity of each item.
- Model number, including options. See "How To Build a Model Number".
- Any special service required.

Note: • The indicates that a choice is required.

- The absence of the indicates that no choice is required.
- Alpha-numeric characters in place of indicate that no other alternatives are available.

HOW TO BUILD A MODEL NUMBER

- A** Select basic model.
- B** Select base finish.
Refer to color addendum at ki.com or KI Fabrics & Finishes binder.
- C** Select door color.
Refer to color addendum at ki.com or KI Fabrics & Finishes binder.
- D** Select receptacle color.
Refer to color addendum at ki.com or KI Fabrics & Finishes binder.



Delivered Pricing	
\$ 133	
139	
247	
255	
247	
255	
\$ 209	
209	
\$ 35	
35	
35	
35	
35	
35	
\$ 35	
35	
35	
35	
35	

SPECIAL SERVICES

Special Carton Marking



With specially marked information N/C

Shipping

Shipped k.d. freight prepaid f.o.b. Manitowoc, Wisconsin 54220 factory. Freight class #100.

Specifications and prices are subject to change without prior notice.

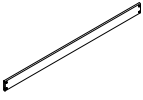
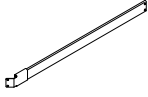
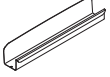
Accessories

	MODEL	W	MODEL NUMBER			Approx. Packaged Weight
			Basic Model	Paint Color	Base Finish	
 GXBR	Cross-Braces for Rectangles <ul style="list-style-type: none"> Included on adjustable Only necessary when using mini cable tray Cross-brace is non-directional Cross-brace for fixed height two legged corners 	30"	GXBR30		<input type="checkbox"/> <input type="checkbox"/>	2.0#
		36"	GXBR36		<input type="checkbox"/> <input type="checkbox"/>	2.0#
		42"	GXBR42		<input type="checkbox"/> <input type="checkbox"/>	3.0#
		48"	GXBR48		<input type="checkbox"/> <input type="checkbox"/>	3.0#
		54"	GXBR54		<input type="checkbox"/> <input type="checkbox"/>	4.0#
		60"	GXBR60		<input type="checkbox"/> <input type="checkbox"/>	4.0#
		66"	GXBR66		<input type="checkbox"/> <input type="checkbox"/>	5.0#
		72"	GXBR72		<input type="checkbox"/> <input type="checkbox"/>	5.0#
 GXBR	Cross-Braces for Corners/Shoes (for one side only) <ul style="list-style-type: none"> Included on adjustable Only necessary when using mini cable tray Cross-brace is non-directional 	36"	GXBR36C		<input type="checkbox"/> <input type="checkbox"/>	2.0#
		42"	GXBR42C		<input type="checkbox"/> <input type="checkbox"/>	3.0#
		48"	GXBR48C		<input type="checkbox"/> <input type="checkbox"/>	3.0#
		54"	GXBR54C		<input type="checkbox"/> <input type="checkbox"/>	3.0#
		60"	GXBR60C		<input type="checkbox"/> <input type="checkbox"/>	4.0#
		66"	GXBR66C		<input type="checkbox"/> <input type="checkbox"/>	4.0#
		72"	GXBR72C		<input type="checkbox"/> <input type="checkbox"/>	5.0#
		84"	GXBR84C		<input type="checkbox"/> <input type="checkbox"/>	6.0#
 HRDPT	Mini Cable Tray (requires Cross-Brace) <ul style="list-style-type: none"> Allow cables to be stored within tray 48" must be used on 54" tables or wider When cable trays are specified on CORNER UNITS & SQUARE SHOES, 24" trays will fit under lengths of 36" - 54" and 48" trays will fit under lengths of 60" - 84" 	24"	GXBT.24	<input type="checkbox"/> <input type="checkbox"/>		5.0#
		48"	GXBT.48	<input type="checkbox"/> <input type="checkbox"/>		9.0#
 HRDPT	Fixed Height Ganging Kit		GANG.24			1.0#
			GANG.30			2.0#

A **B** **C**

HOW TO ORDER

Indicate the following information on order form:

- Quantity of each item.
- Model number, including options. See "How To Build a Model Number".
- Any special service required.

Note: • The indicates that a choice is required.

- The absence of the indicates that no choice is required.
- Alpha-numeric characters in place of indicate that no other alternatives are available.

HOW TO BUILD A MODEL NUMBER

- A** Select basic model.
- B** Select paint color.
Refer to color addendum at ki.com or KI Fabrics & Finishes binder.
- C** Select base finish.
Refer to color addendum at ki.com or KI Fabrics & Finishes binder.

Accessories Worksurfaces

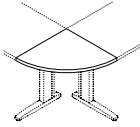
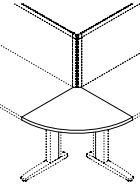
	MODEL	W	MODEL NUMBER				Approx. Packaged Weight
			Basic Model	Edge Style	Edge Color	Surface Finish	
 GTQR	Quarter Round Transitional Surface <ul style="list-style-type: none"> • Two splice plates provided for 24" • Four splice plates provided for 30" • For use with fixed height workstations only • For use as conferencing corner • Wireway option not available • Modesty panel not required • 24" surface has radius of 26-2/3" and 30" surface has a radius of 35" • Only one privacy screen can be used with this surface 	24"	GTQR24	<input type="checkbox"/> <input type="checkbox"/>	<input type="checkbox"/> <input type="checkbox"/>	<input type="checkbox"/> <input type="checkbox"/>	19.0#
		30"	GTQR30	<input type="checkbox"/> <input type="checkbox"/>	<input type="checkbox"/> <input type="checkbox"/>	<input type="checkbox"/> <input type="checkbox"/>	29.0#
 GTQR	Quarter Round Transitional Surface <ul style="list-style-type: none"> • Two splice plates provided for 24" • Four splice plates provided for 30" • For use with fixed height workstations only • For use as conferencing corner • Wireway option not available • Modesty panel not required • 24" surface has radius of 26-2/3" and 30" surface has a radius of 35" 	24"	GTQR24P	<input type="checkbox"/> <input type="checkbox"/>	<input type="checkbox"/> <input type="checkbox"/>	<input type="checkbox"/> <input type="checkbox"/>	21.0#
		30"	GTQR30P	<input type="checkbox"/> <input type="checkbox"/>	<input type="checkbox"/> <input type="checkbox"/>	<input type="checkbox"/> <input type="checkbox"/>	31.0#

A **B** **C** **D**

HOW TO ORDER

Indicate the following information on order form:

1. Quantity of each item.
2. Model number, including options. See "How To Build a Model Number".
3. Any special service required.

Note:

- The indicates that a choice is required.
- The absence of the indicates that no choice is required.
- Alpha-numeric characters in place of indicate that no other alternatives are available.

HOW TO BUILD A MODEL NUMBER

- A** Select basic model.
- B** Select edge style.
- | | |
|------------|-----------------|
| 74P | - 74P edge |
| KN | - Knife edge |
| MP | - Membrane edge |
- C** Select edge color.
Refer to color addendum at ki.com or KI Fabrics & Finishes binder.
Edge color offerings are based on edge style selections. Trim color doesn't apply to the membrane edge selection.
- D** Select surface finish.
Refer to color addendum at ki.com or KI Fabrics & Finishes binder.
Surface finish offerings are based on edge style selections. Laminate finishes are only available on (74P) edge and (KN) knife edge worksurfaces. The membrane color selections are only available on the (MP) membrane edge worksurfaces.

FINISH INFORMATION

Additional Laminate Offering

Additional laminates beyond KI standard offering, are available with two weeks extended leadtime. To specify additional laminates, use these designators followed by the supplier's color/pattern code:

Formica - LF/supplier's color pattern code
Nevamar - LN/supplier's color pattern code
Wilsonart - LW/supplier's color pattern code

KI's standard finish is the supplier's recommended finish for that color/pattern. Note: Nonstandard laminates from these suppliers (example: textured laminates), require an upcharge and additional leadtime. Contact KI.



Accessories Worksurfaces

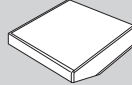
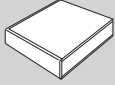

74P Edge
(74P)

Knife Edge
(KN)

Membrane Edge
(MP)

\$ 316

\$ 341

\$ 341

358

402

402

\$ 350

\$ 373

\$ 373

392

435

435

SPECIAL SERVICES

Special Carton Marking

With specially marked information N/C

Shipping

Shipped **k.d. freight prepaid f.o.b. Manitowoc, Wisconsin 54220** factory.
Freight class #100.

Specifications and prices are subject to change without prior notice.

Accessories Worksurfaces

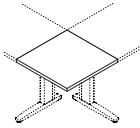
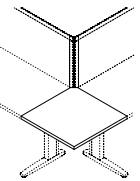
	MODEL	W	MODEL NUMBER				Approx. Packaged Weight
			Basic Model	Edge Style	Edge Color	Surface Finish	
 <p>GTSQ</p>	Square Transitional Surface	24"	GTSQ24	<input type="checkbox"/> <input type="checkbox"/>	<input type="checkbox"/> <input type="checkbox"/>	<input type="checkbox"/> <input type="checkbox"/>	25.0#
	<ul style="list-style-type: none"> • For use with fixed height workstations only • For use as conferencing corner • Wireway option not available • Modesty panel not required • Only one privacy screen can be used with this surface 	30"	GTSQ30	<input type="checkbox"/> <input type="checkbox"/>	<input type="checkbox"/> <input type="checkbox"/>	<input type="checkbox"/> <input type="checkbox"/>	39.0#
 <p>GTSQ</p>	Square Transitional Surface	24"	GTSQ24P	<input type="checkbox"/> <input type="checkbox"/>	<input type="checkbox"/> <input type="checkbox"/>	<input type="checkbox"/> <input type="checkbox"/>	27.0#
	<ul style="list-style-type: none"> • For use with fixed height workstations only • For use as conferencing corner • Wireway option not available • Modesty panel not required 	30"	GTSQ30P	<input type="checkbox"/> <input type="checkbox"/>	<input type="checkbox"/> <input type="checkbox"/>	<input type="checkbox"/> <input type="checkbox"/>	41.0#

A **B** **C** **D**

HOW TO ORDER

Indicate the following information on order form:

1. Quantity of each item.
2. Model number, including options. See "How To Build a Model Number".
3. Any special service required.

Note:

- The indicates that a choice is required.
- The absence of the indicates that no choice is required.
- Alpha-numeric characters in place of indicate that no other alternatives are available.

HOW TO BUILD A MODEL NUMBER

- A** Select basic model.
- B** Select edge style.

74P	- 74P edge
KN	- Knife edge
MP	- Membrane edge
- C** Select edge color. Refer to color addendum at ki.com or KI Fabrics & Finishes binder. Edge color offerings are based on edge style selections. Trim color doesn't apply to the membrane edge selection.
- D** Select surface finish. Refer to color addendum at ki.com or KI Fabrics & Finishes binder. Surface finish offerings are based on edge style selections. Laminate finishes are only available on (74P) edge and (KN) knife edge worksurfaces. The membrane color selections are only available on the (MP) membrane edge worksurfaces.

FINISH INFORMATION

Additional Laminate Offering

Additional laminates beyond KI standard offering, are available with two weeks extended leadtime. To specify additional laminates, use these designators followed by the supplier's color/pattern code:

Formica - LF/supplier's color pattern code
 Nevamar - LN/supplier's color pattern code
 Wilsonart - LW/supplier's color pattern code

KI's standard finish is the supplier's recommended finish for that color/pattern. Note: Nonstandard laminates from these suppliers (example: textured laminates), require an upcharge and additional leadtime. Contact KI.



Accessories Worksurfaces

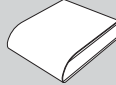
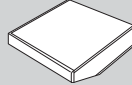
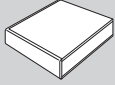

74P Edge
(74P)

Knife Edge
(KN)

Membrane Edge
(MP)

\$ 316

\$ 341

\$ 341

358

402

402

\$ 350

\$ 373

\$ 373

392

435

435

SPECIAL SERVICES

Special Carton Marking

With specially marked information N/C

Shipping

Shipped **k.d. freight prepaid f.o.b. Manitowoc, Wisconsin 54220** factory.
Freight class #100.

Specifications and prices are subject to change without prior notice.

Accessories Worksurfaces

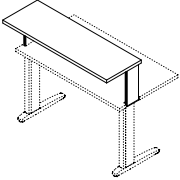
MODEL	W	MODEL NUMBER					Approx. Packaged Weight
		Basic Model	Edge Style	Base Finish	Edge Color	Surface Finish	
 <p>GTRA</p> <p>Rectangle Transitional Top</p> <ul style="list-style-type: none"> • For use with any fixed surface with overhead grommets • Surface is designed to clear the 42" high screen • Receiving surface must have overhead grommet 	30"	GTRA30	<input type="checkbox"/> <input type="checkbox"/> <input type="checkbox"/>	<input type="checkbox"/>	<input type="checkbox"/> <input type="checkbox"/> <input type="checkbox"/>	<input type="checkbox"/> <input type="checkbox"/>	25.0#
	36"	GTRA36	<input type="checkbox"/> <input type="checkbox"/> <input type="checkbox"/>	<input type="checkbox"/>	<input type="checkbox"/> <input type="checkbox"/> <input type="checkbox"/>	<input type="checkbox"/> <input type="checkbox"/>	29.0#
	42"	GTRA42	<input type="checkbox"/> <input type="checkbox"/> <input type="checkbox"/>	<input type="checkbox"/>	<input type="checkbox"/> <input type="checkbox"/> <input type="checkbox"/>	<input type="checkbox"/> <input type="checkbox"/>	33.0#
	48"	GTRA48	<input type="checkbox"/> <input type="checkbox"/> <input type="checkbox"/>	<input type="checkbox"/>	<input type="checkbox"/> <input type="checkbox"/> <input type="checkbox"/>	<input type="checkbox"/> <input type="checkbox"/>	37.0#
	54"	GTRA54	<input type="checkbox"/> <input type="checkbox"/> <input type="checkbox"/>	<input type="checkbox"/>	<input type="checkbox"/> <input type="checkbox"/> <input type="checkbox"/>	<input type="checkbox"/> <input type="checkbox"/>	41.0#
	60"	GTRA60	<input type="checkbox"/> <input type="checkbox"/> <input type="checkbox"/>	<input type="checkbox"/>	<input type="checkbox"/> <input type="checkbox"/> <input type="checkbox"/>	<input type="checkbox"/> <input type="checkbox"/>	44.0#
	66"	GTRA66	<input type="checkbox"/> <input type="checkbox"/> <input type="checkbox"/>	<input type="checkbox"/>	<input type="checkbox"/> <input type="checkbox"/> <input type="checkbox"/>	<input type="checkbox"/> <input type="checkbox"/>	54.0#
	72"	GTRA72	<input type="checkbox"/> <input type="checkbox"/> <input type="checkbox"/>	<input type="checkbox"/>	<input type="checkbox"/> <input type="checkbox"/> <input type="checkbox"/>	<input type="checkbox"/> <input type="checkbox"/>	58.0#
				A	B	C	D

HOW TO ORDER

Indicate the following information on order form:

1. Quantity of each item.
2. Model number, including options. See "How To Build a Model Number".
3. Any special service required.

Note:

- The indicates that a choice is required.
- The absence of the indicates that no choice is required.
- Alpha-numeric characters in place of indicate that no other alternatives are available.

HOW TO BUILD A MODEL NUMBER

- A** Select basic model.
- B** Select edge style.
- | | |
|------------|------------------------------|
| 74P | - 74P edge |
| EP | - Elliptical postformed edge |
| KN | - Knife edge |
| MP | - Membrane edge |
- C** Select base finish.
Refer to color addendum at ki.com or KI Fabrics & Finishes binder.
- D** Select edge color.
Refer to color addendum at ki.com or KI Fabrics & Finishes binder.
Edge color offerings are based on edge style selections. Trim color doesn't apply to the membrane edge selection.
- E** Select surface finish.
Refer to color addendum at ki.com or KI Fabrics & Finishes binder.
Surface finish offerings are based on edge

style selections. Laminate finishes are only available on (74P) edge and (KN) knife edge worksurfaces. The membrane color selections are only available on the (MP) membrane edge worksurfaces.

FINISH INFORMATION

Additional Laminate Offering

Additional laminates beyond KI standard offering, are available with two weeks extended leadtime. To specify additional laminates, use these designators followed by the supplier's color/pattern code:

Formica - LF/supplier's color pattern code
Nevamar - LN/supplier's color pattern code
Wilsonart - LW/supplier's color pattern code

KI's standard finish is the supplier's recommended finish for that color/pattern. Note: Nonstandard laminates from these suppliers (example: textured laminates), require an upcharge and additional leadtime. Contact KI.



Accessories Worksurfaces

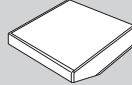
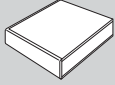

74P Edge
(74P)

Elliptical Postformed Edge
(EP)

Knife Edge
(KN)

Membrane Edge
(MP)

\$ 306

\$ 318

\$ 342

\$ 342

329

345

369

369

355

370

399

399

380

399

427

427

404

426

455

455

431

452

484

484

522

546

586

586

561

588

631

631

SPECIAL SERVICES

Special Carton Marking

With specially marked information N/C

Shipping

Shipped **k.d. freight prepaid f.o.b. Manitowoc, Wisconsin 54220** factory.
Freight class #100.

Specifications and prices are subject to change without prior notice.

Index

Model No.	Description	Page	Model No.	Description	Page
BLCF30/GBO	Overhead Storage: Balance® Overhead Cabinet-Fabric Upper Door	114	GCTE24424224S	Tripod Corner Electric Height Adjustable: Tripod Corner Electric Height Adjustable Single	24
BLCL30/GBO	Overhead Storage: Balance® Overhead Cabinet Laminated Upper Door	114	GCTE24424230S	Reduction Tripod Corner Electric Height Adjustable: Reduction Tripod Corner Electric Height Adjustable Single-Left	44
BLCS30/GBO	Overhead Storage: Balance® Overhead Cabinet-Solid Color Upper Door	114	GCTE24484824D	Tripod Corner Electric Height Adjustable: Tripod Corner electric Height Adjustable Dual	26
BTLT5.24	Balance® Task Lights: Balance® Task Lights	116	GCTE24484830D	Reduction Tripod Corner Electric Height Adjustable Dual: Reduction Tripod Corner Electric Height Adjustable Dual-Left	48
G4DS30	Electrical: Rigid Wireway	140	GCTE30424224S	Reduction Tripod Corner Electric Height Adjustable: Reduction Tripod Corner Electric Height Adjustable Single-Right	46
G6DS30	Electrical: Rigid Wireway	140	GCTE30484824D	Reduction Tripod Corner Electric Height Adjustable Dual: Reduction Tripod Corner Electric Height Adjustable Dual-Right	50
GANG.24	Fixed Height Ganging Kit	144	GDVD24/O	Privacy Screens: Table Mounted Plastic Dividers	136
GC2C2442S/CR	Two-Legged Corner: Crank Height Adjustable	110	GE.RECP4.1	Electrical: Receptacles - Shared Ground 4-4-2	142
GC2C2442S/F	Two-Legged Corner: Fixed Height	108	GE.RECP6.1	Electrical: Receptacles - Shared Ground 6-2-2	142
GC2C2442S/P	Two-Legged Corner: Pin Height Adjustable	110	GEIFF442	Electrical: Infeeds	142
GC2C3048D/CR	Two-Legged Corner: Crank Height Dual	110	GSAP244860S/F	Arcade Peninsula: Fixed Height-Right	104
GC2C3048D/F	Two-Legged Corner: Fixed Height Dual	108	GSAP244860S/P	Arcade Peninsula: Pin Height Adjustable-Right	106
GC2E2442S	Two-Legged Corner: Electric Height Adjustable Single	112	GSAP604824S/F	Arcade Peninsula: Fixed Height-Left	104
GC2E3048D	Two-Legged Corner: Electric Height Adjustable Dual	112	GSAP604824S/P	Arcade Peninsula: Pin Height Adjustable-Left	106
GCCT24363624S/F	Tripod Corner Fixed Height: Tripod Corner Fixed Height	18	GSCR2442/EF	Privacy Screens: Exposed Frame Fabric Screen	128
GCCT24424224S/CR	Tripod Corner Pin and Crank Height Adjustable: Tripod Corner Crank Height Adjustable	20	GSCR2442/TF	Privacy Screens: Clear Fluted Plastic Core Screen	134
GCCT24424224S/P	Tripod Corner Pin and Crank Height Adjustable: Tripod Corner Pin Height Adjustable	20	GSCR2442/UF	Privacy Screens: Fully Upholstered Fabric Screen	132
GCCT24424230S/F	Reduction Tripod Corner Fixed Height: Reduction Tripod Corner Fixed Height-Left	28	GSCR6042/EF	Privacy Screens: Exposed Frame Fabric Screen	130
GCCT24424230S/P	Reduction Tripod Corner Pin Height Adjustable: Reduction Tripod Corner Pin Height Adjustable-Left	36	GSCR6042/TF	Privacy Screens: Clear Fluted Plastic Core Screen	136
GCCT24484824D/CR	Tripod Corner Pin and Crank Height Adjustable: Tripod Corner Crank Height Dual	22	GSHE24485424D	Square Shoe Electric Height Adjustable Dual: Basic Square Shoe Electric Height Adjustable Dual-Right	74
GCCT24484824D/F	Tripod Corner Fixed Height: Tripod Corner Fixed Height Dual	18	GSHE24485424S	Square Shoe Electric Height Adjustable: Basic Square Shoe Electric Height Adjustable Single-Right	70
GCCT24484830D/CR	Reduction Tripod Corner Crank Height Dual: Reduction Tripod Corner Crank Height Dual-Left	40	GSHE24485430D	Reduction Square Shoe Electric Height Adjustable Dual: Reduction Basic Square Shoe Electric Height Adjustable Dual-Right	98
GCCT24484830D/F	Reduction Tripod Corner Fixed Height Dual: Reduction Tripod Corner Fixed Height Dual-Left	32	GSHE24485430S	Reduction Square Shoe Electric Height Adjustable: Reduction Basic Square Shoe Electric Height Adjustable Single-Right	94
GCCT24484830S/CR	Reduction Tripod Corner Crank Height Adjustable: Reduction Tripod Corner Crank Height Adjustable-Left	38	GSHE24544824D	Square Shoe Electric Height Adjustable Dual: Basic Square Shoe Electric Height Adjustable Dual-Left	72
GCCT30424224S/F	Reduction Tripod Corner Fixed Height: Reduction Tripod Corner Fixed Height-Right	30	GSHE24544824S	Square Shoe Electric Height Adjustable: Basic Square Shoe Electric Height Adjustable Single-Left	68
GCCT30424224S/P	Reduction Tripod Corner Pin Height Adjustable: Reduction Tripod Corner Pin Height Adjustable-Right	36	GSHE24544830D	Reduction Square Shoe Electric Height Adjustable Dual: Reduction Basic Square Shoe Electric Height Adjustable Dual-Left	96
GCCT30484824D/CR	Reduction Tripod Corner Crank Height Dual: Reduction Tripod Corner Crank Height Dual-Right	42	GSHE24544830S	Reduction Square Shoe Electric Height Adjustable: Reduction Basic Square Shoe Electric Height Adjustable Single-Left	92
GCCT30484824D/F	Reduction Tripod Corner Fixed Height Dual: Reduction Tripod Corner Fixed Height Dual-Right	34	GSRE2436S	Basic Rectangular: Electric Height Adjustable Single	14
GCCT30484824S/CR	Reduction Tripod Corner Crank Height Adjustable: Reduction Tripod Corner Crank Height Adjustable-Right	38	GSRE3048D	Basic Rectangular: Electric Height Adjustable Dual	16
GCJ.18	Electrical: Jumpers	142			



Model No.	Description	Page	Model No.	Description	Page
GSSH24485424D/CR	Square Shoe Crank Height Dual: Basic Square Shoe Crank Height Dual-Right	66	GSTP244860S/P "P" Shaped Peninsula: Pin Height Adjustable-Right		102
GSSH24485424D/F	Square Shoe Fixed Height Dual: Basic Square Shoe Fixed Height Dual-Right	58	GSTP604824S/F "P" Shaped Peninsula: Fixed Height-Left		100
GSSH24485424S/CR	Square Shoe Crank Height Adjustable: Basic Square Shoe Crank Height Adjustable-Right	62	GSTP604824S/P "P" Shaped Peninsula: Pin Height Adjustable-Left		102
GSSH24485424S/F	Square Shoe Fixed Height: Basic Square Shoe Fixed Height-Right	54	GSTR2430S/CR Basic Rectangular: Crank Height Adjustable		10
GSSH24485424S/P	Square Shoe Pin Height Adjustable: Basic Square Shoe Pin Height Adjustable-Right	60	GSTR2430S/F Basic Rectangular: Fixed Height		6
GSSH24485430D/CR	Reduction Square Shoe Crank Height Dual: Reduction Basic Square Shoe Crank Height Dual-Right	90	GSTR2430S/P Basic Rectangular: Pin Height Adjustable		8
GSSH24485430D/F	Reduction Square Shoe Fixed Height Dual: Reduction Basic Square Shoe Fixed Height Dual-Right	82	GSTR2430SS/CR Basic Rectangular: Crank Sit/Stand Height Adjustable		12
GSSH24485430S/CR	Reduction Square Shoe Crank Height Adjustable: Reduction Basic Square Shoe Crank Height Adjustable-Right	86	GSTR2442D/F Basic Rectangular: Fixed Height Dual		6
GSSH24485430S/F	Reduction Square Shoe Fixed Height: Reduction Basic Square Shoe Fixed Height-Right	78	GSTR3042D/CR Basic Rectangular: Crank Height Dual		10
GSSH24485430S/P	Reduction Square Shoe Pin Height Adjustable: Reduction Square Shoe Pin Height Adjustable-Right	84	GTBS30 Overhead Shelf/Tool Rail Kits: Tool Rail Kits		122
GSSH24544824D/CR	Square Shoe Crank Height Dual: Basic Square Shoe Crank Height Dual-Left	64	GTQR24 Quarter Round Transitional Surface		146
GSSH24544824D/F	Square Shoe Fixed Height Dual: Basic Square Shoe Fixed Height Dual-Left	56	GTQR24P Quarter Round Transitional Surface		146
GSSH24544824S/CR	Square Shoe Crank Height Adjustable: Basic Square Shoe Crank Height Adjustable-Left	62	GTRA30 Rectangle Transitional Top		150
GSSH24544824S/F	Square Shoe Fixed Height: Basic Square Shoe Fixed Height-Left	52	GTSQ24 Square Transitional Surface		148
GSSH24544824S/P	Square Shoe Pin Height Adjustable: Basic Square Shoe Pin Height Adjustable-Left	60	GTSQ24P Square Transitional Surface		148
GSSH24544830D/CR	Reduction Square Shoe Crank Height Dual: Reduction Basic Square Shoe Crank Height Dual-Left	88	GUOF30 Overhead Storage: Universal - Fabric Door Overhead Cabinet		118
GSSH24544830D/F	Reduction Square Shoe Fixed Height Dual: Reduction Basic Square Shoe Fixed Height Dual-Left	80	GUOL30 Overhead Storage: Universal - Laminate Door Overhead Cabinet		118
GSSH24544830S/CR	Reduction Square Shoe Crank Height Adjustable: Reduction Basic Square Shoe Crank Height Adjustable-Left	86	GUOS30 Overhead Storage: Universal - Steel Door Overhead Cabinet		118
GSSH24544830S/F	Reduction Square Shoe Fixed Height: Reduction Basic Square Shoe Fixed Height-Left	76	GUSS30 Overhead Shelf/Tool Rail Kits: Shelf Kits		122
GSSH24544830S/P	Reduction Square Shoe Pin Height Adjustable: Reduction Square Shoe Pin Height Adjustable-Left	84	GWTC36L Electrical: Corner Wire Trough - Left		138
GSTP244860S/F "P" Shaped Peninsula: Fixed Height-Right		100	GWTC36R Electrical: Corner Wire Trough - Right		138
			GWTD Electrical: Wire Trough Data Face Plate		140
			GWTECLH Electrical: Wire Trough End Cap		140
			GWTR30 Electrical: Straight Wire Trough		138
			GXBR30 Cross-Braces for Rectangles		144
			GXBR36C Cross-Braces for Corners/Shoes (for one side only)		144
			GXBT.24 Mini Cable Tray (requires Cross-Brace)		144
			NSD Overhead Shelf/Tool Rail Kits: Shelf Divider		122
			PAT Paper Management: Accessory Tray		126
			PDS Paper Management: Diagonal Storage		124
			PLL Paper Management: Paper Tray		124
			PPC Paper Management: Pencil Cup		126
			PTC Paper Management: Telephone Caddy		126
			PVS Paper Management: Vertical Storage		124
			TLT5.24 Universal Task Lights: Universal Task Lights		120



KI
1330 Bellevue Street
P.O. Box 8100
Green Bay, Wisconsin 54308-8100
1-800-424-2432
www.ki.com

KI and Furnishing Knowledge
are registered trademarks
of Krueger International, Inc.

© 2011 KI
All Rights Reserved.
Litho in USA.
Code KI-11382R5/KI/VL/211

Printed using only water-based inks,
including metallics. Please recycle.