

# 4Post™

Commercial and GSA Price  
Book and Specification Guide

Version 6.0 - **Section 2d**  
Effective January 1, 2015

Rev. 2016-04



**DATUM**®  
storage solutions



# Commercial Terms & Conditions

---

**Payment Terms:** Deposits are required for all 1st time orders and until credit has been established. Datum's standard terms are NET 30, and Datum does offer prompt pay discounts. All invoices and payments in U.S. dollars.

**Pricing:** All prices shown are F.O.B. Emigsville, PA 17318-0355 and are subject to change without notice. See separate contract for GSA pricing, terms and conditions.

**Minimum Order:** \$100 (net). Any order less than \$100 net will be subject to a \$25.00 net service charge.

**Shipping:** All orders are shipped best way, prepaid and add, unless otherwise noted. Inside delivery, liftgate, 2-man delivery and call-before delivery are available for an additional charge. Please consult factory for additional pricing information.

**Ordering Instructions:** All orders must be in writing and accompanied by a purchase order number. Quantities, part numbers, paint, and laminate colors must be clearly noted on order. All orders will be confirmed with a written acknowledgment. MobileTrak® orders must have signed layout approval for order placement.

**Changes to orders:** Once an order has entered the production schedule, any changes to that order will be subject to a 25% restocking fee and extended lead time.

**Design Service:** Datum Storage Solutions offers complete layout-planning services at \$75.00 per hour.

**Standard Paint Colors:** Products are available in 8 standard paint colors, unless otherwise noted. Other colors may be subjected to an extended lead-time; please consult factory for more information. Datum's state-of-the-art electrostatic powder coat has the capability to paint virtually any color. Minimum upcharge: \$300.00 NET. Please contact the factory for more information.

**Datum will only accept returns according to the Cancellation & Returns Policy on the following paint finishes: T15, T47 and T86.**

**Design Ownership:** All designs, plans, layouts, drawings, and specifications are the property of Datum Storage Solutions and may not be used, reproduced or distributed, in whole or part, without prior written consent.

**Freight Charges:** All shipments will be pre-pay and add unless otherwise specified. Freight charges will be added to the invoice or billed separately, depending on arrangements. Selection of the delivering carrier will be made by Datum Storage Solutions. All freight charges, except carrier's minimums, non-direct and intrastate, will be discounted. Datum Storage Solutions participates in various discount programs with carriers. Any remaining discount amounts not credited to the buyer are used to offset handling, processing, packaging, and related administrative expenses. Buyer has the option of selecting their own carrier, F.O.B. Shipping Point. If this option is selected, shipment must go Freight Collect or third party, and Datum Storage Solutions' responsibilities end when the order leaves our dock. A per-package handling charge of \$10.00 may be added for UPS and FedEx shipments. Datum Storage Solutions is not responsible for brokerage, customs, warehousing or any other fees associated with international shipments.

**Weight:** Weights shown are approximate and do not include dunnage.

**Freight Claims:** Datum takes the utmost care when packing our product to prevent shipping damage. It is your responsibility to note on the freight carrier's delivery receipt any damage incurred while in transit. All damage claims must be submitted by you with the carrier.

Concealed damage must be reported to Datum and/or the freight carrier in less than 15 days from the receipt of shipment. If concealed damage is reported in less than 15 days, the carrier and Datum will absorb two third's of the net product cost, the balance of the cost for the replacement product will be billed to the dealer under the original purchase order number. All damage claims must be submitted by you with the carrier.

All concealed damage claims reported after the 15-day time limit become the responsibility of the dealer. All concealed damage claims must be submitted by you with the carrier.

All product that is delivered to a warehouse or an installation facility must be inspected prior to delivering to end destination. If damage is reported after the product is moved, the dealer is responsible for filing the claim with the carrier. If damage is found prior to moving the product, after being signed clear, it must be reported in less than 15 days from delivery.

Concealed damage incurred by a third party carrier is not the responsibility of Datum Storage Solutions.

**Note: Crating your product may reduce damage. Datum offers crating for a charge of \$75.00 per skid. Please contact the factory for details.**

**CAUTION: When you give a delivering carrier a clear receipt for a shipment in which there is damaged merchandise or a shortage, the carrier is relieved of further responsibility. DAMAGE AND SHORTAGE CLAIMS MUST BE FILED BY YOU WITH THE DELIVERING CARRIER. Datum Storage Solutions will not accept return merchandise damaged in transit. Your claim is with the delivering carrier.**

# Commercial Terms & Conditions, Continued

---

**Cancellations & Returns:** ORDERS FOR "SPECIAL" OR "CUSTOM" ITEMS ARE NOT SUBJECT TO CHANGE OR CANCELLATION. No returned merchandise will be accepted without written consent of Datum Storage Solutions. All returned shipments are to be freight prepaid by the shipper and are subject to a handling charge of 25% plus reimbursement of all original transportation charges incurred by Datum Storage Solutions. Once production of "non-stock" items has begun, cancellation of the order is subject to Datum Storage Solutions' approval and a 25% surcharge will be assessed on all approved cancellation items. Custom colors or laminate panels are not returnable.

Return authorization must be requested within 30 days of invoicing and no product may be returned without a prior written return authorization. All returns must be made within 30 days of receiving the written return authorization and are subject to a 25% restocking charge (\$20.00 minimum) plus all incurred freight charges. All returns must be in original packaging and in resellable condition for a credit to be issued. Datum will not issue return authorizations on product that has been assembled by the dealer or the end user.

NO GOODS ACCEPTED FOR RETURN WITHOUT PRIOR APPROVAL. Seller must have the right to inspect any goods claimed to be defective at Buyer's place of business or require Buyer to return the goods to the Seller for inspection on Seller's premises. Transportation charges covering returned goods will be borne by Seller only if such goods are proven to be defective.

**Storage:** Datum does not have the facilities to store completed orders, therefore all orders must ship when completed. If a postponement of product shipment is requested by the Dealer after the ordered goods are released to manufacturing or at a time when Datum is ready to ship the ordered goods, Datum may transfer the ordered goods to storage at the Dealer's risk and expense. This transfer to storage will be considered delivery to the Dealer for all purposes including invoicing and payment.

**Replacements:** Replacement requests for damaged or missing parts must be submitted to Datum within 30 days of receipt of product. Damaged product must be signed for, damaged or refused, and reported within 30 days of receipt of product. Replacement requests made after 30 days of receipt of order will be sent out at dealer cost plus freight.

**Lifetime Warranty:\*** Datum Storage Solutions warrants to the original purchaser for the life of the product that it shall be free of any defect in materials or workmanship, so long as the original purchaser is the owner and possessor of the product and the product is installed by a Datum Certified Installer. **For a period of two years from the date of shipment, Datum Storage Solutions will provide all labor free of charge** at the location of the product to repair or replace any part that fails because of such defects. After two years from date of shipment, labor will no longer be provided. All replacements parts will be supplied for the life of the product so long as all requirements are met as set forth in this warranty. This warranty does not include defects to the product resulting from accident, misuse, improper installation or operation, normal wear, neglect, unauthorized repair or alteration. The purchase of this product shall constitute a purchaser's agreement that the sole remedy for any breach of warranty shall be such repair or replacement as expressly provided above. In no event shall Datum Storage Solutions be liable for any incidental or consequential damages arising out of the use or inability to use the product for any purpose whatsoever. Effective January 1, 2015.

**ANY PRODUCT NOT INSTALLED BY A DATUM CERTIFIED INSTALLER WILL RECEIVE A ONE-YEAR PARTS WARRANTY.**

Contact Datum Storage Solutions for a Datum Certified Installer in your area.

\*Lifetime Warranty excludes all tambour doors and all electrical components, which carry a two-year warranty.

Excludes all sales outside of the contiguous 48 states, Canada and Mexico.



## General Service Administration Terms & Conditions Authorized Federal Supply Schedule

### Datum Filing Systems, Inc. / dba Datum Storage Solutions Contract GS-28F-005BA

- Supply Schedule FSC Group 71, Part 1 – Office Furniture
- Contract Period: November 5, 2013 through November 4, 2018
- Datum Storage Solutions Cage Number – 0A9H7
- Datum Storage Solutions DUNS # 061974549
- Datum Storage Solutions Federal ID Number – 11-2156739
- Datum is a Small Business and registered in S.A.M.
- Datum Storage Solutions is on GSA Advantage. To purchase Datum products on GSA go to:



- Special Item Numbers:
  - SIN 711-2 Computer Furniture (Technical Furniture)
  - SIN 711-3 Filing & Storage Shelving (Ez2<sup>®</sup> Rotary Action File, 4Post<sup>™</sup> Shelving and Computer Security)
  - SIN 711-7 High-Density, Movable Filing Systems (ThinStak<sup>®</sup>, TrakSlider<sup>™</sup> and MobileTrak<sup>®</sup>)

#### Contact Datum for discounting.

- SIN 711-94 Design Services (if used, \$75.00/Hour)
- SIN 711-95 Installation-related Services
- Maximum Order: \$500,000.00 Net
- Minimum Order: \$100.00 Net
- Geographic Coverage: Worldwide
- Point of Production: Emigsville, PA 17318
- Discount from List Price:
  - 57.9% \$100.00 – \$74,999.00
  - 60.1% \$75,000 – \$500,000.00
- Prompt Payment Discount Terms: ½% 20 Days, Net 30 Days
- Government Purchase Cards are accepted.
- Foreign Items: None
- Delivery: 30-90 Days ARO, expedited and overnight delivery not on contract.
- Shipping Terms: F.O.B. Origin, Freight Prepay and Add. Contact Datum for freight quotes.
- ORDERING & PAYMENT ADDRESS:

Datum Filing Systems, Inc. dba/ Datum Storage Solutions  
89 Church Road  
P.O. Box 355  
Emigsville, PA 17318-0355

Phone: 800-828-8018  
Fax: 888-345-4641  
www.datumstorage.com  
gsa@datumstorage.com

**Datum Filing & Storage products on GSA contract are denoted with a single asterisk in the Table of Contents. Additionally, all Datum products in this Price Book are on GSA unless noted with a "NOT ON GSA" banner across the page or an asterisk after the item number and corresponding asterisk with "Item is not available in GSA contract". Pages containing product on GSA will have a GSA logo on the bottom outside corner of the page.**



# General Service Administration Terms & Conditions Authorized Federal Supply Schedule

- **Warranty Information:** Datum Storage Solutions warrants to the original purchaser for the life of the product that it shall be free of any defect in materials or workmanship, so long as the original purchaser is the owner and possessor of the product and the product is installed by a Datum Certified Installer. **For a period of two years from the date of shipment, Datum Storage Solutions will provide all labor free of charge** at the location of the product to repair or replace any part that fails because of such defects. After two years from date of shipment, labor will no longer be provided. All replacement parts will be supplied for the life of the product so long as all requirements are met as set forth in this warranty. This warranty does not include defects to the product resulting from accident, misuse, improper installation or operation, normal wear, neglect, unauthorized repair or alteration. The purchase of this product shall constitute a purchaser's agreement that the sole remedy for any breach of warranty shall be such repair or replacement as expressly provided above. In no event shall Datum Storage Solutions be liable for any incidental or consequential damages arising out of the use or inability to use the product for any purpose whatsoever. Effective January 1, 2015.
- **Export Packaging:** Not included in contract
- **Datum accepts government purchase cards.**
- **Rental, Maintenance and Repair:** Not Applicable
- **Terms of Installation Service:** For orders with a NET value of \$500.00 or less, the install price is \$75.00. Installation charges for orders with a NET value over \$500.00 will need to be negotiated between the Datum dealer and the customer
- **Cancellation Policy:** Cancellation must be submitted in writing and approved by Datum Storage Solutions. No charge prior to production. After production has begun only actual cost incurred will be billed to the government that cannot be recovered through resale in six months.
- **Return/Restocking Policy:** Datum Storage Solutions will accept the return of non-custom merchandise after shipment with prior authorization from Datum. Request must be submitted within 30 days of receipt of product. Product must be returned to Datum in resellable condition within 30 days after getting authorization from Datum. Returns will be subject to a 20% restocking charge, plus freight.

**Datum Filing & Storage products on GSA contract are denoted with a single asterisk in the Table of Contents. Additionally, all Datum products in this Price Book are on GSA unless noted with a "NOT ON GSA" banner across the page or an asterisk after the item number and corresponding asterisk with "Item is not available in GSA contract". Pages containing product on GSA will have a GSA logo on the bottom outside corner of the page.**

# 4Post™ Shelving General Information & Specifications

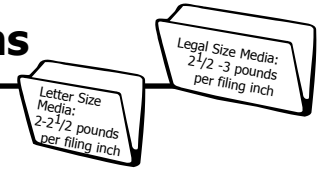

## GENERAL INFORMATION

**Product Description:** Datum Standard, Heavy, and Heavy Duty Plus Shelving offers exceptional strength and durability for a variety of storage applications. 4Post shelving incorporates both "L" & "T" shaped uprights allowing for a variety of shelving configurations. Interlocking keyhole uprights combined with double rivet shelf supports are designed to offer maximum strength and durability with exceptional versatility. All shelf units are assembled without the use of nuts, bolts, or clips and are available for both single entry (wall unit) and double entry (back to back storage) allowing for maximum filing/storage capacity with minimal floor intrusion. Shelves are available slotted to accept adjustable file dividers. All shelf units are designed for expansion and are available as mobile ready for easy conversion to Datum TrakSlider Systems. Datum 4Post Shelving is ready to assemble with no special tools required. Available depths make it an ideal choice for letter, legal, binder, and book storage applications.

## SPECIFICATIONS

**Open Uprights:** Are 18 gauge cold rolled steel, roll formed into a 2" wide "T" upright with keyhole slot holes punched on 1-1/2" centers on inner wall of upright only. There are no holes on the exterior portion of the upright. Front and rear posts are joined together with a minimum of three 3" high 18 gauge spacers maintaining proper upright spacing along the entire length of the upright and adds rigidity and strength. The open "L" upright is typically used for row ends with Open "T" uprights used as a common upright between shelf units. All uprights include an identifiable pair of punched holes every 6" on center allowing a visual confirmation for proper shelf spacing.

**Closed Uprights:** Includes same specifications as the Open Uprights except welded spacers are replaced with a welded 24 gauge full height closure sheet incorporating a 5/8" wide stiffener flange at the bottom of the closure sheet.

**Standard Duty Shelves:** Shelves are formed of 22 gauge cold rolled steel with a 3/4" flange on all sides. Front and Back shelf sides to include a 9/32" stiffener flange for added strength. Shelves are available plain or with slots punched on 2" centers to accept adjustable file dividers.

**Heavy Duty Shelves:** Include same specification as Standard Duty Shelving except shelves are formed of 18 gauge cold rolled steel.

**Heavy Duty Plus Shelves:** Include the same specification as Heavy Duty Shelving, except shelves include a 1-1/8" flange on all sides.

**TrakSlider Standard Duty Tops:** Tops are formed of 22 gauge cold rolled steel with a 3/4" flange on all sides. Front and Back top sides to include a 9/32" stiffener flange for added strength. All tops are prepunched with knock-outs to accept TrakSlider overhead anti-tip mounting hardware.

**Shelf Support:** Shelf supports are formed of 14 gauge (11 gauge for 42" and 48" widths) hot rolled pickled steel 3/4" high. Each support end is formed flat and includes two shoulder rivets with 7/16" diameter heads for attachment to corresponding keyholes in upright. Shelf supports are available with single or double rivets. All single rivet shelf supports are designed to sit flush with bottom of shelf upright and are prepunched to align with holes on Datum TrakSlider carriages for easy attachment.

**Shelf Reinforcement:** Shelf reinforcements are formed of 13 gauge hot rolled, pickled steel and formed into a channel shape. Shelf reinforcements are notched on each end and align with respective shelf support.

**Back Stops:** Back stops are formed of 18 gauge cold rolled steel with a 7/16" channel at the top and similar bend at the bottom and are slotted on the face. Slots on Back stops are punched on same centers as the shelf and are used to accept back tab of adjustable file divider. Ends of Back stop include one shoulder rivet with 7/16" diameter head for attachment to corresponding keyholes in upright. Back stops are used for single entry shelving only.

**Center Stops:** Center stops are formed of 20 gauge cold rolled steel with a 9/16" formed channel on the top and a 9/16" return bend on the bottom. Formed channels on the top are punched on same centers as the shelf and are used for back to back support of adjustable divider. The overall height of center stop is 4" and includes mounting holes on bottom flange for easy assembly using 1/4" nuts and bolts. Center stops are used for double entry shelving only.

**Kick Plate:** Kick Plates are formed of 14 or 16 gauge cold rolled steel formed with a stiffener flange on top and bottom edge. Kick Plates are available in 2" and 4" heights.

**Adjustable File Dividers:** File dividers are formed from 20 gauge cold rolled steel. Dividers are punched to include two tabs on the base and one located on the rear. File dividers can only be used with Back or Center stops.

**Sectional Backs:** Sectional backs are formed of 20 gauge cold rolled steel, positioned on the inner rear post, and are securely held in place by a formed retainer flange positioned between the shelf support and post. Each back section will include a formed channel on the top and bottom and include punched holes for joining sections together. Backs of 40" high are one-piece, 64" high are two-piece, and up to 97" are of three-piece construction. Sectional back panels will add 3/8" to overall depth of shelving.

**Pull Out Reference Shelves:** Pull out reference shelves shall be formed of 20 gauge cold rolled steel and attach to underside of shelf supports. Pull out reference shelves operate on full extension ball bearing suspensions and are available to mount on single or double entry shelving.

**Finish:** All steel parts are thoroughly cleaned using a three-stage iron phosphate washer and then coated with an Epoxy-Hybrid powder coat finish using a state-of-the-art electrostatic paint system. Powder coating is more environmentally friendly than liquid paint and provides a durable uniform finish that is scratch and corrosion resistant.



**FOR ADDITIONAL INFORMATION ON ORDERING, TERMS AND CONDITIONS, PRICING AND SHIPPING, REFER TO TERMS SECTION.**

# Preconfigured 64-1/4" High, 22 Gauge

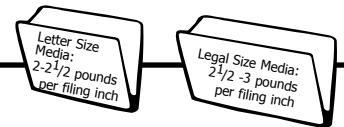

ALL PRECONFIGURED UNITS DO NOT INCLUDE DIVIDERS. PLEASE REFER TO PAGE 2d:43 FOR DIVIDER INFORMATION.

## 7 Shelves, 6 Openings

All shelves are placed on 10-1/2" centers for 9-3/4" clear vertical height. Shelf supports are adjustable on 1-1/2" centers. The following units are only available as Mobile Ready Shelving (see "For Mobile Ready Shelving" notes below). Utilizing reference shelves on the following units will result in the loss of clear vertical height within one shelf opening.

STARTER						
Item #	D	W	H	Est. Lbs.	List Price	
641224-S6M	12"	24"	64-1/4"	67	393.80	 Starter
641230-S6M	12"	30"	64-1/4"	78	399.40	
641236-S6M	12"	36"	64-1/4"	91	405.90	
641242-S6M	12"	42"	64-1/4"	114	476.60	
641248-S6M	12"	48"	64-1/4"	130	515.50	
642424-S6M*	24"	24"	64-1/4"	117	572.60	
642430-S6M*	24"	30"	64-1/4"	130	579.10	
642436-S6M*	24"	36"	64-1/4"	145	589.90	
642442-S6M**	24"	42"	64-1/4"	184	712.90	
642448-S6M**	24"	48"	64-1/4"	204	775.10	
641524-S6M	15"	24"	64-1/4"	79	447.60	 Adder
641530-S6M	15"	30"	64-1/4"	90	455.80	
641536-S6M	15"	36"	64-1/4"	103	463.30	
641542-S6M	15"	42"	64-1/4"	127	532.80	
641548-S6M	15"	48"	64-1/4"	141	579.90	
643024-S6M**	30"	24"	64-1/4"	141	692.10	
643030-S6M**	30"	30"	64-1/4"	161	699.60	
643036-S6M**	30"	36"	64-1/4"	183	709.30	
643042-S6M**	30"	42"	64-1/4"	203	828.00	
643048-S6M**	30"	48"	64-1/4"	242	897.30	

ADDER						
Item #	D	W	H	Est. Lbs.	List Price	
641224-A6M	12"	24"	64-1/4"	56	324.00	 Adder
641230-A6M	12"	30"	64-1/4"	66	329.50	
641236-A6M	12"	36"	64-1/4"	78	336.00	
641242-A6M	12"	42"	64-1/4"	101	406.40	
641248-A6M	12"	48"	64-1/4"	117	445.60	
642424-A6M*	24"	24"	64-1/4"	95	467.60	
642430-A6M*	24"	30"	64-1/4"	108	474.30	
642436-A6M*	24"	36"	64-1/4"	123	485.10	
642442-A6M**	24"	42"	64-1/4"	162	608.10	
642448-A6M**	24"	48"	64-1/4"	182	670.40	
641524-A6M	15"	24"	64-1/4"	63	367.00	 Adder
641530-A6M	15"	30"	64-1/4"	74	374.70	
641536-A6M	15"	36"	64-1/4"	87	382.20	
641542-A6M	15"	42"	64-1/4"	112	451.90	
641548-A6M	15"	48"	64-1/4"	125	499.10	
643024-A6M**	30"	24"	64-1/4"	118	560.50	
643030-A6M**	30"	30"	64-1/4"	137	568.00	
643036-A6M**	30"	36"	64-1/4"	158	578.00	
643042-A6M**	30"	42"	64-1/4"	178	696.30	
643048-A6M**	30"	48"	64-1/4"	207	765.70	

## 6 Shelves, 5 Openings

All shelves are placed on 12" centers for 11-1/4" clear vertical height. Shelf supports are adjustable on 1-1/2" centers. When ordering reference shelves for the following units, Mobile Ready Shelving must be ordered. Not specifying Mobile Ready Shelving will result in loss of clear vertical height within one shelf opening.

STARTER						
Item #	D	W	H	Est. Lbs.	List Price	
641224-S5	12"	24"	64-1/4"	61	362.80	 Starter
641230-S5	12"	30"	64-1/4"	70	367.60	
641236-S5	12"	36"	64-1/4"	81	373.70	
641242-S5	12"	42"	64-1/4"	103	434.70	
641248-S5	12"	48"	64-1/4"	115	468.80	
642424-S5*	24"	24"	64-1/4"	106	521.90	
642430-S5*	24"	30"	64-1/4"	117	527.90	
642436-S5*	24"	36"	64-1/4"	130	538.10	
642442-S5**	24"	42"	64-1/4"	162	643.80	
642448-S5**	24"	48"	64-1/4"	183	697.90	
641524-S5	15"	24"	64-1/4"	72	410.80	 Adder
641530-S5	15"	30"	64-1/4"	81	417.70	
641536-S5	15"	36"	64-1/4"	92	424.70	
641542-S5	15"	42"	64-1/4"	114	484.70	
641548-S5	15"	48"	64-1/4"	127	526.00	
643024-S5**	30"	24"	64-1/4"	132	628.70	
643030-S5**	30"	30"	64-1/4"	145	635.70	
643036-S5**	30"	36"	64-1/4"	160	644.70	
643042-S5**	30"	42"	64-1/4"	183	746.50	
643048-S5**	30"	48"	64-1/4"	208	806.70	

ADDER						
Item #	D	W	H	Est. Lbs.	List Price	
641224-A5	12"	24"	64-1/4"	42	292.60	 Adder
641230-A5	12"	30"	64-1/4"	57	297.70	
641236-A5	12"	36"	64-1/4"	74	303.60	
641242-A5	12"	42"	64-1/4"	90	364.90	
641248-A5	12"	48"	64-1/4"	104	398.80	
642424-A5*	24"	24"	64-1/4"	84	417.30	
642430-A5*	24"	30"	64-1/4"	95	423.20	
642436-A5*	24"	36"	64-1/4"	108	433.20	
642442-A5**	24"	42"	64-1/4"	140	539.10	
642488-A5**	24"	48"	64-1/4"	161	593.20	
641524-A5	15"	24"	64-1/4"	56	329.70	 Adder
641530-A5	15"	30"	64-1/4"	65	336.80	
641536-A5	15"	36"	64-1/4"	76	343.60	
641542-A5	15"	42"	64-1/4"	99	403.90	
641548-A5	15"	48"	64-1/4"	111	445.00	
643024-A5**	30"	24"	64-1/4"	111	497.10	
643030-A5**	30"	30"	64-1/4"	122	504.10	
643036-A5**	30"	36"	64-1/4"	135	513.00	
643042-A5**	30"	42"	64-1/4"	157	615.20	
643048-A5**	30"	48"	64-1/4"	182	675.20	

All units ship knocked down and bulk packed.

\*Includes one shelf reinforcement per shelf.

\*\*Includes two shelf reinforcements per shelf.

Shelf reinforcements are not included for top shelf.

Top shelves are unslotted and include prepunched knockout holes for TrakSlider hardware attachment.

All starter units include 2 closed "L" uprights and all adder units include 1 open "T" upright.

All units include 64-1/4" high uprights, and 2" high front base.

Shelves are 22 gauge designed for record storage. 18 gauge shelves are available, contact factory for more information.

### FOR MOBILE READY SHELVING

Add "M" to the end of the model number when ordering mobile ready shelving. For example: 641224-A5M

Single rivet shelf supports replace front Kick Plate and standard support on bottom shelf allowing for easy attachment to mobile carriages.

Holes are prepunched into single rivet support to match up with corresponding holes on Datum TrakSlider carriages.

When ordering mobile ready shelving to be used in conjunction with Datum TrakSlider Systems please refer to page 2d:69 for additional hardware needs.





# Preconfigured 64-1/4" High, 22 Gauge

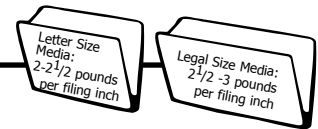

ALL PRECONFIGURED UNITS DO NOT INCLUDE DIVIDERS. PLEASE REFER TO PAGE 2d:43 FOR DIVIDER INFORMATION.

## 5 Shelves, 4 Openings

All shelves are placed on 13-1/2" centers for 12-3/4" clear vertical height. Shelf supports are adjustable on 1-1/2" centers.

	STARTER					
	Item #	D	W	H	Est. Lbs.	List Price
LETTER	641224-S4	12"	24"	64-1/4"	56	323.40
	641230-S4	12"	30"	64-1/4"	63	327.70
	641236-S4	12"	36"	64-1/4"	71	332.60
	641242-S4	12"	42"	64-1/4"	90	384.30
	641248-S4	12"	48"	64-1/4"	101	412.10
	642424-S4*	24"	24"	64-1/4"	95	462.50
	642430-S4*	24"	30"	64-1/4"	105	466.80
	642436-S4*	24"	36"	64-1/4"	115	475.70
	642442-S4**	24"	42"	64-1/4"	141	563.30
	642448-S4**	24"	48"	64-1/4"	162	611.70
LEGAL	641524-S4	15"	24"	64-1/4"	65	365.80
	641530-S4	15"	30"	64-1/4"	73	371.50
	641536-S4	15"	36"	64-1/4"	81	377.60
	641542-S4	15"	42"	64-1/4"	100	427.50
	641548-S4	15"	48"	64-1/4"	112	461.90
	643024-S4**	30"	24"	64-1/4"	118	550.60
	643030-S4**	30"	30"	64-1/4"	129	556.80
	643036-S4**	30"	36"	64-1/4"	141	564.50
	643042-S4**	30"	42"	64-1/4"	158	653.70
	643048-S4**	30"	48"	64-1/4"	182	703.70

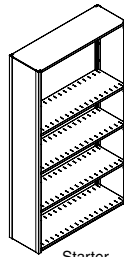

Starter

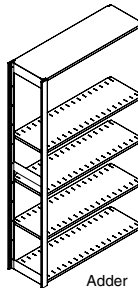

Adder

	ADDER					
	Item #	D	W	H	Est. Lbs.	List Price
LETTER	641224-A4	12"	24"	64-1/4"	37	253.70
	641230-A4	12"	30"	64-1/4"	50	257.80
	641236-A4	12"	36"	64-1/4"	64	262.90
	641242-A4	12"	42"	64-1/4"	77	314.20
	641248-A4	12"	48"	64-1/4"	90	342.10
	642424-A4*	24"	24"	64-1/4"	73	357.70
	642430-A4*	24"	30"	64-1/4"	83	361.80
	642436-A4*	24"	36"	64-1/4"	93	371.10
	642442-A4**	24"	42"	64-1/4"	119	458.60
	642448-A4**	24"	48"	64-1/4"	140	507.00
LEGAL	641524-A4	15"	24"	64-1/4"	49	284.80
	641530-A4	15"	30"	64-1/4"	57	290.80
	641536-A4	15"	36"	64-1/4"	65	296.50
	641542-A4	15"	42"	64-1/4"	85	346.70
	641548-A4	15"	48"	64-1/4"	96	380.80
	643024-A4**	30"	24"	64-1/4"	97	419.20
	643030-A4**	30"	30"	64-1/4"	106	425.50
	643036-A4**	30"	36"	64-1/4"	116	432.90
	643042-A4**	30"	42"	64-1/4"	132	522.20
	643048-A4**	30"	48"	64-1/4"	156	572.50

All units ship knocked down and bulk packed.

\*Includes one shelf reinforcement per shelf.

\*\*Includes two shelf reinforcements per shelf.

Shelf reinforcements are not included for top shelf.

Top shelves are unslotted and include prepunched knockout holes for TrakSlider hardware attachment.

All starter units include 2 closed "L" uprights and all adder units include 1 open "T" upright.

All units include 64-1/4" high uprights, and 2" high front base.

Shelves are 22 gauge designed for record storage. 18 gauge shelves are available, contact factory for more information.

### FOR MOBILE READY SHELVING

Add "M" to the end of the model number when ordering mobile ready shelving. For example: 641224-A5M

Single rivet shelf supports replace front Kick Plate and standard support on bottom shelf allowing for easy attachment to mobile carriages.

Holes are prepunched into single rivet support to match up with corresponding holes on Datum TrakSlider carriages.

When ordering mobile ready shelving to be used in conjunction with Datum TrakSlider Systems please refer to page 2d:69 for additional hardware needs.

# Preconfigured 76-1/4" High, 22 Gauge

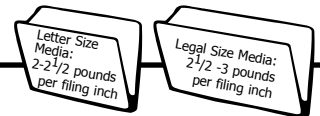

ALL PRECONFIGURED UNITS DO NOT INCLUDE DIVIDERS. PLEASE REFER TO PAGE 2d:43 FOR DIVIDER INFORMATION.

## 8 Shelves, 7 Openings

All shelves are placed on 10-1/2" centers for 9-3/4" clear vertical height. Shelf supports are adjustable on 1-1/2" centers. When ordering reference shelves for the following units, Mobile Ready Shelving must be ordered. Not specifying Mobile Ready Shelving will result in loss of clear vertical height within one shelf opening.

	STARTER					
	Item #	D	W	H	Est. Lbs.	List Price
LETTER	761224-S7	12"	24"	76-1/4"	75	446.30
	761230-S7	12"	30"	76-1/4"	90	453.70
	761236-S7	12"	36"	76-1/4"	107	461.20
	761242-S7	12"	42"	76-1/4"	139	543.00
	761248-S7	12"	48"	76-1/4"	158	588.30
	762424-S7*	24"	24"	76-1/4"	135	665.40
	762430-S7*	24"	30"	76-1/4"	153	674.80
	762436-S7*	24"	36"	76-1/4"	173	687.70
	762442-S7**	24"	42"	76-1/4"	218	830.70
	762448-S7**	24"	48"	76-1/4"	248	903.30
LEGAL	761524-S7	15"	24"	76-1/4"	84	505.80
	761530-S7	15"	30"	76-1/4"	101	515.60
	761536-S7	15"	36"	76-1/4"	120	524.80
	761542-S7	15"	42"	76-1/4"	153	604.90
	761548-S7	15"	48"	76-1/4"	171	659.80
	763024-S7**	30"	24"	76-1/4"	171	802.40
	763030-S7**	30"	30"	76-1/4"	191	813.20
	763036-S7**	30"	36"	76-1/4"	213	824.70
	763042-S7**	30"	42"	76-1/4"	249	962.80
	763048-S7**	30"	48"	76-1/4"	283	1,043.80

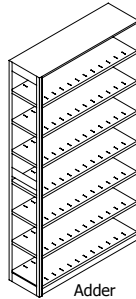
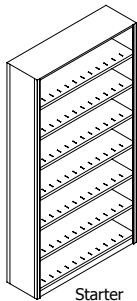

	ADDER					
	Item #	D	W	H	Est. Lbs.	List Price
LETTER	761224-A7	12"	24"	76-1/4"	61	374.30
	761230-A7	12"	30"	76-1/4"	75	381.80
	761236-A7	12"	36"	76-1/4"	91	389.30
	761242-A7	12"	42"	76-1/4"	123	471.00
	761248-A7	12"	48"	76-1/4"	143	516.30
	762424-A7*	24"	24"	76-1/4"	109	548.80
	762430-A7*	24"	30"	76-1/4"	126	558.30
	762436-A7*	24"	36"	76-1/4"	145	571.20
	762442-A7**	24"	42"	76-1/4"	190	714.10
	762448-A7**	24"	48"	76-1/4"	220	786.80
LEGAL	761524-A7	15"	24"	76-1/4"	70	423.30
	761530-A7	15"	30"	76-1/4"	84	433.50
	761536-A7	15"	36"	76-1/4"	100	442.40
	761542-A7	15"	42"	76-1/4"	133	522.60
	761548-A7	15"	48"	76-1/4"	151	577.30
	763024-A7**	30"	24"	76-1/4"	136	657.00
	763030-A7**	30"	30"	76-1/4"	157	668.00
	763036-A7**	30"	36"	76-1/4"	180	679.50
	763042-A7**	30"	42"	76-1/4"	216	817.60
	763048-A7**	30"	48"	76-1/4"	250	898.40

## 7 Shelves, 6 Openings

All shelves are placed on 12" centers for 11-1/4" clear vertical height. Shelf supports are adjustable on 1-1/2" centers.

	STARTER					
	Item #	D	W	H	Est. Lbs.	List Price
LETTER	761224-S6	12"	24"	76-1/4"	70	407.20
	761230-S6	12"	30"	76-1/4"	83	413.60
	761236-S6	12"	36"	76-1/4"	98	420.40
	761242-S6	12"	42"	76-1/4"	126	491.80
	761248-S6	12"	48"	76-1/4"	143	531.70
	762424-S6*	24"	24"	76-1/4"	123	605.90
	762430-S6*	24"	30"	76-1/4"	139	614.40
	762436-S6*	24"	36"	76-1/4"	157	625.40
	762442-S6**	24"	42"	76-1/4"	197	750.10
	762448-S6**	24"	48"	76-1/4"	223	813.80
LEGAL	761524-S6	15"	24"	76-1/4"	77	460.70
	761530-S6	15"	30"	76-1/4"	93	469.70
	761536-S6	15"	36"	76-1/4"	111	477.50
	761542-S6	15"	42"	76-1/4"	139	547.80
	761548-S6	15"	48"	76-1/4"	155	595.60
	763024-S6**	30"	24"	76-1/4"	155	730.30
	763030-S6**	30"	30"	76-1/4"	173	739.70
	763036-S6**	30"	36"	76-1/4"	193	749.70
	763042-S6**	30"	42"	76-1/4"	225	869.80
	763048-S6**	30"	48"	76-1/4"	255	940.70

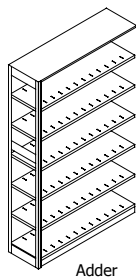
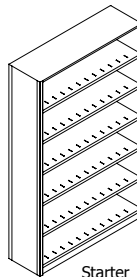

	ADDER					
	Item #	D	W	H	Est. Lbs.	List Price
LETTER	761224-A6	12"	24"	76-1/4"	54	335.30
	761230-A6	12"	30"	76-1/4"	67	341.90
	761236-A6	12"	36"	76-1/4"	82	348.40
	761242-A6	12"	42"	76-1/4"	110	419.80
	761248-A6	12"	48"	76-1/4"	128	459.70
	762424-A6*	24"	24"	76-1/4"	95	489.30
	762430-A6*	24"	30"	76-1/4"	111	497.80
	762436-A6*	24"	36"	76-1/4"	129	508.80
	762442-A6**	24"	42"	76-1/4"	169	633.60
	762448-A6**	24"	48"	76-1/4"	195	697.30
LEGAL	761524-A6	15"	24"	76-1/4"	64	378.40
	761530-A6	15"	30"	76-1/4"	76	387.40
	761536-A6	15"	36"	76-1/4"	90	395.20
	761542-A6	15"	42"	76-1/4"	119	465.60
	761548-A6	15"	48"	76-1/4"	135	513.40
	763024-A6**	30"	24"	76-1/4"	121	584.80
	763030-A6**	30"	30"	76-1/4"	139	594.50
	763036-A6**	30"	36"	76-1/4"	159	604.60
	763042-A6**	30"	42"	76-1/4"	191	724.80
	763048-A6**	30"	48"	76-1/4"	221	795.60

All units ship knocked down and bulk packed.

\*Includes one shelf reinforcement per shelf.

\*\*Includes two shelf reinforcements per shelf.

Shelf reinforcements are not included for top shelf.

Top shelves are unslotted and include prepunched knock out holes for TrakSlider hardware attachment.

All starter units include 2 closed "L" uprights and all adder units include 1 open "T" upright.

All units include 76-1/4" high uprights, and 2" high front base.

Shelves are 22 gauge designed for record storage. 18 gauge shelves are available, contact factory for more information.

### FOR MOBILE READY SHELVING

Add "M" to the end of the model number when ordering mobile ready shelving. For example: 761224-A6M

Single rivet shelf supports replace front Kick Plate and standard support on bottom shelf allowing for easy attachment to mobile carriages.

Holes are prepunched into single rivet support to match up with corresponding holes on Datum TrakSlider carriages.

When ordering mobile ready shelving to be used in conjunction with Datum TrakSlider Systems please refer to page 2d:69 for additional hardware needs.

# Preconfigured 76-1/4" High, 22 Gauge

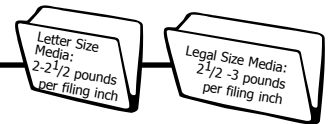

ALL PRECONFIGURED UNITS DO NOT INCLUDE DIVIDERS. PLEASE REFER TO PAGE 2d:43 FOR DIVIDER INFORMATION.

## 6 Shelves, 5 Openings

All shelves are placed on 13-1/2" centers for 12-3/4" clear vertical height. Shelf supports are adjustable on 1-1/2" centers.

	STARTER						
	Item #	D	W	H	Est. Lbs.	List Price	
LETTER	761224-S5	12"	24"	76-1/4"	65	368.10	
	761230-S5	12"	30"	76-1/4"	76	373.90	
	761236-S5	12"	36"	76-1/4"	88	379.50	
	761242-S5	12"	42"	76-1/4"	113	441.10	
	761248-S5	12"	48"	76-1/4"	129	474.90	
	762424-S5*	24"	24"	76-1/4"	112	546.60	
	762430-S5*	24"	30"	76-1/4"	127	553.20	
	762436-S5*	24"	36"	76-1/4"	142	563.50	
	762442-S5**	24"	42"	76-1/4"	176	669.60	
	762448-S5**	24"	48"	76-1/4"	202	727.70	
	LEGAL	761524-S5	15"	24"	76-1/4"	70	415.80
		761530-S5	15"	30"	76-1/4"	85	423.40
761536-S5		15"	36"	76-1/4"	100	430.10	
761542-S5		15"	42"	76-1/4"	125	490.50	
761548-S5		15"	48"	76-1/4"	140	531.70	
763024-S5**		30"	24"	76-1/4"	141	652.20	
763030-S5**		30"	30"	76-1/4"	157	661.10	
763036-S5**		30"	36"	76-1/4"	174	669.60	
763042-S5**		30"	42"	76-1/4"	200	777.10	
763048-S5**		30"	48"	76-1/4"	229	837.90	

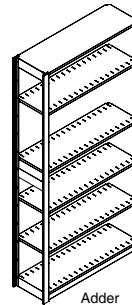
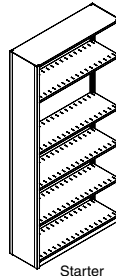

	ADDER						
	Item #	D	W	H	Est. Lbs.	List Price	
LETTER	761224-A5	12"	24"	76-1/4"	49	296.20	
	761230-A5	12"	30"	76-1/4"	60	302.00	
	761236-A5	12"	36"	76-1/4"	72	307.50	
	761242-A5	12"	42"	76-1/4"	97	369.50	
	761248-A5	12"	48"	76-1/4"	114	402.80	
	762424-A5*	24"	24"	76-1/4"	84	429.90	
	762430-A5*	24"	30"	76-1/4"	99	436.60	
	762436-A5*	24"	36"	76-1/4"	114	447.00	
	762442-A5**	24"	42"	76-1/4"	148	553.20	
	762448-A5**	24"	48"	76-1/4"	174	611.30	
	LEGAL	761524-A5	15"	24"	76-1/4"	57	333.60
		761530-A5	15"	30"	76-1/4"	68	341.20
761536-A5		15"	36"	76-1/4"	79	348.00	
761542-A5		15"	42"	76-1/4"	105	408.30	
761548-A5		15"	48"	76-1/4"	120	449.30	
763024-A5**		30"	24"	76-1/4"	107	506.90	
763030-A5**		30"	30"	76-1/4"	123	515.70	
763036-A5**		30"	36"	76-1/4"	140	524.60	
763042-A5**		30"	42"	76-1/4"	166	631.90	
763048-A5**		30"	48"	76-1/4"	195	692.70	

All units ship knocked down and bulk packed.  
 \*Includes one shelf reinforcement per shelf.  
 \*\*Includes two shelf reinforcements per shelf.  
 Shelf reinforcements are not included for top shelf.  
 Top shelves are unslotted and include prepunched knockout holes for TrakSlider hardware attachment.  
 All starter units include 2 closed "L" uprights and all adder units include 1 open "T" upright.  
 All units include 76-1/4" high uprights, and 2" high front base.  
 Shelves are 22 gauge designed for record storage. 18 gauge shelves are available, contact factory for more information.

### FOR MOBILE READY SHELVING

Add "M" to the end of the model number when ordering mobile ready shelving. For example: 641224-A5M  
 Single rivet shelf supports replace front Kick Plate and standard support on bottom shelf allowing for easy attachment to mobile carriages.  
 Holes are prepunched into single rivet support to match up with corresponding holes on Datum TrakSlider carriages.  
 When ordering mobile ready shelving to be used in conjunction with Datum TrakSlider Systems please refer to page 2d:69 for additional hardware needs.

# Preconfigured 85-1/4" High, 22 Gauge

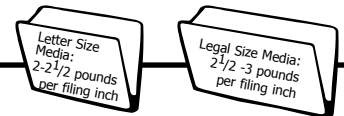

ALL PRECONFIGURED UNITS DO NOT INCLUDE DIVIDERS. PLEASE REFER TO PAGE 2d:43 FOR DIVIDER INFORMATION.

## 9 Shelves, 8 Openings

All shelves are placed on 10-1/2" centers for 9-3/4" clear vertical height. Shelf supports are adjustable on 1-1/2" centers. The following units are only available as Mobile Ready Shelving (see "For Mobile Ready Shelving" as noted below). Utilizing reference shelves on the following units will result in the loss of clear vertical height within one shelf opening.

	STARTER					
	Item #	D	W	H	Est Lbs.	List Price
LETTER	851224-S8M	12"	24"	85-1/4"	83	503.40
	851230-S8M	12"	30"	85-1/4"	101	511.60
	851236-S8M	12"	36"	85-1/4"	121	520.40
	851242-S8M	12"	42"	85-1/4"	157	611.90
	851248-S8M	12"	48"	85-1/4"	180	663.30
	852424-S8M*	24"	24"	85-1/4"	149	766.50
	852430-S8M*	24"	30"	85-1/4"	171	777.00
	852436-S8M*	24"	36"	85-1/4"	195	791.70
	852442-S8M**	24"	42"	85-1/4"	247	959.30
	852448-S8M**	24"	48"	85-1/4"	281	1,041.30
LEGAL	851524-S8M	15"	24"	85-1/4"	100	570.00
	851530-S8M	15"	30"	85-1/4"	117	581.10
	851536-S8M	15"	36"	85-1/4"	136	591.20
	851542-S8M	15"	42"	85-1/4"	173	681.60
	851548-S8M	15"	48"	85-1/4"	194	743.40
	853024-S8M**	30"	24"	85-1/4"	188	898.00
	853030-S8M**	30"	30"	85-1/4"	212	910.10
	853036-S8M**	30"	36"	85-1/4"	238	923.10
	853042-S8M**	30"	42"	85-1/4"	279	1,079.00
	853048-S8M**	30"	48"	85-1/4"	318	1,169.90

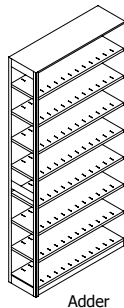
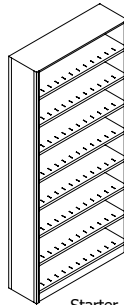

	ADDER					
	Item #	D	W	H	Est Lbs.	List Price
LETTER	851224-A8M	12"	24"	85-1/4"	66	420.50
	851230-A8M	12"	30"	85-1/4"	83	428.70
	851236-A8M	12"	36"	85-1/4"	102	437.40
	851242-A8M	12"	42"	85-1/4"	137	529.20
	851248-A8M	12"	48"	85-1/4"	160	580.40
	852424-A8M*	24"	24"	85-1/4"	121	620.50
	852430-A8M*	24"	30"	85-1/4"	141	630.90
	852436-A8M*	24"	36"	85-1/4"	163	645.40
	852442-A8M**	24"	42"	85-1/4"	215	813.30
	852448-A8M**	24"	48"	85-1/4"	249	895.30
LEGAL	851524-A8M	15"	24"	85-1/4"	75	475.40
	851530-A8M	15"	30"	85-1/4"	94	486.60
	851536-A8M	15"	36"	85-1/4"	113	497.00
	851542-A8M	15"	42"	85-1/4"	132	587.30
	851548-A8M	15"	48"	85-1/4"	151	648.80
	853024-A8M**	30"	24"	85-1/4"	135	735.90
	853030-A8M**	30"	30"	85-1/4"	169	747.90
	853036-A8M**	30"	36"	85-1/4"	203	761.00
	853042-A8M**	30"	42"	85-1/4"	237	916.90
	853048-A8M**	30"	48"	85-1/4"	271	1,007.80

## 8 Shelves, 7 Openings

All shelves are placed on 12" centers for 11-1/4" clear vertical height. Shelf supports are adjustable on 1-1/2" centers. The following units are only available as Mobile Ready Shelving (see "For Mobile Ready Shelving" as noted below). Utilizing reference shelves on the following units will result in the loss of clear vertical height within one shelf opening.

	STARTER					
	Item #	D	W	H	Est Lbs.	List Price
LETTER	851224-S7M	12"	24"	85-1/4"	81	456.40
	851230-S7M	12"	30"	85-1/4"	93	463.40
	851236-S7M	12"	36"	85-1/4"	111	470.70
	851242-S7M	12"	42"	85-1/4"	143	551.60
	851248-S7M	12"	48"	85-1/4"	163	596.60
	852424-S7M*	24"	24"	85-1/4"	139	697.30
	852430-S7M*	24"	30"	85-1/4"	158	706.50
	852436-S7M*	24"	36"	85-1/4"	179	718.30
	852442-S7M**	24"	42"	85-1/4"	225	865.70
	852448-S7M**	24"	48"	85-1/4"	255	938.00
LEGAL	851524-S7M	15"	24"	85-1/4"	94	517.20
	851530-S7M	15"	30"	85-1/4"	108	527.10
	851536-S7M	15"	36"	85-1/4"	124	535.60
	851542-S7M	15"	42"	85-1/4"	157	615.20
	851548-S7M	15"	48"	85-1/4"	175	669.20
	853024-S7M**	30"	24"	85-1/4"	160	817.00
	853030-S7M**	30"	30"	85-1/4"	195	827.10
	853036-S7M**	30"	36"	85-1/4"	217	837.90
	853042-S7M**	30"	42"	85-1/4"	254	974.60
	853048-S7M**	30"	48"	85-1/4"	288	1,055.00

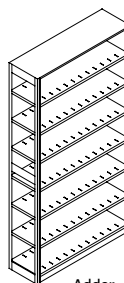
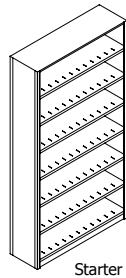

	ADDER					
	Item #	D	W	H	Est Lbs.	List Price
LETTER	851224-A7M	12"	24"	85-1/4"	61	373.70
	851230-A7M	12"	30"	85-1/4"	75	380.70
	851236-A7M	12"	36"	85-1/4"	91	387.70
	851242-A7M	12"	42"	85-1/4"	124	468.80
	851248-A7M	12"	48"	85-1/4"	144	513.60
	852424-A7M*	24"	24"	85-1/4"	109	551.30
	852430-A7M*	24"	30"	85-1/4"	127	560.40
	852436-A7M*	24"	36"	85-1/4"	147	572.50
	852442-A7M**	24"	42"	85-1/4"	193	719.80
	852448-A7M**	24"	48"	85-1/4"	223	791.90
LEGAL	851524-A7M	15"	24"	85-1/4"	68	422.90
	851530-A7M	15"	30"	85-1/4"	84	432.40
	851536-A7M	15"	36"	85-1/4"	102	440.90
	851542-A7M	15"	42"	85-1/4"	135	520.70
	851548-A7M	15"	48"	85-1/4"	153	574.60
	853024-A7M**	30"	24"	85-1/4"	140	654.80
	853030-A7M**	30"	30"	85-1/4"	160	665.30
	853036-A7M**	30"	36"	85-1/4"	182	675.80
	853042-A7M**	30"	42"	85-1/4"	219	812.50
	853048-A7M**	30"	48"	85-1/4"	253	892.70

All units ship knocked down and bulk packed.

\*Includes one shelf reinforcement per shelf.

\*\*Includes two shelf reinforcements per shelf.

Shelf reinforcements are not included for top shelf.

Top shelves are unslotted and include prepunched knock out holes for TrakSlider hardware attachment.

All starter units include 2 closed "L" uprights and all adder units include 1 open "T" upright.

All units include 85-1/4" high uprights, and 2" high front base.

Shelves are 22 gauge designed for record storage. 18 gauge shelves are available, contact factory for more information.

### FOR MOBILE READY SHELVING

Add "M" to the end of the model number when ordering mobile ready shelving. For example: 851224-A6M

Single rivet shelf supports replace front Kick Plate and standard support on bottom shelf allowing for easy attachment to mobile carriages.

Holes are prepunched into single rivet support to match up with corresponding holes on Datum TrakSlider carriages.

When ordering mobile ready shelving to be used in conjunction with Datum TrakSlider Systems please refer to page 2d:69 for additional hardware needs.



# Preconfigured 85-1/4" High, 22 Gauge

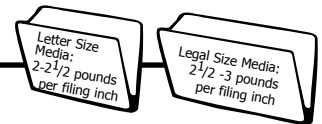

ALL PRECONFIGURED UNITS DO NOT INCLUDE DIVIDERS. PLEASE REFER TO PAGE 2d:43 FOR DIVIDER INFORMATION.

## 7 Shelves, 6 Openings

All shelves are placed on 13-1/2" centers for 12-3/4" clear vertical height. Shelf supports are adjustable on 1-1/2" centers.

	STARTER					
	Item #	D	W	H	Est Lbs.	List Price
LETTER	851224-S6	12"	24"	85-1/4"	75	401.80
	851230-S6	12"	30"	85-1/4"	86	423.40
	851236-S6	12"	36"	85-1/4"	101	429.80
	851242-S6	12"	42"	85-1/4"	130	500.50
	851248-S6	12"	48"	85-1/4"	149	539.70
	852424-S6*	24"	24"	85-1/4"	120	638.00
	852430-S6*	24"	30"	85-1/4"	146	646.30
	852436-S6*	24"	36"	85-1/4"	164	659.00
	852442-S6**	24"	42"	85-1/4"	205	789.70
	852448-S6**	24"	48"	85-1/4"	233	845.20
LEGAL	851524-S6	15"	24"	85-1/4"	86	472.40
	851530-S6	15"	30"	85-1/4"	100	480.80
	851536-S6	15"	36"	85-1/4"	113	488.20
	851542-S6	15"	42"	85-1/4"	143	558.00
	851548-S6	15"	48"	85-1/4"	160	604.90
	853024-S6**	30"	24"	85-1/4"	146	737.80
	853030-S6**	30"	30"	85-1/4"	179	748.70
	853036-S6**	30"	36"	85-1/4"	200	759.40
	853042-S6**	30"	42"	85-1/4"	229	881.60
	853048-S6**	30"	48"	85-1/4"	262	951.90

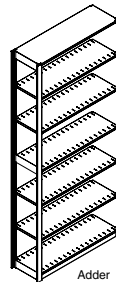
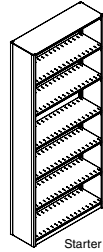

	ADDER					
	Item #	D	W	H	Est Lbs.	List Price
LETTER	851224-A6	12"	24"	85-1/4"	55	342.20
	851230-A6	12"	30"	85-1/4"	68	347.50
	851236-A6	12"	36"	85-1/4"	81	356.70
	851242-A6	12"	42"	85-1/4"	111	427.30
	851248-A6	12"	48"	85-1/4"	130	467.90
	852424-A6*	24"	24"	85-1/4"	98	491.80
	852430-A6*	24"	30"	85-1/4"	115	500.40
	852436-A6*	24"	36"	85-1/4"	132	512.80
	852442-A6**	24"	42"	85-1/4"	173	643.50
	852448-A6**	24"	48"	85-1/4"	201	699.10
LEGAL	851524-A6	15"	24"	85-1/4"	60	385.00
	851530-A6	15"	30"	85-1/4"	76	386.30
	851536-A6	15"	36"	85-1/4"	91	463.30
	851542-A6	15"	42"	85-1/4"	121	476.30
	851548-A6	15"	48"	85-1/4"	153	510.00
	853024-A6**	30"	24"	85-1/4"	127	576.70
	853030-A6**	30"	30"	85-1/4"	144	586.50
	853036-A6**	30"	36"	85-1/4"	165	597.30
	853042-A6**	30"	42"	85-1/4"	194	719.60
	853048-A6**	30"	48"	85-1/4"	227	789.80

All units ship knocked down and bulk packed.

\*Includes one shelf reinforcement per shelf.

\*\*Includes two shelf reinforcements per shelf.

Shelf reinforcements are not included for top shelf.

Top shelves are unslotted and include prepunched knockout holes for TrakSlider hardware attachment.

All starter units include 2 closed "L" uprights and all adder units include 1 open "T" upright.

All units include 85-1/4" high uprights, and 2" high front base.

Shelves are 22 gauge designed for record storage. 18 gauge shelves are available, contact factory for more information.

### FOR MOBILE READY SHELVING

Add "M" to the end of the model number when ordering mobile ready shelving. For example: 851224-A6M

Single rivet shelf supports replace front Kick Plate and standard support on bottom shelf allowing for easy attachment to mobile carriages.

Holes are prepunched into single rivet support to match up with corresponding holes on Datum TrakSlider carriages.

When ordering mobile ready shelving to be used in conjunction with Datum TrakSlider Systems please refer to page 2d:69 for additional hardware needs.



# Preconfigured 88-1/4" High, 22 Gauge

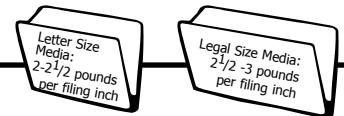

ALL PRECONFIGURED UNITS DO NOT INCLUDE DIVIDERS. PLEASE REFER TO PAGE 2d:43 FOR DIVIDER INFORMATION.

## 9 Shelves, 8 Openings

All shelves are placed on 10-1/2" centers for 9-3/4" clear vertical height. Shelf supports are adjustable on 1-1/2" centers.

	STARTER					
	Item #	D	W	H	Est Lbs.	List Price
LETTER	881224-S8	12"	24"	88-1/4"	84	503.40
	881230-S8	12"	30"	88-1/4"	102	511.60
	881236-S8	12"	36"	88-1/4"	122	520.40
	881242-S8	12"	42"	88-1/4"	158	611.90
	881248-S8	12"	48"	88-1/4"	181	663.30
	882424-S8*	24"	24"	88-1/4"	150	766.50
	882430-S8*	24"	30"	88-1/4"	172	777.00
	882436-S8*	24"	36"	88-1/4"	196	791.70
	882442-S8**	24"	42"	88-1/4"	248	959.30
	882448-S8**	24"	48"	88-1/4"	282	1,041.30
LEGAL	881524-S8	15"	24"	88-1/4"	101	570.00
	881530-S8	15"	30"	88-1/4"	118	581.10
	881536-S8	15"	36"	88-1/4"	137	591.20
	881542-S8	15"	42"	88-1/4"	174	681.60
	881548-S8	15"	48"	88-1/4"	195	743.40
	883024-S8**	30"	24"	88-1/4"	189	898.00
	883030-S8**	30"	30"	88-1/4"	213	910.10
	883036-S8**	30"	36"	88-1/4"	239	923.10
	883042-S8**	30"	42"	88-1/4"	280	1,079.00
	883048-S8**	30"	48"	88-1/4"	318	1,169.90

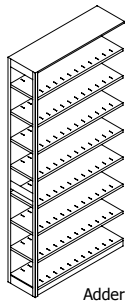
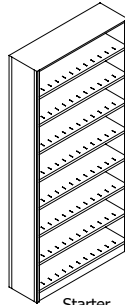

	ADDER					
	Item #	D	W	H	Est Lbs.	List Price
LETTER	881224-A8	12"	24"	88-1/4"	67	420.50
	881230-A8	12"	30"	88-1/4"	84	428.70
	881236-A8	12"	36"	88-1/4"	103	437.40
	881242-A8	12"	42"	88-1/4"	139	529.20
	881248-A8	12"	48"	88-1/4"	161	580.40
	882424-A8*	24"	24"	88-1/4"	122	620.50
	882430-A8*	24"	30"	88-1/4"	142	630.90
	882436-A8*	24"	36"	88-1/4"	164	645.40
	882442-A8**	24"	42"	88-1/4"	216	813.30
	882448-A8**	24"	48"	88-1/4"	250	895.30
LEGAL	881524-A8	15"	24"	88-1/4"	76	475.40
	881530-A8	15"	30"	88-1/4"	95	486.60
	881536-A8	15"	36"	88-1/4"	114	497.00
	881542-A8	15"	42"	88-1/4"	133	587.30
	881548-A8	15"	48"	88-1/4"	152	648.80
	883024-A8**	30"	24"	88-1/4"	136	735.90
	883030-A8**	30"	30"	88-1/4"	170	747.90
	883036-A8**	30"	36"	88-1/4"	204	761.00
	883042-A8**	30"	42"	88-1/4"	238	916.90
	883048-A8**	30"	48"	88-1/4"	272	1,007.80

## 8 Shelves, 7 Openings

All shelves are placed on 12" centers for 11-1/4" clear vertical height. Shelf supports are adjustable on 1-1/2" centers.

	STARTER					
	Item #	D	W	H	Est Lbs.	List Price
LETTER	881224-S7	12"	24"	88-1/4"	82	456.40
	881230-S7	12"	30"	88-1/4"	94	463.40
	881236-S7	12"	36"	88-1/4"	112	470.70
	881242-S7	12"	42"	88-1/4"	144	551.60
	881248-S7	12"	48"	88-1/4"	164	596.60
	882424-S7*	24"	24"	88-1/4"	140	697.30
	882430-S7*	24"	30"	88-1/4"	159	706.50
	882436-S7*	24"	36"	88-1/4"	180	718.30
	882442-S7**	24"	42"	88-1/4"	226	865.70
	882448-S7**	24"	48"	88-1/4"	256	938.00
LEGAL	881524-S7	15"	24"	88-1/4"	95	517.20
	881530-S7	15"	30"	88-1/4"	109	527.10
	881536-S7	15"	36"	88-1/4"	125	535.60
	881542-S7	15"	42"	88-1/4"	158	615.20
	881548-S7	15"	48"	88-1/4"	176	669.20
	883024-S7**	30"	24"	88-1/4"	176	817.00
	883030-S7**	30"	30"	88-1/4"	196	827.10
	883036-S7**	30"	36"	88-1/4"	218	837.90
	883042-S7**	30"	42"	88-1/4"	255	974.60
	883048-S7**	30"	48"	88-1/4"	289	1,055.00

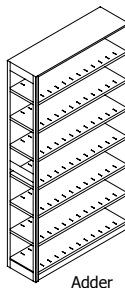
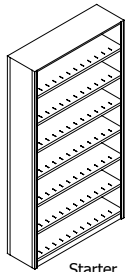

	ADDER					
	Item #	D	W	H	Est Lbs.	List Price
LETTER	881224-A7	12"	24"	88-1/4"	62	373.70
	881230-A7	12"	30"	88-1/4"	76	380.70
	881236-A7	12"	36"	88-1/4"	92	387.70
	881242-A7	12"	42"	88-1/4"	125	468.80
	881248-A7	12"	48"	88-1/4"	145	513.60
	882424-A7*	24"	24"	88-1/4"	110	551.30
	882430-A7*	24"	30"	88-1/4"	128	560.40
	882436-A7*	24"	36"	88-1/4"	148	572.50
	882442-A7**	24"	42"	88-1/4"	194	719.80
	882448-A7**	24"	48"	88-1/4"	224	791.90
LEGAL	881524-A7	15"	24"	88-1/4"	69	422.90
	881530-A7	15"	30"	88-1/4"	85	432.40
	881536-A7	15"	36"	88-1/4"	103	440.90
	881542-A7	15"	42"	88-1/4"	136	520.70
	881548-A7	15"	48"	88-1/4"	154	574.60
	883024-A7**	30"	24"	88-1/4"	141	654.80
	883030-A7**	30"	30"	88-1/4"	161	665.30
	883036-A7**	30"	36"	88-1/4"	183	675.80
	883042-A7**	30"	42"	88-1/4"	220	812.50
	883048-A7**	30"	48"	88-1/4"	254	892.70

All units ship knocked down and bulk packed.

\*Includes one shelf reinforcement per shelf.

\*\*Includes two shelf reinforcements per shelf.

Shelf reinforcements are not included for top shelf.

Top shelves are unslotted and include prepunched knock out holes for TrakSlider hardware attachment.

All starter units include 2 closed "L" uprights and all adder units include 1 open "T" upright.

All units include 88-1/4" high uprights, and 2" high front base.

Shelves are 22 gauge designed for record storage. 18 gauge shelves are available, contact factory for more information.

### FOR MOBILE READY SHELVING

Add "M" to the end of the model number when ordering mobile ready shelving. For example: 881224-A6M

Single rivet shelf supports replace front Kick Plate and standard support on bottom shelf allowing for easy attachment to mobile carriages.

Holes are prepunched into single rivet support to match up with corresponding holes on Datum TrakSlider carriages.

When ordering mobile ready shelving to be used in conjunction with Datum TrakSlider Systems please refer to page 2d:69 for additional hardware needs.



# Preconfigured 88-1/4" High, 22 Gauge

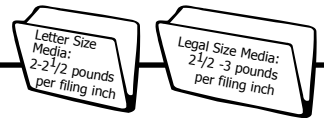

ALL PRECONFIGURED UNITS DO NOT INCLUDE DIVIDERS. PLEASE REFER TO PAGE 2d:43 FOR DIVIDER INFORMATION.

## 7 Shelves, 6 Openings

All shelves are placed on 13-1/2" centers for 12-3/4" clear vertical height. Shelf supports are adjustable on 1-1/2" centers.

	STARTER					
	Item #	D	W	H	Est Lbs.	List Price
<b>LETTER</b>	881224-S6	12"	24"	88-1/4"	75	417.50
	881230-S6	12"	30"	88-1/4"	87	423.40
	881236-S6	12"	36"	88-1/4"	102	429.80
	881242-S6	12"	42"	88-1/4"	131	501.10
	881248-S6	12"	48"	88-1/4"	150	539.70
	882424-S6*	24"	24"	88-1/4"	129	638.00
	882430-S6*	24"	30"	88-1/4"	147	645.20
	882436-S6*	24"	36"	88-1/4"	165	656.20
	882442-S6**	24"	42"	88-1/4"	205	785.40
	882448-S6**	24"	48"	88-1/4"	235	851.80
<b>LEGAL</b>	881524-S6	15"	24"	88-1/4"	75	472.40
	881530-S6	15"	30"	88-1/4"	101	480.80
	881536-S6	15"	36"	88-1/4"	114	488.20
	881542-S6	15"	42"	88-1/4"	144	558.00
	881548-S6	15"	48"	88-1/4"	161	604.90
	883024-S6**	30"	24"	88-1/4"	162	738.90
	883030-S6**	30"	30"	88-1/4"	180	748.70
	883036-S6**	30"	36"	88-1/4"	199	757.70
	883042-S6**	30"	42"	88-1/4"	230	881.80
	883048-S6**	30"	48"	88-1/4"	263	951.90

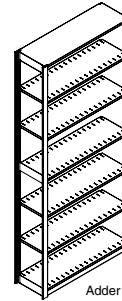
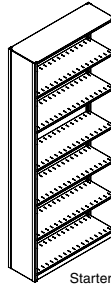

	ADDER					
	Item #	D	W	H	Est Lbs.	List Price
	881224-A6	12"	24"	88-1/4"	57	334.60
	881230-A6	12"	30"	88-1/4"	69	340.80
	881236-A6	12"	36"	88-1/4"	82	347.00
	881242-A6	12"	42"	88-1/4"	112	418.10
	881248-A6	12"	48"	88-1/4"	131	456.60
	882424-A6*	24"	24"	88-1/4"	99	491.80
	882430-A6*	24"	30"	88-1/4"	116	499.10
	882436-A6*	24"	36"	88-1/4"	133	510.20
	882442-A6**	24"	42"	88-1/4"	173	639.40
	882448-A6**	24"	48"	88-1/4"	203	705.70
	881524-A6	15"	24"	88-1/4"	55	383.00
	881530-A6	15"	30"	88-1/4"	77	386.30
	881536-A6	15"	36"	88-1/4"	92	393.70
	881542-A6	15"	42"	88-1/4"	122	463.30
	881548-A6	15"	48"	88-1/4"	139	510.60
	883024-A6**	30"	24"	88-1/4"	127	576.90
	883030-A6**	30"	30"	88-1/4"	145	586.50
	883036-A6**	30"	36"	88-1/4"	164	595.60
	883042-A6**	30"	42"	88-1/4"	195	719.80
	883048-A6**	30"	48"	88-1/4"	228	789.80

All units ship knocked down and bulk packed.

\*Includes one shelf reinforcement per shelf.

\*\*Includes two shelf reinforcements per shelf.

Shelf reinforcements are not included for top shelf.

Top shelves are unslotted and include prepunched knockout holes for TrakSlider hardware attachment.

All starter units include 2 closed "L" uprights and all adder units include 1 open "T" upright.

All units include 88-1/4" high uprights, and 2" high front base.

Shelves are 22 gauge designed for record storage. 18 gauge shelves are available, contact factory for more information.

### FOR MOBILE READY SHELVING

Add "M" to the end of the model number when ordering mobile ready shelving. For example: 881224-A6M

Single rivet shelf supports replace front Kick Plate and standard support on bottom shelf allowing for easy attachment to mobile carriages.

Holes are prepunched into single rivet support to match up with corresponding holes on Datum TrakSlider carriages.

When ordering mobile ready shelving to be used in conjunction with Datum TrakSlider Systems please refer to page 2d:69 for additional hardware needs.

# Preconfigured 97-1/4" High, 22 Gauge

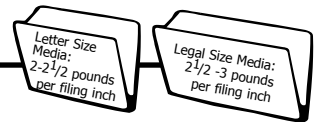

ALL PRECONFIGURED UNITS DO NOT INCLUDE DIVIDERS. PLEASE REFER TO PAGE 2d:43 FOR DIVIDER INFORMATION.

## 10 Shelves, 9 Openings

All shelves are placed on 10-1/2" centers for 9-3/4" clear vertical height. Shelf supports are adjustable on 1-1/2" centers. When ordering reference shelves for the following units, Mobile Ready Shelving must be ordered. Not specifying Mobile Ready Shelving will result in loss of clear vertical height within one shelf opening.

STARTER		Item #	D	W	H	Est Lbs.	List Price
LETTER	971224-S9	12"	24"	97-1/4"	98	595.20	
	971230-S9	12"	30"	97-1/4"	114	604.30	
	971236-S9	12"	36"	97-1/4"	132	614.00	
	971242-S9	12"	42"	97-1/4"	168	716.00	
	971248-S9	12"	48"	97-1/4"	192	772.70	
	972424-S9*	24"	24"	97-1/4"	171	888.70	
	972430-S9*	24"	30"	97-1/4"	191	900.00	
	972436-S9*	24"	36"	97-1/4"	213	916.30	
	972442-S9**	24"	42"	97-1/4"	266	1,103.30	
	972448-S9**	24"	48"	97-1/4"	300	1,194.20	
LEGAL	971524-S9	15"	24"	97-1/4"	95	675.10	
	971530-S9	15"	30"	97-1/4"	131	687.50	
	971536-S9	15"	36"	97-1/4"	169	698.90	
	971542-S9	15"	42"	97-1/4"	186	799.30	
	971548-S9	15"	48"	97-1/4"	207	867.60	
	973024-S9**	30"	24"	97-1/4"	214	1,050.70	
	973030-S9**	30"	30"	97-1/4"	237	1,063.90	
	973036-S9**	30"	36"	97-1/4"	262	1,154.40	
	973042-S9**	30"	42"	97-1/4"	299	1,252.20	
	973048-S9**	30"	48"	97-1/4"	341	1,353.00	

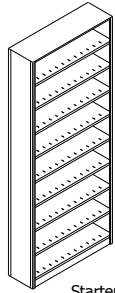

Starter

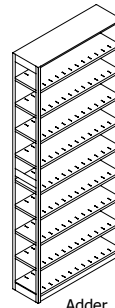

Adder

ADDER		Item #	D	W	H	Est Lbs.	List Price
971224-A9	12"	24"	97-1/4"	76	482.80		
971230-A9	12"	30"	97-1/4"	92	491.90		
971236-A9	12"	36"	97-1/4"	110	502.50		
971242-A9	12"	42"	97-1/4"	146	603.60		
971248-A9	12"	48"	97-1/4"	170	660.40		
972424-A9*	24"	24"	97-1/4"	139	703.10		
972430-A9*	24"	30"	97-1/4"	158	714.60		
972436-A9*	24"	36"	97-1/4"	179	731.00		
972442-A9**	24"	42"	97-1/4"	232	917.80		
972448-A9**	24"	48"	97-1/4"	266	1,008.70		
971524-A9	15"	24"	97-1/4"	89	545.40		
971530-A9	15"	30"	97-1/4"	106	557.50		
971536-A9	15"	36"	97-1/4"	125	569.00		
971542-A9	15"	42"	97-1/4"	162	669.20		
971548-A9	15"	48"	97-1/4"	183	737.80		
973024-A9**	30"	24"	97-1/4"	176	829.60		
973030-A9**	30"	30"	97-1/4"	199	842.60		
973036-A9**	30"	36"	97-1/4"	224	857.30		
973042-A9**	30"	42"	97-1/4"	260	1,030.90		
973048-A9**	30"	48"	97-1/4"	303	1,131.90		

## 9 Shelves, 8 Openings

All shelves are placed on 12" centers for 11-1/4" clear vertical height. Shelf supports are adjustable on 1-1/2" centers. The following units are only available as Mobile Ready Shelving (see "For Mobile Ready Shelving" notes below). Utilizing reference shelves on the following units will result in the loss of clear vertical height within one shelf opening.

STARTER		Item #	D	W	H	Est Lbs.	List Price
LETTER	971224-S8M	12"	24"	97-1/4"	92	556.20	
	971230-S8M	12"	30"	97-1/4"	106	564.30	
	971236-S8M	12"	36"	97-1/4"	122	573.00	
	971242-S8M	12"	42"	97-1/4"	153	664.90	
	971248-S8M	12"	48"	97-1/4"	173	716.00	
	972424-S8M*	24"	24"	97-1/4"	160	828.20	
	972430-S8M*	24"	30"	97-1/4"	177	838.80	
	972436-S8M*	24"	36"	97-1/4"	196	853.40	
	972442-S8M**	24"	42"	97-1/4"	241	1,021.50	
	972448-S8M**	24"	48"	97-1/4"	272	1,103.10	
LEGAL	971524-S8M	15"	24"	97-1/4"	108	630.20	
	971530-S8M	15"	30"	97-1/4"	122	641.40	
	971536-S8M	15"	36"	97-1/4"	138	651.80	
	971542-S8M	15"	42"	97-1/4"	169	741.90	
	971548-S8M	15"	48"	97-1/4"	188	803.40	
	973024-S8M**	30"	24"	97-1/4"	200	941.00	
	973030-S8M**	30"	30"	97-1/4"	220	990.30	
	973036-S8M**	30"	36"	97-1/4"	242	1,003.50	
	973042-S8M**	30"	42"	97-1/4"	273	1,159.30	
	973048-S8M**	30"	48"	97-1/4"	310	1,250.00	

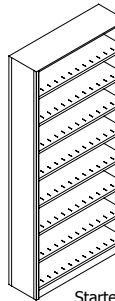

Starter

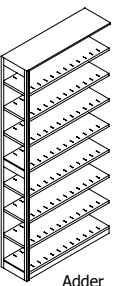

Adder

ADDER		Item #	D	W	H	Est Lbs.	List Price
971224-A8M	12"	24"	97-1/4"	70	443.80		
971230-A8M	12"	30"	97-1/4"	84	452.00		
971236-A8M	12"	36"	97-1/4"	100	460.70		
971242-A8M	12"	42"	97-1/4"	131	552.50		
971248-A8M	12"	48"	97-1/4"	151	603.60		
972424-A8M*	24"	24"	97-1/4"	126	627.30		
972430-A8M*	24"	30"	97-1/4"	143	637.90		
972436-A8M*	24"	36"	97-1/4"	162	652.30		
972442-A8M**	24"	42"	97-1/4"	208	820.20		
972448-A8M**	24"	48"	97-1/4"	239	901.90		
971524-A8M	15"	24"	97-1/4"	82	500.40		
971530-A8M	15"	30"	97-1/4"	97	511.60		
971536-A8M	15"	36"	97-1/4"	114	521.60		
971542-A8M	15"	42"	97-1/4"	145	612.00		
971548-A8M	15"	48"	97-1/4"	164	673.30		
973024-A8M**	30"	24"	97-1/4"	161	757.30		
973030-A8M**	30"	30"	97-1/4"	181	773.10		
973036-A8M**	30"	36"	97-1/4"	203	782.20		
973042-A8M**	30"	42"	97-1/4"	234	938.10		
973048-A8M**	30"	48"	97-1/4"	272	1,029.00		

All units ship knocked down and bulk packed.

\*Includes one shelf reinforcement per shelf.

\*\*Includes two shelf reinforcements per shelf.

Shelf reinforcements are not included for top shelf.

Top shelves are unslotted and include prepunched knockout holes for TrakSlider hardware attachment.

All starter units include 2 closed "L" uprights and all adder units include 1 open "T" upright.

All units include 97-1/4" high uprights, and 2" high front base.

Shelves are 22 gauge designed for record storage. 18 gauge shelves are available, contact factory for more information.

### FOR MOBILE READY SHELVING

Add "M" to the end of the model number when ordering mobile ready shelving. For example: 971224-A8M

Single rivet shelf supports replace front Kick Plate and standard support on bottom shelf allowing for easy attachment to mobile carriages.

Holes are prepunched into single rivet support to match up with corresponding holes on Datum TrakSlider carriages.

When ordering mobile ready shelving to be used in conjunction with Datum TrakSlider Systems please refer to page 2d:69 for additional hardware needs.





# Preconfigured 97-1/4" High, 22 Gauge

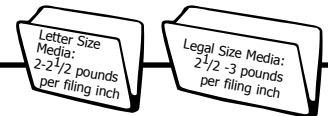

ALL PRECONFIGURED UNITS DO NOT INCLUDE DIVIDERS. PLEASE REFER TO PAGE 2d:43 FOR DIVIDER INFORMATION.

## 8 Shelves, 7 Openings

All shelves are placed on 13" centers for 12" clear vertical height. Shelf supports are adjustable on 1-1/2" centers. When ordering reference shelves for the following units, Mobile Ready Shelving must be ordered. Not specifying Mobile Ready Shelving will result in loss of clear vertical height within one shelf opening.

	STARTER					
	Item #	D	W	H	Est Lbs.	List Price
LETTER	971224-S7	12"	24"	97-1/4"	87	517.00
	971230-S7	12"	30"	97-1/4"	99	524.40
	971236-S7	12"	36"	97-1/4"	112	532.20
	971242-S7	12"	42"	97-1/4"	140	614.20
	971248-S7	12"	48"	97-1/4"	159	659.30
	972424-S7*	24"	24"	97-1/4"	149	768.80
	972430-S7*	24"	30"	97-1/4"	165	777.40
	972436-S7*	24"	36"	97-1/4"	181	791.30
	972442-S7**	24"	42"	97-1/4"	220	940.90
	972448-S7**	24"	48"	97-1/4"	251	1,016.90
LEGAL	971524-S7	15"	24"	97-1/4"	101	585.30
	971530-S7	15"	30"	97-1/4"	114	601.70
	971536-S7	15"	36"	97-1/4"	127	604.30
	971542-S7	15"	42"	97-1/4"	155	685.20
	971548-S7	15"	48"	97-1/4"	173	739.50
	973024-S7**	30"	24"	97-1/4"	186	900.50
	973030-S7**	30"	30"	97-1/4"	204	911.90
	973036-S7**	30"	36"	97-1/4"	223	926.50
	973042-S7**	30"	42"	97-1/4"	248	1,066.50
	973048-S7**	30"	48"	97-1/4"	284	1,147.20

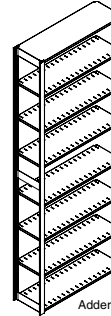
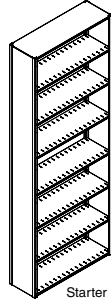

	ADDER					
	Item #	D	W	H	Est Lbs.	List Price
LETTER	971224-A7	12"	24"	97-1/4"	65	404.90
	971230-A7	12"	30"	97-1/4"	77	412.20
	971236-A7	12"	36"	97-1/4"	90	419.70
	971242-A7	12"	42"	97-1/4"	118	501.80
	971248-A7	12"	48"	97-1/4"	137	546.90
	972424-A7*	24"	24"	97-1/4"	115	583.40
	972430-A7*	24"	30"	97-1/4"	131	592.30
	972436-A7*	24"	36"	97-1/4"	147	605.80
	972442-A7**	24"	42"	97-1/4"	187	755.30
	972448-A7**	24"	48"	97-1/4"	218	831.40
LEGAL	971524-A7	15"	24"	97-1/4"	75	455.40
	971530-A7	15"	30"	97-1/4"	89	465.40
	971536-A7	15"	36"	97-1/4"	103	474.40
	971542-A7	15"	42"	97-1/4"	131	554.90
	971548-A7	15"	48"	97-1/4"	149	609.50
	973024-A7**	30"	24"	97-1/4"	147	679.20
	973030-A7**	30"	30"	97-1/4"	165	690.60
	973036-A7**	30"	36"	97-1/4"	184	702.00
	973042-A7**	30"	42"	97-1/4"	209	845.30
	973048-A7**	30"	48"	97-1/4"	246	926.10

All units ship knocked down and bulk packed.  
 \*Includes one shelf reinforcement per shelf.  
 \*\*Includes two shelf reinforcements per shelf.  
 Shelf reinforcements are not included for top shelf.  
 Top shelves are unslotted & include prepunched knockout holes for TrakSlider hardware attachment.  
 All starter units include 2 closed "L" uprights and all adder units include 1 open "T" upright.  
 All units include 97-1/4" high uprights, and 2" high front base.  
 Shelves are 22 gauge designed for record storage. 18 gauge shelves are available, contact factory for more information.

### FOR MOBILE READY SHELVING

Add "M" to the end of the model number when ordering mobile ready shelving. For example: 971224-A8M  
 Single rivet shelf supports replace front Kick Plate and standard support on bottom shelf allowing for easy attachment to mobile carriages.  
 Holes are prepunched into single rivet support to match up with corresponding holes on Datum TrakSlider carriages.  
 When ordering mobile ready shelving to be used in conjunction with Datum TrakSlider Systems please refer to page 2d:69 for additional hardware needs.

# Library Shelving General Information & Specifications



## GENERAL INFORMATION

**Product Description:** Datum Library Shelving offers exceptional strength and durability for a variety of storage applications. 4Post shelving incorporates both "L" & "T" shaped uprights allowing for a variety of shelving configurations. Interlocking keyhole uprights combined with double rivet shelf supports are designed to offer maximum strength and durability with exceptional versatility. All shelf units are assembled without the use of nuts, bolts, or clips and are available for both single entry (wall unit) and double entry (back to back storage) allowing for maximum filing/storage capacity with minimal floor intrusion. Shelves are available slotted to accept adjustable file dividers. All shelf units are designed for expansion and are available as mobile ready for easy conversion to Datum TrakSlider Systems. Datum 4Post Shelving is ready to assemble with no special tools required. Available in a variety of depths making it an ideal choice for storage applications.

## SPECIFICATIONS

**Closed Uprights:** Are 18 gauge cold rolled steel, roll formed into a 1" wide "L" and 2" wide "T" uprights with keyhole slot holes punched on 1-1/2" centers on inner wall of upright only. There are no holes on the exterior portion of the upright. Front and rear posts are joined together with 24 gauge double wall fillers that maintains the proper upright spacing along the entire length of the upright and adds rigidity and strength. The double wall construction of our uprights helps conceal the keyhole slots presenting a clean and contemporary appearance, while preventing books from having their titles obscured. All uprights include an identifiable pair of punched holes every 6" on center allowing a visual confirmation for proper shelf spacing.

**Library Shelves:** Shelves are formed of 22 gauge cold rolled steel with a 3/4" flange on all sides. Front and Back shelf sides to include a 9/32" stiffener flange for added strength. Shelves are available plain or with slots punched on 2" centers to accept adjustable dividers.

**TrakSlider Library Tops:** Tops are formed of 22 gauge cold rolled steel with a 3/4" flange on all sides. Front and Back top sides to include a 9/32" stiffener flange for added strength. All tops are prepunched with knock-outs to accept TrakSlider overhead anti-tip mounting hardware.

**Shelf Support:** Shelf supports are formed of 14 gauge (11 gauge for 42" and 48" widths) hot rolled pickled steel 3/4" high. Each support end is formed flat and includes two shoulder rivets with 7/16" diameter heads for attachment to corresponding keyholes in upright. Shelf supports are available with single or double rivets. All single rivet shelf supports are designed to sit flush with bottom of shelf upright and are prepunched to align with holes on Datum TrakSlider carriages for easy attachment.

**Shelf Reinforcement:** Shelf reinforcements are formed of 13 gauge hot roll, pickled steel and formed into a channel shape. Shelf reinforcements are notched on each end and align with respective shelf support.

**Back Stops:** Back stops are formed of 18 gauge cold rolled steel with a 7/16" channel at the top and similar bend at the bottom and are slotted on the face. Slots on Back stops are punched on same centers as the shelf and are used to accept back tab of adjustable divider. Ends of Back stop include one shoulder rivet with 7/16" diameter head for attachment to corresponding keyholes in upright. Back stops are used for single entry shelving only.

**Center Stops:** Center stops are formed of 20 gauge cold rolled steel with a 9/16" formed channel on the top and a 9/16" return bend on the bottom. Formed channels on the top are punched on same centers as the shelf and are used for back to back support of adjustable divider. The overall height of center stop is 4" and includes mounting holes on bottom flange for easy assembly using 1/4" nuts and bolts. Center stops are used for double entry shelving only.

**Kick Plate:** Kick Plates are formed of 14 or 16 gauge cold rolled steel formed with a stiffener flange on top and bottom edge. Kick Plates are available in 2" and 4" heights.

**Adjustable Dividers:** Dividers are formed from 20 gauge cold rolled steel. Dividers are punched to include two tabs on the base and one located on the rear. Dividers can only be used with Back or Center stops.

**Sectional Backs:** Sectional backs are formed of 22 gauge cold rolled steel, positioned on the inner rear post, and are securely held in place by a formed retainer flange positioned between the shelf support and post. Each back section will include a formed channel on the top and bottom and include punched holes for joining sections together. Backs of 40" high are one-piece, 64" high are two-piece, and up to 97" are three-piece construction. Sectional back panels will add 3/8" to overall depth of shelving.

**Pull Out Reference Shelves:** Pull out reference shelves shall be formed of 20 gauge cold rolled steel and attach to underside of shelf supports. Pull out reference shelves operate on full extension ball bearing suspensions and are available to mount on single or double entry shelving.

**Finish:** All steel parts are thoroughly cleaned using a three-stage iron phosphate washer and then coated with an Epoxy-Hybrid powder coat finish using a state-of-the-art electrostatic paint system. Powder coating provides a superior, attractive, uniform finish that is more durable, scratch and corrosion resistant, and environmentally friendly than liquid paint.



**FOR ADDITIONAL INFORMATION ON ORDERING, TERMS AND CONDITIONS, PRICING AND SHIPPING, REFER TO PAGE TERMS SECTION.**

# Preconfigured 76-1/4" High Library, 22 Gauge

Book Size  
Media:  
3-3 1/2  
pounds per  
filing inch

All preconfigured units do not include dividers. Please refer to page 2d:43 for divider information.

## 7 Shelves, 6 Openings

All shelves are placed on 12" centers for 11-1/4" clear vertical height. Shelf supports are adjustable on 1-1/2" centers. Shelves are unslotted and cannot accept dividers. Closed backs are sold separately, refer to page 44 for more information.

S  
S  
L  
O  
T  
T  
E  
D  
S  
H  
E  
L  
V  
E  
S

STARTER		Item #	D	W	H	Est Lbs.	List Price
S I N G L E E N T R Y		760924-S6L	9"	24"	76"	72	439.50
		760930-S6L	9"	30"	76"	83	445.90
		760936-S6L	9"	36"	76"	94	452.50
		760942-S6L	9"	42"	76"	121	522.40
		760948-S6L	9"	48"	76"	128	558.40
		761224-S6L	12"	24"	76"	83	476.60
		761230-S6L	12"	30"	76"	94	483.10
		761236-S6L	12"	36"	76"	105	489.70
		761242-S6L	12"	42"	76"	132	564.40
		761248-S6L	12"	48"	76"	139	606.20
		761524-S6L	15"	24"	76"	94	530.10
		761530-S6L	15"	30"	76"	105	536.30
		761536-S6L	15"	36"	76"	116	543.10
		761542-S6L	15"	42"	76"	143	613.70
		761548-S6L	15"	48"	76"	150	655.90
D O U B L E E N T R Y		761824-S6L*	18"	24"	76"	110	622.00
		761830-S6L*	18"	30"	76"	122	630.60
		761836-S6L*	18"	36"	76"	150	639.40
		761842-S6L**	18"	42"	76"	177	724.30
		761848-S6L**	18"	48"	76"	197	783.00
		762424-S6L*	24"	24"	76"	135	733.90
		762430-S6L*	24"	30"	76"	146	742.30
		762436-S6L*	24"	36"	76"	157	751.20
		762442-S6L**	24"	42"	76"	191	844.00
		762448-S6L**	24"	48"	76"	211	924.50
		763024-S6L*	30"	24"	76"	169	829.70
		763030-S6L*	30"	30"	76"	176	838.20
		763036-S6L*	30"	36"	76"	196	847.20
		763042-S6L**	30"	42"	76"	223	936.50
		763048-S6L**	30"	48"	76"	256	1,030.20

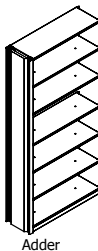
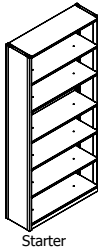

ADDER		Item #	D	W	H	Est Lbs.	List Price
		760924-A6L	9"	24"	76"	57	372.40
		760930-A6L	9"	30"	76"	68	378.90
		760936-A6L	9"	36"	76"	79	385.70
		760942-A6L	9"	42"	76"	106	455.70
		760948-A6L	9"	48"	76"	113	491.50
		761224-A6L	12"	24"	76"	68	390.70
		761230-A6L	12"	30"	76"	73	397.20
		761236-A6L	12"	36"	76"	77	400.90
		761242-A6L	12"	42"	76"	100	472.50
		761248-A6L	12"	48"	76"	124	520.40
		761524-A6L	15"	24"	76"	77	435.00
		761530-A6L	15"	30"	76"	88	441.90
		761536-A6L	15"	36"	76"	99	448.40
		761542-A6L	15"	42"	76"	126	518.80
		761548-A6L	15"	48"	76"	133	560.90
		761824-A6L*	18"	24"	76"	94	522.50
		761830-A6L*	18"	30"	76"	108	531.20
		761836-A6L*	18"	36"	76"	122	540.00
		761842-A6L**	18"	42"	76"	149	625.00
		761848-A6L**	18"	48"	76"	169	683.70
		762424-A6L*	24"	24"	76"	113	603.50
		762430-A6L*	24"	30"	76"	124	612.20
		762436-A6L*	24"	36"	76"	135	620.90
		762442-A6L**	24"	42"	76"	169	713.60
		762448-A6L**	24"	48"	76"	189	794.30
		763024-A6L*	30"	24"	76"	141	676.80
		763030-A6L*	30"	30"	76"	147	682.00
		763036-A6L*	30"	36"	76"	168	690.70
		763042-A6L**	30"	42"	76"	195	782.80
		763048-A6L**	30"	48"	76"	228	874.00

## 7 Shelves, 6 Openings

All shelves are placed on 12" centers for 11-1/4" clear vertical height. Shelf supports are adjustable on 1-1/2" centers. Shelves are slotted to accept dividers. Closed backs are sold separately, refer to page 44 for more information.

S  
S  
L  
O  
T  
T  
E  
D  
S  
H  
E  
L  
V  
E  
S

STARTER		Item #	D	W	H	Est Lbs.	List Price
S I N G L E E N T R Y		760924-S6LS	9"	24"	76"	72	439.50
		760930-S6LS	9"	30"	76"	83	445.90
		760936-S6LS	9"	36"	76"	94	452.50
		760942-S6LS	9"	42"	76"	121	522.40
		760948-S6LS	9"	48"	76"	128	558.40
		761224-S6LS	12"	24"	76"	83	476.60
		761230-S6LS	12"	30"	76"	94	483.10
		761236-S6LS	12"	36"	76"	105	489.70
		761242-S6LS	12"	42"	76"	132	564.40
		761248-S6LS	12"	48"	76"	139	606.20
		761524-S6LS	15"	24"	76"	94	530.10
		761530-S6LS	15"	30"	76"	105	536.30
		761536-S6LS	15"	36"	76"	116	543.10
		761542-S6LS	15"	42"	76"	143	613.70
		761548-S6LS	15"	48"	76"	150	655.90
D O U B L E E N T R Y		761824-S6LS*	18"	24"	76"	110	622.00
		761830-S6LS*	18"	30"	76"	122	630.60
		761836-S6LS*	18"	36"	76"	150	639.40
		761842-S6LS**	18"	42"	76"	177	724.30
		761848-S6LS**	18"	48"	76"	197	783.00
		762424-S6LS*	24"	24"	76"	135	733.90
		762430-S6LS*	24"	30"	76"	146	742.30
		762436-S6LS*	24"	36"	76"	157	751.20
		762442-S6LS**	24"	42"	76"	191	844.00
		762448-S6LS**	24"	48"	76"	211	924.50
		763024-S6LS*	30"	24"	76"	169	829.70
		763030-S6LS*	30"	30"	76"	176	838.20
		763036-S6LS*	30"	36"	76"	196	847.20
		763042-S6LS**	30"	42"	76"	223	938.70
		763048-S6LS**	30"	48"	76"	256	1,030.20

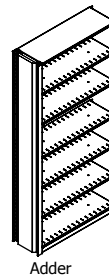
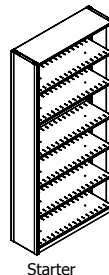

ADDER		Item #	D	W	H	Est Lbs.	List Price
		760924-A6LS	9"	24"	76"	57	372.40
		760930-A6LS	9"	30"	76"	68	378.90
		760936-A6LS	9"	36"	76"	79	385.70
		760942-A6LS	9"	42"	76"	106	455.70
		760948-A6LS	9"	48"	76"	113	491.50
		761224-A6LS	12"	24"	76"	68	390.70
		761230-A6LS	12"	30"	76"	73	397.20
		761236-A6LS	12"	36"	76"	77	400.90
		761242-A6LS	12"	42"	76"	100	472.50
		761248-A6LS	12"	48"	76"	124	520.40
		761524-A6LS	15"	24"	76"	77	435.40
		761530-A6LS	15"	30"	76"	88	441.90
		761536-A6LS	15"	36"	76"	99	448.40
		761542-A6LS	15"	42"	76"	126	518.80
		761548-A6LS	15"	48"	76"	133	560.90
		761824-A6LS*	18"	24"	76"	94	522.50
		761830-A6LS*	18"	30"	76"	108	531.20
		761836-A6LS*	18"	36"	76"	122	540.00
		761842-A6LS**	18"	42"	76"	149	625.00
		761848-A6LS**	18"	48"	76"	169	683.70
		762424-A6LS*	24"	24"	76"	113	603.50
		762430-A6LS*	24"	30"	76"	124	612.20
		762436-A6LS*	24"	36"	76"	135	641.40
		762442-A6LS**	24"	42"	76"	169	713.60
		762448-A6LS**	24"	48"	76"	189	794.30
		763024-A6LS*	30"	24"	76"	141	673.40
		763030-A6LS*	30"	30"	76"	147	682.00
		763036-A6LS*	30"	36"	76"	168	690.70
		763042-A6LS**	30"	42"	76"	195	782.80
		763048-A6LS**	30"	48"	76"	228	874.00

All units ship knocked down and bulk packed.

\*Includes one shelf reinforcement per shelf.

\*\*Includes two shelf reinforcements per shelf.

Shelf reinforcements are not included for top shelf. Top shelves are unslotted and include pre-punched knockout holes for TrakSlider hardware attachment. All starter units include 2 closed "L" uprights and all adder units include 1 closed "T" upright. All units include 64-1/4" high uprights, and 2" high front base. Shelves are 22 gauge designed, but not limited to, book storage. 18 gauge shelves are available, contact factory for more information. Used FDB dividers to 9" deep shelving, FDL dividers for all other sizes.

### FOR MOBILE READY SHELVING

Add "M" to the end of the model number when ordering mobile ready shelving. For example: 641224-A5M

Single rivet shelf supports replace front Kick Plate and standard support on bottom shelf allowing for easy attachment to mobile carriages.

Holes are pre-punched into single rivet support to match up with corresponding holes on Datum TrakSlider carriages.

When ordering mobile ready shelving to be used in conjunction with Datum TrakSlider Systems please refer to page 2d:69 for additional hardware needs.

# Preconfigured 88-1/4" High Library, 22 Gauge

Book Size  
Media:  
3-3 1/2  
pounds per  
filing inch

All preconfigured units do not include dividers. Please refer to page 2d:43 for divider information.

## 8 Shelves, 7 Openings

All shelves are placed on 12" centers for 11-1/4" clear vertical height. Shelf supports are adjustable on 1-1/2" centers. Shelves are unslotted and cannot accept dividers. Closed backs are sold separately, refer to page 44 for more information. Includes Unslotted Center and/or Back Stops as needed.

		STARTER					
		Item #	D	W	H	Est Lbs.	List Price
<b>UNSLOTTED SHELVES</b>	<b>SINGLE ENTRY</b>	880924-S7L	9"	24"	88"	83	457.50
		880930-S7L	9"	30"	88"	96	457.50
		880936-S7L	9"	36"	88"	108	471.40
		880942-S7L	9"	42"	88"	140	551.90
		880948-S7L	9"	48"	88"	147	583.50
		881224-S7L	12"	24"	88"	90	497.20
		881230-S7L	12"	30"	88"	97	504.10
		881236-S7L	12"	36"	88"	122	511.00
		881242-S7L	12"	42"	88"	153	590.30
		881248-S7L	12"	48"	88"	161	634.30
		881524-S7L	15"	24"	88"	102	553.20
		881530-S7L	15"	30"	88"	109	560.00
		881536-S7L	15"	36"	88"	134	567.00
		881542-S7L	15"	42"	88"	173	686.10
		881548-S7L	15"	48"	88"	213	837.70
<b>DOUBLE ENTRY</b>	881824-S7L*	18"	24"	88"	127	649.40	
	881830-S7L*	18"	30"	88"	139	658.20	
	881836-S7L*	18"	36"	88"	149	667.10	
	881842-S7L**	18"	42"	88"	192	757.70	
	881848-S7L**	18"	48"	88"	215	819.80	
	882424-S7L*	24"	24"	88"	156	774.50	
	882430-S7L*	24"	30"	88"	163	783.30	
	882436-S7L*	24"	36"	88"	169	848.60	
	882442-S7L**	24"	42"	88"	220	890.70	
	882448-S7L**	24"	48"	88"	243	976.70	
	883024-S7L*	30"	24"	88"	197	882.70	
	883030-S7L*	30"	30"	88"	204	891.60	
	883036-S7L*	30"	36"	88"	216	956.70	
	883042-S7L**	30"	42"	88"	259	997.80	
	883048-S7L**	30"	48"	88"	297	1,095.20	

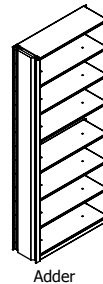
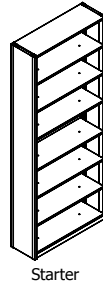

		ADDER					
		Item #	D	W	H	Est Lbs.	List Price
<b>UNSLOTTED SHELVES</b>	<b>SINGLE ENTRY</b>	880924-A7L	9"	24"	88"	72	416.20
		880930-A7L	9"	30"	88"	83	416.20
		880936-A7L	9"	36"	88"	93	431.70
		880942-A7L	9"	42"	88"	129	518.20
		880948-A7L	9"	48"	88"	139	552.40
		881224-A7L	12"	24"	88"	71	443.30
		881230-A7L	12"	30"	88"	78	450.50
		881236-A7L	12"	36"	88"	86	454.70
		881242-A7L	12"	42"	88"	112	536.60
		881248-A7L	12"	48"	88"	142	591.20
		881524-A7L	15"	24"	88"	81	493.20
		881530-A7L	15"	30"	88"	88	500.40
		881536-A7L	15"	36"	88"	113	508.20
		881542-A7L	15"	42"	88"	152	636.80
		881548-A7L	15"	48"	88"	192	800.60
<b>DOUBLE ENTRY</b>	881824-A7L*	18"	24"	88"	106	586.20	
	881830-A7L*	18"	30"	88"	116	595.60	
	881836-A7L*	18"	36"	88"	126	658.00	
	881842-A7L**	18"	42"	88"	169	703.20	
	881848-A7L**	18"	48"	88"	192	770.20	
	882424-A7L*	24"	24"	88"	130	693.70	
	882430-A7L*	24"	30"	88"	137	703.30	
	882436-A7L*	24"	36"	88"	143	765.40	
	882442-A7L**	24"	42"	88"	194	819.40	
	882448-A7L**	24"	48"	88"	217	912.20	
	883024-A7L*	30"	24"	88"	163	782.90	
	883030-A7L*	30"	30"	88"	173	792.30	
	883036-A7L*	30"	36"	88"	182	817.40	
	883042-A7L**	30"	42"	88"	225	907.10	
	883048-A7L**	30"	48"	88"	263	1,012.50	

## 8 Shelves, 7 Openings

All shelves are placed on 12" centers for 11-1/4" clear vertical height. Shelf supports are adjustable on 1-1/2" centers. Shelves are slotted to accept dividers and includes Slotted Center and/or Back Stops as needed. Closed backs are sold separately, refer to page 44.

		STARTER					
		Item #	D	W	H	Est Lbs.	List Price
<b>SLOTTED SHELVES</b>	<b>SINGLE ENTRY</b>	880924-S7LS	9"	24"	88"	83	457.50
		880930-S7LS	9"	30"	88"	96	457.50
		880936-S7LS	9"	36"	88"	108	471.40
		880942-S7LS	9"	42"	88"	140	551.90
		880948-S7LS	9"	48"	88"	147	583.50
		881224-S7LS	12"	24"	88"	90	497.20
		881230-S7LS	12"	30"	88"	97	504.10
		881236-S7LS	12"	36"	88"	122	511.00
		881242-S7LS	12"	42"	88"	153	590.30
		881248-S7LS	12"	48"	88"	161	634.30
		881524-S7LS	15"	24"	88"	102	553.20
		881530-S7LS	15"	30"	88"	109	560.00
		881536-S7LS	15"	36"	88"	134	567.00
		881542-S7LS	15"	42"	88"	173	686.10
		881548-S7LS	15"	48"	88"	213	837.70
<b>DOUBLE ENTRY</b>	881824-S7LS*	18"	24"	88"	129	649.40	
	881830-S7LS*	18"	30"	88"	139	658.20	
	881836-S7LS*	18"	36"	88"	149	667.10	
	881842-S7LS**	18"	42"	88"	192	757.70	
	881848-S7LS**	18"	48"	88"	215	819.80	
	882424-S7LS*	24"	24"	88"	156	774.50	
	882430-S7LS*	24"	30"	88"	163	783.30	
	882436-S7LS*	24"	36"	88"	169	848.60	
	882442-S7LS**	24"	42"	88"	220	890.70	
	882448-S7LS**	24"	48"	88"	243	976.70	
	883024-S7LS*	30"	24"	88"	197	882.70	
	883030-S7LS*	30"	30"	88"	204	891.60	
	883036-S7LS*	30"	36"	88"	216	956.70	
	883042-S7LS**	30"	42"	88"	259	997.80	
	883048-S7LS**	30"	48"	88"	297	1,095.20	

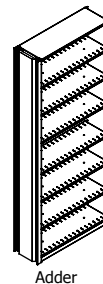
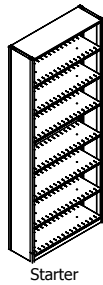

		ADDER					
		Item #	D	W	H	Est Lbs.	List Price
<b>SLOTTED SHELVES</b>	<b>SINGLE ENTRY</b>	880924-A7LS	9"	24"	88"	72	416.20
		880930-A7LS	9"	30"	88"	83	416.20
		880936-A7LS	9"	36"	88"	93	431.70
		880942-A7LS	9"	42"	88"	129	518.20
		880948-A7LS	9"	48"	88"	136	552.40
		881224-A7LS	12"	24"	88"	71	443.30
		881230-A7LS	12"	30"	88"	78	450.50
		881236-A7LS	12"	36"	88"	86	454.70
		881242-A7LS	12"	42"	88"	112	536.60
		881248-A7LS	12"	48"	88"	143	591.20
		881524-A7LS	15"	24"	88"	81	493.20
		881530-A7LS	15"	30"	88"	88	500.40
		881536-A7LS	15"	36"	88"	113	508.20
		881542-A7LS	15"	42"	88"	152	636.80
		881548-A7LS	15"	48"	88"	192	800.60
<b>DOUBLE ENTRY</b>	881824-A7LS*	18"	24"	88"	106	586.20	
	881830-A7LS*	18"	30"	88"	116	595.60	
	881836-A7LS*	18"	36"	88"	126	658.00	
	881842-A7LS**	18"	42"	88"	169	703.20	
	881848-A7LS**	18"	48"	88"	192	770.20	
	882424-A7LS*	24"	24"	88"	130	693.70	
	882430-A7LS*	24"	30"	88"	137	703.30	
	882436-A7LS*	24"	36"	88"	143	765.40	
	882442-A7LS**	24"	42"	88"	194	819.40	
	882448-A7LS**	24"	48"	88"	217	912.20	
	883024-A7LS*	30"	24"	88"	163	782.90	
	883030-A7LS*	30"	30"	88"	173	792.30	
	883036-A7LS*	30"	36"	88"	182	817.40	
	883042-A7LS**	30"	42"	88"	225	907.10	
	883048-A7LS**	30"	48"	88"	263	1,012.50	

All units ship knocked down and bulk packed.

\*Includes one shelf reinforcement per shelf.

\*\*Includes two shelf reinforcements per shelf.

Shelf reinforcements are not included for top shelf.

Top shelves are unslotted and include prepunched knockout holes for TrakSlider hardware attachment.

All starter units include 2 closed "L" uprights and all adder units include 1 closed "T" upright.

All units include 88-1/4" high uprights, and 2" high front base.

Shelves are 22 gauge designed, but not limited to, book storage. 18 gauge shelves are available, contact factory for more information. Used FDB dividers to 9" deep shelving, FDL dividers for all other sizes.

### FOR MOBILE READY SHELVING

Add "M" to the end of the model number when ordering mobile ready shelving. For example: 641224-ASM

Single rivet shelf supports replace front Kick Plate and standard support on bottom shelf allowing for easy attachment to mobile carriages.

Holes are prepunched into single rivet support to match up with corresponding holes on Datum TrakSlider carriages.

When ordering mobile ready shelving to be used in conjunction with Datum TrakSlider Systems please refer to page 2d:69 for additional hardware needs.





# X-Ray Shelving General Information & Specifications

X-Ray Size Media:  
8 pounds per filing  
inch

## GENERAL INFORMATION

**Product Description:** Datum X-Ray Storage Shelving offers exceptional strength and durability making it an ideal choice for heavyweight X-Ray jacket applications. 4Post Shelving incorporates both "L" & "T" shaped uprights allowing for a variety of shelving configurations. Interlocking key-hole uprights combined with double rivet shelf supports are designed to offer maximum strength and durability with exceptional versatility. All shelf units are assembled without the use of nuts, bolts, or clips and are available for both single entry (wall unit) and double entry (back to back storage) allowing for maximum filing/storage capacity with minimal floor intrusion. Shelves are available slotted to accept adjustable file dividers. All shelf units are designed for expansion and are available as mobile ready for easy conversion to Datum TrakSlider Systems. Datum 4Post Shelving is ready to assemble with no special tools required.

## SPECIFICATIONS

**Open Uprights:** Are 18 gauge cold rolled steel, roll formed into a 2" wide "T" upright with keyhole slot holes punched on 1-1/2" centers on inner wall of upright only. There are no holes on the exterior portion of the upright. Front and rear posts are joined together with a minimum of three 3" high 18 gauge spacers maintaining proper upright spacing along the entire length of the upright and adds rigidity and strength. The open "L" upright is typically used for row ends with Open "T" uprights used as a common upright between shelf units. All uprights include an identifiable pair of punched holes every 6" on center allowing a visual confirmation for proper shelf spacing.

**Closed Uprights:** Includes same specifications as the Open Uprights except welded spacers are replaced with a welded 24 gauge full height closure sheet incorporating a 5/8" wide stiffener flange at the bottom of the closure sheet.

**X-Ray Shelves:** Shelves are formed of 18 gauge cold rolled steel with a 1-1/8" flange on all sides. Front and Back shelf sides to include a 9/32" stiffener flange for added strength. Shelves are available plain or with slots punched on 2" centers to accept adjustable file dividers.

**TrakSlider Standard Duty Tops:** Tops are formed of 18 gauge cold rolled steel with a 1-1/8" flange on all sides. Front and Back top sides to include a 9/32" stiffener flange for added strength. All tops are prepunched with knock-outs to accept TrakSlider overhead anti-tip mounting hardware.

**Heavy Duty Shelf Support:** Shelf supports are formed of 11 or 14 gauge (11 gauge for 42" and 48" widths) hot rolled pickled steel 1-1/8" high. Each support end is formed flat and includes two shoulder rivets with 7/16" diameter heads for attachment to corresponding key holes in upright. Shelf supports are available with single or double rivets. All single rivet shelf supports are designed to sit flush with bottom of shelf upright and are prepunched to align with holes on Datum TrakSlider carriages for easy attachment.

**Heavy Duty Shelf Reinforcement:** Shelf reinforcements are formed of 13 gauge hot rolled, pickled steel and formed into a channel shape. Shelf reinforcements are notched on each end and align with respective shelf support.

**Slotted X-Ray Back Stops:** Back stops are formed of 18 gauge cold rolled steel with a 7/16" channel at the top and similar bend at the bottom and are slotted on the face. Slots on Back stops are punched on same centers as the shelf and are used to accept back tab of adjustable file divider. Ends of Back stop include one shoulder rivet with 7/16" diameter head for attachment to corresponding keyholes in upright. Back stops are used for single entry shelving only.

**Slotted X-Ray Center Stops:** Center stops are formed of 18 gauge cold rolled steel with a 9/16" formed channel on the top and a 9/16" return bend on the bottom. Formed channels on the top are punched on same centers as the shelf and are used for back to back support of adjustable divider. The overall height of center stop is 7" and includes mounting holes on bottom flange for easy assembly using 1/4" nuts and bolts. Center stops are used for double entry shelving only.

**Kick Plate:** Kick Plates are formed of 14 or 16 gauge cold rolled steel formed with a stiffener flange on top and bottom edge. Kick Plates are available in 2" and 4" heights.

**Adjustable File Dividers:** X-Ray dividers are formed from 18 gauge cold rolled steel. Dividers are punched to include two tabs on the base and one located on the rear. X-Ray file dividers can be used with X-Ray Back and Center stops only.

**Sectional Backs:** Sectional backs are formed of 22 gauge cold rolled steel, positioned on the inner rear post, and are securely held in place by a formed retainer flange positioned between the shelf support and post. Each back section will include a formed channel on the top and bottom and include punched holes for joining sections together. Backs of 40" high are one-piece, 64" high are two-piece, and up to 97" are of three-piece construction. Sectional back panels will add 3/8" to overall depth of shelving.

**Finish:** All steel parts are thoroughly cleaned using a three-stage iron phosphate washer and then coated with an Epoxy-Hybrid powder coat finish using a state-of-the-art electrostatic paint system. Powder coating provides a superior, attractive, uniform finish that is more durable, scratch and corrosion resistant, and environmentally friendly than liquid paint.



**FOR ADDITIONAL INFORMATION ON ORDERING, TERMS AND CONDITIONS, PRICING AND SHIPPING, REFER TO TERMS SECTION.**

# Preconfigured X-Ray

X-Ray Size Media:  
8 pounds per filing  
inch

ALL PRECONFIGURED UNITS DO NOT INCLUDE DIVIDERS. PLEASE REFER TO PAGE 2d:43 FOR DIVIDER INFORMATION.

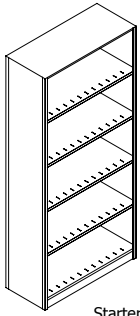

Starter

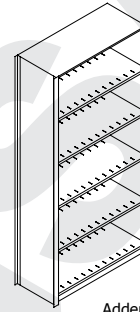

Adder

All units include 85-1/4" high uprights, and 2" high front base.

## 85" High, 6 Shelves, 5 Openings

All shelves are placed on 16-1/2" centers for 15-1/4" clear vertical height. Shelf supports are adjustable on 1-1/2" centers.

STARTER						
	Item #	D	W	H	Est Lbs.	List Price
X - R A Y	851824-S5**	18"	24"	85-1/4"	95	572.60
	851830-S5**	18"	30"	85-1/4"	121	588.10
	851836-S5**	18"	36"	85-1/4"	147	629.00
	851842-S5**	18"	42"	85-1/4"	175	686.10
	851848-S5**	18"	48"	85-1/4"	194	752.30
	853624-S5**	36"	24"	85-1/4"	222	923.40
	853630-S5**	36"	30"	85-1/4"	260	951.00
	853636-S5**	36"	36"	85-1/4"	273	1,004.50
	853642-S5†	36"	42"	85-1/4"	314	1,131.10
	853648-S5§	36"	48"	85-1/4"	356	1,269.10

ADDER						
	Item #	D	W	H	Est Lbs.	List Price
X - R A Y	851824-A5**	18"	24"	85-1/4"	82	493.60
	851830-A5**	18"	30"	85-1/4"	107	509.40
	851836-A5**	18"	36"	85-1/4"	132	556.30
	851842-A5**	18"	42"	85-1/4"	161	614.40
	851848-A5**	18"	48"	85-1/4"	179	673.40
	853624-A5**	36"	24"	85-1/4"	194	799.60
	853630-A5**	36"	30"	85-1/4"	232	827.00
	853636-A5**	36"	36"	85-1/4"	248	880.70
	853642-A5†	36"	42"	85-1/4"	284	1,007.10
	853648-A5§	36"	48"	85-1/4"	328	1,144.90

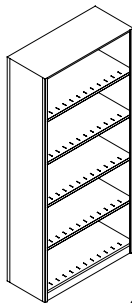

Starter

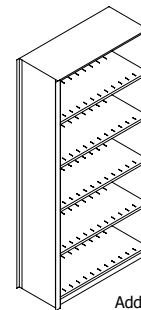

Adder

All units include 88-1/4" high uprights, and 2" high front base.

## 88" High, 6 Shelves, 5 Openings

All shelves are placed on 16-1/2" centers for 15-1/4" clear vertical height. Shelf supports are adjustable on 1-1/2" centers.

STARTER						
	Item #	D	W	H	Est Lbs.	List Price
X - R A Y	881824-S5**	18"	24"	88-1/4"	97	572.90
	881830-S5**	18"	30"	88-1/4"	123	588.40
	881836-S5**	18"	36"	88-1/4"	149	635.60
	881842-S5**	18"	42"	88-1/4"	178	693.50
	881848-S5**	18"	48"	88-1/4"	198	752.70
	883624-S5**	36"	24"	88-1/4"	150	954.60
	883630-S5**	36"	30"	88-1/4"	221	1,008.30
	883636-S5**	36"	36"	88-1/4"	279	1,018.10
	883642-S5†	36"	42"	88-1/4"	318	1,135.00
	883648-S5§	36"	48"	88-1/4"	360	1,272.60

ADDER						
	Item #	D	W	H	Est Lbs.	List Price
X - R A Y	881824-A5**	18"	24"	88-1/4"	82	499.10
	881830-A5**	18"	30"	88-1/4"	108	509.70
	881836-A5**	18"	36"	88-1/4"	134	556.60
	881842-A5**	18"	42"	88-1/4"	162	614.60
	881848-A5**	18"	48"	88-1/4"	181	673.80
	883624-A5**	36"	24"	88-1/4"	174	802.60
	883630-A5**	36"	30"	88-1/4"	212	830.30
	883636-A5**	36"	36"	88-1/4"	250	883.60
	883642-A5†	36"	42"	88-1/4"	289	1,010.20
	883648-A5§	36"	48"	88-1/4"	331	1,148.20

All units ship knocked down and bulk packed.

\*\*Includes two shelf reinforcements per shelf.

†Includes three shelf reinforcements per shelf.

§Includes four shelf reinforcements per shelf.

Shelf reinforcements are not included for top shelf.

All starter units include 2 closed "L" uprights and all adder units include 1 closed "T" upright.

Shelves are 18 gauge designed for X-Ray file jacket storage.

Top shelves are unslotted and include prepunched knockout holes for TrakSlider hardware attachment.

### FOR MOBILE READY SHELVING

Add "M" to the end of the model number when order mobile ready shelving. For example: 881824-A5M

Single rivet shelf supports replace front Kick Plate and standard support on bottom shelf allowing for easy attachment to mobile carriages.

Holes are prepunched into single rivet support to match up with corresponding holes on Datum TrakSlider carriages.

When ordering mobile ready shelving to be used in conjunction with Datum TrakSlider Systems please refer to page 2d:69 for additional hardware needs.

TEL: 800-828-8018

DATUM. www.datumstorage.com • sales@datumstorage.com

2d:16

EFFECTIVE JANUARY 1, 2015

Prices and specifications subject to change without notice.

Version 6.0 • Rev. 2014-10

# Heavy-Duty Plus General Information & Specifications

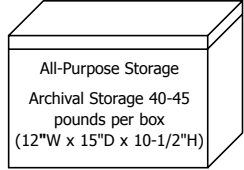

**ALL PRECONFIGURED UNITS DO NOT INCLUDE DIVIDERS. PLEASE REFER TO PAGE 2d:43 FOR DIVIDER INFORMATION.**

## GENERAL INFORMATION

**Product Description:** Datum Heavy Duty Shelving offers exceptional strength and durability for a variety of storage applications. 4Post shelving incorporates both "L" & "T" shaped uprights allowing for a variety of shelving configurations. Interlocking keyhole uprights combined with double rivet shelf supports are designed to offer maximum strength and durability with exceptional versatility. All shelf units are assembled without the use of nuts, bolts, or clips and are available for both single entry (wall unit) and double entry (back to back storage) allowing for maximum filing/storage capacity with minimal floor intrusion. All shelf units are designed for expansion and are available as mobile ready for easy conversion to Datum TrakSlider Systems. Datum 4Post Shelving is ready to assemble with no special tools required. Available depths make it an ideal choice bulk storage application.

## SPECIFICATIONS

**Open Uprights:** Are 18 gauge cold rolled steel, roll formed into a 2" wide "T" upright with keyhole slot holes punched on 1-1/2" centers on inner wall of upright only. There are no holes on the exterior portion of the upright. Front and rear posts are joined together with a minimum of three 3" high 18 gauge spacers maintaining proper upright spacing along the entire length of the upright and adds rigidity and strength. The open "L" upright is typically used for row ends with Open "T" uprights used as a common upright between shelf units. All uprights include an identifiable pair of punched holes every 6" on center allowing a visual confirmation for proper shelf spacing.

**Closed Uprights:** Includes same specifications as the Open Uprights except welded spacers are replaced with a welded 24 gauge full height closure sheet incorporating a 5/8" wide stiffener flange at the bottom of the closure sheet.

**Heavy Duty Shelves:** Shelves are formed of 18 gauge cold rolled steel with a 1-1/8" flange on all sides. Front and Back shelf sides to include a 9/32" stiffener flange for added strength. Shelves are available plain or with slots punched on 2" centers to accept adjustable file dividers.

**TrakSlider Standard Duty Tops:** Tops are formed of 18 gauge cold rolled steel with a 1-1/8" flange on all sides. Front and Back top sides to include a 9/32" stiffener flange for added strength. All tops are prepunched with knock-outs to accept TrakSlider overhead anti-tip mounting hardware.

**Heavy Duty Shelf Support:** Shelf supports are formed of 11 or 14 gauge (11 gauge on 42" & 48" widths only) hot rolled pickled steel 1-1/8" high. Each "support end is formed flat and includes two shoulder rivets with 7/16" diameter heads for attachment to corresponding keyholes in upright. Shelf supports are available with single or double rivets. All single rivet shelf supports are designed to sit flush with bottom of shelf upright and are prepunched to align with holes on Datum TrakSlider carriages for easy attachment.

**Heavy Duty Shelf Reinforcement:** Shelf reinforcements are formed of 13 gauge hot rolled, pickled steel and formed into a channel shape. Shelf reinforcements are notched on each end and align with respective shelf support.

**Unslotted Center Divider:** Unslotted center dividers are formed of 18 gauge cold rolled steel with a 9/16" formed channel on the top and a 9/16" return bend on the bottom. The overall height of center stop is 4" and includes mounting holes on bottom flange for easy assembly using 7/32" nuts and bolts. Center stops are used for unslotted double entry shelving only.

**Kick Plate:** Kick Plates are formed of 14 or 16 gauge cold rolled steel formed with a stiffener flange on top and bottom edge. Kick Plates are available in 2" and 4" heights.

**Sectional Backs:** Sectional backs are formed of 20 gauge cold rolled steel, positioned on the inner rear post, and are securely held in place by a formed retainer flange positioned between the shelf support and post. Each back section will include a formed channel on the top and bottom and include punched holes for joining sections together. Backs of 40" high are one-piece, 64" high are two-piece, and up to 97" are of three-piece construction. Sectional back panels will add 3/8" to overall depth of shelving.

**Finish:** All steel parts are thoroughly cleaned using a three-stage iron phosphate washer and then coated with an Epoxy-Hybrid powder coat finish using a state-of-the-art electrostatic paint system. Powder coating provides a superior, attractive, uniform finish that is more durable, scratch and corrosion resistant, and environmentally friendly than liquid paint.



**FOR ADDITIONAL INFORMATION ON ORDERING, TERMS AND CONDITIONS, PRICING AND SHIPPING, REFER TO TERMS SECTION.**

# Preconfigured 88-1/4" High, 18 Gauge

ALL PRECONFIGURED UNITS BELOW HAVE UNSLOTTED SHELVING.

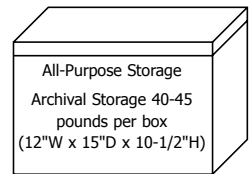

All-Purpose Storage  
Archival Storage 40-45  
pounds per box  
(12"W x 15"D x 10-1/2"H)

## 5 Shelves, 4 Openings (19-3/4" clear height per opening)

STARTER					
Item #	D	W	H	Est Lbs.	List Price
881224-S4H	12"	24"	88-1/4"	73	333.90
881230-S4H	12"	30"	88-1/4"	89	339.90
881236-S4H	12"	36"	88-1/4"	107	370.50
881242-S4H	12"	42"	88-1/4"	127	409.20
881248-S4H	12"	48"	88-1/4"	130	438.40
881524-S4H	15"	24"	88-1/4"	100	406.40
881530-S4H	15"	30"	88-1/4"	112	412.40
881536-S4H	15"	36"	88-1/4"	126	439.80
881542-S4H	15"	42"	88-1/4"	142	475.00
881548-S4H	15"	48"	88-1/4"	155	523.30
881824-S4H	18"	24"	88-1/4"	107	444.70
881830-S4H	18"	30"	88-1/4"	121	450.30
881836-S4H	18"	36"	88-1/4"	137	482.00
881842-S4H	18"	42"	88-1/4"	155	526.20
881848-S4H	18"	48"	88-1/4"	169	578.10
882424-S4H*	24"	24"	88-1/4"	130	553.20
882430-S4H*	24"	30"	88-1/4"	148	559.00
882436-S4H*	24"	36"	88-1/4"	168	590.60
882442-S4H*	24"	42"	88-1/4"	190	659.20
882448-S4H*	24"	48"	88-1/4"	203	721.70
883024-S4H*	30"	24"	88-1/4"	146	664.80
883030-S4H*	30"	30"	88-1/4"	168	670.60
883036-S4H*	30"	36"	88-1/4"	192	702.40
883042-S4H*	30"	42"	88-1/4"	218	765.00
883048-S4H*	30"	48"	88-1/4"	233	824.20
883624-S4H*	36"	24"	88-1/4"	173	744.60
883630-S4H*	36"	30"	88-1/4"	181	763.80
883636-S4H*	36"	36"	88-1/4"	198	783.00
883642-S4H*	36"	42"	88-1/4"	215	874.00
883648-S4H*	36"	48"	88-1/4"	240	955.80

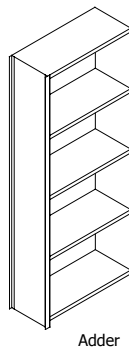
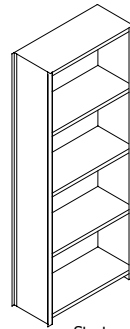

ADDER					
Item #	D	W	H	Est Lbs.	List Price
881224-A4H	12"	24"	88-1/4"	34	274.80
881230-A4H	12"	30"	88-1/4"	46	280.70
881236-A4H	12"	36"	88-1/4"	60	311.10
881242-A4H	12"	42"	88-1/4"	76	350.00
881248-A4H	12"	48"	88-1/4"	85	379.10
881524-A4H	15"	24"	88-1/4"	58	339.40
881530-A4H	15"	30"	88-1/4"	66	345.30
881536-A4H	15"	36"	88-1/4"	76	372.70
881542-A4H	15"	42"	88-1/4"	88	408.00
881548-A4H	15"	48"	88-1/4"	97	456.30
881824-A4H	18"	24"	88-1/4"	65	365.70
881830-A4H	18"	30"	88-1/4"	74	371.40
881836-A4H	18"	36"	88-1/4"	85	403.10
881842-A4H	18"	42"	88-1/4"	98	447.40
881848-A4H	18"	48"	88-1/4"	108	499.20
882424-A4H*	24"	24"	88-1/4"	79	452.50
882430-A4H*	24"	30"	88-1/4"	93	458.50
882436-A4H*	24"	36"	88-1/4"	109	490.20
882442-A4H*	24"	42"	88-1/4"	127	558.60
882448-A4H*	24"	48"	88-1/4"	135	621.20
883024-A4H*	30"	24"	88-1/4"	92	560.60
883030-A4H*	30"	30"	88-1/4"	110	566.30
883036-A4H*	30"	36"	88-1/4"	130	598.10
883042-A4H*	30"	42"	88-1/4"	152	660.80
883048-A4H*	30"	48"	88-1/4"	162	720.00
883624-A4H*	36"	24"	88-1/4"	149	620.00
883630-A4H*	36"	30"	88-1/4"	157	639.40
883636-A4H*	36"	36"	88-1/4"	174	658.40
883642-A4H*	36"	42"	88-1/4"	191	749.30
883648-A4H*	36"	48"	88-1/4"	216	831.10

## 6 Shelves, 5 Openings (15-1/4" clear height per opening)

STARTER					
Item #	D	W	H	Est Lbs.	List Price
881224-S5H	12"	24"	88-1/4"	74	369.90
881230-S5H	12"	30"	88-1/4"	94	376.90
881236-S5H	12"	36"	88-1/4"	116	413.50
881242-S5H	12"	42"	88-1/4"	140	460.20
881248-S5H	12"	48"	88-1/4"	152	495.10
881524-S5H	15"	24"	88-1/4"	106	454.20
881530-S5H	15"	30"	88-1/4"	121	461.10
881536-S5H	15"	36"	88-1/4"	138	494.30
881542-S5H	15"	42"	88-1/4"	157	536.20
881548-S5H	15"	48"	88-1/4"	171	594.40
881824-S5H	18"	24"	88-1/4"	117	496.30
881830-S5H	18"	30"	88-1/4"	133	503.30
881836-S5H	18"	36"	88-1/4"	151	541.20
881842-S5H	18"	42"	88-1/4"	171	594.40
881848-S5H	18"	48"	88-1/4"	188	656.60
882424-S5H*	24"	24"	88-1/4"	143	619.20
882430-S5H*	24"	30"	88-1/4"	164	626.20
882436-S5H*	24"	36"	88-1/4"	187	664.00
882442-S5H*	24"	42"	88-1/4"	212	746.20
882448-S5H*	24"	48"	88-1/4"	227	821.50
883024-S5H*	30"	24"	88-1/4"	158	748.70
883030-S5H*	30"	30"	88-1/4"	185	755.60
883036-S5H*	30"	36"	88-1/4"	214	793.60
883042-S5H*	30"	42"	88-1/4"	245	868.90
883048-S5H*	30"	48"	88-1/4"	262	940.10
883624-S5H*	36"	24"	88-1/4"	197	837.80
883630-S5H*	36"	30"	88-1/4"	206	860.90
883636-S5H*	36"	36"	88-1/4"	226	883.80
883642-S5H*	36"	42"	88-1/4"	246	993.00
883648-S5H*	36"	48"	88-1/4"	276	1,091.10

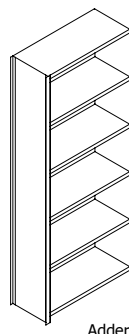
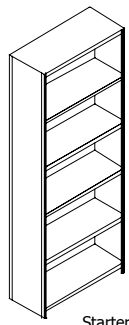

ADDER					
Item #	D	W	H	Est Lbs.	List Price
881224-A5H	12"	24"	88-1/4"	38	310.90
881230-A5H	12"	30"	88-1/4"	53	317.70
881236-A5H	12"	36"	88-1/4"	70	354.30
881242-A5H	12"	42"	88-1/4"	89	400.90
881248-A5H	12"	48"	88-1/4"	99	435.90
881524-A5H	15"	24"	88-1/4"	64	387.10
881530-A5H	15"	30"	88-1/4"	75	393.90
881536-A5H	15"	36"	88-1/4"	88	427.00
881542-A5H	15"	42"	88-1/4"	103	469.20
881548-A5H	15"	48"	88-1/4"	113	527.30
881824-A5H	18"	24"	88-1/4"	75	417.50
881830-A5H	18"	30"	88-1/4"	86	424.50
881836-A5H	18"	36"	88-1/4"	99	462.50
881842-A5H	18"	42"	88-1/4"	114	515.50
881848-A5H	18"	48"	88-1/4"	127	577.50
882424-A5H*	24"	24"	88-1/4"	92	518.50
882430-A5H*	24"	30"	88-1/4"	109	525.60
882436-A5H*	24"	36"	88-1/4"	128	563.60
882442-A5H*	24"	42"	88-1/4"	149	645.80
882448-A5H*	24"	48"	88-1/4"	159	720.90
883024-A5H*	30"	24"	88-1/4"	104	644.50
883030-A5H*	30"	30"	88-1/4"	127	651.50
883036-A5H*	30"	36"	88-1/4"	152	689.60
883042-A5H*	30"	42"	88-1/4"	179	764.80
883048-A5H*	30"	48"	88-1/4"	191	835.70
883624-A5H*	36"	24"	88-1/4"	173	713.20
883630-A5H*	36"	30"	88-1/4"	182	736.10
883636-A5H*	36"	36"	88-1/4"	202	759.30
883642-A5H*	36"	42"	88-1/4"	222	868.30
883648-A5H*	36"	48"	88-1/4"	252	966.80

TEL: 800-828-8018

www.datumstorage.com • sales@datumstorage.com

2d:18

EFFECTIVE JANUARY 1, 2015

Prices and specifications subject to change without notice.

Version 6.0 • Rev. 2016-04



# Preconfigured 88-1/4" High, 18 Gauge

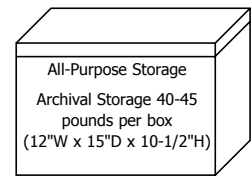

ALL PRECONFIGURED UNITS BELOW HAVE UNSLOTTED SHELVING.

## 7 Shelves, 6 Openings (12-1/4" clear height per opening)

STARTER					
Item #	D	W	H	Est Lbs.	List Price
881224-S6H	12"	24"	88-1/4"	96	405.90
881230-S6H	12"	30"	88-1/4"	110	413.90
881236-S6H	12"	36"	88-1/4"	126	456.60
881242-S6H	12"	42"	88-1/4"	144	511.10
881248-S6H	12"	48"	88-1/4"	154	552.00
881524-S6H	15"	24"	88-1/4"	114	501.70
881530-S6H	15"	30"	88-1/4"	131	510.00
881536-S6H	15"	36"	88-1/4"	150	548.60
881542-S6H	15"	42"	88-1/4"	171	597.40
881548-S6H	15"	48"	88-1/4"	187	665.40
881824-S6H	18"	24"	88-1/4"	127	547.90
881830-S6H	18"	30"	88-1/4"	145	556.10
881836-S6H	18"	36"	88-1/4"	165	600.60
881842-S6H	18"	42"	88-1/4"	187	662.40
881848-S6H	18"	48"	88-1/4"	206	734.90
882424-S6H*	24"	24"	88-1/4"	156	685.10
882430-S6H*	24"	30"	88-1/4"	180	693.30
882436-S6H*	24"	36"	88-1/4"	206	737.70
882442-S6H*	24"	42"	88-1/4"	234	833.40
882448-S6H*	24"	48"	88-1/4"	250	921.10
883024-S6H*	30"	24"	88-1/4"	173	832.40
883030-S6H*	30"	30"	88-1/4"	204	840.60
883036-S6H*	30"	36"	88-1/4"	237	885.10
883042-S6H*	30"	42"	88-1/4"	272	972.60
883048-S6H*	30"	48"	88-1/4"	291	1,055.50
883624-S6H*	36"	24"	88-1/4"	221	930.90
883630-S6H*	36"	30"	88-1/4"	231	957.80
883636-S6H*	36"	36"	88-1/4"	254	984.70
883642-S6H*	36"	42"	88-1/4"	277	1,112.10
883648-S6H*	36"	48"	88-1/4"	312	1,226.50

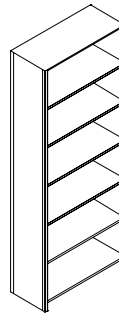

Starter

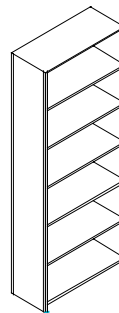

Adder

ADDER					
Item #	D	W	H	Est Lbs.	List Price
881224-A6H	12"	24"	88-1/4"	41	346.70
881230-A6H	12"	30"	88-1/4"	59	354.70
881236-A6H	12"	36"	88-1/4"	79	397.40
881242-A6H	12"	42"	88-1/4"	101	451.90
881248-A6H	12"	48"	88-1/4"	114	492.90
881524-A6H	15"	24"	88-1/4"	72	434.50
881530-A6H	15"	30"	88-1/4"	85	442.90
881536-A6H	15"	36"	88-1/4"	100	481.10
881542-A6H	15"	42"	88-1/4"	117	530.50
881548-A6H	15"	48"	88-1/4"	129	598.10
881824-A6H	18"	24"	88-1/4"	83	469.20
881830-A6H	18"	30"	88-1/4"	97	477.20
881836-A6H	18"	36"	88-1/4"	113	521.80
881842-A6H	18"	42"	88-1/4"	131	583.70
881848-A6H	18"	48"	88-1/4"	145	656.10
882424-A6H*	24"	24"	88-1/4"	105	584.40
882430-A6H*	24"	30"	88-1/4"	125	592.80
882436-A6H*	24"	36"	88-1/4"	147	637.20
882442-A6H*	24"	42"	88-1/4"	171	732.90
882448-A6H*	24"	48"	88-1/4"	183	820.40
883024-A6H*	30"	24"	88-1/4"	121	728.30
883030-A6H*	30"	30"	88-1/4"	147	736.30
883036-A6H*	30"	36"	88-1/4"	175	780.80
883042-A6H*	30"	42"	88-1/4"	205	868.30
883048-A6H*	30"	48"	88-1/4"	220	951.40
883624-A6H*	36"	24"	88-1/4"	197	806.50
883630-A6H*	36"	30"	88-1/4"	207	833.20
883636-A6H*	36"	36"	88-1/4"	230	860.30
883642-A6H*	36"	42"	88-1/4"	253	987.60
883648-A6H*	36"	48"	88-1/4"	288	1,101.90

All units ship knocked down and bulk packed.

\*Includes one shelf reinforcement per shelf.

Shelf reinforcements are not included for top shelf.

All starter units include 2 closed "L" uprights and all adder units include 1 closed "T" upright.

All units include 88-1/4" high uprights.

Shelves are 18 gauge.

Top shelves are unslotted and include prepunched knockout holes for TrakSlider hardware attachment.

### FOR MOBILE READY SHELVING

Add "M" to the end of the model number when ordering mobile ready shelving.

For example: 881224-A6HM

Single rivet shelf supports replace standard supports on bottom shelf allowing for easy attachment to mobile carriages.

Holes are prepunched into single rivet support to match up with corresponding holes on Datum TrakSlider carriages.

When ordering mobile ready shelving to be used in conjunction with Datum TrakSlider Systems please refer to page 2d:69 for additional hardware needs.

# Prepackaged 4Post-In-A-Box

Letter Size Media:  
2-2 1/2 pounds  
per filing inch

X-Ray Size Media:  
8 pounds per filing  
inch

EACH 4POST ITEM # BELOW SHIPS IN ONE, ALL ENCOMPASSING BOX WHICH INCLUDES ALL UPRIGHTS, SHELVES, SHELF SUPPORTS, REINFORCEMENTS (IF APPLICABLE) BACKSTOPS OR CENTER STOPS, FRONT BASE, AND 3 DIVIDERS PER SHELF OPENING. FOR ADDITIONAL PRODUCT SPECIFICATIONS PLEASE REFER TO PAGE 2d:1 (LETTER) AND PAGE 2d:15 (X-RAY).

## All letter prepackaged starter kits include:

- 2 closed "L" uprights
- slotted shelves
- top shelf
- shelf supports
- reinforcements (as noted)
- backstops or centerstops
- dividers
- 2" front Kick Plate

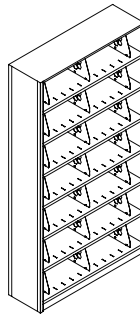

## All letter prepackaged adder kits include:

- 1 open "T" upright
- slotted shelves
- top shelf
- shelf supports
- reinforcements (as noted)
- backstops or centerstops
- dividers
- 2" front Kick Plate

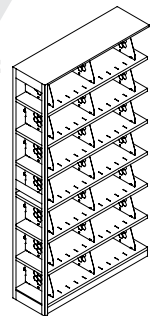

### 76-1/4" High, 8 Shelves, 7 Openings

#### STARTER

LETTER	Item #	LFI	D	W	H	Est Lbs.	List Price
	761236-S7P	238	12"	36"	76-1/4"	123	615.90
762436-S7P*	476	24"	36"	76-1/4"	204	918.20	

### 76-1/4" High, 8 Shelves, 7 Openings

#### ADDER

LETTER	Item #	LFI	D	W	H	Est Lbs.	List Price
	761236-A7P	238	12"	36"	76-1/4"	107	534.30
762436-A7P*	476	24"	36"	76-1/4"	176	776.20	

## All letter prepackaged starter kits include:

- 2 closed "L" uprights
- slotted shelves
- top shelf
- shelf supports
- reinforcements (as noted)
- backstops or centerstops
- dividers
- 2" front Kick Plate

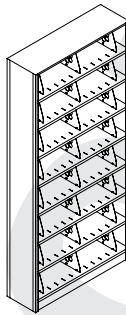

## All letter prepackaged adder kits include:

- 1 open "T" upright
- slotted shelves
- top shelf
- shelf supports
- reinforcements (as noted)
- backstops or centerstops
- dividers
- 2" front Kick Plate

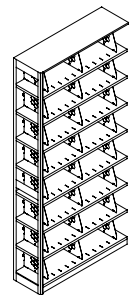

### 88-1/4" High, 9 Shelves, 8 Openings

#### STARTER

LETTER	Item #	LFI	D	W	H	Est Lbs.	List Price
	881236-S8P	272	12"	36"	88-1/4"	140	696.20
882436-S8P*	544	24"	36"	88-1/4"	232	1,031.80	

### 88-1/4" High, 9 Shelves, 8 Openings

#### ADDER

LETTER	Item #	LFI	D	W	H	Est Lbs.	List Price
	881236-A8P	272	12"	36"	88-1/4"	121	609.20
882436-A8P*	544	24"	36"	88-1/4"	200	881.60	

## All X-Ray prepackaged starter kits include:

- 2 closed "L" uprights
- slotted shelves
- top shelf
- shelf supports
- reinforcements (as noted)
- backstops or centerstops
- dividers
- 2" front Kick Plate

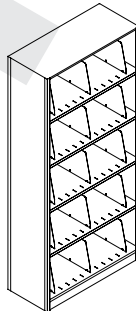

## All X-Ray prepackaged adder kits include:

- 1 closed "T" upright
- slotted shelves
- top shelf
- shelf supports
- reinforcements (as noted)
- backstops or centerstops
- dividers
- 2" front Kick Plate

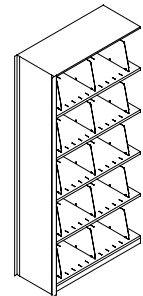

### 88-1/4" High, 6 Shelves, 5 Openings

#### STARTER

X-RAY	Item #	LFI	D	W	H	Est Lbs.	List Price
	881836-S5P**	175	18"	36"	88-1/4"	175	859.90

### 88-1/4" High, 6 Shelves, 5 Openings

#### ADDER

X-RAY	Item #	LFI	D	W	H	Est Lbs.	List Price
	881836-A5P**	175	18"	36"	88-1/4"	160	756.20

\*Includes one shelf reinforcement per shelf.  
\*\*Includes two shelf reinforcements per shelf.

# Library, Component Parts - Closed L & T Uprights

## Closed "L" Uprights

Item #	W	D	H	Pcs/ Ctn	Est Lbs.	List Price
4009LCL	1-1/8"	9"	40-1/4"	2	11	80.00
4012LCL	1-1/8"	12"	40-1/4"	2	12	86.20
4013LCL	1-1/8"	13"	40-1/4"	2	13	87.20
4015LCL	1-1/8"	15"	40-1/4"	2	15	94.80
4018LCL	1-1/8"	18"	40-1/4"	2	16	97.60
4020LCL	1-1/8"	20"	40-1/4"	2	17	99.90
4024LCL	1-1/8"	24"	40-1/4"	2	19	121.80
4026LCL	1-1/8"	26"	40-1/4"	2	20	125.20
4030LCL	1-1/8"	30"	40-1/4"	2	22	145.00
6409LCL	1-1/8"	9"	64-1/4"	2	17	97.00
6412LCL	1-1/8"	12"	64-1/4"	2	20	107.90
6413LCL	1-1/8"	13"	64-1/4"	2	21	109.00
6415LCL	1-1/8"	15"	64-1/4"	2	22	118.50
6418LCL	1-1/8"	18"	64-1/4"	2	24	130.30
6420LCL	1-1/8"	20"	64-1/4"	2	25	136.10
6424LCL	1-1/8"	24"	64-1/4"	2	29	154.80
6426LCL	1-1/8"	26"	64-1/4"	2	30	160.50
6430LCL	1-1/8"	30"	64-1/4"	2	35	178.10
7609LCL	1-1/8"	9"	76-1/4"	2	19	100.30
7612LCL	1-1/8"	12"	76-1/4"	2	21	112.20
7613LCL	1-1/8"	13"	76-1/4"	2	22	114.40
7615LCL	1-1/8"	15"	76-1/4"	2	23	125.00
7618LCL	1-1/8"	18"	76-1/4"	2	24	138.40
7620LCL	1-1/8"	20"	76-1/4"	2	25	144.10
7624LCL	1-1/8"	24"	76-1/4"	2	30	168.50
7626LCL	1-1/8"	26"	76-1/4"	2	31	179.80
7630LCL	1-1/8"	30"	76-1/4"	2	36	198.60
8509LCL	1-1/8"	9"	85-1/4"	2	22	110.70
8512LCL	1-1/8"	12"	85-1/4"	2	24	123.20
8513LCL	1-1/8"	13"	85-1/4"	2	25	128.00
8515LCL	1-1/8"	15"	85-1/4"	2	26	137.00
8518LCL	1-1/8"	18"	85-1/4"	2	28	150.70
8520LCL	1-1/8"	20"	85-1/4"	2	29	159.80
8524LCL	1-1/8"	24"	85-1/4"	2	36	182.40
8526LCL	1-1/8"	26"	85-1/4"	2	37	191.60
8530LCL	1-1/8"	30"	85-1/4"	2	45	214.70
8809LCL	1-1/8"	9"	88-1/4"	2	22	110.70
8812LCL	1-1/8"	12"	88-1/4"	2	25	124.00
8813LCL	1-1/8"	13"	88-1/4"	2	26	128.50
8815LCL	1-1/8"	15"	88-1/4"	2	27	138.50
8818LCL	1-1/8"	18"	88-1/4"	2	29	153.40
8820LCL	1-1/8"	20"	88-1/4"	2	30	164.70
8824LCL	1-1/8"	24"	88-1/4"	2	35	191.10
8826LCL	1-1/8"	26"	88-1/4"	2	38	202.50
8830LCL	1-1/8"	30"	88-1/4"	2	43	229.30
9709LCL	1-1/8"	9"	97-1/4"	2	25	146.20
9712LCL	1-1/8"	12"	97-1/4"	2	29	152.30
9713LCL	1-1/8"	13"	97-1/4"	2	30	162.70
9715LCL	1-1/8"	15"	97-1/4"	2	32	177.80
9718LCL	1-1/8"	18"	97-1/4"	2	35	203.00
9720LCL	1-1/8"	20"	97-1/4"	2	36	210.70
9724LCL	1-1/8"	24"	97-1/4"	2	42	238.80
9726LCL	1-1/8"	26"	97-1/4"	2	43	246.60
9730LCL	1-1/8"	30"	97-1/4"	2	50	274.60

## Closed "T" Uprights

Item #	W	D	H	Pcs/ Ctn	Est Lbs.	List Price
4009TCL	2"	9"	40-1/4"	1	15	97.20
4012TCL	2"	12"	40-1/4"	1	17	108.50
4013TCL	2"	13"	40-1/4"	1	18	111.90
4015TCL	2"	15"	40-1/4"	1	20	119.00
4018TCL	2"	18"	40-1/4"	1	21	129.50
4020TCL	2"	20"	40-1/4"	1	22	136.30
4024TCL	2"	24"	40-1/4"	1	25	145.50
4026TCL	2"	26"	40-1/4"	1	26	151.30
4030TCL	2"	30"	40-1/4"	1	30	161.60
6409TCL	2"	9"	64-1/4"	1	21	121.10
6412TCL	2"	12"	64-1/4"	1	26	130.30
6413TCL	2"	13"	64-1/4"	1	27	136.10
6415TCL	2"	15"	64-1/4"	1	29	145.70
6418TCL	2"	18"	64-1/4"	1	32	160.80
6420TCL	2"	20"	64-1/4"	1	33	170.00
6424TCL	2"	24"	64-1/4"	1	37	194.70
6426TCL	2"	26"	64-1/4"	1	38	211.70
6430TCL	2"	30"	64-1/4"	1	43	228.40
7609TCL	2"	9"	76-1/4"	1	23	134.10
7612TCL	2"	12"	76-1/4"	1	27	138.40
7613TCL	2"	13"	76-1/4"	1	28	143.00
7615TCL	2"	15"	76-1/4"	1	29	155.30
7618TCL	2"	18"	76-1/4"	1	32	177.40
7620TCL	2"	20"	76-1/4"	1	33	185.40
7624TCL	2"	24"	76-1/4"	1	38	206.40
7626TCL	2"	26"	76-1/4"	1	39	217.80
7630TCL	2"	30"	76-1/4"	1	44	240.80
8509TCL	2"	9"	85-1/4"	1	28	141.00
8512TCL	2"	12"	85-1/4"	1	30	154.40
8513TCL	2"	13"	85-1/4"	1	31	159.00
8515TCL	2"	15"	85-1/4"	1	32	170.00
8518TCL	2"	18"	85-1/4"	1	35	185.20
8520TCL	2"	20"	85-1/4"	1	36	211.30
8524TCL	2"	24"	85-1/4"	1	48	229.50
8526TCL	2"	26"	85-1/4"	1	49	240.80
8530TCL	2"	30"	85-1/4"	1	60	273.90
8809TCL	2"	9"	88-1/4"	1	29	143.40
8812TCL	2"	12"	88-1/4"	1	32	154.40
8813TCL	2"	13"	88-1/4"	1	32	160.20
8815TCL	2"	15"	88-1/4"	1	33	172.80
8818TCL	2"	18"	88-1/4"	1	35	191.10
8820TCL	2"	20"	88-1/4"	1	36	213.50
8824TCL	2"	24"	88-1/4"	1	44	239.50
8826TCL	2"	26"	88-1/4"	1	45	243.00
8830TCL	2"	30"	88-1/4"	1	52	287.70
9709TCL	2"	9"	97-1/4"	1	31	175.20
9712TCL	2"	12"	97-1/4"	1	37	198.40
9713TCL	2"	13"	97-1/4"	1	38	206.10
9715TCL	2"	15"	97-1/4"	1	42	220.20
9718TCL	2"	18"	97-1/4"	1	44	242.50
9720TCL	2"	20"	97-1/4"	1	45	259.10
9724TCL	2"	24"	97-1/4"	1	52	293.60
9726TCL	2"	26"	97-1/4"	1	53	300.00
9730TCL	2"	30"	97-1/4"	1	61	344.70

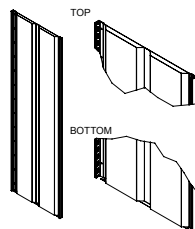
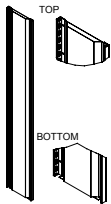

Custom sizes are available, consult factory for more information.

To calculate price for custom sizes, go to next size up and add \$10.00 to the list.

All uprights are double keyhole punched on 1-1/2" centers.

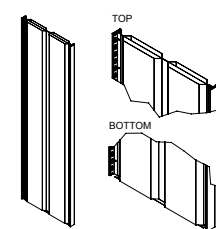
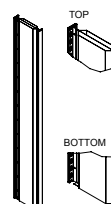

# Component Parts - Closed L Uprights

Item #	W	D	H	Pcs/Ctn	Est Lbs.	List Price
4009LC	1-1/8"	9"	40-1/4"	6	7	42.80
4012LC	1-1/8"	12"	40-1/4"	6	8	46.20
4013LC	1-1/8"	13"	40-1/4"	6	9	47.70
4015LC	1-1/8"	15"	40-1/4"	6	9	50.30
4016LC	1-1/8"	16"	40-1/4"	6	10	54.50
4018LC	1-1/8"	18"	40-1/4"	4	10	55.20
4020LC	1-1/8"	20"	40-1/4"	4	11	57.50
4024LC	1-1/8"	24"	40-1/4"	4	12	60.90
4026LC	1-1/8"	26"	40-1/4"	4	13	64.30
4030LC	1-1/8"	30"	40-1/4"	4	14	71.90
4032LC	1-1/8"	32"	40-1/4"	4	15	76.60
4036LC	1-1/8"	36"	40-1/4"	4	16	77.50
6409LC	1-1/8"	9"	64-1/4"	6	11	58.80
6412LC	1-1/8"	12"	64-1/4"	6	12	64.20
6413LC	1-1/8"	13"	64-1/4"	6	13	66.40
6415LC	1-1/8"	15"	64-1/4"	6	14	70.70
6416LC	1-1/8"	16"	64-1/4"	6	15	75.30
6418LC	1-1/8"	18"	64-1/4"	4	16	75.90
6420LC	1-1/8"	20"	64-1/4"	4	16	79.40
6424LC	1-1/8"	24"	64-1/4"	4	19	84.90
6426LC	1-1/8"	26"	64-1/4"	4	20	89.40
6430LC	1-1/8"	30"	64-1/4"	4	21	100.00
6432LC	1-1/8"	32"	64-1/4"	4	23	111.40
6436LC	1-1/8"	36"	64-1/4"	4	24	112.20
7609LC	1-1/8"	9"	76-1/4"	6	12	65.60
7612LC	1-1/8"	12"	76-1/4"	6	14	68.40
7613LC	1-1/8"	13"	76-1/4"	6	15	70.70
7615LC	1-1/8"	15"	76-1/4"	6	15	74.70
7616LC	1-1/8"	16"	76-1/4"	6	16	81.20
7618LC	1-1/8"	18"	76-1/4"	4	17	81.90
7620LC	1-1/8"	20"	76-1/4"	4	18	86.50
7624LC	1-1/8"	24"	76-1/4"	4	21	96.40
7626LC	1-1/8"	26"	76-1/4"	4	22	102.10
7630LC	1-1/8"	30"	76-1/4"	4	24	113.90
7632LC	1-1/8"	32"	76-1/4"	4	27	126.60
7636LC	1-1/8"	36"	76-1/4"	4	28	127.40
8509LC	1-1/8"	9"	85-1/4"	6	14	71.10
8512LC	1-1/8"	12"	85-1/4"	6	15	77.10
8513LC	1-1/8"	13"	85-1/4"	6	16	79.40
8515LC	1-1/8"	15"	85-1/4"	6	17	84.00
8516LC	1-1/8"	16"	85-1/4"	6	18	92.10
8518LC	1-1/8"	18"	85-1/4"	4	19	92.60
8520LC	1-1/8"	20"	85-1/4"	4	20	98.20
8524LC	1-1/8"	24"	85-1/4"	4	23	109.80
8526LC	1-1/8"	26"	85-1/4"	4	24	114.70
8530LC	1-1/8"	30"	85-1/4"	4	27	124.70
8532LC	1-1/8"	32"	85-1/4"	4	29	140.40
8536LC	1-1/8"	36"	85-1/4"	4	30	141.10

Item #	W	D	H	Pcs/Ctn	Est Lbs.	List Price
8809LC	1-1/8"	9"	88-1/4"	6	15	73.10
8812LC	1-1/8"	12"	88-1/4"	6	16	77.40
8813LC	1-1/8"	13"	88-1/4"	6	17	79.60
8815LC	1-1/8"	15"	88-1/4"	6	17	84.20
8816LC	1-1/8"	16"	88-1/4"	6	19	92.30
8818LC	1-1/8"	18"	88-1/4"	4	20	92.90
8820LC	1-1/8"	20"	88-1/4"	4	21	99.70
8824LC	1-1/8"	24"	88-1/4"	4	24	113.90
8826LC	1-1/8"	26"	88-1/4"	4	25	118.50
8830LC	1-1/8"	30"	88-1/4"	4	27	125.80
8832LC	1-1/8"	32"	88-1/4"	4	30	142.30
8836LC	1-1/8"	36"	88-1/4"	4	31	142.90
9709LC	1-1/8"	9"	97-1/4"	6	17	90.90
9712LC	1-1/8"	12"	97-1/4"	6	18	99.50
9713LC	1-1/8"	13"	97-1/4"	6	19	103.40
9715LC	1-1/8"	15"	97-1/4"	6	21	109.90
9716LC	1-1/8"	16"	97-1/4"	6	22	118.70
9718LC	1-1/8"	18"	97-1/4"	4	23	119.40
9720LC	1-1/8"	20"	97-1/4"	4	24	123.30
9724LC	1-1/8"	24"	97-1/4"	4	27	139.30
9726LC	1-1/8"	26"	97-1/4"	4	28	143.20
9730LC	1-1/8"	30"	97-1/4"	4	31	159.20
9732LC	1-1/8"	32"	97-1/4"	4	34	178.60
9736LC	1-1/8"	36"	97-1/4"	4	35	179.50
12109LC	1-1/8"	9"	121-1/4"	2	20	111.30
12112LC	1-1/8"	12"	121-1/4"	2	23	121.50
12113LC	1-1/8"	13"	121-1/4"	2	25	129.40
12115LC	1-1/8"	15"	121-1/4"	2	26	128.30
12116LC	1-1/8"	16"	121-1/4"	2	28	132.80
12118LC	1-1/8"	18"	121-1/4"	2	29	137.40
12120LC	1-1/8"	20"	121-1/4"	2	32	156.60
12124LC	1-1/8"	24"	121-1/4"	2	34	161.20
12126LC	1-1/8"	26"	121-1/4"	2	37	168.00
12130LC	1-1/8"	30"	121-1/4"	2	39	175.90
12132LC	1-1/8"	32"	121-1/4"	2	41	190.60
12136LC	1-1/8"	36"	121-1/4"	2	43	198.50



TOP

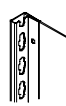

BOTTOM



Custom sizes are available, consult factory for more information.

To calculate price for custom sizes, go to next size up and add \$10.00 to the list.

All uprights are double keyhole punched on 1-1/2" centers.

# Component Parts - Closed T Uprights

Item #	W	D	H	Pcs/ Ctn	Est Lbs.	List Price
4009TC	2"	9"	40-1/4"	6	9	49.70
4012TC	2"	12"	40-1/4"	4	10	53.70
4013TC	2"	13"	40-1/4"	4	11	54.70
4015TC	2"	15"	40-1/4"	4	11	59.90
4016TC	2"	16"	40-1/4"	4	12	61.40
4018TC	2"	18"	40-1/4"	4	12	62.20
4020TC	2"	20"	40-1/4"	4	13	64.50
4024TC	2"	24"	40-1/4"	3	14	69.00
4026TC	2"	26"	40-1/4"	3	15	72.70
4030TC	2"	30"	40-1/4"	3	16	79.70
4032TC	2"	32"	40-1/4"	3	17	85.50
4036TC	2"	36"	40-1/4"	3	18	86.20
6409TC	2"	9"	64-1/4"	6	15	70.90
6412TC	2"	12"	64-1/4"	4	16	76.40
6413TC	2"	13"	64-1/4"	4	17	78.70
6415TC	2"	15"	64-1/4"	4	17	83.30
6416TC	2"	16"	64-1/4"	4	18	87.90
6418TC	2"	18"	64-1/4"	4	19	88.70
6420TC	2"	20"	64-1/4"	4	20	92.20
6424TC	2"	24"	64-1/4"	3	22	99.80
6426TC	2"	26"	64-1/4"	3	23	104.30
6430TC	2"	30"	64-1/4"	3	25	113.40
6432TC	2"	32"	64-1/4"	3	27	125.60
6436TC	2"	36"	64-1/4"	3	28	126.30
7609TC	2"	9"	76-1/4"	6	17	79.70
7612TC	2"	12"	76-1/4"	4	18	82.90
7613TC	2"	13"	76-1/4"	4	19	85.20
7615TC	2"	15"	76-1/4"	4	19	89.90
7616TC	2"	16"	76-1/4"	4	21	97.00
7618TC	2"	18"	76-1/4"	4	22	97.60
7620TC	2"	20"	76-1/4"	4	23	99.90
7624TC	2"	24"	76-1/4"	3	26	105.70
7626TC	2"	26"	76-1/4"	3	27	112.50
7630TC	2"	30"	76-1/4"	3	29	126.90
7632TC	2"	32"	76-1/4"	3	31	142.30
7636TC	2"	36"	76-1/4"	3	32	142.90
8509TC	2"	9"	85-1/4"	6	19	86.50
8512TC	2"	12"	85-1/4"	4	20	93.40
8513TC	2"	13"	85-1/4"	4	21	95.70
8515TC	2"	15"	85-1/4"	4	21	100.80
8516TC	2"	16"	85-1/4"	4	23	105.90
8518TC	2"	18"	85-1/4"	4	24	106.50
8520TC	2"	20"	85-1/4"	4	25	112.20
8524TC	2"	24"	85-1/4"	3	29	123.60
8526TC	2"	26"	85-1/4"	3	30	130.40
8530TC	2"	30"	85-1/4"	3	32	142.60
8532TC	2"	32"	85-1/4"	3	36	157.60
8536TC	2"	36"	85-1/4"	3	37	158.30

Item #	W	D	H	Pcs/ Ctn	Est Lbs.	List Price
8809TC	2"	9"	88-1/4"	6	19	88.70
8812TC	2"	12"	88-1/4"	4	20	95.20
8813TC	2"	13"	88-1/4"	4	21	97.40
8815TC	2"	15"	88-1/4"	4	22	101.60
8816TC	2"	16"	88-1/4"	4	24	106.10
8818TC	2"	18"	88-1/4"	4	25	106.90
8820TC	2"	20"	88-1/4"	4	26	113.80
8824TC	2"	24"	88-1/4"	3	29	127.60
8826TC	2"	26"	88-1/4"	3	30	133.40
8830TC	2"	30"	88-1/4"	3	30	147.20
8832TC	2"	32"	88-1/4"	3	37	160.70
8836TC	2"	36"	88-1/4"	3	38	161.30
9709TC	2"	9"	97-1/4"	6	22	114.60
9712TC	2"	12"	97-1/4"	4	23	120.30
9713TC	2"	13"	97-1/4"	4	24	124.10
9715TC	2"	15"	97-1/4"	4	24	131.20
9716TC	2"	16"	97-1/4"	4	27	139.80
9718TC	2"	18"	97-1/4"	4	28	140.70
9720TC	2"	20"	97-1/4"	3	29	147.20
9724TC	2"	24"	97-1/4"	3	32	160.40
9726TC	2"	26"	97-1/4"	3	33	166.90
9730TC	2"	30"	97-1/4"	3	37	181.50
9732TC	2"	32"	97-1/4"	3	40	200.60
9736TC	2"	36"	97-1/4"	3	41	201.30
12109TC	2"	9"	121-1/4"	2	25	134.00
12112TC	2"	12"	121-1/4"	2	28	139.60
12113TC	2"	13"	121-1/4"	2	30	140.80
12115TC	2"	15"	121-1/4"	2	31	146.40
12116TC	2"	16"	121-1/4"	2	33	140.80
12118TC	2"	18"	121-1/4"	2	34	158.90
12120TC	2"	20"	121-1/4"	2	37	177.00
12124TC	2"	24"	121-1/4"	2	39	185.00
12126TC	2"	26"	121-1/4"	2	42	189.30
12130TC	2"	30"	121-1/4"	2	44	191.70
12132TC	2"	32"	121-1/4"	2	46	199.70
12136TC	2"	36"	121-1/4"	2	48	240.50

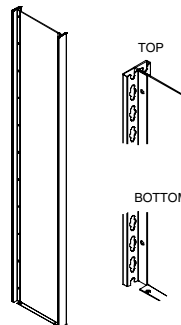

Custom sizes are available, consult factory for more information.

To calculate price for custom sizes, go to next size up and add \$10.00 to the list.

All uprights are double keyhole punched on 1-1/2" centers.

# Component Parts - Open L Uprights

Item #	W	D	H	Pcs/Ctn	Est Lbs.	List Price
4009LO	1-1/8"	9"	40-1/4"	6	5	42.00
4012LO	1-1/8"	12"	40-1/4"	6	6	43.20
4013LO	1-1/8"	13"	40-1/4"	6	6	44.40
4015LO	1-1/8"	15"	40-1/4"	6	6	45.40
4016LO	1-1/8"	16"	40-1/4"	6	7	46.70
4018LO	1-1/8"	18"	40-1/4"	4	7	47.70
4020LO	1-1/8"	20"	40-1/4"	4	7	49.40
4024LO	1-1/8"	24"	40-1/4"	4	8	51.20
4026LO	1-1/8"	26"	40-1/4"	4	8	52.80
4030LO	1-1/8"	30"	40-1/4"	4	8	54.50
4032LO	1-1/8"	32"	40-1/4"	4	9	58.00
4036LO	1-1/8"	36"	40-1/4"	4	9	59.00
6409LO	1-1/8"	9"	64-1/4"	6	8	53.50
6412LO	1-1/8"	12"	64-1/4"	6	9	56.80
6413LO	1-1/8"	13"	64-1/4"	6	9	57.40
6415LO	1-1/8"	15"	64-1/4"	6	10	58.00
6416LO	1-1/8"	16"	64-1/4"	6	10	59.70
6418LO	1-1/8"	18"	64-1/4"	4	10	60.30
6420LO	1-1/8"	20"	64-1/4"	4	10	61.70
6424LO	1-1/8"	24"	64-1/4"	4	11	63.60
6426LO	1-1/8"	26"	64-1/4"	4	11	65.40
6430LO	1-1/8"	30"	64-1/4"	4	12	67.10
6432LO	1-1/8"	32"	64-1/4"	4	13	70.50
6436LO	1-1/8"	36"	64-1/4"	4	13	71.60
7609LO	1-1/8"	9"	76-1/4"	6	9	59.70
7612LO	1-1/8"	12"	76-1/4"	6	10	60.30
7613LO	1-1/8"	13"	76-1/4"	6	10	60.70
7615LO	1-1/8"	15"	76-1/4"	6	10	62.50
7616LO	1-1/8"	16"	76-1/4"	6	11	64.40
7618LO	1-1/8"	18"	76-1/4"	4	11	64.80
7620LO	1-1/8"	20"	76-1/4"	4	11	67.10
7624LO	1-1/8"	24"	76-1/4"	4	12	69.30
7626LO	1-1/8"	26"	76-1/4"	4	12	72.80
7630LO	1-1/8"	30"	76-1/4"	4	13	79.50
7632LO	1-1/8"	32"	76-1/4"	4	14	81.80
7636LO	1-1/8"	36"	76-1/4"	4	14	82.90

Item #	W	D	H	Pcs/Ctn	Est Lbs.	List Price
8509LO	1-1/8"	9"	85-1/4"	6	10	63.60
8512LO	1-1/8"	12"	85-1/4"	6	11	65.80
8513LO	1-1/8"	13"	85-1/4"	6	11	66.40
8515LO	1-1/8"	15"	85-1/4"	6	11	67.10
8516LO	1-1/8"	16"	85-1/4"	6	12	69.30
8518LO	1-1/8"	18"	85-1/4"	4	12	70.50
8520LO	1-1/8"	20"	85-1/4"	4	12	72.60
8524LO	1-1/8"	24"	85-1/4"	4	13	75.00
8526LO	1-1/8"	26"	85-1/4"	4	13	77.90
8530LO	1-1/8"	30"	85-1/4"	4	14	81.80
8532LO	1-1/8"	32"	85-1/4"	4	15	87.40
8536LO	1-1/8"	36"	85-1/4"	4	15	88.60
8809LO	1-1/8"	9"	88-1/4"	6	10	63.60
8812LO	1-1/8"	12"	88-1/4"	6	11	67.10
8813LO	1-1/8"	13"	88-1/4"	6	11	68.20
8815LO	1-1/8"	15"	88-1/4"	6	11	69.30
8816LO	1-1/8"	16"	88-1/4"	6	12	70.50
8818LO	1-1/8"	18"	88-1/4"	4	13	71.60
8820LO	1-1/8"	20"	88-1/4"	4	13	75.20
8824LO	1-1/8"	24"	88-1/4"	4	14	77.30
8826LO	1-1/8"	26"	88-1/4"	4	14	80.00
8830LO	1-1/8"	30"	88-1/4"	4	15	86.30
8832LO	1-1/8"	32"	88-1/4"	4	16	88.60
8836LO	1-1/8"	36"	88-1/4"	4	16	88.60
9709LO	1-1/8"	9"	97-1/4"	6	12	83.00
9712LO	1-1/8"	12"	97-1/4"	6	13	85.70
9713LO	1-1/8"	13"	97-1/4"	6	13	87.70
9715LO	1-1/8"	15"	97-1/4"	6	14	89.50
9716LO	1-1/8"	16"	97-1/4"	6	15	91.80
9718LO	1-1/8"	18"	97-1/4"	4	15	92.20
9720LO	1-1/8"	20"	97-1/4"	4	15	95.20
9724LO	1-1/8"	24"	97-1/4"	4	17	99.90
9726LO	1-1/8"	26"	97-1/4"	4	17	103.80
9730LO	1-1/8"	30"	97-1/4"	4	17	109.00
9732LO	1-1/8"	32"	97-1/4"	4	18	111.90
9736LO	1-1/8"	36"	97-1/4"	4	18	112.90

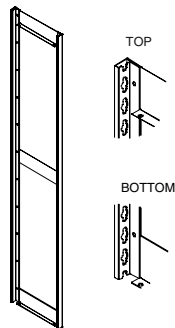

Open "L" uprights are not recommended for X-Ray applications.  
 Custom sizes are available, consult factory for more information.  
 To calculate price for custom sizes, go to next size up and add \$10.00 to list.  
 All uprights are double keyhole punched on 1-1/2" centers.



# Component Parts - Open T Uprights

Item #	W	D	H	Pcs/ Ctn	Est Lbs.	List Price
4009TO	2"	9"	40-1/4"	6	7	50.00
4012TO	2"	12"	40-1/4"	4	8	52.20
4013TO	2"	13"	40-1/4"	4	8	53.30
4015TO	2"	15"	40-1/4"	4	9	54.50
4016TO	2"	16"	40-1/4"	4	9	55.70
4018TO	2"	18"	40-1/4"	4	9	56.80
4020TO	2"	20"	40-1/4"	4	9	60.60
4024TO	2"	24"	40-1/4"	3	10	61.30
4026TO	2"	26"	40-1/4"	3	10	62.00
4030TO	2"	30"	40-1/4"	3	11	64.80
4032TO	2"	32"	40-1/4"	3	11	69.30
4036TO	2"	36"	40-1/4"	3	11	70.50
6409TO	2"	9"	64-1/4"	6	11	68.20
6412TO	2"	12"	64-1/4"	4	12	70.50
6413TO	2"	13"	64-1/4"	4	12	71.40
6415TO	2"	15"	64-1/4"	4	13	72.70
6416TO	2"	16"	64-1/4"	4	13	73.90
6418TO	2"	18"	64-1/4"	4	14	75.00
6420TO	2"	20"	64-1/4"	4	14	76.80
6424TO	2"	24"	64-1/4"	3	15	78.40
6426TO	2"	26"	64-1/4"	3	15	79.90
6430TO	2"	30"	64-1/4"	3	15	81.80
6432TO	2"	32"	64-1/4"	3	16	87.40
6436TO	2"	36"	64-1/4"	3	16	88.60
7609TO	2"	9"	76-1/4"	6	13	76.10
7612TO	2"	12"	76-1/4"	4	14	77.30
7613TO	2"	13"	76-1/4"	4	14	78.40
7615TO	2"	15"	76-1/4"	4	15	80.60
7616TO	2"	16"	76-1/4"	4	16	82.90
7618TO	2"	18"	76-1/4"	4	16	84.00
7620TO	2"	20"	76-1/4"	4	16	86.50
7624TO	2"	24"	76-1/4"	3	18	92.10
7626TO	2"	26"	76-1/4"	3	18	95.20
7630TO	2"	30"	76-1/4"	3	18	98.90
7632TO	2"	32"	76-1/4"	3	19	99.90
7636TO	2"	36"	76-1/4"	3	19	101.10

Item #	W	D	H	Pcs/ Ctn	Est Lbs.	List Price
8509TO	2"	9"	85-1/4"	6	14	81.80
8512TO	2"	12"	85-1/4"	4	15	86.30
8513TO	2"	13"	85-1/4"	4	15	87.00
8515TO	2"	15"	85-1/4"	4	16	88.60
8516TO	2"	16"	85-1/4"	4	17	90.80
8518TO	2"	18"	85-1/4"	4	17	92.10
8520TO	2"	20"	85-1/4"	4	17	93.20
8524TO	2"	24"	85-1/4"	3	19	96.60
8526TO	2"	26"	85-1/4"	3	19	99.50
8530TO	2"	30"	85-1/4"	3	20	102.20
8532TO	2"	32"	85-1/4"	3	21	104.40
8536TO	2"	36"	85-1/4"	3	22	105.70
8809TO	2"	9"	88-1/4"	6	14	82.90
8812TO	2"	12"	88-1/4"	4	15	86.30
8813TO	2"	13"	88-1/4"	4	15	87.20
8815TO	2"	15"	88-1/4"	4	16	88.60
8816TO	2"	16"	88-1/4"	4	17	92.10
8818TO	2"	18"	88-1/4"	4	18	93.10
8820TO	2"	20"	88-1/4"	4	18	96.10
8824TO	2"	24"	88-1/4"	3	19	98.90
8826TO	2"	26"	88-1/4"	3	19	103.90
8830TO	2"	30"	88-1/4"	3	19	106.70
8832TO	2"	32"	88-1/4"	3	22	114.70
8836TO	2"	36"	88-1/4"	3	23	115.90
9709TO	2"	9"	97-1/4"	6	17	105.20
9712TO	2"	12"	97-1/4"	4	18	109.00
9713TO	2"	13"	97-1/4"	4	18	110.30
9715TO	2"	15"	97-1/4"	4	19	112.90
9716TO	2"	16"	97-1/4"	4	20	114.20
9718TO	2"	18"	97-1/4"	4	20	115.50
9720TO	2"	20"	97-1/4"	4	20	118.80
9724TO	2"	24"	97-1/4"	3	21	122.00
9726TO	2"	26"	97-1/4"	3	21	123.90
9730TO	2"	30"	97-1/4"	3	22	127.20
9732TO	2"	32"	97-1/4"	3	23	131.10
9736TO	2"	36"	97-1/4"	3	23	132.40

Open "T" uprights are not recommended for X-Ray applications.  
 Custom sizes are available, consult factory for more information.  
 To calculate price for custom sizes, go to next size up and add \$10.00 to list.  
 All uprights are double keyhole punched on 1-1/2" centers.

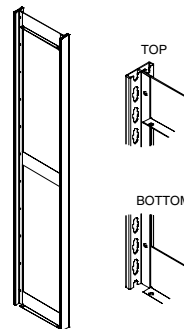

# Component Parts - Upright Extensions

4Post™ Upright Extension Kits extend the current height of the 4Post™ unit to increase usable vertical storage space. Extension kits can be added to 4Post™ stationary units and/or units on MobileTrak5® Systems. Extension Kits CANNOT be used with TrakSlider™ Systems.

## "L" Upright Extension Conversion Chart

Proposed Upright Height		40-1/4"	64-1/4"	76-1/4"	85-1/4"	88-1/4"	97-1/4"	121-1/4"
Current Upright Height	40-1/4"	n/a	24XX-ALC	36XX-ALC	45XX-ALC	48XX-ALC	57XX-ALC	n/a
	64-1/4"	n/a	n/a	n/a	21XX-ALC	24XX-ALC	33XX-ALC	57XX-ALC
	76-1/4"	n/a	n/a	n/a	n/a	n/a	21XX-ALC	45XX-ALC
	85-1/4"	n/a	n/a	n/a	n/a	n/a	n/a	36XX-ALC
	88-1/4"	n/a	n/a	n/a	n/a	n/a	n/a	33XX-ALC
	97-1/4"	n/a	n/a	n/a	n/a	n/a	n/a	24XX-ALC

For applications requiring upright heights greater than 121-1/2", consult the factory.  
 All 4Post™ starter units require 2 "L" Upright Extension Kits.  
 Replace "XX" in each part number with the depth of the upright.

## "T" Upright Extension Conversion Chart

Proposed Upright Height		40-1/4"	64-1/4"	76-1/4"	85-1/4"	88-1/4"	97-1/4"	121-1/4"
Current Upright Height	40-1/4"	n/a	24XX-ATC	36XX-ATC	45XX-ATC	48XX-ATC	57XX-ATC	n/a
	64-1/4"	n/a	n/a	n/a	21XX-ATC	24XX-ATC	33XX-ATC	57XX-ATC
	76-1/4"	n/a	n/a	n/a	n/a	n/a	21XX-ATC	45XX-ATC
	85-1/4"	n/a	n/a	n/a	n/a	n/a	n/a	36XX-ATC
	88-1/4"	n/a	n/a	n/a	n/a	n/a	n/a	33XX-ATC
	97-1/4"	n/a	n/a	n/a	n/a	n/a	n/a	24XX-ATC

For applications requiring upright heights greater than 121-1/2", consult the factory.  
 All 4Post™ adder units require 1 "T" Upright Extension Kit.  
 Replace "XX" in each part number with the depth of the upright.



# Upright Extension Kits

Allows for custom uprights up to 121-1/4" high. Simple assembly, includes all necessary mounting hardware. Upright Extension Kits are only available as closed uprights. Upright Extension Kits can be used with open or closed "L" and "T" uprights. Additional shelves and supports are sold separately.

**Note: All 4Post™ starter units require 2 "L" Upright Extension Kits.**

**All 4Post™ adder units require 1 "T" Upright Extension Kit.**

**Not compatible with Library Closed "L" or "T" Uprights.**

## Closed "L"

Item#	D	H	Est Lbs.	List Price
2109-ALC	9"	21"	4	48.50
2112-ALC	12"	21"	5	52.00
2113-ALC	13"	21"	6	53.10
2115-ALC	15"	21"	6	55.20
2116-ALC	16"	21"	7	56.80
2118-ALC	18"	21"	7	58.50
2120-ALC	20"	21"	8	60.70
2124-ALC	24"	21"	8	65.00
2126-ALC	26"	21"	9	67.30
2130-ALC	30"	21"	9	71.40
2132-ALC	32"	21"	10	74.80
2136-ALC	36"	21"	11	77.90
2409-ALC	9"	24"	5	52.60
2412-ALC	12"	24"	5	56.30
2413-ALC	13"	24"	6	57.60
2415-ALC	15"	24"	6	60.30
2416-ALC	16"	24"	6	62.10
2418-ALC	18"	24"	7	64.00
2420-ALC	20"	24"	9	66.40
2424-ALC	24"	24"	9	71.30
2426-ALC	26"	24"	10	73.90
2430-ALC	30"	24"	10	78.70
2432-ALC	32"	24"	11	82.20
2436-ALC	36"	24"	12	86.20
3309-ALC	9"	33"	6	64.80
3312-ALC	12"	33"	7	69.80
3313-ALC	13"	33"	8	70.70
3315-ALC	15"	33"	8	72.50
3316-ALC	16"	33"	8	73.60
3318-ALC	18"	33"	9	75.00
3320-ALC	20"	33"	11	80.00
3324-ALC	24"	33"	12	90.30
3326-ALC	26"	33"	13	93.60
3330-ALC	30"	33"	14	100.30
3332-ALC	32"	33"	16	105.70
3336-ALC	36"	33"	17	110.70

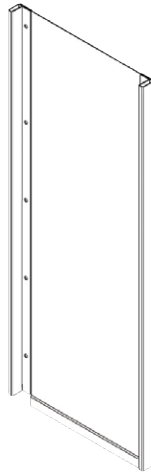

Item#	D	H	Est Lbs.	List Price
3609-ALC	9"	36"	7	68.70
3612-ALC	12"	36"	8	74.40
3613-ALC	13"	36"	9	76.20
3615-ALC	15"	36"	9	79.90
3616-ALC	16"	36"	10	82.90
3618-ALC	18"	36"	11	85.50
3620-ALC	20"	36"	12	89.10
3624-ALC	24"	36"	13	96.60
3626-ALC	26"	36"	15	100.20
3630-ALC	30"	36"	16	107.60
3632-ALC	32"	36"	17	113.30
3636-ALC	36"	36"	18	118.90
4509-ALC	9"	45"	9	80.90
4512-ALC	12"	45"	10	87.90
4513-ALC	13"	45"	11	90.10
4515-ALC	15"	45"	11	94.90
4516-ALC	16"	45"	12	98.20
4518-ALC	18"	45"	13	101.70
4520-ALC	20"	45"	15	106.30
4524-ALC	24"	45"	16	115.60
4526-ALC	26"	45"	18	120.30
4530-ALC	30"	45"	19	129.50
4532-ALC	32"	45"	21	136.40
4536-ALC	36"	45"	23	143.40
5709-ALC	9"	57"	11	97.00
5712-ALC	12"	57"	13	105.80
5713-ALC	13"	57"	14	107.90
5715-ALC	15"	57"	14	112.10
5716-ALC	16"	57"	15	117.70
5718-ALC	18"	57"	17	123.30
5720-ALC	20"	57"	19	129.30
5724-ALC	24"	57"	21	140.90
5726-ALC	26"	57"	22	146.90
5730-ALC	30"	57"	25	158.50
5732-ALC	32"	57"	27	167.30
5736-ALC	36"	57"	29	176.10

# Upright Extension Kits

Allows for custom uprights up to 121-1/4" high. Simple assembly, includes all necessary mounting hardware. Upright Extension Kits are only available as closed uprights. Upright Extension Kits can be used with open or closed "L" and "T" uprights. Additional shelves and supports are sold separately.

**Note: All 4Post™ starter units require 2 "L" Upright Extension Kits.**

**All 4Post™ adder units require 1 "T" Upright Extension Kit.**

**Not compatible with Library Closed "L" or "T" Uprights.**

## Closed "T"

Item#	D	H	Est Lbs.	List Price
2109-ATC	9"	21"	5	67.20
2112-ATC	12"	21"	6	70.10
2113-ATC	13"	21"	6	71.30
2115-ATC	15"	21"	6	73.40
2116-ATC	16"	21"	7	75.10
2118-ATC	18"	21"	7	76.60
2120-ATC	20"	21"	8	79.00
2124-ATC	24"	21"	9	83.40
2126-ATC	26"	21"	10	85.60
2130-ATC	30"	21"	10	89.80
2132-ATC	32"	21"	11	92.90
2136-ATC	36"	21"	11	96.10
2409-ATC	9"	24"	6	71.60
2412-ATC	12"	24"	6	75.30
2413-ATC	13"	24"	7	76.50
2415-ATC	15"	24"	7	79.10
2416-ATC	16"	24"	8	80.90
2418-ATC	18"	24"	8	82.60
2420-ATC	20"	24"	9	84.90
2424-ATC	24"	24"	10	90.20
2426-ATC	26"	24"	11	92.50
2430-ATC	30"	24"	11	97.50
2432-ATC	32"	24"	12	101.40
2436-ATC	36"	24"	13	105.00
3309-ATC	9"	33"	8	85.00
3312-ATC	12"	33"	9	90.20
3313-ATC	13"	33"	10	91.10
3315-ATC	15"	33"	10	92.70
3316-ATC	16"	33"	10	95.20
3318-ATC	18"	33"	10	95.20
3320-ATC	20"	33"	12	101.10
3324-ATC	24"	33"	13	110.70
3326-ATC	26"	33"	15	114.10
3330-ATC	30"	33"	16	120.80
3332-ATC	32"	33"	17	125.80
3336-ATC	36"	33"	18	131.00

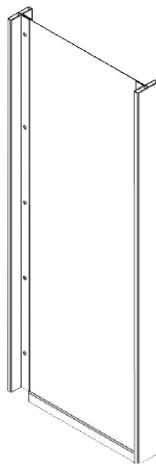

Item#	D	H	Est Lbs.	List Price
3609-ATC	9"	36"	8	89.50
3612-ATC	12"	36"	10	95.20
3613-ATC	13"	36"	11	97.00
3615-ATC	15"	36"	11	100.70
3616-ATC	16"	36"	11	103.60
3618-ATC	18"	36"	12	106.30
3620-ATC	20"	36"	14	110.00
3624-ATC	24"	36"	15	117.50
3626-ATC	26"	36"	16	121.20
3630-ATC	30"	36"	17	128.80
3632-ATC	32"	36"	19	134.30
3636-ATC	36"	36"	20	139.90
4509-ATC	9"	45"	11	103.20
4512-ATC	12"	45"	12	110.00
4513-ATC	13"	45"	13	112.30
4515-ATC	15"	45"	13	117.10
4516-ATC	16"	45"	14	120.50
4518-ATC	18"	45"	15	124.00
4520-ATC	20"	45"	17	128.80
4524-ATC	24"	45"	18	137.90
4526-ATC	26"	45"	19	142.40
4530-ATC	30"	45"	21	151.90
4532-ATC	32"	45"	23	158.70
4536-ATC	36"	45"	24	165.80
5709-ATC	9"	57"	13	121.10
5712-ATC	12"	57"	15	130.00
5713-ATC	13"	57"	16	133.30
5715-ATC	15"	57"	16	138.80
5716-ATC	16"	57"	17	142.80
5718-ATC	18"	57"	19	147.70
5720-ATC	20"	57"	21	153.80
5724-ATC	24"	57"	23	165.20
5726-ATC	26"	57"	25	171.20
5730-ATC	30"	57"	27	182.90
5732-ATC	32"	57"	29	191.80
5736-ATC	36"	57"	31	200.60

# Component Parts - Standard Duty Shelves 22 Gauge

## Slotted Standard Duty Shelf

Item #	# of Entries	W	D	H	Pcs/Ctn	Est Lbs.	List Price
0924SS*	Single	24"	9"	3/4"	16	2	15.20
1224SS	Single	24"	12"	3/4"	16	2	20.00
1324SS	Single	24"	13"	3/4"	16	2	22.20
1524SS	Single	24"	15"	3/4"	16	4	25.80
1824SS*	Double	24"	18"	3/4"	8	5	29.00
2024SS	Double	24"	20"	3/4"	8	5	31.40
2424SS	Double	24"	24"	3/4"	8	6	34.80
2624SS	Double	24"	26"	3/4"	8	7	37.10
3024SS	Double	24"	30"	3/4"	8	8	47.00
3624SS	Double	24"	36"	3/4"	8	10	75.80
0930SS*	Single	30"	9"	3/4"	16	3	15.30
1230SS	Single	30"	12"	3/4"	16	4	20.10
1330SS	Single	30"	13"	3/4"	16	4	22.40
1530SS	Single	30"	15"	3/4"	16	5	26.30
1830SS	Double	30"	18"	3/4"	8	6	29.30
2030SS	Double	30"	20"	3/4"	8	6	31.50
2430SS	Double	30"	24"	3/4"	8	7	35.00
2630SS	Double	30"	26"	3/4"	8	8	37.30
3030SS	Double	30"	30"	3/4"	8	10	47.20
3630SS	Double	30"	36"	3/4"	8	11	77.50
0936SS*	Single	36"	9"	3/4"	16	4	15.50
1236SS	Single	36"	12"	3/4"	16	5	20.20
1336SS	Single	36"	13"	3/4"	16	5	22.50
1536SS	Single	36"	15"	3/4"	16	6	26.50
1836SS*	Double	36"	18"	3/4"	8	7	29.50
2036SS	Double	36"	20"	3/4"	8	7	31.70
2436SS	Double	36"	24"	3/4"	8	8	35.70
2636SS	Double	36"	26"	3/4"	8	9	38.00
3036SS	Double	36"	30"	3/4"	8	11	47.70
3636SS	Double	36"	36"	3/4"	8	14	77.90
0942SS*	Single	42"	9"	3/4"	16	5	19.00
1242SS	Single	42"	12"	3/4"	16	5	23.70
1342SS	Single	42"	13"	3/4"	16	6	26.00
1542SS	Single	42"	15"	3/4"	16	6	29.90
1842SS*	Double	42"	18"	3/4"	8	8	33.90
2042SS	Double	42"	20"	3/4"	8	9	36.20
2442SS	Double	42"	24"	3/4"	8	10	42.40
2642SS	Double	42"	26"	3/4"	8	10	44.70
3042SS	Double	42"	30"	3/4"	8	14	53.10
3642SS	Double	42"	36"	3/4"	8	18	89.40
0948SS*	Single	48"	9"	3/4"	16	6	21.10
1248SS	Single	48"	12"	3/4"	16	6	26.40
1348SS	Single	48"	13"	3/4"	16	7	28.60
1548SS	Single	48"	15"	3/4"	16	7	33.80
1848SS*	Double	48"	18"	3/4"	8	9	37.60
2048SS	Double	48"	20"	3/4"	8	10	39.90
2448SS	Double	48"	24"	3/4"	8	11	48.20
2648SS	Double	48"	26"	3/4"	8	12	50.50
3048SS	Double	48"	30"	3/4"	8	15	59.90
3648SS	Double	48"	36"	3/4"	8	19	103.60

## Unslotted Standard Duty Shelf

Item #	W	D	H	Pcs/Ctn	Est Lbs.	List Price
0924TS	24"	9"	3/4"	16	2	15.20
1224TS	24"	12"	3/4"	16	2	20.00
1324TS	24"	13"	3/4"	16	2	22.20
1524TS	24"	15"	3/4"	8	4	25.80
1824TS	24"	18"	3/4"	8	5	29.00
2024TS	24"	20"	3/4"	8	5	31.40
2424TS	24"	24"	3/4"	8	6	34.80
2624TS	24"	26"	3/4"	8	7	37.10
3024TS	24"	30"	3/4"	8	8	47.00
3624TS	24"	36"	3/4"	8	10	75.80
0930TS	30"	9"	3/4"	16	3	15.30
1230TS	30"	12"	3/4"	16	4	20.10
1330TS	30"	13"	3/4"	16	4	22.40
1530TS	30"	15"	3/4"	8	5	26.30
1830TS	30"	18"	3/4"	8	6	29.30
2030TS	30"	20"	3/4"	8	6	31.50
2430TS	30"	24"	3/4"	8	7	35.00
2630TS	30"	26"	3/4"	8	8	37.30
3030TS	30"	30"	3/4"	8	10	47.20
3630TS	30"	36"	3/4"	8	11	77.50
0936TS	36"	9"	3/4"	16	4	15.50
1236TS	36"	12"	3/4"	16	5	20.20
1336TS	36"	13"	3/4"	16	5	22.50
1536TS	36"	15"	3/4"	8	6	26.50
1836TS	36"	18"	3/4"	8	7	29.50
2036TS	36"	20"	3/4"	8	7	31.70
2436TS	36"	24"	3/4"	8	8	35.70
2636TS	36"	26"	3/4"	8	9	38.00
3036TS	36"	30"	3/4"	8	11	47.70
3636TS	36"	36"	3/4"	8	14	77.90
0942TS	42"	9"	3/4"	16	5	19.00
1242TS	42"	12"	3/4"	16	5	23.70
1342TS	42"	13"	3/4"	16	6	26.00
1542TS	42"	15"	3/4"	8	6	29.90
1842TS	42"	18"	3/4"	8	8	33.90
2042TS	42"	20"	3/4"	8	9	36.20
2442TS	42"	24"	3/4"	8	10	42.40
2642TS	42"	26"	3/4"	8	10	44.70
3042TS	42"	30"	3/4"	8	14	53.10
3642TS	42"	36"	3/4"	8	18	89.40
0948TS	48"	9"	3/4"	16	6	21.10
1248TS	48"	12"	3/4"	16	6	26.40
1348TS	48"	13"	3/4"	16	7	28.60
1548TS	48"	15"	3/4"	8	7	33.80
1848TS	48"	18"	3/4"	8	9	37.60
2048TS	48"	20"	3/4"	8	10	39.90
2448TS	48"	24"	3/4"	8	11	48.20
2648TS	48"	26"	3/4"	8	12	50.50
3048TS	48"	30"	3/4"	8	15	59.90
3648TS	48"	36"	3/4"	8	19	103.60

\*Specify FDB Dividers for 9" & 18" shelves, all other require FDL Dividers.

\*For use with standard L&T Uprights found on pages 2d:22-25 only.

For perforated shelving:

Change the SS suffix to VS and add 20% to the list price, rounded to the dime.

# Component Parts - Standard Duty Shelves 22 Gauge

## Slotted Standard Archive Shelf

Item #	# of Entries	W	D	H	Pcs/Ctn	Est Lbs.	List Price
1624SS	Single	24"	16"	3/4"	4	4	28.40
3224SS	Double	24"	32"	3/4"	4	9	47.70
1630SS	Single	30"	16"	3/4"	4	6	28.50
3230SS	Double	30"	32"	3/4"	4	11	47.90
1636SS	Single	36"	16"	3/4"	4	7	28.60
3236SS	Double	36"	32"	3/4"	4	12	48.30
1642SS	Single	42"	16"	3/4"	4	7	30.80
3242SS	Double	42"	32"	3/4"	4	15	53.80
1648SS	Single	48"	16"	3/4"	4	8	37.00
3248SS	Double	48"	32"	3/4"	4	16	60.80

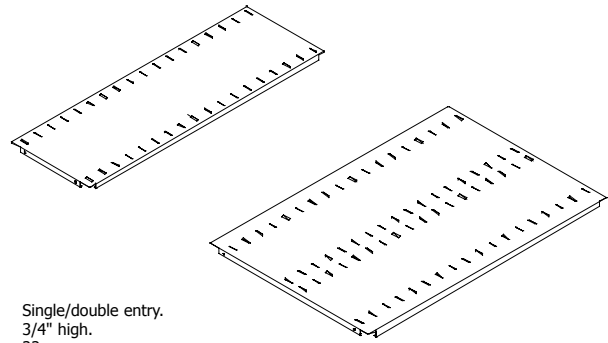

Single/double entry.  
3/4" high.  
22 gauge.  
All shelves require two SS-XXXX shelf supports.  
SR-XX shelf reinforcement for additional weight capacity.

Requires FDL Dividers.  
For use with standard L & T Uprights found on pages 2d:22-25.

## Unslotted Standard Archive Shelf

Item #	W	D	H	Pcs/Ctn	Est Lbs.	List Price
1624TS	24"	16"	3/4"	4	4	28.40
3224TS	24"	32"	3/4"	4	9	47.70
1630TS	30"	16"	3/4"	4	6	28.50
3230TS	30"	32"	3/4"	4	11	47.90
1636TS	36"	16"	3/4"	4	7	28.60
3236TS	36"	32"	3/4"	4	12	48.30
1642TS	42"	16"	3/4"	4	7	30.80
3242TS	42"	32"	3/4"	4	15	53.80
1648TS	48"	16"	3/4"	4	8	37.00
3248TS	48"	32"	3/4"	4	16	60.80

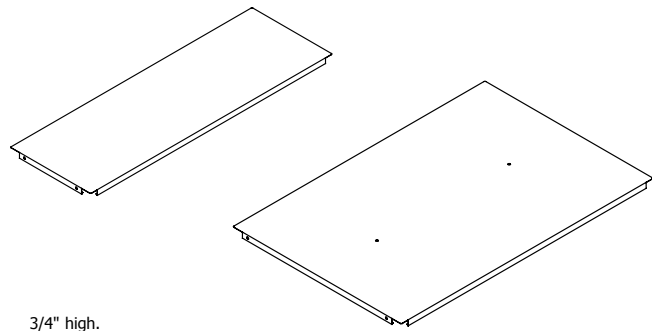

3/4" high.  
22 gauge.  
All shelves require two SS-XXXX shelf supports.  
SR-XX shelf reinforcement for additional weight capacity.

Double entry shelves include holes to accept  
Unslotted Center Divider (CDXX) if needed.

# Component Parts - Heavy Duty Shelves 18 Gauge

## Slotted Heavy Duty Shelf

Item #	# of Entries	W	D	H	Pcs/Ctn	Est Lbs.	List Price
0924SM*	Single	24"	9"	3/4"	16	4	18.20
1224SM	Single	24"	12"	3/4"	16	4	22.50
1324SM	Single	24"	13"	3/4"	16	4	24.70
1524SM	Single	24"	15"	3/4"	16	5	31.20
1824SM*	Double	24"	18"	3/4"	8	7	36.90
2024SM	Double	24"	20"	3/4"	8	7	39.10
2424SM	Double	24"	24"	3/4"	8	9	44.50
2624SM	Double	24"	26"	3/4"	8	9	49.00
3024SM	Double	24"	30"	3/4"	8	10	61.00
3624SM	Double	24"	36"	3/4"	8	11	76.30
0930SM*	Single	30"	9"	3/4"	16	5	18.40
1230SM	Single	30"	12"	3/4"	16	5	22.90
1330SM	Single	30"	13"	3/4"	16	6	25.10
1530SM	Single	30"	15"	3/4"	16	7	31.60
1830SM*	Double	30"	18"	3/4"	8	9	37.20
2030SM	Double	30"	20"	3/4"	8	10	41.70
2430SM	Double	30"	24"	3/4"	8	11	44.90
2630SM	Double	30"	26"	3/4"	8	12	49.40
3030SM	Double	30"	30"	3/4"	8	13	61.30
3630SM	Double	30"	36"	3/4"	8	15	76.30
0936SM*	Single	36"	9"	3/4"	16	5	18.60
1236SM	Single	36"	12"	3/4"	16	6	23.20
1336SM	Single	36"	13"	3/4"	16	6	25.40
1536SM	Single	36"	15"	3/4"	16	9	31.90
1836SM*	Double	36"	18"	3/4"	8	11	37.50
2036SM	Double	36"	20"	3/4"	8	12	42.00
2436SM	Double	36"	24"	3/4"	8	13	45.10
2636SM	Double	36"	26"	3/4"	8	14	49.60
3036SM	Double	36"	30"	3/4"	8	15	61.50
3636SM	Double	36"	36"	3/4"	8	18	79.80
0942SM*	Single	42"	9"	3/4"	16	6	22.00
1242SM	Single	42"	12"	3/4"	16	7	29.30
1342SM	Single	42"	13"	3/4"	16	7	31.50
1542SM	Single	42"	15"	3/4"	16	10	38.90
1842SM*	Double	42"	18"	3/4"	8	13	43.00
2042SM	Double	42"	20"	3/4"	8	14	47.50
2442SM	Double	42"	24"	3/4"	8	15	57.70
2642SM	Double	42"	26"	3/4"	8	16	62.20
3042SM	Double	42"	30"	3/4"	8	18	70.70
3642SM	Double	42"	36"	3/4"	8	21	91.10
0948SM*	Single	48"	9"	3/4"	16	7	24.20
1248SM	Single	48"	12"	3/4"	16	8	33.60
1348SM	Single	48"	13"	3/4"	16	8	36.90
1548SM	Single	48"	15"	3/4"	16	12	44.90
1848SM*	Double	48"	18"	3/4"	8	15	47.80
2048SM	Double	48"	20"	3/4"	8	16	52.30
2448SM	Double	48"	24"	3/4"	8	17	62.70
2648SM	Double	48"	26"	3/4"	8	18	67.30
3048SM	Double	48"	30"	3/4"	8	21	78.20
3648SM	Double	48"	36"	3/4"	8	25	105.40

## Unslotted Heavy Duty Shelf

Item #	# of Entries	W	D	H	Pcs/Ctn	Est Lbs.	List Price
0924TM	Single	24"	9"	3/4"	16	4	18.20
1224TM	Single	24"	12"	3/4"	16	4	22.50
1324TM	Single	24"	13"	3/4"	16	4	24.70
1524TM	Single	24"	15"	3/4"	8	5	31.20
1824TM	Double	24"	18"	3/4"	8	7	36.90
2024TM	Double	24"	20"	3/4"	8	7	39.10
2424TM	Double	24"	24"	3/4"	8	9	44.50
2624TM	Double	24"	26"	3/4"	8	9	49.00
3024TM	Double	24"	30"	3/4"	8	10	61.00
3624TM	Double	24"	36"	3/4"	8	11	76.30
0930TM	Single	30"	9"	3/4"	16	5	18.40
1230TM	Single	30"	12"	3/4"	16	5	22.90
1330TM	Single	30"	13"	3/4"	16	6	25.10
1530TM	Single	30"	15"	3/4"	8	7	31.60
1830TM	Double	30"	18"	3/4"	8	9	37.20
2030TM	Double	30"	20"	3/4"	8	10	41.70
2430TM	Double	30"	24"	3/4"	8	11	44.90
2630TM	Double	30"	26"	3/4"	8	12	49.40
3030TM	Double	30"	30"	3/4"	8	13	61.30
3630TM	Double	30"	36"	3/4"	8	15	76.30
0936TM	Single	36"	9"	3/4"	16	5	18.60
1236TM	Single	36"	12"	3/4"	16	6	23.20
1336TM	Single	36"	13"	3/4"	16	6	25.40
1536TM	Single	36"	15"	3/4"	8	9	31.90
1836TM	Double	36"	18"	3/4"	8	11	37.50
2036TM	Double	36"	20"	3/4"	8	12	42.00
2436TM	Double	36"	24"	3/4"	8	13	45.10
2636TM	Double	36"	26"	3/4"	8	14	49.60
3036TM	Double	36"	30"	3/4"	8	15	61.50
3636TM	Double	36"	36"	3/4"	8	18	79.80
0942TM	Single	42"	9"	3/4"	16	6	22.00
1242TM	Single	42"	12"	3/4"	16	7	29.30
1342TM	Single	42"	13"	3/4"	16	7	31.50
1542TM	Single	42"	15"	3/4"	8	10	38.90
1842TM	Double	42"	18"	3/4"	8	13	43.00
2042TM	Double	42"	20"	3/4"	8	14	47.50
2442TM	Double	42"	24"	3/4"	8	15	57.70
2642TM	Double	42"	26"	3/4"	8	16	62.20
3042TM	Double	42"	30"	3/4"	8	18	70.70
3642TM	Double	42"	36"	3/4"	8	21	91.10
0948TM	Single	48"	9"	3/4"	16	7	24.20
1248TM	Single	48"	12"	3/4"	16	8	33.60
1348TM	Single	48"	13"	3/4"	16	8	36.90
1548TM	Single	48"	15"	3/4"	8	12	44.90
1848TM	Double	48"	18"	3/4"	8	15	47.80
2048TM	Double	48"	20"	3/4"	8	16	52.30
2448TM	Double	48"	24"	3/4"	8	17	62.70
2648TM	Double	48"	26"	3/4"	8	18	67.30
3048TM	Double	48"	30"	3/4"	8	21	78.20
3648TM	Double	48"	36"	3/4"	8	25	105.40

\*Specify FDB Dividers for 9" and 18" shelves, all others require FDL Dividers.

\*For use with standard L&T Uprights found on pages 2d:22-25 only.

For perforated shelving:

Change the SM suffix to VM and add 20% to the list price, rounded to the dime.

# Component Parts - Heavy Duty Shelves 18 Gauge

## Slotted Heavy Duty Archive Shelf

Item #	# of Entries	W	D	H	Pcs/Ctn	Est Lbs.	List Price
1624SM	Single	24"	16"	3/4"	4	6	34.00
3224SM	Double	24"	32"	3/4"	4	11	61.70
1630SM	Single	30"	16"	3/4"	4	8	34.50
3230SM	Double	30"	32"	3/4"	4	14	62.00
1636SM	Single	36"	16"	3/4"	4	8	34.70
3236SM	Double	36"	32"	3/4"	4	16	62.30
1642SM	Single	42"	16"	3/4"	4	12	41.10
3242SM	Double	42"	32"	3/4"	4	19	71.30
1648SM	Single	48"	16"	3/4"	4	14	46.20
3248SM	Double	48"	32"	3/4"	4	22	79.10

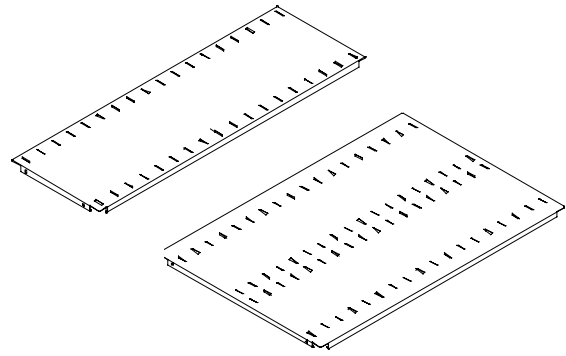

Single/double entry. 3/4" high. 18 gauge.  
All shelves require two MS-XXXX shelf supports.  
SR-XX shelf reinforcement for additional weight capacity.

Requires FDL Dividers.  
For use with standard L & T Uprights found on pages 2d:22-25.

## Unslotted Heavy Duty Archive Shelf

Item #	W	D	H	Pcs/Ctn	Est Lbs.	List Price
1624TM	24"	16"	3/4"	4	6	34.00
3224TM	24"	32"	3/4"	4	11	61.70
1630TM	30"	16"	3/4"	4	8	34.50
3230TM	30"	32"	3/4"	4	14	62.00
1636TM	36"	16"	3/4"	4	8	34.70
3236TM	36"	32"	3/4"	4	16	62.30
1642TM	42"	16"	3/4"	4	12	41.10
3242TM	42"	32"	3/4"	4	19	71.30
1648TM	48"	16"	3/4"	4	14	46.20
3248TM	48"	32"	3/4"	4	22	79.10

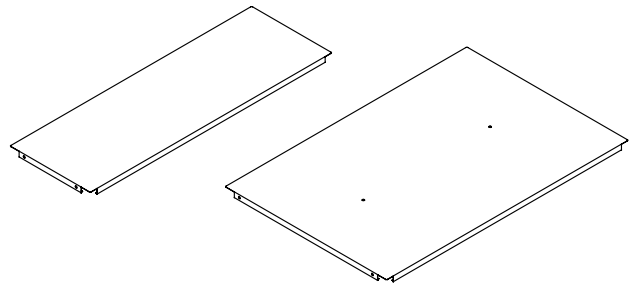

3/4" high. 18 gauge. All shelves require two MS-XXXX shelf supports.  
SR-XX shelf reinforcement for additional weight capacity.

Double entry shelves include holes to accept Unslotted Center Divider (CDXX) if needed.

# Component Parts - Heavy Duty Plus Slotted Shelves 18 Gauge

## Slotted Heavy Duty Plus Shelf

Item #	# of Entries	W	D	H	Pcs/ Ctn	Est Lbs.	List Price
1224SH	Single	24"	12"	1-1/8"	4	5	22.50
1324SH	Single	24"	13"	1-1/8"	4	5	24.70
1524SH	Single	24"	15"	1-1/8"	4	7	34.20
1824SH	Single	24"	18"	1-1/8"	4	9	38.90
2024SH	Single	24"	20"	1-1/8"	4	11	41.20
2424SH	Double	24"	24"	1-1/8"	4	14	45.60
2624SH	Double	24"	26"	1-1/8"	4	15	47.90
3024SH	Double	24"	30"	1-1/8"	4	18	62.30
3624SH	Double	24"	36"	1-1/8"	4	20	74.50
1230SH	Single	30"	12"	1-1/8"	4	6	24.20
1330SH	Single	30"	13"	1-1/8"	4	6	26.50
1530SH	Single	30"	15"	1-1/8"	4	9	35.90
1830SH	Single	30"	18"	1-1/8"	4	10	41.00
2030SH	Single	30"	20"	1-1/8"	4	10	43.30
2430SH	Double	30"	24"	1-1/8"	4	15	49.00
2630SH	Double	30"	26"	1-1/8"	4	16	53.60
3030SH	Double	30"	30"	1-1/8"	4	19	65.60
3630SH	Double	30"	36"	1-1/8"	4	21	77.90
1236SH	Single	36"	12"	1-1/8"	4	7	25.80
1336SH	Single	36"	13"	1-1/8"	4	7	28.00
1536SH	Single	36"	15"	1-1/8"	4	9	37.50
1836SH	Single	36"	18"	1-1/8"	4	11	42.60
2036SH	Single	36"	20"	1-1/8"	4	11	45.90
2436SH	Double	36"	24"	1-1/8"	4	16	52.20
2636SH	Double	36"	26"	1-1/8"	4	17	56.80
3036SH	Double	36"	30"	1-1/8"	4	20	68.90
3636SH	Double	36"	36"	1-1/8"	4	22	81.50
1242SH	Single	42"	12"	1-1/8"	4	8	31.90
1342SH	Single	42"	13"	1-1/8"	4	8	35.30
1542SH	Single	42"	15"	1-1/8"	4	10	42.40
1842SH	Single	42"	18"	1-1/8"	4	12	49.10
2042SH	Single	42"	20"	1-1/8"	4	13	58.20
2442SH	Double	42"	24"	1-1/8"	4	17	79.20
2642SH	Double	42"	26"	1-1/8"	4	22	83.70
3042SH	Double	42"	30"	1-1/8"	4	21	89.30
3642SH	Double	42"	36"	1-1/8"	4	23	93.10
1248SH	Single	48"	12"	1-1/8"	4	8	35.40
1348SH	Single	48"	13"	1-1/8"	4	8	40.10
1548SH	Single	48"	15"	1-1/8"	4	12	49.60
1848SH	Single	48"	18"	1-1/8"	4	14	57.20
2048SH	Single	48"	20"	1-1/8"	4	15	62.90
2448SH	Double	48"	24"	1-1/8"	4	17	73.60
2648SH	Double	48"	26"	1-1/8"	4	18	79.40
3048SH	Double	48"	30"	1-1/8"	4	22	88.70
3648SH	Double	48"	36"	1-1/8"	4	26	107.10

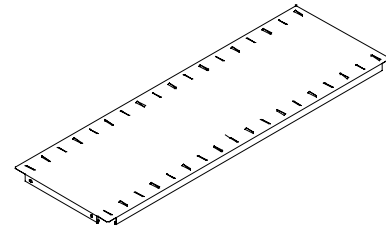

Single/double entry.  
1-1/8" high.  
18 gauge.  
All shelves require two HS-XXXX shelf supports.  
HRXX shelf reinforcement for additional weight capacity.

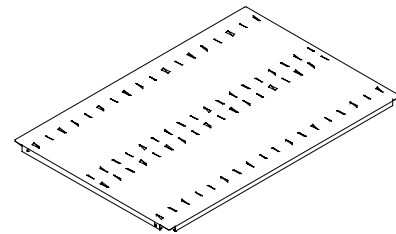

For perforated shelving:  
Change the SH suffix to VH and add 15% to the list price,  
rounded to the dime.



# Component Parts - Heavy Duty Plus Unslotted Shelves 18 Gauge

## Unslotted Heavy Duty Plus Shelf

Item #	# of Entries	W	D	H	Pcs/Ctn	Est Lbs.	List Price
1224TH	Single	24"	12"	1-1/8"	4	5	22.50
1324TH	Single	24"	13"	1-1/8"	4	5	27.10
1524TH	Single	24"	15"	1-1/8"	4	7	34.20
1824TH	Single	24"	18"	1-1/8"	4	9	38.90
2024TH	Single	24"	20"	1-1/8"	4	11	43.50
2424TH	Double	24"	24"	1-1/8"	4	14	45.60
2624TH	Double	24"	26"	1-1/8"	4	15	50.20
3024TH	Double	24"	30"	1-1/8"	4	18	62.30
3624TH	Double	24"	36"	1-1/8"	4	20	74.50
1230TH	Single	30"	12"	1-1/8"	4	6	24.20
1330TH	Single	30"	13"	1-1/8"	4	6	28.70
1530TH	Single	30"	15"	1-1/8"	4	9	35.90
1830TH	Single	30"	18"	1-1/8"	4	10	41.00
2030TH	Single	30"	20"	1-1/8"	4	10	45.50
2430TH	Double	30"	24"	1-1/8"	4	15	49.00
2630TH	Double	30"	26"	1-1/8"	4	16	58.10
3030TH	Double	30"	30"	1-1/8"	4	19	65.60
3630TH	Double	30"	36"	1-1/8"	4	21	77.90
1236TH	Single	36"	12"	1-1/8"	4	7	25.80
1336TH	Single	36"	13"	1-1/8"	4	7	30.30
1536TH	Single	36"	15"	1-1/8"	4	9	37.50
1836TH	Single	36"	18"	1-1/8"	4	11	42.60
2036TH	Single	36"	20"	1-1/8"	4	11	49.40
2436TH	Double	36"	24"	1-1/8"	4	16	52.20
2636TH	Double	36"	26"	1-1/8"	4	17	61.30
3036TH	Double	36"	30"	1-1/8"	4	20	68.90
3636TH	Double	36"	36"	1-1/8"	4	22	81.50
1242TH	Single	42"	12"	1-1/8"	4	8	31.90
1342TH	Single	42"	13"	1-1/8"	4	8	38.70
1542TH	Single	42"	15"	1-1/8"	4	10	42.40
1842TH	Single	42"	18"	1-1/8"	4	12	49.10
2042TH	Single	42"	20"	1-1/8"	4	13	67.30
2442TH	Double	42"	24"	1-1/8"	4	17	79.20
2642TH	Double	42"	26"	1-1/8"	4	22	88.30
3042TH	Double	42"	30"	1-1/8"	4	21	89.30
3642TH	Double	42"	36"	1-1/8"	4	23	93.10
1248TH	Single	48"	12"	1-1/8"	4	8	35.40
1348TH	Single	48"	13"	1-1/8"	4	8	44.60
1548TH	Single	48"	15"	1-1/8"	4	12	49.60
1848TH	Single	48"	18"	1-1/8"	4	14	57.20
2048TH	Single	48"	20"	1-1/8"	4	15	68.60
2448TH	Double	48"	24"	1-1/8"	4	17	73.60
2648TH	Double	48"	26"	1-1/8"	4	18	85.00
3048TH	Double	48"	30"	1-1/8"	4	22	88.70
3648TH	Double	48"	36"	1-1/8"	4	26	107.10

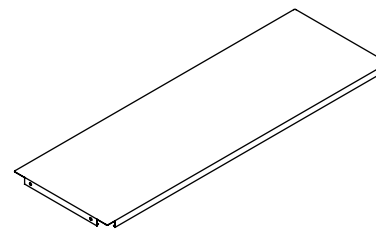

1-1/8" high.  
18 gauge.  
All shelves require two HS-XXXX shelf supports.  
HRXX shelf reinforcement for additional weight capacity.

Double entry shelves include holes to accept  
Unslotted Center Divider (CDXX) if needed.

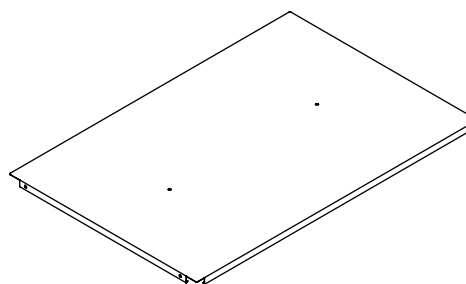



# Library Shelving Component Parts - Standard Duty Shelves 22 Gauge

## Slotted Library Standard Duty Shelving

Item #	# of Entries	W	D	H	Pcs/Ctn	Est Lbs.	List Price
0924SL	Single	24"	9"	3/4"	4	2	15.20
1224SL	Single	24"	12"	3/4"	4	3	17.40
1324SL	Single	24"	13"	3/4"	4	3	18.50
1524SL	Single	24"	15"	3/4"	4	4	21.10
1824SL	Double	24"	18"	3/4"	4	5	26.20
2024SL	Double	24"	20"	3/4"	4	5	28.40
2424SL	Double	24"	24"	3/4"	4	6	32.70
2624SL	Double	24"	26"	3/4"	4	6	34.90
3024SL	Double	24"	30"	3/4"	4	8	37.00
0930SL	Single	30"	9"	3/4"	4	3	15.30
1230SL	Single	30"	12"	3/4"	4	4	17.50
1330SL	Single	30"	13"	3/4"	4	4	18.60
1530SL	Single	30"	15"	3/4"	4	5	21.40
1830SL	Double	30"	18"	3/4"	4	6	26.30
2030SL	Double	30"	20"	3/4"	4	7	28.50
2430SL	Double	30"	24"	3/4"	4	7	32.80
2630SL	Double	30"	26"	3/4"	4	8	35.00
3030SL	Double	30"	30"	3/4"	4	9	37.10
0936SL	Single	36"	9"	3/4"	4	4	15.50
1236SL	Single	36"	12"	3/4"	4	5	17.70
1336SL	Single	36"	13"	3/4"	4	5	18.80
1536SL	Single	36"	15"	3/4"	4	6	21.60
1836SL	Double	36"	18"	3/4"	4	7	26.40
2036SL	Double	36"	20"	3/4"	4	8	28.60
2436SL	Double	36"	24"	3/4"	4	8	33.10
2636SL	Double	36"	26"	3/4"	4	9	35.20
3036SL	Double	36"	30"	3/4"	4	10	37.20
0942SL	Single	42"	9"	3/4"	4	4	19.00
1242SL	Single	42"	12"	3/4"	4	5	21.70
1342SL	Single	42"	13"	3/4"	4	5	22.90
1542SL	Single	42"	15"	3/4"	4	7	24.90
1842SL	Double	42"	18"	3/4"	4	8	31.40
2042SL	Double	42"	20"	3/4"	4	9	33.70
2442SL	Double	42"	24"	3/4"	4	10	38.80
2642SL	Double	42"	26"	3/4"	4	11	41.10
3042SL	Double	42"	30"	3/4"	4	12	43.00
0948SL	Single	48"	9"	3/4"	4	4	21.10
1248SL	Single	48"	12"	3/4"	4	5	24.50
1348SL	Single	48"	13"	3/4"	4	5	25.60
1548SL	Single	48"	15"	3/4"	4	6	27.80
1848SL	Double	48"	18"	3/4"	4	9	33.30
2048SL	Double	48"	20"	3/4"	4	10	35.50
2448SL	Double	48"	24"	3/4"	4	11	43.50
2648SL	Double	48"	26"	3/4"	4	12	45.70
3048SL	Double	48"	30"	3/4"	4	13	48.40

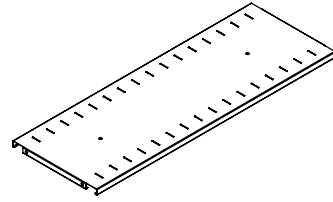

Single/double entry.  
3/4" high.  
22 gauge.

All shelves require two SS-XXXX shelf supports.  
SR-XX shelf reinforcement for additional weight capacity.  
Specify FDB Dividers for 9" Shelves, all other require  
FDL Dividers.

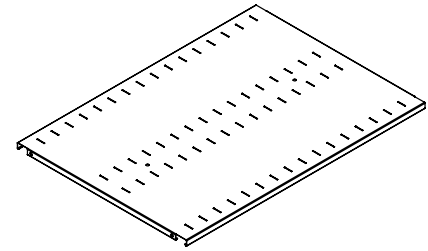

# Library Shelving Component Parts - Standard Duty Shelves 22 Gauge

## Unslotted Library Standard Duty Shelving

Item #	# of Entries	W	D	H	Pcs/Ctn	Est Lbs.	List Price
0924TL	Single	24"	9"	3/4"	4	1	15.20
1224TL	Single	24"	12"	3/4"	4	2	17.40
1324TL	Single	24"	13"	3/4"	4	2	18.50
1524TL	Single	24"	15"	3/4"	4	3	21.10
1824TL	Double	24"	18"	3/4"	4	4	26.20
2024TL	Double	24"	20"	3/4"	4	4	28.40
2424TL	Double	24"	24"	3/4"	4	5	32.70
2624TL	Double	24"	26"	3/4"	4	5	34.90
3024TL	Double	24"	30"	3/4"	4	9	37.00
0930TL	Single	30"	9"	3/4"	4	2	15.30
1230TL	Single	30"	12"	3/4"	4	3	17.50
1330TL	Single	30"	13"	3/4"	4	3	18.60
1530TL	Single	30"	15"	3/4"	4	4	21.40
1830TL	Double	30"	18"	3/4"	4	5	26.30
2030TL	Double	30"	20"	3/4"	4	6	28.50
2430TL	Double	30"	24"	3/4"	4	6	32.80
2630TL	Double	30"	26"	3/4"	4	7	35.00
3030TL	Double	30"	30"	3/4"	4	9	37.10
0936TL	Single	36"	9"	3/4"	4	3	15.20
1236TL	Single	36"	12"	3/4"	4	4	17.30
1336TL	Single	36"	13"	3/4"	4	4	18.80
1536TL	Single	36"	15"	3/4"	4	5	21.60
1836TL	Double	36"	18"	3/4"	4	6	25.60
2036TL	Double	36"	20"	3/4"	4	7	28.60
2436TL	Double	36"	24"	3/4"	4	7	33.00
2636TL	Double	36"	26"	3/4"	4	8	35.20
3036TL	Double	36"	30"	3/4"	4	10	37.20
0942TL	Single	42"	9"	3/4"	4	4	17.90
1242TL	Single	42"	12"	3/4"	4	5	20.70
1342TL	Single	42"	13"	3/4"	4	5	22.90
1542TL	Single	42"	15"	3/4"	4	6	24.90
1842TL	Double	42"	18"	3/4"	4	7	29.70
2042TL	Double	42"	20"	3/4"	4	8	33.70
2442TL	Double	42"	24"	3/4"	4	9	38.70
2642TL	Double	42"	26"	3/4"	4	10	41.10
3042TL	Double	42"	30"	3/4"	4	11	43.00
0948TL	Single	48"	9"	3/4"	4	5	20.00
1248TL	Single	48"	12"	3/4"	4	6	24.40
1348TL	Single	48"	13"	3/4"	4	6	25.60
1548TL	Single	48"	15"	3/4"	4	7	27.80
1848TL	Double	48"	18"	3/4"	4	9	33.30
2048TL	Double	48"	20"	3/4"	4	10	35.50
2448TL	Double	48"	24"	3/4"	4	11	43.40
2648TL	Double	48"	26"	3/4"	4	11	45.70
3048TL	Double	48"	30"	3/4"	4	14	48.30

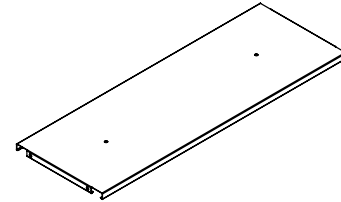

3/4" high.  
22 gauge.  
All shelves require two SS-XXXX shelf supports.  
SR-XX shelf reinforcement for additional weight capacity.

Double entry shelves include holes to accept  
Unslotted Center Divider (CDXX) if needed.

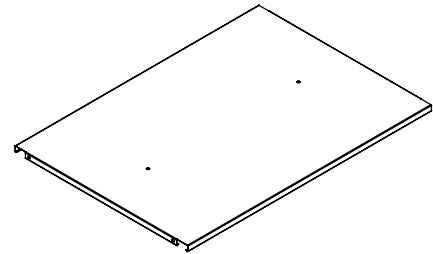

# Component Parts - Standard Duty & Heavy Duty Plus Shelves

## Punched Standard Shelf - 22 Gauge

Item #	# of Entries	W	D	H	Est Lbs.	List Price
1224PS	Single	24"	12"	3/4"	1	20.00
1324PS	Single	24"	13"	3/4"	2	22.20
1524PS	Single	24"	15"	3/4"	4	25.80
1824PS	Single	24"	18"	3/4"	5	29.00
2024PS	Double	24"	20"	3/4"	5	31.40
2424PS	Double	24"	24"	3/4"	6	34.80
2624PS	Double	24"	26"	3/4"	7	37.10
3024PS	Double	24"	30"	3/4"	8	47.00
3624PS	Double	24"	36"	3/4"	10	75.80
1230PS	Single	30"	12"	3/4"	2	20.10
1330PS	Single	30"	13"	3/4"	4	22.40
1530PS	Single	30"	15"	3/4"	5	26.30
1830PS	Single	30"	18"	3/4"	6	29.00
2030PS	Double	30"	20"	3/4"	6	31.50
2430PS	Double	30"	24"	3/4"	7	35.00
2630PS	Double	30"	26"	3/4"	8	37.30
3030PS	Double	30"	30"	3/4"	10	47.20
3630PS	Double	30"	36"	3/4"	11	77.50
1236PS	Single	36"	12"	3/4"	3	20.20
1336PS	Single	36"	13"	3/4"	5	22.50
1536PS	Single	36"	15"	3/4"	6	26.50
1836PS	Single	36"	18"	3/4"	7	29.50
2036PS	Double	36"	20"	3/4"	7	31.70
2436PS	Double	36"	24"	3/4"	8	35.70
2636PS	Double	36"	26"	3/4"	9	38.00
3036PS	Double	36"	30"	3/4"	11	47.70
3636PS	Double	36"	36"	3/4"	14	77.90
1242PS	Single	42"	12"	3/4"	4	23.70
1342PS	Single	42"	13"	3/4"	6	26.00
1542PS	Single	42"	15"	3/4"	6	29.90
1842PS	Single	42"	18"	3/4"	8	33.90
2042PS	Double	42"	20"	3/4"	9	36.20
2442PS	Double	42"	24"	3/4"	10	42.40
2642PS	Double	42"	26"	3/4"	10	44.70
3042PS	Double	42"	30"	3/4"	14	53.10
3642PS	Double	42"	36"	3/4"	18	89.40
1248PS	Single	48"	12"	3/4"	5	26.40
1348PS	Single	48"	13"	3/4"	7	28.60
1548PS	Single	48"	15"	3/4"	7	33.80
1848PS	Single	48"	18"	3/4"	8	37.60
2048PS	Double	48"	20"	3/4"	10	39.90
2448PS	Double	48"	24"	3/4"	11	48.20
2648PS	Double	48"	26"	3/4"	12	50.50
3048PS	Double	48"	30"	3/4"	15	59.90
3648PS	Double	48"	36"	3/4"	19	103.60

## Punched Heavy Duty Plus Shelf - 18 Gauge

Item #	# of Entries	W	D	H	Est Lbs.	List Price
1224PH	Single	24"	12"	1-1/8"	5	22.50
1324PH	Single	24"	13"	1-1/8"	5	24.70
1524PH	Single	24"	15"	1-1/8"	7	34.20
1824PH	Single	24"	18"	1-1/8"	9	38.90
2024PH	Single	24"	20"	1-1/8"	11	41.20
2424PH	Double	24"	24"	1-1/8"	14	45.60
2624PH	Double	24"	26"	1-1/8"	15	47.90
3024PH	Double	24"	30"	1-1/8"	18	62.30
3624PH	Double	24"	36"	1-1/8"	20	74.50
1230PH	Single	30"	12"	1-1/8"	6	24.20
1330PH	Single	30"	13"	1-1/8"	6	26.50
1530PH	Single	30"	15"	1-1/8"	9	35.90
1830PH	Single	30"	18"	1-1/8"	10	41.00
2030PH	Double	30"	20"	1-1/8"	10	43.30
2430PH	Double	30"	24"	1-1/8"	15	49.00
2630PH	Double	30"	26"	1-1/8"	16	53.60
3030PH	Double	30"	30"	1-1/8"	19	65.60
3630PH	Double	30"	36"	1-1/8"	21	77.90
1236PH	Single	36"	12"	1-1/8"	7	25.90
1336PH	Single	36"	13"	1-1/8"	7	28.00
1536PH	Single	36"	15"	1-1/8"	9	37.50
1836PH	Single	36"	18"	1-1/8"	11	42.60
2036PH	Single	36"	20"	1-1/8"	11	45.90
2436PH	Double	36"	24"	1-1/8"	16	52.20
2636PH	Double	36"	26"	1-1/8"	17	56.80
3036PH	Double	36"	30"	1-1/8"	20	68.90
3636PH	Double	36"	36"	1-1/8"	22	81.50
1242PH	Single	42"	12"	1-1/8"	8	31.90
1342PH	Single	42"	13"	1-1/8"	8	35.30
1542PH	Single	42"	15"	1-1/8"	10	42.40
1842PH	Single	42"	18"	1-1/8"	12	49.10
2042PH	Single	42"	20"	1-1/8"	13	58.20
2442PH	Double	42"	24"	1-1/8"	17	63.40
2642PH	Double	42"	26"	1-1/8"	19	83.70
3042PH	Double	42"	30"	1-1/8"	21	89.30
3642PH	Double	42"	36"	1-1/8"	23	93.10
1248PH	Single	48"	12"	1-1/8"	8	35.40
1348PH	Single	48"	13"	1-1/8"	8	40.10
1548PH	Single	48"	15"	1-1/8"	12	49.60
1848PH	Single	48"	18"	1-1/8"	14	57.20
2048PH	Single	48"	20"	1-1/8"	15	62.90
2448PH	Double	48"	24"	1-1/8"	17	73.60
2648PH	Double	48"	26"	1-1/8"	18	79.40
3048PH	Double	48"	30"	1-1/8"	22	88.70
3648PH	Double	48"	36"	1-1/8"	26	107.10

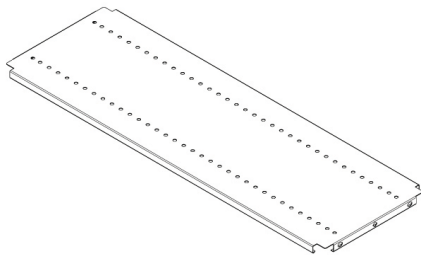

Single/Double Entry.  
 All Shelves are punched on 2" centers to accept Fixed Bin Dividers found on page 2d:46.  
 1-1/8" high.  
 18 gauge.  
 All shelves require two HS-XXXX shelf supports.  
 HRXX shelf reinforcement for additional weight capacity.  
 Double entry shelves include holes to accept Unslotted Center Divider (CDXX) if needed.

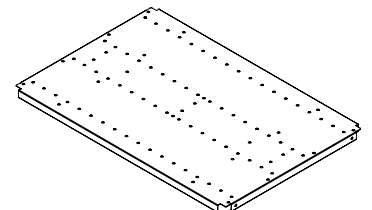
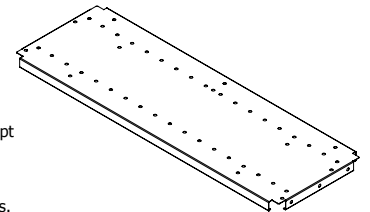

# Component Parts - Wide Span Shelves, Supports and Reinforcements

Use with standard 4Post uprights 12", 13", 15", 18", 24", 30" and 36" deep. Load capacity 500 pounds per shelf with maximum 1000 pounds per upright. (Based on maximum 24" shelf centers or less.) Upright capacity not to exceed 2500 pounds per upright. All shelves require front to back reinforcements. All front to back reinforcements bolt into position. Minimum of 3 shelves required per bay/opening (counting top shelf). Can be used with particle board shelves.

## Wide Span Shelving - Unpunched

Item #	W	D	Pcs/Ctn	Wt. Load Capacity*	Est Lbs	List Price
1260WSS	60"	12"	6	500	7	40.40
1360WSS	60"	13"	6	500	8	50.00
1560WSS	60"	15"	6	500	9	59.80
1860WSS	60"	18"	6	500	11	68.30
2460WSS	60"	24"	6	425	14	81.70
3060WSS	60"	30"	6	425	19	109.40
3660WSS	60"	36"	6	425	24	137.20
1266WSS	66"	12"	6	450	8	41.70
1366WSS	66"	13"	6	450	8	51.50
1566WSS	66"	15"	6	450	9	61.20
1866WSS	66"	18"	6	450	12	69.60
2466WSS	66"	24"	6	400	16	84.40
3066WSS	66"	30"	6	400	21	112.20
3666WSS	66"	36"	6	400	27	139.90
1272WSS	72"	12"	6	400	8	43.90
1372WSS	72"	13"	6	400	9	52.80
1572WSS	72"	15"	6	400	10	62.50
1872WSS	72"	18"	6	400	13	71.10
2472WSS	72"	24"	6	325	17	87.00
3072WSS	72"	30"	6	325	23	114.80
3672WSS	72"	36"	6	325	29	142.70

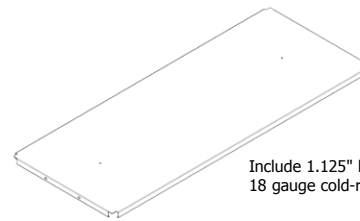
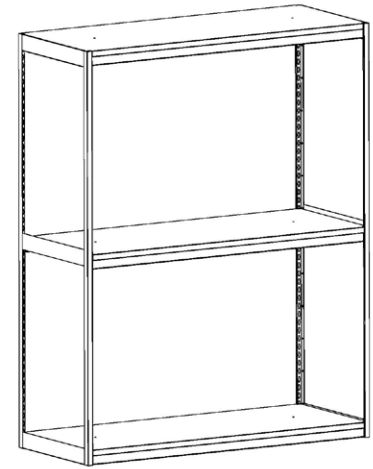

Include 1.125" high flange on all 4 sides.  
18 gauge cold-rolled steel.

\*Weight load capacity is per shelf and based on evenly distributed weight on shelf.

## Wide Span Shelf Supports

Item #	D	H	Pcs/Ctn	Recommended # of Reinforcements	Wt. Load Capacity**	Est. Lbs.	List Price
WSS-36	36"	3"	18	2	650	4	25.00
WSS-48	48"	3"	18	2	650	5	27.00
WSS-54	54"	3"	18	3	550	6	29.00
WSS-60	60"	3"	18	3	500	6	31.00
WSS-66	66"	3"	18	5	450	7	33.00
WSS-72	72"	3"	18	5	400	8	35.00

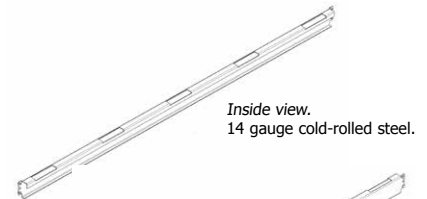

Inside view.  
14 gauge cold-rolled steel.

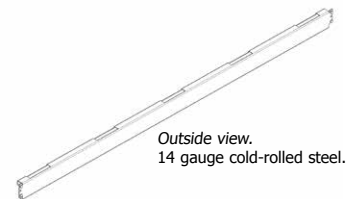

Outside view.  
14 gauge cold-rolled steel.

\*\*Weight load capacity is per pair and based on using the recommended number of reinforcements.

Include (4) shoulder rivets with 7/16" diameter heads for attachment to corresponding keyholes in upright.

Adjustable on 1.5" centers.

## Wide Span Shelf Reinforcements

Item #	D	H	Pcs/Ctn	Est. Lbs.	List Price
WSR-12	12"	1"	144	1	2.80
WSR-13	13"	1"	144	1	3.00
WSR-15	15"	1"	144	1	3.60
WSR-18	18"	1"	72	1	3.70
WSR-24	24"	1"	72	2	4.20
WSR-30	30"	1"	36	2	5.20
WSR-36	36"	1"	36	2	6.10

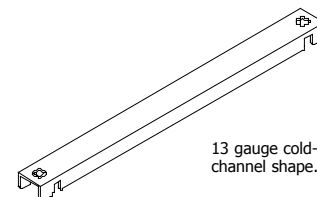

13 gauge cold-rolled steel formed into channel shape.

Attach without any hardware.

# Component Parts - Top Shelves 22 Gauge

## TrakSlider™ Standard Duty Shelf Top

Item #	W	D	H	Pcs/Ctn	Est Lbs.	List Price
0924KS	24"	9"	3/4"	4	2	15.20
1224KS	24"	12"	3/4"	4	2	20.00
1324KS	24"	13"	3/4"	4	2	22.20
1524KS	24"	15"	3/4"	4	4	25.80
1824KS	24"	18"	3/4"	4	5	29.00
2024KS	24"	20"	3/4"	4	5	31.40
2424KS	24"	24"	3/4"	4	6	34.80
2624KS	24"	26"	3/4"	4	7	37.10
3024KS	24"	30"	3/4"	4	8	47.00
3624KS	24"	36"	3/4"	4	10	75.80
0930KS	30"	9"	3/4"	4	3	15.30
1230KS	30"	12"	3/4"	4	4	20.10
1330KS	30"	13"	3/4"	4	4	22.40
1530KS	30"	15"	3/4"	4	5	26.30
1830KS	30"	18"	3/4"	4	6	29.30
2030KS	30"	20"	3/4"	4	6	31.50
2430KS	30"	24"	3/4"	4	7	35.00
2630KS	30"	26"	3/4"	4	8	37.30
3030KS	30"	30"	3/4"	4	10	47.20
3630KS	30"	36"	3/4"	4	11	77.50
0936KS	36"	9"	3/4"	4	4	15.50
1236KS	36"	12"	3/4"	4	5	20.20
1336KS	36"	13"	3/4"	4	5	22.50
1536KS	36"	15"	3/4"	4	6	26.50
1836KS	36"	18"	3/4"	4	7	29.50
2036KS	36"	20"	3/4"	4	7	31.70
2436KS	36"	24"	3/4"	4	8	35.70
2636KS	36"	26"	3/4"	4	9	38.00
3036KS	36"	30"	3/4"	4	11	47.70
3636KS	36"	36"	3/4"	4	14	77.90
0942KS	42"	9"	3/4"	4	5	19.00
1242KS	42"	12"	3/4"	4	5	23.70
1342KS	42"	13"	3/4"	4	6	26.00
1542KS	42"	15"	3/4"	4	6	29.90
1842KS	42"	18"	3/4"	4	8	33.90
2042KS	42"	20"	3/4"	4	9	36.20
2442KS	42"	24"	3/4"	4	10	42.40
2642KS	42"	26"	3/4"	4	10	44.70
3042KS	42"	30"	3/4"	4	14	53.10
3642KS	42"	36"	3/4"	4	18	89.40
0948KS	48"	9"	3/4"	4	6	21.10
1248KS	48"	12"	3/4"	4	6	26.40
1348KS	48"	13"	3/4"	4	7	28.60
1548KS	48"	15"	3/4"	4	7	33.80
1848KS	48"	18"	3/4"	4	9	37.60
2048KS	48"	20"	3/4"	4	10	39.90
2448KS	48"	24"	3/4"	4	11	48.20
2648KS	48"	26"	3/4"	4	12	50.50
3048KS	48"	30"	3/4"	4	15	59.90
3648KS	48"	36"	3/4"	4	19	103.60

The Datum 4Post top shelf can be used in conjunction with Datum's TrakSlider top shelf support (see page 2d:69) to create a 4Post TrakSlider System (Bi, Tri, or Quad) or to retrofit an existing system in the field. All TrakSlider shelf tops are prepunched with knockouts to accept mounting of overhead anti-tip hardware, no drilling required.

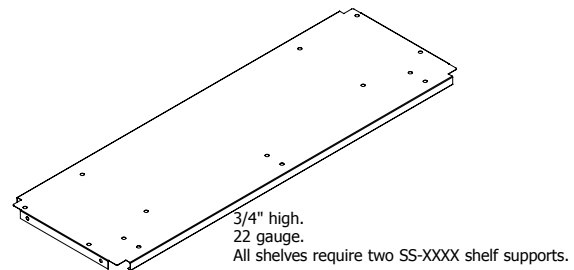

TrakSlider Standard Duty Shelf Top should be used in conjunction with Datum Standard/Medium Duty 4Post Shelving.

## TrakSlider Archive Shelf Top

Item #	W	D	H	Pcs/Ctn	Est Lbs.	List Price
1624KS	24"	16"	3/4"	4	4	28.40
3224KS	24"	32"	3/4"	4	9	47.70
1630KS	30"	16"	3/4"	4	6	28.50
3230KS	30"	32"	3/4"	4	11	47.90
1636KS	36"	16"	3/4"	4	7	28.60
3236KS	36"	32"	3/4"	4	12	48.30
1642KS	42"	16"	3/4"	4	7	33.20
3242KS	42"	32"	3/4"	4	15	53.80
1648KS	48"	16"	3/4"	4	8	37.00
3248KS	48"	32"	3/4"	4	16	60.80

# Component Parts - Top Shelves 18 Gauge

## TrakSlider Heavy Duty Plus Shelf Top

Item #	W	D	H	Pcs/Ctn	Est Lbs.	List Price
0924KH	24"	9"	1-1/8"	4	5	17.90
1224KH	24"	12"	1-1/8"	4	5	22.50
1324KH	24"	13"	1-1/8"	4	5	24.70
1524KH	24"	15"	1-1/8"	4	7	34.20
1824KH	24"	18"	1-1/8"	4	9	38.90
2024KH	24"	20"	1-1/8"	4	8	41.20
2424KH	24"	24"	1-1/8"	4	14	45.60
2624KH	24"	26"	1-1/8"	4	15	47.90
3024KH	24"	30"	1-1/8"	4	18	62.30
3624KH	24"	36"	1-1/8"	4	20	74.50
0930KH	30"	9"	1-1/8"	4	5	19.50
1230KH	30"	12"	1-1/8"	4	6	24.20
1330KH	30"	13"	1-1/8"	4	6	26.50
1530KH	30"	15"	1-1/8"	4	8	35.90
1830KH	30"	18"	1-1/8"	4	10	41.00
2030KH	30"	20"	1-1/8"	4	10	43.30
2430KH	30"	24"	1-1/8"	4	15	49.00
2630KH	30"	26"	1-1/8"	4	16	53.60
3030KH	30"	30"	1-1/8"	4	19	65.60
3630KH	30"	36"	1-1/8"	4	21	77.90
0936KH	36"	9"	1-1/8"	4	6	20.80
1236KH	36"	12"	1-1/8"	4	7	25.90
1336KH	36"	13"	1-1/8"	4	7	28.00
1536KH	36"	15"	1-1/8"	4	9	37.50
1836KH	36"	18"	1-1/8"	4	11	42.60
2036KH	36"	20"	1-1/8"	4	11	45.90
2436KH	36"	24"	1-1/8"	4	16	52.20
2636KH	36"	26"	1-1/8"	4	17	56.80
3036KH	36"	30"	1-1/8"	4	20	68.90
3636KH	36"	36"	1-1/8"	4	22	81.50
0942KH	42"	9"	1-1/8"	4	7	25.40
1242KH	42"	12"	1-1/8"	4	8	31.90
1342KH	42"	13"	1-1/8"	4	8	35.30
1542KH	42"	15"	1-1/8"	4	10	42.40
1842KH	42"	18"	1-1/8"	4	12	49.10
2042KH	42"	20"	1-1/8"	4	13	58.20
2442KH	42"	24"	1-1/8"	4	17	63.40
2642KH	42"	26"	1-1/8"	4	19	83.70
3042KH	42"	30"	1-1/8"	4	21	89.30
3642KH	42"	36"	1-1/8"	4	23	93.10
0948KH	48"	9"	1-1/8"	4	7	28.40
1248KH	48"	12"	1-1/8"	4	8	35.40
1348KH	48"	13"	1-1/8"	4	8	40.10
1548KH	48"	15"	1-1/8"	4	12	49.60
1848KH	48"	18"	1-1/8"	4	14	57.20
2048KH	48"	20"	1-1/8"	4	15	62.90
2448KH	48"	24"	1-1/8"	4	17	73.60
2648KH	48"	26"	1-1/8"	4	18	79.40
3048KH	48"	30"	1-1/8"	4	22	88.70
3648KH	48"	36"	1-1/8"	4	26	107.10

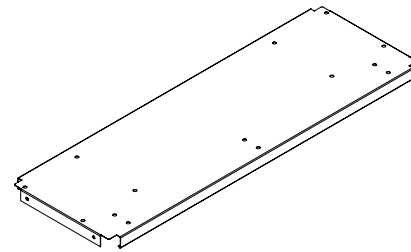

1-1/8" high.  
18 gauge.  
All shelves require two HS-XXXX shelf supports.

TrakSlider Heavy Duty Shelf Top should be used in conjunction with Datum Heavy Duty or X-Ray 4Post Shelving.



# Library Shelving, Comp. Parts - Standard Duty Top Shelves

## TrakSlider Library Standard Duty Shelf Top

Item #	W	D	H	Pcs/Ctn	Est Lbs.	List Price
0924KL	24"	9"	3/4"	4	1	15.20
1224KL	24"	12"	3/4"	4	2	17.40
1324KL	24"	13	3/4"	4	3	18.50
1524KL	24"	15"	3/4"	4	3	21.10
1824KL	24"	18"	3/4"	4	4	26.20
2024KL	24"	20	3/4"	4	5	28.40
2424KL	24"	24"	3/4"	4	5	32.70
2624KL	24"	26	3/4"	4	6	34.90
3024KL	24"	30"	3/4"	4	9	37.00
0930KL	30"	9"	3/4"	4	2	15.30
1230KL	30"	12"	3/4"	4	3	17.50
1330KL	30"	13	3/4"	4	4	18.60
1530KL	30"	15"	3/4"	4	4	21.40
1830KL	30"	18"	3/4"	4	5	26.30
2030KL	30"	20	3/4"	4	6	28.50
2430KL	30"	24"	3/4"	4	7	32.80
2630KL	30"	26	3/4"	4	8	35.00
3030KL	30"	30"	3/4"	4	9	37.10
0936KL	36"	9"	3/4"	4	3	15.20
1236KL	36"	12"	3/4"	4	5	17.30
1336KL	36"	13	3/4"	4	5	18.80
1536KL	36"	15"	3/4"	4	5	21.60
1836KL	36"	18"	3/4"	4	6	25.60
2036KL	36"	20	3/4"	4	7	28.60
2436KL	36"	24"	3/4"	4	8	33.00
2636KL	36"	26	3/4"	4	9	35.20
3036KL	36"	30"	3/4"	4	10	37.20
0942KL	42"	9"	3/4"	4	4	17.90
1242KL	42"	12"	3/4"	4	5	20.70
1342KL	42"	13	3/4"	4	5	22.90
1542KL	42"	15"	3/4"	4	6	24.90
1842KL	42"	18"	3/4"	4	7	29.70
2042KL	42"	20	3/4"	4	9	33.70
2442KL	42"	24"	3/4"	4	9	38.70
2642KL	42"	26	3/4"	4	11	41.10
3042KL	42"	30"	3/4"	4	11	43.00
0948KL	48"	9"	3/4"	4	5	20.00
1248KL	48"	12"	3/4"	4	5	24.40
1348KL	48"	13	3/4"	4	6	25.60
1548KL	48"	15"	3/4"	4	7	27.80
1848KL	48"	18"	3/4"	4	9	33.30
2048KL	48"	20	3/4"	4	10	35.50
2448KL	48"	24"	3/4"	4	11	43.40
2648KL	48"	26	3/4"	4	12	45.70
3048KL	48"	30"	3/4"	4	14	48.30

The Datum 4Post top shelf can be used in conjunction with Datum's TrakSlider top shelf support (see page 2d:69) to create a 4Post TrakSlider System (Bi, Tri, or Quad) or to retrofit an existing system in the field. All TrakSlider shelf tops are prepunched with knockouts to accept mounting of overhead anti-tip hardware, no drilling required.

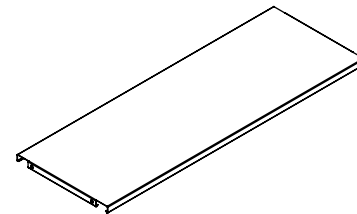

3/4" high.  
22 gauge.  
All shelves require two SS-XXXX shelf supports.

TrakSlider Library Shelf Top should be used in conjunction with Datum Library 4Post Shelving.

# Component Parts - Shelf Supports & Reinforcements

## Double Rivet Shelf Supports

Item #	Gauge	W	H	Pcs/Ctn	Est Lbs.	List Price
<b>Standard Duty Shelf Support</b>						
SS-2414	14	24"	3/4"	30	1	5.80
SS-3014	14	30"	3/4"	30	1	5.90
SS-3614	14	36"	3/4"	30	2	6.10
<b>Medium Duty Shelf Support</b>						
MS-3611	11	36"	3/4"	30	3	7.80
MS-4211	11	42"	3/4"	30	3	9.10
MS-4811	11	48"	3/4"	30	3	10.40
<b>Heavy Duty Shelf Support</b>						
HS-2414	14	24"	1-1/8"	30	1	5.90
HS-3014	14	30"	1-1/8"	30	1	6.10
HS-3614	14	36"	1-1/8"	30	2	6.30
HS-3611	11	36"	1-1/8"	30	3	8.30
HS-4211	11	42"	1-1/8"	30	3	9.50
HS-4811	11	48"	1-1/8"	30	4	10.80

Use with standard duty shelf.  
Two required per shelf.  
Use with SR-XX reinforcements.

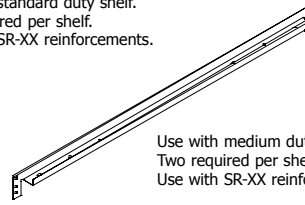

Use with medium duty shelf.  
Two required per shelf.  
Use with SR-XX reinforcements.

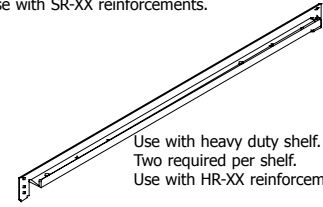

Use with heavy duty shelf.  
Two required per shelf.  
Use with HR-XX reinforcements.

## Single Rivet Shelf Supports

Item #	W	H	Pcs/Ctn	Est Lbs.	List Price
BS24	24"	1-1/4"	30	2	5.80
BS30	30"	1-1/4"	30	2	5.90
BS36	36"	1-1/4"	30	2	6.10
BS42	42"	1-1/4"	30	3	9.10
BS48	48"	1-1/4"	30	3	10.40

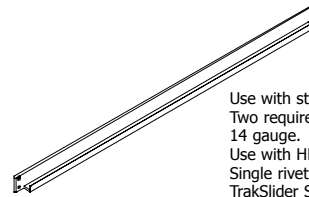

Use with standard, medium or heavy duty shelving.  
Two required per shelf.  
14 gauge.  
Use with HR-XX reinforcements.  
Single rivet supports secure unit to carriage on TrakSlider System.  
Can be used on bottom shelf resulting in flush fit with floor.

## Seismic Mounting Brackets

Item #	W	Pcs/Ctn	Est Lbs.	List Price
SMB24	24"	30	3	15.95
SMB30	30"	30	3	17.50
SMB36	36"	30	3	19.05
SMB42	42"	30	4	20.60
SMB48	48"	30	4	22.15

## Shelf Reinforcements

Item #	D	H	Pcs/Ctn	Est Lbs.	List Price
SR12	12"	5/8"	144	1	2.80
SR13	13"	5/8"	144	1	3.00
SR15	15"	5/8"	144	1	3.60
SR16	16"	5/8"	144	1	3.60
SR18	18"	5/8"	72	1	3.70
SR20	20"	5/8"	72	1	3.80
SR24	24"	5/8"	72	1	4.20
SR26	26"	5/8"	36	1	4.50
SR30	30"	5/8"	36	1	5.20
SR32	32"	5/8"	36	1	6.00
SR36	36"	5/8"	36	2	6.10

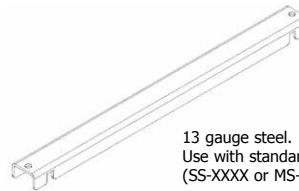

13 gauge steel.  
Use with standard or medium duty shelf supports (SS-XXXX or MS-XXXX).

## Heavy Duty Shelf Reinforcements

Item #	D	H	Pcs/Ctn	Est Lbs.	List Price
HR09	9"	1"	96	1	2.90
HR12	12"	1"	96	1	3.60
HR13	13"	1"	96	1	3.70
HR15	15"	1"	96	1	3.80
HR16	16"	1"	96	1	3.90
HR18	18"	1"	48	1	3.90
HR20	20"	1"	48	1	4.10
HR24	24"	1"	48	2	4.80
HR26	26"	1"	48	2	5.00
HR30	30"	1"	48	2	5.80
HR32	32"	1"	48	2	6.70
HR36	36"	1"	24	2	7.00

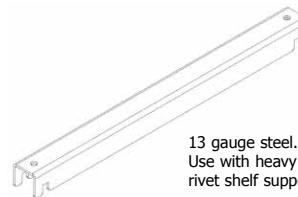

13 gauge steel.  
Use with heavy duty shelf supports or single rivet shelf supports (HS-XXXX or BS-XX).

# Component Parts - Back/Center Stops and Dividers

## Slotted Back Stop

Item #	W	H	Pcs/Ctn	Est Lbs.	List Price
SB24	24"	2"	40	1	7.80
SB30	30"	2"	40	1	8.20
SB36	36"	2"	40	1	8.80
SB42	42"	2"	40	2	9.40
SB48	48"	2"	40	2	10.00

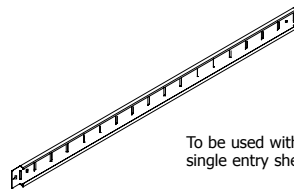

To be used with adjustable file dividers on single entry shelf units.

## Slotted Center Stop

Item #	W	H	Pcs/Ctn	Est Lbs.	List Price
CSSL24	24"	2"	20	1	9.60
CSSL30	30"	2"	20	1	10.00
CSSL36	36"	2"	20	1	11.00
CSSL42	42"	2"	20	2	12.40
CSSL48	48"	2"	20	2	12.90
CS24	24"	4"	20	2	9.00
CS30	30"	4"	20	2	9.40
CS36	36"	4"	20	2	10.40
CS42	42"	4"	20	3	11.40
CS48	48"	4"	20	3	12.30

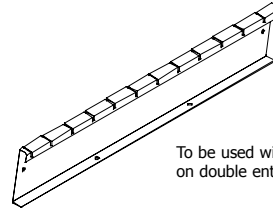

To be used with adjustable file dividers on double entry shelf units.

## Slotted X-Ray Center Stop

Item #	W	H	Pcs/Ctn	Est Lbs.	List Price
SX24	24"	7"	18	3	16.10
SX30	30"	7"	18	3	16.30
SX36	36"	7"	18	4	16.40
SX42	42"	7"	18	5	19.00
SX48	48"	7"	18	5	22.20

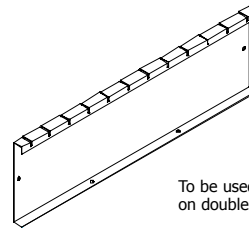

To be used with adjustable X-Ray file dividers on double entry X-Ray shelf units.

## Unslotted Center Divider

Item #	W	H	Pcs/Ctn	Est Lbs.	List Price
CD242	24"	2"	40	1	7.80
CD302	30"	2"	40	1	8.30
CD362	36"	2"	40	2	9.10
CD422	42"	2"	40	2	10.40
CD482	48"	2"	40	2	10.90
CD24	24"	4"	40	2	8.50
CD30	30"	4"	40	2	9.10
CD36	36"	4"	40	2	9.40
CD42	42"	4"	40	3	10.00
CD48	48"	4"	40	3	10.70

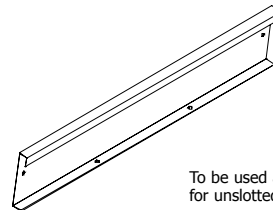

To be used as a center divider for unslotted double entry shelving.

## Dividers

Item #	D	H	Pcs/Ctn	Est Lbs.	List Price
FDL	11"	8"	1	1	3.80
FDSL	11"	4"	1	1	5.30
FDL10	11"	8"	10	9	37.50
FDL-18S	17"	8"	1	2	7.50
FDL35	11"	8"	35	30	131.20
FDB	9"	8"	1	1	4.10
FDSB	9"	4"	1	1	4.10

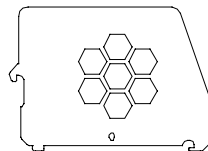

FDL to be used with single and/or double entry shelves.  
 FDB – for 9" deep Library Shelving.  
 FDSL – for low profile media applications. To be used with CSSLXX Slotted Center Stops only for double entry applications. Use Standard Slotted Back Stops for single entry applications.  
 FDL-18S to be used with 18" or 36" deep standard duty shelving.

## X-Ray Divider

Item #	D	H	Description	Est Lbs.	List Price
FDX	17"	11"	One divider	2	9.50
FDXS	17"	11"	Pkg. of 5	12	47.70
FDX20	17"	11"	Pkg. of 20	46	190.60

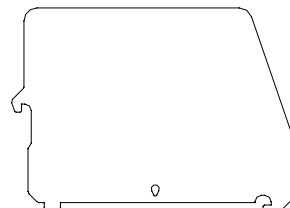

To be used with single and/or double entry slotted X-Ray shelves.

# Component Parts - Kick Plates, Shelf Lips, Plan & Fire Hose Storage

## Kick Plate

Item #	Description	Est Lbs.	List Price
QB2402	24" W x 2" H	1	10.40
QB3002	30" W x 2" H	1	11.00
QB3602	36" W x 2" H	1	11.20
QB4202	42" W x 2" H	2	11.90
QB4802	48" W x 2" H	2	12.60
QB2404	24" W x 4" H	2	11.60
QB3004	30" W x 4" H	2	12.40
QB3604	36" W x 4" H	2	13.20
QB4204	42" W x 4" H	3	14.60
QB4804	48" W x 4" H	3	15.90

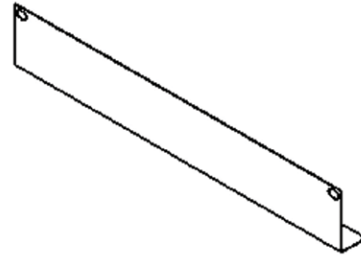

Kick Plate must be ordered with double rivet shelf support (page 2d:42) dependent upon type of shelving ordered (standard, medium, or heavy duty). Kick Plate is compatible with all 4Post™ shelves.

## Plexiglass Shelf Lip

Item #	W	H	Est. Lbs.	List Price
PSL-224	24"	2"	4.2	68.00
PSL-230	30"	2"	4.4	70.00
PSL-236	36"	2"	4.7	72.10
PSL-242	42"	2"	5	74.20
PSL-248	48"	2"	5.3	78.30
PSL-424	24"	4"	7.3	74.20
PSL-430	30"	4"	7.9	78.30
PSL-436	36"	4"	8.5	82.40
PSL-442	42"	4"	9	86.50
PSL-448	48"	4"	9.6	94.80
PSL-624	24"	6"	10.5	88.60
PSL-630	30"	6"	11.3	100.90
PSL-636	36"	6"	12.2	113.30
PSL-642	42"	6"	13	127.70
PSL-648	48"	6"	13.9	144.20

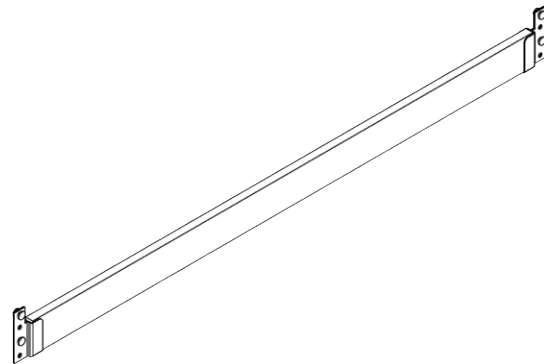

## Plan Storage Dividers

Item #	Dimensions	Est Lbs.	List Price
PD1206	12"D X 6"H	2	12.20
PD1306	13"D X 6"H	2	12.30
PD1506	15"D X 6"H	2	12.60
PD1806	18"D X 6"H	2	12.90
PD2006	20"D X 6"H	2	13.10
PD2406	24"D X 6"H	3	13.30
PD2606	26"D X 6"H	3	13.40
PD3006	30"D X 6"H	3	13.70
PD3206	32"D X 6"H	3	13.90
PD3606	36"D X 6"H	3	14.50

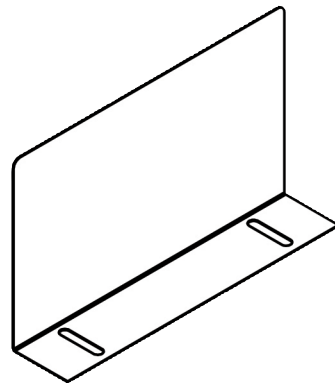

\* Used in conjunction with standard duty punched shelves. Sold separately. See page 2d:37 for pricing information.

## Fire Hose Storage

Item #	W	Est Lbs.	List Price
MS-2411FH	24"	5	46.00
MS-3011FH	30"	5	50.00
MS-3611FH	36	6	52.50
MS4211FH	42'	7	57.50
MS4811FH	48"	8	65.70

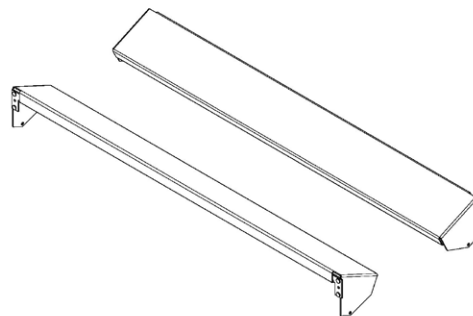

# Component Parts - Reference Shelves, Cut Charges, and Misc.

## Reference Shelves

Item #	W	D	Pcs/Ctn	Est Lbs.	List Price
<b>Reference Shelf Kit</b>					
RSK12	30"	12"	1	9	75.10
RSK13	30"	13"	1	9	75.10
RSK15	30"	15"	1	9	75.10
RSK16	30"	16"	1	9	75.10
RSK18	30"	18"	1	10	75.10
RSK20	30"	20"	1	10	75.10
RSK24	30"	24"	1	11	81.90
RSK26	30"	26"	1	11	81.90
RSK30	30"	30"	1	11	81.90
RSK32	30"	32"	1	13	81.90
RSK36	30"	36"	1	13	81.90
<b>Reference Shelf (Includes pull-out suspension)</b>					
RSA	30"	11-7/8"	1	8	75.10

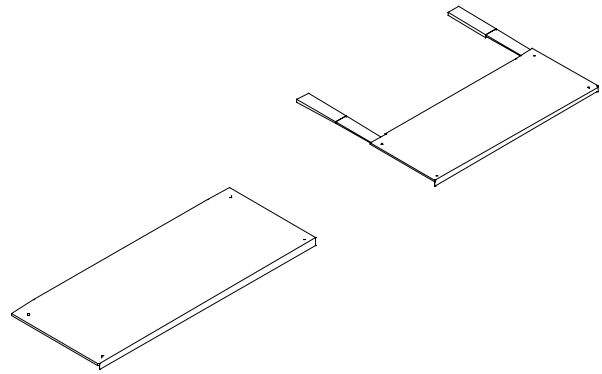

The above part numbers apply to 36", 42" and 48" wide shelving only.

**Reference shelves are also available for 24" and 30" wide shelving.**

To order shelf for 24" wide shelving, add "24" to the end of the part number. Ex: RSK1224

To order shelf for 30" wide shelving, add "30" to the end of the part number. Ex: RSK1230

**Pricing will remain the same.**

\*Refers to depth of shelf to which Reference Shelf is being mounted. For example, a RSK12 Reference Shelf Kit would be ordered for a 12" deep shelf. All shelves include mounting brackets and one pull out reference shelf. For double entry applications, order an additional reference shelf (RSA). One shelf opening will be reduced by 1". Actual Reference Shelf dimensions: 30" W x 11-7/8" D.

## Index Holder

Item#	Description	Est Lbs.	List Price
5205N	Self Adhesive Index Holder	1	25.10
5205D	Datum Label Holder	1	32.40

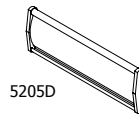

## Wall Tie

Item#	Description	Est Lbs.	List Price
4P-WT	1 Wall Tie	1	24.50

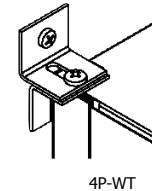

## Library Book End

Item #	Description	D	H	Est Lbs.	List Price
LBE-4	Set of 4	4-1/2"	6"	4	57.50

Available in T25 Black paint only.

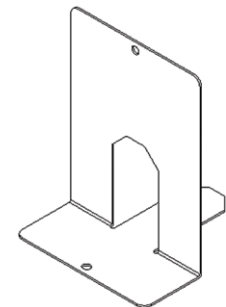

4Post™ Library Book End

## Sample Kit

Item#	Description	Est Lbs.	List Price
4P-DK	4Post Sample Kit	48	624.60

Contact Datum for a list of individual parts.

## Touch-Up Paint\*

Item #	Description	Est Lbs.	List Price
TU#15	Bone White touch-up paint	4.5 oz	21.70
TU#86	Gray touch-up paint	4.5 oz	21.70



\*Touch-up paint is not textured.

## Custom Upright Charge

Item#	Description	List Price
Cut Charge	L&T Upright (each)	11.30

Custom size uprights are available up to 97-1/4" high and must be sized based on 1-1/2" increments. Use next higher upright height when calculating cut charges.

Note: Adjusting upright height will effect clear height requirements between shelves and may limit the ability to use Reference Shelves and/or Bin Dividers.

Bin dividers cannot be used on the top shelf when unit is mounted on a TrakSlider™ System.

Refer to the 4Post™ Standard Shelf Spacing Chart found on pages 2d:76 and 2d:77 for more information.

# Component Parts - Bin Dividers

## Bin Dividers

Item #	D	H	Shelf Openings	Pcs/Ctn	Est Lbs.	List Price
BD1206	12"	6"	4-3/4"	30	1	10.40
BD1207.5	12"	7.5	6-1/4"	30	1	10.80
BD1209	12"	9"	7-3/4"	30	2	11.10
BD1210.5	12"	10.5"	9-1/4"	30	2	11.80
BD1212	12"	12"	10-3/4"	30	2	12.30
BD1213.5	12"	13-1/2"	12-1/4"	30	2	12.80
BD1215	12"	15"	13-3/4"	30	3	13.20
BD1216.5	12"	16-1/2"	15-1/4"	30	3	13.60
BD1218	12"	18"	16-3/4"	30	4	14.10
BD1306	13"	6"	4-3/4"	30	1	10.70
BD1307.5	13	7.5"	6-1/4"	30	2	11.20
BD1309	13"	9"	7-3/4"	30	2	11.50
BD1310.5	13"	10.5"	9-1/4"	30	2	12.30
BD1312	13"	12"	10-3/4"	30	2	12.80
BD1313	13"	13"	12-1/4"	30	2	13.50
BD1313.5	13"	13.5"	12-1/4"	30	2	14.30
BD1315	13"	15"	13-3/4"	30	3	14.40
BD1316.5	13"	16-1/2"	15-1/4"	30	3	11.00
BD1318	13"	18"	16-3/4"	30	4	14.90
BD1506	15"	6"	4-3/4"	30	2	11.00
BD1507.5	15"	7.5"	6-1/4"	30	2	11.60
BD1509	15"	9"	7-3/4"	30	2	12.30
BD1510.5	15"	10.5"	9-1/4"	30	2	12.80
BD1512	15"	12"	10-3/4"	30	2	13.30
BD1513.5	15"	13-1/2"	12-1/4"	30	2	13.90
BD1515	15"	15"	13-3/4"	30	2	14.70
BD1516.5	15"	16-1/2"	15-1/4"	30	3	15.00
BD1518	15"	18"	16-3/4"	30	3	15.30
BD1806	18"	6"	4-3/4"	30	2	11.50
BD1807.5	18"	7.5"	6-1/4"	30	2	13.50
BD1809	18"	9"	7-3/4"	30	2	14.40
BD1810.5	18	10.5	9-1/4"	30	2	14.60
BD1812	18"	12"	10-3/4"	30	3	14.80
BD1813.5	18"	13-1/2"	12-1/4"	30	3	15.10
BD1815	18"	15"	13-3/4"	30	3	15.80
BD1816.5	18"	16-1/2"	15-1/4"	30	3	16.50
BD1818	18"	18"	16-3/4"	30	4	17.20
BD2006	20"	6"	4-3/4"	30	2	12.00
BD2007.5	20"	7.5"	6-1/4"	30	2	14.20
BD2009	20"	9"	7-3/4"	30	2	15.70
BD2010.5	20"	10.5"	9-1/4"	30	2	16.50
BD2012	20"	12"	10-3/4"	30	2	16.90
BD2013.5	20"	13.5"	12-1/4"	30	3	17.60
BD2015	20"	15"	13-3/4"	30	3	18.10
BD2016.5	20"	16-1/2"	15-1/4"	30	3	18.80
BD2018	20"	18"	16-3/4"	30	4	19.90

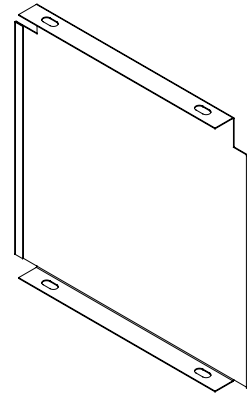

Use with XXXXPH Punched Shelves only found on page 2d:37. Includes all necessary mounting hardware.



# Component Parts - EasyRoller Systems & Garment/Fabric Sample Rods

## EasyRoller Single Entry Units

Item #	Depth	Est Lbs.	List Price
ER12S	12"	2	27.80
ER13S	13"	2	28.30
ER15S	15"	2	35.00
ER16S	16"	2	35.50
ER18S	18"	2	36.10
ER20S	20"	2	42.70
ER24S	24"	3	50.50
ER26S	26"	3	51.50
ER30S	30"	3	59.20
ER32S	32"	3	59.70
ER36S	36"	4	67.50

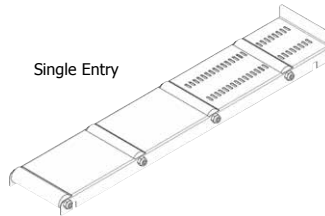

Single Entry

## EasyRoller Double Entry Units

Item #	Depth	Est Lbs.	List Price
ER24D	24"	3	54.60
ER26D	26"	3	55.10
ER30D	30"	4	62.80
ER32D	32"	4	63.90
ER36D	36"	4	67.50

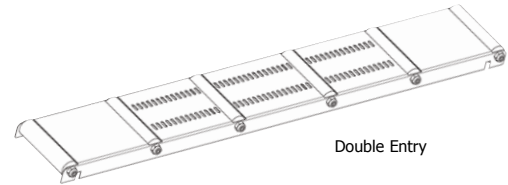

Double Entry

## EasyRoller Book Dividers

Item #	Depth	Est Lbs.	List Price
ER12	12"	1	18.70
ER13	13"	1	18.70
ER15	15"	2	19.10
ER16	16"	2	19.70
ER18	18"	2	20.10
ER20	20"	2	20.10
ER24	24"	2	22.10
ER26	26"	2	22.10
ER30	30"	2	24.10
ER32	32"	2	25.10
ER36	36"	3	26.20

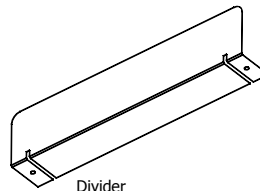

Divider

### How to Order:

Specify with two Standard Duty 4Post™ shelf supports found on page 42. Refer to page 76-77 for standard clear height opening requirements. Specify two Easy Rollers per book up to 18" book height. Dividers can be specified to keep books separated on shelf. Manufactured of 22 gauge steel with a minimum of (4) nylon rollers.

Use the part numbers below to order garment rod components separately.

## Garment/Fabric Sample Rods

Item #	Description	Est Lbs.	List Price
GT24	24" Garment/Fabric Rod (each)	2	29.60
GT30	30" Garment/Fabric Rod (each)	3	34.40
GT36	36" Garment/Fabric Rod (each)	3	36.40
GT42	42" Garment/Fabric Rod (each)	4	38.50
GT48	48" Garment/Fabric Rod (each)	4	39.80
GB09	9" Mounting Bracket (pair)	2	29.80
GB12	12" Mounting Bracket (pair)	2	31.20
GB13	13" Mounting Bracket (pair)	2	32.30
GB15	15" Mounting Bracket (pair)	3	34.10
GB18	18" Mounting Bracket (pair)	3	37.10
GB20	20" Mounting Bracket (pair)	3	42.00
GB24	24" Mounting Bracket (pair)	5	52.00
GB26	26" Mounting Bracket (pair)	5	53.10
GB30	30" Mounting Bracket (pair)	6	54.90
GB36	36" Mounting Bracket (pair)	7	57.80

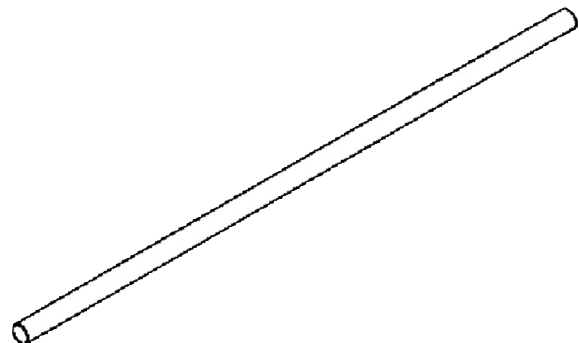
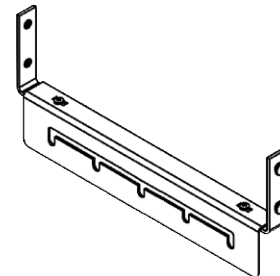

Rod mounting holes are punched on 2" centers for easy adjustment.

Rods are 1-1/2" diameter galvanized coated steel tube and require (1) pair of Mounting Brackets per row.

Must specify paint color for Mounting Brackets.

Includes all necessary mounting hardware.

# Component Parts - Magazine Doors

The retractable door provides a place to store the latest edition of a magazine while the back issues are stored neatly on a shelf behind the retractable door. Door swings up and retracts into the shelving unit. Magazine Doors are available for units 24" Wide through 48" Wide. Magazine Doors are only compatible with 11-1/4" openings.

## Magazine Door - 24"W

Item #	Description	Est Lbs.	List Price
MD-2409	Single Entry for 9"D Unit	7	67.70
MD-2412	Single Entry for 12"D Unit	7	67.70
MD-2413	Single Entry for 13"D Unit	7	67.70
MD-2415	Single Entry for 15"D Unit	7	67.70
MD-2416	Single Entry for 16"D Unit	7	67.70
MD-2418	Single Entry for 18"D Unit	7	67.70
MD-2424	Single Entry for 24"D Unit	7	67.70
MD-2430	Single Entry for 30"D Unit	8	72.20
MD-2432	Single Entry for 32"D Unit	8	72.20
MD-2436	Single Entry for 36"D Unit	8	72.20

MD-24A	Add-on to make Double Entry	6	56.30
--------	-----------------------------	---	-------

## Magazine Door - 30"W

Item #	Description	Est Lbs.	List Price
MD-3009	Single Entry for 9"D Unit	8	69.10
MD-3012	Single Entry for 12"D Unit	8	69.10
MD-3013	Single Entry for 13"D Unit	8	69.10
MD-3015	Single Entry for 15"D Unit	8	69.10
MD-3016	Single Entry for 16"D Unit	8	69.10
MD-3018	Single Entry for 18"D Unit	8	69.10
MD-3024	Single Entry for 24"D Unit	8	69.10
MD-3030	Single Entry for 30"D Unit	9	73.60
MD-3032	Single Entry for 32"D Unit	9	73.60
MD-3036	Single Entry for 36"D Unit	9	73.60

MD-30A	Add-on to make Double Entry	6	57.80
--------	-----------------------------	---	-------

## Magazine Door - 36"W

Item #	Description	Est Lbs.	List Price
MD-3609	Single Entry for 9"D Unit	9	70.80
MD-3612	Single Entry for 12"D Unit	9	70.80
MD-3613	Single Entry for 13"D Unit	9	70.80
MD-3615	Single Entry for 15"D Unit	9	70.80
MD-3616	Single Entry for 16"D Unit	9	70.80
MD-3618	Single Entry for 18"D Unit	9	70.80
MD-3624	Single Entry for 24"D Unit	9	70.80
MD-3630	Single Entry for 30"D Unit	10	75.30
MD-3632	Single Entry for 32"D Unit	10	75.30
MD-3636	Single Entry for 36"D Unit	10	75.30

MD-36A	Add-on to make Double Entry	8	59.30
--------	-----------------------------	---	-------

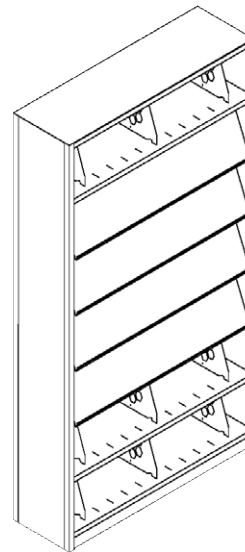

# Component Parts - Magazine Doors Continued

## Magazine Door - 42"W

Item #	Description	Est Lbs.	List Price
MD-4209	Single Entry for 9"D Unit	10	72.20
MD-4212	Single Entry for 12"D Unit	10	72.20
MD-4213	Single Entry for 13"D Unit	10	72.20
MD-4215	Single Entry for 15"D Unit	10	72.20
MD-4216	Single Entry for 16"D Unit	10	72.20
MD-4218	Single Entry for 18"D Unit	10	72.20
MD-4224	Single Entry for 24"D Unit	10	72.20
MD-4230	Single Entry for 30"D Unit	11	76.80
MD-4232	Single Entry for 32"D Unit	11	76.80
MD-4236	Single Entry for 36"D Unit	11	76.80

MD-42A	Add-on to make Double Entry	9	60.90
--------	-----------------------------	---	-------

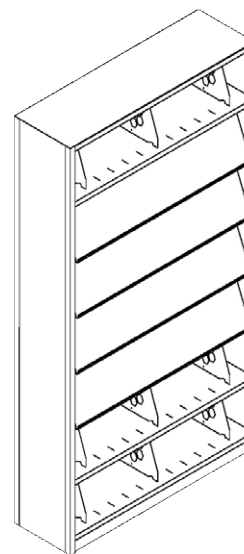

## Magazine Door - 48"W

Item #	Description	Est Lbs.	List Price
MD-4809	Single Entry for 9"D Unit	11	75.90
MD-4812	Single Entry for 12"D Unit	11	75.90
MD-4813	Single Entry for 13"D Unit	11	75.90
MD-4815	Single Entry for 15"D Unit	11	75.90
MD-4816	Single Entry for 16"D Unit	11	75.90
MD-4818	Single Entry for 18"D Unit	11	75.90
MD-4824	Single Entry for 24"D Unit	11	75.90
MD-4830	Single Entry for 30"D Unit	12	80.40
MD-4832	Single Entry for 32"D Unit	12	80.40
MD-4836	Single Entry for 36"D Unit	12	80.40

MD-48A	Add-on to make Double Entry	10	62.30
--------	-----------------------------	----	-------

# Component Parts - Flipper Doors

## Flipper Doors

Item #	Description	W	D	Est Lbs.	List Price
FDMB15	Flipper Door mounting brackets	—	15"	9	56.70
FDMB16	Flipper Door mounting brackets	—	15"	9	57.70
FDMB18	Flipper Door mounting brackets	—	18"	10	59.70
FDMB30	Flipper Door mounting brackets	—	30"	15	83.40
FDMB36	Flipper Door mounting brackets	—	36"	18	89.60
FD1524-11	Flipper Door for 11-1/4" clear	24"	15"	10	141.10
FD1530-11	Flipper Door for 11-1/4" clear	30"	15"	12	144.20
FD1536-11	Flipper Door for 11-1/4" clear	36"	15"	15	147.30
FD1542-11	Flipper Door for 11-1/4" clear	42"	15"	17	150.40
FD1548-11	Flipper Door for 11-1/4" clear	48"	15"	19	153.50
FD1824-11	Flipper Door for 11-1/4" clear	24"	18"	11	151.40
FD1830-11	Flipper Door for 11-1/4" clear	30"	18"	13	154.50
FD1836-11	Flipper Door for 11-1/4" clear	36"	18"	16	157.60
FD1842-11	Flipper Door for 11-1/4" clear	42"	18"	18	160.70
FD1848-11	Flipper Door for 11-1/4" clear	48"	18"	21	163.80
FD1524-12	Flipper Door for 12-3/4" clear	24"	15"	11	146.30
FD1530-12	Flipper Door for 12-3/4" clear	30"	15"	13	149.40
FD1536-12	Flipper Door for 12-3/4" clear	36"	15"	16	152.40
FD1542-12	Flipper Door for 12-3/4" clear	42"	15"	18	155.50
FD1548-12	Flipper Door for 12-3/4" clear	48"	15"	20	158.60
FD1824-12	Flipper Door for 12-3/4" clear	24"	18"	12	156.60
FD1830-12	Flipper Door for 12-3/4" clear	30"	18"	14	159.70
FD1836-12	Flipper Door for 12-3/4" clear	36"	18"	17	162.70
FD1842-12	Flipper Door for 12-3/4" clear	42"	18"	19	165.80
FD1848-12	Flipper Door for 12-3/4" clear	48"	18"	22	168.90
FD1524-11L	Flipper Door for 11-1/4" clear locking	24"	15"	12	161.70
FD1530-11L	Flipper Door for 11-1/4" clear locking	30"	15"	14	164.80
FD1536-11L	Flipper Door for 11-1/4" clear locking	36"	15"	17	167.90
FD1542-11L	Flipper Door for 11-1/4" clear locking	42"	15"	19	171.00
FD1548-11L	Flipper Door for 11-1/4" clear locking	48"	15"	21	174.10
FD1824-11L	Flipper Door for 11-1/4" clear locking	24"	18"	13	172.00
FD1830-11L	Flipper Door for 11-1/4" clear locking	30"	18"	15	175.10
FD1836-11L	Flipper Door for 11-1/4" clear locking	36"	18"	18	178.20
FD1842-11L	Flipper Door for 11-1/4" clear locking	42"	18"	20	181.30
FD1848-11L	Flipper Door for 11-1/4" clear locking	48"	18"	23	184.40
FD1524-12L	Flipper Door for 12-3/4" clear locking	24"	15"	13	166.90
FD1530-12L	Flipper Door for 12-3/4" clear locking	30"	15"	15	170.00
FD1536-12L	Flipper Door for 12-3/4" clear locking	36"	15"	18	173.00
FD1542-12L	Flipper Door for 12-3/4" clear locking	42"	15"	20	176.10
FD1548-12L	Flipper Door for 12-3/4" clear locking	48"	15"	22	179.20
FD1824-12L	Flipper Door for 12-3/4" clear locking	24"	18"	14	177.20
FD1830-12L	Flipper Door for 12-3/4" clear locking	30"	18"	16	180.30
FD1836-12L	Flipper Door for 12-3/4" clear locking	36"	18"	19	183.30
FD1842-12L	Flipper Door for 12-3/4" clear locking	42"	18"	21	186.40
FD1848-12L	Flipper Door for 12-3/4" clear locking	48"	18"	24	189.50

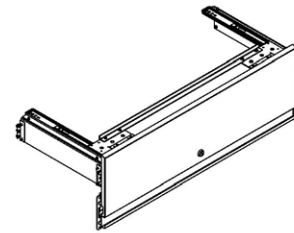

# Component Parts - Hinged Doors

\* when including hinged doors on a mobile carriage, add 2" to the overall depth of the carriage.

## Standard w/ Key Lock

Item #	Description	Est Lbs.	List Price
HD2-2464	24"W x 64.25"H (with lock)	50	588.10
HD2-3064	30"W x 64.25"H (with lock)	55	605.60
HD2-3664	36"W x 64.25"H (with lock)	60	623.20
HD2-4264	42"W x 64.25"H (with lock)	65	640.70
HD2-4864	48"W x 64.25"H (with lock)	70	658.20
HD2-2476	24"W x 76.25"H (with lock)	55	613.90
HD2-3076	30"W x 76.25"H (with lock)	60	631.40
HD2-3676	36"W x 76.25"H (with lock)	65	648.90
HD2-4276	42"W x 76.25"H (with lock)	70	666.40
HD2-4876	48"W x 76.25"H (with lock)	75	683.90
HD2-2485	24"W x 85.25"H (with lock)	55	639.60
HD2-3085	30"W x 85.25"H (with lock)	63	657.10
HD2-3685	36"W x 85.25"H (with lock)	68	674.70
HD2-4285	42"W x 85.25"H (with lock)	73	692.20
HD2-4885	48"W x 85.25"H (with lock)	78	709.70
HD2-2488	24"W x 88.25"H (with lock)	60	649.90
HD2-3088	30"W x 88.25"H (with lock)	65	667.40
HD2-3688	36"W x 88.25"H (with lock)	70	685.00
HD2-4288	42"W x 88.25"H (with lock)	75	702.50
HD2-4888	48"W x 88.25"H (with lock)	80	720.00

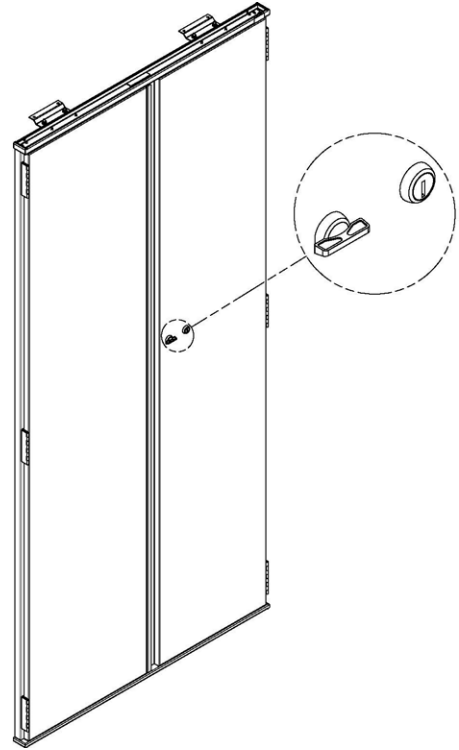

## Standard w/ Electronic Lock

Item #	Description	Est Lbs.	List Price
HD2-2464EL	24"W x 64.25"H (with lock)	50	845.60
HD2-3064EL	30"W x 64.25"H (with lock)	55	863.10
HD2-3664EL	36"W x 64.25"H (with lock)	60	880.70
HD2-4264EL	42"W x 64.25"H (with lock)	65	898.20
HD2-4864EL	48"W x 64.25"H (with lock)	70	915.70
HD2-2476EL	24"W x 76.25"H (with lock)	55	871.40
HD2-3076EL	30"W x 76.25"H (with lock)	60	888.90
HD2-3676EL	36"W x 76.25"H (with lock)	65	906.40
HD2-4276EL	42"W x 76.25"H (with lock)	70	923.90
HD2-4876EL	48"W x 76.25"H (with lock)	75	941.40
HD2-2485EL	24"W x 85.25"H (with lock)	55	897.10
HD2-3085EL	30"W x 85.25"H (with lock)	63	914.60
HD2-3685EL	36"W x 85.25"H (with lock)	68	932.20
HD2-4285EL	42"W x 85.25"H (with lock)	73	949.70
HD2-4885EL	48"W x 85.25"H (with lock)	78	967.20
HD2-2488EL	24"W x 88.25"H (with lock)	60	907.40
HD2-3088EL	30"W x 88.25"H (with lock)	65	924.90
HD2-3688EL	36"W x 88.25"H (with lock)	70	942.50
HD2-4288EL	42"W x 88.25"H (with lock)	75	960.00
HD2-4888EL	48"W x 88.25"H (with lock)	80	977.50

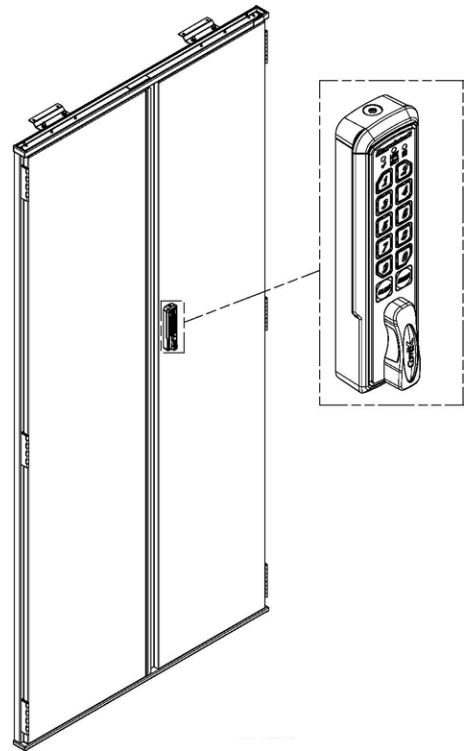

# Component Parts - Hinged Doors, Cont.

\* when including hinged doors on a mobile carriage, add 2" to the overall depth of the carriage.

## Punched w/ Key Lock

Item #	Description	Est Lbs.	List Price
HD2-2464PD	24"W x 64.25"H (with lock)	50	588.10
HD2-3064PD	30"W x 64.25"H (with lock)	55	605.60
HD2-3664PD	36"W x 64.25"H (with lock)	60	623.20
HD2-4264PD	42"W x 64.25"H (with lock)	65	640.70
HD2-4864PD	48"W x 64.25"H (with lock)	70	658.20
HD2-2476PD	24"W x 76.25"H (with lock)	55	613.90
HD2-3076PD	30"W x 76.25"H (with lock)	60	631.40
HD2-3676PD	36"W x 76.25"H (with lock)	65	648.90
HD2-4276PD	42"W x 76.25"H (with lock)	70	666.40
HD2-4876PD	48"W x 76.25"H (with lock)	75	683.90
HD2-2485PD	24"W x 85.25"H (with lock)	55	639.60
HD2-3085PD	30"W x 85.25"H (with lock)	63	657.10
HD2-3685PD	36"W x 85.25"H (with lock)	68	674.70
HD2-4285PD	42"W x 85.25"H (with lock)	73	692.20
HD2-4885PD	48"W x 85.25"H (with lock)	78	709.70
HD2-2488PD	24"W x 88.25"H (with lock)	60	649.90
HD2-3088PD	30"W x 88.25"H (with lock)	65	667.40
HD2-3688PD	36"W x 88.25"H (with lock)	70	685.00
HD2-4288PD	42"W x 88.25"H (with lock)	75	702.50
HD2-4888PD	48"W x 88.25"H (with lock)	80	720.00

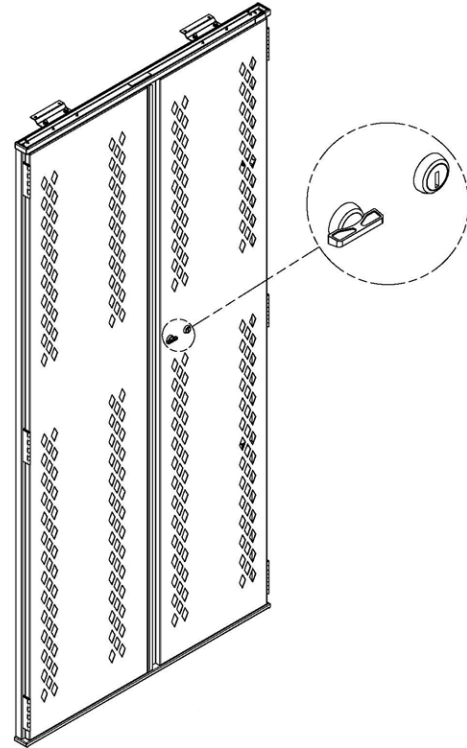

## Punched w/ Electronic Lock

Item #	Description	Est Lbs.	List Price
HD2-2464PDEL	24"W x 64.25"H (with lock)	50	845.60
HD2-3064PDEL	30"W x 64.25"H (with lock)	55	863.10
HD2-3664PDEL	36"W x 64.25"H (with lock)	60	880.70
HD2-4264PDEL	42"W x 64.25"H (with lock)	65	898.20
HD2-4864PDEL	48"W x 64.25"H (with lock)	70	915.70
HD2-2476PDEL	24"W x 76.25"H (with lock)	55	871.40
HD2-3076PDEL	30"W x 76.25"H (with lock)	60	888.90
HD2-3676PDEL	36"W x 76.25"H (with lock)	65	906.40
HD2-4276PDEL	42"W x 76.25"H (with lock)	70	923.90
HD2-4876PDEL	48"W x 76.25"H (with lock)	75	941.40
HD2-2485PDEL	24"W x 85.25"H (with lock)	55	897.10
HD2-3085PDEL	30"W x 85.25"H (with lock)	63	914.60
HD2-3685PDEL	36"W x 85.25"H (with lock)	68	932.20
HD2-4285PDEL	42"W x 85.25"H (with lock)	73	949.70
HD2-4885PDEL	48"W x 85.25"H (with lock)	78	967.20
HD2-2488PDEL	24"W x 88.25"H (with lock)	60	907.40
HD2-3088PDEL	30"W x 88.25"H (with lock)	65	924.90
HD2-3688PDEL	36"W x 88.25"H (with lock)	70	942.50
HD2-4288PDEL	42"W x 88.25"H (with lock)	75	960.00
HD2-4888PDEL	48"W x 88.25"H (with lock)	80	977.50

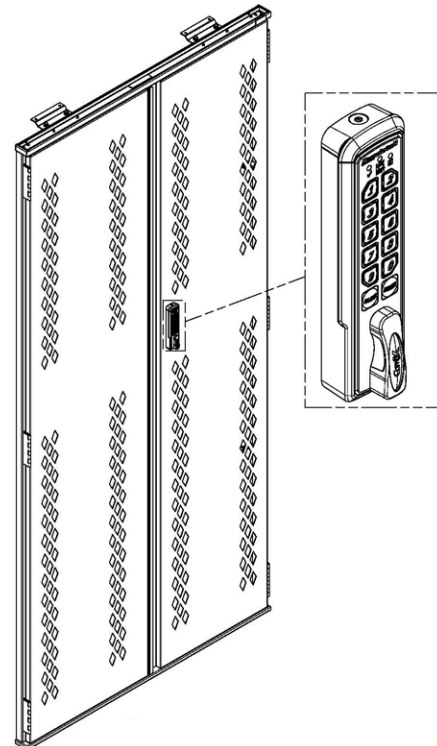



# Component Parts - Back Panels, CD Storage

## Sectional Steel Back Panels

Item #	W	H	Est Lbs.	List Price
RP-2440	24"	40"	12	93.10
RP-2464	24"	64"	19	117.00
RP-2476	24"	76"	21	128.10
RP-2485	24"	85"	23	139.90
RP-2488	24"	88"	24	142.70
RP-2497	24"	97"	26	164.70
RP-24121	24"	121"	34	235.80
RP-3040	30"	40"	14	96.40
RP-3064	30"	64"	22	120.40
RP-3076	30"	76"	25	131.80
RP-3085	30"	85"	27	143.30
RP-3088	30"	88"	29	146.10
RP-3097	30"	97"	32	168.20
RP-30121	30"	121"	43	257.40
RP-3640	36"	40"	17	100.00
PR-3664	36"	64"	26	124.00
RP-3676	36"	76"	30	135.40
RP-3685	36"	85"	32	147.00
RP-3688	36"	88"	34	149.70
RP-3697	36"	97"	37	171.80
RP-36121	36"	121"	47	279.00
RP-4240	42"	40"	21	109.60
RP-4264	42"	64"	28	138.60
RP-4276	42"	76"	36	152.20
RP-4285	42"	85"	39	162.80
RP-4288	42"	88"	42	165.90
RP-4297	42"	97"	45	200.50
RP-42121	42"	121"	58	311.50
RP-4840	48"	40"	23	119.10
RP-4864	48"	64"	35	150.70
RP-4876	48"	76"	41	167.10
RP-4885	48"	85"	44	183.30
RP-4888	48"	88"	47	184.80
RP-4897	48"	97"	51	214.70
RP-48121	48"	121"	65	329.90

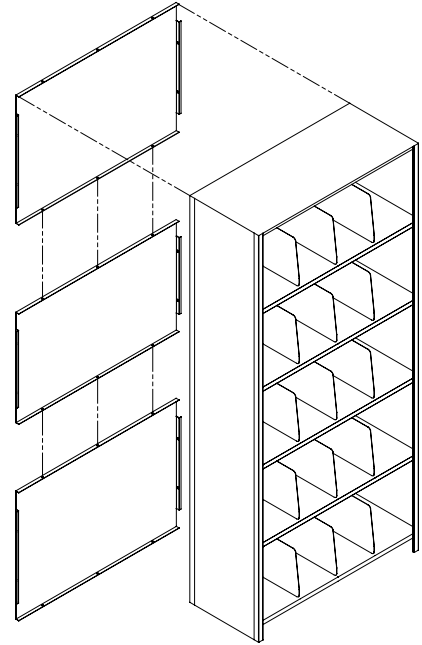

Each back section will include a form channel on the top and bottom and include punched holes for joining sections together. Backs of 40" high are one piece, backs of 64" high are two piece, and up to 97" high are three piece construction. Sectional back panels add 3/8" to overall depth of shelving.

## CD Storage

Item #	Description	W	D	H	Est. Lbs.	List Price
CD24SP	2 tier	24"	11-3/4"	10-3/4"	9	104.40
CD30SP	2 tier	30"	11-3/4"	10-3/4"	11	114.00
CD36SP	2 tier	36"	11-3/4"	10-3/4"	13	123.60
CD42SP	2 tier	42"	11-3/4"	10-3/4"	15	133.40
CD48SP	2 tier	48"	11-3/4"	10-3/4"	17	144.40

Item #	Description	D	H	Est. Lbs.	List Price
CDD	2 pack of dividers	5-1/2"	5"	0.5	10.10

\*Includes everything for (1) double level unit. Works with standard 4Post™ (light, medium, and heavy duty and library). Compatible with hinged and tambour doors. Can't be used on shelving deeper than 12", used back to back on minimum depth of 24".

76-1/4" high shelving = 7 openings, 88-1/4" high shelving = 8 openings, 97-1/4" high shelving = 9 openings.

Shelf spacing is 9-3/4" clear.

Requires quick base and top cover for stability. On systems over 4 tiers high a drawer reinforcement is required.

Shelf is 20 gauge, sides are 16 gauge, mounts are 14 gauge, and divider is 20 gauge steel.

Shelf capacity is 100 pounds evenly distributed (based on standard CD case at .42" thick).

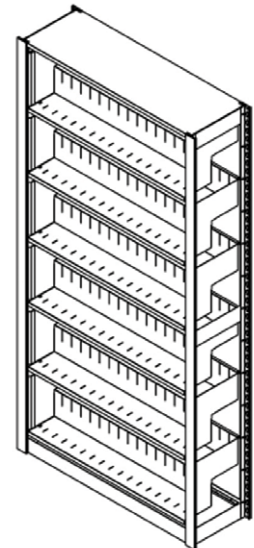

# Athletic Ball Storage

## Single Entry

Item #	D	W	Est Lbs.	List Price
SFBS1224	12"	24"	6	41.20
SFBS1524	15"	24"	7	42.00
SFBS1824	18"	24"	7	43.30
SFBS2424	24"	24"	9	44.40
SFBS3024	30"	24"	10	46.20
SFBS3624	36"	24"	11	46.60
SFBS1230	12"	30"	8	45.50
SFBS1530	15"	30"	9	46.40
SFBS1830	18"	30"	9	47.60
SFBS2430	24"	30"	11	48.70
SFBS3030	30"	30"	12	50.60
SFBS3630	36"	30"	13	61.70
SFBS1236	12"	36"	8	49.90
SFBS1536	15"	36"	9	50.70
SFBS1836	18"	36"	9	51.90
SFBS2436	24"	36"	11	53.00
SFBS3036	30"	36"	12	54.90
SFBS3636	36"	36"	13	55.20
SFBS1242	12"	42"	10	54.20
SFBS1542	15"	42"	11	55.00
SFBS1842	18"	42"	11	56.20
SFBS2442	24"	42"	13	57.40
SFBS3042	30"	42"	14	59.20
SFBS3642	36"	42"	15	59.50
SFBS1248	12"	48"	10	58.50
SFBS1548	15"	48"	11	59.30
SFBS1848	18"	48"	11	60.60
SFBS2448	24"	48"	13	61.70
SFBS3048	30"	48"	14	63.60
SFBS3648	36"	48"	15	63.90

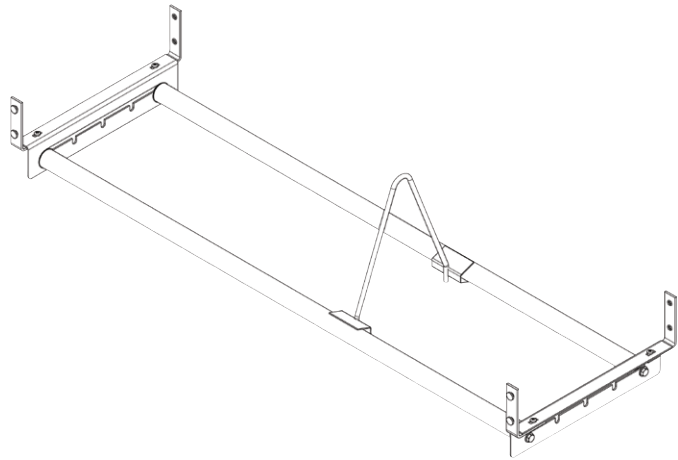

## Double Entry

Item #	D	W	Est Lbs.	List Price
DFBS2424	24"	24"	18	64.10
DFBS3024	30"	24"	20	65.80
DFBS3624	36"	24"	22	66.30
DFBS2430	24"	30"	22	72.70
DFBS3030	30"	30"	24	74.50
DFBS3630	36"	30"	26	75.00
DFBS2436	24"	36"	22	81.40
DFBS3036	30"	36"	24	83.10
DFBS3636	36"	36"	26	83.60
DFBS2442	24"	42"	26	90.00
DFBS3042	30"	42"	28	91.80
DFBS3642	36"	42"	30	92.30
DFBS2448	24"	48"	26	98.70
DFBS3048	30"	48"	28	96.60
DFBS3648	36"	48"	30	100.40

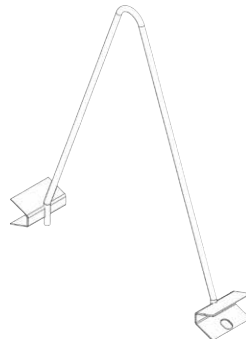

## Wire Divider

Item #	Description	Est Lbs.	List Price
WD8	8" Wire Divider	1	19.10
WD12	12" Wire Divider	1	21.30

# Golf Bag Storage & Complete Garment Racks

## Single Entry Golf Bag Storage

Item #	D	W	Est Lbs.	List Price
SFGB1530	15"	30"	21	115.10
SFGB1830	18"	30"	21	119.00
SFGB1536	15"	36"	21	123.70
SFGB1836	18"	36"	21	127.60
SFGB1542	15"	42"	25	132.40
SFGB1842	18"	42"	25	136.30
SFGB1548	15"	48"	25	141.00
SFGB1848	18"	48"	25	144.90

## Double Entry Golf Bag Storage

Item #	D	W	Est Lbs.	List Price
DFGB3030	15"	30"	42	175.60
DFGB3630	18"	30"	42	176.30
DFGB3036	15"	36"	42	192.90
DFGB3636	18"	36"	42	193.60
DFGB3042	15"	42"	50	210.20
DFGB3642	18"	42"	50	210.90
DFGB3048	15"	48"	50	227.50
DFGB3648	18"	48"	50	228.20

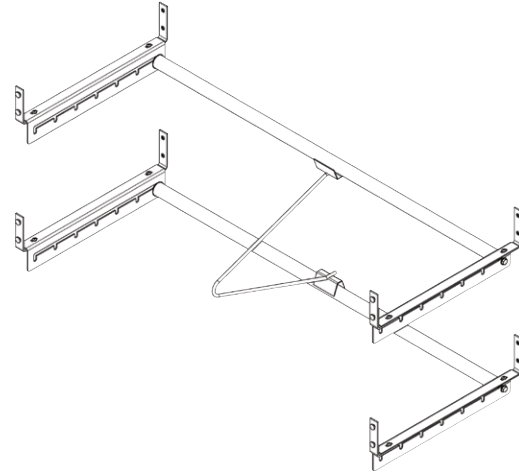

## Single Entry Garment Rack

Item #	D	W	Est Lbs.	List Price
W1542	15"	42"	6	48.70
W1548	15"	48"	7	54.10
W2442	24"	42"	8	59.50
W2448	24"	48"	9	64.90
W3042	30"	42"	10	70.30
W3048	30"	48"	11	75.70

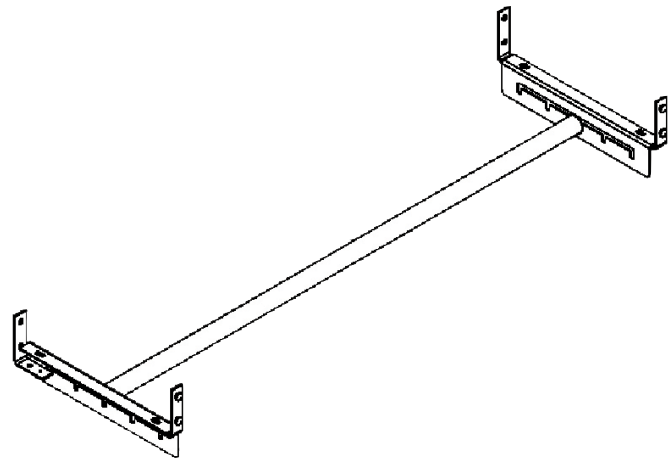

## Double Entry Garment Rack

Item #	D	W	Est Lbs.	List Price
W2442D	24"	42"	11	62.20
W2448D	24"	48"	12	67.60
W3042D	30"	42"	13	78.40
W3048D	30"	48"	14	83.80

Garment racks are sold as a complete unit. To purchase components separately, refer to page 2d:47.

# Hanging Folder Drawer Frames & Drawer Reinforcements

**WHEN USING PULL OUT DRAWERS WITH ANY 4POST™ SHELVING, THE TOP OF ANY DRAWER CANNOT BE ABOVE 54" AND ALL SINGLE ENTRY UNITS MUST BE SECURELY ATTACHED TO THE WALL OR FLOOR.**

## Hanging Folder Frames

RETRACTABLE	Hanging Folder Frames					
	Item #	W	LFI	Est Lbs.	List Price	
	Single Entry	1524HFS	24"	21	5	163.40
		1530HFS	30"	26	6	167.70
		1536HFS	36"	32	8	170.70
		1542HFS	42"	38	10	175.00
		1548HFS	48"	44	12	178.10
	Double Entry	1524HFD	24"	42	10	326.50
		1530HFD	30"	52	12	333.80
		1536HFD	36"	64	16	341.20
1542HFD		42"	76	20	348.80	
1548HFD		48"	88	24	356.20	

Frames are designed to accommodate letter size media (left to right filing). Specify 15" and/or 30" deep 4Post™ uprights. Use FTB Rails for front to back filing. All frames are placed on 10-1/2" centers for 9-3/4" clear vertical height. \*Capacity based on hanging folders stored left-to-right

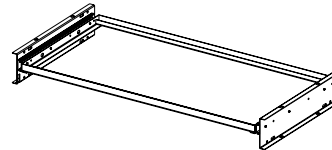

LEGAL	Hanging Folder Frames					
	Item #	W	LFI	Est Lbs.	List Price	
	Single Entry	1824HFS	24"	21	7	173.60
		1830HFS	30"	26	8	176.60
		1836HFS	36"	32	10	181.20
		1842HFS	42"	37	12	184.00
		1848HFS	48"	44	14	186.90
	Double Entry	1824HFD	24"	42	15	347.30
		1830HFD	30"	52	16	353.20
		1836HFD	36"	64	20	363.60
1842HFD		42"	76	24	371.00	
1848HFD		48"	88	28	378.40	

Frames are designed to accommodate legal size media (left to right filing). Specify 18" and/or 36" deep 4Post™ uprights. Use FTB Rails for front to back filing. All frames are placed on 10-1/2" centers for 9-3/4" clear vertical height. \*Capacity based on hanging folders stored left-to-right

## Front to Back Rail

Item #	Description	Est Lbs.	List Price
FTB15	Letter Depth (each)	1	7.30
FTB18	Legal Depth (each)	1	9.00

Specify two FTB rails per row of filing.



## Drawer Reinforcement

Item #	Description	W	H	Est Lbs.	List Price
DR243	3" X 24" (each)	24"	3"	2	12.80
DR303	3" X 30" (each)	30"	3"	3	13.20
DR363	3" X 36" (each)	36"	3"	3	18.10
DR423	3" X 42" (each)	42"	3"	5	20.40
DR483	3" X 48" (each)	48"	3"	5	23.20

One pair of Drawer Reinforcements are required for every 4 levels of drawers. Drawer Reinforcements provide added strength and rigidity to unit.



# Hanging Folder Drawer Filler

## Drawer Filler

Item #	Description	W	H	Est. Lbs.	List Price
DF244	5" X 24" (each)	24"	4-1/2"	3	14.20
DF304	5" X 30" (each)	30"	4-1/2"	4	14.50
DF364	5" X 36" (each)	36"	4-1/2"	5	19.70
DF424	5" X 42" (each)	42"	4-1/2"	6	22.00
DF484	5" X 48" (each)	48"	4-1/2"	6	24.60
DF246	6" X 24" (each)	24"	6"	4	15.80
DF306	6" X 30" (each)	30"	6"	5	16.00
DF366	6" X 36" (each)	36"	6"	6	21.10
DF426	6" X 42" (each)	42"	6"	6	23.50
DF486	6" X 48" (each)	48"	6"	7	26.20
DF247	7" X 24" (each)	24"	7-1/2"	4	17.30
DF307	7" X 30" (each)	30"	7-1/2"	5	17.50
DF367	7" X 36" (each)	36"	7-1/2"	6	22.60
DF427	7" X 42" (each)	42"	7-1/2"	6	25.00
DF487	7" X 48" (each)	48"	7-1/2"	7	27.60
DF249	9" x 24" (each)	24"		5	18.80
DF309	9" x 30" (each)	30"		6	19.10
DF369	9" x 36" (each)	36"		7	24.10
DF429	9" x 42" (each)	42"		7	26.60
DF489	9" x 48" (each)	48"		8	29.00
DF2410	10.5" x 24" (each)	24"		5	20.40
DF3010	10.5" x 30" (each)	30"		6	20.60
DF3610	10.5" x 36" (each)	36"		6	25.60
DF4210	10.5" x 42" (each)	42"		7	28.10
DF4810	10.5" x 48" (each)	48"		8	29.60
DF2412	12" x 24" (each)	24"		6	21.90
DF3012	12" x 30" (each)	30"		7	22.10
DF3612	12" x 36" (each)	36"		8	27.20
DF4212	12" x 42" (each)	42"		8	29.70
DF4812	12" x 48" (each)	48"		9	32.10

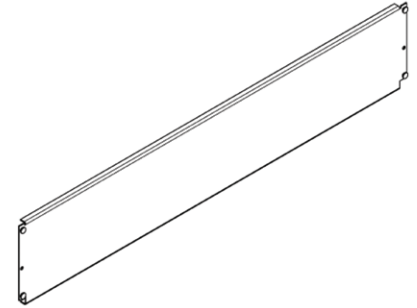

# Pull Out Storage Drawers

Drawers include solid bottom. Can accommodate storage drawer kits for partitioning. Optional locks available on 6" drawers and larger.

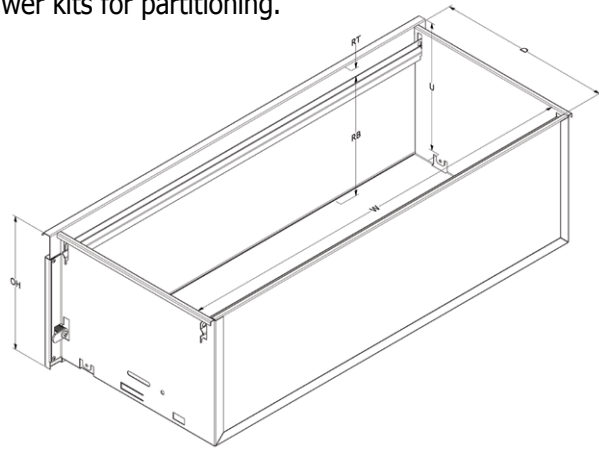

## 3" Storage Drawers

		Item #	Dimensions	Usable			LFI	Est Lbs.	List Price
				W	D	H			
<b>LETTER</b>	Single Entry	SD2412030	24"W x 3"H	19-1/2"	10-13/32"	2-1/8"	20	9	155.00
		SD3012030	30"W x 3"H	25-1/2"	10-13/32"	2-1/8"	26	12	167.00
		SD3612030	36"W x 3"H	31-1/2"	10-13/32"	2-1/8"	32	15	178.00
		SD4212030	42"W x 3"H	37-1/2"	10-13/32"	2-1/8"	38	18	190.00
		SD4812030	48"W x 3"H	43-1/2"	10-13/32"	2-1/8"	42	21	201.00
	Double Entry	SD22412030	24"W x 3"H	19-1/2"	10-13/32"	2-1/8"	40	22	311.00
		SD23012030	30"W x 3"H	25-1/2"	10-13/32"	2-1/8"	52	29	334.00
		SD23612030	36"W x 3"H	31-1/2"	10-13/32"	2-1/8"	64	35	358.00
		SD24212030	42"W x 3"H	37-1/2"	10-13/32"	2-1/8"	76	41	378.00
		SD24812030	48"W x 3"H	43-1/2"	10-13/32"	2-1/8"	88	47	403.00
<b>LEGAL</b>	Single Entry	SD2415030	24"W x 3"H	19-1/2"	13-13/32"	2-1/8"	20	12	167.00
		SD3015030	30"W x 3"H	25-1/2"	13-13/32"	2-1/8"	26	16	178.00
		SD3615030	36"W x 3"H	31-1/2"	13-13/32"	2-1/8"	32	18	190.00
		SD4215030	42"W x 3"H	37-1/2"	13-13/32"	2-1/8"	38	22	201.00
		SD4815030	48"W x 3"H	43-1/2"	13-13/32"	2-1/8"	44	25	214.00
	Double Entry	SD22415030	24"W x 3"H	19-1/2"	13-13/32"	2-1/8"	40	27	334.00
		SD23015030	30"W x 3"H	25-1/2"	13-13/32"	2-1/8"	52	34	358.00
		SD23615030	36"W x 3"H	31-1/2"	13-13/32"	2-1/8"	64	41	381.00
		SD24215030	42"W x 3"H	37-1/2"	13-13/32"	2-1/8"	76	48	405.00
		SD24815030	48"W x 3"H	43-1/2"	13-13/32"	2-1/8"	88	55	429.00

## 4-1/2" Storage Drawers

		Item #	Dimensions	Usable			LFI	Est Lbs.	
				W	D	H			
<b>LETTER</b>	Single Entry	SD2412045	24"W X 4-1/2"H	19-1/2"	10-13/32"	3-7/8"	20	10	161.00
		SD3012045	30"W x 4-1/2"H	25-1/2"	10-13/32"	3-7/8"	26	13	173.00
		SD3612045	36"W x 4-1/2"H	31-1/2"	10-13/32"	3-7/8"	32	16	185.00
		SD4212045	42"W x 4-1/2"H	37-1/2"	10-13/32"	3-7/8"	38	19	196.00
		SD4812045	48"W x 4-1/2"H	43-1/2"	10-13/32"	3-7/8"	42	22	208.00
	Double Entry	SD22412045	24"W X 4-1/2"H	19-1/2"	10-13/32"	3-7/8"	40	23	323.00
		SD23012045	30"W x 4-1/2"H	25-1/2"	10-13/32"	3-7/8"	52	30	330.00
		SD23612045	36"W x 4-1/2"H	31-1/2"	10-13/32"	3-7/8"	64	36	369.00
		SD24212045	42"W x 4-1/2"H	37-1/2"	10-13/32"	3-7/8"	76	42	394.00
		SD24812045	48"W x 4-1/2"H	43-1/2"	10-13/32"	3-7/8"	88	48	417.00
<b>LEGAL</b>	Single Entry	SD2415045	24"W X 4-1/2"H	19-1/2"	13-13/32"	3-7/8"	20	13	173.00
		SD3015045	30"W x 4-1/2"H	25-1/2"	13-13/32"	3-7/8"	26	17	185.00
		SD3615045	36"W x 4-1/2"H	31-1/2"	13-13/32"	3-7/8"	32	19	196.00
		SD4215045	42"W x 4-1/2"H	37-1/2"	13-13/32"	3-7/8"	38	22	208.00
		SD4815045	48"W x 4-1/2"H	43-1/2"	13-13/32"	3-7/8"	42	25	390.00
	Double Entry	SD22415045	24"W X 4-1/2"H	19-1/2"	13-13/32"	3-7/8"	40	28	346.00
		SD23015045	30"W x 4-1/2"H	25-1/2"	13-13/32"	3-7/8"	52	35	369.00
		SD23615045	36"W x 4-1/2"H	31-1/2"	13-13/32"	3-7/8"	64	42	393.00
		SD24215045	42"W x 4-1/2"H	37-1/2"	13-13/32"	3-7/8"	76	49	417.00
		SD24815045	48"W x 4-1/2"H	43-1/2"	13-13/32"	3-7/8"	88	56	441.00



# Pull Out Storage Drawers, Continued

Drawers include solid bottom. Can accommodate storage drawer kits for partitioning. Lock optional.

## 6" Storage Drawers

		Usable			LFI	Est Lbs.	List Price			
Item #	Dimensions	W	D	H						
LETTER	Single Entry	Non-Locking	SD2412060	24"W x 6"H	19-1/2"	10-13/32"	5-3/8"	20	11	168.00
			SD3012060	30"W x 6"H	25-1/2"	10-13/32"	5-3/8"	26	14	179.00
			SD3612060	36"W x 6"H	31-1/2"	10-13/32"	5-3/8"	32	17	190.00
			SD4212060	42"W x 6"H	37-1/2"	10-13/32"	5-3/8"	38	20	223.00
			SD4812060	48"W x 6"H	43-1/2"	10-13/32"	5-3/8"	44	23	256.00
	Locking	SD2412060L	24"W x 6"H	19-1/2"	10-13/32"	5-3/8"	20	12	185.00	
		SD3012060L	30"W x 6"H	25-1/2"	10-13/32"	5-3/8"	26	15	196.00	
		SD3612060L	36"W x 6"H	31-1/2"	10-13/32"	5-3/8"	32	18	207.00	
		SD4212060L	42"W x 6"H	37-1/2"	10-13/32"	5-3/8"	38	21	240.00	
		SD4812060L	48"W x 6"H	43-1/2"	10-13/32"	5-3/8"	44	24	273.00	
Double Entry	Non-Locking	SD22412060	24"W x 6"H	19-1/2"	10-13/32"	5-3/8"	40	24	337.00	
		SD23012060	30"W x 6"H	25-1/2"	10-13/32"	5-3/8"	52	31	359.00	
		SD23612060	36"W x 6"H	31-1/2"	10-13/32"	5-3/8"	64	37	381.00	
		SD24212060	42"W x 6"H	37-1/2"	10-13/32"	5-3/8"	76	44	447.00	
		SD24812060	48"W x 6"H	43-1/2"	10-13/32"	5-3/8"	88	50	513.00	
	Locking	SD22412060L	24"W x 6"H	19-1/2"	10-13/32"	5-3/8"	40	28	370.00	
		SD23012060L	30"W x 6"H	25-1/2"	10-13/32"	5-3/8"	52	33	392.00	
		SD23612060L	36"W x 6"H	31-1/2"	10-13/32"	5-3/8"	64	39	414.00	
		SD24212060L	42"W x 6"H	37-1/2"	10-13/32"	5-3/8"	76	46	480.00	
		SD24812060L	48"W x 6"H	43-1/2"	10-13/32"	5-3/8"	88	52	546.00	
LEGAL	Single Entry	Non-Locking	SD2415060	24"W x 6"H	19-1/2"	13-13/32"	5-3/8"	20	14	179.00
			SD3015060	30"W x 6"H	25-1/2"	13-13/32"	5-3/8"	26	17	190.00
			SD3615060	36"W x 6"H	31-1/2"	13-13/32"	5-3/8"	32	20	223.00
			SD4215060	42"W x 6"H	37-1/2"	13-13/32"	5-3/8"	38	23	256.00
			SD4815060	48"W x 6"H	43-1/2"	13-13/32"	5-3/8"	44	27	289.00
	Locking	SD2415060L	24"W x 6"H	19-1/2"	13-13/32"	5-3/8"	20	15	196.00	
		SD3015060L	30"W x 6"H	25-1/2"	13-13/32"	5-3/8"	26	18	207.00	
		SD3615060L	36"W x 6"H	31-1/2"	13-13/32"	5-3/8"	32	21	240.00	
		SD4215060L	42"W x 6"H	37-1/2"	13-13/32"	5-3/8"	38	24	273.00	
		SD4815060L	48"W x 6"H	43-1/2"	13-13/32"	5-3/8"	44	28	306.00	
Double Entry	Non-Locking	SD22415060	24"W x 6"H	19-1/2"	13-13/32"	5-3/8"	40	29	359.00	
		SD23015060	30"W x 6"H	25-1/2"	13-13/32"	5-3/8"	52	36	381.00	
		SD23615060	36"W x 6"H	31-1/2"	13-13/32"	5-3/8"	64	42	447.00	
		SD24215060	42"W x 6"H	37-1/2"	13-13/32"	5-3/8"	76	49	513.00	
		SD24815060	48"W x 6"H	43-1/2"	13-13/32"	5-3/8"	88	55	579.00	
Locking	SD22415060L	24"W x 6"H	19-1/2"	13-13/32"	5-3/8"	40	31	392.00		
	SD23015060L	30"W x 6"H	25-1/2"	13-13/32"	5-3/8"	52	38	414.00		
	SD23615060L	36"W x 6"H	31-1/2"	13-13/32"	5-3/8"	64	44	480.00		
	SD24215060L	42"W x 6"H	37-1/2"	13-13/32"	5-3/8"	76	51	546.00		
	SD24815060L	48"W x 6"H	43-1/2"	13-13/32"	5-3/8"	88	57	612.00		

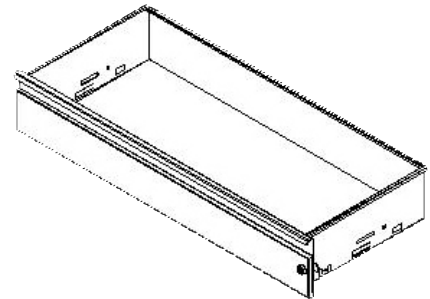

# Pull Out Storage Drawers, Continued

Drawers include solid bottom. Can accommodate storage drawer kits for partitioning. Lock optional.

## 7-1/2" Storage Drawers

		Item #	Dimensions	Usable			LFI	Est Lbs.	List Price	
				W	D	H				
LETTER	Single Entry	Non-Locking	SD2412075	24"W x 7-1/2"H	19-1/2"	10-13/32"	6-7/8"	20	12	173.00
			SD3012075	30"W x 7-1/2"H	25-1/2"	10-13/32"	6-7/8"	26	155	184.00
			SD3612075	36"W x 7-1/2"H	31-1/2"	10-13/32"	6-7/8"	32	18	195.00
			SD4212075	42"W x 7-1/2"H	37-1/2"	10-13/32"	6-7/8"	38	21	228.00
			SD4812075	48"W x 7-1/2"H	43-1/2"	10-13/32"	6-7/8"	44	24	261.00
	Double Entry	Locking	SD2412075L	24"W x 7-1/2"H	19-1/2"	10-13/32"	6-7/8"	20	13	189.00
			SD3012075L	30"W x 7-1/2"H	25-1/2"	10-13/32"	6-7/8"	26	16	200.00
			SD3612075L	36"W x 7-1/2"H	31-1/2"	10-13/32"	6-7/8"	32	19	211.00
			SD4212075L	42"W x 7-1/2"H	37-1/2"	10-13/32"	6-7/8"	38	22	244.00
			SD4812075L	48"W x 7-1/2"H	43-1/2"	10-13/32"	6-7/8"	44	25	277.00
LEGAL	Single Entry	Non-Locking	SD22412075	24"W x 7-1/2"H	19-1/2"	10-13/32"	6-7/8"	40	25	345.00
			SD23012075	30"W x 7-1/2"H	25-1/2"	10-13/32"	6-7/8"	52	32	367.00
			SD23612075	36"W x 7-1/2"H	31-1/2"	10-13/32"	6-7/8"	64	38	389.00
			SD24212075	42"W x 7-1/2"H	37-1/2"	10-13/32"	6-7/8"	76	45	455.00
			SD24812075	48"W x 7-1/2"H	43-1/2"	10-13/32"	6-7/8"	88	51	521.00
	Double Entry	Locking	SD22412075L	24"W x 7-1/2"H	19-1/2"	10-13/32"	6-7/8"	40	29	378.00
			SD23012075L	30"W x 7-1/2"H	25-1/2"	10-13/32"	6-7/8"	52	34	400.00
			SD23612075L	36"W x 7-1/2"H	31-1/2"	10-13/32"	6-7/8"	64	40	422.00
			SD24212075L	42"W x 7-1/2"H	37-1/2"	10-13/32"	6-7/8"	76	47	488.00
			SD24812075L	48"W x 7-1/2"H	43-1/2"	10-13/32"	6-7/8"	88	53	554.00
LEGAL	Single Entry	Non-Locking	SD2415075	24"W x 7-1/2"H	19-1/2"	13-13/32"	6-7/8"	20	15	184.00
			SD3015075	30"W x 7-1/2"H	25-1/2"	13-13/32"	6-7/8"	26	18	195.00
			SD3615075	36"W x 7-1/2"H	31-1/2"	13-13/32"	6-7/8"	32	21	228.00
			SD4215075	42"W x 7-1/2"H	37-1/2"	13-13/32"	6-7/8"	38	24	261.00
			SD4815075	48"W x 7-1/2"H	43-1/2"	13-13/32"	6-7/8"	44	28	294.00
	Double Entry	Locking	SD2415075L	24"W x 7-1/2"H	19-1/2"	13-13/32"	6-7/8"	20	16	200.00
			SD3015075L	30"W x 7-1/2"H	25-1/2"	13-13/32"	6-7/8"	26	19	211.00
			SD3615075L	36"W x 7-1/2"H	31-1/2"	13-13/32"	6-7/8"	32	22	244.00
			SD4215075L	42"W x 7-1/2"H	37-1/2"	13-13/32"	6-7/8"	38	25	277.00
			SD4815075L	48"W x 7-1/2"H	43-1/2"	13-13/32"	6-7/8"	44	29	310.00
LEGAL	Double Entry	Non-Locking	SD22415075	24"W x 7-1/2"H	19-1/2"	13-13/32"	6-7/8"	40	30	367.00
			SD23015075	30"W x 7-1/2"H	25-1/2"	13-13/32"	6-7/8"	52	37	389.00
			SD23615075	36"W x 7-1/2"H	31-1/2"	13-13/32"	6-7/8"	64	43	455.00
			SD24215075	42"W x 7-1/2"H	37-1/2"	13-13/32"	6-7/8"	76	50	521.00
			SD24815075	48"W x 7-1/2"H	43-1/2"	13-13/32"	6-7/8"	88	56	587.00
LEGAL	Double Entry	Locking	SD22415075L	24"W x 7-1/2"H	19-1/2"	13-13/32"	6-7/8"	40	32	400.00
			SD23015075L	30"W x 7-1/2"H	25-1/2"	13-13/32"	6-7/8"	52	39	422.00
			SD23615075L	36"W x 7-1/2"H	31-1/2"	13-13/32"	6-7/8"	64	45	488.00
			SD24215075L	42"W x 7-1/2"H	37-1/2"	13-13/32"	6-7/8"	76	52	554.00
			SD24815075L	48"W x 7-1/2"H	43-1/2"	13-13/32"	6-7/8"	88	58	609.00

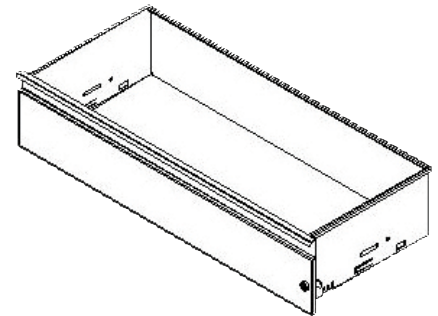

# Pull Out Storage Drawers, Continued

Drawers include solid bottom. Can accommodate storage drawer kits for partitioning. Lock optional.

## 9" Storage Drawers

		Item #	Dimensions	Usable			LFI	Est Lbs.	List Price
				W	D	H			
LETTER	Single Entry	SD2412090	24"W x 9"H	19-1/2"	10-13/32"	8-3/8"	20	13	182.00
		SD3012090	30"W x 9"H	25-1/2"	10-13/32"	8-3/8"	26	16	193.00
		SD3612090	36"W x 9"H	31-1/2"	10-13/32"	8-3/8"	32	19	204.00
		SD4212090	42"W x 9"H	37-1/2"	10-13/32"	8-3/8"	38	22	237.00
		SD4812090	48"W x 9"H	43-1/2"	10-13/32"	8-3/8"	44	25	270.00
	Double Entry	SD2412090L	24"W x 9"H	19-1/2"	10-13/32"	8-3/8"	20	14	198.00
		SD3012090L	30"W x 9"H	25-1/2"	10-13/32"	8-3/8"	26	17	209.00
		SD3612090L	36"W x 9"H	31-1/2"	10-13/32"	8-3/8"	32	20	253.00
		SD4212090L	42"W x 9"H	37-1/2"	10-13/32"	8-3/8"	38	23	286.00
		SD4812090L	48"W x 9"H	43-1/2"	10-13/32"	8-3/8"	44	26	348.00
LEGAL	Single Entry	SD22412090	24"W x 9"H	19-1/2"	10-13/32"	8-3/8"	40	26	363.00
		SD23012090	30"W x 9"H	25-1/2"	10-13/32"	8-3/8"	52	33	385.00
		SD23612090	36"W x 9"H	31-1/2"	10-13/32"	8-3/8"	64	39	407.00
		SD24212090	42"W x 9"H	37-1/2"	10-13/32"	8-3/8"	76	46	473.00
		SD24812090	48"W x 9"H	43-1/2"	10-13/32"	8-3/8"	88	52	539.00
	Double Entry	SD22412090L	24"W x 9"H	19-1/2"	10-13/32"	8-3/8"	40	28	396.00
		SD23012090L	30"W x 9"H	25-1/2"	10-13/32"	8-3/8"	52	35	418.00
		SD23612090L	36"W x 9"H	31-1/2"	10-13/32"	8-3/8"	64	41	440.00
		SD24212090L	42"W x 9"H	37-1/2"	10-13/32"	8-3/8"	76	48	506.00
		SD24812090L	48"W x 9"H	43-1/2"	10-13/32"	8-3/8"	88	54	572.00
LEGAL	Single Entry	SD2415090	24"W x 9"H	19-1/2"	13-13/32"	8-3/8"	20	16	193.00
		SD3015090	30"W x 9"H	25-1/2"	13-13/32"	8-3/8"	26	19	204.00
		SD3615090	36"W x 9"H	31-1/2"	13-13/32"	8-3/8"	32	22	237.00
		SD4215090	42"W x 9"H	37-1/2"	13-13/32"	8-3/8"	38	25	270.00
		SD4815090	48"W x 9"H	43-1/2"	13-13/32"	8-3/8"	44	29	303.00
	Double Entry	SD2415090L	24"W x 9"H	19-1/2"	13-13/32"	8-3/8"	20	17	209.00
		SD3015090L	30"W x 9"H	25-1/2"	13-13/32"	8-3/8"	26	20	220.00
		SD3615090L	36"W x 9"H	31-1/2"	13-13/32"	8-3/8"	32	23	253.00
		SD4215090L	42"W x 9"H	37-1/2"	13-13/32"	8-3/8"	38	26	286.00
		SD4815090L	48"W x 9"H	43-1/2"	13-13/32"	8-3/8"	44	30	319.00
LEGAL	Double Entry	SD22415090	24"W x 9"H	19-1/2"	13-13/32"	8-3/8"	40	31	385.00
		SD23015090	30"W x 9"H	25-1/2"	13-13/32"	8-3/8"	52	38	407.00
		SD23615090	36"W x 9"H	31-1/2"	13-13/32"	8-3/8"	64	44	473.00
		SD24215090	42"W x 9"H	37-1/2"	13-13/32"	8-3/8"	76	51	539.00
		SD24815090	48"W x 9"H	43-1/2"	13-13/32"	8-3/8"	88	57	605.00
LEGAL	Double Entry	SD22415090L	24"W x 9"H	19-1/2"	13-13/32"	8-3/8"	40	33	418.00
		SD23015090L	30"W x 9"H	25-1/2"	13-13/32"	8-3/8"	52	40	440.00
		SD23615090L	36"W x 9"H	31-1/2"	13-13/32"	8-3/8"	64	46	506.00
		SD24215090L	42"W x 9"H	37-1/2"	13-13/32"	8-3/8"	76	53	572.00
		SD24815090L	48"W x 9"H	43-1/2"	13-13/32"	8-3/8"	88	59	638.00

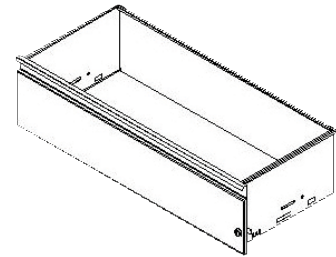

# Pull Out Storage Drawers, Continued

Drawers include solid bottom. Can accommodate storage drawer kits for partitioning. Lock optional.

## 10-1/2" Storage Drawers

		Item #	Dimensions	Usable			LFI	Est Lbs.	List Price	
				W	D	H				
LETTER	Single Entry	Non-Locking	SD2412105	24"W x 10-1/2"H	19-1/2"	10-13/32"	9-3/8"	20	14	188.00
			SD3012105	30"W x 10-1/2"H	25-1/2"	10-13/32"	9-3/8"	26	17	198.00
			SD3612105	36"W x 10-1/2"H	31-1/2"	10-13/32"	9-3/8"	32	20	208.00
			SD4212105	42"W x 10-1/2"H	37-1/2"	10-13/32"	9-3/8"	38	23	242.00
			SD4812105	48"W x 10-1/2"H	43-1/2"	10-13/32"	9-3/8"	44	26	275.00
	Locking	SD2412105L	24"W x 10-1/2"H	19-1/2"	10-13/32"	9-3/8"	20	15	204.00	
		SD3012105L	30"W x 10-1/2"H	25-1/2"	10-13/32"	9-3/8"	26	18	215.00	
		SD3612105L	36"W x 10-1/2"H	31-1/2"	10-13/32"	9-3/8"	32	21	226.00	
		SD4212105L	42"W x 10-1/2"H	37-1/2"	10-13/32"	9-3/8"	38	24	259.00	
		SD4812105L	48"W x 10-1/2"H	43-1/2"	10-13/32"	9-3/8"	44	27	292.00	
LEGAL	Double Entry	Non-Locking	SD22412105	24"W x 10-1/2"H	19-1/2"	10-13/32"	9-3/8"	40	27	374.00
			SD23012105	30"W x 10-1/2"H	25-1/2"	10-13/32"	9-3/8"	52	34	396.00
			SD23612105	36"W x 10-1/2"H	31-1/2"	10-13/32"	9-3/8"	64	40	418.00
			SD24212105	42"W x 10-1/2"H	37-1/2"	10-13/32"	9-3/8"	76	47	484.00
			SD24812105	48"W x 10-1/2"H	43-1/2"	10-13/32"	9-3/8"	88	53	550.00
	Locking	SD22412105L	24"W x 10-1/2"H	19-1/2"	10-13/32"	9-3/8"	40	29	406.00	
		SD23012105L	30"W x 10-1/2"H	25-1/2"	10-13/32"	9-3/8"	52	36	429.00	
		SD23612105L	36"W x 10-1/2"H	31-1/2"	10-13/32"	9-3/8"	64	42	450.00	
		SD24212105L	42"W x 10-1/2"H	37-1/2"	10-13/32"	9-3/8"	76	49	517.00	
		SD24812105L	48"W x 10-1/2"H	43-1/2"	10-13/32"	9-3/8"	88	55	584.00	
Single Entry	Non-Locking	SD2415105	24"W x 10-1/2"H	19-1/2"	13-13/32"	9-3/8"	20	17	198.00	
		SD3015105	30"W x 10-1/2"H	25-1/2"	13-13/32"	9-3/8"	26	20	209.00	
		SD3615105	36"W x 10-1/2"H	31-1/2"	13-13/32"	9-3/8"	32	23	242.00	
		SD4215105	42"W x 10-1/2"H	37-1/2"	13-13/32"	9-3/8"	38	26	274.00	
		SD4815105	48"W x 10-1/2"H	43-1/2"	13-13/32"	9-3/8"	44	30	308.00	
	Locking	SD2415105L	24"W x 10-1/2"H	19-1/2"	13-13/32"	9-3/8"	20	18	215.00	
		SD3015105L	30"W x 10-1/2"H	25-1/2"	13-13/32"	9-3/8"	26	21	226.00	
		SD3615105L	36"W x 10-1/2"H	31-1/2"	13-13/32"	9-3/8"	32	24	259.00	
		SD4215105L	42"W x 10-1/2"H	37-1/2"	13-13/32"	9-3/8"	38	27	292.00	
		SD4815105L	48"W x 10-1/2"H	43-1/2"	13-13/32"	9-3/8"	44	31	325.00	
Double Entry	Non-Locking	SD22415105	24"W x 10-1/2"H	19-1/2"	13-13/32"	9-3/8"	40	32	406.00	
		SD23015105	30"W x 10-1/2"H	25-1/2"	13-13/32"	9-3/8"	52	39	418.00	
		SD23615105	36"W x 10-1/2"H	31-1/2"	13-13/32"	9-3/8"	64	45	484.00	
		SD24215105	42"W x 10-1/2"H	37-1/2"	13-13/32"	9-3/8"	76	52	550.00	
		SD24815105	48"W x 10-1/2"H	43-1/2"	13-13/32"	9-3/8"	88	58	616.00	
Locking	SD22415105L	24"W x 10-1/2"H	19-1/2"	13-13/32"	9-3/8"	40	34	440.00		
	SD23015105L	30"W x 10-1/2"H	25-1/2"	13-13/32"	9-3/8"	52	41	450.00		
	SD23615105L	36"W x 10-1/2"H	31-1/2"	13-13/32"	9-3/8"	64	47	517.00		
	SD24215105L	42"W x 10-1/2"H	37-1/2"	13-13/32"	9-3/8"	76	54	581.00		
	SD24815105L	48"W x 10-1/2"H	43-1/2"	13-13/32"	9-3/8"	88	60	649.00		

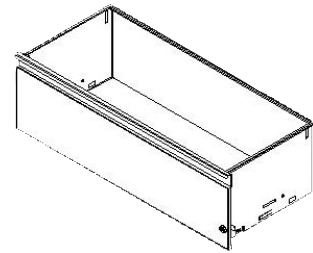

# Pull Out Storage Drawers, Continued

Drawers include solid bottom. Can accommodate storage drawer kits for partitioning. Lock optional.

## 12" Storage Drawers

		Usable			LFI	Est Lbs.	List Price			
Item #	Dimensions	W	D	H						
GALILEO	Single Entry	Non-Locking	SD2412120	24"W x 12"H	19-1/2"	10-13/32"	11-3/8"	20	14	210.00
			SD3012120	30"W x 12"H	25-1/2"	10-13/32"	11-3/8"	26	17	220.00
			SD3612120	36"W x 12"H	31-1/2"	10-13/32"	11-3/8"	32	20	220.00
			SD4212120	42"W x 12"H	37-1/2"	10-13/32"	11-3/8"	38	23	230.00
			SD4812120	48"W x 12"H	43-1/2"	10-13/32"	11-3/8"	44	26	245.00
	Locking	SD2412120L	24"W x 12"H	19-1/2"	10-13/32"	11-3/8"	20	14	220.00	
		SD3012120L	30"W x 12"H	25-1/2"	10-13/32"	11-3/8"	26	18	230.00	
		SD3612120L	36"W x 12"H	31-1/2"	10-13/32"	11-3/8"	32	21	230.00	
		SD4212120L	42"W x 12"H	37-1/2"	10-13/32"	11-3/8"	38	24	240.00	
		SD4812120L	48"W x 12"H	43-1/2"	10-13/32"	11-3/8"	44	27	255.00	
Double Entry	Non-Locking	SD22412120	24"W x 12"H	19-1/2"	10-13/32"	11-3/8"	40	27	330.00	
		SD23012120	30"W x 12"H	25-1/2"	10-13/32"	11-3/8"	52	34	360.00	
		SD23612120	36"W x 12"H	31-1/2"	10-13/32"	11-3/8"	64	40	360.00	
		SD24212120	42"W x 12"H	37-1/2"	10-13/32"	11-3/8"	76	47	410.00	
		SD24812120	48"W x 12"H	43-1/2"	10-13/32"	11-3/8"	88	53	460.00	
	Locking	SD22412120L	24"W x 12"H	19-1/2"	10-13/32"	11-3/8"	40	29	350.00	
		SD23012120L	30"W x 12"H	25-1/2"	10-13/32"	11-3/8"	52	36	380.00	
		SD23612120L	36"W x 12"H	31-1/2"	10-13/32"	11-3/8"	64	42	380.00	
		SD24212120L	42"W x 12"H	37-1/2"	10-13/32"	11-3/8"	76	49	430.00	
		SD24812120L	48"W x 12"H	43-1/2"	10-13/32"	11-3/8"	88	55	480.00	
GALILEO	Single Entry	Non-Locking	SD2415120	24"W x 12"H	19-1/2"	13-13/32"	11-3/8"	20	17	210.00
			SD3015120	30"W x 12"H	25-1/2"	13-13/32"	11-3/8"	26	20	230.00
			SD3615120	36"W x 12"H	31-1/2"	13-13/32"	11-3/8"	32	23	230.00
			SD4215120	42"W x 12"H	37-1/2"	13-13/32"	11-3/8"	38	26	250.00
			SD4815120	48"W x 12"H	43-1/2"	13-13/32"	11-3/8"	44	30	280.00
	Locking	SD2415120L	24"W x 12"H	19-1/2"	13-13/32"	11-3/8"	20	18	220.00	
		SD3015120L	30"W x 12"H	25-1/2"	13-13/32"	11-3/8"	26	21	240.00	
		SD3615120L	36"W x 12"H	31-1/2"	13-13/32"	11-3/8"	32	24	240.00	
		SD4215120L	42"W x 12"H	37-1/2"	13-13/32"	11-3/8"	38	27	260.00	
		SD4815120L	48"W x 12"H	43-1/2"	13-13/32"	11-3/8"	44	31	290.00	
Double Entry	Non-Locking	SD22415120	24"W x 12"H	19-1/2"	13-13/32"	11-3/8"	40	32	390.00	
		SD23015120	30"W x 12"H	25-1/2"	13-13/32"	11-3/8"	52	39	410.00	
		SD23615120	36"W x 12"H	31-1/2"	13-13/32"	11-3/8"	64	45	410.00	
		SD24215120	42"W x 12"H	37-1/2"	13-13/32"	11-3/8"	76	52	450.00	
		SD24815120	48"W x 12"H	43-1/2"	13-13/32"	11-3/8"	88	58	500.00	
Locking	SD22415120L	24"W x 12"H	19-1/2"	13-13/32"	11-3/8"	40	34	410.00		
	SD23015120L	30"W x 12"H	25-1/2"	13-13/32"	11-3/8"	52	41	430.00		
	SD23615120L	36"W x 12"H	31-1/2"	13-13/32"	11-3/8"	64	47	430.00		
	SD24215120L	42"W x 12"H	37-1/2"	13-13/32"	11-3/8"	76	54	470.00		
	SD24815120L	48"W x 12"H	43-1/2"	13-13/32"	11-3/8"	88	60	520.00		

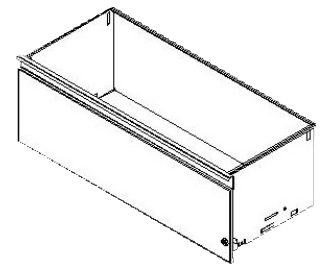

\*All 12" drawers include hanging file folder rails kits.

# Pull Out Storage Drawer Kits

## Storage Drawer Kits

Item #	Dimensions	Est Lbs.	List Price
SDSK031224	3"H x 24"W	3	47.50
SDSK031230	3"H x 30"W	3	52.40
SDSK031236	3"H x 36"W	4	56.20
SDSK041224	4-1/2"H x 24"W	4	50.00
SDSK041230	4-1/2"H x 30"W	5	54.90
SDSK041236	4-1/2"H x 36"W	5	59.90
SDSK061224	6"H x 24"W	7	52.40
SDSK061230	6"H x 30"W	8	57.50
SDSK061236	6"H x 36"W	9	63.70
SDSK061242	6"H x 42"W	10	68.70
SDSK061248	6"H x 48"W	11	73.60
SDSK071224	7-1/2"H x 24"W	8	56.20
SDSK071230	7-1/2"H x 30"W	9	62.50
SDSK071236	7-1/2"H x 36"W	10	67.50
SDSK071242	7-1/2"H x 42"W	11	73.60
SDSK071248	7-1/2"H x 48"W	12	78.70
SDSK091224	9"H x 24"W	9	61.20
SDSK091230	9"H x 30"W	11	67.50
SDSK091236	9"H x 36"W	12	73.60
SDSK091242	9"H x 42"W	13	79.90
SDSK091248	9"H x 48"W	15	86.20
SDSK101224	10-1/2"H x 24"W	11	66.20
SDSK101230	10-1/2"H x 30"W	13	72.50
SDSK101236	10-1/2"H x 36"W	14	79.90
SDSK101242	10-1/2"H x 42"W	16	86.20
SDSK101248	10-1/2"H x 48"W	17	92.50
SDSK121224	12"H x 24"W	12	71.20
SDSK121230	12"H x 30"W	14	78.70
SDSK121236	12"H x 36"W	16	86.20
SDSK121242	12"H x 42"W	18	93.60
SDSK121248	12"H x 48"W	20	98.10
SDSK031524	3"H x 24"W	3	53.80
SDSK031530	3"H x 30"W	4	57.50
SDSK031536	3"H x 36"W	4	62.50
SDSK041524	4-1/2"H x 24"W	4	56.20
SDSK041530	4-1/2"H x 30"W	5	61.20
SDSK041536	4-1/2"H x 36"W	6	66.20
SDSK061524	6"H x 24"W	7	59.90
SDSK061530	6"H x 30"W	8	65.00
SDSK061536	6"H x 36"W	9	69.90
SDSK061542	6"H x 42"W	11	75.00
SDSK061548	6"H x 48"W	12	79.90

LETTER

LEGAL

DRAWER KITS ONLY. DOES NOT INCLUDE DRAWERS. DRAWER KITS AND PARTITIONS MUST BE PURCHASED SEPARATELY.

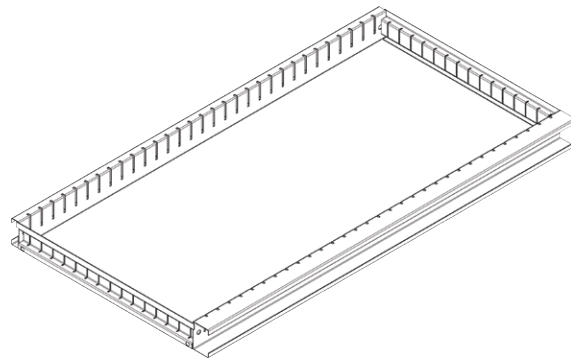

\* Adjustable on 1" centers.

Continued on next page.





# Pull Out Storage Drawer Partitions

## Flat Partitions

Item #	Opening Dimensions	Est Lbs.	List Price
SDFP0303	3"H x 3"W	0.1	3.80
SDFP0304	3"H x 4"W	0.1	4.90
SDFP0305	3"H x 5"W	0.1	4.90
SDFP0306	3"H x 6"W	0.1	4.90
SDFP0307	3"H x 7"W	0.1	4.90
SDFP0308	3"H x 8"W	0.1	6.30
SDFP0309	3"H x 9"W	0.2	6.30
SDFP0310	3"H x 10"W	0.2	7.40
SDFP0311	3"H x 11"W	0.2	7.40
SDFP0312	3"H x 12"W	0.2	7.40
SDFP0313	3"H x 13"W	0.2	8.80
SDFP0403	4-1/2"H x 3"W	0.1	3.80
SDFP0404	4-1/2"H x 4"W	0.2	4.90
SDFP0405	4-1/2"H x 5"W	0.2	6.30
SDFP0406	4-1/2"H x 6"W	0.2	6.30
SDFP0407	4-1/2"H x 7"W	0.3	7.40
SDFP0408	4-1/2"H x 8"W	0.3	7.40
SDFP0409	4-1/2"H x 9"W	0.3	8.80
SDFP0410	4-1/2"H x 10"W	0.3	10.00
SDFP0411	4-1/2"H x 11"W	0.3	10.00
SDFP0412	4-1/2"H x 12"W	0.3	11.20
SDFP0413	4-1/2"H x 13"W	0.4	11.20
SDFP0603	6"H x 3"W	0.2	4.90
SDFP0604	6"H x 4"W	0.3	4.90
SDFP0605	6"H x 5"W	0.3	6.30
SDFP0606	6"H x 6"W	0.4	7.40
SDFP0607	6"H x 7"W	0.4	7.40
SDFP0608	6"H x 8"W	0.5	8.80
SDFP0609	6"H x 9"W	0.5	10.00
SDFP0610	6"H x 10"W	0.5	10.00
SDFP0611	6"H x 11"W	0.5	11.20
SDFP0612	6"H x 12"W	0.6	12.60
SDFP0613	6"H x 13"W	0.6	12.60
SDFP0703	7-1/2"H x 3"W	0.3	4.90
SDFP0704	7-1/2"H x 4"W	0.4	6.30
SDFP0705	7-1/2"H x 5"W	0.4	7.40
SDFP0706	7-1/2"H x 6"W	0.5	8.80
SDFP0707	7-1/2"H x 7"W	0.5	8.80
SDFP0708	7-1/2"H x 8"W	0.5	10.00
SDFP0709	7-1/2"H x 9"W	0.6	11.20
SDFP0710	7-1/2"H x 10"W	0.7	12.60
SDFP0711	7-1/2"H x 11"W	0.7	13.70
SDFP0712	7-1/2"H x 12"W	0.8	13.70
SDFP0713	7-1/2"H x 13"W	0.8	15.00

DRAWER PARTITIONS ONLY. DOES NOT INCLUDE DRAWERS.  
DRAWER KITS AND PARTITIONS MUST BE PURCHASED SEPARATELY.

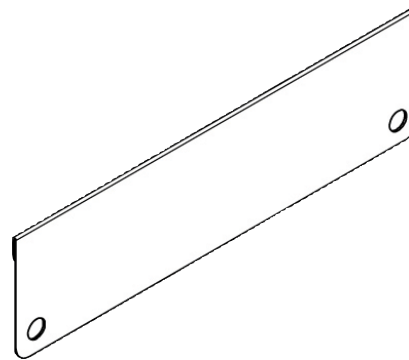

Continued on next page.

\* Flat partitions run left to right only.

# Pull Out Storage Drawer Partitions, Cont.

## Flat Partitions (continued)

Item #	Opening Dimensions	Est Lbs.	List Price
SDFP0903	9"H x 3"W	0.3	4.90
SDFP0904	9"H x 4"W	0.4	6.30
SDFP0905	9"H x 5"W	0.5	7.40
SDFP0906	9"H x 6"W	0.6	8.80
SDFP0907	9"H x 7"W	0.6	10.00
SDFP0908	9"H x 8"W	0.7	11.20
SDFP0909	9"H x 9"W	0.7	11.20
SDFP0910	9"H x 10"W	0.9	12.60
SDFP0911	9"H x 11"W	0.9	13.70
SDFP0912	9"H x 12"W	0.9	15.00
SDFP0913	9"H x 13"W	1.0	16.30
SDFP1003	10-1/2"H x 3"W	0.4	6.30
SDFP1004	10-1/2"H x 4"W	0.4	7.40
SDFP1005	10-1/2"H x 5"W	0.5	8.80
SDFP1006	10-1/2"H x 6"W	0.6	10.00
SDFP1007	10-1/2"H x 7"W	0.7	11.20
SDFP1008	10-1/2"H x 8"W	0.7	12.60
SDFP1009	10-1/2"H x 9"W	0.9	13.70
SDFP1010	10-1/2"H x 10"W	0.9	15.00
SDFP1011	10-1/2"H x 11"W	1.1	16.30
SDFP1012	10-1/2"H x 12"W	1.1	17.50
SDFP1013	10-1/2"H x 13"W	1.2	18.70
SDFP1203	12"H x 3"W	0.5	6.30
SDFP1204	12"H x 4"W	0.6	7.40
SDFP1205	12"H x 5"W	0.6	8.80
SDFP1206	12"H x 6"W	0.7	11.20
SDFP1207	12"H x 7"W	0.8	12.60
SDFP1208	12"H x 8"W	0.9	13.70
SDFP1209	12"H x 9"W	1.0	15.00
SDFP1210	12"H x 10"W	1.1	16.30
SDFP1211	12"H x 11"W	1.2	17.50
SDFP1212	12"H x 12"W	1.3	20.00
SDFP1213	12"H x 13"W	1.4	21.20

DRAWER KITS ONLY. DOES NOT INCLUDE DRAWERS. DRAWER KITS AND PARTITIONS MUST BE PURCHASED SEPARATELY.

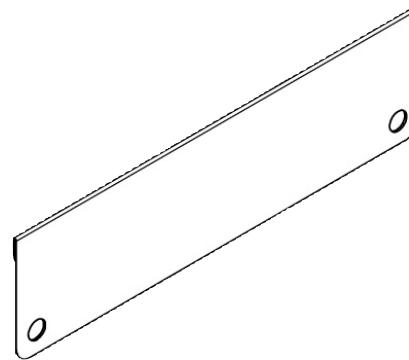

\* Flat partitions run left to right only.

# Personal Storage Lockers

Item #	Description	D	W	H	Est. Lbs.	List Price
PLOC1	Starter	24"	18"	76"	190	1437.00
PLOC1-A	Adder	24"	18"	76"	175	1288.00
WSL-161575-HD-LD-DAFN	Heavy-duty Locker	15"	16"	75"		1195.00
WS-L-151572-LD-DAFB	Heavy-duty Locker	15"	15"	72"		1195.00

\*Units include garment rod, louvered drawer, louvered hinged door with padlock cam, accessory hook and two shelves.

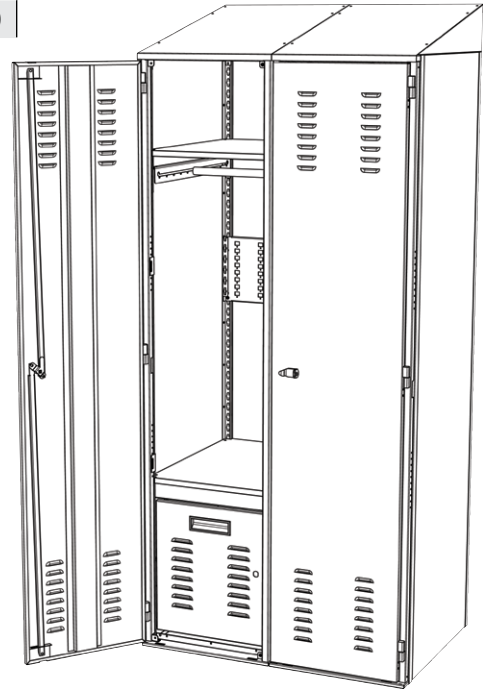

# Component Parts - TrakSlider Top Shelf Support

Item #	W	Est Lbs.	List Price
B4F-S	24"	5	30.10
B4F-A	24"	9	63.40
T4F-S	24"	5	30.10
T4F-A	24"	18	130.20
Q4F-S	24"	5	30.10
Q4F-A	24"	27	197.00
B0F-S	30"	6	31.70
B0F-A	30"	11	65.10
T0F-S	30"	6	31.70
T0F-A	30"	22	131.90
Q0F-S	30"	6	31.70
Q0F-A	30"	33	198.80
B6F-S	36"	7	33.40
B6F-A	36"	13	66.80
T6F-S	36"	7	33.40
T6F-A	36"	26	133.60
Q6F-S	36"	7	33.40
Q6F-A	36"	39	200.30
B2F-S	42"	8	35.00
B2F-A	42"	15	68.50
T2F-S	42"	8	35.00
T2F-A	42"	30	135.20
Q2F-S	42"	8	35.00
Q2F-A	42"	4	202.00
B8F-S	48"	9	36.90
B8F-A	48"	17	70.10
T8F-S	48"	9	36.90
T8F-A	48"	34	137.00
Q8F-S	48"	9	36.90
Q8F-A	48"	51	203.70

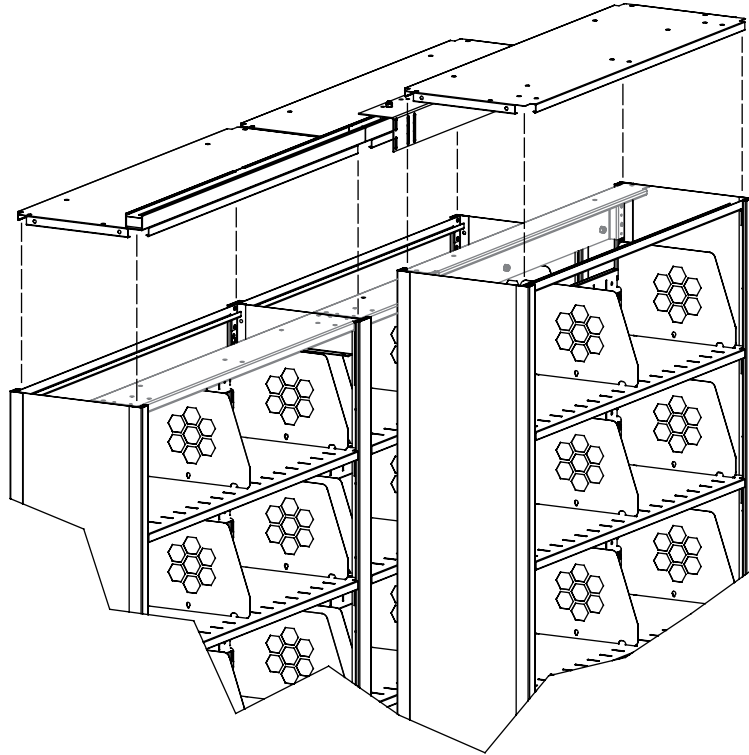

The Datum TrakSlider Top Shelf is to be used in conjunction with Datum TrakSlider Systems. TrakSlider Top Shelf Supports ensure that the overhead anti-tip mechanism is properly attached and are strongly recommended.

Please refer to the information below when ordering a Datum 4Post TrakSlider System as component parts or when converting stationary 4Post to a TrakSlider System.

	Starter	Adder
BiSlider	Deduct one shelf support*	Deduct two shelf supports*
TriSlider	Deduct one shelf support*	Deduct four shelf supports*
QuadSlider	Deduct one shelf support*	Deduct six shelf supports*

\*Shelf supports are available in Standard, Medium, and Heavy Duty. Please deduct corresponding shelf supports. For example, if Standard Duty Shelving is being used, deduct Standard Duty Shelf Supports.

# 36" Wide Complete BiSlider Systems

ALL COMPLETE SYSTEMS DO NOT INCLUDE DIVIDERS. PLEASE REFER TO PAGE 2d:43 FOR DIVIDER INFORMATION  
Includes 7 or 8 level 4Post™ Shelving for Letter or Legal Depth. X-Ray Shelving includes 5 level 4Post™ Shelving.

## BiSlider Systems

Item #	Media	Overall Depth	W	H	LFI	Est Lbs.	List Price
B621LT-4P7	Letter	26-1/2"	76"	81-3/4"	714	406	2,387.10
B621LT-4P8	Letter	26-1/2"	76"	93-3/4"	816	468	2,553.20
B621LG-4P7	Legal	32-1/2"	76"	81-3/4"	714	450	2,640.70
B621LG-4P8	Legal	32-1/2"	76"	93-3/4"	816	498	2,828.00
B621XR-4P5	X-Ray	38-1/2"	76"	93-3/4"	612	548	3,080.30
B632LT-4P7	Letter	26-1/2"	112"	81-3/4"	1,190	700	3,951.10
B632LT-4P8	Letter	26-1/2"	112"	93-3/4"	1,360	769	4,223.40
B632LG-4P7	Legal	32-1/2"	112"	81-3/4"	1,190	738	4,358.20
B632LG-4P8	Legal	32-1/2"	112"	93-3/4"	1,360	817	4,668.00
B632XR-4P5	X-Ray	38-1/2"	112"	93-3/4"	850	903	5,092.60
B643LT-4P7	Letter	26-1/2"	148"	81-3/4"	1,666	974	5,514.90
B643LT-4P8	Letter	26-1/2"	148"	93-3/4"	1,904	1,070	5,895.90
B643LG-4P7	Legal	32-1/2"	148"	81-3/4"	1,666	1,026	6,075.80
B643LG-4P8	Legal	32-1/2"	148"	93-3/4"	1,904	1,136	6,508.10
B643XR-4P5	X-Ray	38-1/2"	148"	93-3/4"	1,190	1,258	7,103.80
B654LT-4P7	Letter	26-1/2"	184"	81-3/4"	2,142	1,248	7,080.00
B654LT-4P8	Letter	26-1/2"	184"	93-3/4"	2,448	1,371	7,567.30
B654LG-4P7	Legal	32-1/2"	184"	81-3/4"	2,142	1,314	7,794.60
B654LG-4P8	Legal	32-1/2"	184"	93-3/4"	2,448	1,455	8,345.50
B654XR-4P5	X-Ray	38-1/2"	184"	93-3/4"	1,530	1,613	9,117.40
B665LT-4P7	Letter	26-1/2"	224"	81-3/4"	2,618	1,522	8,645.30
B665LT-4P8	Letter	26-1/2"	224"	93-3/4"	2,992	1,572	9,238.60
B665LG-4P7	Legal	32-1/2"	224"	81-3/4"	2,618	1,602	9,512.20
B665LG-4P8	Legal	32-1/2"	224"	93-3/4"	2,992	1,774	10,185.50
B665XR-4P5	X-Ray	38-1/2"	224"	93-3/4"	1,870	1,968	11,128.50
B676LT-4P7	Letter	26-1/2"	260"	81-3/4"	3,094	1,796	10,209.20
B676LT-4P8	Letter	26-1/2"	260"	93-3/4"	3,536	1,973	10,911.10
B676LG-4P7	Legal	32-1/2"	260"	81-3/4"	3,094	1,890	11,230.90
B676LG-4P8	Legal	32-1/2"	260"	93-3/4"	3,536	2,093	12,024.10
B676XR-4P5	X-Ray	38-1/2"	260"	93-3/4"	2,210	2,323	13,139.60

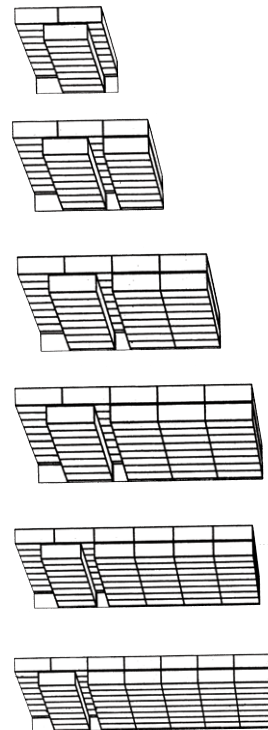

\*All widths include necessary overtravel on each side of the system. Please NOTE systems up to a 4/3 configuration do not require overtravel, deduct 4" off width of system. Single rivet shelf supports replace front Kick Plate and standard support on bottom shelf allowing for easy attachment to mobile carriages. Holes are prepunched into single rivet support to match up with corresponding holes on TrakSlider carriages. All complete systems include TrakSlider Top Shelf Supports.



# 36" Wide Complete TriSlider Systems

ALL COMPLETE SYSTEMS DO NOT INCLUDE DIVIDERS. PLEASE REFER TO PAGE 2d:43 FOR DIVIDER INFORMATION  
Includes 7 or 8 level 4Post™ Shelving for Letter or Legal Depth. X-Ray Shelving includes 5 level 4Post™ Shelving.

## TriSlider Systems

Item #	Media	Overall Depth	W	H	LFI	Est Lbs.	List Price
T621LT-4P7	Letter	41"	76"	82-3/4"	952	646	3,696.20
T621LT-4P8	Letter	41"	76"	94-3/4"	1,088	703	3,921.00
T621LG-4P7	Legal	49-1/2"	76"	82-3/4"	952	703	4,042.20
T621LG-4P8	Legal	49-1/2"	76"	94-3/4"	1,088	768	4,297.10
T621XR-4P5	X-Ray	58-1/2"	76"	94-3/4"	680	838	4,668.00
T632LT-4P7	Letter	41"	112"	82-3/4"	1,666	1,109	6,383.10
T632LT-4P8	Letter	41"	112"	94-3/4"	1,904	1,208	6,774.10
T632LG-4P7	Legal	49-1/2"	112"	82-3/4"	1,666	1,207	6,979.00
T632LG-4P8	Legal	49-1/2"	112"	94-3/4"	1,904	1,320	7,421.20
T632XR-4P5	X-Ray	58-1/2"	112"	94-3/4"	840	1,441	8,064.40
T643LT-4P7	Letter	41"	148"	82-3/4"	2,380	1,572	9,068.70
T643LT-4P8	Letter	41"	148"	94-3/4"	2,720	1,713	9,625.80
T643LG-4P7	Legal	49-1/2"	148"	82-3/4"	2,380	1,711	9,915.60
T643LG-4P8	Legal	49-1/2"	148"	94-3/4"	2,720	1,872	10,546.50
T643XR-4P5	X-Ray	58-1/2"	148"	94-3/4"	1,700	2,044	11,462.00
T654LT-4P7	Letter	41"	184"	82-3/4"	3,094	2,035	11,755.60
T654LT-4P8	Letter	41"	184"	94-3/4"	3,536	2,218	12,477.60
T654LG-4P7	Legal	49-1/2"	184"	82-3/4"	3,094	2,215	12,851.00
T654LG-4P8	Legal	49-1/2"	184"	94-3/4"	3,536	2,424	13,669.30
T654XR-4P5	X-Ray	58-1/2"	184"	94-3/4"	2,210	2,647	14,858.40
T665LT-4P7	Letter	41"	224"	82-3/4"	3,808	2,498	14,441.30
T665LT-4P8	Letter	41"	224"	94-3/4"	4,352	2,723	15,330.60
T665LG-4P7	Legal	49-1/2"	224"	82-3/4"	3,808	2,719	15,787.70
T665LG-4P8	Legal	49-1/2"	224"	94-3/4"	4,352	2,976	16,793.30
T665XR-4P5	X-Ray	58-1/2"	224"	94-3/4"	2,720	3,250	18,256.00
T676LT-4P7	Letter	41"	260"	82-3/4"	4,522	2,961	17,128.20
T676LT-4P8	Letter	41"	260"	94-3/4"	5,168	3,228	18,182.40
T676LG-4P7	Legal	49-1/2"	260"	82-3/4"	4,522	3,223	18,724.60
T676LG-4P8	Legal	49-1/2"	260"	94-3/4"	5,168	3,528	19,917.40
T676XR-4P5	X-Ray	58-1/2"	260"	94-3/4"	3,230	3,853	21,653.70

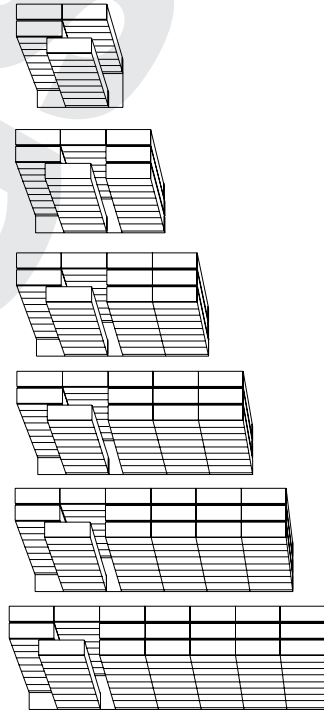

\*All widths include necessary overtravel on each side of the system. Please NOTE systems up to a 4/3 configuration do not require overtravel, deduct 4" off width of system. Single rivet shelf supports replace front Kick Plate and standard support on bottom shelf allowing for easy attachment to mobile carriages. Holes are prepunched into single rivet support to match up with corresponding holes on TrakSlider carriages. All complete systems include TrakSlider Top Shelf Supports.

# 42" Wide Complete BiSlider Systems

ALL COMPLETE SYSTEMS DO NOT INCLUDE DIVIDERS. PLEASE REFER TO PAGE 2d:43 FOR DIVIDER INFORMATION. Includes 7 or 8 level 4Post™ Shelving for Letter or Legal Depth. X-Ray Shelving includes 5 level 4Post™ Shelving.

## BiSlider Systems

Item #	Media	Overall Depth	W	H	LFI	Est Lbs.	List Price
B221LT-4P7	Letter	26-1/2"	88"	81-3/4"	840	535	2,728.10
B221LT-4P8	Letter	26-1/2"	88"	93-3/4"	960	589	2,922.90
B221LG-4P7	Legal	32-1/2"	88"	81-3/4"	840	583	2,980.40
B221LG-4P8	Legal	32-1/2"	88"	93-3/4"	960	625	3,199.10
B221XR-4P5	X-Ray	38-1/2"	88"	93-3/4"	600	665	3,371.40
B232LT-4P7	Letter	26-1/2"	130"	81-3/4"	1400	881	4,514.40
B232LT-4P8	Letter	26-1/2"	130"	93-3/4"	1600	970	4,837.90
B232LG-4P7	Legal	32-1/2"	130"	81-3/4"	1400	920	4,921.50
B232LG-4P8	Legal	32-1/2"	130"	93-3/4"	1600	1,021	5,280.10
B232XR-4P5	X-Ray	38-1/2"	130"	93-3/4"	1000	1,096	5,566.10
B243LT-4P7	Letter	26-1/2"	172"	81-3/4"	1960	1,227	6,302.00
B243LT-4P8	Letter	26-1/2"	172"	93-3/4"	2240	1,351	6,751.50
B243LG-4P7	Legal	32-1/2"	172"	81-3/4"	1960	1,334	6,861.40
B243LG-4P8	Legal	32-1/2"	172"	93-3/4"	2240	1,418	7,362.40
B243XR-4P5	X-Ray	38-1/2"	172"	93-3/4"	1400	1,527	7,760.80
B254LT-4P7	Letter	26-1/2"	214"	81-3/4"	2520	1,573	8,089.40
B254LT-4P8	Letter	26-1/2"	214"	93-3/4"	2880	1,732	8,666.50
B254LG-4P7	Legal	32-1/2"	214"	81-3/4"	2520	1,709	8,803.80
B254LG-4P8	Legal	32-1/2"	214"	93-3/4"	2880	1,814	9,443.50
B254XR-4P5	X-Ray	38-1/2"	214"	93-3/4"	1800	1,958	9,953.10
B265LT-4P7	Letter	26-1/2"	260"	81-3/4"	3080	1,919	9,876.90
B265LT-4P8	Letter	26-1/2"	260"	93-3/4"	3520	2,113	10,580.20
B265LG-4P7	Legal	32-1/2"	260"	81-3/4"	3080	2,085	10,743.80
B265LG-4P8	Legal	32-1/2"	260"	93-3/4"	3520	2,211	11,526.90
B265XR-4P5	X-Ray	38-1/2"	260"	93-3/4"	2200	2,389	12,147.80
B276LT-4P7	Letter	26-1/2"	302"	81-3/4"	3640	2,265	11,664.40
B276LT-4P8	Letter	26-1/2"	302"	93-3/4"	4160	2,494	12,495.10
B276LG-4P7	Legal	32-1/2"	302"	81-3/4"	3640	2,460	12,685.00
B276LG-4P8	Legal	32-1/2"	302"	93-3/4"	4160	2,607	13,608.10
B276XR-4P5	X-Ray	38-1/2"	302"	93-3/4"	2600	2,820	14,342.50

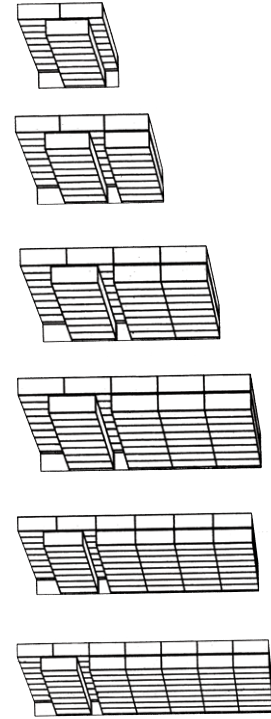

\*All widths include necessary overtravel on each side of the system. Please NOTE systems up to a 4/3 configuration do not require overtravel, deduct 4" off width of system. Single rivet shelf supports replace front Kick Plate and standard support on bottom shelf allowing for easy attachment to mobile carriages. Holes are prepunched into single rivet support to match up with corresponding holes on TrakSlider carriages. All complete systems include TrakSlider Top Shelf Supports.

# 42" Wide Complete TriSlider Systems

ALL COMPLETE SYSTEMS DO NOT INCLUDE DIVIDERS. PLEASE REFER TO PAGE 2D:43 FOR DIVIDER INFORMATION. Includes 7 or 8 level 4Post™ Shelving for Letter or Legal Depth. X-Ray Shelving includes 5 level 4Post™ Shelving.

## TriSlider Systems

Item #	Media	Overall Depth	Width	Height	LFI	Est Lbs.	List Price
T221LT-4P7	Letter	41"	88"	82-3/4"	1120	797	4,190.90
T221LT-4P8	Letter	41"	88"	94-3/4"	1280	870	4,455.70
T221LG-4P7	Legal	49-1/2"	88"	82-3/4"	1120	860	4,545.60
T221LG-4P8	Legal	49-1/2"	88"	94-3/4"	1280	923	4,839.10
T221XR-4P5	X-Ray	58-1/2"	88"	94-3/4"	800	973	5,095.20
T232LT-4P7	Letter	41"	130"	82-3/4"	1960	1,372	7,237.50
T232LT-4P8	Letter	41"	130"	94-3/4"	2240	1,499	7,698.40
T232LG-4P7	Legal	49-1/2"	130"	82-3/4"	1960	1,479	7,844.60
T232LG-4P8	Legal	49-1/2"	130"	94-3/4"	2240	1,584	8,355.50
T232XR-4P5	X-Ray	58-1/2"	130"	94-3/4"	1400	1,673	8,796.40
T243LT-4P7	Letter	41"	172"	82-3/4"	2800	1,947	10,282.90
T243LT-4P8	Letter	41"	172"	94-3/4"	3200	2,128	10,939.90
T243LG-4P7	Legal	49-1/2"	172"	82-3/4"	2800	2,098	11,142.20
T243LG-4P8	Legal	49-1/2"	172"	94-3/4"	3200	2,245	11,871.80
T243XR-4P5	X-Ray	58-1/2"	172"	94-3/4"	2000	2,373	12,500.10
T254LT-4P7	Letter	41"	214"	82-3/4"	3640	2,522	13,328.30
T254LT-4P8	Letter	41"	214"	94-3/4"	4160	2,757	14,181.30
T254LG-4P7	Legal	49-1/2"	214"	82-3/4"	3640	2,717	14,440.00
T254LG-4P8	Legal	49-1/2"	214"	94-3/4"	4160	2,906	15,388.00
T254XR-4P5	X-Ray	58-1/2"	214"	94-3/4"	2600	3,073	16,201.30
T265LT-4P7	Letter	41"	260"	82-3/4"	4480	3,098	16,374.80
T265LT-4P8	Letter	41"	260"	94-3/4"	5120	3,387	17,422.90
T265LG-4P7	Legal	49-1/2"	260"	82-3/4"	4480	3,336	17,739.00
T265LG-4P8	Legal	49-1/2"	260"	94-3/4"	5120	3,567	18,904.40
T265XR-4P5	X-Ray	58-1/2"	260"	94-3/4"	3200	3,773	19,903.70
T276LT-4P7	Letter	41"	302"	82-3/4"	5320	3,672	19,419.00
T276LT-4P8	Letter	41"	302"	94-3/4"	6080	4,015	20,665.60
T276LG-4P7	Legal	49-1/2"	302"	82-3/4"	5320	3,955	21,036.70
T276LG-4P8	Legal	49-1/2"	302"	94-3/4"	6080	4,288	22,419.40
T276XR-4P5	X-Ray	58-1/2"	302"	94-3/4"	3800	4,476	23,604.80

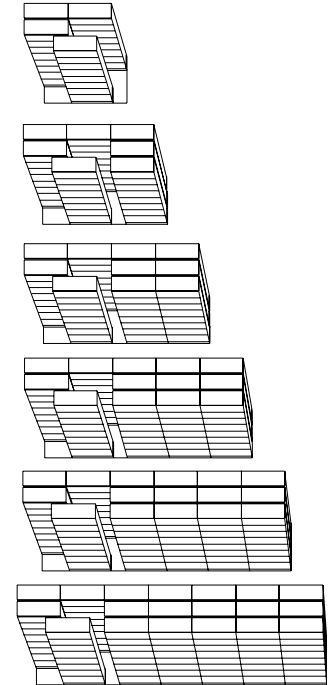

\*All widths include necessary overtravel on each side of the system. Please NOTE systems up to a 4/3 configuration do not require overtravel, deduct 4" off width of system. Single rivet shelf supports replace front Kick Plate and standard support on bottom shelf allowing for easy attachment to mobile carriages. Holes are prepunched into single rivet support to match up with corresponding holes on TrakSlider carriages. All complete systems include TrakSlider Top Shelf Supports.

# 48" Wide Complete BiSlider Systems

ALL COMPLETE SYSTEMS DO NOT INCLUDE DIVIDERS. PLEASE REFER TO PAGE 2D:43 FOR DIVIDER INFORMATION. Includes 7 or 8 level 4Post™ Shelving for Letter or Legal Depth. X-Ray Shelving includes 5 level 4Post™ Shelving.

BiSlider Systems							
Item #	Media	Overall Depth	W	H	LFI	Est Lbs.	List Price
B821LT-4P7	Letter	26-1/2"	100"	81-3/4"	966	606	2,922.80
B821LT-4P8	Letter	26-1/2"	100"	93-3/4"	1,104	670	3,135.40
B821LG-4P7	Legal	32-1/2"	100"	81-3/4"	996	650	3,206.50
B821LG-4P8	Legal	32-1/2"	100"	93-3/4"	1,104	699	3,445.10
B821XR-4P5	X-Ray	38-1/2"	100"	93-3/4"	690	732	3,615.00
B832LT-4P7	Letter	26-1/2"	148"	81-3/4"	1,610	999	4,839.10
B832LT-4P8	Letter	26-1/2"	148"	93-3/4"	1,840	1,104	5,192.60
B832LG-4P7	Legal	32-1/2"	148"	81-3/4"	1,610	1,070	5,295.00
B832LG-4P8	Legal	32-1/2"	148"	93-3/4"	1,840	1,144	5,688.60
B832XR-4P5	X-Ray	38-1/2"	148"	93-3/4"	1,150	1,206	5,972.10
B843LT-4P7	Letter	26-1/2"	196"	81-3/4"	2,254	1,392	6,757.80
B843LT-4P8	Letter	26-1/2"	196"	93-3/4"	2,576	1,538	7,250.00
B843LG-4P7	Legal	32-1/2"	196"	81-3/4"	2,254	1,490	7,386.10
B843LG-4P8	Legal	32-1/2"	196"	93-3/4"	2,576	1,589	7,933.30
B843XR-4P5	X-Ray	38-1/2"	196"	93-3/4"	1,610	1,680	8,329.20
B854LT-4P7	Letter	26-1/2"	249"	81-3/4"	2,898	1,785	8,675.30
B854LT-4P8	Letter	26-1/2"	249"	93-3/4"	3,312	1,972	9,306.10
B854LG-4P7	Legal	32-1/2"	249"	81-3/4"	2,898	1,910	9,474.70
B854LG-4P8	Legal	32-1/2"	249"	93-3/4"	3,312	2,034	10,170.40
B854XR-4P5	X-Ray	38-1/2"	249"	93-3/4"	2,070	2,154	10,686.40
B865LT-4P7	Letter	26-1/2"	296"	81-3/4"	3,542	2,178	10,595.10
B865LT-4P8	Letter	26-1/2"	296"	93-3/4"	4,048	2,406	11,364.60
B865LG-4P7	Legal	32-1/2"	296"	81-3/4"	3,542	2,330	11,554.50
B865LG-4P8	Legal	32-1/2"	296"	93-3/4"	4,048	2,479	12,421.40
B865XR-4P5	X-Ray	38-1/2"	296"	93-3/4"	2,530	2,628	13,042.30
B876LT-4P7	Letter	26-1/2"	340"	81-3/4"	3,542	2,573	12,513.80
B876LT-4P8	Letter	26-1/2"	340"	93-3/4"	4,784	2,840	13,421.90
B876LG-4P7	Legal	32-1/2"	340"	81-3/4"	3,542	2,750	13,653.10
B876LG-4P8	Legal	32-1/2"	340"	93-3/4"	4,784	2,924	14,666.10
B876XR-4P5	X-Ray	38-1/2"	340"	93-3/4"	2,990	3,102	15,399.20

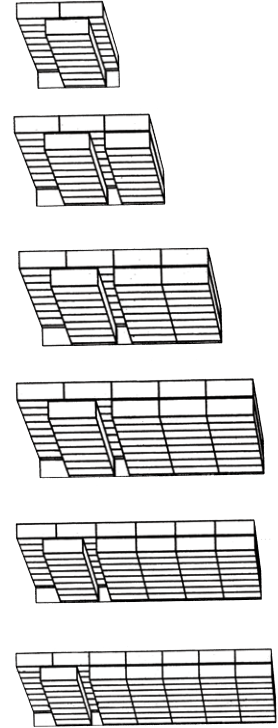

# 48" Wide Complete TriSlider Systems

ALL COMPLETE SYSTEMS DO NOT INCLUDE DIVIDERS. PLEASE REFER TO PAGE 2D:43 FOR DIVIDER INFORMATION. Includes 7 or 8 level 4Post™ Shelving for Letter or Legal Depth. X-Ray Shelving includes 5 level 4Post™ Shelving.

## TriSlider Systems

Item #	Media	Overall Depth	W	H	LFI	Est Lbs.	List Price
T821LT-4P7	Letter	41"	100"	82-3/4"	1,288	896	4,476.90
T821LT-4P8	Letter	41"	100"	94-3/4"	1,472	983	4,765.40
T821LG-4P7	Legal	49-1/2"	100"	82-3/4"	1,288	956	4,872.90
T821LG-4P8	Legal	49-1/2"	100"	94-3/4"	1,472	1,019	5,195.10
T821XR-4P5	X-Ray	58-1/2"	100"	82-3/4"	920	1,103	5,452.50
T832LT-4P7	Letter	41"	148"	94-3/4"	2,254	1,545	6,483.00
T832LT-4P8	Letter	41"	148"	82-3/4"	2,576	1,696	8,234.30
T832LG-4P7	Legal	49-1/2"	148"	94-3/4"	2,254	1,645	8,410.40
T832LG-4P8	Legal	49-1/2"	148"	82-3/4"	2,576	1,747	8,971.30
T832XR-4P5	X-Ray	58-1/2"	148"	94-3/4"	1,610	1,881	9,414.70
T843LT-4P7	Letter	41"	196"	82-3/4"	3,220	2,194	10,987.40
T843LT-4P8	Letter	41"	196"	94-3/4"	3,680	2,409	11,703.20
T843LG-4P7	Legal	49-1/2"	196"	82-3/4"	3,220	2,334	11,948.00
T843LG-4P8	Legal	49-1/2"	196"	94-3/4"	3,680	2,475	12,747.40
T843XR-4P5	X-Ray	58-1/2"	196"	82-3/4"	2,300	2,659	13,378.30
T854LT-4P7	Letter	41"	249"	94-3/4"	4,186	2,843	14,242.60
T854LT-4P8	Letter	41"	249"	82-3/4"	4,784	3,122	15,171.90
T854LG-4P7	Legal	49-1/2"	249"	94-3/4"	4,186	3,023	15,484.30
T854LG-4P8	Legal	49-1/2"	249"	82-3/4"	4,784	3,203	16,521.00
T854XR-4P5	X-Ray	58-1/2"	249"	94-3/4"	2,990	3,437	17,339.20
T865LT-4P7	Letter	41"	296"	82-3/4"	5,152	3,492	17,496.60
T865LT-4P8	Letter	41"	296"	94-3/4"	5,888	3,835	18,640.80
T865LG-4P7	Legal	49-1/2"	296"	82-3/4"	5,152	3,712	19,021.70
T865LG-4P8	Legal	49-1/2"	296"	94-3/4"	5,888	3,931	20,297.20
T865XR-4P5	X-Ray	58-1/2"	296"	82-3/4"	3,680	4,215	21,301.40
T876LT-4P7	Letter	41"	340"	94-3/4"	6,118	4,141	20,750.60
T876LT-4P8	Letter	41"	340"	82-3/4"	6,992	4,548	22,109.70
T876LG-4P7	Legal	49-1/2"	340"	94-3/4"	6,118	4,401	22,559.40
T876LG-4P8	Legal	49-1/2"	340"	82-3/4"	6,992	4,659	24,073.40
T876XR-4P5	X-Ray	58-1/2"	340"	94-3/4"	4,370	4,993	25,265.00

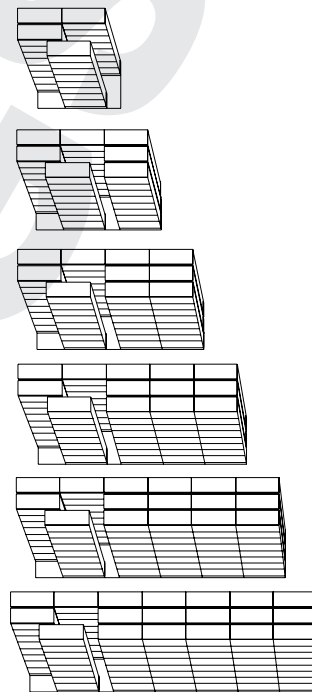

\*All widths include necessary overtravel on each side of the system. Please NOTE systems up to a 4/3 configuration do not require overtravel, deduct 4" off width of system. Single rivet shelf supports replace front Kick Plate and standard support on bottom shelf allowing for easy attachment to mobile carriages. Holes are prepunched into single rivet support to match up with corresponding holes on TrakSlider carriages. All complete systems include TrakSlider Top Shelf Supports.

# Standard Shelf Spacing Chart

## STANDARD & MEDIUM DUTY 4POST SHELVING, NO BASE (MOBILE READY)

Clear Opening Required	Number of Shelf Openings By Shelving Height					
	40-1/4" High	64-1/4" High	76-1/4" High	85-1/4" High	88-1/4" High	97-1/4" High
2-1/4"	13 + 0"	21 + 0"	25 + 0"	28 + 0"	29 + 0"	32 + 0"
3-3/4"	8 + 3"	14 + 0"	16 + 3"	18 + 3"	19 + 1-1/2"	21 + 1-1/2"
5-1/4"	6 + 3"	10 + 3"	12 + 3"	14 + 0"	14 + 3"	16 + 0"
6-3/4"	5 + 1-1/2"	8 + 3"	10 + 0"	11 + 1-1/2"	11 + 4-1/2"	12 + 6"
8-1/4"	4 + 3"	7 + 0"	8 + 3"	9 + 3"	9 + 6"	10 + 6"
9-3/4"	3 + 7-1/2"	6 + 0"	7 + 1-1/2"	8 + 0"	8 + 3"	9 + 1-1/2"
11-1/4"	3 + 3"	5 + 3"	6 + 3"	7 + 0"	7 + 3"	8 + 0"
12-3/4"	2 + 12"	4 + 9"	5 + 7-1/2"	6 + 3"	6 + 6"	7 + 1-1/2"
14-1/4"	2 + 9"	4 + 3"	5 + 0"	5 + 9"	5 + 12"	6 + 6"
15-3/4"	2 + 6"	3 + 13-1/2"	4 + 9"	5 + 1-1/2"	5 + 4-1/2"	5 + 13-1/2"
17-1/4"	2 + 3"	3 + 9"	4 + 3"	4 + 12"	4 + 15"	5 + 6"
18-3/4"	2 + 0"	3 + 4-1/2"	3 + 16-1/2"	4 + 6"	4 + 9"	4 + 18"
20-1/4"	1 + 18"	3 + 0"	3 + 12"	4 + 0"	4 + 3"	4 + 12"
21-3/4"	1 + 16-1/2"	2 + 18"	3 + 7-1/2"	3 + 16-1/2"	3 + 19-1/2"	4 + 6"

## STANDARD & MEDIUM DUTY 4POST SHELVING WITH 2" KICK PLATE

Clear Opening Required	Number of Shelf Openings By Shelving Height					
	40-1/4" High	64-1/4" High	76-1/4" High	85-1/4" High	88-1/4" High	97-1/4" High
2-1/4"	12 + 1-1/2"	20 + 1-1/2"	24 + 1-1/2"	27 + 1-1/2"	28 + 1-1/2"	31 + 1-1/2"
3-3/4"	8 + 1-1/2"	13 + 3"	16 + 1-1/2"	18 + 1-1/2"	19 + 0"	21 + 0"
5-1/4"	6 + 1-1/2"	10 + 1-1/2"	12 + 1-1/2"	13 + 4-1/2"	14 + 1-1/2"	15 + 4-1/2"
6-3/4"	5 + 0"	8 + 1-1/2"	9 + 6"	11 + 0"	11 + 3"	12 + 4-1/2"
8-1/4"	4 + 1-1/2"	6 + 7-1/2"	8 + 1-1/2"	9 + 1-1/2"	9 + 4-1/2"	10 + 4-1/2"
9-3/4"	3 + 6"	5 + 9"	7 + 0"	7 + 9"	8 + 1-1/2"	9 + 0"
11-1/4"	3 + 1-1/2"	5 + 1-1/2"	6 + 1-1/2"	6 + 10-1/2"	7 + 1-1/2"	7 + 10-1/2"
12-3/4"	2 + 10-1/2"	4 + 7-1/2"	5 + 6"	6 + 1-1/2"	6 + 4-1/2"	7 + 0"
14-1/4"	2 + 7-1/2"	4 + 1-1/2"	4 + 13-1/2"	5 + 7-1/2"	5 + 10-1/2"	6 + 4-1/2"
15-3/4"	2 + 4-1/2"	3 + 12"	4 + 7-1/2"	5 + 0"	5 + 3"	5 + 12"
17-1/4"	2 + 1-1/2"	3 + 7-1/2"	4 + 1-1/2"	4 + 10-1/2"	4 + 13-1/2"	5 + 4-1/2"
18-3/4"	1 + 18"	3 + 3"	3 + 15"	4 + 4-1/2"	4 + 7-1/2"	4 + 16-1/2"
20-1/4"	1 + 16-1/2"	2 + 19-1/2"	3 + 10-1/2"	3 + 19-1/2"	4 + 1-1/2"	4 + 10-1/2"
21-3/4"	1 + 15"	2 + 16-1/2"	3 + 6"	3 + 15"	3 + 18"	4 + 4-1/2"

## STANDARD & MEDIUM DUTY 4POST SHELVING WITH 4" KICK PLATE

Clear Opening Required	Number of Shelf Openings By Shelving Height					
	40-1/4" High	64-1/4" High	76-1/4" High	85-1/4" High	88-1/4" High	97-1/4" High
2-1/4"	12 + 0"	20 + 0"	24 + 0"	27 + 0"	28 + 0"	31 + 0"
3-3/4"	8 + 0"	13 + 1-1/2"	16 + 0"	18 + 0"	18 + 3"	20 + 3"
5-1/4"	6 + 0"	10 + 0"	12 + 0"	13 + 3"	14 + 0"	15 + 3"
6-3/4"	4 + 6"	8 + 0"	9 + 4-1/2"	10 + 6"	11 + 1-1/2"	12 + 3"
8-1/4"	4 + 0"	6 + 6"	8 + 0"	9 + 0"	9 + 3"	10 + 3"
9-3/4"	3 + 4-1/2"	5 + 7-1/2"	6 + 9"	7 + 7-1/2"	8 + 0"	8 + 9"
11-1/4"	3 + 0"	5 + 0"	6 + 0"	6 + 9"	7 + 0"	7 + 9"
12-3/4"	2 + 9"	4 + 6"	5 + 4-1/2"	6 + 0"	6 + 3"	6 + 12"
14-1/4"	2 + 6"	4 + 0"	4 + 12"	5 + 6"	5 + 9"	6 + 3"
15-3/4"	2 + 3"	3 + 10-1/2"	4 + 6"	4 + 15"	5 + 1-1/2"	5 + 10-1/2"
17-1/4"	2 + 0"	3 + 6"	4 + 0"	4 + 9"	4 + 12"	5 + 3"
18-3/4"	1 + 16-1/2"	3 + 1-1/2"	3 + 13-1/2"	4 + 3"	4 + 6"	4 + 15"
20-1/4"	1 + 15"	2 + 18"	3 + 9"	3 + 18"	4 + 0"	4 + 9"
21-3/4"	1 + 13-1/2"	2 + 15"	3 + 4-1/2"	3 + 13-1/2"	3 + 16-1/2"	4 + 3"



# Standard Shelf Spacing Chart

## HEAVY DUTY AND X-RAY DUTY 4POST SHELVING, NO BASE (MOBILE READY)

Clear Opening Required	Number of Shelf Openings By Shelving Height					
	40-1/4" High	64-1/4" High	76-1/4" High	85-1/4" High	88-1/4" High	97-1/4" High
3-1/4"	8 + 3"	14 + 0"	16 + 3"	18 + 3"	19 + 1-1/2"	21 + 1-1/2"
4-3/4"	6 + 3"	10 + 3"	12 + 3"	14 + 0"	14 + 3"	16 + 0"
6-1/4"	5 + 1-1/2"	8 + 3"	10 + 0"	11 + 1-1/2"	11 + 4-1/2"	12 + 6"
7-3/4"	4 + 3"	7 + 0"	8 + 3"	9 + 3"	9 + 6"	10 + 6"
9-1/4"	3 + 7-1/2"	6 + 0"	7 + 1-1/2"	8 + 0"	8 + 3"	9 + 1-1/2"
10-3/4"	3 + 3"	5 + 3"	6 + 3"	7 + 0"	7 + 3"	8 + 0"
12-1/4"	2 + 12"	4 + 9"	5 + 7-1/2"	6 + 3"	6 + 6"	7 + 1-1/2"
13-3/4"	2 + 9"	4 + 3"	5 + 0"	5 + 9"	5 + 12"	6 + 6"
15-1/4"	2 + 6"	3 + 13-1/2"	4 + 9"	5 + 1-1/2"	5 + 4-1/2"	5 + 13-1/2"
16-3/4"	2 + 3"	3 + 9"	4 + 3"	4 + 12"	4 + 15"	5 + 6"
18-1/4"	2 + 0"	3 + 4-1/2"	3 + 16-1/2"	4 + 6"	4 + 9"	4 + 18"
19-3/4"	1 + 18"	3 + 0"	3 + 12"	4 + 0"	4 + 3"	4 + 12"
21-1/4"	1 + 16-1/2"	2 + 18"	3 + 7-1/2"	3 + 16-1/2"	3 + 19-1/2"	4 + 6"
22-3/4"	1 + 15"	2 + 15"	3 + 3"	3 + 12"	3 + 15"	4 + 0"

## HEAVY DUTY AND X-RAY DUTY 4POST SHELVING WITH 2" KICK PLATE

Clear Opening Required	Number of Shelf Openings By Shelving Height					
	40-1/4" High	64-1/4" High	76-1/4" High	85-1/4" High	88-1/4" High	97-1/4" High
3-1/4"	8 + 1-1/2"	13 + 3"	16 + 1-1/2"	18 + 1-1/2"	19 + 0"	21 + 0"
4-3/4"	6 + 1-1/2"	10 + 1-1/2"	12 + 1-1/2"	13 + 4-1/2"	14 + 1-1/2"	15 + 4-1/2"
6-1/4"	5 + 0"	8 + 1-1/2"	9 + 6"	11 + 0"	11 + 3"	12 + 4-1/2"
7-3/4"	4 + 1-1/2"	6 + 7-1/2"	8 + 1-1/2"	9 + 1-1/2"	9 + 4-1/2"	10 + 4-1/2"
9-1/4"	3 + 6"	5 + 9"	7 + 0"	7 + 9"	8 + 1-1/2"	9 + 0"
10-3/4"	3 + 1-1/2"	5 + 1-1/2"	6 + 1-1/2"	6 + 10-1/2"	7 + 1-1/2"	7 + 10-1/2"
12-1/4"	2 + 10-1/2"	4 + 7-1/2"	5 + 6"	6 + 1-1/2"	6 + 4-1/2"	7 + 0"
13-3/4"	2 + 7-1/2"	4 + 1-1/2"	4 + 13-1/2"	5 + 7-1/2"	5 + 10-1/2"	6 + 4-1/2"
15-1/4"	2 + 4-1/2"	3 + 12"	4 + 7-1/2"	5 + 0"	5 + 3"	5 + 12"
16-3/4"	2 + 1-1/2"	3 + 7-1/2"	4 + 1-1/2"	4 + 10-1/2"	4 + 13-1/2"	5 + 4-1/2"
18-1/4"	1 + 18"	3 + 3"	3 + 15"	4 + 4-1/2"	4 + 7-1/2"	4 + 16-1/2"
19-3/4"	1 + 16-1/2"	2 + 19-1/2"	3 + 10-1/2"	3 + 19-1/2"	4 + 1-1/2"	4 + 10-1/2"
21-1/4"	1 + 15"	2 + 16-1/2"	3 + 6"	3 + 15"	3 + 18"	4 + 4-1/2"
22-3/4"	1 + 13-1/2"	2 + 13-1/2"	3 + 1-1/2"	3 + 10-1/2"	3 + 13-1/2"	3 + 22-1/2"

## HEAVY DUTY AND X-RAY DUTY 4POST SHELVING WITH 4" KICK PLATE

Clear Opening Required	Number of Shelf Openings By Shelving Height					
	40-1/4" High	64-1/4" High	76-1/4" High	85-1/4" High	88-1/4" High	97-1/4" High
3-1/4"	8 + 0"	13 + 1-1/2"	16 + 0"	18 + 0"	18 + 3"	20 + 3"
4-3/4"	6 + 0"	10 + 0"	12 + 0"	13 + 3"	14 + 0"	15 + 3"
6-1/4"	4 + 6"	8 + 0"	9 + 4-1/2"	10 + 6"	11 + 1-1/2"	12 + 3"
7-3/4"	4 + 0"	6 + 6"	8 + 0"	9 + 0"	9 + 3"	10 + 3"
9-1/4"	3 + 4-1/2"	5 + 7-1/2"	6 + 9"	7 + 7-1/2"	8 + 0"	8 + 9"
10-3/4"	3 + 0"	5 + 0"	6 + 0"	6 + 9"	7 + 0"	7 + 9"
12-1/4"	2 + 9"	4 + 6"	4 + 4-1/2"	6 + 0"	6 + 3"	6 + 12"
13-3/4"	2 + 6"	4 + 0"	4 + 12"	5 + 6"	5 + 9"	6 + 3"
15-1/4"	2 + 3"	3 + 10-1/2"	4 + 6"	4 + 15"	5 + 1-1/2"	5 + 10-1/2"
16-3/4"	2 + 0"	3 + 6"	4 + 0"	4 + 9"	4 + 12"	5 + 3"
18-1/4"	1 + 16-1/2"	3 + 1-1/2"	3 + 13-1/2"	4 + 3"	4 + 6"	4 + 15"
19-3/4"	1 + 15"	2 + 18"	3 + 9"	3 + 18"	4 + 0"	4 + 9"
21-1/4"	1 + 13-1/2"	2 + 15"	3 + 4-1/2"	3 + 13-1/2"	3 + 16-1/2"	4 + 3"
22-3/4"	1 + 12"	2 + 12"	3 + 0"	3 + 9"	3 + 12"	3 + 21"





**DATUM**<sup>®</sup>  
storage solutions

89 Church Road • P. O. Box 355  
Emigsville, PA 17318-0355  
Factory: 1-800-828-8018  
National: 1-800-FILING-1 • Fax: 1-888-FILING-1 (345-4641)  
[www.datumstorage.com](http://www.datumstorage.com) • [sales@datumstorage.com](mailto:sales@datumstorage.com)