

A close-up, black and white photograph of a dark wood table. The table has a curved edge and a metal leg. The wood grain is visible. The background is a light, neutral color.

TABLES BY

PRISMATIQUE

**JANUARY 2015
SPECIFICATION GUIDE
AND LIST PRICEBOOK**

TABLE OF CONTENTS

GENERAL INFORMATION	Guaranteed Freight / Packing Rate Program 3 Meeting Table Seating Capacity Guide 4 Surface Finishes 5 Top-Edge Configurations 5 Woodgrain Direction 6 Table Bases and Modesty Panels 7 Standard Table Bases Details 8, 9 Selected Component Features and Specifications 10 Table Carts 11 Standard Power Communication Cable Management 12, 13 Training Tables Standard Cable Management 14 Training Tables Standard Power Communication Cable Management 15 Typical Base and Power Unit Locations 16 – 28 Surface Recessed Power/Communication Units 29 Undertop Power/Communication Apron and UTP Units 30 Undertop Power/Communication UTP and COVE Units and Daisylink 31 Voice – Network – Presentation Ports 32 Wire Management – Miscellaneous 32
BLADE BASE TABLES	Laminate and Veneer Top 34 – 37 Vidro Painted Back Glass Top 38 – 41 Stone Top 42 – 45
NEXTT T and CROSS BASE TABLES	Laminate and Veneer Top 46 – 49 Vidro Painted Back Glass Top 50 – 55 Stone Top 56 – 61
NEXTT C BASE TRAINING TABLES	Laminate and Veneer Top 62, 63
NEXTT T BASE TABLES - MODULAR	Laminate and Veneer Top 64, 65
DRUM BASE TABLES	Laminate and Veneer Top 66 – 69 Vidro Painted Back Glass Top 70 – 73 Stone Top 74 – 77
PANEL LR BASE TABLES	Laminate and Veneer Top 78 – 81 Vidro Painted Back Glass Top 82 – 85 Stone Top 86 – 89
KONVERSE T and CROSS BASE TABLES	Laminate and Veneer Top 90 – 93 Vidro Painted Back Glass Top 94 – 97 Stone Top 98 – 103
SQUARE EDGE PLATE BASE TABLES	Laminate and Veneer Top 104, 105
BEVELED EDGE PLATE BASE TABLES	Vidro Painted Back Glass Top 106 – 109
CUBE BASE TABLES	Laminate and Veneer Top 110 – 113
KABLE T and CROSS BASE TABLES	Laminate and Veneer Top 114 – 119
KABLE C BASE TRAINING TABLES	Laminate and Veneer Top 120, 121
KABLE T BASE TABLES - MODULAR MEETING	Laminate and Veneer Top 122 – 125
BRIDGE TOPS and MODESTY PANEL PANELS for MODULAR TABLES	Laminate and Veneer Top 126, 127
MODULAR TABLE COLLECTION 128
MODULAR CONFIGURATIONS 129
TUBULAR T and CROSS BASE TABLES	Laminate and Veneer Top 130 – 133
TUBULAR C BASE TABLES	Laminate and Veneer Top 134, 135
TUBULAR T BASE TABLES - MODULAR	Laminate and Veneer Top 136, 137
HALF ROUND T and CROSS BASE TABLES	Laminate and Veneer Top 138 – 141
COLUMN BASE TABLES - MODULAR	Laminate and Veneer Top 142, 143
FOLDING COLUMN BASE TABLES 144, 145
PARSONS BASE COMMUNITY TABLES	Vidro Painted Back Glass Top 146, 147
BROOKLYN BASE COMMUNITY TABLES	Key Details 148, 149 Laminate and Veneer Top 150, 151 Laminate Base - Vidro Painted Back Glass Top and Stone Tops 152, 153 Veneer Base - Vidro Painted Back Glass Top and Stone Tops 154, 155 Vidro Painted Back Glass Top and Stone Tops 156, 157
CABINET UNITS	Features and Options 160 Wiring Options 161 Laminate and Veneer Top 162, 163 Vidro Painted Back Glass Top 164, 165 Stone Top 166, 167 Carts - Lecterns 168, 169 Console/Server - Visual Boards 170, 171
OCCASIONAL TABLES	Finishes and Specifications 189 Piato 190 – 193 Ronde 194, 195 Parsons 196 – 201 Drums 202 – 205 Cubes 206 – 209

TERMS AND CONDITIONS

- PRICES**
- Prices are list, FOB our factory in Toronto, Canada.
 - U.S. shipments are customs cleared and related fees paid by Prismaticque.
 - Freight rate chart provided adds freight (including packaging) as percentage of total order list price based on geographic location. Crating is extra as noted.
- TERMS**
- New customers without established Prismaticque payment history must 100% prepay prior to shipment on first three orders. 50% due at time of PO receipt.
 - Customers will be accorded terms subject to credit reference approval following first three orders.
 - Prismaticque reserves the right to invoice an order at time of completion regardless of shipment date.
 - Custom orders require 50% deposit at time of PO receipt regardless of customer terms.
 - Orders exceeding \$25,000 net require 50% deposit at time of PO receipt regardless of customer terms.
 - Interest of 1 1/2% per month will be charged on overdue accounts.
- ORDERS**
- Orders will not be scheduled - lead time calculation does not start - until all items, finishes, pricing and approval drawings (where required) are final and received by customer service.
 - An ORDER CONFIRMATION (OC) document will be sent immediately upon receipt of PO to allocate a Prismaticque Job # for reference.
 - OC document will be updated with ship date and re-issued approximately two weeks after receipt of PO (subject to final approval drawing sign off).
- CHANGES or CANCELLATIONS**
- Changes or cancellations to received purchase orders are subject to Prismaticque approval and terms. Prismaticque reserves the right to charge for material and labor costs incurred. Changes may result in delayed ship date.
- RETURNS SHIPPING**
- Prismaticque is a made-to-order manufacturer and returns are not allowed under any circumstances.
 - Freight charges are extra.
 - Packing costs will be added when shipments cannot be blanket wrapped.
- CLAIMS**
- All furniture is given to the carrier and signed for in good condition.
 - At this point, the merchandise becomes the property of the customer.
 - Claims for damages or shortages must be placed with the carrier upon shipment receipt.
 - All products are either crated or blanket wrapped. Crates – failure to open and inspect crates at time of delivery null and voids any concealed damage claim. Blankets – all blankets remain with carrier therefore inspection at time of delivery must occur.
 - Unless damage is noted on POD, no concealed damage claims will be considered.
 - Warehouse delivery – our drivers will wait for proper inspection and load signoff. We support driver wait time as a procedure to eliminate later claims of concealed damage. Extreme wait time charges will be chargeable to consignee.
- STORAGE**
- Prismaticque's facility is unable to store finished orders. Orders must ship on scheduled ship date and customer must coordinate local storage arrangements.
- WARRANTY**
- All standard products manufactured by Prismaticque are warranted to be free of material and workmanship defects for five years from the date of delivery. Warranty is non-transferable and applies to original purchaser only. Prismaticque will replace or repair (at our discretion) without cost to our customers any item found to be defective due to materials or workmanship. Prismaticque retains the right to decline repair or replacement of items that have been abused (including exposure to climate variations in temperature or humidity) or subjected to any use other than that which was originally intended for our product. Any repairs by the customer must be pre-approved by Prismaticque or warranty is voided. In no event shall liability under this warranty exceed the original purchase price.
 - The following exceptions are included in the above warranty:
 - a) Customized products – any item deemed “custom” will not qualify for full warranty. Limited warranty may be available but must be negotiated prior to order acceptance and clearly stated on the order. If Prismaticque agrees to supply an uncommon tabletop material, we will follow all related manufacturer published instructions but as these materials are often not recommended for large, horizontal surfaces inspection must take into account the inherent nature of the material. Warranty for such materials must be negotiated prior to order acceptance.
 - b) Painted Back Glass – As a third party manufactured material, glass can include some inherent imperfections (eg. small scratches, blemishes and/or dirt particles) often located within the layers of the glass. The degree of visual impact once painted can vary based on location and color selected. We strive to minimize this presence on our finished tabletops but because it is the nature of glass, these imperfections may appear but are not considered a material defect and therefore not subject to replacement under warranty.
 - c) Electrical components – warranty limited to one year from date of delivery;
 - d) Functional Mechanisms – warranty limited to three years from date of delivery;
 - e) Plastic Laminates – warranty is covered by specific laminate manufacturer, not covered under Prismaticque warranty;
 - f) Wood Veneers / Finishes – the natural variations of wood are beyond the control of Prismaticque and are therefore not considered defects under this warranty. All veneers are carefully selected for uniformity of color and grain. Light finishes do not mask the characteristics of most wood species; often pieces of the same wood product will not look matched. The natural color of lightly stained veneers also causes variations in the overall appearance of the products.
- REASONABLE INSPECTION**
- For purposes of product warranty no claims will be considered without adherence to reasonable inspection. This includes but is not limited to:
 - a) Normal office lighting conditions. This includes overhead ambient lighting of all types but does not include unfiltered, side natural light.
 - b) Arms length distance. Inspection distance must be reasonable.
 - c) Timely inspection within one day of final assembly/installation.

GUARANTEED FREIGHT / PACKING RATE PROGRAM

This program is based on TOTAL LIST PER ORDER. The product will ship on air-ride moving van, blanket wrapped. Crating for glass and stone tables is extra with pricing noted on individual product pages. Prismatique reserves the right to choose the mode of transportation carrier and packaging specifications. Shipments are to loading dock only. Site shipments can be arranged depending on load size, site access and other variables. Freight / Pack Program charges are net.

- Fuel surcharges are included in rates below.
- For GTA (Toronto) factory pickup by customer.

LIST ORDER VALUE	ZONE 1	ZONE 2	ZONE 3
(Minimum List Order) Minimum Charge	(\$3725 or less) \$335 net	(\$3950 or less) \$395 net	(\$4100 or less) \$430 net
Minimum Order to \$9000	9%	10%	10.5%
\$9001 to \$20000	6%	7%	8.5%
\$20001 to \$30000	4%	4.5%	5.5%
\$30001 to \$40000	3%	3.5%	4%
\$40001 plus	2.5%	3%	3.5%

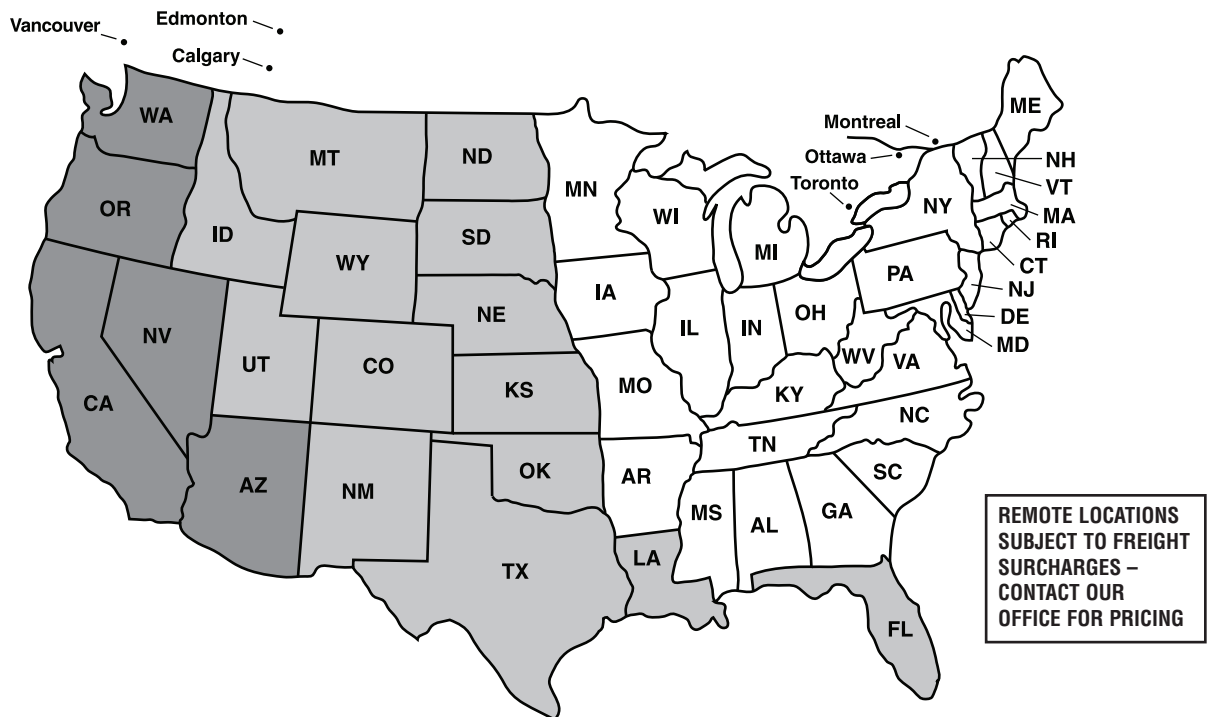









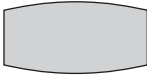
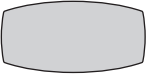
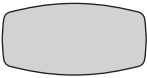

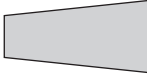
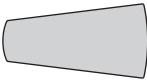

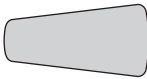
REMOTE LOCATIONS
SUBJECT TO FREIGHT
SURCHARGES –
CONTACT OUR
OFFICE FOR PRICING

ZONE 1	ZONE 2	ZONE 3
Montreal Ottawa SW Ontario SE Ontario Arkansas Delaware Illinois Indiana Maryland Massachusetts Michigan New Jersey New York Ohio	Pennsylvania Rhode Island Virginia Connecticut West Virginia Alabama Georgia Iowa Kentucky Maine Minnesota Mississippi Missouri New Hampshire	North Carolina North Dakota South Carolina South Carolina Tennessee Vermont Washington D.C. Wisconsin
Colorado Florida Idaho Kansas Louisiana Montana Nebraska New Mexico North Dakota Oklahoma South Dakota Texas Utah Wyoming	Vancouver Calgary Edmonton Arizona California Nevada Oregon Washington	

MEETING TABLE SEATING CAPACITY GUIDE

Seating capacity is approximate and based on 24" or 25" chair width, 5" apart. The chart below includes several custom table dimensions in addition to all standard offerings.

	Length	Width	Capacity		Length	Width	Capacity	
ROUND TOPS				BOAT TOPS				
	42"	42"	4	True	72"	36"/25"	6	
	48"	48"	4-5		84"	42"/30"	6	
	54"	54"	5		96"	42"/30"	8	
	60"	60"	6	Arced	96"	48"/35"	8	
	72"	72"	7-8		108"	48"/35"	8-10	
	84"	84"	8		120"	48"/35"	10	
	96"	96"	10	Rounded	132"	48"/35"	10	
	108"	108"	11		144"	48"/35"	12	
	120"	120"	12		120"	60"/42"	10-12	
SQUARE TOPS				WEDGE TOPS				
	42"	42"	4	True	84"	48"/28"	5-6	
	Arced	48"	48"	4		96"	48"/28"	7-8
		60"	60"	8		108"	48"/28"	7-8
	Rounded	72"	72"	8	Arced	120"	60"/35"	9-10
		84"	84"	8-12		132"	60"/35"	9-10
	RECTANGLE TOPS					Rounded	144"	60"/35"
		72"	36"	6		168"	60"/35"	11-12
84"		36"	6-8	192"		60"/35"	13-14	
96"		36"	8	216"	60"/35"	15-16		
Arced		72"	42"	6-8	240"	60"/35"	17-18	
		84"	42"	6-8	ARTICULATING			
Rounded		96"	42"	8	End Table	57"	42"	1-3
		96"	48"	8		Center Table		
108"		48"	8-10			96"	33"	3
120"		48"	10		120"	35"	4	
132"		48"	10	144"	38"	4-5		
144"		48"	12	180"	41"	6		
120"		60"	10-12	MODULAR				
132"		60"	10-12	Rectangle	60"	42"	4-5	
144"		60"	12		66"	42"	4-5	
168"		60"	12-14		72"	42"	4-5	
192"		60"	14	Bullet	60"	48"	4-5	
216"	60"	16		66"	48"	4-5		
240"	60"	18		72"	48"	4-5		
288"	60"	20-22	MODULAR					
				Rectangle	84"	48"	4-7	
					90"	48"	6-7	
					72"	54"	4-5	
				Bullet	84"	48"	4-7	
					90"	54"	6-7	
					84"	54"	4-7	
				MODULAR				
				Rectangle	60"	42"	4-5	
					66"	42"	4-5	
					72"	42"	4-5	
				Bullet	60"	48"	4-5	
					66"	48"	4-5	
					72"	48"	4-5	
				84"	48"	4-7		
				90"	48"	6-7		
				72"	54"	4-5		
				84"	54"	4-7		
				90"	54"	6-7		

SURFACE FINISHES

WOOD VENEERS • HARDWOOD EDGES

General Info

Veneer tops and hardwood edges are available in all flat cut species.

Top surfaces are book matched Architectural Grade A Veneers; lesser quality veneers are bonded to underside of tops for balance. Top finish is semi-open, medium sheen, clear catalyzed lacquer.

Refer to VENEER BROCHURE for standard finishes.

Custom Stains and Veneers

Custom stain charge is \$208.00 NET for set-up and \$46.00 NET per unit.

Premium veneers such as Sycamore, Anigre, Bird's Eye Maple and Curly Maple are available at an upcharge.

Maintenance

Clean with mild soap and water. Wipe dry with pattern direction. Do not use abrasive cleaners or wax.

PLASTIC LAMINATES

General Info

High pressure plastic laminates in solids, patterns and woodgrains from Formica, Wilsonart, Nevamar and Pionite are available in matte finishes and represent our standard list prices. Premium priced laminates within these lines are subject to an upcharge. For these or laminates from other manufacturers such as Laminart or Abet, upcharge will apply.

Laminate tops with COLORA or wood edge feature an 1/8" dia. COLORA Inlay.

Pionite 800 746-6483 Std=all "- Suede" laminates.

Nevamar 800 638-4380 Std=all "- T" laminates.

Wilsonart 800 433-3222 Std=all "- 60" laminates.

Formica 800 FORMICA Std=all "- 58" laminates.

Vinyl Edge

Flat Vinyl edges are available in 15 standard colors. Custom color charge is \$595.00 NET.

EFFECTIVE FEBRUARY 1, 2015
VINYL EDGE PROFILE CHANGE:

Old style may be ordered at same price until inventory is depleted. Upcharges will then apply.

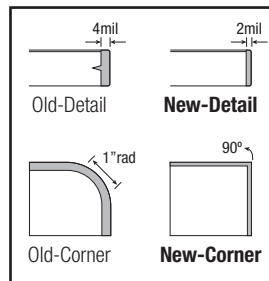

COLORA

General Info

COLORA is a textured polyurethane material applied to MDF board in two steps. Although highly durable, COLORA surfaces are not as hard as laminates. It is applied to table tops, edges, bases and cabinets. COLORA is available in 15 standard colors. Custom color charge is \$289.00 NET per color mix.

Maintenance

Clean with mild soap and water. Do not use abrasive cleaners or wax.

STONE

General Info

Standard marble and granite varieties are shown in the STONE BROCHURE. Prismatic will make available most stones specified by customer, often at no upcharge. Stone surfaces vary greatly in color, texture, pattern and quality. Marble in particular is seldom free of fine cracks or other imperfections. All stone surfaces have natural polish. All stone tops are supplied with black painted plywood subtops.

Maintenance

Clean with mild soap and water. Do not use abrasive cleaners. Regular waxing of marble (only) surfaces is recommended.

GLASS

General Info

Light scratches, waves or tiny bubbles are inherent to glass fabrication and to be expected. Vidro Painted Back Glass tops offer simple color (all standard 15 color colors) in Clear (CL) and Matte/Etched (MA) or ceramic frit printed (Vidro Art). Custom color charge is \$662.00 NET per color.

Maintenance Clean with commercial glass cleaner only.

TOP-EDGE CONFIGURATIONS

VENEER TOPS are 1" thick (3/4" for Whitby and Parsons) medium or high density particleboard core edged with hardwood or COLORA colors.

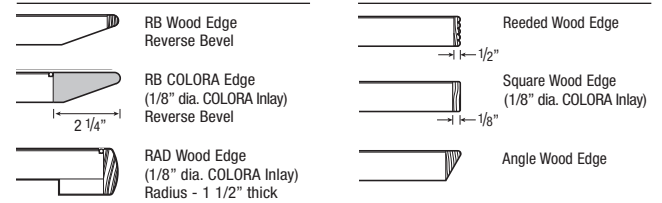

LAMINATE TOPS are 1" thick (3/4" for Whitby and Parsons) medium or high density particleboard core edged with hardwood, vinyl or COLORA colors.

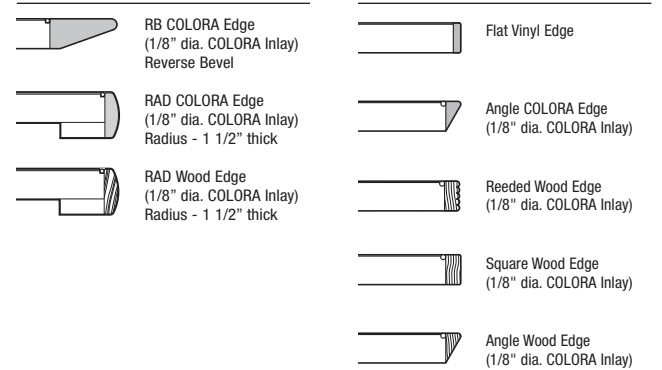

COLORA TOPS are 1" thick (3/4" for Whitby and Parsons) high density particleboard with self or hardwood edges.

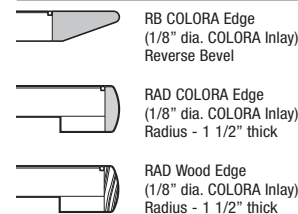

STONE TOPS are 3/4" thick with same or built-up edges

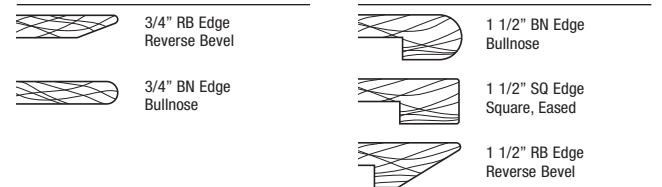

VIDRO PAINTED BACK GLASS TOPS are 1 1/4" thick with starphire glass adhered to MDF subtop available in any color - clear or matte finish.

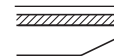

OTHER GLASS TOPS are 1/2" or 3/4" thick and are clear or sandblasted Occasionals

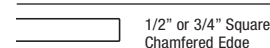

WOODGRAIN DIRECTION ON VENEER and LAMINATE TOPS

Grain directions on wood veneer and wood pattern laminate table tops vary according to size, shape and configuration. Every effort is made to ensure continuation of wood grain direction and pattern, and consistency of stain and sheen on sectioned-top meeting tables and ganged configurations of modular tables.

MEETING TABLES

All shapes of table tops that are 96" or smaller have Length Grain – wood grain runs parallel to length of top. Table tops in one or more sections, 108"L or larger have Width Grain – wood grain runs across the width of top. Sectioned tops utilize Same-Flitch Veneers to ensure consistent grain pattern.

LENGTH GRAIN TOPS WIDTH GRAIN TOPS

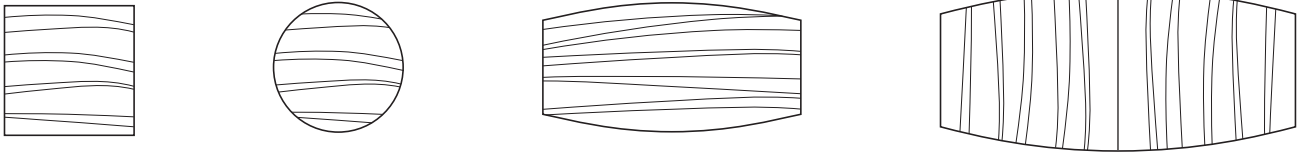

ARTICULATING TABLES

Articulating table tops are uniformly Length Grain. 144" and 180"L tops are sectioned and End-Matched as close as possible.

LENGTH GRAIN TOPS



MODULAR TABLES

Modular tables utilize Same-Flitch Veneers or wood grain laminates with same pattern, color and sheen and are consistently Side- or End-Matched depending on the table configuration. Grain directions and/or Side- or End-Matching can be customized – an upcharge applies.

SIDE-MATCHED TABLE LAYOUTS

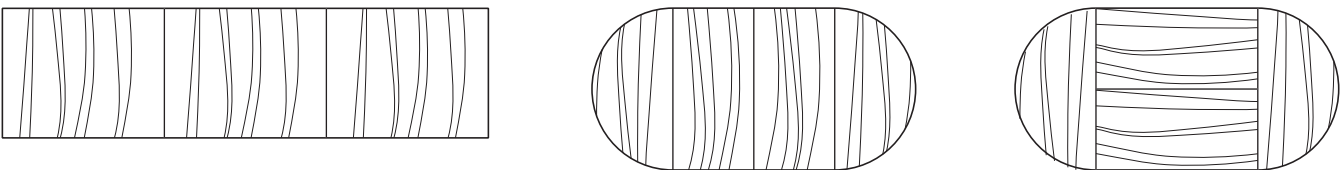

END-MATCHED TABLE LAYOUTS

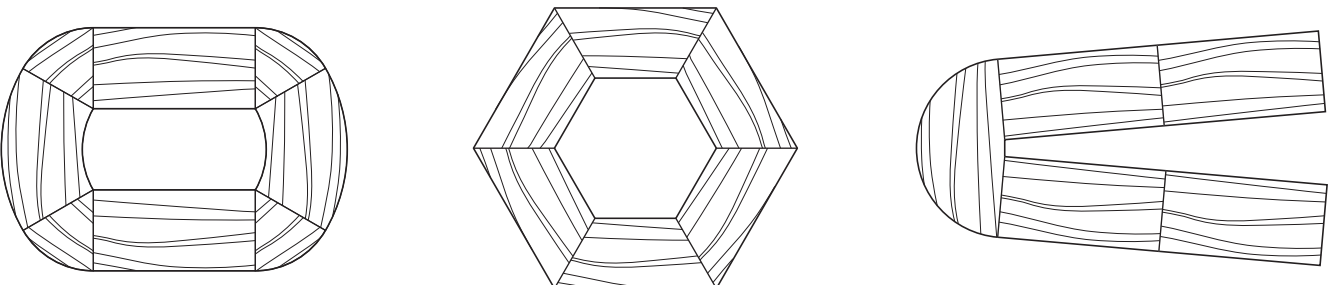

TABLE BASES AND MODESTY PANELS • CONSTRUCTION AND FINISHES

TABLE BASES • METAL

For the most part, table bases incorporate various gauges of sheet, barstock or tubular steel and extruded or cast aluminum components. Tubular steel in square or round profiles are utilized for T-, C- and Cross shapes. Sheet steel is rolled to form Drum bases and Occasional Metal Drum Tables. Barstock steel, rolled and welded is used for base elements of Konverse, T and Cross tables and Ronde series. Mounting top plates in various sizes and meeting table underframes are constructed with sheet and tubular steel respectively. Stainless sheets are applied to wood cores in production of Occasional Metal Cube Tables. Infinity series incorporate extruded columns and cast aluminum components in Column, T and C base styles. Panel base trim and Marker Board frame are extruded aluminum. Steel and aluminum bases, connector plates, top support rails and flip top mechanism are coated with COLORA colors. Certain table series also offer plated finishes on steel.

TABLE BASES • WOOD

Whitby table legs and apron are solid maple available in clear or stained finishes. Cube bases are medium or high-density particleboard in COLORA colors or veneers. Wood veneers are laminated to wood core in Occasional Drum tables and steel core in Drum bases.

MODESTY PANELS

Flat, Flat Folding and J Modesty Panels, Articulating, Training and Modular tables are formed or extruded aluminum. Flat Modesty is bolted to underside of top and requires tools for installation and removal. Flat Folding Modesty folds under and parallel to table underside and features an optional wire manager. J Modesty is in ribbed pattern, contains a large wire through and is removable without tools. J Modesty is available up to 10' long. All panels are finished in COLORA colors to match table bases unless specified otherwise.

FINISHES

Colora

COLORA is a textured polyurethane material applied to steel and aluminum in two steps. It is scratch-resistant and stain proof. COLORA is leather-like in appearance and seamless. COLORA is available in 15 standard colors. Custom color charge is \$289.00 NET per color mix.

Plated Finishes • Chrome

Nickel chrome in polished (mirror) or satin finishes is applied to steel base components where noted.

Stainless Steel

Blade, NEXTT and all Parsons bases are stainless steel construction offered in polished or brushed finish.

Maintenance

COLORA and plated steel surfaces can be cleaned with mild soap solution or glass cleaner and wiped dry with soft cloth. Do not apply abrasive cleaners, polish or lubricants to table bases or mechanical parts.

STANDARD TABLE BASES-DETAILS

Drum Base

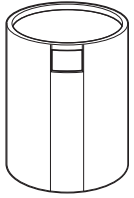

- Rolled steel sheet metal reinforced with tubular steel inner rings
- Removable and reversible 6" wide access panel

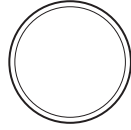

- Dimensions: 18", 22", 24" and 28" dia.
- Finishes:
 - Polished and Satin Chrome
 - COLORA colors
 - Wood Veneers (wrapped on steel)

Blade Base

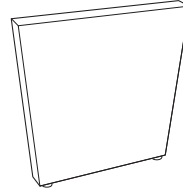

- 2 1/2" thick solid core panel with 4" downward taper
- Finished in COLORA colors, veneer or stainless steel clad (polished or brushed)

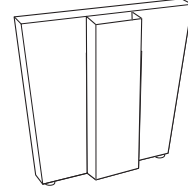

- 10"W x 1 1/4"D vertical infeed panel/wire manager can be mounted to any Blade base

Panel Base

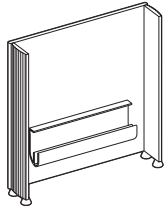

- 6" thick panel design
- Wire bin for excess cables
- Removable Side Panel
- 1 1/4"h black adjustable glides (optional)

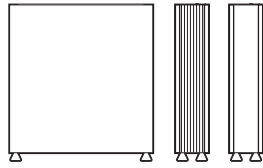

- Removable Side Panel
- 22", 26" and 32" wide
- Finished in COLORA colors or Wood Veneers
- Fixed aluminum trim panels in ribbed pattern and finished in COLORA colors

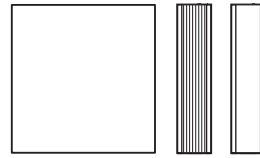

- Standard LR low rise glides with 1" manual height adjustment range
- Optional flat end panel available in COLORA or veneers

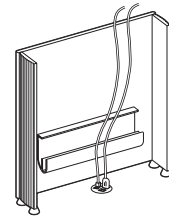

- Cables through base
- Floor monument housed inside base with 4 1/2" wide cavity

Cross Panel Base

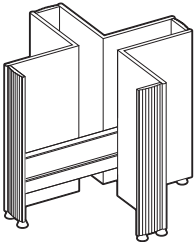

- (1) Removable and (3) fixed Side and (4) fixed Trim Panels
- 1 1/4"h black adjustable glides
- Wire bin for excess cables
- 26", 32" and 38" wide

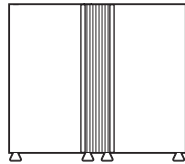

- L Shape Side Panels (one Removable) and available in COLORA colors or Wood Veneers
- End Trim Panels are aluminum in ribbed pattern and finished in COLORA colors

Nextt T Base



- 2 x 4 1/2" vertical with removable access panel on one side
- Stainless steel (polished or brushed) or in COLORA colors

Nextt Cross Base

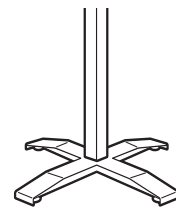

- Standard without access door (available at upcharge)

Konverse T Base

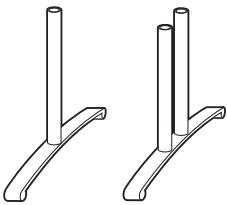

- Rolled barstock steel (2 1/2" x 3/4") with 2 1/2" dia. tubular steel center column(s)
- Dimensions: 26", 32" and 38"
- Finishes:
 - Polished and Satin Chrome
 - COLORA colors

Konverse Cross Base

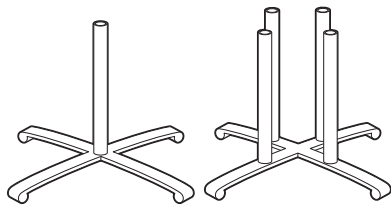

- Rolled barstock steel (2 1/2" x 3/4") with 2 1/2" dia. tubular steel center column(s)
- Dimensions: 26", 32" and 38"
- Finishes:
 - Polished and Satin Chrome
 - COLORA colors

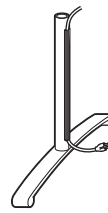

- Snap-on black PVC wire manager

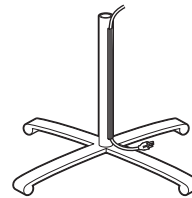

- Snap-on black PVC wire manager

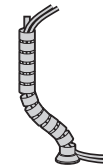

- Snake Wire manager
- Black or silver flexible PVC wire channel, 2 1/2" dia. and 32" long. Steel weighted base is 4" dia.

STANDARD TABLE BASES-DETAILS

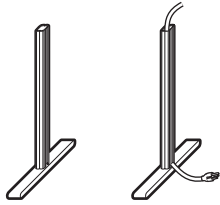

Kable T Base

Leg is 2" x 1" steel in 12 gauge with bullnose ends. Column consists of four 16 gauge steel rods and removable ribbed plastic cover strips. Finish is COLORA colors – cover strips can be specified in contrast color. Wires are managed internally.

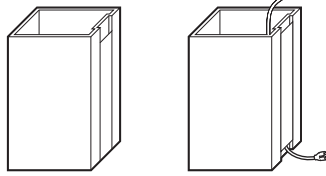

Cube Base

Constructed of MDF and reinforced with steel brackets. Open at top and bottom. Wire access through removable side panel which can be slightly raised at floor level to allow cable exit. Finished in COLORA colors or in veneer.

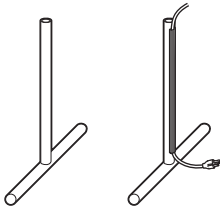

Tubular T Base

Leg and column are 2" dia. 14 gauge steel with welded end caps. Available in COLORA colors, optional polished or satin chrome. Black PVC external wire manager.

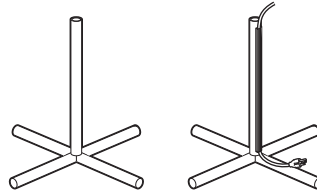

Tubular Cross Base

Leg and column are 2" dia. 14 gauge steel with welded end caps. Available in COLORA colors, polished or satin chrome. Black PVC external wire manager.

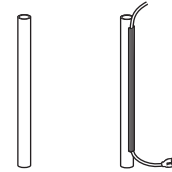

Column Bases

2", 2 1/2" or 4" dia. columns in 16 gauge steel finished in COLORA colors, polished or satin chrome. External wire manager is black PVC.

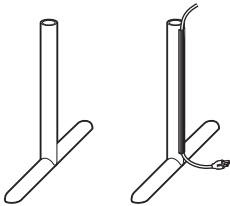

Half Round T Base

3" dia. leg and column in 14 gauge steel with half bullnose end caps. Finishes are COLORA colors, polished or satin chrome. External wire manager is black PVC.

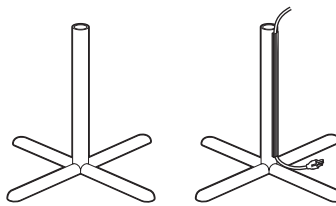

Half Round Cross Base

3" dia. leg and column in 14 gauge steel with half bullnose end caps. Finishes are COLORA colors, polished or satin chrome. External wire manager is black PVC.

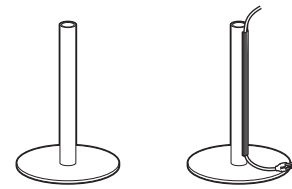
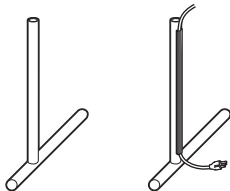

Plate Base

3/8" thick steel with 16 gauge spun steel cover plate and 14 gauge steel column 3" or 4" dia. Finishes are COLORA colors, polished or satin chrome. External wire manager in black PVC.

TRAINING TABLES



Tubular C Base

2" dia. leg and column in 14 gauge steel with welded end caps. Available in COLORA colors, polished or satin chrome. External wire manager is black PVC.

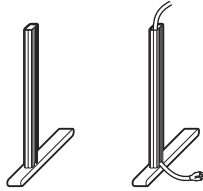

Kable C Base

Leg is 2" x 1" steel in 12 gauge with bullnose ends. Cantilevered column consists of four 16 gauge steel rods and removable ribbed plastic cover strips. Available in COLORA colors – cover strips can be specified in contrast color. Wires are managed internally.

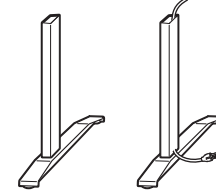

Next C Base

2 x 4 1/2" vertical with removable access panel on one side. Stainless steel (polished or brushed) or in COLORA colors. Wires are managed internally, exit above lower horizontal footpad.

SELECTED COMPONENT FEATURES and SPECIFICATIONS



Flip Top • Double Base

Rigid and simple to operate heavy duty flip top assembly comprised of tubular and formed steel components painted in same color as bases and 2 levers which operate the double-engaging locking system. Flip top option is available for virtually all modular table shapes and meeting tables up to 8' long. Flip top tables are shipped assembled.



Flip Top • Single Base

Multipurpose Round and Square tables are optionally equipped with flip mechanism constructed of steel which hinges open like clam shell upon rotation of handle bar. Safety latch locks top in flat and open positions. Finished in same color as table base.



Nesting 1

Modular/Training tables with Flat Folding Modesty require small amount of space for storage when not in use.



Nesting 2

Modular / Training tables with J Modesty (or fixed Flat Modesty) require no additional nesting space.

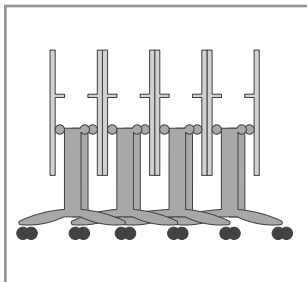

Nesting 3

Back-to-back table nesting allows storing more tables in less space. Calculate recommended space required for 8 nested tables by 9' x Table Length.



Folding Base

Heavy duty construction with nylon injected molded frame and an extruded aluminum mechanism. Single press-down lever; can be operated by hand or foot. Positive lock in folded or upright positions. Black finish. Bases lay flat on tables as short as 56"L. Folding base tables are shipped assembled.



Folding Modesty

Flat pattern aluminum in 15 COLORA colors. Hinge mechanism provides articulation to fixed or folding (over table bases) positions. Optional plastic wire manager. Dimensions: 9" high x 60" or 72" long.



Fixed Modesty

Flat pattern aluminum panel in 15 COLORA colors is bolted to underside of tabletop. Dimensions: 9" high x 42" – 84" long.



J Modesty

Extruded aluminum in ribbed pattern, features a large divided wire management tray. Removable without tools. Available in 15 COLORA colors. Dimensions: 7 1/2" high x 42" – 120" long.



Glides

All table bases (except the Occasionals) provide up to 3/4" height adjustability. Depending on table series, glides are black, 1" to 1 3/4" dia.

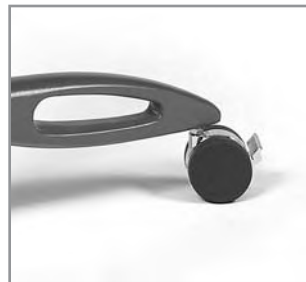

Castors

Locking casters are available for most table series. They must be specified at time of order. Caster option does not change height of tables. Infinity: 3" dia., black with silver brake. AV Carts, Lectern: 3" dia. Frames: 3" dia., Silver face with black lining and brakes. Low rise casters (optional): 1 1/2" dia.

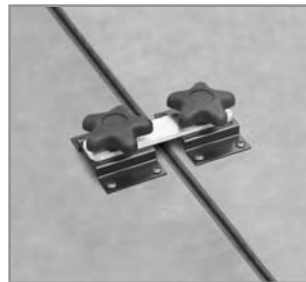

Gang Set

Each set consists of two brackets, a linking bar and two thumb screws. Gang Sets are utilized to link and level multiple table configurations. Ganging 20", 24", 30" and 36" sides require 1 set; 42" and over sides require 2 sets. No tools required for adjustment.

TABLE CARTS

Table carts are tubular steel construction in black finish and equipped with 5" dia. wheels.

TRH6 CART (removable bases only)

Stores 6 Tables without Modesty Panel. Base connector plates with bumper tipped inner columns remain attached to table undertops to protect tables during storage. Sets of Column or T Bases slide into rubber tipped shafts welded to Cart platform and stay upright between table tops.

Dimensions: 36" x 32 1/2" x 36" H
TRH6 CART

QTY1	QTY3	QTY10
1849	1710	1489

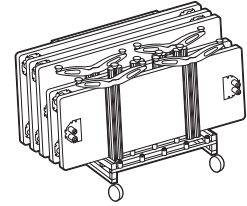
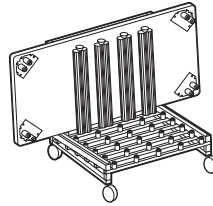
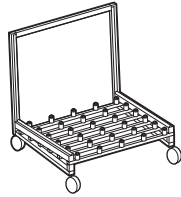

TRV6 CART

Stores 6 Tables with folding T or C bases with or without folding modesty. Also suitable for Tables with J Modesty Panel which user elects not to remove. Infinity Column or T Base store above table undertops. Max. table depth, 36".

Dimensions: 42" x 30" x 71" H
TRV6 CART

QTY1	QTY3	QTY10
1785	1581	1421

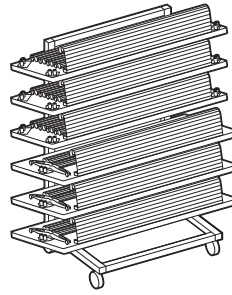
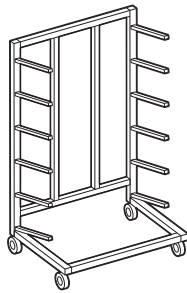

TR4 CART

Stores 4 Folding T or C Base Tables with or without Flat Folding Modesty or 4 GOSH! Folding (2" dia.) Column Base Tables. Cart length and divider heights vary depending on table dimensions. Minimum Door Clearance: 32" wide. Larger carts for 5 or more tables are customized according to door clearance.

Dimensions: 36" x 42" x 32" H
TR4 CART

QTY1	QTY3	QTY10
1581	1382	1293

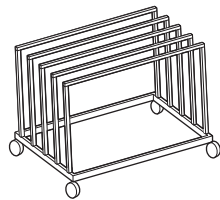

TVA CART!

Stores 4 Folding 4" dia. Column Base Tables

Dimensions: 52" x 30" x 41" H
TVA CART

QTY1	QTY3	QTY10
1785	1581	1421

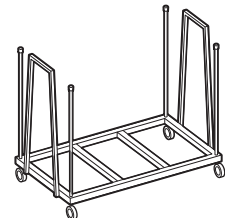

STANDARD POWER COMMUNICATION CABLE MANAGEMENT - DETAILS/TYPICALS

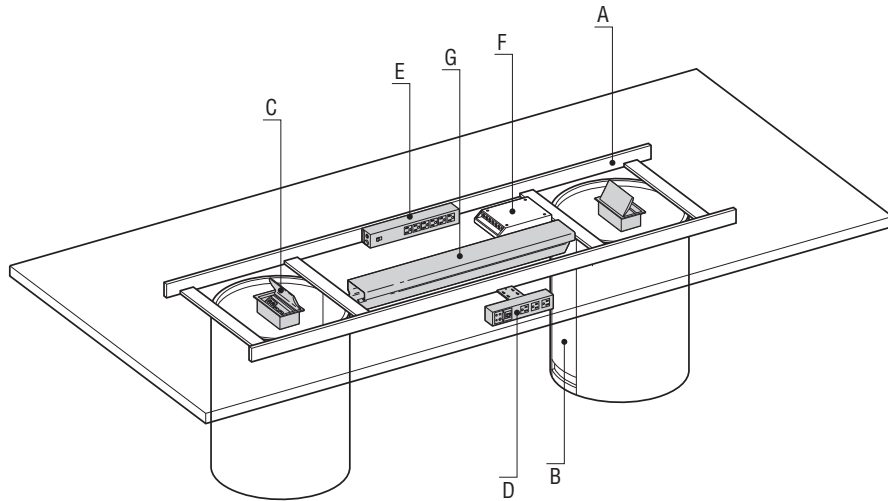

Drum Base • Wood, Vidro and Stone

- A Table Top Support Rail
- B Removable Base Access Panel
- C Surface Power Unit
- D Under top Power Unit
- E Surge Protected Power Bar
- F Data Hub (client supplied)
- G Large Wire Manager

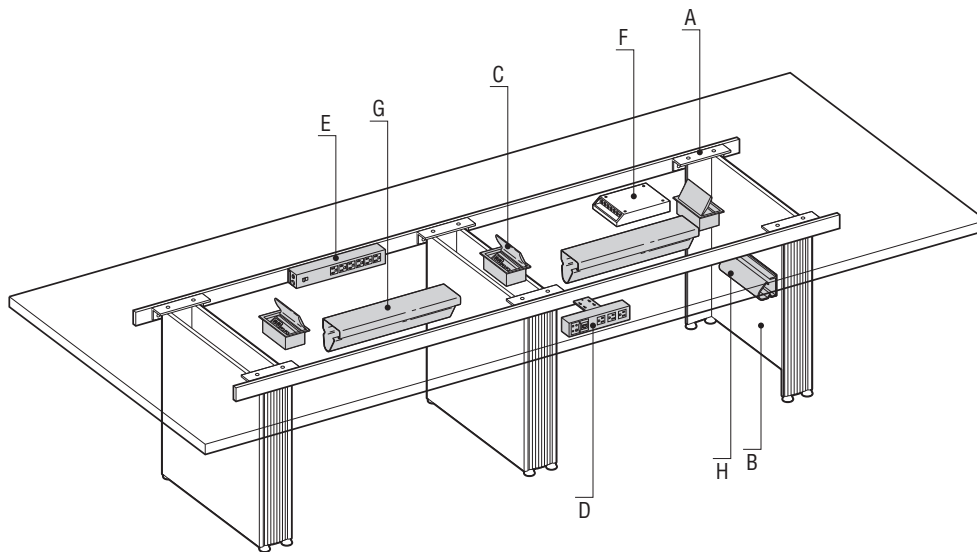

Panel Base • Wood, Vidro and Stone

- A Table Top Support Rail
- B Removable Side Panel
- C Surface Power Unit
- D Under top Power Unit
- E Surge Protected Power Bar
- F Data Hub (client supplied)
- G Large Wire Manager
- H Cable Bin

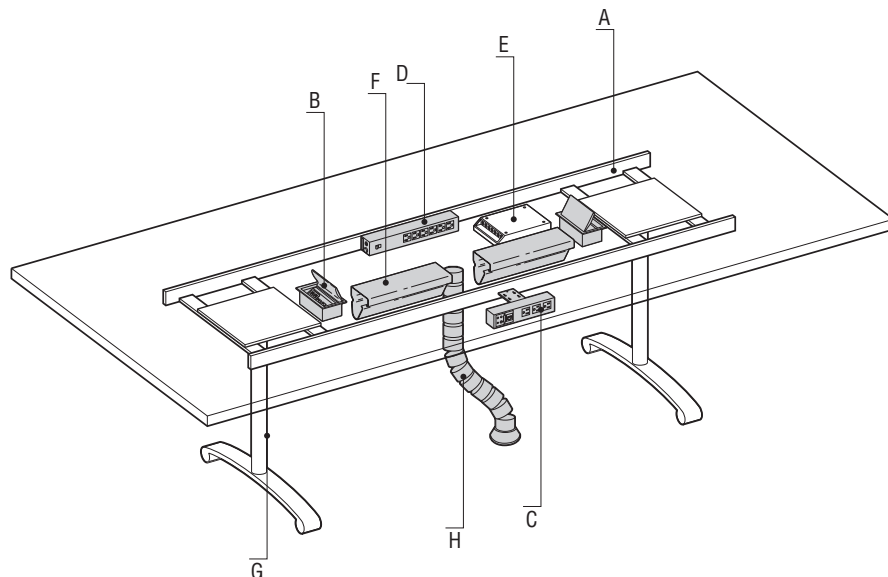

T Base • Wood, Vidro and Stone

- A Table Top Support Rail
- B Surface Power Unit
- C Under top Power Unit
- D Surge Protected Power Bar
- E Data Hub (client supplied)
- F Large Wire Manager
- G Snap-on Leg Wire Manager
- H Snake Wire Manager

STANDARD POWER COMMUNICATION CABLE MANAGEMENT - DETAILS/TYPICALS

Cabling through base cavities. Core drill within or adjacent to table base.

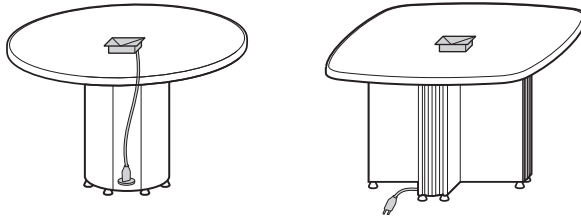

Two surface power units daisychained – single floor monument. Cables routed through Large Wire Manager.

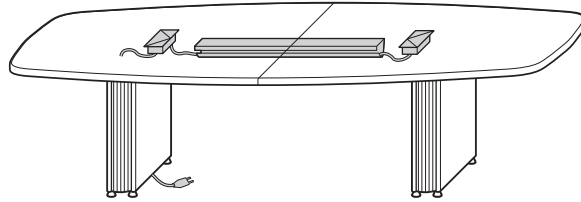

Two surface power unit cables run through Large Wire Manager and routed down to floor level with Snake Manager.

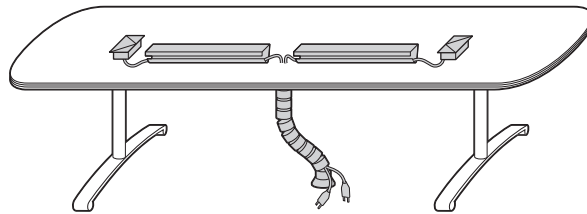

Three surface power units daisychained – single core drill. Horizontal cabling within Large Wire Managers.

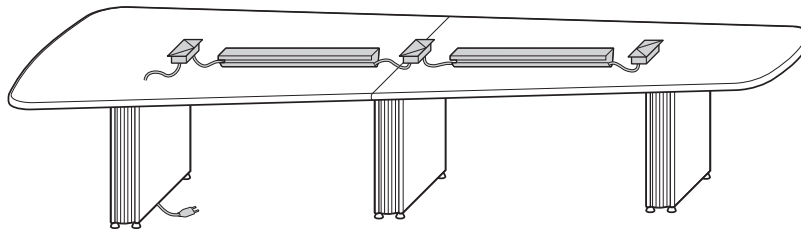

Three surface power units with three floor power sources. Large amounts of communication cables run inside Large Wire Manager.

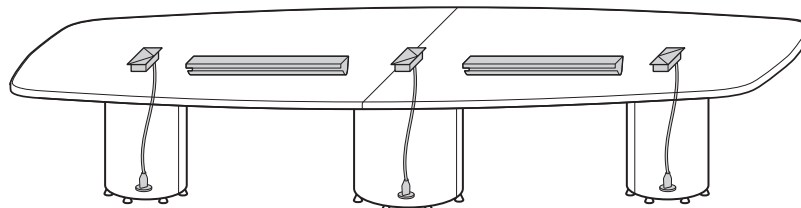

TRAINING TABLES - STANDARD CABLE MANAGEMENT - DETAILS/TYPICALS

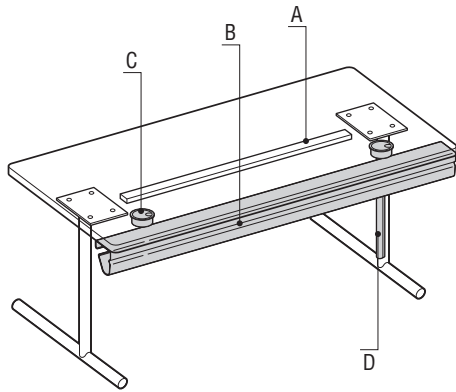

Tubular C Base • Fixed

- A Top Support Rail (when required)
- B Large Wire Manager
- C Grommet
- D Snap-on Leg Wire Manager

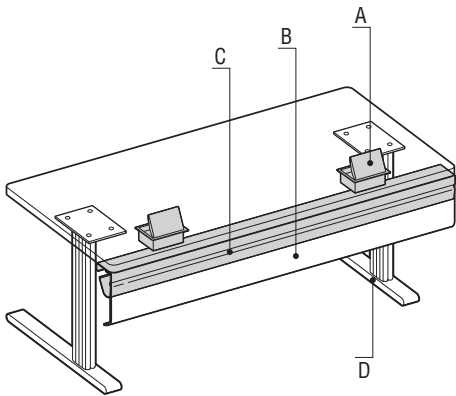

Nextt and Kable (shown)

C Base • Fixed

- A Surface Power Unit
- B Large Wire Manager
- C Flat Fixed Modesty
- D Removable Base Cover Strip

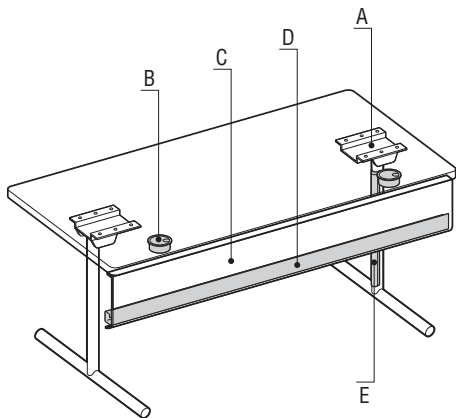

Tubular T Base • Folding Base

- A Folding Base Mechanism
- B Grommet
- C Flat Folding Modesty with:
- D Horizontal Wire Manager
- E Snap on Leg Wire Manager

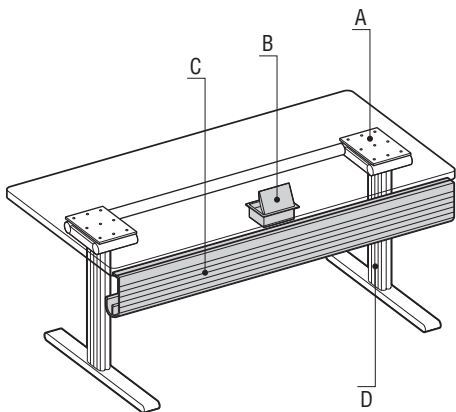

Nextt and Kable (shown)

T Base • Flip Top

- A Flip Top Mechanism
- B Surface Power Unit
- C J Modesty/Wire Bin
- D Removable Base Cover Strip

TRAINING TABLES - STANDARD POWER COMMUNICATION CABLE MANAGEMENT - DETAILS/TYPICALS

Surface power units in various positions and cabling components are illustrated for various modular shapes.

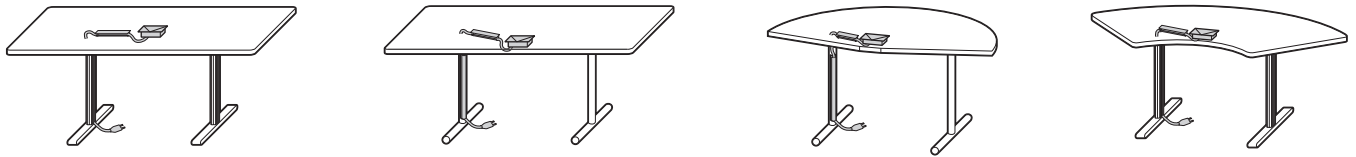

Training Tables featuring power units and leg wire management require single or multiple floor plugs depending on extent of daisy chaining.



TABLE TOP POWER AND GROMMET LOCATION GUIDE

To specify power/communication units and/or grommets on table tops, simply indicate illustration code and number of units. Alternate locations are available. All units are factory installed.

RECTANGLE

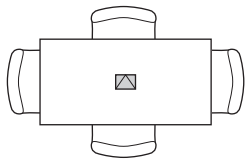

Center • C1

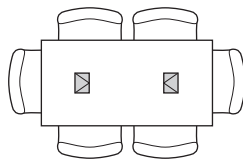

Center-Width x 2 • WC2

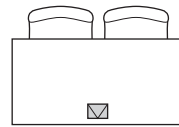

Center-Back • BC1

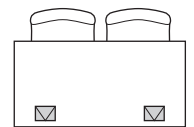

Back x 2 • B2

HALF ROUND

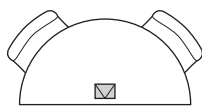

Center-Straight • SC1

ARC

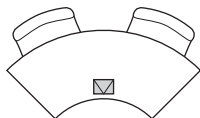

Center-Small Curve • SCC1

V END

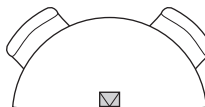

Center-Angle • AC1

TRAPEZOID



Center-Wide • WC1

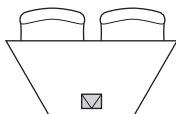

Center-Narrow • NC1

ROUND

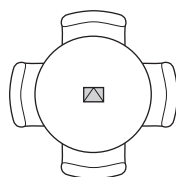

Center • C1

SQUARE

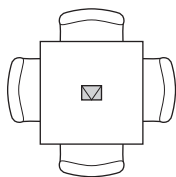

Center • C1

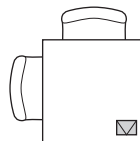

Center-Corner • CC1

TYPICAL BASE and POWER UNIT LOCATIONS

DRUM BASE • WOOD, VIDRO AND STONE TOPS

Wood, Stone & Vidro
All sizes

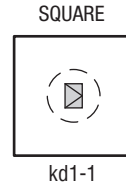
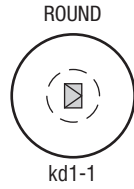

Wood, Stone & Vidro A
84" x 42" 36"
96" x 48" 42"

RECTANGLE - ARCED RECTANGLE - ARCED BOAT - ARCED WEDGE

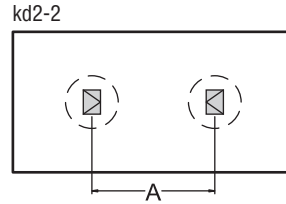
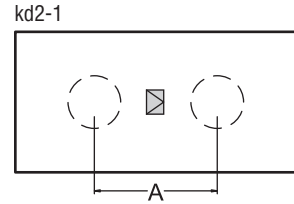

Wood **A**
108" x 48" 54"

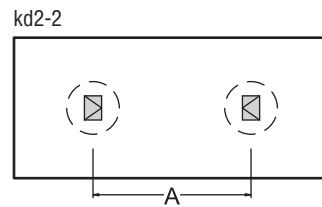
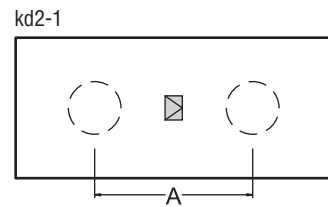

Stone & Vidro **A**
108" x 48" 54"

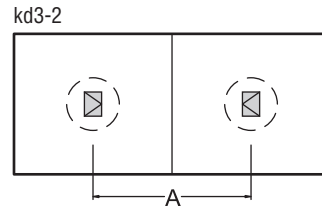
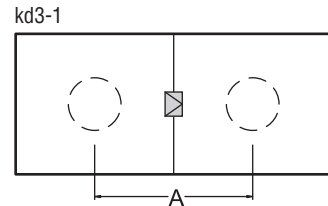

Wood, Stone & Vidro A
120" x 48" or 60" 56"
132" x 48" or 60" 68"
144" x 48" or 60" 78"

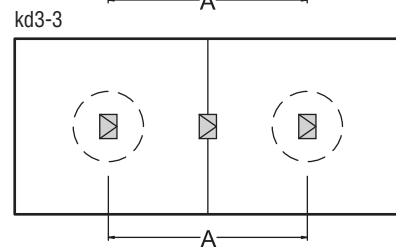
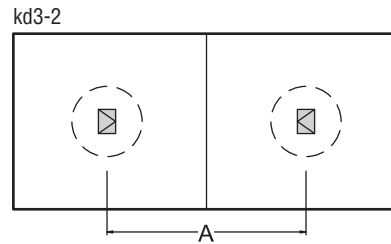
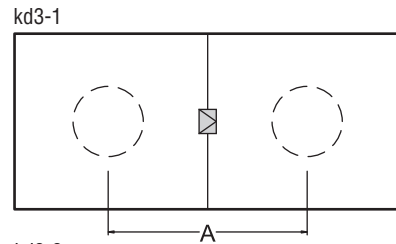

Wood, Stone & Vidro A
168" x 60" 52"

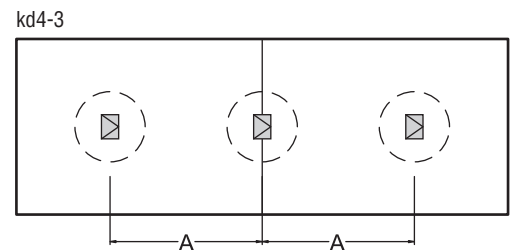
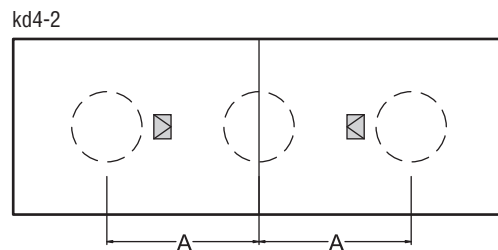

TYPICAL BASE and POWER UNIT LOCATIONS

DRUM BASE • WOOD, VIDRO AND STONE TOPS

RECTANGLE - ARCED RECTANGLE - ARCED BOAT - ARCED WEDGE

Wood Only
192" x 60"
216" x 60"

A
63"
74"

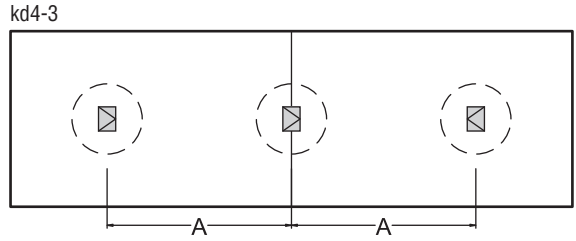
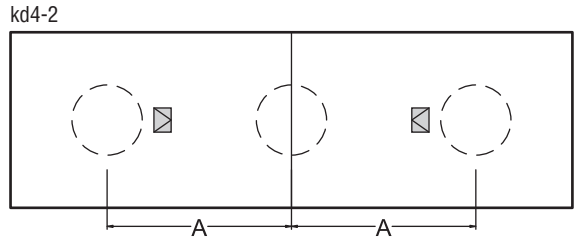

Stone & Vidro
192" x 60"
216" x 60"

A
63"
74"

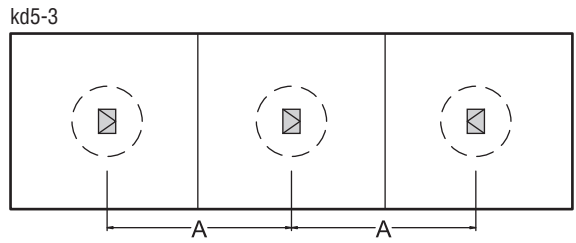
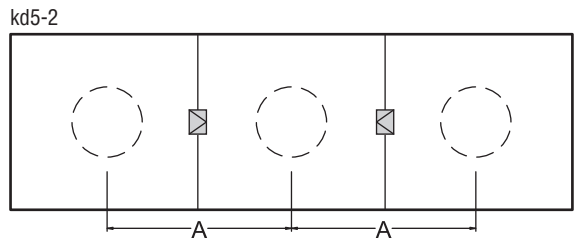

Wood, Stone & Vidro A
240" x 60"

86"

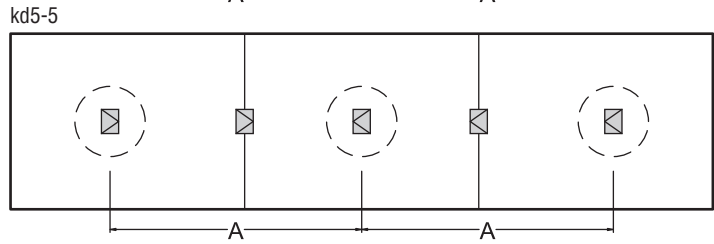
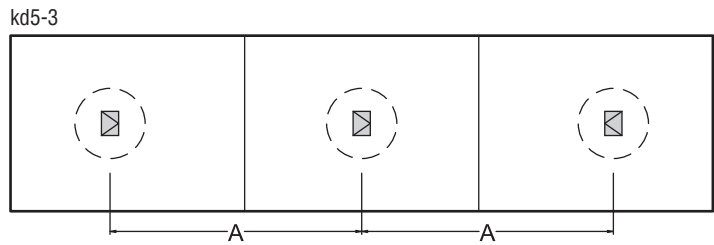

TYPICAL BASE and POWER UNIT LOCATIONS

DRUM BASE • WOOD TOPS

Wood
240" x 72"

A
86"

ARCED BOAT

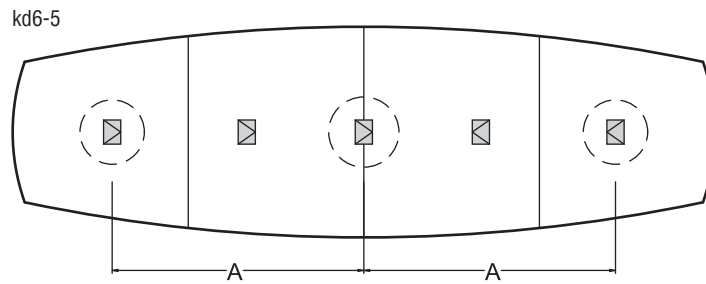
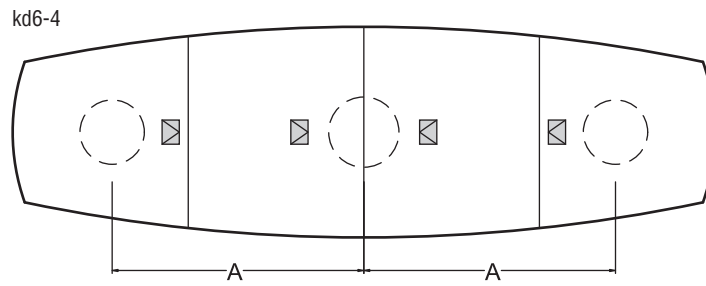
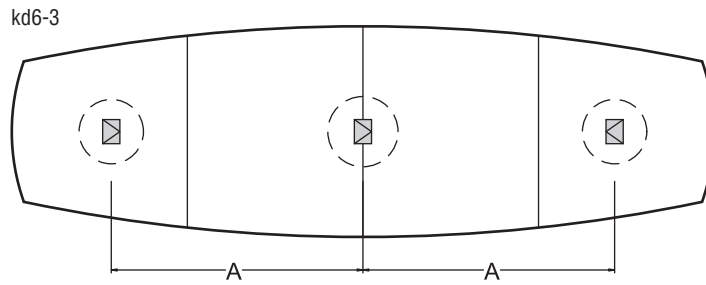

TYPICAL BASE and POWER UNIT LOCATIONS

BLADE & PANEL BASE • WOOD, VIDRO AND STONE TOPS

Wood, Stone & Vidro
All sizes

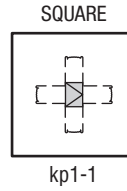
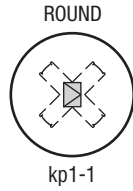

RECTANGLE - ARCED RECTANGLE - ARCED BOAT - ARCED WEDGE

Wood, Stone & Vidro A
84" x 42" 38"
96" x 48" 50"

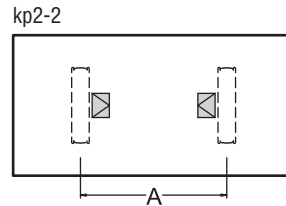
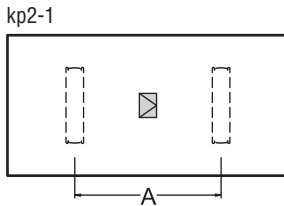

Wood **A**
108" x 48" 62"

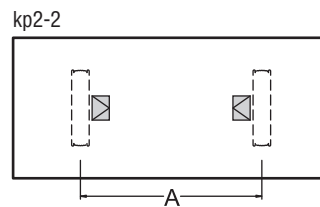
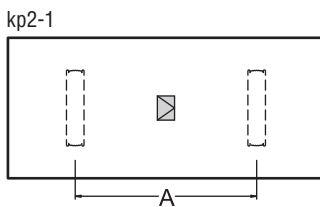

Stone & Vidro **A**
108" x 48" 62"

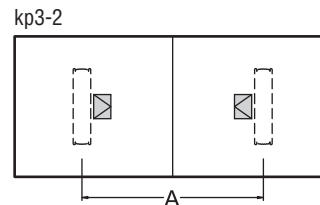
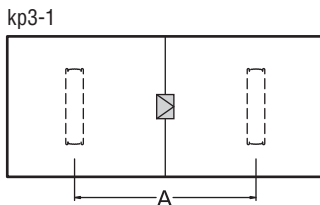

Wood, Stone & Vidro A
120" x 48" or 60" 74"
132" x 48" or 60" 86"

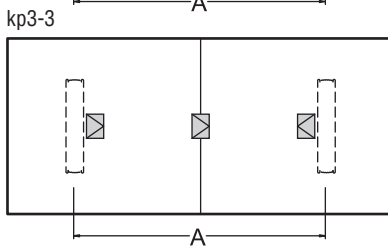
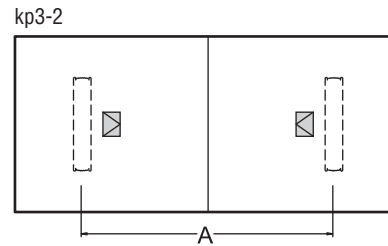
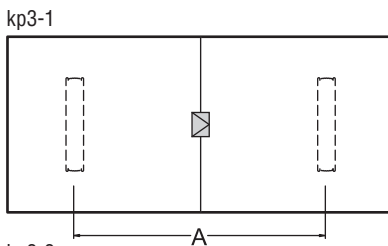

Wood, Stone & Vidro A
144" x 48" or 60" 49"
168" x 48" or 60" 61"

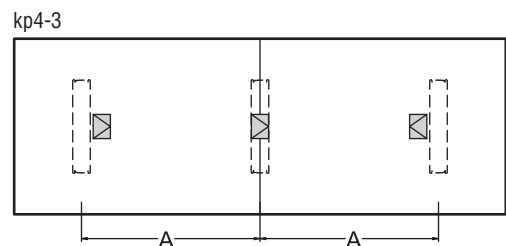
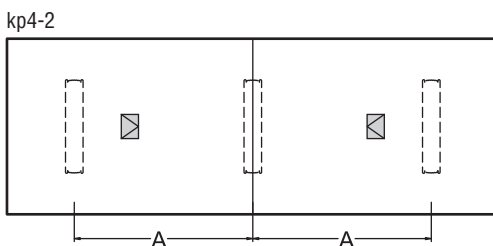

TYPICAL BASE and POWER UNIT LOCATIONS

BLADE & PANEL BASE • WOOD, VIDRO AND STONE TOPS

Wood
192" x 60"

A
70"

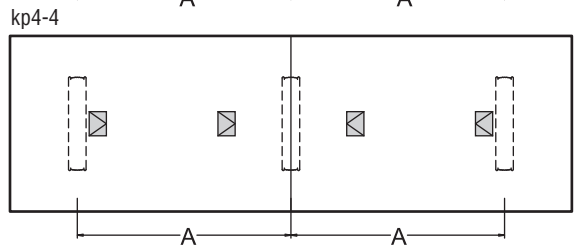
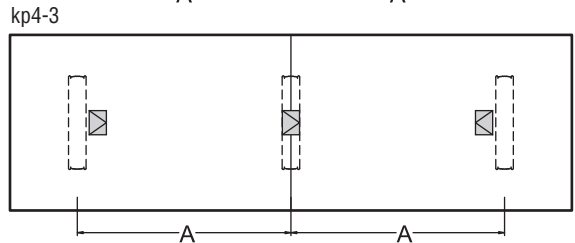
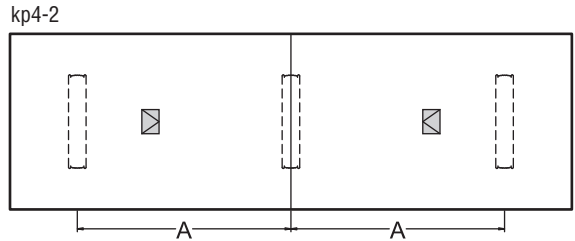

Stone & Vidro
192" x 60"

A
70"

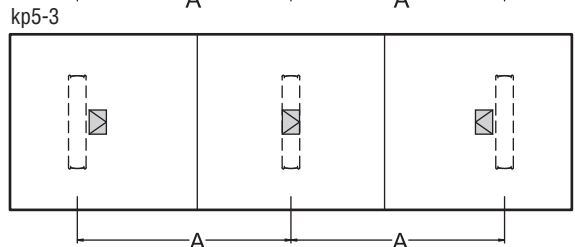
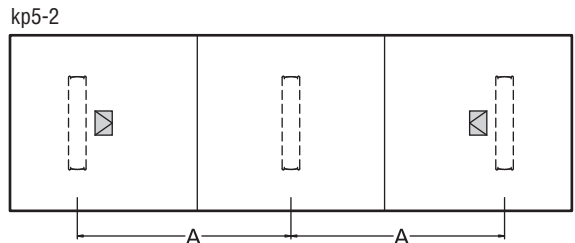

Wood
216" x 60"

A
56"

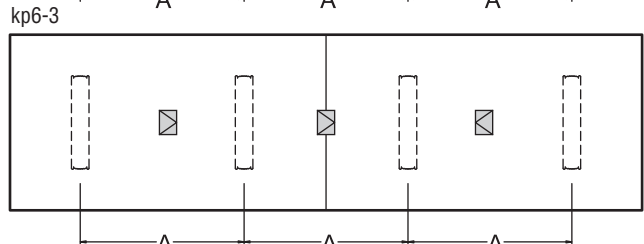
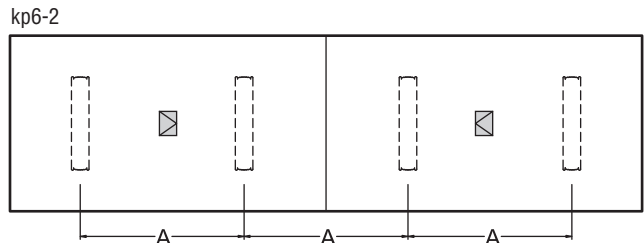

TYPICAL BASE and POWER UNIT LOCATIONS

BLADE & PANEL BASE • WOOD, VIDRO AND STONE TOPS

Wood
216" x 60"

A
56"

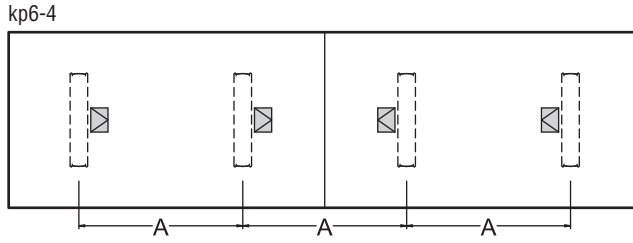

Stone & Vidro
216" x 60"

A
56"

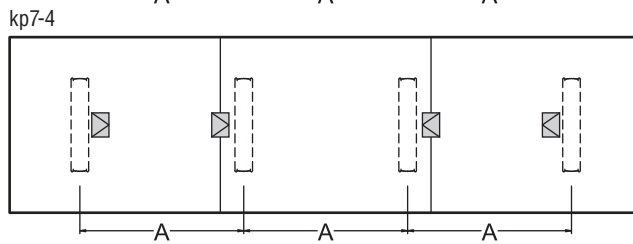
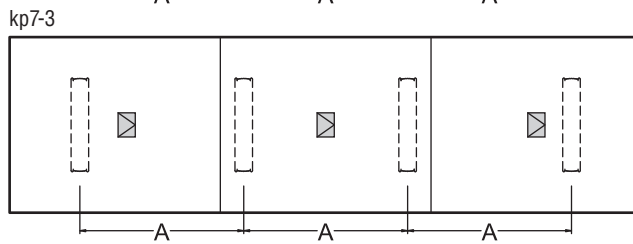
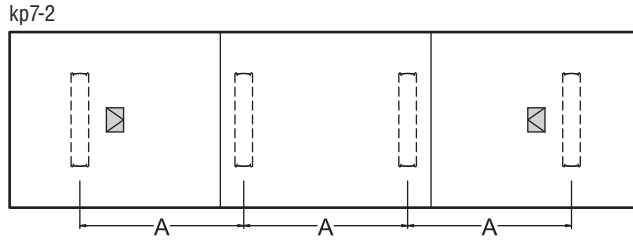

Wood, Stone & Vidro A
240" x 60"

A
64"

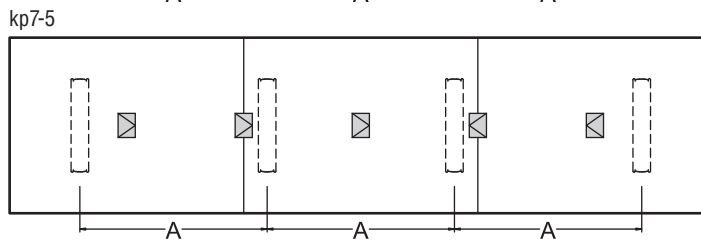
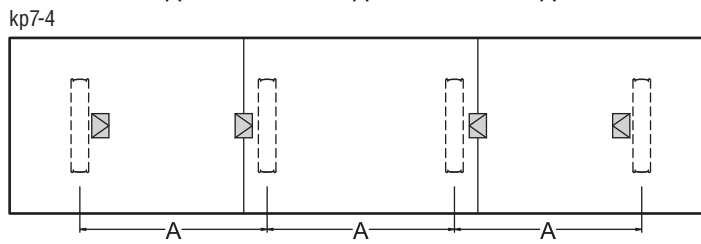
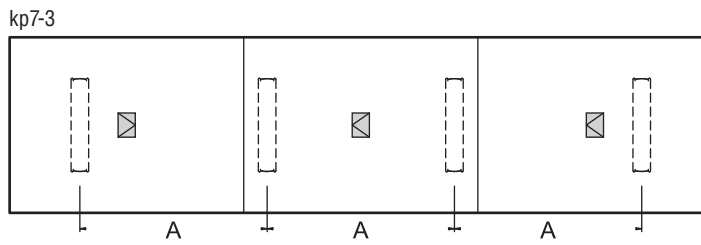

TYPICAL BASE and POWER UNIT LOCATIONS

BLADE & PANEL BASE • WOOD TOPS

ARCED BOAT

Wood
240" x 72"

A
64"

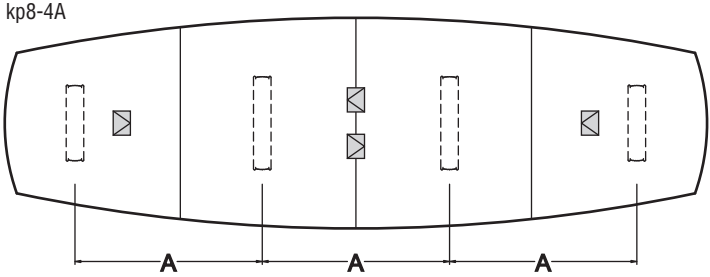
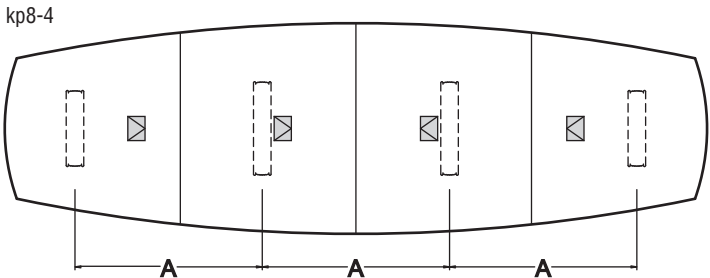
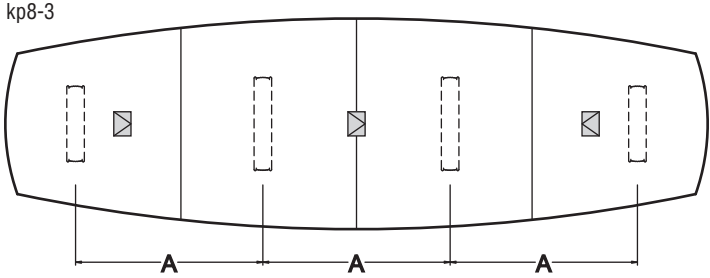

TYPICAL BASE and POWER UNIT LOCATIONS

NEXTT T BASE & KONVERSE T BASE • WOOD, VIDRO AND STONE TOPS

RECTANGLE - ARCED RECTANGLE - ARCED BOAT

Wood, Stone & Vidro A

72" x 36" 32"
 84" x 42" 42"
 96" x 48" 50"

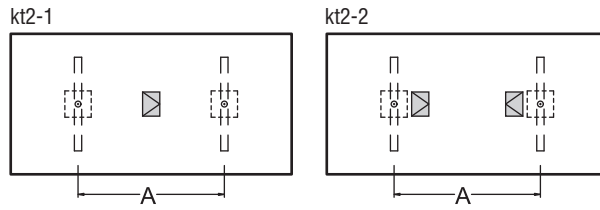

Wood 108" x 48"

A
 62"

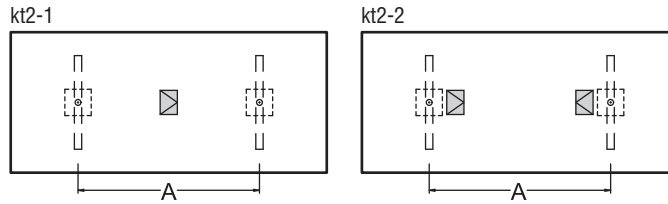

Stone & Vidro 108" x 48"

A
 31"

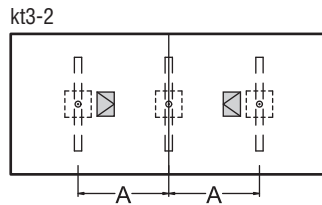

• Center Located Power Unit over T-Base:
 Add \$516.

Wood, Stone & Vidro A

120" x 48" or 60" 37"
 132" x 48" or 60" 43"
 144" x 48" or 60" 49"

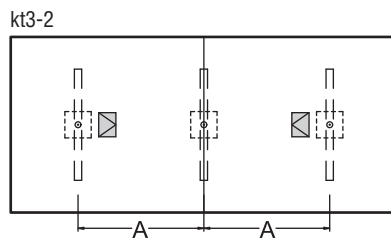

TYPICAL BASE and POWER UNIT LOCATIONS

NEXTT T BASE & KONVERSE T BASE • WOOD, VIDRO AND STONE TOPS

Wood, Stone & Vidro A
168" x 60" 40"

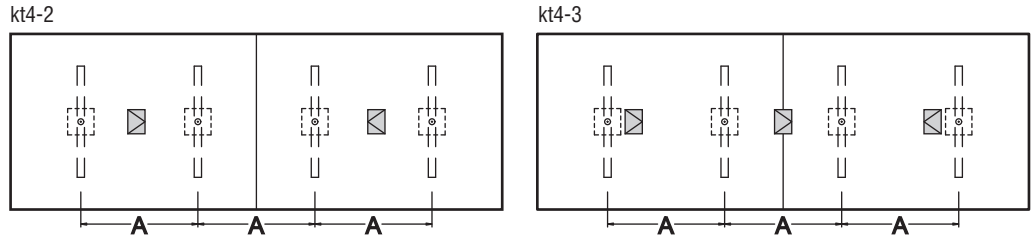

Wood
192" x 60" 48"

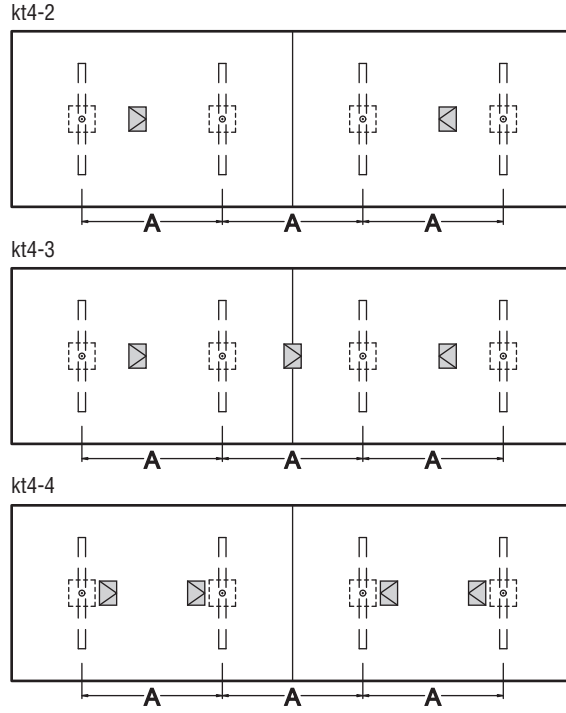

Stone & Vidro
192" x 60" 48"

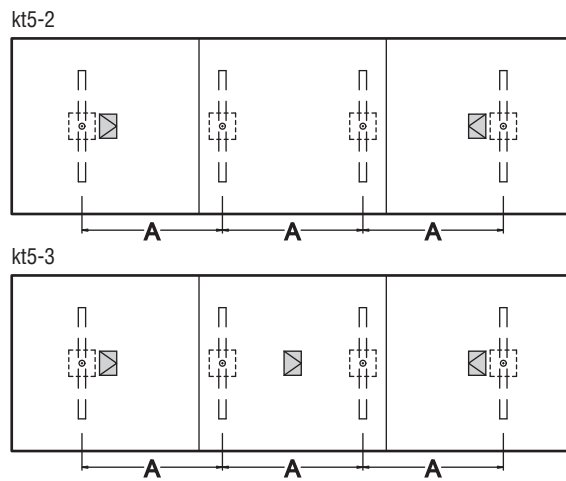

TYPICAL BASE and POWER UNIT LOCATIONS

NEXTT T BASE & KONVERSE T BASE • WOOD, VIDRO AND STONE TOPS

RECTANGLE - ARC'D RECTANGLE - ARC'D BOAT

Wood
216" x 60"

A
42"

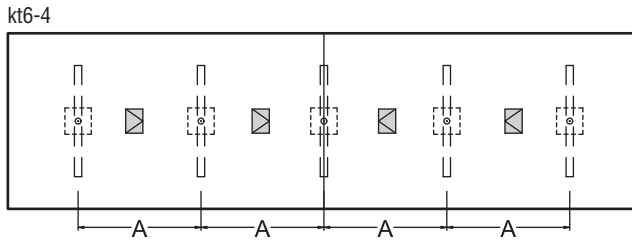
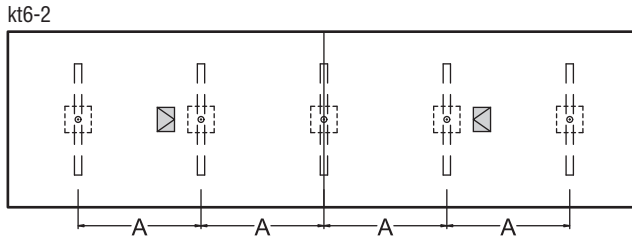

• Center Located Power Unit over T-Base:
Add \$516.

Stone & Vidro
216" x 60"

A
42"

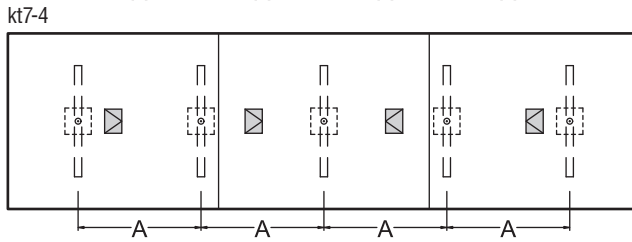
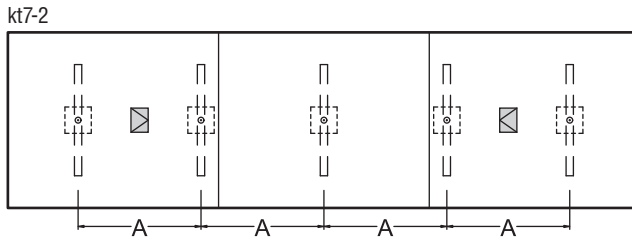

Wood, Stone & Vidro A
240" x 60"

A
48"

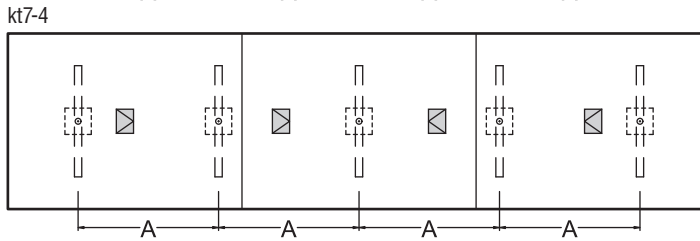
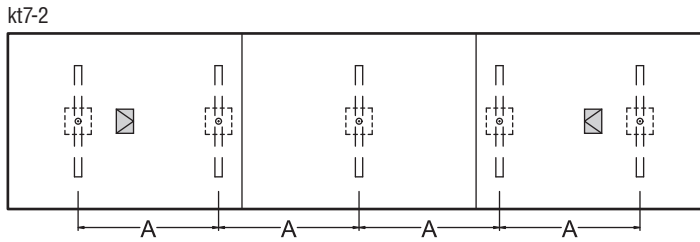

TYPICAL BASE and POWER UNIT LOCATIONS

KABLE T BASE & TUBULAR T BASE & HALF ROUND

4 Column Only
54"
60"

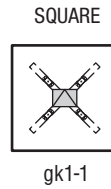
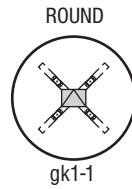

RECTANGLE - BOAT - WEDGE - RACETRACK

Top
72" x 36" or 42" **A** 32"
84" x 42" 42"
96" x 42" or 48" 50"
108" x 48" 62"

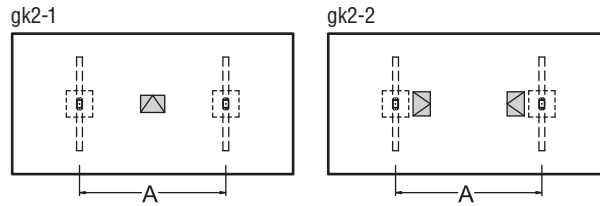

Top
120" x 48" **A** 37"
144" x 48" or 60" 49"

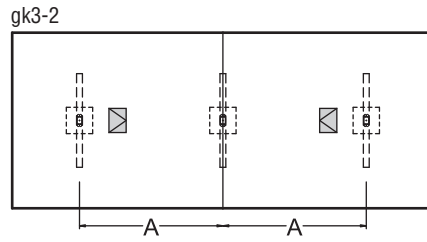

• Center Located Power Unit over T-Base and Cross Base: Add \$516.

Top
168" x 60" **A** 40"
192" x 60" 48"

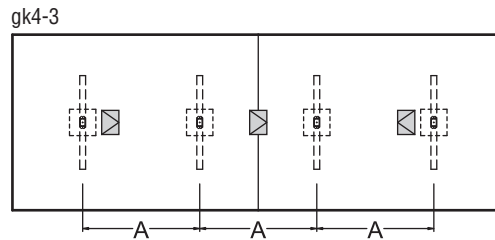
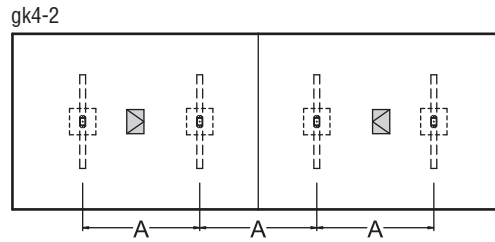

TYPICAL BASE and POWER UNIT LOCATIONS

KABLE T BASE & TUBULAR T BASE & HALF ROUND

RECTANGLE - BOAT - WEDGE - RACETRACK

Top
216" x 60"

A
42"

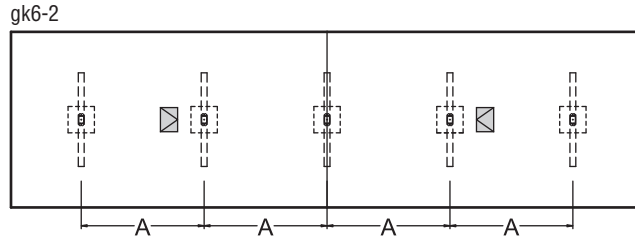

• Center Located Power Unit over T-Base and Cross Base: Add \$516.

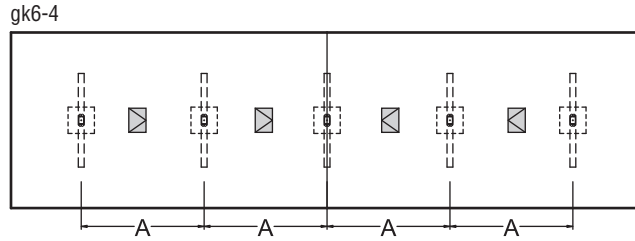

Top
240" x 60"

A
48"

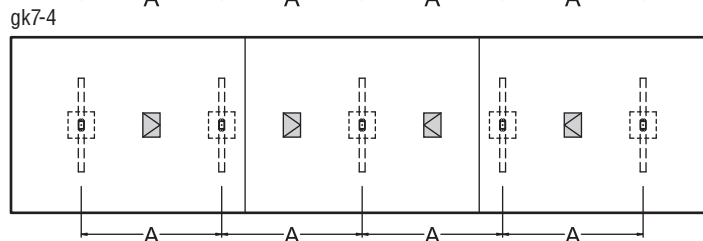
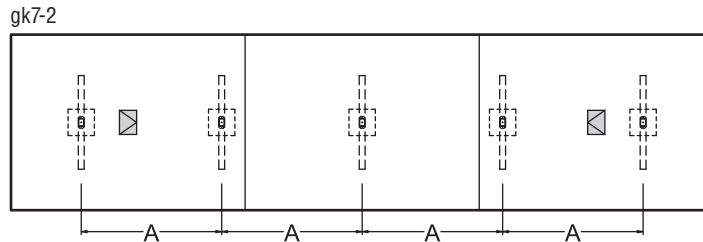

MODULAR

Top
60"
72"
84"
90"

A
24"
32"
42"
44"

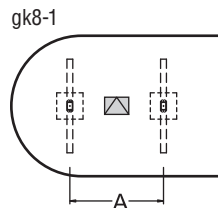
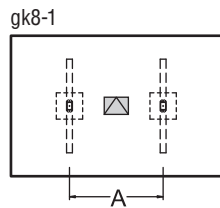

72"
84"
90"

A
32"
42"
44"

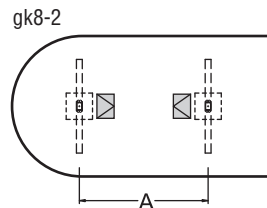
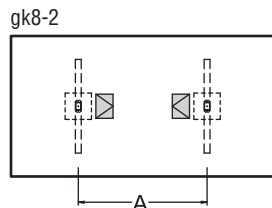

TYPICAL BASE and POWER UNIT LOCATIONS

CUBE BASE • WOOD, VIDRO AND STONE TOPS

Top
42"
48"
54"
60"

ROUND

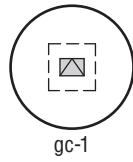

SQUARE

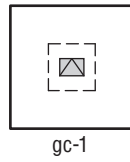

RECTANGLE - BOAT - WEDGE - RACETRACK

Top
84" x 42"
96" x 42" or 48"
108" x 48"

A
36"
42"
54"

gc2-1

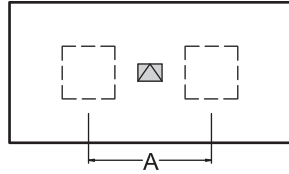

gc2-2

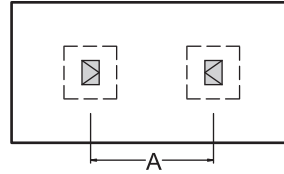

Top
120" x 48"
144" x 48" or 60"

A
56"
78"

gc3-1

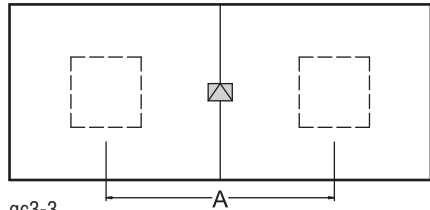

gc3-2

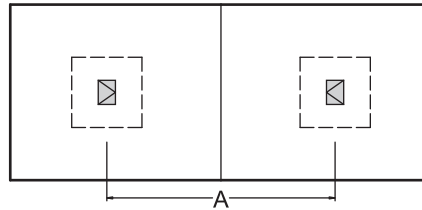

gc3-3

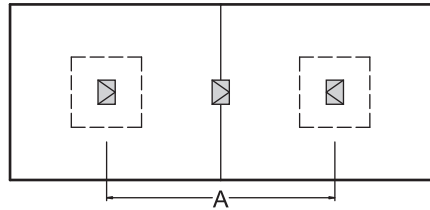

Top
168" x 60"
192" x 60"
216" x 60"

A
52"
63"
74"

gc4-2

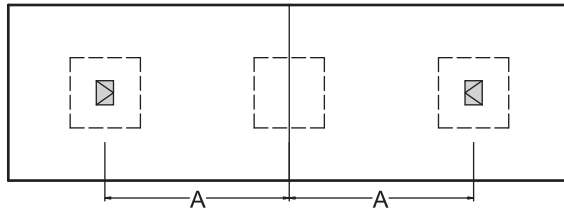

gc4-3

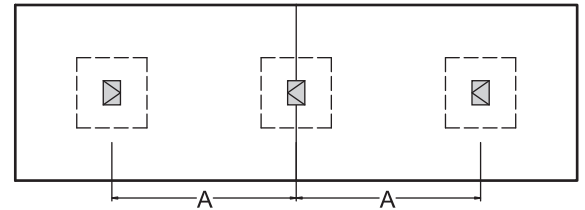

Top
240" x 60"

A
86"

gc5-3

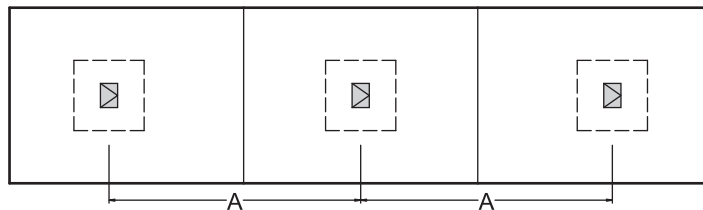

gc5-5

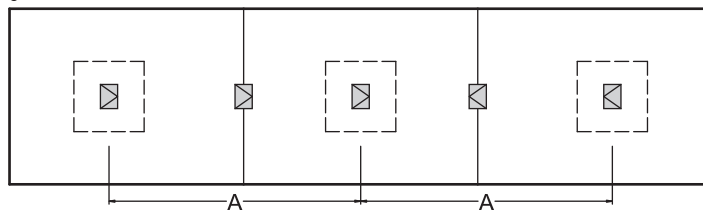

SURFACE RECESSED POWER/COMMUNICATION UNITS

All items below are factory installed. COVE/BOX Access Doors with Frame are Prismatique's proprietary components. Power units are UL Listed and CSA certified. Faceplate connectors must be added.

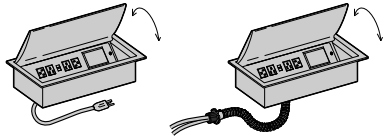

ITEM	DESCRIPTION	LIST
COVEB – 4	BOX 4 (Available Black or White)	\$1079.00
COVEB – 4H	BOX 4 HARDWIRED	\$1079.00
COVEB – 4S	BOX 4 FOR STONE TOP	\$1369.00
COVEB – 4SH	BOX 4 FOR STONE TOP – HARDWIRED	\$1369.00
COVEB – 4V	BOX 4 FOR GLASS TOP	\$1369.00
COVEB – 4VH	BOX 4 FOR GLASS TOP – HARDWIRED	\$1369.00
	Mounts beneath table surface; contains four angled simplex outlets, one angled side and three bottom faceplates. Also includes two USB (2.1) charging outlets. Box is steel. 9' cord with 15 amp plug. Access door is framed, wing shape, flush-fit aluminum available in 21 COLORA colors. Frame (with brushline): 14" x 6". Faceplates extra (see page 32).	
	ADD FOR BRUSHED OR POLISHED FINISH LID	\$501.00
	ADD FOR VENEER OR PAINTED BACK GLASS LID	\$1444.00
	ADD FOR STONE LID	TBA

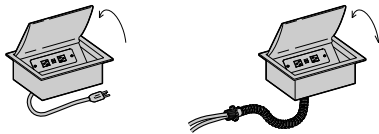

COVEB – 2	BOX 2 (Available Black or White)	\$880.00
COVEB – 2H	BOX 2 HARDWIRED	\$880.00
COVEB – 2S	BOX 2 FOR STONE TOP	\$1171.00
COVEB – 2SH	BOX 2 FOR STONE TOP – HARDWIRED	\$1171.00
COVEB – 2V	BOX 2 FOR GLASS TOP	\$1171.00
COVEB – 2VH	BOX 2 FOR GLASS TOP – HARDWIRED	\$1171.00
	Mounts beneath table surface; contains two angled simplex outlets and two bottom faceplates. Also includes two USB (2.1) charging outlets. Box is steel. 9' cord with 15 amp plug. Access door is framed, wing shape, flush-fit aluminum available in 21 COLORA colors. Frame (with brushline): 8" x 6". Faceplates extra (see page 32).	
	ADD FOR BRUSHED OR POLISHED FINISH LID	\$414.00
	ADD FOR VENEER OR PAINTED BACK GLASS LID	\$1390.00
	ADD FOR STONE LID	TBA



INT	INTERACT	\$444.00
INT – H	INTERACT HARDWIRED	\$444.00
INT – S	INTERACT FOR STONE TOP	\$735.00
INT – SH	INTERACT FOR STONE TOP – HARDWIRED	\$735.00
	Recessed power/communication unit with two angled simplex outlets and one angled side faceplate with a simplex outlet under box for daisy chaining. Two pre-punched inserts below simplex allow up to four added RJ45 or RJ11. Lid flush notched. Black and silver finish only with 9' cord with 15 amp plug. 8 1/2" x 5". Faceplates extra (see page 32).	

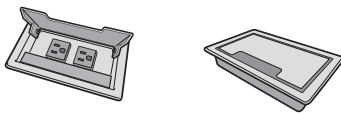

INTP	PRESET SMALL INTERACT	\$555.00
INTP – H	PRESET SMALL INTERACT HARDWIRED	\$555.00
INTP – S	PRESET SMALL INTERACT FOR STONE TOP	\$832.00
INTP – SH	PRESET SMALL INTERACT FOR STONE TOP – HARDWIRED	\$832.00
INTP – V	PRESET SMALL INTERACT FOR GLASS TOP	\$832.00
INTP – VH	PRESET SMALL INTERACT FOR GLASS TOP – HARDWIRED	\$832.00
	Preset recessed power/communication box with two simplex outlets and two RJ45 cat 6 data jacks located on flat bottom of unit. One additional simplex unit under box provides cord daisy chaining option. Flush Notched access lid includes brushline. Black and silver lid color options with 6' cord with 15 amp plug. 8 3/4" x 3 1/2".	

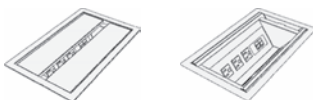

RETRACT	POWER/COMM RETRACT	\$2142.00
RETRACT – H	POWER/COMM HARDWIRED	\$2142.00
RETRACT – S	POWER/COMM FOR STONE TOP	\$2387.00
RETRACT – SH	POWER/COMM FOR STONE TOP – HARDWIRED	\$2387.00
RETRACT – V	POWER/COMM FOR GLASS TOP	\$2540.00
RETRACT – VH	POWER/COMM FOR GLASS TOP – HARDWIRED	\$2540.00
	Recessed power/communication unit mounts beneath table surface. Contains six angled simplex outlets and two angled side faceplates. Box is steel with 9' cord and 15 amp plug. Integral twin aluminum doors retract/telescope within the unit providing optimum access. Black painted and natural silver pearl aluminum door color options: 15" x 9". Faceplates extra (see page 32).	

UNDERTOP POWER/COMMUNICATION APRON and UTP UNITS

As an option to recessed surface units, power and communications can be located anywhere along a perimeter undertop apron. Apron is MDF construction attached to subtop. Finish is standard colors of textured colors. UTP power units are flush mounted to apron, quantity and spacing based as specifications.

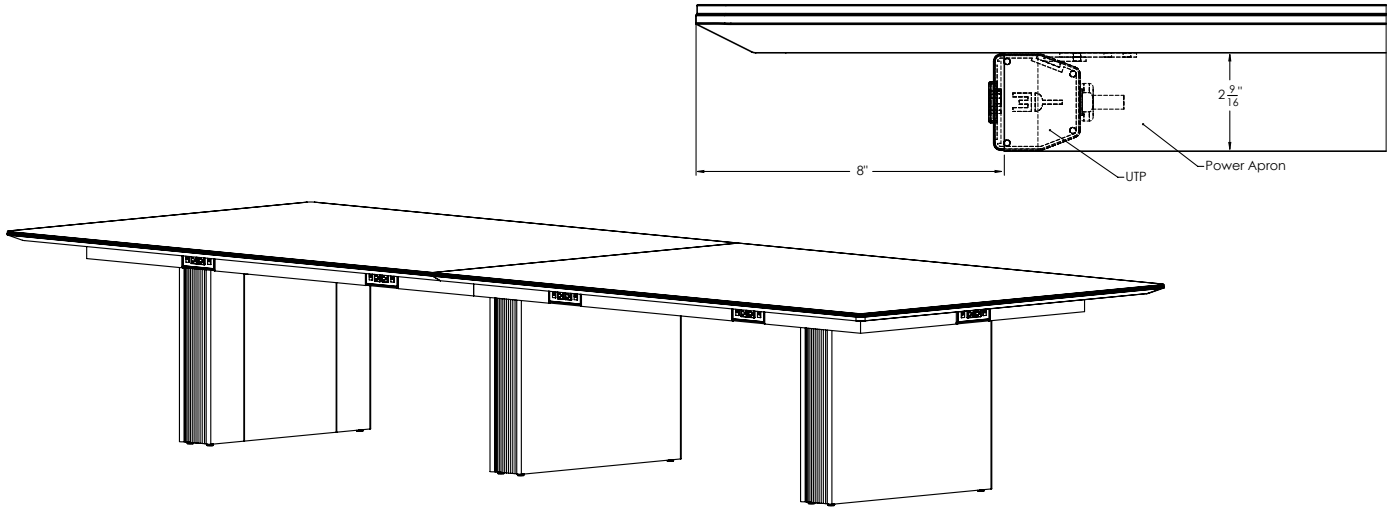

LIST PRICES ARE FOR CONTINUOUS, 3”H PERIMETER APRON RECESSED 8” FROM TABLE EDGE. PRICES DO NOT INCLUDE UTP UNITS.

ROUND/SQUARE	QTY1	QTY3	QTY10
48" dia	1983	1761	1333
54" dia	2231	2010	1555
60" dia	2479	2257	1778
72" dia	2975	2753	2000

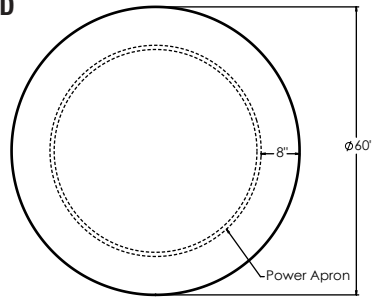

RECTANGLE/ARCED REC	QTY1	QTY3	QTY10
72" x 36"	2518	2076	1334
84" x 42"	2569	2128	1334
96" x 48"	2621	2179	1334
108" x 48"	2655	2214	1334
120" x 48" or 60"	3387	2945	2000
132" x 48" or 60"	3420	2979	2000
144" x 48" or 60"	3677	3234	2223
168" x 60"	3745	3302	2223
192" x 60"	4034	3593	2445
216" x 60"	4103	3883	2667
240" x 60" or 72"	4869	4426	3111

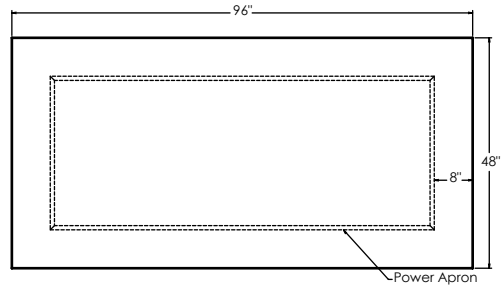

BOAT/WEDGE	QTY1	QTY3	QTY10
72" x 36"	2518	2076	1334
84" x 42"	2569	2128	1334
96" x 48"	2621	2179	1334
108" x 48"	2655	2214	1334
120" x 48" or 60"	3608	3165	2223
132" x 48" or 60"	3642	3200	2223
144" x 48" or 60"	3897	3455	2445
168" x 60"	3965	3524	2445
192" x 60"	4255	3814	2667
216" x 60"	4545	4103	2889
240" x 60" or 72"	4869	4426	3111

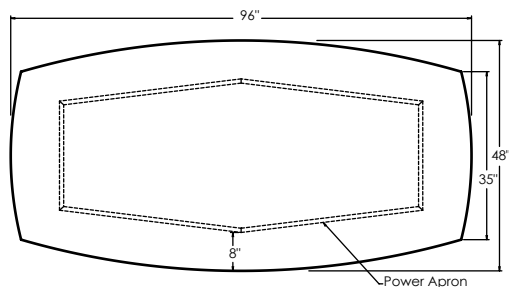

UNDERTOP POWER/COMMUNICATION UTP and COVE UNITS and DAISYLINK

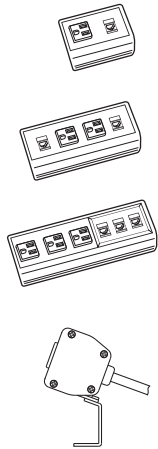

ITEM	DESCRIPTION	LIST
UTP	UNDERTOP POWER UNIT Preset power/communications unit includes flat bracket for undertop connection. Can also be mounted within continuous undertop IT aprons. Black finish. 6' cord with 15 amp plug.	
UTP - 1 - 1	(one simplex + one RJ45) 3 1/2" x 2 1/4" x 2 1/2" H	\$251.00
UTP - 2 - 2	(two simplex + two RJ45) 6 1/2" x 2 1/4" x 2 1/2" H	\$305.00
UTP - 3 - 1	(three simplex + one faceplate. See page 12) 8 1/4" x 2 1/4" x 2 1/2" H	\$325.00
	ADD FOR SILVER FINISH	\$87.00
	ADD FOR TTP (TABLETOP) ANGLE BRACKET	\$65.00

UTP - DL	UNDERTOP POWER UNIT W. DAISYLINK As per UTP except unit is modified to receive encased interconnect cables for daisychain application. Provides 4 wire/2 circuit system. Requires added Power Infeed and Interconnect Cables. Refer to page.	
UTP -DL - 1 - 1	(DAISYLINK)	\$283.00
UTP -DL - 2 - 2	(DAISYLINK)	\$338.00
UTP -DL - 3 - 1	(DAISYLINK)	\$358.00
	ADD FOR SILVER FINISH	\$87.00

REV 05.05.15

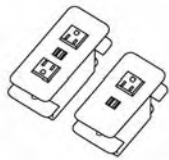

COVE	COVE FLUSH MOUNT UNITS WITH USB CHARGING PORTS	
COVE-1-2	(one simplex + two charging USB's) 5" x 2 1/2" x 3 1/4" H (Black, White or Silver)	\$468.00
COVE-2-2	(two simplex + two charging USB's) 5 3/4" x 2 1/2" x 3 1/4" H (Black, White or Silver)	\$489.00

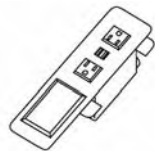

COVE-D	COVE FLUSH MOUNT UNITS WITH USB CHARGING PORTS AND DATA CAPABILITY	
COVE-D-2-2	(two simplex + two charging USB's + one face plate) 9 1/2" x 2 1/2" x 3 1/4" H (Black, White or Silver)	\$498.00

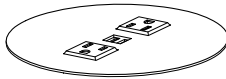

COVE-R	COVE ROUND SERIES	
COVE-R	(two simplex + two charging USB's) 6" dia x 3 1/4" H (Black, White or Silver)	\$498.00
	ADD FOR STONE + VIDRO PBG TOPS	\$480.00



INTP - DL - PI	DAISYLINK POWER INFEED CABLES	
	4 wire, 2 circuit hardwire power infeed	
	72"	\$113.00
	144"	\$183.00















INTP - DL - IC	DAISYLINK INTERCONNECTING CABLES	\$61.00
	ADD PER INCH OF CABLE	\$1.10/inch

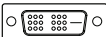



INTP - DL - T	DAISYLINK "T" CONNECTOR	\$131.00
	Intersection/junction point of interconnecting cables	

VOICE – NETWORK – PRESENTATION PORTS

All connector modules listed below are mounted on telecom faceplates which snap into surface power/communication units. Supply cables and/or plugs are not supplied and must be hardwired on location by specialists. If no connectors are specified, faceplates are supplied blank. Faceplate capacity is up to 4 ports; more can be accommodated depending on the types required.

ITEM	LIST
 RJ45 DATA JACK • Cat6 • Siemons • Orange/Black Icon • Hardwired	\$68.00
 RJ11 VOICE JACK • Cat3 • Siemons • White/Black Icon • Hardwired	\$45.00
 USB CONNECTOR • A or B Type • Peripherals • Female	\$68.00
USB 3.0 CHARGING (includes transformer)	\$205.00
 DB9 9 PIN CONNECTOR • Whiteboard, Video Imaging • Female/Female	\$74.00
 VGA CONNECTOR 15 PIN VGA CONNECTOR • Computer, Video • Female/Female	\$117.00
 DVI Digital Visual Interface	\$174.00
 HDMI High Definition Multi Media Interface	\$131.00
 MINI STEREO AUDIO JACK • 3.5mm • Female/Solder	\$14.00
 RCA AUDIO/VIDEO PORT • White, Red or Yellow • Female/Female	\$29.00
 XLR 4 PIN CONNECTOR • Audio (microphones, etc.) • Female/Solder	\$138.00
 S VIDEO SVHS CONNECTOR • Audio Visual • Female/Solder	\$147.00
 BLANK FACEPLATE	\$25.00
 CORDMINDER PLATE	\$57.00

SAMPLE FACEPLATES include many of more popular combos with item # and total list price. Telecom faceplates measuring 3 1/8" x 1 3/4" may be specified in a variety of configurations for connections to voice, network, multimedia and presentation equipment. Below are a few samples.

	(1) RJ11 (1) RJ45
	(1) USB (1) S VIDEO (1) RJ45

WIRE MANAGEMENT • MISCELLANEOUS

ITEM	LIST
COM POWER UNIT cutout only up-charge	(laminate/veneer) \$250.00 (glass/stone) \$580.00
COM POWER UNIT housing only up-charge - (laminate/veneer) N/A (glass/stone) \$979.00	
COM POWER UNIT housing + glass lid up-charge - (laminate/veneer) N/A (glass) \$2395.00	
MICROPHONE HOLE cutout up-charge	(laminate/veneer) \$35.00 (glass/stone) \$107.00
GROM1 GROMMET • 2 1/4' dia. (3" dia. Cover). Black or Silver	\$35.00
GROM2 GROMMET • 1 3/4" dia. (2 3/4" dia. Cover). Black. Grommets are factory installed.	\$35.00
GROM3 2" dia BRUSHED GROMMET.	(laminate/veneer) \$154.00 (glass/stone) \$230.00
GROM4 2" dia POLISHED GROMMET.	(laminate/veneer) \$164.00 (glass/stone) \$240.00
WHV HORIZONTAL WIRE MANAGER Self stick. Price per foot. Supplied (no charge) with Surface Power/Communication Units.	\$14.00 /ft.
LWM LARGE WIRE MANAGER Supplied (no charge) with all meeting table series.	\$26.00 /ft.
IT PODIUM 10" x 10" tabletop to floor box with hinged access door (colora) \$1970.00 (brushed or polished stainless steel) \$2166.00	
SNAKE VERTICAL WIRE MANAGER Flexible wire through in Black or Silver. 2 1/2" dia. X 32" long; 4" dia. Weighted base.	\$211.00
LM LEG WIRE MANAGER Snap on table legs. Approx. 24" long. Supplied (no charge) with Surface Power/Communication Units. Black.	\$35.00
PBS POWER BAR • SUPPRESSOR Single circuit power bar with six 15 amp outlets, off/on switch with light indicator, surge suppressor and noise filter. Provides maximum protection for computers and other electronic equipment. Metal housing. 6' cord.	\$376.00

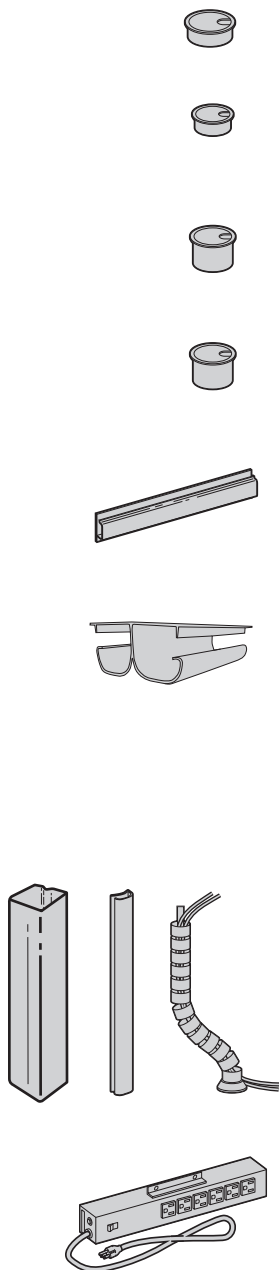



BLADE BASE TABLES • LAMINATE and VENEER TOPS

All table tops, except for veneer with wood edge feature inlays between top surface and edge in matching color to either top or edge unless specified otherwise. Standard base finish is COLORA colors; veneer and stainless steel base upcharges are shown below. Tables are 29" high.

Specify: model number – top finish – edge profile and finish – inlay color (if applicable and in contrast color) – base finish – power and comm. options.

ITEM TOP DIMENSIONS

ROUND

501-48	48" dia.
501-54	54" dia.
501-60	60" dia.
501-72 (Center seam in laminate)	72" dia.

SQUARE

507-48	48" x 48"
507-54	54" x 54"
507-60	60" x 60"

RECTANGLE

505-8442	84" x 42"
505-9648	96" x 48"
505-1084	108" x 48"

sectioned tops

505-1204	120" x 48"
505-1324	132" x 48"
505-1444	144" x 48"
505-1206	120" x 60"
505-1326	132" x 60"
505-1446	144" x 60"

505-1686	168" x 60"
505-1926	192" x 60"
505-2166	216" x 60" (Four bases)
505-2406 (Top in 3 sections)	240" x 60" (Four bases)

ARCED RECTANGLE

508-8442	84" x 42"
508-9648	96" x 48"
508-1084	108" x 48"

sectioned tops

508-1204	120" x 48"
508-1324	132" x 48"
508-1444	144" x 48"
508-1206	120" x 60"
508-1326	132" x 60"
508-1446	144" x 60"

508-1686	168" x 60"
508-1926	192" x 60"
508-2166	216" x 60" (Four bases)
508-2406 (Top in 3 sections)	240" x 60" (Four bases)

- Center Located Power Unit: Add \$516.
- Vertical Infeed/Wire Manager (attach to any base - 10"W x 1 1/4"D)
Add: \$742 (Colora). \$857 (Veneer). \$910 (Stain Steel)

PLASTIC LAMINATE or COLORA TOP

VENEER TOP

ADD BASE UPGRADES

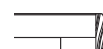
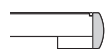
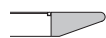
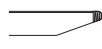
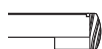
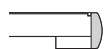
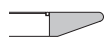

RB or RAD Colora
QTY1 QTY 3

RAD Wood
QTY1 QTY 3

RB Wood
QTY1 QTY 3

RB or RAD Colora
QTY1 QTY 3

RAD Wood
QTY1 QTY 3

ADD BASE UPGRADES
VENEER BRUSH + POL STAIN.

4496	3776	5225	4340	5549	4689	5617	4533	5883	4801	877	3069
5319	4351	6066	4958	6472	5322	6806	5379	7106	5678	953	3180
5840	4797	6606	5447	6766	5655	7559	5966	7891	7440	953	3545
7635	6197	8466	6914	7921	6811	9697	7608	10094	8007	1021	3888
4496	3776	5387	4447	4987	4146	5617	4533	5955	4872	877	3069
5259	4775	6152	5462	5881	5225	6746	5801	7128	6184	953	3180
5840	5281	6884	6080	6407	6066	7559	6450	7983	6871	953	3545
4897	4234	5822	4969	5734	4877	6471	5336	6261	5343	877	2293
5180	4470	6103	5220	6526	5522	7606	6235	7284	6185	953	2738
5758	4970	6690	5739	6956	5874	8211	6714	7838	6641	953	2738
6452	5477	8159	6999	7845	6894	9446	7758	8884	7533	953	2738
6668	5663	8522	7282	8465	7378	9824	8064	9261	7825	953	2738
8268	6985	10272	8688	10091	8758	11588	9494	11025	9253	1427	4086
7121	6057	8913	7634	8929	7760	10390	8468	9764	8200	1024	2947
7289	6199	9446	7848	9348	8113	10856	8797	10222	8552	1024	2947
8985	7609	11053	9335	11074	9624	12788	10366	12142	10113	1536	4407
10111	8639	12457	10516	12518	10867	13992	11243	13325	11102	1536	4407
10440	8919	13065	10946	13690	11871	14924	11902	14236	11798	1536	4407
12940	11246	15841	13428	16124	14119	17116	13807	16408	13744	2047	5896
13794	11903	17212	14518	18005	15810	19291	16147	18107	15161	2047	5896
4976	4285	6072	5128	6388	5477	6797	5555	7241	5998	877	2293
5268	4529	6361	5385	7254	6142	8020	6515	8529	7022	953	2738
5543	5034	6956	5909	7729	6491	8672	7027	9221	7577	953	2738
6271	5562	8615	7331	9159	7353	10024	8163	10617	8867	953	2738
6801	5751	7860	7628	9437	7715	10423	8481	11057	9070	953	2738
8403	7074	10778	9045	11102	9240	12207	9918	12885	10526	1427	4086
7258	6148	9395	7980	9920	8198	11020	8897	11655	9486	1024	2947
7429	6289	9723	8207	10438	8622	11513	9238	12189	9869	1020	2947
9130	7706	11585	9705	12159	10120	13469	10817	14189	11465	1536	4407
10262	8741	13036	10910	13353	11242	14727	11716	15533	12521	1536	4407
10601	9025	13693	11361	14585	12076	15711	12397	16600	13285	1536	4407
13112	11357	16520	13867	17272	14944	17958	15381	18930	15296	2047	5895
14001	12038	18042	15065	19273	16734	20015	16773	21073	17037	2047	5895

• Undertop IT trough with removable side panels - custom quote required.

BLADE BASE TABLES • LAMINATE and VENEER TOPS

All table tops, except for veneer with wood edge feature inlays between top surface and edge in matching color to either top or edge unless specified otherwise. Standard base finish is COLORA colors; veneer and stainless steel base upcharges are shown below. Tables are 29" high.

Specify: model number – top finish – edge profile and finish – inlay color (if applicable and in contrast color) – base finish – power and comm. options.

ITEM

TOP DIMENSIONS

ARCED BOAT

506-8442	84" x 42"/30"
506-9648	96" x 48"/35"
506-1084	108" x 48"/35"

sectioned tops

506-1204	120" x 48"/35"
506-1324	132" x 48"/35"
506-1444	144" x 48"/35"
506-1206	120" x 60"/42"
506-1326	132" x 60"/42"
506-1446	144" x 60"/42"

506-1686	168" x 60"/42"
506-1926	192" x 60"/42"
506-2166	216" x 60"/42" (Four bases)
506-2406 (Top in 3 sections)	240" x 60"/42" (Four bases)
506-2407 (Top in 4 sections)	240" x 72"/48" (Four bases)

ARCED WEDGE

509-8448	84" x 48"/28"
509-9648	96" x 48"/28"
509-1084	108" x 48"/28"

Sectioned tops

509-1206	120" x 60"/35"
509-1326	132" x 60"/35"
509-1446	144" x 60"/35"

509-1686	168" x 60"/35"
509-1926	192" x 60"/35"
509-2166	216" x 60"/35" (Four bases)
509-2406 (Top in 3 sections)	240" x 60"/35" (Four bases)

- Center Located Power Unit: Add \$516.
- Vertical Infeed/Wire Manager (attach to any base - 10"W x 1 1/4"D)
Add: \$742 (Colora). \$857 (Veneer). \$910 (Stain Steel)

PLASTIC LAMINATE or COLORA TOP

VENEER TOP

ADD BASE UPGRADES

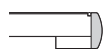
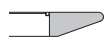

RB or RAD Colora
QTY1 QTY 3

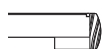

RAD Wood
QTY1 QTY 3

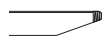

RB Wood
QTY1 QTY 3

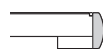
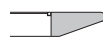

RB or RAD Colora
QTY1 QTY 3

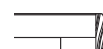

RAD Wood
QTY1 QTY 3

VENEER **BRUSH + POL STAIN.**

4976	4285	6072	5661	6388	5477	6797	5555	7241	5998	877	2293
5254	4514	6345	5949	7254	6142	8020	6515	8529	7022	877	2293
5817	4999	6923	6478	7729	6491	8672	7027	9221	7577	877	2293

6528	5512	8564	7299	9159	7353	10024	8163	10617	8867	877	2293
6731	5682	8934	7560	9437	7715	10423	8481	11057	9070	877	2293
9106	7762	11482	9732	11102	9240	12207	9918	12885	10526	1354	3780
7211	6101	9348	7934	9920	7053	11020	8897	11655	9486	953	2738
7380	6242	9675	8161	10438	8622	11513	9238	12189	9869	953	2738
9750	8311	12205	10310	12159	10120	13469	10817	14189	11465	1464	4086

10613	9085	13386	11255	13353	11242	14727	11716	15533	12521	1464	4086
10953	9371	14045	11707	14585	12076	15711	12397	16601	13285	1464	4086
13465	11702	16869	14211	17272	14944	17958	15381	18930	15296	1975	5895
14351	12383	18390	15409	19273	16734	20015	16773	21073	17037	1975	5895
15789	13590	20470	17054	22625	19658	23270	22912	24370	20049	2530	8298

5424	4720	6563	5607	6583	5631	8379	6615	8844	7081	916	2393
6799	4906	6747	5762	7010	5981	8407	6891	8914	7398	916	2393
6238	5410	7343	6286	7441	6335	9058	7403	9607	7953	916	2393

7596	6477	9734	8311	8877	780	11359	9234	11981	9818	916	2393
7767	6621	10062	8538	9349	8272	11850	9575	12527	10201	916	2393
9708	8270	12161	10271	11526	10145	14048	11395	14766	12029	1426	4086

10571	9043	13341	11212	12421	10936	15035	12021	15840	12823	1426	4086
10911	9329	14001	11664	13319	11737	16020	12701	16908	13589	1426	4086
13678	11917	17086	14425	17838	15511	18523	14882	19497	15856	1901	5872
14568	12597	18610	15623	19840	17302	20581	17068	21639	18126	1901	5872

• Undertop IT trough with removable side panels - custom quote required.

BLADE BASE TABLES • VIDRO PAINTED BACK GLASS TOP

See standard color choices. Customer's own color must be pre-approved through custom quotation.

Bases standard in COLORA see optional base upgrades. Polished and Brushed Stainless options upcharged. Tables are 29" high.

ITEM TOP DIMENSIONS

ROUND

501V-48	48" dia.
501V-54	54" dia.
501V-60	60" dia.

SQUARE

507V-48	48" x 48"
507V-54	54" x 54"
507V-60	60" x 60"

RECTANGLE

505V-8442	84" x 42"
505V-9648	96" x 48"
505V-1084 (Top in 2 sections)	108" x 48"

sectioned tops

505V-1204	120" x 48"
505V-1324	132" x 48"
505V-1444	144" x 48"
505V-1206	120" x 60"
505V-1326	132" x 60"
505V-1446	144" x 60"

505V-1686	168" x 60"
505V-1926 (Top in 3 sections)	192" x 60"
505V-2166 (Top in 3 sections)	216" x 60" (Four bases)
505V-2406 (Top in 4 sections)	240" x 60" (Four bases)

ARCED RECTANGLE

508V-8442	84" x 42"
508V-9648	96" x 48"
508V-1084 (Top in 2 sections)	108" x 48"

sectioned tops

508V-1204	120" x 48"
508V-1324	132" x 48"
508V-1444	144" x 48"
508V-1206	120" x 60"
508V-1326	132" x 60"
508V-1446	144" x 60"

508V-1686	168" x 60"
508V-1926 (Top in 3 sections)	192" x 60"
508V-2166 (Top in 3 sections)	216" x 60" (Four bases)
508V-2406 (Top in 4 sections)	240" x 60" (Four bases)

- Center Located Power Unit: Add \$516.
- Vertical Infeed/Wire Manager (attach to any base - 10"W x 1 1/4"D)
Add: \$742 (Colora). \$857 (Veneer). \$910 (Stain Steel)

PAINTED BACK GLASS TOP (CL GLASS)

MATTE (MA GLASS)

ADD BASE UPGRADES

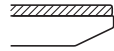

1 1/4" RB

QTY1 QTY3

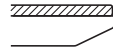

1 1/4" RB

QTY1 QTY3

ADD
CRATE
NET \$

veneer

BRUSH +
POL STAIN

5829	5199	6834	6159	153	877	3069
6965	6132	8200	7322	172	958	3071
7639	6806	9129	8251	191	958	3545
5741	5152	6731	6098	153	877	3069
6965	6726	8200	7916	172	958	3180
7638	6936	9128	8381	191	958	3545
7242	6815	8773	8302	243	877	2293
8271	7829	10192	9706	277	958	2737
9701	8877	11840	10972	312	958	2737
10639	9714	13217	12159	347	958	2738
11104	10181	13878	12822	382	958	2738
13957	12719	16949	15578	416	1427	2942
11857	10931	14924	13866	382	1024	2947
12701	11772	16058	14996	420	1024	2947
15760	14520	19406	18033	458	1536	4407
16960	15720	21095	19724	535	1536	4407
19616	18373	24507	23131	611	1536	4407
22607	21316	28076	26653	686	2047	5895
24052	22756	30033	28604	762	2047	5895
7921	7483	9565	9082	243	877	2293
9157	8717	11225	10740	277	958	2737
9873	9433	12177	11693	312	958	2737
11801	10874	14562	13502	347	958	2738
12397	11468	15373	14311	382	958	2738
14549	13345	17760	16424	416	1427	4086
13290	12362	16586	15526	382	1024	2738
14272	13343	17881	16819	420	1024	2738
16773	15563	21184	19842	458	1536	4407
18533	17308	22989	21632	535	1536	4407
21464	20238	26721	25362	611	1536	4407
24246	22975	30127	28724	686	2047	5895
26333	25055	32772	31361	762	2047	5895

- Undertop IT trough with removable side panels - custom quote required.
- Vidro Art option require additional details - custom quote required.

BLADE BASE TABLES • VIDRO PAINTED BACK GLASS TOP

See standard color choices. Customer's own color must be pre-approved through custom quotation.

Bases standard in COLORA see optional base upgrades. Polished and Brushed Stainless options upcharged. Tables are 29" high.

ITEM

TOP DIMENSIONS

ARCED BOAT

506V-8442	84" x 42"/30"
506V-9648	96" x 48"/35"
506V-1084 (Top in 2 sections)	108" x 48"/35"

sectioned tops

506V-1204	120" x 48"/35"
506V-1324	132" x 48"/35"
506V-1444	144" x 48"/35"
506V-1206	120" x 60"/42"
506V-1326	132" x 60"/42"
506V-1446	144" x 60"/42"

506V-1686	168" x 60"/42"
506V-1926 (Top in 3 sections)	192" x 60"/42"
506V-2166 (Top in 3 sections)	216" x 60"/42" (Four bases)
506V-2406 (Top in 4 sections)	240" x 60"/42" (Four bases)

ARCED WEDGE

509V-8448	84" x 48"/28"
509V-9648	96" x 48"/28"
509V-1084 (Top in 2 sections)	108" x 48"/28"

Sectioned tops

509V-1206	120" x 60"/35"
509V-1326	132" x 60"/35"
509V-1446	144" x 60"/35"

509V-1686	168" x 60"/35"
509V-1926 (Top in 3 sections)	192" x 60"/35"
509V-2166 (Top in 3 sections)	216" x 60"/35" (Four bases)
509V-2406 (Top in 4 sections)	240" x 60"/35" (Four bases)

- Center Located Power Unit: Add \$516.
- Vertical Infeed/Wire Manager (attach to any base - 10"W x 1 1/4"D)
Add: \$742 (Colora). \$857 (Veneer). \$910 (Stain Steel)

PAINTED BACK GLASS TOP (CL GLASS)

MATTE (MA GLASS)

ADD BASE UPGRADES

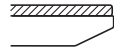

1 1/4" RB

QTY1 QTY3

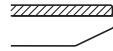

1 1/4" RB

QTY1 QTY3

ADD
CRATE
NET \$

veneER

BRUSH +
POL STAIN

7921	7483	9565	9082	243	877	2293
9141	8701	11209	10724	277	877	2293
9837	9399	12141	11659	312	877	2293
11747	10823	14508	13451	347	877	2293
12322	11399	15298	14242	382	877	2293
15286	14049	18497	17128	416	1354	3780
13242	12315	16538	15479	382	953	2737
14223	13296	17832	16772	420	953	2737
17421	16182	21342	19970	458	1464	4086
18900	17658	23356	21982	535	1464	4086
21832	20588	27089	25712	611	1464	4086
25099	23809	30980	29558	686	1975	5895
26822	25526	33261	31832	762	1975	5895
8845	8388	10676	10175	243	916	2393
9264	9104	11332	11127	277	916	2393
10278	9589	12582	11849	312	916	2393
13646	12700	16942	15864	382	916	2393
14628	13682	18237	17158	420	916	2393
17377	16141	21298	19929	458	1426	4086
18856	17617	23312	21941	535	1426	4086
21788	20547	27045	25671	611	1426	4086
25325	24027	31206	29776	686	1901	5872
27049	25744	33488	32050	762	1901	5872

- Undertop IT trough with removable side panels - custom quote required.
- Vidro Art option require additional details - custom quote required.

BLADE BASE TABLES • STONE TOP

See selection of top and base finishes. Standard base finish is COLORA colors; veneer and stainless steel base upcharges are shown below. Tables are 29" high. Crate charge applies to stone tops.

Note: 60" wide marble tops are subject to availability – please inquire.

Specify: model number – stone top variety – edge profile – base finish – power and comm. options.

ITEM TOP DIMENSIONS

ROUND

501M-48	48" dia.
501M-54	54" dia.
501M-60	60" dia.

SQUARE

507M-48	48" x 48"
507M-54	54" x 54"
507M-60	60" x 60"

RECTANGLE

505M-8442	84" x 42"
505M-9648	96" x 48"

sectioned tops

505M-1084	108" x 48"
505M-1204	120" x 48"
505M-1324	132" x 48"
505M-1444	144" x 48"
505M-1206	120" x 60"
505M-1326	132" x 60"
505M-1446	144" x 60"

505M-1686 (Top in 2 sections)	168" x 60"
505M-1926	192" x 60"
505M-2166	216" x 60" (Four bases)
505M-2406	240" x 60" (Four bases)

ARCED RECTANGLE

508M-8442	84" x 42"
508M-9648	96" x 48"

sectioned tops

508M-1084	108" x 48"
508M-1204	120" x 48"
508M-1324	132" x 48"
508M-1444	144" x 48"
508M-1206	120" x 60"
508M-1326	132" x 60"
508M-1446	144" x 60"

508M-1686 (Top in 2 sections)	168" x 60"
508M-1926	192" x 60"
508M-2166	216" x 60" (Four bases)
508M-2406	240" x 60" (Four bases)

- Number of sectioned tops may vary based on type of stone.
- Center Located Power Unit: Add \$516.
- Vertical Infeed/Wire Manager (attach to any base - 10"W x 1 1/4"D)
Add: \$742 (Colora). \$857 (Veneer). \$910 (Stain Steel)

MARBLE or GRANITE TOP

ADD BASE UPGRADES

BLADE

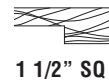
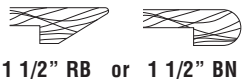
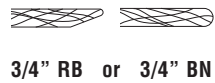

ADD
CRATE
NET \$

veneer

BRUSH +
POL STAIN.

9963	11625	10628	153	877	3069
12173	14044	12922	172	953	3180
14004	16081	14834	191	953	3545
9821	10725	9859	153	877	3069
11901	12915	11944	172	953	3180
13712	14837	13758	191	953	3545
13069	14179	13069	243	877	2293
15686	16956	15686	277	953	2738
19072	20390	19072	312	953	2738
20402	21884	20403	347	953	2738
21736	23322	21736	382	953	2738
24286	25979	24286	416	1427	4086
23258	24844	23258	382	1024	2947
24840	26532	24840	420	1024	2947
27719	29517	27719	458	1536	4407
31829	33889	31829	535	1536	4407
37693	40025	37693	611	1536	4407
43140	45755	43140	686	2047	5895
46516	49689	46516	762	2047	5895
13851	15516	14220	243	877	2293
16677	18581	17100	277	953	2738
20161	22171	20584	312	953	2738
21589	23704	22011	347	953	2738
23018	25238	23440	382	953	2738
25665	27992	26088	416	1427	4086
24740	27119	25268	382	1024	2947
26441	28926	26970	420	1024	2947
29442	32033	29971	458	1536	4407
33847	36718	34387	535	1536	4407
40129	43294	40684	611	1536	4407
45897	49365	46465	686	2047	5895
49478	54197	50536	762	2047	5895

• Undertop IT trough with removable side panels - custom quote required.

BLADE BASE TABLES • STONE TOP

See selection of top and base finishes. Standard base finish is COLORA colors; veneer and stainless steel base upcharges are shown below. Tables are 29" high. Crate charge applies to stone tops.

Note: 60" wide marble tops are subject to availability – please inquire.

Specify: model number – stone top variety – edge profile – base finish – power and comm. options.

ITEM

TOP DIMENSIONS

ARCED BOAT

506M-8442	84" x 42"/30"
506M-9648	96" x 48"/35"

sectioned tops

506M-1084	108" x 48"/35"
506M-1204	120" x 48"/35"
506M-1324	132" x 48"/35"
506M-1444	144" x 48"/35"
506M-1206	120" x 60"/42"
506M-1326	132" x 60"/42"
506M-1446	144" x 60"/42"

506M-1686 (Top in 2 sections)	168" x 60"/42"
506M-1926	192" x 60"/42"
506M-2166	216" x 60"/42" (Four bases)
506M-2406	240" x 60"/42" (Four bases)

ARCED WEDGE

509M-8448	84" x 48"/28"
509M-9648	96" x 48"/28"

Sectioned tops



509M-1084	108" x 48"/28"
509M-1206	120" x 60"/35"
509M-1326	132" x 60"/35"
509M-1446	144" x 60"/35"

509M-1686 (Top in 2 sections)	168" x 60"/35"
509M-1926	192" x 60"/35"
509M-1686	216" x 60"/35" (Four bases)
509M-2406	240" x 60"/35" (Four bases)

- Number of sectioned tops may vary based on type of stone.
- Center Located Power Unit: Add \$516.
- Vertical Infeed/Wire Manager (attach to any base - 10"W x 1 1/4"D)
Add: \$742 (Colora). \$857 (Veneer). \$910 (Stain Steel)

MARBLE or GRANITE TOP

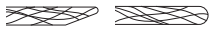
ADD BASE UPGRADES

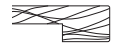
									ADD CRATE NET \$	VENEER	BRUSH + POL STAIN.
3/4" RB	or 3/4" BN		1 1/2" RB	or 1 1/2" BN		1 1/2" SQ					
13046		15594		14066		243	805	2104			
15673		18584		16838		277	805	2104			
18900		22053		20161		312	805	2104			
20243		23639		21602		347	805	2104			
21586		25224		23041		382	805	2104			
24774		28655		26326		416	1242	3468			
23138		26776		24593		382	874	2512			
24747		28628		26300		420	874	2512			
28161		32284		29897		458	1343	3749			
32069		36792		33957		535	1343	3749			
37952		43301		40091		611	1343	3749			
43367		49364		45826		686	1812	5408			
46276		53552		49186		762	1812	5408			
14121		15771		14510		243	840	2195			
15653		17400		16042		277	840	2195			
18850		20692		19237		312	840	2195			
22983		25166		23469		382	840	2195			
24543		26822		25028		420	840	2195			
27542		29918		28027		458	1308	3749			
31333		33969		31831		535	1308	3749			
37099		40003		37608		611	1308	3749			
42627		45808		43149		686	1744	5408			
45965		50331		46935		762	1744	5408			

• Undertop IT trough with removable side panels - custom quote required.

NEXTT T and CROSS BASE TABLES • LAMINATE and VENEER TOPS

All table tops, except for veneer with wood edge feature inlays between top surface and edge in matching color to either top or edge unless specified otherwise. Standard Stainless Steel base finish in COLORA colors; Polished and Satin Stainless options upcharged. Tables are 29" high.

Specify: model number – top finish – edge profile and finish – inlay color (if applicable and in contrast color) – base finish – power and comm. options.

ITEM

TOP DIMENSIONS



ROUND

641-42	42" dia.
641-48	48" dia.
641-54	54" dia.
641-60	60" dia.



SQUARE

One-Column

647-42	42" x 42"
647-48	48" x 48"

Four-Column

647-54	54" x 54"
647-60	60" x 60"

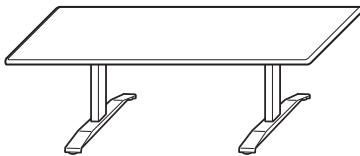

RECTANGLE

645-7236	72" x 36"
645-8442	84" x 42"
645-9648	96" x 48"
645-1084	108" x 48"

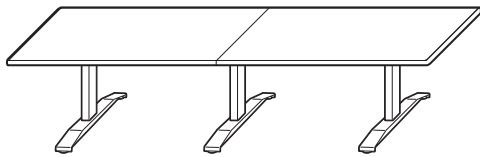

sectioned tops

645-1204	120" x 48"
645-1324	132" x 48"
645-1444	144" x 48"
645-1206	120" x 60"
645-1326	132" x 60"
645-1446	144" x 60"

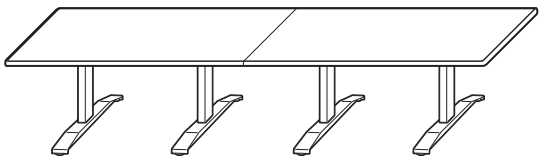

645-1686	168" x 60"
645-1926	192" x 60"

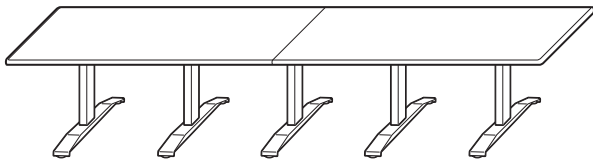

645-2166	216" x 60"
645-2406 (Top in 3 sections)	240" x 60"

- Center Located Power Unit over T-Base or One-Column Cross Base: Add \$516.
- Access Door in One-Column Cross Base: Add \$269.
- All T-Bases include Access Door.

PLASTIC LAMINATE or COLORA TOP

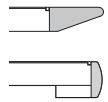

RB or RAD Colora
QTY1 QTY 3

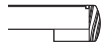

RAD Wood
QTY1 QTY 3

VENEER TOP

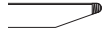

RB Wood
QTY1 QTY 3

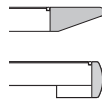

RB or RAD Colora
QTY1 QTY 3

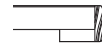

RAD Wood
QTY1 QTY 3

ADD BASE UPGRADES

POL
STAIN.

BRUSH
STAIN.

2815	2293	3523	2819	3752	3068	3606	2815	3838	3048	1501	1036
3169	2599	3898	3164	4135	3417	4288	3357	4555	3622	1799	1259
3475	2857	4222	3463	4447	3706	4962	3885	5260	4185	1799	1259
4082	3380	4848	4031	4867	4092	5801	4550	6133	4881	1799	1259

2815	2293	3680	2942	3144	2510	3606	2815	3901	3111	1501	1036
3169	2599	4053	3270	3556	2859	4288	3357	4627	3695	1799	1259

4273	3574	5164	4263	4767	3890	5760	4602	6140	4983	2256	1344
4793	4020	5838	4821	5208	4648	6513	5189	6935	5611	2256	1344

3793	3232	4578	3859	4493	3722	5061	4135	4938	4187	1577	1021
4595	3931	5522	4667	5124	4224	6167	5033	5958	5040	1577	1021
5112	4384	6035	5132	6265	5185	7538	6148	7217	6096	1706	1076
5746	4936	6681	5703	6725	5562	8199	6680	7827	6606	1706	1076

7315	6251	9022	7774	8470	7378	10308	8530	9746	8309	2558	1614
7712	6605	9567	8224	9251	8007	10867	8964	10304	8768	2558	1614
8105	6956	10111	8659	9644	8368	11425	9399	10863	9227	2558	1614
8283	7106	10075	8683	9800	8462	11551	9474	10925	9251	3221	2054
8630	7414	10559	9066	10370	8953	12198	9971	11562	9769	3221	2054
9043	7779	11111	9506	10781	9360	12846	10467	12199	10285	3221	2054

11053	9592	13398	11471	13052	11345	14933	12196	14266	12054	4295	2738
11511	9989	14135	12017	14299	12406	15994	12972	15306	12869	4295	2738

14136	12354	17037	14538	16800	14621	18310	14914	17600	14852	5368	3423
14909	12930	18329	15546	18554	16180	20141	16382	19221	16188	5368	3423

NEXT T and CROSS

NEXTT T and CROSS BASE TABLES • LAMINATE and VENEER TOPS

All table tops, except for veneer with wood edge feature inlays between top surface and edge in matching color to either top or edge unless specified otherwise. Standard Stainless Steel base finish in COLORA colors; Polished and Satin Stainless options upcharged. Tables are 29" high.

Specify: model number – top finish – edge profile and finish – inlay color (if applicable and in contrast color) – base finish – power and comm. options.

ITEM

TOP DIMENSIONS

ARCED RECTANGLE

648-7236	72" x 36"
648-8442	84" x 42"
648-9648	96" x 48"
648-1084	108" x 48"

sectioned tops

648-1204	120" x 48"
648-1324	132" x 48"
648-1444	144" x 48"
648-1206	120" x 60"
648-1326	132" x 60"
648-1446	144" x 60"

648-1686	168" x 60"
648-1926	192" x 60"

648-2166	216" x 60"
648-2406 (Top in 3 sections)	240" x 60"

ARCED BOAT

646-7236	72" x 36"/25"
646-8442	84" x 42"/30"
646-9648	96" x 48"/35"
646-1084	108" x 48"/35"

sectioned tops

646-1204	120" x 48"/35"
646-1324	132" x 48"/35"
646-1206	120" x 60"/42"
646-1326	132" x 60"/42"
646-1446	144" x 60"/42"

646-1686	168" x 60"/42"
646-1926	192" x 60"/42"

646-2166	216" x 60"/42"
646-2406 (Top in 3 sections)	240" x 60"/42"

- Center Located Power Unit over T-Base: Add \$516.
- All T-Bases include Access Door.

PLASTIC LAMINATE or COLORA TOP

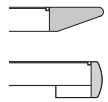

RB or RAD Colora
QTY1 QTY 3

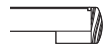

RAD Wood
QTY1 QTY 3

VENEER TOP

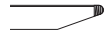

RB Wood
QTY1 QTY 3

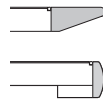

RB or RAD Colora
QTY1 QTY 3

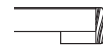

RAD Wood
QTY1 QTY 3

ADD BASE UPGRADES

POL STAIN. BRUSH STAIN.

3864	3279	4797	3997	5094	4317	5313	4301	5694	4682	1577	1021
4675	3982	5772	4827	5788	4833	6495	5249	6940	5694	1577	1021
5200	4442	6294	5297	7001	5814	7953	6427	8462	6935	1706	1076
5840	4997	6945	5874	7509	6187	8660	6990	9209	7541	1706	1076

7443	6336	9480	8106	9802	7845	10887	8936	11480	9529	2558	1614
7844	6692	10049	8571	10236	8349	11466	9379	12101	10015	2558	1614
8240	7045	10619	9019	10671	8853	12046	9823	12722	10500	2558	1614
8419	7195	10558	9031	10806	8907	12181	9904	12816	10537	3221	2054
8770	7506	11066	9424	11474	9469	12855	10412	13531	11087	3221	2054
9187	7874	11644	9875	11881	9861	13528	10919	14247	11638	3221	2054

11205	9692	13980	11864	13899	11716	15670	12670	16473	13473	4295	2738
11672	10096	14765	12433	15204	12615	16782	13467	17671	14355	4295	2738

14304	12466	17716	14977	17965	15457	19150	15432	20124	16406	5368	3423
15115	13066	19160	16094	19842	17116	21130	17007	22188	18065	5368	3423

3864	3279	4797	3997	5094	4317	5313	4301	5694	4682	1577	1021
4675	3982	5772	5360	5788	4833	6495	5249	6940	5694	1577	1021
5200	4442	6294	5879	7001	5814	7953	6427	8462	6935	1706	1076
5840	4997	6945	6477	7509	6187	8660	6990	9209	7541	1706	1076

7443	6336	9480	8125	9802	7845	10887	8936	11480	9529	2558	1614
7844	6692	10049	8571	10236	8349	11466	9379	12101	10015	2558	1614
8240	7045	10619	9019	10671	8853	12046	9823	12722	10500	2558	1614
8419	7195	10558	9031	10806	8907	12181	9904	12816	10537	3221	2054
8770	7506	11066	9424	11474	9469	12855	10412	13531	11087	3221	2054
9187	7874	11644	9875	12268	10084	13528	10919	14247	11638	3221	2054

11205	9692	13980	11864	14350	11978	15670	12670	16473	13473	4295	2738
11672	10096	14765	12433	15721	12911	16782	13467	17671	14355	4295	2738

14304	12466	17716	14977	17965	15457	19150	15432	20124	16406	5368	3423
15115	13066	19160	16094	19842	17116	21130	17007	22188	18065	5368	3423

NEXTT T and CROSS BASE TABLES • VIDRO PAINTED BACK GLASS TOP

See standard color choices. Customer's own color must be pre-approved through custom quotation.
Bases standard Stainless Steel in COLORA, Polished and Brushed Stainless options upcharged. Tables are 29" high.



ITEM

TOP DIMENSIONS

ROUND

641V-30	30" dia.
641V-36	36" dia.
641V-42	42" dia.
641V-48	48" dia.
641V-54	54" dia.
641V-60	60" dia.



SQUARE

One-Column

642V-42	42" x 42"
642V-48	48" x 48"

Four-Column

642V-54	54" x 54"
642V-60	60" x 60"

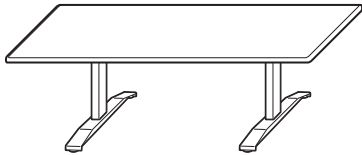

RECTANGLE

645V-7236	72" x 36"
645V-8442	84" x 42"
645V-9648	96" x 48"
645V-1084 (Top in 2 sections)	108" x 48"

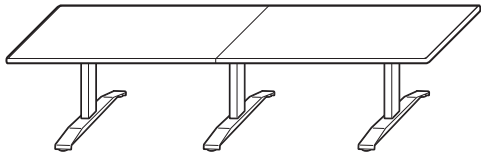

sectioned tops

645V-1204	120" x 48"	
645V-1324	132" x 48"	
645V-1444	144" x 48"	
645V-1206	120" x 60"	(includes double column bases)
645V-1326	132" x 60"	(includes double column bases)
645V-1446	144" x 60"	(includes double column bases)

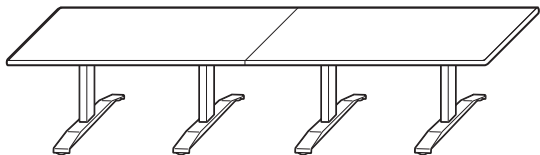

645V-1686	168" x 60"	(includes double column bases)
645V-1926 (Top in 3 sections)	192" x 60"	(includes double column bases)

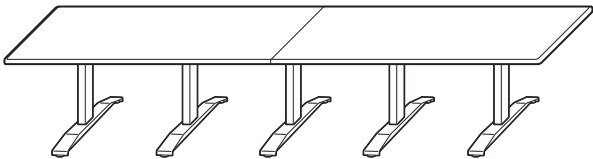

645V-2166 (Top in 3 sections)	216" x 60"	(includes double column bases)
645V-2406 (Top in 4 sections)	240" x 60"	(includes double column bases)

- Center Located Power Unit over T-Base or One-Column Cross Base: Add \$516.
- Access Door in One-Column Cross Base: Add \$269.
- All T-Bases include Access Door.

PAINTED BACK GLASS TOP (CL GLASS)

MATTE (MA GLASS)

ADD BASE UPGRADES

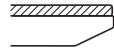

1 1/4" RB

QTY1 QTY3

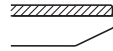

1 1/4" RB

QTY1 QTY3

ADD
CRATE
NET \$

POL.
STAIN

BRUSH
STAIN

2494	2260	2916	2660	95	1501	1036
2859	2625	3424	3168	114	1501	1036
3562	3317	4327	4060	134	1501	1036
4396	4022	5401	4982	153	1799	1259
5012	4637	6247	5827	172	1799	1259
5773	5389	7263	6834	191	1799	1259
3804	3475	4614	4240	134	1501	1036
4308	3973	5398	4919	153	1799	1259
5789	5400	7024	6590	172	2256	1344
6463	6072	7953	7517	191	2256	1344
5820	5435	7011	6582	208	1577	1021
6852	6457	8383	7944	243	1577	1021
8092	7680	10013	9557	277	1706	1076
8773	8355	10912	10450	312	1706	1076
11462	10497	14040	12942	347	2558	1614
12127	11146	14901	13787	382	2558	1614
12912	11919	15902	14778	416	2558	1614
12972	11980	16039	14915	382	3221	2054
13993	12979	17350	16203	420	3221	2054
15023	14000	18669	17513	458	3221	2054
17369	16267	21504	20271	535	4295	2738
20150	19037	25041	23795	611	4295	2738
23217	22004	28686	27341	686	5368	3423
24577	23360	30558	29208	762	5368	3423

NEXT T and CROSS

• Vidro Art option require additional details - custom quote required.

NEXTT T and CROSS BASE TABLES • VIDRO PAINTED BACK GLASS TOP

See standard color choices. Customer's own color must be pre-approved through custom quotation.
Bases standard Stainless Steel in COLORA, Polished and Brushed Stainless options upcharged. Tables are 29" high.

ITEM

TOP DIMENSIONS

ARCED RECTANGLE

648V-7236	72" x 36"
648V-8442	84" x 42"
648V-9648	96" x 48"
648V-1084 (Top in 2 sections)	108" x 48"

sectioned tops

648V-1204	120" x 48"
648V-1324	132" x 48"
648V-1444	144" x 48"
648V-1206	120" x 60" (includes double column bases)
648V-1326	132" x 60" (includes double column bases)
648V-1446	144" x 60" (includes double column bases)

648V-1686	168" x 60" (includes double column bases)
648V-1926 (Top in 3 sections)	192" x 60" (includes double column bases)

648V-2166 (Top in 3 sections)	216" x 60" (includes double column bases)
648V-2406 (Top in 4 sections)	240" x 60" (includes double column bases)

ARCED BOAT

646V-7236	72" x 36"/25"
646V-8442	84" x 42"/30"
646V-9648	96" x 48"/35"
646V-1084 (Top in 2 sections)	108" x 48"/35"

sectioned tops

646V-1204	120" x 48"/35"
646V-1324	132" x 48"/35"
646V-1444	144" x 48"/35"
646V-1206	120" x 60"/42" (includes double column bases)
646V-1326	132" x 60"/42" (includes double column bases)
646V-1446	144" x 60"/42" (includes double column bases)

646V-1686	168" x 60"/42" (includes double column bases)
646V-1926 (Top in 3 sections)	192" x 60"/42" (includes double column bases)

646V-2166 (Top in 3 sections)	216" x 60"/42" (includes double column bases)
646V-2406 (Top in 4 sections)	240" x 60"/42" (includes double column bases)

- Center Located Power Unit over T-Base: Add \$516.
- All T-Bases include Access Door.

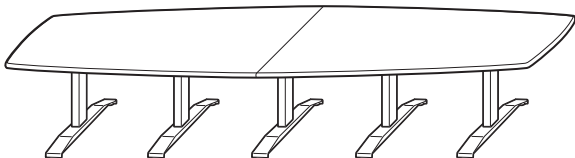
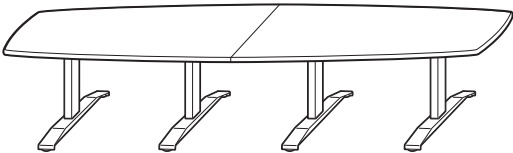
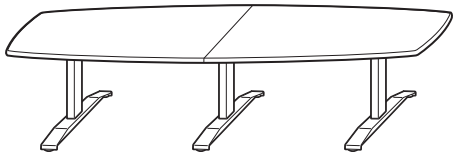
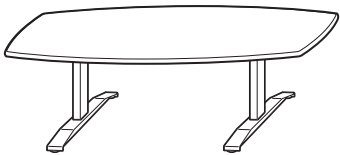
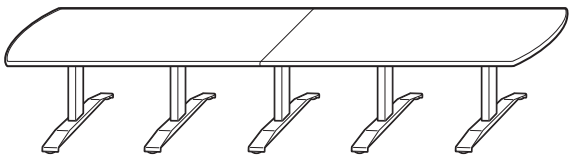
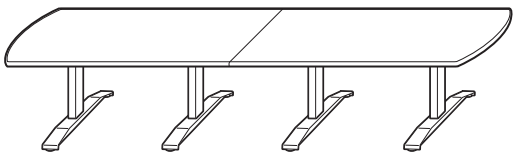
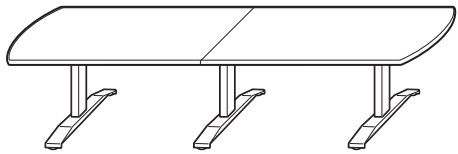
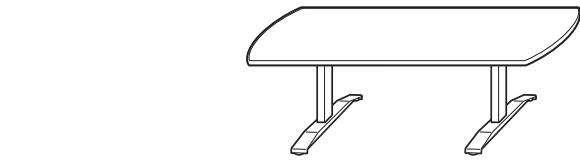

PAINTED BACK GLASS TOP (CL GLASS)

MATTE (MA GLASS)

ADD BASE UPGRADES

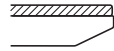

1 1/4" RB

QTY1 QTY3

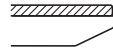

1 1/4" RB

QTY1 QTY3

ADD
CRATE
NET \$

POL.
STAIN

BRUSH
STAIN

6318	5934	7591	7164	208	1577	1021
7531	7136	9175	8735	243	1577	1021
8978	8565	11046	10588	277	1706	1076
9771	9352	12075	11612	312	1706	1076
12570	11604	15331	14232	347	2558	1614
13345	12365	16321	15208	382	2558	1614
14242	13248	17453	16327	416	2558	1614
14356	13366	17652	16530	382	3221	2054
15517	14513	19126	17989	420	3221	2054
16679	15661	21090	19940	458	3221	2054
19308	18205	23764	22529	535	4295	2738
22366	21252	27623	26376	611	4295	2738
25225	24013	31106	29762	686	5368	3423
27225	26007	33664	32313	762	5368	3423
6318	5934	7591	7164	208	1577	1021
7531	7136	9175	8735	243	1577	1021
8978	8565	11046	10588	277	1706	1076
9771	9352	12075	11612	312	1706	1076
12570	11604	15331	14232	347	2558	1614
13345	12365	16321	15208	382	2558	1614
14242	13248	17453	16327	416	2558	1614
14356	13366	17652	16530	382	3221	2054
15517	14513	19126	17989	420	3221	2054
16679	15661	20600	19449	458	3221	2054
19308	18205	23764	22529	535	4295	2738
22366	21252	27623	26376	611	4295	2738
25710	24497	31591	30246	686	5368	3423
27347	26129	33786	32435	762	5368	3423

NEXT T and CROSS

• Vidro Art option requires additional details - custom quote required.

NEXT T and CROSS BASE TABLES • VIDRO PAINTED BACK GLASS TOP

See standard color choices. Customer's own color must be pre-approved through custom quotation.
Bases standard Stainless Steel in COLORA, Polished and Brushed Stainless options upcharged. Tables are 29" high.

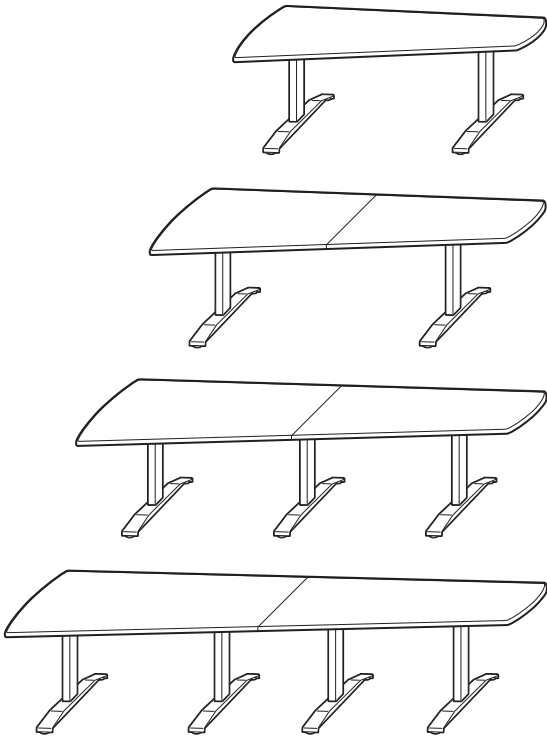

ITEM

TOP DIMENSIONS

ARCED WEDGE

629V-8448	84" x 48"/28"
629V-9648	96" x 48"/28"
629V-1084 (Top in 2 sections)	108" x 48"/28"

Sectioned tops

629V-1206	120" x 60"/35"	(includes double column bases)
629V-1326	132" x 60"/35"	(includes double column bases)

629V-1446	144" x 60"/35"	(includes double column bases)
629V-1686	168" x 60"/35"	(includes double column bases)
629V-1926 (Top in 3 sections)	192" x 60"/35"	(includes double column bases)

629V-2166 (Top in 3 sections)	216" x 60"/35"	(includes double column bases)
629V-2406 (Top in 4 sections)	240" x 60"/35"	(includes double column bases)

- Center Located Power Unit over T-Base: Add \$516.
- All T-Bases include Access Door.

PAINTED BACK GLASS TOP (CL GLASS)

MATTE (MA GLASS)

ADD BASE UPGRADES

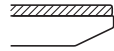

1 1/4" RB

QTY1 QTY3

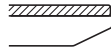

1 1/4" RB

QTY1 QTY3

**ADD
CRATE
NET \$**

**POL.
STAIN**

**BRUSH
STAIN**

8035	7640	9866	9427	243	1577	1021
8978	8565	11046	10588	277	1706	1076
9771	9352	12075	11612	312	1706	1076
14356	13366	17652	16530	382	3221	2054
15517	14513	19126	17989	420	3221	2054
16679	15661	20600	19449	458	3221	2054
19308	18205	23764	22529	535	4295	2738
22366	21252	27623	26376	611	4295	2738
25710	24497	31591	30246	686	5368	3423
27347	26129	33786	32435	762	5368	3423

NEXT T and CROSS

• Vidro Art option requires additional details - custom quote required.

NEXTT T and CROSS BASE TABLES • STONE TOP

See selection of top and base finishes. Standard Stainless Steel base finish in COLORA colors; Polished and Satin Stainless options upcharged.

Tables are 29" high. Crate charges apply to stone tops.

Note: 60" wide marble tops are subject to availability – please inquire.

Specify: model number – stone top variety – edge profile – base finish – power and comm. options.

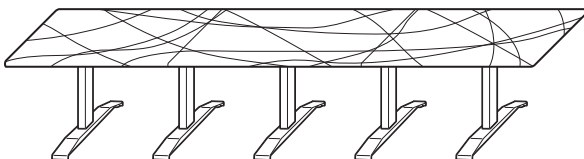
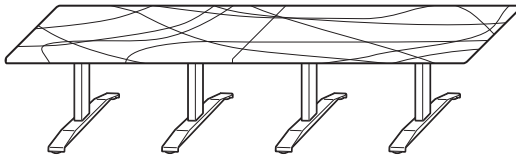
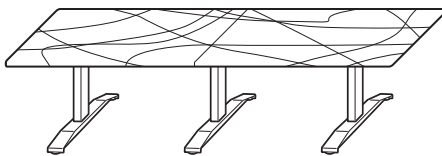
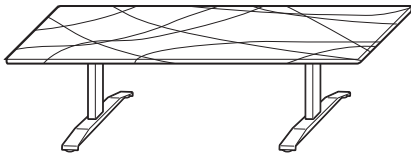
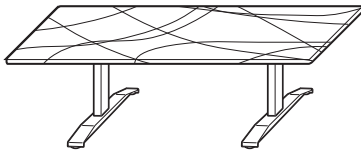
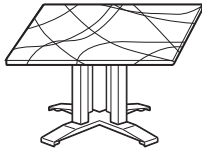
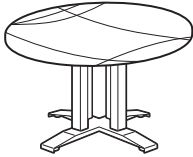

ITEM

TOP DIMENSIONS

ROUND

One-Column

641M-42 42" dia.

641M-48 48" dia.

Four-Column

641M-54 54" dia.

641M-60 60" dia.

SQUARE

One-Column

647M-42 42" x 42"

647M-48 48" x 48"

Four-Column

647M-54 54" x 54"

647M-60 60" x 60"

RECTANGLE

645M-7236 72" x 36"

645M-8442 84" x 42"

645M-9648 96" x 48"

sectioned tops

645M-1084 108" x 48"

645M-1204 120" x 48"

645M-1324 132" x 48"

645M-1444 144" x 48"

645M-1206 120" x 60" (includes double column bases)

645M-1326 132" x 60" (includes double column bases)

645M-1446 144" x 60" (includes double column bases)

645M-1686 168" x 60" (includes double column bases)

645M-1926 (Top in 3 sections) 192" x 60" (includes double column bases)

645M-2166 216" x 60" (includes double column bases)

645M-2406 240" x 60" (includes double column bases)

- Number of sectioned tops may vary based on type of stone.
- Center Located Power Unit over T-Base or One-Column Cross Base: Add \$516.
- Access Door in One-Column Cross Base: Add \$269.
- All T-Bases include Access Door.

MARBLE or GRANITE TOP

ADD BASE UPGRADES

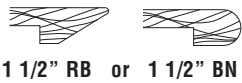
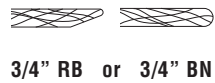

**ADD
CRATE
NET \$**

**POL
STAIN.**

**BRUSH
STAIN.**

7154	8608	7735	134	1501	1036
8786	10448	9451	153	1799	1259
10480	12351	11229	172	2256	1344
12399	14476	13229	191	2256	1344
7077	7867	7109	134	1501	1036
8645	9549	8683	153	1799	1259
11068	12084	11111	172	2256	1344
12817	13944	12865	191	2256	1344
10613	11565	10613	208	1577	1021
13106	14217	13106	243	1577	1021
15959	17229	15959	277	1706	1076
19403	20779	19403	312	1706	1076
21608	23089	21608	347	2558	1614
23121	24708	23121	382	2558	1614
24634	26328	24634	416	2558	1614
25737	27325	25737	382	3221	2054
27501	29193	27501	420	3221	2054
29263	31063	29263	458	3221	2054
34585	36646	34585	535	4295	2738
40581	42914	40581	611	4295	2738
46609	49227	46609	686	5368	3423
51011	53920	51011	762	5368	3423

NEXT T and CROSS

NEXTT T and CROSS BASE TABLES • STONE TOP

See selection of top and base finishes. Standard Stainless Steel base finish in COLORA colors; Polished and Satin Stainless options upcharged.

Tables are 29" high. Crate charges apply to stone tops.

Note: 60" wide marble tops are subject to availability – please inquire.

Specify: model number – stone top variety – edge profile – base finish – power and comm. options.

ITEM

TOP DIMENSIONS

ARCED RECTANGLE

648M-7236	72" x 36"
648M-8442	84" x 42"

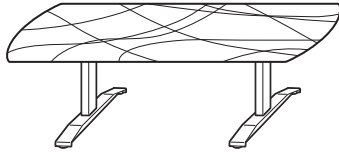

648M-9648	96" x 48"
-----------	-----------

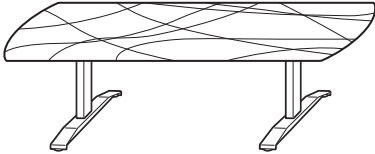

sectioned tops

648M-1084	108" x 48"
648M-1204	120" x 48"
648M-1324	132" x 48"
648M-1444	144" x 48"
648M-1206	120" x 60" (includes double column bases)
648M-1326	132" x 60" (includes double column bases)
648M-1446	144" x 60" (includes double column bases)

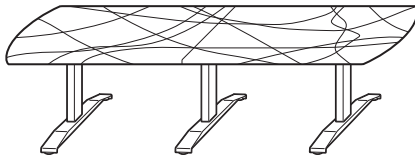

648M-1686	168" x 60" (includes double column bases)
648M-1926 (Top in 3 sections)	192" x 60" (includes double column bases)

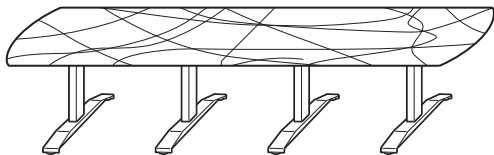

648M-2166	216" x 60" (includes double column bases)
648M-2406	240" x 60" (includes double column bases)

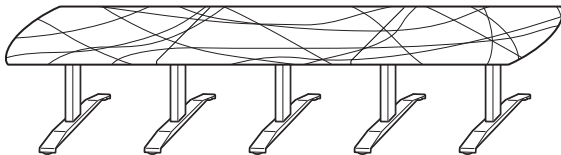

- Number of sectioned tops may vary based on type of stone.
- Center Located Power Unit over T-Base: Add \$516.
- All T-Bases include Access Door.

MARBLE or GRANITE TOP

ADD BASE UPGRADES

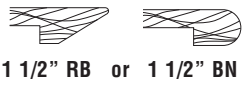
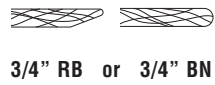

**ADD
CRATE
NET \$**

**POL
STAIN.**

**BRUSH
STAIN.**

11211	12639	11528	208	1577	1021
13888	15554	14258	243	1577	1021
16948	18854	17372	277	1706	1076
20491	22502	20915	312	1706	1076
22793	24909	23216	347	2558	1614
24404	26625	24827	382	2558	1614
26015	28342	26438	416	2558	1614
27219	29600	27748	382	3221	2054
29103	31590	29634	420	3221	2054
30989	33581	31517	458	3221	2054
36602	39478	37145	535	4295	2738
43019	46187	43575	611	4295	2738
49249	52719	49817	686	5368	3423
53978	57761	54561	762	5368	3423

NEXT T and CROSS

NEXTT T and CROSS BASE TABLES • STONE TOP

See selection of top and base finishes. Standard Stainless Steel base finish in COLORA colors; Polished and Satin Stainless options upcharged.

Tables are 29" high. Crate charges apply to stone tops.

Note: 60" wide marble tops are subject to availability – please inquire.

Specify: model number – stone top variety – edge profile – base finish – power and comm. options.

ITEM

TOP DIMENSIONS

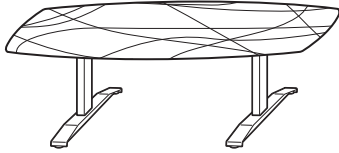

ARCED BOAT

646M-7236

72" x 36"/25"

646M-8442

84" x 42"/30"

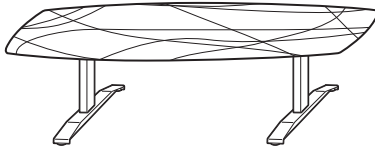

646M-9648

96" x 48"/35"

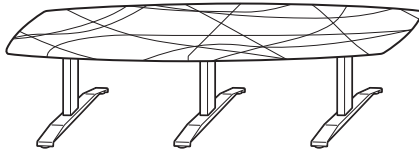

sectioned tops

646M-1084

108" x 48"/35"

646M-1204

120" x 48"/35"

646M-1324

132" x 48"/35"

646M-1444

144" x 48"/35"

646M-1206

120" x 60"/42" (includes double column bases)

646M-1326

132" x 60"/42" (includes double column bases)

646M-1446

144" x 60"/42" (includes double column bases)

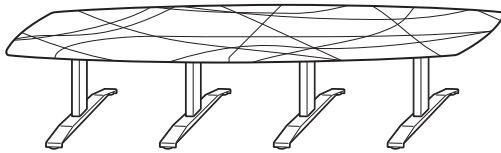

646M-1686

168" x 60"/42" (includes double column bases)

646M-1926 (Top in 3 sections)

192" x 60"/42" (includes double column bases)

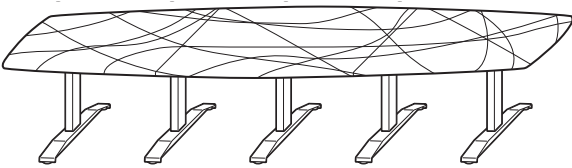

646M-2166

216" x 60"/42" (includes double column bases)

646M-2406

240" x 60"/42" (includes double column bases)

- Number of sectioned tops may vary based on type of stone.
- Center Located Power Unit over T-Base: Add \$516.
- All T-Bases include Access Door.

MARBLE or GRANITE TOP

ADD BASE UPGRADES

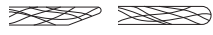

3/4" RB or 3/4" BN

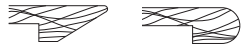

1 1/2" RB or 1 1/2" BN

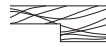

1 1/2" SQ

**ADD
CRATE
NET \$**

**POL
STAIN.**

**BRUSH
STAIN.**

11528	13909	12479	208	1577	1021
14258	17036	15368	243	1577	1021
17372	20548	18642	277	1706	1076
18442	21881	19817	312	1706	1076
23322	27027	24804	347	2558	1614
24986	28955	26573	382	2558	1614
26649	30882	28342	416	2558	1614
27748	31718	29336	382	3221	2054
29686	33920	31379	420	3221	2054
31624	36120	33423	458	3221	2054
37362	42514	39422	535	4295	2738
43908	49742	46241	611	4295	2738
50273	56814	52890	686	5368	3423
55142	62418	58052	762	5368	3423

NEXTT C BASE TRAINING TABLES • LAMINATE and VENEER TOPS

Laminate tops with wood or COLORA edge feature 1/8" dia. vinyl inlay in COLORA between top surface and edge. Standard base finish is COLORA colors; polished and satin chrome are available at upcharge. Modesty panels are in COLORA colors. Tables are 29" high.

Specify: model number – top finish – edge profile and finish – inlay color (if applicable) – base finish – modesty finish – options.

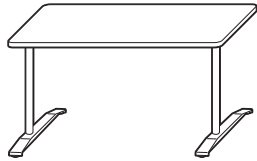

ITEM

DIMENSIONS

WITHOUT MODESTY PANEL

633-4220	42" x 20"	
633-4820	48" x 20"	
633-6020	60" x 20"	
633-7220	72" x 20"	C-Bases located 6" from end of table
633-4224	42" x 24"	table (non-folding only)
633-4824	48" x 24"	
633-6024	60" x 24"	
633-7224	72" x 24"	
633-4830	48" x 30"	
633-6030	60" x 30"	
633-7230	72" x 30"	

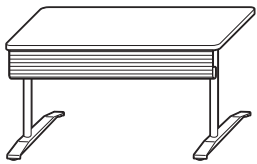

WITH J MODESTY PANEL (REMOVABLE)

Extruded aluminum modesty panel in ribbed pattern features a large wire management tray. 7 1/2" high. Removable (without tools) for folding base tables.

635-4220	42" x 20"	
635-4820	48" x 20"	
635-6020	60" x 20"	
635-7220	72" x 20"	C-Bases located 6" from end of table
635-4224	42" x 24"	table (non-folding only)
635-4824	48" x 24"	
635-6024	60" x 24"	
635-7224	72" x 24"	
635-4830	48" x 30"	
635-6030	60" x 30"	
635-7230	72" x 30"	

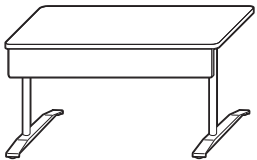

WITH FLAT FIXED MODESTY

Flat aluminum modesty panel fixed to table top, 9" high.

637-4220	42" x 20"	
637-4820	48" x 20"	
637-6020	60" x 20"	
637-7220	72" x 20"	C-Bases located 6" from end of table
637-4224	42" x 24"	table (non-folding only)
637-4824	48" x 24"	
637-6024	60" x 24"	
637-7224	72" x 24"	
637-4830	48" x 30"	
637-6030	60" x 30"	
637-7230	72" x 30"	

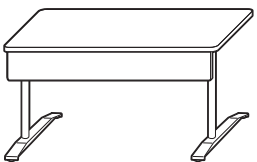

WITH FLAT FOLDING MODESTY

Utilized with Folding Base or Flip Top options - add costs. Flat aluminum modesty panel is 9" high and folds over bases in folded position or over table underside with flip top option.

639-6024	60" x 24"	C-Bases located 6" from end of table
639-7224	72" x 24"	table (non-folding only)
639-6030	60" x 30"	
639-7230	72" x 30"	



BRIDGE TOP - Connector plates included

90-deg PIE

996-20	20" R x 20"
996-24	24" R x 24"
996-30	30" R x 30"

45-deg PIE

997-20	20" R x 20"
997-24	24" R x 24"
997-30	30" R x 30"

30-deg PIE

998-20	20" R x 20"
998-24	24" R x 24"
998-30	30" R x 30"



GANG SET

Each set \$87.00 factory installed. Consists of two brackets, a linking bar and two thumb screws. Ganging 24", 30" and 36" sides requires 1 set; 42" sides and over requires 2 sets.

PLASTIC LAMINATE TOP

VENEER TOP

Flat Vinyl			Reeded Wood			Square Wood			ADD FOLDING BASE*	ADD FLIP TOP	ADD BRUSH STAIN	ADD POL STAIN
QTY1	QTY3	QTY10	QTY1	QTY3	QTY10	QTY1	QTY3	QTY10				
1813	1664	1504	2645	2252	1963	2617	2194	1968		517	438	1051
1826	1675	1514	2686	2289	1994	2673	2250	2024		517	438	1051
1960	1793	1623	2884	2489	2154	2847	2406	2176	428	517	438	1051
2053	1875	1698	3043	2598	2279	3028	2558	2328	428	517	438	1051
1845	1694	1532	2691	2294	2003	2700	2277	2051		517	444	1063
1863	1710	1547	2744	2339	2045	2770	2346	2120		517	444	1063
1986	1818	1646	2931	2503	2192	2966	2521	2291	428	517	444	1063
2078	1900	1721	3090	2643	2318	3165	2695	2462	428	517	444	1063
1994	1827	1657	2903	2482	2178	2980	2535	2305		517	448	1077
2093	1915	1737	3067	2627	2308	3225	2752	2515	428	517	448	1077
2209	2017	1831	3249	2786	2450	3489	2965	2724	428	517	448	1077
2294	2025	1839	3126	2613	2298	3098	2555	2303			438	1051
2307	2036	1849	3167	2650	2329	3154	2611	2359			438	1051
2445	2190	1993	3369	2886	2524	3332	2803	2546	428		438	1051
2574	2310	2106	3564	3033	2687	3549	2993	2736	428		438	1051
2326	2055	1867	3172	2655	2338	3181	2638	2386		517	444	1063
2344	2071	1882	3225	2700	2380	3251	2707	2455		517	444	1063
2471	2215	2016	3416	2900	2562	3451	2918	2661	428	517	444	1063
2599	2335	2129	3611	3078	2726	3686	3130	2870	428	517	444	1063
2475	2188	1992	3384	2843	2513	3461	2896	2640		517	448	1077
2578	2312	2107	3552	3024	2678	3710	3149	2885	428	517	448	1077
2730	2452	2239	3770	3221	2858	4010	3400	3232	428	517	448	1077
2093	1911	1727	2925	2499	2186	2897	2441	2191			438	1051
2106	1922	1737	2966	2536	2217	2953	2497	2247			438	1051
2254	2052	1858	3178	2748	2389	3141	2665	2411			438	1051
2411	2198	1998	3401	2921	2579	3386	2881	2628			438	1051
2125	1941	1755	2971	2541	2226	2980	2524	2274		517	444	1063
2143	1957	1770	3024	2586	2268	3050	2593	2343		517	444	1063
2280	2077	1881	3225	2762	2427	3260	2780	2526		517	444	1063
2436	2223	2021	3448	2966	2618	3523	3018	2762		517	444	1063
2274	2074	1880	3183	2729	2401	3260	2782	2528		517	448	1077
2387	2174	1972	3361	2886	2543	3519	3011	2750		517	448	1077
2567	2340	2131	3607	3109	2750	3847	3288	3024		517	448	1077
2567	2342	2144	3512	3027	2690	3547	3045	2789	428	517	444	1063
2761	2479	2247	3773	3222	2844	3848	3274	2988	428	517	444	1063
2674	2439	2235	3648	3151	2806	3806	3276	3013	428	517	448	1077
2892	2596	2357	3932	3365	2976	4172	3544	3250	428	517	448	1077
430	404	387	956	813	718	829	731	676				
452	423	404	977	833	739	894	797	739				
493	459	436	1033	889	791	946	850	791				
408	382	365	934	791	697	758	659	603				
430	402	382	956	813	718	820	723	666				
472	437	417	1012	868	771	853	755	700				
400	372	354	922	780	687	713	616	558				
419	390	370	943	801	706	722	623	567				
458	426	404	998	855	756	731	633	577				

NEXT C - TRAINING

- Self Edge Laminate available at same price as Vinyl Edge.
- Low Rise Casters: \$160.00 per C Base. Always recommended for Flip Top tables.
- *• 60" long folding tables have narrow range of suitable Surface Power Units based on location(s) and quantity - please inquire

NEXTT T BASE TABLES • MODULAR • LAMINATE and VENEER TOPS

Laminate tops with wood or COLORA edge feature 1/8" dia. vinyl inlay in COLORA between top surface and edge. Standard base finish is COLORA colors; polished and satin chrome are available at upcharge. Tables are 29" high.

Specify: model number – top finish – edge profile and finish – inlay color (if applicable) – base finish – options.

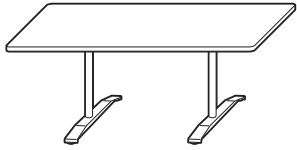

ITEM

DIMENSIONS

RECTANGLE

632-4220	42" x 20"	
632-4820	48" x 20"	
632-6020	60" x 20"	
632-7220	72" x 20"	T-Bases located 12" from end of table (non-folding only)
632-4224	42" x 24"	
632-4824	48" x 24"	
632-6024	60" x 24"	
632-7224	72" x 24"	
632-4830	48" x 30"	
632-6030	60" x 30"	
632-7230	72" x 30"	

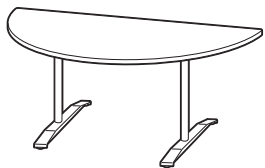

HALF ROUND

634-4820	48" dia. x 20"
634-4824	48" dia. x 24"
634-5427	54" dia. x 27"
634-6030	60" dia. x 30"

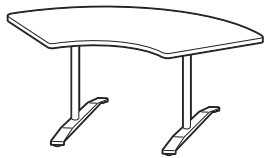

ARC

636-3620	36" R x 20"
636-3624	36" R x 24"
636-4824	48" R x 24"
636-4830	48" R x 30"
636-6024	60" R x 24"
636-6030	60" R x 30"

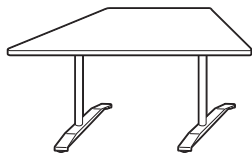

TRAPEZOID

638-4824	48" X 24" X 24"
638-6030	60" X 30" X 30"
638-7230	72" X 30" X 30"

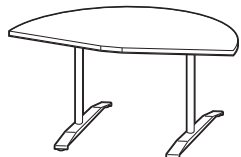

V END

170-deg PIE

640-24 (for 24" D Tables)	54" x 30"
640-30 (for 30" D Tables)	66" x 36"

PLASTIC LAMINATE TOP

VENEER TOP

Flat Vinyl			Reeded Wood			Square Wood			ADD FOLDING BASE*	ADD FLIP TOP	ADD BRUSH STAIN	ADD POL STAIN
QTY1	QTY3	QTY10	QTY1	QTY3	QTY10	QTY1	QTY3	QTY10				
1813	1664	1504	2645	2252	1963	2617	2194	1968		517	438	1051
1826	1675	1514	2686	2289	1994	2673	2250	2024		517	438	1051
1960	1793	1623	2884	2489	2154	2847	2406	2176	428	517	438	1051
2053	1875	1698	3043	2598	2279	3028	2558	2328	428	517	438	1051
1845	1694	1532	2691	2294	2003	2700	2277	2051		517	444	1063
1863	1710	1547	2744	2339	2045	2770	2346	2120		517	444	1063
1986	1818	1646	2931	2503	2192	2966	2521	2291	428	517	444	1063
2078	1900	1721	3090	2643	2318	3165	2695	2462	428	517	444	1063
1994	1827	1657	2903	2482	2178	2980	2535	2305		517	448	1077
2093	1915	1737	3067	2627	2308	3225	2752	2515	428	517	448	1077
2209	2017	1831	3249	2786	2450	3489	2965	2724	428	517	448	1077
2066	1890	1713	3077	2641	2319	3141	2639	2330		517	438	1051
2093	1915	1738	3131	2692	2368	3248	2746	2437		517	444	1063
2251	2056	1867	3323	2867	2525	3412	2903	2590		517	444	1063
2436	2222	2022	3541	3066	2706	3664	3140	2814		517	448	1077
2048	1874	1699	3410	2939	2617	3352	2892	2584		517	438	1051
2099	1921	1743	3464	2989	2664	3373	2914	2605		517	444	1063
2198	2229	2027	3895	3360	3000	3990	3448	3125		517	444	1063
2606	2374	2162	4049	3499	3128	4093	3522	3188		517	448	1077
2678	2435	2217	4261	3668	3276	4742	4113	3772		595	444	1063
2569	2341	2132	4173	3594	3211	4769	4140	3799		595	448	1077
1983	1818	1648	2849	2433	2131	2806	2375	2142		517	444	1063
2301	2103	1912	3232	2772	2440	3261	2780	2536		517	448	1077
2606	2374	2162	3579	3076	2714	3644	3069	2818		517	448	1077
2281	2083	1892	3773	3239	2887	3615	3084	2750		517	448	1077
2606	2374	2162	4183	3588	3202	4018	3455	3103		526	448	1077

NEXT T - MODULAR

- Self Edge Laminate available at same price as Vinyl Edge.
- Low Rise Casters: \$160.00 per T Base. Always recommended for Flip Top tables.
- *• 60" long folding tables have narrow range of suitable Surface Power Units based on location(s) and quantity - please inquire

DRUM BASE TABLES • LAMINATE and VENEER TOPS

All table tops, except for veneer with wood edge feature inlays between top surface and edge in matching color to either top or edge unless specified otherwise. Standard base finish is COLORA colors; veneer and chrome base upcharges are shown below. Tables are 29" high.

Specify: model number – top finish – edge profile and finish – inlay color (if applicable and in contrast color) – base finish – power and comm. options.

ITEM	TOP DIMENSIONS	BASE DIMENSIONS
------	----------------	-----------------

ROUND

801-42	42" dia.	18" dia.
801-48	48" dia.	18" dia.
801-54	54" dia.	22" dia.
801-60	60" dia.	22" dia.
801-72 (Center seam in laminate)	72" dia.	28" dia.

SQUARE

807-42	42" x 42"	18" dia.
807-48	48" x 48"	18" dia.
807-54	54" x 54"	22" dia.
807-60	60" x 60"	24" dia.

RECTANGLE

805-8442	84" x 42"	18" dia.
805-9648	96" x 48"	18" dia.
805-1084	108" x 48"	18" dia.

sectioned tops

805-1204	120" x 48"	18" dia.
805-1324	132" x 48"	18" dia.
805-1444	144" x 48"	18" dia.
805-1206	120" x 60"	24" dia.
805-1326	132" x 60"	24" dia.
805-1446	144" x 60"	24" dia.

805-1686	168" x 60"	24" dia.
805-1926	192" x 60"	24" dia.
805-2166	216" x 60"	24" dia.
805-2406 (Top in 3 sections)	240" x 60"	24" dia.

ARCED RECTANGLE

808-8442	84" x 42"	18" dia.
808-9648	96" x 48"	18" dia.
808-1084	108" x 48"	18" dia.

sectioned tops

808-1204	120" x 48"	18" dia.
808-1324	132" x 48"	18" dia.
808-1444	144" x 48"	18" dia.
808-1206	120" x 60"	24" dia.
808-1326	132" x 60"	24" dia.
808-1446	144" x 60"	24" dia.

808-1686	168" x 60"	24" dia.
808-1926	192" x 60"	24" dia.
808-2166	216" x 60"	24" dia.
808-2406 (Top in 3 sections)	240" x 60"	24" dia.

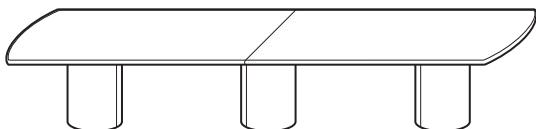
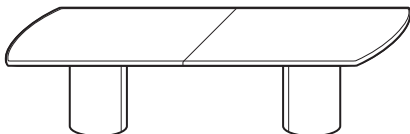
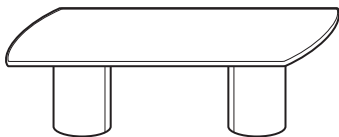
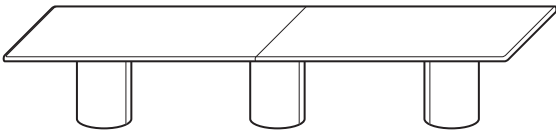
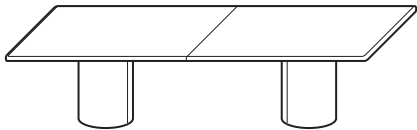
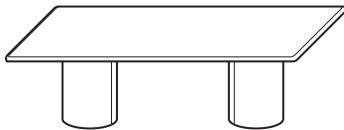
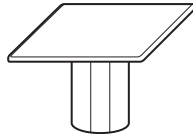
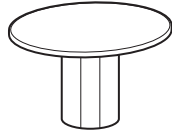

PLASTIC LAMINATE or COLORA TOP

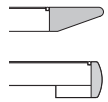

RB or RAD Colora
QTY1 QTY 3

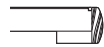

RAD Wood
QTY1 QTY 3

VENEER TOP

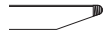

RB Wood
QTY1 QTY 3

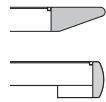

RB or RAD Colora
QTY1 QTY 3



RAD Wood
QTY1 QTY 3

ADD BASE UPGRADES

VENEER **SATIN + POL CHROME**

3351	2953	4057	3478	4351	3800	4141	3475	4373	3708	996	1053
3616	3180	4345	3743	4668	4092	4736	3937	5002	4203	996	1053
4025	3539	4771	4145	5110	4509	5512	4568	5811	4868	1091	1171
4545	3985	5310	4636	5469	4845	6264	5152	6596	5486	1091	1171
6793	5838	7625	6555	7077	6454	8853	7252	9252	7650	1238	1462

3351	2953	4214	3600	3758	3256	4141	3475	4436	3771	996	1053
3616	3180	4500	3850	4105	3549	4736	3937	5074	4276	996	1053
4025	3539	4917	4227	4646	3989	5512	4568	5891	4949	1091	1171
4653	4093	5699	4894	5221	4880	6371	5261	6795	5684	1118	1177

6159	5648	7085	6384	6997	6248	7732	6749	7523	6757	1991	2105
6465	5908	7388	6657	7810	6916	8890	7671	8570	7621	1991	2105
7098	6463	8031	7231	8296	7324	9551	8209	9179	8134	1991	2105

7792	6972	9500	8492	9185	8346	10787	9249	10225	9027	1991	2105
8014	7160	9867	8777	9809	8833	11168	9518	10605	9323	1991	2105
8584	7703	10588	9405	10407	9409	11904	10145	11340	9974	1991	2105
8786	7872	10577	9450	10593	9532	12053	10242	11429	10019	2236	2354
8954	8017	10881	9667	11014	9891	12523	10574	11886	10371	2236	2354
9544	8575	11614	10299	11635	10521	13347	11262	12702	11080	2236	2354

12327	11241	14670	13119	14734	13418	16206	13846	15540	13705	3351	3532
12786	11650	15407	13677	16035	14550	17268	14632	16580	14530	3351	3532
14504	13209	17402	15391	17686	16015	18678	15770	17969	15708	3351	3532
15200	13712	18618	16327	19411	17552	20433	17166	19514	16970	3351	3532

6239	5700	7335	6543	7651	6850	8058	6966	8502	7412	1991	2105
6553	5967	7645	6821	8538	7537	9305	7950	9814	8458	1991	2105
7191	6525	8296	7401	9068	7941	10011	8521	10561	9071	1991	2105

7921	7053	9957	8825	10501	8804	11365	9655	11957	10247	1991	2105
8146	7247	10348	9125	10781	9169	11768	9934	12402	10570	1991	2105
8719	7790	11094	9764	11418	9891	12523	10570	13201	11246	1991	2105
8923	7964	11060	9796	11585	9972	12684	10670	13319	11304	2236	2354
9094	8109	11389	10026	12103	10399	13179	11013	13856	11691	2236	2354
9690	8670	12146	10668	12720	11014	14029	11712	14749	12433	2236	2354

12477	11340	15250	13512	15568	13785	16943	14318	17747	15122	3351	3532
12946	11757	16037	14092	16930	14755	18055	15128	18944	16015	3351	3532
14671	13320	18080	15829	18834	16841	19519	16287	20492	17259	3351	3532
15407	13848	19449	16876	20682	18477	21423	17790	22480	18847	3351	3532

- 42" and 48" Round and Square table bases do not have removable access panel
- Drum bases are available seamless (rolled, welded and finished). Specify "without access door"

DRUM BASE TABLES • LAMINATE and VENEER TOPS

All table tops, except for veneer with wood edge feature inlays between top surface and edge in matching color to either top or edge unless specified otherwise. Standard base finish is COLORA colors; veneer and chrome base upcharges are shown below. Tables are 29" high.

Specify: model number – top finish – edge profile and finish – inlay color (if applicable and in contrast color) – base finish – power and comm. options.

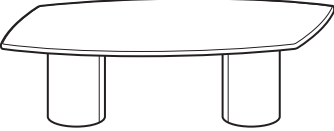
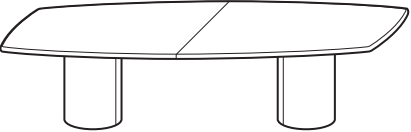
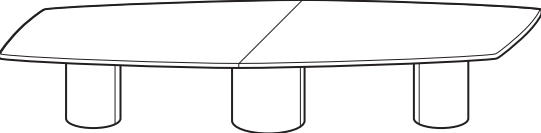
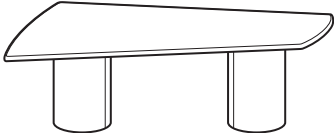
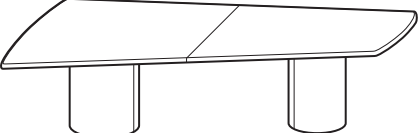
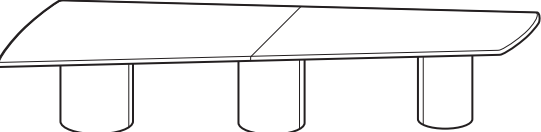
	ITEM	TOP DIMENSIONS	BASE DIMENSIONS
	ARCED BOAT		
	806-8442	84" x 42"/30"	18" dia.
	806-9648	96" x 48"/35"	18" dia.
	806-1084	108" x 48"/35"	18" dia.
	sectioned tops		
	806-1204	120" x 48"/35"	18" dia.
	806-1324	132" x 48"/35"	18" dia.
	806-1444	144" x 48"/35"	18" dia.
	806-1206	120" x 60"/42"	22" dia.
	806-1326	132" x 60"/42"	22" dia.
	806-1446	144" x 60"/42"	22" dia.
	806-1686	168" x 60"/42"	22"/24"/22" dia.
	806-1926	192" x 60"/42"	22"/24"/22" dia.
	806-2166	216" x 60"/42"	22"/24"/22" dia.
	806-2406 (Top in 3 sections)	240" x 60"/42"	22"/24"/22" dia.
	806-2407 (Top in 4 sections)	240" x 72"/48"	22"/24"/22" dia.
	ARCED WEDGE		
	809-8448	84" x 48"/28"	18" dia.
	809-9648	96" x 48"/28"	18" dia.
	809-1084	108" x 48"/28"	18" dia.
	Sectioned tops		
	809-1206	120" x 60"/35"	22"/18" dia.
	809-1326	132" x 60"/35"	22"/18" dia.
	809-1446	144" x 60"/35"	22"/18" dia.
	809-1686	168" x 60"/35"	24"/22"/18" dia.
	809-1926	192" x 60"/35"	24"/22"/18" dia.
	809-2166	216" x 60"/35"	24"/22"/18" dia.
	809-2406 (Top in 3 sections)	240" x 60"/35"	24"/22"/18" dia.

PLASTIC LAMINATE or COLORA TOP

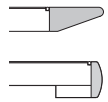

RB or RAD Colora
QTY1 QTY 3

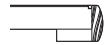

RAD Wood
QTY1 QTY 3

VENEER TOP

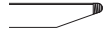

RB Wood
QTY1 QTY 3

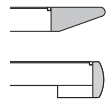

RB or RAD Colora
QTY1 QTY 3



RAD Wood
QTY1 QTY 3

ADD BASE UPGRADES

VENEER **SATIN + POL CHROME**

6239	5700	7335	7075	7651	6850	8058	6966	8502	7412	1991	2105
6553	5967	7645	7401	8538	7537	9305	7950	9814	8458	1991	2105
7191	6525	8296	8005	9068	7941	10011	8521	10561	9071	1991	2105

7921	7053	9957	8842	10501	8804	11365	9655	11957	10247	1991	2105
8146	7247	10348	9125	10781	9169	11768	9934	12402	10570	1991	2105
8719	7790	11094	9764	11418	9891	12523	10570	13201	11246	1991	2105
8740	7780	10877	9614	10411	9351	12501	10487	13136	11121	2179	2338
8913	7926	11206	9844	11921	10217	12996	10830	13673	11508	2179	2338
9524	8502	11979	10502	12934	11068	13864	11545	14582	12265	2179	2338

12477	11340	15250	13512	16013	14045	16943	14318	17747	15122	3296	3515
12946	11757	16037	14092	17437	15047	18055	15128	18944	16015	3296	3515
14671	13320	18080	15829	18834	16841	19519	16287	20492	17259	3296	3515
15407	13848	19449	16876	20682	18477	21423	17790	22480	18847	3296	3515
17981	16128	22662	19607	23113	20891	25462	21105	26561	22204	3296	3515

6284	5741	7423	6627	7441	6600	9240	7638	9705	8103	1991	2105
6553	5967	7645	6821	7909	6989	9305	7950	9814	8458	1991	2105
7191	6525	8296	7401	8395	7398	10011	8521	10561	9071	1991	2105

8646	7687	10783	9520	9926	9036	12409	10394	13043	11029	2085	2220
8797	7812	11092	9728	10381	9412	12882	10716	13557	11393	2085	2220
9015	7995	11470	9994	10834	9789	13357	11038	14075	11758	2085	2220

12477	11340	15250	13512	14327	13179	16943	14318	17747	15122	3202	3398
12946	11757	16037	14092	15355	14104	18055	15128	18944	16015	3202	3398
14671	13320	18080	15829	18834	16841	19519	16287	20492	17259	3202	3398
15407	13848	19449	16876	20682	18477	21423	17790	22480	18847	3202	3398

• Drum bases are available seamless (rolled, welded and finished). Specify “without access door”

DRUM BASE TABLES • VIDRO PAINTED BACK GLASS TOP

See standard color choices. Customer's own color must be pre-approved through custom quotation.

Bases standard in COLORA see optional base upgrades. Polished and Satin Chrome options upcharged. Tables are 29" high.

ITEM	TOP DIMENSIONS	BASE DIMENSIONS
------	----------------	-----------------

ROUND

801V-42	42" dia.	18" dia.
801V-48	48" dia.	18" dia.
801V-54	54" dia.	22" dia.
801V-60	60" dia.	22" dia.

SQUARE

807V-42	42" x 42"	18" dia.
807V-48	48" x 48"	18" dia.
807V-54	54" x 54"	22" dia.
807V-60	60" x 60"	24" dia.

RECTANGLE

805V-8442	84" x 42"	18" dia.
805V-9648	96" x 48"	18" dia.
805V-1084 (Top in 2 sections)	108" x 48"	18" dia.

sectioned tops

805V-1204	120" x 48"	18" dia.
805V-1324	132" x 48"	18" dia.
805V-1444	144" x 48"	18" dia.
805V-1206	120" x 60"	24" dia.
805V-1326	132" x 60"	24" dia.
805V-1446	144" x 60"	24" dia.

805V-1686	168" x 60"	24" dia.
805V-1926 (Top in 3 sections)	192" x 60"	24" dia.
805V-2166 (Top in 3 sections)	216" x 60"	24" dia.
805V-2406 (Top in 4 sections)	240" x 60"	24" dia.

ARCED RECTANGLE

808V-8442	84" x 42"	18" dia.
808V-9648	96" x 48"	18" dia.
808V-1084 (Top in 2 sections)	108" x 48"	18" dia.

sectioned tops

808V-1204	120" x 48"	18" dia.
808V-1324	132" x 48"	18" dia.
808V-1444	144" x 48"	18" dia.
808V-1206	120" x 60"	24" dia.
808V-1326	132" x 60"	24" dia.
808V-1446	144" x 60"	24" dia.

808V-1686	168" x 60"	24" dia.
808V-1926 (Top in 3 sections)	192" x 60"	24" dia.
808V-2166 (Top in 3 sections)	216" x 60"	24" dia.
808V-2406 (Top in 4 sections)	240" x 60"	24" dia.

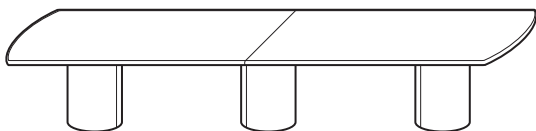
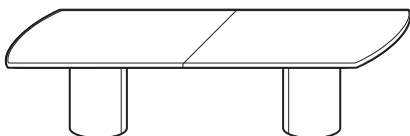
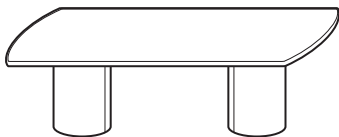
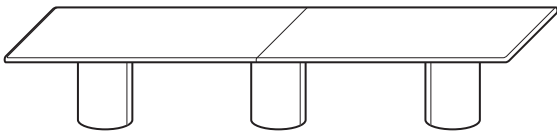
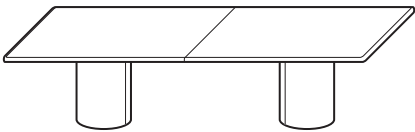
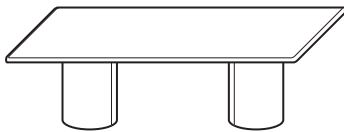
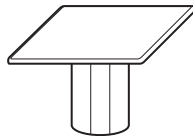
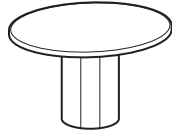

PAINTED BACK GLASS TOP (CL GLASS)

MATTE (MA GLASS)

ADD BASE UPGRADES

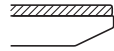

1 1/4" RB

QTY1 QTY3

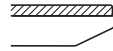

1 1/4" RB

QTY1 QTY3

ADD
CRATE
NET \$

VENEER

SATIN +
POL CHROME

4098	3892	4863	4635	134	996	1053
4845	4517	5850	5477	153	996	1053
5563	5232	6798	6422	172	1091	1171
6236	5906	7726	7351	191	1091	1171
4340	4049	5150	4814	134	996	1053
4757	4469	5747	5415	153	996	1053
5563	5232	6798	6422	172	1091	1171
6344	6008	7834	7453	191	1118	1177
8418	7996	9949	9483	243	1991	2105
9468	9043	11389	10920	277	1991	2105
10126	9701	12265	11796	312	1991	2105
11944	11032	14522	13477	347	1991	2105
12430	11517	15204	14158	382	1991	2105
13394	12462	16386	15321	416	1991	2105
13478	12548	16545	15483	382	2236	2354
14324	13392	17681	16616	420	2236	2354
15524	14575	19170	18088	458	2236	2354
18648	17605	22783	21609	535	3351	3532
21428	20379	26319	25137	611	3351	3532
23591	22517	29060	27854	686	3351	3532
24876	23801	30857	29649	762	3351	3532
9096	8675	10740	10274	243	1991	2105
10353	9930	12421	11953	277	1991	2105
11125	10697	13429	12957	312	1991	2105
13052	12139	15813	14767	347	1991	2105
13649	12736	16625	15579	382	1991	2105
14724	13793	17935	16872	416	1991	2105
14862	13933	18158	17097	382	2236	2354
15846	14916	19455	18392	420	2236	2354
17186	16237	21597	20516	458	2236	2354
20586	19544	25042	23868	535	3351	3532
23644	22595	28901	27719	611	3351	3532
25598	24524	31479	30273	686	3351	3532
27523	26450	33962	32756	762	3351	3532

- 42" and 48" Round and Square table bases do not have removable access panel
- Drum bases are available seamless (rolled, welded and finished). Specify "without access door"
- Vidro Art option require additional details - custom quote required.

DRUM BASE TABLES • VIDRO PAINTED BACK GLASS TOP

See standard color choices. Customer's own color must be pre-approved through custom quotation.

Bases standard in COLORA see optional base upgrades. Polished and Satin Chrome options upcharged. Tables are 29" high.

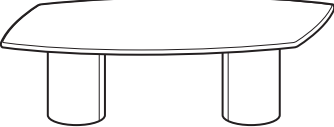
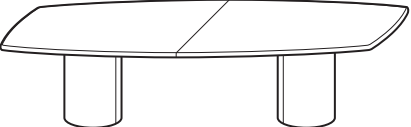
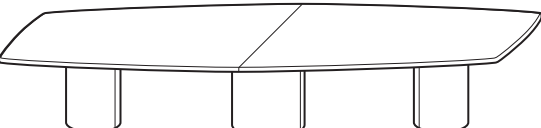
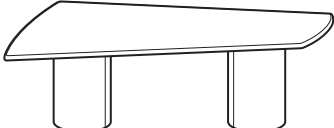
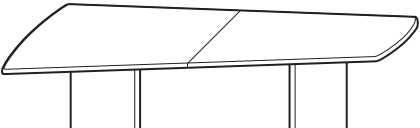
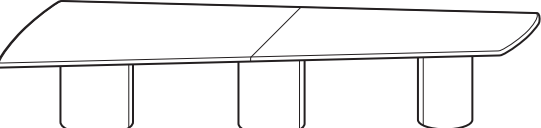
	ITEM	TOP DIMENSIONS	BASE DIMENSIONS
	ARCED BOAT		
	806V-8442	84" x 42"/30"	18" dia.
	806V-9648	96" x 48"/35"	18" dia.
 	sectioned tops		
	806V-1204	120" x 48"/35"	18" dia.
	806V-1324	132" x 48"/35"	18" dia.
	806V-1444	144" x 48"/35"	18" dia.
	806V-1206	120" x 60"/42"	22" dia.
	806V-1326	132" x 60"/42"	22" dia.
	806V-1446	144" x 60"/42"	22" dia.
	806V-1686	168" x 60"/42"	22"/24"/22" dia.
	806V-1926 (Top in 3 sections)	192" x 60"/42"	22"/24"/22" dia.
	806V-2166 (Top in 3 sections)	216" x 60"/42"	22"/24"/22" dia.
806V-2406 (Top in 4 sections)	240" x 60"/42"	22"/24"/22" dia.	
	ARCED WEDGE		
	809V-8448	84" x 48"/28"	18" dia.
	809V-9648	96" x 48"/28"	18" dia.
 	Sectioned tops		
	809V-1206	120" x 60"/35"	22"/18" dia.
	809V-1326	132" x 60"/35"	22"/18" dia.
	809V-1446	144" x 60"/35"	22"/18" dia.
	809V-1686	168" x 60"/35"	24"/22"/18" dia.
	809V-1926 (Top in 3 sections)	192" x 60"/35"	24"/22"/18" dia.
	809V-2166 (Top in 3 sections)	216" x 60"/35"	24"/22"/18" dia.
	809V-2406 (Top in 4 sections)	240" x 60"/35"	24"/22"/18" dia.

PAINTED BACK GLASS TOP (CL GLASS)

MATTE (MA GLASS)

ADD BASE UPGRADES

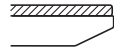

1 1/4" RB

QTY1 QTY3

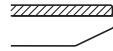

1 1/4" RB

QTY1 QTY3

ADD
CRATE
NET \$

VENEER

SATIN +
POL CHROME

9096	8675	10740	10274	243	1991	2105
10353	9930	12421	11953	277	1991	2105
11125	10697	13429	12959	312	1991	2105
13052	12139	15813	14767	347	1991	2105
13649	12736	16625	15581	382	1991	2105
14724	13793	17935	16872	416	1991	2105
14862	13933	18158	17097	382	2179	2338
15846	14916	19455	18392	420	2179	2338
17186	16237	21107	20025	458	2179	2338
20586	19544	25042	23868	535	3296	3515
23644	22595	28901	27719	611	3296	3515
26084	25010	31965	30759	686	3296	3515
27646	26571	34085	32877	762	3296	3515
9601	9179	11432	10966	243	1991	2105
10353	9930	12421	11953	277	1991	2105
11125	10697	13429	12959	312	1991	2105
14586	13670	17882	16834	382	2085	2220
15549	14631	19158	18107	420	2085	2220
16511	15595	20432	19383	458	2085	2220
20586	19544	25042	23868	535	3202	3398
23644	22595	28901	27719	611	3202	3398
26084	25010	29525	30759	686	3202	3398
27646	26571	34085	32877	762	3202	3398

DRUM

- Drum bases are available seamless (rolled, welded and finished). Specify "without access door"
- Vidro Art option require additional details - custom quote required.

DRUM BASE TABLES • STONE TOP

See selection of top and base finishes. Standard base finish is COLORA colors; veneer and chrome base upcharges are shown below.

Tables are 29" high. Crate charge applies to stone tops.

Note: 60" wide marble tops are subject to availability – please inquire.

Specify: model number – stone top variety – edge profile – base finish – power and comm. options.

ITEM	TOP DIMENSIONS	BASE DIMENSIONS
------	----------------	-----------------

ROUND

801M-42	42" dia.	18" dia.
801M-48	48" dia.	18" dia.
801M-54	54" dia.	22" dia.
801M-60	60" dia.	22" dia.

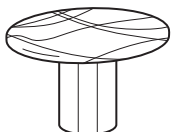

SQUARE

807M-42	42" x 42"	18" dia.
807M-48	48" x 48"	18" dia.
807M-54	54" x 54"	22" dia.
807M-60	60" x 60"	24" dia.

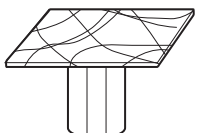

RECTANGLE

805M-8442	84" x 42"	18" dia.
805M-9648	96" x 48"	18" dia.

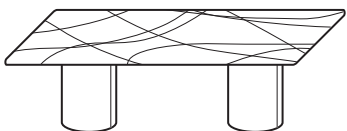

sectioned tops

805M-1084	108" x 48"	18" dia.
805M-1204	120" x 48"	18" dia.
805M-1324	132" x 48"	18" dia.
805M-1444	144" x 48"	18" dia.
805M-1206	120" x 60"	24" dia.
805M-1326	132" x 60"	24" dia.
805M-1446	144" x 60"	24" dia.

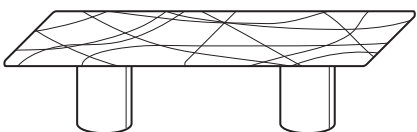

805M-1686 (Top in 2 sections)	168" x 60"	24" dia.
805M-1926	192" x 60"	24" dia.
805M-2166	216" x 60"	24" dia.
805M-2406	240" x 60"	24" dia.

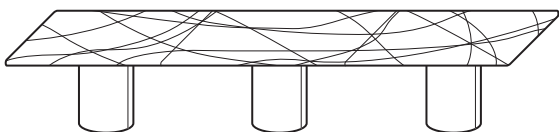

ARCED RECTANGLE

808M-8442	84" x 42"	18" dia.
808M-9648	96" x 48"	18" dia.

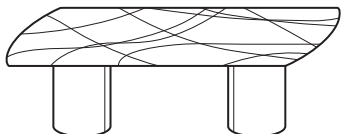

sectioned tops

808M-1084	108" x 48"	18" dia.
808M-1204	120" x 48"	18" dia.
808M-1324	132" x 48"	18" dia.
808M-1444	144" x 48"	18" dia.
808M-1206	120" x 60"	24" dia.
808M-1326	132" x 60"	24" dia.
808M-1446	144" x 60"	24" dia.

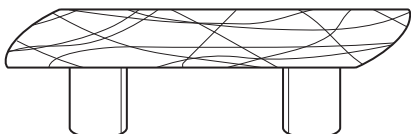

808M-1686 (Top in 2 sections)	168" x 60"	24" dia.
808M-1926	192" x 60"	24" dia.
808M-2166	216" x 60"	24" dia.
808M-2406	240" x 60"	24" dia.

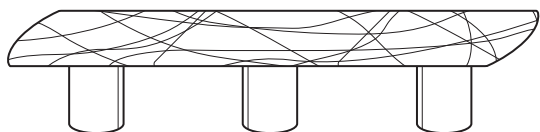

• Number of sectioned tops may vary based on type of stone.

MARBLE or GRANITE TOP

ADD BASE UPGRADES

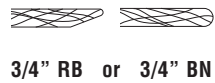

3/4" RB or 3/4" BN

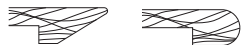

1 1/2" RB or 1 1/2" BN

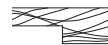

1 1/2" SQ

ADD
CRATE
NET \$

veneer

SATIN +
POL
CHROME

7687	9139	8268	134	996	1053
9230	10891	9895	153	996	1053
11028	12895	11773	172	1091	1171
12857	14932	13686	191	1091	1171
7608	8396	7641	132	996	1053
9088	9992	9127	153	996	1053
10816	11831	10859	172	1091	1171
12672	13798	12718	191	1118	1177
14665	15774	14665	243	1991	2105
17305	18573	17305	277	1991	2105
20745	22119	20745	312	1991	2105
22079	23558	22079	347	1991	2105
23413	24999	23413	382	1991	2105
25103	26794	25103	416	1991	2105
25255	26842	25255	382	2236	2354
26840	28531	26840	420	2236	2354
28778	30577	28778	458	2236	2354
34544	36604	34544	535	3351	3532
40537	42869	40537	611	3351	3532
44700	47314	44700	686	3351	3532
49139	52048	49139	762	3351	3532
15446	17112	15816	243	1991	2105
18293	20197	18717	277	1991	2105
21833	23843	22256	312	1991	2105
23262	25377	23685	347	1991	2105
24693	26914	25116	382	1991	2105
26480	28808	26903	416	1991	2105
26737	29116	27265	382	2236	2354
28441	30927	28983	420	2236	2354
30503	33093	31031	458	2236	2354
36560	39433	37103	535	3351	3532
42972	46139	43529	611	3351	3532
47454	50924	48024	686	3351	3532
52105	55886	52687	762	3351	3532

DRUM

- 42" and 48" Round and Square table bases do not have removable access panel
- Drum bases are available seamless (rolled, welded and finished). Specify "without access door"

DRUM BASE TABLES • STONE TOP

See selection of top and base finishes. Standard base finish is COLORA colors; veneer and chrome base upcharges are shown below.

Tables are 29" high. Crate charge applies to stone tops.

Note: 60" wide marble tops are subject to availability – please inquire.

Specify: model number – stone top variety – edge profile – base finish – power and comm. options.

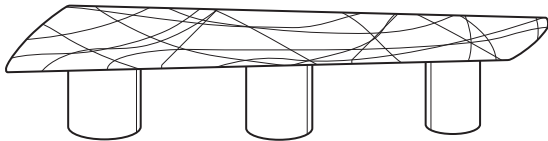
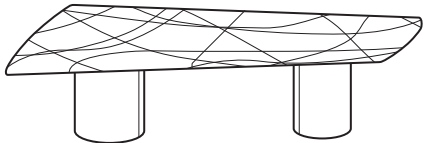
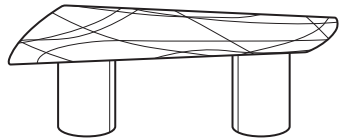
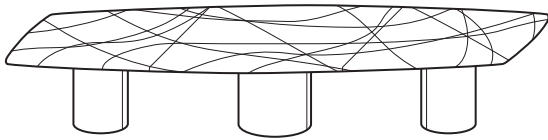
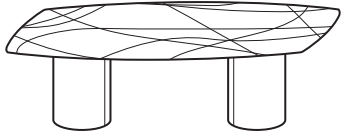
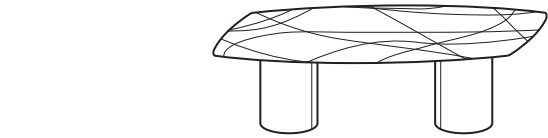

ITEM	TOP DIMENSIONS	BASE DIMENSIONS
------	----------------	-----------------

ARCED BOAT

806M-8442	84" x 42"/30"	18" dia.
806M-9648	96" x 48"/35"	18" dia.

sectioned tops

806M-1084	108" x 48"/35"	18" dia.
806M-1204	120" x 48"/35"	18" dia.
806M-1324	132" x 48"/35"	18" dia.
806M-1444	144" x 48"/35"	18" dia.
806M-1206	120" x 60"/42"	22" dia.
806M-1326	132" x 60"/42"	22" dia.
806M-1446	144" x 60"/42"	22" dia.

806M-1686 (Top in 2 sections)	168" x 60"/42"	22"/24"/22" dia.
806M-1926	192" x 60"/42"	22"/24"/22" dia.
806M-2166	216" x 60"/42"	22"/24"/22" dia.
806M-2406	240" x 60"/42"	22"/24"/22" dia.

ARCED WEDGE

809M-8448	84" x 48"/28"	18" dia.
809M-9648	96" x 48"/28"	18" dia.

Sectioned tops



809M-1084	108" x 48"/28"	18" dia.
809M-1206	120" x 60"/35"	22"/18" dia.
809M-1326	132" x 60"/35"	22"/18" dia.
809M-1446	144" x 60"/35"	22"/18" dia.

809M-1686 (Top in 2 sections)	168" x 60"/35"	24"/22"/18" dia.
809M-1926	192" x 60"/35"	24"/22"/18" dia.
809M-1686	216" x 60"/35"	24"/22"/18" dia.
809M-2406	240" x 60"/35"	24"/22"/18" dia.

• Number of sectioned tops may vary based on type of stone.

MARBLE or GRANITE TOP

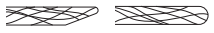
ADD BASE UPGRADES

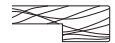
									ADD CRATE NET \$	VENEER	SATIN + POL CHROME
3/4" RB	or	3/4" BN	1 1/2" RB	or	1 1/2" BN	1 1/2" SQ					
15816			18592			16928	243	1991	2105		
18717			21889			19986	277	1991	2105		
22309			25746			23684	312	1991	2105		
23790			27492			25271	347	1991	2105		
25275			29240			26862	382	1991	2105		
27116			31345			28808	416	1991	2105		
27082			31048			28668	382	2179	2338		
28840			33071			30532	420	2179	2338		
30970			35464			32769	458	2179	2338		
37318			42467			39378	535	3296	3515		
43861			49691			46193	611	3296	3515		
48479			55014			51093	686	3296	3515		
53268			60540			56176	762	3296	3515		
16588			18384			17009	243	1991	2105		
18293			20197			18717	277	1991	2105		
21833			23843			22256	312	1991	2105		
26434			28813			26962	382	2085	2220		
28114			30601			28643	420	2085	2220		
29828			32419			30357	458	2085	2220		
36560			39433			37103	535	3202	3398		
42972			46139			43529	611	3202	3398		
47442			50924			48024	686	3202	3398		
52105			55886			52687	762	3202	3398		

DRUM

• Drum bases are available seamless (rolled, welded and finished). Specify "without access door"

PANEL LR BASE TABLES • LAMINATE and VENEER TOPS

All table tops, except for veneer with wood edge feature inlays between top surface and edge in matching color to either top or edge unless specified otherwise. Standard base finish is COLORA; trim and side panels can be specified in different colors. Veneer side panels upcharge is shown below. Tables are 29" high.
Specify: model number – top finish – edge profile and finish – inlay color (if applicable and in contrast color)
 – base trim and side panel finishes – power and comm. options.

LOW RISE
GLIDES

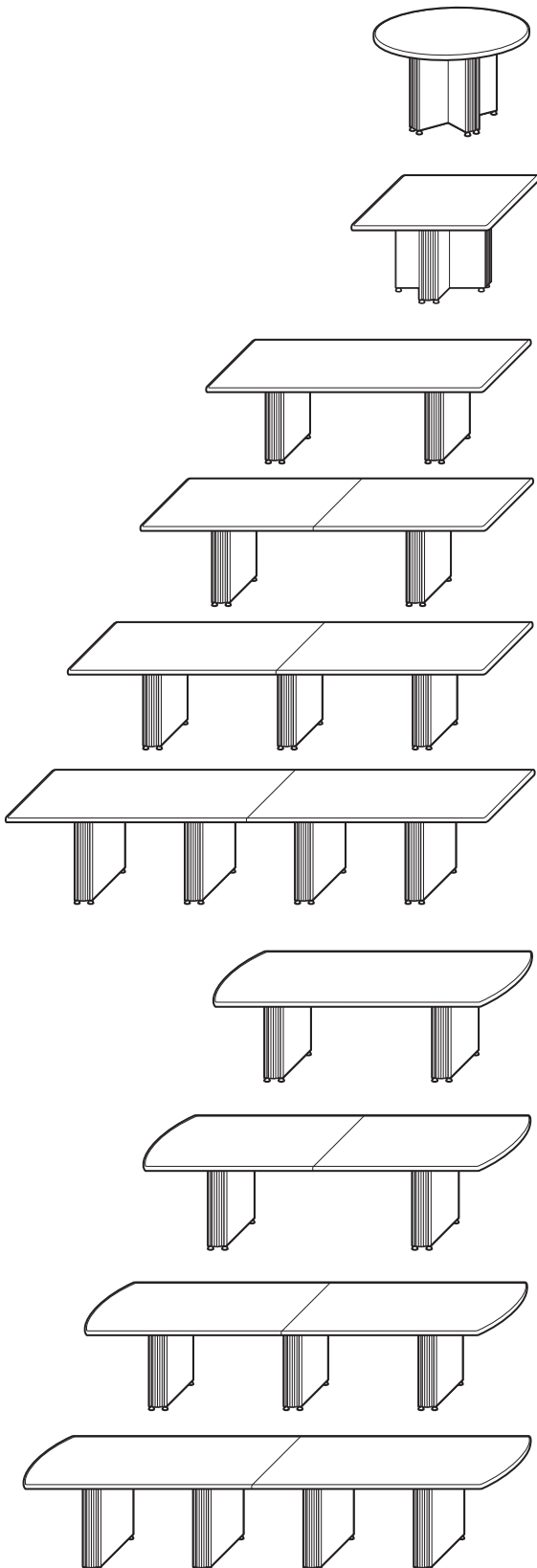
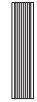

ITEM

TOP DIMENSIONS

LOW RISE
GLIDES

ROUND

821-48	48" dia.	– LR
821-54	54" dia.	– LR
821-60	60" dia.	– LR
821-72 (Center seam in laminate)	72" dia.	– LR

SQUARE

827-48	48 x 48"	– LR
827-54	54 x 54"	– LR
827-60	60 x 60"	– LR

RECTANGLE

825-8442	84" x 42"	– LR
825-9648	96" x 48"	– LR
825-1084	108" x 48"	– LR

sectioned tops

825-1204	120" x 48"	– LR
825-1324	132" x 48"	– LR
825-1206	120" x 60"	– LR
825-1326	132" x 60"	– LR
825-1444	144" x 48"	– LR
825-1446	144" x 60"	– LR
825-1686	168" x 60"	– LR
825-1926	192" x 60"	– LR

825-2166	216" x 60"	– LR
825-2406 (Top in 3 sections)	240" x 60"	– LR

ARCED RECTANGLE

828-8442	84" x 42"	– LR
828-9648	96" x 48"	– LR
828-1084	108" x 48"	– LR

sectioned tops

828-1204	120" x 48"	– LR
828-1324	132" x 48"	– LR
828-1206	120" x 60"	– LR
828-1326	132" x 60"	– LR
828-1444	144" x 48"	– LR
828-1446	144" x 60"	– LR
828-1686	168" x 60"	– LR
828-1926	192" x 60"	– LR

828-2166	216" x 60"	– LR
828-2406 (Top in 3 sections)	240" x 60"	– LR

PLASTIC LAMINATE or COLORA TOP

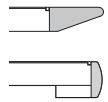

RB or RAD Colora
QTY1 QTY 3

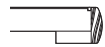

RAD Wood
QTY1 QTY 3

VENEER TOP

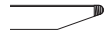

RB Wood
QTY1 QTY 3

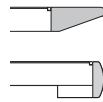

RB or RAD Colora
QTY1 QTY 3



RAD Wood
QTY1 QTY 3

**ADD
VENEER
BASE**

**ADD
FLAT
END
PANEL**

**ADD
POL OR
BRUSH
STAIN
CLAD FLAT
END ONLY
(included)**

4014	3577	4744	4142	5067	4491	5135	4335	5401	4603	877	458	
4381	3897	5127	4504	5534	4868	5867	4925	6167	5223	953	458	
4902	4343	5668	4992	5827	5200	6621	5511	6952	5841	953	458	
6697	5742	7528	6459	6983	6357	8758	7155	9156	7553	1055	458	

4014	3577	4898	4250	4505	3949	5135	4335	5473	4674	877	458	
4321	3837	5213	4524	4942	4287	5808	4862	6189	5245	953	458	
4902	4343	5946	5142	5469	5127	6621	5511	7045	5933	953	458	

4227	3672	5151	4409	5063	4316	5800	4775	5590	4783	877	458	
4509	3910	5433	4660	5855	4962	6936	5675	6614	5624	953	458	3992
5087	4410	6020	5178	6286	5313	7540	6154	7168	6081	953	458	3992

5781	4917	7488	6438	7173	6334	8775	7196	8213	6973	953	458	3992
5997	5102	7851	6722	7795	6818	9154	7504	8589	7264	953	458	3992
6451	5496	8243	7073	8259	7199	9720	7907	9093	7640	1024	458	4304
6618	5637	8546	7287	8677	7553	10186	8237	9551	7991	1024	458	4304

7262	6314	9266	8017	9085	8087	10582	8822	10019	8583	1427	687	5988
7979	6939	10047	8664	10068	8953	11782	9696	11137	9443	1536	687	6456
9105	7969	11450	9846	11511	10196	12986	10573	12319	10431	1536	687	6456
9434	8248	12059	10275	12684	11200	13918	11231	13230	11128	1536	687	6456

11600	10239	14499	12422	14784	13113	15774	12801	15066	12739	2047	916	8608
12452	10897	15870	13512	16663	14804	17949	15142	16765	14155	2047	916	8608

4306	3725	5402	4568	5718	4917	6127	4993	6571	5438	877	458	
4598	3968	5691	4824	6584	5582	7350	5954	7858	6460	953	458	3992
5181	4472	6286	5349	7058	5930	8002	6467	8551	7016	953	458	3992

5909	5002	7945	6771	8489	6793	9353	7602	9946	8192	953	458	3992
6130	5191	8334	7068	8767	7155	9752	7920	10387	8510	953	458	3992
6588	5586	8724	7419	9250	7638	10350	8335	10985	8926	1024	458	4304
6758	5728	9051	7645	9767	8061	10842	8676	11518	9309	1024	458	4304

7397	6404	9772	8374	10096	8568	11201	9248	11879	9856	1427	687	5988
8124	7035	10578	9035	11153	9449	12464	10146	13182	10794	1536	687	6456
9256	8070	12030	10238	12346	10572	13721	11046	14526	11850	1536	687	6456
9595	8355	12687	10691	13579	11405	14705	11725	15594	12615	1536	687	6456

11770	10351	15178	12861	15930	13938	16616	14375	17588	14290	2047	916	8608
12659	11032	16701	14059	17932	15728	18674	15767	19731	16031	2047	916	8608

- Adjustable Glides in COLORA colors: add \$189.00
- 48" Round and Square table bases do not have removable side panel

PANEL LR BASE TABLES • LAMINATE and VENEER TOPS

All table tops, except for veneer with wood edge feature inlays between top surface and edge in matching color to either top or edge unless specified otherwise. Standard base finish is COLORA; trim and side panels can be specified in different colors. Veneer side panels upcharge is shown below. Tables are 29" high.
Specify: model number – top finish – edge profile and finish – inlay color (if applicable and in contrast color)
– base trim and side panel finishes – power and comm. options.

LOW RISE
GLIDES

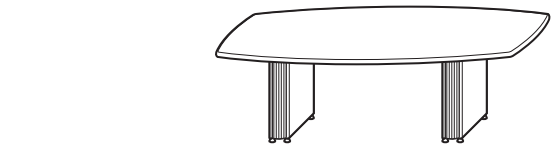

ITEM

TOP DIMENSIONS

ARCED BOAT

826-8442	84" x 42"/30"	– LR
826-9648	96" x 48"/35"	– LR
826-1084	108" x 48"/35"	– LR

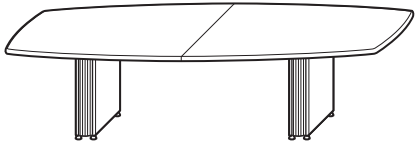

sectioned tops

826-1204	120" x 48"/35"	– LR
826-1324	132" x 48"/35"	– LR
826-1206	120" x 60"/42"	– LR
826-1326	132" x 60"/42"	– LR

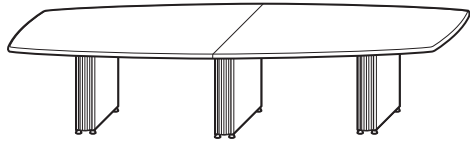

826-1444	144" x 48"/35"	– LR
826-1446	144" x 60"/42"	– LR
826-1686	168" x 60"/42"	– LR
826-1926	192" x 60"/42"	– LR

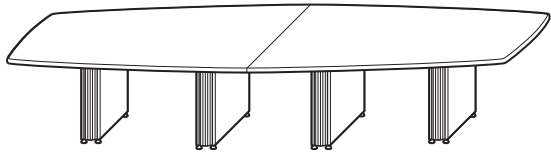

826-2166	216" x 60"/42"	– LR
826-2406 (Top in 3 sections)	240" x 60"/42"	– LR
826-2407 (Top in 4 sections)	240" x 72"/48"	– LR

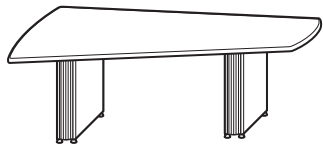

ARCED WEDGE

829-8448	84" x 48"/28"	– LR
829-9648	96" x 48"/28"	– LR
829-1084	108" x 48"/28"	– LR

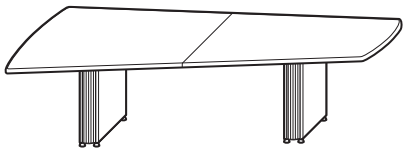

Sectioned tops

829-1206	120" x 60"/35"	– LR
829-1326	132" x 60"/35"	– LR

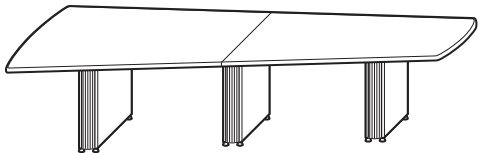

829-1446	144" x 60"/35"	– LR
829-1686	168" x 60"/35"	– LR
829-1926	192" x 60"/35"	– LR

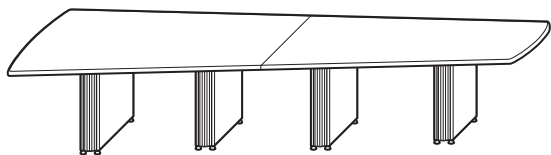

829-2166	216" x 60"/35"	– LR
829-2406 (Top in 3 sections)	240" x 60"/35"	– LR

PLASTIC LAMINATE or COLORA TOP

VENEER TOP

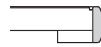
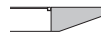
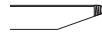
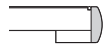
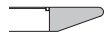

RB or RAD Colora
QTY1 QTY 3

RAD Wood
QTY1 QTY 3

RB Wood
QTY1 QTY 3

RB or RAD Colora
QTY1 QTY 3

RAD Wood
QTY1 QTY 3

ADD VENEER BASE

ADD FLAT END PANEL

ADD POL OR BRUSH STAIN CLAD FLAT END ONLY (included)

4306	3725	5402	5101	5718	4917	6127	4993	6571	5438	877	458	
4582	3953	5675	5388	6568	5566	7335	5937	7843	6445	877	458	3992
5147	4438	6252	5918	7024	5895	7967	6433	8517	6984	877	458	3992

5858	4951	7894	6737	8438	6739	9301	7592	9894	8141	877	458	3992
6060	5122	8263	7000	8697	7085	9682	7850	10318	8443	877	458	3992
6541	5539	8677	7373	9203	7591	10302	8287	10937	8879	953	458	4304
6710	5681	9003	7599	9720	8015	10794	8628	11470	9263	953	458	4304

8100	7092	10476	9063	10800	9270	11905	9951	12581	10542	1354	687	5988
8744	7641	11199	9640	12154	10287	13083	10766	13803	11401	1464	687	6456
9607	8415	12380	10584	13142	11171	14073	11392	14876	12196	1464	687	6456
9947	8700	13039	11036	14438	12048	15056	12071	15946	12959	1464	687	6456

12121	10696	15527	13205	16280	14288	16966	13662	17939	14635	1975	916	8608
13009	11377	17050	14403	18283	16079	19024	15319	20081	16376	1975	916	8608
14415	12502	19097	15967	21252	18570	21897	18390	22997	18962	1975	916	

4753	4159	5891	5046	5911	5071	7708	6055	8174	6520	916	458	3992
4985	4346	6076	5200	6339	5421	7737	6331	8244	6838	916	458	3992
5567	4849	6673	5725	6771	5774	8386	6843	8936	7392	916	458	3992

6926	5915	9063	7751	8207	7316	10689	8674	11323	9256	916	458	4304
7097	6060	9390	7978	8679	7712	11179	9014	11857	9640	916	458	4304

8701	7599	11155	9600	10520	9474	13042	10725	13760	11358	1426	687	6456
9565	8372	12338	10541	11414	10265	14029	11350	14834	12152	1426	687	6456
9905	8658	12995	10993	12313	11062	15014	12030	15902	12918	1426	687	6456

12337	10911	15745	13419	16497	14505	17183	13876	18155	14850	1901	916	8608
13227	11591	17268	14617	18498	16296	19241	16062	20298	17120	1901	916	8608

REV 03.20.15

PANEL LR

• Adjustable Glides in COLORA colors: add \$189.00

PANEL LR BASE TABLES • VIDRO PAINTED BACK GLASS TOP

See standard color choices. Customer's own color must be pre-approved through custom quotation.
Bases standard in COLORA see optional base upgrades. Tables are 29" high.

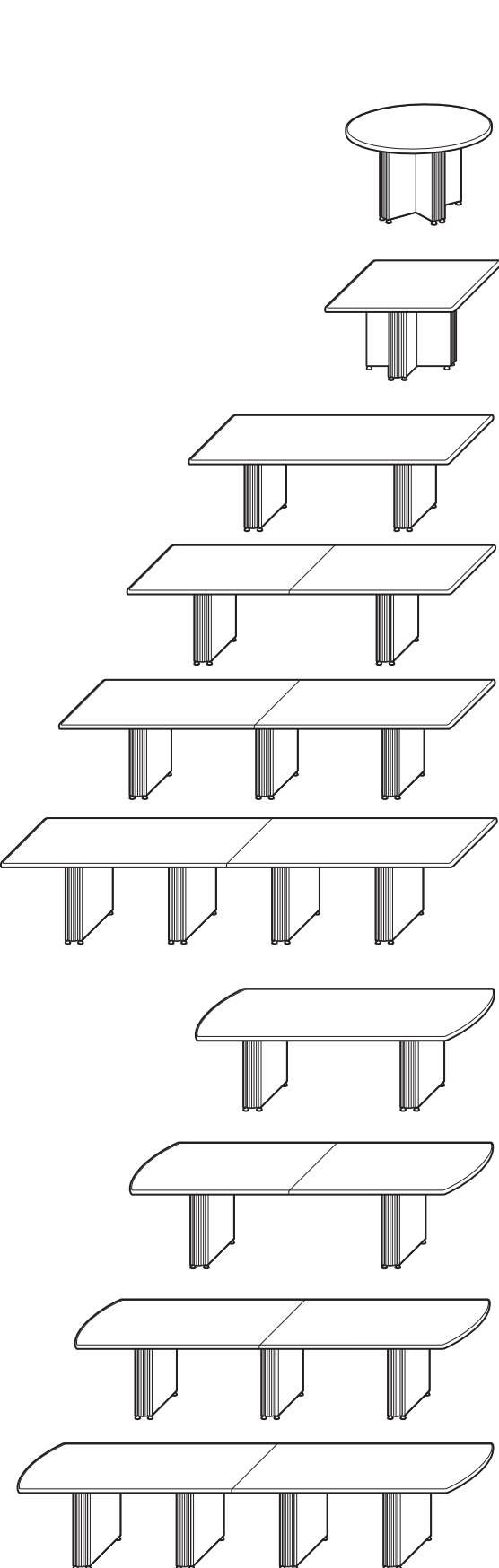

ITEM

TOP DIMENSIONS

LOW RISE GLIDES



ROUND

821V-48	48" dia.	- LR
821V-54	54" dia.	- LR
821V-60	60" dia.	- LR

SQUARE

827V-48	48 x 48"	- LR
827V-54	54 x 54"	- LR
827V-60	60 x 60"	- LR

RECTANGLE

825V-8442	84" x 42"	- LR
825V-9648	96" x 48"	- LR
825V-1084 (Top in 2 sections)	108" x 48"	- LR

sectioned tops

825V-1204	120" x 48"	- LR
825V-1324	132" x 48"	- LR
825V-1206	120" x 60"	- LR
825V-1326	132" x 60"	- LR

825V-1444	144" x 48"	- LR
825V-1446	144" x 60"	- LR
825V-1686	168" x 60"	- LR
825V-1926 (Top in 3 sections)	192" x 60"	- LR

825V-2166 (Top in 3 sections)	216" x 60"	- LR
825V-2406 (Top in 4 sections)	240" x 60"	- LR

ARCED RECTANGLE

828V-8442	84" x 42"	- LR
828V-9648	96" x 48"	- LR
828V-1084 (Top in 2 sections)	108" x 48"	- LR

sectioned tops

828V-1204	120" x 48"	- LR
828V-1324	132" x 48"	- LR
828V-1206	120" x 60"	- LR
828V-1326	132" x 60"	- LR

828V-1444	144" x 48"	- LR
828V-1446	144" x 60"	- LR
828V-1686	168" x 60"	- LR
828V-1926 (Top in 3 sections)	192" x 60"	- LR

828V-2166 (Top in 3 sections)	216" x 60"	- LR
828V-2406 (Top in 4 sections)	240" x 60"	- LR

PAINTED BACK GLASS TOP (CL GLASS)

MATTE (MA GLASS)

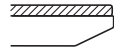

1 1/4" RB

QTY1 QTY3

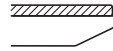

1 1/4" RB

QTY1 QTY3

ADD
CRATE
NET \$

ADD
VENEER
BASE

ADD
FLAT END
PANEL

ADD POL OR
BRUSH STAIN
CLAD FLAT
END ONLY
(included)

5348	5002	6353	5962	153	877	458	
6027	5678	7262	6868	172	953	458	
6700	6353	8190	7798	191	953	458	
5259	4954	6249	5900	153	877	458	
6027	5679	7262	6869	172	953	458	
6699	6351	8189	7796	191	953	458	
6572	6244	8103	7731	243	877	458	
7601	7269	9522	9146	277	953	458	3992
8207	7875	10346	9970	312	953	458	3992
9969	9154	12547	11599	347	953	458	3992
10433	9619	13207	12260	382	953	458	3992
11187	10369	14254	13304	382	1024	458	4304
12030	11212	15387	14436	420	1024	458	4304
12951	12048	15943	14907	416	1427	687	5988
14754	13850	18408	17363	458	1536	687	6456
15954	15049	20089	19053	535	1536	687	6456
18610	17702	23501	22460	611	1536	687	6456
21265	20310	26734	25647	686	2047	916	8608
22710	21750	28691	27598	762	2047	916	8608
7251	6922	8895	8521	243	877	458	
8487	8155	10555	10178	277	953	458	3992
9203	8873	11507	11133	312	953	458	3992
11130	10314	13891	12942	347	953	458	3992
11725	10908	14701	13751	382	1024	458	3992
12619	11801	15915	14965	382	1024	458	4304
13601	12781	17210	16257	420	1024	458	4304
13543	12675	16754	15754	416	1427	687	5988
15767	14893	20178	19172	458	1536	687	6456
17527	16638	21983	20962	535	1536	687	6456
20458	19568	25715	24692	611	1536	687	6456
22905	21969	28786	27718	686	2047	916	8608
24993	24049	31432	30355	762	2047	916	8608

- Adjustable Glides in COLORA colors: add \$189.00
- 48" Round and Square table bases do not have removable side panel
- Vidro Art option require additional details - custom quote required.

REV 03.20.15

PANEL LR BASE TABLES • VIDRO PAINTED BACK GLASS TOP

See standard color choices. Customer's own color must be pre-approved through custom quotation.
Bases standard in COLORA see optional base upgrades. Tables are 29" high.

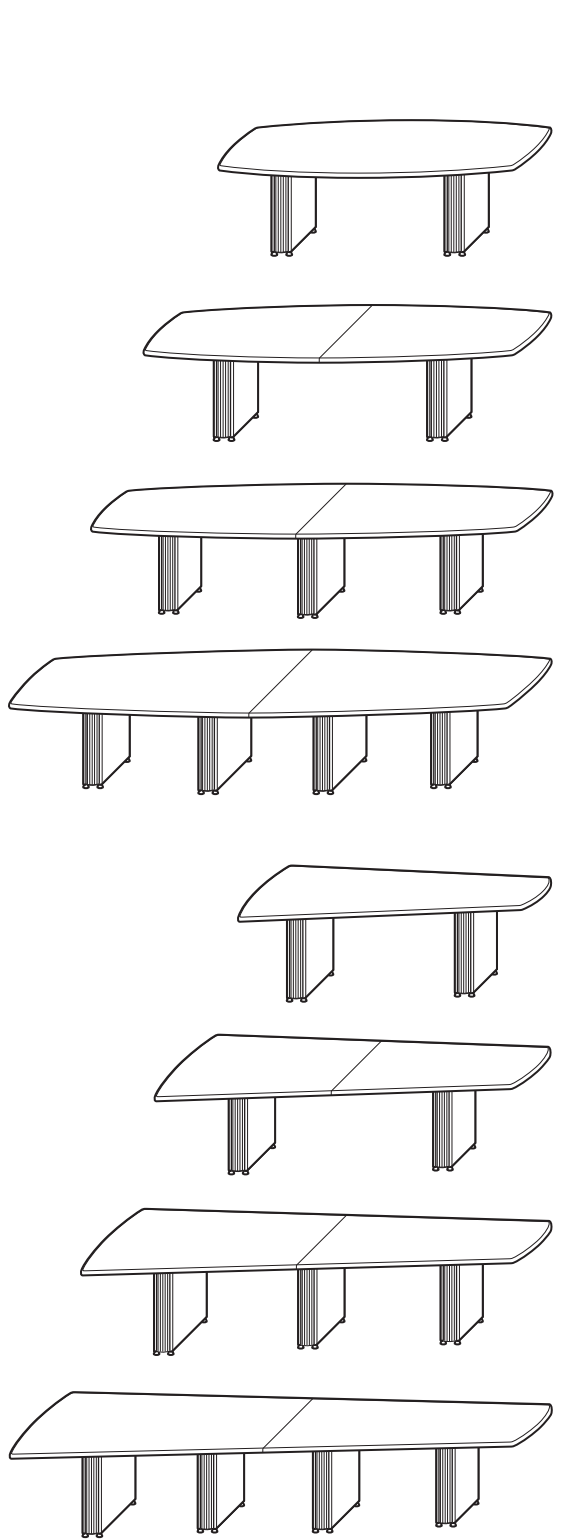

ITEM

TOP DIMENSIONS

LOW RISE GLIDES



ARCED BOAT

826V-8442	84" x 42"/30"	- LR
826V-9648	96" x 48"/35"	- LR
826V-1084 (Top in 2 sections)	108" x 48"/35"	- LR

sectioned tops

826V-1204	120" x 48"/35"	- LR
826V-1324	132" x 48"/35"	- LR
826V-1206	120" x 60"/42"	- LR
826V-1326	132" x 60"/42"	- LR

826V-1444	144" x 48"/35"	- LR
826V-1446	144" x 60"/42"	- LR
826V-1686	168" x 60"/42"	- LR
826V-1926 (Top in 3 sections)	192" x 60"/42"	- LR

826V-2166 (Top in 3 sections)	216" x 60"/42"	- LR
826V-2406 (Top in 4 sections)	240" x 60"/42"	- LR

ARCED WEDGE

829V-8448	84" x 48"/28"	- LR
829V-9648	96" x 48"/28"	- LR
829V-1084 (Top in 2 sections)	108" x 48"/28"	- LR

Sectioned tops

829V-1206	120" x 60"/35"	- LR
829V-1326	132" x 60"/35"	- LR

829V-1446	144" x 60"/35"	- LR
829V-1686	168" x 60"/35"	- LR
829V-1926 (Top in 3 sections)	192" x 60"/35"	- LR

829V-2166 (Top in 3 sections)	216" x 60"/35"	- LR
829V-2406 (Top in 4 sections)	240" x 60"/35"	- LR

PAINTED BACK GLASS TOP (CL GLASS)

MATTE (MA GLASS)

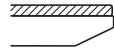

1 1/4" RB

QTY1 QTY3

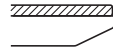

1 1/4" RB

QTY1 QTY3

ADD
CRATE
NET \$

ADD
VENEER
BASE

ADD
FLAT END
PANEL

ADD POL OR
BRUSH STAIN
CLAD FLAT
END ONLY
(included)

7251	6922	8895	8521	243	877	458	
8470	8141	10538	10164	277	877	458	3992
9166	8838	11470	11098	312	877	458	3992
11077	10261	13838	12889	347	877	458	3992
11652	10839	14628	13682	382	877	458	3992
12571	11755	15867	14919	382	953	458	4304
13553	12734	17162	16210	420	953	458	4304
14280	13378	17491	16457	416	1354	687	5988
16415	15512	20336	19300	458	1464	687	6456
17893	16988	22349	21312	535	1464	687	6456
20826	19918	26083	25042	611	1464	687	6456
23758	22803	29639	28552	686	1975	916	8608
25480	24520	31919	30826	762	1975	916	8608
8175	7827	10006	9614	243	916	458	3992
8890	8542	10958	10565	277	916	458	3992
9607	9256	11911	11516	312	916	458	3992
12975	12138	16271	15302	382	916	458	4304
13957	13120	17566	16596	420	916	458	4304
16371	15470	20292	19258	458	1426	687	6456
17850	16945	22306	21269	535	1426	687	6456
20782	19875	26039	24999	611	1426	687	6456
23984	23021	29865	28770	686	1901	916	8608
25708	24738	32147	31044	762	1901	916	8608

REV 03.20.15

PANEL LR

- Adjustable Glides in COLORA colors: add \$189.00
- Vidro Art option require additional details - custom quote required.

PANEL LR BASE TABLES • STONE TOP

See selection of top and base finishes. Standard base finish is COLORA; trim and side panels can be specified in different colors.

Veneer side panels upcharge is shown below. Tables are 29" high. Crate charges apply to stone tops.

Note: 60" wide marble tops are subject to availability – please inquire. Specify: model number – stone top variety – edge profile – base trim and side panel finishes – power and comm. options.

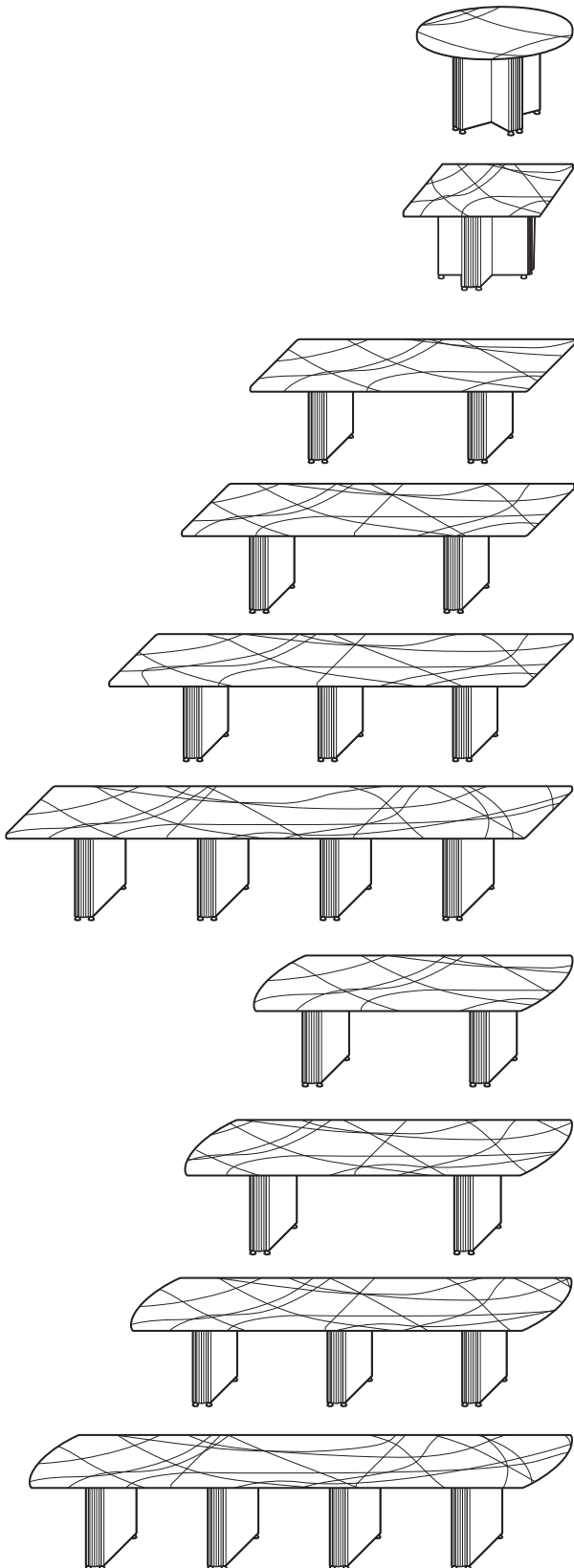

ITEM

TOP DIMENSIONS

LOW RISE GLIDES

ROUND

821M-48	48" dia.	– LR
821M-54	54" dia.	– LR
821M-60	60" dia.	– LR

SQUARE

827M-48	48" x 48"	– LR
827M-54	54" x 54"	– LR
827M-60	60" x 60"	– LR

RECTANGLE

825M-8442	84" x 42"	– LR
825M-9648	96" x 48"	– LR

sectioned tops

825M-1084	108" x 48"	– LR
825M-1204	120" x 48"	– LR
825M-1324	132" x 48"	– LR
825M-1206	120" x 60"	– LR
825M-1326	132" x 60"	– LR

825M-1444	144" x 48"	– LR
825M-1446	144" x 60"	– LR
825M-1686	168" x 60"	– LR
825M-1926 (Top in 3 sections)	192" x 60"	– LR

825M-2166	216" x 60"	– LR
825M-2406	240" x 60"	– LR

ARCED RECTANGLE

828M-8442	84" x 42"	– LR
828M-9648	96" x 48"	– LR

sectioned tops

828M-1084	108" x 48"	– LR
828M-1204	120" x 48"	– LR
828M-1324	132" x 48"	– LR
828M-1206	120" x 60"	– LR
828M-1326	132" x 60"	– LR

828M-1444	144" x 48"	– LR
828M-1446	144" x 60"	– LR
828M-1686	168" x 60"	– LR
828M-1926 (Top in 3 sections)	192" x 60"	– LR

828M-2166	216" x 60"	– LR
828M-2406	240" x 60"	– LR

• Number of sectioned tops may vary based on type of stone.

MARBLE or GRANITE TOP

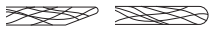
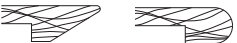
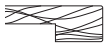
 3/4" RB or 3/4" BN		 1 1/2" RB or 1 1/2" BN		 1 1/2" SQ	ADD CRATE NET \$	ADD VENEER BASE	ADD FLAT END PANEL	ADD POL OR BRUSH STAIN CLAD FLAT END ONLY (included)
9481	11143	10146	153	877	458			
11235	13105	11983	172	953	458			
13066	15142	13895	191	953	458			
9339	10243	9377	153	877	458			
10962	11977	11006	172	953	458			
12774	13899	12819	191	953	458			
12399	13508	12399	243	877	458			
15016	16285	15016	277	953	458	3992		
18401	19776	18401	312	953	458	3992		
19732	21214	19732	347	953	458	3992		
21064	22651	21064	382	953	458	3992		
22588	24174	22588	382	1024	458	4304		
24170	25861	24170	420	1024	458	4304		
23280	24973	23280	416	1427	687	5988		
26713	28511	26713	458	1536	687	6456		
30823	32883	30823	535	1536	687	6456		
36687	39019	36687	611	1536	687	6456		
41798	44413	41798	686	2047	916	8608		
45175	48347	45175	762	2047	916	8608		
13180	14846	13550	243	877	458			
16006	17910	16430	277	953	458	3992		
19489	21499	19913	312	953	458	3992		
20918	23033	21340	347	953	458	3992		
22346	24566	22770	382	1024	458	3992		
24069	26448	24598	382	1024	458	4304		
25771	28255	26300	420	1024	458	4304		
24659	26986	25082	416	1427	687	5988		
28436	31028	28965	458	1536	687	6456		
32841	35712	33381	535	1536	687	6456		
39123	42288	39678	611	1536	687	6456		
44556	48023	45123	686	2047	916	8608		
48137	52855	49194	762	2047	916	8608		

PANEL LR

- Adjustable Glides in COLORA colors: add \$189.00
- 48" Round and Square table bases do not have removable side panel

REV 03.20.15

PANEL LR BASE TABLES • STONE TOP

See selection of top and base finishes. Standard base finish is COLORA; trim and side panels can be specified in different colors.

Veneer side panels upcharge is shown below. Tables are 29" high. Crate charges apply to stone tops.

Note: 60" wide marble tops are subject to availability – please inquire. Specify: model number – stone top variety – edge profile – base trim and side panel finishes – power and comm. options.

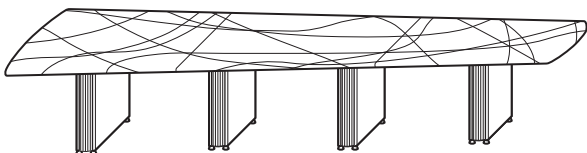
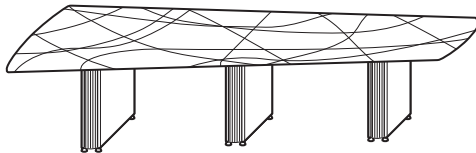
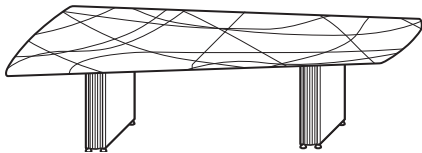
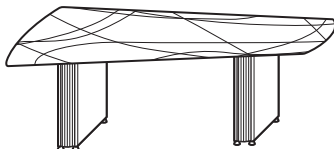
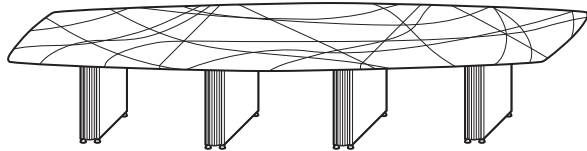
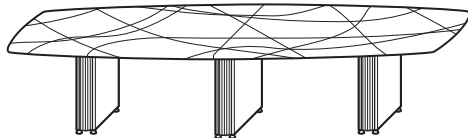
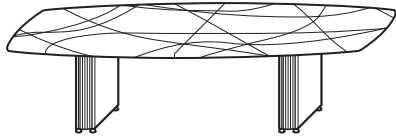
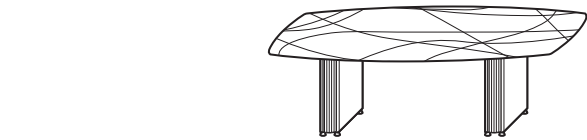

ITEM

TOP DIMENSIONS

LOW RISE GLIDES

ARCED BOAT

826M-8442	84" x 42"/30"	– LR
826M-9648	96" x 48"/35"	– LR

sectioned tops

826M-1084	108" x 48"/35"	– LR
826M-1204	120" x 48"/35"	– LR
826M-1324	132" x 48"/35"	– LR
826M-1206	120" x 60"/42"	– LR
826M-1326	132" x 60"/42"	– LR

826M-1444	144" x 48"/35"	– LR
826M-1446	144" x 60"/42"	– LR
826M-1686	168" x 60"/42"	– LR
826M-1926 (Top in 3 sections)	192" x 60"/42"	– LR

826M-2166	216" x 60"/42"	– LR
826M-2406	240" x 60"/42"	– LR

ARCED WEDGE

829M-8448	84" x 48"/28"	– LR
829M-9648	96" x 48"/28"	– LR

Sectioned tops

829M-108	108" x 48"/28"	– LR
829M-1206	120" x 60"/35"	– LR
829M-1326	132" x 60"/35"	– LR

829M-1446	144" x 60"/35"	– LR
829M-1686	168" x 60"/35"	– LR
829M-1926 (Top in 3 sections)	192" x 60"/35"	– LR

829M-2166	216" x 60"/35"	– LR
829M-2406	240" x 60"/35"	– LR

• Number of sectioned tops may vary based on type of stone.

MARBLE or GRANITE TOP

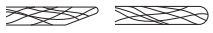
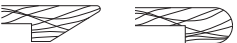
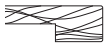
 3/4" RB or 3/4" BN		 1 1/2" RB or 1 1/2" BN		 1 1/2" SQ	ADD CRATE NET \$	ADD VENEER BASE	ADD FLAT END PANEL	ADD POL OR BRUSH STAIN CLAD FLAT END ONLY (included)
13550	16326	14662	243	877	458			
16413	19586	17683	277	877	458		3992	
19931	23367	21305	312	877	458		3992	
21395	25095	22875	347	877	458		3992	
22858	26824	24444	382	877	458		3992	
24550	28515	26136	382	953	458		4304	
26304	30534	27997	420	953	458		4304	
25998	30228	27689	416	1354	687		5988	
29689	34183	31582	458	1464	687		6456	
33949	39097	36007	535	1464	687		6456	
40362	46192	42693	611	1464	687		6456	
45929	52465	48610	686	1975	916		8608	
49099	57031	52272	762	1975	916		8608	
14722	16520	15146	243	916	458		3992	
16391	18295	16815	277	916	458		3992	
19875	21884	20298	312	916	458		3992	
24381	26761	24910	382	916	458		4304	
26080	28566	26610	420	916	458		4304	
29015	31605	29543	458	1426	687		6456	
33147	36020	33690	535	1426	687		6456	
39432	42597	39987	611	1426	687		6456	
45122	48590	45691	686	1901	916		8608	
48760	53519	49817	762	1901	916		8608	

REV 03.20.15

PANEL LR

• Adjustable Glides in COLORA colors: add \$189.00

KONVERSE T and CROSS BASE TABLES • LAMINATE and VENEER TOPS

All table tops, except for veneer with wood edge feature inlays between top surface and edge in matching color to either top or edge unless specified otherwise. Standard base finish is COLORA colors; chrome base upcharges are shown below. Tables are 29" high.

Specify: model number – top finish – edge profile and finish – inlay color (if applicable and in contrast color) – base finish – power and comm. options.



ITEM

TOP DIMENSIONS

ROUND

841-42	42" dia.
841-48	48" dia.
841-54	54" dia.
841-60	60" dia.



SQUARE

847-42	42" x 42"
847-48	48" x 48"
847-54	54" x 54"
847-60	60" x 60"

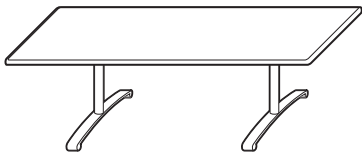

RECTANGLE

845-7236	72" x 36"
845-8442	84" x 42"
845-9648	96" x 48"
845-1084	108" x 48"

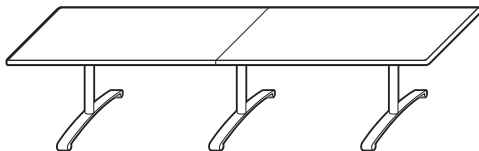

sectioned tops

845-1204	120" x 48"
845-1324	132" x 48"
845-1444	144" x 48"
845-1206	120" x 60"
845-1326	132" x 60"
845-1446	144" x 60"

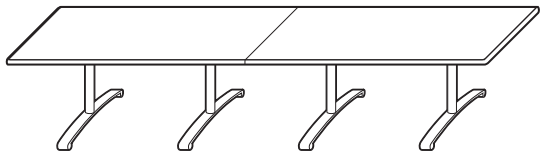

845-1686	168" x 60"
845-1926	192" x 60"

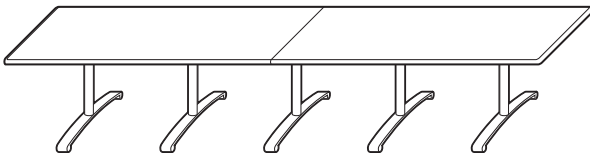

845-2166	216" x 60"
845-2406 (Top in 3 sections)	240" x 60"

• Center Located Power Unit over T-Base and Cross Base: Add \$516.

PLASTIC LAMINATE or COLORA TOP

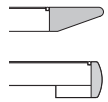

RB or RAD Colora
QTY1 QTY 3



RAD Wood
QTY1 QTY 3

VENEER TOP

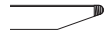

RB Wood
QTY1 QTY 3

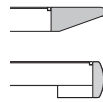

RB or RAD Colora
QTY1 QTY 3



RAD Wood
QTY1 QTY 3

ADD BASE UPGRADES

**SATIN +
POL
CHROME**

3340	2942	4045	3466	4340	3665	4129	3462	4361	3695	542
3604	3166	4332	3731	4656	3957	4723	3926	4989	4191	542
3974	3487	4720	4094	5059	4334	5461	4516	5758	4816	603
4493	3933	5259	4583	5417	4670	6211	5101	6544	5434	603

3340	2942	4202	3588	3746	3120	4129	3462	4425	3759	542
3667	3231	4552	3901	4157	3477	4787	3988	5125	4327	542
3974	3487	4865	4175	4594	3816	5461	4516	5840	4897	603
4493	3933	5538	4733	5061	4597	6211	5101	6635	5524	603

3831	3368	4617	3990	4648	3887	5100	4271	4977	4321	370
4883	4316	5809	5052	5720	4621	6457	5416	6247	5425	370
5611	4986	6533	5732	6957	5920	8035	6750	7715	6699	462
6245	5540	7178	6309	7443	6327	8696	7284	8324	7211	462

8170	7254	9878	8773	9563	8456	11165	9531	10601	9306	693
8565	7617	10420	9234	10363	9119	11722	10072	11159	9773	693
8960	7976	10964	9679	10783	9521	12279	10522	11719	10244	693
8891	7883	10684	9458	10698	9377	12159	10347	11534	10025	829
9239	8199	11166	9849	11298	9904	12805	10856	12171	10549	829
9651	8575	11720	10299	11741	10348	13454	11368	12808	11075	829

11936	10758	14281	12635	14343	12699	15817	13362	15152	13616	1105
12395	11165	15017	13190	15644	13830	16878	14147	16190	14448	1105

15199	13784	18099	15966	18382	16299	19373	16346	18665	16282	1382
15898	14289	19314	16905	20105	17836	21129	17742	20210	17548	1382

KONVERSE T and CROSS BASE TABLES • LAMINATE and VENEER TOPS

All table tops, except for veneer with wood edge feature inlays between top surface and edge in matching color to either top or edge unless specified otherwise. Standard base finish is COLORA colors; chrome base upcharges are shown below. Tables are 29" high.

Specify: model number – top finish – edge profile and finish – inlay color (if applicable and in contrast color) – base finish – power and comm. options.

ITEM

TOP DIMENSIONS

ARCED RECTANGLE

848-7236	72" x 36"
848-8442	84" x 42"
848-9648	96" x 48"
848-1084	108" x 48"

sectioned tops

848-1204	120" x 48"
848-1324	132" x 48"
848-1444	144" x 48"
848-1206	120" x 60"
848-1326	132" x 60"
848-1446	144" x 60"

848-1686	168" x 60"
848-1926	192" x 60"

848-2166	216" x 60"
848-2406 (Top in 3 sections)	240" x 60"

ARCED BOAT

846-7236	72" x 36"/25"
846-8442	84" x 42"/30"
846-9648	96" x 48"/35"
846-1084	108" x 48"/35"

sectioned tops

846-1204	120" x 48"/35"
846-1324	132" x 48"/35"
846-1444	144" x 48"/35"
846-1206	120" x 60"/42"
846-1326	132" x 60"/42"
846-1446	144" x 60"/42"

846-1686	168" x 60"/42"
846-1926	192" x 60"/42"

846-2166	216" x 60"/42"
846-2406 (Top in 3 sections)	240" x 60"/42"

• Center Located Power Unit over T-Base: Add \$516.

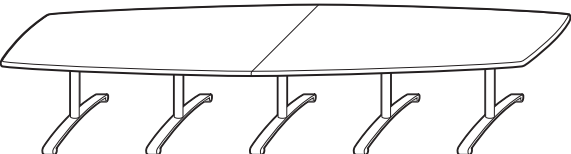
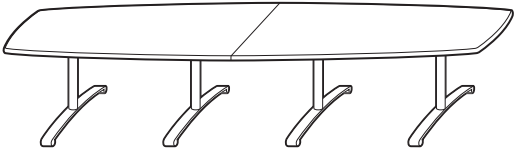
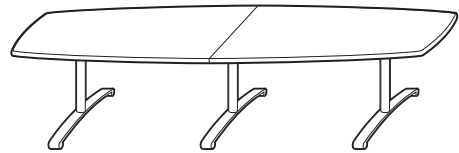
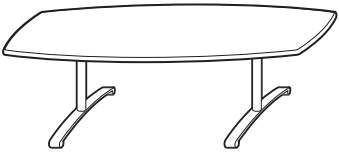
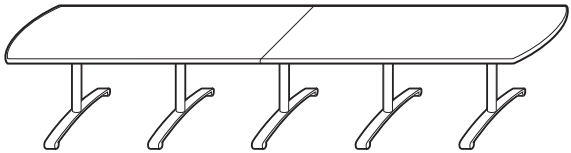
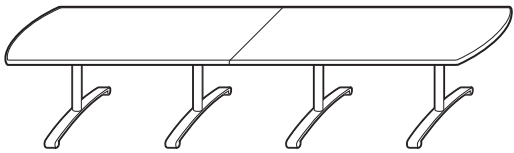
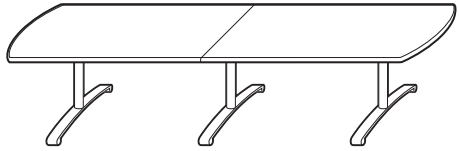
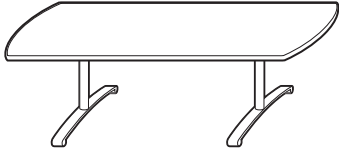

PLASTIC LAMINATE or COLORA TOP

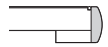
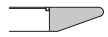

RB or RAD Colora
QTY1 QTY 3



RAD Wood
QTY1 QTY 3

VENEER TOP

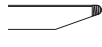

RB Wood
QTY1 QTY 3

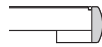
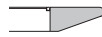

RB or RAD Colora
QTY1 QTY 3



RAD Wood
QTY1 QTY 3

ADD BASE UPGRADES

**SATIN +
POL
CHROME**

3903	3414	4835	4130	5240	4473	5353	4435	5732	4817	370
4963	4368	6059	5211	6375	5222	6783	5635	7228	6079	370
5700	5043	6791	5900	7685	6541	8451	7028	8959	7537	462
6337	5603	7443	6478	8215	6943	9157	7596	9708	8147	462

8298	7338	10333	9106	10877	8916	11743	9936	12334	10526	693
8698	7703	10902	9581	11335	9457	12320	10488	12955	11019	693
9094	8064	11470	10036	11795	10001	12900	10945	13576	11515	693
9027	7971	11166	9805	11691	9817	12790	10776	13423	11309	829
9378	8292	11672	10209	12387	10412	13462	11297	14138	11869	829
9796	8670	12251	10670	12826	10843	14136	11818	14855	12428	829

12088	10859	14862	13028	15179	13066	16554	13835	17357	14640	1105
12556	11270	15647	13605	16540	14034	17666	14642	18554	15531	1105

15368	13894	18777	16406	19530	17123	20214	16862	21425	17836	1382
16104	14425	20143	17451	21376	18760	22117	18367	23174	19425	1382

3903	3414	4835	4130	5240	4473	5353	4435	5732	4817	370
4963	4368	6059	5743	6375	5222	6783	5635	7228	6079	370
5649	4994	6739	6432	7634	6493	8401	6979	8909	7488	462
6287	5552	7392	7032	8165	6840	9107	7548	9657	8098	462

8298	7338	10333	9125	10877	8916	11743	10031	12334	10526	693
8698	7703	10902	9581	11335	9457	12320	10488	12955	11019	693
9094	8064	11470	10036	11795	10001	12900	10945	13576	11515	693
9027	7971	11166	9805	11691	9817	12790	10776	13423	11309	829
9378	8292	11672	10209	12387	10412	13462	11297	14138	11869	829
9796	8670	12251	10670	13206	11062	14136	11818	14855	12428	829

12088	10859	14862	13028	15623	13455	16554	13835	17357	14640	1105
12556	11270	15647	13605	17047	14327	17666	14642	18554	15531	1105

15368	13896	18777	16394	19530	17123	20214	16862	21425	17836	1382
16104	14425	20143	17451	21376	18760	22117	18367	23174	19425	1382

KONVERSE T and CROSS BASE TABLES • VIDRO PAINTED BACK GLASS TOP

See standard color choices. Customer's own color must be pre-approved through custom quotation.
Bases standard in COLORA, Polished and Satin Chrome options upcharged. Tables are 29" high.



ITEM

TOP DIMENSIONS

ROUND

841V-42	42" dia.
841V-48	48" dia.
841V-54	54" dia.
841V-60	60" dia.



SQUARE

847V-42	42" x 42"
847V-48	48" x 48"
847V-54	54" x 54"
847V-60	60" x 60"

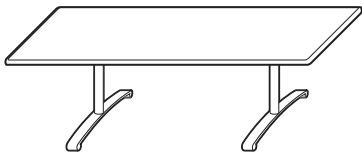

RECTANGLE

845V-7236	72" x 36"
845V-8442	84" x 42"
845V-9648	96" x 48"
845V-1084 (Top in 2 sections)	108" x 48"

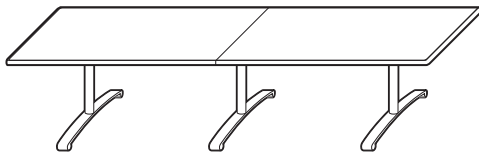

sectioned tops

845V-1204	120" x 48"
845V-1324	132" x 48"
845V-1444	144" x 48"
845V-1206	120" x 60" (includes double column bases)
845V-1326	132" x 60" (includes double column bases)
845V-1446	144" x 60" (includes double column bases)

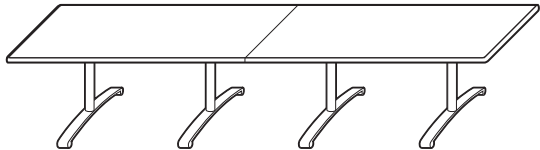

845V-1686	168" x 60" (includes double column bases)
845V-1926 (Top in 3 sections)	192" x 60" (includes double column bases)

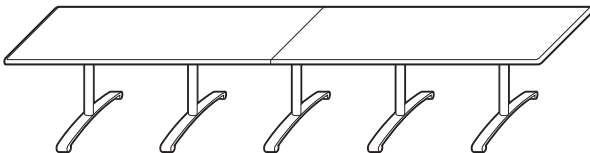

845V-2166 (Top in 3 sections)	216" x 60" (includes double column bases)
845V-2406 (Top in 4 sections)	240" x 60" (includes double column bases)

• Center Located Power Unit over T-Base and Cross Base: Add \$516.

PAINTED BACK GLASS TOP (CL GLASS)

MATTE (MA GLASS)

ADD BASE UPGRADES

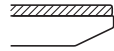

1 1/4" RB

QTY1 QTY3

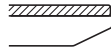

1 1/4" RB

QTY1 QTY3

ADD
CRATE
NET \$

SATIN +
POL CHROME

3977	3778	4742	4521	134	542
4723	4403	5728	5363	153	542
5625	5290	6860	6480	172	603
6743	6386	8233	7831	191	603
4220	3935	5030	4700	134	542
4636	4355	5626	5301	153	542
5625	5292	6860	6482	172	603
6742	6393	8232	7838	191	603
5853	5512	7044	6659	208	370
7142	6782	8673	8269	232	370
8563	8182	10484	10059	277	462
9200	8816	11339	10911	312	462
12321	11392	14899	13837	347	693
12984	12045	15758	14686	382	693
13771	12821	16763	15680	416	693
13582	12649	16649	15584	382	829
14605	13661	17962	16885	420	829
15631	14676	19277	18189	458	829
18258	17234	22393	21238	535	1105
21038	20007	25929	24765	611	1105
24287	23180	29756	28517	686	1382
25571	24464	31552	30312	762	1382

• Vidro Art option require additional details - custom quote required.

KONVERSE T and CROSS BASE TABLES • VIDRO PAINTED BACK GLASS TOP

See standard color choices. Customer's own color must be pre-approved through custom quotation.
Bases standard in COLORA, Polished and Satin Chrome options upcharged. Tables are 29" high.

ITEM

TOP DIMENSIONS

ARCED RECTANGLE

848V-7236	72" x 36"
848V-8442	84" x 42"
848V-9648	96" x 48"
848V-1084 (Top in 2 sections)	108" x 48"

sectioned tops

848V-1204	120" x 48"
848V-1324	132" x 48"
848V-1444	144" x 48"
848V-1206	120" x 60" (includes double column bases)
848V-1326	132" x 60" (includes double column bases)
848V-1446	144" x 60" (includes double column bases)

848V-1686	168" x 60" (includes double column bases)
848V-1926 (Top in 3 sections)	192" x 60" (includes double column bases)

848V-2166 (Top in 3 sections)	216" x 60" (includes double column bases)
848V-2406 (Top in 4 sections)	240" x 60" (includes double column bases)

ARCED BOAT

846V-7236	72" x 36"/25"
846V-8442	84" x 42"/30"
846V-9648	96" x 48"/35"
846V-1084 (Top in 2 sections)	108" x 48"/35"

sectioned tops

846V-1204	120" x 48"/35"
846V-1324	132" x 48"/35"
846V-1444	144" x 48"/35"
846V-1206	120" x 60"/42" (includes double column bases)
846V-1326	132" x 60"/42" (includes double column bases)
846V-1446	144" x 60"/42" (includes double column bases)

846V-1686	168" x 60"/42" (includes double column bases)
846V-1926 (Top in 3 sections)	192" x 60"/42" (includes double column bases)

846V-2166 (Top in 3 sections)	216" x 60"/42" (includes double column bases)
846V-2406 (Top in 4 sections)	240" x 60"/42" (includes double column bases)

• Center Located Power Unit over T-Base: Add \$516.

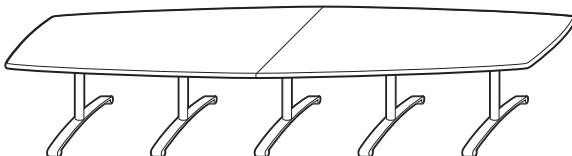
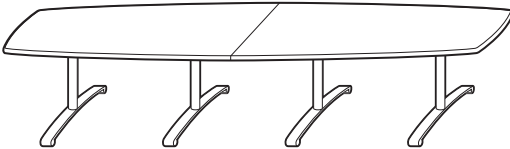
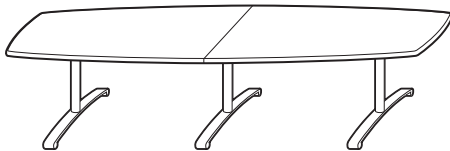
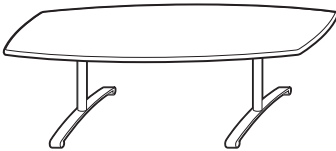
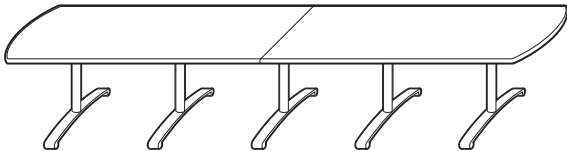
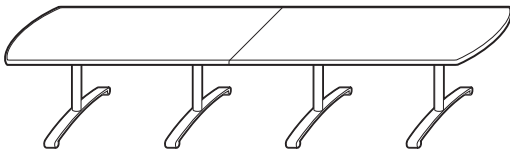
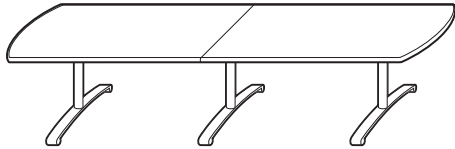
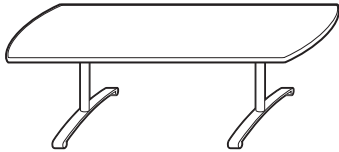

PAINTED BACK GLASS TOP (CL GLASS)

MATTE (MA GLASS)

ADD BASE UPGRADES

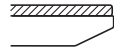

1 1/4" RB

QTY1 QTY3

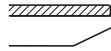

1 1/4" RB

QTY1 QTY3

ADD
CRATE
NET \$

SATIN +
POL CHROME

6353	6010	7626	7240	208	370
7821	7461	9465	9060	243	370
9450	9068	11518	11091	277	462
10196	9814	12500	12074	312	462
13430	12499	16191	15127	347	693
14204	13263	17180	16106	382	693
15100	14150	18311	17229	416	693
14968	14034	18264	17198	382	829
16129	15184	19738	18660	420	829
17292	16338	21703	20617	458	829
20196	19173	24652	23497	535	1105
23254	22223	28511	27347	611	1105
26296	25188	32177	30937	686	1382
28221	27114	34660	33420	762	1382
6353	6010	7626	7240	208	370
7821	7461	9465	9060	243	370
9450	9068	11518	11091	277	462
10221	9836	12525	12096	312	462
13430	12499	16191	15127	347	693
14204	13263	17180	16106	382	693
15100	14150	18311	17229	416	693
14968	14034	18264	17198	382	829
16129	15184	19738	18660	420	829
17292	16338	21213	20126	458	829
20196	19173	24652	23497	535	1105
23254	22223	28511	27347	611	1105
26780	25673	32661	31422	686	1382
28341	27234	34780	33540	762	1382

• Vidro Art option require additional details - custom quote required.

KONVERSE T and CROSS BASE TABLES • STONE TOP

See selection of top and base finishes. Standard base finish is COLORA colors; chrome base upcharges are shown below.

Tables are 29" high. Crate charges apply to stone tops.

Note: 60" wide marble tops are subject to availability – please inquire.

Specify: model number – stone top variety – edge profile – base finish – power and comm. options.

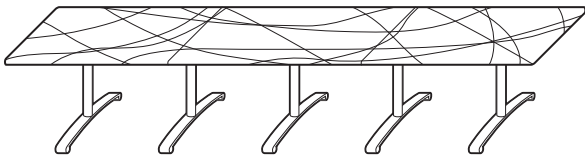
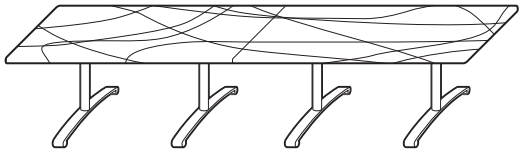
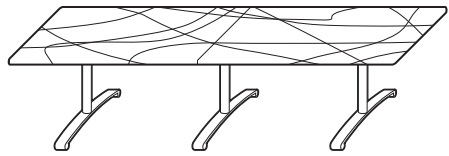
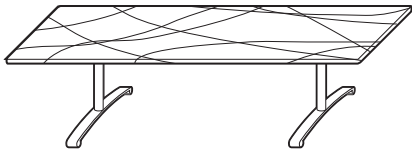
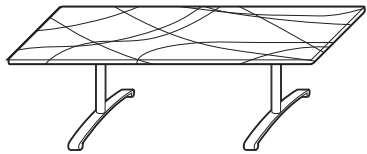
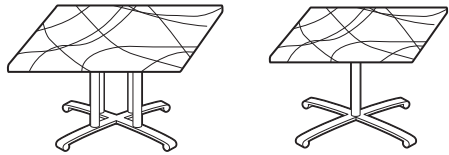
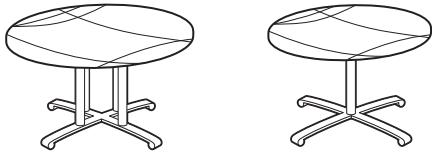

ITEM

TOP DIMENSIONS

ROUND

One-Column

841M-42 42" dia.

841M-48 48" dia.

Four-Column

841M-54 54" dia.

841M-60 60" dia.

SQUARE

One-Column

847M-42 42" x 42"

847M-48 48" x 48"

Four-Column

847M-54 54" x 54"

847M-60 60" x 60"

RECTANGLE

845M-7236 72" x 36"

845M-8442 84" x 42"

845M-9648 96" x 48"

sectioned tops

845M-1084 108" x 48"

845M-1204 120" x 48"

845M-1324 132" x 48"

845M-1444 144" x 48"

845M-1206 120" x 60" (includes double column bases)

845M-1326 132" x 60" (includes double column bases)

845M-1446 144" x 60" (includes double column bases)

845M-1686 168" x 60" (includes double column bases)

845M-1926 (Top in 3 sections) 192" x 60" (includes double column bases)

845M-2166 216" x 60" (includes double column bases)

845M-2406 240" x 60" (includes double column bases)

- Number of sectioned tops may vary based on type of stone.
- Center Located Power Unit over T-Base and Cross Base: Add \$516.

MARBLE or GRANITE TOP

ADD BASE UPGRADES

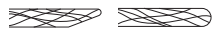

3/4" RB or 3/4" BN



1 1/2" RB or 1 1/2" BN



1 1/2" SQ

**ADD
CRATE
NET \$**

**SATIN +
POL
CHROME**

7567	9019	8148	134	542
9110	10772	9774	153	542
11087	12957	11834	172	603
12917	14994	13747	191	603
7489	8277	7520	134	542
9252	10157	9290	153	542
10877	11892	10919	172	603
12624	13750	12670	191	603
11203	12156	11203	208	370
13544	14654	13544	243	370
16676	17944	16676	277	462
21369	22745	21369	312	693
22683	24163	22683	347	693
24196	25782	24196	382	693
25708	27399	25708	416	693
25590	27176	25590	382	829
27351	29043	27351	420	829
29114	30910	29114	458	829
34386	36446	34386	535	1105
40379	42712	40379	611	1105
46641	49254	46641	686	1382
51280	54188	51280	762	1382

KONVERSE T and CROSS BASE TABLES • STONE TOP

See selection of top and base finishes. Standard base finish is COLORA colors; chrome base upcharges are shown below.

Tables are 29" high. Crate charges apply to stone tops.

Note: 60" wide marble tops are subject to availability – please inquire.

Specify: model number – stone top variety – edge profile – base finish – power and comm. options.

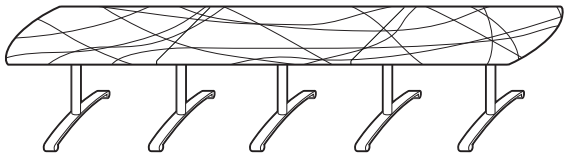
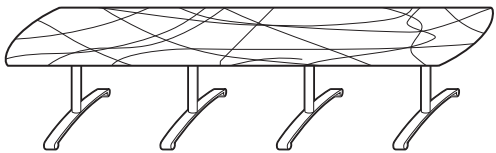
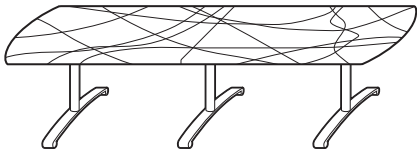
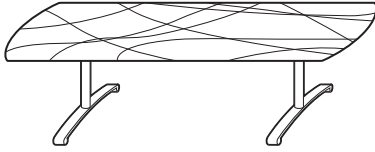
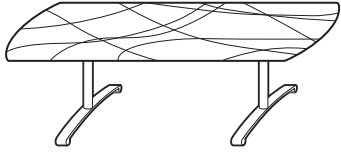

ITEM

TOP DIMENSIONS

ARCED RECTANGLE

848M-7236	72" x 36"
848M-8442	84" x 42"

848M-9648	96" x 48"
-----------	-----------

sectioned tops

848M-1084	108" x 48"
848M-1204	120" x 48"
848M-1324	132" x 48"
848M-1444	144" x 48"
848M-1206	120" x 60" (includes double column bases)
848M-1326	132" x 60" (includes double column bases)
848M-1446	144" x 60" (includes double column bases)

848M-1686	168" x 60" (includes double column bases)
848M-1926 (Top in 3 sections)	192" x 60" (includes double column bases)

848M-2166	216" x 60" (includes double column bases)
848M-2406	240" x 60" (includes double column bases)

- Number of sectioned tops may vary based on type of stone.
- Center Located Power Unit over T-Base: Add \$516.

MARBLE or GRANITE TOP

ADD BASE UPGRADES

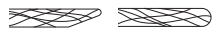

3/4" RB or 3/4" BN



1 1/2" RB or 1 1/2" BN



1 1/2" SQ

**ADD
CRATE
NET \$**

**SATIN +
POL
CHROME**

11800	13228	12118	208	370
14325	15990	14694	243	370
17666	19569	18089	277	462
22457	24466	22880	312	693
23868	25982	24290	347	693
25477	27697	25898	382	693
27087	29413	27509	416	693
27070	29450	27599	382	829
28954	31438	29482	420	829
30836	33427	31365	458	829
36403	39261	36946	535	1105
42816	45981	43371	611	1105
49277	52744	49846	686	1382
54247	58027	54828	762	1382

KONVERSE T and CROSS BASE TABLES • STONE TOP

See selection of top and base finishes. Standard base finish is COLORA colors; chrome base upcharges are shown below.

Tables are 29" high. Crate charges apply to stone tops.

Note: 60" wide marble tops are subject to availability – please inquire.

Specify: model number – stone top variety – edge profile – base finish – power and comm. options.

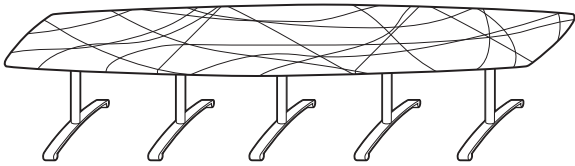
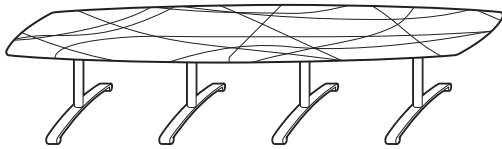
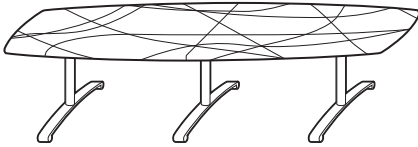
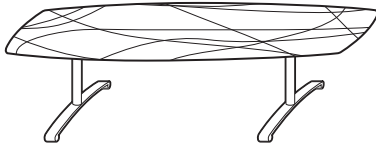
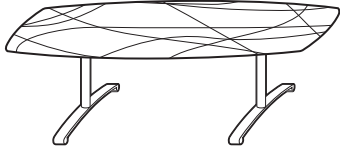

ITEM

TOP DIMENSIONS

ARCED BOAT

846M-7236	72" x 36"/25"
846M-8442	84" x 42"/30"

846M-9648	96" x 48"/35"
-----------	---------------

sectioned tops

846M-1084	108" x 48"/35"
846M-1204	120" x 48"/35"
846M-1324	132" x 48"/35"
846M-1444	144" x 48"/35"
846M-1206	120" x 60"/42" (includes double column bases)
846M-1326	132" x 60"/42" (includes double column bases)
846M-1446	144" x 60"/42" (includes double column bases)

846M-1686	168" x 60"/42" (includes double column bases)
846M-1926 (Top in 3 sections)	192" x 60"/42" (includes double column bases)

846M-2166	216" x 60"/42" (includes double column bases)
846M-2406	240" x 60"/42" (includes double column bases)

- Number of sectioned tops may vary based on type of stone.
- Center Located Power Unit over T-Base: Add \$516.

MARBLE or GRANITE TOP

ADD BASE UPGRADES

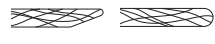

3/4" RB or 3/4" BN



1 1/2" RB or 1 1/2" BN



1 1/2" SQ

**ADD
CRATE
NET \$**

**SATIN +
POL
CHROME**

12118	14497	13069	208	370
14694	17471	15804	243	370
18038	21211	19308	277	462
21630	25067	23004	312	693
24396	28098	25876	347	693
26058	30024	27645	382	693
27721	31951	29413	416	693
27599	31564	29185	382	829
29535	33765	31226	420	829
31472	35966	33269	458	829
37162	42301	39220	535	1105
43705	49534	46036	611	1105
50299	56837	52915	686	1382
55410	62680	58318	762	1382

SQUARE EDGE PLATE BASE TABLES • LAMINATE and VENEER TOPS

Laminate tops with wood or COLORA edge feature 1/8" dia. vinyl inlay in COLORA between top surface and edge. Standard base finish is COLORA colors; polished and satin chrome are available at upcharge.

Tables are 29" high.

Specify: model number – top finish – edge profile and finish – inlay color (if applicable) – base finish – options.



ITEM

DIMENSIONS

ROUND

941-30	30" dia.
941-36	36" dia.
941-42	42" dia.
941-48	48" dia.
941-54	54" dia.
941-60	60" dia.

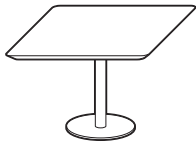

SQUARE

942-30	30" x 30"
942-36	36" x 36"
942-42	42" x 42"
942-48	48" x 48"



RECTANGLE

943-3024	30" x 24"
943-3630	36" x 30"
943-4230	42" x 30"
943-4830	48" x 30"
943-4836	48" x 36"
943-6030	60" x 30"
943-6036	60" x 36"

• Center Located Power Unit over Column Plate Base: Add \$516.

PLASTIC LAMINATE TOP

VENEER TOP

											
											
											
QTY1	QTY3	QTY10	QTY1	QTY3	QTY10	QTY1	QTY3	QTY10	ADD FLIP TOP	ADD SATIN CHROME	ADD POL CHROME

1165	1057	923	2067	1690	1400	2694	2164	1804	211	179	290
1339	1216	1072	2273	1890	1574	2998	2444	2056	211	205	331
1526	1386	1230	2504	2107	1764	3281	2704	2291	211	205	331
1872	1711	1542	2938	2530	2142	3762	3162	2720	211	226	383
2109	2039	1949	3232	3035	2589	4088	3692	3206	324	226	383
2741	2494	2260	3965	3485	2981	4677	4016	3502		294	507

1177	1071	937	1941	1591	1336	2142	1709	1487	211	205	331
1305	1184	1042	2118	1745	1475	2432	1950	1719	211	205	331
1649	1510	1353	2492	2097	1805	2921	2388	2147	211	226	383
1821	1664	1493	2718	2294	1986	3251	2673	2421	324	226	383

1075	975	847	1814	1473	1226	1962	1553	1335	211	179	290
1235	1122	984	2021	1662	1401	2253	1807	1581	211	205	331
1296	1176	1034	2103	1733	1464	2377	1909	1683	211	205	331
1559	1430	1279	2395	2012	1733	2678	2191	1963	211	226	383
1641	1502	1347	2499	2103	1812	2869	2351	2119	211	226	383
1663	1522	1363	2550	2148	1854	2928	2403	2166	211	226	383
1790	1635	1467	2697	2274	1967	3184	2601	2357	324	226	383

• Standing Height, 40" or 42": \$100.00

BEVELED EDGE PLATE BASE TABLES • VIDRO PAINTED BACK GLASS TOP

See standard color choices. Customer's own color must be pre-approved through custom quotation. Steel plate base standard in COLORA; Polished and Satin Chrome options upcharged. Plate bases in Round (R) and Square (S) can be specified. Standard with 3/4" beveled edge profile. Bases do not provide internal wire management option. Column 3" dia. up to 20" dia. base; 4" dia. for all bases 24" dia. and above. Tables are 29" high.

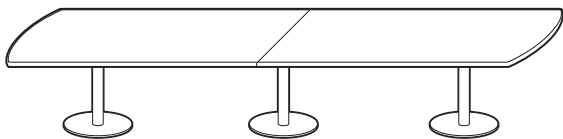
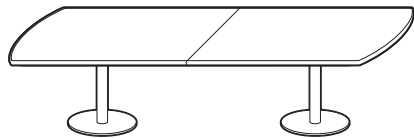
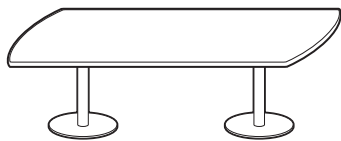
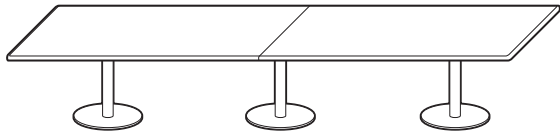
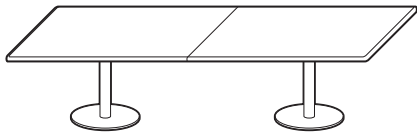
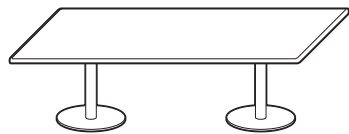
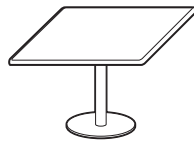

ITEM	RD BASE = R	TOP DIMENSIONS	BASE DIMENSIONS	
	SQ BASE = S		RD	SQ
ROUND				
901V-30	R or S	30" dia.	20" dia.	20" x 20"
901V-36	R or S	36" dia.	20" dia.	20" x 20"
901V-42	R or S	42" dia.	24" dia.	24" x 24"
901V-48	R or S	48" dia.	24" dia.	24" x 24"
901V-54	R or S	54" dia.	28" dia.	28" x 28"
901V-60	R or S	60" dia.	28" dia.	28" x 28"

SQUARE				
907V-42	R or S	42" x 42"	24" dia.	24" x 24"
907V-48	R or S	48" x 48"	28" dia.	28" x 28"

RECTANGLE				
905V-7236	R or S	72" x 36"	20" dia.	20" x 20"
905V-8442	R or S	84" x 42"	24" dia.	24" x 24"
905V-9648	R or S	96" x 48"	28" dia.	28" x 28"
905V-1084 (Top 2 sections)	R or S	108" x 48"	28" dia.	28" x 28"

sectioned tops				
905V-1204	R or S	120" x 48"	28" dia.	28" x 28"
905V-1324	R or S	132" x 48"	28" dia.	28" x 28"
905V-1444	R or S	144" x 48"	28" dia.	28" x 28"
905V-1206	R or S	120" x 60"	28" dia.	28" x 28"
905V-1326	R or S	132" x 60"	28" dia.	28" x 28"
905V-1446	R or S	144" x 60"	28" dia.	28" x 28"

905V-1686	R or S	168" x 60"	28" dia.	28" x 28"
905V-1926 (Top 3 sections)	R or S	192" x 60"	28" dia.	28" x 28"
905V-2166 (Top 3 sections)	R or S	216" x 60"	28" dia.	28" x 28"
905V-2406 (Top 4 sections)	R or S	240" x 60"	28" dia.	28" x 28"

ARCED RECTANGLE				
908V-7236	R or S	72" x 36"	20" dia.	20" x 20"
908V-8442	R or S	84" x 42"	24" dia.	24" x 24"
908V-9648	R or S	96" x 48"	28" dia.	28" x 28"
908V-1048 (Top 2 sections)	R or S	108" x 48"	28" dia.	28" x 28"

sectioned tops				
908V-1204	R or S	120" x 48"	28" dia.	28" x 28"
908V-1324	R or S	132" x 48"	28" dia.	28" x 28"
908V-1444	R or S	144" x 48"	28" dia.	28" x 28"
908V-1206	R or S	120" x 60"	28" dia.	28" x 28"
908V-1326	R or S	132" x 60"	28" dia.	28" x 28"
908V-1446	R or S	144" x 60"	28" dia.	28" x 28"

908V-1686	R or S	168" x 60"	28" dia.	28" x 28"
908V-1926 (Top 3 sections)	R or S	192" x 60"	28" dia.	28" x 28"
908V-2166 (Top 3 sections)	R or S	216" x 60"	28" dia.	28" x 28"
908V-2406 (Top 4 sections)	R or S	240" x 60"	28" dia.	28" x 28"

• Center Located Power Unit over Column Plate Base: Add \$516.

PAINTED BACK GLASS TOP (CL GLASS)

MATTE (MA GLASS)

ADD BASE UPGRADES

1 1/4" RB		1 1/4" RB		ADD CRATE NET \$	RD BASE POL & SATIN CHROME + SQ BASE BRUSH STAIN	SQ BASE POL STAIN
QTY1	QTY3	QTY1	QTY3			
2351	2026	2773	2426	94	441	522
2717	2390	3282	2933	114	441	522
3503	3141	4268	3884	134	530	710
4251	3766	5256	4726	153	530	710
5148	4627	6383	5817	172	655	847
6035	5497	7525	6942	191	655	847
3746	3297	4556	4062	134	530	710
4444	3963	5434	4909	153	655	847
6130	5774	7321	6921	208	884	1044
7335	6893	8866	8380	243	1059	1419
8898	8055	10819	9932	277	1309	1694
9558	8716	11697	10811	312	1309	1694
11373	10425	13951	12870	347	1309	1694
12039	11083	14813	13724	382	1309	1694
12823	11874	15815	14733	416	1309	1694
12981	11995	16048	14930	382	1327	1852
13998	13009	17355	16233	420	1327	1852
15011	14026	18657	17539	458	1327	1852
17570	16786	21705	20790	535	1990-	2777
20349	19568	25240	24326	611	1990	2777
22407	21474	27876	26811	686	1990	2777
24100	23013	30081	28861	762	1990	2777
6629	6272	7902	7502	208	884	1044
8014	7571	9658	9170	243	1059	1419
9783	8941	11851	10964	277	1309	1694
10554	9713	12858	11973	312	1309	1694
12481	11533	15242	14161	347	1309	1694
13258	12302	16234	15145	382	1309	1694
14151	13204	17362	16285	416	1309	1694
14366	13381	17662	16545	382	1327	1852
15521	14533	19130	18009	420	1327	1852
16673	15687	21084	19966	458	1327	1852
19508	18725	23964	23049	535	1990	2777
22565	21784	27822	26908	611	1990	2777
24415	23482	30296	29231	686	1990	2777
26750	25662	33189	31968	762	1990	2777

PLATE BEVELED EDGE



• Vidro Art option require additional details - custom quote required.

BEVELED EDGE PLATE BASE TABLES • VIDRO PAINTED BACK GLASS TOP

See standard color choices. Customer's own color must be pre-approved through custom quotation. Steel plate base standard in COLORA; Polished and Satin Chrome options upcharged. Plate bases in Round (R) and Square (S) can be specified. Standard with 3/4" beveled edge profile. Bases do not provide internal wire management option. Column 3" dia. up to 20" dia. base; 4" dia. for all bases 24" dia. and above. Tables are 29" high.

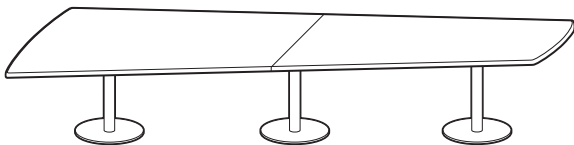
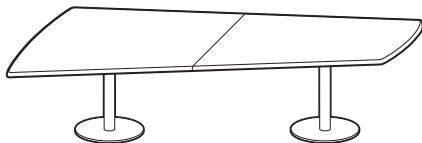
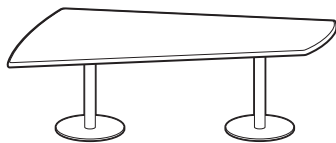
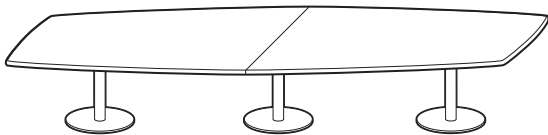
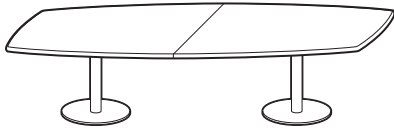
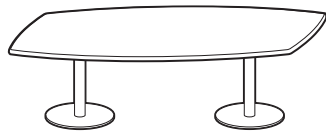

ITEM	RD BASE = R	TOP DIMENSIONS	BASE DIMENSIONS	
	SQ BASE = S		RD	SQ
ARCED BOAT				
906V-7236	R or S	72" x 36"/34"	20" dia.	20" x 20"
906V-8442	R or S	84" x 42"/30"	24" dia.	24" x 24"
906V-9648	R or S	96" x 48"/35"	28" dia.	28" x 28"
906V-1084 (Top 2 sections)	R or S	108" x 48"/35"	28" dia.	28" x 28"

sectioned tops

906V-1204	R or S	120" x 48"/35"	28" dia.	28" x 28"
906V-1324	R or S	132" x 48"/35"	28" dia.	28" x 28"
906V-1444	R or S	144" x 48"/35"	28" dia.	28" x 28"
906V-1206	R or S	120" x 60"/42"	28" dia.	28" x 28"
906V-1326	R or S	132" x 60"/42"	28" dia.	28" x 28"
906V-1446	R or S	144" x 60"/42"	28" dia.	28" x 28"

906V-1686	R or S	168" x 60"/42"	28" dia.	28" x 28"
906V-1926 (Top 3 sections)	R or S	192" x 60"/42"	28" dia.	28" x 28"
906V-2166 (Top 3 sections)	R or S	216" x 60"/42"	28" dia.	28" x 28"
906V-2406 (Top 4 sections)	R or S	240" x 60"/42"	28" dia.	28" x 28"

ARCED WEDGE

909V-8448	R or S	84" x 48"/28"	28"/20" dia.	28" / 20"
909V-9648	R or S	96" x 48"/28"	28"/20" dia.	28" / 20"
909V-1084 (Top 2 sections)	R or S	108" x 48"/28"	28"/20" dia.	28" / 20"

sectioned tops

909V-1206	R or S	120" x 60"/35"	28" / 24" dia.	28" / 24"
909V-1326	R or S	132" x 60"/35"	28" / 24" dia.	28" / 24"
909V-1446	R or S	144" x 60"/35"	28" / 24" dia.	28" / 24"

909V-1686	R or S	168" x 60"/35"	28"/28"/24" dia.	28"/28"/24"
909V-1926 (Top 3 sections)	R or S	192" x 60"/35"	28"/28"/24" dia.	28"/28"/24"
909V-2166 (Top 3 sections)	R or S	216" x 60"/35"	28"/28"/24" dia.	28"/28"/24"
909V-2406 (Top 4 sections)	R or S	240" x 60"/35"	28"/28"/24" dia.	28"/28"/24"

• Center Located Power Unit over Column Plate Base: Add \$516.

PAINTED BACK GLASS TOP (CL GLASS)

MATTE (MA GLASS)

ADD BASE UPGRADES

1 1/4" RB		1 1/4" RB		ADD CRATE NET \$	RD BASE POL & SATIN CHROME + SQ BASE BRUSH STAIN	SQ BASE POL STAIN
QTY1	QTY3	QTY1	QTY3			
6629	6272	7902	7502	208	884	1044
8014	7571	9658	9170	243	1059	1419
9783	8941	11851	10964	277	1309	1694
10554	9713	12858	11973	312	1309	1694
12481	11533	15242	14161	347	1309	1694
13258	12302	16234	15145	382	1309	1694
14151	13204	17362	16283	416	1309	1694
14366	13381	17662	16545	382	1327	1852
15521	14533	19130	18009	420	1327	1852
16673	15687	20594	19475	458	1327	1852
19508	18725	23964	23049	535	1990	2777
22565	21784	27822	26908	611	1990	2777
24900	23967	30781	29716	686	1990	2777
26870	25783	33309	32089	762	1990	2777
8606	8173	10437	9960	243	1097	1369
9363	8548	11431	10571	277	1097	1369
10135	9320	12439	11580	312	1097	1369
13898	12939	17194	16103	382	1194	1635
15046	14093	18655	17569	420	1194	1635
16195	15247	20116	19035	458	1194	1635
19029	18090	23485	22414	535	1849	2482
22087	21148	27344	26272	611	1849	2482
24421	23330	30302	29079	686	1849	2482
26391	25148	32830	31454	762	1849	2482

PLATE BEVELED EDGE



• Vidro Art option require additional details - custom quote required.

CUBE BASE TABLES • LAMINATE and VENEER TOPS

Laminate tops with wood or COLORA edge feature 1/8" dia. vinyl inlay in COLORA between top surface and edge. Standard base finish is COLORA colors. Tables are 29" high. Tables include one access door per base.

Specify: model number – top finish – edge profile and finish – inlay color (if applicable) – base finish – options.

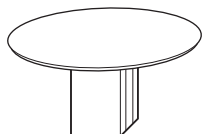

ITEM	DIMENSIONS	BASE DIMENSIONS
ROUND		
1001-42	42" dia.	16" x 16"
1001-48	48" dia.	18" x 18"
1001-54	54" dia.	18" x 18"
1001-60	60" dia.	22" x 22"

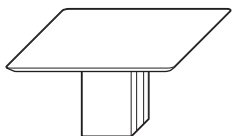

SQUARE		
1002-42	42" x 42"	16" x 16"
1002-48	48" x 48"	18" x 18"
1002-54	54" x 54"	22" x 22"
1002-60	60" x 60"	24" x 24"

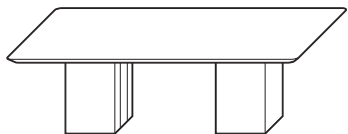

RECTANGLE		
1003-8442	84" x 42"	16" x 16"
1003-9642	96" x 42"	16" x 16"
1003-9648	96" x 48"	18" x 18"
1003-1084	108" x 48"	18" x 18"

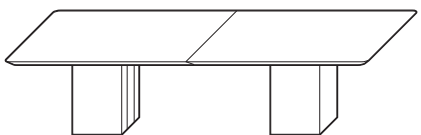

1003-1204	120" x 48"	18" x 18"
1003-1444	144" x 48"	18" x 18"
1003-1446	144" x 60"	22" x 22"

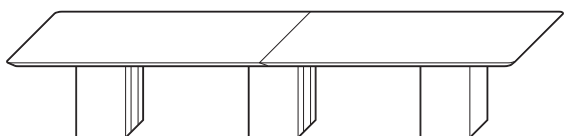

1003-1686	168" x 60"	22" x 22"
1003-1926	192" x 60"	22" x 22"
1003-2166	216" x 60"	22" x 22"
1003-2406 (Top in 3 sections)	240" x 60"	22" x 22"

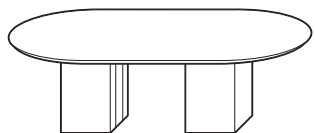

RACETRACK		
1004-8442	84" x 42"	16" x 16"
1004-9642	96" x 42"	16" x 16"
1004-9648	96" x 48"	18" x 18"
1004-1084	108" x 48"	18" x 18"

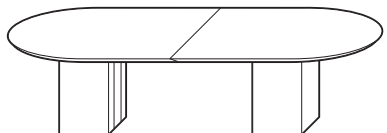

1004-1204	120" x 48"	18" x 18"
1004-1444	144" x 48"	18" x 18"
1004-1446	144" x 60"	22" x 22"

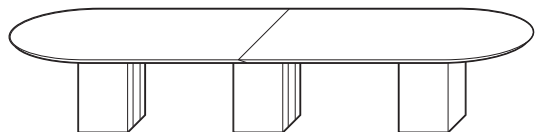

1004-1686	168" x 60"	22" x 22"
1004-1926	192" x 60"	22" x 22"
1004-2166	216" x 60"	22" x 22"
1004-2406 (Top in 3 sections)	240" x 60"	22" x 22"

PLASTIC LAMINATE TOP

VENEER TOP

Flat Vinyl			Angle Wood			Angle Colora			ADD VENEER BASE
QTY1	QTY3	QTY10	Reeded Wood QTY1	QTY3	QTY10	Reeded Wood QTY1	QTY3	QTY10	
1763	1411	1322	2741	2132	1855	3516	2729	2383	641
1966	1596	1466	3031	2413	2067	3854	3047	2644	716
2204	1810	1668	3325	2692	2306	4181	3350	2922	716
2658	2220	2033	3885	3210	2753	4595	3741	3273	791
1711	1359	1273	2553	1946	1723	2981	2238	2064	641
1914	1547	1418	2812	2179	1910	3346	2556	2345	716
2198	1806	1651	3120	2457	2155	3830	2951	2728	791
2537	2110	1929	3516	2814	2476	4312	3715	3097	867
3190	2724	2590	4167	3427	3134	5007	3998	3801	1281
3477	2978	2819	4508	3728	3403	5351	4323	4079	1281
3670	3132	2936	4728	3904	3539	5798	4627	4389	1432
4111	3524	3298	5175	4302	3907	6189	4949	4697	1432
4225	3624	3389	5423	4407	4005	6999	5878	5300	1432
4577	3935	3670	5974	4896	4440	7783	6520	5922	1432
4887	4209	3919	6319	5211	4711	8747	7363	6738	1582
6536	5609	5234	8122	6709	6101	10895	9142	8393	2372
7455	6426	5981	9170	7604	6898	11971	10066	9216	2372
8039	6895	6384	10169	8510	7586	14026	11083	10072	2372
8530	7382	6859	11011	9262	8413	14662	12415	11007	2372
3694	3173	3004	5233	4352	3931	5602	4542	4240	1281
3938	3394	3205	5544	4605	4163	5978	4833	4524	1281
4298	3695	3457	5920	4905	4413	6458	5191	4844	1432
4850	4189	3913	6508	5401	4868	6890	5509	5147	1432
5096	4407	4113	7070	5901	5348	8194	6296	5884	1432
5794	5030	4686	7881	6541	5959	8703	6956	6526	1432
6403	5575	5185	8502	7077	6463	9733	7812	7356	1582
8425	7308	6806	10611	8861	8083	11653	9476	8954	2372
9131	7941	7387	11430	9538	8704	12786	10251	9714	2372
9890	8615	8064	11895	10653	9633	14313	11889	10866	2372
10638	9285	8624	13686	11464	10450	15815	13255	11810	2372

- Self Edge Laminate available at same price as Vinyl Edge.
- 42" and 48" Round and Square table bases do not have removable side panel

CUBE BASE TABLES • LAMINATE and VENEER TOPS

Laminate tops with wood or COLORA edge feature 1/8" dia. vinyl inlay in COLORA between top surface and edge. Standard base finish is COLORA colors. Tables are 29" high. Tables include one access door per base.

Specify: model number – top finish – edge profile and finish – inlay color (if applicable) – base finish – options.

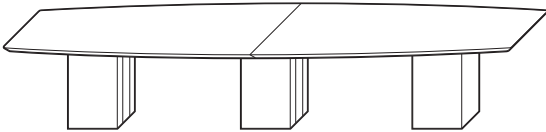
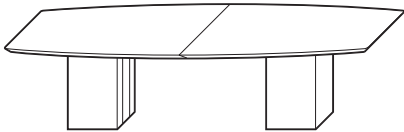
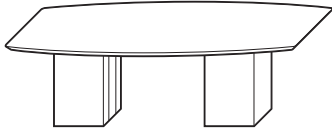

ITEM	DIMENSIONS	BASE DIMENSIONS
------	------------	-----------------

BOAT

1005-8442	84" x 42"/30"	16" x 16"
1005-9642	96" x 42"/30"	16" x 16"
1005-9648	96" x 48"/35"	16" x 16"
1005-1084	108" x 48"/35"	16" x 16"

1005-1204	120" x 48"/35"	16" x 16"
1005-1444	144" x 48"/35"	18" x 18"
1005-1446	144" x 60"/42"	18" x 18"

1005-1686	168" x 60"/42"	18" x 18"
1005-1926	192" x 60"/42"	18" x 18"
1005-2166	216" x 60"/42"	18" x 18"
1005-2406 (Top in 3 sections)	240" x 60"/42"	18" x 18"

PLASTIC LAMINATE TOP

VENEER TOP

Flat Vinyl			Angle Wood			Angle Color			Reeded Wood			Square Wood			ADD VENEER BASE
QTY1	QTY3	QTY10	QTY1	QTY3	QTY10	QTY1	QTY3	QTY10	QTY1	QTY3	QTY10	QTY1	QTY3	QTY10	
3741	3220	3051	5233	4352	3931	5602	4542	4240							1281
3966	3422	3233	5544	4605	4163	5978	4833	4524							1281
4230	3654	3445	5853	4862	4400	6391	5149	4830							1281
4784	4147	3899	6441	5360	4854	6823	5466	5134							1281
5093	4425	4153	7059	5911	5379	8127	6254	5872							1281
5794	5030	4686	7881	6541	5959	8703	6956	6526							1432
6738	5876	5464	8789	7328	6693	9944	7891	7436							1432
8775	7618	7098	10901	9111	8317	11855	9528	9011							2147
9564	8325	7747	11794	9853	8996	13043	10333	9799							2147
9950	8679	8093	12652	10729	9722	14341	11654	10738							2147
10434	9101	8461	13482	11279	10286	15611	13071	11648							2147--

CUBE

• Self Edge Laminate available at same price as Vinyl Edge.

KABLE T AND CROSS BASE TABLES • LAMINATE and VENEER TOPS

Laminate tops with wood or COLORA edge feature 1/8" dia. vinyl inlay in COLORA between top surface and edge. Standard base finish is COLORA colors; removable ribbed base cover strips can be specified in contrast color. Tables are 29" high.

Specify: model number – top finish – edge profile and finish – inlay color (if applicable) – base finish – options.



ITEM

DIMENSIONS

ROUND

One-Column

1101-30	30" dia.
1101-36	36" dia.
1101-42	42" dia.
1101-48	48" dia.



Four-Column

Center Space for Power & Comm. Units

1101-48P	48" dia.
1101-54P	54" dia.
1101-60P	60" dia.



SQUARE

One-Column

1102-30	30" x 30"
1102-36	36" x 36"
1102-42	42" x 42"

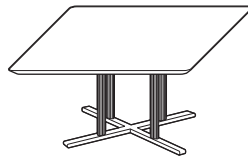

Four-Column

Center Space for Power & Comm. Units

1102-42P	42" x 42"
1102-48P	48" x 48"
1102-54P	54" x 54"
1102-60P	60" x 60"

PLASTIC LAMINATE TOP

VENEER TOP

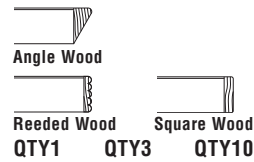
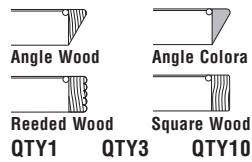

**ADD
FLIP
TOP**

1347	1214	1108	2248	1848	1585	2875	2320	1989	211
1493	1343	1228	2426	2018	1730	3151	2571	2213	211
1689	1524	1395	2667	2244	1927	3443	2842	2455	211
1873	1687	1546	2940	2505	2147	3763	3138	2723	211

2412	2177	2005	3477	2995	2605	4301	3629	3183	
2650	2394	2205	3771	3273	2844	4625	3932	3460	
3047	2745	2526	4273	3737	3247	4985	4267	3768	

1332	1199	1094	2095	1719	1493	2294	1837	1644	211
1469	1321	1206	2280	1884	1639	2595	2087	1884	211
1650	1486	1358	2493	2073	1809	2922	2364	2151	211

2189	1976	1816	3030	2560	2267	3460	2854	2608	
2372	2141	1966	3270	2772	2457	3803	3150	2894	
2586	2333	2144	3509	2983	2651	4219	3477	3222	
2927	2635	2419	3907	3339	2968	4700	4240	3587	

KABLE T and CROSS

- Self Edge Laminate available at same price as Vinyl Edge.
- Black Lockable Casters (3" dia.): \$90.00 per table. Always recommended for Flip Top tables.
- Option: Infinity Lockable Casters: \$202.00 per table.
- Standing Height, 40" or 42": \$100.00 Single Column.

KABLE T AND CROSS BASE TABLES • LAMINATE and VENEER TOPS

Laminate tops with wood or COLORA edge feature 1/8" dia. vinyl inlay in COLORA between top surface and edge. Standard base finish is COLORA colors; removable ribbed base cover strips can be specified in contrast color. Tables are 29" high.

Specify: model number – top finish – edge profile and finish – inlay color (if applicable) – base finish – options.

ITEM DIMENSIONS

RECTANGLE

1103-7236	72" x 36"
1103-7242	72" x 42"
1103-8442	84" x 42"
1103-9642	96" x 42"
1103-9648	96" x 48"
1103-1084	108" x 48"

1103-1204	120" x 48"
1103-1444	144" x 48"
1103-1446	144" x 60"

1103-1686	168" x 60"
1103-1926	192" x 60"

1103-2166	216" x 60"
1103-2406 (Top in 3 sections)	240" x 60"

RACETRACK

1104-7236	72" x 36"
1104-8442	84" x 42"
1104-9642	96" x 42"
1104-9648	96" x 48"
1104-1084	108" x 48"

1104-1204	120" x 48"
1104-1444	144" x 48"
1104-1446	144" x 60"

1104-1686	168" x 60"
1104-1926	192" x 60"

1104-2166	216" x 60"
1104-2406 (Top in 3 sections)	240" x 60"

• Center Located Power Unit over T-Base: Add \$516.

PLASTIC LAMINATE TOP

VENEER TOP

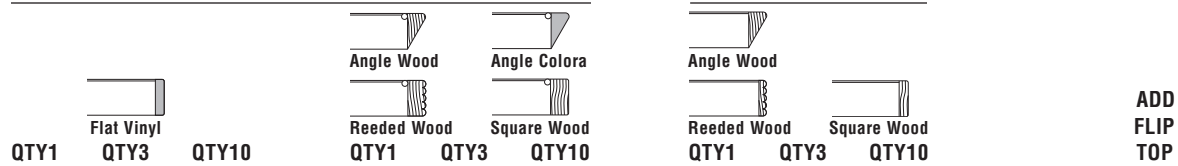

1919	1823	1760	2870	2504	2293	3478	2915	2782	517
2351	2234	2156	3308	2917	2691	3999	3381	3237	581
2535	2400	2312	3512	3104	2855	4352	3672	3523	734
2863	2693	2581	3893	3445	3163	4736	4038	3840	913
3249	3064	2942	4304	3839	3547	5375	4561	4396	913
3688	3458	3304	4753	4237	3913	5766	4882	4704	953

4584	4354	4200	5896	5239	4908	7474	6709	6203	
5050	4767	4574	6448	5727	5345	8258	7352	6827	
5224	4920	4716	6658	5920	5507	9086	8073	7535	

6704	6335	6087	8288	7435	6953	11062	9868	9245	
7623	7150	6835	9339	8329	7753	12139	10790	10069	

8846	8313	7958	10895	9820	9161	13899	12380	11381	
9380	8789	8395	11860	10667	9948	15511	13822	12543	

2407	2271	2179	3858	3408	3071	4094	3526	3282	517
3040	2850	2725	4579	4029	3653	4948	4218	3961	734
3323	3109	2965	4930	4321	3923	5362	4550	4283	913
3875	3628	3465	5497	4837	4420	6035	5124	4849	913
4428	4122	3919	6085	5334	4873	6468	5441	5152	953

5570	5237	5017	7544	6732	6251	8669	7126	6789	
6268	5863	5591	8355	7372	6864	9178	7787	7432	
6741	6284	5979	8841	7788	7259	10071	8522	8153	

8592	8032	7659	10778	9584	8939	11821	10200	9809	
9300	8664	8241	11598	10261	9558	12952	10977	10568	

10730	10015	9538	13291	11787	11001	14944	13131	12123	
11488	10691	10160	14536	12869	11986	16665	14663	13346	

- Self Edge Laminate available at same price as Vinyl Edge.
- Black Lockable Casters (3" dia.): \$46.00 per T Base. Always recommended for Flip Top tables.
- Option: Infinity Lockable Casters: \$100.00 per T Base.

KABLE T AND CROSS BASE TABLES • LAMINATE and VENEER TOPS

Laminate tops with wood or COLORA edge feature 1/8" dia. vinyl inlay in COLORA between top surface and edge. Standard base finish is COLORA colors; removable ribbed base cover strips can be specified in contrast color. Tables are 29" high.

Specify: model number – top finish – edge profile and finish – inlay color (if applicable) – base finish – options.

ITEM

DIMENSIONS

BOAT

1105-7236	72" x 36"/25"
1105-8442	84" x 42"/30"
1105-9642	96" x 42"/30"
1105-9648	96" x 48"/35"
1105-1084	108" x 48"/35"

1105-1204	120" x 48"/35"
1105-1444	144" x 48"/35"
1105-1446	144" x 60"/42"

1105-1686	168" x 60"/42"
1105-1926	192" x 60"/42"

1105-2166	216" x 60"/42"
1105-2406 (Top in 3 sections)	240" x 60"/42"

WEDGE

1106-8448	84" x 48"/28"
1106-9648	96" x 48"/28"
1106-1084	108" x 48"/28"

1106-1206	120" x 60"/35"
1106-1446	144" x 60"/35"

1106-1686	168" x 60"/35"
1106-1926	192" x 60"/35"





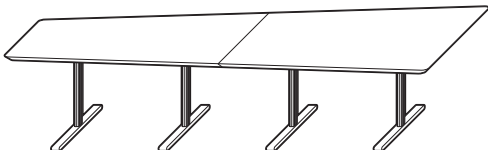
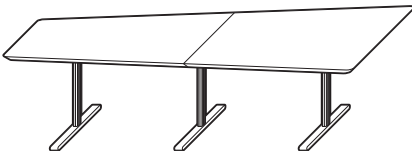
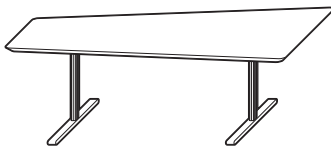
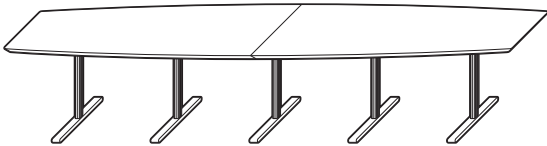
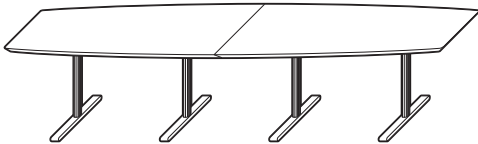
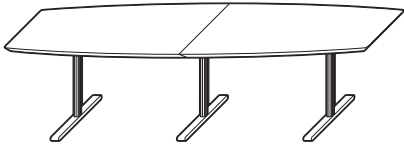
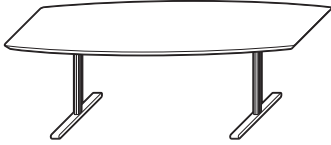



1106-2166	216" x 60"/35"
1106-2406 (Top in 3 sections)	240" x 60"/35"

• Center Located Power Unit over T-Base: Add \$516.



PLASTIC LAMINATE TOP

VENEER TOP

									
									
									
QTY1	QTY3	QTY10	QTY1	QTY3	QTY10	QTY1	QTY3	QTY10	ADD FLIP TOP

2407	2271	2179	3858	3408	3071	4094	3526	3282	517
3070	2882	2755	4562	4012	3636	4931	4203	3945	734
3334	3121	2977	4914	4304	3907	5348	4533	4267	913
3858	3613	3450	5481	4823	4404	6019	5109	4833	913
4412	4106	3916	6069	5319	4857	6451	5426	5137	953

5611	5273	5047	7578	6759	6273	8645	7102	6765	
6244	5838	5567	8332	7348	6840	9154	7763	7408	
7213	6706	6367	9264	8159	7596	10419	8721	8339	

9147	8528	8115	11272	10019	9333	12225	10436	10028	
9937	9233	8763	12164	10760	10011	13415	11242	10817	

10730	10015	9538	13291	11787	11001	14944	13131	12123	
11488	10691	10160	14536	12869	11986	16665	14663	13346	

3442	3208	3053	4358	3848	3525	4756	3990	3815	734
4034	3767	3588	4987	4436	4090	5447	4611	4425	913
4412	4106	3903	5362	4770	4398	5838	4933	4733	953

6561	6117	5825	7703	6828	6345	8102	7292	6743	
7381	6852	6500	8550	7567	7021	8971	8019	7451	

9182	8559	8144	10360	9261	8645	10693	9649	8929	
9973	9263	8793	11188	9979	9300	11521	10386	9701	

10971	10227	9731	13531	11999	11192	14944	13131	12123	
11756	10928	10375	14804	13106	12200	16665	14663	13346	

- Self Edge Laminate available at same price as Vinyl Edge.
- Black Lockable Casters (3" dia.): \$46.00 per T Base. Always recommended for Flip Top tables.
- Option: Infinity Lockable Casters: \$100.00 per T Base.

KABLE C BASE TRAINING TABLES • LAMINATE and VENEER TOPS

Laminate tops with wood or COLORA edge feature 1/8" dia. vinyl inlay in COLORA between top surface and edge. Standard base finish is COLORA colors; removable ribbed base cover strips can be specified in contrast color. Modesty panels are in COLORA colors. Tables are 29" high.

Specify: model number – top finish – edge profile and finish – inlay color (if applicable) – base finish – modesty finish – options.

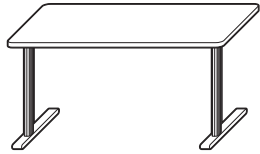

ITEM

DIMENSIONS

WITHOUT MODESTY PANEL

1121-4220	42" x 20"	
1121-4820	48" x 20"	
1121-6020	60" x 20"	
1121-7220	72" x 20"	C-Bases located 6" from end of table
1121-4224	42" x 24"	(non-folding only)
1121-4824	48" x 24"	
1121-6024	60" x 24"	
1121-7224	72" x 24"	
1121-4830	48" x 30"	
1121-6030	60" x 30"	
1121-7230	72" x 30"	

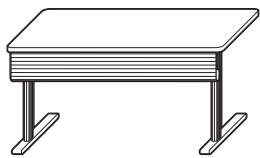

WITH J MODESTY PANEL (REMOVABLE)

Extruded aluminum modesty panel in ribbed pattern features a large wire management tray. 7 1/2" high. Removable (without tools) for folding base tables.

1122-4220	42" x 20"	
1122-4820	48" x 20"	
1122-6020	60" x 20"	
1122-7220	72" x 20"	C-Bases located 6" from end of table
1122-4224	42" x 24"	(non-folding only)
1122-4824	48" x 24"	
1122-6024	60" x 24"	
1122-7224	72" x 24"	
1122-4830	48" x 30"	
1122-6030	60" x 30"	
1122-7230	72" x 30"	

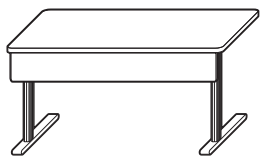

WITH FLAT FIXED MODESTY

Flat aluminum modesty panel fixed to table top, 9" high.

1125-4220	42" x 20"	
1125-4820	48" x 20"	
1125-6020	60" x 20"	
1125-7220	72" x 20"	C-Bases located 6" from end of table
1125-4224	42" x 24"	(non-folding only)
1125-4824	48" x 24"	
1125-6024	60" x 24"	
1125-7224	72" x 24"	
1125-4830	48" x 30"	
1125-6030	60" x 30"	
1125-7230	72" x 30"	

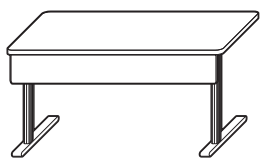

WITH FLAT FOLDING MODESTY

Utilized with Folding Base or Flip Top options - add costs. Flat aluminum modesty panel is 9" high and folds over bases in folded position or over table underside with flip top option.

1124-6024	60" x 24"	C-Bases located 6" from end of table
1124-7224	72" x 24"	(non-folding only)
1124-6030	60" x 30"	
1124-7230	72" x 30"	



BRIDGE TOP - Connector plates included

90-deg PIE

996-20	20" R x 20"
996-24	24" R x 24"
996-30	30" R x 30"

45-deg PIE

997-20	20" R x 20"
997-24	24" R x 24"
997-30	30" R x 30"

30-deg PIE

998-20	20" R x 20"
998-24	24" R x 24"
998-30	30" R x 30"



GANG SET

Each set \$87.00 factory installed. Consists of two brackets, a linking bar and two thumb screws. Ganging 24", 30" and 36" sides requires 1 set; 42" sides and over requires 2 sets.

PLASTIC LAMINATE TOP

VENEER TOP

 <p>Flat Vinyl</p>			 <p>Reeded Wood</p>			 <p>Square Wood</p>			 <p>Reeded Wood</p>			 <p>Square Wood</p>			ADD FOLDING BASE*	ADD FLIP TOP
QTY1	QTY3	QTY10	QTY1	QTY3	QTY10	QTY1	QTY3	QTY10	QTY1	QTY3	QTY10					

1213	1171	1143	2032	1740	1584	2216	1829	1717					517
1226	1182	1155	2043	1752	1596	2248	1861	1749					517
1363	1309	1276	2229	1918	1749	2478	2064	1949	428				517
1512	1446	1404	2429	2099	1915	2711	2267	2148	428				517
1219	1178	1150	2038	1745	1589	2258	1872	1760					517
1232	1190	1162	2049	1757	1600	2290	1902	1791					517
1370	1318	1282	2237	1925	1757	2531	2118	2001	428				517
1520	1454	1412	2438	2106	1923	2774	2332	2212	428				517
1365	1309	1274	2201	1891	1725	2482	2072	1954					517
1510	1442	1397	2395	2067	1887	2772	2324	2200	428				517
1666	1587	1533	2604	2255	2059	3083	2571	2444	428				517

1640	1511	1456	2462	2081	1899	2644	2170	2032					
1671	1543	1489	2491	2505	1927	2694	2219	2082					
1847	1700	1645	2714	2315	2120	2960	2462	2318	428				
2030	1880	1811	2950	2532	2321	3233	2702	2555	428				
1648	1519	1465	2467	2086	1903	2686	2213	2075					517
1680	1549	1496	2495	2115	1935	2737	2263	2126					517
1854	1715	1653	2720	2321	2127	3014	2515	2372	428				517
2041	1889	1819	2957	2541	2330	3296	2765	2617	428				517
1811	1669	1606	2648	2251	2059	2930	2430	2289					517
1993	1838	1766	2879	2464	2257	3257	2720	2569	428				517
2189	2018	1940	3125	2688	2467	3602	3005	2850	428				517

1474	1395	1347	2361	1965	1788	2478	2054	1922					
1505	1428	1377	2324	1997	1816	2528	2106	1972					
1655	1569	1511	2522	2178	1986	2771	2324	2184					
1867	1768	1702	2786	2421	2214	3069	2590	2446					
1481	1402	1353	2299	1971	1792	2520	2097	1964					517
1512	1435	1385	2329	2001	1822	2570	2149	2014					517
1665	1576	1518	2530	2184	1991	2823	2376	2238					517
1877	1777	1711	2794	2429	2220	3133	2654	2509					517
1645	1556	1494	2480	2136	1948	2764	2316	2178					517
1802	1701	1631	2688	2326	2123	3066	2582	2434					517
2025	1909	1832	2959	2578	2358	3439	2894	2742					517

1953	1840	1780	2818	2449	2253	3112	2640	2499	428				517
2204	2034	1939	3120	2685	2449	3459	2910	2737	428				517
2091	1966	1893	2976	2590	2384	3354	2846	2696	428				517
2351	2166	2060	3287	2834	2584	3766	3151	2970	428				517

430	404	387	956	813	718	829	731	676					
452	423	404	977	833	739	894	797	739					
493	459	436	1033	889	791	946	850	791					

408	382	365	934	791	697	758	659	603					
430	402	382	956	813	718	820	723	666					
472	437	417	1012	868	771	853	755	700					

400	372	354	922	780	687	713	616	558					
423	394	374	931	801	706	722	623	567					
458	426	404	998	855	756	731	633	577					

- Self Edge Laminate available at same price as Vinyl Edge.
- Black Lockable Casters (3" dia.): \$46.00 per C Base. Always recommended for Flip Top tables.
- Option: Infinity Lockable Casters: \$100.00 per C Base.
- Standing Height, 40" or 42": \$152.00
- * 60" long folding tables have narrow range of suitable Surface Power Units based on location(s) and quantity - please inquire

KABLE T BASE TABLES • MODULAR MEETING • LAMINATE and VENEER TOPS

Laminate tops with wood or COLORA edge feature 1/8" dia. vinyl inlay in COLORA between top surface and edge. Standard base finish is COLORA colors; removable ribbed base cover strips can be specified in contrast color. Tables are 29" high.

Specify: model number – top finish – edge profile and finish – inlay color (if applicable) – base finish – options.

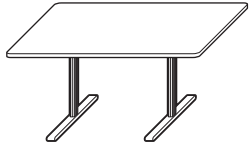

ITEM

DIMENSIONS

RECTANGLE

1153-6042	60" x 42"
1153-6642	66" x 42"
1153-7242	72" x 42"
1153-6048	60" x 48"
1153-6648	66" x 48"
1153-7248	72" x 48"
1153-8448	84" x 48"
1153-9048	90" x 48"
1153-7254	72" x 54"
1153-8454	84" x 54"
1153-9054	90" x 54"

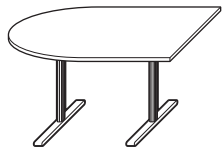

BULLET

1157-6042	60" x 42"
1157-6642	66" x 42"
1157-7242	72" x 42"
1157-6048	60" x 48"
1157-6648	66" x 48"
1157-7248	72" x 48"
1157-8448	84" x 48"
1157-9048	90" x 48"
1157-7254	72" x 54"
1157-8454	84" x 54"
1157-9054	90" x 54"



GANG SET

Each set \$87.00 factory installed.

Consists of two plates bolted to underside of adjacent tables and a linking bar and thumb screws. Gang Set connects and levels tables. 2 sets are required to connect each 2 top sides.

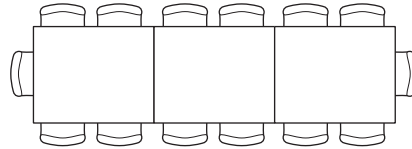
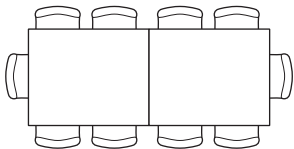

PLASTIC LAMINATE TOP

VENEER TOP

 <p>Flat Vinyl</p>			 <p>Reeded Wood</p>			 <p>Square Wood</p>			 <p>Reeded Wood</p>			 <p>Square Wood</p>			<p>ADD FLIP TOP</p>
QTY1	QTY3	QTY10	QTY1	QTY3	QTY10	QTY1	QTY3	QTY10	QTY1	QTY3	QTY10	QTY1	QTY3	QTY10	

2080	1991	1930	3001	2642	2443	3633	3076	2938	526
2220	2116	2049	3159	2785	2568	3895	3247	3105	526
2351	2234	2156	3308	2917	2691	3999	3381	3237	581
2368	2254	2178	3297	2912	2688	3901	3315	3182	526
2641	2498	2402	3562	3146	2900	4102	3512	3352	526
2876	2706	2596	3826	3382	3112	4301	3710	3524	581
3133	2935	2804	4138	3661	3363	4755	4012	3855	734
3263	3051	2911	4292	3800	3489	4957	4183	4029	860
3055	2865	3979	4029	3562	3277	4610	3935	3744	581
3182	2980	2846	4208	3726	3423	5111	4298	4134	734
3351	3128	2981	4400	3897	3578	5348	4489	4316	860

2231	2129	2060	3611	3212	2910	4139	3584	3347	526
2385	2265	2186	3819	3390	3071	4350	3752	3508	526
2536	2402	2313	4029	3566	3230	4562	3923	3668	581
2557	2424	2334	4002	3558	3223	4434	3825	3586	526
2887	2720	2609	4350	3854	3496	4751	4081	3815	526
3124	2929	2799	4633	4093	3714	5119	4216	3958	581
3320	3102	2960	4922	4328	3932	5380	4568	4301	734
3463	3233	3079	5102	4479	4070	5587	4716	4455	860
3242	3035	2896	4788	4219	3829	5295	4459	4202	581
3553	3311	3151	5188	4552	4137	5774	4861	4587	734
3714	3453	3281	5389	4719	4290	6009	5043	4759	860

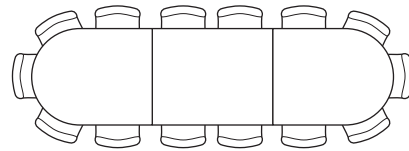
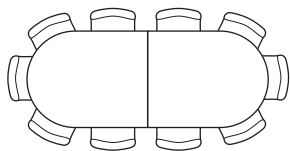

- Self Edge Laminate available at same price as Vinyl Edge.
- Black Lockable Casters (3" dia.): \$46.00 per T Base. Always recommended for Flip Top tables.
- Option: Infinity Lockable Casters: \$100.00 per T Base.

KABLE T BASE TABLES • MODULAR • LAMINATE and VENEER TOPS

Laminate tops with wood or COLORA edge feature 1/8" dia. vinyl inlay in COLORA between top surface and edge. Standard base finish is COLORA colors; removable ribbed base cover strips can be specified in contrast color. Tables are 29" high.

Specify: model number – top finish – edge profile and finish – inlay color (if applicable) – base finish – optional modesty finish – options.

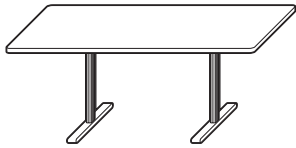

ITEM

DIMENSIONS

RECTANGLE

ITEM	DIMENSIONS
1133-4824	48" x 24"
1133-6024	60" x 24"
1133-7224	72" x 24"
1133-8424	84" x 24"
1133-4830	48" x 30"
1133-6030	60" x 30"
1133-7230	72" x 30"
1133-8430	84" x 30"
1133-4836	48" x 36"
1133-6036	60" x 36"
1133-7236	72" x 36"
1133-8436	84" x 36"

T-Bases located 12" from end of table (non-folding only)

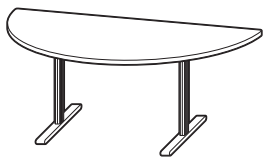

HALF ROUND

1134-48	48" dia. x 24"
1134-54	54" dia. x 27"
1134-60	60" dia. x 30"
1134-66	66" dia. x 33"
1134-72	72" dia. x 36"

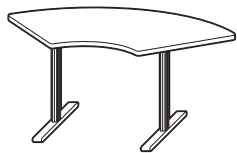

ARC

1135-3624	36" R x 24"
1135-4824	48" R x 24"
1135-4830	48" R x 30"
1135-6030	60" R x 30"
1135-6036	60" R x 36"
1135-7236	72" R x 36"

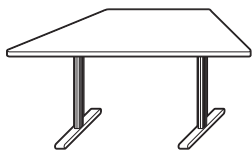

TRAPEZOID

1136-4824	48" X 24" X 24"
1136-6030	60" X 30" X 30"
1136-7236	72" X 36" X 36"



V END

170-deg PIE

1138-24 (for 24" D Tables)	54" x 30"
1138-30 (for 30" D Tables)	66" x 36"
1138-36 (for 36" D Tables)	78" x 42"

PLASTIC LAMINATE TOP

VENEER TOP

Flat Vinyl			Reeded Wood			Square Wood			ADD FOLDING BASE*	ADD FLIP TOP
QTY1	QTY3	QTY10	QTY1	QTY3	QTY10	QTY1	QTY3	QTY10		
1232	1190	1162	2049	1757	1600	2290	1902	1791		517
1370	1318	1282	2237	1925	1757	2531	2118	2001	428	517
1520	1454	1412	2438	2106	1923	2774	2332	2212	428	517
1693	1618	1569	2654	2309	2112	3079	2584	2462	428	780
1365	1309	1274	2201	1891	1725	2482	2072	1954		517
1510	1442	1397	2395	2067	1887	2772	2324	2200	428	517
1666	1587	1533	2604	2255	2059	3083	2571	2444	428	517
1885	1791	1728	2856	2490	2279	3419	2865	2727	428	780
1454	1388	1345	2312	1988	1810	2676	2230	2111		517
1636	1553	1500	2543	2194	2000	3029	2519	2389	428	517
1919	1823	1760	2870	2504	2293	3478	2915	2782	428	517
2199	2082	2005	3175	2784	2550	3858	3241	3099	428	780

1488	1421	1376	2458	2130	1943	2881	2396	2182		517
1653	1567	1512	2647	2299	2095	3036	2543	2325		517
1857	1752	1681	2860	2495	2269	3273	2764	2528		517
2058	1930	1845	3083	2696	2451	3463	2945	2701		517
2362	2210	2112	3398	2991	2723	3818	3275	3014		517

1446	1383	1342	2753	2390	2206	2999	2568	2355		517
1672	1588	1532	3029	2628	2420	3608	3074	2843		517
1871	1766	1695	3218	2795	2572	3716	3146	2904		517
2084	1952	1866	3563	3085	2833	4325	3685	3432		595
2302	2144	2039	3790	3283	3014	4530	3801	3543		595
2665	2476	2351	4259	3690	3388	5560	4648	4373		694

1416	1355	1315	2213	1901	1734	2334	1939	1820		517
1773	1675	1609	2608	2251	2051	2776	2318	2187		517
2165	2029	1939	3038	2633	2400	3374	2801	2659		517

1599	1521	1470	2917	2530	2332	2924	2431	2215		517
1813	1715	1649	3209	2772	2551	3332	2812	2568		526
2237	2101	2012	3711	3210	2950	3872	3313	3045		662

- Self Edge Laminate available at same price as Vinyl Edge.
- Black Lockable Casters (3" dia.): \$46.00 per T Base. Always recommended for Flip Top tables.
- Option: Infinity Lockable Casters: \$100.00 per T Base.
- Standing Height, 40" or 42": \$139.00
- *• 60" long folding tables have narrow range of suitable Surface Power Units based on location(s) and quantity - please inquire

BRIDGE TOPS and MODESTY PANELS for MODULAR TABLES • LAMINATE and VENEER TOPS

Laminate tops with wood or COLORA edge feature 1/8" dia. vinyl inlay in COLORA between top surface and edge.

Specify: model number – top finish – edge profile and finish – inlay color (if applicable) – modesty finish

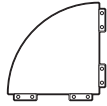

ITEM

DIMENSIONS

BRIDGE TOPS - Connector plates included

90-deg PIE

996-24	24" R x 24"
996-30	30" R x 30"
996-36	36" R x 36"

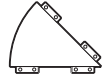

45-deg PIE

997-24	24" R x 24"
997-30	30" R x 30"
997-36	36" R x 36"

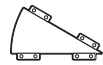

30-deg PIE

998-24	24" R x 24"
998-30	30" R x 30"
998-36	36" R x 36"



GANG SET

Each set \$80.00 factory installed.

Consists of two plates bolted to underside of adjacent tables and a linking bar and thumb screws. Gang Set connects and levels tables. Ganging 24", 30" and 36" sides requires 1 set. Ganging 42", 48", 60", 72", 90" sides and over requires 2 sets.

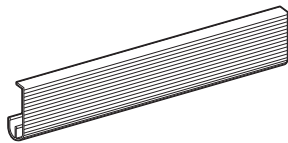

J MODESTY

Extruded aluminum modesty panel in ribbed pattern features a large wire management tray. 7 1/2" high. Removable without tools. Available in COLORA colors.

- Available with Fixed and Flip Top tables
- Folding Base tables – remove modesty prior to folding bases

	QTY1	QTY3	QTY10
48" L Tables	481	361	335
60" L Tables	485	397	370
72" L Tables	521	435	408
84" L Tables	558	471	444

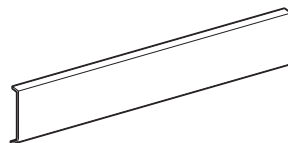

FLAT FOLDING MODESTY

Flat aluminum modesty panel is 9" high and folds over bases in folded position or over table underside with flip top option. Available in COLORA colors.

- Available with Flip Top and Folding Base tables. (Note: 48" L folding table not available with folding modesty)

	QTY1	QTY3	QTY10
48" L Tables	487	435	407
60" L Tables	581	524	498
72" L Tables	683	579	526

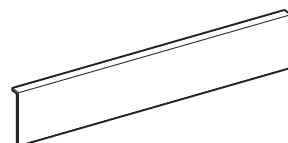

FLAT FIXED MODESTY

Flat aluminum modesty panel, 9" high. Available in COLORA colors.

Not recommended for flip top or folding base tables.

	QTY1	QTY3	QTY10
48" L Tables	280	247	223
60" L Tables	294	259	235
72" L Tables	358	323	300
84" L Tables	393	361	337

PLASTIC LAMINATE TOP

VENEER TOP

Flat Vinyl		
QTY1	QTY3	QTY10

Reeded Wood		Square Wood	
QTY1	QTY3	QTY10	

Reeded Wood		Square Wood	
QTY1	QTY3	QTY10	

452	423	404	977	833	739	894	797	739
493	459	436	1033	889	791	946	850	791
555	517	490	1083	940	872	1002	910	841

430	402	382	956	813	718	820	723	666
472	437	417	1012	868	771	853	755	700
533	495	469	1055	911	807	893	796	738

419	390	370	943	801	706	722	623	567
458	426	404	998	855	756	731	633	577
519	479	453	1037	891	804	742	644	589

• Self Edge Laminate available at same price as Vinyl Edge.

MODULAR TABLE COLLECTION

Scale: 3/16" = 1'

RECTANGULAR TABLES



48" x 24"



60" x 24"



72" x 24"



84" x 24"

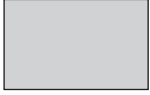

48" x 30"

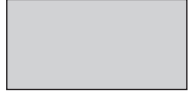

60" x 30"

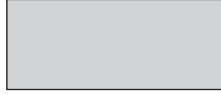

72" x 30"

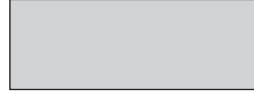

84" x 30"



48" x 36"



60" x 36"



72" x 36"



84" x 36"

HALF ROUND TABLES



48" dia. x 24"



54" dia. x 27"

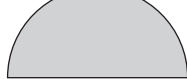

60" dia. x 30"

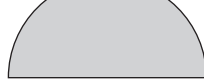

66" dia. x 33"

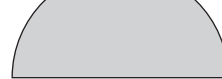

72" dia. x 36"

ARC TABLES

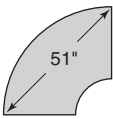

36"R x 24"d

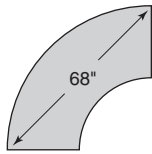

48"R x 24"d

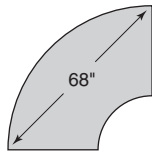

48"R x 30"d

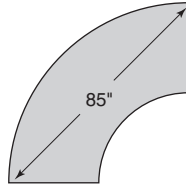

60"R x 30"d

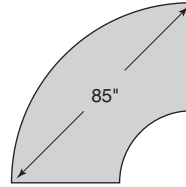

60"R x 36"d

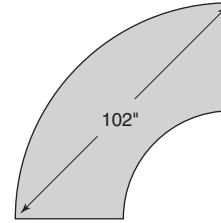

72"R x 36"d

TRAPEZOID TABLES

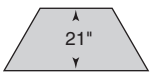

48" x 24" x 24"



60" x 30" x 30"

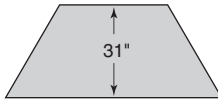

72" x 36" x 36"

V END TABLES

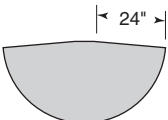

54" x 30"

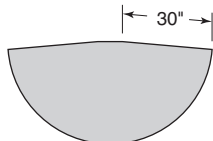

66" x 36"

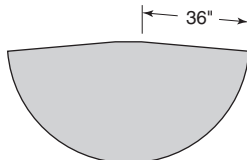

78" x 42"

QUARTER ROUND TABLES • BRIDGE TOPS

90° Pie



24"R x 24"



30"R x 30"

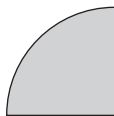

36"R x 36"

45° Pie



24"R x 24"



30"R x 30"



36"R x 36"

30° Pie



24"R x 24"



30"R x 30"



36"R x 36"

MODULAR CONFIGURATIONS

Seating capacity is based on 24" or 25" wide chairs, 5" apart. Scale: 1/8" - 1'

GS1

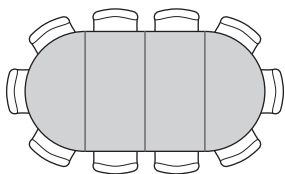

GS2

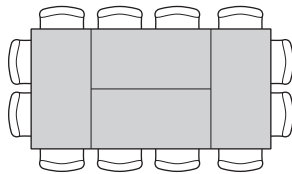

GS3

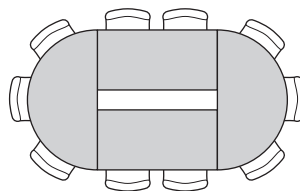

GS4

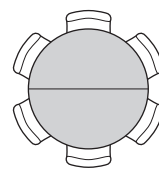

GS5

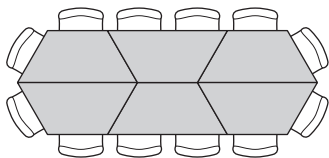

GS6

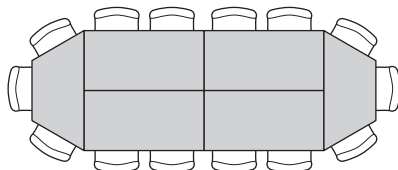

GS7

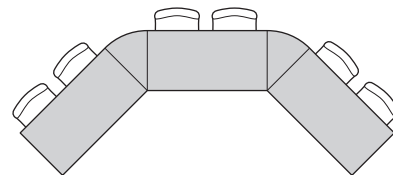

GS8

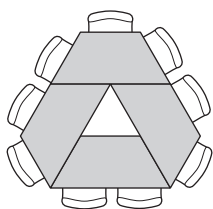

GS9

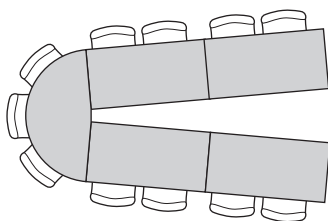

GS10

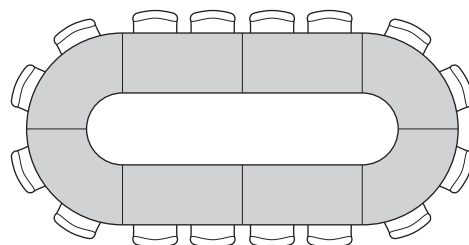

GS11

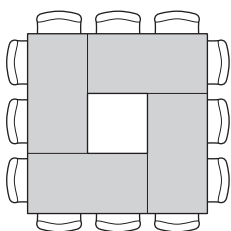

GS12

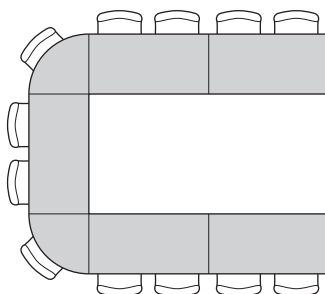

GS13

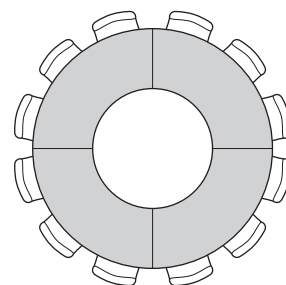

GS14

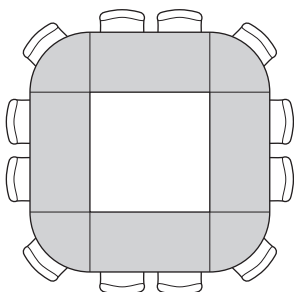

GS15

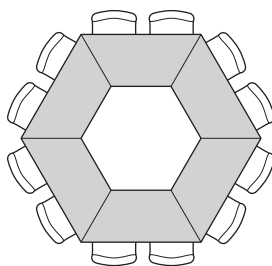

GS16

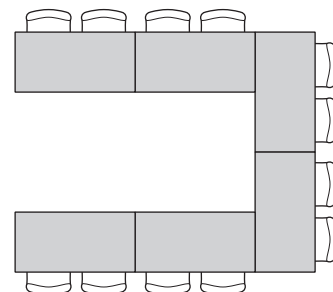

TUBULAR T and CROSS BASE TABLES • LAMINATE and VENEER TOPS

Laminate tops with wood or COLORA edge feature 1/8" dia. vinyl inlay in COLORA between top surface and edge. Standard base finish is COLORA colors; polished and satin chrome are available at upcharge. Tables are 29" high.

Specify: model number – top finish – edge profile and finish – inlay color (if applicable) – base finish – options.



ITEM

DIMENSIONS

ROUND

901-24	24" dia.
901-30	30" dia.
901-36	36" dia.
901-42	42" dia.
901-48	48" dia.



SQUARE

902-24	24" x 24"
902-30	30" x 30"
902-36	36" x 36"
902-42	42" x 42"
902-48	48" x 48"



RECTANGLE

903-3024	30" x 24"
903-3630	36" x 30"
903-4230	42" x 30"
903-4830	48" x 30"
903-4836	48" x 36"

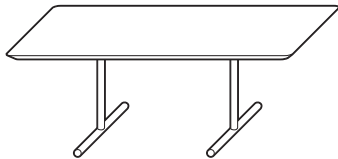

RECTANGLE

913-7236	72" x 36"
913-8436	84" x 36"
913-9636	96" x 36"
913-7242	72" x 42"
913-8442	84" x 42"
913-9642	96" x 42"
913-9648	96" x 48"

• Center Located Power Unit over T-Base and Cross Base: Add \$516.

PLASTIC LAMINATE TOP

VENEER TOP

Flat Vinyl			Angle Wood			Angle Colors			Reeded Wood			Square Wood			ADD FLIP TOP	ADD POL or SATIN CHROME
QTY1	QTY3	QTY10	QTY1	QTY3	QTY10	QTY1	QTY3	QTY10	QTY1	QTY3	QTY10	QTY1	QTY3	QTY10		
664	598	520	1503	1206	970	2017	1547	1265	211	106						
734	663	582	1635	1296	1059	2264	1769	1463	211	120						
908	821	731	1841	1495	1233	2567	2050	1715	211	133						
1103	998	897	2080	1721	1431	2856	2316	1955	211	146						
1296	1175	1057	2363	1991	1660	3186	2626	2238	211	159						
633	570	496	1345	1049	859	1396	1049	889	211	106						
746	677	596	1511	1197	996	1711	1313	1146	211	133						
881	796	707	1692	1358	1142	2009	1563	1385	211	146						
1074	973	871	1916	1558	1322	2345	1850	1663	211	159						
1246	1126	1011	2144	1758	1502	2678	2134	1939	324	173						
643	580	505	1383	1079	885	1530	1160	994	211	120						
804	726	643	1589	1268	1061	1822	1413	1238	211	133						
870	789	699	1678	1345	1129	1952	1521	1347	211	146						
960	867	772	1794	1448	1225	2078	1627	1455	211	146						
1067	964	863	1924	1564	1330	2293	1813	1635	324	159						
1588	1491	1428	2539	2173	1963	3146	2582	2449	517	146						
1847	1731	1652	2832	2441	2205	3514	2897	2756	734	146						
2000	1867	1779	3041	2630	2374	3792	3201	3014	860	146						
1840	1723	1645	2787	2397	2172	3478	2861	2718	581	159						
2048	1913	1824	3025	2615	2366	3865	3185	3035	734	159						
2385	2216	2103	3416	2968	2686	4259	3562	3363	860	159						
2583	2398	2276	3638	3172	2880	4709	3895	3730	860	179						

- Self Edge Laminate available at same price as Vinyl Edge.
- Black Lockable Casters (3" dia.): \$90.00 per table. Always recommended for Flip Top tables.
- Option: Infinity Lockable Casters: \$202.00 per table.
- Standing Height, 40" or 42": \$100.00 Single Column; \$137.00 Double Column.

TUBULAR T and CROSS BASE TABLES • LAMINATE and VENEER TOPS

Laminate tops with wood or COLORA edge feature 1/8" dia. vinyl inlay in COLORA between top surface and edge. Standard base finish is COLORA colors; polished and satin chrome are available at upcharge. Tables are 29" high.

Specify: model number – top finish – edge profile and finish – inlay color (if applicable) – base finish – options.

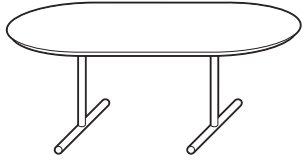

ITEM

DIMENSIONS

RACETRACK

914-7236	72" x 36"
914-8436	84" x 36"
914-9636	96" x 36"
914-7242	72" x 42"
914-8442	84" x 42"
914-9642	96" x 42"
914-9648	96" x 48"

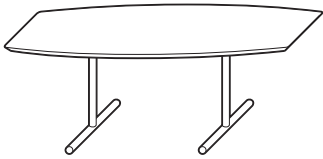

BOAT

915-7236	72" x 36"/25"
915-8442	84" x 42"/30"
915-9642	96" x 42"/30"
915-9648	96" x 48"/35"

PLASTIC LAMINATE TOP

VENEER TOP



QTY1	QTY3	QTY10	QTY1	QTY3	QTY10	QTY1	QTY3	QTY10	ADD FLIP TOP	ADD POL or SATIN CHROME
1998	1860	1768	3448	2998	2659	3684	3114	2870	517	146
2286	2123	2015	3803	3297	2942	4079	3439	3186	734	146
2513	2328	2205	4103	3540	3164	4609	3708	3450	860	146
2263	2100	1993	3735	3246	2891	4043	3403	3150	581	159
2551	2363	2237	4091	3540	3163	4459	3731	3474	734	159
2845	2632	2487	4454	3843	3447	4884	4071	3805	860	159
3210	2962	2799	4831	4171	3753	5370	4458	4183	860	179

1974	1836	1744	3424	2974	2635	3660	3091	2846	517	133
2502	2314	2187	3996	3447	3069	4365	3636	3378	734	133
2768	2554	2409	4347	3738	3340	4780	3965	3701	860	133
3188	2941	2777	4809	4151	3733	5349	4436	4163	860	146

- Self Edge Laminate available at same price as Vinyl Edge.
- Black Lockable Casters (3" dia.): \$46.00 per T Base. Always recommended for Flip Top tables.
- Option: Infinity Lockable Casters: \$100.00 per T Base.
- Standing Height, 40" or 42": \$152.00

TUBULAR C BASE TABLES • LAMINATE and VENEER TOPS

Laminate tops with wood or COLORA edge feature 1/8" dia. vinyl inlay in COLORA between top surface and edge. Standard base finish is COLORA colors; polished and satin chrome are available at upcharge. Modesty panels are in COLORA colors. Tables are 29" high.

Specify: model number – top finish – edge profile and finish – inlay color (if applicable) – base finish – modesty finish – options.

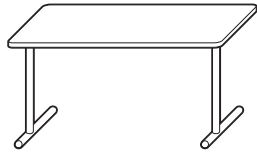

ITEM

DIMENSIONS

WITHOUT MODESTY PANEL

981-4220	42" x 20"	
981-4820	48" x 20"	
981-6020	60" x 20"	
981-7220	72" x 20"	C-Bases located 6" from end of table
981-4224	42" x 24"	(non-folding only)
981-4824	48" x 24"	
981-6024	60" x 24"	
981-7224	72" x 24"	
981-4830	48" x 30"	
981-6030	60" x 30"	
981-7230	72" x 30"	

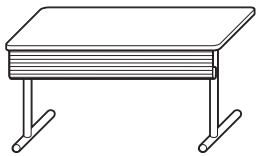

WITH J MODESTY PANEL (REMOVABLE)

Extruded aluminum modesty panel in ribbed pattern features a large wire management tray. 7 1/2" high. Removable (without tools) for folding base tables.

982-4220	42" x 20"	
982-4820	48" x 20"	
982-6020	60" x 20"	
982-7220	72" x 20"	C-Bases located 6" from end of table
982-4224	42" x 24"	(non-folding only)
982-4824	48" x 24"	
982-6024	60" x 24"	
982-7224	72" x 24"	
982-4830	48" x 30"	
982-6030	60" x 30"	
982-7230	72" x 30"	

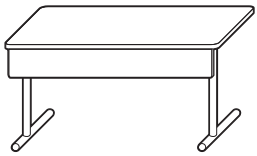

WITH FLAT FIXED MODESTY

Flat aluminum modesty panel fixed to table top, 9" high.

985-4220	42" x 20"	
985-4820	48" x 20"	
985-6020	60" x 20"	
985-7220	72" x 20"	C-Bases located 6" from end of table
985-4224	42" x 24"	(non-folding only)
985-4824	48" x 24"	
985-6024	60" x 24"	
985-7224	72" x 24"	
985-4830	48" x 30"	
985-6030	60" x 30"	
985-7230	72" x 30"	

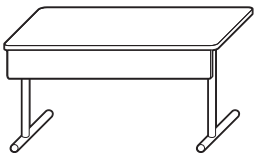

WITH FLAT FOLDING MODESTY

Utilized with Folding Base or Flip Top options - add costs. Flat aluminum modesty panel is 9" high and folds over bases in folded position or over table underside with flip top option.

984-6024	60" x 24"	C-Bases located 6" from end of table
984-7224	72" x 24"	(non-folding only)
984-6030	60" x 30"	
984-7230	72" x 30"	



BRIDGE TOP - Connector plates included

90-deg PIE

996-20	20" R x 20"
996-24	24" R x 24"
996-30	30" R x 30"

45-deg PIE

997-20	20" R x 20"
997-24	24" R x 24"
997-30	30" R x 30"

30-deg PIE

998-20	20" R x 20"
998-24	24" R x 24"
998-30	30" R x 30"



GANG SET

Each set \$87.00 factory installed. Consists of two brackets, a linking bar and two thumb screws. Ganging 24", 30" and 36" sides requires 1 set; 42" sides and over requires 2 sets.

PLASTIC LAMINATE TOP

VENEER TOP

Flat Vinyl			Reeded Wood			Square Wood			ADD FOLDING BASE*	ADD FLIP TOP	ADD POL or SATIN CHROME
QTY1	QTY3	QTY10	QTY1	QTY3	QTY10	QTY1	QTY3	QTY10			
784	742	713	1603	1311	1156	1788	1400	1288		517	112
796	755	726	1615	1322	1167	1820	1433	1321		517	112
935	882	847	1802	1490	1321	2050	1635	1521	428	517	112
1082	1018	974	2000	1671	1487	2284	1839	1719	428	517	112
791	749	722	1609	1318	1161	1830	1443	1332		517	120
805	762	735	1621	1329	1172	1862	1474	1364		517	120
941	889	854	1808	1497	1329	2103	1688	1574	428	517	120
1092	1026	985	2009	1678	1494	2347	1902	1783	428	517	120
936	880	844	1770	1462	1296	2054	1642	1526		517	133
1080	1012	968	1965	1637	1458	2342	1893	1769	428	517	133
1237	1157	1105	2175	1825	1628	2653	2142	2014	428	517	133

1213	1083	1028	2032	1652	1470	2216	1741	1603			112
1243	1113	1098	2061	1683	1500	2266	1791	1654			112
1417	1278	1217	2286	1887	1691	2533	2032	1891	428		112
1603	1450	1383	2521	2104	1893	2806	2273	2127	428		112
1219	1089	1036	2038	1658	1475	2258	1784	1647		517	120
1250	1122	1067	2067	1713	1505	2309	1834	1697		517	120
1426	1285	1225	2291	1893	1698	2585	2085	1943	428	517	120
1612	1461	1390	2530	2111	1901	2868	2337	2190	428	517	120
1381	1240	1175	2217	1821	1628	2500	2000	1860		517	133
1564	1409	1337	2449	2034	1828	2827	2290	2139	428	517	133
1759	1590	1511	2694	2258	2036	3173	2577	2421	428	517	133

1046	966	918	1866	1537	1359	2050	1625	1493			112
1077	1000	949	1896	1570	1389	2100	1678	1543			112
1228	1141	1083	2095	1749	1557	2342	1896	1757			112
1440	1339	1274	2358	1993	1785	2640	2161	2018			112
1053	974	660	1872	1542	1365	2092	1669	1536		517	120
1084	1007	955	1900	1574	1394	2142	1721	1585		517	120
1235	1148	1090	2102	1757	1563	2396	1948	1809		517	120
1448	1349	1284	2365	2000	1792	2704	2226	2081		517	120
1216	1125	1065	2051	1708	1518	2334	1887	1748		517	133
1373	1272	1202	2258	1897	1692	2636	2153	2005		517	133
1594	1480	1403	2531	2148	1927	3008	2466	2313		517	133

1523	1413	1352	2389	2021	1825	2684	2213	2072	428	517	120
1775	1605	1511	2692	2257	2021	3030	2481	2309	428	517	120
1661	1536	1465	2546	2160	1953	2924	2418	2266	428	517	133
1921	1736	1632	2858	2403	2155	3336	2721	2541	428	517	133

430	404	387	956	813	718	829	731	676			
452	423	404	977	833	739	894	797	739			
493	459	436	1033	889	791	946	850	791			

408	382	365	934	791	697	758	659	603			
430	402	382	956	813	718	820	723	666			
472	437	417	1012	868	771	853	755	700			

400	372	354	922	780	687	713	616	558			
419	390	370	943	801	706	722	623	567			
458	426	404	998	855	756	731	633	577			

- Self Edge Laminate available at same price as Vinyl Edge.
- Black Lockable Casters (3" dia.): \$46.00 per C Base. Always recommended for Flip Top tables.
- Option: Infinity Lockable Casters: \$100.00 per C Base.
- Standing Height, 40" or 42": \$152.00
- * • 60" long folding tables have narrow range of suitable Surface Power Units based on location(s) and quantity - please inquire

TUBULAR T BASE TABLES • MODULAR • LAMINATE and VENEER TOPS

Laminate tops with wood or COLORA edge feature 1/8" dia. vinyl inlay in COLORA between top surface and edge. Standard base finish is COLORA colors; polished and satin chrome are available at upcharge. Tables are 29" high.

Specify: model number – top finish – edge profile and finish – inlay color (if applicable) – base finish – options.

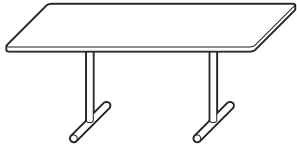

ITEM

DIMENSIONS

RECTANGLE

963-4824	48" x 24"	
963-6024	60" x 24"	
963-7224	72" x 24"	
963-8424	84" x 24"	T-Bases located 12" from end of table (non-folding only)
963-4830	48" x 30"	
963-6030	60" x 30"	
963-7230	72" x 30"	
963-8430	84" x 30"	
963-4836	48" x 36"	
963-6036	60" x 36"	
963-7236	72" x 36"	
963-8436	84" x 36"	

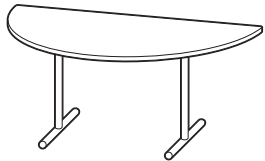

HALF ROUND

964-48	48" dia. x 24"
964-54	54" dia. x 27"
964-60	60" dia. x 30"
964-66	66" dia. x 33"
964-72	72" dia. x 36"

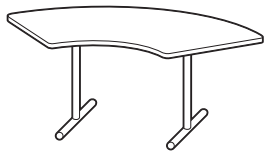

ARC

965-3624	36" R x 24"
965-4824	48" R x 24"
965-4830	48" R x 30"
965-6030	60" R x 30"
965-6036	60" R x 36"
965-7236	72" R x 36"

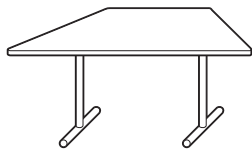

TRAPEZOID

966-4824	48" X 24" X 24"
966-6030	60" X 30" X 30"
966-7236	72" X 36" X 36"



V END

170-deg PIE

968-24 (for 24" D Tables)	54" x 30"
968-30 (for 30" D Tables)	66" x 36"
968-36 (for 36" D Tables)	78" x 42"

PLASTIC LAMINATE TOP

VENEER TOP

Flat Vinyl			Reeded Wood			Square Wood			ADD FOLDING BASE*	ADD FLIP TOP	ADD POL or SATIN CHROME
QTY1	QTY3	QTY10	QTY1	QTY3	QTY10	QTY1	QTY3	QTY10			
788	746	717	1603	1311	1156	1846	1460	1347		517	120
902	849	816	1767	1458	1287	2062	1649	1534	428	517	120
1067	1000	960	1984	1652	1469	2321	1877	1758	428	517	120
1169	1094	1045	2129	1784	1588	2554	2060	1937	428	780	120
920	864	827	1755	1445	1281	2038	1625	1511		517	133
1039	972	928	1925	1598	1418	2304	1854	1730	428	517	133
1212	1132	1079	2149	1801	1603	2628	2118	1989	428	517	133
1449	1356	1292	2421	2054	1843	2983	2429	2291	428	780	133
1006	941	898	1863	1540	1364	2233	1789	1671		517	146
1210	1129	1073	2118	1769	1575	2604	2093	1964	428	517	146
1588	1491	1428	2539	2173	1963	3146	2582	2449	428	517	146
1847	1731	1652	2832	2441	2205	3514	2897	2756	428	780	146
1044	975	1053	2015	1686	1500	2438	1951	1739		517	120
1209	1123	1067	2202	1855	1650	2591	2099	1880		517	120
1403	1299	1227	2415	2050	1825	2829	2317	2082		517	133
1611	1483	1401	2636	2251	2006	3019	2499	2255		517	133
1984	1833	1734	3021	2613	2347	3441	2899	2638		517	146
1009	944	904	2309	1947	1763	2555	2124	1912		517	120
1227	1144	1088	2584	2182	1975	3162	2630	2399		517	120
1429	1325	1253	2771	2350	2128	3271	2702	2457		517	133
1638	1507	1420	3117	2639	2387	3878	3239	2986		529	133
2012	1855	1751	3492	2984	2717	4232	3503	3246		595	146
2304	2115	1989	3881	3314	3011	5182	4272	3998		694	146
972	910	871	1767	1458	1288	1890	1494	1374		517	120
1342	1245	1180	2179	1821	1622	2347	1890	1757		517	133
1740	1604	1513	2613	2207	1974	2948	2376	2233		517	146
1155	1076	1024	2472	2085	1887	2480	1988	1770		517	120
1382	1285	1220	2780	2342	2122	2903	2383	2137		526	133
1788	1652	1561	3246	2745	2484	3406	2846	2580		662	146

TUBULAR T

- Self Edge Laminate available at same price as Vinyl Edge.
- Black Lockable Casters (3" dia.): \$46.00 per T Base. Always recommended for Flip Top tables.
- Option: Infinity Lockable Casters: \$100.00 per T Base.
- Standing Height, 40" or 42": \$152.00
- *• 60" long folding tables have narrow range of suitable Surface Power Units based on location(s) and quantity - please inquire

HALF ROUND T and CROSS BASE TABLES • LAMINATE and VENEER TOPS

Laminate tops with wood or COLORA edge feature 1/8" dia. vinyl inlay in COLORA between top surface and edge. Standard base finish is COLORA colors; polished and satin chrome are available at upcharge. Tables are 29" high.

Specify: model number – top finish – edge profile and finish – inlay color (if applicable) – base finish – options.



ITEM

DIMENSIONS

ROUND

931-30	30" dia.
931-36	36" dia.
931-42	42" dia.
931-48	48" dia.
931-54	54" dia.
931-60	60" dia.



SQUARE

932-30	30" x 30"
932-36	36" x 36"
932-42	42" x 42"
932-48	48" x 48"



RECTANGLE

933-3024	30" x 24"
933-3630	36" x 30"
933-4230	42" x 30"
933-4836	48" x 36"

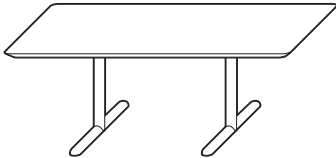

RECTANGLE

923-7236	72" x 36"
923-8436	84" x 36"
923-9636	96" x 36"
923-7242	72" x 42"
923-8442	84" x 42"
923-9642	96" x 42"
923-9648	96" x 48"

• Center Located Power Unit over T-Base and Cross Base: Add \$516.

PLASTIC LAMINATE TOP

VENEER TOP

Flat Vinyl			Angle Wood			Angle Colors			Reeded Wood			Square Wood			ADD FLIP TOP	ADD POL or SATIN CHROME
QTY1	QTY3	QTY10	QTY1	QTY3	QTY10	QTY1	QTY3	QTY10	QTY1	QTY3	QTY10	QTY1	QTY3	QTY10		
1107	948	853	2007	1581	1331	2635	2054	1734	211	154						
1285	1111	1021	2218	1785	1523	2944	2339	2005	211	167						
1486	1296	1193	2464	2017	1725	3239	2613	2253	211	175						
1720	1510	1393	2787	2329	1994	3611	2960	2571	211	190						
1960	1728	1595	3081	2607	2233	3936	3266	2848	324	190						
2376	2098	1936	3601	3088	2656	4313	3620	3177	438	197						
1124	967	886	1887	1487	1285	2087	1603	1436	211	167						
1264	1092	1004	2076	1654	1438	2393	1860	1681	211	175						
1499	1309	1207	2340	1896	1657	2770	2188	1998	211	190						
1700	1493	1377	2599	2126	1867	3133	2502	2304	324	197						
1015	865	776	1755	1364	1156	1901	1444	1265	211	154						
1180	1016	930	1966	1558	1351	2200	1701	1528	211	167						
1253	1085	997	2061	1642	1425	2337	1816	1645	211	175						
1491	1302	1199	2349	1901	1663	2718	2151	1971	324	190						
1752	1657	1593	2704	2338	2128	3313	2747	2614	517	175						
2188	2073	1996	3173	2783	2547	3855	3239	3098	734	175						
2343	2211	2123	3383	2972	2716	4134	3543	3357	860	175						
2179	2063	1985	3135	2745	2519	3826	3209	3066	581	175						
2396	2261	2172	3372	2963	2715	4213	3533	3382	734	190						
2732	2563	2451	3764	3315	3035	4606	3910	3710	860	190						
2926	2743	2620	3982	3515	3223	5052	4239	4074	860	197						

HALF ROUND

- Self Edge Laminate available at same price as Vinyl Edge.
- Black Lockable Casters (3" dia.): \$90.00 per table. Always recommended for Flip Top tables.
- Option: Infinity Lockable Casters: \$202.00 per table.
- Standing Height, 40" or 42": \$100.00 Single Column; \$152.00 Double Column.

HALF ROUND T and CROSS BASE TABLES • LAMINATE and VENEER TOPS

Laminate tops with wood or COLORA edge feature 1/8" dia. vinyl inlay in COLORA between top surface and edge. Standard base finish is COLORA colors; polished and satin chrome are available at upcharge. Tables are 29" high.

Specify: model number – top finish – edge profile and finish – inlay color (if applicable) – base finish – options.

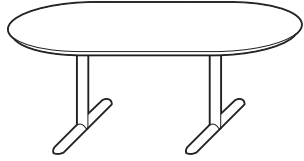

ITEM

DIMENSIONS

RACETRACK

924-7236	72" x 36"
924-8436	84" x 36"
924-9636	96" x 36"
924-7242	72" x 42"
924-8442	84" x 42"
924-9642	96" x 42"
924-9648	96" x 48"

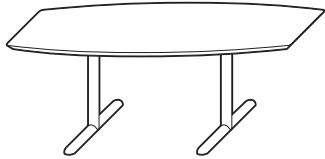



BOAT

925-7236	72" x 36"/25"
925-8442	84" x 42"/30"
925-9642	96" x 42"/30"
925-9648	96" x 48"/35"

PLASTIC LAMINATE TOP

VENEER TOP

												ADD FLIP TOP	ADD POL or SATIN CHROME
QTY1	QTY3	QTY10	QTY1	QTY3	QTY10	QTY1	QTY3	QTY10	QTY1	QTY3	QTY10		

2163	2026	1932	3612	3162	2823	3849	3281	3036	517	175
2628	2465	2359	4145	3640	3283	4421	3780	3528	734	175
2856	2671	2547	4445	3883	3508	4951	4050	3792	860	175
2610	2448	2340	4082	3593	3237	4392	3751	3498	581	190
2898	2709	2584	4438	3889	3511	4807	4079	3822	734	190
3193	2979	2836	4800	4191	3793	5233	4420	4155	860	190
3553	3306	3142	5174	4516	4096	5714	4801	4528	860	197

2223	2086	1994	3672	3223	2885	3910	3341	3097	517	167
2936	2746	2621	4428	3877	3501	4797	4068	3812	734	167
3199	2986	2843	4780	4169	3772	5212	4398	4133	860	167
3530	3283	3119	5151	4493	4076	5691	4780	4505	860	175

HALF ROUND

- Self Edge Laminate available at same price as Vinyl Edge.
- Black Lockable Casters (3" dia.): \$46.00 per T Base. Always recommended for Flip Top tables.
- Option: Infinity Lockable Casters: \$100.00 per T Base.
- Standing Height, 40" or 42": \$152.00

COLUMN BASE TABLES • MODULAR • LAMINATE and VENEER TOPS

Laminate tops with wood or COLORA edge feature 1/8" dia. vinyl inlay in COLORA between top surface and edge. Column Base is 2 1/2" diameter. Standard base finish is COLORA colors; polished and satin chrome are available at upcharge. Tables are 29" high.

Specify: model number – top finish – edge profile and finish – inlay color (if applicable) – base finish – optional modesty finish – options.

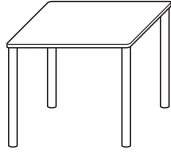

ITEM

DIMENSIONS

SQUARE

972-30	30" x 30"
972-36	36" x 36"
972-42	42" x 42"
972-48	48" x 48"

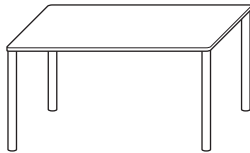

RECTANGLE

973-4824	48" x 24"
973-6024	60" x 24"
973-7224	72" x 24"
973-4830	48" x 30"
973-6030	60" x 30"
973-7230	72" x 30"
973-6036	60" x 36"
973-7236	72" x 36"

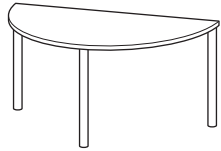

HALF ROUND

974-48	48" dia. x 24"
974-54	54" dia. x 27"
974-60-3	60" dia. x 30"
974-60-4	60" dia. x 30"
974-66	66" dia. x 33"
974-72	72" dia. x 36"

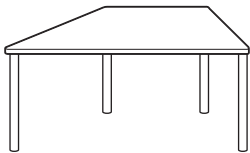

TRAPEZOID

976-4824	48" x 24" x 24"
976-6030	60" x 30" x 30"
976-7236	72" x 36" x 36"

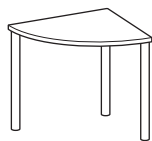

QUARTER ROUND

977-24	24" R x 24"
977-30	30" R x 30"
977-36	36" R x 36"

PLASTIC LAMINATE TOP

VENEER TOP

Flat Vinyl			Reeded Wood			Square Wood			ADD POL or SATIN CHROME
QTY1	QTY3	QTY10	QTY1	QTY3	QTY10	QTY1	QTY3	QTY10	
746	714	692	1511	1234	1092	1711	1352	1240	146
874	826	796	1686	1389	1231	2001	1595	1473	146
1041	977	935	1885	1563	1386	2314	1855	1727	146
1284	1201	1144	2181	1833	1635	2716	2211	2073	146
826	785	757	1644	1351	1195	1885	1497	1386	146
993	941	908	1861	1550	1381	2155	1741	1626	146
1105	1039	997	2022	1691	1507	2361	1916	1795	146
953	897	860	1788	1478	1312	2072	1658	1543	146
1127	1060	1014	2013	1685	1505	2390	1941	1816	146
1246	1165	1112	2181	1833	1637	2660	2151	2022	146
1253	1170	1117	2160	1813	1620	2648	2136	2007	146
1388	1292	1229	2340	1974	1764	2948	2384	2251	146
971	904	858	1942	1612	1426	2364	1879	1666	146
1137	1051	994	2129	1783	1577	2519	2026	1808	146
1404	1300	1229	2417	2051	1827	2830	2318	2084	111
1557	1452	1381	2568	2203	1977	2981	2471	2237	146
1766	1638	1554	2790	2403	2159	3172	2653	2408	146
1960	1809	1710	3026	2617	2352	3448	2905	2642	146
1009	949	909	1807	1495	1329	1927	1533	1414	146
1438	1340	1276	2276	1917	1717	2444	1987	1853	146
1833	1697	1607	2706	2303	2068	3043	2470	2327	146
634	604	583	1560	1269	1097	1953	1546	1305	111
697	659	634	1679	1372	1188	2224	1765	1515	111
845	791	755	1897	1558	1351	2491	2012	1735	111

COLUMN

- Self Edge Laminate available at same price as Vinyl Edge.
- Black Lockable Casters (3" dia.): \$90.00 per table.
- Option: Infinity Lockable Casters: \$202.00 per table.
- Standing Height, 40" or 42": \$152.00
- Bridge Tops and optional Modesty Panels: see page 158.

FOLDING COLUMN BASE TABLES

Laminate tops with wood edge feature 1/8" dia. vinyl inlay in COLORA between top surface and edge.

4" DIA. FOLDING COLUMN BASE TABLES

4" dia. Column bases in COLORA colors or optional chrome finishes. Bases are folding. Specify TVA Cart for table storage and transport. Tables are 29" high.

Specify: model number – top finish – edge profile and finish – inlay color (if applicable) – base color - options.

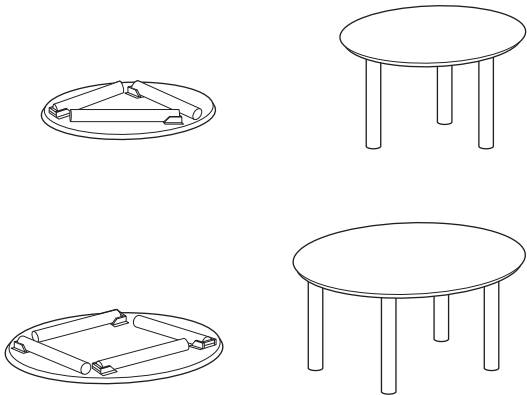

ITEM	DIMENSIONS
------	------------

971-48	48" dia.
--------	----------

971-54	54" dia.
--------	----------

971-60	60" dia.
--------	----------

971-72 (Top with center seam)	72" dia.
-------------------------------	----------

2" DIA. FOLDING COLUMN BASE TABLES

2" dia. Column bases in **Black** or optional **Anodized Satin Aluminum** finishes. Bases are folding. Specify TR4 Cart for table storage and transport. Tables are 29" high.

Specify: model number – top finish – edge profile and finish – inlay color (if applicable) – base color - options.

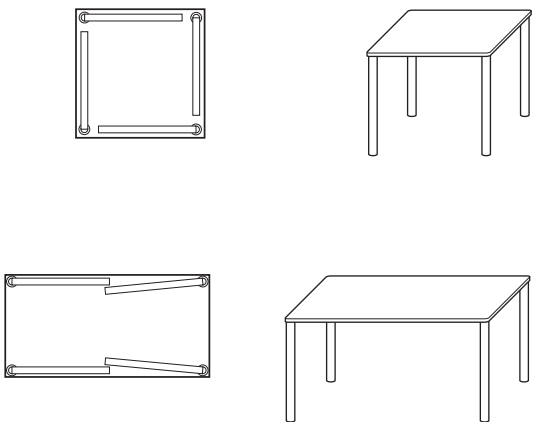

ITEM	DIMENSIONS
------	------------

978-36	36" x 36"
--------	-----------

978-42	42" x 42"
--------	-----------

Optional Satin Aluminum bases, add \$110.00

979-4824	48" x 24"
----------	-----------

979-6024	60" x 24"
----------	-----------

979-4830	48" x 30"
----------	-----------

979-6030	60" x 30"
----------	-----------

Optional ribbed, Satin Aluminum bases, add \$120.00

PLASTIC LAMINATE TOP



**ADD POL
or SATIN
CHROME**

2032	1946	1889	3098	2764	2491	182
------	------	------	------	------	------	-----

2674	2564	2494	3794	3447	3133	242
3059	2906	2804	4285	3897	3525	242
4192	3926	3750	5397	4869	4395	242

959	794	772	1712	1370	1161
1106	990	1005	1889	1525	1300

1042	920	826	1845	1487	1263
1206	1102	956	2079	1827	1612
1142	1036	966	1946	1626	1468
1299	1166	1055	2184	1830	1681

COLUMN FOLDING

- Black Lockable Casters (3" dia.): \$90.00 per table. Always recommended for Flip Top tables.
- Option: Infinity Lockable Casters: \$202.00 per table.

PARSONS BASE TABLES • VIDRO PAINTED BACK GLASS

See standard color choices. Customer's own color must be pre-approved through custom quotation.

Bases 2" x 2" Steel (COLORA) and Stainless Steel (Polished or Brushed). Tops have RB edge profile resulting in 1 1/2" overhang. Tables are 29" high.

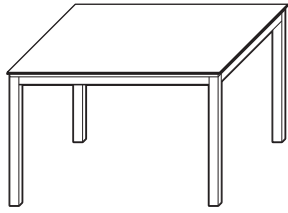

ITEM

DIMENSIONS

SQUARE

220V-4848	48" x 48" x 29" H
220V-5454	54" x 54" x 29" H
220V-6060	60" x 60" x 29" H
220V-8080 (Top in 2 sections)	80" x 80" x 29" H
220V-9090 (Top in 2 sections)	90" x 90" x 29" H

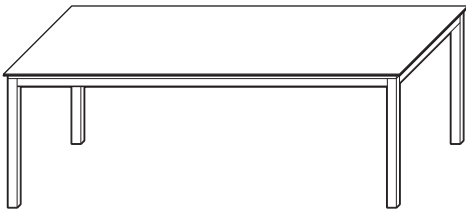

RECTANGLE

220V-7236	72" x 36" x 29" H
220V-8442	84" x 42" x 29" H
220V-9648	96" x 48" x 29" H
220V-1084 (Top in 2 sections)	108" x 48" x 29" H
220V-1204 (Top in 2 sections)	120" x 48" x 29" H
220V-1206 (Top in 2 sections)	120" x 60" x 29" H

- All tables include four vertical bases located at corners. Base verticals do not offer internal wire management option.

PAINTED BACK GLASS TOP (CL GLASS)

MATTE (MA GLASS)

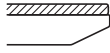

1 1/4" RB
QTY1 QTY3

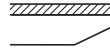

1 1/4" RB
QTY1 QTY3

PAINTED BACK GLASS TOP (CL GLASS)		MATTE (MA GLASS)		ADD CRATE NET \$	ADD POL STAIN	ADD BRUSH STAIN
QTY1	QTY3	QTY1	QTY3			
5514	5123	6504	6069	153	2869	1309
6629	6236	7864	7426	172	3023	1424
7712	7322	9202	8767	191	3176	1538
12818	11925			416	3476	1923
14966	14073			458	3720	2124
6573	6181	7764	7328	208	3028	1433
8270	7860	9801	9347	243	3317	1646
9770	9361	11691	11238	277	3327	1845
10553	10044	12692	12139	312	3505	1986
12569	11677	15147	14122	347	3641	2082
14051	13158	17118	16093	382	3884	2286

• Top RB edge profile (overhang)

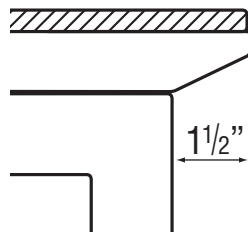

• Vidro Art option require additional details - custom quote required.

BROOKLYN BASE COMMUNITY TABLES

With a variety of surface finishes available the Brooklyn series utilizes an internal welded steel rail system to maximize stability. Internal continuous top corner rail provides added support with connection point for assembly occurring at mid-span seam. Corner profile - 45° mitre.

3 1/2" construction thickness allows for power unit location along entire top surface or upper section of either end panel.

Undertop wireway covers shield wiring across table to the point of access doors.

For all laminate and all veneer items recessed INF, INFJ and COVE power units can be placed at any position along the centerline of the table top.

For glass and stone top items options are: a) undertop IT apron which locates power units 8" from table edge; or b) recessed UTP and COVE units located in end panels.

REV 03.20.15



KEY DETAILS INCL. INFJ CENTER SURFACE RECESSED POWER COMMUNICATION UNIT - FULLY LAMINATE AND VENEER ITEMS ONLY.

REV 03.20.15

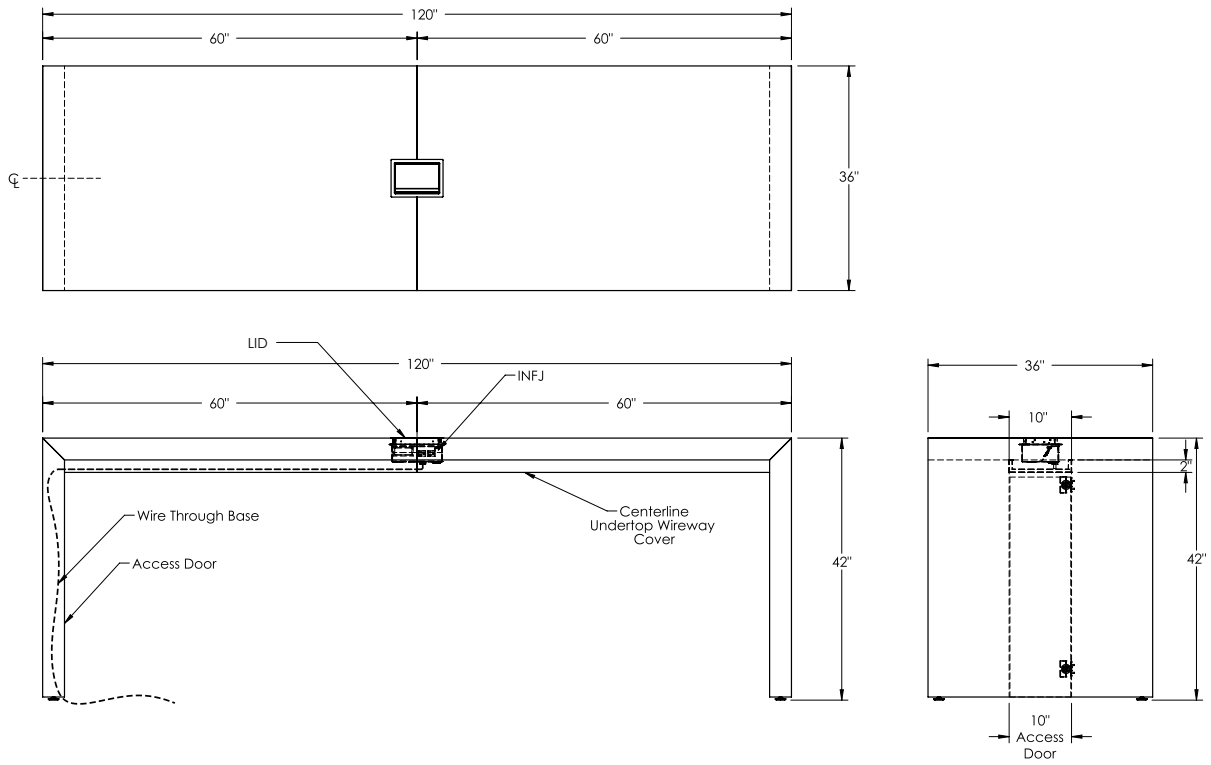

KEY DETAILS INCL. SIDE PANEL UTP POWER COMMUNICATION UNIT (OPTION-COVE UNITS) - ALL TABLE ITEMS.

REV 03.20.15

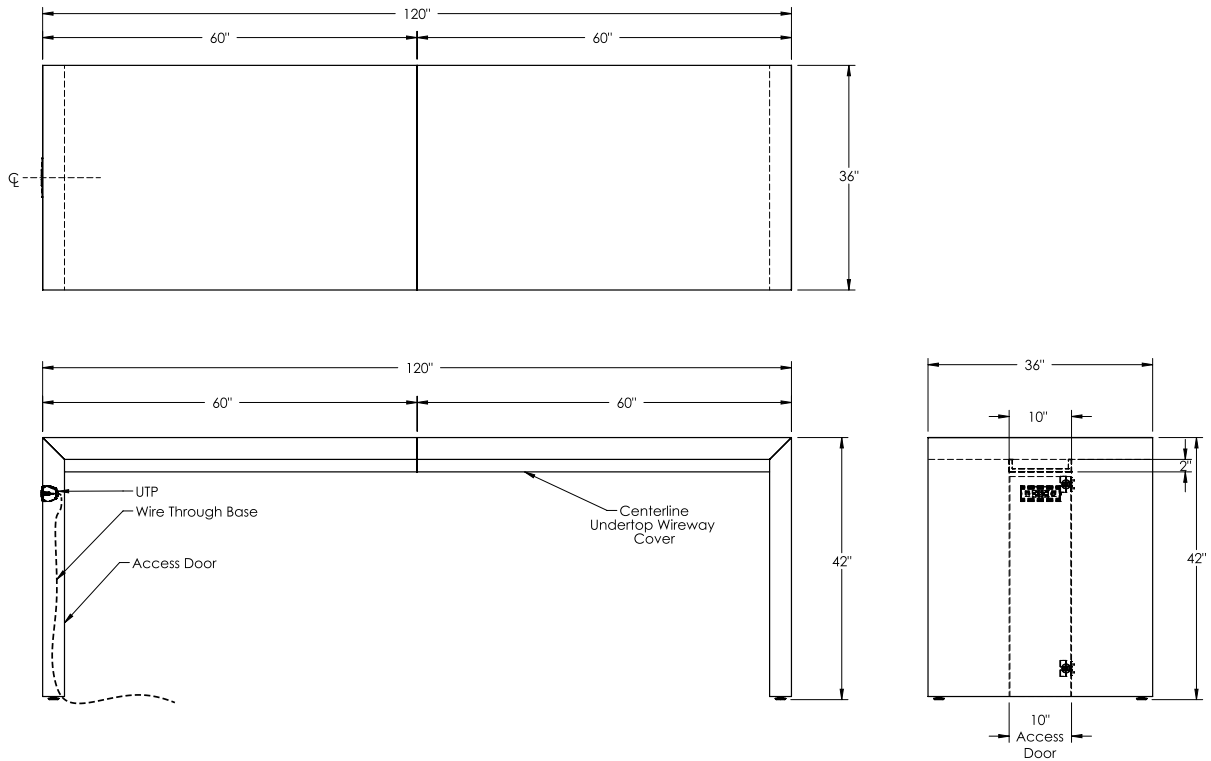

BROOKLYN BASE COMMUNITY TABLES • LAMINATE and VENEER TOPS

All tables with mitred corners for all surface materials. Connection and assembly at tabletop center not at corner. Recessed surface power units may be located on centerline only or upper location on end panels. Optional undertop apron with power units available. **Only one access door per table.**

ONE PIECE

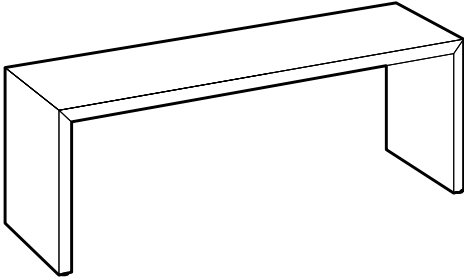

ITEM	DIMENSIONS
310B-7230	72" x 30" x 30 – 42"H
310B-8430	84" x 30" x 30 – 42"H
310B-9630	96" x 30" x 30 – 42"H
310B-7236	72" x 36" x 30 – 42"H
310B-8436	84" x 36" x 30 – 42"H
310B-9636	96" x 36" x 30 – 42"H
310B-7242	72" x 42" x 30 – 42"H
310B-8472	84" x 42" x 30 – 42"H
310B-9672	96" x 42" x 30 – 42"H
310B-7248	72" x 48" x 30 – 42"H
310B-8448	84" x 48" x 30 – 42"H
310B-9648	96" x 48" x 30 – 42"H

TWO PIECE

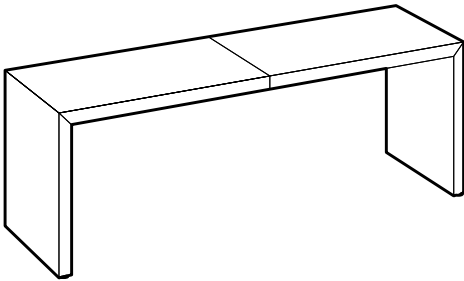

320B-10830	108" x 30" x 30 – 42"H
320B-11430	114" x 30" x 30 – 42"H
320B-12030	120" x 30" x 30 – 42"H
320B-10836	108" x 36" x 30 – 42"H
320B-11436	114" x 36" x 30 – 42"H
320B-12036	120" x 36" x 30 – 42"H
320B-10842	108" x 42" x 30 – 42"H
320B-11442	114" x 42" x 30 – 42"H
320B-12042	120" x 42" x 30 – 42"H
320B-10848	108" x 48" x 30 – 42"H
320B-11448	114" x 48" x 30 – 42"H
320B-12048	120" x 48" x 30 – 42"H

TWO PIECE WITH CUTBACK CENTER PANEL

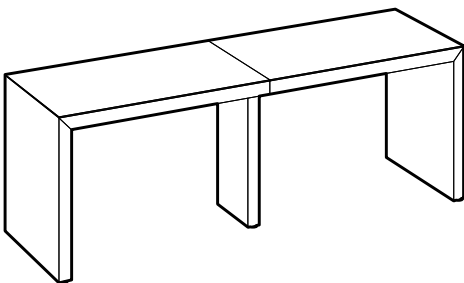

330B-14430	144" x 30" x 30 – 42"H
330B-16830	168" x 30" x 30 – 42"H
330B-19230	192" x 30" x 30 – 42"H
330B-14436	144" x 36" x 30 – 42"H
330B-16836	168" x 36" x 30 – 42"H
330B-19236	192" x 36" x 30 – 42"H
330B-14442	144" x 42" x 30 – 42"H
330B-16842	168" x 42" x 30 – 42"H
330B-19242	192" x 42" x 30 – 42"H
330B-14448	144" x 48" x 30 – 42"H
330B-16848	168" x 48" x 30 – 42"H
330B-19248	192" x 48" x 30 – 42"H

PLASTIC LAMINATE TOP/BASE

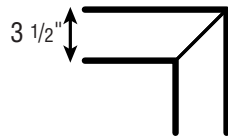

VENEER TOP/BASE

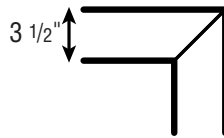

PLASTIC LAMINATE TOP/BASE			VENEER TOP/BASE			ADD RECESSED UNDERTOP IT APRON UTP'S EXTRA LAMINATE or VENEER	ADD CENTERLINE UNDERTOP WIREWAY COVER LAMINATE or VENEER	ADD ACCESS DOOR ONE PER TABLE ONLY	
QTY1	QTY3	QTY10	QTY1	QTY3	QTY10			LAMINATE	VENEER
5271	4804	4494	8242	7931	7620	930	712	533	851
5562	5096	4785	8720	8409	8098	975	712	533	851
5904	5438	5127	9404	9094	8783	1020	735	533	851
5440	4974	4663	8853	8542	8231	930	712	533	851
5738	5272	4961	9332	9022	8711	975	712	533	851
6086	5620	5309	10019	9708	9398	1020	735	533	851
5835	5369	5058	9463	9152	8842	930	712	533	851
6183	5717	5406	9945	9634	9323	975	712	533	851
6538	6071	5761	10634	10323	10012	1020	735	533	851
6003	5537	5226	10074	9763	9452	930	712	533	851
6359	5891	5580	10558	10297	9936	975	712	533	851
6719	6253	5942	11249	10938	10627	1020	735	533	851
9760	9449	9138	14436	13815	13193	1063	758	533	851
10230	9919	9608	14800	14178	13557	1086	770	533	851
10820	10509	10198	15217	14595	13974	1107	780	533	851
9867	9556	9245	15330	14708	14087	1063	758	533	851
10337	10026	9715	15747	15125	14504	1086	770	533	851
10928	10617	10306	16164	15542	14920	1107	780	533	851
10004	9693	9383	16224	15602	14981	1063	758	533	851
10474	10163	9853	16641	16019	15397	1086	770	533	851
11065	10574	10444	17110	16489	15867	1107	780	533	851
10580	10269	9958	17118	16496	15874	1063	758	533	851
11166	10855	10544	17587	16966	16344	1086	770	533	851
11176	10865	10554	18057	17436	16814	1107	780	533	851
9959	9027	8405	16338	15406	14784	1528	1201	533	851
10696	9763	9142	16701	15769	15147	1616	1247	533	851
11117	10185	9563	17273	16340	15719	1706	1293	533	851
10182	9249	8628	17300	16367	15746	1528	1201	533	851
10918	9986	9364	17715	16783	16161	1616	1247	533	851
11340	10408	9786	18339	17406	16785	1706	1293	533	851
10404	9472	8850	18209	17277	16655	1528	1201	533	851
11141	10209	9587	18677	17744	17123	1616	1247	533	851
11563	10630	10009	19352	18420	17798	1706	1293	533	851
10629	9697	9075	19171	18239	17617	1528	1201	533	851
11366	10433	9812	19691	18914	18137	1616	1247	533	851
11787	10855	10233	20418	19486	18864	1706	1293	533	851

BROOKLYN LAMINATE BASE COMMUNITY TABLES • VIDRO PAINTED BACK GLASS and STONE TOPS

All tables with mitred corners for all surface materials. Connection and assembly at tabletop center not at corner. Recessed surface power units may be located on end panels only. Optional undertop apron with power units available. **Only one access door per table.** Glass and Stone tops secured but removeable.

REV 03.20.15

ONE PIECE LAMINATE

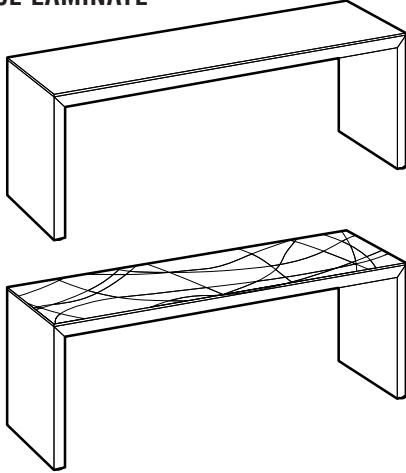

ITEM

DIMENSIONS

340B-7230	72" x 30" x 30 – 42"H
340B-8430	84" x 30" x 30 – 42"H
340B-9630	96" x 30" x 30 – 42"H
340B-7236	72" x 36" x 30 – 42"H
340B-8436	84" x 36" x 30 – 42"H
340B-9636	96" x 36" x 30 – 42"H
340B-7242	72" x 42" x 30 – 42"H
340B-8442	84" x 42" x 30 – 42"H
340B-9642	96" x 42" x 30 – 42"H
340B-7248	72" x 48" x 30 – 42"H
340B-8448	84" x 48" x 30 – 42"H
340B-9648	96" x 48" x 30 – 42"H

TWO PIECE LAMINATE

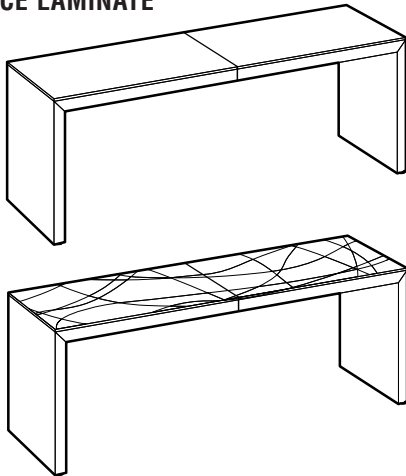

350B-10830	108" x 30" x 30 – 42"H
350B-11430	114" x 30" x 30 – 42"H
350B-12030	120" x 30" x 30 – 42"H
350B-10836	108" x 36" x 30 – 42"H
350B-11436	114" x 36" x 30 – 42"H
350B-12036	120" x 36" x 30 – 42"H
350B-10842	108" x 42" x 30 – 42"H
350B-11442	114" x 42" x 30 – 42"H
350B-12042	120" x 42" x 30 – 42"H
350B-10848	108" x 48" x 30 – 42"H
350B-11448	114" x 48" x 30 – 42"H
350B-12048	120" x 48" x 30 – 42"H

1/4" PBG (CLEAR)
GLASS TOP (SQ)

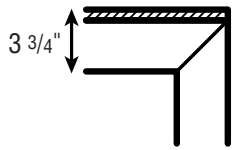

1/4" PBG (MATTE)
GLASS TOP (SQ)

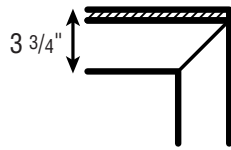

3/4" STONE
SQ. EDGE

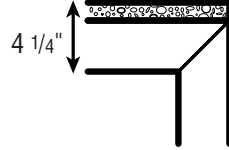

1/4" PBG (CLEAR) GLASS TOP (SQ)			1/4" PBG (MATTE) GLASS TOP (SQ)			3/4" STONE SQ. EDGE			ADD CRATE NET \$	ADD RECESSED UNDERTOP IT APRON UTP'S EXTRA LAMINATE OR VENEER	ADD CENTERLINE UNDERTOP WIREWAY COVER LAMINATE OR VENEER	ADD ACCESS DOOR ONE PER TABLE ONLY	
QTY1	QTY3	QTY10	QTY1	QTY3	QTY10	QTY1	QTY3	QTY10				LAMINATE OR VENEER	LAMINATE OR VENEER
8703	7991	7557	9712	8955	7738	9753	9286	8976	208	930	712	533	851
9487	8775	8341	10625	9867	8561	10791	10325	10014	232	975	712	533	851
10321	9608	9174	11587	10830	9433	11880	11414	11103	277	1020	735	533	851
9207	8495	8061	10369	9612	8289	10552	10086	9775	208	930	712	533	851
10043	9330	8896	11356	10599	9172	11702	11236	10925	232	975	712	533	851
10928	10215	9782	12394	11637	10105	12902	12436	12125	277	1020	735	533	851
9937	9224	8790	11250	10493	9066	11577	11111	10800	208	930	712	533	851
10867	10155	9721	12359	11600	10053	12882	12416	12105	232	975	712	533	851
11805	11093	10659	13471	12714	11047	14194	13727	13417	277	1020	735	533	851
10439	9726	9292	11905	11148	9616	12375	11909	11598	208	930	712	533	851
11422	10710	10276	13088	12331	10663	13791	13325	13014	232	975	712	533	851
12412	11700	11266	14278	13521	11718	15215	14749	14438	277	1020	735	533	851
14223	13666	13262	15629	15028	13526	18037	17726	17415	312	1063	758	533	851
16016	14966	14409	17683	16499	14697	18770	18459	18148	330	1086	770	533	851
17006	16018	15461	18765	17654	15755	19622	19311	19000	347	1107	780	533	851
14800	14243	13809	16430	15829	14177	19089	18778	18467	312	1063	758	533	851
16616	15567	15010	18518	17334	15374	19874	19563	19252	330	1086	770	533	851
17630	16642	16085	19636	18525	16461	20780	20469	20158	347	1107	780	533	851
15409	14729	14418	17262	16515	14858	20171	19860	19550	312	1063	758	533	851
17247	16198	15641	19384	18201	16083	21009	20698	20387	330	1086	770	533	851
18345	17296	16739	20609	19426	17196	21967	21656	21346	347	1107	780	533	851
16455	15775	15464	18532	17785	15978	21692	21381	21070	312	1063	758	533	851
18433	17383	16826	20805	19621	17345	22698	22387	22076	330	1086	770	533	851
18973	17923	17366	21483	20300	17905	23128	22817	22506	347	1107	780	533	851

BROOKLYN VENEER BASE COMMUNITY TABLES • VIDRO PAINTED BACK GLASS and STONE TOPS

All tables with mitred corners for all surface materials. Connection and assembly at tabletop center not at corner. Recessed surface power units may be located on end panels only. Optional undertop apron with power units available. **Only one access door per table.** Glass and Stone tops secured but removeable.

REV 03.20.15

ONE PIECE VENEER

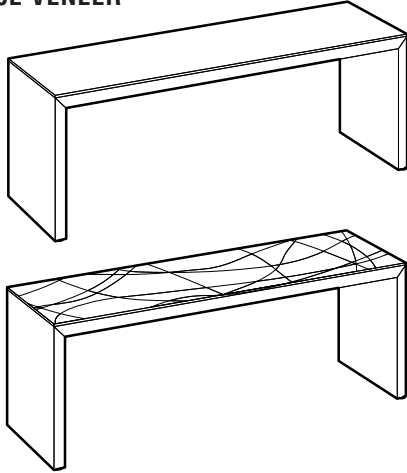

ITEM

DIMENSIONS

360B-7230	72" x 30" x 30 – 42"H
360B-8430	84" x 30" x 30 – 42"H
360B-9630	96" x 30" x 30 – 42"H
360B-7236	72" x 36" x 30 – 42"H
360B-8436	84" x 36" x 30 – 42"H
360B-9636	96" x 36" x 30 – 42"H
360B-7242	72" x 42" x 30 – 42"H
360B-8442	84" x 42" x 30 – 42"H
360B-9642	96" x 42" x 30 – 42"H
360B-7248	72" x 48" x 30 – 42"H
360B-8448	84" x 48" x 30 – 42"H
360B-9648	96" x 48" x 30 – 42"H

TWO PIECE VENEER

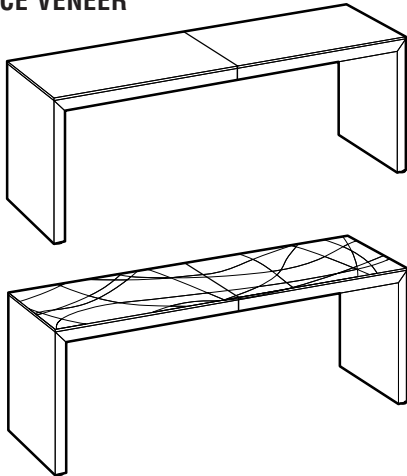

370B-10830	108" x 30" x 30 – 42"H
370B-11430	114" x 30" x 30 – 42"H
370B-12030	120" x 30" x 30 – 42"H
370B-10836	108" x 36" x 30 – 42"H
370B-11436	114" x 36" x 30 – 42"H
370B-12036	120" x 36" x 30 – 42"H
370B-10842	108" x 42" x 30 – 42"H
370B-11442	114" x 42" x 30 – 42"H
370B-12042	120" x 42" x 30 – 42"H
370B-10848	108" x 48" x 30 – 42"H
370B-11448	114" x 48" x 30 – 42"H
370B-12048	120" x 48" x 30 – 42"H

1/4" PBG (CLEAR)
GLASS TOP (SQ)

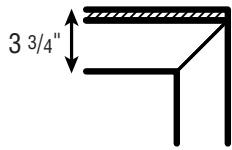

1/4" PBG (MATTE)
GLASS TOP (SQ)

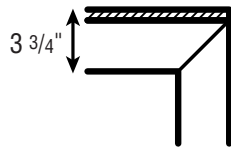

3/4" STONE
SQ. EDGE

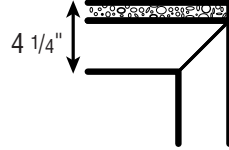

1/4" PBG (CLEAR) GLASS TOP (SQ)			1/4" PBG (MATTE) GLASS TOP (SQ)			3/4" STONE SQ. EDGE			ADD CRATE NET \$	ADD RECESSED UNDERTOP IT APRON UTP'S EXTRA LAMINATE OR VENEER	ADD CENTERLINE UNDERTOP WIREWAY COVER LAMINATE OR VENEER	ADD ACCESS DOOR ONE PER TABLE ONLY	
QTY1	QTY3	QTY10	QTY1	QTY3	QTY10	QTY1	QTY3	QTY10				LAMINATE OR VENEER	LAMINATE OR VENEER
11107	10550	10116	12115	11514	10297	12724	12413	12102	208	930	712	533	851
11897	11340	10906	13035	12433	11126	13949	13638	13327	232	975	712	533	851
12996	12439	12006	14263	13661	12264	15380	15070	14759	277	1020	735	533	851
11959	11402	10968	13120	12518	11196	13965	13654	13343	208	930	712	533	851
12781	12224	11790	14095	13493	12066	15296	14986	14675	232	975	712	533	851
13912	13355	12921	15379	14777	13245	16835	16524	16214	277	1020	735	533	851
12811	12254	11820	14124	13523	12096	15205	14894	14584	208	930	712	533	851
13665	13108	12674	15155	14553	13006	16644	16333	16022	232	975	712	533	851
14828	14271	13837	16494	15892	14225	18290	17979	17668	277	1020	735	533	851
13663	13106	12672	15129	14527	12995	16446	16135	15824	208	930	712	533	851
14549	13992	13558	16215	15613	13946	17992	17681	17370	232	975	712	533	851
15744	15187	14753	17610	17008	15206	19745	19434	19123	277	1020	735	533	851
18200	17332	16587	19606	18694	16881	22713	22692	21470	312	1063	758	533	851
19848	18488	17620	21515	20020	17907	23340	22718	22096	330	1086	770	533	851
20626	19327	18459	22385	20963	18754	24019	23397	22776	347	1107	780	533	851
19424	18557	17812	21055	20142	18179	24552	23930	23309	312	1063	758	533	851
21141	19780	18913	23042	21548	19277	25284	24662	24041	330	1086	770	533	851
21934	20635	19767	23939	22518	20143	26016	25394	24772	347	1107	780	533	851
20646	19658	19037	22503	21445	19477	26391	25769	25148	312	1063	758	533	851
22381	21020	20152	24517	23023	20594	27175	26554	25932	330	1086	770	533	851
23303	21943	21075	25567	24073	21532	28012	27391	26769	347	1107	780	533	851
21874	20883	20262	23951	22893	20775	28230	27608	26986	312	1063	758	533	851
23673	22313	21445	26045	24551	21964	29119	28498	27876	330	1086	770	533	851
24611	23250	22383	27122	25627	22922	30009	29388	28766	347	1107	780	533	851

BROOKLYN BASE COMMUNITY TABLES • VIDRO PAINTED BACK GLASS and STONE TOPS

All tables with mitred corners for all surface materials. Connection and assembly at tabletop center not at corner. Recessed surface power units may be located on end panels only. Optional undertop apron with power units available. **Only one access door per table.** Glass and Stone tops secured but removeable.

REV 03.20.15

TWO PIECE WITH CUTBACK CENTER PANEL LAMINATE

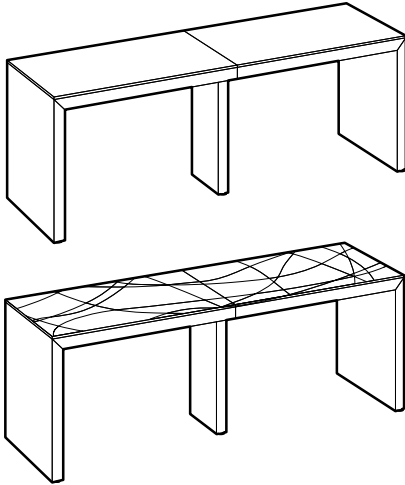

ITEM

DIMENSIONS

380B-14430	144" x 30" x 30 - 42"H
380B-16830	168" x 30" x 30 - 42"H
380B-19230	192" x 30" x 30 - 42"H
380B-14436	144" x 36" x 30 - 42"H
380B-16836	168" x 36" x 30 - 42"H
380B-19236	192" x 36" x 30 - 42"H
380B-14442	144" x 42" x 30 - 42"H
380B-16842	168" x 42" x 30 - 42"H
380B-19242	192" x 42" x 30 - 42"H
380B-14448	144" x 48" x 30 - 42"H
380B-16848	168" x 48" x 30 - 42"H
380B-19248	192" x 48" x 30 - 42"H

TWO PIECE WITH CUTBACK CENTER PANEL VENEER

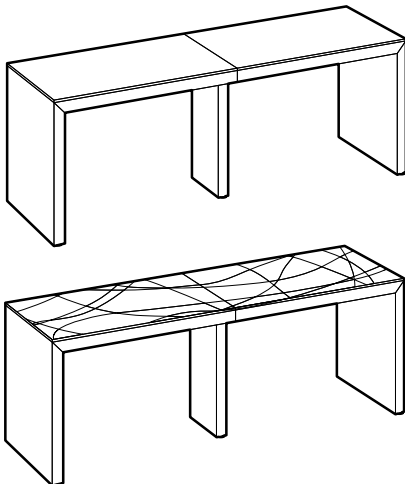

390B-14430	144" x 30" x 30 - 42"H
390B-16830	168" x 30" x 30 - 42"H
390B-19230	192" x 30" x 30 - 42"H
390B-14436	144" x 36" x 30 - 42"H
390B-16836	168" x 36" x 30 - 42"H
390B-19236	192" x 36" x 30 - 42"H
390B-14442	144" x 42" x 30 - 42"H
390B-16842	168" x 42" x 30 - 42"H
390B-19242	192" x 42" x 30 - 42"H
390B-14448	144" x 48" x 30 - 42"H
390B-16848	168" x 48" x 30 - 42"H
390B-19248	192" x 48" x 30 - 42"H

1/4" PBG (CLEAR) GLASS TOP (SQ)

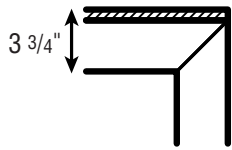

1/4" PBG (MATTE) GLASS TOP (SQ)

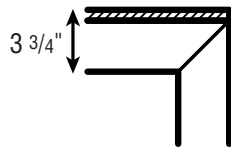

3/4" STONE SQ. EDGE

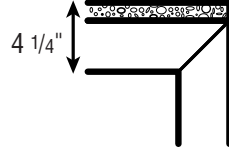

1/4" PBG (CLEAR) GLASS TOP (SQ)			1/4" PBG (MATTE) GLASS TOP (SQ)			3/4" STONE SQ. EDGE			ADD CRATE NET \$	ADD RECESSED UNDERTOP IT APRON UTP'S EXTRA LAMINATE OR VENEER	ADD CENTERLINE UNDERTOP WIREWAY COVER LAMINATE OR VENEER	ADD ACCESS DOOR ONE PER TABLE ONLY	
QTY1	QTY3	QTY10	QTY1	QTY3	QTY10	QTY1	QTY3	QTY10				LAMINATE	VENEER
17504	15833	14965	19553	17747	15331	19811	18879	18257	416	1528	1201	533	851
19167	17495	16381	21518	19713	16825	21598	20665	20044	535	1616	1247	533	851
20637	18720	17606	23313	21217	18121	23069	22137	21515	611	1706	1293	533	851
18297	16626	15758	20633	18828	16225	21294	20361	19740	416	1528	1201	533	851
20051	18380	17266	22736	20931	17827	23290	22358	21736	535	1616	1247	533	851
21615	19695	18581	24670	22574	19230	24972	24040	23418	611	1706	1293	533	851
19090	17419	16552	21713	19908	17119	22776	21844	21222	416	1528	1201	533	851
20935	19264	18150	23955	22150	18829	24983	24051	23429	535	1616	1247	533	851
22587	20670	19556	26027	23931	20340	26875	25942	25321	611	1706	1293	533	851
19886	18215	17347	22796	20991	18015	24261	23329	22707	416	1528	1201	533	851
21821	20150	19036	25175	23370	19833	26678	25745	25124	535	1616	1247	533	851
23564	21647	20533	27385	25289	21452	28779	27847	27225	611	1706	1293	533	851
22545	20874	20006	24593	22788	20372	26190	25258	24636	416	1528	1201	533	851
23628	21957	20843	25979	24174	21287	27603	26671	26049	535	1616	1247	533	851
25042	23125	22010	27718	25622	22525	29225	28292	27671	611	1706	1293	533	851
23891	22219	21352	26226	24421	21818	28412	27479	26858	416	1528	1201	533	851
25085	23414	22300	27771	25966	22862	30087	29155	28533	535	1616	1247	533	851
26611	24694	23580	29669	27573	24230	31971	31038	30417	611	1706	1293	533	851
25184	23513	22645	27807	26002	23213	30581	29649	29027	416	1528	1201	533	851
26491	24820	23706	29511	27706	24385	32519	31586	30965	535	1616	1247	533	851
28129	26211	25097	31568	29472	25882	34664	33732	33110	611	1706	1293	533	851
226530	24859	23991	29446	27635	24659	32803	31871	31249	416	1528	1201	533	851
27949	26433	25163	31303	29653	25960	35003	34226	33449	535	1616	1247	533	851
29695	27781	26667	33519	31423	27586	37410	36478	35856	611	1706	1293	533	851



CABINET UNITS

FEATURES AND OPTIONS

> Cabinets are designed to match or compliment all Prismatic meeting and training room tables. Cabinet tops can be specified in same finish and edge profile as the selected table series. Storage components are modular and available in two, three, four or five door configurations. Typical conference and training room accessories and electronic equipment can be housed in wire-managed storage cabinets.

> Storage units are constructed with 3/4" thick medium or high density particleboard and finished in COLORA colors or in wood veneers. Cabinet interiors and backs are fully finished to match the exterior surfaces. Veneer doors and drawers are equipped with European hinges and full-extension slides and are book matched across their width.

> Each storage section is equipped with one adjustable shelf.

Metal Base Trim

Cabinets are equipped with tubular steel base trim finished in COLORA colors or optional Pol. or Satin Chrome, or Veneers.

Levelling Glides

Cabinets can be levelled from inside with an L key (supplied).

Door and Drawer Pulls

Drawers are equipped with Flap or Bar Pulls. Doors are touch latch but can be specified with Flap or Bar Pulls at an upcharge.

Flap Pull

	Colora	\$24.00
	Pol. Chrome	\$24.00
	Satin Chrome	\$35.00

Bar Pull

	Colora	\$52.00
	Brushed Aluminum	\$52.00

Cantilever Pull

	Colora	\$52.00
	Brushed Aluminum	\$52.00
	Polished Aluminum	\$52.00

DOOR and DRAWER PULL CONFIGURATIONS

Flap Pull

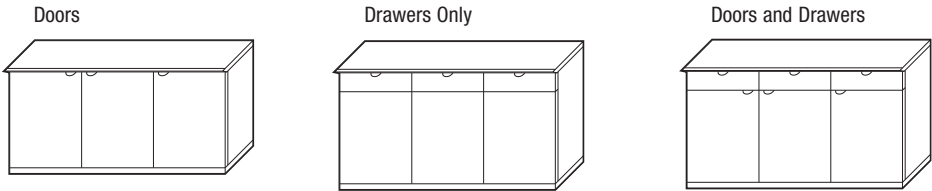

Bar Pull

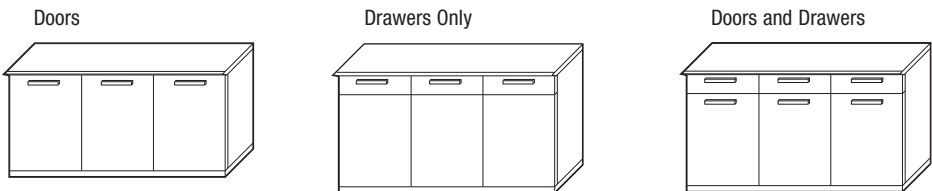

LOCKS

Locks are optional; single or double door or drawer lock are \$126.00 each. Polished Chrome only.

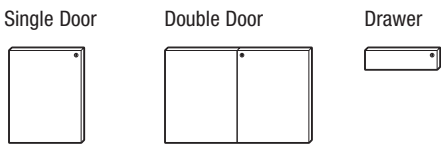

WIRING OPTIONS

Cabinet wiring

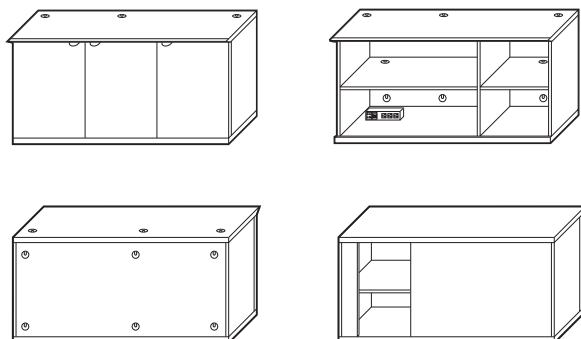

Wood or Stone Top Cabinets, Two to Five-Door Units with or without drawers are optionally equipped with grommets and cut-out backs to accommodate all media equipment and wire management. TV or computer monitors, laptops, overhead projectors, VCR and DVD players and other electronic equipment can be housed on top and interior surfaces. Optional UTP Power/Communication Unit or a six-outlet Power Bar.

Back Panel Knockouts Cutouts can be located at any location on cabinet rear panel. Standard 8" x 8" opening is located at floor for \$93.00 each. Custom sizes are available.

CABINET ELECTRONIC SUPPORT RACKS

ITEM	DESCRIPTION	LIST
SER	SLIDING EQUIPMENT RACK UNIT Nominal 22" W x 19" D x 24" H insert. Black steel, ball bearing slides, capacity 150 lbs. Includes cabinet rear cutout.	\$1803.00 each
FER	FIXED EQUIPMENT RACK UNIT as above without slides	\$818.00 each
AFT	AIR CIRCULATION FAN AND THERMOSTAT UNIT	\$681.00 each

AV and Computer cart wiring

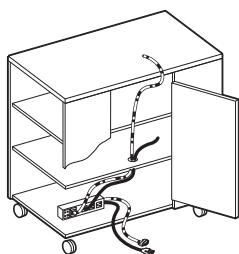

AV and Computer carts accommodate TV or computer monitors, laptops, overhead projectors, VCR and DVD players on top and interior surfaces. Vertical and horizontal grommets, and hinged access door provide easy connections. Optional UTP Power/Communication Unit or a six-outlet Power Bar.

Lectern wiring

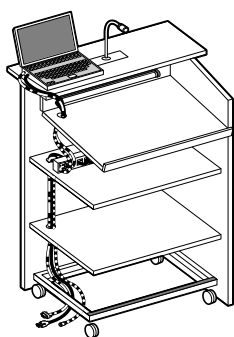

Laptop computer and customer supplied microphone mounted on an aluminum plate are accommodated on straight top surface of lectern. Angle-adjustable work surface and adjustable shelves or cabinet feature grommets for wire management. Optional Reading Light is slim florescent with switch and 6' cord managed through the unit. Optional UTP Power/Presentation Unit.

CABINET UNITS • LAMINATE and VENEER TOPS

See selection of top, edge and case finishes. Drawers are equipped with Pulls; optional for touch-latch doors.

Standard base trim is COLORA; chrome and veneer are upcharged.

Specify: model number - top finish and edge profile - cabinet finish - base color - drawer and (optional) door pull style and finish - optional base finishes, locks, extra shelves, etc.

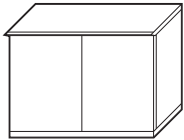

ITEM CASE DIMENSIONS

TWO-DOOR CABINET

2120-29 38" x 24" x 29"H

2120-34 38" x 24" x 34"H

Optional Door Pulls

Flap: Colora or Pol. Chrome, \$48.00 ; Satin Chrome, \$66.00

Bar: Colora or Satin Aluminum, \$106.00

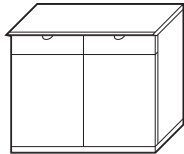

TWO-DOOR CABINET WITH DRAWERS

2121-34 38" x 24" x 34"H

Optional Door Pulls

Flap: Colora or Pol. Chrome, \$48.00 ; Satin Chrome, \$66.00

Bar: Colora or Satin Aluminum, \$106.00

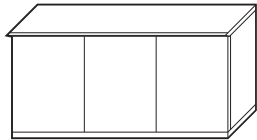

THREE-DOOR CABINET

2130-29 57" x 24" x 29"H

2130-34 57" x 24" x 34"H

Optional Door Pulls

Flap: Colora or Pol. Chrome, \$72.00 ; Satin Chrome, \$99.00

Bar: Colora or Satin Aluminum, \$159.00

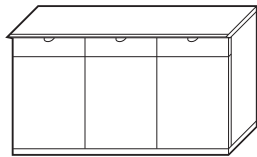

THREE-DOOR CABINET WITH DRAWERS

2131-34 57" x 24" x 34"H

Optional Door Pulls

Flap: Colora or Pol. Chrome, \$72.00 ; Satin Chrome, \$99.00

Bar: Colora or Satin Aluminum, \$159.00

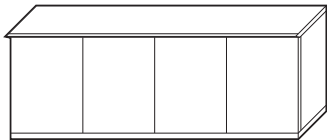

FOUR-DOOR CABINET

2140-29 76" x 24" x 29"H

2140-34 76" x 24" x 34"H

Optional Door Pulls

Flap: Colora or Pol. Chrome, \$96.00 ; Satin Chrome, \$133.00

Bar: Colora or Satin Aluminum, \$211.00

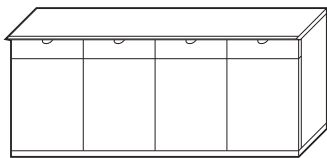

FOUR-DOOR CABINET WITH DRAWERS

2141-34 76" x 24" x 34"H

Optional Door Pulls

Flap: Colora or Pol. Chrome, \$96.00 ; Satin Chrome, \$133.00

Bar: Colora or Satin Aluminum, \$211.00

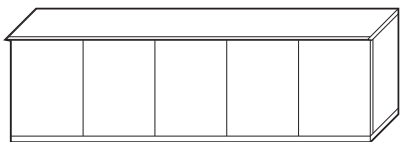

FIVE-DOOR CABINET

2150-29 95" x 24" x 29"H

2150-34 95" x 24" x 34"H

Optional Door Pulls

Flap: Colora or Pol. Chrome, \$120.00 ; Satin Chrome, \$166.00

Bar: Colora or Satin Aluminum, \$265.00

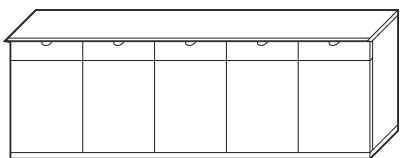

FIVE-DOOR CABINET WITH DRAWERS

2151-34 95" x 24" x 34"H

Optional Door Pulls

Flap: Colora or Pol. Chrome, \$120.00 ; Satin Chrome, \$166.00

Bar: Colora or Satin Aluminum, \$265.00

- **Additional Shelf (adjustable) for 19" or 38" compartments:**
Colora, \$152.00 Veneer, \$194.00
- **Locks: Single or Double Door or Drawer Lock, \$123.00**

CABINET UNITS

P. LAM or COLORA TOP SPECIFY EDGE				VENEER TOP SPECIFY EDGE		STANDARD BASE ADD BASE UPCHARGE		1"x1" Or 2"x2" Thick 6"H RAISED BASE ADD BASE UPCHARGE		
COLORA CABINET		VENEER CABINET		VENEER CABINET		SATIN + POL. CHROME	VENEER	COLORA	STAINLESS STEEL POL	BRUSH
QTY1	QTY3	QTY1	QTY3	QTY1	QTY3					
2032	1704	3721	3485	4243	3852	201	201			
1974	1745	3866	3635	4392	4002	201	201	253	1039	826
2589	2293	4480	4181	5003	4547	201	201	253	1039	826
2988	2734	6107	5610	7024	6331	301	218			
3051	2798	6327	5833	7641	6549	301	218	300	1127	896
3932	3620	7208	6654	8124	7374	301	218	300	1127	896
3600	3059	7093	6422	8016	7077	401	233			
3764	3142	7422	6722	8308	7378	401	233	350	1284	1039
4832	4238	8573	7815	9456	8461	401	233	350	1284	1039
4609	4088	9209	8546	10439	9557	500	251			
4722	4214	9547	8893	10778	9903	500	251	407	1337	1059
6057	5568	10887	10258	12115	11267	500	251	407	1337	1059

• Cabinet Door Insert Options (19" W Units) | Standard Door, Price Included Above; Item Code = SD | File / File, Add \$1367.00 Each; Item Code = FF
 Four Box Drawers, Add \$1949.00 Each; Item Code = BD | (Inside) Pullout Cutlery Drawer, Add \$1215.00 Each; Item Code = ICD
 Box / Box / File, Add \$1658.00 Each; Item Code = BBF | (Inside) Pullout Garbage Drawer, Add \$1127.00 Each; Item Code = IGD

• Specify Cabinet Door Inserts LEFT to RIGHT (Eg. Two Door Cabinet with Standard Door = Item # 2120-29-SD-SD)

CABINET UNITS • VIDRO PAINTED BACK GLASS TOP

See standard options. Drawers are equipped with either Flap or Bar Pulls; optional for touch-latch doors. Standard base trim is COLORA; chrome and veneer options upcharged. Stainless steel (2" x 2" square post) 6" high raised base option upcharged.

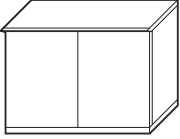
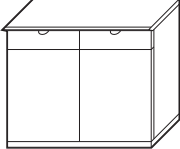
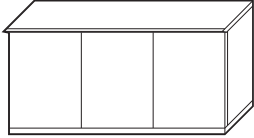
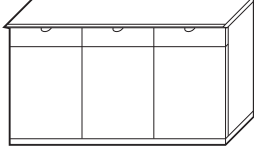
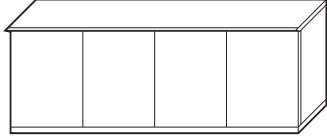
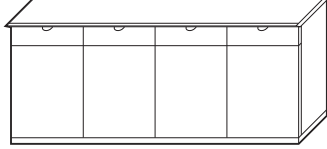
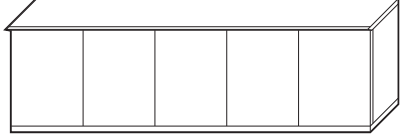
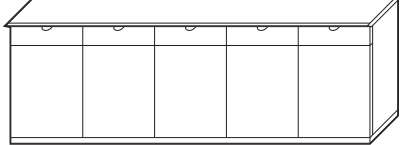
	ITEM	CASE DIMENSIONS	WITH RB TOP DIMENSIONS
	TWO-DOOR CABINET		
	2120V-29	38" x 24" x 29"H	41" x 25.5" x 29"H
	TWO-DOOR CABINET WITH DRAWERS		
	2121V-34	38" x 24" x 34"H	41" x 25.5" x 34"H
	THREE-DOOR CABINET		
	2130V-29	57" x 24" x 29"H	60" x 25.5" x 29"H
	THREE-DOOR CABINET WITH DRAWERS		
	2131V-34	57" x 24" x 34"H	60" x 25.5" x 34"H
	FOUR-DOOR CABINET		
	2140V-29	76" x 24" x 29"H	79" x 25.5" x 29"H
	FOUR-DOOR CABINET WITH DRAWERS		
	2141V-34	76" x 24" x 34"H	79" x 25.5" x 34"H
	FIVE-DOOR CABINET		
	2150V-29	95" x 24" x 29"H	98" x 25.5" x 29"H
	FIVE-DOOR CABINET WITH DRAWERS		
	2151V-34	95" x 24" x 34"H	98" x 25.5" x 34"H

• Locks: Single or Double Door or Drawer Lock, \$126.00

CABINET UNITS

<u>PAINTED BACK GLASS TOP (CL GLASS)</u>		<u>MATTE (MA GLASS) ADD TOP UPCHARGE</u>				<u>STANDARD BASE ADD BASE UPCHARGE</u>		<u>1"x1" Or 2"x2" Thick 6"H RAISED BASE ADD BASE UPCHARGE</u>				
COLORA QTY1	CABINET QTY3	VENEER QTY1	CABINET QTY3	QTY1	QTY3	ADD CRATE NET \$	POL + SATIN CHROME	VENEER	COLORA	STAINLESS POL	STEEL BRUSH	
2979	2749	4765	4530	500	477	82	201	201				
3019	2790	4912	4679	500	477	82	201	201	253	1039	826	
3634	3339	5524	5225	500	477	82	201	201	253	1039	826	
4467	4214	7586	7089	683	662	118	301	218				
4531	4278	7807	7312	683	662	118	301	218	300	1127	896	
5411	5099	8687	8132	683	662	118	301	218	300	1127	896	
5487	4944	8978	7049	868	845	156	401	233				
5651	5028	9308	8608	868	845	156	401	233	350	1284	1039	
6719	6124	10459	9702	868	845	156	401	233	350	1284	1039	
6936	6412	11535	10873	1072	1029	196	500	251				
7049	6541	11874	11219	1072	1029	196	500	251	407	1337	1059	
8383	7895	13213	12585	1072	1029	196	500	251	407	1337	1059	

CABINETS

- Cabinet Door Insert Options (19" W Units) | Standard Door, Price Included Above; Item Code = SD | Four Box Drawers, Add \$1948.00 Each; Item Code = BD | Box / Box / File, Add \$1657.00 Each; Item Code = BBF | File / File, Add \$1367.00 Each; Item Code = FF | (Inside) Pullout Cutlery Drawer, Add \$1215.00 Each; Item Code = ICD | (Inside) Pullout Garbage Drawer, Add \$1127.00 Each; Item Code = IGD

• Specify Cabinet Door Inserts LEFT to RIGHT (Eg. Two Door Cabinet with Standard Door = Item # 2120V-29-SD-SD)

CABINET UNITS • STONE TOPS

See selection of top, edge and case finishes. Drawers are equipped with Pulls; optional for touch-latch doors, standard base trim is COLORA; chrome and veneer are upcharged.

Specify: model number - stone top variety and edge profile - cabinet finish - base color - drawer and (optional) door pull style and finish - optional base finishes, locks, extra shelves, etc.

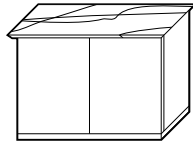

ITEM CASE DIMENSIONS

TWO-DOOR CABINET

2120M-29 38" x 24" x 29"H

2120M-34 38" x 24" x 34"H

Optional Door Pulls

Flap: Colora or Pol. Chrome, \$48.00 ; Satin Chrome, \$66.00

Bar: Colora or Satin Aluminum, \$106.00

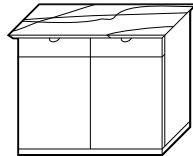

TWO-DOOR CABINET WITH DRAWERS

2121M-34 38" x 24" x 34"H

Optional Door Pulls

Flap: Colora or Pol. Chrome, \$48.00 ; Satin Chrome, \$66.00

Bar: Colora or Satin Aluminum, \$106.00

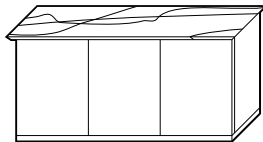

THREE-DOOR CABINET

2130M-29 57" x 24" x 29"H

2130M-34 57" x 24" x 34"H

Optional Door Pulls

Flap: Colora or Pol. Chrome, \$72.00 ; Satin Chrome, \$99.00

Bar: Colora or Satin Aluminum, \$159.00

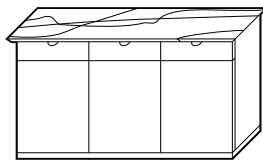

THREE-DOOR CABINET WITH DRAWERS

2131M-34 57" x 24" x 34"H

Optional Door Pulls

Flap: Colora or Pol. Chrome, \$72.00 ; Satin Chrome, \$99.00

Bar: Colora or Satin Aluminum, \$159.00

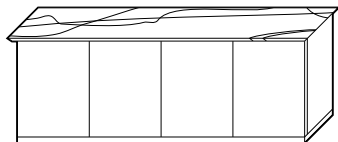

FOUR-DOOR CABINET

2140M-29 76" x 24" x 29"H

2140M-34 76" x 24" x 34"H

Optional Door Pulls

Flap: Colora or Pol. Chrome, \$96.00 ; Satin Chrome, \$133.00

Bar: Colora or Satin Aluminum, \$211.00

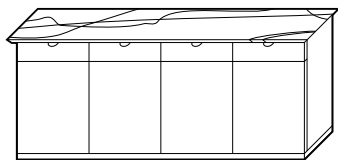

FOUR-DOOR CABINET WITH DRAWERS

2141M-34 76" x 24" x 34"H

Optional Door Pulls

Flap: Colora or Pol. Chrome, \$96.00 ; Satin Chrome, \$133.00

Bar: Colora or Satin Aluminum, \$211.00

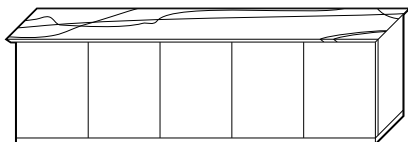

FIVE-DOOR CABINET

2150M-29 95" x 24" x 29"H

2150M-34 95" x 24" x 34"H

Optional Door Pulls

Flap: Colora or Pol. Chrome, \$120.00 ; Satin Chrome, \$166.00

Bar: Colora or Satin Aluminum, \$265.00

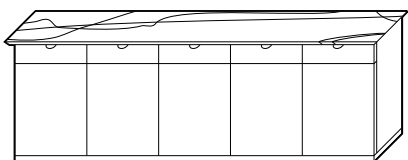

FIVE-DOOR CABINET WITH DRAWERS

2151M-34 95" x 24" x 34"H

Optional Door Pulls

Flap: Colora or Pol. Chrome, \$120.00 ; Satin Chrome, \$166.00

Bar: Colora or Satin Aluminum, \$265.00

- **Additional Shelf (adjustable) for 19" or 38" compartments:**
Colora, \$152.00 Veneer, \$199.00
- **Locks: Single or Double Door or Drawer Lock, \$126.00**

CABINET UNITS

CABINETS

<u>MARBLE OR GRANITE TOP</u> 3/4" RB or 3/4" BN EDGE				<u>MARBLE OR GRANITE TOP</u> 1 1/2" RB or BN or SQ EDGE				ADD CRATE NET \$	<u>STANDARD BASE</u> ADD UPCHARGE		<u>1" x1" Or 2" x2" Thick 6"H</u> RAISED BASE ADD BASE UPCHARGE		
COLORA QTY1	CABINET QTY3	VENEER QTY1	CABINET QTY3	COLORA QTY1	CABINET QTY3	VENEER QTY1	CABINET QTY3		SATIN + POL. CHROME	VENEER	COLORA	STAINLESS POL	STEEL BRUSH
3474	3322	5208	5106	4698	4574	6483	6356	82	201	201			
3515	3366	5405	5254	4740	4617	6630	6504	82	201	201	253	1039	826
4128	3912	6019	5800	5352	5164	7243	7051	82	201	201	253	1039	826
5542	5282	8518	8158	7075	6847	10043	9724	118	301	218			
5605	5348	8736	8381	7138	6913	10270	9947	118	301	218	300	1127	896
6478	6167	9616	9203	8018	7732	11149	10767	118	301	218	300	1127	896
6726	6343	10256	8889	8568	8236	12096	10768	156	401	233			
6811	6441	10477	9188	8651	8321	12389	11069	156	401	233	350	1284	1039
7958	7533	11698	10282	9799	9414	13536	12161	156	401	233	350	1284	1039
8645	8316	13246	11943	10793	9861	15394	14138	196	500	251			
8759	8430	13584	12289	10905	10004	15731	14483	196	500	251	407	1337	1059
10096	9797	14922	13657	12245	11369	17069	15849	196	500	251	407	1337	1059

• Cabinet Door | Standard Door, Price Included Above; Item Code = SD | File / File, Add \$1367.00 Each; Item Code = FF
 Insert Options | Four Box Drawers, Add \$1948.00 Each; Item Code = BD | (Inside) Pullout Cutlery Drawer, Add \$1215.00 Each; Item Code = ICD
 (19" W Units) | Box / Box / File, Add \$1657.00 Each; Item Code = BBF | (Inside) Pullout Garbage Drawer, Add \$1127.00 Each; Item Code = IGD

• Specify Cabinet Door Inserts LEFT to RIGHT (Eg. Two Door Cabinet with Standard Door = Item # 2120-29-SD-SD)

CARTS • LECTERNS

Specify: model number - case finish - options such as door pulls, locks, stone for Serving Carts, UTP Power Unit and Light for the Lecterns, etc.

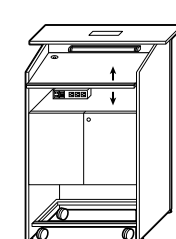
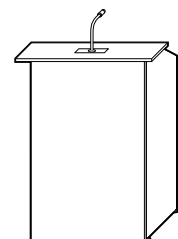
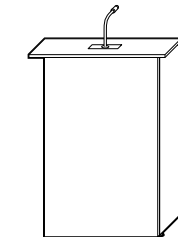
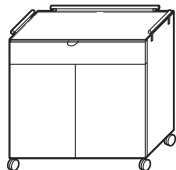
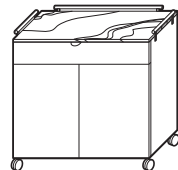
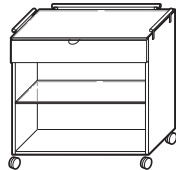
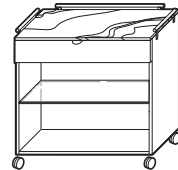
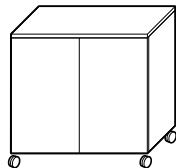
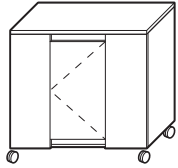
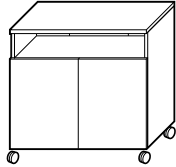
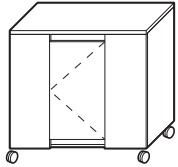
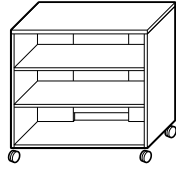
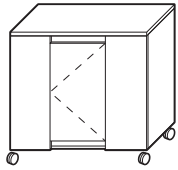

ITEM

DIMENSIONS

AV • COMPUTER CART

2030 34" x 22" x 36"H
Accommodates multimedia equipment. Two adjustable shelves with grommets and hinged rear access door allow wire access and management. 3" dia. locking casters.

AV • COMPUTER CART

2033 34" x 22" x 36"H
Features open shelf with backside grommet for wire access into cabinet, an adjustable shelf behind doors and hinged rear access door.

AV CART

2034 34" x 22" x 36"H
Two adjustable shelves with grommets behind doors and hinged rear access door.
3" dia. locking casters.
Additional Shelf: Colora, \$159.00 ; Veneer, \$209.00

SERVING CART

2050 34" x 22" x 36"H
Divided top drawer and open cabinet with adjustable 3/8" clear glass shelf. Serving surface is 3/8" clear glass or optional stone. Handle and guard bars in COLORA colors.
3" dia. locking casters.
Marble or Granite Top Surface, add \$907.00
Additional 3/8" clear glass shelf, \$329.00

SERVING CART

2051 34" x 22" x 36"H
Divided top drawer and double doors with adjustable shelf inside. Serving surface is 3/8" clear glass or optional stone. Handle and guard bars in COLORA colors.
3" dia. locking casters.
Marble or Granite Top Surface, add \$907.00
Additional Shelf: Colora, \$159.00 ; Veneer, \$209.00

LECTERN

2060 34" x 26" x 48"H
Case: 28" x 24"
Straight top surface, 36" x 12", can accommodate a laptop and is equipped with a removable aluminum plate for customer supplied microphone. Work surface, 28" x 19", is angle-adjustable with paper stop and grommet. Two adjustable shelves with grommets, non-marking foot rest, 3" dia. locking casters are provided.
Reading Light, \$439.00 • UTP Power and Presentation Unit, see pages 10 and 11.

LECTERN

2061 34" x 26" x 48"H
Case: 28" x 24"
Straight top surface, 36" x 12", can accommodate a laptop and is equipped with a removable aluminum plate for customer supplied microphone. Work surface, 28" x 19", is angle-adjustable with paper stop and grommet. Two-door cabinet with grommets for internal wiring, non-marking foot rest, 3" dia. locking casters are provided.
Reading Light, \$439.00 • UTP Power and Presentation Unit, see pages 10 and 11.
Door Lock, \$126.00

COLORA QTY1	QTY3	VENEER QTY1	QTY3
2191	1824	4797	4166
2553	2110	5385	4666
2568	2127	5443	4724
2983	2640	5385	4847
3346	2943	5946	5348
2579	2100	4049	3369
3088	2376	4696	3928

CONSOLE / SERVER • VISUAL BOARDS

Specify: model number - top, panel, edge finish and profile for Console/Servers; case and door or frame finish for Visual and Marker Board - optional Marker Board accessories.



ITEM

DIMENSIONS

PANEL CONSOLE / SERVER

2024-4829	48" x 20" x 29"H
2024-4834	48" x 20" x 34"H
2024-6029	60" x 20" x 29"H
2024-6034	60" x 20" x 34"H
2024-7229	72" x 20" x 29"H
2024-7234	72" x 20" x 34"H

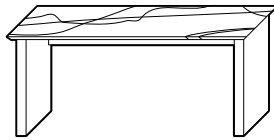

PANEL CONSOLE / SERVER • STONE TOP

2024M-4829	48" x 20" x 29"H
2024M-4834	48" x 20" x 34"H
2024M-6029	60" x 20" x 29"H
2024M-6034	60" x 20" x 34"H
2024M-7229	72" x 20" x 29"H
2024M-7234	72" x 20" x 34"H

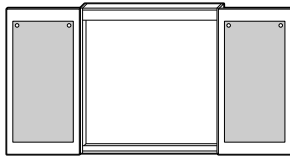
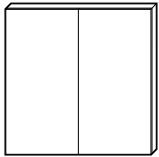

VISUAL CABINET

2040M	48" X 48" X 5"
-------	----------------

Equipped with white porcelain marker board, fabric tackboards behind 180° hinged doors, universal flipchart clip, marker tray and valance for optional projector screen. Marker set, neutral grey/beige tackboard fabric (1 1/2 yds for com) and hanging cleat are included.

Optional pull down Projector Screen,	\$344.00
Colora Inlays (for Colora or Veneer doors),	\$265.00

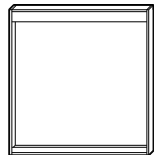

VISUAL CABINET w/o DOORS

2041M	48" X 48" X 4"
-------	----------------

Features white porcelain marker board, marker tray and valance for optional projector screen. Marker set and hanging cleat are included.

Optional pull down Projector Screen,	\$343.00
--------------------------------------	----------

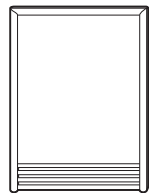

MARKER BOARD

		Whiteboard
3049-36	36" x 48"	33" X 40"H
3049-48	48" x 48"	45" X 40"H
3049-60	60" x 48"	57" X 40"H

1 1/2" dia. extruded aluminum frame in ribbed pattern with accessory rail and available in COLORA colors. Porcelain or laminate marker surface. Mounting hardware included.

MARKER BOARD ACCESSORIES

Letter Tray

3081	Silver, metal	12" x 8"	\$50.00
------	---------------	----------	---------

Large Box

3082-L	Clear Acrylic	12" x 4"	\$37.00
--------	---------------	----------	---------

Medium Box

3082-M	Clear Acrylic	8" x 4"	\$35.00
--------	---------------	---------	---------

Small Box

3082-S	Clear Acrylic	6" x 4"	\$26.00
--------	---------------	---------	---------

FILE HOLDER CLIPS (pair)

3084	Clear Acrylic	4" x 2"	\$62.00
------	---------------	---------	---------

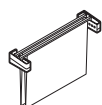
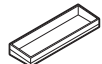
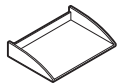

P. LAM or COLORA TOP • SPECIFY EDGE

COLORA PANELS		VENEER PANELS	
QTY1	QTY3	QTY1	QTY3
1795	1368	2922	2377
1828	1398	3075	2531
1870	1442	3062	2519
1901	1473	3214	2673
1943	1515	3202	2659
1975	1548	3356	2812

VENEER TOP • SPECIFY EDGE

VENEER PANELS	
QTY1	QTY3
3527	2982
3681	3136
3737	3313
3890	3465
3944	3508
4098	3661

MARBLE OR GRANITE TOP

3/4" RB or 3/4" BN EDGE

COLORA PANELS		VENEER PANELS	
QTY1	QTY3	QTY1	QTY3
3471	3278	4595	4289
3501	3311	4748	4442
4076	3884	5267	4962
4106	3916	5421	5114
4679	4490	5938	5634
4712	4521	6092	5727

MARBLE OR GRANITE TOP

1 1/2" RB or BN or SQ EDGE

COLORA PANELS		VENEER PANELS	
QTY1	QTY3	QTY1	QTY3
4897	4707	6022	5717
4929	4738	6177	5869
5715	5523	6907	6600
5745	5556	7059	6755
6530	6341	7789	7485
6563	6371	7943	7638

COLORA CASE and DOORS

QTY1	QTY3
2801	2393

COLORA CASE, VENEER DOORS

QTY1	QTY3
3643	3129

VENEER CASE and DOORS

QTY1	QTY3
4247	3588

COLORA CASE

QTY1	QTY3
1455	1292

VENEER CASE

QTY1	QTY3
2059	1753

PORCELAIN

QTY1	QTY3
1639	1275
1846	1481
2258	1893

WHITE P. LAM

QTY1	QTY3
1427	1071
1528	1172
1783	1418





POWER AND COMMUNICATION MODULES • CABLE MANAGEMENT COMPONENTS

Training and Modular Tables in fix or folding base and flip top configurations offer convenient access to power, voice and data outlets and incorporate vertical and horizontal wire management components. Cables are accommodated within the base cavities, removable plastic cover strips allow access to wireways. Small and Large Wire Managers and J Modesty/Wire bin provide horizontal wire routing. Daisychaining available with most factory installed surface power/communication units reduce the need for multiple core drills.

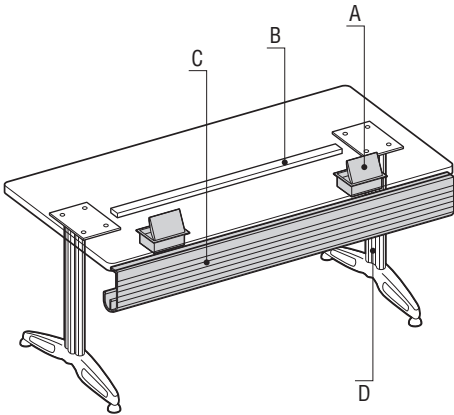

T Base • Fixed

- A Top Support Rail (when required)
- B Surface Power Unit
- C J Modesty/Wire Bin
- D Removable Base Cover Strip

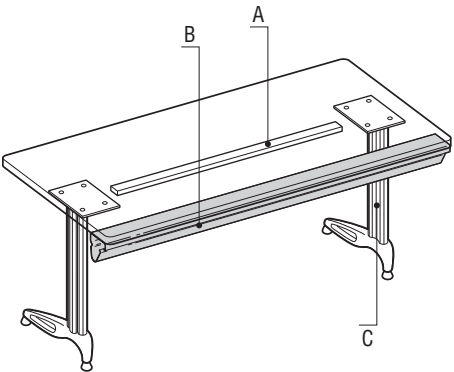

C Base • Fixed

- A Top Support Rail (when required)
- B Large Wire Manager
- C Removable Base Cover Strip

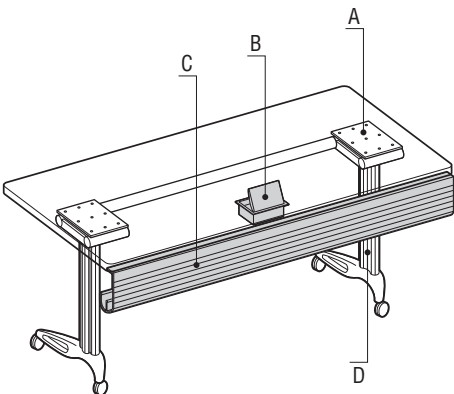

C Base • Flip Top

- A Flip Top Mechanism
- B Surface Power Unit
- C J Modesty/Wire Bin
- D Removable Base Cover Strip

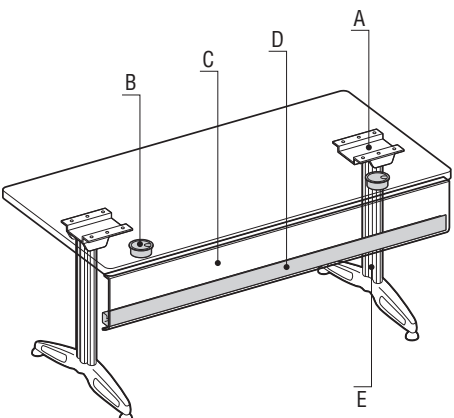

T Base • Folding Base

- A Folding Base Mechanism
- B Grommet
- C Flat Folding Modesty with:
D Horizontal Wire Manager
- E Removable Base Cover Strip

Surface power units in various positions and cabling components are illustrated for various modular shapes.

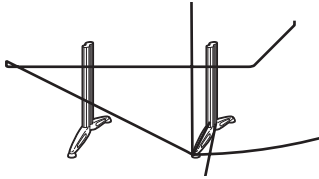

Training Tables featuring power units and leg wire management require single or multiple floor plugs depending on extent of daisy chaining.

TABLE TOP POWER AND GROMMET LOCATION GUIDE

To specify power/communication units and/or grommets on table tops, simply indicate illustration code and number of units. Alternate locations are available. All units are factory installed.

RECTANGLE

- Center • C1
- Center-Width x 2 • WC2
- Center-Back • BC1
- Back x 2 • B2

CONCAVE

CONCAVE/CONVEX

- Center-Straight • SC1
- Center-Concave • VC1
- Center-Concave • VC1
- Center-Convex • XC2

WAVE ASCENDING

WAVE DESCENDING

- Center-Top Ascending • ATC1
- Center-Below Ascending • ABC1
- Center-Top Descending • DTC1
- Center-Below Descending • DBC1

HALF ROUND

ARC

V END

- Center-Straight • SC1
- Center-Small Curve • SCC1
- Center-Large Curve • LCC1
- Center-Angle • AC1

SQUARE

- Center • C1
- Center-Corner • CC1



TRAINING TABLES • COLUMN BASE

Tables are 29" high.

Specify: model number - p. lam. brand and number and vinyl edge color; or veneer finish - base color - options.

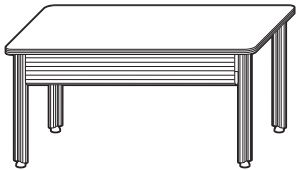
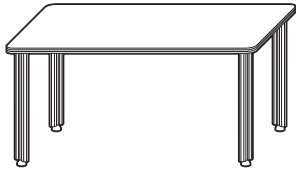

ITEM

DIMENSIONS

WITHOUT J MODESTY

1731-4220	42" x 20"
1731-4820	48" x 20"
1731-6020	60" x 20"
1731-7220	72" x 20"
1731-4224	42" x 24"
1731-4824	48" x 24"
1731-6024	60" x 24"
1731-7224	72" x 24"
1731-4830	48" x 30"
1731-6030	60" x 30"
1731-7230	72" x 30"

WITH J MODESTY

1732-4220	42" x 20"
1732-4820	48" x 20"
1732-6020	60" x 20"
1732-7220	72" x 20"
1732-4224	42" x 24"
1732-4824	48" x 24"
1732-6024	60" x 24"
1732-7224	72" x 24"
1732-4830	48" x 30"
1732-6030	60" x 30"
1732-7230	72" x 30"

BRIDGE TOPS - Connector plates included

90-deg PIE

1780-20	20" R x 20"
1780-24	24" R x 24"
1780-30	30" R x 30"

45-deg PIE

1782-20	20" R x 20"
1782-24	24" R x 24"
1782-30	30" R x 30"

30-deg PIE

1783-20	20" R x 20"
1783-24	24" R x 24"
1783-30	30" R x 30"

GANG SET

Each set \$80.00 factory installed.

Consists of two plates bolted to underside of adjacent tables and a linking bar and thumb screws. Gang Set connects and levels tables. Ganging 24" and 30" sides requires 1 set.

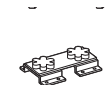
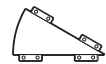
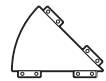
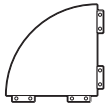

PLASTIC LAMINATE TOP



Flat Vinyl Edge

QTY1 QTY3 QTY10

VENEER TOP



Reeded Wood Edge

QTY1 QTY3 QTY10

1515	1472	1444	2406	2019	1909
1526	1483	1456	2439	2051	1940
1670	1618	1583	2656	2242	2128
1827	1761	1718	2879	2434	2314
1521	1478	1451	2449	2061	1950
1534	1492	1465	2480	2093	1982
1678	1626	1592	2709	2294	2180
1835	1769	1727	2943	2497	2377
1660	1604	1568	2657	2244	2130
1811	1743	1699	2934	2485	2362
1976	1895	1842	3233	2722	2594

1943	1813	1759	2835	2361	2224
1973	1844	1790	2885	2411	2273
2154	2015	1954	3139	2639	2497
2345	2194	2126	3400	2868	2721
1949	1820	1766	2878	2402	2265
1981	1850	1797	2928	2453	2315
2163	2021	1961	3194	2692	2551
2356	2204	2134	3462	2931	2785
2106	1965	1901	3105	2605	2464
2294	2139	2068	3419	2882	2732
2495	2328	2250	3753	3157	3001

430	404	387	829	731	676
452	423	404	894	797	739
493	459	436	946	850	791

408	382	365	758	659	603
430	402	382	820	723	666
472	437	417	853	755	700

400	372	354	713	616	558
419	390	370	722	623	567
458	426	404	731	633	577

- Standard Base is Fixed Height (Removable) with black Glide.
- Adjustable Height (Removable) Base: Add \$126.00 per Table.
- 3" diameter Infinity Lockable Casters: Add \$45.00 per Column Base.
- Glides in COLORA colors: Add \$189.00
- Table Cart: See page 9.



TRAINING TABLES • C BASE

Tables are 29" high.

Specify: model number - p. lam. brand and number and vinyl edge color; or veneer finish - base color - options, see opposite below

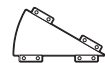
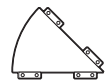
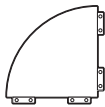
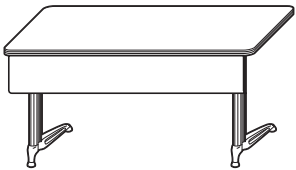
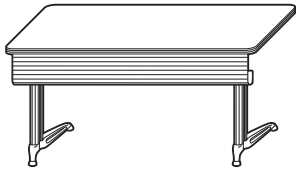
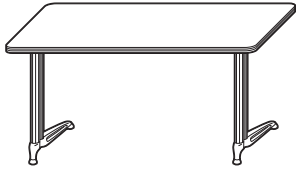

ITEM

DIMENSIONS

WITHOUT MODESTY PANEL

1791-4220	42" x 20"	
1791-4820	48" x 20"	
1791-6020	60" x 20"	
1791-7220	72" x 20"	
1791-4224	42" x 24"	C-Bases located 6" from end of table (non-folding only)
1791-4824	48" x 24"	
1791-6024	60" x 24"	
1791-7224	72" x 24"	
1791-4830	48" x 30"	
1791-6030	60" x 30"	
1791-7230	72" x 30"	

WITH J MODESTY PANEL (REMOVABLE)

Extruded aluminum modesty panel in ribbed pattern features a large wire management tray. 7 1/2" high. Removable (without tools) for folding base tables.

1792-4224	42" x 24"	
1792-4824	48" x 24"	
1792-6024	60" x 24"	C-Bases located 6" from end of table (non-folding only)
1792-7224	72" x 24"	
1792-4830	48" x 30"	
1792-6030	60" x 30"	
1792-7230	72" x 30"	

WITH FLAT FOLDING MODESTY PANEL

Utilized with Folding Base or Flip Top options - add cost. Flat aluminum modesty panel. 9" high. Folds over bases in folded position or over table underside with flip top option.

1794-6024	60" x 24"	
1794-7224	72" x 24"	
1794-6030	60" x 30"	C-Bases located 6" from end of table (non-folding only)
1794-7230	72" x 30"	

BRIDGE TOPS - Connector plates included

90-deg PIE

1780-20	20" R x 20"	
1780-24	24" R x 24"	
1780-30	30" R x 30"	

45-deg PIE

1782-20	20" R x 20"	
1782-24	24" R x 24"	
1782-30	30" R x 30"	

30-deg PIE

1783-20	20" R x 20"	
1783-24	24" R x 24"	
1783-30	30" R x 30"	

GANG SET

Each set \$80.00 factory installed.

Consists of two plates bolted to underside of adjacent tables and a linking bar and thumb screws. Gang Set connects and levels tables. Ganging 24" and 30" sides requires 1 set.

PLASTIC LAMINATE TOP



Flat Vinyl Edge

QTY1 QTY3 QTY10

VENEER TOP



Reeded Wood Edge

QTY1 QTY3 QTY10

ADD
FOLDING
BASE*

ADD
FLIP
TOP

1331	1289	1262	2225	1837	1725		
1343	1301	1274	2256	1868	1758		
1488	1436	1401	2474	2060	1946		
1643	1578	1537	2696	2252	2131		
1339	1295	1268	2266	1879	1767		517
1352	1309	1282	2298	1912	1801		517
1495	1442	1409	2527	2112	1998	428	517
1652	1587	1545	2760	2315	2194	428	517
1522	1466	1430	2520	2107	1993	0	517
1674	1605	1560	2797	2349	2225	428	517
1840	1759	1707	3097	2585	2457	428	517

1769	1640	1585	2694	2180	2082		517
1798	1668	1615	2745	2269	2132		517
1981	1839	1779	3011	2509	2367	428	517
2173	2018	1952	3281	2748	2603	428	517
1969	1827	1763	2968	2468	2326		517
2157	2002	1930	3282	2745	2594	428	517
2359	2192	2149	3617	3020	2866	428	517

2077	1967	1906	3109	2636	2495	428	517
2335	2165	2071	3443	2894	2721	428	517
2255	2129	2058	3379	2871	2721	428	517
2521	2337	2231	3779	3164	2983	428	517

430	404	387	829	731	676		
456	427	408	894	797	739		
493	459	436	946	850	791		

408	382	365	758	659	603		
434	406	386	820	723	666		
472	437	417	853	755	700		

400	372	354	713	616	558		
423	394	374	722	623	567		
458	426	404	731	633	577		

- Standard Base is Fixed Height (Removable) with black Glides.
- Adjustable Height (Removable) Base: Add \$63.00 per Table.
- 3" diameter Infinity Lockable Casters: Add \$88.00 per T Base. Recommended for all Flip Top tables.
- Glides in COLORA colors: Add \$189.00
- *• 60" long folding tables have narrow range of suitable Surface Power Units based on location(s) and quantity - please inquire
- Table Cart: See page 9.

INFINITY



TRAINING TABLES • T BASE

Tables are 29" high.

Specify: model number - p. lam. brand and number and vinyl edge color; or veneer finish - base color - options.



ITEM

DIMENSIONS

WITHOUT MODESTY PANEL

1735-4220	42" x 20"	
1735-4820	48" x 20"	
1735-6020	60" x 20"	
1735-7220	72" x 20"	
1735-4224	42" x 24"	T-Bases located 6" from end of table (non-folding only)
1735-4824	48" x 24"	
1735-6024	60" x 24"	
1735-7224	72" x 24"	
1735-4830	48" x 30"	
1735-6030	60" x 30"	
1735-7230	72" x 30"	

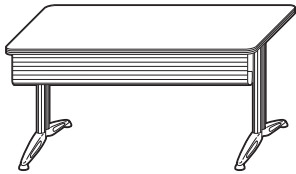

WITH J MODESTY PANEL (REMOVABLE)

1736-4220	42" x 20"	
1736-4820	48" x 20"	
1736-6020	60" x 20"	
1736-7220	72" x 20"	
1736-4224	42" x 24"	T-Bases located 6" from end of table (non-folding only)
1736-4824	48" x 24"	
1736-6024	60" x 24"	
1736-7224	72" x 24"	
1736-4830	48" x 30"	
1736-6030	60" x 30"	
1736-7230	72" x 30"	

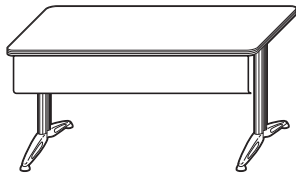

WITH FLAT FOLDING MODESTY PANEL

Utilized with Folding Base or Flip Top options - add cost. Flat aluminum modesty panel features black plastic wire manager. 9" high. Folds over bases in folded position or over table underside with flip top option.

1738-6024	60" x 24"	
1738-7224	72" x 24"	T-Bases located 6" from end of table (non-folding only)
1738-6030	60" x 30"	
1738-7230	72" x 30"	

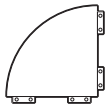

BRIDGE TOPS - Connector plates included

90-deg PIE

1780-24	24" R x 24"
1780-30	30" R x 30"
1780-36	36" R x 36"

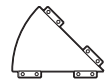

45-deg PIE

1782-24	24" R x 24"
1782-30	30" R x 30"
1782-36	36" R x 36"

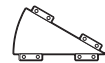

30-deg PIE

1783-24	24" R x 24"
1783-30	30" R x 30"
1783-36	36" R x 36"

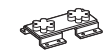

GANG SET

Each set \$87.00 factory installed.

Consists of two plates bolted to underside of adjacent tables and a linking bar and thumb screws. Gang Set connects and levels tables. Ganging 24" and 30" sides requires 1 set.

PLASTIC LAMINATE TOP



Flat Vinyl Edge

QTY1 QTY3 QTY10

veneER TOP



Reeded Wood Edge

QTY1 QTY3 QTY10

ADD
FOLDING
BASE*

ADD
FLIP
TOP

1331	1289	1262	2225	1837	1725		517
1343	1301	1274	2256	1868	1758		517
1488	1436	1401	2474	2060	1946	428	517
1643	1578	1537	2696	2252	2131	428	517
1339	1295	1268	2266	1879	1767		517
1352	1309	1282	2298	1912	1801		517
1495	1442	1409	2527	2112	1998	428	517
1652	1587	1545	2760	2315	2194	428	517
1522	1466	1430	2520	2107	1993		517
1674	1605	1560	2797	2349	2225	428	517
1840	1759	1707	3097	2585	2457	428	517

1760	1630	1577	2653	2172	2040		517
1791	1660	1607	2703	2228	2091		517
1971	1832	1771	2957	2456	2315	428	517
2163	2013	1943	3218	2685	2539	428	517
1767	1638	1583	2694	2219	2082		517
1798	1668	1615	2745	2269	2132		517
1981	1839	1779	3011	2509	2367	428	517
2173	2020	1952	3281	2748	2603	428	517
1969	1827	1763	2968	2468	2326		517
2157	2002	1930	3282	2745	2594	428	517
2359	2192	2149	3617	3020	2866	428	517

2077	1967	1906	3109	2636	2495	428	517
2335	2165	2071	3443	2894	2721	428	517
2255	2129	2058	3379	2871	2721	428	517
2521	2337	2231	3779	3164	2983	428	517

430	404	387	829	731	676		
456	427	408	894	797	739		
511	477	454	946	850	791		

408	382	365	758	659	603		
434	406	386	820	723	666		
490	455	435	853	755	700		

400	372	354	713	616	558		
423	394	374	722	623	567		
476	444	422	731	633	577		

- Standard Base is Fixed Height (Removable) with black Glides.
- Adjustable Height (Removable) Base: Add \$63.00 per Table.
- 3" diameter Infinity Lockable Casters: Add \$88.00 per T Base. Recommended for all Flip Top tables.
- Glides in COLORA colors: Add \$189.00
- *• 60" long folding tables have narrow range of suitable Surface Power Units based on location(s) and quantity - please inquire
- Table Cart: See page 9.

INFINITY



MODULAR TABLES • T BASE

Tables are 29" high.

Specify: model number - p. lam. brand and number and vinyl edge color; or veneer finish - base color - options.

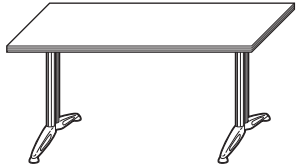

ITEM

DIMENSIONS

RECTANGLE

1762-4824	48" x 24"	
1762-6024	60" x 24"	
1762-7224	72" x 24"	
1762-9024	90" x 24"	
1762-4830	48" x 30"	
1762-6030	60" x 30"	T-Bases located 12" from end of table (non-folding only)
1762-7230	72" x 30"	
1762-9030	90" x 30"	
1762-4836	48" x 36"	
1762-6036	60" x 36"	
1762-7236	72" x 36"	
1762-9036	90" x 36"	
1762-4842	48" x 42"	
1762-6042	60" x 42"	
1762-7242	72" x 42"	
1762-9042	90" x 42"	
1762-6048	60" x 48"	
1762-7248	72" x 48"	
1762-9048	90" x 48"	

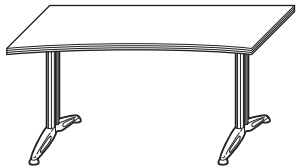

CONCAVE

1766-6030	60" x 30"	27 1/2" D	T-Bases located 12"
1766-7230	72" x 30"	26 1/2" D	from end of table
1766-7236	72" x 36"	32 1/2" D	(non-folding)

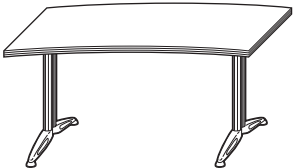

CONCAVE/CONVEX

1767-6030	60" x 32 1/2"	30" D	T-Bases located 12"
1767-7230	72" x 33 1/2"	30" D	from end of table
1767-7236	72" x 38 1/2"	36" D	(non-folding)

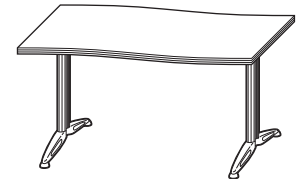

WAVE - DESCENDING

1768-6030	60" x 37"	30" D	T-Bases located 12"
1768-7230	72" x 42"	30" D	from end of table
1768-7236	72" x 48"	36" D	(non-folding)

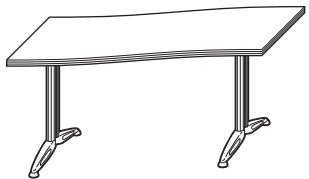

WAVE - ASCENDING

1769-6030	60" x 37"	30" D	T-Bases located 12"
1769-7230	72" x 42"	30" D	from end of table
1769-7236	72" x 48"	36" D	(non-folding)

PLASTIC LAMINATE TOP

VENEER TOP



Flat Vinyl Edge
QTY1

Reeded Wood Edge
QTY3

QTY10



QTY1

FOLDING
QTY3

FLIP
QTY10

ADD
BASE*

ADD
TOP

1352	1309	1282	2298	1912	1801		517
1495	1442	1409	2527	2112	1998	428	517
1652	1587	1545	2760	2315	2194	428	517
1891	1817	1768	3104	2609	2485	428	860
1522	1466	1430	2520	2107	1993		517
1674	1605	1560	2797	2349	2225	428	517
1840	1759	1707	3097	2585	2457	428	517
2116	2021	1958	3486	2931	2794	428	860
1604	1540	1497	2703	2258	2139		517
1799	1717	1663	3045	2534	2405	428	517
1984	1886	1823	3336	2811	2678	428	517
2302	2186	2108	3924	3335	3146	428	860
1718	1642	1590	2904	2411	2287		526
1886	1796	1735	3297	2729	2591	428	526
2603	2487	2409	4076	3901	3315	428	581
2846	2711	2622	4627	3926	3726	428	860
2616	2500	2424	3999	3403	3266	428	526
2918	2782	2690	4433	3842	3656	428	581
3700	3517	3395	5600	4787	4622	428	860

1942	1870	1824	3125	2699	2499	428	517
2069	1986	1930	3369	2885	2665	428	517
2223	2122	2054	3659	3146	2928	428	517

1968	1942	1889	3241	2807	2604	428	517
2182	2085	2018	3369	2926	2721	428	517
2328	2215	2132	3486	3035	2829	428	517

2162	2071	2008	3381	2936	2732		526
2276	2173	2105	3479	3026	2780		581
2448	2327	2246	3608	3159	2947		581

2162	2071	2008	3381	2936	2732		526
2276	2173	2105	3479	3026	2780		581
2448	2327	2246	3608	3159	2947		581

- Standard Base is Fixed Height (Removable) with black Glides.
- Adjustable Height (Removable) Base: Add \$63.00 per Table.
- 3" diameter Infinity Lockable Casters: Add \$88.00 per T Base. Recommended for all Flip Top tables.
- Glides in COLORA colors: Add \$189.00
- * 60" long folding tables have narrow range of suitable Surface Power Units based on location(s) and quantity - please inquire
- Table Cart: See page 9.



MODULAR TABLES • T BASE

Tables are 29" high.

Specify: model number - p. lam. brand and number and vinyl edge color; or veneer finish - base color - options.

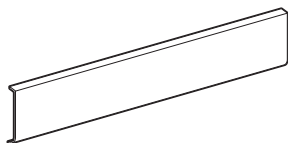
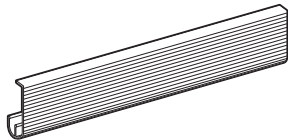
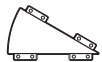
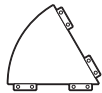
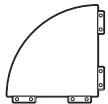
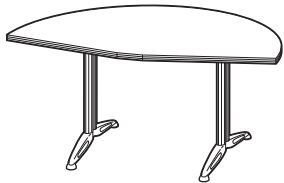
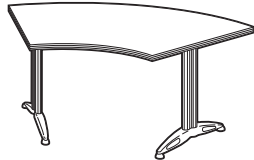
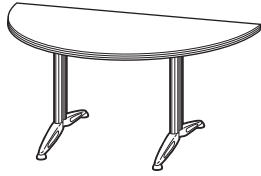

ITEM

DIMENSIONS

HALF ROUND

1763-48	48" dia x 24"
1763-60	60" dia x 30"
1763--72	72" dia x 36"

ARC

Overall Dim.

1764-60	60" x 33"	60" R 30" R
1764-90	90" x 36"	60" R 30" R

V END - Connector plates included

170-deg PIE

1765-24 (for 24" D Tables)	54" D x 30"
1765-30 (for 30" D Tables)	66" D x 36"
1765-36 (for 36" D Tables)	78" D x 42"

BRIDGE TOPS - Connector plates included

90-deg PIE

1780-24	24" R x 24"
1780-30	30" R x 30"
1780-36	36" R x 36"

60-deg PIE

1781-24	24" R x 24"
1781-30	30" R x 30"
1781-36	36" R x 36"

45-deg PIE

1782-24	24" R x 24"
1782-30	30" R x 30"
1782-36	36" R x 36"

GANG SET

Each set \$87.00 factory installed.

Consists of two plates bolted to underside of adjacent tables and a linking bar and thumb screws. Gang Set connects and levels tables. Ganging 24", 30" and 36" sides requires 1 set. Ganging 42", 48", 60", 72", 90" sides and over requires 2 sets.

J MODESTY

Extruded aluminum modesty panel in ribbed pattern features a large wire management tray. 7 1/2" high. Removable without tools. Available in COLORA colors.

- Also available with Flip Top tables
- Folding Base tables - remove modesty prior to folding bases.

	QTY1	QTY3	QTY10
48" L Tables	448	361	335
60" L Tables	486	398	371
72" L Tables	521	435	408
90" L Tables	646	543	512

FLAT FOLDING MODESTY

Flat aluminum modesty panel is 9" high, and folds over bases in folded position or over table underside with flip top option. Available in COLORA colors. Available with Flip Top and Folding Base tables.

	QTY1	QTY3	QTY10
48" L Tables	488	435	407
60" L Tables	582	524	498
72" L Tables	683	580	526

Standard Base is Fixed Height (Removable) with black Glides

PLASTIC LAMINATE TOP



Flat Vinyl Edge

QTY1 QTY3 QTY10

VENEER TOP



Reeded Wood Edge

QTY1 QTY3 QTY10

**ADD
FLIP
TOP**

1643	1576	1530	3037	2553	2339	517
2043	1937	1868	3469	2957	2722	517
2569	2417	2319	4026	3484	3222	517
2153	2048	1978	3810	3239	2996	
2488	2358	2270	4426	3787	3534	
1800	1723	1672	3126	2632	2417	517
2097	2002	1936	3618	3099	2855	517
2454	2317	2227	4088	3527	3260	662
452	423	404	894	797	739	
493	459	436	946	850	791	
555	517	490	1002	910	841	
441	410	390	857	754	709	
481	449	429	891	806	738	
543	505	475	965	855	779	
430	402	382	820	723	666	
472	437	417	853	755	700	
533	495	469	893	796	738	

- Standard Base is Fixed Height (Removable) with black Glides.
- Adjustable Height (Removable) Base: Add \$63.00 per Table.
- 3" diameter Infinity Lockable Casters: Add \$88.00 per T Base. Recommended for all Flip Top tables.
- Glides in COLORA colors: Add \$189.00
- Table Cart: See page 9.



FINISHES - TABLE TOPS

Colora

COLORA is a textured polyurethane material applied to MDF board in two steps. It is scratch-resistant and stain proof. Although highly durable, COLORA surfaces are not as hard as laminates. It is applied to table tops and edges. COLORA is available in 15 standard colors. Custom color charge is \$289.00 NET per color mix.

Wood Veneers, Wood Edges

Veneer tops and hardwood edges are flat cut species of Maple, Cherry and Walnut offered in numerous stains. Custom stain charge is \$208.00 NET for set-up and \$46.00 NET per unit. Prismatic offers all regular and premium veneers which are readily available – please inquire for pricing. Veneered surfaces are semi-open and finished in a low-medium sheen and clear catalyzed lacquer.

Glass

Light scratches, waves or tiny bubbles are inherent to glass fabrication and to be expected. Prismatic offers 1/2” or 3/4” thick glass tops which are clear or sandblasted. Also painted back glass (PBG) consisting of 1/4” starphire glass silicone adhered to 1” thick MDF subtop. Available with clear and matte glass types.

Stone

See standard marble and granite varieties. Prismatic will make available most stones specified by customer, often at no up-charge. Stone surfaces vary greatly in color, texture, pattern and quality. Marble in particular is seldom free of fine cracks or other imperfections. All stone surfaces have natural polish.

FINISHES - BASE METAL PRODUCTS

Occasional table bases and metal drums are made of high grade steel, buffed and plated or sprayed in COLORA colors.

Plated finishes include polished or satin chrome.

Metal cube tables are stainless steel sheets applied to wood cores. Metal drums are available in stainless steel for quantity orders.

Custom COLORA charge is NET \$289 per match.

TABLE TOP - EDGE CONFIGURATIONS

COLORA and Wood Veneer Tops , 3/4” Thick



3/4” SQUARE EDGE (SE)
 • COLORA Top and Edge
 • Veneer Top and Edge
Ronde, Piato and 200 Parsons Tables

Stone Tops, 3/4” Thick

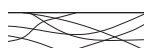

SQUARE EDGE (SE)
Ronde, 200 Parsons, 500M, 550M, 700M, 750M Drum and Cube Tables

Glass Tops, 1/2” or 3/4” Thick

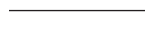

STRAIGHT EDGE (SE)
 (Slight Chamfer)
 • 1/2” or 3/4” Thick
 • Clear or Sandblast
Ronde, Piato, 200 Parsons, 500G, 550G, 700G, 750G, Drum and Cube Tables

Painted Back Glass Tops, 1 1/4” Thick

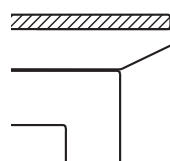

REVERSE BEVEL EDGE (RB)
 (Overhang)
Ronde, 200 Parsons, Piato, Drum and Cube Tables

PIATO TABLES • GLASS TOP

Welded steel COLORA bases with 2" column either offset (end tables) or centered (coffee and end tables) with clear (CL), tempered glass tops and 1/2" thick finished round plate bases. Optional colored glass in either painted back glass (PBG) clear or painted back glass matte (MA) in any standard COLORA color (custom color available at upcharge).

Specify: model number - base finish - glass type

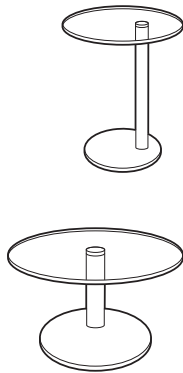

ITEM	DIMENSIONS
------	------------

160-1822	18" dia x 22" H
160-1825	18" dia x 25" H
160-2022	20" dia x 22" H
160-2025	20" dia x 25" H

160-2416	24" dia x 16" H
160-2422	24" dia x 22" H
160-2425	24" dia x 25" H
160-3016	30" dia x 16" H
160-3022	30" dia x 22" H
160-3025	30" dia x 25" H
160-3616	36" dia x 16" H
160-3622	36" dia x 22" H
160-3625	36" dia x 25" H
160-4216	42" dia x 16" H
160-4222	42" dia x 22" H
160-4225	42" dia x 25" H
160-4816	48" dia x 16" H
160-4822	48" dia x 22" H
160-4825	48" dia x 25" H

PIATO TABLES • STONE TOP

Welded steel COLORA bases with 2" column either offset (end tables) or centered (coffee and end tables) with either square edge (SQ) or reverse bevel edge (RB) stone tops. See standard options. Custom options to match customers own stone available at an upcharge.

Specify: model number - base finish - stone type

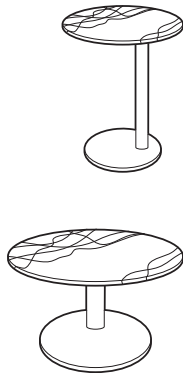

ITEM	DIMENSIONS
------	------------

160M-1822	18" dia x 22" H
160M-1825	18" dia x 25" H
160M-2022	20" dia x 22" H
160M-2025	20" dia x 25" H

160M-2416	24" dia x 16" H
160M-2422	24" dia x 22" H
160M-2425	24" dia x 25" H
160M-3016	30" dia x 16" H
160M-3022	30" dia x 22" H
160M-3025	30" dia x 25" H
160M-3616	36" dia x 16" H
160M-3622	36" dia x 22" H
160M-3625	36" dia x 25" H
160M-4216	42" dia x 16" H
160M-4222	42" dia x 22" H
160M-4225	42" dia x 25" H
160M-4816	48" dia x 16" H
160M-4822	48" dia x 22" H
160M-4825	48" dia x 25" H

1/2" CL GLASS TOP			3/4" CL GLASS TOP			CL ADD CRATE NET \$	1 1/4" PBG (CL) GLASS TOP			1 1/4" PBG (MA) GLASS TOP			PBG ADD CRATE NET \$	ADD SATIN CHROME	ADD POL CHROME
COLORA BASE QTY1 QTY3 QTY10			COLORA BASE QTY1 QTY3 QTY10				COLORA BASE QTY1 QTY3 QTY10			COLORA BASE QTY1 QTY3 QTY10					
1081	989	876	1264	1172	1059	18	1501	1305	1150	1736	1517	1353	24	134	287
1081	989	876	1264	1172	1059	18	1501	1305	1150	1736	1517	1353	24	134	287
1129	1037	924	1343	1250	1138	22	1550	1354	1199	1814	1597	1431	30	134	287
1129	1037	924	1343	1250	1138	22	1550	1354	1199	1814	1597	1431	30	134	287
1353	1260	1148	1678	1585	1473	32	1764	1569	1414	2097	1879	1713	43	134	287
1454	1360	1249	1779	1686	1574	32	1864	1669	1514	2197	1981	1814	43	134	287
1465	1372	1260	1790	1697	1585	32	1876	1680	1526	2209	1991	1826	43	134	287
1597	1503	1391	2105	2011	1899	66	2167	1971	1756	2588	2371	2133	95	155	364
1697	1603	1491	2205	2111	1999	66	2267	2072	1856	2688	2471	2235	95	155	364
1709	1615	1503	2217	2123	2011	66	2279	2083	1868	2700	2482	2245	95	155	364
							2720	2523	2309	3285	3066	2830	114	206	434
							2820	2625	2409	3386	3166	2930	114	206	434
							2832	2636	2421	3396	3178	2942	114	206	434
							3512	3317	3102	4278	4060	3823	134	221	505
							3613	3417	3202	4379	4162	3923	134	221	505
							3624	3429	3213	4391	4173	3935	134	221	505
							4509	4156	3921	5514	5116	4859	153	292	632
							4610	4256	4022	5615	5217	4961	153	292	632
							4622	4267	4033	5627	5228	4971	153	292	632

3/4" SQ GRANITE OR MARBLE TOP			3/4" RB GRANITE OR MARBLE TOP			ADD CRATE NET \$	ADD SATIN CHROME	ADD POL CHROME
COLORA BASE QTY1 QTY3 QTY10			COLORA BASE QTY1 QTY3 QTY10					
1467	1282	1134	2221	2036	1887	24	134	287
1467	1282	1134	2221	2036	1887	24	134	287
1598	1413	1263	2436	2251	2103	30	134	287
1598	1413	1263	2436	2251	2103	30	134	287
2000	1815	1667	3007	2822	2674	43	134	287
2102	1916	1767	3109	2923	2774	43	134	287
2112	1927	1779	3120	2934	2786	43	134	287
2653	2468	2318	3911	3726	3576	95	155	364
2753	2568	2420	4011	3826	3678	95	155	364
2765	2580	2431	4023	3838	3689	95	155	364
3887	3757	3609	5397	5267	5119	114	206	434
3987	3859	3709	5497	5368	5219	114	206	434
3999	3870	3721	5509	5379	5231	114	206	434
4518	4334	4183	6279	6095	5945	134	221	505
4619	4435	4284	6381	6197	6045	134	221	505
4630	4446	4296	6392	6208	6057	134	221	505
5786	5564	5341	7799	7578	7354	153	292	632
5886	5666	5442	7899	7678	7456	153	292	632
5898	5677	5453	7911	7690	7467	153	292	632

REV 05.05.15

REV 05.05.15

REV 05.05.15

OCCASIONAL

• Crating charges per top. Crating for Qty: 4+ will be quoted.

PIATO TABLES • VENEER TOP

Welded steel COLORA bases with 2" column either offset (end tables) or centered (coffee and end tables) with square edge (SQ) veneer tops. See standard options. Custom options to match customers own veneer available at an upcharge.

Specify: model number - base finish - veneer type

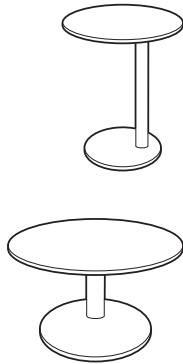

ITEM	DIMENSIONS
160W-1822	18" dia x 22" H
160W-1825	18" dia x 25" H
160W-2022	20" dia x 22" H
160W-2025	20" dia x 25" H
160W-2416	24" dia x 16" H
160W-2422	24" dia x 22" H
160W-2425	24" dia x 25" H
160W-3016	30" dia x 16" H
160W-3022	30" dia x 22" H
160W-3025	30" dia x 25" H
160W-3616	36" dia x 16" H
160W-3622	36" dia x 22" H
160W-3625	36" dia x 25" H
160W-4216	42" dia x 16" H
160W-4222	42" dia x 22" H
160W-4225	42" dia x 25" H
160W-4816	48" dia x 16" H
160W-4822	48" dia x 22" H
160W-4825	48" dia x 25" H

3/4" SQ VENEER TOP

COLORA BASE			ADD	ADD
QTY1	QTY3	QTY10	SATIN	POL
			CHROME	CHROME
1311	956	728	134	287
1311	956	728	134	287
1331	976	765	134	287
1331	976	765	134	287
2410	1746	1474	134	287
2511	1848	1575	134	287
2522	1858	1586	134	287
2737	2038	1743	155	364
2837	2139	1844	155	364
2848	2151	1855	155	364
3217	2660	2289	206	434
3317	2761	2389	206	434
3328	2772	2401	206	434
3723	3145	2748	221	505
3824	3246	2848	221	505
3836	3257	2860	221	505
4325	3687	3245	292	632
4428	3789	3345	292	632
4437	3800	3357	292	632

• QTY 1 shipments subject to extra packaging charges to be quoted.

RONDE TABLES • GLASS TOP

Welded solid barstock steel base in plated finishes and COLORA colors. 1/2" clear or sandblast glass tops.

Custom sizes available for quantity orders only.

Specify: model number - base finish - glass type

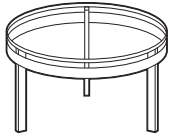

ITEM	DIMENSIONS
170-2021	20" dia x 21" H
170-2421	24" dia x 21" H
170-3016	30" dia x 16" H
170-3616	36" dia x 16" H
170-4216	42" dia x 16" H

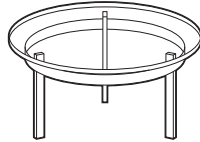

OVERHANG GLASS

170-2421-OH	24" dia x 21" H
170-3616-OH	36" dia x 16" H
170-4216-OH	42" dia x 16" H

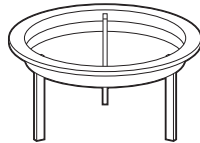

OVERHANG GLASS SANDBLAST BORDER

170-2421-SB	24" dia x 21" H (2" Border)
170-3616-SB	36" dia x 16" H (3" Border)
170-4216-SB	42" dia x 16" H (3" Border)

RONDE TABLES • STONE TOP

Welded solid barstock steel base in plated finishes and COLORA colors. Stone tops with **Square** edge.

Custom sizes available for quantity orders only.

Specify: model number - base finish - stone type

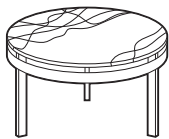

ITEM	DIMENSIONS
170M-2021	20" dia x 21" H
170M-2421	24" dia x 21" H
170M-3016	30" dia x 16" H
170M-3616	36" dia x 16" H
170M-4216	42" dia x 16" H

RONDE TABLES • COLORA and WOOD TOP

Welded solid barstock steel frame in all standard COLORA colors. COLORA or veneer tops with **Square** self edge.

Specify: model number - metal finish - Colora color or veneer top

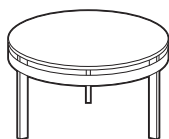

ITEM	DIMENSIONS
FLUSH TOP • SQUARE EDGE	
170W-2021	20" dia x 21" H
170W-2421	24" dia x 21" H
170W-3016	30" dia x 16" H
170W-3616	36" dia x 16" H
170W-4216	42" dia x 16" H

1/2" GLASS TOP			1/2" SANDBLAST GLASS TOP			ADD CRATE NET \$	ADD SATIN + POL CHROME
COLORA BASE QTY1	QTY3	QTY10	COLORA BASE QTY1	QTY3	QTY10		
993	946	896	1017	970	921	22	455
1116	1053	1019	1168	1121	1071	32	488
1330	1281	1232	1433	1383	1335	66	488
2030	1982	1848	2181	2134	1999	80	707
2572	2526	2388	2776	2730	2591	94	883
1047	998	952	1115	1068	1017	32	455
1507	1460	1412	1658	1610	1562	80	497
2241	2193	2059	2446	2399	2263	94	707
1215	1168	1119				32	455
1853	1804	1757				80	488
2644	2595	2463				94	707

MARBLE OR GRANITE TOP

COLORA BASE QTY1	QTY3	QTY10		
1692	1645	1599	30	455
2130	2082	2036	43	488
3003	2958	2697	95	488
4178	4104	4010	114	707
5510	5464	5322	134	883

COLORA TOP

WOOD VENEER TOP

COLORA BASE QTY1	QTY3	QTY10	COLORA BASE QTY1	QTY3	QTY10		
1097	943	855	1246	1081	960	417	455
1141	1068	895	1352	1175	1030	448	488
1374	1166	1046	1606	1412	1234	448	488
1993	1737	1533	2342	1961	1794	649	707
2394	2127	1912	2853	2607	2252	810	883

REV 05.05.15

- Crating charges per top. Crating for Qty: 4+ will be quoted.
- QTY 1 shipments subject to extra packaging charges to be quoted.

210 PARSONS TABLES • GLASS, COLORA, WOOD TOP

1" square stainless steel frame. 1/2" or 3/4" clear or sandblast glass and 3/4" COLORA or veneer tops are flush with base.

Specify: model number - base finish - glass type and thickness or Colora color or veneer type

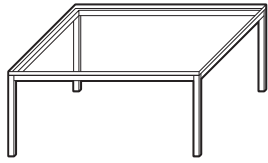

ITEM

DIMENSIONS

210-3030	30" x 30" x 16" H
210-3636	36" x 36" x 16" H
210-4242	42" x 42" x 16" H
210-4024	40" x 24" x 16" H
210-4626	46" x 26" x 16" H
210-4830	48" x 30" x 16" H
210-4848	48" x 48" x 16" H

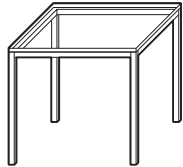

210-1822	18" x 18" x 22" H
210-2022	20" x 20" x 22" H
210-2422	24" x 24" x 22" H
210-3022	30" x 30" x 22" H

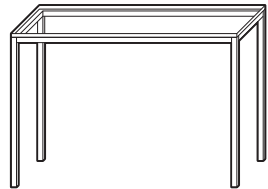

210-4215	42" x 15" x 29" H
210-4815	48" x 15" x 29" H

210 PARSONS TABLES • STONE TOP

1" square stainless steel frame. Marble or granite tops are **Square** edge and flush with base.

Specify: model number - base finish - marble or granite variety

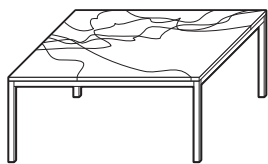

ITEM

DIMENSIONS

210M-3030	30" x 30" x 16" H
210M-3636	36" x 36" x 16" H
210M-4242	42" x 42" x 16" H
210M-4024	40" x 24" x 16" H
210M-4626	46" x 26" x 16" H
210M-4830	48" x 30" x 16" H
210M-4848	48" x 48" x 16" H

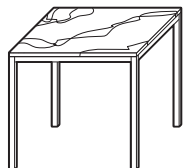

210M-1822	18" x 18" x 22" H
210M-2022	20" x 20" x 22" H
210M-2422	24" x 24" x 22" H
210M-3022	30" x 30" x 22" H

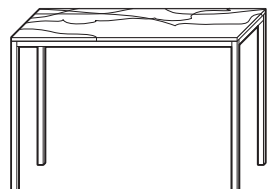

210M-4215	42" x 15" x 29" H
210M-4815	48" x 15" x 29" H

1/2" GLASS or COLORA TOP			3/4" GLASS or VENEER TOP			GLASS ADD CRATE NET \$	ADD SANDBLAST	ADD BRUSH STAIN	ADD POL STAIN
COLORA BASE			COLORA BASE						
QTY1	QTY3	QTY10	QTY1	QTY3	QTY10				
1330	1263	1197	1696	1611	1527	66	100	340	699
1505	1429	1355	2023	1923	1821	80	145	373	752
1808	1718	1627	2515	2388	2263	94	198	386	861
1367	1298	1231	1747	1661	1573	51	109	351	701
1468	1395	1322	1947	1850	1753	64	133	373	752
1716	1630	1543	2330	2214	2097	77	173	385	816
2024	1924	1822	2946	2798	2652	107	256	543	950
1127	1071	1015	1285	1221	1158	18	38	252	532
1137	1079	1024	1295	1230	1165	22	46	282	565
1215	1154	1094	1446	1374	1303	32	64	299	658
1359	1292	1223	1721	1635	1550	66	100	373	752
1374	1306	1237	1745	1658	1572	36	74	444	848
1417	1346	1275	1821	1730	1639	40	86	476	872

MARBLE or GRANITE TOP			ADD CRATE NET \$	ADD BRUSH STAIN	ADD POL STAIN
COLORA BASE					
QTY1	QTY3	QTY10			
2757	2673	2520	95	340	699
3578	3496	3344	114	373	752
4647	4564	4411	134	386	861
2884	2799	2649	73	351	701
3377	3293	3141	91	373	752
4178	4094	3944	110	385	816
5377	5282	5104	153	543	950
1571	1491	1414	24	252	532
1733	1648	1560	30	282	565
2103	2018	1866	43	299	658
2780	2694	2544	95	373	752
2363	2245	2128	48	444	848
2510	2384	2260	54	476	872

OCCASIONAL

• Crating charges per top. Crating for Qty: 4+ will be quoted.

212 DOUBLE BAR PARSONS TABLES • GLASS, COLORA, WOOD TOP

1" square stainless steel frame. 1/2" or 3/4" clear or sandblast glass and 3/4" COLORA or veneer tops are flush with base.

Specify: model number - base finish - glass type and thickness or Colora color or veneer type

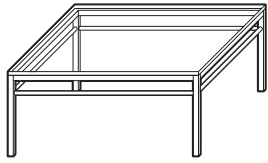

ITEM

DIMENSIONS

212-3030	30" x 30" x 16" H
212-3636	36" x 36" x 16" H
212-4242	42" x 42" x 16" H
212-4024	40" x 24" x 16" H
212-4626	46" x 26" x 16" H
212-4830	48" x 30" x 16" H
212-4848	48" x 48" x 16" H

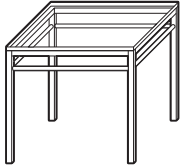

212-1822	18" x 18" x 22" H
212-2022	20" x 20" x 22" H
212-2422	24" x 24" x 22" H
212-3022	30" x 30" x 22" H

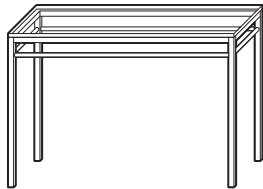

212-4215	42" x 15" x 29" H
212-4815	48" x 15" x 29" H

212 DOUBLE BAR PARSONS TABLES • STONE TOP

1" square stainless steel frame. Marble or granite tops are **Square** edge and flush with base.

Specify: model number - base finish - marble or granite variety

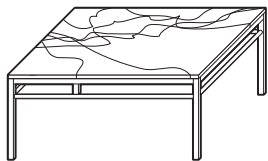

ITEM

DIMENSIONS

212M-3030	30" x 30" x 16" H
212M-3636	36" x 36" x 16" H
212M-4242	42" x 42" x 16" H
212M-4024	40" x 24" x 16" H
212M-4626	46" x 26" x 16" H
212M-4830	48" x 30" x 16" H
212M-4848	48" x 48" x 16" H

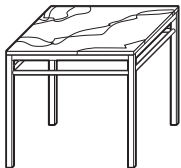

212M-1822	18" x 18" x 22" H
212M-2022	20" x 20" x 22" H
212M-2422	24" x 24" x 22" H
212M-3022	30" x 30" x 22" H

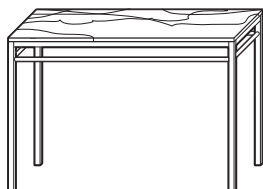

212M-4215	42" x 15" x 29" H
212M-4815	48" x 15" x 29" H

1/2" GLASS or COLORA TOP			3/4" GLASS or VENEER TOP			GLASS ADD CRATE NET \$	ADD SANDBLAST	ADD BRUSH STAIN	ADD POL STAIN
COLORA BASE QTY1	QTY3	QTY10	COLORA BASE QTY1	QTY3	QTY10				
1573	1493	1416	1939	1841	1745	66	100	520	891
1757	1669	1582	2274	2160	2046	80	145	589	983
2067	1964	1860	2772	2633	2495	94	198	638	1130
1612	1533	1451	1994	1894	1794	51	109	549	912
1719	1633	1548	2199	2088	1978	64	133	589	983
1972	1874	1776	2584	2455	2326	77	173	618	1067
2320	2204	2087	3242	3079	2917	107	256	735	1258
1355	1287	1220	1513	1438	1363	18	38	360	647
1369	1300	1232	1526	1449	1373	22	46	388	699
1450	1378	1305	1683	1599	1514	32	64	429	813
1602	1523	1442	1964	1866	1767	66	100	552	944
1619	1537	1457	1988	1889	1789	36	74	558	1031
1662	1578	1495	2067	1964	1860	40	86	602	1075

MARBLE or GRANITE TOP			ADD CRATE NET \$	ADD BRUSH STAIN	ADD POL STAIN
COLORA BASE QTY1	QTY3	QTY10			
3000	2854	2700	95	520	891
3829	3684	3484	114	589	983
4906	4761	4559	134	638	1130
3132	2984	2818	73	549	912
3629	3481	3282	91	589	983
4433	4288	4089	110	618	1067
5672	5503	5271	153	735	1258
1797	1708	1618	24	360	647
1964	1866	1767	30	388	699
2338	2221	2105	43	429	813
3023	2875	2721	95	552	944
2605	2474	2344	48	558	1031
2757	2619	2481	54	602	1075

OCCASIONAL

• Crating charges per top. Crating for Qty: 4+ will be quoted.

215 PARSONS TABLES • GLASS, COLORA, WOOD TOP

1 1/2" x 1 1/2" square stainless steel frame. 1/2" or 3/4" clear or sandblast glass and 3/4" COLORA or veneer tops are flush or optionally raised over base.

Specify: model number - base finish - glass type and thickness or Colora color or veneer type - optional raised top

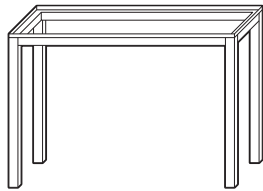
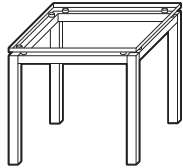
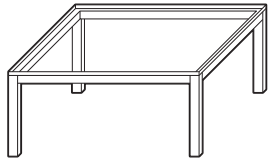

ITEM

DIMENSIONS

215-3030	30" x 30" x 16" H
215-3636	36" x 36" x 16" H
215-4242	42" x 42" x 16" H
215-4848	48" x 48" x 16" H
215-4024	40" x 24" x 16" H
215-4626	46" x 26" x 16" H
215-4830	48" x 30" x 16" H
215-5436	54" x 36" x 16" H

215-2022	20" x 20" x 22" H
215-2422	24" x 24" x 22" H
215-3022	30" x 30" x 22" H

215-4215	42" x 15" x 29" H
215-4815	48" x 15" x 29" H
215-6018	60" x 18" x 29" H
215-7220	72" x 20" x 29" H

215 PARSONS TABLES • STONE TOP

1 1/2" x 1 1/2" square stainless steel frame. Marble or granite tops are **Square** edge and flush or optionally raised over base.

Specify: model number - base finish - marble or granite variety

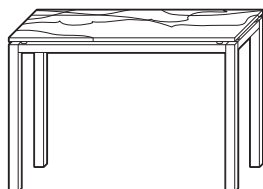
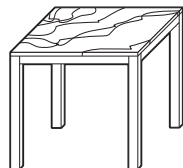
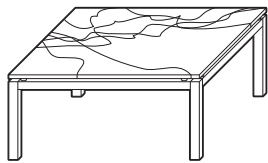

ITEM

DIMENSIONS

215M-3030	30" x 30" x 16" H
215M-3636	36" x 36" x 16" H
215M-4242	42" x 42" x 16" H
215M-4848	48" x 48" x 16" H
215M-4024	40" x 24" x 16" H
215M-4626	46" x 26" x 16" H
215M-4830	48" x 30" x 16" H
215M-5436	54" x 36" x 16" H

215M-2022	20" x 20" x 22" H
215M-2422	24" x 24" x 22" H
215M-3022	30" x 30" x 22" H

215M-4215	42" x 15" x 29" H
215M-4815	48" x 15" x 29" H
215M-6018	60" x 18" x 29" H
215M-7220	72" x 20" x 29" H

1/2" GLASS or COLORA TOP			3/4" GLASS or VENEER TOP			GLASS ADD CRATE NET \$	ADD SANDBLAST	ADD BRUSH STAIN	ADD POL STAIN	ADD RAISED TOP
COLORA BASE QTY1	QTY3	QTY10	COLORA BASE QTY1	QTY3	QTY10					
1432	1359	1288	1790	1700	1611	66	100	735	1236	225
1608	1528	1448	2127	2020	1914	80	145	783	1319	225
1923	1827	1731	2628	2496	2364	94	198	873	1383	225
2154	2046	1939	3075	2922	2768	107	256	1005	1607	338
1463	1390	1317	1846	1754	1662	51	109	763	1255	225
1572	1492	1415	2050	1947	1845	64	133	790	1324	225
1827	1735	1644	2442	2318	2197	77	173	827	1368	280
2005	1903	1804	2784	2644	2505	104	216	913	1462	280
1228	1166	1105	1383	1315	1245	22	46	645	1102	225
1310	1245	1180	1540	1464	1386	32	64	702	1203	225
1463	1390	1317	1822	1731	1640	66	100	808	1343	225
1502	1426	1352	1755	1667	1579	36	74	803	1372	225
1552	1474	1396	1839	1747	1655	40	86	822	1406	280
1725	1640	1553	2159	2052	1943	57	120	942	1550	280
1898	1803	1708	2472	2349	2225	76	161	1128	1789	280

MARBLE or GRANITE TOP			ADD CRATE NET \$	ADD BRUSH STAIN	ADD POL STAIN	ADD RAISED TOP
COLORA BASE QTY1	QTY3	QTY10				
2845	2761	2608	95	735	1236	225
3675	3592	3441	114	783	1319	225
4753	4670	4518	134	873	1383	225
5496	5411	5260	153	1005	1607	338
2976	2892	2740	73	763	1255	225
3394	3310	3158	91	790	1324	225
4280	4197	4045	110	827	1368	280
5133	5048	4897	148	913	1462	280
1815	1732	1633	30	645	1102	225
2191	2106	1972	43	702	1203	225
2905	2793	2641	95	808	1343	225
2458	2376	2226	48	803	1372	225
2657	2572	2422	54	822	1406	280
3424	3340	3187	82	942	1550	280
4188	3983	3952	109	1128	1789	280

OCCASIONAL

• Crating charges per top. Crating for Qty: 4+ will be quoted.

500 METAL DRUM TABLES

Seamless steel cylinders available in plated finishes. 1/4" protective clear glass is included.

Specify: model number - drum finish

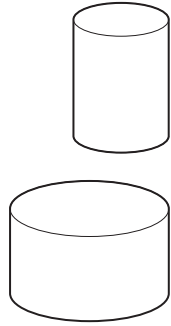

ITEM	DIMENSIONS
500-1818	18" dia x 18 1/2" H
500-1821	18" dia x 21 1/2" H
500-2215	22" dia x 15 1/2" H
500-2221	22" dia x 21 1/2" H
500-2421	24" dia x 21 1/2" H
500-3015	30" dia x 15 1/2" H

500G METAL DRUMS • GLASS TOP

Seamless steel cylinder with 3/4" clear or sandblast glass top, flush or raised over base.

Specify: model number - drum finish - glass type - if raised top, finish of steel risers

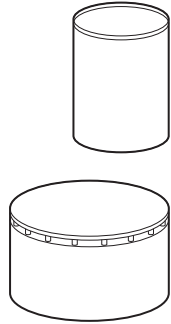

ITEM	DIMENSIONS	RAISED TOP HEIGHT
500G-1819	18" dia x 19" H	20" H
500G-1822	18" dia x 22" H	23" H
500G-2216	22" dia x 16" H	17" H
500G-2222	22" dia x 22" H	23" H
500G-2422	24" dia x 22" H	23" H
500G-3016	30" dia x 16" H	17" H

500M METAL DRUMS • STONE TOP

Stainless steel cylinder with marble or granite tops, flush or raised over base.

Specify: model number - drum finish - marble or granite variety - if raised top, finish of steel risers

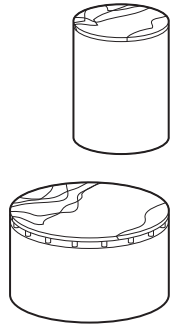

ITEM	DIMENSIONS	RAISED TOP HEIGHT
500M-1819	18" dia x 19" H	20" H
500M-1822	18" dia x 22" H	23" H
500M-2216	22" dia x 16" H	17" H
500M-2222	22" dia x 22" H	23" H
500M-2422	24" dia x 22" H	23" H
500M-3016	30" dia x 16" H	17" H

• Steel risers are in black, polished or satin chrome.

SATIN + POL CHROME
QTY1 QTY3 QTY10

1954	1857	1627
2170	2072	1839
2129	2033	1801
2482	2381	2146
2807	2705	2470
3321	3217	2969

3/4" CLEAR GLASS TOP

SATIN + POL CHROME DRUM
QTY1 QTY3 QTY10

			ADD CRATE NET \$	ADD SANDBLAST	ADD RAISED TOP
2226	2129	1899	18	33	262
2442	2341	2109	18	33	262
2522	2426	2195	32	46	315
2878	2774	2541	32	46	315
3289	3186	2952	32	58	340
4041	3935	3685	66	85	419

MARBLE or GRANITE TOP, SQ EDGE

SATIN + POL CHROME DRUM
QTY1 QTY3 QTY10

				ADD RAISED TOP
2339	2242	2012	24	564
2554	2456	2224	24	564
2730	2632	2402	43	705
3084	2982	2747	43	705
3489	3389	3154	43	832
4449	4345	4095	95	1134

OCCASIONAL

- Crating charges per top. Crating for Qty: 4+ will be quoted.
- QTY 1 shipments subject to extra packaging charges to be quoted.

550 VENEER and COLORA DRUM TABLES

Available in standard COLORA finishes or in wood veneers.

Specify: model number - Colora finish or veneer type

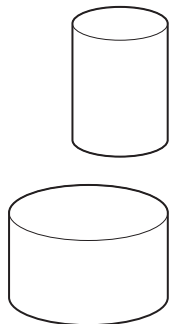

ITEM	DIMENSIONS
550-1818	18" dia x 18 1/2" H
550-1821	18" dia x 21 1/2" H
550-2215	22" dia x 15 1/2" H
550-2218	22" dia x 18 1/2" H
550-2221	22" dia x 21 1/2" H
550-2418	24" dia x 18 1/2" H
550-2421	24" dia x 21 1/2" H
550-3015	30" dia x 15 1/2" H
550-3021	30" dia x 21 1/2" H
550-3615	36" dia x 15 1/2" H

550G VENEER and COLORA DRUM TABLES • GLASS TOP

Same as 550 table except with 3/4" clear or sandblasted glass top, flush or raised over base.

Specify: model number - Colora finish, or veneer type - glass type - if raised top, finish of steel risers

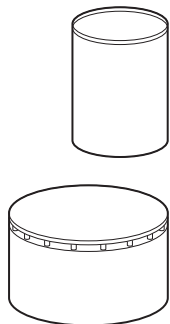

ITEM	DIMENSIONS	RAISED TOP HEIGHT
550G-1819	18" dia x 19" H	20" H
550G-1822	18" dia x 22" H	23" H
550G-2216	22" dia x 16" H	17" H
550G-2219	22" dia x 19" H	20" H
550G-2222	22" dia x 22" H	23" H
550G-2419	24" dia x 19" H	20" H
550G-2422	24" dia x 22" H	23" H
550G-3016	30" dia x 16" H	17" H
550G-3022	30" dia x 22" H	23" H
550G-3616	36" dia x 16" H	17" H

550M VENEER and COLORA DRUM TABLES • STONE TOP

Same as 550 table but with marble or granite top, flush or raised over base.

Specify: model number - Colora finish or veneer type - marble or granite variety - if raised top, finish of steel risers

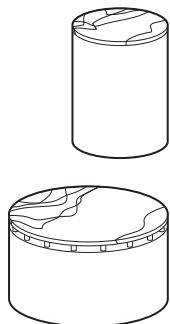

ITEM	DIMENSIONS	RAISED TOP HEIGHT
550M-1819	18" dia x 19" H	20" H
550M-1822	18" dia x 22" H	23" H
550M-2216	22" dia x 16" H	17" H
550M-2219	22" dia x 19" H	20" H
550M-2222	22" dia x 22" H	23" H
550M-2419	24" dia x 19" H	20" H
550M-2422	24" dia x 22" H	23" H
550M-3016	30" dia x 16" H	17" H
550M-3022	30" dia x 22" H	23" H
500M-3616	36" dia x 16" H	17" H

- COLORA and Veneer Drum diameters are nominal. Please call us for exact dimensions for C.O.M. glass or stone tops.
- Steel risers are in black, polished or satin chrome; Colora Drum Tables have matching steel risers unless specified otherwise.

COLORA DRUM			VENEER DRUM		
QTY1	QTY3	QTY10	QTY1	QTY3	QTY10
1118	908	762	1575	1091	947
1146	934	788	1671	1170	1027
1212	1003	857	1584	1119	982
1242	1031	888	1695	1209	1062
1273	1062	917	1712	1233	1079
1370	1070	1015	1787	1296	1148
1404	1118	1049	1899	1390	1233
1572	1285	1215	1963	1489	1337
1671	1386	1317	2188	1691	1536
1832	1572	1492	2887	2544	2294

3/4" CLEAR GLASS TOP

COLORA DRUM			VENEER DRUM			ADD CRATE NET \$	ADD SANDBLAST	ADD RAISED TOP
QTY1	QTY3	QTY10	QTY1	QTY3	QTY10			
1631	1419	1274	2086	1602	1461	18	39	280
1654	1446	1298	2181	1681	1537	18	40	280
1723	1513	1369	2099	1632	1493	32	59	338
1755	1543	1398	2205	1717	1573	32	59	338
1784	1574	1431	2216	1749	1602	32	59	338
1921	1637	1571	2339	1849	1699	32	71	364
1955	1671	1601	2453	1943	1787	32	71	364
2432	2148	2080	2827	2351	2203	66	110	449
2534	2250	2180	3051	2555	2399	66	110	449
3081	2820	2741	4138	3793	3546	80	146	517

MARBLE or GRANITE TOP, SQ EDGE

COLORA DRUM			VENEER DRUM			ADD CRATE NET \$	ADD RAISED TOP
QTY1	QTY3	QTY10	QTY1	QTY3	QTY10		
1763	1574	1443	2176	1739	1610	24	280
1785	1597	1465	2262	1809	1679	24	280
2220	2032	1901	2559	2139	2014	43	338
2250	2060	1929	2656	2176	2043	43	338
2276	2086	1955	2665	2214	2075	43	338
2579	2320	2261	2953	2512	2377	43	364
2608	2351	2289	3056	2596	2455	43	364
3514	3257	3196	3868	3440	3305	95	449
3606	3347	3287	4070	3624	3483	95	449
4188	3939	3835	5235	4900	4650	114	517

- Crating charges per top. Crating for Qty: 4+ will be quoted.
- QTY 1 shipments subject to extra packaging charges to be quoted.

OCCASIONAL

700 STAINLESS STEEL CUBE TABLES

Polished or satin stainless steel laminated on wood core with hand-filed seamed edges. 1/4" protective clear glass top is included.

Specify: model number - finish of stainless steel

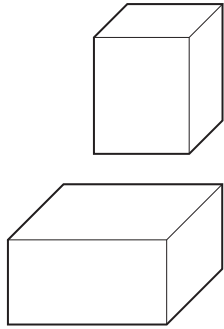

ITEM	DIMENSIONS
700-1818	18" x 18" x 18 1/2" H
700-1821	18" x 18" x 21 1/2" H
700-2215	22" x 22" x 15 1/2" H
700-2221	22" x 22" x 21 1/2" H
700-2415	24" x 24" x 15 1/2" H
700-2421	24" x 24" x 21 1/2" H
700-3015	30" x 30" x 15 1/2" H
700-3018	30" x 30" x 18 1/2" H
700-3021	30" x 30" x 21 1/2" H

700G STAINLESS STEEL CUBE TABLES • GLASS TOP

Same as 700 tables except with 3/4" clear or sandblasted glass, flush or raised over base.

Specify: model number - finish of stainless steel

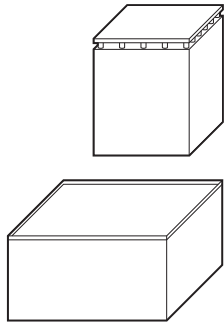

ITEM	DIMENSIONS
700G-1818	18" x 18" x 18 1/2" H
700G-1821	18" x 18" x 21 1/2" H
700G-2215	22" x 22" x 15 1/2" H
700G-2221	22" x 22" x 21 1/2" H
700G-2415	24" x 24" x 15 1/2" H
700G-2421	24" x 24" x 21 1/2" H
700G-3015	30" x 30" x 15 1/2" H
700G-3018	30" x 30" x 18 1/2" H
700G-3021	30" x 30" x 21 1/2" H

700M STAINLESS STEEL CUBE TABLES • STONE TOP

Same as the 700 tables except with marble or granite top, flush or raised over base.

Specify: model number - finish of stainless steel

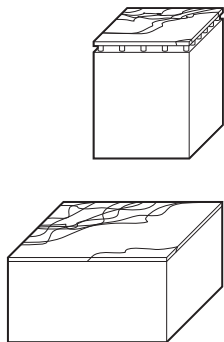

ITEM	DIMENSIONS
700M-1818	18" x 18" x 18 1/2" H
700M-1821	18" x 18" x 21 1/2" H
700M-2215	22" x 22" x 15 1/2" H
700M-2221	22" x 22" x 21 1/2" H
700M-2415	24" x 24" x 15 1/2" H
700M-2421	24" x 24" x 21 1/2" H
700M-3015	30" x 30" x 15 1/2" H
700M-3018	30" x 30" x 18 1/2" H
700M-3021	30" x 30" x 21 1/2" H

• Steel risers are in black, polished or satin chrome.

QTY1	QTY3	QTY10
1704	1603	1420
1820	1717	1533
1917	1816	1632
2190	2087	1902
2111	2010	1827
2403	2304	2120
2753	2656	2471
2934	2835	2651
3114	3013	2830

3/4" CLEAR GLASS TOP

QTY1	QTY3	QTY10	ADD CRATE NET \$	ADD SANDBLAST	ADD RAISED TOP
1901	1802	1619	18	32	315
2017	1915	1730	18	32	315
2212	2110	1925	32	46	419
2482	2382	2197	32	46	419
2462	2359	2176	32	52	419
2753	2653	2469	32	52	419
3298	3202	3018	66	85	524
3481	3381	3196	66	85	524
3661	3560	3375	66	85	524

MARBLE or GRANITE TOP, SQ EDGE

QTY1	QTY3	QTY10	ADD CRATE NET \$	ADD SANDBLAST	ADD RAISED TOP
2051	1950	1766	24		508
2166	2064	1879	24		508
2434	2334	2149	43		705
2706	2606	2420	43		705
2726	2624	2441	43		752
3018	2917	2733	43		752
3711	3614	3429	95		1031
3893	3793	3609	95		1031
4074	3973	3789	95		1031

OCCASIONAL

- Crating charges per top. Crating for Qty: 4+ will be quoted.
- QTY 1 shipments subject to extra packaging charges to be quoted.

750 VENEER and COLORA CUBE TABLES

Available in COLORA finishes or in wood veneers.

Specify: model number - Colora finish or veneer type

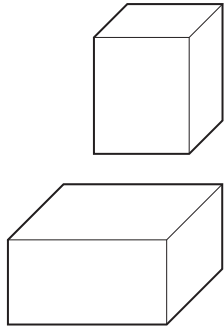

ITEM

DIMENSIONS

750-1818	18" x 18" x 18 1/2" H
750-1821	18" x 18" x 21 1/2" H
750-2215	22" x 22" x 15 1/2" H
750-2221	22" x 22" x 21 1/2" H
750-2415	24" x 24" x 15 1/2" H
750-2421	24" x 24" x 21 1/2" H
750-3015	30" x 30" x 15 1/2" H
750-3018	30" x 30" x 18 1/2" H
750-3021	30" x 30" x 21 1/2" H
750-3615	36" x 36" x 15 1/2" H

750G VENEER AND COLORA CUBE TABLES • GLASS TOP

Same as 750 tables except with 3/4" clear or sandblast glass, flush or raised over base.

Specify: model number - Colora finish or veneer type - type of glass - if raised top, finish of steel risers

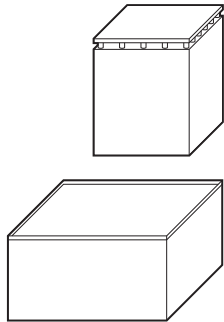

ITEM

DIMENSIONS

RAISED TOP HEIGHT

750G-1819	18" x 18" x 19" H	20"
750G-1822	18" x 18" x 22" H	23"
750G-2216	22" x 22" x 16" H	17"
750G-2222	22" x 22" x 22" H	23"
750G-2416	24" x 24" x 16" H	17"
750G-2422	24" x 24" x 22" H	23"
750G-3016	30" x 30" x 16" H	17"
750G-3019	30" x 30" x 19" H	20"
750G-3022	30" x 30" x 22" H	23"
750G-3616	36" x 36" x 16" H	17"

750M VENEER and COLORA CUBE TABLES • STONE TOP

Same as 750 tables except with marble or granite tops, flush or raised over base.

Specify: model number - Colora finish or veneer type - marble or granite variety - if raised top, finish of steel risers

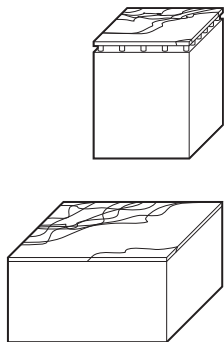

ITEM

DIMENSIONS

RAISED TOP HEIGHT

750M-1819	18" x 18" x 19" H	20"
750M-1822	18" x 18" x 22" H	23"
750M-2216	22" x 22" x 16" H	17"
750M-2222	22" x 22" x 22" H	23"
750M-2416	24" x 24" x 16" H	17"
750M-2422	24" x 24" x 22" H	23"
750M-3016	30" x 30" x 16" H	17"
750M-3019	30" x 30" x 19" H	20"
750M-3022	30" x 30" x 22" H	23"
750M-3616	36" x 36" x 16" H	17"

• Steel risers are in black, polished or satin chrome; Colora Cube Tables have matching steel risers unless specified otherwise.

COLORA CUBE

VENEER CUBE

QTY1	QTY3	QTY10	QTY1	QTY3	QTY10
848	674	557	1343	993	851
891	716	588	1425	1077	933
935	759	592	1418	1059	898
991	815	634	1569	1188	1024
1043	864	669	1501	1127	958
1115	936	729	1664	1273	1095
1269	1093	813	1660	1336	1128
1317	1141	851	1832	1395	1215
1356	1180	884	1902	1492	1305
1389	1211	936	1916	1528	1352

3/4" CLEAR GLASS TOP

COLORA CUBE			VENEER CUBE			GLASS ADD CRATE NET \$	ADD SANDBLAST	ADD RAISED TOP
QTY1	QTY3	QTY10	QTY1	QTY3	QTY10			
1124	946	832	1639	1288	1146	18	38	305
1166	989	861	1722	1372	1230	18	38	305
1269	1094	925	1782	1421	1261	32	58	408
1325	1166	968	1927	1550	1388	32	60	408
1439	1261	1068	1929	1557	1392	32	65	408
1512	1335	1128	2095	1700	1525	32	66	408
1892	1715	1436	2333	1972	1801	66	104	510
1937	1775	1470	2451	2068	1889	66	104	510
1977	1830	1523	2577	2164	1975	66	104	510
2418	2239	1965	2944	2557	2378	80	120	611

MARBLE or GRANITE TOP, SQ EDGE

COLORA CUBE			VENEER CUBE			STONE ADD CRATE NET \$	ADD RAISED TOP
QTY1	QTY3	QTY10	QTY1	QTY3	QTY10		
1478	1301	1187	1874	1550	1418	24	305
1521	1344	1216	1950	1627	1494	24	305
1876	1699	1533	2255	1923	1776	43	408
1929	1771	1575	2393	2042	1891	43	408
2160	1984	1790	2512	2166	2009	43	408
2236	2172	1851	2663	2298	2135	43	408
3021	2844	2623	3289	2955	2796	95	510
3064	2903	2601	3401	3044	2878	95	510
3108	2958	2652	3512	3133	2958	95	510
3529	3352	3079	5085	4698	4519	114	611

- Crating charges per top. Crating for Qty: 4+ will be quoted.
- QTY 1 shipments subject to extra packaging charges to be quoted.



PRISMATIQUE

95 Wingold Avenue
Toronto, Ontario, Canada M6B 1P8

Phone 416 961 7333
Toll free 888 414 7333
Fax 416 925 3295

tables@prismatique.com
www.prismatique.com