

January 3, 2011

Updated February 16, 2017

800-424-2432





Ordering C.O.M., C.O.L., and C.O.V.	BONDUEL, GREEN BAY, ONTARIO, and	
TUPELO		2
HIGH POINT		4
Shipping Location		6

Stack/Nesting	Apply® Chairs	10
	Apply® Cafe Stools	12
	Dorsal®	16
	Grazie® Chairs	24
	Grazie® Cafe Stools	38
	Maestro® Chairs	42
	Matrix®	46
	Opt4®	60
	Opt4® Cafe Stools	70
	Opt4®	74
	Perry®	78
	Piretti Stack Chairs	84
	Rapture® Chairs	92
	Rapture® Cafe Stools	100
	Silhouette®	104
	Silhouette® Cafe Stools	108
	Strive® Chairs	114
	Strive® Cafe Stools	144
	Strive® High Density Stack Chair	150
	Strive® Nesting Chairs	156
	Torsion® on the Go!® Nesting Chairs	166
	Torsion®	172
	Torsion Air®	186
	Torsion Air® Nesting Chairs	194
	Versa® Basic	200
	Versa® Conference	204
	Versa® Standard	214
	Versa® Standard Cafe Stools	228
	Versa® XL	232
	Xylon®	238

Guest Chairs	AerDyn®	242
	Bantam™	246

Index		248
--------------	--	-----

Ordering C.O.M., C.O.L., and C.O.V.

BONDUEL, GREEN BAY, ONTARIO, and TUPELO

How to Specify C.O.M. Upholstery

Textile designs often have intricate patterns. Not all individuals will interpret fabric direction in the same manner.

As a standard procedure, KI cuts fabrics off the roll in a horizontal fashion as shown in Diagram A at the right. By cutting in this fashion, most waste is eliminated. Our requirements for yardage in this book are based on this type of cutting. When directional or patterned fabrics are used, they often require more yardage than solid colors.

By providing KI with a completely filled-out copy of the form on this page, we will be able to expedite your order. We find it particularly helpful with directional or patterned upholstery material. It is critical that copies of this form accompany test quantities as well as production quantities of C.O.M.

C.O.M. must be supplied in continuous yardage.

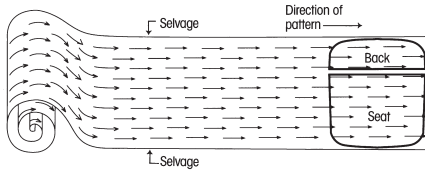

C.O.M., C.O.L. and C.O.V. Testing

KI will require for testing actual yardage to upholster one chair. The testing requirements depend on which chair you have selected on your order.

Test samples will be applied to the order and will be held for 6 months if needed. After 6 months, the sample can no longer be applied to your order. For all products to be tested, send test samples for approval to:

KI
Attn: C.O.M. Specialist
1687 Westminster Drive, Gate 3
Green Bay WI 54302

To expedite the procedure, attach a copy of the "C.O.M. Information Form" on this page.

All C.O.M., C.O.L. and C.O.V. must be labeled with the purchase order number.

C.O.M., C.O.L. and C.O.V. Production

Customer's fabrics and leathers must be approved prior to acceptance for production. Upon test approval, a 1" square sample swatch of upholstery material must accompany the order. KI assumes no responsibility for wear, defects or performance of customer's own fabrics, vinyl or leather. C.O.M., C.O.L. and C.O.V. orders are available on a deferred delivery basis.

Orders for production of C.O.M., C.O.L. and C.O.V. upholstered products are not scheduled for processing until upholstery material is received. Upon receipt, KI will provide an acknowledgement and an estimated shipping date.

KI recommends that leather be ordered in yardage. Leather must be usable. The outer edges cannot be calculated as square feet or yardage.

The C.O.M., C.O.L. and C.O.V. yardage requirements accompanying products in the pricing section are for 10 chairs/seats or less, 54" wide nondirectional material. On larger orders, less material is required.

For exact production yardage requirements, call 1-800-424-2432, ext. 2707.

C.O.M., C.O.L. and C.O.V. Order Processing

For products shipped from Green Bay, WI facility, ship upholstery material to:

KI
Attn: C.O.M. Storage
1687 Westminster Drive, Gate 3
Green Bay, WI 54302

For products shipped from Tupelo, MS facility ship material to:

KI Tupelo
Attn: C.O.M. Storage
2112 South Green Street
Tupelo, MS 38801

For products shipped from Bonduel, WI facility, ship material to:

KI
Attn: C.O.M. Storage
204 West South Street
Bonduel, WI 54107

For products shipped from Ontario, CA facility, ship material to:

Avail/Impress/Kismet/Medical & Laboratory Stools/Pilot
Attn: C.O.M. Storage
1110 S. Mildred Ave.
Ontario, CA 91761

Intricate Patterns

In the event of specific requirements for positioning of intricate patterns or pattern repeats on seats and backrests, provide a sketch noting requirements, as in Diagram B, along with materials for testing, and with the order.

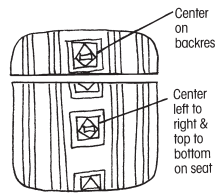

Diagram B

Treated Materials

If C.O.M. requires processing such as Scotchgard® or acrylic backing, it often shrinks. To prevent delays in delivery or back ordering due to shrinkage, please have your processor remeasure after processing and assure adequate yardage shipment.

Split Orders

If a portion of the shipment which does not require C.O.M., C.O.L. or C.O.V. applications is to be processed and shipped early, KI will enter the order immediately at your request. These split shipments are subject to minimum order changes.

Contact the C.O.M. Specialist at 1-800-424-2432, ext. 2707, with questions or to verify a split order.

Excess Upholstery Material

KI will dispose of excess upholstery material at the time of shipment unless expressly requested to return it with the product shipment.

Cancelled or Changed Orders

KI assumes no responsibility for extra C.O.M., C.O.L. or C.O.V. material due to a change of upholstery or cancellation of an order. It is the customer's responsibility to arrange for return of this material.

C.O.M., C.O.L. and C.O.V. Information Form

A copy of this form should accompany test requests and production orders. Please fill it out completely, and, if your order has been acknowledged, provide the acknowledgement number.

Purchasing Agent (Dealer or buying organization) _____
 Attention _____
 Address _____
 City _____ State _____ Zip _____
 Project Name _____
 Type of seating and number of units of each type _____

Please see information below and check the appropriate box.

Submitted for testing.

Test approved. Submitted for production.

Purchase Order Number _____

KI Acknowledgement Number _____

In all instances, send this form to the C.O.M. Specialist.

A Selvage Top and Bottom



B Selvage Side and Side





Ordering C.O.M., C.O.L., and C.O.V.
BONDUEL, GREEN BAY, ONTARIO, and TUPELO



Ordering C.O.M., C.O.L., and C.O.V.

HIGH POINT

Customer's Own Material ■

Specifications Form

January 2017

All fabrics, including COM, COL, KOM and in grades will be applied at the factory's discretion. If a pattern or stripe is to be applied in a certain direction, the customer MUST specify this in writing on the P.O. and attach a sample of the fabric with it running in the application direction to the P.O. Specifying fabric direction may increase the amount of COM or KOM yardage required. Check with KI Customer Service to see if an increase in yardage is necessary BEFORE specifying, ordering and sending COM and COL to the factory or having KOM quoted.

ALL C.O.M AND C.O.L SHIPMENTS
MUST BE PREPAID TO: KI
217 Feld Avenue
High Point, NC 27263

COM and COL must be identified as follows:

1. Name and address
2. Your purchase order number
3. Our style number to which fabric is to be applied
4. Supplier name and fabric name, number, and color

COLLECT SHIPMENTS WILL BE REFUSED.

SHIPMENT SCHEDULE WILL BE GIVEN WHEN ALL FABRIC IS RECEIVED FOR ENTIRE ORDER

YARDAGE REQUIREMENTS LISTED IN PRICE LIST ARE BASED ON PLAIN GOODS 54" WIDE. Fabrics less than 54" wide, or those requiring matching (stripes, plaids, prints, large patterns) will require additional yardage based on the fabric used and the item ordered. CONSULT MATRIX BELOW FOR ADDITIONAL YARDAGE NEEDED.

C.O.M. INCREASE MATRIX (The yardage matrix is also applicable to any reservations of KI Ingrade, Pallas, or KOM upholsteries).

This table is a general guide.

FABRIC WIDTH	PLAIN FABRIC	UNDER 7" REPEAT	8"-13" REPEAT	14"-21" REPEAT	22"-27" REPEAT	28"-33" REPEAT	34"-40" REPEAT	41"-48" REPEAT
54"	0	20%	25%	30%	45%	55%	70%	80%
51"-53"	15%	25%	30%	35%	50%	60%	80%	90%
48"-50"	20%	30%	35%	40%	55%	65%	85%	95%
45"-47"	30%	45%	50%	55%	60%	80%	90%	100%
36"-44"	50%	65%	70%	75%	80%	100%	110%	120%

FABRIC WITH DOUBLE REPEAT: IF USING A FABRIC WITH A DOUBLE REPEAT, PLEASE FOLLOW THIS FORMULA: TAKE THE TOTAL AMOUNT OF THE LARGER AND HALF OF THE SMALLER REPEAT; ADD TOGETHER TO FIND THE CORRECT OVERALL REPEAT. EXAMPLE: 10" VERTICAL WITH 14" HORIZONTAL WOULD BE $14+5=19$.

IF FABRIC COMES IN ON MULTIPLE ROLLS, ONE ADDITIONAL YARD PER ROLL NEEDS TO BE ADDED TO THE YARDAGE REQUIREMENT.

SPECIAL NOTE: WE CAN ASSUME NO RESPONSIBILITY FOR THE DURABILITY OR TAILORING QUALITY OF CUSTOMER FURNISHED COVERINGS (C.O.M.) OR KOM. KOM: is fabric that KI will purchase for you at jobber's price (net) plus a nominal charge for handling, shipping, and managing.



Customer's Own Material ■

Specifications Form

January 2017

ADDITIONAL NOTES:

- Orders cannot go into production without the information listed at right.
- Attach memo sample to this approval sheet.
- If your order has been placed, list PO# _____
- The cost of the COM sample will be paid by the client.
- Even after preliminary approval, KI reserves the right to reject COM/COL if necessary when the quality is not satisfactory for the product to be upholstered. KI assumes no responsibility for its overall appearance, flammability, durability, color fastness or any other quality after upholstered on a KI product.

ALL COM MUST BE APPROVED.

Photocopy this form and submit with COM fabric for approval:

(This fabric approval is for the purpose of advising how to apply your COM fabric, verify yardage required, and suitability.)

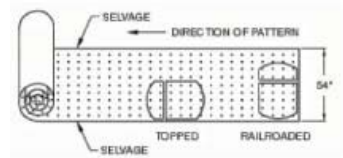

YOUR COMPANY NAME _____

PHONE _____ FAX _____

Material Supplier _____

Material Name _____ Number _____

Material Color _____ Width _____

Vertical Repeat _____ Horizontal Repeat _____

Fiber Content _____

Direction Stripe/Pattern to be applied _____

COM TO BE USED ON THE FOLLOWING:

QTY	PRODUCT NAME/NUMBER
_____	_____
_____	_____
_____	_____
_____	_____
_____	_____



Ordering C.O.M., C.O.L., and C.O.V.

Shipping Location

C.O.M. SHIPPING LOCATION

Architectural Walls

Genius Walls MN

Casegoods

Dante Benches AG
Darwin Tackboards MN
Aristotle Tackboards MN

Classroom Furniture

360° Classroom Furniture BW
Dorsal 1090 Chairs GB
Intellect Wave Chairs GB
Learn2 GB

Desking

700 Series Desking KP
Balance Overheads MN
Genesis Desking MN
True Desking KP
Universal Overheads MN
WorkZone Desking MN

Files & Storage

700 Series Pedestal Cushion GB
Connection Zone Pads BW
U-Series Pedestal Cushion GB

Fixed Seating

Concerto Auditorium Seating BW
Single Pedestal Seating GB
Jury Base Seating GB
Hi5 GB
Lancaster Auditorium Seating BW
Sequence Seating GB
University Seating GB

Panel Systems

All Terrain KP
Balance Overheads MN

System 3000 MN
Universal Overheads MN
Wireworks MN
Unite MN

Residence Hall Furniture

RoomScape Furniture MN

Screens

All Terrain KP
Connection Zone BW
True/Volition KP
Genesis KP

Seating

100 Series Folding Chairs BW
300 Series Folding Chairs BW
600 Series Stools BW
700 Series Folding Chairs BW
1000 Series GB
1100 Series Folding Chairs BW
Aerdyn Guest Seating HN
Affina Collection HN
Arissa Lounge HN
Altus Task Chairs TM
Apply Stack Chairs GB
Auditorium Folding Chairs BW
Avail Task Chairs OM
Bantam Guest Seating HN
Boss Design Chairs HN
Cinturon Lounge & Professional Seating HN
Cody Lounge Seating HN
Connection Zone Privacy Booths HN
Doni Collection GB
Dorsal Stack & Tandem Seating GB
Engage Task Chairs & Stools GB
Front Row Seats (Silk Screening) BW
GateOne Public Seating BW
Grazie Seating GB

Hub Modular Lounge Seating HN
Impress Task Chairs OM
Impress Ultra Task Chairs OM
Jessa Lounge Seating HN
Jubi Guest Chair GB
Kismet Task/Guest Chairs & Stools OM
Kurv Benches HN
LaResta Day Beds HN
Lyra Lounge Seating HN
Maestro Stack Chairs GB
Matrix Stack Chairs GB
Medical & Laboratory Stools OM
Mesa Lounge & Task Seating HN
MyWay Seating HN
Neena Benches HN
Opt4 GB
Perry Stack Chairs GB
Perth Multiple & Healthcare Seating HN
Perth II Healthcare Seating HN
Pilot Task Chairs OM
Piretti Stack Chairs GB
Promenade Seating System BW
Rapture Stack Chairs & Stools GB
Ruckus GB
Rose Healthcare BW
Sela Lounge Seating HN
Sift Task Chairs TM
Silhouette Stack Chairs & Stools BW
Soltice Metal Collection HN
Soltice Multiple, Healthcare & Guest HN
Soltice II Healthcare Seating HN
Strive Multiple, Stack & Task GB
Sway BW
Tea Cup Lounge Seating HN
Torsion-on-the-Go! Nesting Chairs GB
Torsion Air Stack and Task Seating GB
Torsion Stack and Task Seating GB
Versa Stack Chairs & Stools GB



KI Manufacturing Sites - Customer's Own Material Shipment Manufacturing Site Addresses

AG

Contact KI at
1-800-424-2432

GB

KI Green Bay
Attn: COM Storage
1687 Westminster Drive - Gate 3
Green Bay, WI 54302

KP

KI Pembroke
Attn: COM Storage
1000 Olympic Dr.
Pembroke, Ontario K8A6X7

MN

KI Manitowoc
Attn: COM Storage
1400 S. 41st St.
Manitowoc, WI 54220

BW

KI Bonduel
Attn: COM Storage
204 West South St.
Bonduel, WI 54107

HN

KI-HN
Attn: COM Storage
217 Feld Avenue
High Point, NC 27263

OM

KI
Attn: COM Storage
1110 S. Mildred Ave.
Ontario, CA 91761

TM

KI Tupelo
2112 South Green St.
Tupelo, MS 38804



Ordering C.O.M., C.O.L., and C.O.V.
Shipping Location

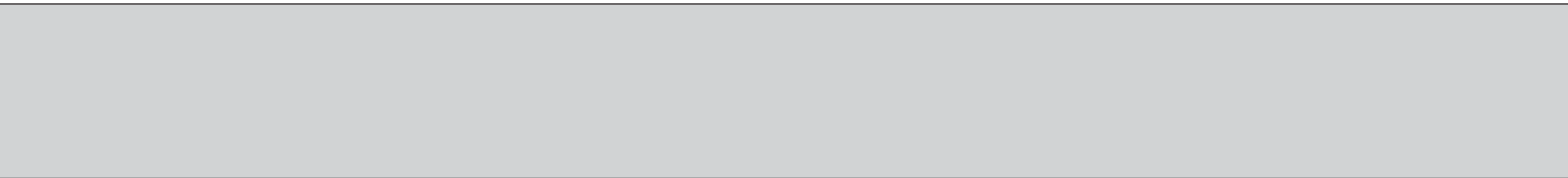

Stack/Nesting

Apply™ General Information



**Four-Leg Chair
(ALNAU)**



**Sled Base Chair
(ASNAU)**



**High Back Cafe Stool
24" or 30" Seat Height
(ALHSP)**



**Low Back Cafe Stool
24" or 30" Seat Height
(ALLSP)**

**Transport Dolly
(ACD.BL)**

Features					
Stackable	•	•			
Molded plywood, optional upholstered seat pad	•	•	•	•	
300 lb tested	•	•	•	•	
General Dimensions					
Seat width	17-1/2"	17-1/2"	17-1/2"	17-1/2"	
Seat depth	17-3/8"	17-3/8"	17-3/8"	17-3/8"	
Seat height (upholstered add 1/2")	17-1/2"	17-1/2"	24" Model: 23-3/4" 30" Model: 29-3/4"	24" Model: 23-3/4" 30" Model: 29-3/4"	
Overall Dimensions					
Width	20-1/4"	20"	24" Model: 17-3/4" 30" Model: 18-3/4"	24" Model: 17-3/4" 30" Model: 18-3/4"	21-1/4"
Depth	25 1/4"	24 3/4"	24" Model: 22-1/2" 30" Model: 23-3/4"	24" Model: 22-1/2" 30" Model: 23-3/4"	29"
Height	32-1/2"	32-1/2"	24" Model: 38-3/8" 30" Model: 44-3/8"	24" Model: 30" 30" Model: 36"	15-1/2"
Stacking on Dolly					
Width	20-1/4"	20-1/4"			
Depth	43"	43"			
Quantity/height (plywood)	15 Chairs/63-1/4" High	15 Chairs/63-1/4" High			
Quantity/height (upholstered)	6 Chairs/48" High	6 Chairs/48" High			
Stacking on Floor					
Width	20-1/4"	20"			
Depth	32-1/2"	32"			
Quantity/height (plywood)	6 Chairs/43" High	6 Chairs/43" High			
Quantity/height (upholstered)	6 Chairs/45-1/2" High	6 Chairs/45-1/2" High			

SPECIFICATIONS

Shell

One-piece contoured wood shell is constructed of formed plywood, .460"- .480" thick, 7-ply maple and poplar construction. The mold-formed seat and back provide for comfort and strength. Top/bottom and front/back surfaces are vertical grade postforming, product type 335, high-pressure laminate thickness of .028". Standard finish is #38 or #60 with a sanded, waxed edge. The wood shell is supported by four plywood circular disks and 1/4"-20 t-nuts bonded with construction-grade adhesive and fastened to a variety of base structures with four 1/4"-20x1/2" thread-locking screws. The chair perimeter is designed such that it provides a feature to support backpacks or courier bags. Shells are available in wood grain laminates or solid laminates.

Upholstered Seat

As an option, shells may be equipped with an upholstered seat pad. Urethane foam is

attached to a formed plywood upholstery liner, then upholstered using a drawstring process. The foam is a nominal 1/2" thickness. The pad assembly is attached to the shell using 10-24 screws, engaging T-nuts in the liner.

Frame

Legs are formed from 3/4" OD x 13-gauge tubular steel. The seat plate is formed from 12-gauge steel and reinforced with 7/16" diameter wire crossmembers. All joints are welded. The frames are finished in either baked-on electrostatically-applied 30 degree gloss epoxy powder coating, or bright nickel-chrome plating. An injection-molded polypropylene shroud finishes the underside of the assembly, and provides a contoured surface for stacking. Sled base or 4-leg chairs stack 6-high on the floor.

Cafe Stool

Available in nominal 24" and 30" seat heights and are not stackable. Legs are formed from 3/4" OD x 13-gauge tubular steel. The seat

plate is formed from 12-gauge steel and reinforced with 7/16" diameter wire crossmembers. All joints are welded. The frames are finished in either baked-on electrostatically-applied 30 degree gloss epoxy powder coating or bright nickel-chrome plating. An injection-molded polypropylene shroud finishes the underside of the assembly. Stool frames have an added footing made of 1/2" diameter steel wire.

Glides

4-leg chairs and stools have the option of a swivel glides with a stainless steel contact surface or a nylon glide. Standard sled chairs have no glides, but optional glides may be ordered. The optional glides are attached to the sled tube using screws and are available in black nylon, natural nylon, non-skid, or capped in stainless steel.

Stacking Vinyl, Polyurethane, and Imitation Leather Upholstered Chairs

It is recommended that chairs to be stacked be covered in material other than vinyl,

polyurethane, or imitation leather as an impression in the seat may result. KI does not warrant the effects of stacking on stock or C.O.M. vinyl, polyurethane, or imitation leather upholstery.

INFORMATION

C.O.M. Testing and Production Requirements

Not all materials are suitable for upholstering this product. A 1 yd. x 54" sample must be submitted and approved prior to acceptance of an order. Upholstered only and cushioned/upholstered chairs must be tested separately. If the fabric is directional in pattern or weave, the direction must be indicated on the submitted sample, and additional yardage may be requested. Customer's own vinyl cannot be used on this product.

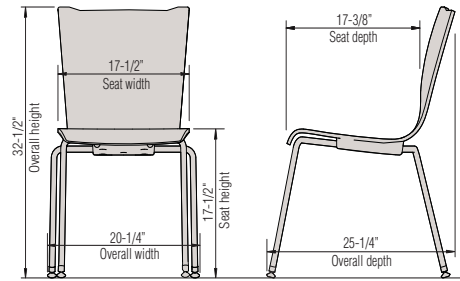

Apply Four-Leg Chair

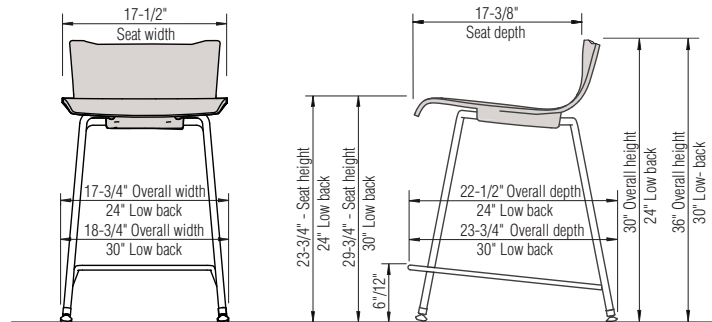

Apply 24"/30" Low Back Cafe Stool

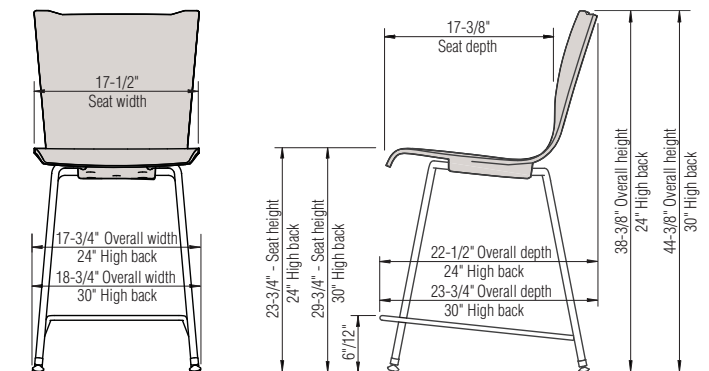

Apply 24"/30" High Back Cafe Stool

Test samples must be sent to:

KI
Attn: C.O.M. Specialist
1687 Westminster Drive - Gate 3
Green Bay, WI 54302

Fabric Disclaimer

Fabric will be applied as swatched by the fabric manufacturer. Fabric that is required to be applied differently than is swatched will need a Special Cost Request written specifying the direction the fabric is to be applied. The posted standard lead time will apply to the Special Cost Request.

INFORMATION

Warranty

Refer to KI Terms & Conditions document or visit ki.com

Stack/Nesting

Apply™ Chairs

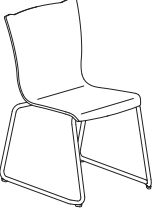
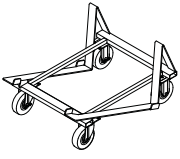
			MODEL NUMBER						
MODEL	Features	Basic Model	Frame Color	Shell Color	Fire Code	Upholstery Color	Glide (4-Leg)	Glide (Sled Base)	
 <p>Four-Leg Armless Chair</p> <ul style="list-style-type: none"> • Wood laminate shell • Woodgrain and solid laminate options • Tested to 300 pounds and BIFMA standards 	Laminate Shell	ALNAP	<input type="checkbox"/> <input type="checkbox"/>	<input type="checkbox"/> <input type="checkbox"/>			<input type="checkbox"/>		
	Upholstered Seat Pad	ALNAU	<input type="checkbox"/> <input type="checkbox"/>	<input type="checkbox"/> <input type="checkbox"/>	<input type="checkbox"/> <input type="checkbox"/> <input type="checkbox"/> <input type="checkbox"/>	<input type="checkbox"/> <input type="checkbox"/> <input type="checkbox"/> <input type="checkbox"/> <input type="checkbox"/> <input type="checkbox"/>	<input type="checkbox"/>		
ALP ALU									
 <p>Sled Base Armless Chair</p> <ul style="list-style-type: none"> • Wood laminate shell • Woodgrain and solid laminate options • Tested to 300 pounds and BIFMA standards 	Laminate Shell	ASNAP	<input type="checkbox"/> <input type="checkbox"/>	<input type="checkbox"/> <input type="checkbox"/>				<input type="checkbox"/> <input type="checkbox"/>	
	Upholstered Seat Pad	ASNAU	<input type="checkbox"/> <input type="checkbox"/>	<input type="checkbox"/> <input type="checkbox"/>	<input type="checkbox"/> <input type="checkbox"/> <input type="checkbox"/> <input type="checkbox"/>	<input type="checkbox"/> <input type="checkbox"/> <input type="checkbox"/> <input type="checkbox"/> <input type="checkbox"/> <input type="checkbox"/>		<input type="checkbox"/> <input type="checkbox"/>	
								<input type="checkbox"/> <input type="checkbox"/>	
								<input type="checkbox"/> <input type="checkbox"/>	
ASP ASU									
 <p>Transport Dolly for Fixed Cushion Chairs</p> <ul style="list-style-type: none"> • Easy maneuverability with 5" casters; two fixed, two swivel • Black powder-coated finish • For use with fixed cushion chairs 		ACD.BL							
HRDPT									

A **B** **C** **D** **E** **F** **G**

HOW TO ORDER

Indicate the following information on order form:

1. Quantity of each item.
2. Model number, including options. See "How To Build a Model Number".
3. Any special service required.

Note: • The indicates that a choice is required.

- The absence of the indicates that no choice is required.
- Alpha-numeric characters in place of indicate that no other alternatives are available.

HOW TO BUILD A MODEL NUMBER

- A** Select basic model.
- B** Select frame color.
Refer to color addendum at ki.com or KI Fabrics & Finishes binder.
- C** Select laminate shell color.
Refer to color addendum at ki.com or KI Fabrics & Finishes binder.
- D** Select fire code.
NFR - Compliance to TB 117-2013
FR - Compliance to TB 133

See Upholstery Information for TB133 upcharge.
- E** Select upholstery grade/color.
Refer to color addendum at ki.com or KI Fabrics & Finishes binder.
- F** Select 4-leg base glide option.
N - Nylon glides

- S** - Steel glides
- G** Select sled base glide option.
GNG - No glides
GNM - Non-marring glides
GNS - Non-skid glides; add \$26
GBL - Plastic glides
GSS - Stainless steel glide; add \$26



Stack/Nesting

Apply™ Chairs

Approx. Packaged Weight	Delivered Pricing Upholstered	Delivered Pricing Fabric Grade 1 & C.O.M.	Delivered Pricing Fabric Grade 2	Delivered Pricing Fabric Grade 3	Delivered Pricing C.O.V.	Delivered Pricing Vinyl Group 2V	Delivered Pricing Pallas Fabric Group P0	Delivered Pricing Pallas Fabric Group P1	Delivered Pricing Pallas Fabric Group P2	Delivered Pricing Pallas Fabric Group P3	Delivered Pricing Pallas Fabric Group P4
20.0#	\$ 355										
20.0#	N/A	483	487	502	483	502	504	520	570	589	616
20.0#	\$ 366										
20.0#	N/A	493	497	512	493	512	515	530	580	599	627
0.0#	\$ 408										

OPTIONS

California TB133 Fire Safety Code
 For California Technical Bulletin 133 compliant models, add the following upcharge:
 Model=Upholstered Seat
 Added List Price=\$42

SPECIAL SERVICES



Special Carton Marking
 With specially marked information N/C

Shipping
 Shipped assembled f.o.b. Green Bay, Wisconsin 54302 factory. Freight class #125.

Specifications and prices are subject to change without prior notice.

Stack/Nesting

Apply® Cafe Stools

			MODEL NUMBER						
MODEL	Features	Basic Model	Seat Height	Frame Color	Shell Color	Fire Code	Upholstery Color	Glide	
 <p>24" Shown</p>	Four-Leg High Back Armless Cafe Stool • Wood laminate shell • Woodgrain and solid laminate options • Two seat heights (24" & 30") • Tested to 300 pounds and BIFMA standards	Laminate Shell	ALHSNAP	<input type="checkbox"/>	<input type="checkbox"/>	<input type="checkbox"/>		<input type="checkbox"/>	
	Upholstered Seat Pad	ALHSNAU	<input type="checkbox"/>	<input type="checkbox"/>	<input type="checkbox"/>	<input type="checkbox"/>	<input type="checkbox"/>	<input type="checkbox"/>	
ALHSP									
ALHSU									
 <p>24" Shown</p>	Four-Leg Low Back Armless Cafe Stool • Wood laminate shell • Woodgrain and solid laminate options • Two seat heights (24" & 30") • Tested to 300 pounds and BIFMA standards	Laminate Shell	ALLSNAP	<input type="checkbox"/>	<input type="checkbox"/>	<input type="checkbox"/>		<input type="checkbox"/>	
	Upholstered Seat Pad	ALLSNAU	<input type="checkbox"/>	<input type="checkbox"/>	<input type="checkbox"/>	<input type="checkbox"/>	<input type="checkbox"/>	<input type="checkbox"/>	
ALLSP									
ALLSU									
			A	B	C	D	E	F	
								G	

HOW TO ORDER

Indicate the following information on order form:

- Quantity of each item.
- Model number, including options. See "How To Build a Model Number".
- Any special service required.

Note: • The indicates that a choice is required.

- The absence of the indicates that no choice is required.
- Alpha-numeric characters in place of indicate that no other alternatives are available.

HOW TO BUILD A MODEL NUMBER

Fabrics & Finishes binder.

- A** Select basic model.
- B** Select seat height.

24	- 24" Seat Height
30	- 30" Seat Height
- C** Select frame color.
Refer to color addendum at ki.com or KI Fabrics & Finishes binder.
- D** Select laminate shell color.
Refer to color addendum at ki.com or KI Fabrics & Finishes binder.
- E** Select fire code.

NFR	- Compliance to TB 117-2013
FR	- Compliance to TB 133

See Upholstery Information for TB133 upcharge.

- F** Select upholstery grade/color.
Refer to color addendum at ki.com or KI

- G** Select glide option.

N	- Nylon glides
S	- Steel glides



Approx. Packaged Weight	Delivered Pricing Unupholstered	Delivered Pricing Fabric Grade 1 & C.O.M.	Delivered Pricing Fabric Grade 2	Delivered Pricing Fabric Grade 3	Delivered Pricing C.O.V.	Delivered Pricing Vinyl Group 2V	Delivered Pricing Pallas Fabric Group P0	Delivered Pricing Pallas Fabric Group P1	Delivered Pricing Pallas Fabric Group P2	Delivered Pricing Pallas Fabric Group P3	Delivered Pricing Pallas Fabric Group P4
32.0#	\$ 528										
32.0#	N/A	658	663	683	658	683	698	714	745	764	790
31.0#	\$ 518										
31.0#	N/A	647	652	673	647	673	687	703	734	753	780

OPTIONS

California TB133 Fire Safety Code
 For California Technical Bulletin 133 compliant models, add the following upcharge:
 Model=Upholstered Seat
 Added List Price=\$42

SPECIAL SERVICES

Special Carton Marking
 With specially marked information N/C

Shipping
 Shipped assembled f.o.b. Green Bay, Wisconsin 54302 factory. Freight class #125.

Specifications and prices are subject to change without prior notice.

Stack/Nesting

Dorsal® General Information



Armless Stacking Round Leg Chair (DRNA)



Stacking Tablet Arm Round Leg Chair (DRTL)



Round Leg Chair Transport Dolly (VTD.BL)

Features			
Stackable	•	•	
Ganging	•		
Articulating backrest	•	•	
Available unupholstered	•	•	
Available with upholstered seat only	•	•	
Available with upholstered seat and back	•	•	
General Dimensions			
Seat width	19"	19"	
Seat depth	17-1/2"	17-1/2"	
Seat height	18-1/4"	18-1/4"	
Overall Dimensions			
Width	22-3/4"	25-1/2"	24"
Depth	21-3/4"	28"	21"
Height	32"	32"	7"
Tablet width		12"	
Tablet depth		21"	
Stacking on dolly			
Quantity/dimensions	8 Chairs/25" x 27" x 76"	6 Chairs/30" x 27" x 65"	
Stacking on floor			
Quantity	5 Chairs		

SPECIFICATIONS

Seat and Back

Unupholstered chairs have a textured thermoplastic shell. Body contact areas have textured pattern. Upholstered chairs have fabric covered, extra thick, soft foam backrest and seat cushions fastened to an inner shell. Automatic mechanism governs backrest movement.

Legs

3/4" o.d., seam-welded tubular.

Ganging Elements

Built-in couplers for ganging are optional. Monochromatic with frame color.

Tablet Arm Chair

Tablet arm chair stacks. Tablet arm of round tubular steel frame welded to leg and hinged at tablet. Tips up for entry and storage. Standard size tablet of resin core, with laminate writing surface and backing sheet. Round tablet edge with clear lacquer finish.

Powder-coated frame. Seating clearance is 12-1/2". Tablet is 20-5/8" long and 12" wide.

Bookrack

Chairs are nonstacking with bookrack attached. Welded wire frame, chrome finish. May be field installed.

Glides

Self-leveling nylon base glides are replaceable. Finish matches chair color.

Stacking

See the above chart for stacking capabilities on a transport dolly. Do not exceed these capacities.

Stacking Vinyl, Polyurethane, and Imitation Leather Upholstered Chairs

It is recommended that chairs to be stacked be covered in material other than vinyl, polyurethane, or imitation leather as an impression in the seat may result. KI does not warrant the effects of stacking on stock

or C.O.M. vinyl, polyurethane, or imitation leather upholstery.

INFORMATION

C.O.M. Testing and Production Requirements

Not all materials are suitable for upholstering this product. A 1 yard sample must be submitted and approved prior to acceptance of an order. If the fabric is directional in pattern or weave, the direction must be indicated on the submitted sample, and additional yardage may be requested.

Test samples must be sent to:

KI
Attn: C.O.M. Specialist
1687 Westminster Drive - Gate 3
Green Bay, WI 54302

Fabric Disclaimer

Fabric will be applied as swatched by the fabric manufacturer. Fabric that is required

to be applied differently than is swatched will need a Special Cost Request written specifying the direction the fabric is to be applied. The posted standard lead time will apply to the Special Cost Request.

Design

Designed and developed by Emilio Ambasz and Giancarlo Piretti for OPENArk B.V. Manufactured in the USA by Krueger International, Inc. under license from OPENArk B.V.

Dorsal® is a registered trademark of OPENArk B.V. and is used under license by Krueger International, Inc.



Ganging



Bookrack





INFORMATION

Warranty

Refer to KI Terms & Conditions document
or visit ki.com

Stack/Nesting

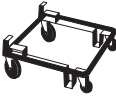
Dorsal®

	MODEL	Features	MODEL NUMBER						
			Basic Model	Frame Color	Shell Color	Fire Code	Uph. Color	Tablet Arm Color	Glide Option
 <p>DR DRU</p>	Armless Stacking Round Leg Chair • Articulating backrest	Unupholstered	DRNA	<input type="checkbox"/> <input type="checkbox"/> <input type="checkbox"/>	<input type="checkbox"/> <input type="checkbox"/>	<input type="checkbox"/> <input type="checkbox"/> <input type="checkbox"/>			<input type="checkbox"/>
		Upholstered Seat	DRNA/SO	<input type="checkbox"/> <input type="checkbox"/> <input type="checkbox"/>	<input type="checkbox"/> <input type="checkbox"/>	<input type="checkbox"/> <input type="checkbox"/> <input type="checkbox"/>	<input type="checkbox"/> <input type="checkbox"/> <input type="checkbox"/>		<input type="checkbox"/>
		Upholstered Seat/Back	DRNA/SB	<input type="checkbox"/> <input type="checkbox"/> <input type="checkbox"/>	<input type="checkbox"/> <input type="checkbox"/>	<input type="checkbox"/> <input type="checkbox"/> <input type="checkbox"/>	<input type="checkbox"/> <input type="checkbox"/> <input type="checkbox"/>		<input type="checkbox"/>
 <p>DR DRU</p>	Stacking Round Leg Tablet Arm Chair • Articulating backrest • Available in right- and left-hand models • Plastic laminate tablet surface	Unupholstered, Left Hand	DRTL	<input type="checkbox"/> <input type="checkbox"/> <input type="checkbox"/>	<input type="checkbox"/> <input type="checkbox"/>	<input type="checkbox"/> <input type="checkbox"/> <input type="checkbox"/>		<input type="checkbox"/> <input type="checkbox"/> <input type="checkbox"/>	<input type="checkbox"/>
		Upholstered Seat, Left Hand	DRTL/SO	<input type="checkbox"/> <input type="checkbox"/> <input type="checkbox"/>	<input type="checkbox"/> <input type="checkbox"/>	<input type="checkbox"/> <input type="checkbox"/> <input type="checkbox"/>	<input type="checkbox"/> <input type="checkbox"/> <input type="checkbox"/>	<input type="checkbox"/> <input type="checkbox"/> <input type="checkbox"/>	<input type="checkbox"/>
		Upholstered Seat/Back, Left Hand	DRTL/SB	<input type="checkbox"/> <input type="checkbox"/> <input type="checkbox"/>	<input type="checkbox"/> <input type="checkbox"/>	<input type="checkbox"/> <input type="checkbox"/> <input type="checkbox"/>	<input type="checkbox"/> <input type="checkbox"/> <input type="checkbox"/>	<input type="checkbox"/> <input type="checkbox"/> <input type="checkbox"/>	<input type="checkbox"/>
		Unupholstered, Right Hand	DRTR	<input type="checkbox"/> <input type="checkbox"/> <input type="checkbox"/>	<input type="checkbox"/> <input type="checkbox"/>	<input type="checkbox"/> <input type="checkbox"/> <input type="checkbox"/>		<input type="checkbox"/> <input type="checkbox"/> <input type="checkbox"/>	<input type="checkbox"/>
		Upholstered Seat, Right Hand	DRTR/SO	<input type="checkbox"/> <input type="checkbox"/> <input type="checkbox"/>	<input type="checkbox"/> <input type="checkbox"/>	<input type="checkbox"/> <input type="checkbox"/> <input type="checkbox"/>	<input type="checkbox"/> <input type="checkbox"/> <input type="checkbox"/>	<input type="checkbox"/> <input type="checkbox"/> <input type="checkbox"/>	<input type="checkbox"/>
		Upholstered Seat/Back, Right Hand	DRTR/SB	<input type="checkbox"/> <input type="checkbox"/> <input type="checkbox"/>	<input type="checkbox"/> <input type="checkbox"/>	<input type="checkbox"/> <input type="checkbox"/> <input type="checkbox"/>	<input type="checkbox"/> <input type="checkbox"/> <input type="checkbox"/>	<input type="checkbox"/> <input type="checkbox"/> <input type="checkbox"/>	<input type="checkbox"/>
 <p>HRDPT</p>	Round Leg Chair Transport Dolly • Easy maneuverability with caster wheels; two 3" fixed, two 5" swivel • Seam-welded tubular steel frame • Black powder-coated finish		VTD.BL						
	Bookrack • Welded wire frame • Chrome frame • 20-1/2" wide x 11" deep • SEE PRICING BELOW								

A **B** **C** **D** **E** **F** **G**

HOW TO ORDER

Indicate the following information on order form:

- Quantity of each item.
- Model number, including options. See "How To Build a Model Number".
- Any special service required.

Note: • The indicates that a choice is required.

- The absence of the indicates that no choice is required.
- Alpha-numeric characters in place of indicate that no other alternatives are available.

HOW TO BUILD A MODEL NUMBER

- A** Select basic model.
- B** Select frame color.
Refer to color addendum at ki.com or KI Fabrics & Finishes binder.
- C** Select shell color.
Refer to color addendum at ki.com or KI Fabrics & Finishes binder.
- D** Select fire code.

NFR	- Compliance to TB 117-2013
FR	- Compliance to TB 133
- E** Select upholstery grade/color.
Refer to color addendum at ki.com or KI Fabrics & Finishes binder.
- F** Select tablet arm color.
Refer to color addendum at ki.com or KI Fabrics & Finishes binder.

G Select glide option.

- | | |
|----------|------------------|
| P | - Plastic glides |
| S | - Steel glides |

UPHOLSTERY INFORMATION

C.O.M. Upholstery

C.O.M. requirement for 10 chairs or less is 5/8 yard per upholstered seat chair and 1 yard per upholstered seat and back chair of 54" wide nondirectional fabric. For orders of 11 or more chairs and for complete information on ordering C.O.M., see "Ordering C.O.M., C.O.V. and C.O.L." section.



Approx. Packaged Weight	Delivered Pricing Unupholstered	Delivered Pricing Fabric Grade 1 & C.O.M.	Delivered Pricing Fabric Grade 2	Delivered Pricing Fabric Grade 3	Delivered Pricing Vinyl Group 2V	Delivered Pricing Pallas Fabric Group P0	Delivered Pricing Pallas Fabric Group P1	Delivered Pricing Pallas Fabric Group P2	Delivered Pricing Pallas Fabric Group P3	Delivered Pricing Pallas Fabric Group P4
17.0#	\$ 221									
17.0#	N/A	344	366	375	375	382	398	432	461	486
19.0#	N/A	406	467	474	474	433	470	508	540	575
23.0#	\$ 470									
24.0#	N/A	596	624	630	630	637	652	688	712	741
25.0#	N/A	660	720	726	726	685	722	762	796	829
23.0#	470									
24.0#	N/A	596	624	630	630	637	652	688	712	741
25.0#	N/A	660	720	726	726	685	722	762	796	829
19.0#	\$ 375									

OPTIONS

California TB133 Fire Safety Code

For California Technical Bulletin 133 compliant models, add the following upcharge:

Model=No Upholstery
 Added Lead Time=1 week
 Added List Price= \$55
 Model=Upholstered
 Added Lead Time=1 week
 Added List Price= \$92

Gangers

For ganging mechanism, add "/G" to end of model numbers.
 List price upcharge is \$12

Bookrack

Add "/BR" to end of model number. List price upcharge is \$35

SPECIAL SERVICES

Special Carton Marking

With specially marked information N/C

Shipping

Shipped **assembled freight prepaid f.o.b. Green Bay, Wisconsin 54302** factory.
 Freight class #125.

Specifications and prices are subject to change without prior notice.

Stack/Nesting

Grazie® General Information



**Armless Four-Leg Chair
(GLNAU)**



**Four-Leg Cantilever Arm
Chair
(GLCAP)**



**Four-Leg Flip-up Tablet
Arm Chair
(GLTAURH)**



**Four-Leg Flip-up Oversize
Tablet Arm Chair**



**Four-Leg Flip-and-Store
(G2) Tablet Arm Chair**

Features					
Stackable	•	•			
Poly, upholstered seat, or upholstered seat/back	•	•	•	•	•
Ergonomic articulation (Perfect Pivot)	•	•	•	•	•
General Dimensions					
Seat width	18-1/2"	18-1/2"	18-1/2"	18-1/2"	18-1/2"
Seat depth	18-5/16"	18-5/16"	18-5/16"	18-5/16"	18-5/16"
Seat height (upholstered add 1")	17-3/4"	17-3/4"	17-3/4"	17-3/4"	17-3/4"
Tablet to chair back clearance			14-1/2"	14-1/2"	14-1/2"
Overall Dimensions					
Width	22-3/16"	25-7/8"	23-1/2"	23-1/2"	23-1/2"
Depth	21-5/16"	21-5/16"	27-3/8"	31"	26-3/4"
Height	32-5/8"	32-5/8"	32-5/8"	32-5/8"	32-5/8"
Arms to floor		26-1/4"			
Stacking on Dolly					
Overall width	25"	25-7/8"			
Overall depth	36"	36"			
Quantity/height	12 Poly Chairs/60" High (6 Uph Chairs)	12 Poly Chairs/60" High (6 Uph Chairs)			
Stacking on Floor					
Width	22-3/16"	25-7/8"			
Depth	28"	28"			
Quantity/height	5 Chairs/43" High	5 Chairs/43" High			

SPECIFICATIONS

4-Leg Frame

Legs are 7/8" o.d. x 13-gauge tubular steel. A double ring of 7/16" diameter steel wire forms the cross member. The fixed backrest mechanism structure is formed of 1/2" diameter steel wire. All joints are welded.

Sled Frame

Frames are 3/4" o.d. x 13-gauge tubular steel. A double ring of 7/16" diameter steel wire forms the cross member. The fixed backrest mechanism structure is formed of 1/2" diameter steel wire. All joints are welded.

Arms

Optional cantilever arms are available. When equipped with arms, the support structure is a continuation of the rear leg finished to match the frame color. The armrests are injection-molded, glass-reinforced nylon matching the frame finish (except for chrome, hammertone, and metallic finishes

which will match poly color. Diamond translucent poly will have light tone armrests; Pewter translucent will have flannel armrests; Bronze translucent will have chocolate armrests). The steel frame tube is inserted into a socket molded into the armrest and secured with a screw.

Seat and Shroud

Injection molded polypropylene.

Backrest Articulation Mechanism

A pair of outer backrest supports formed from 1" diameter tubular steel are inserted into sockets molded into the backrest and secured with screws. The backrest assembly moves over molded thermoplastic slide bushings and is supported by steel coil springs. This mechanism allows the backrest to move through 15 degrees of movement, about an axis of rotation that is through the hips of the occupant.

Optional Upholstered Seat and Back

Urethane foam is attached to an injection-

molded polypropylene liner board, then upholstered using a draw-string process. Seat foam is molded nominal 1" thickness and back foam is nominal 1/2" thickness. The fasteners that attach the back pad are color-matched to the polypropylene.

Frame Finishes

Baked-on electrostatically-applied 30° gloss epoxy powder coating or bright nickel-chrome plating.

Flip-up Tablet Arm

Tablet support loop is a continuation of the rear leg and may be ordered on the right or left side. A formed steel hinge is welded to the top of the support structure and secured with screws to the underside of the writing surface. Writing surface for standard tablet is 9-1/2" x 20-3/4" x 12-1/2" and oversize tablet is 15-1/2" x 22-1/2" x 14". Plywood core of 5/8" thick, 11-ply hardwood surfaced with .030" high-pressure laminate top and plain backer undersurface. Tablet flips up for easy access. Edges are lacquered and

sealed.

Flip-and-Store (G2) Tablet Arm

The pivot mechanism consists of two pivot cams, two steel hinge barrels, a pivot shaft, and a hinged steel support plate which fastens to the tablet board. Available in right- or left-hand models. The working surface is 13-3/4" x 18-1/8".

Glides

The bottom ends of the leg tubes are formed to be vertical where they meet the floor. The leg tubes are capped with polypropylene end caps matching the leg color (except chrome, hammertone, and metallic finishes which use black caps). Optional glides for the sled base are co-extruded to provide a softer, non-skid surface to protect the floor, but do not glide. Sled base chairs are also available with black nylon (plastic), stainless steel, or non-marring (clear nylon) glides.

Casters

4-leg chairs may be ordered with casters



Armless Sled Base Chair (GSNAP)



Sled Base Cantilever Arm Chair (GSCAU)



Sled Base Flip-up Tablet Arm Chair (GSTAPRH)



Sled Base Flip-up Oversize Tablet Arm Chair



Sled Base Flip-and-Store (G2) Tablet Arm Chair



Transport Dolly (GCD.BL)

Features						
Stackable	•	•				
Poly, upholstered seat, or upholstered seat/back	•	•	•	•	•	
Ergonomic articulation (Perfect Pivot)	•	•	•	•	•	
General Dimensions						
Seat width	18-1/2"	18-1/2"	18-1/2"	18-1/2"	18-1/2"	
Seat depth	18-5/16"	18-5/16"	18-5/16"	18-5/16"	18-5/16"	
Seat height (upholstered add 1")	17-3/4"	17-3/4"	17-3/4"	17-3/4"	17-3/4"	
Tablet to chair back clearance			14-1/2"	14-1/2"	14-1/2"	
Overall Dimensions						
Width	22"	25-7/8"	23-1/2"	23-1/2"	23-1/2"	25"
Depth	21-1/4"	21-1/4"	27-3/8"	31"	26-3/4"	29"
Height	32-5/8"	32-5/8"	32-5/8"	32-5/8"	32-5/8"	15-3/4"
Arms to floor		26-1/4"				
Stacking on Dolly						
Overall width	25"	25-7/8"				
Overall depth	36"	36"				
Quantity/height	12 Poly Chairs/60" High (6 Uph Chairs)	12 Poly Chairs/60" High (6 Uph Chairs)				
Stacking on Floor						
Width	22-3/16"	25-7/8"				
Depth	28"	28"				
Quantity/height	5 Chairs/43" High	5 Chairs/43" High				

instead of glides. Casters are double-wheel, high-impact thermoplastic available with hard or soft wheel surface, in black only.

Stacking Vinyl, Polyurethane, and Imitation Leather Upholstered Chairs

It is recommended that chairs to be stacked be covered in material other than vinyl, polyurethane, or imitation leather as an impression in the seat may result. KI does not warrant the effects of stacking on stock or C.O.M. vinyl, polyurethane, or imitation leather upholstery.

INFORMATION

C.O.M. Testing and Production Requirements

Not all materials are suitable for upholstering this product. A 1 yd. x 54" sample must be submitted and approved prior to acceptance of an order. If the fabric is directional in pattern or weave, the direction must be indicated on the submitted sample, and additional yardage may be requested.

Test samples must be sent to:

KI
Attn: C.O.M. Specialist
1687 Westminster Drive - Gate 3
Green Bay, WI 54302

Fabric Disclaimer

Fabric will be applied as swatched by the fabric manufacturer. Fabric that is required to be applied differently than is swatched will need a Special Cost Request written specifying the direction the fabric is to be applied. The posted standard lead time will apply to the Special Cost Request.

Design

Designed by Giancarlo Piretti and manufactured in the USA by Krueger International, Inc. under license from Pro-Cord S.p.A

INFORMATION

Warranty

Refer to KI Terms & Conditions document or visit ki.com

Stack/Nesting

Grazie® General Information



Armless Four-Leg Chair with Casters (GLNAUC)



Four-Leg Cantilever Arm Chair with Casters (GLCAUC)



Four-Leg Flip-up Tablet Arm Chair with Casters (GLTAPCRH)



Four-Leg Flip-up Oversize Tablet Arm Chair with Casters



Four-Leg Flip-and-Store (G2) Tablet Arm Chair with Casters

Features					
Stackable	•	•			
Poly, upholstered seat, or upholstered seat/back	•	•	•	•	•
Ergonomic articulation (Perfect Pivot)	•	•	•	•	•
General Dimensions					
Seat width	18-1/2"	18-1/2"	18-1/2"	18-1/2"	18-1/2"
Seat depth	18-5/16"	18-5/16"	18-5/16"	18-5/16"	18-5/16"
Seat height (upholstered add 1")	17-3/4"	17-3/4"	17-3/4"	17-3/4"	17-3/4"
Tablet to chair back clearance			14-1/2"	14-1/2"	14-1/2"
Overall Dimensions					
Width	23"	25-7/8"	24"	24"	24"
Depth	21-5/16"	21-5/16"	27-3/8"	31"	26-3/4"
Height	32-5/8"	32-5/8"	32-5/8"	32-5/8"	32-5/8"
Arms to floor		26-1/4"			
Stacking on Floor					
Width	23"	25-7/8"			
Depth	28"	28"			
Quantity/height	5 Chairs/43" High	5 Chairs/43" High			

SPECIFICATIONS

4-Leg Frame

Legs are 7/8" o.d. x 13-gauge tubular steel. A double ring of 7/16" diameter steel wire forms the cross member. The fixed backrest mechanism structure is formed of 1/2" diameter steel wire. All joints are welded.

Sled Frame

Frames are 3/4" o.d. x 13-gauge tubular steel. A double ring of 7/16" diameter steel wire forms the cross member. The fixed backrest mechanism structure is formed of 1/2" diameter steel wire. All joints are welded.

Arms

Optional cantilever arms are available. When equipped with arms, the support structure is a continuation of the rear leg finished to match the frame color. The armrests are injection-molded, glass-reinforced nylon matching the frame finish (except for chrome, hammertone, and metallic finishes

which will match poly color. Diamond translucent poly will have light tone armrests; Pewter translucent will have flannel armrests; Bronze translucent will have chocolate armrests). The steel frame tube is inserted into a socket molded into the armrest and secured with a screw.

Seat and Shroud

Injection molded polypropylene.

Backrest Articulation Mechanism

A pair of outer backrest supports formed from 1" diameter tubular steel are inserted into sockets molded into the backrest and secured with screws. The backrest assembly moves over molded thermoplastic slide bushings and is supported by steel coil springs. This mechanism allows the backrest to move through 15 degrees of movement, about an axis of rotation that is through the hips of the occupant.

Optional Upholstered Seat and Back

Urethane foam is attached to an injection-

molded polypropylene liner board, then upholstered using a draw-string process. Seat foam is molded nominal 1" thickness and back foam is nominal 1/2" thickness. The fasteners that attach the back pad are color-matched to the polypropylene.

Frame Finishes

Baked-on electrostatically-applied 30° gloss epoxy powder coating or bright nickel-chrome plating.

Flip-up Tablet Arm

Tablet support loop is a continuation of the rear leg and may be ordered on the right or left side. A formed steel hinge is welded to the top of the support structure and secured with screws to the underside of the writing surface. Writing surface for standard tablet is 9-1/2" x 20-3/4" x 12-1/2" and oversize tablet is 15-1/2" x 22-1/2" x 14". Plywood core of 5/8" thick, 11-ply hardwood surfaced with .030" high-pressure laminate top and plain backer undersurface. Tablet flips up for easy access. Edges are lacquered and

sealed.

Flip-and-Store (G2) Tablet Arm

The pivot mechanism consists of two pivot cams, two steel hinge barrels, a pivot shaft, and a hinged steel support plate which fastens to the tablet board. Available in right- or left-hand models. The working surface is 13-3/4" x 18-1/8".

Glides

The bottom ends of the leg tubes are formed to be vertical where they meet the floor. The leg tubes are capped with polypropylene end caps matching the leg color (except chrome, hammertone, and metallic finishes which use black caps). Optional glides for the sled base are co-extruded to provide a softer, non-skid surface to protect the floor, but do not glide. Sled base chairs are also available with black nylon (plastic), stainless steel, or non-marring (clear nylon) glides.

Casters

4-leg chairs may be ordered with casters

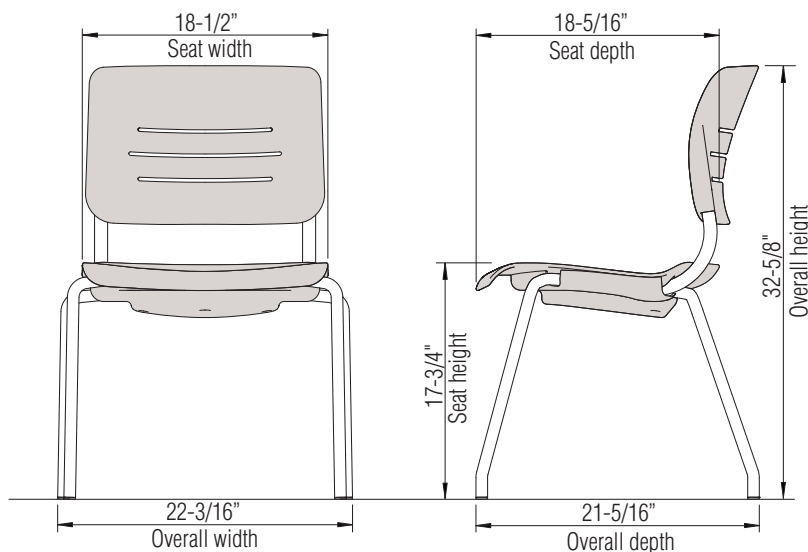

Grazie Armless Four Leg Chair

instead of glides. Casters are double-wheel, high-impact thermoplastic available with hard or soft wheel surface, in black only.

Stacking Vinyl, Polyurethane, and Imitation Leather Upholstered Chairs

It is recommended that chairs to be stacked be covered in material other than vinyl, polyurethane, or imitation leather as an impression in the seat may result. KI does not warrant the effects of stacking on stock or C.O.M. vinyl, polyurethane, or imitation leather upholstery.

INFORMATION

C.O.M. Testing and Production Requirements

Not all materials are suitable for upholstering this product. A 1 yd. x 54" sample must be submitted and approved prior to acceptance of an order. If the fabric is directional in pattern or weave, the direction must be indicated on the submitted sample, and additional yardage may be requested.

Test samples must be sent to:

KI
Attn: C.O.M. Specialist
1687 Westminster Drive - Gate 3
Green Bay, WI 54302

Fabric Disclaimer

Fabric will be applied as swatched by the fabric manufacturer. Fabric that is required to be applied differently than is swatched will need a Special Cost Request written specifying the direction the fabric is to be applied. The posted standard lead time will apply to the Special Cost Request.

Design

Designed by Giancarlo Piretti and manufactured in the USA by Krueger International, Inc. under license from Pro-Cord S.p.A

INFORMATION

Warranty

Refer to KI Terms & Conditions document or visit ki.com

Stack/Nesting

Grazie® General Information



**Four-Leg Armless Cafe Stool -
24" or 30" Seat Height
(GLSNAP)**

**Four-Leg Cantilever Arm
Cafe Stool - 24" or 30" Seat Height**

Features		
Stackable	•	•
Poly, upholstered seat, or upholstered seat/back	•	•
Ergonomic articulation (Perfect Pivot)	•	•
General Dimensions		
Seat width	18-1/2"	18-1/2"
Seat depth	18-5/16"	18-5/16"
Seat height (upholstered add 1")	23-3/4" or 29-3/4"	23-3/4" or 29-3/4"
Overall Dimensions		
Width	22-3/16"	25-7/8"
Depth	21-5/16"	21-5/16"
Height	38-5/8" or 44-5/8"	38-5/8" or 44-5/8"
Arms to floor		32-1/4" or 38-1/4"
Stacking on Floor		
Width	22-3/16"	25-7/8"
Depth	28"	28"
Quantity/height	4 Chairs/48" or 54" High	4 Chairs/48" or 54" High

SPECIFICATIONS

4-Leg Frame

Legs are 7/8" o.d. x 13 -gauge tubular steel. A double ring of 7/16" diameter steel wire forms the cross member. The fixed backrest mechanism structure is formed of 1/2" diameter steel wire. A 3-sided foot ring is made of a pair of 7/16" diameter steel wires. All joints are welded.

Arms

Optional cantilever arms are available. When equipped with arms, the support structure is a continuation of the rear leg finished to match the frame color. The armrests are injection-molded, glass-reinforced nylon matching the frame finish (except for chrome, hammertone, and metallic finishes which will match poly color. Diamond translucent poly will have light tone armrests; Pewter translucent will have flannel armrests; Bronze translucent will have chocolate armrests). The steel frame tube is inserted into a socket molded into the armrest and

secured with a screw.

Seat and Shroud

Injection molded polypropylene.

Backrest Articulation Mechanism

A pair of outer backrest supports formed from 1" diameter tubular steel are inserted into sockets molded into the backrest and secured with screws. The backrest assembly moves over molded thermoplastic slide bushings and is supported by steel coil springs. This mechanism allows the backrest to move through 15 degrees of movement, about an axis of rotation that is through the hips of the occupant.

Optional Upholstered Seat and Back

Urethane foam is attached to an injection-molded polypropylene liner board, then upholstered using a draw-string process. Seat foam is molded nominal 1" thickness and back foam is nominal 1/2" thickness. The fasteners that attach the back pad are color-matched to the polypropylene.

Frame Finishes

Baked-on electrostatically-applied 30° gloss epoxy powder coating or bright nickel-chrome plating.

Glides

The bottom ends of the leg tubes are formed to be vertical where they meet the floor. The leg tubes are capped with polypropylene end caps matching the leg color (except chrome, hammertone, and metallic finishes which use black caps).

Stacking Vinyl, Polyurethane, and Imitation Leather Upholstered Stools

It is recommended that stools to be stacked be covered in material other than vinyl, polyurethane, or imitation leather as an impression in the seat may result. KI does not warrant the effects of stacking on stock or C.O.M. vinyl, polyurethane, or imitation leather upholstery.

INFORMATION

C.O.M. Testing and Production Requirements

Not all materials are suitable for upholstering this product. A 1 yd. x 54" sample must be submitted and approved prior to acceptance of an order. If the fabric is directional in pattern or weave, the direction must be indicated on the submitted sample, and additional yardage may be requested.

Test samples must be sent to:

KI
Attn: C.O.M. Specialist
1687 Westminster Drive - Gate 3
Green Bay, WI 54302

Fabric Disclaimer

Fabric will be applied as swatched by the fabric manufacturer. Fabric that is required to be applied differently than is swatched will need a Special Cost Request written specifying the direction the fabric is to be applied.

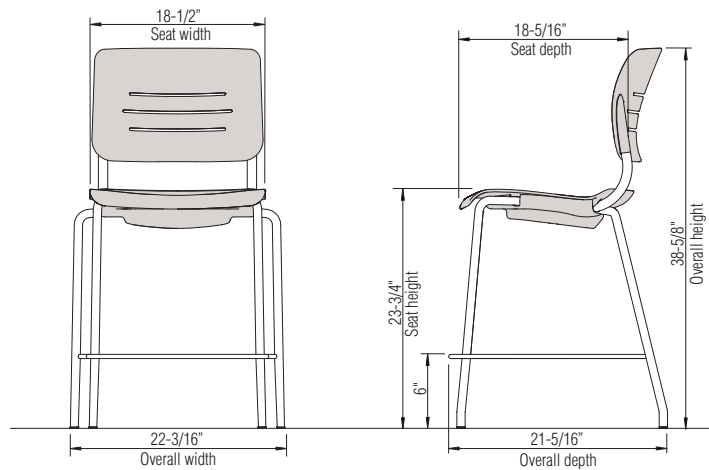

Grazie 24" Cafe Stool

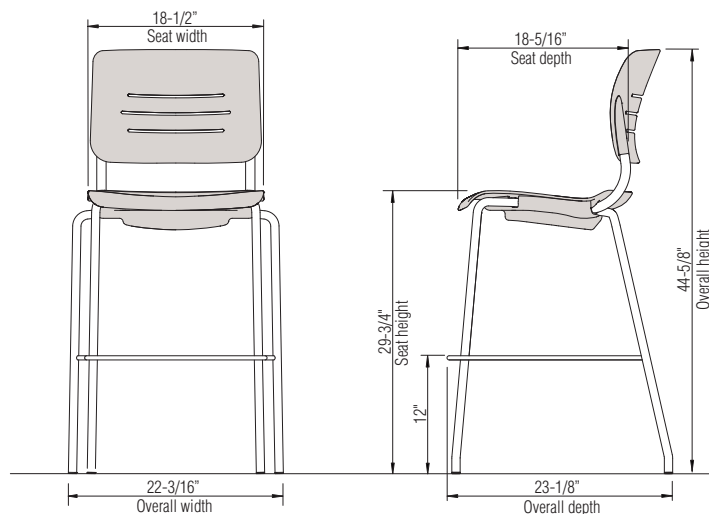

Grazie 30" Cafe Stool

The posted standard lead time will apply to the Special Cost Request.

Design

Designed by Giancarlo Piretti and manufactured in the USA by Krueger International, Inc. under license from Pro-Cord S.p.A



INFORMATION

Warranty

Refer to KI Terms & Conditions document or visit ki.com

Stack/Nesting

Grazie® Chairs

MODEL	Features	MODEL NUMBER						
		Basic Model	Frame Color	Seat & Back Color	Caster Type	Glide Option	Fire Code	Upholstery Color
 <p>Four-Leg Armless Chair</p> <ul style="list-style-type: none"> Ergonomic articulation (Perfect Pivot) Stacking 	Polypropylene	GLNAP	<input type="checkbox"/> <input type="checkbox"/>	<input type="checkbox"/> <input type="checkbox"/> <input type="checkbox"/> <input type="checkbox"/>		<input type="checkbox"/>	<input type="checkbox"/> <input type="checkbox"/> <input type="checkbox"/> <input type="checkbox"/>	
	Upholstered Seat	GLNAU	<input type="checkbox"/> <input type="checkbox"/>	<input type="checkbox"/> <input type="checkbox"/> <input type="checkbox"/> <input type="checkbox"/>		<input type="checkbox"/>	<input type="checkbox"/> <input type="checkbox"/> <input type="checkbox"/> <input type="checkbox"/> <input type="checkbox"/> <input type="checkbox"/>	
	Upholstered Seat/Back	GLNAUB	<input type="checkbox"/> <input type="checkbox"/>	<input type="checkbox"/> <input type="checkbox"/> <input type="checkbox"/> <input type="checkbox"/>		<input type="checkbox"/>	<input type="checkbox"/> <input type="checkbox"/> <input type="checkbox"/> <input type="checkbox"/>	<input type="checkbox"/> <input type="checkbox"/> <input type="checkbox"/> <input type="checkbox"/> <input type="checkbox"/> <input type="checkbox"/>
GLP								
GLU								
GLUB								
 <p>Four-Leg Armless Chair with Casters</p> <ul style="list-style-type: none"> Ergonomic articulation (Perfect Pivot) Stacking. Caution should be exercised to prevent casters from marring components such as frames, fabric, etc., and to prevent casters from becoming "hung up" underneath the seat of the chair Stacking on dollies is NOT recommended 	Polypropylene, Casters	GLNAPC	<input type="checkbox"/> <input type="checkbox"/>	<input type="checkbox"/> <input type="checkbox"/> <input type="checkbox"/> <input type="checkbox"/>	<input type="checkbox"/>		<input type="checkbox"/> <input type="checkbox"/> <input type="checkbox"/> <input type="checkbox"/>	
	Uph. Seat, Casters	GLNAUC	<input type="checkbox"/> <input type="checkbox"/>	<input type="checkbox"/> <input type="checkbox"/> <input type="checkbox"/> <input type="checkbox"/>	<input type="checkbox"/>		<input type="checkbox"/> <input type="checkbox"/> <input type="checkbox"/> <input type="checkbox"/> <input type="checkbox"/> <input type="checkbox"/>	
	Uph. Seat/Back, Casters	GLNAUBC	<input type="checkbox"/> <input type="checkbox"/>	<input type="checkbox"/> <input type="checkbox"/> <input type="checkbox"/> <input type="checkbox"/>	<input type="checkbox"/>		<input type="checkbox"/> <input type="checkbox"/> <input type="checkbox"/> <input type="checkbox"/>	<input type="checkbox"/> <input type="checkbox"/> <input type="checkbox"/> <input type="checkbox"/> <input type="checkbox"/> <input type="checkbox"/>
GLP								
GLU								
GLUB								

A **B** **C** **D** **E** **F** **G**

HOW TO ORDER

Indicate the following information on order form:

- Quantity of each item.
- Model number, including options. See "How To Build a Model Number".
- Any special service required.

Note: • The indicates that a choice is required.

- The absence of the indicates that no choice is required.
- Alpha-numeric characters in place of indicate that no other alternatives are available.

HOW TO BUILD A MODEL NUMBER

- A** Select basic model.
- B** Select frame color.
Refer to color addendum at ki.com or KI Fabrics & Finishes binder.
- C** Select poly seat and back color.
Refer to color addendum at ki.com or KI Fabrics & Finishes binder.
- D** Select casters.

C	- Carpet casters
S	- Hard floor casters
- E** Select glide option.

P	- Plastic glides
S	- Steel glides
- F** Select fire code.

NFR	- Compliance to TB 117-2013
FR	- Compliance to TB 133

upcharge.

- G** Select upholstery grade/color.
Refer to color addendum at ki.com or KI Fabrics & Finishes binder.

UPHOLSTERY INFORMATION

C.O.M. Upholstery

C.O.M. requirement for 10 chairs or less with upholstered seat or upholstered seat and back is 3/4 yard per chair of 54" wide nondirectional fabric. For orders of 11 or more with upholstered seat and back and for complete information on ordering C.O.M. see "Ordering C.O.M., C.O.V. and C.O.L." section.

California TB133 Fire Safety Code

For California Technical Bulletin 133 compliant models, add the following upcharge:
 Model=Polypropylene
 Added List Price=\$10
 Model=Upholstered Seat
 Added List Price=\$65
 Model=Upholstered Seat and Back
 Added List Price=\$93

See Upholstery Information for TB133



Stack/Nesting

Grazie® Chairs

Approx. Packaged Weight	Delivered Pricing Unupholstered	Delivered Pricing Fabric Grade 1 & C.O.M.	Delivered Pricing Fabric Grade 2	Delivered Pricing Fabric Grade 3	Delivered Pricing C.O.V.	Delivered Pricing Vinyl Group 2V	Delivered Pricing Pallas Fabric Group P0	Delivered Pricing Pallas Fabric Group P1	Delivered Pricing Pallas Fabric Group P2	Delivered Pricing Pallas Fabric Group P3	Delivered Pricing Pallas Fabric Group P4
23.0#	\$ 317										
26.0#	N/A	430	438	452	430	452	460	497	512	530	557
28.0#	N/A	456	465	480	456	480	488	525	540	558	584
24.0#	\$ 338										
27.0#	N/A	450	458	473	450	473	481	518	534	552	577
28.0#	N/A	476	485	500	476	500	508	545	560	578	605

SPECIAL SERVICES

Special Carton Marking

With specially marked information N/C



Shipping

Shipped **assembled freight prepaid f.o.b. Green Bay, Wisconsin 54302** factory. Freight class #125.

Specifications and prices are subject to change without prior notice.

Stack/Nesting

Grazie® Chairs

	MODEL	Features	MODEL NUMBER								
			Basic Model	Frame Color	Seat & Back Color	Caster Type	Glide Option	Fire Code	Upholstery Color		
 <p>GLP GLU GLUB</p>	Four-Leg Cantilever Armchair	Polypropylene	GLCAP	<input type="checkbox"/>	<input type="checkbox"/>	<input type="checkbox"/>	<input type="checkbox"/>	<input type="checkbox"/>	<input type="checkbox"/>		
		• Ergonomic articulation (Perfect Pivot)	Upholstered Seat	GLCAU	<input type="checkbox"/>	<input type="checkbox"/>	<input type="checkbox"/>	<input type="checkbox"/>	<input type="checkbox"/>	<input type="checkbox"/>	<input type="checkbox"/>
		• Stacking	Upholstered Seat/Back	GLCAUB	<input type="checkbox"/>	<input type="checkbox"/>	<input type="checkbox"/>	<input type="checkbox"/>	<input type="checkbox"/>	<input type="checkbox"/>	<input type="checkbox"/>
 <p>GLP GLU GLUB</p>	Four-Leg Cantilever Armchair with Casters	Polypropylene, Casters	GLCAPC	<input type="checkbox"/>	<input type="checkbox"/>	<input type="checkbox"/>	<input type="checkbox"/>	<input type="checkbox"/>	<input type="checkbox"/>		
		• Ergonomic articulation (Perfect Pivot)	Uph. Seat, Casters	GLCAUC	<input type="checkbox"/>	<input type="checkbox"/>	<input type="checkbox"/>	<input type="checkbox"/>	<input type="checkbox"/>	<input type="checkbox"/>	<input type="checkbox"/>
		• Stacking. Caution should be exercised to prevent casters from marring components such as frames, fabric, etc., and to prevent casters from becoming "hung up" underneath the seat of the chair	Uph. Seat/Back, Casters	GLCAUBC	<input type="checkbox"/>	<input type="checkbox"/>	<input type="checkbox"/>	<input type="checkbox"/>	<input type="checkbox"/>	<input type="checkbox"/>	<input type="checkbox"/>
		• Stacking on dollies is NOT recommended									

A **B** **C** **D** **E** **F** **G**

HOW TO ORDER

Indicate the following information on order form:

- Quantity of each item.
- Model number, including options. See "How To Build a Model Number".
- Any special service required.

Note: • The indicates that a choice is required.

- The absence of the indicates that no choice is required.
- Alpha-numeric characters in place of indicate that no other alternatives are available.

HOW TO BUILD A MODEL NUMBER

A Select basic model.

B Select frame color.
Refer to color addendum at ki.com or KI Fabrics & Finishes binder.

C Select poly seat and back color.
Refer to color addendum at ki.com or KI Fabrics & Finishes binder.

D Select casters.
C _____ - Carpet casters
S _____ - Hard floor casters

E Select glide option.
P _____ - Plastic glides
S _____ - Steel glides

F Select fire code.
NFR _____ - Compliance to TB 117-2013
FR _____ - Compliance to TB 133

See Upholstery Information for TB133

upcharge.

G Select upholstery grade/color.
Refer to color addendum at ki.com or KI Fabrics & Finishes binder.

UPHOLSTERY INFORMATION

C.O.M. Upholstery

C.O.M. requirement for 10 chairs or less with upholstered seat or upholstered seat and back is 3/4 yard per chair of 54" wide nondirectional fabric. For orders of 11 or more with upholstered seat and back and for complete information on ordering C.O.M. see "Ordering C.O.M., C.O.V. and C.O.L." section.

California TB133 Fire Safety Code

For California Technical Bulletin 133 compliant models, add the following upcharge:
Model=Polypropylene
Added List Price=\$10
Model=Upholstered Seat
Added List Price=\$65
Model=Upholstered Seat and Back
Added List Price=\$93



Stack/Nesting

Grazie® Chairs

Approx. Packaged Weight	Delivered Pricing Unupholstered	Delivered Pricing Fabric Grade 1 & C.O.M.	Delivered Pricing Fabric Grade 2	Delivered Pricing Fabric Grade 3	Delivered Pricing C.O.V.	Delivered Pricing Vinyl Group 2V	Delivered Pricing Pallas Fabric Group P0	Delivered Pricing Pallas Fabric Group P1	Delivered Pricing Pallas Fabric Group P2	Delivered Pricing Pallas Fabric Group P3	Delivered Pricing Pallas Fabric Group P4
26.0#	\$ 422										
29.0#	N/A	535	543	557	535	557	567	604	618	637	662
31.0#	N/A	561	570	585	561	585	592	629	644	662	688
27.0#	\$ 443										
30.0#	N/A	555	563	577	555	577	586	623	638	656	682
31.0#	N/A	581	590	605	581	605	613	650	666	684	710

SPECIAL SERVICES

Special Carton Marking

With specially marked information N/C



Shipping

Shipped **assembled freight prepaid f.o.b. Green Bay, Wisconsin 54302** factory. Freight class #125.

Specifications and prices are subject to change without prior notice.

Stack/Nesting

Grazie® Chairs

			MODEL NUMBER						
MODEL	Features	Basic Model	Frame Color	Seat & Back Color	Glide Option	Tablet Arm Color	Fire Code	Uph. Color	
 <p>GLP GLU GLUB</p>	Four-Leg Flip-up Tablet Arm Chair • Ergonomic articulation (Perfect Pivot) • NONSTACKING	Polypropylene, Left Hand	GLTAPLH	<input type="checkbox"/> <input type="checkbox"/>	<input type="checkbox"/> <input type="checkbox"/> <input type="checkbox"/> <input type="checkbox"/>	<input type="checkbox"/>	<input type="checkbox"/> <input type="checkbox"/>	<input type="checkbox"/> <input type="checkbox"/>	
		Polypropylene, Right Hand	GLTAPRH	<input type="checkbox"/> <input type="checkbox"/>	<input type="checkbox"/> <input type="checkbox"/> <input type="checkbox"/> <input type="checkbox"/>	<input type="checkbox"/>	<input type="checkbox"/> <input type="checkbox"/>	<input type="checkbox"/> <input type="checkbox"/>	
		Uph. Seat, Left Hand	GLTAULH	<input type="checkbox"/> <input type="checkbox"/>	<input type="checkbox"/> <input type="checkbox"/> <input type="checkbox"/> <input type="checkbox"/>	<input type="checkbox"/>	<input type="checkbox"/> <input type="checkbox"/>	<input type="checkbox"/> <input type="checkbox"/>	<input type="checkbox"/> <input type="checkbox"/>
		Uph. Seat, Right Hand	GLTAURH	<input type="checkbox"/> <input type="checkbox"/>	<input type="checkbox"/> <input type="checkbox"/> <input type="checkbox"/> <input type="checkbox"/>	<input type="checkbox"/>	<input type="checkbox"/> <input type="checkbox"/>	<input type="checkbox"/> <input type="checkbox"/>	<input type="checkbox"/> <input type="checkbox"/>
		Uph. Seat/Back, Left Hand	GLTAUBLH	<input type="checkbox"/> <input type="checkbox"/>	<input type="checkbox"/> <input type="checkbox"/> <input type="checkbox"/> <input type="checkbox"/>	<input type="checkbox"/>	<input type="checkbox"/> <input type="checkbox"/>	<input type="checkbox"/> <input type="checkbox"/>	<input type="checkbox"/> <input type="checkbox"/>
		Uph. Seat/Back, Right Hand	GLTAURH	<input type="checkbox"/> <input type="checkbox"/>	<input type="checkbox"/> <input type="checkbox"/> <input type="checkbox"/> <input type="checkbox"/>	<input type="checkbox"/>	<input type="checkbox"/> <input type="checkbox"/>	<input type="checkbox"/> <input type="checkbox"/>	<input type="checkbox"/> <input type="checkbox"/>
 <p>GLP GLU GLUB</p>	Four-Leg Flip-up Oversize Tablet Arm Chair • Oversized tablet • Ergonomic articulation (Perfect Pivot) • NONSTACKING	Polypropylene, Left Hand	GLOVTAPLH	<input type="checkbox"/> <input type="checkbox"/>	<input type="checkbox"/> <input type="checkbox"/> <input type="checkbox"/> <input type="checkbox"/>	<input type="checkbox"/>	<input type="checkbox"/> <input type="checkbox"/>	<input type="checkbox"/> <input type="checkbox"/>	
		Polypropylene, Right Hand	GLOVTAPRH	<input type="checkbox"/> <input type="checkbox"/>	<input type="checkbox"/> <input type="checkbox"/> <input type="checkbox"/> <input type="checkbox"/>	<input type="checkbox"/>	<input type="checkbox"/> <input type="checkbox"/>	<input type="checkbox"/> <input type="checkbox"/>	
		Uph. Seat, Left Hand	GLOVTAULH	<input type="checkbox"/> <input type="checkbox"/>	<input type="checkbox"/> <input type="checkbox"/> <input type="checkbox"/> <input type="checkbox"/>	<input type="checkbox"/>	<input type="checkbox"/> <input type="checkbox"/>	<input type="checkbox"/> <input type="checkbox"/>	<input type="checkbox"/> <input type="checkbox"/>
		Uph. Seat, Right Hand	GLOVTURH	<input type="checkbox"/> <input type="checkbox"/>	<input type="checkbox"/> <input type="checkbox"/> <input type="checkbox"/> <input type="checkbox"/>	<input type="checkbox"/>	<input type="checkbox"/> <input type="checkbox"/>	<input type="checkbox"/> <input type="checkbox"/>	<input type="checkbox"/> <input type="checkbox"/>
		Uph. Seat/Back, Left Hand	GLOVTAUBLH	<input type="checkbox"/> <input type="checkbox"/>	<input type="checkbox"/> <input type="checkbox"/> <input type="checkbox"/> <input type="checkbox"/>	<input type="checkbox"/>	<input type="checkbox"/> <input type="checkbox"/>	<input type="checkbox"/> <input type="checkbox"/>	<input type="checkbox"/> <input type="checkbox"/>
		Uph. Seat/Back, Right Hand	GLOVTAURH	<input type="checkbox"/> <input type="checkbox"/>	<input type="checkbox"/> <input type="checkbox"/> <input type="checkbox"/> <input type="checkbox"/>	<input type="checkbox"/>	<input type="checkbox"/> <input type="checkbox"/>	<input type="checkbox"/> <input type="checkbox"/>	<input type="checkbox"/> <input type="checkbox"/>
 <p>GLP GLU GLUB</p>	Four-Leg Flip-and-Store (G2) Tablet Arm Chair • Ergonomic articulation (Perfect Pivot) • NONSTACKING	Polypropylene, Left Hand	GLG2APLH	<input type="checkbox"/> <input type="checkbox"/>	<input type="checkbox"/> <input type="checkbox"/> <input type="checkbox"/> <input type="checkbox"/>	<input type="checkbox"/>	<input type="checkbox"/> <input type="checkbox"/>	<input type="checkbox"/> <input type="checkbox"/>	
		Polypropylene, Right Hand	GLG2APRH	<input type="checkbox"/> <input type="checkbox"/>	<input type="checkbox"/> <input type="checkbox"/> <input type="checkbox"/> <input type="checkbox"/>	<input type="checkbox"/>	<input type="checkbox"/> <input type="checkbox"/>	<input type="checkbox"/> <input type="checkbox"/>	
		Uph. Seat, Left Hand	GLG2AULH	<input type="checkbox"/> <input type="checkbox"/>	<input type="checkbox"/> <input type="checkbox"/> <input type="checkbox"/> <input type="checkbox"/>	<input type="checkbox"/>	<input type="checkbox"/> <input type="checkbox"/>	<input type="checkbox"/> <input type="checkbox"/>	<input type="checkbox"/> <input type="checkbox"/>
		Uph. Seat, Right Hand	GLG2AURH	<input type="checkbox"/> <input type="checkbox"/>	<input type="checkbox"/> <input type="checkbox"/> <input type="checkbox"/> <input type="checkbox"/>	<input type="checkbox"/>	<input type="checkbox"/> <input type="checkbox"/>	<input type="checkbox"/> <input type="checkbox"/>	<input type="checkbox"/> <input type="checkbox"/>
		Uph. Seat/Back, Left Hand	GLG2AUBLH	<input type="checkbox"/> <input type="checkbox"/>	<input type="checkbox"/> <input type="checkbox"/> <input type="checkbox"/> <input type="checkbox"/>	<input type="checkbox"/>	<input type="checkbox"/> <input type="checkbox"/>	<input type="checkbox"/> <input type="checkbox"/>	<input type="checkbox"/> <input type="checkbox"/>
		Uph. Seat/Back, Right Hand	GLG2AURH	<input type="checkbox"/> <input type="checkbox"/>	<input type="checkbox"/> <input type="checkbox"/> <input type="checkbox"/> <input type="checkbox"/>	<input type="checkbox"/>	<input type="checkbox"/> <input type="checkbox"/>	<input type="checkbox"/> <input type="checkbox"/>	<input type="checkbox"/> <input type="checkbox"/>

A **B** **C** **D** **E** **F** **G**

HOW TO ORDER

Indicate the following information on order form:

- Quantity of each item.
- Model number, including options. See "How To Build a Model Number".
- Any special service required.

Note: • The indicates that a choice is required.

- The absence of the indicates that no choice is required.
- Alpha-numeric characters in place of indicate that no other alternatives are available.

HOW TO BUILD A MODEL NUMBER

A Select basic model.

B Select frame color.
Refer to color addendum at ki.com or KI Fabrics & Finishes binder.

C Select poly seat and back color.
Refer to color addendum at ki.com or KI Fabrics & Finishes binder.

D Select glide option.
P - Plastic glides
S - Steel glides

E Select tablet arm color.
Refer to color addendum at ki.com or KI Fabrics & Finishes binder.

F Select fire code.
NFR - Compliance to TB 117-2013
FR - Compliance to TB 133

See Upholstery Information for TB133

upcharge.

G Select upholstery grade/color.
Refer to color addendum at ki.com or KI Fabrics & Finishes binder.

UPHOLSTERY INFORMATION

C.O.M. Upholstery

C.O.M. requirement for 10 chairs or less with upholstered seat or upholstered seat and back is 3/4 yard per chair of 54" wide nondirectional fabric. For orders of 11 or more with upholstered seat and back and for complete information on ordering C.O.M. see "Ordering C.O.M., C.O.V. and C.O.L." section.

California TB133 Fire Safety Code

For California Technical Bulletin 133 compliant models, add the following upcharge:
 Model=Polypropylene
 Added List Price=\$10
 Model=Upholstered Seat
 Added List Price=\$65
 Model=Upholstered Seat and Back
 Added List Price=\$93



Stack/Nesting
Grazie® Chairs

Approx. Packaged Weight	Delivered Pricing Unupholstered	Delivered Pricing Fabric Grade 1 & C.O.M.	Delivered Pricing Fabric Grade 2	Delivered Pricing Fabric Grade 3	Delivered Pricing C.O.V.	Delivered Pricing Vinyl Group 2V	Delivered Pricing Pallas Fabric Group P0	Delivered Pricing Pallas Fabric Group P1	Delivered Pricing Pallas Fabric Group P2	Delivered Pricing Pallas Fabric Group P3	Delivered Pricing Pallas Fabric Group P4
29.0#	\$ 518										
29.0#	518										
32.0#	N/A	630	639	652	630	652	661	698	713	731	757
32.0#	N/A	630	639	652	630	652	661	698	713	731	757
34.0#	N/A	657	665	680	657	680	687	724	741	757	784
34.0#	N/A	657	665	680	657	680	687	724	741	757	784
31.0#	\$ 571										
31.0#	571										
34.0#	N/A	683	692	706	683	706	714	751	766	784	811
34.0#	N/A	683	692	706	683	706	714	751	766	784	811
35.0#	N/A	710	718	733	710	733	741	778	792	811	837
35.0#	N/A	710	718	733	710	733	741	778	792	811	837
30.0#	\$ 547										
30.0#	547										
33.0#	N/A	660	668	682	660	682	691	728	743	761	787
33.0#	N/A	660	668	682	660	682	691	728	743	761	787
35.0#	N/A	686	695	710	686	710	717	754	769	787	814
35.0#	N/A	686	695	710	686	710	717	754	769	787	814

SPECIAL SERVICES

Special Carton Marking

With specially marked information N/C



Shipping

Shipped **assembled freight prepaid f.o.b. Green Bay, Wisconsin 54302** factory. Freight class #125.

Specifications and prices are subject to change without prior notice.

Stack/Nesting

Grazie® Chairs

MODEL	Features	MODEL NUMBER						
		Basic Model	Frame Color	Seat & Back Color	Caster Type	Tablet Arm Color	Fire Code	Uph. Color
 <p>Four-Leg Flip-up Tablet Arm Chair with Casters</p> <ul style="list-style-type: none"> Ergonomic articulation (Perfect Pivot) NONSTACKING 	Poly, Left Hand, Casters	GLTAPCLH	<input type="checkbox"/> <input type="checkbox"/>	<input type="checkbox"/> <input type="checkbox"/> <input type="checkbox"/>	<input type="checkbox"/>	<input type="checkbox"/> <input type="checkbox"/>	<input type="checkbox"/> <input type="checkbox"/>	
	Poly, Right Hand, Casters	GLTAPCRH	<input type="checkbox"/> <input type="checkbox"/>	<input type="checkbox"/> <input type="checkbox"/> <input type="checkbox"/>	<input type="checkbox"/>	<input type="checkbox"/> <input type="checkbox"/>	<input type="checkbox"/> <input type="checkbox"/>	
	Uph. Seat, Left Hand, Cast.	GLTAUCLH	<input type="checkbox"/> <input type="checkbox"/>	<input type="checkbox"/> <input type="checkbox"/> <input type="checkbox"/>	<input type="checkbox"/>	<input type="checkbox"/> <input type="checkbox"/>	<input type="checkbox"/> <input type="checkbox"/>	<input type="checkbox"/> <input type="checkbox"/>
	Uph. Seat, Right Hand, Cast.	GLTAUCRH	<input type="checkbox"/> <input type="checkbox"/>	<input type="checkbox"/> <input type="checkbox"/> <input type="checkbox"/>	<input type="checkbox"/>	<input type="checkbox"/> <input type="checkbox"/>	<input type="checkbox"/> <input type="checkbox"/>	<input type="checkbox"/> <input type="checkbox"/>
	Uph. Seat/Back, Left Hand, Cast.	GLTAUBCLH	<input type="checkbox"/> <input type="checkbox"/>	<input type="checkbox"/> <input type="checkbox"/> <input type="checkbox"/>	<input type="checkbox"/>	<input type="checkbox"/> <input type="checkbox"/>	<input type="checkbox"/> <input type="checkbox"/>	<input type="checkbox"/> <input type="checkbox"/>
	Uph. Seat/Back, Right Hand, Cast.	GLTAUBCRH	<input type="checkbox"/> <input type="checkbox"/>	<input type="checkbox"/> <input type="checkbox"/> <input type="checkbox"/>	<input type="checkbox"/>	<input type="checkbox"/> <input type="checkbox"/>	<input type="checkbox"/> <input type="checkbox"/>	<input type="checkbox"/> <input type="checkbox"/>
GLP								
GLU								
GLUB								
 <p>Four-Leg Flip-up Oversize Tablet Arm Chair with Casters</p> <ul style="list-style-type: none"> Oversized tablet Ergonomic articulation (Perfect Pivot) NONSTACKING 	Poly, Left Hand, Casters	GLOVTAPCLH	<input type="checkbox"/> <input type="checkbox"/>	<input type="checkbox"/> <input type="checkbox"/> <input type="checkbox"/>	<input type="checkbox"/>	<input type="checkbox"/> <input type="checkbox"/>	<input type="checkbox"/> <input type="checkbox"/>	
	Poly, Right Hand, Casters	GLOVTAPCRH	<input type="checkbox"/> <input type="checkbox"/>	<input type="checkbox"/> <input type="checkbox"/> <input type="checkbox"/>	<input type="checkbox"/>	<input type="checkbox"/> <input type="checkbox"/>	<input type="checkbox"/> <input type="checkbox"/>	
	Uph. Seat, Left Hand, Cast.	GLOVTAUCLH	<input type="checkbox"/> <input type="checkbox"/>	<input type="checkbox"/> <input type="checkbox"/> <input type="checkbox"/>	<input type="checkbox"/>	<input type="checkbox"/> <input type="checkbox"/>	<input type="checkbox"/> <input type="checkbox"/>	<input type="checkbox"/> <input type="checkbox"/>
	Uph. Seat, Right Hand, Cast.	GLOVTAUCRH	<input type="checkbox"/> <input type="checkbox"/>	<input type="checkbox"/> <input type="checkbox"/> <input type="checkbox"/>	<input type="checkbox"/>	<input type="checkbox"/> <input type="checkbox"/>	<input type="checkbox"/> <input type="checkbox"/>	<input type="checkbox"/> <input type="checkbox"/>
	Uph. Seat/Back, Left Hand, Cast.	GLOVTAUBCLH	<input type="checkbox"/> <input type="checkbox"/>	<input type="checkbox"/> <input type="checkbox"/> <input type="checkbox"/>	<input type="checkbox"/>	<input type="checkbox"/> <input type="checkbox"/>	<input type="checkbox"/> <input type="checkbox"/>	<input type="checkbox"/> <input type="checkbox"/>
	Uph. Seat/Back, Right Hand, Cast.	GLOVTAUBCRH	<input type="checkbox"/> <input type="checkbox"/>	<input type="checkbox"/> <input type="checkbox"/> <input type="checkbox"/>	<input type="checkbox"/>	<input type="checkbox"/> <input type="checkbox"/>	<input type="checkbox"/> <input type="checkbox"/>	<input type="checkbox"/> <input type="checkbox"/>
GLP								
GLU								
GLUB								
 <p>Four-Leg Flip-and-Store (G2) Tablet Arm Chair with Casters</p> <ul style="list-style-type: none"> Ergonomic articulation (Perfect Pivot) NONSTACKING 	Poly, Left Hand, Casters	GLG2APCLH	<input type="checkbox"/> <input type="checkbox"/>	<input type="checkbox"/> <input type="checkbox"/> <input type="checkbox"/>	<input type="checkbox"/>	<input type="checkbox"/> <input type="checkbox"/>	<input type="checkbox"/> <input type="checkbox"/>	
	Poly, Right Hand, Casters	GLG2APCRH	<input type="checkbox"/> <input type="checkbox"/>	<input type="checkbox"/> <input type="checkbox"/> <input type="checkbox"/>	<input type="checkbox"/>	<input type="checkbox"/> <input type="checkbox"/>	<input type="checkbox"/> <input type="checkbox"/>	
	Uph. Seat, Left Hand, Cast.	GLG2AUCLH	<input type="checkbox"/> <input type="checkbox"/>	<input type="checkbox"/> <input type="checkbox"/> <input type="checkbox"/>	<input type="checkbox"/>	<input type="checkbox"/> <input type="checkbox"/>	<input type="checkbox"/> <input type="checkbox"/>	<input type="checkbox"/> <input type="checkbox"/>
	Uph. Seat, Right Hand, Cast.	GLG2AUCRH	<input type="checkbox"/> <input type="checkbox"/>	<input type="checkbox"/> <input type="checkbox"/> <input type="checkbox"/>	<input type="checkbox"/>	<input type="checkbox"/> <input type="checkbox"/>	<input type="checkbox"/> <input type="checkbox"/>	<input type="checkbox"/> <input type="checkbox"/>
	Uph. Seat/Back, Left Hand, Cast.	GLG2AUBCLH	<input type="checkbox"/> <input type="checkbox"/>	<input type="checkbox"/> <input type="checkbox"/> <input type="checkbox"/>	<input type="checkbox"/>	<input type="checkbox"/> <input type="checkbox"/>	<input type="checkbox"/> <input type="checkbox"/>	<input type="checkbox"/> <input type="checkbox"/>
	Uph. Seat/Back, Right Hand, Cast.	GLG2AUBCRH	<input type="checkbox"/> <input type="checkbox"/>	<input type="checkbox"/> <input type="checkbox"/> <input type="checkbox"/>	<input type="checkbox"/>	<input type="checkbox"/> <input type="checkbox"/>	<input type="checkbox"/> <input type="checkbox"/>	<input type="checkbox"/> <input type="checkbox"/>
GLP								
GLU								
GLUB								

A **B** **C** **D** **E** **F** **G**

HOW TO ORDER

Indicate the following information on order form:

- Quantity of each item.
- Model number, including options. See "How To Build a Model Number".
- Any special service required.

Note: • The indicates that a choice is required.

- The absence of the indicates that no choice is required.
- Alpha-numeric characters in place of indicate that no other alternatives are available.

HOW TO BUILD A MODEL NUMBER

upcharge.

- A** Select basic model.
- B** Select frame color.
Refer to color addendum at ki.com or KI Fabrics & Finishes binder.
- C** Select poly seat and back color.
Refer to color addendum at ki.com or KI Fabrics & Finishes binder.
- D** Select casters.

C	- Carpet casters
S	- Hard floor casters
- E** Select tablet arm color.
Refer to color addendum at ki.com or KI Fabrics & Finishes binder.
- F** Select fire code.

NFR	- Compliance to TB 117-2013
FR	- Compliance to TB 133
- G** Select upholstery grade/color.
Refer to color addendum at ki.com or KI Fabrics & Finishes binder.

See Upholstery Information for TB133

UPHOLSTERY INFORMATION

C.O.M. Upholstery

C.O.M. requirement for 10 chairs or less with upholstered seat or upholstered seat and back is 3/4 yard per chair of 54" wide nondirectional fabric. For orders of 11 or more with upholstered seat and back and for complete information on ordering C.O.M. see "Ordering C.O.M., C.O.V. and C.O.L." section.

California TB133 Fire Safety Code

For California Technical Bulletin 133 compliant models, add the following upcharge:
 Model=Polypropylene
 Added List Price=\$10
 Model=Upholstered Seat
 Added List Price=\$65
 Model=Upholstered Seat and Back
 Added List Price=\$93



Stack/Nesting

Grazie® Chairs

Approx. Packaged Weight	Delivered Pricing Unupholstered	Delivered Pricing Fabric Grade 1 & C.O.M.	Delivered Pricing Fabric Grade 2	Delivered Pricing Fabric Grade 3	Delivered Pricing C.O.V.	Delivered Pricing Vinyl Group 2V	Delivered Pricing Pallas Fabric Group P0	Delivered Pricing Pallas Fabric Group P1	Delivered Pricing Pallas Fabric Group P2	Delivered Pricing Pallas Fabric Group P3	Delivered Pricing Pallas Fabric Group P4
30.0#	\$ 538										
30.0#	538										
33.0#	N/A	650	659	673	650	673	681	718	734	751	778
33.0#	N/A	650	659	673	650	673	681	718	734	751	778
34.0#	N/A	677	685	700	677	700	709	746	761	779	804
34.0#	N/A	677	685	700	677	700	709	746	761	779	804

31.0#	\$ 591										
31.0#	591										
34.0#	N/A	703	712	726	703	726	734	771	786	804	830
34.0#	N/A	703	712	726	703	726	734	771	786	804	830
36.0#	N/A	730	739	753	730	753	762	799	814	832	857
36.0#	N/A	730	739	753	730	753	762	799	814	832	857

31.0#	\$ 568										
31.0#	568										
34.0#	N/A	680	688	702	680	702	711	748	763	781	808
34.0#	N/A	680	688	702	680	702	711	748	763	781	808
35.0#	N/A	707	715	730	707	730	739	776	786	809	834
35.0#	N/A	707	715	730	707	730	739	776	786	809	834

SPECIAL SERVICES

Special Carton Marking

With specially marked information N/C



Shipping

Shipped **assembled freight prepaid f.o.b. Green Bay, Wisconsin 54302** factory. Freight class #125.

Specifications and prices are subject to change without prior notice.

Stack/Nesting

Grazie® Chairs

	MODEL	Features	MODEL NUMBER						Approx. Packaged Weight
			Basic Model	Frame Color	Seat & Back Color	Glide Option	Fire Code	Upholstery Color	
 <p>GSP GSU GSUB</p>	Sled Base Armless Chair • Ergonomic articulation (Perfect Pivot) • Stacking	Polypropylene	GSNAP	<input type="checkbox"/> <input type="checkbox"/>	<input type="checkbox"/> <input type="checkbox"/> <input type="checkbox"/> <input type="checkbox"/>	<input type="checkbox"/> <input type="checkbox"/> <input type="checkbox"/> <input type="checkbox"/>	<input type="checkbox"/> <input type="checkbox"/> <input type="checkbox"/> <input type="checkbox"/>	<input type="checkbox"/> <input type="checkbox"/> <input type="checkbox"/> <input type="checkbox"/> <input type="checkbox"/> <input type="checkbox"/>	25.0#
		Upholstered Seat	GSNAU	<input type="checkbox"/> <input type="checkbox"/>	<input type="checkbox"/> <input type="checkbox"/> <input type="checkbox"/> <input type="checkbox"/>	<input type="checkbox"/> <input type="checkbox"/> <input type="checkbox"/> <input type="checkbox"/>	<input type="checkbox"/> <input type="checkbox"/> <input type="checkbox"/> <input type="checkbox"/>	<input type="checkbox"/> <input type="checkbox"/> <input type="checkbox"/> <input type="checkbox"/> <input type="checkbox"/> <input type="checkbox"/>	28.0#
		Upholstered Seat/Back	GSNAUB	<input type="checkbox"/> <input type="checkbox"/>	<input type="checkbox"/> <input type="checkbox"/> <input type="checkbox"/> <input type="checkbox"/>	<input type="checkbox"/> <input type="checkbox"/> <input type="checkbox"/> <input type="checkbox"/>	<input type="checkbox"/> <input type="checkbox"/> <input type="checkbox"/> <input type="checkbox"/>	<input type="checkbox"/> <input type="checkbox"/> <input type="checkbox"/> <input type="checkbox"/> <input type="checkbox"/> <input type="checkbox"/>	30.0#
 <p>GSP GSU GSUB</p>	Sled Base Cantilever Armchair • Ergonomic articulation (Perfect Pivot) • Stacking	Polypropylene	GSCAP	<input type="checkbox"/> <input type="checkbox"/>	<input type="checkbox"/> <input type="checkbox"/> <input type="checkbox"/> <input type="checkbox"/>	<input type="checkbox"/> <input type="checkbox"/> <input type="checkbox"/> <input type="checkbox"/>	<input type="checkbox"/> <input type="checkbox"/> <input type="checkbox"/> <input type="checkbox"/>	<input type="checkbox"/> <input type="checkbox"/> <input type="checkbox"/> <input type="checkbox"/> <input type="checkbox"/> <input type="checkbox"/>	27.0#
		Upholstered Seat	GSCAU	<input type="checkbox"/> <input type="checkbox"/>	<input type="checkbox"/> <input type="checkbox"/> <input type="checkbox"/> <input type="checkbox"/>	<input type="checkbox"/> <input type="checkbox"/> <input type="checkbox"/> <input type="checkbox"/>	<input type="checkbox"/> <input type="checkbox"/> <input type="checkbox"/> <input type="checkbox"/>	<input type="checkbox"/> <input type="checkbox"/> <input type="checkbox"/> <input type="checkbox"/> <input type="checkbox"/> <input type="checkbox"/>	30.0#
		Upholstered Seat/Back	GSCAUB	<input type="checkbox"/> <input type="checkbox"/>	<input type="checkbox"/> <input type="checkbox"/> <input type="checkbox"/> <input type="checkbox"/>	<input type="checkbox"/> <input type="checkbox"/> <input type="checkbox"/> <input type="checkbox"/>	<input type="checkbox"/> <input type="checkbox"/> <input type="checkbox"/> <input type="checkbox"/>	<input type="checkbox"/> <input type="checkbox"/> <input type="checkbox"/> <input type="checkbox"/> <input type="checkbox"/> <input type="checkbox"/>	32.0#
				A	B	C	D	E	F

HOW TO ORDER

Indicate the following information on order form:

- Quantity of each item.
- Model number, including options. See "How To Build a Model Number".
- Any special service required.

Note: • The indicates that a choice is required.

- The absence of the indicates that no choice is required.
- Alpha-numeric characters in place of indicate that no other alternatives are available.

HOW TO BUILD A MODEL NUMBER

A Select basic model.

B Select frame color.
Refer to color addendum at ki.com or KI Fabrics & Finishes binder.

C Select poly seat and back color.
Refer to color addendum at ki.com or KI Fabrics & Finishes binder.

D Select glide option.

NGL	- No glides
GNM	- Non-marring glides
GNS	- Non-skid glides
GBL	- Black plastic glides
GSS	- Stainless steel glide

E Select fire code.

NFR	- Compliance to TB 117-2013
FR	- Compliance to TB 133

See Upholstery Information for TB133 upcharge.

F Select upholstery grade/color.
Refer to color addendum at ki.com or KI Fabrics & Finishes binder.

UPHOLSTERY INFORMATION

C.O.M. Upholstery

C.O.M. requirement for 10 chairs or less with upholstered seat or upholstered seat and back is 3/4 yard per chair of 54" wide nondirectional fabric. For orders of 11 or more with upholstered seat and back and for complete information on ordering C.O.M. see "Ordering C.O.M., C.O.V. and C.O.L." section.

California TB133 Fire Safety Code

For California Technical Bulletin 133 compliant models, add the following upcharge:
 Model=Polypropylene
 Added List Price=\$10
 Model=Upholstered Seat
 Added List Price=\$65
 Model=Upholstered Seat and Back
 Added List Price=\$93



Stack/Nesting

Grazie® Chairs

Delivered Pricing Unupholstered	Delivered Pricing Fabric Grade 1 & C.O.M.	Delivered Pricing Fabric Grade 2	Delivered Pricing Fabric Grade 3	Delivered Pricing C.O.V.	Delivered Pricing Vinyl Group 2V	Delivered Pricing Pallas Fabric Group P0	Delivered Pricing Pallas Fabric Group P1	Delivered Pricing Pallas Fabric Group P2	Delivered Pricing Pallas Fabric Group P3	Delivered Pricing Pallas Fabric Group P4	
\$ 328	N/A	440	449	462	440	462	471	508	523	541	568
	N/A	467	475	490	467	490	499	536	551	569	594
\$ 433	N/A	545	554	568	545	568	577	614	629	647	673
	N/A	572	580	595	572	595	603	640	655	673	699

SPECIAL SERVICES

Special Carton Marking

With specially marked information N/C



Shipping

Shipped **assembled freight prepaid f.o.b. Green Bay, Wisconsin 54302** factory. Freight class #125.

Specifications and prices are subject to change without prior notice.

Stack/Nesting

Grazie® Chairs

MODEL	Features	MODEL NUMBER						
		Basic Model	Frame Color	Seat & Back Color	Glide Option	Tablet Arm Color	Fire Code	Uph. Color
 <p>Sled Base Flip-up Tablet Arm Chair</p> <ul style="list-style-type: none"> Ergonomic articulation (Perfect Pivot) NONSTACKING 	Polypropylene, Left Hand	GSTAPLH	<input type="checkbox"/>	<input type="checkbox"/>	<input type="checkbox"/>	<input type="checkbox"/>	<input type="checkbox"/>	
	Polypropylene, Right Hand	GSTAPRH	<input type="checkbox"/>	<input type="checkbox"/>	<input type="checkbox"/>	<input type="checkbox"/>	<input type="checkbox"/>	
	Uph. Seat, Left Hand	GSTAULH	<input type="checkbox"/>	<input type="checkbox"/>	<input type="checkbox"/>	<input type="checkbox"/>	<input type="checkbox"/>	<input type="checkbox"/>
	Uph. Seat, Right Hand	GSTAURH	<input type="checkbox"/>	<input type="checkbox"/>	<input type="checkbox"/>	<input type="checkbox"/>	<input type="checkbox"/>	<input type="checkbox"/>
	Uph. Seat/Back, Left Hand	GSTAUBLH	<input type="checkbox"/>	<input type="checkbox"/>	<input type="checkbox"/>	<input type="checkbox"/>	<input type="checkbox"/>	<input type="checkbox"/>
	Uph. Seat/Back, Right Hand	GSTAUBRH	<input type="checkbox"/>	<input type="checkbox"/>	<input type="checkbox"/>	<input type="checkbox"/>	<input type="checkbox"/>	<input type="checkbox"/>
GSP								
GSU								
GSUB								
 <p>Sled Base Flip-up Oversize Tablet Arm Chair</p> <ul style="list-style-type: none"> Oversized tablet Ergonomic articulation (Perfect Pivot) NONSTACKING 	Polypropylene, Left Hand	GSOVTAPLH	<input type="checkbox"/>	<input type="checkbox"/>	<input type="checkbox"/>	<input type="checkbox"/>	<input type="checkbox"/>	
	Polypropylene, Right Hand	GSOVTAPRH	<input type="checkbox"/>	<input type="checkbox"/>	<input type="checkbox"/>	<input type="checkbox"/>	<input type="checkbox"/>	
	Uph. Seat, Left Hand	GSOVTAULH	<input type="checkbox"/>	<input type="checkbox"/>	<input type="checkbox"/>	<input type="checkbox"/>	<input type="checkbox"/>	<input type="checkbox"/>
	Uph. Seat, Right Hand	GSOVTAURH	<input type="checkbox"/>	<input type="checkbox"/>	<input type="checkbox"/>	<input type="checkbox"/>	<input type="checkbox"/>	<input type="checkbox"/>
	Uph. Seat/Back, Left Hand	GSOVTAUBLH	<input type="checkbox"/>	<input type="checkbox"/>	<input type="checkbox"/>	<input type="checkbox"/>	<input type="checkbox"/>	<input type="checkbox"/>
	Uph. Seat/Back, Right Hand	GSOVTAUBRH	<input type="checkbox"/>	<input type="checkbox"/>	<input type="checkbox"/>	<input type="checkbox"/>	<input type="checkbox"/>	<input type="checkbox"/>
GSP								
GSU								
GSUB								
 <p>Sled Base Flip-and-Store (G2) Tablet Arm Chair</p> <ul style="list-style-type: none"> Ergonomic articulation (Perfect Pivot) NONSTACKING 	Polypropylene, Left Hand	GSG2APLH	<input type="checkbox"/>	<input type="checkbox"/>	<input type="checkbox"/>	<input type="checkbox"/>	<input type="checkbox"/>	
	Polypropylene, Right Hand	GSG2APRH	<input type="checkbox"/>	<input type="checkbox"/>	<input type="checkbox"/>	<input type="checkbox"/>	<input type="checkbox"/>	
	Uph. Seat, Left Hand	GSG2AULH	<input type="checkbox"/>	<input type="checkbox"/>	<input type="checkbox"/>	<input type="checkbox"/>	<input type="checkbox"/>	<input type="checkbox"/>
	Uph. Seat, Right Hand	GSG2AURH	<input type="checkbox"/>	<input type="checkbox"/>	<input type="checkbox"/>	<input type="checkbox"/>	<input type="checkbox"/>	<input type="checkbox"/>
	Uph. Seat/Back, Left Hand	GSG2AUBLH	<input type="checkbox"/>	<input type="checkbox"/>	<input type="checkbox"/>	<input type="checkbox"/>	<input type="checkbox"/>	<input type="checkbox"/>
	Uph. Seat/Back, Right Hand	GSG2AUBRH	<input type="checkbox"/>	<input type="checkbox"/>	<input type="checkbox"/>	<input type="checkbox"/>	<input type="checkbox"/>	<input type="checkbox"/>
GSP								
GSU								
GSUB								

A **B** **C** **D** **E** **F** **G**

HOW TO ORDER

Indicate the following information on order form:

- Quantity of each item.
- Model number, including options. See "How To Build a Model Number".
- Any special service required.

Note: • The indicates that a choice is required.

- The absence of the indicates that no choice is required.
- Alpha-numeric characters in place of indicate that no other alternatives are available.

HOW TO BUILD A MODEL NUMBER

- A** Select basic model.
- B** Select frame color.
Refer to color addendum at ki.com or KI Fabrics & Finishes binder.
- C** Select poly seat and back color.
Refer to color addendum at ki.com or KI Fabrics & Finishes binder.
- D** Select glide option.
- | | |
|------------|-------------------------|
| NGL | - No glides |
| GNM | - Non-marring glides |
| GNS | - Non-skid glides |
| GBL | - Black plastic glides |
| GSS | - Stainless steel glide |
- E** Select tablet arm color.
Refer to color addendum at ki.com or KI Fabrics & Finishes binder.
- F** Select fire code.
NFR - Compliance to TB 117-2013

FR - Compliance to TB 133

See Upholstery Information for TB133 upcharge.

- G** Select upholstery grade/color.
Refer to color addendum at ki.com or KI Fabrics & Finishes binder.

UPHOLSTERY INFORMATION

C.O.M. Upholstery

C.O.M. requirement for 10 chairs or less with upholstered seat or upholstered seat and back is 3/4 yard per chair of 54" wide nondirectional fabric. For orders of 11 or more with upholstered seat and back and for complete information on ordering C.O.M. see "Ordering C.O.M., C.O.V. and C.O.L." section.

California TB133 Fire Safety Code

For California Technical Bulletin 133 compliant models, add the following upcharge:
 Model=Polypropylene
 Added List Price=\$10
 Model=Upholstered Seat
 Added List Price=\$65
 Model=Upholstered Seat and Back
 Added List Price=\$93



Stack/Nesting

Grazie® Chairs

Approx. Packaged Weight	Delivered Pricing Unupholstered	Delivered Pricing Fabric Grade 1 & C.O.M.	Delivered Pricing Fabric Grade 2	Delivered Pricing Fabric Grade 3	Delivered Pricing C.O.V.	Delivered Pricing Vinyl Group 2V	Delivered Pricing Pallas Fabric Group P0	Delivered Pricing Pallas Fabric Group P1	Delivered Pricing Pallas Fabric Group P2	Delivered Pricing Pallas Fabric Group P3	Delivered Pricing Pallas Fabric Group P4
31.0#	\$ 528										
31.0#	528										
34.0#	N/A	641	649	663	641	663	672	709	723	742	768
34.0#	N/A	641	649	663	641	663	672	709	723	742	768
36.0#	N/A	667	676	691	667	691	698	735	751	768	794
36.0#	N/A	667	676	691	667	691	698	735	751	768	794
33.0#	\$ 581										
33.0#	581										
36.0#	N/A	694	702	716	694	716	724	762	777	794	821
36.0#	N/A	694	702	716	694	716	724	762	777	794	821
37.0#	N/A	720	729	744	720	744	751	788	803	821	848
37.0#	N/A	720	729	744	720	744	751	788	803	821	848
32.0#	\$ 558										
32.0#	558										
35.0#	N/A	671	679	693	671	693	701	739	753	771	798
35.0#	N/A	671	679	693	671	693	701	739	753	771	798
37.0#	N/A	697	706	720	697	720	728	765	780	798	824
37.0#	N/A	697	706	720	697	720	728	765	780	798	824

SPECIAL SERVICES

Special Carton Marking

With specially marked information N/C

Shipping

Shipped **assembled freight prepaid f.o.b. Green Bay, Wisconsin 54302** factory. Freight class #125.

Specifications and prices are subject to change without prior notice.

Stack/Nesting

Grazie® Chairs

	MODEL NUMBER	
	Basic Model	Approx. Packaged Weight
 <p>MODEL</p> <p>Transport Dolly</p> <ul style="list-style-type: none"> • Easy maneuverability with 5" casters: two fixed, two swivel • Rugged weld tubular steel frame • Black powder-coat finish 	GCD.BL	32.0#

HRDPT

A

HOW TO ORDER

Indicate the following information on order form:

1. Quantity of each item.
2. Model number, including options. See "How To Build a Model Number".
3. Any special service required.

Note: • The indicates that a choice is required.

- The absence of the indicates that no choice is required.
- Alpha-numeric characters in place of indicate that no other alternatives are available.

HOW TO BUILD A MODEL NUMBER

A Select basic model.



Delivered
Pricing
\$ 402

SPECIAL SERVICES

Special Carton Marking

With specially marked information N/C



Shipping

Shipped **assembled freight prepaid f.o.b.**
Green Bay, Wisconsin 54302 factory.
Freight class #125.

Specifications and prices are subject to
change without prior notice.

Stack/Nesting

Grazie® Cafe Stools

	MODEL	Features	MODEL NUMBER						
			Basic Model	Seat Height	Frame Color	Seat & Back Color	Glide Option	Fire Code	Upholstery Color
 <p>GLSP GLSU GLSUB</p>	Four-Leg Armless Cafe Stool • Ergonomic articulation (Perfect Pivot) • Stacking • Two seat heights	Polypropylene	GLSNAP	<input type="checkbox"/> <input type="checkbox"/>	<input type="checkbox"/> <input type="checkbox"/>	<input type="checkbox"/> <input type="checkbox"/> <input type="checkbox"/> <input type="checkbox"/>	<input type="checkbox"/>	<input type="checkbox"/> <input type="checkbox"/>	
		Upholstered Seat	GLSNAU	<input type="checkbox"/> <input type="checkbox"/>	<input type="checkbox"/> <input type="checkbox"/>	<input type="checkbox"/> <input type="checkbox"/> <input type="checkbox"/> <input type="checkbox"/>	<input type="checkbox"/>	<input type="checkbox"/> <input type="checkbox"/>	<input type="checkbox"/> <input type="checkbox"/> <input type="checkbox"/> <input type="checkbox"/> <input type="checkbox"/> <input type="checkbox"/>
		Upholstered Seat/Back	GLSNAUB	<input type="checkbox"/> <input type="checkbox"/>	<input type="checkbox"/> <input type="checkbox"/>	<input type="checkbox"/> <input type="checkbox"/> <input type="checkbox"/> <input type="checkbox"/>	<input type="checkbox"/>	<input type="checkbox"/> <input type="checkbox"/>	<input type="checkbox"/> <input type="checkbox"/> <input type="checkbox"/> <input type="checkbox"/> <input type="checkbox"/> <input type="checkbox"/>
 <p>GLSP GLSU GLSUB</p>	Four-Leg Cantilever Arm Cafe Stool • Ergonomic articulation (Perfect Pivot) • Stacking • Two seat heights	Polypropylene	GLSCAP	<input type="checkbox"/> <input type="checkbox"/>	<input type="checkbox"/> <input type="checkbox"/>	<input type="checkbox"/> <input type="checkbox"/> <input type="checkbox"/> <input type="checkbox"/>	<input type="checkbox"/>	<input type="checkbox"/> <input type="checkbox"/>	
		Upholstered Seat	GLSCAU	<input type="checkbox"/> <input type="checkbox"/>	<input type="checkbox"/> <input type="checkbox"/>	<input type="checkbox"/> <input type="checkbox"/> <input type="checkbox"/> <input type="checkbox"/>	<input type="checkbox"/>	<input type="checkbox"/> <input type="checkbox"/>	<input type="checkbox"/> <input type="checkbox"/> <input type="checkbox"/> <input type="checkbox"/> <input type="checkbox"/> <input type="checkbox"/>
		Upholstered Seat/Back	GLSCAUB	<input type="checkbox"/> <input type="checkbox"/>	<input type="checkbox"/> <input type="checkbox"/>	<input type="checkbox"/> <input type="checkbox"/> <input type="checkbox"/> <input type="checkbox"/>	<input type="checkbox"/>	<input type="checkbox"/> <input type="checkbox"/>	<input type="checkbox"/> <input type="checkbox"/> <input type="checkbox"/> <input type="checkbox"/> <input type="checkbox"/> <input type="checkbox"/>

A **B** **C** **D** **E** **F** **G**

HOW TO ORDER

Indicate the following information on order form:

- Quantity of each item.
- Model number, including options. See "How To Build a Model Number".
- Any special service required.

Note: • The indicates that a choice is required.

- The absence of the indicates that no choice is required.
- Alpha-numeric characters in place of indicate that no other alternatives are available.

HOW TO BUILD A MODEL NUMBER

- A** Select basic model.
- B** Select seat height.
 24 _____ - 24" Seat Height
 30 _____ - 30" Seat Height
- C** Select frame color.
 Refer to color addendum at ki.com or KI Fabrics & Finishes binder.
- D** Select poly seat and back color.
 Refer to color addendum at ki.com or KI Fabrics & Finishes binder.
- E** Select glide option.
 P _____ - Plastic glides
 S _____ - Steel glides
- F** Select fire code.
 NFR _____ - Compliance to TB 117-2013
 FR _____ - Compliance to TB 133

upcharge.

- G** Select upholstery grade/color.
 Refer to color addendum at ki.com or KI Fabrics & Finishes binder.

See Upholstery Information for TB133



Approx. Packaged Weight	Delivered Pricing Unupholstered	Delivered Pricing Fabric Grade 1 & C.O.M.	Delivered Pricing Fabric Grade 2	Delivered Pricing Fabric Grade 3	Delivered Pricing C.O.V.	Delivered Pricing Vinyl Group 2V	Delivered Pricing Pallas Fabric Group P0	Delivered Pricing Pallas Fabric Group P1	Delivered Pricing Pallas Fabric Group P2	Delivered Pricing Pallas Fabric Group P3	Delivered Pricing Pallas Fabric Group P4
32.0#	\$ 434										
35.0#	N/A	546	555	569	546	569	577	614	629	647	674
37.0#	N/A	573	581	596	573	596	605	642	657	675	700
35.0#	\$ 539										
38.0#	N/A	651	660	674	651	674	683	720	735	753	779
40.0#	N/A	678	686	701	678	701	709	746	761	779	805

UPHOLSTERY INFORMATION

C.O.M. Upholstery

C.O.M. requirement for 10 chairs or less with upholstered seat or upholstered seat and back is 3/4 yard per chair of 54" wide nondirectional fabric. For orders of 11 or more with upholstered seat and back and for complete information on ordering C.O.M. see "Ordering C.O.M., C.O.V. and C.O.L." section.

California TB133 Fire Safety Code

For California Technical Bulletin 133 compliant models, add the following upcharge:
 Model=Polypropylene
 Added List Price=\$10
 Model=Upholstered Seat
 Added List Price=\$65
 Model=Upholstered Seat and Back
 Added List Price=\$93

SPECIAL SERVICES

Special Carton Marking

With specially marked information N/C

Shipping

Shipped **assembled freight prepaid f.o.b. Green Bay, Wisconsin 54302** factory. Freight class #125.

Specifications and prices are subject to change without prior notice.

Stack/Nesting

Maestro® General Information



Stacking Chair (MSP)



Stacking Chair with Fixed Seat/Back Cushion (MSUSB)



Tablet Arm Chair (MSP/MSTL.CH)



Transport Dolly

Features				
Stackable	•	•		
Ganging	•	•		
Polypropylene seat and back	•	•	•	
Upholstered seat and back fixed cushion		•		
General Dimensions				
Seat width	18"	18"	18"	
Seat depth	17-1/2"	17-1/2"	17-1/2"	
Seat height	17-1/2"	18"	17-1/2"	
Floor to back height	31-1/2"	31-1/2"	31-1/2"	
Overall Dimensions				
Width	19-1/4"	19-1/4"	19-1/4"	22-3/8"
Depth	21-1/4"	21-1/4"	21-1/4"	25-5/8"
Ganging on center	20"	20"	20"	
Stacking on Dolly				
Width	23"	23"		
Depth	42"	42"		
Quantity/height	38 Chairs/80" High	15 Chairs/80" High		
Stacking on Floor				
Width	19-1/4"	19-1/4"		
Depth	31"	31"		
Quantity/height	10 Chairs/38-3/4" High	10 Chairs/38-3/4" High		

SPECIFICATIONS

Seat and Backrest

Injection-molded polypropylene seat and back. Back features a contoured handle for easy lifting and stacking.

Chair Frame

7/16" solid steel rod in bright nickel-chrome or with electrostatically-applied epoxy.

Bright Chrome Finish

Surfaces are duplex nickel-chrome plated in a twenty-one step process.

Powder-Coated Finish

Electrostatically-applied epoxy, baked onto surface. Stacking powder-coated frames is not recommended.

Transport Dolly

Tubular and plate steel welded together. 5" casters: two fixed, two swivel. Powder-coated finish.

Tablet Arm

7/16" solid steel rod frame, hinged tablet for easy access. Standard size has resin core; high pressure laminate surface. Round tablet edge with clear lacquer finish. Bright chrome frame only. Chairs are nonstacking when attached, not available for use with powder-coated frame chairs. Tablet flips up for easy access. Seating clearance is 14". Tablet is 20-1/2" long and 12" wide. Ganging with tablet is not recommended.

Seat and Back Pads

Fixed seat and back pads consist of a 3/16" thick plywood board with threaded inserts for attachment. The boards are covered in 1/2" foam padding and wrapped with fabric. The pads are attached to the seat and back with screws into the threaded fasteners.

INFORMATION

C.O.M. Testing and Production Requirements

Not all materials are suitable for upholstering this product. A 1 yd. x 54" sample must be submitted and approved prior to acceptance of an order. Upholstered chairs must be tested separately. If the fabric is directional in pattern or weave, the direction must be indicated on the submitted sample, and additional yardage may be requested. Customer's own vinyl and KI's 2V cannot be used on the MXU Matrix® model (upholstered seat/back, no cushion) but can be used on fixed cushion models.

Test samples must be sent to:

KI
Attn: C.O.M. Specialist
1687 Westminster Drive - Gate 3
Green Bay, WI 54302

Fabric Disclaimer

Fabric will be applied as swatched by the fabric manufacturer. Fabric that is required to be applied differently than is swatched will need a Special Cost Request written specifying the direction the fabric is to be applied. The posted standard lead time will apply to the Special Cost Request.





INFORMATION

Warranty
Refer to KI Terms & Conditions document
or visit ki.com

Stack/Nesting

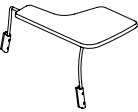
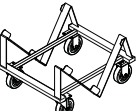
Maestro®

MODEL	Features	MODEL NUMBER							
		Basic Model	Glide Option	Frame Color	Seat & Back Color	Fire Code	Upholstery Color	Tablet Arm Color	
 <p>MSP MSUS MSUSB</p>	Stack Chair • Polypropylene seat and backrest • Polypropylene seat and back with upholstered seat cushion • Polypropylene seat and back with upholstered cushion on seat and back • Steel rod frame in chrome or colors • 38 chairs on the dolly stack to 80" high	Polypropylene	MSP	<input type="checkbox"/> <input type="checkbox"/>	<input type="checkbox"/> <input type="checkbox"/>	<input type="checkbox"/> <input type="checkbox"/> <input type="checkbox"/> <input type="checkbox"/>	<input type="checkbox"/> <input type="checkbox"/> <input type="checkbox"/> <input type="checkbox"/>		
	Fixed Seat Cushion	MSUS	<input type="checkbox"/> <input type="checkbox"/>	<input type="checkbox"/> <input type="checkbox"/>	<input type="checkbox"/> <input type="checkbox"/> <input type="checkbox"/> <input type="checkbox"/>	<input type="checkbox"/> <input type="checkbox"/> <input type="checkbox"/> <input type="checkbox"/>	<input type="checkbox"/> <input type="checkbox"/> <input type="checkbox"/> <input type="checkbox"/> <input type="checkbox"/> <input type="checkbox"/>		
	Fixed Seat/Back Cushion	MSUSB	<input type="checkbox"/> <input type="checkbox"/>	<input type="checkbox"/> <input type="checkbox"/>	<input type="checkbox"/> <input type="checkbox"/> <input type="checkbox"/> <input type="checkbox"/>	<input type="checkbox"/> <input type="checkbox"/> <input type="checkbox"/> <input type="checkbox"/>	<input type="checkbox"/> <input type="checkbox"/> <input type="checkbox"/> <input type="checkbox"/>		
 <p>MST</p>	Standard Flip-Up Tablet Arm • NONSTACKING • 12" wide X 20-1/2" deep • Field installable • For use ONLY on chrome framed chairs	Left Hand	MSTARM/STD/L					<input type="checkbox"/> <input type="checkbox"/> <input type="checkbox"/>	
	Right Hand	MSTARM/STD/R					<input type="checkbox"/> <input type="checkbox"/> <input type="checkbox"/>		
 <p>HRDPT</p>	Transport Dolly for Poly Chairs • Accommodates up to 38 chairs at a height of 80" • Easy maneuverability with 5" casters; two fixed, two swivel • Black powder-coated finish • 38 plastic seat chairs stacked on the dolly occupy a space: 23" wide, 42" deep, 80" high		CSD.BL						
 <p>HRDPT</p>	Transport Dolly for Upholstered Chairs • Accommodates up to 15 chairs at a height of 80" • Easy maneuverability with 5" casters; two fixed, two swivel • Black powder-coated finish • 15 upholstered chairs stacked on the dolly occupy a space: 23" wide, 42" deep, 80" high		MFSD.BL						

A **B** **C** **D** **E** **F** **G**

HOW TO ORDER

Indicate the following information on order form:

- Quantity of each item.
- Model number, including options. See "How To Build a Model Number".
- Any special service required.

Note: • The indicates that a choice is required.
 • The absence of the indicates that no choice is required.
 • Alpha-numeric characters in place of indicate that no other alternatives are available.

HOW TO BUILD A MODEL NUMBER

- A** Select basic model.

- B** Select glide option.
NG - No glides
G - Ganging polycarbonate glides; add \$5
GS - Ganging steel glides; add \$5
H - Polycarbonate glides; add \$5
NS - PVC non-skid glides; add \$5
S - Stainless steel glides; add \$5
- C** Select frame color.
 Refer to color addendum at ki.com or KI Fabrics & Finishes binder.
- D** Select seat and back color.
 Refer to color addendum at ki.com or KI Fabrics & Finishes binder.
- E** Select fire code.
NFR - Compliance to TB 117-2013
FR - Compliance to TB 133

- F** Select upholstery grade/color.
 Refer to color addendum at ki.com or KI Fabrics & Finishes binder.
- G** Select tablet arm color.
 Refer to color addendum at ki.com or KI Fabrics & Finishes binder.

OPTIONS

California TB133 Fire Safety Code
 For California Technical Bulletin 133 compliant models, add the following upcharge:
 Model=Polypropylene
 Added Lead Time=1 week
 Added List Price=\$24
 Model=Uph. Seat Pad Only
 Added Lead Time=N/A
 Added List Price=\$68
 Model=Uph. Seat/Back Pad
 Added Lead Time=N/A
 Added List Price=\$82



Approx. Packaged Weight	Delivered Pricing Unupholstered	Delivered Pricing Fabric Grade 1 & C.O.M.	Delivered Pricing Fabric Grade 2	Delivered Pricing Fabric Grade 3	Delivered Pricing Pallas Fabric Group P0	Delivered Pricing Pallas Fabric Group P1	Delivered Pricing Pallas Fabric Group P2	Delivered Pricing Pallas Fabric Group P3	Delivered Pricing Pallas Fabric Group P4
16.0#	\$ 151								
18.0#	N/A	225	239	247	246	256	276	289	309
20.0#	N/A	317	342	356	331	379	410	435	465

9.0#	\$ 177
9.0#	177

30.0#	\$ 416
-------	--------

30.0#	\$ 416
-------	--------

UPHOLSTERY INFORMATION

C.O.M. Upholstery

C.O.M. requirement for 10 chairs or less with upholstered seat or upholstered seat and back is 3/4 yard per chair of 54" wide nondirectional fabric. Requirement for orders of 11 or more with upholstered seat only is 1/2 yard per chair. For orders of 11 or more with upholstered seat and back and for complete information on ordering C.O.M. see "Ordering C.O.M., C.O.V. and C.O.L." section.

SPECIAL SERVICES

Special Carton Marking

With specially marked information N/C

Shipping

Shipped **assembled freight prepaid f.o.b. Green Bay, Wisconsin 54302** factory. Freight class #125.

Specifications and prices are subject to change without prior notice.

Stack/Nesting

Matrix® General Information



Armless Stacking Chair (MX)



Armless Stacking Chair with Fixed Seat/Back Cushion (MXFSB)



Stacking Armchair (MXA)

Features			
Ganging	•	•	
Polypropylene seat and back	•		•
Upholstered seat and back fixed cushion		•	
Overall Dimensions			
Width	18-7/8" (26" With Arm)	18-7/8" (26" With Arm)	18-7/8" (26" With Arm)
Depth	21-3/4"	21-3/4"	21-3/4"
Height	32-1/2"	32-1/2"	32-1/2"
Seat height	18"	18"	18"
Stacking on Dolly			
Polypropylene seat	45 Chairs/79" High		45 Chairs/79" High
Upholstered seat, no cushion	22 Chairs/54" High		22 Chairs/54" High
Fixed seat		15 Chairs/60" High	15 Chairs/60" High
Fixed seat and back		16 Chairs/63-1/2" High	16 Chairs/63-1/2" High
Depth	37-1/2"	37-1/2"	37-1/2"
Stacking on Floor			
Polypropylene seat	15 Chairs/42" High		15 Chairs/42" High



Tablet Arm

SPECIFICATIONS

Plastic Seats, Backrests and Armcaps
Injection-molded polypropylene.

Upholstery

"Fixed Seat and/or Back Cushions" have padded fabric only on the seat and on the front of the back. Both the seat and front of the back have plastic exposed around the cushions.

Chair Frame

7/16" solid steel rod, bright duplex nickel chrome. Optional with electrostatically-applied epoxy (not recommended on tablet arm models).

Tablet Arm

7/16" solid steel rod frame, hinged tablet for easy access. Standard size has resin core; high-pressure laminate surface. Round tablet edge with clear lacquer finish. Oversized has plywood core with clear lacquered edges. Black has black painted

edges. Bright chrome frame only. Chairs are nonstacking when attached, not available for use with powder-coated frame chairs. Tablet flips up for easy access. Seating clearance is 14" for standard and oversized tablet arms. Standard tablet is 20-1/2" long and 12" wide. Oversized tablet is 20-1/2" long and 17" wide. Ganging with tablet is not recommended.

Tablet Arm on Upholstered Chair

It is recommended that the tablet arm not be removed after it is affixed to the chair.

Bright Chrome Finish

Surfaces are duplex nickel-chrome plated in a twenty-one step process.

Powder-Coated Finish

Electrostatically-applied epoxy, baked onto surface. Stacking and use of tablet arms on powder-coated frames not recommended.

Stacking Vinyl, Polyurethane, and Imitation Leather Upholstered Chairs

It is recommended that chairs to be stacked be covered in material other than vinyl, polyurethane, or imitation leather as an impression in the seat may result. KI does not warrant the effects of stacking on stock or C.O.M. vinyl, polyurethane, or imitation leather upholstery.

INFORMATION

C.O.M. Testing and Production Requirements

Not all materials are suitable for upholstering this product. A 1 yd. x 54" sample must be submitted and approved prior to acceptance of an order. Upholstered chairs must be tested separately. If the fabric is directional in pattern or weave, the direction must be indicated on the submitted sample, and additional yardage may be requested. Customer's own vinyl and KI's 2V cannot be used on the MXU Matrix® model (upholstered seat/back, no cushion) but can be used on fixed cushion models.

Test samples must be sent to:

KI
Attn: C.O.M. Specialist
1687 Westminster Drive - Gate 3
Green Bay, WI 54302

Fabric Disclaimer

Fabric will be applied as swatched by the fabric manufacturer. Fabric that is required to be applied differently than is swatched will need a Special Cost Request written specifying the direction the fabric is to be applied. The posted standard lead time will apply to the Special Cost Request.



Transport Dolly
(Poly or Upholstered
Chairs - No Cushion)
(MXD.BL)



Transport Dolly
(Fixed Cushion Chairs)
(MVP.BL)

Overall Dimensions

Width	22-3/8"	22-3/8"
Depth	25-5/8"	25-5/8"
Height		14"



INFORMATION

Warranty

Refer to KI Terms & Conditions document
or visit ki.com

Stack/Nesting

Matrix®

			MODEL NUMBER						
MODEL	Features	Basic Model	Glide Option	Frame Color	Seat & Back Color	Fire Code	Uph. Color	Tablet Arm Color	
 <p>MX MXFS MXFSB</p>	Armless Stack Chair • Polypropylene seat and backrest • Polypropylene seat and back with upholstered seat cushion • Polypropylene seat and back with upholstered cushions on seat and back • Steel rod frame in chrome or colors • Wire stacking bumper frame is standard on upholstered chair	Polypropylene	MX	<input type="checkbox"/> <input type="checkbox"/>	<input type="checkbox"/> <input type="checkbox"/>	<input type="checkbox"/> <input type="checkbox"/> <input type="checkbox"/> <input type="checkbox"/>	<input type="checkbox"/> <input type="checkbox"/>		
	Fixed Seat Cushion	MXFS	<input type="checkbox"/> <input type="checkbox"/>	<input type="checkbox"/> <input type="checkbox"/>	<input type="checkbox"/> <input type="checkbox"/> <input type="checkbox"/> <input type="checkbox"/>	<input type="checkbox"/> <input type="checkbox"/>	<input type="checkbox"/> <input type="checkbox"/>		
	Fixed Seat/Back Cushion	MXFSB	<input type="checkbox"/> <input type="checkbox"/>	<input type="checkbox"/> <input type="checkbox"/>	<input type="checkbox"/> <input type="checkbox"/> <input type="checkbox"/> <input type="checkbox"/>	<input type="checkbox"/> <input type="checkbox"/>	<input type="checkbox"/> <input type="checkbox"/>		
 <p>MXT</p>	Standard Flip-Up Tablet Arm • NONSTACKING • 12" wide x 20-1/2" deep • Field installable • For use only on chrome framed chairs	Left Hand	MXTARM/STD/L					<input type="checkbox"/> <input type="checkbox"/>	
	Right Hand	MXTARM/STD/R						<input type="checkbox"/> <input type="checkbox"/>	
 <p>MXT</p>	Oversize Flip-Up Tablet Arm • NONSTACKING • 17" wide x 20-1/2" deep • Field installable • For use only on chrome framed chairs	Left Hand	MXTARM/OVS/L					<input type="checkbox"/> <input type="checkbox"/>	
	Right Hand	MXTARM/OVS/R						<input type="checkbox"/> <input type="checkbox"/>	
			A	B	C	D	E	F	G

HOW TO ORDER

Indicate the following information on order form:

- Quantity of each item.
- Model number, including options. See "How To Build a Model Number".
- Any special service required.

Note: • The indicates that a choice is required.

- The absence of the indicates that no choice is required.
- Alpha-numeric characters in place of indicate that no other alternatives are available.

HOW TO BUILD A MODEL NUMBER

A Select basic model.

B Select glide option.

- G** - Ganging polycarbonate glides; add \$5
- GS** - Ganging steel glides; add \$5
- NG** - No glides
- H** - Polycarbonate glides; add \$5
- NS** - PVC non-skid glides; add \$5
- S** - Stainless steel glides; add \$5

C Select frame color.

Refer to color addendum at ki.com or KI Fabrics & Finishes binder.

D Select seat and back color.

Refer to color addendum at ki.com or KI Fabrics & Finishes binder.

E Select fire code.

- FR** - Compliance to TB 133
- NFR** - Compliance to TB 117-2013

F Select upholstery grade/color. Refer to color addendum at ki.com or KI Fabrics & Finishes binder.

G Select tablet arm color. Refer to color addendum at ki.com or KI Fabrics & Finishes binder.

OPTIONS

California TB133 Fire Safety Code

For California Technical Bulletin 133 compliant models, add the following upcharge:

- Model=Polypropylene
Added Lead Time=1 week
Added List Price=\$25
- Model=Upholstered
Added Lead Time=1 week
Added List Price=\$44



Approx. Packaged Weight	Delivered Pricing Unupholstered	Delivered Pricing Fabric Grade 1 & C.O.M.	Delivered Pricing Fabric Grade 2	Delivered Pricing Fabric Grade 3	Delivered Pricing C.O.V.	Delivered Pricing Vinyl Group 2V	Delivered Pricing Pallas Fabric Group P0	Delivered Pricing Pallas Fabric Group P1	Delivered Pricing Pallas Fabric Group P2	Delivered Pricing Pallas Fabric Group P3	Delivered Pricing Pallas Fabric Group P4
17.0#	\$ 218										
19.0#	N/A	293	307	312	293	312	314	324	342	356	375
21.0#	N/A	385	409	424	385	424	400	448	478	502	531

7.0#	\$ 177
7.0#	177

9.0#	\$ 231
9.0#	231

UPHOLSTERY INFORMATION

C.O.M. Upholstery

C.O.M. requirement for 10 chairs or less is 1 yard per chair of 54" wide nondirectional fabric. For orders of 11 or more chairs and for complete information on ordering C.O.M. see "Ordering C.O.M., C.O.V. and C.O.L." section.

OPTIONS

Custom-Matched Polypropylene

Colors
Colors to be matched require a 3" x 3" swatch. Minimum order is 100 chairs. Additional lead time required.

SPECIAL SERVICES

Special Carton Marking



With specially marked information N/C

Shipping

Shipped **assembled freight prepaid f.o.b. Green Bay, Wisconsin 54302** factory. Freight class #125.

Specifications and prices are subject to change without prior notice.

Stack/Nesting Matrix®

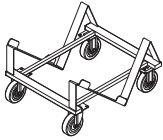
MODEL	Features	MODEL NUMBER						
		Basic Model	Glide Option	Frame Color	Seat & Back Color	Fire Code	Upholstery Color	
 <p>MXA MXFP MXSBP</p>	Stacking Armchair • Polypropylene seat, back, armcap • Polypropylene seat and back with upholstered seat cushion • Polypropylene seat, back, and armcap with upholstered seat and back cushion • Steel rod frame in chrome or colors	Polypropylene	MXA	<input type="checkbox"/> <input type="checkbox"/>	<input type="checkbox"/> <input type="checkbox"/>	<input type="checkbox"/> <input type="checkbox"/> <input type="checkbox"/> <input type="checkbox"/>	<input type="checkbox"/> <input type="checkbox"/>	
	Fixed Seat Cushion	MXFSPA	<input type="checkbox"/> <input type="checkbox"/>	<input type="checkbox"/> <input type="checkbox"/>	<input type="checkbox"/> <input type="checkbox"/> <input type="checkbox"/> <input type="checkbox"/>	<input type="checkbox"/> <input type="checkbox"/>	<input type="checkbox"/> <input type="checkbox"/> <input type="checkbox"/> <input type="checkbox"/> <input type="checkbox"/> <input type="checkbox"/>	
	Fixed Seat/Back Cushion	MXFSBPA	<input type="checkbox"/> <input type="checkbox"/>	<input type="checkbox"/> <input type="checkbox"/>	<input type="checkbox"/> <input type="checkbox"/> <input type="checkbox"/> <input type="checkbox"/>	<input type="checkbox"/> <input type="checkbox"/>	<input type="checkbox"/> <input type="checkbox"/> <input type="checkbox"/> <input type="checkbox"/>	
 <p>HRDPT</p>	Transport Dolly for Fixed Cushion Chairs • Easy maneuverability with 5" casters; two fixed, two swivel • Black powder-coated finish • For use with fixed cushion chairs		MVP.BL					
 <p>HRDPT</p>	Transport Dolly for Poly/Upholstered Chairs • Easy maneuverability with 5" casters; two fixed, two swivel • Black powder-coated finish • For use with poly		MXD.BL					

A B C D E F

HOW TO ORDER

Indicate the following information on order form:

- Quantity of each item.
- Model number, including options. See "How To Build a Model Number".
- Any special service required.

Note: • The indicates that a choice is required.
 • The absence of the indicates that no choice is required.
 • Alpha-numeric characters in place of indicate that no other alternatives are available.

HOW TO BUILD A MODEL NUMBER

Fabrics & Finishes binder.

- A** Select basic model.
- B** Select glide option.
 - NG** - No glides
 - H** - Polycarbonate glides; add \$5
 - NS** - PVC non-skid glides; add \$5
 - S** - Stainless steel glides; add \$5
- C** Select frame color.
Refer to color addendum at ki.com or KI Fabrics & Finishes binder.
- D** Select seat and back color.
Refer to color addendum at ki.com or KI Fabrics & Finishes binder.
- E** Select fire code.
 - NFR** - Compliance to TB 117-2013
 - FR** - Compliance to TB 133
- F** Select upholstery grade/color.
Refer to color addendum at ki.com or KI

OPTIONS

California TB133 Fire Safety Code
 For California Technical Bulletin 133 compliant models, add the following upcharge:
 Model=Polypropylene
 Added Lead Time=1 week
 Added List Price=\$25
 Model=Upholstered
 Added Lead Time=1 week
 Added List Price=\$44



Approx. Packaged Weight	Delivered Pricing Unupholstered	Delivered Pricing Fabric Grade 1 & C.O.M.	Delivered Pricing Fabric Grade 2	Delivered Pricing Fabric Grade 3	Delivered Pricing C.O.V.	Delivered Pricing Vinyl Group 2V	Delivered Pricing Pallas Fabric Group P0	Delivered Pricing Pallas Fabric Group P1	Delivered Pricing Pallas Fabric Group P2	Delivered Pricing Pallas Fabric Group P3	Delivered Pricing Pallas Fabric Group P4
20.0#	\$ 298										
21.0#	N/A	370	385	393	370	393	391	402	420	436	454
22.0#	N/A	470	492	508	470	508	485	533	563	588	615

19.0# \$ 438

30.0# \$ 404

UPHOLSTERY INFORMATION

C.O.M. Upholstery

C.O.M. requirement for 10 chairs or less is 1 yard per chair of 54" wide nondirectional fabric. For orders of 11 or more chairs and for complete information on ordering C.O.M. see "Ordering C.O.M., C.O.V. and C.O.L." section.

OPTIONS

Custom-Matched Polypropylene

Colors
Colors to be matched require a 3" x 3" swatch. Minimum order is 100 chairs. Additional lead time required.

SPECIAL SERVICES

Special Carton Marking

With specially marked information N/C

Shipping

Shipped **assembled freight prepaid f.o.b. Green Bay, Wisconsin 54302** factory. Freight class #125.

Specifications and prices are subject to change without prior notice.

Stack/Nesting

Opt4® General Information



**Mesh Seat, Mesh Back
Four-Leg Chair
(O4LNAMSMB)**



**Mesh Seat, Poly Back
Four-Leg Chair
(O4LNAMSPB)**



**Poly Seat, Mesh Back
Four-Leg Chair
(O4LNAPSMB)**



**Poly Seat, Poly Back
Four-Leg Chair
(O4LNAPSPB)**

**Transport Dolly
(O4LD.BL)**

Features

Stackable	•	•	•	•
Mesh or poly seat and back	•	•	•	•

General Dimensions

Seat width	17-1/2"	17-1/2"	17-1/2"	17-1/2"
Seat depth	17-3/4"	17-3/4"	17-3/4"	17-3/4"
Seat height	17-3/4"	17-3/4"	17-3/4"	17-3/4"

Overall Dimensions

Width	20-1/2"	20-1/2"	20-1/2"	20-1/2"	22-1/2"
Depth	21-13/16"	21-13/16"	21-13/16"	21-13/16"	26-1/8"
Height	32-3/16"	32-3/16"	32-3/16"	32-3/16"	15-1/2"

Stacking on dolly

Overall width	22-1/2"	22-1/2"	22-1/2"	22-1/2"
Overall depth	37"	37"	37"	37"
Quantity/height	15 Chairs/68" High	15 Chairs/68" High	15 Chairs/68" High	15 Chairs/68" High

Stacking on floor

Quantity/height	6 Chairs/43-1/2" High	6 Chairs/43-1/2" High	6 Chairs/43-1/2" High	6 Chairs/43-1/2" High
-----------------	-----------------------	-----------------------	-----------------------	-----------------------

SPECIFICATIONS

Frame

Frame is fabricated from 7/8" o.d. x 17-gauge tubular steel. All joints are welded.

Seat and Back

Seats and backs are available in four combinations of mesh and/or polypropylene. Polypropylene frame and mesh are monochromatic. An integral handle is available on the poly-back models. Opt4 seating is engineered to be eco-friendly. Mesh material is made from 100% post-consumer PET bottles. All resin parts (back, seat, and glides) are 100% recycled polypropylene.

Arms

Optional armrests are available. When equipped with arms, a formed steel tube is welded directly to the chair frame. Armcaps are polypropylene material.

Glides

Glides are molded from nylon. Available in black or stone grey.

Frame Finish

Baked-on, electrostatically-applied powder coating or bright nickel chrome plating.

Transport Dolly

Powder coated tubular steel frame. Two swivel casters and two fixed casters.

Design

Designed by Taku Kumazawa and axona AICHI and manufactured in the USA by Krueger International, Inc.

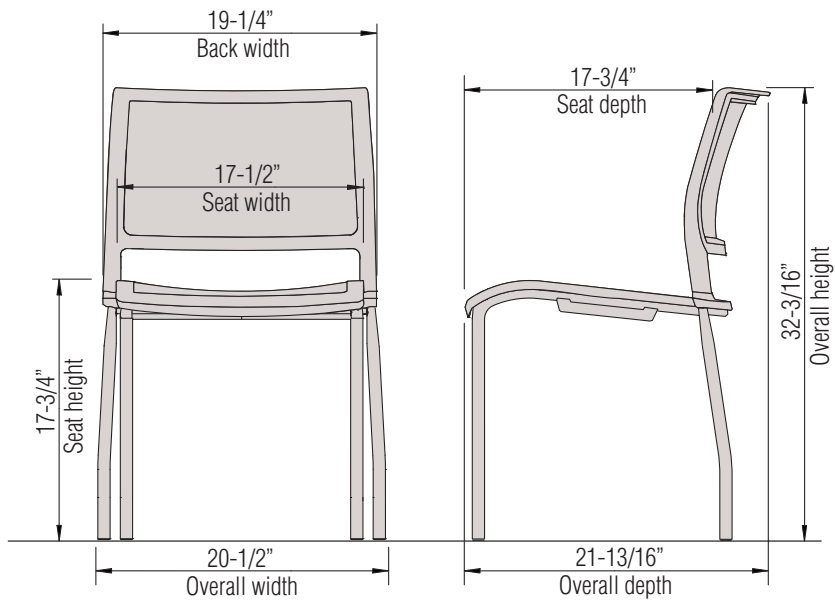

INFORMATION

Warranty

Refer to KI Terms & Conditions document or visit ki.com

Stack/Nesting

Opt4® General Information



**Mesh Seat, Mesh Back
Four-Leg Arnrchair
(O4LWAMSMB)**



**Mesh Seat, Poly Back
Four-Leg Arnrchair
(O4LWAMSPB)**



**Poly Seat, Mesh Back
Four-Leg Arnrchair
(O4LWAPSMB)**



**Poly Seat, Poly Back
Four-Leg Arnrchair
(O4LWAPSPB)**

Features				
Stackable	•	•	•	•
Mesh or poly seat and back	•	•	•	•
General Dimensions				
Seat width	17-1/2"	17-1/2"	17-1/2"	17-1/2"
Seat depth	17-3/4"	17-3/4"	17-3/4"	17-3/4"
Seat height	17-3/4"	17-3/4"	17-3/4"	17-3/4"
Overall Dimensions				
Width	24-5/8"	24-5/8"	24-5/8"	24-5/8"
Depth	21-13/16"	21-13/16"	21-13/16"	21-13/16"
Height	32-3/16"	32-3/16"	32-3/16"	32-3/16"
Stacking on dolly				
Overall width	22-1/2"	22-1/2"	22-1/2"	22-1/2"
Overall depth	37"	37"	37"	37"
Quantity/height	15 Chairs/68" High	15 Chairs/68" High	15 Chairs/68" High	15 Chairs/68" High
Stacking on floor				
Quantity/height	6 Chairs/43-1/2" High	6 Chairs/43-1/2" High	6 Chairs/43-1/2" High	6 Chairs/43-1/2" High

SPECIFICATIONS

Frame

Frame is fabricated from 7/8" o.d. x 17-gauge tubular steel. All joints are welded.

Seat and Back

Seats and backs are available in four combinations of mesh and/or polypropylene. Polypropylene frame and mesh are monochromatic. An integral handle is available on the poly-back models. Opt4 seating is engineered to be eco-friendly. Mesh material is made from 100% post-consumer PET bottles. All resin parts (back, seat, and glides) are 100% recycled polypropylene.

Arms

Optional armrests are available. When equipped with arms, a formed steel tube is welded directly to the chair frame. Armcaps are polypropylene material.

Glides

Glides are molded from nylon. Available in black or stone grey.

Frame Finish

Baked-on, electrostatically-applied powder coating or bright nickel chrome plating.

Transport Dolly

Powder coated tubular steel frame. Two swivel casters and two fixed casters.

Design

Designed by Taku Kumazawa and axona AICHI and manufactured in the USA by Krueger International, Inc.

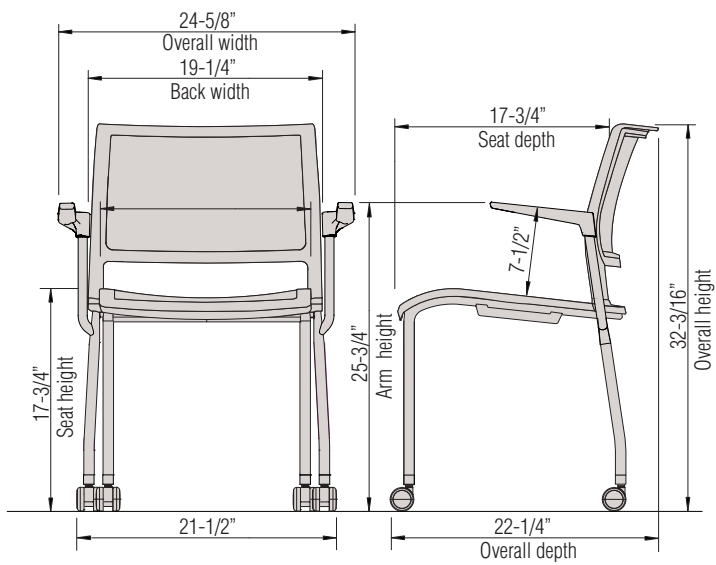
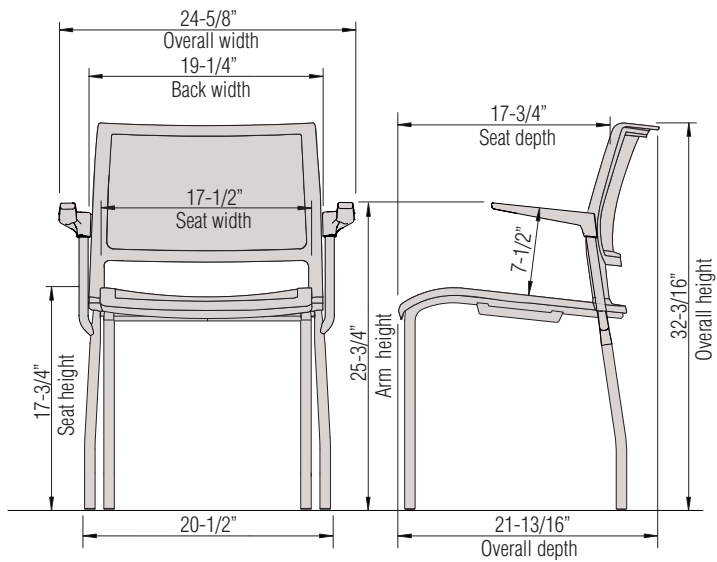

Stack/Nesting

Opt4®



**Mesh Seat, Mesh Back
Four-Leg Chair with Casters
(O4LNAMSMBC)**



**Mesh Seat, Poly Back
Four-Leg Chair with Casters
(O4LNAMSPBC)**



**Poly Seat, Mesh Back
Four-Leg Chair with Casters
(O4LNAPSMBC)**



**Poly Seat, Poly Back
Four-Leg Chair with Casters
(O4LNAPSPBC)**

Features				
Stackable	•	•	•	•
Mesh or poly seat and back	•	•	•	•
General Dimensions				
Seat width	17-1/2"	17-1/2"	17-1/2"	17-1/2"
Seat depth	17-3/4"	17-3/4"	17-3/4"	17-3/4"
Seat height	17-3/4"	17-3/4"	17-3/4"	17-3/4"
Overall Dimensions				
Width	20-1/2"	20-1/2"	20-1/2"	20-1/2"
Depth	21-13/16"	21-13/16"	21-13/16"	21-13/16"
Height	32-3/16"	32-3/16"	32-3/16"	32-3/16"
Stacking on floor				
Quantity/height	6 Chairs/43-1/2" High	6 Chairs/43-1/2" High	6 Chairs/43-1/2" High	6 Chairs/43-1/2" High

SPECIFICATIONS

Frame

Frame and front cross member are fabricated from 1/2" o.d. x 16-gauge tubular steel. All joints are welded.

Seat and Back

Seats and backs are available in four combinations of mesh and/or polypropylene. Plastic frame and mesh are monochromatic. An integral handle is available on the poly-back models. Opt4 seating is engineered to be eco-friendly. Mesh material is made from 100% post-consumer PET bottles. All resin parts (back, seat, and glides) are 100% recycled polypropylene.

Arms

Optional armrests are available. When equipped with arms, a formed steel tube is welded directly to the chair frame. Armcaps are polypropylene material.

Casters

Casters are double-wheel, high-impact thermoplastic. 50mm in diameter. Available in black.

Frame Finish

Baked-on, electrostatically-applied powder coating or bright nickel chrome plating.

Design

Designed by Taku Kumazawa and axona AICHI and manufactured in the USA by Krueger International, Inc.



**Mesh Seat, Mesh Back
Four-Leg Armchair with Casters
(O4LWAMSMBC)**



**Mesh Seat, Poly Back
Four-Leg Armchair with Casters
(O4LWAMSPBC)**



**Poly Seat, Mesh Back
Four-Leg Armchair with Casters
(O4LWAPSMBC)**



**Poly Seat, Poly Back
Four-Leg Armchair with Casters
(O4LWAPSPBC)**

Features				
Stackable	•	•	•	•
Mesh or poly seat and back	•	•	•	•
General Dimensions				
Seat width	17-1/2"	17-1/2"	17-1/2"	17-1/2"
Seat depth	17-3/4"	17-3/4"	17-3/4"	17-3/4"
Seat height	17-3/4"	17-3/4"	17-3/4"	17-3/4"
Overall Dimensions				
Width	24-5/8"	24-5/8"	24-5/8"	24-5/8"
Depth	21-13/16"	21-13/16"	21-13/16"	21-13/16"
Height	32-3/16"	32-3/16"	32-3/16"	32-3/16"
Stacking on floor				
Quantity/height	6 Chairs/43-1/2" High	6 Chairs/43-1/2" High	6 Chairs/43-1/2" High	6 Chairs/43-1/2" High

INFORMATION

Warranty
Refer to KI Terms & Conditions document
or visit ki.com

Stack/Nesting

Opt4® General Information



**Mesh Seat, Mesh Back
Sled Base Chair
(O4MSMB)**



**Mesh Seat, Poly Back
Sled Base Chair
(O4MSPB)**



**Poly Seat, Mesh Back
Sled Base Chair
(O4PSMB)**



**Poly Seat, Poly Back
Sled Base Chair
(O4PSPB)**



**Transport Dolly
(O4DA.BL)**

Features					
Stackable	•	•	•	•	
Ganging	•	•	•	•	
Mesh or poly seat and back	•	•	•	•	
General Dimensions					
Seat width	17-1/2"	17-1/2"	17-1/2"	17-1/2"	
Seat depth	17-3/4"	17-3/4"	17-3/4"	17-3/4"	
Seat height	17-3/4"	17-3/4"	17-3/4"	17-3/4"	
Overall Dimensions					
Width	19-3/4"	19-3/4"	19-3/4"	19-3/4"	22-3/8"
Depth	21-13/16"	21-13/16"	21-13/16"	21-13/16"	32"
Height	32-3/16"	32-3/16"	32-3/16"	32-3/16"	16-3/4"
Stacking on dolly					
Overall width	22-3/8"	22-3/8"	22-3/8"	22-3/8"	
Overall depth	38-1/4"	38-1/4"	38-1/4"	38-1/4"	
Quantity/height	38 Chairs/80" High	38 Chairs/80" High	38 Chairs/80" High	38 Chairs/80" High	
Stacking on floor					
Quantity/height	10 Chairs/40-1/4" High	10 Chairs/40-1/4" High	10 Chairs/40-1/4" High	10 Chairs/40-1/4" High	

SPECIFICATIONS

Frame

Frame and front cross member are fabricated from 1/2" o.d. x 16-gauge tubular steel. All joints are welded.

Seat and Back

Seats and backs are available in four combinations of mesh and/or polypropylene. Plastic frame and mesh are monochromatic. An integral handle is available on the poly-back models. Opt4 seating is engineered to be eco-friendly. Mesh material is made from 100% post-consumer PET bottles. All resin parts (back, seat, and glides) are 100% recycled polypropylene.

Glides

Glides are molded from a thermoplastic elastomer and can come with or without integral ganging clips. Glides are stone grey.

Frame Finish

Baked-on, electrostatically-applied powder

coating or bright nickel chrome plating.

Transport Dolly

Powder coated tubular steel frame. Two swivel casters and two fixed casters.

Design

Designed by Taku Kumazawa and axona AICHI and manufactured in the USA by Krueger International, Inc.

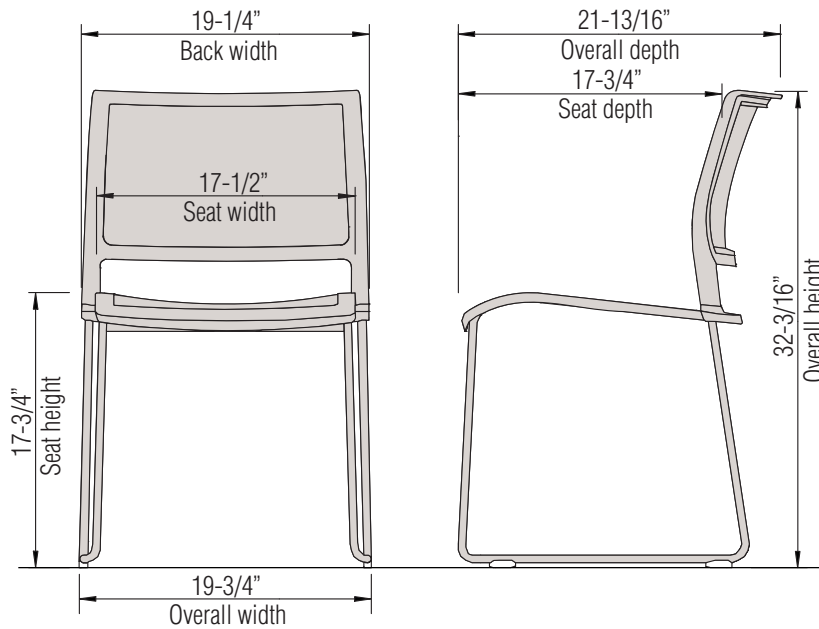

Dimensions are the same for all mesh/poly combination chairs.

INFORMATION

Warranty

Refer to KI Terms & Conditions document or visit ki.com

Stack/Nesting

Opt4® General Information



**Mesh Seat, Mesh Back
Stool
(04SMSMB)**



**Mesh Seat, Poly Back
Stool
(04SMSPB)**



**Poly Seat, Mesh Back
Stool
(04SPSMB)**



**Poly Seat, Poly Back
Stool
(04SPSPB)**



**Transport Dolly
(04SD.BL)**

Features

Stackable	•	•	•	•
Ganging	•	•	•	•
Mesh or poly seat and back	•	•	•	•

General Dimensions

Seat width	17-1/2"	17-1/2"	17-1/2"	17-1/2"
Seat depth	17-3/4"	17-3/4"	17-3/4"	17-3/4"
Seat height	28-3/8"	28-3/8"	28-3/8"	28-3/8"

Overall Dimensions

Width	20-1/8"	20-1/8"	20-1/8"	20-1/8"	22-3/8"
Depth	23"	23"	23"	23"	25-5/8"
Height	42"	42"	42"	42"	14"
Height on dolly	30 Chairs/80"H x 24"W x 52"D	30 Chairs/80"H x 24"W x 52"D	30 Chairs/80"H x 24"W x 52"D	30 Chairs/80"H x 24"W x 52"D	
Height on floor	8 Chairs/48-1/2" High	8 Chairs/48-1/2" High	8 Chairs/48-1/2" High	8 Chairs/48-1/2" High	

SPECIFICATIONS

Frame

Frame and front cross member are fabricated from 1/2" o.d. x 16-gauge tubular steel. All joints are welded.

Seat and Back

Seats and backs are available in four combinations of mesh and/or polypropylene. Plastic frame and mesh are monochromatic. An integral handle is available on the poly-back models. Opt4 seating is engineered to be eco-friendly. Mesh material is made from 100% post-consumer PET bottles. All resin parts (back, seat, and glides) are 100% recycled polypropylene.

Glides

Glides are molded from a thermoplastic elastomer and can come with or without integral ganging clips. Glides are stone grey.

Frame Finish

Baked-on, electrostatically-applied powder

coating or bright nickel chrome plating.

Transport Dolly

Powder coated tubular steel frame. Two swivel casters and two fixed casters.

Design



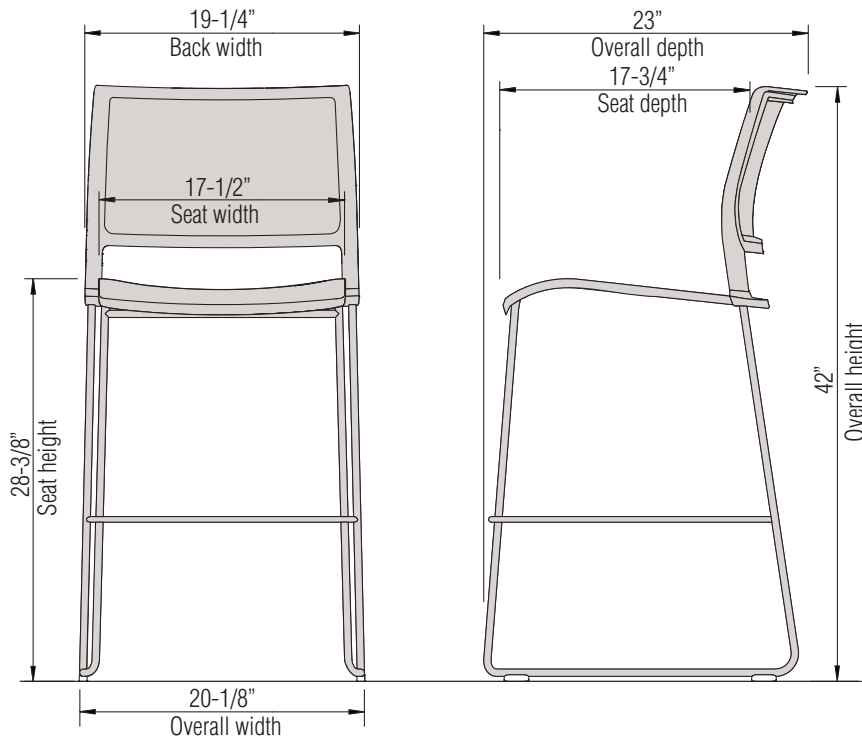

Designed by Taku Kumazawa and axona AICHI and manufactured in the USA by Krueger International, Inc.



Dimensions are the same for all mesh/poly combination chairs.

Stack/Nesting

Opt4®

	MODEL	Features	MODEL NUMBER					Approx. Packaged Weight
			Basic Model	Frame Color	Fire Code	Seat & Back Color	Glide Option	
 <p>OPT4L</p>	Four-Leg Armless Chair • Stacking	Mesh Seat, Mesh Back	O4LNAMSMB	<input type="checkbox"/> <input type="checkbox"/>	<input type="checkbox"/> <input type="checkbox"/>	<input type="checkbox"/> <input type="checkbox"/> <input type="checkbox"/> <input type="checkbox"/>	<input type="checkbox"/>	12.0#
 <p>OPT4L</p>	Four-Leg Armless Chair • Stacking	Mesh Seat, Poly Back	O4LNAMSPB	<input type="checkbox"/> <input type="checkbox"/>	NFR	<input type="checkbox"/> <input type="checkbox"/> <input type="checkbox"/> <input type="checkbox"/>	<input type="checkbox"/>	12.0#
 <p>OPT4L</p>	Four-Leg Armless Chair • Stacking	Poly Seat, Mesh Back	O4LNAPSMB	<input type="checkbox"/> <input type="checkbox"/>	NFR	<input type="checkbox"/> <input type="checkbox"/> <input type="checkbox"/> <input type="checkbox"/>	<input type="checkbox"/>	12.0#
 <p>OPT4L</p>	Four-Leg Armless Chair • Stacking	Poly Seat, Poly Back	O4LNAPSPB	<input type="checkbox"/> <input type="checkbox"/>	NFR	<input type="checkbox"/> <input type="checkbox"/> <input type="checkbox"/> <input type="checkbox"/>	<input type="checkbox"/>	12.0#

A **B** **C** **D** **E**

HOW TO ORDER

Indicate the following information on order form:

- Quantity of each item.
- Model number, including options. See "How To Build a Model Number".
- Any special service required.

Note: • The indicates that a choice is required.

- The absence of the indicates that no choice is required.
- Alpha-numeric characters in place of indicate that no other alternatives are available.

HOW TO BUILD A MODEL NUMBER

- A** Select basic model.
- B** Select frame color.
Refer to color addendum at ki.com or KI Fabrics & Finishes binder.
- C** Select fire code. (Available on mesh seat/mesh back model only).

FR	- Compliance to TB 133
NFR	- Compliance to TB 117-2013
- D** Select poly and/or mesh seat and back color.
Refer to color addendum at ki.com or KI Fabrics & Finishes binder.
- E** Select glide option.

GBL	- Black glide
GSG	- Stone Grey glide

INFORMATION

California TB133 Fire Safety Code
 Standard Opt4™ chair meets the California TB133 Fire Safety Code. No upcharge and no added lead time. (Available on mesh seat/mesh back model only.)



Delivered
Pricing
\$ 357

\$ 323

\$ 323

\$ 280

SPECIAL SERVICES

Special Carton Marking

With specially marked information N/C





Shipping

Shipped **assembled freight prepaid f.o.b.**
Green Bay, Wisconsin 54302 factory.
Freight class #125.

Specifications and prices are subject to
change without prior notice.

Stack/Nesting

Opt4®

	MODEL	Features	MODEL NUMBER					Approx. Packaged Weight
			Basic Model	Frame Color	Fire Code	Seat & Back Color	Caster Type	
	Four-Leg Armless Chair with Casters • Stacking. Caution should be exercised to prevent casters from marring components such as frames, fabric, etc., and to prevent casters from becoming "hung up" underneath the seat of the chair • Stacking on dollies NOT recommended	Mesh Seat, Mesh Back, Casters	O4LNAMSMBC	<input type="checkbox"/> <input type="checkbox"/>	<input type="checkbox"/> <input type="checkbox"/> <input type="checkbox"/>	<input type="checkbox"/> <input type="checkbox"/> <input type="checkbox"/> <input type="checkbox"/>	<input type="checkbox"/>	13.0#
OPT4L								
	Four-Leg Armless Chair with Casters • Stacking. Caution should be exercised to prevent casters from marring components such as frames, fabric, etc., and to prevent casters from becoming "hung up" underneath the seat of the chair • Stacking on dollies NOT recommended	Mesh Seat, Poly Back, Casters	O4LNAMSPBC	<input type="checkbox"/> <input type="checkbox"/>	NFR	<input type="checkbox"/> <input type="checkbox"/> <input type="checkbox"/> <input type="checkbox"/>	<input type="checkbox"/>	13.0#
OPT4L								
	Four-Leg Armless Chair with Casters • Stacking. Caution should be exercised to prevent casters from marring components such as frames, fabric, etc., and to prevent casters from becoming "hung up" underneath the seat of the chair • Stacking on dollies NOT recommended	Poly Seat, Mesh Back, Casters	O4LNAPSMBC	<input type="checkbox"/> <input type="checkbox"/>	NFR	<input type="checkbox"/> <input type="checkbox"/> <input type="checkbox"/> <input type="checkbox"/>	<input type="checkbox"/>	13.0#
OPT4L								
	Four-Leg Armless Chair with Casters • Stacking. Caution should be exercised to prevent casters from marring components such as frames, fabric, etc., and to prevent casters from becoming "hung up" underneath the seat of the chair • Stacking on dollies NOT recommended	Poly Seat, Poly Back, Casters	O4LNAPSPBC	<input type="checkbox"/> <input type="checkbox"/>	NFR	<input type="checkbox"/> <input type="checkbox"/> <input type="checkbox"/> <input type="checkbox"/>	<input type="checkbox"/>	13.0#
OPT4L								

A

B

C

D

E

HOW TO ORDER

Indicate the following information on order form:

- Quantity of each item.
- Model number, including options. See "How To Build a Model Number".
- Any special service required.

Note: • The indicates that a choice is required.

- The absence of the indicates that no choice is required.
- Alpha-numeric characters in place of indicate that no other alternatives are available.

HOW TO BUILD A MODEL NUMBER

A Select basic model.

B Select frame color.
Refer to color addendum at ki.com or KI Fabrics & Finishes binder.

C Select fire code. (Available on mesh seat/mesh back model only).

FR - Compliance to TB 133

NFR - Compliance to TB 117-2013

D Select poly and/or mesh seat and back color.
Refer to color addendum at ki.com or KI Fabrics & Finishes binder.

E Select caster option.

S - Soft wheel casters

C - Carpet casters

INFORMATION

California TB133 Fire Safety Code

Standard Opt4™ chair meets the California TB133 Fire Safety Code. No upcharge and no added lead time. (Available on mesh seat/mesh back model only.)



Delivered
Pricing
\$ 393

\$ 359

\$ 359

\$ 316

SPECIAL SERVICES

Special Carton Marking

With specially marked information N/C





Shipping

Shipped **assembled freight prepaid f.o.b.**
Green Bay, Wisconsin 54302 factory.
Freight class #125.

Specifications and prices are subject to
change without prior notice.

Stack/Nesting

Opt4®

	MODEL	Features	MODEL NUMBER					Approx. Packaged Weight
			Basic Model	Frame Color	Fire Code	Seat & Back Color	Glide Option	
 <p>OPT4L</p>	Four-Leg Armchair • Stacking	Mesh Seat, Mesh Back	O4LWAMSMB	<input type="checkbox"/>	<input type="checkbox"/>	<input type="checkbox"/>	<input type="checkbox"/>	12.0#
 <p>OPT4L</p>	Four-Leg Armchair • Stacking	Mesh Seat, Poly Back	O4LWAMSPB	<input type="checkbox"/>	NFR	<input type="checkbox"/>	<input type="checkbox"/>	12.0#
 <p>OPT4L</p>	Four-Leg Armchair • Stacking	Poly Seat, Mesh Back	O4LWAPSMB	<input type="checkbox"/>	NFR	<input type="checkbox"/>	<input type="checkbox"/>	12.0#
 <p>OPT4L</p>	Four-Leg Armchair • Stacking	Poly Seat, Poly Back	O4LWAPSPB	<input type="checkbox"/>	NFR	<input type="checkbox"/>	<input type="checkbox"/>	12.0#

A **B** **C** **D** **E**

HOW TO ORDER

Indicate the following information on order form:

- Quantity of each item.
- Model number, including options. See "How To Build a Model Number".
- Any special service required.

Note: • The indicates that a choice is required.

- The absence of the indicates that no choice is required.
- Alpha-numeric characters in place of indicate that no other alternatives are available.

HOW TO BUILD A MODEL NUMBER

- A** Select basic model.
- B** Select frame color.
Refer to color addendum at ki.com or KI Fabrics & Finishes binder.
- C** Select fire code. (Available on mesh seat/mesh back model only).

NFR	- Compliance to TB 117-2013
FR	- Compliance to TB 133
- D** Select poly and/or mesh seat and back color.
Refer to color addendum at ki.com or KI Fabrics & Finishes binder.
- E** Select glide option.

GBL	- Black
GSG	- Stone Grey glide

INFORMATION

California TB133 Fire Safety Code
 Standard Opt4™ chair meets the California TB133 Fire Safety Code. No upcharge and no added lead time. (Available on mesh seat/mesh back model only.)



Delivered
Pricing

N/A

N/A

N/A

N/A

SPECIAL SERVICES

Special Carton Marking

With specially marked information N/C





Shipping

Shipped **assembled freight prepaid f.o.b.**
Green Bay, Wisconsin 54302 factory.
Freight class #125.

Specifications and prices are subject to
change without prior notice.

Stack/Nesting

Opt4®

MODEL	Features	MODEL NUMBER				
		Basic Model	Frame Color	Fire Code	Seat & Back Color	Caster Type
 <p>Four-Leg Armchair with Casters</p> <ul style="list-style-type: none"> Stacking. Caution should be exercised to prevent casters from marring components such as frames, fabric, etc., and to prevent casters from becoming "hung up" underneath the seat of the chair Stacking on dollies NOT recommended 	Mesh Seat, Mesh Back, Casters	O4LWAMSMBC	<input type="checkbox"/>	<input type="checkbox"/> <input type="checkbox"/> <input type="checkbox"/>	<input type="checkbox"/> <input type="checkbox"/> <input type="checkbox"/> <input type="checkbox"/>	<input type="checkbox"/>
OPT4L						
 <p>Four-Leg Armchair with Casters</p> <ul style="list-style-type: none"> Stacking. Caution should be exercised to prevent casters from marring components such as frames, fabric, etc., and to prevent casters from becoming "hung up" underneath the seat of the chair Stacking on dollies NOT recommended 	Mesh Seat, Poly Back, Casters	O4LWAMSPBC	<input type="checkbox"/>	NFR	<input type="checkbox"/> <input type="checkbox"/> <input type="checkbox"/> <input type="checkbox"/>	<input type="checkbox"/>
OPT4L						
 <p>Four-Leg Armchair with Casters</p> <ul style="list-style-type: none"> Stacking. Caution should be exercised to prevent casters from marring components such as frames, fabric, etc., and to prevent casters from becoming "hung up" underneath the seat of the chair Stacking on dollies NOT recommended 	Poly Seat, Mesh Back, Casters	O4LWAPSMBC	<input type="checkbox"/>	NFR	<input type="checkbox"/> <input type="checkbox"/> <input type="checkbox"/> <input type="checkbox"/>	<input type="checkbox"/>
OPT4L						
 <p>Four-Leg Armchair with Casters</p> <ul style="list-style-type: none"> Stacking. Caution should be exercised to prevent casters from marring components such as frames, fabric, etc., and to prevent casters from becoming "hung up" underneath the seat of the chair Stacking on dollies NOT recommended 	Poly Seat, Poly Back, Casters	O4LWAPSPBC	<input type="checkbox"/>	NFR	<input type="checkbox"/> <input type="checkbox"/> <input type="checkbox"/> <input type="checkbox"/>	<input type="checkbox"/>
OPT4L						

A **B** **C** **D** **E**

HOW TO ORDER

Indicate the following information on order form:

- Quantity of each item.
- Model number, including options. See "How To Build a Model Number".
- Any special service required.

Note: • The indicates that a choice is required.

- The absence of the indicates that no choice is required.
- Alpha-numeric characters in place of indicate that no other alternatives are available.

HOW TO BUILD A MODEL NUMBER

- A** Select basic model.
- B** Select frame color.
Refer to color addendum at ki.com or KI Fabrics & Finishes binder.
- C** Select fire code. (Available on mesh seat/mesh back model only).
FR - Compliance to TB 133
NFR - Compliance to TB 117-2013
- D** Select poly and/or mesh seat and back color.
Refer to color addendum at ki.com or KI Fabrics & Finishes binder.
- E** Select caster option.
S - Soft wheel casters
C - Carpet casters

INFORMATION

California TB133 Fire Safety Code
Standard Opt4™ chair meets the California TB133 Fire Safety Code. No upcharge and no added lead time. (Available on mesh seat/mesh back model only.)



Approx. Packaged Weight	Delivered Pricing
13.0#	N/A

13.0#	N/A
-------	-----

13.0#	N/A
-------	-----

13.0#	N/A
-------	-----

SPECIAL SERVICES

Special Carton Marking

With specially marked information N/C





Shipping

Shipped **assembled freight prepaid f.o.b. Green Bay, Wisconsin 54302** factory. Freight class #125.

Specifications and prices are subject to change without prior notice.

Stack/Nesting

Opt4®

	MODEL	Features	MODEL NUMBER					Approx. Packaged Weight
			Basic Model	Frame Color	Fire Code	Seat & Back Color	Glide Option	
 <p>OPT4</p>	Sled Base Chair • Stacking • Ganging	Mesh Seat, Mesh Back	O4MSMB	<input type="checkbox"/> <input type="checkbox"/>	<input type="checkbox"/> <input type="checkbox"/>	<input type="checkbox"/> <input type="checkbox"/> <input type="checkbox"/> <input type="checkbox"/>	<input type="checkbox"/>	11.0#
 <p>OPT4</p>	Sled Base Chair • Stacking • Ganging	Mesh Seat, Poly Back	O4MSPB	<input type="checkbox"/> <input type="checkbox"/>	NFR	<input type="checkbox"/> <input type="checkbox"/> <input type="checkbox"/> <input type="checkbox"/>	<input type="checkbox"/>	11.0#
 <p>OPT4</p>	Sled Base Chair • Stacking • Ganging	Poly Seat, Mesh Back	O4PSMB	<input type="checkbox"/> <input type="checkbox"/>	NFR	<input type="checkbox"/> <input type="checkbox"/> <input type="checkbox"/> <input type="checkbox"/>	<input type="checkbox"/>	11.0#
 <p>OPT4</p>	Sled Base Chair • Stacking • Ganging	Poly Seat, Poly Back	O4PSPB	<input type="checkbox"/> <input type="checkbox"/>	NFR	<input type="checkbox"/> <input type="checkbox"/> <input type="checkbox"/> <input type="checkbox"/>	<input type="checkbox"/>	11.0#

A **B** **C** **D** **E**

HOW TO ORDER

Indicate the following information on order form:

- Quantity of each item.
- Model number, including options. See "How To Build a Model Number".
- Any special service required.

Note: • The indicates that a choice is required.

- The absence of the indicates that no choice is required.
- Alpha-numeric characters in place of indicate that no other alternatives are available.

HOW TO BUILD A MODEL NUMBER

- A** Select basic model.
- B** Select frame color.
Refer to color addendum at ki.com or KI Fabrics & Finishes binder.
- C** Select fire code. (Available on mesh seat/ mesh back model only).

NFR	- Compliance to TB 117-2013
FR	- Compliance to TB 133
- D** Select poly and/or mesh seat and back color.
Refer to color addendum at ki.com or KI Fabrics & Finishes binder.
- E** Select glide option.

G	- Ganging glides
NG	- Non-ganging glides

INFORMATION

California TB133 Fire Safety Code
 Standard Opt4™ chair meets the California TB133 Fire Safety Code. No upcharge and no added lead time. (Available on mesh seat/ mesh back model only.)



Delivered
Pricing
\$ 317

\$ 269

\$ 269

\$ 210

INFORMATION

Cartoning
4 chairs per carton

SPECIAL SERVICES



Special Carton Marking
With specially marked information N/C

Shipping
Shipped **assembled freight prepaid f.o.b.**
Green Bay, Wisconsin 54302 factory.
Freight class #125.

Specifications and prices are subject to
change without prior notice.

Stack/Nesting

Opt4® Cafe Stools

MODEL	Features	MODEL NUMBER					Approx. Packaged Weight	
		Basic Model	Frame Color	Fire Code	Seat & Back Color	Glide Option		
 <p>Cafe Stool</p> <ul style="list-style-type: none"> • Stacking • Ganging 	Mesh Seat, Mesh Back	O4SMSMB	<input type="checkbox"/> <input type="checkbox"/>	<input type="checkbox"/> <input type="checkbox"/> <input type="checkbox"/>	<input type="checkbox"/> <input type="checkbox"/> <input type="checkbox"/> <input type="checkbox"/>	<input type="checkbox"/>	18.0#	
OPT4S								
 <p>Cafe Stool</p> <ul style="list-style-type: none"> • Stacking • Ganging 	Mesh Seat, Poly Back	O4SMSPB	<input type="checkbox"/> <input type="checkbox"/>	NFR	<input type="checkbox"/> <input type="checkbox"/> <input type="checkbox"/> <input type="checkbox"/>	<input type="checkbox"/>	18.0#	
OPT4S								

A **B** **C** **D** **E**

HOW TO ORDER

Indicate the following information on order form:

1. Quantity of each item.
2. Model number, including options. See "How To Build a Model Number".
3. Any special service required.

Note: • The indicates that a choice is required.

- The absence of the indicates that no choice is required.
- Alpha-numeric characters in place of indicate that no other alternatives are available.

HOW TO BUILD A MODEL NUMBER

- A** Select basic model.
- B** Select frame color.
Refer to color addendum at ki.com or KI Fabrics & Finishes binder.
- C** Select fire code. (Available on mesh seat/mesh back model only).

NFR	- Compliance to TB 117-2013
FR	- Compliance to TB 133
- D** Select poly and/or mesh seat and back color.
Refer to color addendum at ki.com or KI Fabrics & Finishes binder.
- E** Select glide option.

G	- Ganging glides
NG	- Non-ganging glides

INFORMATION

California TB133 Fire Safety Code
Standard Opt4™ chair meets the California TB133 Fire Safety Code. No upcharge and no added lead time.



Delivered
Pricing
\$ 447

\$ 399

INFORMATION

Cartoning
2 stools per carton

SPECIAL SERVICES

Special Carton Marking
With specially marked information N/C

Shipping
Shipped **assembled freight prepaid f.o.b.**
Green Bay, Wisconsin 54302 factory.
Freight class #125.

Specifications and prices are subject to
change without prior notice.

Stack/Nesting

Opt4® Cafe Stools

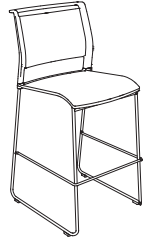
MODEL	Features	MODEL NUMBER					Approx. Packaged Weight
		Basic Model	Frame Color	Fire Code	Seat & Back Color	Glide Option	
 <p>Cafe Stool</p> <ul style="list-style-type: none"> • Stacking • Ganging <p>OPT4S</p>	Poly Seat, Mesh Back	04SPSMB	<input type="checkbox"/> <input type="checkbox"/>	NFR	<input type="checkbox"/> <input type="checkbox"/> <input type="checkbox"/> <input type="checkbox"/>	<input type="checkbox"/>	18.0#
 <p>Cafe Stool</p> <ul style="list-style-type: none"> • Stacking • Ganging <p>OPT4S</p>	Poly Seat, Poly Back	04SPSPB	<input type="checkbox"/> <input type="checkbox"/>	NFR	<input type="checkbox"/> <input type="checkbox"/> <input type="checkbox"/> <input type="checkbox"/>	<input type="checkbox"/>	18.0#

A **B** **C** **D** **E**

HOW TO ORDER

Indicate the following information on order form:

1. Quantity of each item.
2. Model number, including options. See "How To Build a Model Number".
3. Any special service required.

Note: • The indicates that a choice is required.

- The absence of the indicates that no choice is required.
- Alpha-numeric characters in place of indicate that no other alternatives are available.

HOW TO BUILD A MODEL NUMBER

- A** Select basic model.
- B** Select frame color.
Refer to color addendum at ki.com or KI Fabrics & Finishes binder.
- C** Select fire code. (Available on mesh seat/mesh back model only).

NFR	- Compliance to TB 117-2013
FR	- Compliance to TB 133
- D** Select poly and/or mesh seat and back color.
Refer to color addendum at ki.com or KI Fabrics & Finishes binder.
- E** Select glide option.

G	- Ganging glides
NG	- Non-ganging glides

INFORMATION

Cartoning
2 stools per carton



Stack/Nesting

Opt4® Cafe Stools

Delivered
Pricing
\$ 399

\$ 339

SPECIAL SERVICES

Special Carton Marking

With specially marked information N/C

Shipping

Shipped **assembled freight prepaid f.o.b.**
Green Bay, Wisconsin 54302 factory.
Freight class #125.

Specifications and prices are subject to
change without prior notice.

Stack/Nesting

Opt4®

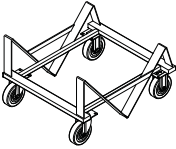
	MODEL	MODEL NUMBER	
		Basic Model	Approx. Packaged Weight
HRDPT	Transport Dolly for Four-Leg Chair <ul style="list-style-type: none"> • Easy maneuverability with 5" casters; two fixed, two swivel • Black powder-coated finish 	O4LD.BL	30.0#
	Transport Dolly for Sled Base Chair <ul style="list-style-type: none"> • Easy maneuverability with 5" casters; two fixed, two swivel • Black powder-coated finish 	O4DA.BL	30.0#
HRDPT	Transport Dolly for Stool <ul style="list-style-type: none"> • Easy maneuverability with 5" casters; two fixed, two swivel • Black powder-coated finish 	O4SD.BL	30.0#

A

HOW TO ORDER

Indicate the following information on order form:

1. Quantity of each item.
2. Model number, including options. See "How To Build a Model Number".
3. Any special service required.

Note: • The indicates that a choice is required.

- The absence of the indicates that no choice is required.
- Alpha-numeric characters in place of indicate that no other alternatives are available.

HOW TO BUILD A MODEL NUMBER

- A** Select basic model.



Delivered

Pricing

\$ 392

\$ 392

\$ 415

SPECIAL SERVICES

Special Carton Marking

With specially marked information N/C

Shipping

Shipped **assembled freight prepaid f.o.b.**
Green Bay, Wisconsin 54302 factory.
Freight class #125.

Specifications and prices are subject to
change without prior notice.

Stack/Nesting

Perry® General Information



Armless Stacking Chair (PRYU)



Stacking Armchair (PRYPA)



Armless Chair Dolly (PRY.D.BL)

Armchair Dolly (PRY.DA.BL)

Features				
Ganging		•		
Articulated backrest		•	•	
Polypropylene seat and back		•	•	
Upholstered seat and back		•	•	
Cushioned/upholstered seat and back		•	•	
General Dimensions				
Seat width	18-1/4"		18-1/4"	
Seat depth	17-1/2"		17-1/2"	
Seat height	18"		18"	
Overall Dimensions				
Width	19-1/2"	23-3/8"	22-1/2"	24"
Depth	21-1/2"	21-1/2"	25-1/2"	25-1/2"
Height	32-1/2"	32-1/2"	22-1/2"	19-1/2"
Top of arm to floor		27"		
Stacking on Dolly				
Depth	36"	36"		
Maximum Stack Quantities and Height on Dolly				
Polypropylene seat	25 Chairs/79" High	12 Chairs/67" High	25 Chairs	12 Chairs
Upholstered seat, no cushion	25 Chairs/79" High	12 Chairs/67" High	25 Chairs	12 Chairs
Cushioned/upholstered seat	12 Chairs/60" High	12 Chairs/70" High	12 Chairs	12 Chairs
Stacking on Floor				
Width	20"	23-1/2"		
Depth	35"	35"		
Quantity/height	8 Chairs / 44" High	6 Chairs / 45" High		

SPECIFICATIONS

Plastic Chair Seats and Backrests

Injection-molded polypropylene. Seat is one piece screwed to frame. Backrest has two sections which form a snap-fit and are then screwed together. Chair seats have two die-formed 7-gauge straps welded to side frames.

Upholstery

Covers front of seat and backrest. Cushioned and upholstered models have 1/2" foam padding on seat and backrest. Upholstered models without cushions have upholstery fastened to shell. The back panel of the backrest is not upholstered.

Chair Frame

Armless version has 7/16" o.d. solid steel rod welded into a one-piece unit. Armchair version has 7/16" o.d. steel rod and 5/8" steel tubing welded into a one-piece unit. Seats have two die-formed 7-gauge straps welded to side frames. Bright duplex nickel-

chrome plated or painted finish.

Back Articulation

Articulation is achieved with a single-piece frame which flexes as the back pivots around its upper and lower crossbars.

The seat is hung from the lower back so that the user's weight perfectly counterbalances the tilting pressure of the upper back.

Polypropylene Arm

Injection-molded polypropylene. Two-piece arm is joined by screws to encapsulate the frame. Arm is integral to frame.

Stacking Bumpers

An integral part of the frame, the bumpers are welded to the lower front frame radius. Two scuff protectors will be glued to the rear crossbrace of the chair to prevent scuffing of seat wires when chairs are stacked.

Stacking

Stacking on dolly recommended.

Bright Chrome Finish

Surfaces are duplex nickel-chrome plated in a twenty-two step process.

Tablet Arm

7/16" solid steel rod frame, hinged for easy access. Resin core tablet; high pressure laminate surface. Round tablet edge with clear lacquer finish. Bright chrome frame. Chairs are nonstacking with tablet arm. Not for use with powder-coated frames. Field-installable. Seating clearance is 16-1/4". Tablet is 20-5/8" long and 12" wide. An oversized tablet arm is also available. Tablet is 20-1/2" long and 17" wide.

Powder-Coated Finish

Electrostatically-applied epoxy baked onto surface. Tubular and plate steel welded together. 5" casters: two swivel, two fixed. Black powder-coated finish.

Ganging

Wire loop ganging device. 5/16" steel rod is

bent and welded to chair frame. Factory-installed only. Available only on armless stack chairs with chrome frames.

INFORMATION

C.O.M. Testing and Production Requirements

Not all materials are suitable for upholstering this product. A 1 yd. x 54" sample must be submitted and approved prior to acceptance of an order. Upholstered only and cushioned/upholstered chairs must be tested separately. If the fabric is directional in pattern or weave, the direction must be indicated on the submitted sample, and additional yardage may be requested. Customer's own vinyl cannot be used on this product.

Test samples must be sent to:



Tablet Arm



Ganging Device

KI
Attn: C.O.M. Specialist
1687 Westminster Drive - Gate 3
Green Bay, WI 54302

Fabric Disclaimer

Fabric will be applied as swatched by the fabric manufacturer. Fabric that is required to be applied differently than is swatched will need a Special Cost Request written specifying the direction the fabric is to be applied. The posted standard lead time will apply to the Special Cost Request.

Design

Designed by Charles O. Perry.



INFORMATION

Warranty

Refer to KI Terms & Conditions document or visit ki.com

Stack/Nesting

Perry®

	MODEL	Features	MODEL NUMBER						Approx. Packaged Weight	
			Basic Model	Glide Option	Frame Color	Seat & Back Color	Fire Code	Upholstery Color		
 PRYP PRYU PRYC	Armless Stack Chair	Polypropylene	PRYP	<input type="checkbox"/>	<input type="checkbox"/>	<input type="checkbox"/>	<input type="checkbox"/>		23.0#	
		Upholstered	PRYU	<input type="checkbox"/>	<input type="checkbox"/>	<input type="checkbox"/>	<input type="checkbox"/>	<input type="checkbox"/>	<input type="checkbox"/>	24.0#
		Cushioned/Upholstered	PRYC	<input type="checkbox"/>	<input type="checkbox"/>	<input type="checkbox"/>	<input type="checkbox"/>	<input type="checkbox"/>	<input type="checkbox"/>	24.0#
		<ul style="list-style-type: none"> Articulating backrest movement is governed by weight of the user to provide proper support Polypropylene seat and back Upholstered models have fabric glued to seat and backrest Cushioned and upholstered models have foam pad and upholstery Back panel of backrest on upholstered models is polypropylene. It is not upholstered 								
 PRYPA PRYUA PRYCA	Stack Armchair	Polypropylene	PRYPA	<input type="checkbox"/>	<input type="checkbox"/>	<input type="checkbox"/>	<input type="checkbox"/>		24.0#	
		Upholstered	PRYUA	<input type="checkbox"/>	<input type="checkbox"/>	<input type="checkbox"/>	<input type="checkbox"/>	<input type="checkbox"/>	<input type="checkbox"/>	25.0#
		Cushioned/Upholstered	PRYCA	<input type="checkbox"/>	<input type="checkbox"/>	<input type="checkbox"/>	<input type="checkbox"/>	<input type="checkbox"/>	<input type="checkbox"/>	25.0#
		<ul style="list-style-type: none"> Articulating backrest movement is governed by weight of the user to provide proper support Polypropylene seat and back Upholstered models have fabric glued to seat and backrest Cushioned and upholstered models have foam pad and upholstery Back panel of backrest on upholstered models is polypropylene. It is not upholstered Polypropylene armrests match seat and backrest A GLIDE MUST BE SELECTED 								
				A	B	C	D	E	F	

HOW TO ORDER

Indicate the following information on order form:

- Quantity of each item.
- Model number, including options. See "How To Build a Model Number".
- Any special service required.

Note: • The indicates that a choice is required.

- The absence of the indicates that no choice is required.
- Alpha-numeric characters in place of indicate that no other alternatives are available.

HOW TO BUILD A MODEL NUMBER

A Select basic model.

B Select glide option.

- NG** - No glides
- H** - Polycarbonate glides; add \$5
- NS** - PVC non-skid glides; add \$5
- S** - Stainless steel glides; add \$5
- W** - Ganging, no glides (only on chrome frame); add \$56
- WH** - Ganging, polycarbonate glides (only on chrome frame); add \$61
- WNS** - Ganging, PVC non-skid glides (only on chrome frame); add \$61
- WS** - Ganging, stainless steel glides (only on chrome frame); add \$61

Ganging option not available on the armchair.

C Select frame color.

Refer to color addendum at ki.com or KI Fabrics & Finishes binder.

D Select seat and back color.

Refer to color addendum at ki.com or KI Fabrics & Finishes binder. When specifying an upholstered chair, a backrest backpanel color must be specified.

E Select fire code.

- FR** - Compliance to TB 133
- NFR** - Compliance to TB 117-2013

F Select upholstery grade/color.

Refer to color addendum at ki.com or KI Fabrics & Finishes binder.



Delivered Pricing Unupholstered	Delivered Pricing Fabric Grade 1 & C.O.M.	Delivered Pricing Fabric Grade 2	Delivered Pricing Fabric Grade 3	Delivered Pricing Pallas Fabric Group P0	Delivered Pricing Pallas Fabric Group P1	Delivered Pricing Pallas Fabric Group P2	Delivered Pricing Pallas Fabric Group P3	Delivered Pricing Pallas Fabric Group P4
\$ 263								
N/A	431	465	487	486	496	537	549	582
N/A	547	584	608	605	615	653	672	701

\$ 352								
N/A	522	557	582	577	588	627	645	673
N/A	642	679	701	699	710	748	763	792

OPTIONS

California TB133 Fire Safety Code

For California Technical Bulletin 133 compliant models, add the following upcharge:

- Model=Polypropylene
- Added Lead Time=1 week
- Added List Price=\$29
- Model=Upholstered and Cushioned/Upholstered
- Added Lead Time=1 week
- Added List Price=\$82

UPHOLSTERY INFORMATION

C.O.M. Upholstery

C.O.M. requirement for 10 chairs or less is 1 yard per chair of 54" wide nondirectional fabric. For orders of 11 or more chairs and for complete information on ordering C.O.M. see "Ordering C.O.M., C.O.V. and C.O.L." section.

SPECIAL SERVICES

Special Carton Marking

With specially marked information N/C



Shipping

Shipped **assembled freight prepaid f.o.b. Green Bay, Wisconsin 54302** factory. Freight class #125.

Specifications and prices are subject to change without prior notice.

Stack/Nesting

Perry®

	MODEL	Features	MODEL NUMBER		Approx. Packaged Weight
			Basic Model	Tablet Arm Color	
 HRDPT	Transport Dolly • 5" Casters: two fixed, two swivel • Black enamel finish	Armless Chairs	PRY.D.BL		30.0#
		Armchair	PRY.DA.BL		30.0#
 PRYT	Tablet Arm • Chrome finish • Laminate surface • Only available on armless models • 20-5/8" long x 12" wide • NONSTACKING • Field installable	Left Hand	PRYTARM/STD/L	<input type="checkbox"/> <input type="checkbox"/>	6.0#
		Right Hand	PRYTARM/STD/R	<input type="checkbox"/> <input type="checkbox"/>	6.0#
 PRYT	Oversized Tablet Arm • Chrome finish • Laminate surface • Only available on armless models • 17" wide x 20-1/2" deep • NONSTACKING • Field installable	Left Hand	PRYTARM/OVS/L	<input type="checkbox"/> <input type="checkbox"/>	8.0#
		Right Hand	PRYTARM/OVS/R	<input type="checkbox"/> <input type="checkbox"/>	8.0#

A

B

HOW TO ORDER

Indicate the following information on order form:

1. Quantity of each item.
2. Model number, including options. See "How To Build a Model Number".
3. Any special service required.

- Note:
- The indicates that a choice is required.
 - The absence of the indicates that no choice is required.
 - Alpha-numeric characters in place of indicate that no other alternatives are available.

HOW TO BUILD A MODEL NUMBER

- A** Select basic model.
- B** Select tablet arm color.
Refer to color addendum at ki.com or KI Fabrics & Finishes binder.



Delivered
Pricing

\$ 435

435

\$ 179

179

\$ 234

234

SPECIAL SERVICES

Special Carton Marking

With specially marked information N/C

Shipping

Shipped **assembled freight prepaid f.o.b.**
Green Bay, Wisconsin 54302 factory.
Freight class #125.

Specifications and prices are subject to
change without prior notice.

Stack/Nesting

Piretti Stack Chairs General Information



Four-Leg Stacking Chair (PSLNAP)



Four-Leg Flex Arm Stacking Chair (PSLFAP)



Four-Leg Tablet Arm Chair (PSLTARP)

Features			
Stackable	•	•	•
Ganging	•		•
Upholstered seat and back	•	•	•
General Dimensions			
Seat width	17-1/2"	17-1/2"	17-1/2"
Seat depth	18-3/4"	18-3/4"	18-3/4"
Seat height	17-1/4"	17-1/4"	17-1/4"
Back width	18-1/2"	18-1/2"	18-1/2"
Back height	11-1/4"	11-1/4"	11-1/4"
Overall Dimensions			
Width	19-1/2"	23-1/2"	21-3/4"
Depth	21-1/2"	21-1/2"	26-1/4"
Height	31-1/4"	31-1/4"	31-1/4"
Top of arm to floor		25-1/2"	25-1/2"
Ganging on center	19-3/4"		19-3/4"
Stacking on Dolly			
Upholstered chairs quantity/height	8 Chairs/61" High	8 Chairs/61" High	5 Chairs/65" High
Poly chairs quantity/height	10 Chairs/64" High	10 Chairs/64" High	5 Chairs/63" High
Floor space	22" x 35"	22-1/2" x 35"	23" x 35"
Stacking on Floor			
Quantity/floor space	5 Chairs/20" x 27"	5 Chairs/21-3/4" x 27"	4 Chairs/23" x 27"



Ganging Device



Sled Base Glides



Bookrack



Four-Leg Carpet Glide

SPECIFICATIONS

Seat and Backrest

Seats and backrests are molded compound-curved polypropylene with a textured finish. Backrest edges have an integral channel into which upholstery is secured. Upholstered chairs have partially exposed polypropylene surfaces. Upholstery covers 1/2" foam on the backrest and 3/4" on the seat.

Molded plastic seat liner covers the seat underside, anchors the ganging devices, and has integral bumpers for stacking chairs. Seat liner matches the seat and back color. The back tilt is 15°.

Lever Mechanism

Two hidden lever mechanisms which respond to user's weight, are located in the seat. Each has a double cam action. The rear cam is tied to the back structure and is set in motion when the occupant leans back. This, in turn, through a spring linkage, activates the front cam at a slightly different

ratio (1-1/2" to 1"). The mechanisms consist of stamped steel frame and levers, a steel spring and molded Delvin and nylon components. It is calibrated at the factory and needs no further adjustment.

Four-Leg Chair Frame

The frame consists of two "U"-shaped leg sections, one front and one rear. These are 1" o.d., 14-gauge seam-welded tubular steel. Seat straps are welded to the legs. Lever mechanisms are bolted to the seat straps, and, in turn, are attached to the backrest by the backrest supports. When specifying a glide for the Piretti Four-Leg Stack Chair, the glide will be monochromatic with the frame.

Sled Base Frame

Frames are one continuous segment of 5/8" o.d., 16-gauge seam-welded tubular steel. Seat straps are welded to the legs. Lever mechanisms are bolted to the seat straps, and, in turn, are attached to the backrest by backrest supports. Carpet, nonmarring hard floor glides and stainless steel glides

are optional.

Bookrack

Chairs are nonstacking with bookrack attached. Welded wire frame; powder-coated finish. May be field-installed; requires attaching with eight screws.

Leg Finishes

Baked-on electrostatically-applied epoxy powder coating, or bright nickel-chrome plating.

Tablet Arm

Plywood core tablet with high-pressure laminate surface. Tablet edge is painted black. Tablet arm support matches frame color. Standard tablet is 19-1/2" long and 12-3/4" wide. Oversized tablet is 22-1/2" long and 15-3/4" wide.

Flex Arm

Fiberglass reinforced nylon; color permeates armrest. Hinge pin is welded to backrest support and bolted to underside of seat.

Arm attachments are not field-installable. Plastic armcap is field-installable. Flex arm is available in black only.

Sled Base Chair Steel Guide

Stainless steel. Fixed in position by mechanical fastener.

Transport Dolly

Tubular and plate steel welded together. 5" casters: two fixed, two swivel. Black powder-coated finish.

Stacking Vinyl, Polyurethane, and Imitation Leather Upholstered Chairs

It is recommended that chairs to be stacked be covered in material other than vinyl, polyurethane, or imitation leather as an impression in the seat may result. KI does not warrant the effects of stacking on stock or C.O.M. vinyl, polyurethane, or imitation leather upholstery.



Stack/Nesting

Piretti Stack Chairs General Information



**Sled Base Stacking
Chair (PSSNAP)**



**Sled Base Flex Armchair
(PSSFAP)**



**Sled Base Tablet Arm
Chair
(PSSTARP)**



**Transport Dolly
(MVP.BL)**

Features				
Stackable	•			
Ganging	•		•	
Upholstered seat and back	•	•	•	
General Dimensions				
Seat width	17-1/2"	17-1/2"	17-1/2"	
Seat depth	18-3/4"	18-3/4"	18-3/4"	
Seat height	17-1/4"	17-1/4"	17-1/4"	
Back width	18-1/2"	18-1/2"	18-1/2"	
Back height	11-1/4"	11-1/4"	11-1/4"	
Overall Dimensions				
Width	19-1/2"	23-1/4"	23-1/4"	22-1/2"
Depth	21-1/2"	21-1/2"	26-1/4"	25-1/2"
Height	31-1/4"	31-1/4"	31-1/4"	12"
Top of arm to floor		25-1/2"	25-1/2"	
Ganging on center	19-3/4"		19-3/4" or 21"	
Stacking on Dolly				
Upholstered chairs quantity/height	8 Chairs/60" High			
Poly chairs quantity/height	10 Chairs/65" High			
Floor space	22" x 35"			
Stacking on Floor				
Quantity/floor space	5 Chairs/20" x 27"			

INFORMATION

C.O.M. Testing and Production Requirements

Not all materials are suitable for upholstering this product. A 3/4" yd. x 54" sample must be submitted and approved prior to acceptance of an order. If the fabric is directional in pattern or weave, the direction must be indicated on the submitted sample, and additional yardage may be requested.

Test samples must be sent to:

KI
Attn: C.O.M. Specialist
1687 Westminster Drive - Gate 3
Green Bay, WI 54302

Fabric Disclaimer

Fabric will be applied as swatched by the fabric manufacturer. Fabric that is required to be applied differently than is swatched will need a Special Cost Request written specifying the direction the fabric is to be applied.

The posted standard lead time will apply to the Special Cost Request.

Design

Designed by Giancarlo Piretti and manufactured in the USA by Krueger International, Inc. under license from Pro-Cord S.p.A.





INFORMATION

Warranty

Refer to KI Terms & Conditions document or visit ki.com

Stack/Nesting

Piretti Stack Chairs

	MODEL	Features	MODEL NUMBER						
			Basic Model	Frame Color	Seat & Back Color	Tablet Arm Color	Fire Code	Uph. Color	Glide Option
	Four-Leg Stack Chair	Polypropylene	PSLNAP	<input type="checkbox"/>	<input type="checkbox"/>		<input type="checkbox"/>		<input type="checkbox"/>
	<ul style="list-style-type: none"> Backrest tilt tension varies automatically based on occupant weight and is governed by the seat lever mechanism Spring-loaded ganging device concealed under the seat 19-3/4" on center ganging 	Upholstered	PSLNAU	<input type="checkbox"/>	<input type="checkbox"/>		<input type="checkbox"/>	<input type="checkbox"/>	<input type="checkbox"/>
PSLP PSLU									
	Four-Leg Flex Arm Stack Chair	Polypropylene	PSLFAP	<input type="checkbox"/>	<input type="checkbox"/>		<input type="checkbox"/>		<input type="checkbox"/>
	<ul style="list-style-type: none"> Backrest tilt tension varies automatically based on occupant weight and is governed by the seat lever mechanism GANGING NOT AVAILABLE 	Upholstered	PSLFAU	<input type="checkbox"/>	<input type="checkbox"/>		<input type="checkbox"/>	<input type="checkbox"/>	<input type="checkbox"/>
PSLP PSLU									
	Four-Leg Stack Tablet Arm Chair	Polypropylene, Left Hand	PSLTALP	<input type="checkbox"/>	<input type="checkbox"/>	<input type="checkbox"/>	<input type="checkbox"/>		<input type="checkbox"/>
	<ul style="list-style-type: none"> Backrest tilt tension varies automatically based on occupant weight and is governed by the seat lever mechanism Tablet arm surface in high-density plastic laminate flips up for easy entry Tablet arm is 12-3/4" wide by 19-1/2" deep 19-3/4" on center ganging 	Upholstered, Left Hand	PSLTALU	<input type="checkbox"/>	<input type="checkbox"/>	<input type="checkbox"/>	<input type="checkbox"/>	<input type="checkbox"/>	<input type="checkbox"/>
		Polypropylene, Right Hand	PSLTARP	<input type="checkbox"/>	<input type="checkbox"/>	<input type="checkbox"/>	<input type="checkbox"/>		<input type="checkbox"/>
		Upholstered, Right Hand	PSLTARU	<input type="checkbox"/>	<input type="checkbox"/>	<input type="checkbox"/>	<input type="checkbox"/>	<input type="checkbox"/>	<input type="checkbox"/>
PSLP PSLU									
	Four-Leg Stack Oversize Tablet Arm Chair	Polypropylene, Left Hand	PSLOTALP	<input type="checkbox"/>	<input type="checkbox"/>	<input type="checkbox"/>	<input type="checkbox"/>		<input type="checkbox"/>
	<ul style="list-style-type: none"> Backrest tilt tension varies automatically based on occupant weight and is governed by the seat lever mechanism Tablet arm surface in high-density plastic laminate flips up for easy entry Tablet arm is 15-3/4" wide by 22-1/2" deep 19-3/4" on center ganging 	Upholstered, Left Hand	PSLOTALU	<input type="checkbox"/>	<input type="checkbox"/>	<input type="checkbox"/>	<input type="checkbox"/>	<input type="checkbox"/>	<input type="checkbox"/>
		Polypropylene, Right Hand	PSLOTARP	<input type="checkbox"/>	<input type="checkbox"/>	<input type="checkbox"/>	<input type="checkbox"/>		<input type="checkbox"/>
		Upholstered, Right Hand	PSLOTARU	<input type="checkbox"/>	<input type="checkbox"/>	<input type="checkbox"/>	<input type="checkbox"/>	<input type="checkbox"/>	<input type="checkbox"/>
PSLP PSLU									

A **B** **C** **D** **E** **F** **G**

HOW TO ORDER

Indicate the following information on order form:

- Quantity of each item.
- Model number, including options. See "How To Build a Model Number".
- Any special service required.

Note: • The indicates that a choice is required.

- The absence of the indicates that no choice is required.
- Alpha-numeric characters in place of indicate that no other alternatives are available.

HOW TO BUILD A MODEL NUMBER

- A** Select basic model.
- B** Select frame color.
Refer to color addendum at ki.com or KI Fabrics & Finishes binder.
- C** Select seat and back color.
Refer to color addendum at ki.com or KI Fabrics & Finishes binder.
- D** Select tablet arm color.
Refer to color addendum at ki.com or KI Fabrics & Finishes binder.
- E** Select fire code.
FR - Compliance to TB 133
NFR - Compliance to TB 117-2013
- F** Select upholstery grade/color.
Refer to color addendum at ki.com or KI Fabrics & Finishes binder.

G Select glide option.

- CRD - Nickel-plated steel glides
PGL - Plastic glides



Stack/Nesting
Piretti Stack Chairs

Approx. Packaged Weight	Delivered Pricing Unupholstered	Delivered Pricing Fabric Grade 1 & C.O.M.	Delivered Pricing Fabric Grade 2	Delivered Pricing Fabric Grade 3	Delivered Pricing Vinyl Group 2V	Delivered Pricing Pallas Fabric Group P0	Delivered Pricing Pallas Fabric Group P1	Delivered Pricing Pallas Fabric Group P2	Delivered Pricing Pallas Fabric Group P3	Delivered Pricing Pallas Fabric Group P4
26.0#	\$ 366									
27.0#	N/A	617	673	684	684	627	638	666	698	723
28.0#	\$ 551									
29.0#	N/A	808	919	934	934	829	840	905	961	1017
31.0#	\$ 614									
33.0#	N/A	871	979	1002	1002	895	906	971	1023	1079
31.0#	614									
33.0#	N/A	871	979	1002	1002	895	906	971	1023	1079
31.0#	\$ 656									
33.0#	N/A	912	1018	1040	1040	936	948	1011	1064	1121
31.0#	656									
33.0#	N/A	912	1018	1040	1040	936	948	1011	1064	1121

UPHOLSTERY INFORMATION

C.O.M. Upholstery

C.O.M. requirement for 10 chairs or less is 3/4 yard per chair of 54" wide nondirectional fabric. For orders of 11 or more chairs and for complete information on ordering C.O.M. see "Ordering C.O.M., C.O.V. and C.O.L." section.

OPTIONS

California TB133 Fire Safety Code

For California Technical Bulletin 133 compliant models, add the following upcharge:
 Model=Polypropylene
 Added Lead Time=1 week
 Added List Price=\$20
 Model=Upholstered
 Added Lead Time=1 week
 Added List Price=\$121

Gangers

For ganging mechanism, add '/G' to end of model number.
 List price upcharge is \$8

SPECIAL SERVICES

Special Carton Marking

With specially marked information N/C





Shipping

Shipped **assembled freight prepaid f.o.b. Green Bay, Wisconsin 54302** factory. Freight class #125.

Specifications and prices are subject to change without prior notice.

Stack/Nesting

Piretti Stack Chairs

MODEL	Features	MODEL NUMBER						
		Basic Model	Frame Color	Seat & Back Color	Tablet Arm Color	Fire Code	Up. Color	Glide Option
 <p>Sled Base Stack Chair</p> <ul style="list-style-type: none"> Backrest tilt tension varies automatically based on occupant weight and is governed by the seat lever mechanism Spring-loaded ganging device concealed under the seat 19-3/4" on center ganging 	Polypropylene	PSSNAP	<input type="checkbox"/>	<input type="checkbox"/>		<input type="checkbox"/>	<input type="checkbox"/>	
	Upholstered	PSSNAU	<input type="checkbox"/>	<input type="checkbox"/>		<input type="checkbox"/>	<input type="checkbox"/>	
 <p>Sled Base Flex Arm Chair</p> <ul style="list-style-type: none"> Backrest tilt tension varies automatically based on occupant weight and is governed by the seat lever mechanism NONSTACKING 	Polypropylene	PSSFAP	<input type="checkbox"/>	<input type="checkbox"/>		<input type="checkbox"/>	<input type="checkbox"/>	
	Upholstered	PSSFAU	<input type="checkbox"/>	<input type="checkbox"/>		<input type="checkbox"/>	<input type="checkbox"/>	
 <p>Sled Base Tablet Arm Chair</p> <ul style="list-style-type: none"> Backrest tilt tension varies automatically based on occupant weight and is governed by the seat lever mechanism Tablet arm surface in high-density plastic laminate flips up for easy entry Tablet arm is 12-3/4"W by 19-1/2" D NONSTACKING 	Polypropylene, Left Hand	PSSTALP	<input type="checkbox"/>	<input type="checkbox"/>	<input type="checkbox"/>	<input type="checkbox"/>	<input type="checkbox"/>	
	Upholstered, Left Hand	PSSTALU	<input type="checkbox"/>	<input type="checkbox"/>	<input type="checkbox"/>	<input type="checkbox"/>	<input type="checkbox"/>	
	Polypropylene, Right Hand	PSSTARP	<input type="checkbox"/>	<input type="checkbox"/>	<input type="checkbox"/>	<input type="checkbox"/>	<input type="checkbox"/>	
	Upholstered, Right Hand	PSSTARU	<input type="checkbox"/>	<input type="checkbox"/>	<input type="checkbox"/>	<input type="checkbox"/>	<input type="checkbox"/>	
 <p>Sled Base Oversize Tablet Arm Chair</p> <ul style="list-style-type: none"> Backrest tilt tension varies automatically based on occupant weight Tablet arm surface in high-density plastic laminate flips up for easy entry Tablet arm is 15-3/4"W by 22-1/2" D NONSTACKING 	Polypropylene, Left Hand	PSSOTALP	<input type="checkbox"/>	<input type="checkbox"/>	<input type="checkbox"/>	<input type="checkbox"/>	<input type="checkbox"/>	
	Upholstered, Left Hand	PSSOTALU	<input type="checkbox"/>	<input type="checkbox"/>	<input type="checkbox"/>	<input type="checkbox"/>	<input type="checkbox"/>	
	Polypropylene, Right Hand	PSSOTARP	<input type="checkbox"/>	<input type="checkbox"/>	<input type="checkbox"/>	<input type="checkbox"/>	<input type="checkbox"/>	
	Upholstered, Right Hand	PSSOTARU	<input type="checkbox"/>	<input type="checkbox"/>	<input type="checkbox"/>	<input type="checkbox"/>	<input type="checkbox"/>	

A **B** **C** **D** **E** **F** **G**

HOW TO ORDER

Indicate the following information on order form:

- Quantity of each item.
- Model number, including options. See "How To Build a Model Number".
- Any special service required.

Note: • The indicates that a choice is required.

- The absence of the indicates that no choice is required.
- Alpha-numeric characters in place of indicate that no other alternatives are available.

HOW TO BUILD A MODEL NUMBER

- A** Select basic model.
- B** Select frame color.
Refer to color addendum at ki.com or KI Fabrics & Finishes binder.
- C** Select seat and back color.
Refer to color addendum at ki.com or KI Fabrics & Finishes binder.
- D** Select tablet arm color.
Refer to color addendum at ki.com or KI Fabrics & Finishes binder.
- E** Select fire code.

NFR	- Compliance to TB 117-2013
FR	- Compliance to TB 133
- F** Select upholstery grade/color.
Refer to color addendum at ki.com or KI Fabrics & Finishes binder.

G Select glide option.

NGL	- No glides
GLD	- Clear plastic
GNM	- Mar-resistant white plastic
SSG	- Stainless steel; add \$19



Stack/Nesting

Piretti Stack Chairs

Approx. Packaged Weight	Delivered Pricing Unupholstered	Delivered Pricing Fabric Grade 1 & C.O.M.	Delivered Pricing Fabric Grade 2	Delivered Pricing Fabric Grade 3	Delivered Pricing Vinyl Group 2V	Delivered Pricing Pallas Fabric Group P0	Delivered Pricing Pallas Fabric Group P1	Delivered Pricing Pallas Fabric Group P2	Delivered Pricing Pallas Fabric Group P3	Delivered Pricing Pallas Fabric Group P4
26.0#	\$ 366									
27.0#	N/A	617	729	751	751	649	660	716	778	833
28.0#	\$ 551									
29.0#	N/A	808	862	873	873	815	825	856	885	915
31.0#	\$ 614									
33.0#	N/A	871	979	1002	1002	895	906	971	1023	1079
31.0#	614									
33.0#	N/A	871	979	1002	1002	895	906	971	1023	1079
31.0#	\$ 656									
33.0#	N/A	912	1018	1040	1040	936	948	1011	1064	1121
31.0#	656									
33.0#	N/A	912	1018	1040	1040	936	948	1011	1064	1121

UPHOLSTERY INFORMATION

C.O.M. Upholstery

C.O.M. requirement for 10 chairs or less is 3/4 yard per chair of 54" wide nondirectional fabric. For orders of 11 or more chairs and for complete information on ordering C.O.M. see "Ordering C.O.M., C.O.V. and C.O.L." section.

OPTIONS

California TB133 Fire Safety Code

For California Technical Bulletin 133 compliant models, add the following upcharge:

Model=Polypropylene
 Added Lead Time=1 week
 Added List Price=\$20
 Model=Upholstered
 Added Lead Time=1 week
 Added List Price=\$121

Gangers

For ganging mechanism, add "/G" to end of model number.
 List price upcharge is \$8

Bookrack

For bookrack, add "/BR" to end of the model number.
 List price upcharge is \$59

SPECIAL SERVICES

Special Carton Marking

With specially marked information N/C

Shipping

Shipped **assembled freight prepaid f.o.b. Green Bay, Wisconsin 54302** factory. Freight class #125.

Specifications and prices are subject to change without prior notice.

Stack/Nesting

Piretti Stack Chairs

	MODEL	MODEL NUMBER	
		Basic Model	Approx. Packaged Weight
HRDPT	Bookrack <ul style="list-style-type: none"> Welded wire frame NONSTACKING Field-installable - to order with chair, see note below 	87.7844	4.0#
	Transport Dolly <ul style="list-style-type: none"> 5" casters: two fixed, two swivel 	MVP.BL	19.0#
HRDPT	Sled Base Chair Plastic Glides - White <ul style="list-style-type: none"> Mar-resistant, white plastic For field-installation 	53.8237.SET	0.1#
HRDPT	Sled Base Chair Plastic Glides - Clear <ul style="list-style-type: none"> Mar-resistant, clear plastic For field-installation 	53.8236.SET	0.1#
HRDPT	Sled Base Chair Steel Glides <ul style="list-style-type: none"> Stainless steel For field-installation 	06.0448.SET	0.1#

A

HOW TO ORDER

Indicate the following information on order form:

- Quantity of each item.
- Model number, including options. See "How To Build a Model Number".
- Any special service required.

Note:

- The indicates that a choice is required.
- The absence of the indicates that no choice is required.
- Alpha-numeric characters in place of indicate that no other alternatives are available.

HOW TO BUILD A MODEL NUMBER

A Select basic model.



Delivered
Pricing
\$ 59

\$ 438

\$ 4

\$ 4

\$ 19

SPECIAL SERVICES

Special Carton Marking

With specially marked information N/C

Shipping

Shipped **assembled freight prepaid f.o.b. Green Bay, Wisconsin 54302** factory. Freight class #125.

Specifications and prices are subject to change without prior notice.

Stack/Nesting

Rapture® General Information



Four-Leg Stacking Armchair (RAPWAUS)



Four-Leg Armless Stacking Chair (RAPNAP)



Four-Leg Wallsaver Armchair (RAPWAUSWS)



Four-Leg Armchair with Casters (RAPWAUSC)

Features				
Stackable	•	•	•	
Field-replaceable seat and back pad	•	•	•	•
Poly, upholstered, or combination of both	•	•	•	•
Arms	•		•	•
General Dimensions				
Seat width	16-1/2"	16-1/2"	16-1/2"	16-1/2"
Seat depth	17"	17"	17"	17"
Seat height	18"	18"	18"	18"
Floor to back height	32"	32"	32"	32"
Overall Dimensions				
Width	23-1/2"	20-1/2"	23-1/2"	23-1/2"
Depth	23"	22"	24-1/2"	23"
Height	32"	32"	32"	32"
Top of arm to floor	26-1/2"			
Stacking on Dolly				
Width	23-1/2"	22-1/2"		
Depth	36"	36"		
Maximum quantity	10	10		
Stacking on Floor				
Maximum quantity	6	6	6	

SPECIFICATIONS

Frame

Legs are 1" o.d. x 16-gauge tubular steel. Cross members are 1" o.d. x 14-gauge tubular steel. Side members are 7/8" o.d. x 14-gauge tubular steel. On the stools, the footing is 16-gauge tubular steel. For both chairs and stools, all joints are welded. Wallsaver frame has an angled rear leg. Caster-based frame has a curved front leg.

Armrests

Injection molded nylon. Armrests are attached to the backrest without fasteners. Arms are assembled over the backrest attachment tubes of the frame when the backrest is installed. The backrest is then locked in place using a patented "turn and lock" feature.

Polypropylene Seat and Backrest

Injection-molded polypropylene

Upholstered Seat and Back

Molded urethane foam is attached to the seatboard, which is injection molded polypropylene. Slab urethane foam is attached to the back board, which is injection molded polypropylene. The boards are attached to the seat and back using four 10-24 x 3/8" truss head screws. Seat screws are not exposed. Backrest screws are exposed and are color matched to the polypropylene.

Glides

Chrome plated steel or plastic.

Casters

Carpet casters available in black finish only.

Frame Finishes

Baked-on electrostatically-applied epoxy powder coating, or bright nickel-chrome plating.

Tablet

Tablet measures 20-5/8 x 12" Transport Dolly Tubular steel frame, black powder-

coated finish. Four 5" swivel wheels.

Stacking Vinyl, Polyurethane, and Imitation Leather Upholstered Chairs

It is recommended that chairs to be stacked be covered in material other than vinyl, polyurethane, or imitation leather as an impression in the seat may result. KI does not warrant the effects of stacking on stock or C.O.M. vinyl, polyurethane, or imitation leather upholstery.

INFORMATION

C.O.M. Testing and Production Requirements

Not all materials are suitable for upholstering this product. A 1 yd. x 54" sample for any upholstery model must be submitted and approved prior to acceptance of an order. If the fabric is directional in pattern or weave, the direction must be indicated on the submitted sample, and additional yardage may be requested.

Test samples must be sent to:

KI
Attn: C.O.M. Specialist
1687 Westminster Drive - Gate 3
Green Bay, WI 54302

Fabric Disclaimer

Fabric will be applied as swatched by the fabric manufacturer. Fabric that is required to be applied differently than is swatched will need a Special Cost Request written specifying the direction the fabric is to be applied. The posted standard lead time will apply to the Special Cost Request.

Design

Designed by Giancarlo Piretti and manufactured in the USA by Krueger International, Inc. under license from Pro-Cord S.p.A.



Cafe Stool with Arms
(SRAPWAUB)



Armless Cafe Stool
(SRAPNAP)



Features		
Stackable		
Field-replaceable seat and back pad	•	•
Poly, upholstered, or combination of both	•	•
Arms	•	
General Dimensions		
Seat width	16-1/2"	16-1/2"
Seat depth	17"	17"
Seat height	30"	30"
Floor to back height	44"	44"
Floor to top of arm height	38-1/4"	
Overall Dimensions		
Width	23-1/2"	20-1/2"
Depth	23"	22"
Height	44"	44"

INFORMATION

Warranty
Refer to KI Terms & Conditions document
or visit ki.com

Stack/Nesting

Rapture®

	MODEL	Features	MODEL NUMBER						Approx. Packaged Weight
			Basic Model	Frame Color	Seat & Back Color	Glide Option	Fire Code	Upholstery Color	
 <p>RAPP RAPU</p>	Four-Leg Armless Chair • Poly, upholstered, or combination of both • Field-replaceable seat & back pad • Stackable	Poly Seat/Back	RAPNAP	<input type="checkbox"/>	<input type="checkbox"/>	<input type="checkbox"/>	<input type="checkbox"/>	<input type="checkbox"/>	19.0#
		Uph Seat/Poly Back	RAPNAUS	<input type="checkbox"/>	<input type="checkbox"/>	<input type="checkbox"/>	<input type="checkbox"/>	<input type="checkbox"/>	22.0#
		Uph Seat/Back	RAPNAUB	<input type="checkbox"/>	<input type="checkbox"/>	<input type="checkbox"/>	<input type="checkbox"/>	<input type="checkbox"/>	23.0#
 <p>RAPP RAPU</p>	Four-Leg Armchair • Poly, upholstered, or combination of both • Arm version • Field-replaceable seat & back pad • Stackable	Poly Seat/Back	RAPWAP	<input type="checkbox"/>	<input type="checkbox"/>	<input type="checkbox"/>	<input type="checkbox"/>	<input type="checkbox"/>	21.0#
		Uph Seat/Poly Back	RAPWAUS	<input type="checkbox"/>	<input type="checkbox"/>	<input type="checkbox"/>	<input type="checkbox"/>	<input type="checkbox"/>	23.0#
		Uph Seat/Back	RAPWAUB	<input type="checkbox"/>	<input type="checkbox"/>	<input type="checkbox"/>	<input type="checkbox"/>	<input type="checkbox"/>	24.0#
 <p>HRDPT</p>	Dolly • Accommodates up to 10 chairs • Easy maneuverability with 5" casters: two fixed, two swivel • Black powder-coated finish		RAPD.BL						32.0#

A **B** **C** **D** **E** **F**

HOW TO ORDER

Indicate the following information on order form:

- Quantity of each item.
- Model number, including options. See "How To Build a Model Number".
- Any special service required.

Note: • The indicates that a choice is required.

- The absence of the indicates that no choice is required.
- Alpha-numeric characters in place of indicate that no other alternatives are available.

HOW TO BUILD A MODEL NUMBER

- A** Select basic model.
- B** Select frame color.
Refer to color addendum at ki.com or KI Fabrics & Finishes binder.
- C** Select seat and back color.
Refer to color addendum at ki.com or KI Fabrics & Finishes binder.
- D** Select glide option.

P	- Plastic glides
S	- Steel glides
- E** Select fire code.

FR	- Compliance to TB 133
NFR	- Compliance to TB 117-2013
- F** Select upholstery grade/color.
Refer to color addendum at ki.com or KI Fabrics & Finishes binder.

UPHOLSTERY INFORMATION

C.O.M. Upholstery

C.O.M. requirement 1/2 yard per upholstered seat and 3/4 yard per upholstered seat and back of 54" wide nondirectional fabric. For complete information on ordering C.O.M., see "Ordering C.O.M., C.O.V. and C.O.L." section.



Delivered Pricing Unupholstered	Delivered Pricing Fabric Grade 1 & C.O.M.	Delivered Pricing Fabric Grade 2	Delivered Pricing Fabric Grade 3	Delivered Pricing C.O.V.	Delivered Pricing Vinyl Group 2V	Delivered Pricing Pallas Fabric Group P0	Delivered Pricing Pallas Fabric Group P1	Delivered Pricing Pallas Fabric Group P2	Delivered Pricing Pallas Fabric Group P3	Delivered Pricing Pallas Fabric Group P4	
\$ 275	N/A	333	339	340	333	340	349	386	404	422	435
N/A	378	404	406	378	406	419	456	482	507	529	

\$ 294	N/A	349	358	359	349	359	369	406	424	438	456
N/A	397	425	427	397	427	444	481	501	526	550	

\$ 419										
--------	--	--	--	--	--	--	--	--	--	--

OPTIONS

California TB133 Fire Safety Code

For California Technical Bulletin 133 compliant models, add the following upcharge:

- Model=Poly Seat/Back
Added Lead Time=None
Added List Price=\$32
- Model=Uph Seat/Poly Back
Added Lead Time=None
Added List Price=\$93
- Model=Uph Seat/Back
Added Lead Time=None
Added List Price=\$104

SPECIAL SERVICES

Special Carton Marking

With specially marked information N/C



Shipping

Shipped **assembled freight prepaid f.o.b. Green Bay, Wisconsin 54302** factory. Freight class #125.

Specifications and prices are subject to change without prior notice.

Stack/Nesting

Rapture®

Features	MODEL NUMBER							Approx. Packaged Weight
	Basic Model	Frame Color	Seat & Back Color	Glide Option	Laminate Color	Fire Code	Upholstery Color	
 <p>RAPP RAPU Four-Leg Tablet Arm Chair (Right Hand)</p> <ul style="list-style-type: none"> • Poly, upholstered, or combination of both • Field-replaceable seat & back pad • NONSTACKING 	Right Tablet, Poly Seat/Back	RAPTARP	<input type="checkbox"/>	<input type="checkbox"/>	<input type="checkbox"/>	<input type="checkbox"/>	<input type="checkbox"/>	21.0#
	Right Tablet, Uph Seat/Poly Back	RAPTARUS	<input type="checkbox"/>	<input type="checkbox"/>	<input type="checkbox"/>	<input type="checkbox"/>	<input type="checkbox"/>	24.0#
	Right Tablet, Uph Seat/Back	RAPTARUB	<input type="checkbox"/>	<input type="checkbox"/>	<input type="checkbox"/>	<input type="checkbox"/>	<input type="checkbox"/>	25.0#
 <p>RAPP RAPU Four-Leg Tablet Arm Chair (Left Hand)</p>	Left Tablet, Poly Seat/Back	RAPTALP	<input type="checkbox"/>	<input type="checkbox"/>	<input type="checkbox"/>	<input type="checkbox"/>	<input type="checkbox"/>	21.0#
	Left Tablet, Uph Seat/Poly Back	RAPTALUS	<input type="checkbox"/>	<input type="checkbox"/>	<input type="checkbox"/>	<input type="checkbox"/>	<input type="checkbox"/>	24.0#
	Left Tablet, Uph Seat/Back	RAPTALUB	<input type="checkbox"/>	<input type="checkbox"/>	<input type="checkbox"/>	<input type="checkbox"/>	<input type="checkbox"/>	25.0#

A **B** **C** **D** **E** **F** **G**

HOW TO ORDER

Indicate the following information on order form:

1. Quantity of each item.
2. Model number, including options. See "How To Build a Model Number".
3. Any special service required.

Note: • The indicates that a choice is required.

- The absence of the indicates that no choice is required.
- Alpha-numeric characters in place of indicate that no other alternatives are available.

HOW TO BUILD A MODEL NUMBER

- A** Select basic model.
- B** Select frame color.
Refer to color addendum at ki.com or KI Fabrics & Finishes binder.
- C** Select seat and back color.
Refer to color addendum at ki.com or KI Fabrics & Finishes binder.
- D** Select glide option.

P	- Plastic glides
S	- Steel glides
- E** Select tablet arm laminate.
Refer to color addendum at ki.com or KI Fabrics & Finishes binder.
- F** Select fire code.

FR	- Compliance to TB 133
NFR	- Compliance to TB 117-2013

- G** Select upholstery grade/color.
Refer to color addendum at ki.com or KI Fabrics & Finishes binder.

UPHOLSTERY INFORMATION

C.O.M. Upholstery
C.O.M. requirement 1/2 yard per upholstered seat and 3/4 yard per upholstered seat and back of 54" wide nondirectional fabric. For complete information on ordering C.O.M., see "Ordering C.O.M., C.O.V. and C.O.L." section.



Delivered Pricing Unupholstered	Delivered Pricing Fabric Grade 1 & C.O.M.	Delivered Pricing Fabric Grade 2	Delivered Pricing Fabric Grade 3	Delivered Pricing C.O.V.	Delivered Pricing Vinyl Group 2V	Delivered Pricing Pallas Fabric Group P0	Delivered Pricing Pallas Fabric Group P1	Delivered Pricing Pallas Fabric Group P2	Delivered Pricing Pallas Fabric Group P3	Delivered Pricing Pallas Fabric Group P4	
\$ 460	N/A	520	526	527	520	527	537	574	592	608	625
N/A	563	590	592	563	592	605	642	666	695	715	

\$ 460	N/A	520	526	527	520	527	537	574	592	608	625
N/A	563	590	592	563	592	605	642	666	695	715	

OPTIONS

California TB133 Fire Safety Code

For California Technical Bulletin 133 compliant models, add the following upcharge:

- Model=Poly Seat/Back
Added Lead Time=None
Added List Price=\$32
- Model=Uph Seat/Poly Back
Added Lead Time=None
Added List Price=\$93
- Model=Uph Seat/Back
Added Lead Time=None
Added List Price=\$104

SPECIAL SERVICES

Special Carton Marking

With specially marked information N/C



Shipping

Shipped **assembled freight prepaid f.o.b. Green Bay, Wisconsin 54302** factory. Freight class #125.

Specifications and prices are subject to change without prior notice.

Stack/Nesting

Rapture®

			MODEL NUMBER						Approx. Packaged Weight
			Basic Model	Frame Color	Seat & Back Color	Glide Option	Fire Code	Upholstery Color	
 <p>RAPP RAPU</p>	Four-Leg Wallsaver Armless Chair • Poly, upholstered, or combination of both • Field-replaceable seat & back pad • Stackable • Wallsaver rear legs touch base of wall preventing chair back from contacting wall surface	Poly Seat/Back	RAPNAPWS	<input type="checkbox"/> <input type="checkbox"/>	<input type="checkbox"/> <input type="checkbox"/> <input type="checkbox"/> <input type="checkbox"/>	<input type="checkbox"/>	<input type="checkbox"/> <input type="checkbox"/> <input type="checkbox"/> <input type="checkbox"/>	<input type="checkbox"/> <input type="checkbox"/> <input type="checkbox"/> <input type="checkbox"/> <input type="checkbox"/> <input type="checkbox"/>	19.0#
		Uph Seat/Poly Back	RAPNAUSWS	<input type="checkbox"/> <input type="checkbox"/>	<input type="checkbox"/> <input type="checkbox"/> <input type="checkbox"/> <input type="checkbox"/>	<input type="checkbox"/>	<input type="checkbox"/> <input type="checkbox"/> <input type="checkbox"/> <input type="checkbox"/>	<input type="checkbox"/> <input type="checkbox"/> <input type="checkbox"/> <input type="checkbox"/> <input type="checkbox"/> <input type="checkbox"/>	22.0#
		Uph Seat/Back	RAPNAUBWS	<input type="checkbox"/> <input type="checkbox"/>	<input type="checkbox"/> <input type="checkbox"/> <input type="checkbox"/> <input type="checkbox"/>	<input type="checkbox"/>	<input type="checkbox"/> <input type="checkbox"/> <input type="checkbox"/> <input type="checkbox"/>	<input type="checkbox"/> <input type="checkbox"/> <input type="checkbox"/> <input type="checkbox"/> <input type="checkbox"/> <input type="checkbox"/>	23.0#
 <p>RAPP RAPU</p>	Four-Leg Wallsaver Armchair • Poly, upholstered, or combination of both • Field-replaceable seat & back pad • Stackable • Wallsaver rear legs touch base of wall preventing chair back from contacting wall surface	Poly Seat/Back	RAPWAPWS	<input type="checkbox"/> <input type="checkbox"/>	<input type="checkbox"/> <input type="checkbox"/> <input type="checkbox"/> <input type="checkbox"/>	<input type="checkbox"/>	<input type="checkbox"/> <input type="checkbox"/> <input type="checkbox"/> <input type="checkbox"/>	<input type="checkbox"/> <input type="checkbox"/> <input type="checkbox"/> <input type="checkbox"/> <input type="checkbox"/> <input type="checkbox"/>	21.0#
		Uph Seat/Poly Back	RAPWAUSWS	<input type="checkbox"/> <input type="checkbox"/>	<input type="checkbox"/> <input type="checkbox"/> <input type="checkbox"/> <input type="checkbox"/>	<input type="checkbox"/>	<input type="checkbox"/> <input type="checkbox"/> <input type="checkbox"/> <input type="checkbox"/>	<input type="checkbox"/> <input type="checkbox"/> <input type="checkbox"/> <input type="checkbox"/> <input type="checkbox"/> <input type="checkbox"/>	23.0#
		Uph Seat/Back	RAPWAUBWS	<input type="checkbox"/> <input type="checkbox"/>	<input type="checkbox"/> <input type="checkbox"/> <input type="checkbox"/> <input type="checkbox"/>	<input type="checkbox"/>	<input type="checkbox"/> <input type="checkbox"/> <input type="checkbox"/> <input type="checkbox"/>	<input type="checkbox"/> <input type="checkbox"/> <input type="checkbox"/> <input type="checkbox"/> <input type="checkbox"/> <input type="checkbox"/>	24.0#

A **B** **C** **D** **E** **F**

HOW TO ORDER

Indicate the following information on order form:

- Quantity of each item.
- Model number, including options. See "How To Build a Model Number".
- Any special service required.

Note: • The indicates that a choice is required.

- The absence of the indicates that no choice is required.
- Alpha-numeric characters in place of indicate that no other alternatives are available.

HOW TO BUILD A MODEL NUMBER

- A** Select basic model.
- B** Select frame color.
Refer to color addendum at ki.com or KI Fabrics & Finishes binder.
- C** Select seat and back color.
Refer to color addendum at ki.com or KI Fabrics & Finishes binder.
- D** Select glide option.

P	- Plastic glides
S	- Steel glides
- E** Select fire code.

NFR	- Compliance to TB 117-2013
FR	- Compliance to TB 133
- F** Select upholstery grade/color.
Refer to color addendum at ki.com or KI Fabrics & Finishes binder.

UPHOLSTERY INFORMATION

C.O.M. Upholstery

C.O.M. requirement 1/2 yard per upholstered seat and 3/4 yard per upholstered seat and back of 54" wide nondirectional fabric. For complete information on ordering C.O.M., see "Ordering C.O.M., C.O.V. and C.O.L." section.



Delivered Pricing Unupholstered	Delivered Pricing Fabric Grade 1 & C.O.M.	Delivered Pricing Fabric Grade 2	Delivered Pricing Fabric Grade 3	Delivered Pricing C.O.V.	Delivered Pricing Vinyl Group 2V	Delivered Pricing Pallas Fabric Group P0	Delivered Pricing Pallas Fabric Group P1	Delivered Pricing Pallas Fabric Group P2	Delivered Pricing Pallas Fabric Group P3	Delivered Pricing Pallas Fabric Group P4	
\$ 308	N/A	367	373	374	367	374	385	422	438	456	471
N/A	412	437	438	412	438	453	490	517	542	563	

\$ 328	N/A	385	392	393	385	393	401	438	457	473	490
N/A	431	458	461	431	461	479	516	537	559	585	

OPTIONS

California TB133 Fire Safety Code

For California Technical Bulletin 133 compliant models, add the following upcharge:

- Model=Poly Seat/Back
Added Lead Time=None
Added List Price=\$32
- Model=Uph Seat/Poly Back
Added Lead Time=None
Added List Price=\$93
- Model=Uph Seat/Back
Added Lead Time=None
Added List Price=\$104

SPECIAL SERVICES

Special Carton Marking

With specially marked information N/C



Shipping

Shipped **assembled freight prepaid f.o.b. Green Bay, Wisconsin 54302** factory. Freight class #125.

Specifications and prices are subject to change without prior notice.

Stack/Nesting

Rapture®

	MODEL	Features	MODEL NUMBER					Approx. Packaged Weight
			Basic Model	Frame Color	Seat & Back Color	Fire Code	Upholstery Color	
 <p>RAPP RAPU</p>	Four-Leg Armless Chair with Casters	Poly Seat/Back	RAPNAPC	<input type="checkbox"/> <input type="checkbox"/>	<input type="checkbox"/> <input type="checkbox"/> <input type="checkbox"/> <input type="checkbox"/>	<input type="checkbox"/> <input type="checkbox"/> <input type="checkbox"/> <input type="checkbox"/>		19.0#
	<ul style="list-style-type: none"> • Poly, upholstered, or combination of both • Field-replaceable seat & back pad • Stacking. Caution should be exercised to prevent casters from marring components such as frames, fabric, etc., and to prevent casters from becoming "hung up" underneath the seat of the chair below • Stackable on dollies is NOT recommended 	Uph Seat/Poly Back	RAPNAUSC	<input type="checkbox"/> <input type="checkbox"/>	<input type="checkbox"/> <input type="checkbox"/> <input type="checkbox"/> <input type="checkbox"/>	<input type="checkbox"/> <input type="checkbox"/> <input type="checkbox"/> <input type="checkbox"/> <input type="checkbox"/> <input type="checkbox"/>		22.0#
		Uph Seat/Back	RAPNAUBC	<input type="checkbox"/> <input type="checkbox"/>	<input type="checkbox"/> <input type="checkbox"/> <input type="checkbox"/> <input type="checkbox"/>	<input type="checkbox"/> <input type="checkbox"/> <input type="checkbox"/> <input type="checkbox"/>		23.0#
 <p>RAPP RAPU</p>	Four-Leg Armchair with Casters	Poly Seat/Back	RAPWAPC	<input type="checkbox"/> <input type="checkbox"/>	<input type="checkbox"/> <input type="checkbox"/> <input type="checkbox"/> <input type="checkbox"/>	<input type="checkbox"/> <input type="checkbox"/> <input type="checkbox"/> <input type="checkbox"/>		21.0#
	<ul style="list-style-type: none"> • Poly, upholstered, or combination of both • Arm version • Field-replaceable seat & back pad • Stacking. Caution should be exercised to prevent casters from marring components such as frames, fabric, etc., and to prevent casters from becoming "hung up" underneath the seat of the chair below • Stackable on dollies is NOT recommended 	Uph Seat/Poly Back	RAPWAUSC	<input type="checkbox"/> <input type="checkbox"/>	<input type="checkbox"/> <input type="checkbox"/> <input type="checkbox"/> <input type="checkbox"/>	<input type="checkbox"/> <input type="checkbox"/> <input type="checkbox"/> <input type="checkbox"/> <input type="checkbox"/> <input type="checkbox"/>		23.0#
		Uph Seat/Back	RAPWAUBC	<input type="checkbox"/> <input type="checkbox"/>	<input type="checkbox"/> <input type="checkbox"/> <input type="checkbox"/> <input type="checkbox"/>	<input type="checkbox"/> <input type="checkbox"/> <input type="checkbox"/> <input type="checkbox"/>		24.0#
				A	B	C	D	E

HOW TO ORDER

Indicate the following information on order form:

1. Quantity of each item.
2. Model number, including options. See "How To Build a Model Number".
3. Any special service required.

Note: • The indicates that a choice is required.

- The absence of the indicates that no choice is required.
- Alpha-numeric characters in place of indicate that no other alternatives are available.

HOW TO BUILD A MODEL NUMBER

- A** Select basic model.
- B** Select frame color.
Refer to color addendum at ki.com or KI Fabrics & Finishes binder.
- C** Select seat and back color.
Refer to color addendum at ki.com or KI Fabrics & Finishes binder.
- D** Select fire code.

NFR	- Compliance to TB 117-2013
FR	- Compliance to TB 133
- E** Select upholstery grade/color.
Refer to color addendum at ki.com or KI Fabrics & Finishes binder.

UPHOLSTERY INFORMATION

C.O.M. Upholstery

C.O.M. requirement 1/2 yard per upholstered seat and 3/4 yard per upholstered seat and back of 54" wide nondirectional fabric. For complete information on ordering C.O.M., see "Ordering C.O.M., C.O.V. and C.O.L." section.



Delivered Pricing Unupholstered	Delivered Pricing Fabric Grade 1 & C.O.M.	Delivered Pricing Fabric Grade 2	Delivered Pricing Fabric Grade 3	Delivered Pricing C.O.V.	Delivered Pricing Vinyl Group 2V	Delivered Pricing Pallas Fabric Group P0	Delivered Pricing Pallas Fabric Group P1	Delivered Pricing Pallas Fabric Group P2	Delivered Pricing Pallas Fabric Group P3	Delivered Pricing Pallas Fabric Group P4	
\$ 378	N/A	434	441	445	434	445	452	489	510	524	540
N/A	482	510	511	482	511	522	559	585	611	633	

\$ 397	N/A	454	461	462	454	462	474	511	527	544	559
N/A	500	528	530	500	530	546	584	605	630	655	

OPTIONS

California TB133 Fire Safety Code

For California Technical Bulletin 133 compliant models, add the following upcharge:

- Model=Poly Seat/Back
Added Lead Time=None
Added List Price=\$32
- Model=Uph Seat/Poly Back
Added Lead Time=None
Added List Price=\$93
- Model=Uph Seat/Back
Added Lead Time=None
Added List Price=\$104

SPECIAL SERVICES

Special Carton Marking

With specially marked information N/C



Shipping

Shipped **assembled freight prepaid f.o.b. Green Bay, Wisconsin 54302** factory. Freight class #125.

Specifications and prices are subject to change without prior notice.

Stack/Nesting

Rapture® Cafe Stools

	MODEL	Features	MODEL NUMBER						Approx. Packaged Weight
			Basic Model	Frame Color	Seat & Back Color	Glide Option	Fire Code	Upholstery Color	
 <p>SRAPP SRAPU</p>	Four-Leg Armless Cafe Stool • Poly, upholstered, or combination of both • Field-replaceable seat & back pad	Poly Seat/Back	SRAPNAP	<input type="checkbox"/>	<input type="checkbox"/>	<input type="checkbox"/>	<input type="checkbox"/>	<input type="checkbox"/>	29.0#
		Uph Seat/Poly Back	SRAPNAPB	<input type="checkbox"/>	<input type="checkbox"/>	<input type="checkbox"/>	<input type="checkbox"/>	<input type="checkbox"/>	31.0#
		Uph Seat/Back	SRAPNAUB	<input type="checkbox"/>	<input type="checkbox"/>	<input type="checkbox"/>	<input type="checkbox"/>	<input type="checkbox"/>	33.0#
 <p>SRAPP SRAPU</p>	Four-Leg Cafe Stool with Arms • Poly, upholstered, or combination of both • Arm version • Field-replaceable seat & back pad	Poly Seat/Back	SRAPWAP	<input type="checkbox"/>	<input type="checkbox"/>	<input type="checkbox"/>	<input type="checkbox"/>	<input type="checkbox"/>	31.0#
		Uph Seat/Poly Back	SRAPWAPB	<input type="checkbox"/>	<input type="checkbox"/>	<input type="checkbox"/>	<input type="checkbox"/>	<input type="checkbox"/>	33.0#
		Uph Seat/Back	SRAPWAUB	<input type="checkbox"/>	<input type="checkbox"/>	<input type="checkbox"/>	<input type="checkbox"/>	<input type="checkbox"/>	35.0#

A **B** **C** **D** **E** **F**

HOW TO ORDER

Indicate the following information on order form:

- Quantity of each item.
- Model number, including options. See "How To Build a Model Number".
- Any special service required.

Note: • The indicates that a choice is required.

- The absence of the indicates that no choice is required.
- Alpha-numeric characters in place of indicate that no other alternatives are available.

HOW TO BUILD A MODEL NUMBER

- A** Select basic model.
- B** Select frame color.
Refer to color addendum at ki.com or KI Fabrics & Finishes binder.
- C** Select seat and back color.
Refer to color addendum at ki.com or KI Fabrics & Finishes binder.
- D** Select glide option.

P	- Plastic glides
S	- Steel glides
- E** Select fire code.

FR	- Compliance to TB 133
NFR	- Compliance to TB 117-2013
- F** Select upholstery grade/color.
Refer to color addendum at ki.com or KI Fabrics & Finishes binder.

UPHOLSTERY INFORMATION

C.O.M. Upholstery

C.O.M. requirement 1/2 yard per upholstered seat and 3/4 yard per upholstered seat and back of 54" wide nondirectional fabric. For complete information on ordering C.O.M., see "Ordering C.O.M., C.O.V. and C.O.L." section.



Stack/Nesting

Rapture® Cafe Stools

Delivered Pricing Unupholstered	Delivered Pricing Fabric Grade 1 & C.O.M.	Delivered Pricing Fabric Grade 2	Delivered Pricing Fabric Grade 3	Delivered Pricing C.O.V.	Delivered Pricing Vinyl Group 2V	Delivered Pricing Pallas Fabric Group P0	Delivered Pricing Pallas Fabric Group P1	Delivered Pricing Pallas Fabric Group P2	Delivered Pricing Pallas Fabric Group P3	Delivered Pricing Pallas Fabric Group P4	
\$ 602	N/A	661	667	668	661	668	679	716	739	753	768
N/A	709	741	742	709	742	752	789	815	843	865	

\$ 623	N/A	681	688	691	681	691	703	741	755	773	789
N/A	727	756	759	727	759	773	810	836	862	886	

OPTIONS

California TB133 Fire Safety Code

For California Technical Bulletin 133 compliant models, add the following upcharge:

- Model=Poly Seat/Back
Added Lead Time=None
Added List Price=\$32
- Model=Uph Seat/Poly Back
Added Lead Time=None
Added List Price=\$93
- Model=Uph Seat/Back
Added Lead Time=None
Added List Price=\$104

SPECIAL SERVICES

Special Carton Marking

With specially marked information N/C

Shipping

Shipped **assembled freight prepaid f.o.b. Green Bay, Wisconsin 54302** factory. Freight class #125.

Specifications and prices are subject to change without prior notice.

Stack/Nesting

Silhouette® General Information



**Tubular Steel Armchair
(SILUFA)**



**Armless Tubular
Steel Chair
(SILNA)**



**Cast Aluminum
Frame Armchair
(SIGUFA)**



**Armless Cast
Aluminum
Frame Chair
(SIGNA)**



**Transport Dolly
(SILD)**

Features					
Stackable	•	•	•	•	
Upholstered seat and back	•	•	•	•	
Nylon seat and back	•	•	•	•	
Nylon arms	•				
General Dimensions					
Seat width	17-1/2"	17-1/2"	17-1/2"	17-1/2"	
Seat depth	16"	16"	16"	16"	
Seat height	17-3/4"	17-3/4"	17-3/4"	17-3/4"	
Overall Dimensions					
Width	24"	18-1/4"	24"	18-1/4"	35"
Depth	20"	20"	20"	20"	33"
Height	32-1/4"	32-1/4"	32-1/4"	32-1/4"	48"
Arms to floor	27"		27"		
Stacking on Dolly					
Overall width	25"	25"	25"	25"	
Overall depth	39"	39"	39"	39"	
Quantity/height	12 Chairs/65" High	12 Chairs/65" High	12 Chairs/65" High	12 Chairs/65" High	
Stacking on Floor					
Width	24"	20"	24"	20"	
Depth	30"	30"	30"	30"	
Quantity/height	8 Chairs/51" High	8 Chairs/51" High	8 Chairs/51" High	8 Chairs/51" High	

SPECIFICATIONS

Chair Frame

Frame of 3/4" o.d. x 14-gauge tubular steel. Two leg frames are joined by means of "U"-shaped metal plates. Legs and side tubes are welded. Optional cast aluminum frame.

Stool Foot Ring

Footrest is 16mm solid steel rod wrapped around leg tubes and MIG welded top and bottom. Does not apply to cast aluminum frame.

Shell

One-piece, textured nylon with fiberglass reinforcement. Back of shell is ribbed to allow back flex.

Armrests

Nylon reinforced with fiberglass on tubular steel frame or cast aluminum on cast aluminum frame.

Tube Endcaps

Armless chair. Does not apply to cast aluminum frame.

Glides

Ball and socket joints to provide better leveling on any floor. Glides are available in black plastic or chromed steel. Ball and socket joint glides are not available on cast aluminum frame.

Stacking Bumper

Plastic seat pan (black) for stacking support.

Frame Finishes

Baked-on, electrostatically-applied epoxy powder coating, bright nickel-chrome plating, or cast aluminum.

Transport Dolly

Tubular steel frame, black powder-coat finish. Four 5" swivel wheels. Stacks 12 high.

Upholstered Seat

Seat is constructed of injection-molded

polypropylene with 3/4" polyurethane foam cushion applied. Fastened to the shell with three screws through T-nuts embedded in inner structure.

Upholstered Backrest

Back is constructed of injection-molded polypropylene with 3/8" polyurethane foam cushion applied. Fastened to the shell with three screws through T-nuts embedded in inner structure.

Stacking Vinyl, Polyurethane, and Imitation Leather Upholstered Chairs

It is recommended that chairs to be stacked be covered in material other than vinyl, polyurethane, or imitation leather as an impression in the seat may result. KI does not warrant the effects of stacking on stock or C.O.M. vinyl, polyurethane, or imitation leather upholstery.

INFORMATION

C.O.M. Testing and Production Requirements

Not all materials are suitable for upholstering this product. A 1 yd. x 54" sample must be submitted and approved prior to acceptance of an order. If the fabric is directional in pattern or weave, the direction must be indicated on the submitted sample, and additional yardage may be requested.

Test samples must be sent to:

KI
Attn: C.O.M. Specialist
204 West South St
Bonduel, WI 54107

Fabric Disclaimer

Fabric will be applied as swatched by the fabric manufacturer. Fabric that is required to be applied differently than is swatched will need a Special Cost Request written specify-



**Tubular Steel Cafe Stool
with Arms
(SSILUFA)**



**Armless Tubular Steel
Cafe Stool
(SSILNA)**

Features

Stackable

Upholstered seat and back

Nylon seat and back

Nylon arms

•

•

•

•

•

General Dimensions

Seat width

17-1/2"

17-1/2"

Seat depth

16"

16"

Seat height

29"

29"

Overall Dimensions

Width

24"

18-1/4"

Depth

20"

20"

Height

43-1/2"

43-1/2"

Arms to floor

37"



ing the direction the fabric is to be applied.
The posted standard lead time will apply to
the Special Cost Request.

INFORMATION

Warranty

Refer to KI Terms & Conditions document
or visit ki.com

Stack/Nesting Silhouette®

	MODEL	Features	MODEL NUMBER							Approx. Packaged Weight
			Basic Model	Frame Color	Seat & Back Color	Armrest Color	Glide Option	Fire Code	Upholstery Color	
 SIL SILU	Tubular Steel Frame Four-Leg Armless Chair	Nylon	SILNA	<input type="checkbox"/> <input type="checkbox"/>	<input type="checkbox"/> <input type="checkbox"/> <input type="checkbox"/>		<input type="checkbox"/> <input type="checkbox"/> <input type="checkbox"/>	<input type="checkbox"/> <input type="checkbox"/> <input type="checkbox"/>		17.0#
		Upholstered	SILUNA	<input type="checkbox"/> <input type="checkbox"/>	<input type="checkbox"/> <input type="checkbox"/> <input type="checkbox"/>		<input type="checkbox"/> <input type="checkbox"/> <input type="checkbox"/>	<input type="checkbox"/> <input type="checkbox"/> <input type="checkbox"/>	<input type="checkbox"/> <input type="checkbox"/> <input type="checkbox"/> <input type="checkbox"/> <input type="checkbox"/>	19.0#
 SIL SILU	Tubular Steel Frame Four-Leg Armchair	Nylon	SILFA	<input type="checkbox"/> <input type="checkbox"/>	<input type="checkbox"/> <input type="checkbox"/> <input type="checkbox"/>	<input type="checkbox"/> <input type="checkbox"/> <input type="checkbox"/>	<input type="checkbox"/> <input type="checkbox"/> <input type="checkbox"/>	<input type="checkbox"/> <input type="checkbox"/> <input type="checkbox"/>		19.0#
		Upholstered	SILUFA	<input type="checkbox"/> <input type="checkbox"/>	<input type="checkbox"/> <input type="checkbox"/> <input type="checkbox"/>	<input type="checkbox"/> <input type="checkbox"/> <input type="checkbox"/>	<input type="checkbox"/> <input type="checkbox"/> <input type="checkbox"/>	<input type="checkbox"/> <input type="checkbox"/> <input type="checkbox"/>	<input type="checkbox"/> <input type="checkbox"/> <input type="checkbox"/> <input type="checkbox"/> <input type="checkbox"/>	21.0#
 HRDPT	Dolly • For tubular steel or cast aluminum frame		SILD							26.0#

A **B** **C** **D** **E** **F** **G**

HOW TO ORDER

Indicate the following information on order form:

- Quantity of each item.
- Model number, including options. See "How To Build a Model Number".
- Any special service required.

Note: • The indicates that a choice is required.

- The absence of the indicates that no choice is required.
- Alpha-numeric characters in place of indicate that no other alternatives are available.

HOW TO BUILD A MODEL NUMBER

- A** Select basic model.
- B** Select frame color.
Refer to color addendum at ki.com or KI Fabrics & Finishes binder.
- C** Select seat and back color.
Refer to color addendum at ki.com or KI Fabrics & Finishes binder.
- D** Select armrest color.
Refer to color addendum at ki.com or KI Fabrics & Finishes binder.
- E** Select glide option.

GCH	- Chromed steel glides
GBL	- Black plastic glides
- F** Select fire code.

FR	- Compliance to TB 133
NFR	- Compliance to TB 117-2013

- G** Select upholstery grade/color.
Refer to color addendum at ki.com or KI Fabrics & Finishes binder.

UPHOLSTERY INFORMATION

C.O.M. Upholstery
C.O.M. requirement is 3/4 yard per chair of 54" wide nondirectional fabric. For complete information on ordering C.O.M., see "Ordering C.O.M., C.O.V. and C.O.L. section."



Delivered Pricing Unupholstered	Delivered Pricing Fabric Grade 1 & C.O.M.	Delivered Pricing Fabric Grade 2	Delivered Pricing Fabric Grade 3	Delivered Pricing C.O.V.	Delivered Pricing Vinyl Group 2V	Delivered Pricing Pallas Fabric Group P0	Delivered Pricing Pallas Fabric Group P1	Delivered Pricing Pallas Fabric Group P2	Delivered Pricing Pallas Fabric Group P3	Delivered Pricing Pallas Fabric Group P4	
\$ 343	N/A	506	539	540	506	540	535	545	584	615	652
\$ 391	N/A	552	586	587	552	587	584	594	632	664	701
\$ 535											

OPTIONS

California TB133 Fire Safety Code

The above seating products can be manufactured using the appropriate flame-retardant materials for compliance to California Technical Bulletin 133. Add "FR" to end of model number.
 Model=Upholstered
 Added Lead Time=1 week
 Added List Price=\$79
 Model=Nylon
 Added Lead Time=1 week
 Added List Price=N/C

SPECIAL SERVICES

Special Carton Marking





With specially marked information N/C

Shipping

Shipped **assembled freight prepaid f.o.b. Bonduel, Wisconsin 54107** factory. Freight class #125.

Specifications and prices are subject to change without prior notice.

Stack/Nesting Silhouette®

	MODEL	Features	MODEL NUMBER					Approx. Packaged Weight	Delivered Pricing Unupholstered
			Basic Model	Frame Color	Seat & Back Color	Fire Code	Upholstery Color		
	Cast Aluminum Frame Four-Leg Armless Chair in Nylon (Plastic)	Polished	SIGNA	PA	<input type="checkbox"/> <input type="checkbox"/> <input type="checkbox"/>	<input type="checkbox"/> <input type="checkbox"/> <input type="checkbox"/>		25.0#	\$ 655
		Powder Coat	SIGNAPC	<input type="checkbox"/> <input type="checkbox"/>	<input type="checkbox"/> <input type="checkbox"/> <input type="checkbox"/>	<input type="checkbox"/> <input type="checkbox"/> <input type="checkbox"/>		25.0#	605
SIG									
	Cast Aluminum Frame Four-Leg Armless Chair Upholstered	Polished	SIGUNA	PA	<input type="checkbox"/> <input type="checkbox"/> <input type="checkbox"/>	<input type="checkbox"/> <input type="checkbox"/> <input type="checkbox"/>	<input type="checkbox"/> <input type="checkbox"/> <input type="checkbox"/> <input type="checkbox"/> <input type="checkbox"/> <input type="checkbox"/>	25.0#	N/A
		Powder Coat	SIGUNAPC	<input type="checkbox"/> <input type="checkbox"/>	<input type="checkbox"/> <input type="checkbox"/> <input type="checkbox"/>	<input type="checkbox"/> <input type="checkbox"/> <input type="checkbox"/>	<input type="checkbox"/> <input type="checkbox"/> <input type="checkbox"/> <input type="checkbox"/> <input type="checkbox"/> <input type="checkbox"/>	25.0#	N/A
SIGU									
	Cast Aluminum Frame Four-Leg Armchair in Nylon (Plastic)	Polished	SIGFA	PA	<input type="checkbox"/> <input type="checkbox"/> <input type="checkbox"/>	<input type="checkbox"/> <input type="checkbox"/> <input type="checkbox"/>		30.0#	\$ 796
		Powder Coat	SIGFAPC	<input type="checkbox"/> <input type="checkbox"/>	<input type="checkbox"/> <input type="checkbox"/> <input type="checkbox"/>	<input type="checkbox"/> <input type="checkbox"/> <input type="checkbox"/>		30.0#	672
SIG									
	Cast Aluminum Frame Four-Leg Armchair Upholstered	Polished	SIGUFA	PA	<input type="checkbox"/> <input type="checkbox"/> <input type="checkbox"/>	<input type="checkbox"/> <input type="checkbox"/> <input type="checkbox"/>	<input type="checkbox"/> <input type="checkbox"/> <input type="checkbox"/> <input type="checkbox"/> <input type="checkbox"/> <input type="checkbox"/>	30.0#	N/A
		Powder Coat	SIGUFAPC	<input type="checkbox"/> <input type="checkbox"/>	<input type="checkbox"/> <input type="checkbox"/> <input type="checkbox"/>	<input type="checkbox"/> <input type="checkbox"/> <input type="checkbox"/>	<input type="checkbox"/> <input type="checkbox"/> <input type="checkbox"/> <input type="checkbox"/> <input type="checkbox"/> <input type="checkbox"/>	30.0#	N/A
SIGU									

A **B** **C** **D** **E**

HOW TO ORDER

Indicate the following information on order form:

- Quantity of each item.
- Model number, including options. See "How To Build a Model Number".
- Any special service required.

Note: • The indicates that a choice is required.

- The absence of the indicates that no choice is required.
- Alpha-numeric characters in place of indicate that no other alternatives are available.

HOW TO BUILD A MODEL NUMBER

- A** Select basic model.
- B** Select frame color.
Refer to color addendum at ki.com or KI Fabrics & Finishes binder.
- C** Select seat and back color.
Refer to color addendum at ki.com or KI Fabrics & Finishes binder.
- D** Select fire code.

FR	- Compliance to TB 133
NFR	- Compliance to TB 117-2013
- E** Select upholstery grade/color.
Refer to color addendum at ki.com or KI Fabrics & Finishes binder.

UPHOLSTERY INFORMATION

C.O.M. Upholstery

C.O.M. requirement is 3/4 yard per chair of 54" wide nondirectional fabric. For complete information on ordering C.O.M., see "Ordering C.O.M., C.O.V. and C.O.L. section."



Delivered Pricing Fabric Grade 1 & C.O.M.	Delivered Pricing Fabric Grade 2	Delivered Pricing Fabric Grade 3	Delivered Pricing C.O.V.	Delivered Pricing Vinyl Group 2V	Delivered Pricing Pallas Fabric Group P0	Delivered Pricing Pallas Fabric Group P1	Delivered Pricing Pallas Fabric Group P2	Delivered Pricing Pallas Fabric Group P3	Delivered Pricing Pallas Fabric Group P4
---	----------------------------------	----------------------------------	--------------------------	----------------------------------	--	--	--	--	--

\$ 802 746	\$ 834 778	\$ 835 779	\$ 802 746	\$ 835 779	\$ 832 777	\$ 843 787	\$ 881 824	\$ 915 856	\$ 949 891
---------------	---------------	---------------	---------------	---------------	---------------	---------------	---------------	---------------	---------------

\$ 949 816	\$ 981 849	\$ 982 850	\$ 949 816	\$ 982 850	\$ 979 848	\$ 989 858	\$ 1026 894	\$ 1060 927	\$ 1096 964
---------------	---------------	---------------	---------------	---------------	---------------	---------------	----------------	----------------	----------------

OPTIONS

California TB133 Fire Safety Code

The above seating products can be manufactured using the appropriate flame-retardant materials for compliance to California Technical Bulletin 133. Add "FR" to end of model number.

- Model=Upholstered
Added Lead Time=1 week
Added List Price=\$96
- Model=Nylon
Added Lead Time=1 week
Added List Price=N/C

SPECIAL SERVICES

Special Carton Marking

With specially marked information N/C



Shipping

Shipped **assembled freight prepaid f.o.b. Bonduel, Wisconsin 54107** factory. Freight class #175.

Specifications and prices are subject to change without prior notice.

Stack/Nesting

Silhouette® Cafe Stools

MODEL	Features	MODEL NUMBER							Approx. Packaged Weight
		Basic Model	Frame Color	Seat & Back Color	Armrest Color	Glide Option	Fire Code	Upholstery Color	
 <p>Armless Cafe Stool</p> <ul style="list-style-type: none"> • Stool does not stack • Tubular steel frame 	Nylon	SSILNA	<input type="checkbox"/>	<input type="checkbox"/>		<input type="checkbox"/>	<input type="checkbox"/>		30.0#
	Upholstered	SSILUNA	<input type="checkbox"/>	<input type="checkbox"/>		<input type="checkbox"/>	<input type="checkbox"/>	<input type="checkbox"/>	32.0#
 <p>Cafe Stool with Arms</p> <ul style="list-style-type: none"> • Stool does not stack • Tubular steel frame 	Nylon	SSILFA	<input type="checkbox"/>	<input type="checkbox"/>	<input type="checkbox"/>	<input type="checkbox"/>	<input type="checkbox"/>		32.0#
	Upholstered	SSILUFA	<input type="checkbox"/>	<input type="checkbox"/>	<input type="checkbox"/>	<input type="checkbox"/>	<input type="checkbox"/>	<input type="checkbox"/>	34.0#

A B C D E F G

HOW TO ORDER

Indicate the following information on order form:

1. Quantity of each item.
2. Model number, including options. See "How To Build a Model Number".
3. Any special service required.

Note: • The indicates that a choice is required.

- The absence of the indicates that no choice is required.
- Alpha-numeric characters in place of indicate that no other alternatives are available.

HOW TO BUILD A MODEL NUMBER

- A** Select basic model.
- B** Select frame color.
Refer to color addendum at ki.com or KI Fabrics & Finishes binder.
- C** Select seat and back color.
Refer to color addendum at ki.com or KI Fabrics & Finishes binder.
- D** Select armrest color.
Refer to color addendum at ki.com or KI Fabrics & Finishes binder.
Refer to the color addendum at ki.com or in KI Fabrics & Finishes binders.
- E** Select glide option.

GCH	- Chromed steel glides
GBL	- Black plastic glides
- F** Select fire code.

FR	- Compliance to TB 133
NFR	- Compliance to TB 117-2013
- G** Select upholstery grade/color.
Refer to color addendum at ki.com or KI Fabrics & Finishes binder.

UPHOLSTERY INFORMATION

C.O.M. Upholstery
C.O.M. requirement is 3/4 yard per chair of 54" wide nondirectional fabric. For complete information on ordering C.O.M., see "Ordering C.O.M., C.O.V. and C.O.L. section."



Stack/Nesting

Silhouette® Cafe Stools

Delivered Pricing Unupholstered	Delivered Pricing Fabric Grade 1 & C.O.M.	Delivered Pricing Fabric Grade 2	Delivered Pricing Fabric Grade 3	Delivered Pricing C.O.V.	Delivered Pricing Vinyl Group 2V	Delivered Pricing Pallas Fabric Group P0	Delivered Pricing Pallas Fabric Group P1	Delivered Pricing Pallas Fabric Group P2	Delivered Pricing Pallas Fabric Group P3	Delivered Pricing Pallas Fabric Group P4	
\$ 560	N/A	722	756	757	722	757	752	763	802	833	870
\$ 608	N/A	770	804	805	770	805	802	813	849	883	920

OPTIONS

California TB133 Fire Safety Code

The above seating products can be manufactured using the appropriate flame-retardant materials for compliance to California Technical Bulletin 133. Add "FR" to end of model number.
 Model=Upholstered
 Added Lead Time=1 week
 Added List Price=\$79
 Model=Nylon
 Added Lead Time=1 week
 Added List Price=N/C

SPECIAL SERVICES

Special Carton Marking

With specially marked information N/C

Shipping

Shipped **assembled freight prepaid f.o.b. Bonduel, Wisconsin 54107** factory. Freight class #125.

Specifications and prices are subject to change without prior notice.

Stack/Nesting

Strive® General Information



**Armless Four-Leg
Chair
(SLNAU)**



**Four-Leg Cantilever
Arm Chair
(SLCAP)**



**Four-Leg Loop
Arm Chair
(SLLAU)**



**Four-Leg Tablet
Arm Chair
(SLTAPRH)**



**Four-Leg Oversize
Tablet Arm Chair
(SLOVTAURH)**



**Four-Leg Cantilever
Arm Cafe Stool - 23"
or 29" Seat Height
(SLSCAUB)**

Features						
Stackable	•	•	•			•
Poly, upholstered seat, or upholstered seat/back	•	•	•	•	•	•
Flex back	•	•	•	•	•	•
General Dimensions						
Seat width	18"	18"	18"	18"	18"	18"
Seat depth	18"	18"	18"	18"	18"	18"
Seat height (upholstered add 1")	17-1/2"	17-1/2"	17-1/2"	17-1/2"	17-1/2"	23-1/2" / 29-1/2"
Tablet to chair back clearance				14"	14"	
Overall Dimensions						
Width	20-3/4"	25"	25"	24"	24"	25"
Depth	21-3/4"	21-3/4"	21-3/4"	27-3/4"	31"	23-1/2" / 25"
Height	33"	33"	33"	33"	33"	39-1/4" / 45-1/4"
Arms to floor		26-1/4"	26-1/4"	28-1/2"	28-1/2"	32-1/2" / 38-1/2"
Stacking on Dolly						
Overall width	24"	25"	25"			
Overall depth - poly	40"	40"	40"			
Quantity/height - poly	15 Chairs/61" High	15 Chairs/62" High	15 Chairs/63" High			
Overall depth - upholstered	45"	45"	45"			
Quantity/height - upholstered	8 Chairs/50" High	8 Chairs/51" High	8 Chairs/51" High			
Stacking on Floor						
Width	20-3/4"	25"	25"			25-7/8"
Depth	27-1/2"	27-1/2"	27-1/2"			28"
Quantity/height	4 Chairs/39" High	4 Chairs/39" High	4 Chairs/39" High			4 Chairs/48" or 54" High

SPECIFICATIONS

Frame

Legs are 7/8" o.d. x 13-gauge tubular steel. Cross members are 1" o.d. x 14-gauge tubular steel and 7/16" diameter solid steel. All joints are welded. Frames are available in 4-leg or sled base configurations.

Arms

Optional cantilever arms or loop arms are available. When equipped with arms, the supporting structure is a continuation of the rear leg finished to match the frame color. The armcaps are injection molded nylon matching the frame finish (except for chrome, hammertone, and metallic finishes which will match poly color. Diamond translucent poly will have light tone armrests; Pewter translucent will have flannel armrests; Bronze translucent will have chocolate armrests). The armcaps are attached to the steel structure by means of screws.

Seat and Shroud

Injection molded polypropylene.

Backrest

Injection molded polypropylene with integral steel cantilever springs. The combination of the slotted polypropylene back and the spring steel provides a supportive flexing back. Springs are nominal 4.5mm diameter chrome silicon valve spring wire.

Optional Upholstered Seat

Molded urethane foam is attached to an injection molded polypropylene seat board, then upholstered using a draw-string process. The assembled seat pad is attached to the seat by means of hidden fasteners.

Optional Upholstered Back

1/2" thick urethane foam is attached to an injection molded polypropylene back board, then upholstered using a draw-string process. The assembled back pad is attached to the back by means of fasteners which are exposed and are color matched to the

polypropylene.

Frame Finishes

Baked-on electrostatically-applied 45° gloss epoxy powder coating or bright nickel-chrome plating.

Tablet Arm

Tablet support loop is a continuation of the rear leg and may be ordered on the right or left side. A formed steel hinge is welded to the top of the support structure and secured with screws to the underside of the writing surface. Writing surface for standard tablet is 9-1/2" x 20-3/4" x 12-1/2" and oversize tablet is 15-1/2" x 22-1/2" x 14" plywood core of 5/8" thick, 11-ply hardwood surfaced with .030" high-pressure laminate top and plain backer undersurface. Tablet flips up for easy access. Edges are lacquered and sealed.

Four-Leg Cafe Stools

Four-leg models on glides are available in 23-1/2" and 29-1/2" seat heights. Stool-

height units are equipped with a reinforcing foot ring made of a 1/2" diameter wire ring, which is open in the back to allow stacking of armless and cantilever arm stools.

Stacking Vinyl, Polyurethane, and Imitation Leather Upholstered Chairs

It is recommended that chairs to be stacked be covered in material other than vinyl, polyurethane, or imitation leather as an impression in the seat may result. KI does not warrant the effects of stacking on stock or C.O.M. vinyl, polyurethane, or imitation leather upholstery.

INFORMATION

C.O.M. Testing and Production Requirements

Not all materials are suitable for upholstering this product. A 1 yd. x 54" sample must be submitted and approved prior to acceptance of an order. If the fabric is directional in pattern or weave, the direction must be indicated on the submitted sample,



Four-Leg Armless Cafe Stool - 23" or 29" Seat Height (SLSNAU)



Four-Leg Loop Arm Cafe Stool - 23" or 29" Seat Height (SLSLAP)



Armless Wallsaver Four-Leg Chair (SLNAU)

Four-Leg Wallsaver Cantilever Arm Chair (SLCAP)

Four-Leg Wallsaver Loop Arm Chair (SLLAU)

Features				
Stackable	•	•	•	•
Poly, upholstered seat, or upholstered seat/back	•	•	•	•
Flex back	•	•	•	•
General Dimensions				
Seat width	18"	18"	18"	18"
Seat depth	18"	18"	18"	18"
Seat height (upholstered add 1")	23-1/2" / 29-1/2"	17-1/2"	17-1/2"	17-1/2"
Overall Dimensions				
Width	25"	20-3/4"	25"	25"
Depth	23-1/2" / 25"	22-3/4"	22-3/4"	22-3/4"
Height	39-1/4" / 45-1/4"	33"	33"	33"
Arms to floor	32-1/2" / 38-1/2"		26-1/4"	26-1/4"
Stacking on Floor				
Width	25-7/8"	20-3/4"	25"	25"
Depth	28"	28-1/2"	28-1/2"	28-1/2"
Quantity/height	4 Chairs/48" or 54" High	4 Chairs/39" High	4 Chairs/39" High	4 Chairs/39" High

and additional yardage may be requested.

Test samples must be sent to:

KI
Attn: C.O.M. Specialist
1687 Westminster Drive - Gate 3
Green Bay, WI 54302

Fabric Disclaimer

Fabric will be applied as swatched by the fabric manufacturer. Fabric that is required to be applied differently than is swatched will need a Special Cost Request written specifying the direction the fabric is to be applied. The posted standard lead time will apply to the Special Cost Request.

Design

Designed by Giancarlo Piretti and manufactured in the USA by Krueger International, Inc. under license from Pro-Cord S.p.A

INFORMATION

Warranty

Refer to KI Terms & Conditions document or visit ki.com

Stack/Nesting

Strive® General Information



**Armless Four-Leg
Chair with Casters
(SLNAPC)**

**Four-Leg Cantilever
Arm Chair with Casters
(SLCAUC)**

**Four-Leg Loop Arm
Chair with Casters
(SLLAUC)**

**Armless Sled
Base Chair
(SSNAP)**

**Sled Base Cantilever
Arm Chair
(SSCAU)**

**Sled Base Tablet
Arm Chair
(SSTAPRH)**

Features

Stackable	•	•	•	•	•	•
Poly, upholstered seat, or upholstered seat/back	•	•	•	•	•	•
Flex back	•	•	•	•	•	•

General Dimensions

Seat width	18"	18"	18"	18"	18"	18"
Seat depth	18"	18"	18"	18"	18"	18"
Seat height (upholstered add 1")	17-3/4"	17-3/4"	17-3/4"	17-3/4"	17-3/4"	17-3/4"
Tablet to chair back clearance						14"

Overall Dimensions

Width	21-1/4"	25"	25"	20-3/4"	25"	24"
Depth	22-1/2"	22-1/2"	22-1/2"	21-3/4"	21-3/4"	27-3/4"
Height	33-1/4"	33-1/4"	33-1/4"	33-1/4"	33-1/4"	33-1/4"
Arms to floor		26-1/2"	26-1/2"		26-1/2"	28-1/2"

Stacking on Dolly

Width				24"	25"	
Depth - poly				48"	48"	
Quantity/height - poly				15 Chairs/64" High	15 Chairs/64" High	
Depth - upholstered				48"	48"	
Quantity/height - upholstered				8 Chairs/50" High	8 Chairs/50" High	

Stacking on Floor

Width	20-3/4"	25"	25"	20-3/4"	25"	
Depth	27-1/2"	27-1/2"	27-1/2"	27-1/2"	27-1/2"	
Quantity/height	4 Chairs/39" High	4 Chairs/39" High	4 Chairs/39" High	4 Chairs/39" High	4 Chairs/39" High	

SPECIFICATIONS

Frame

Legs are 7/8" o.d. x 13-gauge tubular steel. Cross members are 1" o.d. x 14-gauge tubular steel and 7/16" diameter solid steel. All joints are welded. Frames are available in 4-leg or sled base configurations.

Arms

Optional cantilever arms or loop arms are available. When equipped with arms, the supporting structure is a continuation of the rear leg finished to match the frame color. The armcaps are injection molded nylon matching the frame finish (except for chrome, hammertone, and metallic finishes which will match poly color. Diamond translucent poly will have light tone armrests; Pewter translucent will have flannel armrests; Bronze translucent will have chocolate armrests). The armcaps are attached to the steel structure by means of screws.

Seat and Shroud

Injection molded polypropylene.

Backrest

Injection molded polypropylene with integral steel cantilever springs. The combination of the slotted polypropylene back and the spring steel provides a supportive flexing back. Springs are nominal 4.5mm diameter chrome silicon valve spring wire.

Optional Upholstered Seat Molded urethane foam is attached to an injection molded polypropylene seat board, then upholstered using a draw-string process. The assembled seat pad is attached to the seat by means of hidden fasteners.

Optional Upholstered Back 1/2" thick urethane foam is attached to an injection molded polypropylene back board, then upholstered using a draw-string process. The assembled back pad is attached to the back by means of fasteners which are exposed and are color matched to the

polypropylene.

Frame Finishes

Baked-on electrostatically-applied 45° gloss epoxy powder coating or bright nickel-chrome plating.

Castors

Four-leg chairs may be ordered with carpet castors or hard floor castors instead of glides (does not apply to cafe stools). Castors are double-wheel, high-impact thermoplastic and are available in black only.

Tablet Arm

Tablet support loop is a continuation of the rear leg and may be ordered on the right or left side. A formed steel hinge is welded to the top of the support structure and secured with screws to the underside of the writing surface. Writing surface for standard tablet is 9-1/2" x 20-3/4" x 12-1/2" and oversize tablet is 15-1/2" x 22-1/2" x 14" plywood core of 5/8" thick, 11-ply hardwood surfaced with .030" high-pressure laminate top and

plain backer undersurface. Tablet flips up for easy access. Edges are lacquered and sealed.

Stacking Vinyl, Polyurethane, and Imitation Leather Upholstered Chairs

It is recommended that chairs to be stacked be covered in material other than vinyl, polyurethane, or imitation leather as an impression in the seat may result. KI does not warrant the effects of stacking on stock or C.O.M. vinyl, polyurethane, or imitation leather upholstery.

INFORMATION

C.O.M. Testing and Production Requirements

Not all materials are suitable for upholstering this product. A 1 yd. x 54" sample must be submitted and approved prior to acceptance of an order. If the fabric is directional in pattern or weave, the direction must be indicated on the submitted sample, and additional yardage may be requested.



**Transport Dolly
(SCDA.BL)**

Overall Dimensions

Width	24"
Depth	29"
Height	16-1/2"

Test samples must be sent to:

KI
Attn: C.O.M. Specialist
1687 Westminster Drive - Gate 3
Green Bay, WI 54302

Fabric Disclaimer



Fabric will be applied as swatched by the fabric manufacturer. Fabric that is required to be applied differently than is swatched will need a Special Cost Request written specifying the direction the fabric is to be applied. The posted standard lead time will apply to the Special Cost Request.

Design

Designed by Giancarlo Piretti and manufactured in the USA by Krueger International, Inc. under license from Pro-Cord S.p.A

Stack/Nesting

Strive® Chairs

	MODEL	Features	MODEL NUMBER							
			Basic Model	Frame Color	Seat & Back Color	Caster Type	Glide Option	Fire Code	Upholstery Color	
 <p>SLP SLU SLUB</p>	Four-Leg Armless Chair	Polypropylene	SLNAP	<input type="checkbox"/>	<input type="checkbox"/>		<input type="checkbox"/>	<input type="checkbox"/>		
		• Flex back	Upholstered Seat	SLNAU	<input type="checkbox"/>	<input type="checkbox"/>		<input type="checkbox"/>	<input type="checkbox"/>	<input type="checkbox"/>
		• Stacking	Upholstered Seat/Back	SLNAUB	<input type="checkbox"/>	<input type="checkbox"/>		<input type="checkbox"/>	<input type="checkbox"/>	<input type="checkbox"/>
 <p>SLP SLU SLUB</p>	Four-Leg Armless Chair with Casters	Polypropylene, Casters	SLNAPC	<input type="checkbox"/>	<input type="checkbox"/>	<input type="checkbox"/>		<input type="checkbox"/>		
		• Flex back	Uph. Seat, Casters	SLNAUC	<input type="checkbox"/>	<input type="checkbox"/>	<input type="checkbox"/>		<input type="checkbox"/>	<input type="checkbox"/>
		• Stacking. Caution should be exercised to prevent casters from marring components such as frames, fabric, etc., and to prevent casters from becoming "hung up" underneath the seat of the chair	Uph. Seat/Back, Casters	SLNAUBC	<input type="checkbox"/>	<input type="checkbox"/>	<input type="checkbox"/>		<input type="checkbox"/>	<input type="checkbox"/>
		• Stacking on dollies is NOT recommended								

A **B** **C** **D** **E** **F** **G**

HOW TO ORDER

Indicate the following information on order form:

- Quantity of each item.
- Model number, including options. See "How To Build a Model Number".
- Any special service required.

Note: • The indicates that a choice is required.

- The absence of the indicates that no choice is required.
- Alpha-numeric characters in place of indicate that no other alternatives are available.

HOW TO BUILD A MODEL NUMBER

A Select basic model.

B Select frame color.
Refer to color addendum at ki.com or KI Fabrics & Finishes binder.

C Select poly seat and back color.
Refer to color addendum at ki.com or KI Fabrics & Finishes binder.

D Select casters.
C _____ - Carpet casters
S _____ - Hard floor casters

E Select glide option.
P _____ - Plastic glides
S _____ - Steel glides

F Select fire code.
NFR _____ - Compliance to TB 117-2013
FR _____ - Compliance to TB 133

G Select upholstery grade/color.
Refer to color addendum at ki.com or KI Fabrics & Finishes binder.

UPHOLSTERY INFORMATION

C.O.M. Upholstery

C.O.M. requirement for 10 chairs or less with upholstered seat or upholstered seat and back is 3/4 yard per chair of 54" wide nondirectional fabric. For orders of 11 or more with upholstered seat and back and for complete information on ordering C.O.M. see "Ordering C.O.M., C.O.V. and C.O.L." section.



Stack/Nesting

Strive® Chairs

Approx. Packaged Weight	Delivered Pricing Unupholstered	Delivered Pricing Fabric Grade 1 & C.O.M.	Delivered Pricing Fabric Grade 2	Delivered Pricing Fabric Grade 3	Delivered Pricing C.O.V.	Delivered Pricing Vinyl Group 2V	Delivered Pricing Pallas Fabric Group P0	Delivered Pricing Pallas Fabric Group P1	Delivered Pricing Pallas Fabric Group P2	Delivered Pricing Pallas Fabric Group P3	Delivered Pricing Pallas Fabric Group P4
20.0#	\$ 191										
23.0#	N/A	252	280	293	252	293	290	328	348	369	387
23.0#	N/A	305	333	345	305	345	344	381	400	422	439
26.0#	\$ 228										
29.0#	N/A	289	317	330	289	330	330	367	387	408	425
29.0#	N/A	342	369	383	342	383	382	419	439	458	478

OPTIONS

California TB133 Fire Safety Code

The above seating products can be manufactured using the appropriate flame-retardant materials for compliance to California Technical Bulletin 133.
 Model=Polypropylene
 Added List Price=\$10
 Model=Upholstered Seat
 Added List Price=\$68
 Model=Upholstered Seat and Back
 Added List Price=\$97

SPECIAL SERVICES

Special Carton Marking

With specially marked information N/C



Shipping

Shipped **assembled freight prepaid f.o.b. Green Bay, Wisconsin 54302** factory. Freight class #125.

Specifications and prices are subject to change without prior notice.

Stack/Nesting

Strive® Chairs

	Features	MODEL NUMBER								Approx. Packaged Weight
		Basic Model	Frame Color	Seat & Back Color	Top Stitch Color	Caster Type	Glide Option	Fire Code	Upholstery Color	
 <p>SLTS SLBTS Four-Leg Armless Chair with Top Stitch on Seat</p> <ul style="list-style-type: none"> Flex back Stacking 	Upholstered Seat	SLNATSU	<input type="checkbox"/> <input type="checkbox"/>	<input type="checkbox"/> <input type="checkbox"/> <input type="checkbox"/> <input type="checkbox"/>	<input type="checkbox"/> <input type="checkbox"/> <input type="checkbox"/> <input type="checkbox"/>		<input type="checkbox"/>	<input type="checkbox"/> <input type="checkbox"/> <input type="checkbox"/> <input type="checkbox"/>	<input type="checkbox"/> <input type="checkbox"/> <input type="checkbox"/> <input type="checkbox"/>	23.0#
	Upholstered Seat/Back	SLNATSUB	<input type="checkbox"/> <input type="checkbox"/>	<input type="checkbox"/> <input type="checkbox"/> <input type="checkbox"/> <input type="checkbox"/>	<input type="checkbox"/> <input type="checkbox"/> <input type="checkbox"/> <input type="checkbox"/>		<input type="checkbox"/>	<input type="checkbox"/> <input type="checkbox"/> <input type="checkbox"/> <input type="checkbox"/>	<input type="checkbox"/> <input type="checkbox"/> <input type="checkbox"/> <input type="checkbox"/>	23.0#
 <p>SLTS SLBTS Four-Leg Armless Chair with Casters with Top Stitch on Seat</p> <ul style="list-style-type: none"> Flex back Stacking. Caution should be exercised to prevent casters from marring components such as frames, fabric, etc., and to prevent casters from becoming "hung up" underneath the seat of the chair Stacking on dollies is NOT recommended 	Uph. Seat, Casters	SLNATSUC	<input type="checkbox"/> <input type="checkbox"/>	<input type="checkbox"/> <input type="checkbox"/> <input type="checkbox"/> <input type="checkbox"/>	<input type="checkbox"/> <input type="checkbox"/> <input type="checkbox"/> <input type="checkbox"/>	<input type="checkbox"/>		<input type="checkbox"/> <input type="checkbox"/> <input type="checkbox"/> <input type="checkbox"/>	<input type="checkbox"/> <input type="checkbox"/> <input type="checkbox"/> <input type="checkbox"/>	29.0#
	Uph. Seat/Back, Casters	SLNATSUBC	<input type="checkbox"/> <input type="checkbox"/>	<input type="checkbox"/> <input type="checkbox"/> <input type="checkbox"/> <input type="checkbox"/>	<input type="checkbox"/> <input type="checkbox"/> <input type="checkbox"/> <input type="checkbox"/>	<input type="checkbox"/>		<input type="checkbox"/> <input type="checkbox"/> <input type="checkbox"/> <input type="checkbox"/>	<input type="checkbox"/> <input type="checkbox"/> <input type="checkbox"/> <input type="checkbox"/>	29.0#
			A	B	C	D	E	F	G	H

HOW TO ORDER

Indicate the following information on order form:

- Quantity of each item.
- Model number, including options. See "How To Build a Model Number".
- Any special service required.

Note: • The indicates that a choice is required.

- The absence of the indicates that no choice is required.
- Alpha-numeric characters in place of indicate that no other alternatives are available.

HOW TO BUILD A MODEL NUMBER

- A** Select basic model.
- B** Select frame color.
Refer to color addendum at ki.com or KI Fabrics & Finishes binder.
- C** Select poly seat and back color.
Refer to color addendum at ki.com or KI Fabrics & Finishes binder.
- D** Select top stitch color.
BLTS - Black
WHTS - White
- E** Select casters.
C - Carpet casters
S - Hard floor casters
- F** Select glide option.
P - Plastic glides
S - Steel glides
- G** Select fire code.

FR - Compliance to TB 133
NFR - Compliance to TB 117-2013

- H** Select upholstery grade/color.
Refer to color addendum at ki.com or KI Fabrics & Finishes binder.

UPHOLSTERY INFORMATION

C.O.M. Upholstery

C.O.M. requirement for 10 chairs or less with upholstered seat or upholstered seat and back is 3/4 yard per chair of 54" wide nondirectional fabric. For orders of 11 or more with upholstered seat and back and for complete information on ordering C.O.M. see "Ordering C.O.M., C.O.V. and C.O.L." section.



Delivered
Pricing
Pallas Fabric
Group P1

\$ 369

422

\$ 408

458

OPTIONS

California TB133 Fire Safety Code

The above seating products can be manufactured using the appropriate flame-retardant materials for compliance to California Technical Bulletin 133.

- Model=Polypropylene
Added List Price=\$10
- Model=Upholstered Seat
Added List Price=\$68
- Model=Upholstered Seat and Back
Added List Price=\$97

SPECIAL SERVICES

Special Carton Marking

With specially marked information N/C



Shipping

Shipped **assembled freight prepaid f.o.b. Green Bay, Wisconsin 54302** factory. Freight class #125.

Specifications and prices are subject to change without prior notice.

Stack/Nesting

Strive® Chairs

	MODEL	Features	MODEL NUMBER								
			Basic Model	Frame Color	Seat & Back Color	Caster Type	Glide Option	Fire Code	Upholstery Color		
 <p>SLP SLU SLUB</p>	Four-Leg Cantilever Armchair • Flex back • Stacking	Polypropylene	SLCAP	<input type="checkbox"/>	<input type="checkbox"/>	<input type="checkbox"/>	<input type="checkbox"/>	<input type="checkbox"/>	<input type="checkbox"/>		
		Upholstered Seat	SLCAU	<input type="checkbox"/>	<input type="checkbox"/>	<input type="checkbox"/>	<input type="checkbox"/>	<input type="checkbox"/>	<input type="checkbox"/>	<input type="checkbox"/>	<input type="checkbox"/>
		Upholstered Seat/Back	SLCAUB	<input type="checkbox"/>	<input type="checkbox"/>	<input type="checkbox"/>	<input type="checkbox"/>	<input type="checkbox"/>	<input type="checkbox"/>	<input type="checkbox"/>	<input type="checkbox"/>
 <p>SLP SLU SLUB</p>	Four-Leg Cantilever Armchair with Casters • Flex back • Stacking. Caution should be exercised to prevent casters from marring components such as frames, fabric, etc., and to prevent casters from becoming "hung up" underneath the seat of the chair • Stacking on dollies is NOT recommended	Polypropylene, Casters	SLCAPC	<input type="checkbox"/>	<input type="checkbox"/>	<input type="checkbox"/>	<input type="checkbox"/>	<input type="checkbox"/>	<input type="checkbox"/>		
		Uph. Seat, Casters	SLCAUC	<input type="checkbox"/>	<input type="checkbox"/>	<input type="checkbox"/>	<input type="checkbox"/>	<input type="checkbox"/>	<input type="checkbox"/>	<input type="checkbox"/>	<input type="checkbox"/>
		Uph. Seat/Back, Casters	SLCAUBC	<input type="checkbox"/>	<input type="checkbox"/>	<input type="checkbox"/>	<input type="checkbox"/>	<input type="checkbox"/>	<input type="checkbox"/>	<input type="checkbox"/>	<input type="checkbox"/>

A **B** **C** **D** **E** **F** **G**

HOW TO ORDER

Indicate the following information on order form:

- Quantity of each item.
- Model number, including options. See "How To Build a Model Number".
- Any special service required.

Note: • The indicates that a choice is required.

- The absence of the indicates that no choice is required.
- Alpha-numeric characters in place of indicate that no other alternatives are available.

HOW TO BUILD A MODEL NUMBER

- A** Select basic model.
- B** Select frame color.
Refer to color addendum at ki.com or KI Fabrics & Finishes binder.
- C** Select poly seat and back color.
Refer to color addendum at ki.com or KI Fabrics & Finishes binder.
- D** Select casters.

C	- Carpet casters
S	- Hard floor casters
- E** Select glide option.

P	- Plastic glides
S	- Steel glides
- F** Select fire code.

FR	- Compliance to TB 133
NFR	- Compliance to TB 117-2013

- G** Select upholstery grade/color.
Refer to color addendum at ki.com or KI Fabrics & Finishes binder.

UPHOLSTERY INFORMATION

C.O.M. Upholstery

C.O.M. requirement for 10 chairs or less with upholstered seat or upholstered seat and back is 3/4 yard per chair of 54" wide nondirectional fabric. For orders of 11 or more with upholstered seat and back and for complete information on ordering C.O.M. see "Ordering C.O.M., C.O.V. and C.O.L." section.



Stack/Nesting

Strive® Chairs

Approx. Packaged Weight	Delivered Pricing Unupholstered	Delivered Pricing Fabric Grade 1 & C.O.M.	Delivered Pricing Fabric Grade 2	Delivered Pricing Fabric Grade 3	Delivered Pricing C.O.V.	Delivered Pricing Vinyl Group 2V	Delivered Pricing Pallas Fabric Group P0	Delivered Pricing Pallas Fabric Group P1	Delivered Pricing Pallas Fabric Group P2	Delivered Pricing Pallas Fabric Group P3	Delivered Pricing Pallas Fabric Group P4
23.0#	\$ 249										
26.0#	N/A	310	339	349	310	349	349	386	406	426	445
26.0#	N/A	362	390	401	362	401	401	438	457	479	496
28.0#	\$ 285										
31.0#	N/A	347	375	388	347	388	387	424	445	465	483
31.0#	N/A	399	427	440	399	440	438	475	496	518	535

OPTIONS

California TB133 Fire Safety Code

The above seating products can be manufactured using the appropriate flame-retardant materials for compliance to California Technical Bulletin 133.
 Model=Polypropylene
 Added List Price=\$10
 Model=Upholstered Seat
 Added List Price=\$68
 Model=Upholstered Seat and Back
 Added List Price=\$97

SPECIAL SERVICES

Special Carton Marking

With specially marked information N/C



Shipping

Shipped **assembled freight prepaid f.o.b. Green Bay, Wisconsin 54302** factory. Freight class #125.

Specifications and prices are subject to change without prior notice.

Stack/Nesting

Strive® Chairs

Features	MODEL NUMBER								Approx. Packaged Weight	
	Basic Model	Frame Color	Seat & Back Color	Top Stitch Color	Caster Type	Glide Option	Fire Code	Upholstery Color		
 <p>SLTS SLBTS</p> <p>Four-Leg Cantilever Armchair with Top Stitch on Seat</p> <ul style="list-style-type: none"> • Flex back • Stacking 	Upholstered Seat	SLCATSU	<input type="checkbox"/>	<input type="checkbox"/>	<input type="checkbox"/>	<input type="checkbox"/>	<input type="checkbox"/>	<input type="checkbox"/>	26.0#	
	Upholstered Seat/Back	SLCATSUB	<input type="checkbox"/>	<input type="checkbox"/>	<input type="checkbox"/>	<input type="checkbox"/>	<input type="checkbox"/>	<input type="checkbox"/>	<input type="checkbox"/>	26.0#
 <p>SLTS SLBTS</p> <p>Four-Leg Cantilever Armchair with Casters with Top Stitch on Seat</p> <ul style="list-style-type: none"> • Flex back • Stacking. Caution should be exercised to prevent casters from marring components such as frames, fabric, etc., and to prevent casters from becoming "hung up" underneath the seat of the chair • Stacking on dollies is NOT recommended 	Uph. Seat, Casters	SLCATSUC	<input type="checkbox"/>	<input type="checkbox"/>	<input type="checkbox"/>	<input type="checkbox"/>	<input type="checkbox"/>	<input type="checkbox"/>	31.0#	
	Uph. Seat/Back, Casters	SLCATSUBC	<input type="checkbox"/>	<input type="checkbox"/>	<input type="checkbox"/>	<input type="checkbox"/>	<input type="checkbox"/>	<input type="checkbox"/>	<input type="checkbox"/>	31.0#
			A	B	C	D	E	F	G	H

HOW TO ORDER

Indicate the following information on order form:

- Quantity of each item.
- Model number, including options. See "How To Build a Model Number".
- Any special service required.

Note: • The indicates that a choice is required.

- The absence of the indicates that no choice is required.
- Alpha-numeric characters in place of indicate that no other alternatives are available.

HOW TO BUILD A MODEL NUMBER

- A** Select basic model.
- B** Select frame color.
Refer to color addendum at ki.com or KI Fabrics & Finishes binder.
- C** Select poly seat and back color.
Refer to color addendum at ki.com or KI Fabrics & Finishes binder.
- D** Select top stitch color.
BLTS - Black
WHTS - White
- E** Select casters.
C - Carpet casters
S - Hard floor casters
- F** Select glide option.
P - Plastic glides
S - Steel glides
- G** Select fire code.

NFR - Compliance to TB 117-2013
FR - Compliance to TB 133

UPHOLSTERY INFORMATION

C.O.M. Upholstery

C.O.M. requirement for 10 chairs or less with upholstered seat or upholstered seat and back is 3/4 yard per chair of 54" wide nondirectional fabric. For orders of 11 or more with upholstered seat and back and for complete information on ordering C.O.M. see "Ordering C.O.M., C.O.V. and C.O.L." section.



Delivered
Pricing
Pallas Fabric
Group P1

\$ 427

480

\$ 464

517

OPTIONS

California TB133 Fire Safety Code

The above seating products can be manufactured using the appropriate flame-retardant materials for compliance to California Technical Bulletin 133.

- Model=Polypropylene
Added List Price=\$10
- Model=Upholstered Seat
Added List Price=\$68
- Model=Upholstered Seat and Back
Added List Price=\$97

SPECIAL SERVICES

Special Carton Marking

With specially marked information N/C



Shipping

Shipped **assembled freight prepaid f.o.b. Green Bay, Wisconsin 54302** factory. Freight class #125.

Specifications and prices are subject to change without prior notice.

Stack/Nesting

Strive® Chairs

	MODEL	Features	MODEL NUMBER							
			Basic Model	Frame Color	Seat & Back Color	Caster Type	Glide Option	Fire Code	Upholstery Color	
 <p>SLP SLU SLUB</p>	Four-Leg Loop Arm Chair	Polypropylene	SLLAP	<input type="checkbox"/>	<input type="checkbox"/>	<input type="checkbox"/>	<input type="checkbox"/>	<input type="checkbox"/>	<input type="checkbox"/>	
		• Flex back	Upholstered Seat	SLLAU	<input type="checkbox"/>	<input type="checkbox"/>	<input type="checkbox"/>	<input type="checkbox"/>	<input type="checkbox"/>	<input type="checkbox"/>
		• Stacking	Upholstered Seat/Back	SLLAUB	<input type="checkbox"/>	<input type="checkbox"/>	<input type="checkbox"/>	<input type="checkbox"/>	<input type="checkbox"/>	<input type="checkbox"/>
 <p>SLP SLU SLUB</p>	Four-Leg Loop Arm Chair with Casters	Polypropylene, Casters	SLLAPC	<input type="checkbox"/>	<input type="checkbox"/>	<input type="checkbox"/>	<input type="checkbox"/>	<input type="checkbox"/>	<input type="checkbox"/>	
		• Flex back	Upholstered Seat, Casters	SLLAUC	<input type="checkbox"/>	<input type="checkbox"/>	<input type="checkbox"/>	<input type="checkbox"/>	<input type="checkbox"/>	<input type="checkbox"/>
		• Stacking. Caution should be exercised to prevent casters from marring components such as frames, fabric, etc., and to prevent casters from becoming "hung up" underneath the seat of the chair below	Uph. Seat/Back, Casters	SLLAUBC	<input type="checkbox"/>	<input type="checkbox"/>	<input type="checkbox"/>	<input type="checkbox"/>	<input type="checkbox"/>	<input type="checkbox"/>
		• Stacking on dollies is NOT recommended								

A **B** **C** **D** **E** **F** **G**

HOW TO ORDER

Indicate the following information on order form:

- Quantity of each item.
- Model number, including options. See "How To Build a Model Number".
- Any special service required.

Note: • The indicates that a choice is required.

- The absence of the indicates that no choice is required.
- Alpha-numeric characters in place of indicate that no other alternatives are available.

HOW TO BUILD A MODEL NUMBER

- A** Select basic model.
- B** Select frame color.
Refer to color addendum at ki.com or KI Fabrics & Finishes binder.
- C** Select poly seat and back color.
Refer to color addendum at ki.com or KI Fabrics & Finishes binder.
- D** Select casters.

C	- Carpet casters
S	- Hard floor casters
- E** Select glide option.

P	- Plastic glides
S	- Steel glides
- F** Select fire code.

NFR	- Compliance to TB 117-2013
FR	- Compliance to TB 133
- G** Select upholstery grade/color.
Refer to color addendum at ki.com or KI Fabrics & Finishes binder.

UPHOLSTERY INFORMATION

C.O.M. Upholstery

C.O.M. requirement for 10 chairs or less with upholstered seat or upholstered seat and back is 3/4 yard per chair of 54" wide nondirectional fabric. For orders of 11 or more with upholstered seat and back and for complete information on ordering C.O.M. see "Ordering C.O.M., C.O.V. and C.O.L." section.



Stack/Nesting

Strive® Chairs

Approx. Packaged Weight	Delivered Pricing Unupholstered	Delivered Pricing Fabric Grade 1 & C.O.M.	Delivered Pricing Fabric Grade 2	Delivered Pricing Fabric Grade 3	Delivered Pricing C.O.V.	Delivered Pricing Vinyl Group 2V	Delivered Pricing Pallas Fabric Group P0	Delivered Pricing Pallas Fabric Group P1	Delivered Pricing Pallas Fabric Group P2	Delivered Pricing Pallas Fabric Group P3	Delivered Pricing Pallas Fabric Group P4
25.0#	\$ 261										
27.0#	N/A	321	349	363	321	363	362	399	419	438	456
27.0#	N/A	374	401	414	374	414	414	451	471	490	508
30.0#	\$ 299										
32.0#	N/A	359	388	401	359	401	399	436	456	479	494
32.0#	N/A	412	440	453	412	453	451	488	508	529	546

OPTIONS

California TB133 Fire Safety Code

The above seating products can be manufactured using the appropriate flame-retardant materials for compliance to California Technical Bulletin 133.
 Model=Polypropylene
 Added List Price=\$10
 Model=Upholstered Seat
 Added List Price=\$68
 Model=Upholstered Seat and Back
 Added List Price=\$97

SPECIAL SERVICES

Special Carton Marking

With specially marked information N/C



Shipping

Shipped **assembled freight prepaid f.o.b. Green Bay, Wisconsin 54302** factory.
 Freight class #125.

Specifications and prices are subject to change without prior notice.

Stack/Nesting

Strive® Chairs

Features	MODEL NUMBER								Approx. Packaged Weight
	Basic Model	Frame Color	Seat & Back Color	Top Stitch Color	Caster Type	Glide Option	Fire Code	Upholstery Color	
 <p>SLTS SLBTS</p> <p>Four-Leg Loop Arm Chair with Top Stitch on Seat</p> <ul style="list-style-type: none"> • Flex back • Stacking 	Upholstered Seat	SLLATSU	<input type="checkbox"/> <input type="checkbox"/>	<input type="checkbox"/> <input type="checkbox"/> <input type="checkbox"/> <input type="checkbox"/>	<input type="checkbox"/> <input type="checkbox"/> <input type="checkbox"/> <input type="checkbox"/>	<input type="checkbox"/>	<input type="checkbox"/> <input type="checkbox"/> <input type="checkbox"/> <input type="checkbox"/>	<input type="checkbox"/> <input type="checkbox"/> <input type="checkbox"/> <input type="checkbox"/> <input type="checkbox"/> <input type="checkbox"/>	27.0#
	Upholstered Seat/Back	SLLATSUB	<input type="checkbox"/> <input type="checkbox"/>	<input type="checkbox"/> <input type="checkbox"/> <input type="checkbox"/> <input type="checkbox"/>	<input type="checkbox"/> <input type="checkbox"/> <input type="checkbox"/> <input type="checkbox"/>	<input type="checkbox"/>	<input type="checkbox"/> <input type="checkbox"/> <input type="checkbox"/> <input type="checkbox"/>	<input type="checkbox"/> <input type="checkbox"/> <input type="checkbox"/> <input type="checkbox"/> <input type="checkbox"/> <input type="checkbox"/>	27.0#
 <p>SLTS SLBTS</p> <p>Four-Leg Loop Arm Chair with Casters with Top Stitch on Seat</p> <ul style="list-style-type: none"> • Flex back • Stacking. Caution should be exercised to prevent casters from marring components such as frames, fabric, etc., and to prevent casters from becoming "hung up" underneath the seat of the chair below • Stacking on dollies is NOT recommended 	Uph. Seat, Casters	SLLATSUC	<input type="checkbox"/> <input type="checkbox"/>	<input type="checkbox"/> <input type="checkbox"/> <input type="checkbox"/> <input type="checkbox"/>	<input type="checkbox"/>	<input type="checkbox"/> <input type="checkbox"/> <input type="checkbox"/> <input type="checkbox"/>	<input type="checkbox"/> <input type="checkbox"/> <input type="checkbox"/> <input type="checkbox"/> <input type="checkbox"/> <input type="checkbox"/>	32.0#	
	Uph. Seat/Back, Casters	SLLATSUBC	<input type="checkbox"/> <input type="checkbox"/>	<input type="checkbox"/> <input type="checkbox"/> <input type="checkbox"/> <input type="checkbox"/>	<input type="checkbox"/>	<input type="checkbox"/> <input type="checkbox"/> <input type="checkbox"/> <input type="checkbox"/>	<input type="checkbox"/> <input type="checkbox"/> <input type="checkbox"/> <input type="checkbox"/> <input type="checkbox"/> <input type="checkbox"/>	32.0#	

A B C D E F G H

HOW TO ORDER

Indicate the following information on order form:

- Quantity of each item.
- Model number, including options. See "How To Build a Model Number".
- Any special service required.

Note: • The indicates that a choice is required.

- The absence of the indicates that no choice is required.
- Alpha-numeric characters in place of indicate that no other alternatives are available.

HOW TO BUILD A MODEL NUMBER

- A** Select basic model.
- B** Select frame color.
Refer to color addendum at ki.com or KI Fabrics & Finishes binder.
- C** Select poly seat and back color.
Refer to color addendum at ki.com or KI Fabrics & Finishes binder.
- D** Select top stitch color.
BLTS - Black
WHTS - White
- E** Select casters.
C - Carpet casters
S - Hard floor casters
- F** Select glide option.
P - Plastic glides
S - Steel glides
- G** Select fire code.

NFR - Compliance to TB 117-2013
FR - Compliance to TB 133

UPHOLSTERY INFORMATION

C.O.M. Upholstery
C.O.M. requirement for 10 chairs or less with upholstered seat or upholstered seat and back is 3/4 yard per chair of 54" wide nondirectional fabric. For orders of 11 or more with upholstered seat and back and for complete information on ordering C.O.M. see "Ordering C.O.M., C.O.V. and C.O.L." section.



Delivered
Pricing
Pallas Fabric
Group P1

\$ 439
491

\$ 478
528

OPTIONS

California TB133 Fire Safety Code

The above seating products can be manufactured using the appropriate flame-retardant materials for compliance to California Technical Bulletin 133.
Model=Polypropylene
Added List Price=\$10
Model=Upholstered Seat
Added List Price=\$68
Model=Upholstered Seat and Back
Added List Price=\$97

SPECIAL SERVICES

Special Carton Marking

With specially marked information N/C



Shipping

Shipped **assembled freight prepaid f.o.b. Green Bay, Wisconsin 54302** factory.
Freight class #125.

Specifications and prices are subject to change without prior notice.

Stack/Nesting

Strive® Chairs

			MODEL NUMBER						
MODEL	Features	Basic Model	Frame Color	Seat & Back Color	Glide Option	Tablet Arm Color	Fire Code	Upholstery Color	
 <p>SLP SLU SLUB</p>	Four-Leg Tablet Arm Chair • Flex back • NONSTACKING	Polypropylene, Left Hand	SLTAPLH	<input type="checkbox"/>	<input type="checkbox"/>	<input type="checkbox"/>	<input type="checkbox"/>	<input type="checkbox"/>	
		Polypropylene, Right Hand	SLTAPRH	<input type="checkbox"/>	<input type="checkbox"/>	<input type="checkbox"/>	<input type="checkbox"/>	<input type="checkbox"/>	
		Uph. Seat, Left Hand	SLTAULH	<input type="checkbox"/>	<input type="checkbox"/>	<input type="checkbox"/>	<input type="checkbox"/>	<input type="checkbox"/>	
		Uph. Seat, Right Hand	SLTAURH	<input type="checkbox"/>	<input type="checkbox"/>	<input type="checkbox"/>	<input type="checkbox"/>	<input type="checkbox"/>	
		Uph. Seat/Back, Left Hand	SLTAUBLH	<input type="checkbox"/>	<input type="checkbox"/>	<input type="checkbox"/>	<input type="checkbox"/>	<input type="checkbox"/>	
		Uph. Seat/Back, Right Hand	SLTAUBRH	<input type="checkbox"/>	<input type="checkbox"/>	<input type="checkbox"/>	<input type="checkbox"/>	<input type="checkbox"/>	
 <p>SLP SLU SLUB</p>	Four-Leg Oversize Tablet Arm Chair • Oversized tablet • Flex back • NONSTACKING	Polypropylene, Left Hand	SLOVTAPLH	<input type="checkbox"/>	<input type="checkbox"/>	<input type="checkbox"/>	<input type="checkbox"/>	<input type="checkbox"/>	
		Polypropylene, Right Hand	SLOVTAPRH	<input type="checkbox"/>	<input type="checkbox"/>	<input type="checkbox"/>	<input type="checkbox"/>	<input type="checkbox"/>	
		Uph. Seat, Left Hand	SLOVTAULH	<input type="checkbox"/>	<input type="checkbox"/>	<input type="checkbox"/>	<input type="checkbox"/>	<input type="checkbox"/>	
		Uph. Seat, Right Hand	SLOVTAURH	<input type="checkbox"/>	<input type="checkbox"/>	<input type="checkbox"/>	<input type="checkbox"/>	<input type="checkbox"/>	
		Uph. Seat/Back, Left Hand	SLOVTAUBLH	<input type="checkbox"/>	<input type="checkbox"/>	<input type="checkbox"/>	<input type="checkbox"/>	<input type="checkbox"/>	
		Uph. Seat/Back, Right Hand	SLOVTAUBRH	<input type="checkbox"/>	<input type="checkbox"/>	<input type="checkbox"/>	<input type="checkbox"/>	<input type="checkbox"/>	

A **B** **C** **D** **E** **F** **G**

HOW TO ORDER

Indicate the following information on order form:

- Quantity of each item.
- Model number, including options. See "How To Build a Model Number".
- Any special service required.

Note: • The indicates that a choice is required.

- The absence of the indicates that no choice is required.
- Alpha-numeric characters in place of indicate that no other alternatives are available.

HOW TO BUILD A MODEL NUMBER

- A** Select basic model.
- B** Select frame color.
Refer to color addendum at ki.com or KI Fabrics & Finishes binder.
- C** Select poly seat and back color.
Refer to color addendum at ki.com or KI Fabrics & Finishes binder.
- D** Select glide option.

<u> P </u>	- Plastic glides
<u> S </u>	- Steel glides
- E** Select tablet arm color.
Refer to color addendum at ki.com or KI Fabrics & Finishes binder.
- F** Select fire code.

<u> FR </u>	- Compliance to TB 133
<u> NFR </u>	- Compliance to TB 117-2013

- G** Select upholstery grade/color.
Refer to color addendum at ki.com or KI Fabrics & Finishes binder.

UPHOLSTERY INFORMATION

C.O.M. Upholstery

C.O.M. requirement for 10 chairs or less with upholstered seat or upholstered seat and back is 3/4 yard per chair of 54" wide nondirectional fabric. For orders of 11 or more with upholstered seat and back and for complete information on ordering C.O.M. see "Ordering C.O.M., C.O.V. and C.O.L." section.



Stack/Nesting

Strive® Chairs

Approx. Packaged Weight	Delivered Pricing Unupholstered	Delivered Pricing Fabric Grade 1 & C.O.M.	Delivered Pricing Fabric Grade 2	Delivered Pricing Fabric Grade 3	Delivered Pricing C.O.V.	Delivered Pricing Vinyl Group 2V	Delivered Pricing Pallas Fabric Group P0	Delivered Pricing Pallas Fabric Group P1	Delivered Pricing Pallas Fabric Group P2	Delivered Pricing Pallas Fabric Group P3	Delivered Pricing Pallas Fabric Group P4
33.0#	\$ 369										
33.0#	369										
35.0#	N/A	431	457	471	431	471	470	507	527	546	565
35.0#	N/A	431	457	471	431	471	470	507	527	546	565
35.0#	N/A	483	510	523	483	523	522	559	579	599	616
35.0#	N/A	483	510	523	483	523	522	559	579	599	616

33.0#	\$ 431										
33.0#	431										
35.0#	N/A	491	580	593	491	593	593	630	650	668	688
35.0#	N/A	491	580	593	491	593	593	630	650	668	688
35.0#	N/A	543	632	645	543	645	645	682	701	720	741
35.0#	N/A	543	632	645	543	645	645	682	701	720	741

OPTIONS

California TB133 Fire Safety Code

The above seating products can be manufactured using the appropriate flame-retardant materials for compliance to California

Technical Bulletin 133.

Model=Polypropylene

Added List Price=\$10

Model=Upholstered Seat

Added List Price=\$68

Model=Upholstered Seat and Back

Added List Price=\$97

SPECIAL SERVICES

Special Carton Marking

With specially marked information N/C



Shipping

Shipped **assembled freight prepaid f.o.b. Green Bay, Wisconsin 54302** factory. Freight class #125.

Specifications and prices are subject to change without prior notice.

Stack/Nesting

Strive® Chairs

Features	MODEL NUMBER								Approx. Packaged Weight	
	Basic Model	Frame Color	Seat & Back Color	Top Stitch Color	Glide Option	Tablet Arm Color	Fire Code	Upholstery Color		
 <p>SLTS SLBTS</p> <p>Four-Leg Tablet Arm Chair with Top Stitch on Seat</p> <ul style="list-style-type: none"> Flex back NONSTACKING 	Uph Seat, Left Hand	SLTATSULH	<input type="checkbox"/>	<input type="checkbox"/>	<input type="checkbox"/>	<input type="checkbox"/>	<input type="checkbox"/>	<input type="checkbox"/>	35.0#	
	Uph Seat, Right Hand	SLTATSURH	<input type="checkbox"/>	<input type="checkbox"/>	<input type="checkbox"/>	<input type="checkbox"/>	<input type="checkbox"/>	<input type="checkbox"/>	35.0#	
	Uph Seat/Back, Left Hand	SLTATSUBLH	<input type="checkbox"/>	<input type="checkbox"/>	<input type="checkbox"/>	<input type="checkbox"/>	<input type="checkbox"/>	<input type="checkbox"/>	35.0#	
	Uph Seat/Back, Right Hand	SLTATSUBRH	<input type="checkbox"/>	<input type="checkbox"/>	<input type="checkbox"/>	<input type="checkbox"/>	<input type="checkbox"/>	<input type="checkbox"/>	35.0#	
 <p>SLTS SLBTS</p> <p>Four-Leg Oversize Tablet Arm Chair with Top Stitch on Seat</p> <ul style="list-style-type: none"> Oversized tablet Flex back NONSTACKING 	Uph Seat, Left Hand	SLOVTATSULH	<input type="checkbox"/>	<input type="checkbox"/>	<input type="checkbox"/>	<input type="checkbox"/>	<input type="checkbox"/>	<input type="checkbox"/>	35.0#	
	Uph Seat, Right Hand	SLOVTATSURH	<input type="checkbox"/>	<input type="checkbox"/>	<input type="checkbox"/>	<input type="checkbox"/>	<input type="checkbox"/>	<input type="checkbox"/>	35.0#	
	Uph Seat/Back, Left Hand	SLOVTATSUBLH	<input type="checkbox"/>	<input type="checkbox"/>	<input type="checkbox"/>	<input type="checkbox"/>	<input type="checkbox"/>	<input type="checkbox"/>	35.0#	
	Uph Seat/Back, Right Hand	SLOVTATSUBRH	<input type="checkbox"/>	<input type="checkbox"/>	<input type="checkbox"/>	<input type="checkbox"/>	<input type="checkbox"/>	<input type="checkbox"/>	35.0#	
			A	B	C	D	E	F	G	H

HOW TO ORDER

Indicate the following information on order form:

- Quantity of each item.
- Model number, including options. See "How To Build a Model Number".
- Any special service required.

Note: • The indicates that a choice is required.

- The absence of the indicates that no choice is required.
- Alpha-numeric characters in place of indicate that no other alternatives are available.

HOW TO BUILD A MODEL NUMBER

- A** Select basic model.
- B** Select frame color.
Refer to color addendum at ki.com or KI Fabrics & Finishes binder.
- C** Select poly seat and back color.
Refer to color addendum at ki.com or KI Fabrics & Finishes binder.
- D** Select top stitch color.

BLTS	- Black
WHTS	- White
- E** Select glide option.

P	- Plastic glides
S	- Steel glides
- F** Select tablet arm color.
Refer to color addendum at ki.com or KI Fabrics & Finishes binder.
- G** Select fire code.

NFR - Compliance to TB 117-2013
FR - Compliance to TB 133

UPHOLSTERY INFORMATION

C.O.M. Upholstery

C.O.M. requirement for 10 chairs or less with upholstered seat or upholstered seat and back is 3/4 yard per chair of 54" wide nondirectional fabric. For orders of 11 or more with upholstered seat and back and for complete information on ordering C.O.M. see "Ordering C.O.M., C.O.V. and C.O.L." section.



Delivered
Pricing
Pallas Fabric
Group P1

\$ 547
547
600
600

\$ 670
670
721
721

OPTIONS

California TB133 Fire Safety Code

The above seating products can be manufactured using the appropriate flame-retardant materials for compliance to California Technical Bulletin 133.
 Model=Polypropylene
 Added List Price=\$10
 Model=Upholstered Seat
 Added List Price=\$68
 Model=Upholstered Seat and Back
 Added List Price=\$97

SPECIAL SERVICES

Special Carton Marking

With specially marked information N/C



Shipping

Shipped **assembled freight prepaid f.o.b. Green Bay, Wisconsin 54302** factory.
 Freight class #125.

Specifications and prices are subject to change without prior notice.

Stack/Nesting

Strive® Chairs

	MODEL	Features	MODEL NUMBER					
			Basic Model	Frame Color	Seat & Back Color	Glide Option	Fire Code	Upholstery Color
 <p>SLP SLU SLUB</p>	Four-Leg Wallsaver Armless Chair • Flex back • Stacking • Wallsaver rear legs touch base of wall preventing chair back from contacting wall surface	Polypropylene	SLNAPWS	<input type="checkbox"/>	<input type="checkbox"/>	S	<input type="checkbox"/>	
		Upholstered Seat	SLNAUWS	<input type="checkbox"/>	<input type="checkbox"/>	S	<input type="checkbox"/>	<input type="checkbox"/>
		Upholstered Seat/Back	SLNAUBWS	<input type="checkbox"/>	<input type="checkbox"/>	S	<input type="checkbox"/>	<input type="checkbox"/>
 <p>SLP SLU SLUB</p>	Four-Leg Wallsaver Cantilever Armchair • Flex back • Stacking • Wallsaver rear legs touch base of wall preventing chair back from contacting wall surface	Polypropylene	SLCAPWS	<input type="checkbox"/>	<input type="checkbox"/>	S	<input type="checkbox"/>	
		Upholstered Seat	SLCAUWS	<input type="checkbox"/>	<input type="checkbox"/>	S	<input type="checkbox"/>	<input type="checkbox"/>
		Upholstered Seat/Back	SLCAUBWS	<input type="checkbox"/>	<input type="checkbox"/>	S	<input type="checkbox"/>	<input type="checkbox"/>
 <p>SLP SLU SLUB</p>	Four-Leg Wallsaver Loop Arm Chair • Flex back • Stacking • Wallsaver rear legs touch base of wall preventing chair back from contacting wall surface	Polypropylene	SLLAPWS	<input type="checkbox"/>	<input type="checkbox"/>	S	<input type="checkbox"/>	
		Upholstered Seat	SLLAUWS	<input type="checkbox"/>	<input type="checkbox"/>	S	<input type="checkbox"/>	<input type="checkbox"/>
		Upholstered Seat/Back	SLLAUBWS	<input type="checkbox"/>	<input type="checkbox"/>	S	<input type="checkbox"/>	<input type="checkbox"/>

A **B** **C** **D** **E** **F**

HOW TO ORDER

Indicate the following information on order form:

- Quantity of each item.
- Model number, including options. See "How To Build a Model Number".
- Any special service required.

Note: • The indicates that a choice is required.

- The absence of the indicates that no choice is required.
- Alpha-numeric characters in place of indicate that no other alternatives are available.

HOW TO BUILD A MODEL NUMBER

- A** Select basic model.
- B** Select frame color.
Refer to color addendum at ki.com or KI Fabrics & Finishes binder.
- C** Select seat and back color.
Refer to color addendum at ki.com or KI Fabrics & Finishes binder.
- D** Select glide option.
S - Steel glides
- E** Select fire code.
FR - Compliance to TB 133
NFR - Compliance to TB 117-2013
- F** Select upholstery grade/color.
Refer to color addendum at ki.com or KI Fabrics & Finishes binder.

UPHOLSTERY INFORMATION

C.O.M. Upholstery

C.O.M. requirement for 10 chairs or less with upholstered seat or upholstered seat and back is 3/4 yard per chair of 54" wide nondirectional fabric. For orders of 11 or more with upholstered seat and back and for complete information on ordering C.O.M. see "Ordering C.O.M., C.O.V. and C.O.L." section.



Stack/Nesting

Strive® Chairs

Approx. Packaged Weight	Delivered Pricing	Delivered Pricing Fabric Grade 1 & C.O.M.	Delivered Pricing Fabric Grade 2	Delivered Pricing Fabric Grade 3	Delivered Pricing C.O.V.	Delivered Pricing Vinyl Group 2V	Delivered Pricing Pallas Fabric Group P0	Delivered Pricing Pallas Fabric Group P1	Delivered Pricing Pallas Fabric Group P2	Delivered Pricing Pallas Fabric Group P3	Delivered Pricing Pallas Fabric Group P4
20.0#	\$ 232										
23.0#	N/A	293	320	335	293	335	332	369	390	411	428
23.0#	N/A	345	373	386	345	386	385	422	441	462	481
23.0#	\$ 289										
26.0#	N/A	350	379	391	350	391	390	427	448	468	486
26.0#	N/A	402	431	443	402	443	443	480	499	520	538
25.0#	\$ 303										
27.0#	N/A	364	391	403	364	403	402	439	460	481	496
27.0#	N/A	415	443	455	415	455	454	491	512	531	549

OPTIONS

California TB133 Fire Safety Code

The above seating products can be manufactured using the appropriate flame-retardant materials for compliance to California Technical Bulletin 133.
 Model=Polypropylene
 Added List Price=\$10
 Model=Upholstered Seat
 Added List Price=\$68
 Model=Upholstered Seat and Back
 Added List Price=\$97

SPECIAL SERVICES

Special Carton Marking

With specially marked information N/C



Shipping

Shipped **assembled freight prepaid f.o.b. Green Bay, Wisconsin 54302** factory.
 Freight class #125.

Specifications and prices are subject to change without prior notice.

Stack/Nesting

Strive® Chairs

		MODEL NUMBER							
		Basic Model	Frame Color	Seat & Back Color	Top Stitch Color	Glide Option	Fire Code	Upholstery Color	
	Four-Leg Wallsaver Armless Chair with Top Stitch on Seat • Flex back • Stacking • Wallsaver rear legs touch base of wall preventing chair back from contacting wall surface	Upholstered Seat	SLNATSUWS	<input type="checkbox"/>	<input type="checkbox"/>	<input type="checkbox"/>	S	<input type="checkbox"/>	<input type="checkbox"/>
	Upholstered Seat/Back	SLNATSUBWS	<input type="checkbox"/>	<input type="checkbox"/>	<input type="checkbox"/>	S	<input type="checkbox"/>	<input type="checkbox"/>	
SLTS	SLBTS								
	Four-Leg Wallsaver Cantilever Armchair with Top Stitch on Seat • Flex back • Stacking • Wallsaver rear legs touch base of wall preventing chair back from contacting wall surface	Upholstered Seat	SLCATSUWS	<input type="checkbox"/>	<input type="checkbox"/>	<input type="checkbox"/>	S	<input type="checkbox"/>	<input type="checkbox"/>
	Upholstered Seat/Back	SLCATSUBWS	<input type="checkbox"/>	<input type="checkbox"/>	<input type="checkbox"/>	S	<input type="checkbox"/>	<input type="checkbox"/>	
SLTS	SLBTS								
	Four-Leg Wallsaver Loop Arm Chair with Top Stitch on Seat • Flex back • Stacking • Wallsaver rear legs touch base of wall preventing chair back from contacting wall surface	Upholstered Seat	SLLATSUWS	<input type="checkbox"/>	<input type="checkbox"/>	<input type="checkbox"/>	S	<input type="checkbox"/>	<input type="checkbox"/>
	Upholstered Seat/Back	SLLATSUBWS	<input type="checkbox"/>	<input type="checkbox"/>	<input type="checkbox"/>	S	<input type="checkbox"/>	<input type="checkbox"/>	
SLTS	SLBTS								
			A	B	C	D	E	F	G

HOW TO ORDER

Indicate the following information on order form:

- Quantity of each item.
- Model number, including options. See "How To Build a Model Number".
- Any special service required.

Note: • The indicates that a choice is required.

- The absence of the indicates that no choice is required.
- Alpha-numeric characters in place of indicate that no other alternatives are available.

HOW TO BUILD A MODEL NUMBER

- A** Select basic model.
- B** Select frame color.
Refer to color addendum at ki.com or KI Fabrics & Finishes binder.
- C** Select seat and back color.
Refer to color addendum at ki.com or KI Fabrics & Finishes binder.
- D** Select top stitch color.

BLTS	- Black
WHTS	- White
- E** Select glide option.

S	- Steel glides
----------	----------------
- F** Select fire code.

NFR	- Compliance to TB 117-2013
FR	- Compliance to TB 133
- G** Select upholstery grade/color.

Refer to color addendum at ki.com or KI Fabrics & Finishes binder.

UPHOLSTERY INFORMATION

C.O.M. Upholstery

C.O.M. requirement for 10 chairs or less with upholstered seat or upholstered seat and back is 3/4 yard per chair of 54" wide nondirectional fabric. For orders of 11 or more with upholstered seat and back and for complete information on ordering C.O.M. see "Ordering C.O.M., C.O.V. and C.O.L." section.



Approx. Packaged Weight	Delivered Pricing Pallas Fabric Group P1
23.0#	\$ 410
23.0#	461

26.0#	\$ 468
26.0#	520

27.0#	\$ 481
27.0#	531

OPTIONS

California TB133 Fire Safety Code

The above seating products can be manufactured using the appropriate flame-retardant materials for compliance to California Technical Bulletin 133.
 Model=Polypropylene
 Added List Price=\$10
 Model=Upholstered Seat
 Added List Price=\$68
 Model=Upholstered Seat and Back
 Added List Price=\$97

SPECIAL SERVICES

Special Carton Marking

With specially marked information N/C



Shipping

Shipped **assembled freight prepaid f.o.b. Green Bay, Wisconsin 54302** factory. Freight class #125.

Specifications and prices are subject to change without prior notice.

Stack/Nesting

Strive® Chairs

MODEL	Features	MODEL NUMBER						Approx. Packaged Weight
		Basic Model	Frame Color	Seat & Back Color	Glide Option	Fire Code	Upholstery Color	
 <p>Sled Base Armless Chair</p> <ul style="list-style-type: none"> • Flex back • Stacking 	Polypropylene	SSNAP	<input type="checkbox"/> <input type="checkbox"/>	<input type="checkbox"/> <input type="checkbox"/> <input type="checkbox"/> <input type="checkbox"/>	<input type="checkbox"/> <input type="checkbox"/> <input type="checkbox"/> <input type="checkbox"/>	<input type="checkbox"/> <input type="checkbox"/> <input type="checkbox"/> <input type="checkbox"/>	<input type="checkbox"/> <input type="checkbox"/> <input type="checkbox"/> <input type="checkbox"/> <input type="checkbox"/> <input type="checkbox"/>	22.0#
	Upholstered Seat	SSNAU	<input type="checkbox"/> <input type="checkbox"/>	<input type="checkbox"/> <input type="checkbox"/> <input type="checkbox"/> <input type="checkbox"/>	<input type="checkbox"/> <input type="checkbox"/> <input type="checkbox"/> <input type="checkbox"/>	<input type="checkbox"/> <input type="checkbox"/> <input type="checkbox"/> <input type="checkbox"/>	<input type="checkbox"/> <input type="checkbox"/> <input type="checkbox"/> <input type="checkbox"/> <input type="checkbox"/> <input type="checkbox"/>	25.0#
	Upholstered Seat/Back	SSNAUB	<input type="checkbox"/> <input type="checkbox"/>	<input type="checkbox"/> <input type="checkbox"/> <input type="checkbox"/> <input type="checkbox"/>	<input type="checkbox"/> <input type="checkbox"/> <input type="checkbox"/> <input type="checkbox"/>	<input type="checkbox"/> <input type="checkbox"/> <input type="checkbox"/> <input type="checkbox"/>	<input type="checkbox"/> <input type="checkbox"/> <input type="checkbox"/> <input type="checkbox"/> <input type="checkbox"/> <input type="checkbox"/>	25.0#
SSP								
SSU								
SSUB								
 <p>Sled Base Cantilever Arm Chair</p> <ul style="list-style-type: none"> • Flex back • Stacking 	Polypropylene	SSCAP	<input type="checkbox"/> <input type="checkbox"/>	<input type="checkbox"/> <input type="checkbox"/> <input type="checkbox"/> <input type="checkbox"/>	<input type="checkbox"/> <input type="checkbox"/> <input type="checkbox"/> <input type="checkbox"/>	<input type="checkbox"/> <input type="checkbox"/> <input type="checkbox"/> <input type="checkbox"/>	<input type="checkbox"/> <input type="checkbox"/> <input type="checkbox"/> <input type="checkbox"/> <input type="checkbox"/> <input type="checkbox"/>	24.0#
	Upholstered Seat	SSCAU	<input type="checkbox"/> <input type="checkbox"/>	<input type="checkbox"/> <input type="checkbox"/> <input type="checkbox"/> <input type="checkbox"/>	<input type="checkbox"/> <input type="checkbox"/> <input type="checkbox"/> <input type="checkbox"/>	<input type="checkbox"/> <input type="checkbox"/> <input type="checkbox"/> <input type="checkbox"/>	<input type="checkbox"/> <input type="checkbox"/> <input type="checkbox"/> <input type="checkbox"/> <input type="checkbox"/> <input type="checkbox"/>	27.0#
	Upholstered Seat/Back	SSCAUB	<input type="checkbox"/> <input type="checkbox"/>	<input type="checkbox"/> <input type="checkbox"/> <input type="checkbox"/> <input type="checkbox"/>	<input type="checkbox"/> <input type="checkbox"/> <input type="checkbox"/> <input type="checkbox"/>	<input type="checkbox"/> <input type="checkbox"/> <input type="checkbox"/> <input type="checkbox"/>	<input type="checkbox"/> <input type="checkbox"/> <input type="checkbox"/> <input type="checkbox"/> <input type="checkbox"/> <input type="checkbox"/>	27.0#
SSP								
SSU								
SSUB								

A **B** **C** **D** **E** **F**

HOW TO ORDER

Indicate the following information on order form:

1. Quantity of each item.
2. Model number, including options. See "How To Build a Model Number".
3. Any special service required.

Note: • The indicates that a choice is required.

- The absence of the indicates that no choice is required.
- Alpha-numeric characters in place of indicate that no other alternatives are available.

HOW TO BUILD A MODEL NUMBER

Fabrics & Finishes binder.

- A** Select basic model.
- B** Select frame color.
Refer to color addendum at ki.com or KI Fabrics & Finishes binder.
- C** Select poly seat and back color.
Refer to color addendum at ki.com or KI Fabrics & Finishes binder.
- D** Select glide option.
 - NG** - No glides
 - GBL** - Black plastic glides; add \$34
 - NS** - Non-skid glides; add \$28
 - GSS** - Stainless steel glide; add \$29
- E** Select fire code.
 - FR** - Compliance to TB 133
 - NFR** - Compliance to TB 117-2013
- F** Select upholstery grade/color.
Refer to color addendum at ki.com or KI

UPHOLSTERY INFORMATION

C.O.M. Upholstery

C.O.M. requirement for 10 chairs or less with upholstered seat or upholstered seat and back is 3/4 yard per chair of 54" wide nondirectional fabric. For orders of 11 or more with upholstered seat and back and for complete information on ordering C.O.M. see "Ordering C.O.M., C.O.V. and C.O.L." section.



Stack/Nesting

Strive® Chairs

Delivered Pricing Unupholstered	Delivered Pricing Fabric Grade 1 & C.O.M.	Delivered Pricing Fabric Grade 2	Delivered Pricing Fabric Grade 3	Delivered Pricing C.O.V.	Delivered Pricing Vinyl Group 2V	Delivered Pricing Pallas Fabric Group P0	Delivered Pricing Pallas Fabric Group P1	Delivered Pricing Pallas Fabric Group P2	Delivered Pricing Pallas Fabric Group P3	Delivered Pricing Pallas Fabric Group P4	
\$ 217	N/A	278	307	317	278	317	317	354	374	394	412
N/A	329	357	369	329	369	369	406	426	446	464	

\$ 275	N/A	337	363	375	337	375	374	411	432	452	470
N/A	387	414	427	387	427	425	462	484	503	522	

OPTIONS

California TB133 Fire Safety Code

The above seating products can be manufactured using the appropriate flame-retardant materials for compliance to California Technical Bulletin 133.
 Model=Polypropylene
 Added List Price=\$10
 Model=Upholstered Seat
 Added List Price=\$68
 Model=Upholstered Seat and Back
 Added List Price=\$97

SPECIAL SERVICES

Special Carton Marking

With specially marked information N/C



Shipping

Shipped **assembled freight prepaid f.o.b. Green Bay, Wisconsin 54302** factory.
 Freight class #125.

Specifications and prices are subject to change without prior notice.

Stack/Nesting

Strive® Chairs

	MODEL	Features	MODEL NUMBER						
			Basic Model	Frame Color	Seat & Back Color	Top Stitch Color	Glide Option	Fire Code	Upholstery Color
 <p>SSTS SSBT</p>	Sled Base Armless Chair with Top Stitch on Seat	Upholstered Seat	SSNATSU	<input type="checkbox"/> <input type="checkbox"/>	<input type="checkbox"/> <input type="checkbox"/> <input type="checkbox"/> <input type="checkbox"/>	<input type="checkbox"/> <input type="checkbox"/> <input type="checkbox"/> <input type="checkbox"/> <input type="checkbox"/> <input type="checkbox"/>	<input type="checkbox"/> <input type="checkbox"/> <input type="checkbox"/>	<input type="checkbox"/> <input type="checkbox"/> <input type="checkbox"/>	<input type="checkbox"/> <input type="checkbox"/> <input type="checkbox"/> <input type="checkbox"/> <input type="checkbox"/> <input type="checkbox"/>
		Upholstered Seat/Back	SSNATSUB	<input type="checkbox"/> <input type="checkbox"/>	<input type="checkbox"/> <input type="checkbox"/> <input type="checkbox"/> <input type="checkbox"/>	<input type="checkbox"/> <input type="checkbox"/> <input type="checkbox"/> <input type="checkbox"/> <input type="checkbox"/> <input type="checkbox"/>	<input type="checkbox"/> <input type="checkbox"/> <input type="checkbox"/>	<input type="checkbox"/> <input type="checkbox"/> <input type="checkbox"/>	<input type="checkbox"/> <input type="checkbox"/> <input type="checkbox"/> <input type="checkbox"/> <input type="checkbox"/> <input type="checkbox"/>
 <p>SSTS SSBT</p>	Sled Base Cantilever Arm Chair with Top Stitch on Seat	Upholstered Seat	SSCATSU	<input type="checkbox"/> <input type="checkbox"/>	<input type="checkbox"/> <input type="checkbox"/> <input type="checkbox"/> <input type="checkbox"/>	<input type="checkbox"/> <input type="checkbox"/> <input type="checkbox"/> <input type="checkbox"/> <input type="checkbox"/> <input type="checkbox"/>	<input type="checkbox"/> <input type="checkbox"/> <input type="checkbox"/>	<input type="checkbox"/> <input type="checkbox"/> <input type="checkbox"/>	<input type="checkbox"/> <input type="checkbox"/> <input type="checkbox"/> <input type="checkbox"/> <input type="checkbox"/> <input type="checkbox"/>
		Upholstered Seat/Back	SSCATSUB	<input type="checkbox"/> <input type="checkbox"/>	<input type="checkbox"/> <input type="checkbox"/> <input type="checkbox"/> <input type="checkbox"/>	<input type="checkbox"/> <input type="checkbox"/> <input type="checkbox"/> <input type="checkbox"/> <input type="checkbox"/> <input type="checkbox"/>	<input type="checkbox"/> <input type="checkbox"/> <input type="checkbox"/>	<input type="checkbox"/> <input type="checkbox"/> <input type="checkbox"/>	<input type="checkbox"/> <input type="checkbox"/> <input type="checkbox"/> <input type="checkbox"/> <input type="checkbox"/> <input type="checkbox"/>

A **B** **C** **D** **E** **F** **G**

HOW TO ORDER

Indicate the following information on order form:

- Quantity of each item.
- Model number, including options. See "How To Build a Model Number".
- Any special service required.

Note: • The indicates that a choice is required.

- The absence of the indicates that no choice is required.
- Alpha-numeric characters in place of indicate that no other alternatives are available.

HOW TO BUILD A MODEL NUMBER

- A** Select basic model.
- B** Select frame color.
Refer to color addendum at ki.com or KI Fabrics & Finishes binder.
- C** Select seat and back color.
Refer to color addendum at ki.com or KI Fabrics & Finishes binder.
- D** Select top stitch color.
 BLTS - Black
 WHTS - White
- E** Select glide option.
 NG - No glides
 GBL - Black plastic glides; add \$34
 NS - Non-skid glides; add \$28
 GSS - Stainless steel glide; add \$29
- F** Select fire code.
 FR - Compliance to TB 133
 NFR - Compliance to TB 117-2013
- G** Select upholstery grade/color.
Refer to color addendum at ki.com or KI Fabrics & Finishes binder.

UPHOLSTERY INFORMATION

C.O.M. Upholstery

C.O.M. requirement for 10 chairs or less with upholstered seat or upholstered seat and back is 3/4 yard per chair of 54" wide nondirectional fabric. For orders of 11 or more with upholstered seat and back and for complete information on ordering C.O.M. see "Ordering C.O.M., C.O.V. and C.O.L." section.



Approx. Packaged Weight	Delivered Pricing Pallas Fabric Group P1
25.0#	\$ 394
25.0#	446

27.0#	\$ 451
27.0#	502

OPTIONS

California TB133 Fire Safety Code

The above seating products can be manufactured using the appropriate flame-retardant materials for compliance to California

Technical Bulletin 133.
 Model=Polypropylene
 Added List Price=\$10
 Model=Upholstered Seat
 Added List Price=\$68
 Model=Upholstered Seat and Back
 Added List Price=\$97

SPECIAL SERVICES

Special Carton Marking

With specially marked information N/C



Shipping

Shipped **assembled freight prepaid f.o.b.**
Green Bay, Wisconsin 54302 factory.
 Freight class #125.

Specifications and prices are subject to change without prior notice.

Stack/Nesting

Strive® Chairs

			MODEL NUMBER						
MODEL	Features	Basic Model	Frame Color	Seat & Back Color	Glide Option	Tablet Arm Color	Fire Code	Upholstery Color	
 <p>Sled Base Tablet Arm Chair</p> <ul style="list-style-type: none"> Flex back NONSTACKING 	Polypropylene, Left Hand	SSTAPLH	<input type="checkbox"/>	<input type="checkbox"/>	<input type="checkbox"/>	<input type="checkbox"/>	<input type="checkbox"/>		
	Polypropylene, Right Hand	SSTAPRH	<input type="checkbox"/>	<input type="checkbox"/>	<input type="checkbox"/>	<input type="checkbox"/>	<input type="checkbox"/>		
	Uph. Seat, Left Hand	SSTAULH	<input type="checkbox"/>	<input type="checkbox"/>	<input type="checkbox"/>	<input type="checkbox"/>	<input type="checkbox"/>	<input type="checkbox"/>	
	Uph. Seat, Right Hand	SSTAURH	<input type="checkbox"/>	<input type="checkbox"/>	<input type="checkbox"/>	<input type="checkbox"/>	<input type="checkbox"/>	<input type="checkbox"/>	
	Upholstered Seat/Back	SSTAUBLH	<input type="checkbox"/>	<input type="checkbox"/>	<input type="checkbox"/>	<input type="checkbox"/>	<input type="checkbox"/>	<input type="checkbox"/>	
	Upholstered Seat/Back	SSTAUBRH	<input type="checkbox"/>	<input type="checkbox"/>	<input type="checkbox"/>	<input type="checkbox"/>	<input type="checkbox"/>	<input type="checkbox"/>	
SSP									
SSU									
SSUB									
 <p>Sled Base Oversize Tablet Arm Chair</p> <ul style="list-style-type: none"> Oversized tablet Flex back NONSTACKING 	Polypropylene, Left Hand	SSOVTAPLH	<input type="checkbox"/>	<input type="checkbox"/>	<input type="checkbox"/>	<input type="checkbox"/>	<input type="checkbox"/>		
	Polypropylene, Right Hand	SSOVTAPRH	<input type="checkbox"/>	<input type="checkbox"/>	<input type="checkbox"/>	<input type="checkbox"/>	<input type="checkbox"/>		
	Uph. Seat, Left Hand	SSOVTAULH	<input type="checkbox"/>	<input type="checkbox"/>	<input type="checkbox"/>	<input type="checkbox"/>	<input type="checkbox"/>	<input type="checkbox"/>	
	Uph. Seat, Right Hand	SSOVTaurH	<input type="checkbox"/>	<input type="checkbox"/>	<input type="checkbox"/>	<input type="checkbox"/>	<input type="checkbox"/>	<input type="checkbox"/>	
	Uph. Seat/Back, Left Hand	SSOVTaUBLH	<input type="checkbox"/>	<input type="checkbox"/>	<input type="checkbox"/>	<input type="checkbox"/>	<input type="checkbox"/>	<input type="checkbox"/>	
	Uph. Seat/Back, Right Hand	SSOVTaUBRH	<input type="checkbox"/>	<input type="checkbox"/>	<input type="checkbox"/>	<input type="checkbox"/>	<input type="checkbox"/>	<input type="checkbox"/>	
SSP									
SSU									
SSUB									
			A	B	C	D	E	F	G

HOW TO ORDER

Indicate the following information on order form:

- Quantity of each item.
- Model number, including options. See "How To Build a Model Number".
- Any special service required.

Note: • The indicates that a choice is required.

- The absence of the indicates that no choice is required.
- Alpha-numeric characters in place of indicate that no other alternatives are available.

HOW TO BUILD A MODEL NUMBER

- A** Select basic model.
- B** Select frame color.
Refer to color addendum at ki.com or KI Fabrics & Finishes binder.
- C** Select poly seat and back color.
Refer to color addendum at ki.com or KI Fabrics & Finishes binder.
- D** Select glide option.

NG	- No glides
GBL	- Black plastic glides; add \$34
NS	- Non-skid glides; add \$28
GSS	- Stainless steel glide; add \$29
- E** Select tablet arm color.
Refer to color addendum at ki.com or KI Fabrics & Finishes binder.
- F** Select fire code.

NFR	- Compliance to TB 117-2013
FR	- Compliance to TB 133
- G** Select upholstery grade/color.
Refer to color addendum at ki.com or KI Fabrics & Finishes binder.

UPHOLSTERY INFORMATION

C.O.M. Upholstery

C.O.M. requirement for 10 chairs or less with upholstered seat or upholstered seat and back is 3/4 yard per chair of 54" wide nondirectional fabric. For orders of 11 or more with upholstered seat and back and for complete information on ordering C.O.M. see "Ordering C.O.M., C.O.V. and C.O.L." section.



Stack/Nesting

Strive® Chairs

Approx. Packaged Weight	Delivered Pricing Unupholstered	Delivered Pricing Fabric Grade 1 & C.O.M.	Delivered Pricing Fabric Grade 2	Delivered Pricing Fabric Grade 3	Delivered Pricing C.O.V.	Delivered Pricing Vinyl Group 2V	Delivered Pricing Pallas Fabric Group P0	Delivered Pricing Pallas Fabric Group P1	Delivered Pricing Pallas Fabric Group P2	Delivered Pricing Pallas Fabric Group P3	Delivered Pricing Pallas Fabric Group P4
31.0#	\$ 412										
31.0#	412										
33.0#	N/A	473	501	516	473	516	511	549	572	589	608
33.0#	N/A	473	501	516	473	516	511	549	572	589	608
33.0#	N/A	525	553	567	525	567	564	602	624	641	660
33.0#	N/A	525	553	567	525	567	564	602	624	641	660

31.0#	\$ 473										
31.0#	473										
33.0#	N/A	535	563	576	535	576	573	610	632	651	668
33.0#	N/A	535	563	576	535	576	573	610	632	651	668
33.0#	N/A	586	614	628	586	628	625	662	684	702	720
33.0#	N/A	586	614	628	586	628	625	662	684	702	720

OPTIONS

California TB133 Fire Safety Code

The above seating products can be manufactured using the appropriate flame-retardant materials for compliance to California Technical Bulletin 133.
 Model=Polypropylene
 Added List Price=\$10
 Model=Upholstered Seat
 Added List Price=\$68
 Model=Upholstered Seat and Back
 Added List Price=\$97

SPECIAL SERVICES

Special Carton Marking

With specially marked information N/C



Shipping

Shipped **assembled freight prepaid f.o.b. Green Bay, Wisconsin 54302** factory. Freight class #125.

Specifications and prices are subject to change without prior notice.

Stack/Nesting

Strive® Chairs

Features	MODEL NUMBER								Approx. Packaged Weight	
	Basic Model	Frame Color	Seat & Back Color	Top Stitch Color	Glide Option	Tablet Arm Color	Fire Code	Upholstery Color		
 <p>SSTS SSBT</p> <p>Sled Base Tablet Arm Chair with Top Stitch on Seat</p> <ul style="list-style-type: none"> Flex back NONSTACKING 	Uph Seat, Left Hand	SSTALTSU	<input type="checkbox"/>	<input type="checkbox"/>	<input type="checkbox"/>	<input type="checkbox"/>	<input type="checkbox"/>	<input type="checkbox"/>	<input type="checkbox"/>	33.0#
	Uph Seat, Right Hand	SSTARTSU	<input type="checkbox"/>	<input type="checkbox"/>	<input type="checkbox"/>	<input type="checkbox"/>	<input type="checkbox"/>	<input type="checkbox"/>	<input type="checkbox"/>	33.0#
	Uph Seat/Back, Left Hand	SSTALTSUB	<input type="checkbox"/>	<input type="checkbox"/>	<input type="checkbox"/>	<input type="checkbox"/>	<input type="checkbox"/>	<input type="checkbox"/>	<input type="checkbox"/>	33.0#
	Uph Seat/Back, Right Hand	SSTARTSUB	<input type="checkbox"/>	<input type="checkbox"/>	<input type="checkbox"/>	<input type="checkbox"/>	<input type="checkbox"/>	<input type="checkbox"/>	<input type="checkbox"/>	33.0#
 <p>SSTS SSBT</p> <p>Sled Base Oversize Tablet Arm Chair with Top Stitch on Seat</p> <ul style="list-style-type: none"> Oversized tablet Flex back NONSTACKING 	Uph Seat, Left Hand	SSOVTATSULH	<input type="checkbox"/>	<input type="checkbox"/>	<input type="checkbox"/>	<input type="checkbox"/>	<input type="checkbox"/>	<input type="checkbox"/>	<input type="checkbox"/>	33.0#
	Uph Seat, Right Hand	SSOVTATSURH	<input type="checkbox"/>	<input type="checkbox"/>	<input type="checkbox"/>	<input type="checkbox"/>	<input type="checkbox"/>	<input type="checkbox"/>	<input type="checkbox"/>	33.0#
	Uph Seat/Back, Left Hand	SSOVTATSUBLH	<input type="checkbox"/>	<input type="checkbox"/>	<input type="checkbox"/>	<input type="checkbox"/>	<input type="checkbox"/>	<input type="checkbox"/>	<input type="checkbox"/>	33.0#
	Uph Seat/Back, Right Hand	SSOVTATSUBRH	<input type="checkbox"/>	<input type="checkbox"/>	<input type="checkbox"/>	<input type="checkbox"/>	<input type="checkbox"/>	<input type="checkbox"/>	<input type="checkbox"/>	33.0#
			A	B	C	D	E	F	G	H

HOW TO ORDER

Indicate the following information on order form:

- Quantity of each item.
- Model number, including options. See "How To Build a Model Number".
- Any special service required.

Note: • The indicates that a choice is required.

- The absence of the indicates that no choice is required.
- Alpha-numeric characters in place of indicate that no other alternatives are available.

HOW TO BUILD A MODEL NUMBER

A Select basic model.

B Select frame color.
Refer to color addendum at ki.com or KI Fabrics & Finishes binder.

C Select poly seat and back color.
Refer to color addendum at ki.com or KI Fabrics & Finishes binder.

D Select top stitch color.
BLTS - Black
WHTS - White

E Select glide option.
NG - No glides
GBL - Black plastic glides; add \$34
NS - Non-skid glides; add \$28
GSS - Stainless steel glide; add \$29

F Select tablet arm color.
Refer to color addendum at ki.com or KI Fabrics & Finishes binder.

G Select fire code.

FR - Compliance to TB 133
NFR - Compliance to TB 117-2013

H Select upholstery grade/color.
Refer to color addendum at ki.com or KI Fabrics & Finishes binder.

UPHOLSTERY INFORMATION

C.O.M. Upholstery

C.O.M. requirement for 10 chairs or less with upholstered seat or upholstered seat and back is 3/4 yard per chair of 54" wide nondirectional fabric. For orders of 11 or more with upholstered seat and back and for complete information on ordering C.O.M. see "Ordering C.O.M., C.O.V. and C.O.L." section.



Delivered
Pricing
Pallas Fabric
Group P1

\$ 589
589
641
641

\$ 651
651
702
702

OPTIONS

California TB133 Fire Safety Code

The above seating products can be manufactured using the appropriate flame-retardant materials for compliance to California Technical Bulletin 133.
 Model=Polypropylene
 Added List Price=\$10
 Model=Upholstered Seat
 Added List Price=\$68
 Model=Upholstered Seat and Back
 Added List Price=\$97

SPECIAL SERVICES

Special Carton Marking

With specially marked information N/C

Shipping

Shipped **assembled freight prepaid f.o.b. Green Bay, Wisconsin 54302** factory.
 Freight class #125.

Specifications and prices are subject to change without prior notice.

Stack/Nesting

Strive® Chairs

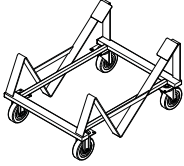
MODEL	MODEL NUMBER	Approx. Packaged Weight
	Basic Model	
 <p>Transport Dolly for 4-Leg and Sled Base Chairs</p> <ul style="list-style-type: none"> • Easy maneuverability with 5" casters: two fixed, two swivel • Rugged weld tubular steel frame • Black powder-coated finish 	SCDA.BL	31.0#

HRDPT



HOW TO ORDER

Indicate the following information on order form:

1. Quantity of each item.
2. Model number, including options. See "How To Build a Model Number".
3. Any special service required.

- Note:
- The indicates that a choice is required.
 - The absence of the indicates that no choice is required.
 - Alpha-numeric characters in place of indicate that no other alternatives are available.

HOW TO BUILD A MODEL NUMBER

- A** Select basic model.



Delivered
Pricing
\$ 420

SPECIAL SERVICES

Special Carton Marking

With specially marked information N/C



Shipping

Shipped **assembled freight prepaid f.o.b.**
Green Bay, Wisconsin 54302 factory.
Freight class #125.

Specifications and prices are subject to
change without prior notice.

Stack/Nesting

Strive® Cafe Stools

MODEL	Features	MODEL NUMBER						
		Basic Model	Seat Height	Frame Color	Seat & Back Color	Glide Option	Fire Code	Upholstery Color
 <p>Four-Leg Armless Cafe Stool</p> <ul style="list-style-type: none"> • Flex back • Stacking • Two seat heights 	Polypropylene	SLSNAP	<input type="checkbox"/>	<input type="checkbox"/>	<input type="checkbox"/>	<input type="checkbox"/>	<input type="checkbox"/>	
	Upholstered Seat	SLSNAU	<input type="checkbox"/>	<input type="checkbox"/>	<input type="checkbox"/>	<input type="checkbox"/>	<input type="checkbox"/>	<input type="checkbox"/>
	Upholstered Seat/Back	SLSNAUB	<input type="checkbox"/>	<input type="checkbox"/>	<input type="checkbox"/>	<input type="checkbox"/>	<input type="checkbox"/>	<input type="checkbox"/>
 <p>Four-Leg Cantilever Arm Cafe Stool</p> <ul style="list-style-type: none"> • Flex back • Stacking • Two seat heights 	Polypropylene	SLSCAP	<input type="checkbox"/>	<input type="checkbox"/>	<input type="checkbox"/>	<input type="checkbox"/>	<input type="checkbox"/>	
	Upholstered Seat	SLSCAU	<input type="checkbox"/>	<input type="checkbox"/>	<input type="checkbox"/>	<input type="checkbox"/>	<input type="checkbox"/>	<input type="checkbox"/>
	Upholstered Seat/Back	SLSCAUB	<input type="checkbox"/>	<input type="checkbox"/>	<input type="checkbox"/>	<input type="checkbox"/>	<input type="checkbox"/>	<input type="checkbox"/>
 <p>Four-Leg Loop Arm Cafe Stool</p> <ul style="list-style-type: none"> • Flex back • NONSTACKING • Two seat heights 	Polypropylene	SLSLAP	<input type="checkbox"/>	<input type="checkbox"/>	<input type="checkbox"/>	<input type="checkbox"/>	<input type="checkbox"/>	
	Upholstered Seat	SLSLAU	<input type="checkbox"/>	<input type="checkbox"/>	<input type="checkbox"/>	<input type="checkbox"/>	<input type="checkbox"/>	<input type="checkbox"/>
	Upholstered Seat/Back	SLSLAUB	<input type="checkbox"/>	<input type="checkbox"/>	<input type="checkbox"/>	<input type="checkbox"/>	<input type="checkbox"/>	<input type="checkbox"/>

A **B** **C** **D** **E** **F** **G**

HOW TO ORDER

Indicate the following information on order form:

- Quantity of each item.
- Model number, including options. See "How To Build a Model Number".
- Any special service required.

Note: • The indicates that a choice is required.

- The absence of the indicates that no choice is required.
- Alpha-numeric characters in place of indicate that no other alternatives are available.

HOW TO BUILD A MODEL NUMBER

- A** Select basic model.
- B** Select seat height.

<u>23</u>	- 23" Seat Height
<u>29</u>	- 29" Seat Height
- C** Select frame color.
Refer to color addendum at ki.com or KI Fabrics & Finishes binder.
- D** Select poly seat and back color.
Refer to color addendum at ki.com or KI Fabrics & Finishes binder.
- E** Select glide option.

<u>P</u>	- Plastic glides
<u>S</u>	- Steel glides
- F** Select fire code.

<u>FR</u>	- Compliance to TB 133
<u>NFR</u>	- Compliance to TB 117-2013

- G** Select upholstery grade/color.
Refer to color addendum at ki.com or KI Fabrics & Finishes binder.

UPHOLSTERY INFORMATION

C.O.M. Upholstery

C.O.M. requirement for 10 chairs or less with upholstered seat or upholstered seat and back is 3/4 yard per chair of 54" wide nondirectional fabric. For orders of 11 or more with upholstered seat and back and for complete information on ordering C.O.M. see "Ordering C.O.M., C.O.V. and C.O.L." section.



Stack/Nesting

Strive® Cafe Stools

Approx. Packaged Weight	Delivered Pricing Unupholstered	Delivered Pricing Fabric Grade 1 & C.O.M.	Delivered Pricing Fabric Grade 2	Delivered Pricing Fabric Grade 3	Delivered Pricing C.O.V.	Delivered Pricing Vinyl Group 2V	Delivered Pricing Pallas Fabric Group P0	Delivered Pricing Pallas Fabric Group P1	Delivered Pricing Pallas Fabric Group P2	Delivered Pricing Pallas Fabric Group P3	Delivered Pricing Pallas Fabric Group P4
31.0#	\$ 285										
33.0#	N/A	347	375	388	347	388	387	424	445	465	483
33.0#	N/A	399	427	440	399	440	438	475	496	518	535
33.0#	\$ 344										
35.0#	N/A	404	433	446	404	446	445	482	501	522	540
35.0#	N/A	456	485	497	456	497	495	533	553	574	592
35.0#	\$ 356										
37.0#	N/A	417	446	457	417	457	456	493	516	535	551
37.0#	N/A	470	497	510	470	510	508	545	567	586	604

OPTIONS

California TB133 Fire Safety Code

The above seating products can be manufactured using the appropriate flame-retardant materials for compliance to California Technical Bulletin 133.
 Model=Polypropylene
 Added List Price=\$10
 Model=Upholstered Seat
 Added List Price=\$68
 Model=Upholstered Seat and Back
 Added List Price=\$97

SPECIAL SERVICES

Special Carton Marking

With specially marked information N/C



Shipping

Shipped **assembled freight prepaid f.o.b. Green Bay, Wisconsin 54302** factory.
 Freight class #125.

Specifications and prices are subject to change without prior notice.

Stack/Nesting

Strive® Cafe Stools

MODEL	Features	MODEL NUMBER							
		Basic Model	Seat Height	Frame Color	Seat & Back Color	Top Stitch Color	Glide Option	Fire Code	Uph. Color
 <p>Four-Leg Armless Cafe Stool with Top Stitch on Seat</p> <ul style="list-style-type: none"> • Flex back • Stacking • Two seat heights 	Upholstered Seat	SLSNATSU	<input type="checkbox"/>	<input type="checkbox"/>	<input type="checkbox"/>	<input type="checkbox"/>	<input type="checkbox"/>	<input type="checkbox"/>	<input type="checkbox"/>
	Upholstered Seat/Back	SLSNATSUB	<input type="checkbox"/>	<input type="checkbox"/>	<input type="checkbox"/>	<input type="checkbox"/>	<input type="checkbox"/>	<input type="checkbox"/>	<input type="checkbox"/>
SLSTS									
SLSBT									
 <p>Four-Leg Cantilever Arm Cafe Stool with Top Stitch on Seat</p> <ul style="list-style-type: none"> • Flex back • Stacking • Two seat heights 	Upholstered Seat	SLSCATSU	<input type="checkbox"/>	<input type="checkbox"/>	<input type="checkbox"/>	<input type="checkbox"/>	<input type="checkbox"/>	<input type="checkbox"/>	<input type="checkbox"/>
	Upholstered Seat/Back	SLSCATSUB		<input type="checkbox"/>	<input type="checkbox"/>	<input type="checkbox"/>	<input type="checkbox"/>	<input type="checkbox"/>	<input type="checkbox"/>
SLSTS									
SLSBT									
 <p>Four-Leg Loop Arm Cafe Stool with Top Stitch on Seat</p> <ul style="list-style-type: none"> • Flex back • NONSTACKING • Two seat heights 	Upholstered Seat	SLSLATSU	<input type="checkbox"/>	<input type="checkbox"/>	<input type="checkbox"/>	<input type="checkbox"/>	<input type="checkbox"/>	<input type="checkbox"/>	<input type="checkbox"/>
	Upholstered Seat/Back	SLSLATSUB	<input type="checkbox"/>	<input type="checkbox"/>	<input type="checkbox"/>	<input type="checkbox"/>	<input type="checkbox"/>	<input type="checkbox"/>	<input type="checkbox"/>
SLSTS									
SLSBT									

A B C D E F G H

HOW TO ORDER

Indicate the following information on order form:

- Quantity of each item.
- Model number, including options. See "How To Build a Model Number".
- Any special service required.

Note: • The indicates that a choice is required.

- The absence of the indicates that no choice is required.
- Alpha-numeric characters in place of indicate that no other alternatives are available.

HOW TO BUILD A MODEL NUMBER

- A** Select basic model.
- B** Select seat height.
 - 23 - 23" Seat Height
 - 29 - 29" Seat Height
- C** Select frame color. Refer to color addendum at ki.com or KI Fabrics & Finishes binder.
- D** Select poly seat and back color. Refer to color addendum at ki.com or KI Fabrics & Finishes binder.
- E** Select top stitch color.
 - BLTS - Black
 - WHTS - White
- F** Select glide option.
 - P - Plastic glides
 - S - Steel glides
- G** Select fire code.

FR - Compliance to TB 133
NFR - Compliance to TB 117-2013

H Select upholstery grade/color. Refer to color addendum at ki.com or KI Fabrics & Finishes binder.

UPHOLSTERY INFORMATION

C.O.M. Upholstery

C.O.M. requirement for 10 chairs or less with upholstered seat or upholstered seat and back is 3/4 yard per chair of 54" wide nondirectional fabric. For orders of 11 or more with upholstered seat and back and for complete information on ordering C.O.M. see "Ordering C.O.M., C.O.V. and C.O.L." section.



Approx. Packaged Weight	Delivered Pricing Pallas Fabric Group P1
33.0#	\$ 464
33.0#	517

35.0#	\$ 522
35.0#	574

37.0#	\$ 535
37.0#	586

OPTIONS

California TB133 Fire Safety Code

The above seating products can be manufactured using the appropriate flame-retardant materials for compliance to California Technical Bulletin 133.
 Model=Polypropylene
 Added List Price=\$10
 Model=Upholstered Seat
 Added List Price=\$68
 Model=Upholstered Seat and Back
 Added List Price=\$97

SPECIAL SERVICES

Special Carton Marking

With specially marked information N/C

Shipping

Shipped **assembled freight prepaid f.o.b.**
Green Bay, Wisconsin 54302 factory.
 Freight class #125.

Specifications and prices are subject to change without prior notice.

Stack/Nesting

Strive® High Density Stack Chair General Information



Wire Rod High Density Stacking Chair (SWNA)



Wire Rod High Density Stacking Chair with Uph. Seat Pad (SWNAU)



Wire Rod High Density Stacking Chair with Tablet Arm (SWTAR)



Transport Dolly (CSD.BL)

Features				
Stackable	•	•		
Poly or upholstered seat	•	•	•	
Flex back	•	•	•	
General Dimensions				
Seat width	17-3/4"	17-3/4"	17-3/4"	
Seat depth	18-1/2"	18-1/2"	18-1/2"	
Seat height	17-1/2"	17-1/2"	17-1/2"	
Tablet to chair back clearance			15-1/4"	
Overall Dimensions				
Width	19-1/2"	19-1/2"	19-1/2"	22-3/8"
Depth	22-1/4"	22-1/4"	22-1/4"	25-5/8"
Height	32-1/2"	32-1/2"	32-1/2"	
Stacking on Dolly				
Overall width	22-1/2"	23"		
Overall depth	45"	39"		
Quantity/height	30 Chairs/77" High	15 Chairs/65" High		
Stacking on Floor				
Width	19-1/2"	19-1/2"		
Depth	29-1/2"	30"		
Quantity/height	6 Chairs/37-1/2" High	5 Chairs/41" High		

SPECIFICATIONS

Seat

Injection molded polypropylene.

Backrest

Injection molded polypropylene with integral steel cantilever springs. The combination of the slotted polypropylene back and the spring steel provides a supportive flexing back. Springs are nominal 4.5mm diameter chrome silicon valve spring wire. Top of back has an integral handle for ease of lifting and stacking.

Chair Frame

7/16" solid steel rod in bright nickel-chrome or with electrostatically-applied epoxy.

Bright Chrome Finish

Surfaces are duplex nickel-chrome plated in a twenty-one step process.

Powder-Coated Finish

Electrostatically-applied epoxy baked onto

surface.

Optional Upholstered Seat

Molded urethane foam is attached to an injection molded polypropylene seat board, then upholstered using a draw-string process. The assembled seat pad is attached to the seat by means of hidden fasteners.

Transport Dolly

Tubular and plate steel welded together. 5" casters: two fixed, two swivel. Powder-coated finish.

Tablet Arm

7/16" solid steel rod frame, hinged tablet for easy access. Tablet is plywood core; high pressure laminate surface. Round tablet edge with clear lacquer finish. Bright chrome frame only. Chairs are nonstacking when attached, not available for use with powder coated frame chairs. Tablet flips up for easy access. Ganging with tablet is not recommended.

Stacking Vinyl, Polyurethane, and Imitation Leather Upholstered Chairs

It is recommended that chairs to be stacked be covered in material other than vinyl, polyurethane, or imitation leather as an impression in the seat may result. KI does not warrant the effects of stacking on stock or C.O.M. vinyl, polyurethane, or imitation leather upholstery.

INFORMATION

C.O.M. Testing and Production Requirements

Not all materials are suitable for upholstering this product. A 1 yd. x 54" sample must be submitted and approved prior to acceptance of an order. If the fabric is directional in pattern or weave, the direction must be indicated on the submitted sample, and additional yardage may be requested.

Test samples must be sent to:

KI
Attn: C.O.M. Specialist
1687 Westminster Drive - Gate 3
Green Bay, WI 54302

Fabric Disclaimer

Fabric will be applied as swatched by the fabric manufacturer. Fabric that is required to be applied differently than is swatched will need a Special Cost Request written specifying the direction the fabric is to be applied. The posted standard lead time will apply to the Special Cost Request.

Design

Designed by Giancarlo Piretti and manufactured in the USA by Krueger International, Inc. under license from Pro-Cord S.p.A



INFORMATION

Warranty

Refer to KI Terms & Conditions document
or visit ki.com

Stack/Nesting

Strive® High Density Stack Chair

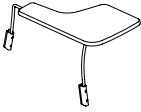
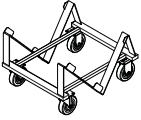
MODEL	Features	MODEL NUMBER						
		Basic Model	Frame Color	Seat & Back Color	Upholstery Color	Glide Option	Fire Code	Tablet Arm Color
 SWSCP SWSCU Armless Chair • Flex back	Polypropylene	SWNA	<input type="checkbox"/> <input type="checkbox"/>	<input type="checkbox"/> <input type="checkbox"/> <input type="checkbox"/>		<input type="checkbox"/> <input type="checkbox"/>	<input type="checkbox"/> <input type="checkbox"/> <input type="checkbox"/>	
	Upholstered Seat	SWNAU	<input type="checkbox"/> <input type="checkbox"/>	<input type="checkbox"/> <input type="checkbox"/> <input type="checkbox"/> <input type="checkbox"/> <input type="checkbox"/>		<input type="checkbox"/> <input type="checkbox"/>	<input type="checkbox"/> <input type="checkbox"/> <input type="checkbox"/>	
 SWTA Standard Flip-Up Tablet Arm • NONSTACKING • 12" wide x 20-1/2" deep • Field installable • For use only on chrome framed chairs	Left Hand	SWTAL					<input type="checkbox"/> <input type="checkbox"/> <input type="checkbox"/>	
	Right Hand	SWTAR					<input type="checkbox"/> <input type="checkbox"/> <input type="checkbox"/>	
 HRDPT Transport Dolly • Accommodates up to 30 chairs (poly) and 15 chairs (upholstered) • Easy maneuverability with 5" casters: two fixed, two swivel • Black powder-coated finish		CSD.BL						

A **B** **C** **D** **E** **F** **G**

HOW TO ORDER

Indicate the following information on order form:

- Quantity of each item.
- Model number, including options. See "How To Build a Model Number".
- Any special service required.

Note: • The indicates that a choice is required.

- The absence of the indicates that no choice is required.
- Alpha-numeric characters in place of indicate that no other alternatives are available.

HOW TO BUILD A MODEL NUMBER

- A** Select basic model.
- B** Select frame color.
Refer to color addendum at ki.com or KI Fabrics & Finishes binder.
- C** Select seat and back color.
Refer to color addendum at ki.com or KI Fabrics & Finishes binder.
- D** Select upholstery grade/color.
Refer to color addendum at ki.com or KI Fabrics & Finishes binder.
- E** Select glide option.

G	- Ganging polycarbonate glides; add \$5
GS	- Ganging steel glides; add \$5
NG	- No glides
H	- Polycarbonate glides; add \$5
NS	- PVC non-skid glides; add \$5
S	- Stainless steel glides; add \$5

- F** Select fire code.

FR	- Compliance to TB 133
NFR	- Compliance to TB 117-2013
- G** Select tablet arm color.
Refer to color addendum at ki.com or KI Fabrics & Finishes binder.

UPHOLSTERY INFORMATION

C.O.M. Upholstery
 C.O.M. requirement for 10 chairs or less with upholstered seat or upholstered seat and back is 3/4 yard per chair of 54" wide nondirectional fabric. For orders of 11 or more with upholstered seat and back and for complete information on ordering C.O.M. see "Ordering C.O.M., C.O.V. and C.O.L." section.



Stack/Nesting

Strive® High Density Stack Chair

Approx. Packaged Weight	Delivered Pricing Unupholstered	Delivered Pricing Fabric Grade 1 & C.O.M.	Delivered Pricing Fabric Grade 2	Delivered Pricing Fabric Grade 3	Delivered Pricing Vinyl Group 2V	Delivered Pricing Pallas Fabric Group P0	Delivered Pricing Pallas Fabric Group P1	Delivered Pricing Pallas Fabric Group P2	Delivered Pricing Pallas Fabric Group P3	Delivered Pricing Pallas Fabric Group P4
17.0#	\$ 187									
17.0#	N/A	250	278	289	289	288	325	346	367	385

7.0#	\$ 183
7.0#	183

30.0#	\$ 416
-------	--------

OPTIONS

California TB133 Fire Safety Code

The above seating products can be manufactured using the appropriate flame-retardant materials for compliance to California Technical Bulletin 133. No additional lead time.

Model=Polypropylene
 Added list price=\$10
 Model=Upholstered Seat
 Added list price=\$68

SPECIAL SERVICES

Special Carton Marking

With specially marked information N/C

Shipping

Shipped **assembled freight prepaid f.o.b. Green Bay, Wisconsin 54302** factory. Freight class #125.

Specifications and prices are subject to change without prior notice.

Stack/Nesting

Strive® High Density Stack Chair

MODEL	Features	MODEL NUMBER							
		Basic Model	Frame Color	Seat & Back Color	Top Stitch Color	TB133	Upholstery Color	Glide Option	
 <p>SWSTS</p>	Armless Chair with Top Stitch on Seat • Flex back	Upholstered Seat	SWNATSU	<input type="checkbox"/> <input type="checkbox"/>	<input type="checkbox"/> <input type="checkbox"/> <input type="checkbox"/>	<input type="checkbox"/> <input type="checkbox"/> <input type="checkbox"/> <input type="checkbox"/>	<input type="checkbox"/> <input type="checkbox"/> <input type="checkbox"/>	<input type="checkbox"/> <input type="checkbox"/> <input type="checkbox"/> <input type="checkbox"/> <input type="checkbox"/>	<input type="checkbox"/> <input type="checkbox"/>

A **B** **C** **D** **E** **F** **G**

HOW TO ORDER

Indicate the following information on order form:

1. Quantity of each item.
2. Model number, including options. See "How To Build a Model Number".
3. Any special service required.

Note: • The indicates that a choice is required.

- The absence of the indicates that no choice is required.
- Alpha-numeric characters in place of indicate that no other alternatives are available.

HOW TO BUILD A MODEL NUMBER

- A** Select basic model.
- B** Select frame color.
Refer to color addendum at ki.com or KI Fabrics & Finishes binder.
- C** Select seat and back color.
Refer to color addendum at ki.com or KI Fabrics & Finishes binder.
- D** Select top stitch color.
BLTS - Black
WHTS - White
- E** Select fire code.
FR - Compliance to TB 133
NFR - Compliance to TB 117-2013

- G** Select glide option.
G - Ganging polycarbonate glides; add \$5
GS - Ganging steel glides; add \$5
NG - No glides
H - Polycarbonate glides; add \$5
NS - PVC non-skid glides; add \$5
S - Stainless steel glides; add \$5



Approx. Packaged Weight	Delivered Pricing Pallas Fabric Group P1
17.0#	\$ 367

UPHOLSTERY INFORMATION

C.O.M. Upholstery

C.O.M. requirement for 10 chairs or less with upholstered seat or upholstered seat and back is 3/4 yard per chair of 54" wide nondirectional fabric. For orders of 11 or more with upholstered seat and back and for complete information on ordering C.O.M. see "Ordering C.O.M., C.O.V. and C.O.L." section.

OPTIONS

California TB133 Fire Safety Code

The above seating products can be manufactured using the appropriate flame-retardant materials for compliance to California Technical Bulletin 133. No additional lead time.
Model=Polypropylene
Added list price=\$10
Model=Upholstered Seat
Added list price=\$68

SPECIAL SERVICES

Special Carton Marking

With specially marked information N/C

Shipping

Shipped **assembled freight prepaid f.o.b. Green Bay, Wisconsin 54302** factory. Freight class #125.

Specifications and prices are subject to change without prior notice.

Stack/Nesting

Strive® Nesting General Information



Cantilever Armchair
(SNCAU)



Armless Chair
(SNNAP)



Tablet Arm Chair (SNTAURH)

Oversize Tablet Arm Chair

Features				
Poly or upholstered seat	•	•	•	•
Flex back	•	•	•	•
Flip-up seat	•	•	•	•
Integral handle	•	•	•	•
Nesting	•	•	•	•
General Dimensions				
Seat width	17"	17"	17"	17"
Seat depth	18"	18"	18"	18"
Seat height (upholstered add 1")	16-1/2"	16-1/2"	16-1/2"	16-1/2"
Tablet to chair back clearance			14"	14"
Overall Dimensions				
Width	23"	23"	24"	24"
Depth	22-3/4"	22-3/4"	29"	32"
Height	33-3/4"	33-3/4"	33-3/4"	33-3/4"
Top of arm to floor	25-1/2"		28-1/4"	28-1/4"
Nesting (two chairs) (upholstered add 1")	28-1/2"	28-1/2"	34-3/4"	37-3/4"

Nesting - For each additional chair, add 5-3/4"
(upholstered add 1")

SPECIFICATIONS

Seat and Backrest

Seat is two-piece construction of injection-molded polypropylene, reinforced with internal steel channels and assembled using hidden fasteners. The seat is available in a poly version or upholstered. For the upholstered version, molded urethane foam (1" depth) is applied to the seat board. Fabric is then upholstered over the foam using a drawstring process.

Backrest is injection-molded polypropylene with integral steel cantilever springs. The combination of the slotted polypropylene back and the spring steel provides a supportive flexing back. Springs are nominal 4.5mm diameter chrome silicon valve spring wire. Backrest is available poly only. Backrest has an integral molded "handle."

Seat flips up to allow chairs to nest for storage and transport.

Seat assembly and backrest are field replaceable.

Frame

The legs are 1" 13-gauge high-strength steel tubing. All frame joints are welded.

Frame Finishes

Baked-on electrostatically-applied 45° gloss epoxy powder coating or bright nickel chrome plating.

Casters/Glides

Double wheels (60mm) of high-impact thermoplastic. High-impact plastic frame. Carpet and hard floor casters are always black. Bell glide (2" high) made of high-impact plastic also available, black only.

Arm

Optional fixed-position T-arms are available. Arm supports are a continuation of the frame crossmember tube with injection-molded polypropylene armcaps attached by screws.

Tablet Arm

An optional tablet arm is available on either the RH or LH side. When so equipped, the tablet arm support structure is a continuation of the frame crossmember tube. A formed steel hinge is welded to the top of the support structure and secured with screws to the underside of the writing surface. Writing surface for standard tablet is 9-1/2" x 20-3/4" x 12-1/2" and oversize tablet is 15-1/2" x 22-1/2" x 14" plywood core of 5/8" thick, 11-ply hardwood surfaced with .030" high-pressure laminate top and plain backer undersurface. Tablet arm flips up for easy access. Edges are lacquered and sealed.

INFORMATION

C.O.M Testing and Production Requirements

Not all materials are suitable for upholstering this product. A 3/4 yd. x 54" sample must be submitted and approved prior to acceptance of an order. If the fabric is

directional in pattern or weave, the direction must be indicated on the submitted sample, and additional yardage may be requested.

Test samples must be sent to:

KI
Attn: C.O.M. Specialist
1687 Westminster Drive - Gate 3
Green Bay, WI 54302





Fabric Disclaimer

Fabric will be applied as swatched by the fabric manufacturer. Fabric that is required to be applied differently than is swatched will need a Special Cost Request written specifying the direction the fabric is to be applied. The posted standard lead time will apply to the Special Cost Request.



Stack/Nesting

Strive® Nesting Chairs

MODEL	MODEL NUMBER						Approx. Packaged Weight	Delivered Pricing
	Basic Model	Frame Color	Poly Seat & Back Color	Base	Fire Code	Upholstery Color		
 <p>SNP</p> <p>Armless Chair with Poly Seat</p> <ul style="list-style-type: none"> • Flex back • Nests 	SNNAP	<input type="checkbox"/>	<input type="checkbox"/>	<input type="checkbox"/>	<input type="checkbox"/>	<input type="checkbox"/>	23.0#	\$ 406
 <p>SNU</p> <p>Armless Chair with Upholstered Seat</p> <ul style="list-style-type: none"> • Flex back • Nests 	SNNAU	<input type="checkbox"/>	<input type="checkbox"/>	<input type="checkbox"/>	<input type="checkbox"/>	<input type="checkbox"/>	23.0#	N/A
 <p>SNP</p> <p>Armchair with Poly Seat</p> <ul style="list-style-type: none"> • Flex back • Nests 	SNCAP	<input type="checkbox"/>	<input type="checkbox"/>	<input type="checkbox"/>	<input type="checkbox"/>	<input type="checkbox"/>	25.0#	\$ 461
 <p>SNU</p> <p>Armchair with Upholstered Seat</p> <ul style="list-style-type: none"> • Flex back • Nests 	SNCAU	<input type="checkbox"/>	<input type="checkbox"/>	<input type="checkbox"/>	<input type="checkbox"/>	<input type="checkbox"/>	25.0#	N/A

A **B** **C** **D** **E** **F**

HOW TO ORDER

Indicate the following information on order form:

1. Quantity of each item.
2. Model number, including options. See "How To Build a Model Number".
3. Any special service required.

Note: • The indicates that a choice is required.

- The absence of the indicates that no choice is required.
- Alpha-numeric characters in place of indicate that no other alternatives are available.

HOW TO BUILD A MODEL NUMBER

- A** Select basic model.
- B** Select frame color.
Refer to color addendum at ki.com or KI Fabrics & Finishes binder.
- C** Select poly seat and back color
Refer to color addendum at ki.com or KI Fabrics & Finishes binder.
- D** Select base option.
- | | |
|----------|-----------------------------------|
| G | - Bell glides (black only) |
| C | - Carpet casters (black only) |
| S | - Hard floor casters (black only) |
- E** Select fire code.
- | | |
|------------|-----------------------------|
| NFR | - Compliance to TB 117-2013 |
| FR | - Compliance to TB 133 |
- F** Select upholstery grade/color.
Refer to color addendum at ki.com or KI Fabrics & Finishes binder.



Stack/Nesting

Strive® Nesting Chairs

Delivered Pricing Fabric Grade 1 & C.O.M.	Delivered Pricing Fabric Grade 2	Delivered Pricing Fabric Grade 3	Delivered Pricing C.O.V.	Delivered Pricing Vinyl Group 2V	Delivered Pricing Pallas Fabric Group P0	Delivered Pricing Pallas Fabric Group P1	Delivered Pricing Pallas Fabric Group P2	Delivered Pricing Pallas Fabric Group P3	Delivered Pricing Pallas Fabric Group P4
\$ 465	\$ 491	\$ 503	\$ 465	\$ 503	\$ 501	\$ 538	\$ 557	\$ 578	\$ 594
\$ 521	\$ 546	\$ 559	\$ 521	\$ 559	\$ 556	\$ 593	\$ 612	\$ 633	\$ 650

UPHOLSTERY INFORMATION

C.O.M. Upholstery

C.O.M. requirement for 10 chairs or less with upholstered seat or upholstered seat and back is 3/4 yard per chair of 54" wide nondirectional fabric. For orders of 11 or more with upholstered seat and back and for complete information on ordering C.O.M. see "Ordering C.O.M., C.O.V. and C.O.L." section.

OPTIONS

California TB133 Fire Safety Code

The above seating products can be manufactured using the appropriate flame-retardant materials for compliance to California Technical Bulletin 133. No additional lead time.
 Model=Polypropylene
 Added list price=\$10
 Model=Upholstered Seat
 Added list price=\$68

SPECIAL SERVICES

Special Carton Marking

With specially marked information N/C



Shipping

Shipped **assembled freight prepaid f.o.b. Green Bay, Wisconsin 54302** factory. Freight class #125.

Specifications and prices are subject to change without prior notice.

Stack/Nesting

Strive® Nesting Chairs

			MODEL NUMBER							
			Basic Model	Frame Color	Poly Seat & Back Color	Top Stitch Color	Base	TB133	Upholstery Color	
MODEL	Features									
 <p>SNTS</p>	Armless Chair with Upholstered Seat with Top Stitch on Seat • Flex back • Nests	Upholstered Seat	SNNATSU	<input type="checkbox"/> <input type="checkbox"/>	<input type="checkbox"/> <input type="checkbox"/> <input type="checkbox"/>	<input type="checkbox"/> <input type="checkbox"/> <input type="checkbox"/> <input type="checkbox"/>	<input type="checkbox"/>	<input type="checkbox"/> <input type="checkbox"/> <input type="checkbox"/>	<input type="checkbox"/> <input type="checkbox"/> <input type="checkbox"/> <input type="checkbox"/>	
 <p>SNTS</p>	Armchair with Upholstered Seat with Top Stitch on Seat • Flex back • Nests	Upholstered Seat	SNCATSU	<input type="checkbox"/> <input type="checkbox"/>	<input type="checkbox"/> <input type="checkbox"/> <input type="checkbox"/>	<input type="checkbox"/> <input type="checkbox"/> <input type="checkbox"/> <input type="checkbox"/>	<input type="checkbox"/>	<input type="checkbox"/> <input type="checkbox"/> <input type="checkbox"/>	<input type="checkbox"/> <input type="checkbox"/> <input type="checkbox"/> <input type="checkbox"/>	

A **B** **C** **D** **E** **F** **G**

HOW TO ORDER

Indicate the following information on order form:

- Quantity of each item.
- Model number, including options. See "How To Build a Model Number".
- Any special service required.

Note: • The indicates that a choice is required.

- The absence of the indicates that no choice is required.
- Alpha-numeric characters in place of indicate that no other alternatives are available.

HOW TO BUILD A MODEL NUMBER

- A** Select basic model.
- B** Select frame color.
Refer to color addendum at ki.com or KI Fabrics & Finishes binder.
- C** Select poly seat and back color
Refer to color addendum at ki.com or KI Fabrics & Finishes binder.
- D** Select top stitch color.

BLTS	- Black
WHTS	- White
- E** Select base option.

G	- Bell glides (black only)
C	- Carpet casters (black only)
S	- Hard floor casters (black only)
- F** Select fire code.

NFR	- Compliance to TB 117-2013
FR	- Compliance to TB 133
- G** Select upholstery grade/color.
Refer to color addendum at ki.com or KI Fabrics & Finishes binder.



Approx. Packaged Weight	Delivered Pricing Pallas Fabric Group P1
23.0#	\$ 578

25.0#	\$ 633
-------	--------

UPHOLSTERY INFORMATION

C.O.M. Upholstery

C.O.M. requirement for 10 chairs or less with upholstered seat or upholstered seat and back is 3/4 yard per chair of 54" wide nondirectional fabric. For orders of 11 or more with upholstered seat and back and for complete information on ordering C.O.M. see "Ordering C.O.M., C.O.V. and C.O.L." section.

OPTIONS

California TB133 Fire Safety Code

The above seating products can be manufactured using the appropriate flame-retardant materials for compliance to California Technical Bulletin 133. No additional lead time.
 Model=Polypropylene
 Added list price=\$10
 Model=Upholstered Seat
 Added list price=\$68

SPECIAL SERVICES

Special Carton Marking

With specially marked information N/C





Shipping

Shipped **assembled freight prepaid f.o.b. Green Bay, Wisconsin 54302** factory. Freight class #125.

Specifications and prices are subject to change without prior notice.

Stack/Nesting

Strive® Nesting Chairs

MODEL	MODEL NUMBER							Approx. Packaged Weight
	Basic Model	Frame Color	Poly Seat & Back Color	Base	Tablet Arm Color	Fire Code	Upholstery Color	
 <p>Tablet Arm Chair with Poly Seat</p> <ul style="list-style-type: none"> Flex back Nests 	SNTAPRH	<input type="checkbox"/>	<input type="checkbox"/>	<input type="checkbox"/>	<input type="checkbox"/>	<input type="checkbox"/>		28.0#
	SNTAPLH	<input type="checkbox"/>	<input type="checkbox"/>	<input type="checkbox"/>	<input type="checkbox"/>	<input type="checkbox"/>		28.0#
 <p>Tablet Arm Chair with Upholstered Seat</p> <ul style="list-style-type: none"> Flex back Nests 	SNTAURH	<input type="checkbox"/>	<input type="checkbox"/>	<input type="checkbox"/>	<input type="checkbox"/>	<input type="checkbox"/>	<input type="checkbox"/>	28.0#
	SNTAULH	<input type="checkbox"/>	<input type="checkbox"/>	<input type="checkbox"/>	<input type="checkbox"/>	<input type="checkbox"/>	<input type="checkbox"/>	28.0#
 <p>Oversize Tablet Arm Chair with Poly Seat</p> <ul style="list-style-type: none"> Flex back Nests 	SNOVTAPRH	<input type="checkbox"/>	<input type="checkbox"/>	<input type="checkbox"/>	<input type="checkbox"/>	<input type="checkbox"/>		28.0#
	SNOVTAPLH	<input type="checkbox"/>	<input type="checkbox"/>	<input type="checkbox"/>	<input type="checkbox"/>	<input type="checkbox"/>		28.0#
 <p>Oversize Tablet Arm Chair with Upholstered Seat</p> <ul style="list-style-type: none"> Flex back Nests 	SNOVTaurH	<input type="checkbox"/>	<input type="checkbox"/>	<input type="checkbox"/>	<input type="checkbox"/>	<input type="checkbox"/>	<input type="checkbox"/>	28.0#
	SNOVTaulH	<input type="checkbox"/>	<input type="checkbox"/>	<input type="checkbox"/>	<input type="checkbox"/>	<input type="checkbox"/>	<input type="checkbox"/>	28.0#

A **B** **C** **D** **E** **F** **G**

HOW TO ORDER

Indicate the following information on order form:

- Quantity of each item.
- Model number, including options. See "How To Build a Model Number".
- Any special service required.

Note: • The indicates that a choice is required.

- The absence of the indicates that no choice is required.
- Alpha-numeric characters in place of indicate that no other alternatives are available.

HOW TO BUILD A MODEL NUMBER

- A** Select basic model.
- B** Select frame color.
Refer to color addendum at ki.com or KI Fabrics & Finishes binder.
- C** Select poly seat and back color
Refer to color addendum at ki.com or KI Fabrics & Finishes binder.
- D** Select base option.

G	- Bell glides (black only)
C	- Carpet casters (black only)
S	- Hard floor casters (black only)
- E** Select tablet arm color.
Refer to color addendum at ki.com or KI Fabrics & Finishes binder.
- F** Select fire code.

NFR	- Compliance to TB 117-2013
FR	- Compliance to TB 133
- G** Select upholstery grade/color.
Refer to color addendum at ki.com or KI Fabrics & Finishes binder.



Stack/Nesting

Strive® Nesting Chairs

Delivered Pricing	Delivered Pricing Fabric Grade 1 & C.O.M.	Delivered Pricing Fabric Grade 2	Delivered Pricing Fabric Grade 3	Delivered Pricing C.O.V.	Delivered Pricing Vinyl Group 2V	Delivered Pricing Pallas Fabric Group P0	Delivered Pricing Pallas Fabric Group P1	Delivered Pricing Pallas Fabric Group P2	Delivered Pricing Pallas Fabric Group P3	Delivered Pricing Pallas Fabric Group P4
-------------------	---	----------------------------------	----------------------------------	--------------------------	----------------------------------	--	--	--	--	--

\$ 578
578

N/A	\$ 637	\$ 663	\$ 674	\$ 637	\$ 674	\$ 673	\$ 710	\$ 728	\$ 750	\$ 766
N/A	637	663	674	637	674	673	710	728	750	766

\$ 637
637

N/A	\$ 696	\$ 721	\$ 734	\$ 696	\$ 734	\$ 731	\$ 768	\$ 788	\$ 809	\$ 825
N/A	696	721	734	696	734	731	768	788	809	825

UPHOLSTERY INFORMATION

C.O.M. Upholstery

C.O.M. requirement for 10 chairs or less with upholstered seat or upholstered seat and back is 3/4 yard per chair of 54" wide nondirectional fabric. For orders of 11 or more with upholstered seat and back and for complete information on ordering C.O.M. see "Ordering C.O.M., C.O.V. and C.O.L." section.

OPTIONS

California TB133 Fire Safety Code

The above seating products can be manufactured using the appropriate flame-retardant materials for compliance to California Technical Bulletin 133. No additional lead time.
Model=Polypropylene
Added list price=\$10
Model=Upholstered Seat
Added list price=\$68

SPECIAL SERVICES

Special Carton Marking

With specially marked information N/C



Shipping

Shipped **assembled freight prepaid f.o.b. Green Bay, Wisconsin 54302** factory. Freight class #125.

Specifications and prices are subject to change without prior notice.

Stack/Nesting

Strive® Nesting Chairs

		MODEL NUMBER								Approx. Packaged Weight
		Basic Model	Frame Color	Poly Seat & Back Color	Top Stitch Color	Base	Tablet Arm Color	TB133	Upholstery Color	
 <p>SNTS Tablet Arm Chair with Upholstered Seat with Top Stitch on Seat</p> <ul style="list-style-type: none"> • Flex back • Nests 	Uph Seat, Left Hand	SNTATSULH	<input type="checkbox"/>	<input type="checkbox"/>	<input type="checkbox"/>	<input type="checkbox"/>	<input type="checkbox"/>	<input type="checkbox"/>	<input type="checkbox"/>	28.0#
	Uph Seat, Right Hand	SNTATSURH	<input type="checkbox"/>	<input type="checkbox"/>	<input type="checkbox"/>	<input type="checkbox"/>	<input type="checkbox"/>	<input type="checkbox"/>	<input type="checkbox"/>	28.0#
 <p>SNTS Oversize Tablet Arm Chair with Upholstered Seat with Top Stitch on Seat</p> <ul style="list-style-type: none"> • Flex back • Nests 	Uph Seat, Left Hand	SNOVATSULH	<input type="checkbox"/>	<input type="checkbox"/>	<input type="checkbox"/>	<input type="checkbox"/>	<input type="checkbox"/>	<input type="checkbox"/>	28.0#	
	Uph Seat, Right Hand	SNOVATSURH	<input type="checkbox"/>	<input type="checkbox"/>	<input type="checkbox"/>	<input type="checkbox"/>	<input type="checkbox"/>	<input type="checkbox"/>	<input type="checkbox"/>	28.0#

A **B** **C** **D** **E** **F** **G** **H**

HOW TO ORDER

Indicate the following information on order form:

- Quantity of each item.
- Model number, including options. See "How To Build a Model Number".
- Any special service required.

Note: • The indicates that a choice is required.

- The absence of the indicates that no choice is required.
- Alpha-numeric characters in place of indicate that no other alternatives are available.

HOW TO BUILD A MODEL NUMBER

A Select basic model.

B Select frame color.
Refer to color addendum at ki.com or KI Fabrics & Finishes binder.

C Select poly seat and back color
Refer to color addendum at ki.com or KI Fabrics & Finishes binder.

D Select top stitch color.
BLTS - Black
WHTS - White

E Select base option.
G - Bell glides (black only)
C - Carpet casters (black only)
S - Hard floor casters (black only)

F Select tablet arm color.
Refer to color addendum at ki.com or KI Fabrics & Finishes binder.

G Select fire code.

NFR - Compliance to TB 117-2013
FR - Compliance to TB 133

H Select upholstery grade/color.
Refer to color addendum at ki.com or KI Fabrics & Finishes binder.



Delivered
Pricing
Pallas Fabric
Group P1

\$ 750
750

\$ 809
809

UPHOLSTERY INFORMATION

C.O.M. Upholstery

C.O.M. requirement for 10 chairs or less with upholstered seat or upholstered seat and back is 3/4 yard per chair of 54" wide nondirectional fabric. For orders of 11 or more with upholstered seat and back and for complete information on ordering C.O.M. see "Ordering C.O.M., C.O.V. and C.O.L." section.

OPTIONS

California TB133 Fire Safety Code

The above seating products can be manufactured using the appropriate flame-retardant materials for compliance to California Technical Bulletin 133. No additional lead time.
Model=Polypropylene
Added list price=\$10
Model=Upholstered Seat
Added list price=\$68

SPECIAL SERVICES

Special Carton Marking

With specially marked information N/C

Shipping

Shipped **assembled freight prepaid f.o.b. Green Bay, Wisconsin 54302** factory. Freight class #125.

Specifications and prices are subject to change without prior notice.

Stack/Nesting

Torsion® on the Go® General Information



**Upholstered Back Armchair
(TGWAUB)**



**Armless Upholstered Back Chair
(TGNAUB)**



**Poly Back Armchair
(TGWAPB)**

Features

Back flex	•	•	•
Flip-up seat	•	•	•
Nesting	•	•	•
Casters	•	•	•

General Dimensions

Seat width	17-1/4"	17-1/4"	17-1/4"
Seat depth	18-1/2"	18-1/2"	18-1/2"
Seat height	18"	18"	18"
Back width	18-1/4"	18-1/4"	18-1/4"
Back height	14"	14"	14"

Overall Dimensions

Width	23-1/2"	23-1/2"	23-1/2"
Depth	24-1/4"	24-1/4"	24-1/4"
Height	32-1/4"	32-1/4"	32-1/4"
Top of arm to floor	24-1/4"		24-1/4"
Nesting (two chairs)	24" x 24"	24" x 24"	24" x 24"

(Each additional chair - add 5")



Arm



Caster



Back Handle

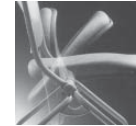

Flip-up Seat

SPECIFICATIONS

Seat and Backrest

Seat is two-piece construction of molded plywood upholstery board with a molded compound curved nylon shroud with a textured finish. Seat is always upholstered. Foam (1-3/4") is applied to the molded plywood upholstery board. Fabric is then upholstered over the foam. Backrest is available in either a polypropylene or upholstered version. Backrest is molded compound curved polypropylene with a textured finish. Backrest has an integral, molded "handle."

Back upholstery liner is molded polypropylene with glued-on foam (1/2"). Fabric is upholstered over the foam. The liner is secured to the backrest by four #10 color-matched machine screws.

Seat flips up to allow chairs to nest for storage and transport.

Backrest Supports

Two welded steel backrest supports attach the backrest to the torsion mechanism.

Torsion® Mechanism

The back flex is achieved by the torsion mechanism. It consists of two flat torsion springs captured at both ends by steel bushings that are welded to the backrest supports. The torsion mechanism creates gradually increasing resistance over the full 12° of back flex.

Frame

The frame is made up of four legs welded to a steel mechanism tube. The legs are 1", 13-gauge steel tubing. Reinforcement plates are welded between front and back legs for added strength. Nylon covers fit over the plates.

Arms

Armrests are made of nylon and match the seat and back poly color. Armrests rotate with the back.

Leg Finishes

Baked-on electrostatically-applied epoxy powder coating or bright nickel-chrome plating.

Casters/Glides

Double wheels (60mm) of high-impact thermoplastic. High-impact plastic frame. Carpet and hard floor casters are always black. Bell glide (2" high) made of high-impact plastic also available, black only.

Tablet/Tablet Arm

The tablet is available in a plywood core (5/8" thick, 11-ply hardwood surfaced with .030" high-pressure laminate top and plain backer undersurface) or a black molded polyethylene. It is connected to the mechanism and supported by a 12-gauge steel plate. It has an effective working surface 12" deep by 22" across. The tablet arm is not field addable. The tablet arm is available in right-hand and left-hand versions. The tablet mechanism consists of aluminum die

cast housings and through bolted pivots with bushings on two axis. The mechanism allows for horizontal rotation for ingress/egress without stowing the tablet. The mechanism stows the tablet so that the chair will nest with other Torsion® on the Go!® chairs with tablets and Torsion® on the Go!® chairs without tablet or arms.

INFORMATION

C.O.M. Testing and Production Requirements

Not all materials are suitable for upholstering this product. A 1 yd. x 54" sample must be submitted and approved prior to acceptance of an order. If the fabric is directional in pattern or weave, the direction must be indicated on the submitted sample, and additional yardage may be requested.

Test samples must be sent to:



**Armless Poly Back Chair
(TGNAPB)**



**Poly Back Tablet Arm Chair
(TGTARPB)**

Features		
Back flex	•	•
Flip-up seat	•	•
Nesting	•	•
Casters	•	•
General Dimensions		
Seat width	17-1/4"	17-1/4"
Seat depth	18-1/2"	18-1/2"
Seat height	18"	18"
Back width	18-14"	18-1/4"
Back height	14"	14"
Overall Dimensions		
Width	23-1/2"	27"
Depth	24-1/4"	31"
Height	32-1/4"	32-1/4"
Top of arm to floor		29"
Nesting (two chairs)	24" x 24"	24" x 24"

(Each additional chair - add 5")

KI
Attn: C.O.M. Specialist
1687 Westminster Drive - Gate 3
Green Bay, WI 54302

Fabric Disclaimer

Fabric will be applied as swatched by the fabric manufacturer. Fabric that is required to be applied differently than is swatched will need a Special Cost Request written specifying the direction the fabric is to be applied. The posted standard lead time will apply to the Special Cost Request.

Design

Designed by Giancarlo Piretti and manufactured in the USA by Krueger International, Inc. under license from Pro-Cord S.p.A.





INFORMATION

Warranty

Refer to KI Terms & Conditions document or visit ki.com

Stack/Nesting

Torsion® on the Go® Nesting Chairs

MODEL	MODEL NUMBER						Approx. Packaged Weight	Delivered Pricing Fabric Grade 1 & C.O.M.
	Basic Model	Frame Color	Seat & Back Color	Base	Upholstery Color	Fire Code		
 <p>Armless Chair with Poly Back</p> <ul style="list-style-type: none"> • Flex back • Flip-up seat • Nests • Casters or glides 	TGNAPB	<input type="checkbox"/>	<input type="checkbox"/>	<input type="checkbox"/>	<input type="checkbox"/>	<input type="checkbox"/>	32.0#	\$ 634
TGU								
 <p>Armless Chair with Upholstered Back</p> <ul style="list-style-type: none"> • Flex back • Flip-up seat • Nests • Casters or glides 	TGNAUB	<input type="checkbox"/>	<input type="checkbox"/>	<input type="checkbox"/>	<input type="checkbox"/>	<input type="checkbox"/>	33.0#	\$ 677
TGU								
 <p>Armchair with Poly Back</p> <ul style="list-style-type: none"> • Flex back • Flip-up seat • Nests • Casters or glides 	TGWAPB	<input type="checkbox"/>	<input type="checkbox"/>	<input type="checkbox"/>	<input type="checkbox"/>	<input type="checkbox"/>	33.0#	\$ 663
TGU								
 <p>Armchair with Upholstered Back</p> <ul style="list-style-type: none"> • Flex back • Flip-up seat • Nests • Casters or glides 	TGWAUB	<input type="checkbox"/>	<input type="checkbox"/>	<input type="checkbox"/>	<input type="checkbox"/>	<input type="checkbox"/>	35.0#	\$ 705
TGU								

A **B** **C** **D** **E** **F**

HOW TO ORDER

Indicate the following information on order form:

1. Quantity of each item.
2. Model number, including options. See "How To Build a Model Number".
3. Any special service required.

Note:

- The indicates that a choice is required.
- The absence of the indicates that no choice is required.
- Alpha-numeric characters in place of indicate that no other alternatives are available.

HOW TO BUILD A MODEL NUMBER

A Select basic model.

B Select frame color.
Refer to color addendum at ki.com or KI Fabrics & Finishes binder.
The metal back support matches the frame color.

C Select seat and back color.
Refer to color addendum at ki.com or KI Fabrics & Finishes binder.
Armrest color will match seat/back poly color.

D Select base option.

G	- Bell glides (black only)
C	- Carpet casters (black only)
S	- Hard floor casters (black only)

E Select upholstery grade/color.
Refer to color addendum at ki.com or KI Fabrics & Finishes binder.

F Select fire code.

NFR	- Compliance to TB 117-2013
FR	- Compliance to TB 133



Stack/Nesting

Torsion® on the Go® Nesting Chairs

Delivered Pricing Fabric Grade 2	Delivered Pricing Fabric Grade 3	Delivered Pricing Vinyl Group 2V	Delivered Pricing Pallas Fabric Group P0	Delivered Pricing Pallas Fabric Group P1	Delivered Pricing Pallas Fabric Group P2	Delivered Pricing Pallas Fabric Group P3	Delivered Pricing Pallas Fabric Group P4
\$ 647	\$ 663	\$ 663	\$ 658	\$ 668	\$ 701	\$ 727	\$ 757
\$ 692	\$ 706	\$ 706	\$ 701	\$ 712	\$ 744	\$ 769	\$ 801
\$ 677	\$ 691	\$ 691	\$ 687	\$ 698	\$ 724	\$ 755	\$ 783
\$ 719	\$ 733	\$ 733	\$ 731	\$ 742	\$ 769	\$ 798	\$ 826

UPHOLSTERY INFORMATION

C.O.M. Upholstery

C.O.M. requirement for 10 chairs either poly or upholstered is 3/4 yard of 54" wide nondirectional fabric. For orders of 11 of more chairs and for complete information on ordering C.O.M., see "Ordering C.O.M., C.O.V. and C.O.L. section."

OPTIONS

California TB133 Fire Safety Code

For California Technical Bulletin 133 compliant models, add the following upcharge:

Model=Polypropylene Back
 Added Lead Time=1 week
 Added list price=\$48
 Model=Upholstered Seat/Back
 Added Lead Time=1 week
 Added list price=\$74

SPECIAL SERVICES

Special Carton Marking

With specially marked information N/C



Shipping

Shipped **assembled freight prepaid f.o.b. Green Bay, Wisconsin 54302** factory. Freight class #125.

Specifications and prices are subject to change without prior notice.

Stack/Nesting

Torsion® on the Go® Nesting Chairs

	MODEL	Features	MODEL NUMBER							Approx. Packaged Weight	
			Basic Model	Surface Type	Frame Color	Seat & Back Color	Surface Finish/Plastic Color	Base	Upholstery Color		
 <p>TGU</p>	Tablet Arm Chair with Poly Back	<ul style="list-style-type: none"> • Flex back • Flip-up seat • Nests • Casters or glides • The tablet is available in right-hand and left-hand versions 	Left Hand	TGTALPB	<input type="checkbox"/>	<input type="checkbox"/>	<input type="checkbox"/>	<input type="checkbox"/>	<input type="checkbox"/>	<input type="checkbox"/>	30.0#
			Right Hand	TGTARPB	<input type="checkbox"/>	<input type="checkbox"/>	<input type="checkbox"/>	<input type="checkbox"/>	<input type="checkbox"/>	<input type="checkbox"/>	30.0#
 <p>TGU</p>	Tablet Arm Chair with Upholstered Back	<ul style="list-style-type: none"> • Flex back • Flip-up seat • Nests • Casters or glides • The tablet is available in right-hand and left-hand versions 	Left Hand	TGTALUB	<input type="checkbox"/>	<input type="checkbox"/>	<input type="checkbox"/>	<input type="checkbox"/>	<input type="checkbox"/>	<input type="checkbox"/>	31.0#
			Right Hand	TGTARUB	<input type="checkbox"/>	<input type="checkbox"/>	<input type="checkbox"/>	<input type="checkbox"/>	<input type="checkbox"/>	<input type="checkbox"/>	31.0#

A **B** **C** **D** **E** **F** **G**

HOW TO ORDER

Indicate the following information on order form:

1. Quantity of each item.
2. Model number, including options. See "How To Build a Model Number".
3. Any special service required.

Note:

- The indicates that a choice is required.
- The absence of the indicates that no choice is required.
- Alpha-numeric characters in place of indicate that no other alternatives are available.

HOW TO BUILD A MODEL NUMBER

- A** Select basic model.
- B** Select worksurface type.
 - LW** - Laminate worksurface; add \$56
 - PW** - Plastic worksurface
- C** Select frame color. Refer to color addendum at ki.com or KI Fabrics & Finishes binder.
- D** Select seat and back color. Refer to color addendum at ki.com or KI Fabrics & Finishes binder. Armrest color will match seat/back poly color.
- E** Select surface finish. Refer to color addendum at ki.com or KI Fabrics & Finishes binder.
- F** Select base option.
 - G** - Bell glides (black only)
 - C** - Carpet casters (black only)
 - S** - Hard floor casters (black only)
- G** Select upholstery grade/color. Refer to color addendum at ki.com or KI Fabrics & Finishes binder.



Delivered Pricing Fabric Grade 1 & C.O.M.	Delivered Pricing Fabric Grade 2	Delivered Pricing Fabric Grade 3	Delivered Pricing Vinyl Group 2V	Delivered Pricing Pallas Fabric Group P0	Delivered Pricing Pallas Fabric Group P1	Delivered Pricing Pallas Fabric Group P2	Delivered Pricing Pallas Fabric Group P3	Delivered Pricing Pallas Fabric Group P4
\$ 940	\$ 953	\$ 969	\$ 969	\$ 965	\$ 976	\$ 1008	\$ 1034	\$ 1064
940	953	969	969	965	976	1008	1034	1064

\$ 983	\$ 996	\$ 1012	\$ 1012	\$ 1006	\$ 1018	\$ 1049	\$ 1074	\$ 1105
983	996	1012	1012	1006	1018	1049	1074	1105

UPHOLSTERY INFORMATION

C.O.M. Upholstery

C.O.M. requirement for 10 chairs either poly or upholstered is 3/4 yard of 54" wide nondirectional fabric. For orders of 11 of more chairs and for complete information on ordering C.O.M., see "Ordering C.O.M., C.O.V. and C.O.L." section.

SPECIAL SERVICES

Special Carton Marking

With specially marked information N/C

Shipping

Shipped **assembled freight prepaid f.o.b. Green Bay, Wisconsin 54302** factory. Freight class #125.

Specifications and prices are subject to change without prior notice.

Stack/Nesting

Torsion® General Information



Cantilevered Sled Base Armchair (TCFAP)



Full Sled Base Chair (TSNAU)



Four-Leg Armchair (TLFAU)



Transport Dolly (TVD and TLD Dolly)

Features

Stackable

General Dimensions

Seat width	18"	18"	18"
Seat depth	18"	18"	18"
Seat height	17-3/8"	17-3/8"	17-7/8"
Back width	17-7/8"	17-7/8"	17-7/8"
Back height	14-3/4"	15-1/4"	15-1/4"

Overall Dimensions

Width	19" No Arm/24" Arm	21" No Arm	20" No Arm/24" Arm	22-1/2"
Depth	23-1/4"	22-3/4"	23-1/4"	25-1/2"
Height	33"	32-3/4"	32-3/4"	12"
Top of arm to floor	25-5/8"		25-5/8"	

Stacking on Dolly

Quantity/height	6 Chairs/50" High No Arm	5 Chairs/52" High No Arm & Arm
Floor space (no arms)	21" x 29"	24" x 32"
Floor space (arms)		25" x 32"

Stacking on Floor

Quantity/height	4 Chairs/43" High No Arm & Arm	5 Chairs/44" High No Arm	5 Chairs/47" High No Arm & Arm
Floor space (no arms)	20" x 27"	21" x 28"	20" x 30"
Floor space (arms)	24" x 27"		24" x 30"



Standard Flip-Up Tablet Arm



G2-Tablet Arm (Down)
(only on TS and TL frames)



G2-Tablet Arm (Up)
(only on TS and TL frames)



Cantilevered Arm

SPECIFICATIONS

Seat and Backrest

Seats and backrests are molded compound curved polypropylene with a textured finish. Seat is two-piece construction. Upholstered chairs have partially exposed polypropylene surfaces. Fabric is upholstered over 9/16" foam on the backrest and 5/16" foam on the seat.

Backrest Supports

Two die-cast aluminum backrest supports attach the backrest to the Torsion® mechanism. A steel tube is cast into each backrest support for added strength.

Torsion® Mechanism

The back flex is achieved by the Torsion® mechanism. It consists of two flat torsion springs captured at both ends by steel bushings which in turn engage with the backrest supports. The Torsion® mechanism creates gradually-increasing resistance over the full 12° of back flex.

Full Sled Base Frame (TS)

The sled base frame consists of two segments of 3/4", 16-gauge seam-welded tubular steel and two steel seat supports.

Cantilevered Sled Base Frame (TC)

The cantilevered sled frame consists of one continuous segment of 1", 14-gauge seam-welded tubular steel with reinforced bends.

Four-Leg Frame (TL)

The four-leg frame consists of two U-shaped sections, one front and one rear, welded together with two support brackets to form the four-leg chair. The sections are formed of 15/16", 15-gauge seam-welded tubular steel.

Cantilevered Arm (TC, TS, TL Chairs)

Fiberglass-reinforced nylon; color permeates armrest. Arms flex with the back. Not field-installable.

Leg Finishes

Baked-on, electrostatically-applied epoxy powder coating, or bright nickel-chrome plating.

Standard Flip-Up Tablet Arm

Plywood core tablet with high-pressure laminate surface. The edge is black laminate, otherwise clear lacquer. Tablet arm support matches frame color. Tablet is 19-1/2" long and 12-3/4" wide.

Fold-Down, G2-Tablet Arm

Only available on TS and TL frames. Tablet is constructed of plywood core with high-pressure laminate surface and a clear lacquered edge. Tablet arm support matches frame color (hinge is always black). The tablet is 18" long and 13-3/4" wide. 4" of clearance is needed behind chair to allow table to fold away. Nonstacking.

Transport Dolly

Tubular and plate steel welded together. 5" casters: two fixed, two swivel. Powder-

coated finish.

Stacking Vinyl, Polyurethane, and Imitation Leather Upholstered Chairs

It is recommended that chairs to be stacked be covered in material other than vinyl, polyurethane, or imitation leather as an impression in the seat may result. KI does not warrant the effects of stacking on stock or C.O.M. vinyl, polyurethane, or imitation leather upholstery.

INFORMATION

C.O.M Testing and Production Requirements

Not all materials are suitable for upholstering this product. A 3/4 yd. x 54" sample must be submitted and approved prior to acceptance of an order. If the fabric is directional in pattern or weave, the direction must be indicated on the submitted sample, and additional yardage may be requested.



**Full Sled Base G2-Tablet
Arm Chair (TSG2ARU)**

**Four-Leg Tablet Arm Chair
25-5/8"**

Features		
Stackable		
General Dimensions		
Seat width	18"	18"
Seat depth	18"	18"
Seat height	17-3/8"	17-3/8"
Back width	17-7/8"	17-7/8"
Back height	15-1/4"	15-1/4"
Overall Dimensions		
Width	21"	21"
Depth	22-3/4"	22-3/4"
Height	32-3/4"	32-3/4"
Top of arm to floor	25-5/8"	25-5/8"
Stacking on Floor		
Quantity/height		4 Chairs/47-1/2" High
Floor space (arms)		28-1/2" x 35-1/2"

Test samples must be sent to:

KI
Attn: C.O.M. Specialist
1687 Westminster Drive - Gate 3
Green Bay, WI 54302

Fabric Disclaimer

Fabric will be applied as swatched by the fabric manufacturer. Fabric that is required to be applied differently than is swatched will need a Special Cost Request written specifying the direction the fabric is to be applied. The posted standard lead time will apply to the Special Cost Request.

Design



Designed by Giancarlo Piretti and manufactured in the USA by Krueger International, Inc. under license from Pro-Cord S.p.A.

INFORMATION

Warranty

Refer to KI Terms & Conditions document or visit ki.com

Stack/Nesting Torsion®

	MODEL	Features	MODEL NUMBER						Approx. Packaged Weight
			Basic Model	Frame Color	Seat & Back Color	Armrest Color	Upholstery Color	Fire Code	
	Cantilevered Sled Base Chair	Polypropylene	TCNAP	<input type="checkbox"/> <input type="checkbox"/>	<input type="checkbox"/> <input type="checkbox"/> <input type="checkbox"/>			<input type="checkbox"/> <input type="checkbox"/>	24.0#
		Upholstered	TCNAU	<input type="checkbox"/> <input type="checkbox"/>	<input type="checkbox"/> <input type="checkbox"/> <input type="checkbox"/>		<input type="checkbox"/> <input type="checkbox"/> <input type="checkbox"/> <input type="checkbox"/> <input type="checkbox"/> <input type="checkbox"/>	<input type="checkbox"/> <input type="checkbox"/>	25.0#
TCP TCU									
	Cantilevered Sled Base Armchair	Polypropylene	TCFAP	<input type="checkbox"/> <input type="checkbox"/>	<input type="checkbox"/> <input type="checkbox"/> <input type="checkbox"/>	<input type="checkbox"/> <input type="checkbox"/> <input type="checkbox"/>		<input type="checkbox"/> <input type="checkbox"/>	25.0#
		Upholstered	TCFAU	<input type="checkbox"/> <input type="checkbox"/>	<input type="checkbox"/> <input type="checkbox"/> <input type="checkbox"/>	<input type="checkbox"/> <input type="checkbox"/> <input type="checkbox"/>	<input type="checkbox"/> <input type="checkbox"/> <input type="checkbox"/> <input type="checkbox"/> <input type="checkbox"/> <input type="checkbox"/>	<input type="checkbox"/> <input type="checkbox"/>	26.0#
TCP TCU									
				A	B	C	D	E	F

HOW TO ORDER

Indicate the following information on order form:

- Quantity of each item.
- Model number, including options. See "How To Build a Model Number".
- Any special service required.

Note:

- The indicates that a choice is required.
- The absence of the indicates that no choice is required.
- Alpha-numeric characters in place of indicate that no other alternatives are available.

HOW TO BUILD A MODEL NUMBER

- A** Select basic model.
- B** Select frame color.
Refer to color addendum at ki.com or KI Fabrics & Finishes binder.
The metal back support matches the frame color.
When Hammertone or chrome frames are specified, back support matches seat and back color.
The arm support and tablet arm support match the frame color.
- C** Select seat and back color.
Refer to color addendum at ki.com or KI Fabrics & Finishes binder.
- D** Select armrest color.
- E** Select upholstery grade/color.
Refer to color addendum at ki.com or KI Fabrics & Finishes binder.

- F** Select fire code.
FR - Compliance to TB 133
NFR - Compliance to TB 117-2013

UPHOLSTERY INFORMATION

C.O.M. Upholstery
C.O.M. requirement for 10 chairs or less is 3/4 yard per chair of 54" wide nondirectional fabric. For orders of 11 or more chairs and for complete information on ordering C.O.M., see "Ordering C.O.M., C.O.V. and C.O.L." section.



Delivered Pricing Unupholstered	Delivered Pricing Fabric Grade 1 & C.O.M.	Delivered Pricing Fabric Grade 2	Delivered Pricing Fabric Grade 3	Delivered Pricing Vinyl Group 2V	Delivered Pricing Pallas Fabric Group P0	Delivered Pricing Pallas Fabric Group P1	Delivered Pricing Pallas Fabric Group P2	Delivered Pricing Pallas Fabric Group P3	Delivered Pricing Pallas Fabric Group P4
\$ 284									
N/A	483	526	535	535	489	500	522	545	565
\$ 433									
N/A	631	672	682	682	633	644	668	691	713

OPTIONS

California TB133 Fire Safety Code

For California Technical Bulletin 133 compliant models, add the following upcharge:

Model=Polypropylene
 Added Lead Time=1 week
 Added list price=\$71
 Model=Upholstered
 Added Lead Time=1 week
 Added list price=\$79

Glides

For cantilevered sled base glides, add "/GBL" to end of model number. Glides are nylon (plastic). List price upcharge is \$34.

INFORMATION

Note:

Torsion® in 2V Vinyl with FR requires a customer waiver since addition of the FR fire barrier to the upholstery detracts from the aesthetics of the chair.

SPECIAL SERVICES

Special Carton Marking

With specially marked information N/C



Shipping

Shipped **assembled freight prepaid f.o.b. Green Bay, Wisconsin 54302** factory. Freight class #125.

Specifications and prices are subject to change without prior notice.

Stack/Nesting

Torsion®

	MODEL	Features	MODEL NUMBER							Approx. Packaged Weight	
			Basic Model	Frame Color	Seat & Back Color	Armrest Color	Glide Option	Upholstery Color	Fire Code		
	Four-Leg Chair	Polypropylene	TLNAP	<input type="checkbox"/>	<input type="checkbox"/>			<input type="checkbox"/>		<input type="checkbox"/>	22.0#
	<ul style="list-style-type: none"> • Flex back • No arm • Stacking • Glide is plastic and standard 	Upholstered	TLNAU	<input type="checkbox"/>	<input type="checkbox"/>			<input type="checkbox"/>	<input type="checkbox"/>	<input type="checkbox"/>	<input type="checkbox"/>
TLP											
TLU											
	Four-Leg Armchair	Polypropylene	TLFAP	<input type="checkbox"/>	<input type="checkbox"/>	<input type="checkbox"/>	<input type="checkbox"/>	<input type="checkbox"/>		<input type="checkbox"/>	23.0#
	<ul style="list-style-type: none"> • Flex back • Stacking • Glide is plastic and standard 	Upholstered	TLFAU	<input type="checkbox"/>	<input type="checkbox"/>	<input type="checkbox"/>	<input type="checkbox"/>	<input type="checkbox"/>	<input type="checkbox"/>	<input type="checkbox"/>	25.0#
TLP											
TLU											

A **B** **C** **D** **E** **F** **G**

HOW TO ORDER

Indicate the following information on order form:

1. Quantity of each item.
2. Model number, including options. See "How To Build a Model Number".
3. Any special service required.

Note: • The indicates that a choice is required.
 • The absence of the indicates that no choice is required.
 • Alpha-numeric characters in place of indicate that no other alternatives are available.

HOW TO BUILD A MODEL NUMBER

- A** Select basic model.
- B** Select frame color.
 Refer to color addendum at ki.com or KI Fabrics & Finishes binder.
 The metal back support matches the frame color.
 When Hammertone or chrome frames are specified, back support matches seat and back color.
 The arm support and tablet arm support match the frame color.
- C** Select seat and back color.
 Refer to color addendum at ki.com or KI Fabrics & Finishes binder.
- D** Select armrest color.
- E** Select glide option.
 P - Plastic glides
 S - Stainless steel glides

- F** Select upholstery grade/color.
 Refer to color addendum at ki.com or KI Fabrics & Finishes binder.

- G** Select fire code.
 FR - Compliance to TB 133
 NFR - Compliance to TB 117-2013

UPHOLSTERY INFORMATION

C.O.M. Upholstery

C.O.M. requirement for 10 chairs or less is 3/4 yard per chair of 54" wide nondirectional fabric. For orders of 11 or more chairs and for complete information on ordering C.O.M., see "Ordering C.O.M., C.O.V. and C.O.L." section.



Delivered Pricing Unupholstered	Delivered Pricing Fabric Grade 1 & C.O.M.	Delivered Pricing Fabric Grade 2	Delivered Pricing Fabric Grade 3	Delivered Pricing Vinyl Group 2V	Delivered Pricing Pallas Fabric Group P0	Delivered Pricing Pallas Fabric Group P1	Delivered Pricing Pallas Fabric Group P2	Delivered Pricing Pallas Fabric Group P3	Delivered Pricing Pallas Fabric Group P4
\$ 284									
N/A	483	526	535	535	489	500	522	545	565
\$ 433									
N/A	631	672	682	682	633	644	668	691	713

OPTIONS

California TB133 Fire Safety Code

For California Technical Bulletin 133 compliant models, add the following upcharge:

- Model=Polypropylene
- Added Lead Time=1 week
- Added list price=\$71
- Model=Upholstered
- Added Lead Time=1 week
- Added list price=\$79

INFORMATION

Note:

Torsion in 2V Vinyl with FR requires a customer waiver since addition of the FR fire barrier to the upholstery detracts from the aesthetics of the chair.

SPECIAL SERVICES

Special Carton Marking



With specially marked information N/C

Shipping

Shipped **assembled freight prepaid f.o.b. Green Bay, Wisconsin 54302** factory. Freight class #125.

Specifications and prices are subject to change without prior notice.

Stack/Nesting Torsion®

MODEL	Features	MODEL NUMBER						
		Basic Model	Frame Color	Seat & Back Color	Tablet Arm Color	Glide Option	Upholstery Color	Fire Code
 <p>Four-Leg Tablet Arm Chair</p> <ul style="list-style-type: none"> • Flex back • Stacking • Glide is plastic and standard • Flip-up tablet 	Polypropylene, Left Hand	TLTALP	<input type="checkbox"/> <input type="checkbox"/>	<input type="checkbox"/> <input type="checkbox"/> <input type="checkbox"/>	<input type="checkbox"/> <input type="checkbox"/> <input type="checkbox"/>	<input type="checkbox"/>		<input type="checkbox"/> <input type="checkbox"/>
	Polypropylene, Right Hand	TLTARP	<input type="checkbox"/> <input type="checkbox"/>	<input type="checkbox"/> <input type="checkbox"/> <input type="checkbox"/>	<input type="checkbox"/> <input type="checkbox"/> <input type="checkbox"/>	<input type="checkbox"/>		<input type="checkbox"/> <input type="checkbox"/>
	Upholstered, Left Hand	TLTALU	<input type="checkbox"/> <input type="checkbox"/>	<input type="checkbox"/> <input type="checkbox"/> <input type="checkbox"/>	<input type="checkbox"/> <input type="checkbox"/> <input type="checkbox"/>	<input type="checkbox"/>	<input type="checkbox"/> <input type="checkbox"/> <input type="checkbox"/> <input type="checkbox"/> <input type="checkbox"/> <input type="checkbox"/>	<input type="checkbox"/> <input type="checkbox"/>
	Upholstered, Right Hand	TLTARU	<input type="checkbox"/> <input type="checkbox"/>	<input type="checkbox"/> <input type="checkbox"/> <input type="checkbox"/>	<input type="checkbox"/> <input type="checkbox"/> <input type="checkbox"/>	<input type="checkbox"/>	<input type="checkbox"/> <input type="checkbox"/> <input type="checkbox"/> <input type="checkbox"/> <input type="checkbox"/> <input type="checkbox"/>	<input type="checkbox"/> <input type="checkbox"/>
 <p>Four-Leg G2-Tablet Arm Chair</p> <ul style="list-style-type: none"> • Flex back • NONSTACKING • Glide is plastic and standard • Fold-down tablet 	Polypropylene, Left Hand	TLG2ALP	<input type="checkbox"/> <input type="checkbox"/>	<input type="checkbox"/> <input type="checkbox"/> <input type="checkbox"/>	<input type="checkbox"/> <input type="checkbox"/> <input type="checkbox"/>	<input type="checkbox"/>		<input type="checkbox"/> <input type="checkbox"/>
	Polypropylene, Right Hand	TLG2ARP	<input type="checkbox"/> <input type="checkbox"/>	<input type="checkbox"/> <input type="checkbox"/> <input type="checkbox"/>	<input type="checkbox"/> <input type="checkbox"/> <input type="checkbox"/>	<input type="checkbox"/>		<input type="checkbox"/> <input type="checkbox"/>
	Upholstered, Left Hand	TLG2ALU	<input type="checkbox"/> <input type="checkbox"/>	<input type="checkbox"/> <input type="checkbox"/> <input type="checkbox"/>	<input type="checkbox"/> <input type="checkbox"/> <input type="checkbox"/>	<input type="checkbox"/>	<input type="checkbox"/> <input type="checkbox"/> <input type="checkbox"/> <input type="checkbox"/> <input type="checkbox"/> <input type="checkbox"/>	<input type="checkbox"/> <input type="checkbox"/>
	Upholstered, Right Hand	TLG2ARU	<input type="checkbox"/> <input type="checkbox"/>	<input type="checkbox"/> <input type="checkbox"/> <input type="checkbox"/>	<input type="checkbox"/> <input type="checkbox"/> <input type="checkbox"/>	<input type="checkbox"/>	<input type="checkbox"/> <input type="checkbox"/> <input type="checkbox"/> <input type="checkbox"/> <input type="checkbox"/> <input type="checkbox"/>	<input type="checkbox"/> <input type="checkbox"/>

A **B** **C** **D** **E** **F** **G**

HOW TO ORDER

Indicate the following information on order form:

1. Quantity of each item.
2. Model number, including options. See "How To Build a Model Number".
3. Any special service required.

Note: • The indicates that a choice is required.
 • The absence of the indicates that no choice is required.
 • Alpha-numeric characters in place of indicate that no other alternatives are available.

HOW TO BUILD A MODEL NUMBER

- A** Select basic model.
- B** Select frame color.
Refer to color addendum at ki.com or KI Fabrics & Finishes binder.
The metal back support matches the frame color.
When Hammertone or chrome frames are specified, back support matches seat and back color.
The arm support and tablet arm support match the frame color.
- C** Select seat and back color.
Refer to color addendum at ki.com or KI Fabrics & Finishes binder.
- D** Select tablet arm color.
Refer to color addendum at ki.com or KI Fabrics & Finishes binder.
- E** Select glide option.
P - Plastic glides

S - Stainless steel glides

- F** Select upholstery grade/color.
Refer to color addendum at ki.com or KI Fabrics & Finishes binder.
- G** Select fire code.
FR - Compliance to TB 133
NFR - Compliance to TB 117-2013

UPHOLSTERY INFORMATION

C.O.M. Upholstery
 C.O.M. requirement for 10 chairs or less is 3/4 yard per chair of 54" wide nondirectional fabric. For orders of 11 or more chairs and for complete information on ordering C.O.M., see "Ordering C.O.M., C.O.V. and C.O.L." section.



Approx. Packaged Weight	Delivered Pricing Unupholstered	Delivered Pricing Fabric Grade 1 & C.O.M.	Delivered Pricing Fabric Grade 2	Delivered Pricing Fabric Grade 3	Delivered Pricing Vinyl Group 2V	Delivered Pricing Pallas Fabric Group P0	Delivered Pricing Pallas Fabric Group P1	Delivered Pricing Pallas Fabric Group P2	Delivered Pricing Pallas Fabric Group P3	Delivered Pricing Pallas Fabric Group P4
32.0#	\$ 482									
32.0#	482									
34.0#	N/A	681	721	729	729	685	696	717	740	761
34.0#	N/A	681	721	729	729	685	696	717	740	761

32.0#	\$ 572									
32.0#	572									
34.0#	N/A	769	809	817	817	770	781	806	827	848
34.0#	N/A	769	809	817	817	770	781	806	827	848

OPTIONS

California TB133 Fire Safety Code

For California Technical Bulletin 133 compliant models, add the following upcharge:

- Model=Polypropylene
- Added Lead Time=1 week
- Added list price=\$71
- Model=Upholstered
- Added Lead Time=1 week
- Added list price=\$79

INFORMATION

Note:

Torsion® in 2V Vinyl with FR requires a customer waiver since addition of the FR fire barrier to the upholstery detracts from the aesthetics of the chair.

SPECIAL SERVICES

Special Carton Marking



With specially marked information N/C

Shipping

Shipped **assembled freight prepaid f.o.b. Green Bay, Wisconsin 54302** factory. Freight class #125.

Specifications and prices are subject to change without prior notice.

Stack/Nesting Torsion®

	MODEL	Features	MODEL NUMBER						Approx. Packaged Weight	
			Basic Model	Frame Color	Seat & Back Color	Armrest Color	Upholstery Color	Fire Code		
	Full Sled Base Chair	<ul style="list-style-type: none"> Flex back No arm Stacks Glide is an option 	Polypropylene	TSNAP	<input type="checkbox"/> <input type="checkbox"/>	<input type="checkbox"/> <input type="checkbox"/> <input type="checkbox"/>			<input type="checkbox"/> <input type="checkbox"/>	22.0#
			Upholstered	TSNAU	<input type="checkbox"/> <input type="checkbox"/>	<input type="checkbox"/> <input type="checkbox"/> <input type="checkbox"/>		<input type="checkbox"/> <input type="checkbox"/> <input type="checkbox"/> <input type="checkbox"/> <input type="checkbox"/> <input type="checkbox"/>	<input type="checkbox"/> <input type="checkbox"/>	24.0#
TSP										
TSU										
	Full Sled Base Armchair	<ul style="list-style-type: none"> Flex back NONSTACKING Glide is an option 	Polypropylene	TSFAP	<input type="checkbox"/> <input type="checkbox"/>	<input type="checkbox"/> <input type="checkbox"/> <input type="checkbox"/>	<input type="checkbox"/> <input type="checkbox"/>		<input type="checkbox"/> <input type="checkbox"/>	23.0#
			Upholstered	TSFAU	<input type="checkbox"/> <input type="checkbox"/>	<input type="checkbox"/> <input type="checkbox"/> <input type="checkbox"/>	<input type="checkbox"/> <input type="checkbox"/>	<input type="checkbox"/> <input type="checkbox"/> <input type="checkbox"/> <input type="checkbox"/> <input type="checkbox"/> <input type="checkbox"/>	<input type="checkbox"/> <input type="checkbox"/>	25.0#
TSP										
TSU										

A **B** **C** **D** **E** **F**

HOW TO ORDER

Indicate the following information on order form:

- Quantity of each item.
- Model number, including options. See "How To Build a Model Number".
- Any special service required.

Note:

- The indicates that a choice is required.
- The absence of the indicates that no choice is required.
- Alpha-numeric characters in place of indicate that no other alternatives are available.

HOW TO BUILD A MODEL NUMBER

- A** Select basic model.
- B** Select frame color.
Refer to color addendum at ki.com or KI Fabrics & Finishes binder.
The metal back support matches the frame color.
When Hammertone or chrome frames are specified, back support matches seat and back color.
The arm support and tablet arm support match the frame color.
- C** Select seat and back color.
Refer to color addendum at ki.com or KI Fabrics & Finishes binder.
- D** Select armrest color.
- E** Select upholstery grade/color.
Refer to color addendum at ki.com or KI Fabrics & Finishes binder.

- F** Select fire code.
FR - Compliance to TB 133
NFR - Compliance to TB 117-2013

UPHOLSTERY INFORMATION

C.O.M. Upholstery
C.O.M. requirement for 10 chairs or less is 3/4 yard per chair of 54" wide nondirectional fabric. For orders of 11 or more chairs and for complete information on ordering C.O.M., see "Ordering C.O.M., C.O.V. and C.O.L." section.



Delivered Pricing Unupholstered	Delivered Pricing Fabric Grade 1 & C.O.M.	Delivered Pricing Fabric Grade 2	Delivered Pricing Fabric Grade 3	Delivered Pricing Vinyl Group 2V	Delivered Pricing Pallas Fabric Group P0	Delivered Pricing Pallas Fabric Group P1	Delivered Pricing Pallas Fabric Group P2	Delivered Pricing Pallas Fabric Group P3	Delivered Pricing Pallas Fabric Group P4
\$ 284									
N/A	483	526	535	535	489	500	522	545	565
\$ 433									
N/A	631	672	682	682	633	644	668	691	713

OPTIONS

California TB133 Fire Safety Code

For California Technical Bulletin 133 compliant models, add the following upcharge:

- Model=Polypropylene
- Added Lead Time=1 week
- Added list price=\$71
- Model=Upholstered
- Added Lead Time=1 week
- Added list price=\$79

Glides

For glides, add one of the following to the end of the model number:

- GBL=Plastic Glide; No Charge
- GNM=Non-marring glide; No Charge
- GNS=Non-skid glide; \$29 List Upcharge
- GSS=Stainless Steel glide; \$29 List Upcharge

INFORMATION

Note:

Torsion® in 2V Vinyl with FR requires a customer waiver since addition of the FR fire barrier to the upholstery detracts from the aesthetics of the chair.

SPECIAL SERVICES

Special Carton Marking

With specially marked information N/C



Shipping

Shipped **assembled freight prepaid f.o.b. Green Bay, Wisconsin 54302** factory. Freight class #125.

Specifications and prices are subject to change without prior notice.

Stack/Nesting

Torsion®

	MODEL	Features	MODEL NUMBER					
			Basic Model	Frame Color	Seat & Back Color	Tablet Arm Color	Upholstery Color	Fire Code
	Full Sled Base Tablet Arm Chair • Flex back • NONSTACKING • Glide is an option • Flip-up tablet • Tablet arm is 19-1/2" long and 12-3/4" wide	Polypropylene, Left Hand	TSTALP	<input type="checkbox"/>	<input type="checkbox"/>	<input type="checkbox"/>		<input type="checkbox"/>
		Polypropylene, Right Hand	TSTARP	<input type="checkbox"/>	<input type="checkbox"/>	<input type="checkbox"/>		<input type="checkbox"/>
		Upholstered, Left Hand	TSTALU	<input type="checkbox"/>	<input type="checkbox"/>	<input type="checkbox"/>	<input type="checkbox"/>	<input type="checkbox"/>
		Upholstered, Right Hand	TSTARU	<input type="checkbox"/>	<input type="checkbox"/>	<input type="checkbox"/>	<input type="checkbox"/>	<input type="checkbox"/>
TSP								
TSU								
	Full Sled Base G2-Tablet Arm Chair • Flex back • NONSTACKING • Glide is an option • Fold-down tablet • Tablet arm is 18" long and 13-3/4" wide	Polypropylene, Left Hand	TSG2ALP	<input type="checkbox"/>	<input type="checkbox"/>	<input type="checkbox"/>		<input type="checkbox"/>
		Polypropylene, Right Hand	TSG2ARP	<input type="checkbox"/>	<input type="checkbox"/>	<input type="checkbox"/>		<input type="checkbox"/>
		Upholstered, Left Hand	TSG2ALU	<input type="checkbox"/>	<input type="checkbox"/>	<input type="checkbox"/>	<input type="checkbox"/>	<input type="checkbox"/>
		Upholstered, Right Hand	TSG2ARU	<input type="checkbox"/>	<input type="checkbox"/>	<input type="checkbox"/>	<input type="checkbox"/>	<input type="checkbox"/>
TSP								
TSU								

A
B
C
D
E
F

HOW TO ORDER

Indicate the following information on order form:

1. Quantity of each item.
2. Model number, including options. See "How To Build a Model Number".
3. Any special service required.

Note: • The indicates that a choice is required.
 • The absence of the indicates that no choice is required.
 • Alpha-numeric characters in place of indicate that no other alternatives are available.

HOW TO BUILD A MODEL NUMBER

A Select basic model.

B Select frame color.
 Refer to color addendum at ki.com or KI Fabrics & Finishes binder.
 The metal back support, arm support, and tablet arm support matches the frame color.
 When Hammertone or chrome frames are specified, back support matches seat and back color.

C Select seat and back color.
 Refer to color addendum at ki.com or KI Fabrics & Finishes binder.

D Select tablet arm color.
 Refer to color addendum at ki.com or KI Fabrics & Finishes binder.

E Select upholstery grade/color.
 Refer to color addendum at ki.com or KI Fabrics & Finishes binder.

F Select fire code.

FR - Compliance to TB 133
NFR - Compliance to TB 117-2013

UPHOLSTERY INFORMATION

C.O.M. Upholstery

C.O.M. requirement for 10 chairs or less is 3/4 yard per chair of 54" wide nondirectional fabric. For orders of 11 or more chairs and for complete information on ordering C.O.M., see "Ordering C.O.M., C.O.V. and C.O.L." section.



Approx. Packaged Weight	Delivered Pricing Unupholstered	Delivered Pricing Fabric Grade 1 & C.O.M.	Delivered Pricing Fabric Grade 2	Delivered Pricing Fabric Grade 3	Delivered Pricing Vinyl Group 2V	Delivered Pricing Pallas Fabric Group P0	Delivered Pricing Pallas Fabric Group P1	Delivered Pricing Pallas Fabric Group P2	Delivered Pricing Pallas Fabric Group P3	Delivered Pricing Pallas Fabric Group P4
32.0#	\$ 482									
32.0#	482									
34.0#	N/A	681	721	729	729	685	696	717	740	761
34.0#	N/A	681	721	729	729	685	696	717	740	761
32.0#	\$ 572									
32.0#	572									
34.0#	N/A	769	809	817	817	770	781	806	827	848
34.0#	N/A	769	809	817	817	770	781	806	827	848

OPTIONS

California TB133 Fire Safety Code

For California Technical Bulletin 133 compliant models, add the following upcharge:

- Model=Polypropylene
Added Lead Time=1 week
Added list price=\$71
- Model=Upholstered
Added Lead Time=1 week
Added list price=\$79

Glides

For glides, add one of the following to the end of the model number:

- GBL=Plastic Glide; No Charge
- GNM=Non-marring glide; No Charge
- GNS=Non-skid glide; \$29 List Upcharge
- GSS=Stainless Steel glide; \$29 List Upcharge

INFORMATION

Note:

Torsion® in 2V Vinyl with FR requires a customer waiver since addition of the FR fire barrier to the upholstery detracts from the aesthetics of the chair.

SPECIAL SERVICES

Special Carton Marking

With specially marked information N/C



Shipping

Shipped **assembled freight prepaid f.o.b. Green Bay, Wisconsin 54302** factory. Freight class #125.

Specifications and prices are subject to change without prior notice.

Stack/Nesting

Torsion®

	MODEL	MODEL NUMBER	
		Basic Model	Approx. Packaged Weight
 HRDPT	Transport Dolly for Sled Base Chairs • For full sled base chairs (TS) • 5" casters: two fixed, two swivel • Black only	TVD.BL	30.0#
 HRDPT	Transport Dolly for Four-Leg Chairs • For four-Leg chairs only (TL) • 5" casters: two fixed, two swivel • Black only	TLD.BL	31.0#

A

HOW TO ORDER

Indicate the following information on order form:

1. Quantity of each item.
2. Model number, including options. See "How To Build a Model Number".
3. Any special service required.

- Note:
- The indicates that a choice is required.
 - The absence of the indicates that no choice is required.
 - Alpha-numeric characters in place of indicate that no other alternatives are available.

HOW TO BUILD A MODEL NUMBER

- A** Select basic model.



Delivered
Pricing
\$ 423

\$ 423

SPECIAL SERVICES

Special Carton Marking

With specially marked information N/C

Shipping

Shipped **assembled freight prepaid f.o.b.**
Green Bay, Wisconsin 54302 factory.
Freight class #125.

Specifications and prices are subject to
change without prior notice.

Stack/Nesting

Torsion Air™ General Information



Armless Four-Leg Chair (TALNA)



Four-Leg Armchair (TALWA)

Four-Leg Standard Tablet Arm Chair (TALTAR)

Features			
Back flex	•	•	•
Stackable	•	•	
General Dimensions			
Seat width	17"	17"	17"
Seat depth	18-1/2"	18-1/2"	18-1/2"
Seat height	18"	18"	18"
Back width	17"	17"	17"
Back height	16"	16"	16"
Overall Dimensions			
Width	21"	23-1/2"	23"
Depth	23-3/4"	23-3/4"	29-3/4"
Height	34"	34"	34"
Top of arm to floor		25-1/2"	28"
Stacking on Dolly			
Quantity/height	5 Chairs/55" High	5 Chairs/55" High	
Floor space	22-1/2" x 25-1/2"	23-1/2" x 25-1/2"	
Stacking on Floor			
Quantity/height	4 Chairs/45" High	4 Chairs/45" High	
Floor space	21" x 32"	23-1/2" x 32"	



Standard Flip-Up Tablet Arm

SPECIFICATIONS

Seat and Backrest

Seat is a two-piece construction with a molded polypropylene liner with a molded compound curved polypropylene shroud with a textured finish. Seat is always upholstered. Foam (1-1/2") is applied to the molded polypropylene liner. Fabric is then upholstered over the foam. Backrest frame is molded glass-reinforced nylon. Mesh fabric is 100% polyester. Seat and backrest are field-replaceable.

Back/Arm Supports

Two welded steel backrest supports attach the backrest to the torsion mechanism. If so equipped, optional armrest structure is integral to the backrest support. Armrests are polypropylene and are field-replaceable.

Torsion Mechanism

The back flex is achieved by the torsion mechanism. It consists of two flat torsion springs captured at both ends by steel

bushings that are welded to the backrest supports. The torsion mechanism creates gradually increasing resistance over the full 12° of back flex.

Full Sled Base Frame (TAS)

The sled base frame consists of two segments of 3/4" 16-gauge seam welded tubular steel and two steel seat supports.

Four Leg Frame (TAL)

The four leg frame consists of two U-shaped sections, one front and one rear, welded together with two support brackets to form the four leg chair. The sections are formed of 15/16" 15-gauge seam welded tubular steel.

Leg Finishes

Baked-on, electrostatically-applied powder-coating, or bright nickel-chrome plating.

Standard Tablet Arms

5/8" 11-ply plywood tablet with high-pressure laminate surface and lacquered edge. Tablet arm support matches frame color.

Seating clearance is 13 1/2". Standard tablet measures 19 1/2" long and 12 3/4" wide.

Transport Dolly

Tubular and plate steel welded together. 5" casters; two fixed, two swivel. Powder coated finish. Two distinct dollies are available; one for full Sled Base, and one for Four Leg.

Stacking Vinyl Upholstered Chairs

It is recommended that chairs to be stacked be covered in material other than vinyl as an impression in the seat may result. KI does not warrant the effects of stacking on stock or C.O.M. vinyl upholstery.

Stacking Vinyl, Polyurethane, and Imitation Leather Upholstered Chairs

It is recommended that chairs to be stacked be covered in material other than vinyl, polyurethane, or imitation leather as an impression in the seat may result. KI does not warrant the effects of stacking on stock or C.O.M. vinyl, polyurethane, or imitation

leather upholstery.

INFORMATION

C.O.M Testing and Production Requirements

Not all materials are suitable for upholstering this product. A 3/4 yd. x 54" sample must be submitted and approved prior to acceptance of an order. If the fabric is directional in pattern or weave, the direction must be indicated on the submitted sample, and additional yardage may be requested.

Test samples must be sent to:

KI
Attn: C.O.M. Specialist
1687 Westminster Drive - Gate 3
Green Bay, WI 54302

Fabric Disclaimer

Fabric will be applied as swatched by the fabric manufacturer. Fabric that is required to be applied differently than is swatched will



Stack/Nesting

Torsion Air™ General Information



Armless Sled Base Chair (TASNA)



Sled Base Armchair (TASWA)





Sled Base Standard Tablet Arm Chair (TASTAR)

Features			
Back flex	•	•	•
Stackable	•	•	
General Dimensions			
Seat width	17"	17"	17"
Seat depth	18-1/2"	18-1/2"	18-1/2"
Seat height	18"	18"	18"
Back width	17"	17"	17"
Back height	16"	16"	16"
Overall Dimensions			
Width	21"	23-1/2"	23"
Depth	23-3/4"	23-3/4"	29-3/4"
Height	34"	34"	34"
Top of arm to floor		25-1/2"	28"
Stacking on Dolly			
Quantity/height	5 Chairs/55" High	5 Chairs/55" High	
Floor space	22-1/2" x 25-1/2"	23-1/2" x 25-1/2"	
Stacking on Floor			
Quantity/height	4 Chairs/45" High	4 Chairs/45" High	
Floor space	21" x 32"	23-1/2" x 32"	

need a Special Cost Request written specifying the direction the fabric is to be applied. The posted standard lead time will apply to the Special Cost Request.

Stack/Nesting

Torsion Air™

MODEL	Features	MODEL NUMBER							
		Basic Model	Frame Color	Tablet Arm Color	Glide Option	Upholstery Color	Fire Code	Mesh Color	
 <p>Four-Leg Armless Chair</p> <ul style="list-style-type: none"> • Back flex • Mesh back • Stacking 		TALNA	<input type="checkbox"/> <input type="checkbox"/>		<input type="checkbox"/>	<input type="checkbox"/> <input type="checkbox"/> <input type="checkbox"/> <input type="checkbox"/> <input type="checkbox"/> <input type="checkbox"/>	<input type="checkbox"/> <input type="checkbox"/>	<input type="checkbox"/> <input type="checkbox"/> <input type="checkbox"/> <input type="checkbox"/>	
TALC									
 <p>Four-Leg Armchair</p> <ul style="list-style-type: none"> • Back flex • Mesh back • Stacking 		TALWA			<input type="checkbox"/>	<input type="checkbox"/> <input type="checkbox"/> <input type="checkbox"/> <input type="checkbox"/> <input type="checkbox"/> <input type="checkbox"/>	<input type="checkbox"/> <input type="checkbox"/>	<input type="checkbox"/> <input type="checkbox"/> <input type="checkbox"/> <input type="checkbox"/>	
TALC									
 <p>Four-Leg Tablet Arm Chair</p> <ul style="list-style-type: none"> • Back flex • Mesh back • Nonstacking 	Standard Tablet, Left Hand Standard Tablet, Right Hand	TALTAL TALTAR	<input type="checkbox"/> <input type="checkbox"/> <input type="checkbox"/> <input type="checkbox"/>	<input type="checkbox"/> <input type="checkbox"/> <input type="checkbox"/> <input type="checkbox"/>	<input type="checkbox"/> <input type="checkbox"/>	<input type="checkbox"/> <input type="checkbox"/> <input type="checkbox"/> <input type="checkbox"/> <input type="checkbox"/> <input type="checkbox"/> <input type="checkbox"/> <input type="checkbox"/> <input type="checkbox"/> <input type="checkbox"/> <input type="checkbox"/> <input type="checkbox"/>	<input type="checkbox"/> <input type="checkbox"/> <input type="checkbox"/> <input type="checkbox"/>	<input type="checkbox"/> <input type="checkbox"/> <input type="checkbox"/> <input type="checkbox"/> <input type="checkbox"/> <input type="checkbox"/> <input type="checkbox"/> <input type="checkbox"/>	
TALC									
			A	B	C	D	E	F	G

HOW TO ORDER

Indicate the following information on order form:

1. Quantity of each item.
2. Model number, including options. See "How To Build a Model Number".
3. Any special service required.

Note: • The indicates that a choice is required.

- The absence of the indicates that no choice is required.
- Alpha-numeric characters in place of indicate that no other alternatives are available.

HOW TO BUILD A MODEL NUMBER

- A** Select basic model.
- B** Select frame color.
Refer to color addendum at ki.com or KI Fabrics & Finishes binder.
- C** Select tablet arm color.
Refer to color addendum at ki.com or KI Fabrics & Finishes binder.
- D** Select glide option.

P	- Plastic glides
S	- Stainless steel glides
- E** Select upholstery grade/color.
Refer to color addendum at ki.com or KI Fabrics & Finishes binder.
- F** Select fire code.

NFR	- Compliance to TB 117-2013
FR	- Compliance to TB 133
- G** Select back mesh color.

BLMH	- Black
GRMH	- Grey

Refer to color addendum at ki.com or KI Fabrics & Finishes binder.

UPHOLSTERY INFORMATION

C.O.M. Upholstery
C.O.M. requirement for 10 chairs or less is 3/4 yard per chair of 54" wide nondirectional fabric. For orders of 11 or more chairs and for complete information on ordering C.O.M., see "Ordering C.O.M., C.O.V. and C.O.L." section.



Approx. Packaged Weight	Delivered Pricing Fabric Grade 1 & C.O.M.	Delivered Pricing Fabric Grade 2	Delivered Pricing Fabric Grade 3	Delivered Pricing Vinyl Group 2V	Delivered Pricing Pallas Fabric Group P0	Delivered Pricing Pallas Fabric Group P1	Delivered Pricing Pallas Fabric Group P2	Delivered Pricing Pallas Fabric Group P3	Delivered Pricing Pallas Fabric Group P4
18.0#	\$ 512	\$ 526	\$ 541	\$ 541	\$ 549	\$ 586	\$ 603	\$ 623	\$ 647
20.0#	\$ 540	\$ 553	\$ 571	\$ 571	\$ 576	\$ 613	\$ 631	\$ 650	\$ 674
28.0#	\$ 710	\$ 722	\$ 741	\$ 741	\$ 746	\$ 783	\$ 801	\$ 818	\$ 845
28.0#	710	722	741	741	746	783	801	818	845

OPTIONS

California TB133 Fire Safety Code
 For California Technical Bulletin 133 compliant models, add the following upcharge:
 Added Lead Time=1 week
 Added list price=\$47

SPECIAL SERVICES



Special Carton Marking
 With specially marked information N/C

Shipping
 Shipped **assembled freight prepaid f.o.b. Green Bay, Wisconsin 54302** factory.
 Freight class #125.

Specifications and prices are subject to change without prior notice.

Stack/Nesting

Torsion Air™

MODEL	Features	MODEL NUMBER						
		Basic Model	Frame Color	Tablet Arm Color	Upholstery Color	Fire Code	Mesh Color	Glide Option
 <p>Armless Sled Base Chair</p> <ul style="list-style-type: none"> • Back flex • Mesh back • Stacking 		TASNA	<input type="checkbox"/>		<input type="checkbox"/> <input type="checkbox"/> <input type="checkbox"/> <input type="checkbox"/>	<input type="checkbox"/>	<input type="checkbox"/> <input type="checkbox"/> <input type="checkbox"/>	<input type="checkbox"/> <input type="checkbox"/>
	TASC							
 <p>Sled Base Armchair</p> <ul style="list-style-type: none"> • Back flex • Mesh back • Stacking 		TASWA	<input type="checkbox"/>		<input type="checkbox"/> <input type="checkbox"/> <input type="checkbox"/> <input type="checkbox"/>	<input type="checkbox"/>	<input type="checkbox"/> <input type="checkbox"/> <input type="checkbox"/>	<input type="checkbox"/> <input type="checkbox"/>
	TASC							
 <p>Sled Base Tablet Arm Chair</p> <ul style="list-style-type: none"> • Back flex • Mesh back • Nonstacking 	Standard Tablet, Left Hand	TASTAL	<input type="checkbox"/>	<input type="checkbox"/> <input type="checkbox"/>	<input type="checkbox"/> <input type="checkbox"/> <input type="checkbox"/> <input type="checkbox"/>	<input type="checkbox"/>	<input type="checkbox"/> <input type="checkbox"/> <input type="checkbox"/>	<input type="checkbox"/> <input type="checkbox"/>
	Standard Tablet, Right Hand	TASTAR	<input type="checkbox"/>	<input type="checkbox"/> <input type="checkbox"/>	<input type="checkbox"/> <input type="checkbox"/> <input type="checkbox"/> <input type="checkbox"/>	<input type="checkbox"/>	<input type="checkbox"/> <input type="checkbox"/> <input type="checkbox"/>	<input type="checkbox"/> <input type="checkbox"/>
	TASC							

A **B** **C** **D** **E** **F** **G**

HOW TO ORDER

Indicate the following information on order form:

1. Quantity of each item.
2. Model number, including options. See "How To Build a Model Number".
3. Any special service required.

Note: • The indicates that a choice is required.

- The absence of the indicates that no choice is required.
- Alpha-numeric characters in place of indicate that no other alternatives are available.

HOW TO BUILD A MODEL NUMBER

- A** Select basic model.
- B** Select frame color.
Refer to color addendum at ki.com or KI Fabrics & Finishes binder.
- C** Select tablet arm color.
Refer to color addendum at ki.com or KI Fabrics & Finishes binder.
- D** Select upholstery grade/color.
Refer to color addendum at ki.com or KI Fabrics & Finishes binder.
- E** Select fire code.

NFR	- Compliance to TB 117-2013
FR	- Compliance to TB 133
- F** Select back mesh color.

BLMH	- Black
GRMH	- Grey

 Refer to color addendum at ki.com or KI

Fabrics & Finishes binder.

- G** Select glide option.

N	- No glides
GNM	- Non-marring glides
GNS	- Non-skid glides
GBL	- Plastic glides
GSS	- Stainless steel glide

UPHOLSTERY INFORMATION

C.O.M. Upholstery

C.O.M. requirement for 10 chairs or less is 3/4 yard per chair of 54" wide nondirectional fabric. For orders of 11 or more chairs and for complete information on ordering C.O.M., see "Ordering C.O.M., C.O.V. and C.O.L." section.



Approx. Packaged Weight	Delivered Pricing Fabric Grade 1 & C.O.M.	Delivered Pricing Fabric Grade 2	Delivered Pricing Fabric Grade 3	Delivered Pricing Vinyl Group 2V	Delivered Pricing Pallas Fabric Group P0	Delivered Pricing Pallas Fabric Group P1	Delivered Pricing Pallas Fabric Group P2	Delivered Pricing Pallas Fabric Group P3	Delivered Pricing Pallas Fabric Group P4
18.0#	\$ 512	\$ 526	\$ 541	\$ 541	\$ 549	\$ 586	\$ 603	\$ 623	\$ 647
20.0#	\$ 540	\$ 553	\$ 571	\$ 571	\$ 576	\$ 613	\$ 631	\$ 650	\$ 674
28.0#	\$ 710	\$ 722	\$ 741	\$ 741	\$ 746	\$ 783	\$ 801	\$ 818	\$ 845
28.0#	710	722	741	741	746	783	801	818	845

OPTIONS

California TB133 Fire Safety Code
 For California Technical Bulletin 133 compliant models, add the following upcharge:
 Added Lead Time=1 week
 Added list price=\$47

SPECIAL SERVICES



Special Carton Marking
 With specially marked information N/C

Shipping
 Shipped **assembled freight prepaid f.o.b. Green Bay, Wisconsin 54302** factory.
 Freight class #125.

Specifications and prices are subject to change without prior notice.

Stack/Nesting

Torsion Air™

	MODEL	MODEL NUMBER	
		Basic Model	Approx. Packaged Weight
 HRDPT	Transport Dolly for Sled Base Chairs • For full sled base chairs • 5" casters: two fixed, two swivel • Black only	TVD.BL	30.0#
 HRDPT	Transport Dolly for Four-Leg Chairs • For four-Leg chairs only • 5" casters: two fixed, two swivel • Black only	TLD.BL	31.0#

A

HOW TO ORDER

Indicate the following information on order form:

1. Quantity of each item.
2. Model number, including options. See "How To Build a Model Number".
3. Any special service required.

Note:

- The indicates that a choice is required.
- The absence of the indicates that no choice is required.
- Alpha-numeric characters in place of indicate that no other alternatives are available.

HOW TO BUILD A MODEL NUMBER

A Select basic model.

UPHOLSTERY INFORMATION

C.O.M. Upholstery

C.O.M. requirement for 10 chairs or less is 3/4 yard per chair of 54" wide nondirectional fabric. For orders of 11 or more chairs and for complete information on ordering C.O.M., see "Ordering C.O.M., C.O.V. and C.O.L." section.



Delivered
Pricing
\$ 423

\$ 423

SPECIAL SERVICES

Special Carton Marking

With specially marked information N/C

Shipping

Shipped **assembled freight prepaid f.o.b.**
Green Bay, Wisconsin 54302 factory.
Freight class #125.

Specifications and prices are subject to
change without prior notice.

Stack/Nesting

Torsion Air™ Nesting General Information



**Armless Chair
(TANNA)**



**Armchair
(TANWA)**



**Piretti Tablet
Arm Chair
(TANTARPT)**



**Flip-up Tablet
Arm Chair
(TANTARFD)**

Features				
Back flex	•	•	•	•
Flip-up seat	•	•	•	•
Nesting	•	•	•	•
Casters	•	•	•	•
General Dimensions				
Seat width	17"	17"	17"	17"
Seat depth	18-1/2"	18-1/2"	18-1/2"	18-1/2"
Seat height	18"	18"	18"	18"
Back width	17"	17"	17"	17"
Back height	16"	16"	16"	16"
Overall Dimensions				
Width	23-7/8"	23-7/8"	25"	27"
Depth	24-1/4"	24-1/4"	30-1/4"	31"
Height	33-1/2"	33-1/2"	33-1/2"	33-1/2"
Top of arm to floor		24-7/8"	28-1/2"	28"
Depth of nesting (two chairs)	28"	28"	34"	35"
Depth of each additional chair	7-1/2"	7-1/2"	7-1/2"	7-1/2"

SPECIFICATIONS

Seat and Backrest

Seat is two-piece construction of molded plywood upholstery board with a molded compound curved polypropylene shroud with a textured finish. Seat is always upholstered. Foam (1-3/4") is applied to the molded plywood upholstery board. Fabric is then upholstered over the foam. Backrest is available in either a poly or upholstered version. Backrest frame is molded glass-reinforced nylon. Mesh fabric is 100% polyester. Backrest has an integral "handle."

Seat flips up to allow chairs to nest for storage and transport.

Seat and back are field replaceable.

Backrest Supports

Two welded steel backrest supports attach the backrest to the torsion mechanism.

Torsion Mechanism

The back flex is achieved by the torsion mechanism. It consists of two flat torsion springs captured at both ends by steel bushings that are welded to the backrest supports. The torsion mechanism creates gradually increasing resistance over the full 12° of back flex.

Piretti Tablet

Available on RH or LH side. The tablet support is 1-3/16"OD x 14-gauge round steel tubing. The support is welded to the chair frame. The tablet mechanism consists of two die cast aluminum housings and a stamped steel hinge assembly. The main housing is mounted inside the steel support tube and secured with a thread-forming screw. The mechanism has two through-bolted pivot axes with bushing that allow stowing. The mechanism permits 12 degrees of horizontal rotation for ingress/egress without stowing the tablet. With the tablet stowed, the chair will nest with other Torsion Air chairs with or without tablets.

The tablet is made from blow-molded high-density polyethylene and is only available in black. The tablet is connected to the mechanism and supported by a 12-gauge steel plate. The tablet has an effective working surface 12" deep by 16" across (overall dimensions are 12" deep by 22" across).

Flip-Up Tablet

Available on RH or LH side. The tablet arm support structure is 1-inch diameter, 13-gauge tubing, welded to the main chair frame. A formed steel hinge is welded to the top of the support structure and secured with screws to the underside of the writing surface. Writing surface is nominally 9-1/2" x 20-3/4" x 12-1/2" plywood core of 5/8" thick, 11-ply hardwood, surfaced with 0.030" high-pressure laminate top and plain backer undersurface. Edges are lacquered and sealed. When so equipped, and with the tablet flipped up, chairs will nest with other Torsion Air chairs with tablets, or without.

Frame

The frame is made up of four legs welded to a steel mechanism tube. The legs are 1" diameter, 13-gauge high-strength low alloy steel tubing.

Arms

Armrests are made of polypropylene. Armrests rotate with the back. Armrests are field replaceable.

Leg Finishes

Baked on electrostatically applied 45 sheen epoxy powder coating or bright nickel chrome plating.

Casters/Glides

Double wheels (60mm) of high-impact thermoplastic. High-impact plastic frame. Carpet and hard floor casters are always black. Bell glide (2" high) made of high-impact plastic also available, black only.



INFORMATION

C.O.M Testing and Production Requirements

Not all materials are suitable for upholstering this product. A 3/4 yd. x 54" sample must be submitted and approved prior to acceptance of an order. If the fabric is directional in pattern or weave, the direction must be indicated on the submitted sample, and additional yardage may be requested.

Test samples must be sent to:

KI
Attn: C.O.M. Specialist
1687 Westminster Drive - Gate 3
Green Bay, WI 54302



Fabric Disclaimer

Fabric will be applied as swatched by the fabric manufacturer. Fabric that is required to be applied differently than is swatched will need a Special Cost Request written specify-

ing the direction the fabric is to be applied. The posted standard lead time will apply to the Special Cost Request.

Stack/Nesting

Torsion Air™ Nesting Chairs

MODEL	Features	MODEL NUMBER						
		Basic Model	Frame Color	Tablet Arm Color	Base	Upholstery Color	Fire Code	Mesh Color
 <p>Armless Chair</p> <ul style="list-style-type: none"> • Back flex • Mesh back <p>TANC</p>		TANNA	<input type="checkbox"/> <input type="checkbox"/>		<input type="checkbox"/>	<input type="checkbox"/> <input type="checkbox"/> <input type="checkbox"/> <input type="checkbox"/> <input type="checkbox"/> <input type="checkbox"/>	<input type="checkbox"/> <input type="checkbox"/>	<input type="checkbox"/> <input type="checkbox"/> <input type="checkbox"/> <input type="checkbox"/>
 <p>Armchair</p> <ul style="list-style-type: none"> • Back flex • Mesh back <p>TANC</p>		TANWA	<input type="checkbox"/> <input type="checkbox"/>		<input type="checkbox"/>	<input type="checkbox"/> <input type="checkbox"/> <input type="checkbox"/> <input type="checkbox"/> <input type="checkbox"/> <input type="checkbox"/>	<input type="checkbox"/> <input type="checkbox"/>	<input type="checkbox"/> <input type="checkbox"/> <input type="checkbox"/> <input type="checkbox"/>
 <p>Flip-up Tablet Arm Chair</p> <ul style="list-style-type: none"> • Back flex • Mesh back <p>TANC</p>	Flip Tablet, Left Hand	TANTALFT	<input type="checkbox"/> <input type="checkbox"/>	<input type="checkbox"/> <input type="checkbox"/> <input type="checkbox"/>	<input type="checkbox"/>	<input type="checkbox"/> <input type="checkbox"/> <input type="checkbox"/> <input type="checkbox"/> <input type="checkbox"/> <input type="checkbox"/>	<input type="checkbox"/> <input type="checkbox"/>	<input type="checkbox"/> <input type="checkbox"/> <input type="checkbox"/> <input type="checkbox"/>
	Flip Tablet, Right Hand	TANTARFT	<input type="checkbox"/> <input type="checkbox"/>	<input type="checkbox"/> <input type="checkbox"/> <input type="checkbox"/>	<input type="checkbox"/>	<input type="checkbox"/> <input type="checkbox"/> <input type="checkbox"/> <input type="checkbox"/> <input type="checkbox"/> <input type="checkbox"/>	<input type="checkbox"/> <input type="checkbox"/>	<input type="checkbox"/> <input type="checkbox"/> <input type="checkbox"/> <input type="checkbox"/>

A **B** **C** **D** **E** **F** **G**

HOW TO ORDER

Indicate the following information on order form:

1. Quantity of each item.
2. Model number, including options. See "How To Build a Model Number".
3. Any special service required.

Note: • The indicates that a choice is required.

- The absence of the indicates that no choice is required.
- Alpha-numeric characters in place of indicate that no other alternatives are available.

HOW TO BUILD A MODEL NUMBER

- A** Select basic model.
- B** Select frame color.
Refer to color addendum at ki.com or KI Fabrics & Finishes binder.
- C** Select tablet arm color.
Refer to color addendum at ki.com or KI Fabrics & Finishes binder.
- D** Select base option.

G	- Bell glides (black only)
C	- Carpet casters (black only)
S	- Hard floor casters (black only)
- E** Select upholstery grade/color.
Refer to color addendum at ki.com or KI Fabrics & Finishes binder.
- F** Select fire code.

NFR	- Compliance to TB 117-2013
FR	- Compliance to TB 133
- G** Select back mesh color.

BLMH	- Black
GRMH	- Grey

 Refer to color addendum at ki.com or KI Fabrics & Finishes binder.

UPHOLSTERY INFORMATION

C.O.M. Upholstery
C.O.M. requirement for 10 chairs or less is 3/4 yard per chair of 54" wide nondirectional fabric. For orders of 11 or more chairs and for complete information on ordering C.O.M., see "Ordering C.O.M., C.O.V. and C.O.L." section.



Stack/Nesting

Torsion Air™ Nesting Chairs

Approx. Packaged Weight	Delivered Pricing Fabric Grade 1 & C.O.M.	Delivered Pricing Fabric Grade 2	Delivered Pricing Fabric Grade 3	Delivered Pricing Vinyl Group 2V	Delivered Pricing Pallas Fabric Group P0	Delivered Pricing Pallas Fabric Group P1	Delivered Pricing Pallas Fabric Group P2	Delivered Pricing Pallas Fabric Group P3	Delivered Pricing Pallas Fabric Group P4
24.0#	\$ 692	\$ 705	\$ 719	\$ 719	\$ 728	\$ 765	\$ 781	\$ 801	\$ 826
25.0#	\$ 718	\$ 737	\$ 749	\$ 749	\$ 755	\$ 792	\$ 810	\$ 828	\$ 855
29.0#	\$ 888	\$ 902	\$ 919	\$ 919	\$ 925	\$ 962	\$ 980	\$ 998	\$ 1023
29.0#	888	902	919	919	925	962	980	998	1023

OPTIONS

California TB133 Fire Safety Code
 For California Technical Bulletin 133 compliant models, add the following upcharge:
 Added Lead Time=1 week
 Added list price=\$47

SPECIAL SERVICES

Special Carton Marking
 With specially marked information N/C

Shipping
 Shipped **assembled freight prepaid f.o.b. Green Bay, Wisconsin 54302** factory.
 Freight class #125.

Specifications and prices are subject to change without prior notice.

Stack/Nesting

Torsion Air™ Nesting Chairs

MODEL	Features	MODEL NUMBER					
		Basic Model	Frame Color	Base	Upholstery Color	Fire Code	Mesh Color
 <p>Piretti Tablet Arm Chair</p> <ul style="list-style-type: none"> • Back flex • Mesh back 	Piretti Tablet, Left Hand	TANTALPT	<input type="checkbox"/> <input type="checkbox"/>	<input type="checkbox"/>	<input type="checkbox"/> <input type="checkbox"/> <input type="checkbox"/> <input type="checkbox"/>	<input type="checkbox"/> <input type="checkbox"/>	<input type="checkbox"/> <input type="checkbox"/> <input type="checkbox"/> <input type="checkbox"/>
	Piretti Tablet, Right Hand	TANTARPT	<input type="checkbox"/> <input type="checkbox"/>	<input type="checkbox"/>	<input type="checkbox"/> <input type="checkbox"/> <input type="checkbox"/> <input type="checkbox"/>	<input type="checkbox"/> <input type="checkbox"/>	<input type="checkbox"/> <input type="checkbox"/> <input type="checkbox"/> <input type="checkbox"/>

TANC

A **B** **C** **D** **E** **F**

HOW TO ORDER

Indicate the following information on order form:

1. Quantity of each item.
2. Model number, including options. See "How To Build a Model Number".
3. Any special service required.

Note:

- The indicates that a choice is required.
- The absence of the indicates that no choice is required.
- Alpha-numeric characters in place of indicate that no other alternatives are available.

HOW TO BUILD A MODEL NUMBER

- A** Select basic model.
- B** Select frame color.
Refer to color addendum at ki.com or KI Fabrics & Finishes binder.
- C** Select base option.

G	- Bell glides (black only)
C	- Carpet casters (black only)
S	- Hard floor casters (black only)
- D** Select upholstery grade/color.
Refer to color addendum at ki.com or KI Fabrics & Finishes binder.
- E** Select fire code.

NFR	- Compliance to TB 117-2013
FR	- Compliance to TB 133
- F** Select back mesh color.

BLMH	- Black
-------------	---------

GRMH - Grey
Refer to color addendum at ki.com or KI Fabrics & Finishes binder.

UPHOLSTERY INFORMATION

C.O.M. Upholstery
C.O.M. requirement for 10 chairs or less is 3/4 yard per chair of 54" wide nondirectional fabric. For orders of 11 or more chairs and for complete information on ordering C.O.M., see "Ordering C.O.M., C.O.V. and C.O.L." section.



Stack/Nesting

Torsion Air™ Nesting Chairs

Approx. Packaged Weight	Delivered Pricing Fabric Grade 1 & C.O.M.	Delivered Pricing Fabric Grade 2	Delivered Pricing Fabric Grade 3	Delivered Pricing Vinyl Group 2V	Delivered Pricing Pallas Fabric Group P0	Delivered Pricing Pallas Fabric Group P1	Delivered Pricing Pallas Fabric Group P2	Delivered Pricing Pallas Fabric Group P3	Delivered Pricing Pallas Fabric Group P4
34.0#	\$ 996	\$ 1011	\$ 1026	\$ 1026	\$ 1033	\$ 1070	\$ 1088	\$ 1105	\$ 1132
34.0#	996	1011	1026	1026	1033	1070	1088	1105	1132

SPECIAL SERVICES

Special Carton Marking

With specially marked information N/C

Shipping

Shipped **assembled freight prepaid f.o.b. Green Bay, Wisconsin 54302** factory. Freight class #125.

Specifications and prices are subject to change without prior notice.

Stack/Nesting

Versa® Basic General Information



**Armchair
(VBWAL)**



**Armless Chair
(VBNAL)**



**Transport Dolly
(VBD.BL)**

Features			
Stackable	•	•	
Plastic back shroud	•	•	
Steel tube arms	•		
General Dimensions			
Seat width	17-1/2"	17-1/2"	
Seat depth	17-1/2"	17-1/2"	
Seat height	17-1/2"	17-1/2"	
Overall Dimensions			
Width	21-5/8"	19-3/8"	22-3/8"
Depth	21-1/4"	21-1/4"	24-7/8" No Arm/ 36" Arm
Height	31"	31"	
Arms to floor	25-3/8"		
Stacking on Dolly			
Quantity/height	10 Chairs/52" High	10 Chairs/52" High	
Stacking on Floor			
Quantity/height	4 Chairs/40" High	4 Chairs/40" High	



Kick Back Leg

SPECIFICATIONS

Frame

Legs of 1" o.d. x 13-gauge tubular steel. "Kick back" rear legs on four-leg model increases structural integrity and adds to stability. Side members of 7/8" o.d. x 13-gauge tubular steel. All other joints are robotically welded.

Basic Tube End Caps

Molded plastic. The end cap will match the frame color.

Upholstered Seat

Inner seat is 3/8" polypropylene. Fastens to frame with four screws through T-nuts embedded in seat. 1-1/8" thick polyfoam cushion glued to seatboard.

Upholstered Backrest

Two-piece construction. Inner back is 9-ply hard maple with 3/4" thick polyurethane foam. Outer back is vacuum-formed polystyrene attached with eight wood screws.

Frame Finishes

Baked-on, electrostatically-applied epoxy powder coating, or bright nickel-chrome plated.

Transport Dolly

Tubular steel frame, black powder-coated finish. Four 5" swivel wheels.

Stacking Vinyl, Polyurethane, and Imitation Leather Upholstered Chairs

It is recommended that chairs to be stacked be covered in material other than vinyl, polyurethane, or imitation leather as an impression in the seat may result. KI does not warrant the effects of stacking on stock or C.O.M. vinyl, polyurethane, or imitation leather upholstery.

INFORMATION

C.O.M. Testing and Production Requirements

Not all materials are suitable for upholstering this product. A 1-1/2 yd. x 54" sample

must be submitted and approved prior to acceptance of an order. If the fabric is directional in pattern or weave, the direction must be indicated on the submitted sample, and additional yardage may be requested.

Test samples must be sent to:

KI
Attn: C.O.M. Specialist
1687 Westminster Drive - Gate 3
Green Bay, WI 54302

Fabric Disclaimer

Fabric will be applied as swatched by the fabric manufacturer. Fabric that is required to be applied differently than is swatched will need a Special Cost Request written specifying the direction the fabric is to be applied. The posted standard lead time will apply to the Special Cost Request.





INFORMATION

Warranty

Refer to KI Terms & Conditions document
or visit ki.com

Stack/Nesting

Versa® Basic

	MODEL	Features	MODEL NUMBER				Approx. Packaged Weight	Delivered Pricing
			Basic Model	Frame Color	Upholstery Color	Fire Code		
 VBUP	Four-Leg Armchair • Back and seat are foam cushioned and upholstered • Plastic back shroud • Round tubular steel frame • "Kick back" rear leg style enhances stability • Continuous steel tubular arms • Stacking	Upholstered	VBWAL	<input type="checkbox"/>	<input type="checkbox"/> <input type="checkbox"/> <input type="checkbox"/> <input type="checkbox"/>	<input type="checkbox"/>	20.0#	N/A
 VBUP	Four-Leg Armless Chair • Back and seat are foam cushioned and upholstered • Plastic back shroud • Round tubular steel frame • "Kick back" rear leg style enhances stability • Stacking	Upholstered	VBNAL	<input type="checkbox"/>	<input type="checkbox"/> <input type="checkbox"/> <input type="checkbox"/> <input type="checkbox"/>	<input type="checkbox"/>	18.0#	N/A
 HRDPT	Versa® Basic Transport Dolly		VBD.BL				19.0#	\$ 450

A **B** **C** **D**

HOW TO ORDER

Indicate the following information on order form:

- Quantity of each item.
- Model number, including options. See "How To Build a Model Number".
- Any special service required.

Note: • The indicates that a choice is required.

- The absence of the indicates that no choice is required.
- Alpha-numeric characters in place of indicate that no other alternatives are available.

HOW TO BUILD A MODEL NUMBER

- A** Select basic model.
- B** Select frame color.
Refer to color addendum at ki.com or KI Fabrics & Finishes binder.
- C** Select upholstery grade/color.
Refer to color addendum at ki.com or KI Fabrics & Finishes binder.
- D** Select fire code.

NFR	- Compliance to TB 117-2013
FR	- Compliance to TB 133

UPHOLSTERY INFORMATION

C.O.M. Upholstery

C.O.M. requirement for 10 chairs or less is 1 yd. of 54" wide nondirectional fabric and vinyls. For orders of 11 or more chairs and for complete information on ordering C.O.M., see "Ordering C.O.M., C.O.V. and C.O.L." section.



Delivered Pricing Fabric Grade 1 & C.O.M.	Delivered Pricing Fabric Grade 2	Delivered Pricing Fabric Grade 3	Delivered Pricing C.O.V.	Delivered Pricing Vinyl Group 2V	Delivered Pricing Pallas Fabric Group P0	Delivered Pricing Pallas Fabric Group P1	Delivered Pricing Pallas Fabric Group P2	Delivered Pricing Pallas Fabric Group P3	Delivered Pricing Pallas Fabric Group P4
\$ 345	\$ 379	\$ 380	\$ 345	\$ 380	\$ 380	\$ 390	\$ 428	\$ 460	\$ 496
\$ 317	\$ 350	\$ 355	\$ 317	\$ 355	\$ 351	\$ 362	\$ 399	\$ 434	\$ 471

OPTIONS

California TB133 Fire Safety Code
 For California Technical Bulletin 133 compliant models, add the following upcharge:
 Model=Upholstered
 Added Lead Time=1 week
 Added list price=\$76

SPECIAL SERVICES

Special Carton Marking
 With specially marked information N/C

Shipping
 Shipped **assembled freight prepaid f.o.b. Green Bay, Wisconsin 54302** factory.
 Freight class #125.

Specifications and prices are subject to change without prior notice.

Stack/Nesting

Versa® Conference General Information



Conference Armchair
(VCWAL)



Armless Conference Chair
(VCNAL)



Conference Armchair with
Casters (VCWAC)

Features			
Stackable	•	•	
Ganging	•		
General Dimensions			
Seat width	17-3/4"	17-3/4"	17-3/4"
Seat depth	19-1/2"	19-1/2"	19-1/2"
Seat height	17-1/2"	17-1/2"	17-1/2"
Overall Dimensions			
Width	23-7/8"	20-1/4"	23-7/8"
Depth	23-7/8"	23-7/8"	23-7/8"
Height	32-3/4"	32-3/4"	32-3/4"
Arms to floor	25-5/8"		25-5/8"
Ganging on center	24-3/8"		
Stacking on Dolly			
Overall width	23-7/8"	22-1/2"	
Overall depth	37"	37"	
Quantity/height	8 Chairs/56-3/4" High	8 Chairs/54-1/2" High	
Stacking on Floor			
Width	20-1/2"	20-1/2"	
Depth	29-1/2"	29-1/2"	
Quantity/height	4 Chairs/41" High	4 Chairs/41" High	



Ganging



Kick Back Leg



Upholstered Back

SPECIFICATIONS

Frame

Four-leg and with arm sled models have legs made of 1" o.d. x 16-gauge tubular steel. Armless sled base models have legs made of 1" o.d. x 14-gauge tubular steel. "Kick back" rear legs on all models will increase structural integrity and add to stability. Seat side supports and cross members of 1" o.d. x 14-gauge tubular steel. Legs will be joined to side members by brazing. All other joints will be robotically welded.

Tube End Caps (Armless Chair)

Molded plastic. The end cap will match the frame color. With chrome and hammertone frames, the end caps will be black.

Floor Glides (Four-Leg Models)

Chrome plated steel or plastic and are pressed into the bottom of the leg tubes. Plastic glides match the color of the frame unless frame is chrome or hammertone, then black.

Floor Glides (Sled Base Models)

Black, non-skid glides have a hard PVC upper and soft PVC base. Glides (4) are attached to the frame with one screw each.

Casters

Carpet casters are 60mm double-wheel, high-impact thermoplastic and are available in black only.

Upholstered Seat

Seat board is made of 7 ply compound molded plywood (3/8" thick) that is glued to a 1-1/2" thick urethane foam cushion. Fabric is glued to the foam and C-Gex upholstered. Seat is fastened to the frame with four 10-24 screws that thread into T-nuts embedded in the seat board.

Upholstered Backrest

Two-piece construction. Inner back is 7-ply compound molded plywood (7/16" thick) with 1-1/2" thick urethane foam cushion that is covered in fabric and C-Gex upholstered together. Outer back shroud is 3-ply

compound molded plywood (3/16" thick) with 1/4" thick urethane foam cushion that is covered in fabric and C-Gex upholstered together. The inner back is attached to the frame with four 1/4" screws and the outer back is attached to the inner back and frame with 5 steel spring clips and 2 steel rivets

Armrest

Molded nylon and are pressed into the leg tubes.

Frame Finishes

30 sheen epoxy powder coating is electrostatically applied. The dry coating is then fused and cured in a baking oven to form a smooth, continuous film. Finish is chemical resistant, hard, touch and mar resistant. Bright chrome surfaces are duplex nickel-chrome plated in a twenty-two step process.

Ganging Fixtures (Armchairs Only)

Welded steel construction and chrome-plated for durability. Gangers are attached to the underside of the arms with two screws.

Only armchairs can be ganged. Gangers are shipped unassembled (KD).

Transport Dolly

Tubular steel frame, black powder-coated finish. Four 5" wheels, two fixed and two swivel. Only four-leg (no caster) chairs stack on the dolly.

Stacking Vinyl, Polyurethane, and Imitation Leather Upholstered Chairs

It is recommended that chairs to be stacked be covered in material other than vinyl, polyurethane, or imitation leather as an impression in the seat may result. KI does not warrant the effects of stacking on stock or C.O.M. vinyl, polyurethane, or imitation leather upholstery.

INFORMATION

C.O.M. Testing and Production Requirements

Not all materials are suitable for upholstery this product. A 1 yd. x 54" sample



**Sled Base Armchair
(VCWAS)**



**Armless Sled Base Chair
(VCNAS)**



**Transport Dolly
(MVP.BL)**

Features

Stackable

Ganging

•

General Dimensions

Seat width	17-3/4"	17-3/4"
Seat depth	19-1/2"	19-1/2"
Seat height	17-1/2"	17-1/2"

Overall Dimensions

Width	23-7/8"	20-1/4"	22-3/8"
Depth	23-7/8"	23-7/8"	25-5/8"
Height	32-3/4"	32-3/4"	
Arms to floor	25-5/8"		
Ganging on center	24-3/8"		

must be submitted and approved prior to acceptance of an order. If the fabric is directional in pattern or weave, the direction must be indicated on the submitted sample, and additional yardage may be requested.

Test samples must be sent to:

KI
Attn: C.O.M. Specialist
1687 Westminster Drive - Gate 3
Green Bay, WI 54302

Fabric Disclaimer

Fabric will be applied as swatched by the fabric manufacturer. Fabric that is required to be applied differently than is swatched will need a Special Cost Request written specifying the direction the fabric is to be applied. The posted standard lead time will apply to the Special Cost Request.

INFORMATION

Warranty

Refer to KI Terms & Conditions document or visit ki.com

Stack/Nesting

Versa® Conference

MODEL	Features	MODEL NUMBER						Approx. Packaged Weight	
		Basic Model	Frame Color	Upholstery Color	Fire Code	Glide Option	Back Style		
<p>VRB VSB</p> <p>VCUP</p>	<p>Four-Leg Armchair</p> <ul style="list-style-type: none"> • Generously proportioned seat and back have thick foam cushioning and are upholstered • Back is fully upholstered • Brackets attaching back to frame are concealed • Round tubular steel frame • "Kick back" rear leg style enhances stability • Molded nylon arms • Ganger fastened to armrest and chrome finished • Powder-coated or chrome-plated frames • Stacking. Caution should be exercised to prevent casters from marring components such as frames, fabric, etc., and to prevent casters from becoming "hung up" underneath the seat of the chair below. • Stacking on dollies is NOT recommended with casters 	Upholstered, Casters	VCWAC	<input type="checkbox"/>	<input type="checkbox"/> <input type="checkbox"/> <input type="checkbox"/> <input type="checkbox"/> <input type="checkbox"/>	<input type="checkbox"/>	<input type="checkbox"/> <input type="checkbox"/> <input type="checkbox"/>	26.0#	
		Upholstered, Ganging	VCWAG	<input type="checkbox"/>	<input type="checkbox"/> <input type="checkbox"/> <input type="checkbox"/> <input type="checkbox"/> <input type="checkbox"/>	<input type="checkbox"/>	<input type="checkbox"/>	<input type="checkbox"/> <input type="checkbox"/> <input type="checkbox"/>	26.0#
		Upholstered, Non-Ganging	VCWAL	<input type="checkbox"/>	<input type="checkbox"/> <input type="checkbox"/> <input type="checkbox"/> <input type="checkbox"/> <input type="checkbox"/>	<input type="checkbox"/>	<input type="checkbox"/>	<input type="checkbox"/> <input type="checkbox"/> <input type="checkbox"/>	26.0#

A **B** **C** **D** **E** **F**

HOW TO ORDER

Indicate the following information on order form:

1. Quantity of each item.
2. Model number, including options. See "How To Build a Model Number".
3. Any special service required.

Note:

- The indicates that a choice is required.
- The absence of the indicates that no choice is required.
- Alpha-numeric characters in place of indicate that no other alternatives are available.

HOW TO BUILD A MODEL NUMBER

- A** Select basic model.
- B** Select frame color. Refer to color addendum at ki.com or KI Fabrics & Finishes binder. End caps will match frame color, unless frame is chrome or hammertone (then black).
- C** Select upholstery grade/color. Refer to color addendum at ki.com or KI Fabrics & Finishes binder.
- D** Select fire code.

NFR	- Compliance to TB 117-2013
FR	- Compliance to TB 133
- E** Select glide option.

P	- Plastic glides
S	- Steel glides (standard)
- F** Select back style.

VRB - Round (original style)
VSB - Square (new style)



Delivered Pricing Fabric Grade 1 & C.O.M.	Delivered Pricing Fabric Grade 2	Delivered Pricing Fabric Grade 3	Delivered Pricing C.O.V.	Delivered Pricing Vinyl Group 2V	Delivered Pricing Pallas Fabric Group P0	Delivered Pricing Pallas Fabric Group P1	Delivered Pricing Pallas Fabric Group P2	Delivered Pricing Pallas Fabric Group P3	Delivered Pricing Pallas Fabric Group P4
\$ 668	\$ 708	\$ 711	\$ 668	\$ 711	\$ 717	\$ 781	\$ 862	\$ 934	\$ 1006
611	650	656	611	656	663	727	805	877	950
603	639	644	603	644	650	714	796	867	940

INFORMATION

Note:

There are 2 wood and upholstered back styles to choose from:
Round Back = VRB
Square Back = VSB

UPHOLSTERY INFORMATION

C.O.M. Upholstery

C.O.M. requirement for 10 chairs or less is 1-1/2 yards per chair of 54" wide nondirectional fabric. For orders of 11 or more chairs and for complete information on ordering C.O.M., see "Ordering C.O.M., C.O.V. and C.O.L." section.

OPTIONS

California TB133 Fire Safety Code

For California Technical Bulletin 133 compliant models, add the following upcharge:
Model=Conference
Added Lead Time=1 week
Added list price=\$76

Round Back chairs with both FR and vinyl together must be ordered as a Special.

SPECIAL SERVICES

Special Carton Marking

With specially marked information N/C



Shipping

Shipped **assembled freight prepaid f.o.b. Green Bay, Wisconsin 54302** factory. Freight class #125.

Specifications and prices are subject to change without prior notice.

Stack/Nesting

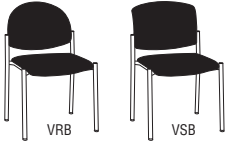
Versa® Conference

MODEL	Features	MODEL NUMBER						Approx. Packaged Weight	
		Basic Model	Frame Color	Upholstery Color	Fire Code	Glide Option	Back Style		
 <p>VCUP</p>	<p>Four-Leg Armless Chair</p> <ul style="list-style-type: none"> • Generously proportioned seat and back have thick foam cushioning and are upholstered • Back is fully upholstered • Brackets attaching back to frame are concealed • Round tubular steel frame • "Kick back" rear leg style enhances stability • Powder-coated or chrome plated frames • Stacking. Caution should be exercised to prevent casters from marring components such as frames, fabric, etc., and to prevent casters from becoming "hung up" underneath the seat of the chair below. • Stacking on dollies is NOT recommended with casters 	Upholstered, Casters	VCNAC	<input type="checkbox"/> <input type="checkbox"/>	<input type="checkbox"/> <input type="checkbox"/> <input type="checkbox"/> <input type="checkbox"/>	<input type="checkbox"/> <input type="checkbox"/>		<input type="checkbox"/> <input type="checkbox"/>	23.0#
		Upholstered, Non-Ganging	VCNAL	<input type="checkbox"/> <input type="checkbox"/>	<input type="checkbox"/> <input type="checkbox"/> <input type="checkbox"/> <input type="checkbox"/>	<input type="checkbox"/> <input type="checkbox"/>	<input type="checkbox"/>	<input type="checkbox"/> <input type="checkbox"/>	23.0#
 <p>HRDPT</p>	<p>Versa® Transport Dolly</p> <ul style="list-style-type: none"> • Accommodates up to 8 conference stacking chairs • Easy maneuverability with 5" casters; two fixed, two swivel • Rugged weld tubular steel frame • Black powder-coated finish 		MVP.BL						19.0#

A B C D E F

HOW TO ORDER

Indicate the following information on order form:

1. Quantity of each item.
2. Model number, including options. See "How To Build a Model Number".
3. Any special service required.

Note: • The indicates that a choice is required.

- The absence of the indicates that no choice is required.
- Alpha-numeric characters in place of indicate that no other alternatives are available.

HOW TO BUILD A MODEL NUMBER

- A** Select basic model.
- B** Select frame color.
Refer to color addendum at ki.com or KI Fabrics & Finishes binder.
End caps will match frame color, unless frame is chrome or hammertone (then black).
- C** Select upholstery grade/color.
Refer to color addendum at ki.com or KI Fabrics & Finishes binder.
- D** Select fire code.

NFR	- Compliance to TB 117-2013
FR	- Compliance to TB 133
- E** Select glide option.

P	- Plastic glides
S	- Steel glides (standard)
- F** Select back style.

- VRB** - Round (original style)
- VSB** - Square (new style)



Delivered Pricing Unupholstered	Delivered Pricing Fabric Grade 1 & C.O.M.	Delivered Pricing Fabric Grade 2	Delivered Pricing Fabric Grade 3	Delivered Pricing C.O.V.	Delivered Pricing Vinyl Group 2V	Delivered Pricing Pallas Fabric Group P0	Delivered Pricing Pallas Fabric Group P1	Delivered Pricing Pallas Fabric Group P2	Delivered Pricing Pallas Fabric Group P3	Delivered Pricing Pallas Fabric Group P4
N/A	\$ 638	\$ 680	\$ 683	\$ 638	\$ 683	\$ 688	\$ 752	\$ 835	\$ 905	\$ 980
N/A	571	611	614	571	614	622	685	768	837	912

\$ 438

INFORMATION

Note:

There are 2 wood and upholstered back styles to choose from:
Round Back = VRB
Square Back = VSB

UPHOLSTERY INFORMATION

C.O.M. Upholstery

C.O.M. requirement for 10 chairs or less is 1-1/2 yards per chair of 54" wide nondirectional fabric. For orders of 11 or more chairs and for complete information on ordering C.O.M., see "Ordering C.O.M., C.O.V. and C.O.L." section.

OPTIONS

California TB133 Fire Safety Code

For California Technical Bulletin 133 compliant models, add the following upcharge:
Model=Conference
Added Lead Time=1 week
Added list price=\$76

Round Back chairs with both FR and vinyl together must be ordered as a Special.

SPECIAL SERVICES

Special Carton Marking

With specially marked information N/C

Shipping

Shipped **assembled freight prepaid f.o.b. Green Bay, Wisconsin 54302** factory. Freight class #125.

Specifications and prices are subject to change without prior notice.

Stack/Nesting

Versa® Conference

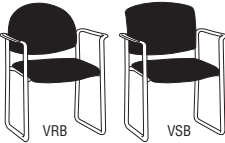
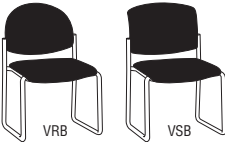
MODEL	Features	MODEL NUMBER						Approx. Packaged Weight	
		Basic Model	Frame Color	Upholstery Color	Fire Code	Glide Option	Back Style		
 <p>VRB VSB</p> <p>VCUP</p>	<p>Sled Base Armchair</p> <ul style="list-style-type: none"> • Generously proportioned seat and back have thick foam cushioning and are upholstered • Back is fully upholstered • Brackets attaching back to frame are concealed • Round tubular steel frame • Molded nylon arms • Ganger fastened to armrest and chrome finished • NONSTACKING 	Upholstered, Non-Ganging	VCWAS	<input type="checkbox"/>	<input type="checkbox"/> <input type="checkbox"/> <input type="checkbox"/> <input type="checkbox"/> <input type="checkbox"/>	<input type="checkbox"/>	<input type="checkbox"/> <input type="checkbox"/>	<input type="checkbox"/> <input type="checkbox"/>	26.0#
		Upholstered, Ganging	VCWASG	<input type="checkbox"/>	<input type="checkbox"/> <input type="checkbox"/> <input type="checkbox"/> <input type="checkbox"/> <input type="checkbox"/>	<input type="checkbox"/>	<input type="checkbox"/> <input type="checkbox"/>	<input type="checkbox"/> <input type="checkbox"/>	27.0#
 <p>VRB VSB</p> <p>VCUP</p>	<p>Sled Base Armless Chair</p> <ul style="list-style-type: none"> • Generously proportioned seat and back have thick foam cushioning and are upholstered • Back is fully upholstered • Brackets attaching back to frame are concealed • Round tubular steel frame • NONSTACKING 	Upholstered, Non-Ganging	VCNAS	<input type="checkbox"/>	<input type="checkbox"/> <input type="checkbox"/> <input type="checkbox"/> <input type="checkbox"/> <input type="checkbox"/>	<input type="checkbox"/>	<input type="checkbox"/> <input type="checkbox"/>	<input type="checkbox"/> <input type="checkbox"/>	23.0#

A **B** **C** **D** **E** **F**

HOW TO ORDER

Indicate the following information on order form:

1. Quantity of each item.
2. Model number, including options. See "How To Build a Model Number".
3. Any special service required.

Note: • The indicates that a choice is required.

- The absence of the indicates that no choice is required.
- Alpha-numeric characters in place of indicate that no other alternatives are available.

HOW TO BUILD A MODEL NUMBER

- A** Select basic model.
- B** Select frame color.
Refer to color addendum at ki.com or KI Fabrics & Finishes binder.
- C** Select upholstery grade/color.
Refer to color addendum at ki.com or KI Fabrics & Finishes binder.
- D** Select fire code.
NFR - Compliance to TB 117-2013
FR - Compliance to TB 133
- E** Select glide option.
NGL - No glides
NSG - Sled base non-skid glides; add \$21
- F** Select back style.
VRB - Round (original style)
VSB - Square (new style)



Delivered Pricing Fabric Grade 1 & C.O.M.	Delivered Pricing Fabric Grade 2	Delivered Pricing Fabric Grade 3	Delivered Pricing C.O.V.	Delivered Pricing Vinyl Group 2V	Delivered Pricing Pallas Fabric Group P0	Delivered Pricing Pallas Fabric Group P1	Delivered Pricing Pallas Fabric Group P2	Delivered Pricing Pallas Fabric Group P3	Delivered Pricing Pallas Fabric Group P4
\$ 781	\$ 821	\$ 828	\$ 781	\$ 828	\$ 834	\$ 897	\$ 980	\$ 1045	\$ 1121
796	836	839	796	839	847	911	987	1058	1133
\$ 752	\$ 797	\$ 801	\$ 752	\$ 801	\$ 809	\$ 872	\$ 949	\$ 1018	\$ 1091

INFORMATION

Note:

There are 2 wood and upholstered back styles to choose from:
Round Back = VRB
Square Back = VSB

UPHOLSTERY INFORMATION

C.O.M. Upholstery

C.O.M. requirement for 10 chairs or less is 1-1/2 yards per chair of 54" wide nondirectional fabric. For orders of 11 of more chairs and for complete information on ordering C.O.M., see "Ordering C.O.M., C.O.V. and C.O.L." section.

OPTIONS

California TB133 Fire Safety Code

For California Technical Bulletin 133 compliant models, add the following upcharge:
Model=Conference
Added Lead Time=1 week
Added list price=\$76

Round Back chairs with both FR and vinyl together must be ordered as a Special.

SPECIAL SERVICES

Special Carton Marking

With specially marked information N/C

Shipping

Shipped **assembled freight prepaid f.o.b. Green Bay, Wisconsin 54302** factory. Freight class #125.

Specifications and prices are subject to change without prior notice.

Stack/Nesting

Versa® Standard General Information



Standard Four-Leg
Armchair (96WAL)



Armless Four-Leg
Chair (96NAL)



Standard Four-Leg
Tablet Arm Chair
(96TAR)



Standard Sled Base
Armchair (96WAS)



Armless Standard
Sled Base Chair
(96NAS)

Features

Stackable	•	•		
Ganging	•	•	•	•

General Dimensions

Seat width	17-1/2"	17-1/2"	17-1/2"	17-1/2"	17-1/2"
Seat depth	17-1/2"	17-1/2"	17-1/2"	17-1/2"	17-1/2"
Seat height	17-1/2"	17-1/2"	17-1/2"	17-1/2"	17-1/2"

Overall Dimensions

Width	22-5/8"	19-3/8"	21-3/4"	22-5/8"	19-3/8"
Depth	20-3/4"	20-3/4"	27-1/4"	20-3/4"	20-3/4"
Height	31"	31"	31"	31"	31"
Ganging on center	23-1/2"	23-1/2"		23-1/2"	23-1/2"
Top of arm to floor	25-3/8"			25-3/8"	

Stacking on Dolly

Overall width	22-3/8"	22-3/8"		
Overall depth	36"	36"		
Quantity/height	10 Chairs/60" High	10 Chairs/54" High		

Stacking on Floor

Width	22-5/8"	19-3/8"		
Depth	25-1/4"	25-1/4"		
Quantity/height	4 Chairs/40" High	4 Chairs/40" High		



Ganging



Kick Back Leg



C01 Square Cut-outs
(Round Back)



C02 Ellipse Cut-outs
(Round Back)



C03 Starburst Cut-outs
(Round Back)



C04 Fan Cut-outs
(Square Back)

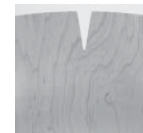

C05 Split Cut-outs
(Square Back)

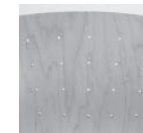

C06 Perforated Cut-outs
(Square Back)

SPECIFICATIONS

Standard Frame

Legs of 7/8" o.d. x 13-gauge tubular steel. "Kick back" rear legs on four-leg model increases structural integrity and adds to stability. Side members of 7/8" o.d. x 13-gauge tubular steel. Cross tube members of 7/8" o.d. x 14-gauge tubular steel. Legs are joined to side members by brazing; all other joints are robotically welded.

Standard Tube End Caps

Molded plastic. The end cap will match the frame color. With chrome frames, the end cap will be black (upholstered and wood chairs) or will match the poly seat and black color.

Armrests

Molded nylon or chrome-plated aluminum (for non-ganging models).

Four-Leg Floor Glides

Chrome plated steel or plastic.

Sled Base Non-Skid Glides

Black PVC material. Fixed in position by a screw. Field-installable.

Upholstered Seat

3/8" thick polypropylene. Fastens to frame with four screws through T-nuts embedded in seat. Polyfoam cushion 3/4" thick glued to seat.

Upholstered Backrest

Two-piece construction. Inner back is polypropylene with 3/4" thick polyurethane foam. Outer back is a polypropylene back insert with 1/4" thick polyurethane foam and three back clips (.018" thick cold-rolled annealed spring steel).

Polypropylene Seat and Backrest

Injection-molded polypropylene.

Ganging Fixture

Welded steel rod. Armrest models have separate fixture that can be installed with screws to underside of arms (shipped

k.d.). Armless models have fixture welded to frame.

Wood Seat and Backrest

Backs are constructed of 9-ply hard maple with "A Grade" flat cut faces. Seats are constructed of 3/8" hard maple. Wood seats and backs are available in maple with "A Grade" flat cut faces. Seats and backs are assembled with four ribbed carriage bolts and low profile screws with black oxide-plated finish. Stacking version has 4 plastic bumpers that protect seat. Caution needs to be used when stacking.

Frame Finishes

Baked-on, electrostatically-applied epoxy powder coating, or bright nickel-chrome plated.

Tablet Arm Chair

Tablet of resin core with laminate writing surface and backing sheet. Round tablet edge with clear lacquer finish. Available in left- or right-hand models. Nonstacking.

Seating clearance is 14". Tablet is 20-5/8" long and 12" wide.

Standard Transport Dolly

Tubular steel frame, black powder-coated finish. Four 5" swivel wheels.

Stacking Vinyl, Polyurethane, and Imitation Leather Upholstered Chairs

It is recommended that chairs to be stacked be covered in material other than vinyl, polyurethane, or imitation leather as an impression in the seat may result. KI does not warrant the effects of stacking on stock or C.O.M. vinyl, polyurethane, or imitation leather upholstery.

INFORMATION

C.O.M. Testing and Production Requirements

Not all materials are suitable for upholstering this product. A 1 yd. x 54" sample for standard models and full back models must be submitted and approved prior to accep-



Stack/Nesting

Versa® Standard General Information



Poly Four-Leg Armchair (15WALP)



Poly Four-Leg Tablet Arm Chair (15TARP)



Armless Poly Sled Base Chair (15NASP)



Armless Round Wood Four-Leg Chair (15NALW)



Armless Square Wood Sled Base Chair (15NASW)

Features					
Stackable	•			•	
Ganging	•		•	•	•
General Dimensions					
Seat width	17"	17"	17"	16-15/16"	16-15/16"
Seat depth	17-1/2"	17-1/2"	17-1/2"	17-1/2"	17-1/2"
Seat height	16-1/8"	16-1/8"	16-1/8"	16-1/8"	16-1/8"
Overall Dimensions					
Width	22-5/8"	22-5/8"	19-1/8"	19-1/8"	19-1/8"
Depth	20-3/4"	20-3/4"	20-3/4"	20-3/4"	20-3/4"
Height	31"	31"	31"	31"	31"
Ganging on center	23-1/2"		23-1/2"	23-1/2"	23-1/2"
Top of arm to floor	24-7/8"		24-7/8"		
Stacking on Dolly					
Overall width	22-3/8"			22-3/8"	
Overall depth	36"			36"	
Quantity/height	10 Chairs/60" High			8 Chairs/60" High	
Stacking on Floor					
Width	22-5/8"			22-5/8"	
Depth	25-1/4"			25-1/4"	
Quantity/height	4 Chairs/40" High			4 Chairs/40" High	

tance of an order. If the fabric is directional in pattern or weave, the direction must be indicated on the submitted sample, and additional yardage may be requested. Test samples must be sent to:

KI
 Attn: C.O.M. Specialist
 1687 Westminster Drive - Gate 3
 Green Bay, WI 54302

Fabric Disclaimer

Fabric will be applied as swatched by the fabric manufacturer. Fabric that is required to be applied differently than is swatched will need a Special Cost Request written specifying the direction the fabric is to be applied. The posted standard lead time will apply to the Special Cost Request.

INFORMATION

Warranty

Refer to KI Terms & Conditions document or visit ki.com

Stack/Nesting

Versa® Standard General Information



Standard Four-Leg Wallsaver Armchair (96WALWS)



Upholstered Seat/Wood Back Four-Leg Armchair (15WALUW)



Armless Upholstered Seat/Wood Back Sled Base Chair (15NASGUW)



Transport Dolly (MVP.BL)

Features				
Stackable	•	•		
Ganging	•	•	•	
General Dimensions				
Seat width	17-1/2"	17-1/2"	17-1/2"	
Seat depth	17-1/2"	17-1/2"	17-1/2"	
Seat height	17-1/2"	17-1/2"	17-1/2"	
Overall Dimensions				
Width	22-5/8"	22-5/8"	19-3/8"	22-3/8"
Depth	21-3/4"	20-3/4"	20-3/4"	25-5/8"
Height	31"	31"	31"	
Ganging on center	23-1/2"			
Top of arm to floor	25-3/8"	25-3/8"		
Stacking on Dolly				
Overall width		22-3/8"		
Overall depth		36"		
Quantity/height		10 Chairs/60" High		
Stacking on Floor				
Width	22-5/8"	22-5/8"		
Depth	26-1/4"	25-1/4"		
Quantity/height	4 Chairs/40" High	4 Chairs/40" High		



Ganging



Kick Back Leg



C01 Square Cut-outs (Round Back)



C02 Ellipse Cut-outs (Round Back)



C03 Starburst Cut-outs (Round Back)



C04 Fan Cut-outs (Square Back)

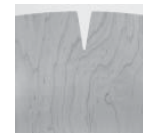

C05 Split Cut-outs (Square Back)

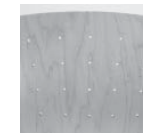

C06 Perforated Cut-outs (Square Back)

SPECIFICATIONS

Standard Frame

Legs of 7/8" o.d. x 13-gauge tubular steel. "Kick back" rear legs on four-leg model increases structural integrity and adds to stability. Side members of 7/8" o.d. x 13-gauge tubular steel. Cross tube members of 7/8" o.d. x 14-gauge tubular steel. Legs are joined to side members by brazing; all other joints are robotically welded.

Stool

Legs of 7/8" o.d. x 13-gauge tubular steel. Side members of 7/8" o.d. x 13-gauge tubular steel. Cross tube members of 7/8" o.d. x 14-gauge tubular steel. Legs are joined to side members by brazing; all other joints are hand welded. The footing is 7/8" outside diameter, 13-gauge.

Standard Tube End Caps

Molded plastic. The end cap will match the frame color. With chrome frames, the end cap will be black (upholstered and wood

chairs) or will match the poly seat and black color.

Armrests

Molded nylon or chrome-plated aluminum (for non-ganging models).

Four-Leg Floor Glides

Chrome plated steel or plastic.

Sled Base Non-Skid Glides

Black PVC material. Fixed in position by a screw. Field-installable.

Upholstered Seat

3/8" thick polypropylene. Fastens to frame with four screws through T-nuts embedded in seat. Polyfoam cushion 3/4" thick glued to seat.

Upholstered Backrest

Two-piece construction. Inner back is polypropylene with 3/4" thick polyurethane foam. Outer back is a polypropylene back insert with 1/4" thick polyurethane foam

and three back clips (.018" thick cold-rolled annealed spring steel).

Polypropylene Seat and Backrest

Injection-molded polypropylene.

Upholstered Square Back

Two-piece construction. Inner back is 11-ply hard maple (.44 thick) with 3/4" thick urethane foam. The outer back is 3-ply gum veneer (.19 thick) with 1/4" urethane foam. Both inner and outer back boards have formed contours. The outer back is attached to the inner back with (3) spring steel clips. The back assembly is attached to the frame with (4) 1/4"-20 screws.

Ganging Fixture

Welded steel rod. Armrest models have separate fixture that can be installed with screws to underside of arms (shipped k.d.). Armless models have fixture welded to frame.

Wood Seat and Backrest

Backs are constructed of 9-ply hard maple with "A Grade" flat cut faces. Seats are constructed of 3/8" hard maple. Wood seats and backs are available in maple with "A Grade" flat cut faces. Seats and backs are assembled with four ribbed carriage bolts and low profile screws with black oxide-plated finish. Stacking version has 4 plastic bumpers that protect seat. Caution needs to be used when stacking.

Frame Finishes

Baked-on, electrostatically-applied epoxy powder coating, or bright nickel-chrome plated.

Standard Transport Dolly

Tubular steel frame, black powder-coated finish. Four 5" swivel wheels.

Stacking Vinyl, Polyurethane, and Imitation Leather Upholstered Chairs

It is recommended that chairs to be stacked



**Upholstered Cafe Stool
with Arms
(S96WAL)**



**Armless Poly Cafe Stool
(S15WALP)**

Features

Stackable

Ganging

General Dimensions

Seat width	17-1/2"	17-1/2"
Seat depth	17-1/2"	17-1/2"
Seat height	29-1/2"	29-1/2"

Overall Dimensions

Width	22-5/8"	19-3/8"
Depth	22-3/8"	22-3/8"
Height	43"	43"
Top of arm to floor	37-3/8"	

be covered in material other than vinyl, polyurethane, or imitation leather as an impression in the seat may result. KI does not warrant the effects of stacking on stock or C.O.M. vinyl, polyurethane, or imitation leather upholstery.

INFORMATION

C.O.M. Testing and Production Requirements

Not all materials are suitable for upholstering this product. A 1 yd. x 54" sample for standard models and full back models must be submitted and approved prior to acceptance of an order. If the fabric is directional in pattern or weave, the direction must be indicated on the submitted sample, and additional yardage may be requested.

Test samples must be sent to:

KI
Attn: C.O.M. Specialist
1687 Westminster Drive - Gate 3

Green Bay, WI 54302

Fabric Disclaimer

Fabric will be applied as swatched by the fabric manufacturer. Fabric that is required to be applied differently than is swatched will need a Special Cost Request written specifying the direction the fabric is to be applied. The posted standard lead time will apply to the Special Cost Request.

INFORMATION

Warranty

Refer to KI Terms & Conditions document or visit ki.com

Stack/Nesting

Versa® Standard

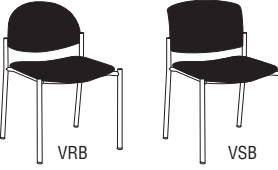
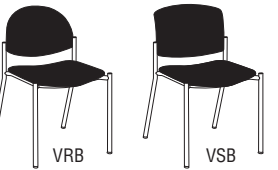
		Features	MODEL NUMBER									
			Basic Model	Frame Color	Seat & Back Color	Wood Seat and Back Color	Upholstery Color	Fire Code	Glide Option	Back Style	Wood Back Cut-outs	Wood Stacking Option
 <p>VRB VSB</p> <p>VRPY VRWD VRUP</p> <p>Four-Leg Armless Chair</p> <ul style="list-style-type: none"> • Back and seat are foam cushioned and uph., polypropylene, or wood • Round tubular steel frame • "Kick back" rear leg style enhances stability • Ganger welded to frame and finished to match frame • Stacking 	Poly, Ganging	15NAGP	<input type="checkbox"/> <input type="checkbox"/>	<input type="checkbox"/> <input type="checkbox"/> <input type="checkbox"/>			<input type="checkbox"/> <input type="checkbox"/>	<input type="checkbox"/>				
	Wood, Ganging	15NAGW	<input type="checkbox"/> <input type="checkbox"/>		<input type="checkbox"/> <input type="checkbox"/> <input type="checkbox"/>			<input type="checkbox"/>	<input type="checkbox"/> <input type="checkbox"/> <input type="checkbox"/>	<input type="checkbox"/> <input type="checkbox"/>	<input type="checkbox"/> <input type="checkbox"/>	
	Poly, Non-Ganging	15NALP	<input type="checkbox"/> <input type="checkbox"/>	<input type="checkbox"/> <input type="checkbox"/> <input type="checkbox"/>			<input type="checkbox"/> <input type="checkbox"/>	<input type="checkbox"/>				
	Wood, Non-Ganging	15NALW	<input type="checkbox"/> <input type="checkbox"/>		<input type="checkbox"/> <input type="checkbox"/> <input type="checkbox"/>			<input type="checkbox"/>	<input type="checkbox"/> <input type="checkbox"/> <input type="checkbox"/>	<input type="checkbox"/> <input type="checkbox"/>	<input type="checkbox"/> <input type="checkbox"/>	
	Uph, Ganging	96NAG	<input type="checkbox"/> <input type="checkbox"/>			<input type="checkbox"/> <input type="checkbox"/> <input type="checkbox"/> <input type="checkbox"/> <input type="checkbox"/> <input type="checkbox"/>	<input type="checkbox"/> <input type="checkbox"/>	<input type="checkbox"/>	<input type="checkbox"/> <input type="checkbox"/> <input type="checkbox"/>			
	Uph, Non-Ganging	96NAL	<input type="checkbox"/> <input type="checkbox"/>			<input type="checkbox"/> <input type="checkbox"/> <input type="checkbox"/> <input type="checkbox"/> <input type="checkbox"/> <input type="checkbox"/>	<input type="checkbox"/> <input type="checkbox"/>	<input type="checkbox"/>	<input type="checkbox"/> <input type="checkbox"/> <input type="checkbox"/>			
 <p>VRB VSB</p> <p>VRPY VRWD VRUP</p> <p>Four-Leg Wallsaver Armless Chair</p> <ul style="list-style-type: none"> • Back and seat are foam cushioned and uph., polypropylene, or wood • Round tubular steel frame • Ganger welded to frame and finished to match frame • Stacking • Wallsaver rear legs touch base of wall preventing chair back from contacting wall 	Poly, Ganging	15NAGPWS	<input type="checkbox"/> <input type="checkbox"/>	<input type="checkbox"/> <input type="checkbox"/> <input type="checkbox"/>			<input type="checkbox"/> <input type="checkbox"/>	S				
	Wood, Ganging	15NAGWWS	<input type="checkbox"/> <input type="checkbox"/>		<input type="checkbox"/> <input type="checkbox"/> <input type="checkbox"/>			S	<input type="checkbox"/> <input type="checkbox"/> <input type="checkbox"/>	<input type="checkbox"/> <input type="checkbox"/> <input type="checkbox"/>	<input type="checkbox"/> <input type="checkbox"/>	
	Poly, Non-Ganging	15NALPWS	<input type="checkbox"/> <input type="checkbox"/>	<input type="checkbox"/> <input type="checkbox"/> <input type="checkbox"/>			<input type="checkbox"/> <input type="checkbox"/>	S				
	Wood, Non-Ganging	15NALWWS	<input type="checkbox"/> <input type="checkbox"/>		<input type="checkbox"/> <input type="checkbox"/> <input type="checkbox"/>			S	<input type="checkbox"/> <input type="checkbox"/> <input type="checkbox"/>	<input type="checkbox"/> <input type="checkbox"/> <input type="checkbox"/>	<input type="checkbox"/> <input type="checkbox"/>	
	Uph, Ganging	96NAGWS	<input type="checkbox"/> <input type="checkbox"/>			<input type="checkbox"/> <input type="checkbox"/> <input type="checkbox"/> <input type="checkbox"/> <input type="checkbox"/> <input type="checkbox"/>	<input type="checkbox"/> <input type="checkbox"/>	S	<input type="checkbox"/> <input type="checkbox"/> <input type="checkbox"/>			
	Uph, Non-Ganging	96NALWS	<input type="checkbox"/> <input type="checkbox"/>			<input type="checkbox"/> <input type="checkbox"/> <input type="checkbox"/> <input type="checkbox"/> <input type="checkbox"/> <input type="checkbox"/>	<input type="checkbox"/> <input type="checkbox"/>	S	<input type="checkbox"/> <input type="checkbox"/> <input type="checkbox"/>			
			A	B	C	D	E	F	G	H	I	J

HOW TO ORDER

Indicate the following information on order form:

1. Quantity of each item.
2. Model number, including options. See "How To Build a Model Number".
3. Any special service required.

Note:

- The indicates that a choice is required.
- The absence of the indicates that no choice is required.
- Alpha-numeric characters in place of indicate that no other alternatives are available.

HOW TO BUILD A MODEL NUMBER

- A** Select basic model.
- B** Select frame color.
Refer to color addendum at ki.com or KI Fabrics & Finishes binder.
- C** Select poly seat and back color.
Refer to color addendum at ki.com or KI Fabrics & Finishes binder.
- D** Select wood seat and back color.
Refer to color addendum at ki.com or KI Fabrics & Finishes binder.
- E** Select upholstery grade/color.
Refer to color addendum at ki.com or KI Fabrics & Finishes binder.
- F** Select fire code.
FR - Compliance to TB 133
NFR - Compliance to TB 117-2013
- G** Select glide option.
P - Plastic glides
S - Steel glides (standard)
- H** Select back style.
VRB - Round (original style)
VSB - Square (new style)
- I** Select wood back cut-out.
C01 - Square (round back only)
C02 - Ellipse (round back only)
C03 - Starburst (round back only)
C04 - Fan (square back only)
C05 - Split (square back only)
C06 - Perforated (square back only)
NC - No cut-out (both styles)
- J** Select wood stacking option.
NS - Nonstacking bumper
SB - Stacking bumper



Approx. Packaged Weight	Delivered Pricing Unupholstered	Delivered Pricing Fabric Grade 1 & C.O.M.	Delivered Pricing Fabric Grade 2	Delivered Pricing Fabric Grade 3	Delivered Pricing C.O.V.	Delivered Pricing Vinyl Group 2V	Delivered Pricing Pallas Fabric Group P0	Delivered Pricing Pallas Fabric Group P1	Delivered Pricing Pallas Fabric Group P2	Delivered Pricing Pallas Fabric Group P3	Delivered Pricing Pallas Fabric Group P4
17.0#	\$ 350										
18.0#	621										
17.0#	327										
18.0#	599										
19.0#	N/A	474	507	508	474	508	506	517	553	587	629
19.0#	N/A	448	483	484	448	484	480	490	527	563	602

17.0#	\$ 385										
18.0#	656										
17.0#	362										
18.0#	633										
19.0#	N/A	510	544	545	510	545	540	551	592	624	664
19.0#	N/A	485	520	521	485	521	517	527	564	600	637

INFORMATION

Note:

There are 2 wood and upholstered back styles to choose from:
Round Back = VRB
Square Back = VSB

Poly backs are round only.

The original ROUND wood back style (RB) has the following wood cut-out options only:
C01 = Square
C02 = Ellipse
C03 = Standard
NC = No cut-out

The new SQUARE wood back style (SB) has the following wood cut-out options only:
C04 = Fan
C05 = Split
C06 = Perforated
NC = No cut-out

OPTIONS

California TB133 Fire Safety Code

For California Technical Bulletin 133 compliant models, add the following upcharge:
Model=Upholstered
Added Lead Time=1 week
Added list price=\$57
Model=Polypropylene
Added Lead Time=1 week
Added list price=\$31

Round Back chairs with both FR and vinyl together must be ordered as a Special.

UPHOLSTERY INFORMATION

C.O.M. Upholstery

C.O.M. requirement 1 yard per chair of 54" wide nondirectional fabric. For complete information on ordering C.O.M., see "Ordering C.O.M., C.O.V. and C.O.L." section.

SPECIAL SERVICES

Special Carton Marking

With specially marked information N/C

Shipping

Shipped **assembled freight prepaid f.o.b. Green Bay, Wisconsin 54302** factory. Freight class #125.

Specifications and prices are subject to change without prior notice.

Stack/Nesting

Versa® Standard

	Features	MODEL NUMBER										
		Basic Model	Frame Color	Seat & Back Color	Wood Seat and Back Color	Uph. Color	Fire Code	Glide Option	Back Style	Wood Back Cut-outs	Wood Stacking Option	Arm Option
<p>VRB VSB</p> <p>VRPY VRWD VRUP</p> <p>Four-Leg Armchair</p> <ul style="list-style-type: none"> • Back and seat are foam cushioned and uph., polypropylene, or wood • Round tubular steel frame • "Kick back" rear leg style enhances stability • Molded nylon or chrome plated (non-ganging) arms • Ganger fastened to nylon armrest • Stacking 	Poly, Ganging	15WAGP	<input type="checkbox"/>	<input type="checkbox"/>			<input type="checkbox"/>	<input type="checkbox"/>			MPA	
	Wood, Ganging	15WAGW	<input type="checkbox"/>		<input type="checkbox"/>		<input type="checkbox"/>	<input type="checkbox"/>	<input type="checkbox"/>	<input type="checkbox"/>	MPA	
	Poly, Non-Ganging	15WALP	<input type="checkbox"/>	<input type="checkbox"/>			<input type="checkbox"/>	<input type="checkbox"/>			<input type="checkbox"/>	
	Wood, Non-Ganging	15WALW	<input type="checkbox"/>		<input type="checkbox"/>		<input type="checkbox"/>	<input type="checkbox"/>	<input type="checkbox"/>	<input type="checkbox"/>	<input type="checkbox"/>	
	Uph, Ganging	96WAG	<input type="checkbox"/>			<input type="checkbox"/>	<input type="checkbox"/>	<input type="checkbox"/>	<input type="checkbox"/>		MPA	
	Uph, Non-Ganging	96WAL	<input type="checkbox"/>				<input type="checkbox"/>	<input type="checkbox"/>	<input type="checkbox"/>		<input type="checkbox"/>	
<p>VRB VSB</p> <p>VRPY VRWD VRUP</p> <p>Four-Leg Wallsaver Armchair</p> <ul style="list-style-type: none"> • Back and seat are foam cushioned and uph., polypropylene, or wood • Round tubular steel frame • Molded nylon or chrome plated (non-ganging) arms • Ganger fastened to nylon armrest • Stacking • Wallsaver rear legs touch base of wall preventing chair back from contacting wall surface 	Poly, Ganging	15WAGPWS	<input type="checkbox"/>	<input type="checkbox"/>			<input type="checkbox"/>	S			MPA	
	Wood, Ganging	15WAGWWS	<input type="checkbox"/>		<input type="checkbox"/>		<input type="checkbox"/>	S	<input type="checkbox"/>	<input type="checkbox"/>	<input type="checkbox"/>	MPA
	Poly, Non-Ganging	15WALPWS	<input type="checkbox"/>	<input type="checkbox"/>			<input type="checkbox"/>	S			<input type="checkbox"/>	
	Wood, Non-Ganging	15WALWWS	<input type="checkbox"/>		<input type="checkbox"/>		<input type="checkbox"/>	S	<input type="checkbox"/>	<input type="checkbox"/>	<input type="checkbox"/>	<input type="checkbox"/>
	Uph, Ganging	96WAGWS	<input type="checkbox"/>			<input type="checkbox"/>	<input type="checkbox"/>	S	<input type="checkbox"/>			MPA
	Uph, Non-Ganging	96WALWS	<input type="checkbox"/>				<input type="checkbox"/>	S	<input type="checkbox"/>			<input type="checkbox"/>

A B C D E F G H I J K

HOW TO ORDER

Indicate the following information on order form:

- Quantity of each item.
- Model number, including options. See "How To Build a Model Number".
- Any special service required.

Note: • The indicates that a choice is required.

- The absence of the indicates that no choice is required.
- Alpha-numeric characters in place of indicate that no other alternatives are available.

HOW TO BUILD A MODEL NUMBER

- A** Select basic model.
- B** Select frame color.
Refer to color addendum at ki.com or KI Fabrics & Finishes binder.
- C** Select poly seat and back color.
Refer to color addendum at ki.com or KI Fabrics & Finishes binder.
- D** Select wood seat and back color.
Refer to color addendum at ki.com or KI Fabrics & Finishes binder.
- E** Select upholstery grade/color.
Refer to color addendum at ki.com or KI Fabrics & Finishes binder.
- F** Select fire code.
NFR - Compliance to TB 117-2013
FR - Compliance to TB 133
- G** Select glide option.
P - Plastic glides
S - Steel glides (standard)
- H** Select back style.
VRB - Round (original style)
VSB - Square (new style)
- I** Select wood back cut-out.
C01 - Square (round back only)
C02 - Ellipse (round back only)
C03 - Starburst (round back only)
C04 - Fan (square back only)
C05 - Split (square back only)
C06 - Perforated (square back only)
NC - No cut-out (both styles)
- J** Select wood stacking option.
NS - Nonstacking bumper
SB - Stacking bumper
- K** Select arm option.
MPA - Poly
CHA - Chrome plated



Approx. Packaged Weight	Delivered Pricing Unupholstered	Delivered Pricing Fabric Grade 1 & C.O.M.	Delivered Pricing Fabric Grade 2	Delivered Pricing Fabric Grade 3	Delivered Pricing C.O.V.	Delivered Pricing Vinyl Group 2V	Delivered Pricing Pallas Fabric Group P0	Delivered Pricing Pallas Fabric Group P1	Delivered Pricing Pallas Fabric Group P2	Delivered Pricing Pallas Fabric Group P3	Delivered Pricing Pallas Fabric Group P4
19.0#	\$ 362										
20.0#	633										
18.0#	350										
19.0#	621										
21.0#	N/A	485	520	521	485	521	517	527	565	600	637
20.0#	N/A	474	507	508	474	508	506	517	553	587	629

19.0#	\$ 397										
20.0#	668										
18.0#	385										
19.0#	656										
21.0#	N/A	521	553	555	521	555	553	563	602	634	672
20.0#	N/A	510	544	545	510	545	540	551	588	624	662

INFORMATION

Note:

There are 2 wood and upholstered back styles to choose from:
Round Back = VRB
Square Back = VSB

Poly backs are round only.

The original ROUND wood back style (RB) has the following wood cut-out options only:
C01 = Square
C02 = Ellipse
C03 = Standard
NC = No cut-out

The new SQUARE wood back style (SB) has the following wood cut-out options only:
C04 = Fan
C05 = Split
C06 = Perforated
NC = No cut-out

OPTIONS

California TB133 Fire Safety Code

For California Technical Bulletin 133 compliant models, add the following upcharge:
Model=Upholstered
Added Lead Time=1 week
Added list price=\$57
Model=Polypropylene
Added Lead Time=1 week
Added list price=\$31

Round Back chairs with both FR and vinyl together must be ordered as a Special.

UPHOLSTERY INFORMATION

C.O.M. Upholstery

C.O.M. requirement 1 yard per chair of 54" wide nondirectional fabric. For complete information on ordering C.O.M., see "Ordering C.O.M., C.O.V. and C.O.L." section.

SPECIAL SERVICES

Special Carton Marking

With specially marked information N/C



Shipping

Shipped assembled freight prepaid f.o.b. Green Bay, Wisconsin 54302 factory. Freight class #125.

Specifications and prices are subject to change without prior notice.

Stack/Nesting

Versa® Standard

	Features	MODEL NUMBER									
		Basic Model	Frame Color	Seat & Back Color	Wood Seat and Back Color	Upholstery Color	Fire Code	Glide Option	Back Style	Wood Back Cut-outs	Tablet Arm Color
	Poly, Left Hand	15TALP	<input type="checkbox"/> <input type="checkbox"/>	<input type="checkbox"/> <input type="checkbox"/> <input type="checkbox"/>			<input type="checkbox"/> <input type="checkbox"/>	<input type="checkbox"/>			<input type="checkbox"/> <input type="checkbox"/> <input type="checkbox"/>
	Wood, Left Hand	15TALW	<input type="checkbox"/> <input type="checkbox"/>		<input type="checkbox"/> <input type="checkbox"/> <input type="checkbox"/>			<input type="checkbox"/>	<input type="checkbox"/> <input type="checkbox"/> <input type="checkbox"/>	<input type="checkbox"/> <input type="checkbox"/> <input type="checkbox"/>	<input type="checkbox"/> <input type="checkbox"/> <input type="checkbox"/>
	Poly, Right Hand	15TARP	<input type="checkbox"/> <input type="checkbox"/>	<input type="checkbox"/> <input type="checkbox"/> <input type="checkbox"/>			<input type="checkbox"/> <input type="checkbox"/>	<input type="checkbox"/>			<input type="checkbox"/> <input type="checkbox"/> <input type="checkbox"/>
	Wood, Right Hand	15TARW	<input type="checkbox"/> <input type="checkbox"/>		<input type="checkbox"/> <input type="checkbox"/> <input type="checkbox"/>			<input type="checkbox"/>	<input type="checkbox"/> <input type="checkbox"/> <input type="checkbox"/>	<input type="checkbox"/> <input type="checkbox"/> <input type="checkbox"/>	<input type="checkbox"/> <input type="checkbox"/> <input type="checkbox"/>
	Uph, Left Hand	96TAL	<input type="checkbox"/> <input type="checkbox"/>			<input type="checkbox"/> <input type="checkbox"/> <input type="checkbox"/> <input type="checkbox"/> <input type="checkbox"/> <input type="checkbox"/>	<input type="checkbox"/> <input type="checkbox"/>	<input type="checkbox"/>	<input type="checkbox"/> <input type="checkbox"/> <input type="checkbox"/>		<input type="checkbox"/> <input type="checkbox"/> <input type="checkbox"/>
	Uph, Right Hand	96TAR	<input type="checkbox"/> <input type="checkbox"/>			<input type="checkbox"/> <input type="checkbox"/> <input type="checkbox"/> <input type="checkbox"/> <input type="checkbox"/> <input type="checkbox"/>	<input type="checkbox"/> <input type="checkbox"/>	<input type="checkbox"/>	<input type="checkbox"/> <input type="checkbox"/> <input type="checkbox"/>		<input type="checkbox"/> <input type="checkbox"/> <input type="checkbox"/>
	VRPY										
	VRWD										
	VRUP										
	Four-Leg Tablet Arm Chair										
	<ul style="list-style-type: none"> • Back and seat are foam cushioned and upholstered, polypropylene, or wood • "Kick back" rear leg style enhances stability • Tablet arm available in left - or right - hand models • Laminate tablet arm surface • Tablet flips up for easy access • NONSTACKING 										

HOW TO ORDER

Indicate the following information on order form:

1. Quantity of each item.
2. Model number, including options. See "How To Build a Model Number".
3. Any special service required.

Note: • The indicates that a choice is required.

- The absence of the indicates that no choice is required.
- Alpha-numeric characters in place of indicate that no other alternatives are available.

HOW TO BUILD A MODEL NUMBER

- A** Select basic model.
- B** Select frame color. Refer to color addendum at ki.com or KI Fabrics & Finishes binder. End caps will match frame color, unless frame is chrome or hammertone (then black).
- C** Select poly seat and back color. Refer to color addendum at ki.com or KI Fabrics & Finishes binder.
- D** Select wood seat and back color. Refer to color addendum at ki.com or KI Fabrics & Finishes binder.
- E** Select upholstery grade/color. Refer to color addendum at ki.com or KI Fabrics & Finishes binder.
- F** Select fire code. **NFR** - Compliance to TB 117-2013

FR - Compliance to TB 133

- G** Select glide option.
 - P** - Plastic glides
 - S** - Steel glides (standard)
- H** Select back style.
 - VRB** - Round (original style)
 - VSB** - Square (new style)
- I** Select wood back cut-out.
 - C01** - Square (round back only)
 - C02** - Ellipse (round back only)
 - C03** - Starburst (round back only)
 - C04** - Fan (square back only)
 - C05** - Split (square back only)
 - C06** - Perforated (square back only)
 - NC** - No cut-out (both styles)
- J** Select tablet arm option. Refer to color addendum at ki.com or KI Fabrics & Finishes binder.



Approx. Packaged Weight	Delivered Pricing Unupholstered	Delivered Pricing Fabric Grade 1 & C.O.M.	Delivered Pricing Fabric Grade 2	Delivered Pricing Fabric Grade 3	Delivered Pricing C.O.V.	Delivered Pricing Vinyl Group 2V	Delivered Pricing Pallas Fabric Group P0	Delivered Pricing Pallas Fabric Group P1	Delivered Pricing Pallas Fabric Group P2	Delivered Pricing Pallas Fabric Group P3	Delivered Pricing Pallas Fabric Group P4
28.0#	\$ 533										
28.0#	805										
28.0#	533										
28.0#	805										
28.0#	N/A	659	691	695	659	695	690	700	739	773	806
28.0#	N/A	659	691	695	659	695	690	700	739	773	806

INFORMATION

Note:

There are 2 wood and upholstered back styles to choose from:
Round Back = VRB
Square Back = VSB

Poly backs are round only.

The original ROUND wood back style (RB) has the following wood cut-out options only:
C01 = Square
C02 = Ellipse
C03 = Standard
NC = No cut-out

The new SQUARE wood back style (SB) has the following wood cut-out options only:
C04 = Fan
C05 = Split
C06 = Perforated
NC = No cut-out

OPTIONS

California TB133 Fire Safety Code

For California Technical Bulletin 133 compliant models, add the following upcharge:
Model=Upholstered
Added Lead Time=1 week
Added list price=\$57
Model=Polypropylene
Added Lead Time=1 week
Added list price=\$31

Round Back chairs with both FR and vinyl together must be ordered as a Special.

UPHOLSTERY INFORMATION

C.O.M. Upholstery

C.O.M. requirement 1 yard per chair of 54" wide nondirectional fabric. For complete information on ordering C.O.M., see "Ordering C.O.M., C.O.V. and C.O.L." section.

SPECIAL SERVICES

Special Carton Marking

With specially marked information N/C

Shipping

Shipped **assembled freight prepaid f.o.b. Green Bay, Wisconsin 54302** factory. Freight class #125.

Specifications and prices are subject to change without prior notice.

Stack/Nesting

Versa® Standard

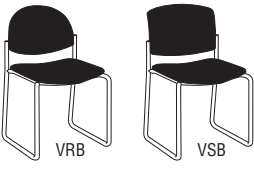
		MODEL NUMBER									Approx. Packaged Weight
		Basic Model	Frame Color	Seat & Back Color	Wood Seat and Back Color	Upholstery Color	Fire Code	Glide Option	Back Style	Wood Back Cut-outs	
 <p>VRB VSB</p> <p>VRPY VRWD VRUP</p> <p>Sled Base Armless Chair</p> <ul style="list-style-type: none"> • Back and seat are foam cushioned and upholstered, polypropylene, or wood • Round tubular steel frame • Ganging version available. Ganger welded to frame and finished to match frame • NONSTACKING 	Features										
	Poly, Ganging	15NASGP	<input type="checkbox"/>	<input type="checkbox"/>			<input type="checkbox"/>	<input type="checkbox"/>			22.0#
	Wood, Ganging	15NASGW	<input type="checkbox"/>		<input type="checkbox"/>			<input type="checkbox"/>	<input type="checkbox"/>	<input type="checkbox"/>	23.0#
	Poly, Non-Ganging	15NASP	<input type="checkbox"/>	<input type="checkbox"/>			<input type="checkbox"/>	<input type="checkbox"/>			21.0#
	Wood, Non-Ganging	15NASW	<input type="checkbox"/>		<input type="checkbox"/>			<input type="checkbox"/>	<input type="checkbox"/>	<input type="checkbox"/>	22.0#
	Uph, Ganging	96NASG	<input type="checkbox"/>				<input type="checkbox"/>	<input type="checkbox"/>	<input type="checkbox"/>		24.0#
Uph, Non-Ganging	96NAS	<input type="checkbox"/>				<input type="checkbox"/>	<input type="checkbox"/>	<input type="checkbox"/>		23.0#	
		A	B	C	D	E	F	G	H	I	

HOW TO ORDER

Indicate the following information on order form:

1. Quantity of each item.
2. Model number, including options. See "How To Build a Model Number".
3. Any special service required.

Note:

- The indicates that a choice is required.
- The absence of the indicates that no choice is required.
- Alpha-numeric characters in place of indicate that no other alternatives are available.

HOW TO BUILD A MODEL NUMBER

- A** Select basic model.
- B** Select frame color.
Refer to color addendum at ki.com or KI Fabrics & Finishes binder.
End caps will match frame color, unless frame is chrome or hammertone (then black).
- C** Select poly seat and back color.
Refer to color addendum at ki.com or KI Fabrics & Finishes binder.
- D** Select wood seat and back color.
Refer to color addendum at ki.com or KI Fabrics & Finishes binder.
- E** Select upholstery grade/color.
Refer to color addendum at ki.com or KI Fabrics & Finishes binder.
- F** Select fire code.
NFR - Compliance to TB 117-2013

FR - Compliance to TB 133

- G** Select glide option.
 - NGL** - No glides
 - NSG** - Sled base non-skid glides; add \$29
- H** Select back style.
 - VRB** - Round (original style)
 - VSB** - Square (new style)
- I** Select wood back cut-out.
 - C01** - Square (round back only)
 - C02** - Ellipse (round back only)
 - C03** - Starburst (round back only)
 - C04** - Fan (square back only)
 - C05** - Split (square back only)
 - C06** - Perforated (square back only)
 - NC** - No cut-out (both styles)



Delivered Pricing Unupholstered	Delivered Pricing Fabric Grade 1 & C.O.M.	Delivered Pricing Fabric Grade 2	Delivered Pricing Fabric Grade 3	Delivered Pricing C.O.V.	Delivered Pricing Vinyl Group 2V	Delivered Pricing Pallas Fabric Group P0	Delivered Pricing Pallas Fabric Group P1	Delivered Pricing Pallas Fabric Group P2	Delivered Pricing Pallas Fabric Group P3	Delivered Pricing Pallas Fabric Group P4
\$ 495										
761										
471										
739										
N/A	617	651	655	617	655	651	662	700	734	770
N/A	596	631	632	596	632	626	637	674	709	747

INFORMATION

Note:

There are 2 wood and upholstered back styles to choose from:
Round Back = VRB
Square Back = VSB

Poly backs are round only.

The original ROUND wood back style (RB) has the following wood cut-out options only:
C01 = Square
C02 = Ellipse
C03 = Standard
NC = No cut-out

The new SQUARE wood back style (SB) has the following wood cut-out options only:
C04= Fan
C05 = Split
C06 = Perforated
NC = No cut-out

OPTIONS

California TB133 Fire Safety Code

For California Technical Bulletin 133 compliant models, add the following upcharge:
Model=Upholstered
Added Lead Time=1 week
Added list price=\$57
Model=Polypropylene
Added Lead Time=1 week
Added list price=\$31

Round Back chairs with both FR and vinyl together must be ordered as a Special.

UPHOLSTERY INFORMATION

C.O.M. Upholstery

C.O.M. requirement 1 yard per chair of 54" wide nondirectional fabric. For complete information on ordering C.O.M., see "Ordering C.O.M., C.O.V. and C.O.L." section.

SPECIAL SERVICES

Special Carton Marking

With specially marked information N/C

Shipping

Shipped **assembled freight prepaid f.o.b. Green Bay, Wisconsin 54302** factory. Freight class #125.

Specifications and prices are subject to change without prior notice.

Stack/Nesting

Versa® Standard

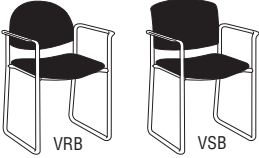
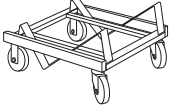
Features	MODEL NUMBER									
	Basic Model	Frame Color	Seat & Back Color	Wood Seat and Back Color	Upholstery Color	Fire Code	Glide Option	Back Style	Wood Back Cut-outs	Arm Option
 <p>VRB VSB</p> <p>VRPY VRWD VRUP</p> <p>Sled Base Armchair</p> <ul style="list-style-type: none"> • Back and seat are foam cushioned and upholstered, polypropylene, or wood • Round tubular steel frame • Molded nylon or chrome plated (non-ganging) arms • Ganger fastened to nylon armrest • NONSTACKING 	Poly, Ganging	15WASGP	<input type="checkbox"/>	<input type="checkbox"/>			<input type="checkbox"/>	<input type="checkbox"/>		MPA
	Wood, Ganging	15WASGW	<input type="checkbox"/>		<input type="checkbox"/>		<input type="checkbox"/>	<input type="checkbox"/>	<input type="checkbox"/>	MPA
	Poly, Non-Ganging	15WASP	<input type="checkbox"/>	<input type="checkbox"/>			<input type="checkbox"/>	<input type="checkbox"/>		<input type="checkbox"/>
	Wood, Non-Ganging	15WASW	<input type="checkbox"/>		<input type="checkbox"/>		<input type="checkbox"/>	<input type="checkbox"/>	<input type="checkbox"/>	<input type="checkbox"/>
	Uph, Ganging	96WASG	<input type="checkbox"/>			<input type="checkbox"/>	<input type="checkbox"/>	<input type="checkbox"/>		MPA
	Uph, Non-Ganging	96WAS	<input type="checkbox"/>			<input type="checkbox"/>	<input type="checkbox"/>	<input type="checkbox"/>		<input type="checkbox"/>
 <p>HRDPT</p> <p>Standard Versa Transport Dolly, Non-Wallsaver</p> <ul style="list-style-type: none"> • Accommodates up to 10 stacking chairs • Easy maneuverability with 5" casters: two fixed, two swivel • Rugged weld tubular steel frame • Black powder-coated finish 	MVP.BL									

A B C D E F G H I J

HOW TO ORDER

Indicate the following information on order form:

- Quantity of each item.
- Model number, including options. See "How To Build a Model Number".
- Any special service required.

Note: • The indicates that a choice is required.
 • The absence of the indicates that no choice is required.
 • Alpha-numeric characters in place of indicate that no other alternatives are available.

HOW TO BUILD A MODEL NUMBER

- A** Select basic model.
- B** Select frame color.
Refer to color addendum at ki.com or KI Fabrics & Finishes binder.
End caps will match frame color, unless frame is chrome or hammertone (then black).
- C** Select poly seat and back color.
Refer to color addendum at ki.com or KI Fabrics & Finishes binder.
- D** Select wood seat and back color.
Refer to color addendum at ki.com or KI Fabrics & Finishes binder.
- E** Select upholstery grade/color.
Refer to color addendum at ki.com or KI Fabrics & Finishes binder.
- F** Select fire code.
NFR - Compliance to TB 117-2013

FR - Compliance to TB 133

- G** Select glide option.
NGL - No glides
NSG - Sled base non-skid glides; add \$29
- H** Select back style.
VRB - Round (original style)
VSB - Square (new style)
- I** Select wood back cut-out.
C01 - Square (round back only)
C02 - Ellipse (round back only)
C03 - Starburst (round back only)
C04 - Fan (square back only)
C05 - Split (square back only)
C06 - Perforated (square back only)
NC - No cut-out (both styles)
- J** Select arm option.
MPA - Poly
CHA - Chrome plated



Approx. Packaged Weight	Delivered Pricing Unupholstered	Delivered Pricing Fabric Grade 1 & C.O.M.	Delivered Pricing Fabric Grade 2	Delivered Pricing Fabric Grade 3	Delivered Pricing C.O.V.	Delivered Pricing Vinyl Group 2V	Delivered Pricing Pallas Fabric Group P0	Delivered Pricing Pallas Fabric Group P1	Delivered Pricing Pallas Fabric Group P2	Delivered Pricing Pallas Fabric Group P3	Delivered Pricing Pallas Fabric Group P4
25.0#	\$ 507										
26.0#	770										
24.0#	495										
25.0#	761										
28.0#	N/A	632	665	666	632	666	661	672	710	744	780
27.0#	N/A	617	651	655	617	655	651	662	700	734	770
19.0#	\$ 438										

INFORMATION

Note:

There are 2 wood and upholstered back styles to choose from:
Round Back = VRB
Square Back = VSB

Poly backs are round only.

The original ROUND wood back style (RB) has the following wood cutout options only:
C01 = Square
C02 = Ellipse
C03 = Standard
NC = No cut-out

The new SQUARE wood back style (SB) has the following wood cutout options only:
C04 = Fan
C05 = Split
C06 = Perforated
NC = No cut-out

OPTIONS

California TB133 Fire Safety Code

For California Technical Bulletin 133 compliant models, add the following upcharge:
Model=Upholstered
Added Lead Time=1 week
Added list price=\$57
Model=Polypropylene
Added Lead Time=1 week
Added list price=\$31

Round Back chairs with both FR and vinyl together must be ordered as a Special.

UPHOLSTERY INFORMATION

C.O.M. Upholstery

C.O.M. requirement 1 yard per chair of 54" wide nondirectional fabric. For complete information on ordering C.O.M., see "Ordering C.O.M., C.O.V. and C.O.L." section.

SPECIAL SERVICES

Special Carton Marking

With specially marked information N/C



Shipping

Shipped **assembled freight prepaid f.o.b. Green Bay, Wisconsin 54302** factory. Freight class #125.

Specifications and prices are subject to change without prior notice.

Stack/Nesting

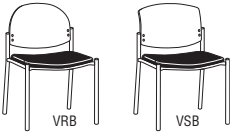
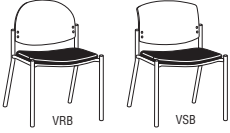
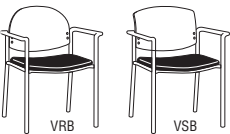
Versa® Standard

MODEL	Features	MODEL NUMBER									
		Basic Model	Frame Color	Wood Back Color	Uph. Color	Fire Code	Glide Option	Back Style	Wood Back Cut-outs	Arm Option	
 VRUW	Four-Leg Armless Chair <ul style="list-style-type: none"> • Seat is foam cushioned and upholstered • Back is wood • Round tubular steel frame • "Kick back" rear leg style enhances stability • Ganger welded to frame and finished to match frame 	Ganging	15NAGUW	<input type="checkbox"/>	<input type="checkbox"/>	<input type="checkbox"/>	<input type="checkbox"/>	<input type="checkbox"/>	<input type="checkbox"/>	<input type="checkbox"/>	
		Non-Ganging	15NALUW	<input type="checkbox"/>	<input type="checkbox"/>	<input type="checkbox"/>	<input type="checkbox"/>	<input type="checkbox"/>	<input type="checkbox"/>	<input type="checkbox"/>	
 VRUW	Four-Leg Wallsaver Armless Chair <ul style="list-style-type: none"> • Seat is foam cushioned and upholstered • Back is wood • Round tubular steel frame • Ganger welded to frame and finished to match frame • Wallsaver rear legs touch base of wall preventing chair back from contacting wall surface 	Ganging	15NAGUWWS	<input type="checkbox"/>	<input type="checkbox"/>	<input type="checkbox"/>	<input type="checkbox"/>	S	<input type="checkbox"/>	<input type="checkbox"/>	
		Non-Ganging	15NALUWWS	<input type="checkbox"/>	<input type="checkbox"/>	<input type="checkbox"/>	<input type="checkbox"/>	S	<input type="checkbox"/>	<input type="checkbox"/>	
 VRUW	Four-Leg Armchair <ul style="list-style-type: none"> • Seat is foam cushioned and upholstered • Back is wood • Round tubular steel frame • "Kick back" rear leg style enhances stability • Molded nylon or chrome plated (non-ganging) arms • Ganger fastened to nylon armrest 	Ganging	15WAGUW	<input type="checkbox"/>	<input type="checkbox"/>	<input type="checkbox"/>	<input type="checkbox"/>	<input type="checkbox"/>	<input type="checkbox"/>	MPA	
		Non-Ganging	15WALUW	<input type="checkbox"/>	<input type="checkbox"/>	<input type="checkbox"/>	<input type="checkbox"/>	<input type="checkbox"/>	<input type="checkbox"/>	<input type="checkbox"/>	<input type="checkbox"/>
 VRUW	Four-Leg Wallsaver Armchair <ul style="list-style-type: none"> • Seat is foam cushioned and upholstered • Back is wood • Round tubular steel frame • Molded nylon or chrome plated (non-ganging) arms • Ganger fastened to nylon armrest • Wallsaver rear legs touch base of wall preventing chair back from contacting wall surface 	Ganging	15WAGUWWS	<input type="checkbox"/>	<input type="checkbox"/>	<input type="checkbox"/>	<input type="checkbox"/>	S	<input type="checkbox"/>	<input type="checkbox"/>	MPA
		Non-Ganging	15WALUWWS	<input type="checkbox"/>	<input type="checkbox"/>	<input type="checkbox"/>	<input type="checkbox"/>	S	<input type="checkbox"/>	<input type="checkbox"/>	<input type="checkbox"/>

A **B** **C** **D** **E** **F** **G** **H** **I**

HOW TO ORDER

Indicate the following information on order form:

1. Quantity of each item.
2. Model number, including options. See "How To Build a Model Number".
3. Any special service required.

Note: • The indicates that a choice is required.

- The absence of the indicates that no choice is required.
- Alpha-numeric characters in place of indicate that no other alternatives are available.

HOW TO BUILD A MODEL NUMBER

- A** Select basic model.
VRB - Round (original style)
VSB - Square (new style)
- B** Select frame color.
Refer to color addendum at ki.com or KI Fabrics & Finishes binder.
- C** Select wood back color.
Refer to color addendum at ki.com or KI Fabrics & Finishes binder.
- D** Select upholstery grade/color.
Refer to color addendum at ki.com or KI Fabrics & Finishes binder.
- E** Select fire code.
NFR - Compliance to TB 117-2013
FR - Compliance to TB 133
- F** Select glide option.
P - Plastic glides
S - Steel glides (standard)

- G** Select back style.
VRB - Round (original style)
VSB - Square (new style)
- H** Select wood back cut-out.
CO1 - Square (round back only)
CO2 - Ellipse (round back only)
CO3 - Starburst (round back only)
CO4 - Fan (square back only)
CO5 - Split (square back only)
CO6 - Perforated (square back only)
NC - No cut-out (both styles)
- I** Select arm option.
CHA - Chrome plated
MPA - Poly



Approx. Packaged Weight	Delivered Pricing Fabric Grade 1 & C.O.M.	Delivered Pricing Fabric Grade 2	Delivered Pricing Fabric Grade 3	Delivered Pricing C.O.V.	Delivered Pricing Vinyl Group 2V	Delivered Pricing Pallas Fabric Group P0	Delivered Pricing Pallas Fabric Group P1	Delivered Pricing Pallas Fabric Group P2	Delivered Pricing Pallas Fabric Group P3	Delivered Pricing Pallas Fabric Group P4
17.0#	\$ 510	\$ 526	\$ 527	\$ 510	\$ 527	\$ 519	\$ 529	\$ 550	\$ 565	\$ 589
15.0#	496	515	517	496	517	509	520	539	553	577

17.0#	\$ 545	\$ 561	\$ 563	\$ 545	\$ 563	\$ 555	\$ 565	\$ 586	\$ 602	\$ 626
15.0#	531	550	551	531	551	544	555	574	592	612

18.0#	\$ 531	\$ 550	\$ 551	\$ 531	\$ 551	\$ 544	\$ 555	\$ 574	\$ 589	\$ 612
16.0#	522	539	540	522	540	534	544	563	577	603

18.0#	\$ 569	\$ 586	\$ 587	\$ 569	\$ 587	\$ 581	\$ 592	\$ 609	\$ 626	\$ 648
16.0#	559	574	576	559	576	570	580	600	612	638

INFORMATION

Note:

There are 2 wood and upholstered back styles to choose from:

Round Back = VRB
Square Back = VSB

Poly backs are round only.

The original ROUND wood back style (RB) has the following wood cut-out options only:

C01 = Square
C02 = Ellipse
C03 = Standard
NC = No cut-out

The new SQUARE wood back style (SB) has the following wood cut-out options only:

C04 = Fan
C05 = Split
C06 = Perforated
NC = No cut-out

OPTIONS

California TB133 Fire Safety Code

For California Technical Bulletin 133 compliant models, add the following upcharge:

Model=Upholstered
Added Lead Time=1 week
Added List Price=\$50

Round Back chairs with both FR and vinyl together must be ordered as a Special.

UPHOLSTERY INFORMATION

C.O.M. Upholstery

C.O.M. requirement 1 yard per chair of 54" wide nondirectional fabric. For complete information on ordering C.O.M., see "Ordering C.O.M., C.O.V. and C.O.L." section.

SPECIAL SERVICES

Special Carton Marking

With specially marked information N/C



Shipping

Shipped **assembled freight prepaid f.o.b. Green Bay, Wisconsin 54302** factory. Freight class #125.

Specifications and prices are subject to change without prior notice.

Stack/Nesting

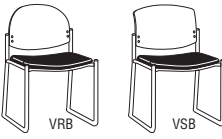
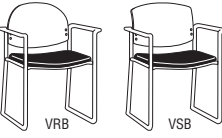
Versa® Standard

MODEL	Features	MODEL NUMBER									
		Basic Model	Frame Color	Wood Back Color	Uph. Color	Fire Code	Glide Option	Back Style	Wood Back Cut-outs	Arm Option	
 <p>VRB VSB</p> <p>VRUW</p>	Sled Base Armless Chair <ul style="list-style-type: none"> • Seat is foam cushioned and upholstered • Back is wood • Round tubular steel frame • Ganger version available. Ganger welded to frame and finished to match frame • NONSTACKING 	Ganging	15NASGUW	<input type="checkbox"/>	<input type="checkbox"/>	<input type="checkbox"/>	<input type="checkbox"/>	<input type="checkbox"/>	<input type="checkbox"/>	<input type="checkbox"/>	
		Non-Ganging	15NASUW	<input type="checkbox"/>	<input type="checkbox"/>	<input type="checkbox"/>	<input type="checkbox"/>	<input type="checkbox"/>	<input type="checkbox"/>	<input type="checkbox"/>	
 <p>VRB VSB</p> <p>VRUW</p>	Sled Base Armchair <ul style="list-style-type: none"> • Seat is foam cushioned and upholstered • Back is wood • Round tubular steel frame • Molded nylon or chrome plated (non-ganging) arms • Ganger fastened to nylon armrest • NONSTACKING 	Ganging	15WASGUW	<input type="checkbox"/>	<input type="checkbox"/>	<input type="checkbox"/>	<input type="checkbox"/>	<input type="checkbox"/>	<input type="checkbox"/>	MPA	
		Non-Ganging	15WASUW	<input type="checkbox"/>	<input type="checkbox"/>	<input type="checkbox"/>	<input type="checkbox"/>	<input type="checkbox"/>	<input type="checkbox"/>	<input type="checkbox"/>	<input type="checkbox"/>
 <p>HRDPT</p>	Standard Versa® Transport Dolly, Non-Wallsaver <ul style="list-style-type: none"> • Accommodates up to 10 stacking chairs • Easy maneuverability with 5" casters; two fixed, two swivel • Rugged weld tubular steel frame • Black powder-coated finish 		MVP.BL								

A B C D E F G H I

HOW TO ORDER

Indicate the following information on order form:

1. Quantity of each item.
2. Model number, including options. See "How To Build a Model Number".
3. Any special service required.

Note: • The indicates that a choice is required.

- The absence of the indicates that no choice is required.
- Alpha-numeric characters in place of indicate that no other alternatives are available.

HOW TO BUILD A MODEL NUMBER

A Select basic model.

B Select frame color.
Refer to color addendum at ki.com or KI Fabrics & Finishes binder.

C Select wood back color.
Refer to color addendum at ki.com or KI Fabrics & Finishes binder.

D Select upholstery grade/color.
Refer to color addendum at ki.com or KI Fabrics & Finishes binder.

E Select fire code.
NFR - Compliance to TB 117-2013
FR - Compliance to TB 133

F Select glide option.
NGL - No glides
NSG - Sled base non-skid glides; add \$21

G Select back style.

VRB - Round (original style)
VSB - Square (new style)

H Select wood back cut-out.

C01 - Square (round back only)
C02 - Ellipse (round back only)
C03 - Starburst (round back only)
C04 - Fan (square back only)
C05 - Split (square back only)
C06 - Perforated (square back only)
NC - No cut-out (both styles)

I Select arm option.

CHA - Chrome plated
MPA - Poly



Approx. Packaged Weight	Delivered Pricing Unupholstered	Delivered Pricing Fabric Grade 1 & C.O.M.	Delivered Pricing Fabric Grade 2	Delivered Pricing Fabric Grade 3	Delivered Pricing C.O.V.	Delivered Pricing Vinyl Group 2V	Delivered Pricing Pallas Fabric Group P0	Delivered Pricing Pallas Fabric Group P1	Delivered Pricing Pallas Fabric Group P2	Delivered Pricing Pallas Fabric Group P3	Delivered Pricing Pallas Fabric Group P4
21.0#	N/A	\$ 671	\$ 686	\$ 688	\$ 671	\$ 688	\$ 680	\$ 691	\$ 711	\$ 726	\$ 750
21.0#	N/A	657	674	675	657	675	668	679	698	714	740
23.0#	N/A	\$ 695	\$ 711	\$ 712	\$ 695	\$ 712	\$ 705	\$ 715	\$ 735	\$ 750	\$ 775
23.0#	N/A	683	698	700	683	700	694	705	721	740	762
19.0#	\$ 438										

INFORMATION

Note:

There are 2 wood and upholstered back styles to choose from:
Round Back = VRB
Square Back = VSB

Poly backs are round only.

The original ROUND wood back style (RB) has the following wood cut-out options only:
C01 = Square
C02 = Ellipse
C03 = Standard
NC = No cut-out

The new SQUARE wood back style (SB) has the following wood cut-out options only:
C04 = Fan
C05 = Split
C06 = Perforated
NC = No cut-out

OPTIONS

California TB133 Fire Safety Code
For California Technical Bulletin 133 compliant models, add the following upcharge:
Model=Upholstered
Added Lead Time=1 week
Added List Price=\$50

Round Back chairs with both FR and vinyl together must be ordered as a Special.

UPHOLSTERY INFORMATION

C.O.M. Upholstery
C.O.M. requirement 1 yard per chair of 54" wide nondirectional fabric. For complete information on ordering C.O.M., see "Ordering C.O.M., C.O.V. and C.O.L." section.

SPECIAL SERVICES

Special Carton Marking

With specially marked information N/C

Shipping

Shipped **assembled freight prepaid f.o.b. Green Bay, Wisconsin 54302** factory. Freight class #125.

Specifications and prices are subject to change without prior notice.

Stack/Nesting

Versa® Standard Cafe Stools

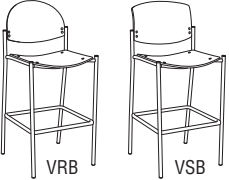
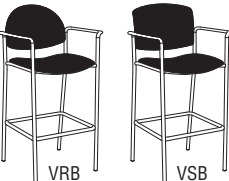
		MODEL NUMBER									
		Basic Model	Frame Color	Seat & Back Color	Wood Back Color	Upholstery Color	Fire Code	Glide Option	Back Style	Wood Back Cut-outs	Arm Option
 <p>VRB VSB</p> <p>SVRPY SVRUP SVRUW SVRWD</p> <p>Four-Leg Armless Cafe Stool</p> <ul style="list-style-type: none"> • Back and seat are foam cushioned and upholstered, polypropylene, or wood • Round tubular steel frame • NONSTACKING 	Polypropylene	S15NALP	<input type="checkbox"/>	<input type="checkbox"/>			<input type="checkbox"/>	<input type="checkbox"/>			
	Upholstered	S96NAL	<input type="checkbox"/>			<input type="checkbox"/>	<input type="checkbox"/>	<input type="checkbox"/>	<input type="checkbox"/>		
	Uph Seat, Wood Back	S15NALUW	<input type="checkbox"/>		<input type="checkbox"/>	<input type="checkbox"/>	<input type="checkbox"/>	<input type="checkbox"/>	<input type="checkbox"/>	<input type="checkbox"/>	
	Wood	S15NALW	<input type="checkbox"/>		<input type="checkbox"/>			<input type="checkbox"/>	<input type="checkbox"/>	<input type="checkbox"/>	
 <p>VRB VSB</p> <p>SVRPY SVRUP SVRUW SVRWD</p> <p>Four-Leg Cafe Stool with Arms</p> <ul style="list-style-type: none"> • Back and seat are foam cushioned and upholstered, polypropylene, or wood • Round tubular steel frame • Molded nylon or chrome plated arms • NONSTACKING 	Polypropylene	S15WALP	<input type="checkbox"/>	<input type="checkbox"/>			<input type="checkbox"/>	<input type="checkbox"/>		<input type="checkbox"/>	
	Upholstered	S96WAL	<input type="checkbox"/>			<input type="checkbox"/>	<input type="checkbox"/>	<input type="checkbox"/>	<input type="checkbox"/>	<input type="checkbox"/>	
	Uph Seat, Wood Back	S15WALUW	<input type="checkbox"/>		<input type="checkbox"/>	<input type="checkbox"/>	<input type="checkbox"/>	<input type="checkbox"/>	<input type="checkbox"/>	<input type="checkbox"/>	<input type="checkbox"/>
	Wood	S15WALW	<input type="checkbox"/>		<input type="checkbox"/>			<input type="checkbox"/>	<input type="checkbox"/>	<input type="checkbox"/>	<input type="checkbox"/>
		A	B	C	D	E	F	G	H	I	J

HOW TO ORDER

Indicate the following information on order form:

- Quantity of each item.
- Model number, including options. See "How To Build a Model Number".
- Any special service required.

Note: • The indicates that a choice is required.

- The absence of the indicates that no choice is required.
- Alpha-numeric characters in place of indicate that no other alternatives are available.

HOW TO BUILD A MODEL NUMBER

A Select basic model.

B Select frame color.
Refer to color addendum at ki.com or KI Fabrics & Finishes binder.

C Select seat and back color.
Refer to color addendum at ki.com or KI Fabrics & Finishes binder.

D Select wood back color.
Refer to color addendum at ki.com or KI Fabrics & Finishes binder.

E Select upholstery grade/color.
Refer to color addendum at ki.com or KI Fabrics & Finishes binder.

F Select fire code.
FR - Compliance to TB 133
NFR - Compliance to TB 117-2013

G Select glide option.

P - Plastic glides
S - Steel glides (standard)

H Select back style.

VRB - Round (original style)
VSB - Square (new style)

I Select wood back cut-out.

C01 - Square (round back only)
C02 - Ellipse (round back only)
C03 - Starburst (round back only)
C04 - Fan (square back only)
C05 - Split (square back only)
C06 - Perforated (square back only)
NC - No cut-out (both styles)

J Select arm option.

CHA - Chrome plated
MPA - Poly



Stack/Nesting

Versa® Standard Cafe Stools

Approx. Packaged Weight	Delivered Pricing Unupholstered	Delivered Pricing Fabric Grade 1 & C.O.M.	Delivered Pricing Fabric Grade 2	Delivered Pricing Fabric Grade 3	Delivered Pricing C.O.V.	Delivered Pricing Vinyl Group 2V	Delivered Pricing Pallas Fabric Group P0	Delivered Pricing Pallas Fabric Group P1	Delivered Pricing Pallas Fabric Group P2	Delivered Pricing Pallas Fabric Group P3	Delivered Pricing Pallas Fabric Group P4
29.0#	\$ 650										
29.0#	N/A	773	805	806	773	806	803	814	848	883	920
29.0#	N/A	818	836	837	818	837	829	840	857	876	898
29.0#	917										

30.0#	\$ 674										
30.0#	N/A	797	830	832	797	832	826	837	876	907	948
30.0#	N/A	844	859	861	844	861	855	865	883	898	922
30.0#	940										

INFORMATION

Note:

There are 2 wood and upholstered back styles to choose from:
 Round Back = VRB
 Square Back = VSB

Poly backs are round only.

The original ROUND wood back style (RB) has the following wood cut-out options only:
 C01 = Square
 C02 = Ellipse
 C03 = Standard
 NC = No cut-out

The new SQUARE wood back style (SB) has the following wood cut-out options only:
 C04 = Fan
 C05 = Split
 C06 = Perforated
 NC = No cut-out

OPTIONS

California TB133 Fire Safety Code
 For California Technical Bulletin 133 compliant models, add the following upcharge:
 Model=Upholstered
 Added Lead Time=1 week
 Added list price=\$55
 Model=Polypropylene
 Added Lead Time=1 week
 Added list price=\$29

Round Back chairs with both FR and vinyl together must be ordered as a Special.

UPHOLSTERY INFORMATION

C.O.M. Upholstery
 C.O.M. requirement 1 yard per chair of 54" wide nondirectional fabric. For complete information on ordering C.O.M., see "Ordering C.O.M., C.O.V. and C.O.L." section.

SPECIAL SERVICES

Special Carton Marking

With specially marked information N/C

Shipping

Shipped **assembled freight prepaid f.o.b. Green Bay, Wisconsin 54302** factory. Freight class #125.

Specifications and prices are subject to change without prior notice.

Stack/Nesting

Versa® XL General Information



**Four-Leg Armchair
Ganging (VXLAG)**



**Four-Leg Armchair
Non-ganging (VXLAN)**

**Armless Four-Leg Chair
Non-ganging (VXLN)**

Features			
Stackable	•	•	•
Ganging	•		
Warranted to 500 lbs.	•	•	•
General Dimensions			
Seat width	30"	30"	30"
Seat depth	20"	20"	20"
Seat height	20"	20"	20"
Overall Dimensions			
Width	35-3/8"	35-3/8"	32"
Depth	25-1/4"	25-1/4"	25-1/4"
Height	37"	37"	37"
Ganging on center	24-3/8"		
Arms to floor	26-1/4"	26-1/4"	
Stacking on Floor			
Width	35-3/4"	35-3/4"	32"
Depth	32-1/2"	32-1/2"	32-1/2"
Quantity/height	4 Chairs/49" High	4 Chairs/49" High	4 Chairs/49" High



Ganging



Kick Back Leg

SPECIFICATIONS

Frame

Legs of 1" o.d. x 16-gauge high-strength tubular steel. "Kick back" rear legs increase structural integrity and adds to stability. The rear legs on the wallsaver frame have a greater "kick back" angle so the legs touch the wall before the backrest. Side members and cross tube members will be of 1" o.d. x 14-gauge tubular steel. 11-gauge gussets will be located on the front legs to increase strength and rigidity. Standard front and rear legs are joined to side members by brazing; all other joints are manually welded. Wall-saver rear legs are manually welded to the side members; front legs are brazed. Formed 11-gauge steel brackets welded to the rear legs are used to support the backrest.

Armrests

Molded nylon pressed into the front and rear leg tubes. Armrests are monochromatic with frame. On chrome and hammertone frames, they will be black.

Tube End Caps (No-Arm Chair)

Molded plastic. The end cap will match the frame color. Chrome and hammertone frames have black end caps.

Floor Glides

Available in chrome-plated steel or monochromatic plastic for standard four-leg. (Black plastic on chrome and hammertone frames.) Wallsaver chairs are only available with chrome-plated steel glides.

Upholstered Seat

Seat is a flat, 5-ply 15/32" thick, radiate pine plywood (AraucoPly or similar) fastened to the frame with four screws through T-nuts embedded in the seat. A 2-1/2" thick urethane foam cushion is glued to seatboard.

Upholstered Backrest-Round or Square (option)

Two-piece construction. The front is constructed of a flat, 4-ply, 1/2" thick #3 gum veneer wood back fastened to frame with eight screws through T-nuts in wood back-

rest. A 2" urethane foam cushion applied to backrest. The back is constructed of 1/4" thick padding, 3-ply, 3/16" thick #3 gum veneer. Attached with eight steel fasteners and the backrest bracket.

Ganging Fixture

Only armchairs may be ganged. Welded steel rod. Gangers fasten to the bottom side of both armrests with three screws each. Ships unassembled (k.d.).

Frame Finishes

30-sheen epoxy powder coating is electrostatically applied. The dry coating is then fused and cured in a baking oven to form a smooth, continuous film. Finish is chemical resistant, hard, touch and mar resistant. Bright chrome surfaces are duplex nickel chrome plated in a twenty-two step process.

INFORMATION

C.O.M. Testing and Production Requirements

Not all materials are suitable for upholstering this product. A 2 yd. x 54" sample must be submitted and approved prior to acceptance of an order. If the fabric is directional in pattern or weave, the direction must be indicated on the submitted sample, and additional yardage may be requested.

Test samples must be sent to:

KI
Attn: C.O.M. Specialist
1687 Westminster Drive - Gate 3
Green Bay, WI 54302

Fabric Disclaimer

Fabric will be applied as swatched by the fabric manufacturer. Fabric that is required to be applied differently than is swatched will need a Special Cost Request written specify-



	Four-Leg Wallsaver Armchair Ganging (VXLAGWS)	Four-Leg Wallsaver Armchair Non-ganging (VXLNWS)	Four-Leg Wallsaver Armless Chair Non-ganging (VXLNWS)
Features			
Stackable	•	•	•
Ganging	•		
Warranted to 500 lbs.	•	•	•
General Dimensions			
Seat width	30"	30"	30"
Seat depth	20"	20"	20"
Seat height	20"	20"	20"
Overall Dimensions			
Width	35-3/8"	35-3/8"	32"
Depth	28-3/4"	28-3/4"	28-3/4"
Height	37"	37"	37"
Ganging on center	24-3/8"		
Arms to floor	26-1/4"	26-1/4"	
Stacking on Floor			
Width	35-3/4"	35-3/4"	32"
Depth	35-3/4"	35-3/4"	35-3/4"
Quantity/height	4 Chairs/49" High	4 Chairs/49" High	4 Chairs/49" High

ing the direction the fabric is to be applied.
The posted standard lead time will apply to
the Special Cost Request.

INFORMATION

Warranty

Refer to KI Terms & Conditions document
or visit ki.com

Stack/Nesting

Versa® XL

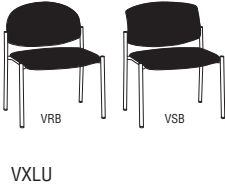
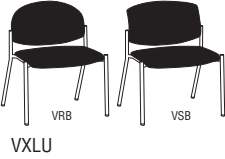
MODEL	Features	MODEL NUMBER						Approx. Packaged Weight		
		Basic Model	Upholstery Color	Fire Code	Frame Color	Back Style	Glide Option			
 <p>VXLU</p>	Four-Leg Armless Chair <ul style="list-style-type: none"> • Generously proportioned seat and back have thick foam cushioning and are upholstered • Back is fully upholstered • Round tubular steel frame • "Kick back" rear leg style enhances stability • Powder-coated or chrome plated frames 	Non-Ganging	VXLN	<input type="checkbox"/> <input type="checkbox"/> <input type="checkbox"/> <input type="checkbox"/> <input type="checkbox"/>	<input type="checkbox"/> <input type="checkbox"/> <input type="checkbox"/>	<input type="checkbox"/> <input type="checkbox"/>	<input type="checkbox"/> <input type="checkbox"/> <input type="checkbox"/>	<input type="checkbox"/>	39.0#	
 <p>VXLU</p>	Four-Leg Wallsaver Armless Chair <ul style="list-style-type: none"> • Generously proportioned seat and back have thick foam cushioning and are upholstered • Back is fully upholstered • Round tubular steel frame • "Kick back" rear leg style enhances stability • Powder-coated or chrome plated frames • Wallsaver rear legs touch base of wall preventing chair back from contacting wall 	Non-Ganging	VXLNWS	<input type="checkbox"/> <input type="checkbox"/> <input type="checkbox"/> <input type="checkbox"/> <input type="checkbox"/>	<input type="checkbox"/> <input type="checkbox"/> <input type="checkbox"/>	<input type="checkbox"/> <input type="checkbox"/>	<input type="checkbox"/> <input type="checkbox"/> <input type="checkbox"/>	S	39.0#	
				A	B	C	D	E	F	

HOW TO ORDER

Indicate the following information on order form:

1. Quantity of each item.
2. Model number, including options. See "How To Build a Model Number".
3. Any special service required.

Note: • The indicates that a choice is required.

- The absence of the indicates that no choice is required.
- Alpha-numeric characters in place of indicate that no other alternatives are available.

HOW TO BUILD A MODEL NUMBER

- A** Select basic model.
- B** Select upholstery grade/color.
Refer to color addendum at ki.com or KI Fabrics & Finishes binder.
- C** Select fire code.
NFR - Compliance to TB 117-2013
FR - Compliance to TB 133
- D** Select frame color.
Refer to color addendum at ki.com or KI Fabrics & Finishes binder.
Armrests or end caps will match frame color, unless frame is chrome or hammertone (then black).
- E** Select back style.
VRB - Round (original style)
VSB - Square (new style)
- F** Select glide option.

- P** - Plastic glides
S - Steel glides (standard)

UPHOLSTERY INFORMATION

C.O.M. Upholstery

C.O.M. requirement for 10 chairs or less is 2 yards per chair of 54" wide nondirectional fabric. For orders of 11 or more chairs and for complete information on ordering C.O.M., see "Ordering C.O.M., C.O.V. and C.O.L." section.



Delivered Pricing Fabric Grade 1 & C.O.M.	Delivered Pricing Fabric Grade 2	Delivered Pricing Fabric Grade 3	Delivered Pricing C.O.V.	Delivered Pricing Vinyl Group 2V	Delivered Pricing Pallas Fabric Group P0	Delivered Pricing Pallas Fabric Group P1	Delivered Pricing Pallas Fabric Group P2	Delivered Pricing Pallas Fabric Group P3	Delivered Pricing Pallas Fabric Group P4
\$ 667	\$ 700	\$ 713	\$ 667	\$ 713	\$ 792	\$ 867	\$ 924	\$ 977	\$ 1018
\$ 751	\$ 784	\$ 797	\$ 751	\$ 797	\$ 877	\$ 951	\$ 1008	\$ 1061	\$ 1101

OPTIONS

California TB133 Fire Safety Code

For California Technical Bulletin 133 compliant models, add the following upcharge:
 Model=XL
 Added Lead Time=1 week
 Added List Price=\$141

Round Back chairs with both FR and vinyl together must be ordered as a Special.

INFORMATION

Note:

There are 2 back styles to choose from:
 Round Back = VRB (original style)
 Square Back = VSB (new style)

SPECIAL SERVICES

Special Carton Marking

With specially marked information N/C

Shipping

Shipped **assembled freight prepaid f.o.b. Green Bay, Wisconsin 54302** factory. Freight class #125.

Specifications and prices are subject to change without prior notice.

Stack/Nesting

Versa® XL

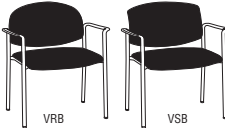
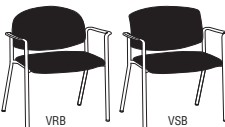
MODEL		Features	MODEL NUMBER						Approx. Packaged Weight
			Basic Model	Upholstery Color	Fire Code	Frame Color	Back Style	Glide Option	
 <p>VRB VSB</p> <p>VXLU</p>	Four-Leg Armchair	Ganging	VXLAG	<input type="checkbox"/> <input type="checkbox"/> <input type="checkbox"/> <input type="checkbox"/>	<input type="checkbox"/> <input type="checkbox"/>	<input type="checkbox"/> <input type="checkbox"/>	<input type="checkbox"/> <input type="checkbox"/> <input type="checkbox"/>	<input type="checkbox"/>	42.0#
	<ul style="list-style-type: none"> • Generously proportioned seat and back have thick foam cushioning and are upholstered • Back is fully upholstered • Round tubular steel frame • "Kick back" rear leg style enhances stability • Molded nylon arms • Ganger fastened to armrest and chrome finished • Powder-coated or chrome plated frames 	Non-Ganging	VXLAN	<input type="checkbox"/> <input type="checkbox"/> <input type="checkbox"/> <input type="checkbox"/>	<input type="checkbox"/> <input type="checkbox"/>	<input type="checkbox"/> <input type="checkbox"/>	<input type="checkbox"/> <input type="checkbox"/> <input type="checkbox"/>	<input type="checkbox"/>	42.0#
 <p>VRB VSB</p> <p>VXLU</p>	Four-Leg Wallsaver Armchair	Ganging	VXLAGWS	<input type="checkbox"/> <input type="checkbox"/> <input type="checkbox"/> <input type="checkbox"/>	<input type="checkbox"/> <input type="checkbox"/>	<input type="checkbox"/> <input type="checkbox"/>	<input type="checkbox"/> <input type="checkbox"/> <input type="checkbox"/>	S	42.0#
	<ul style="list-style-type: none"> • Generously proportioned seat and back have thick foam cushioning and are upholstered • Back is fully upholstered • Round tubular steel frame • "Kick back" rear leg style enhances stability • Powder-coated or chrome plated frames • Wallsaver rear legs touch base of wall preventing chair back from contacting wall 	Non-Ganging	VXLANWS	<input type="checkbox"/> <input type="checkbox"/> <input type="checkbox"/> <input type="checkbox"/>	<input type="checkbox"/> <input type="checkbox"/>	<input type="checkbox"/> <input type="checkbox"/>	<input type="checkbox"/> <input type="checkbox"/> <input type="checkbox"/>	S	42.0#
			A	B	C	D	E	F	

HOW TO ORDER

Indicate the following information on order form:

1. Quantity of each item.
2. Model number, including options. See "How To Build a Model Number".
3. Any special service required.

Note: • The indicates that a choice is required.

- The absence of the indicates that no choice is required.
- Alpha-numeric characters in place of indicate that no other alternatives are available.

HOW TO BUILD A MODEL NUMBER

- A** Select basic model.
- B** Select upholstery grade/color. Refer to color addendum at ki.com or KI Fabrics & Finishes binder.
- C** Select fire code.

NFR	- Compliance to TB 117-2013
FR	- Compliance to TB 133
- D** Select frame color. Refer to color addendum at ki.com or KI Fabrics & Finishes binder. Armrests or end caps will match frame color, unless frame is chrome or hammertone (then black).
- E** Select back style.

VRB	- Round (original style)
VSB	- Square (new style)
- F** Select glide option.

- | | |
|----------|---------------------------|
| P | - Plastic glides |
| S | - Steel glides (standard) |

UPHOLSTERY INFORMATION

C.O.M. Upholstery
 C.O.M. requirement for 10 chairs or less is 2 yards per chair of 54" wide nondirectional fabric. For orders of 11 or more chairs and for complete information on ordering C.O.M., see "Ordering C.O.M., C.O.V. and C.O.L." section.



Delivered Pricing C.O.M.	Delivered Pricing Fabric Grade 1	Delivered Pricing Fabric Grade 2	Delivered Pricing Fabric Grade 3	Delivered Pricing C.O.V.	Delivered Pricing Vinyl Group 2V	Delivered Pricing Pallas Fabric Group P0	Delivered Pricing Pallas Fabric Group P1	Delivered Pricing Pallas Fabric Group P2	Delivered Pricing Pallas Fabric Group P3	Delivered Pricing Pallas Fabric Group P4
\$ 724	\$ 724	\$ 757	\$ 770	\$ 724	\$ 770	\$ 853	\$ 927	\$ 982	\$ 1034	\$ 1074
708	708	741	752	708	752	832	906	961	1016	1058

\$ 809	\$ 809	\$ 842	\$ 854	\$ 809	\$ 854	\$ 936	\$ 1011	\$ 1065	\$ 1119	\$ 1159
791	791	824	836	791	836	916	990	1045	1099	1141

OPTIONS

California TB133 Fire Safety Code

For California Technical Bulletin 133 compliant models, add the following upcharge:
 Model=XL
 Added Lead Time=1 week
 Added List Price=\$141

Round Back chairs with both FR and vinyl together must be ordered as a Special.

INFORMATION

Note:

There are 2 back styles to choose from:
 Round Back = VRB (original style)
 Square Back = VSB (new style)

SPECIAL SERVICES

Special Carton Marking

With specially marked information N/C

Shipping

Shipped **assembled freight prepaid f.o.b. Green Bay, Wisconsin 54302** factory. Freight class #125.

Specifications and prices are subject to change without prior notice.

Stack/Nesting

Xylon® General Information



**Metal Frame Chair
(PXM)**

Features

Stackable	•
Articulating back	•

General Dimensions

Seat width	16-7/8"
Seat depth	17-1/2"
Seat height	18-5/8"
Back width	16-1/4"
Back height	15-1/2"

Overall Dimensions

Width	16-7/8"
Depth	20-7/8"
Height	33-1/8"

Stacking on Dolly

Quantity/height	8 Chairs/54" High
Floor space	24" x 35"

Stacking on Floor

Quantity/height	8 Chairs/50" High
Floor space	24" x 35"

SPECIFICATIONS

Seat and Backrest

Plywood is made of beechwood and gum veneer. Backrest thickness is .4". Seat thickness is .5". Seat and backrest surfaces are finished with stain and/or two applications of clear coat for a very durable finish. Seat/back support is nickel-plated aluminum. The back tilt is 15° (3-3/4").

Spring Action Backrests

Metal plate fixed under the seat containing a spring mechanism which allows movement of the backrest.

Metal Frame Chair

Frames are 7/8" o.d., 16-gauge seam-welded tubular steel.

Metal Frame Finishes

Baked-on, electrostatically-applied epoxy powder coating, or bright nickel-chrome plating.

Metal Frame Glides

Polypropylene.

Transport Dolly

Round tubular steel frame. Four 3" swivel wheels. Back powder-coated finish. 4-3/4" high from floor, empty.

OPTIONS

Lacquered and Aniline Dyes

Contact KI for pricing.

INFORMATION

Design

Designed by Giancarlo Piretti and manufactured in the USA by Krueger International, Inc. under license from Pro-Cord S.p.A.



INFORMATION

Warranty

Refer to KI Terms & Conditions document
or visit ki.com

Stack/Nesting

Xylon®

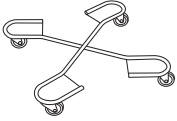
	MODEL	Features	MODEL NUMBER				Approx. Packaged Weight
			Basic Model	Frame Color	Seat & Back Color	Glide Option	
 PX	Four-Leg Metal Frame • Spring mechanism allows movement of backrest • Seat and backrest available in wood stains • Round tubular steel frame	Stacking	PXM	<input type="checkbox"/> <input type="checkbox"/>	<input type="checkbox"/> <input type="checkbox"/> <input type="checkbox"/>	<input type="checkbox"/> <input type="checkbox"/> <input type="checkbox"/>	16.0#
 HRDPT	X-Frame Stack Chair Dolly • Four 3" swivel wheels • Black enamel finish only		FD.BL				12.0#

A **B** **C** **D**

HOW TO ORDER

Indicate the following information on order form:

- Quantity of each item.
- Model number, including options. See "How To Build a Model Number".
- Any special service required.

Note: • The indicates that a choice is required.

- The absence of the indicates that no choice is required.
- Alpha-numeric characters in place of indicate that no other alternatives are available.

HOW TO BUILD A MODEL NUMBER

- A** Select basic model.
- B** Select frame color.
Refer to color addendum at ki.com or KI Fabrics & Finishes binder.
- C** Select seat/back color.
Refer to color addendum at ki.com or KI Fabrics & Finishes binder.
- D** Select glide option.

PGL	- Plastic glides
SGL	- Steel glides

 Steel glides not available on wood legs.

OPTIONS

Lacquered and Aniline Dyes
Contact KI for pricing.



Delivered
Pricing
\$ 572

\$ 208

SPECIAL SERVICES

Special Carton Marking

With specially marked information N/C

Shipping

Shipped **assembled freight prepaid f.o.b.**
Green Bay, Wisconsin 54302 factory.
Freight class #125.

Specifications and prices are subject to
change without prior notice.

Guest Chairs

AerDyn® General Information



**AerDyn®
(Contemporary)**

General Dimensions

Seat width	19"
Seat depth	19"
Seat height	18-3/4"
Arm height (mid point)	27-3/4"

Overall Dimensions

Width	21-3/4"
Depth	20-3/4"
Height	30-1/2"

UPHOLSTERY INFORMATION

C.O.M. Fabric

For C.O.M. fabric sent to KI-High Point on multiple rolls, add an additional yard of fabric per roll to the yardage requirements. Multiple rolls have shorter pieces of fabric on them and do not allow nesting and stacking of the fabric to achieve the best yield as is done with one large roll. This results in yardage shortages and requests for additional fabric from the client, which can hold up the order. For each roll that is sent, one yard needs to be added and needs to be added to one of the rolls, not separately.

Fabric Disclaimer

Fabric will be applied as swatched by the fabric manufacturer. Fabric that is required to be applied differently than is swatched will need a Special Cost Request written specifying the direction the fabric is to be applied. The posted standard lead time will apply to the Special Cost Request.

FINISH INFORMATION

SPECIAL FINISH MATCHES

KI can match special finish requests at an upcharge of \$68 List per item, up to 12 or a maximum charge of \$818 List per order per color. Special finish requests must be sent to your KI customer service representative.

Upon receipt from KI, the finishing department will prepare a "strike-off" which will be sent to the customer for approval.

The approval form accompanying the strike-off should be faxed to your KI customer service representative. Upon receipt of the signed approval form, KI will proceed with the order. Disapproved samples may be sent back to KI directly with an explanation of disapproval. A Special Finish Number (SFN) will be assigned to this finish sample for future reference or reorders.



INFORMATION

Warranty

Refer to KI Terms & Conditions document
or visit ki.com

Guest Chairs

AerDyn®



ADGS

MODEL	Features	COM	MODEL NUMBER					Approx. Packaged Weight
			Basic Model	Non-Contrast or Fabric Contrast 1	Wood Finish	Frame Color	Fire Code	
Armchair • 1 = Seat (Fabric Contrast 1) C.O.M. = 1 yd	Non-contrast	1 yd	1501	□□□□	□□□	□□	□□□	25.0#

A **B** **C** **D** **E**

HOW TO ORDER

Indicate the following information on order form:

1. Quantity of each item.
2. Model number, including options. See "How To Build a Model Number".
3. Any special service required.

Note: • The □ indicates that a choice is required.

- The absence of the □ indicates that no choice is required.
- Alpha-numeric characters in place of □ indicate that no other alternatives are available.

HOW TO BUILD A MODEL NUMBER

- A** Select basic model.
- B** Select non-contrast or fabric contrast 1. Refer to color addendum at ki.com or KI Fabrics & Finishes binder.
- C** Select wood finish color. Refer to color addendum at ki.com or KI Fabrics & Finishes binder.
- D** Select frame color. Refer to color addendum at ki.com or KI Fabrics & Finishes binder.
- E** Select fire code.
 - NFR** - Compliance to TB 117-2013
 - FR** - Compliance to TB 133
 See pricing column for TB133 upcharge.

UPHOLSTERY INFORMATION

C.O.M. Requirements

C.O.M. yardage requirements listed above are based on plain goods 54" wide. If less than 54" wide or fabrics requiring matching (stripes, plaids, prints, large patterns), additional yardage will be needed. Consult C.O.M. matrix for additional yardage needed. For C.O.M. fabric sent to KI-High Point on multiple rolls, add an additional yard of fabric per roll to the yardage requirements.

C.O.L. Requirements

Figure 18 sq. ft. of leather (C.O.L.) for each yard shown (i.e. 4.75 x 18 = 85.5 sq. ft).

Contrasting Upholstery

When contrasting fabric is chosen, price at highest in-grade.

California TB133 Fire Safety Code

The above seating products can be manufactured using the appropriate flame-retardant materials and fabric selections for



Grade C.O.M.	Grade C	Grade D	Grade E & C.O.L.	Grade F	Grade G	Grade H	Grade I	Grade J	Grade K	Grade L Leather	Grade M Leather	TB133 add to list price
\$ 1002	\$ 1005	\$ 1016	\$ 1027	\$ 1034	\$ 1052	\$ 1067	\$ 1086	\$ 1126	\$ 1167	\$ 1207	\$ 1288	\$ 90

compliance to California Technical Bulletin 133. Please contact KI customer service for fabric compliance. Not available with moisture barrier.

Construction

Frame is constructed of solid hardwood panel stock which is steam bent, utilizing finger joints and doweled construction (cannot be done in Beech). Rear leg and seat frame are tubular steel. Silver powder coat is standard. Seat cushion of high-density polyurethane foam (stacks 4 high).

SPECIAL SERVICES

Special Carton Marking

With specially marked information N/C

Shipping

Shipped **assembled freight prepaid f.o.b. High Point, North Carolina 27263** factory. Freight class #175.

Specifications and prices are subject to change without prior notice.

Guest Chairs

Bantam™ General Information



**Bantam™
(Traditional)**

General Dimensions	
Seat width	19"
Seat depth	18-1/2"
Seat height	18-1/2"
Arm height (mid point)	25"
Overall Dimensions	
Width	22-3/4"
Depth	24-1/2"
Height	32"

UPHOLSTERY INFORMATION

C.O.M. Fabric

For C.O.M. fabric sent to KI-High Point on multiple rolls, add an additional yard of fabric per roll to the yardage requirements. Multiple rolls have shorter pieces of fabric on them and do not allow nesting and stacking of the fabric to achieve the best yield as is done with one large roll. This results in yardage shortages and requests for additional fabric from the client, which can hold up the order. For each roll that is sent, one yard needs to be added and needs to be added to one of the rolls, not separately.

Fabric Disclaimer

Fabric will be applied as swatched by the fabric manufacturer. Fabric that is required to be applied differently than is swatched will need a Special Cost Request written specifying the direction the fabric is to be applied. The posted standard lead time will apply to the Special Cost Request.

FINISH INFORMATION

SPECIAL FINISH MATCHES

KI can match special finish requests at an upcharge of \$68 List per item, up to 12 or a maximum charge of \$818 List per order per color. Special finish requests must be sent to your KI customer service representative.

Upon receipt from KI, the finishing department will prepare a "strike-off" which will be sent to the customer for approval.

The approval form accompanying the strike-off should be faxed to your KI customer service representative. Upon receipt of the signed approval form, KI will proceed with the order. Disapproved samples may be sent back to KI directly with an explanation of disapproval. A Special Finish Number (SFN) will be assigned to this finish sample for future reference or reorders.



INFORMATION

Warranty

Refer to KI Terms & Conditions document
or visit ki.com

Guest Chairs

Bantam™

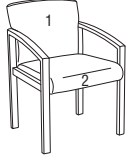

BANT

MODEL	Features	COM	MODEL NUMBER					Approx. Packaged Weight
			Basic Model	Non-Contrast or Fabric Contrast 1	Fabric Contrast 2	Wood Finish	Fire Code	
Armchair • 1 = Back (Fabric Contrast 1) C.O.M. = 1 yd • 2 = Seat (Fabric Contrast 2) C.O.M. = 1 yd	Non-contrast	1.5 yd	1301/NC	□□□□		□□□	□□□	50.0#
	Contrast		1301/FC	□□□□	□□□□	□□□	□□□	50.0#

A **B** **C** **D** **E**

HOW TO ORDER

Indicate the following information on order form:

- Quantity of each item.
- Model number, including options. See "How To Build a Model Number".
- Any special service required.

Note: • The □ indicates that a choice is required.

- The absence of the □ indicates that no choice is required.
- Alpha-numeric characters in place of □ indicate that no other alternatives are available.

HOW TO BUILD A MODEL NUMBER

- A** Select basic model.
- B** Select non-contrast or fabric contrast 1. Refer to color addendum at ki.com or KI Fabrics & Finishes binder.
- C** Select non-contrast or fabric contrast 2. Refer to color addendum at ki.com or KI Fabrics & Finishes binder.
- D** Select wood finish color. Refer to color addendum at ki.com or KI Fabrics & Finishes binder.
- E** Select fire code.
 - NFR** - Compliance to TB 117-2013
 - FR** - Compliance to TB 133
 See pricing column for TB133 upcharge.

UPHOLSTERY INFORMATION

C.O.M. Requirements

C.O.M. yardage requirements listed above are based on plain goods 54" wide. If less than 54" wide or fabrics requiring matching (stripes, plaids, prints, large patterns), additional yardage will be needed. Consult C.O.M. matrix for additional yardage needed. For C.O.M. fabric sent to KI-High Point on multiple rolls, add an additional yard of fabric per roll to the yardage requirements.

C.O.L. Requirements

Figure 18 sq. ft. of leather (C.O.L.) for each yard shown (i.e., 4.75 x 18 = 85.5 sq. ft).

Contrasting Upholstery

When contrasting fabric is chosen, price at highest in-grade.

California TB133 Fire Safety Code

The above seating products can be manufactured using the appropriate flame-retardant materials and fabric selections for



Grade C.O.M.	Grade C	Grade D	Grade E & C.O.L.	Grade F	Grade G	Grade H	Grade I	Grade J	Grade K	Grade L Leather	Grade M Leather	TB133 add to list price
\$ 1005	\$ 1018	\$ 1037	\$ 1066	\$ 1085	\$ 1120	\$ 1156	\$ 1226	\$ 1324	\$ 1438	\$ 1554	\$ 1783	\$ 197
1063	1074	1095	1122	1142	1177	1210	1281	1380	1497	1610	1843	197

compliance to California Technical Bulletin 133. Please contact KI customer service for fabric compliance. Not available with moisture barrier.

Construction

Frame of kiln-dried hardwood. Cushioning of high-density polyurethane foam and Dacron fiber.

KENSINGTON MAPLE UPCHARGE

Kensington Maple requires extended leadtimes.

Model	
1301/NC	\$37
1301/FC	\$37

SPECIAL SERVICES

Special Carton Marking

With specially marked information N/C

Shipping

Shipped **assembled freight prepaid f.o.b. High Point, North Carolina 27263** factory. Freight class #175.

Specifications and prices are subject to change without prior notice.

Index

Model No.	Description	Page	Model No.	Description	Page
06.0448.SET	Piretti Stack Chairs: Sled Base Chair Steel Glides	88	04LWAMSMB	Opt4®: Four-Leg Armchair	60
1301/NC	Bantam™: Armchair	246	04LWAMSMB	Opt4®: Four-Leg Armchair with Casters	60
1501	AerDyn®: Armchair	242	04LWAMSPB	Opt4®: Four-Leg Armchair	60
15NAGP	Versa® Standard: Four-Leg Armless Chair	214	04LWAMSPBC	Opt4®: Four-Leg Armchair with Casters	60
15NAGPWS	Versa® Standard: Four-Leg Wallsaver Armless Chair	214	04LWAPSMB	Opt4®: Four-Leg Armchair	60
15NAGUW	Versa® Standard: Four-Leg Armless Chair	224	04LWAPSMBC	Opt4®: Four-Leg Armchair with Casters	60
15NAGUWWS	Versa® Standard: Four-Leg Wallsaver Armless Chair	224	04LWAPSPB	Opt4®: Four-Leg Armchair	60
15NASGP	Versa® Standard: Sled Base Armless Chair	220	04LWAPSPBC	Opt4®: Four-Leg Armchair with Casters	60
15NASGUW	Versa® Standard: Sled Base Armless Chair	226	04MSMB	Opt4®: Sled Base Chair	68
15TALP	Versa® Standard: Four-Leg Tablet Arm Chair	218	04MSPB	Opt4®: Sled Base Chair	68
15WAGP	Versa® Standard: Four-Leg Armchair	216	04PSMB	Opt4®: Sled Base Chair	68
15WAGPWS	Versa® Standard: Four-Leg Wallsaver Armchair	216	04PSPB	Opt4®: Sled Base Chair	68
15WAGUW	Versa® Standard: Four-Leg Armchair	224	04SD.BL	Opt4®: Transport Dolly for Stool	74
15WAGUWWS	Versa® Standard: Four-Leg Wallsaver Armchair	224	04SMSMB	Opt4® Cafe Stools: Cafe Stool	70
15WASGP	Versa® Standard: Sled Base Armchair	222	04SMSPB	Opt4® Cafe Stools: Cafe Stool	70
15WASGUW	Versa® Standard: Sled Base Armchair	226	04SPSMB	Opt4® Cafe Stools: Cafe Stool	72
53.8236.SET	Piretti Stack Chairs: Sled Base Chair Plastic Glides - Clear	88	04SPSPB	Opt4® Cafe Stools: Cafe Stool	72
53.8237.SET	Piretti Stack Chairs: Sled Base Chair Plastic Glides - White	88	PRY.D.BL	Perry®: Transport Dolly	80
87.7844	Piretti Stack Chairs: Bookrack	88	PRYP	Perry®: Armless Stack Chair	78
ACD.BL	Apply® Chairs: Transport Dolly for Fixed Cushion Chairs	10	PRYPA	Perry®: Stack Armchair	78
ALHSNAP	Apply® Cafe Stools: Four-Leg High Back Armless Cafe Stool	12	PRYTARM/OVS/L	Perry®: Oversized Tablet Arm	80
ALLSNAP	Apply® Cafe Stools: Four-Leg Low Back Armless Cafe Stool	12	PRYTARM/STD/L	Perry®: Tablet Arm	80
ALNAP	Apply® Chairs: Four-Leg Armless Chair	10	PSLFAP	Piretti Stack Chairs: Four-Leg Flex Arm Stack Chair	84
ASNAP	Apply® Chairs: Sled Base Armless Chair	10	PSLNAP	Piretti Stack Chairs: Four-Leg Stack Chair	84
CSD.BL	Maestro® Chairs: Transport Dolly for Poly Chairs	42	PSLOTALP	Piretti Stack Chairs: Four-Leg Stack Oversize Tablet Arm Chair	84
DRNA	Dorsal®: Armless Stacking Round Leg Chair	16	PSLTALP	Piretti Stack Chairs: Four-Leg Stack Tablet Arm Chair	84
DRTL	Dorsal®: Stacking Round Leg Tablet Arm Chair	16	PSSFAP	Piretti Stack Chairs: Sled Base Flex Arm Chair	86
FD.BL	Xylon®: X-Frame Stack Chair Dolly	238	PSSNAP	Piretti Stack Chairs: Sled Base Stack Chair	86
GCD.BL	Grazie® Chairs: Transport Dolly	36	PSSOTALP	Piretti Stack Chairs: Sled Base Oversize Tablet Arm Chair	86
GLCAP	Grazie® Chairs: Four-Leg Cantilever Armchair	26	PSSTALP	Piretti Stack Chairs: Sled Base Tablet Arm Chair	86
GLCAPC	Grazie® Chairs: Four-Leg Cantilever Armchair with Casters	26	PXM	Xylon®: Four-Leg Metal Frame	238
GLG2APCLH	Grazie® Chairs: Four-Leg Flip-and-Store (G2) Tablet Arm Chair with Casters	30	RAPD.BL	Rapture® Chairs: Dolly	92
GLG2APLH	Grazie® Chairs: Four-Leg Flip-and-Store (G2) Tablet Arm Chair	28	RAPNAP	Rapture® Chairs: Four-Leg Armless Chair	92
GLNAP	Grazie® Chairs: Four-Leg Armless Chair	24	RAPNAPC	Rapture® Chairs: Four-Leg Armless Chair with Casters	98
GLNAPC	Grazie® Chairs: Four-Leg Armless Chair with Casters	24	RAPNAPWS	Rapture® Chairs: Four-Leg Wallsaver Armless Chair	96
GLOVTAPCLH	Grazie® Chairs: Four-Leg Flip-up Oversize Tablet Arm Chair with Casters	30	RAPTALP	Rapture® Chairs: Four-Leg Tablet Arm Chair (Left Hand)	94
GLOVTAPLH	Grazie® Chairs: Four-Leg Flip-up Oversize Tablet Arm Chair	28	RAPTARP	Rapture® Chairs: Four-Leg Tablet Arm Chair (Right Hand)	94
GLSCAP	Grazie® Cafe Stools: Four-Leg Cantilever Arm Cafe Stool	38	RAPWAP	Rapture® Chairs: Four-Leg Armchair	92
GLSNAP	Grazie® Cafe Stools: Four-Leg Armless Cafe Stool	38	RAPWAPC	Rapture® Chairs: Four-Leg Armchair with Casters	98
GLTAPCLH	Grazie® Chairs: Four-Leg Flip-up Tablet Arm Chair with Casters	30	RAPWAPWS	Rapture® Chairs: Four-Leg Wallsaver Armchair	96
GLTAPLH	Grazie® Chairs: Four-Leg Flip-up Tablet Arm Chair	28	S15NALP	Versa® Standard Cafe Stools: Four-Leg Armless Cafe Stool	228
GSCAP	Grazie® Chairs: Sled Base Cantilever Armchair	32	S15WALP	Versa® Standard Cafe Stools: Four-Leg Cafe Stool with Arms	228
GSG2APLH	Grazie® Chairs: Sled Base Flip-and-Store (G2) Tablet Arm Chair	34	SCDA.BL	Strive® Chairs: Transport Dolly for 4-Leg and Sled Base Chairs	142
GSNAP	Grazie® Chairs: Sled Base Armless Chair	32	SIGFA	Silhouette®: Cast Aluminum Frame Four-Leg Armchair in Nylon (Plastic)	106
GSOVTAPLH	Grazie® Chairs: Sled Base Flip-up Oversize Tablet Arm Chair	34	SIGNA	Silhouette®: Cast Aluminum Frame Four-Leg Armless Chair in Nylon (Plastic)	106
GSTAPLH	Grazie® Chairs: Sled Base Flip-up Tablet Arm Chair	34	SIGUFA	Silhouette®: Cast Aluminum Frame Four-Leg Armchair Upholstered	106
MFS.D.BL	Maestro® Chairs: Transport Dolly for Upholstered Chairs	42	SIGUNA	Silhouette®: Cast Aluminum Frame Four-Leg Armless Chair Upholstered	106
MSP	Maestro® Chairs: Stack Chair	42	SILD	Silhouette®: Dolly	104
MSTARM/STD/L	Maestro® Chairs: Standard Flip-Up Tablet Arm	42	SILFA	Silhouette®: Tubular Steel Frame Four-Leg Armchair	104
MVP.BL	Matrix®: Transport Dolly for Fixed Cushion Chairs	48	SILNA	Silhouette®: Tubular Steel Frame Four-Leg Armless Chair	104
MX	Matrix®: Armless Stack Chair	46	SLCAP	Strive® Chairs: Four-Leg Cantilever Armchair	118
MXA	Matrix®: Stacking Armchair	48	SLCAPC	Strive® Chairs: Four-Leg Cantilever Armchair with Casters	118
MXD.BL	Matrix®: Transport Dolly for Poly/Upholstered Chairs	48	SLCAPWS	Strive® Chairs: Four-Leg Wallsaver Cantilever Armchair	130
MXTARM/OVS/L	Matrix®: Oversize Flip-Up Tablet Arm	46	SLCATSU	Strive® Chairs: Four-Leg Cantilever Armchair with Top Stitch on Seat	120
MXTARM/STD/L	Matrix®: Standard Flip-Up Tablet Arm	46	SLCATSUC	Strive® Chairs: Four-Leg Cantilever Armchair with Casters with Top Stitch on Seat	120
O4DA.BL	Opt4®: Transport Dolly for Sled Base Chair	74	SLCATSUWS	Strive® Chairs: Four-Leg Wallsaver Cantilever Armchair with Top Stitch on Seat	132
O4LD.BL	Opt4®: Transport Dolly for Four-Leg Chair	74	LLAP	Strive® Chairs: Four-Leg Loop Arm Chair	122
O4LNAMSMB	Opt4®: Four-Leg Armless Chair	60	LLAPC	Strive® Chairs: Four-Leg Loop Arm Chair with Casters	122
O4LNAMSMBC	Opt4®: Four-Leg Armless Chair with Casters	54	LLAPWS	Strive® Chairs: Four-Leg Wallsaver Loop Arm Chair	130
O4LNAMSPB	Opt4®: Four-Leg Armless Chair	60	LLATSU	Strive® Chairs: Four-Leg Loop Arm Chair with Top Stitch on Seat	124
O4LNAMSPBC	Opt4®: Four-Leg Armless Chair with Casters	54	LLATSUC	Strive® Chairs: Four-Leg Loop Arm Chair with Casters with Top Stitch on Seat	124
O4LNAPSMB	Opt4®: Four-Leg Armless Chair	60			
O4LNAPSMB	Opt4®: Four-Leg Armless Chair with Casters	54			
O4LNAPSPB	Opt4®: Four-Leg Armless Chair	60			
O4LNAPSPBC	Opt4®: Four-Leg Armless Chair with Casters	54			



Model No.	Description	Page	Model No.	Description	Page
SLLSATSUWS	Strive® Chairs: Four-Leg Wallsaver Loop Arm Chair with Top Stitch on Seat	132	TASTAL	Torsion Air®: Sled Base Tablet Arm Chair	188
SLNAP	Strive® Chairs: Four-Leg Armless Chair	114	TASWA	Torsion Air®: Sled Base Armchair	188
SLNAPC	Strive® Chairs: Four-Leg Armless Chair with Casters	114	TCFAP	Torsion®: Cantilevered Sled Base Armchair	172
SLNAPWS	Strive® Chairs: Four-Leg Wallsaver Armless Chair	130	TCNAP	Torsion®: Cantilevered Sled Base Chair	172
SLNATSU	Strive® Chairs: Four-Leg Armless Chair with Top Stitch on Seat	116	TGNAPB	Torsion® on the Go!® Nesting Chairs: Armless Chair with Poly Back	166
SLNATSUC	Strive® Chairs: Four-Leg Armless Chair with Casters with Top Stitch on Seat	116	TGNAUB	Torsion® on the Go!® Nesting Chairs: Armless Chair with Upholstered Back	166
SLNATSUWS	Strive® Chairs: Four-Leg Wallsaver Armless Chair with Top Stitch on Seat	132	TGTALPB	Torsion® on the Go!® Nesting Chairs: Tablet Arm Chair with Poly Back	168
SLOVTAPLH	Strive® Chairs: Four-Leg Oversize Tablet Arm Chair	126	TGTALUB	Torsion® on the Go!® Nesting Chairs: Tablet Arm Chair with Upholstered Back	168
SLOVTATSULH	Strive® Chairs: Four-Leg Oversize Tablet Arm Chair with Top Stitch on Seat	128	TGWAPB	Torsion® on the Go!® Nesting Chairs: Armchair with Poly Back	166
SLSCAP	Strive® Cafe Stools: Four-Leg Cantilever Arm Cafe Stool	144	TGWAUB	Torsion® on the Go!® Nesting Chairs: Armchair with Upholstered Back	166
SLSCATSU	Strive® Cafe Stools: Four-Leg Cantilever Arm Cafe Stool with Top Stitch on Seat	146	TLD.BL	Torsion®: Transport Dolly for Four-Leg Chairs	182
SLSLAP	Strive® Cafe Stools: Four-Leg Loop Arm Cafe Stool	144	TLFAP	Torsion®: Four-Leg Armchair	174
SLSLATSU	Strive® Cafe Stools: Four-Leg Loop Arm Cafe Stool with Top Stitch on Seat	146	TLG2ALP	Torsion®: Four-Leg G2-Tablet Arm Chair	176
SLSNAP	Strive® Cafe Stools: Four-Leg Armless Cafe Stool	144	TLNAP	Torsion®: Four-Leg Chair	174
SLSNATSU	Strive® Cafe Stools: Four-Leg Armless Cafe Stool with Top Stitch on Seat	146	TLTALP	Torsion®: Four-Leg Tablet Arm Chair	176
SLTAPLH	Strive® Chairs: Four-Leg Tablet Arm Chair	126	TSFAP	Torsion®: Full Sled Base Armchair	178
SLTATSULH	Strive® Chairs: Four-Leg Tablet Arm Chair with Top Stitch on Seat	128	TSG2ALP	Torsion®: Full Sled Base G2-Tablet Arm Chair	180
SNCAP	Strive® Nesting Chairs: Armchair with Poly Seat	156	TSNAP	Torsion®: Full Sled Base Chair	178
SNCATSU	Strive® Nesting Chairs: Armchair with Upholstered Seat with Top Stitch on Seat	158	TSTALP	Torsion®: Full Sled Base Tablet Arm Chair	180
SNCAU	Strive® Nesting Chairs: Armchair with Upholstered Seat	156	TVD.BL	Torsion®: Transport Dolly for Sled Base Chairs	182
SNNAP	Strive® Nesting Chairs: Armless Chair with Poly Seat	156	VBD.BL	Versa® Basic: Versa® Basic Transport Dolly	200
SNNATSU	Strive® Nesting Chairs: Armless Chair with Upholstered Seat with Top Stitch on Seat	158	VBNAL	Versa® Basic: Four-Leg Armless Chair	200
SNNAU	Strive® Nesting Chairs: Armless Chair with Upholstered Seat	156	VBWAL	Versa® Basic: Four-Leg Armchair	200
SNOVTAPRH	Strive® Nesting Chairs: Oversize Tablet Arm Chair with Poly Seat	160	VCNAC	Versa® Conference: Four-Leg Armless Chair	206
SNOVTATSULH	Strive® Nesting Chairs: Oversize Tablet Arm Chair with Upholstered Seat with Top Stitch on Seat	162	VCNAS	Versa® Conference: Sled Base Armless Chair	208
SNOVTAURH	Strive® Nesting Chairs: Oversize Tablet Arm Chair with Upholstered Seat	160	VCWAC	Versa® Conference: Four-Leg Armchair	204
SNTAPRH	Strive® Nesting Chairs: Tablet Arm Chair with Poly Seat	160	VCWAS	Versa® Conference: Sled Base Armchair	208
SNTATSULH	Strive® Nesting Chairs: Tablet Arm Chair with Upholstered Seat with Top Stitch on Seat	162	VTD.BL	Dorsal®: Round Leg Chair Transport Dolly	16
SNTAURH	Strive® Nesting Chairs: Tablet Arm Chair with Upholstered Seat	160	VXLAG	Versa® XL: Four-Leg Armchair	
SRAPNAP	Rapture® Cafe Stools: Four-Leg Armless Cafe Stool	100	VXLAGWS	Versa® XL: Four-Leg Wallsaver Armchair	
SRAPWAP	Rapture® Cafe Stools: Four-Leg Cafe Stool with Arms	100	VXLN	Versa® XL: Four-Leg Armless Chair	232
SSCAP	Strive® Chairs: Sled Base Cantilever Arm Chair	134	VXLNWS	Versa® XL: Four-Leg Wallsaver Armless Chair	232
SSCATSU	Strive® Chairs: Sled Base Cantilever Arm Chair with Top Stitch on Seat	136			
SSILFA	Silhouette® Cafe Stools: Cafe Stool with Arms	108			
SSILNA	Silhouette® Cafe Stools: Armless Cafe Stool	108			
SSNAP	Strive® Chairs: Sled Base Armless Chair	134			
SSNATSU	Strive® Chairs: Sled Base Armless Chair with Top Stitch on Seat	136			
SSOVTAPLH	Strive® Chairs: Sled Base Oversize Tablet Arm Chair	138			
SSOVTATSULH	Strive® Chairs: Sled Base Oversize Tablet Arm Chair with Top Stitch on Seat	140			
SSTALTSU	Strive® Chairs: Sled Base Tablet Arm Chair with Top Stitch on Seat	140			
SSTAPLH	Strive® Chairs: Sled Base Tablet Arm Chair	138			
SWNA	Strive® High Density Stack Chair: Armless Chair	150			
SWNATSU	Strive® High Density Stack Chair: Armless Chair with Top Stitch on Seat	152			
SWTAL	Strive® High Density Stack Chair: Standard Flip-Up Tablet Arm	150			
TALNA	Torsion Air®: Four-Leg Armless Chair	186			
TALTAL	Torsion Air®: Four-Leg Tablet Arm Chair	186			
TALWA	Torsion Air®: Four-Leg Armchair	186			
TANNA	Torsion Air® Nesting Chairs: Armless Chair	194			
TANTALFT	Torsion Air® Nesting Chairs: Flip-up Tablet Arm Chair	194			
TANTALPT	Torsion Air® Nesting Chairs: Piretti Tablet Arm Chair	196			
TANWA	Torsion Air® Nesting Chairs: Armchair	194			
TASNA	Torsion Air®: Armless Sled Base Chair	188			



KI
1330 Bellevue Street
P.O. Box 8100
Green Bay, Wisconsin 54308-8100
1-800-424-2432
www.ki.com

KI and Furnishing Knowledge
are registered trademarks
of Krueger International, Inc.

© 2011 KI
All Rights Reserved.
Litho in USA.
Code KI-11479R2/KI/VL/211

Printed using only water-based inks,
including metallics. Please recycle.