

True® Desking System Price List ■

January 3, 2011

Updated January 2, 2017

800-424-2432





True® Desking Specifications		2
True® Desking Typicals		4
True® Desking System	Rectangular Desk	6
	Bow Front Desk	10
	Corner Desk	12
	Square Shoe Desk	20
	D-Shaped Desk	28
	P-Shaped Desk	36
	Piano Desk	44
	Transitional Desk	52
	Add-On Worksurfaces	56
	Transaction Worksurfaces	58
True® Desking System Components	Privacy Screens - Exposed Frame	62
	Privacy Screens - Upholstered	66
	Tool Rails	74
	Paper Management	76
	Balance® Overhead Storage	80
	Balance® Task Lights	86
	Universal Overhead Storage	88
	Universal Overhead Shelves and Divider	96
	Universal Overhead and Shelves Task Lights	98
True® Desking System Accessories	Center Drawer	100
	Grommets	102
	Corner Power Infeed Leg	104
	Modesty Panel Inserts	106
	Worksurface Accessories	108
True® Desking System Data/Comm.	Accessories	110
True® Desking System Electrical	Electrical	112
Index		122

True® Desking Specifications

Basic Worksurfaces

Worksurfaces shall define the shape of the workstation and provide support for overhead storage, hanging pedestals, electrical componentry, and privacy screens.

Rectangular Worksurfaces

Laminated worksurfaces shall be constructed from 1-1/8" medium density fiberboard with a .030 high-pressure laminate surface or veneer and a .030 phenolic backing sheet with a choice of three edge styles: 74P, 74P with knife edge along front, or 3/8" wood. polypropylene edge shall be available in multiple colors. The knife edge shall only be applied to the front edge of the worksurface and extend 2" beyond the desk frame. The wood edge shall be constructed from natural red oak and be available in a clear finish (standard) or in a maple wood band with additional stains. Worksurfaces shall be available in 24", 30", 36", 42", 48", 54", 60", 66", and 72" widths, 24" and 30" depths, and 29" height.

Rectangular worksurfaces up to 60" wide shall include two triangular worksurface grommets and covers, located in the back corners of each worksurface. 66" and 72" wide worksurfaces shall have an optional third triangular worksurface grommet and cover located near the back center of the desk. Grommets shall be molded from polycarbonate and available in colors or translucent. Worksurfaces that are 60", 66", and 72" wide shall have an integrated steel reinforcement to allow adequate support for load bearing. All worksurfaces shall have pre-drilled holes for attachment to the desk frame.

Two leg supports shall support the worksurface and be formed of 16-gauge steel, overall dimensions shall be 6.00 x 6.00 x 27.25, with 16-gauge internal reinforcements resistance welded for additional strength. The leg assemblies shall be attached to the underside of the worksurface from above by use of threaded inserts. A steel leg cover on inside of desk shall be standard and removable without tools. A glide shall be attached to the bottom of the leg for up to 1" of adjustability. Two 3.25" x 2.25" grommets and covers molded from polycarbonate shall be standard on the top of each leg side.

The modesty panel beam shall be formed of 18-gauge steel, overall dimensions are 3.00 x 9.00 x length determined by size of worksurface. The modesty panel beam shall be attached to leg supports and the underside of the worksurface, will provide support for the worksurface and allow electrical and data cable to be run along the width of the desk. Plastic worksurface spacers shall provide a 1/4" stand off distance between the worksurface and modesty panel beam and snap into place for easier assembly.

An optional lower modesty panel shall be formed of 18-gauge steel, overall dimensions are 1.00 x 18.00 x length determined by size of worksurface. The lower modesty panel shall be attached to the leg supports and

provide full enclosure of the desk back from floor to the modesty panel beam.

Two end panels shall support the worksurface and be formed of 18-gauge steel with an 18-gauge steel reinforcement resistance welded for strength. The end panel shall have a honeycomb core for additional strength and noise reduction. Overall dimensions shall be 1.25 x 27.00 x depth determined by worksurface size or configuration. Standard depths shall be 9" for transitional depth, 18" for 24" worksurfaces and 24" for 30" worksurfaces. End panel assembly shall be attached to the underside of the worksurface and leg assembly. Plastic worksurface spacers shall provide a 1/4" stand off distance between the worksurface and end panel and snap into place for easier assembly. A glide shall be attached to the bottom of the end panel for up to 1" of adjustability.

All steel desk components shall be powder-coated or otherwise finished.

Rectangular Reduction Worksurface

Rectangular reduction worksurfaces shall have the same basic construction as the rectangular worksurfaces. Worksurfaces shall have two curving arcs along the front edge that transition from a depth of 30" on one end and 24" on the opposite end.

Bow Front Worksurface

Bow front worksurfaces shall have the same basic construction as the rectangular worksurfaces. These worksurfaces shall have a depth of 30" or 36" with a radius edge that extends 6" from the desk support structure on the visitor side. Worksurfaces shall only be available in 60", 66", and 72" widths, without the center grommet and cover.

Corner Worksurface

Corner worksurfaces shall have the same basic construction as the rectangular worksurfaces with an additional leg support, modesty panel beam, and optional lower modesty panel. Depths of 24" and 30" and widths of 42" and 48" shall be standard. Worksurfaces shall have three grommets and covers, one per corner, located in the back corners of each worksurface as standard.

P-Shaped and Piano Shaped Worksurfaces

P-shaped and piano shaped worksurfaces shall have the same basic construction as the rectangular worksurfaces with an additional round support leg and modesty panel. The round support leg shall be attached towards the rounded front end of the worksurface and be constructed from 4" diameter, 14-gauge steel, and be fitted with a glide for up to 1" of adjustability. The modesty panel shall be constructed from 18-gauge steel and extend 9" from the underside of the worksurface. Worksurfaces shall be available in 60", 66" and 72" depths and 48" widths.

D-Shaped Worksurfaces

D-shaped worksurfaces shall have the same basic construction as the rectangular worksurfaces with an additional round support leg and modesty panel. The round support leg

shall be attached towards the rounded end of the worksurface and be constructed from 4" diameter, 14-gauge steel, and be fitted with a glide for up to 1" of adjustability. Worksurfaces shall be available in 24", 30" or 36" widths and 48", 54", 60", 66" and 72" depths.

Round Add-On Worksurface

Round add-on worksurfaces shall be available with the same edge treatments as the rectangular worksurfaces. They shall be available in 36" diameter with a 24" flat and 42" diameter with a 30" flat. A round support leg shall support the worksurface and be constructed from 4" diameter, 14-gauge steel, and be fitted with a glide for 1" of adjustability. Two steel splice plates and hardware shall be included to attach the round add on worksurface to a rectangular worksurface.

Half Round and Quarter Round Add-On Worksurfaces

Half round and quarter round add-on worksurfaces shall be available with the same edge treatments as the rectangular worksurfaces. They shall be available in 48" diameter and 60" diameter. A round support leg shall support the worksurface and be constructed from 4" diameter, 14-gauge steel, and be fitted with a glide for 1" of adjustability. Four steel splice plates and hardware shall be included to attach the half round add on worksurface to two back rectangular worksurfaces. Four steel splice plates and hardware shall be included to attach the quarter round add on worksurface to two rectangular worksurfaces that are perpendicular to each other.

Transaction Worksurface

Transaction worksurfaces shall be available with the same edge treatments as the rectangular worksurfaces. Worksurfaces shall attach via two support stanchions to rectangular worksurfaces and three support stanchions to corner worksurfaces. The worksurfaces shall be available in 16" depth with a 4" overhang in overall sizes that match the base rectangular and corner workstations. Worksurfaces shall be available in 31" wheelchair accessible height or 42" stand-up height.

Backpack Wire Trough Component Kit

Backpack wire trough components shall allow for lay-in wiring along the back of workstation. The kit shall consist of a pair of trough mounting brackets attached to the leg supports and constructed from 16-gauge steel, three 1.25" x .92" wire troughs constructed from 18-gauge steel that span the width of a desk, and a cover constructed from 18-gauge steel capable of being opened without the use of any tools. Applicable end trim, corner, and splice components shall also be available for the cover.

Electrical

Power shall be supplied through a UL listed 10-wire system available in two different configurations that are not interchangeable: 6 hot wires, 2 neutral wires, and 2 ground wires or 4 hot wires, 4 neutral wires, and 2 ground wires. The system shall have a rated

capacity of 120 VAC@ 20 amps.

A rigid one-piece wireway shall be attached to the inside of the modesty panel beam by two 16-gauge steel brackets and hardware and be covered by an 18-gauge steel cover. The wireway design shall allow for easy connection of the wireway of one desk to another through the use of a jumper. All desks 30" and wider shall be ready to accept electrical components.

The receptacles for the system shall be snap fit into the wireways and be rated for 15 amps.

The electrical system shall allow for a method of passing power from one powered desk through the modesty panel beam of a non-powered desk and connected to the wireway of a third desk. This power pass through shall attach with snap fit connections.

The electrical system shall allow power to feed from the top of the desk through the triangular grommet in the worksurface. The top infeed kit shall include 12' of flexible metal conduit with a snap fit attachment to the wireway on one end and open whip on the other, a 7' or 10' extruded aluminum power pole and cover, and ceiling trim. The interior of the power pole shall be divided into two cavities for power and communication cable management.

The electrical system shall allow for power to infeed from the base of the desk through the lower leg grommet or leg cover. The base infeed kit shall include 6' of plastic covered flexible conduit that transitions into flexible metal conduit with a snap fit attachment to the wireway on one end and open whip on the other. A relocatable power tap (RPT) shall provide above worksurface power to the support stanchions from an installed 10-wire electrical system or use of the building outlets. Two RPT's, each containing two 15 amp outlets, shall be mountable per stanchion. Cord lengths shall be available in 36" or 96".

A steel bracket shall be available to attach to the underside of the modesty panel beam near the worksurface. It shall have a 1.38" x 2.70" opening to accept several different manufacturers data faceplates and the RPT.

Pedestal Storage

Pedestal storage for True® shall be provided by KI's 700 Series, 700 Series Curve, and U-Series® Pedestals. 3 pedestals shall be available in 2 depths, 17-5/8" that may be used with any depth worksurface, 21- 5/8" for maximum storage under a 30" worksurface. Multiple drawer combinations shall be available.

The 12" file drawer sizes shall have full extension slide arm suspensions for full access to storage space. The 3" pencil drawers and 6" box drawers shall have 3/4" extension, steel ball-bearing suspension.

Locks shall be included in each pedestal. Specific keying combinations shall be avail-

able. See Key Options.

Center Drawer

The center drawer shall mount below a 24" or 30" deep worksurface which has an 18" wide clearance. The drawer pan shall be constructed of 22-gauge steel with a hem along the front edge for safety and strength. A deep rib shall form a pencil tray and provide additional strength and a double flange across the back shall prevent spillage of contents. The drawer sides shall be 20-gauge with a hem along the top edge for safety. The drawer shall run on a pair of full extension, ball-bearing suspensions and shall be available with or without a lock, keyed randomly as standard. Field drilling for installation shall be necessary.

Privacy Screens

Privacy screens shall be available to provide sit down or stand up privacy within the True® workstation. Screens shall be 3/4" or 1" thick, 18-1/4", 21" or 38" high and available in 24", 30", 36", 42", 48", 54", 60", 66" and 72" widths to fit all worksurfaces. The 66" and 72" widths shall consist of a pair of screens (1) 30" plus (1) 36" screen for 66" applications and (2) 36" screens for 72" applications. The screens shall include mounting brackets for attachment to either the overhead supports, the underside of the worksurface, the top of the worksurface, or with a combination of attachment to an overhead support and a worksurface top.

Two privacy screen construction methods shall be available: two 1/2" industrial insulation boards, covered with fabric and glued together or an exposed, powder-coated aluminum frame. The exposed frame construction shall allow for different core materials to be inserted.

Overhead Support Stanchions

The overhead support stanchions shall be formed of 16-gauge steel, with overall dimensions of 6.00" x 6.00" x 19.50". A reinforcement plate constructed of 16-gauge steel shall be welded in place to provide additional strength and have 4 cutouts to accommodate either commercially available data plates or two RPT's. Support stanchions shall be designed to hinge open to allow access to the inside of the overhead support stanchions. A flexible rubber trim piece shall allow power or data cables to be run from the worksurface into the overhead support stanchions with the covers closed.

Overhead Storage

Overhead storage shall consist of the Balance® overhead and Universal overhead and shelves. Overhead storage shall attach to worksurface with two overhead support stanchions. 24", 30", 36", 42", 48", 54", 60", 66" and 72" sizes shall be available. 66" and 72" overheads shall incorporate a single shelf with two doors

Shelf dividers shall be power-coated steel with installation and removal accomplished without the use of tools or fasteners.

Universal overheads and shelves shall be

17" high and shall have 19-1/2" clearance between the worksurface and the bottom of shelf. Overhead doors shall be available with painted steel, fabric, laminate, or veneer, with a polypropylene extrusion handle. Locks shall be randomly assigned or keyed per customer requests.

The end panels shall be constructed of 14-gauge steel and have self-locking mounting tabs formed into the back edge. The shelf, back, and top shall be constructed from 18-gauge steel. The front edge of the shelf shall be a polypropylene extrusion that also provides space for a concealed flush mount task light.

Balance® overheads shall be 17" high and have 19-1/2" clearance between the worksurface and the bottom of shelf. The upper door shall be available in colored or translucent extruded rigid polypropylene with spatter-coat finish, fabric, or laminate applied. The overall door thickness shall be 3/8". The lower door shall be an aluminum extrusion and be ergonomic in design. A center lock mechanism shall be utilized between the upper and lower doors for security.

The overhead doors shall be effortlessly operated from either a seated or standing position through use of the upper or lower door. The upper door and lower door shall be synchronized in motion through the use of two 10-gauge linkages. The doors shall be assisted with two extension springs and require less than 5 pounds of force to operate. The upper door shall open over the outside of the case.

Task Lights

Task lights shall be offered in one standard level of efficiency and cost. The standard light shall have a magnetic high power ballast with rapid start, cool white T-8 fluorescent lamp. Task lights shall attach to the underside of the shelf on overhead cabinets.

Paper Management System

The paper management system shall address the storage and movement of files, binders, and documents. Components shall be available with integrated hooks for attachment to the work bar.

Key Options

There are various key options available depending on the component model. The key alike option (KA) allows multiple components of a workstation to be keyed alike. The key standard option (KS) allows each component to have its own randomly selected key number shipped with the individual component. The No lock core (NLC) provides more flexibility in keying workstations alike. All locks and keys for the individual components specified with no lock core will be packaged separately from the components. The location of the lock core and corresponding numbered key will be determined upon installation.

ANSI/BIFMA

True® desking shall meet or exceed the

required ANSI/BIFMA X5.5-2008 desk systems test.

Quality

All True® desking components shall originate from ISO 9000, ISO 9001 or ISO 9002 registered facilities.

UL Listed

True® desks shall be listed to applicable UL standards and requirements by Underwriters Laboratories Inc. Two of the standards used to evaluate True® desks are UL 1286 Office Furnishing and UL 723 Standard Test for Surface Burning Characteristics of Building Materials.

Fabric

Fabric will be applied as swatched by the fabric manufacturer. Fabric that is required to be applied differently than is swatched will need a Special Cost Request written specifying the direction the fabric is to be applied. The posted standard lead time will apply to the Special Cost Request.

True® Desking Typicals

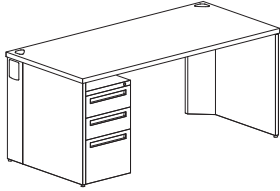

- 30" x 60" Rectangular Desk with Partial Modesty Panel, 74P Edge, Standard End Panels
- 700 Series Freestanding Pedestal - Box/Box/File

Model No.	Price
TR3060/P-74P-S-NCG	\$1389
S7P/1524FBBF	\$739
Total Price	\$2128

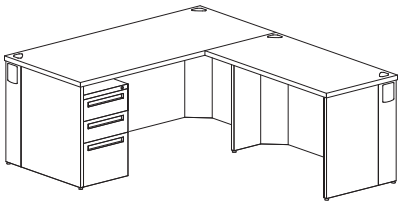

- 30" x 60" Rectangular Desk with Full Modesty Panel, 74P Edge, Standard End Panels
- 24" x 28" Rectangular Desk with Full Modesty Panel, 74P Edge, Left Transitional End Panel
- 700 Series Freestanding Pedestal - Box/Box/File

Model No.	Price
TR3060/F-74P-S-NCG	\$1688
TR2448/F-74P-L	\$1463
S7P/1524FBBF	\$739
Total Price	\$3890

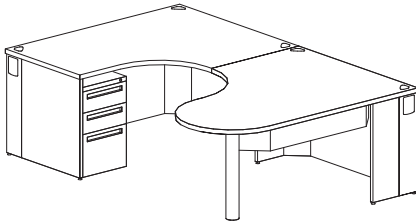

- 30" x 60" x 48" x 30" Square Shoe Desk with Full/Full Modesty Panel, 74P Edge, Right Transitional End Panel
- 30" x 48" x 66" Piano Shaped Desk with Full Modesty Panel and Guest Modesty Panel, 74P Edge, Both Transitional End Panels
- 700 Series Freestanding Pedestal - Box/Box/File

Model No.	Price
TS30604830/F/FS-74P-R-NCG	\$2490
TI304866/F/G-74P-B	\$2326
S7P/1524FBBF	\$739
Total Price	\$5555

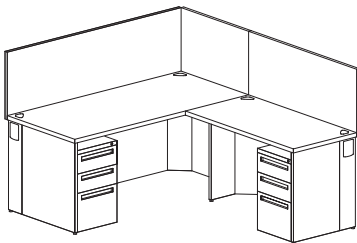

- 30" x 60" Rectangular Desk with Full Modesty Panel, 74P Edge, Standard End Panels
- 24" x 42" Rectangular Desk with Full Modesty Panel, 74P Edge, Left Transitional End Panel
- 30"W x 20"H Privacy Screen, Mounted Behind the Worksurface, Upholstered
- 42"W x 20"H Privacy Screen, Mounted Behind the Worksurface, Upholstered
- 66"W x 20"H Privacy Screen, Mounted Behind the Worksurface, Upholstered
- 700 Series Freestanding Pedestal - Box/Box/File
- 700 Series Freestanding Pedestal - Box/Box/File

Model No.	Price
TR3060/F-74P-S-NCG	\$1688
TR2442/F-74P-L	\$1401
TBW2030	\$236
TBW2042	\$344
TBW2066	\$528
S7P/1524FBBF	\$739
S7P/1520FBBF	\$700
Total Price	\$5636

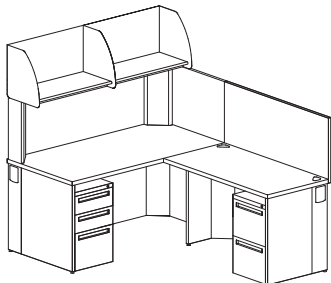

- 30" x 60" Rectangular Desk with Partial Modesty Panel, 74P Edge, Standard End Panels with Center Grommet to Mount Overhead Shelf
- 24" x 48" Rectangular Desk with Full Modesty Panel, 74P Edge, Left Transitional End Panel
- 30"W x 20"H Privacy Screen, Mounted Behind the Worksurface, Upholstered
- 48"W x 20"H Privacy Screen, Mounted Behind the Worksurface, Upholstered
- 60"W x 19"H Privacy Screen, Mounted Between Stanchions, Upholstered
- 60"W Universal Overhead Regular Shelf Mounted on Stanchions
- 700 Series Freestanding Pedestal - Box/Box/File
- 700 Series Freestanding Pedestal - File/File

Model No.	Price
TR3060/P-74P-S-NCG	\$1389
TR2448/F-74P-L	\$1463
TBW2030	\$236
TBW2048	\$392
TBS60/U	\$464
URSR60/TR	\$663
S7P/1524FBBF	\$739
S7P/1520FFF	\$666
Total Price	\$6012

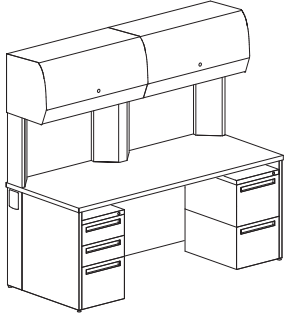

- 30" x 72" Rectangular Desk with Full Modesty Panel, 74P Edge, Standard End Panels with Center Grommet to Mount Overhead Cabinet
- 72"W x 19"H Privacy Screen, Mounted Between Stanchions, Upholstered
- 72"W Balance Solid Color Overhead Cabinet Mounted on Stanchions
- 700 Series Freestanding Pedestal - Box/Box/File
- 700 Series Freestanding Pedestal - File/File

Model No.	Price
TR3072/F-74P-S-YCG	\$1849
TBS72/U	\$569
BLCS72D/TR	\$2342
S7P/1524FBBF	\$739
S7P/1524FFF	\$700
Total Price	\$6199

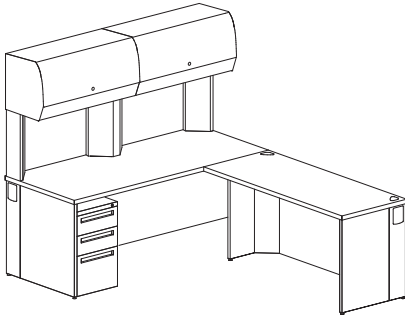

- 30" x 72" Rectangular Desk with Full Modesty Panel, 74P Edge, Standard End Panels with Center Grommet to Mount Overhead Cabinet
- 24" x 60" Rectangular Desk with Full Modesty Panel, 74P Edge, Left Transitional End Panel
- 72"W x 19"H Privacy Screen, Mounted Between Stanchions, Upholstered
- 72"W Balance Solid Color Overhead Cabinet Mounted on Stanchions
- 700 Series Freestanding Pedestal - Box/Box/File

Model No.	Price
TR3072/F-74P-S-YCG	\$1849
TR2460/F-74P-L	\$1591
TBS72/U	\$569
BLCS72D/TR	\$2342
S7P/1524FBBF	\$739
Total Price	\$7090

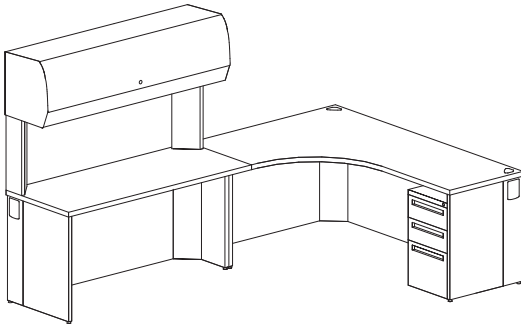

- 24" x 60" Rectangular Desk with Full Modesty Panel, 74P Edge, Right Transitional End Panel
- 24" x 48" x 72" x 24" Square Shoe Desk with Full Modesty/Full Modesty Panels, 74P Edge, Left Transitional End Panel
- 60"W x 19"H Privacy Screen, Mounted Between Stanchions, Upholstered
- 60"W Balance Solid Color Overhead Cabinet Mounted on Stanchions
- 700 Series Freestanding Pedestal - Box/Box/File

Model No.	Price
TR2460/F-74P-R	\$1591
TS24487224/F/FS-74P-L-NCG	\$2460
TBS60/U	\$464
BLCS60/TR	\$1454
S7P/1520FBBF	\$700
Total Price	\$6669

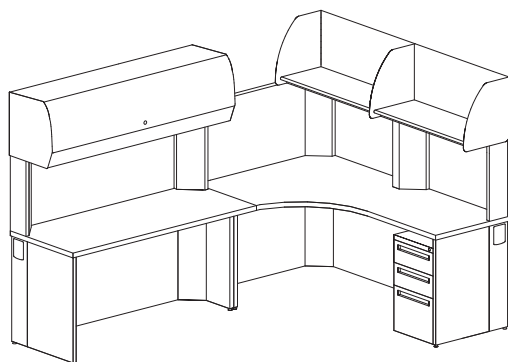

- 24" x 60" Rectangular Desk with Full Modesty Panel, 74P Edge, Right Transitional End Panel
- 24" x 48" x 72" x 24" Square Shoe Desk with Full Modesty/Full Modesty Panels, 74P Edge, Left Transitional End Panel
- 60"W x 19"H Privacy Screen, Mounted Between Stanchions, Upholstered
- 48"W x 20"H Privacy Screen, Mounted Behind the Worksurface, Upholstered
- 72"W x 20"H Privacy Screen, Mounted Behind the Worksurface, Upholstered
- 60"W Balance Solid Color Overhead Cabinet Mounted on Stanchions
- 72"W Universal Overhead Regular Shelf Mounted on Stanchions
- 700 Series Freestanding Pedestal - Box/Box/File

Model No.	Price
TR2460/F-74P-R	\$1591
TS24487224/F/FS-74P-L-NCG	\$2460
TBS60/U	\$464
TBW2048	\$392
TBW2072	\$581
BLCS60/TR	\$1454
URSR72/TR	\$1010
S7P/1520FBBF	\$700
Total Price	\$8652

True[®] Desking System

Rectangular Desk

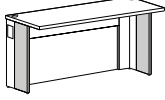
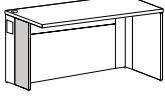
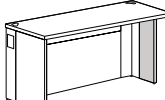
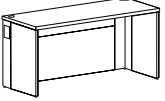
MODEL	D x W	MODEL NUMBER									
		Basic Model	Edge Style	End Panel	Center Grom.	Surface Grom. Color	Surface Finish	Edge Color	Frame Grom. Color	Desk Color	
 <p>(B) Both transitional</p>  <p>(L) Left transitional</p>  <p>(R) Right transitional</p>  <p>(S) Two full end panels</p>	Rectangular Desk with Full Modesty Panel	TR2424/F	<input type="checkbox"/>	<input type="checkbox"/>	NCG	<input type="checkbox"/>	<input type="checkbox"/>	<input type="checkbox"/>	<input type="checkbox"/>	<input type="checkbox"/>	
	24 x 24"	TR2430/F	<input type="checkbox"/>	<input type="checkbox"/>	NCG	<input type="checkbox"/>	<input type="checkbox"/>	<input type="checkbox"/>	<input type="checkbox"/>	<input type="checkbox"/>	
	24 x 30"	TR2436/F	<input type="checkbox"/>	<input type="checkbox"/>	NCG	<input type="checkbox"/>	<input type="checkbox"/>	<input type="checkbox"/>	<input type="checkbox"/>	<input type="checkbox"/>	
	24 x 36"	TR2442/F	<input type="checkbox"/>	<input type="checkbox"/>	NCG	<input type="checkbox"/>	<input type="checkbox"/>	<input type="checkbox"/>	<input type="checkbox"/>	<input type="checkbox"/>	
	24 x 42"	TR2448/F	<input type="checkbox"/>	<input type="checkbox"/>	NCG	<input type="checkbox"/>	<input type="checkbox"/>	<input type="checkbox"/>	<input type="checkbox"/>	<input type="checkbox"/>	
	24 x 48"	TR2454/F	<input type="checkbox"/>	<input type="checkbox"/>	NCG	<input type="checkbox"/>	<input type="checkbox"/>	<input type="checkbox"/>	<input type="checkbox"/>	<input type="checkbox"/>	
	24 x 54"	TR2460/F	<input type="checkbox"/>	<input type="checkbox"/>	NCG	<input type="checkbox"/>	<input type="checkbox"/>	<input type="checkbox"/>	<input type="checkbox"/>	<input type="checkbox"/>	
	24 x 60"	TR2466/F	<input type="checkbox"/>	<input type="checkbox"/>	NCG	<input type="checkbox"/>	<input type="checkbox"/>	<input type="checkbox"/>	<input type="checkbox"/>	<input type="checkbox"/>	
	24 x 66"	TR2472/F	<input type="checkbox"/>	<input type="checkbox"/>	NCG	<input type="checkbox"/>	<input type="checkbox"/>	<input type="checkbox"/>	<input type="checkbox"/>	<input type="checkbox"/>	
	24 x 72"	TR3024/F	<input type="checkbox"/>	<input type="checkbox"/>	NCG	<input type="checkbox"/>	<input type="checkbox"/>	<input type="checkbox"/>	<input type="checkbox"/>	<input type="checkbox"/>	
	30 x 24"	TR3030/F	<input type="checkbox"/>	<input type="checkbox"/>	NCG	<input type="checkbox"/>	<input type="checkbox"/>	<input type="checkbox"/>	<input type="checkbox"/>	<input type="checkbox"/>	
	30 x 30"	TR3036/F	<input type="checkbox"/>	<input type="checkbox"/>	NCG	<input type="checkbox"/>	<input type="checkbox"/>	<input type="checkbox"/>	<input type="checkbox"/>	<input type="checkbox"/>	
	30 x 36"	TR3042/F	<input type="checkbox"/>	<input type="checkbox"/>	NCG	<input type="checkbox"/>	<input type="checkbox"/>	<input type="checkbox"/>	<input type="checkbox"/>	<input type="checkbox"/>	
	30 x 42"	TR3048/F	<input type="checkbox"/>	<input type="checkbox"/>	NCG	<input type="checkbox"/>	<input type="checkbox"/>	<input type="checkbox"/>	<input type="checkbox"/>	<input type="checkbox"/>	
	30 x 48"	TR3054/F	<input type="checkbox"/>	<input type="checkbox"/>	NCG	<input type="checkbox"/>	<input type="checkbox"/>	<input type="checkbox"/>	<input type="checkbox"/>	<input type="checkbox"/>	
	30 x 54"	TR3060/F	<input type="checkbox"/>	<input type="checkbox"/>	NCG	<input type="checkbox"/>	<input type="checkbox"/>	<input type="checkbox"/>	<input type="checkbox"/>	<input type="checkbox"/>	
30 x 60"	TR3066/F	<input type="checkbox"/>	<input type="checkbox"/>	NCG	<input type="checkbox"/>	<input type="checkbox"/>	<input type="checkbox"/>	<input type="checkbox"/>	<input type="checkbox"/>		
30 x 66"	TR3072/F	<input type="checkbox"/>	<input type="checkbox"/>	NCG	<input type="checkbox"/>	<input type="checkbox"/>	<input type="checkbox"/>	<input type="checkbox"/>	<input type="checkbox"/>		
30 x 72"											

TRUE

HOW TO ORDER

Indicate the following information on order form:

- Quantity of each item.
- Model number, including options. See "How To Build a Model Number".
- Any special service required.

Note: • The indicates that a choice is required.

- The absence of the indicates that no choice is required.
- Alpha-numeric characters in place of indicate that no other alternatives are available.

HOW TO BUILD A MODEL NUMBER

- A** Select basic model.
- B** Select edge style.
 KN is not recommended in L-Shaped configurations.
74P - 74P edge
KN - Knife edge
34S - 3/8" Wood band edge
VN - Wood edge veneer
 With 74P, KN and 34S edges, select from laminates for surface finish (Lxx). For edge color, 74P and KN, select from Exx colors and for 34S, select Mxx colors. For VN, select from Mxx for surface finish and do not select an edge color.
- C** Select end panel.
B - Two transitional end panels
L - Left transitional end panel; add \$55
R - Right transitional end panel; add \$55
S - Two full end panels; add \$108

- D** Select desk center grommet option.
NCG - No center grommet
YCG - Yes center grommet
 "YCG" option only available on 66" and 72" wide desks. "YCG" is needed to mount overheads, transaction surfaces or stanchion mounted privacy screens.
- E** Select leg and surface grommet color.
 Refer to color addendum at ki.com or KI Fabrics & Finishes binder.
- F** Select surface finish.
 Refer to color addendum at ki.com or KI Fabrics & Finishes binder.
 Surface finish offerings are based on edge style selections.
- G** Select edge color.
 Refer to color addendum at ki.com or KI Fabrics & Finishes binder.
 Edge color offerings are based on edge style selections.
- H** Select frame grommet color.
 Refer to color addendum at ki.com or KI Fabrics & Finishes binder.
- I** Select desk color.
 Refer to color addendum at ki.com or KI Fabrics & Finishes binder.

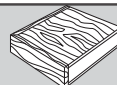
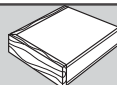
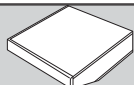
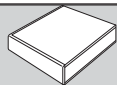

Approx. Packaged Weight	74P Edge (74P)	Knife Edge (KN)	3/8" Wood Band Edge (34S)	Wood Edge Veneer (VN)
57.0#	\$ 1224	\$ 1329	\$ 1518	\$ 1626
84.0#	1241	1348	1543	1654
93.0#	1276	1384	1583	1693
100.0#	1346	1462	1667	1784
108.0#	1408	1522	1733	1854
115.0#	1464	1584	1799	1923
128.0#	1536	1660	1882	2010
136.0#	1607	1736	1966	2100
144.0#	1700	1834	2076	2215
89.0#	1255	1365	1561	1673
97.0#	1275	1384	1584	1694
107.0#	1316	1430	1636	1751
116.0#	1376	1495	1706	1826
125.0#	1450	1569	1787	1910
133.0#	1506	1628	1853	1981
142.0#	1580	1707	1939	2070
152.0#	1636	1767	2005	2138
160.0#	1741	1878	2128	2271

FINISH INFORMATION

Additional Laminate Offering

Additional laminates beyond KI standard offering, are available with two weeks extended leadtime. To specify additional laminates, use these designators followed by the supplier's color/pattern code:

Formica - LF/supplier's color pattern code
 Nevamar - LN/supplier's color pattern code
 Wilsonart - LW/supplier's color pattern code

KI's standard finish is the supplier's recommended finish for that color/pattern.

Note: Nonstandard laminates from these suppliers (example: textured laminates), require an upcharge and additional leadtime. Contact KI.

SPECIAL SERVICES

Special Carton Marking

With specially marked information N/C

Shipping

Delivered. Shipped k.d. freight prepaid f.o.b. **Pembroke, Ontario K8A 0E1** factory. Freight class #70.

Specifications and prices are subject to change without prior notice.

True[®] Desking System

Rectangular Desk

MODEL	D x W	MODEL NUMBER								
		Basic Model	Edge Style	End Panel	Center Grom.	Surface Grom. Color	Surface Finish	Edge Color	Frame Grom. Color	Desk Color
Rectangular Desk with Partial Modesty Panel <ul style="list-style-type: none"> Consists of top, two legs, modesty panel, two end panels (optional transitional size), ganging plates, and all required assembly hardware Each leg has two upper cable access grommet locations Top has two cable access grommets above the legs (66" and 72" wide have optional third middle grommet used for mounting stanchions and not intended for routing cables) Top grommets allow for attachment of overhead storage units Modesty panel allows for optional 10-wire electrical system (see Electrical section) Pricing is for two transitional end panels, see "HOW TO BUILD A MODEL NUMBER" below for more options NOTE: Rectangular worksurfaces specified with a knife (KN) edge cannot be ganged at 90 degree angles. 	24 x 24"	TR2424/P	<input type="checkbox"/>	<input type="checkbox"/>	NCG	<input type="checkbox"/>	<input type="checkbox"/>	<input type="checkbox"/>	<input type="checkbox"/>	<input type="checkbox"/>
	24 x 30"	TR2430/P	<input type="checkbox"/>	<input type="checkbox"/>	NCG	<input type="checkbox"/>	<input type="checkbox"/>	<input type="checkbox"/>	<input type="checkbox"/>	<input type="checkbox"/>
	24 x 36"	TR2436/P	<input type="checkbox"/>	<input type="checkbox"/>	NCG	<input type="checkbox"/>	<input type="checkbox"/>	<input type="checkbox"/>	<input type="checkbox"/>	<input type="checkbox"/>
	24 x 42"	TR2442/P	<input type="checkbox"/>	<input type="checkbox"/>	NCG	<input type="checkbox"/>	<input type="checkbox"/>	<input type="checkbox"/>	<input type="checkbox"/>	<input type="checkbox"/>
	24 x 48"	TR2448/P	<input type="checkbox"/>	<input type="checkbox"/>	NCG	<input type="checkbox"/>	<input type="checkbox"/>	<input type="checkbox"/>	<input type="checkbox"/>	<input type="checkbox"/>
	24 x 54"	TR2454/P	<input type="checkbox"/>	<input type="checkbox"/>	NCG	<input type="checkbox"/>	<input type="checkbox"/>	<input type="checkbox"/>	<input type="checkbox"/>	<input type="checkbox"/>
	24 x 60"	TR2460/P	<input type="checkbox"/>	<input type="checkbox"/>	NCG	<input type="checkbox"/>	<input type="checkbox"/>	<input type="checkbox"/>	<input type="checkbox"/>	<input type="checkbox"/>
	24 x 66"	TR2466/P	<input type="checkbox"/>	<input type="checkbox"/>	<input type="checkbox"/>	<input type="checkbox"/>	<input type="checkbox"/>	<input type="checkbox"/>	<input type="checkbox"/>	<input type="checkbox"/>
	24 x 72"	TR2472/P	<input type="checkbox"/>	<input type="checkbox"/>	<input type="checkbox"/>	<input type="checkbox"/>	<input type="checkbox"/>	<input type="checkbox"/>	<input type="checkbox"/>	<input type="checkbox"/>
	30 x 24"	TR3024/P	<input type="checkbox"/>	<input type="checkbox"/>	NCG	<input type="checkbox"/>	<input type="checkbox"/>	<input type="checkbox"/>	<input type="checkbox"/>	<input type="checkbox"/>
	30 x 30"	TR3030/P	<input type="checkbox"/>	<input type="checkbox"/>	NCG	<input type="checkbox"/>	<input type="checkbox"/>	<input type="checkbox"/>	<input type="checkbox"/>	<input type="checkbox"/>
	30 x 36"	TR3036/P	<input type="checkbox"/>	<input type="checkbox"/>	NCG	<input type="checkbox"/>	<input type="checkbox"/>	<input type="checkbox"/>	<input type="checkbox"/>	<input type="checkbox"/>
	30 x 42"	TR3042/P	<input type="checkbox"/>	<input type="checkbox"/>	NCG	<input type="checkbox"/>	<input type="checkbox"/>	<input type="checkbox"/>	<input type="checkbox"/>	<input type="checkbox"/>
	30 x 48"	TR3048/P	<input type="checkbox"/>	<input type="checkbox"/>	NCG	<input type="checkbox"/>	<input type="checkbox"/>	<input type="checkbox"/>	<input type="checkbox"/>	<input type="checkbox"/>
	30 x 54"	TR3054/P	<input type="checkbox"/>	<input type="checkbox"/>	NCG	<input type="checkbox"/>	<input type="checkbox"/>	<input type="checkbox"/>	<input type="checkbox"/>	<input type="checkbox"/>
	30 x 60"	TR3060/P	<input type="checkbox"/>	<input type="checkbox"/>	NCG	<input type="checkbox"/>	<input type="checkbox"/>	<input type="checkbox"/>	<input type="checkbox"/>	<input type="checkbox"/>
30 x 66"	TR3066/P	<input type="checkbox"/>	<input type="checkbox"/>	<input type="checkbox"/>	<input type="checkbox"/>	<input type="checkbox"/>	<input type="checkbox"/>	<input type="checkbox"/>	<input type="checkbox"/>	
30 x 72"	TR3072/P	<input type="checkbox"/>	<input type="checkbox"/>	<input type="checkbox"/>	<input type="checkbox"/>	<input type="checkbox"/>	<input type="checkbox"/>	<input type="checkbox"/>	<input type="checkbox"/>	

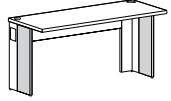

(B) Both transitional

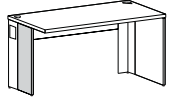

(L) Left transitional

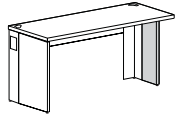

(R) Right transitional

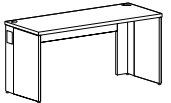

(S) Two full end panels

TRUE

A B C D E F G H I

HOW TO ORDER

Indicate the following information on order form:

- Quantity of each item.
- Model number, including options. See "How To Build a Model Number".
- Any special service required.

Note: • The indicates that a choice is required.

• The absence of the indicates that no choice is required.

• Alpha-numeric characters in place of indicate that no other alternatives are available.

HOW TO BUILD A MODEL NUMBER

A Select basic model.

B Select edge style.

KN is not recommended in L-Shaped configurations.

- 74P** - 74P edge
- KN** - Knife edge
- 34S** - 3/8" Wood band edge
- VN** - Wood edge veneer

With 74P, KN and 34S edges, select from laminates for surface finish (Lxx). For edge color, 74P and KN, select from Exx colors and for 34S, select Mxx colors. For VN, select from Mxx for surface finish and do not select an edge color.

C Select end panel.

- B** - Two transitional end panels
- L** - Left transitional end panel; add \$55
- R** - Right transitional end panel; add \$55
- S** - Two full end panels; add \$108

D Select desk center grommet option.

NCG - No center grommet

NCG - No center grommet

YCG - Yes center grommet

"YCG" option only available on 66" and 72" wide desks. "YCG" is needed to mount overheads, transaction surfaces or stanchion mounted privacy screens.

E Select surface grommet color.

Refer to color addendum at ki.com or KI Fabrics & Finishes binder.

F Select surface finish.

Refer to color addendum at ki.com or KI Fabrics & Finishes binder. Surface finish offerings are based on edge style selections.

G Select edge color.

Refer to color addendum at ki.com or KI Fabrics & Finishes binder.

Edge color offerings are based on edge style selections.

H Select frame grommet color.

Refer to color addendum at ki.com or KI Fabrics & Finishes binder.

I Select desk color.

Refer to color addendum at ki.com or KI Fabrics & Finishes binder.

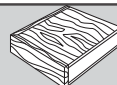
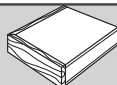
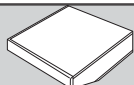
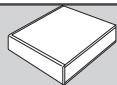

Approx. Packaged Weight	74P Edge (74P)	Knife Edge (KN)	3/8" Wood Band Edge (34S)	Wood Edge Veneer (VN)
52.0#	\$ 1059	\$ 1162	\$ 1353	\$ 1463
78.0#	1075	1186	1378	1489
85.0#	1098	1206	1406	1517
91.0#	1148	1260	1469	1586
97.0#	1167	1284	1495	1614
103.0#	1203	1324	1540	1662
114.0#	1238	1364	1586	1712
120.0#	1289	1416	1648	1781
127.0#	1344	1477	1722	1861
84.0#	1094	1200	1399	1509
91.0#	1106	1218	1417	1531
99.0#	1138	1251	1458	1573
107.0#	1176	1296	1508	1628
114.0#	1209	1333	1549	1672
121.0#	1245	1368	1592	1721
128.0#	1281	1410	1641	1772
136.0#	1316	1447	1686	1822
143.0#	1385	1522	1773	1916

FINISH INFORMATION

Additional Laminate Offering

Additional laminates beyond KI standard offering, are available with two weeks extended leadtime. To specify additional laminates, use these designators followed by the supplier's color/pattern code:

Formica - LF/supplier's color pattern code
 Nevamar - LN/supplier's color pattern code
 Wilsonart - LW/supplier's color pattern code

KI's standard finish is the supplier's recommended finish for that color/pattern.

Note: Nonstandard laminates from these suppliers (example: textured laminates), require an upcharge and additional leadtime. Contact KI.

SPECIAL SERVICES

Special Carton Marking

With specially marked information N/C

Shipping

Delivered. Shipped k.d. freight prepaid f.o.b. **Pembroke, Ontario K8A 0E1** factory. Freight class #70.

Specifications and prices are subject to change without prior notice.

True® Desking System

Bow Front Desk

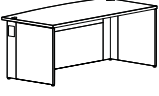
	MODEL	D x W	MODEL NUMBER									
			Basic Model	Edge Style	End Panel	Center Grom.	Surface Grom. Color	Surface Finish	Edge Color	Frame Grom. Color		Desk Color
 <p>TRUE</p>	Bow Front Desk with Full Modesty Panel • Consists of top, two legs, modesty panel, filler panel (full modesty panel), and standard depth end panels • Each leg has two cable access grommet locations • Top has two cable access grommets above the legs • Modesty panel allows for optional 10-wire electrical system (see Electrical section) • "Guest" side of desk has a 6" deep bowed overhang worksurface edge • Pedestals ordered with Bow Front Desks are required to be undersized from the desk's depth by 12"	30 x 60"	TE3060	<input type="checkbox"/>	<input type="checkbox"/>	NCG	<input type="checkbox"/>	<input type="checkbox"/>	<input type="checkbox"/>	<input type="checkbox"/>	<input type="checkbox"/>	
		30 x 66"	TE3066	<input type="checkbox"/>	<input type="checkbox"/>	NCG	<input type="checkbox"/>	<input type="checkbox"/>	<input type="checkbox"/>	<input type="checkbox"/>	<input type="checkbox"/>	
		30 x 72"	TE3072	<input type="checkbox"/>	<input type="checkbox"/>	NCG	<input type="checkbox"/>	<input type="checkbox"/>	<input type="checkbox"/>	<input type="checkbox"/>	<input type="checkbox"/>	
		36 x 60"	TE3660	<input type="checkbox"/>	<input type="checkbox"/>	NCG	<input type="checkbox"/>	<input type="checkbox"/>	<input type="checkbox"/>	<input type="checkbox"/>	<input type="checkbox"/>	
		36 x 66"	TE3666	<input type="checkbox"/>	<input type="checkbox"/>	NCG	<input type="checkbox"/>	<input type="checkbox"/>	<input type="checkbox"/>	<input type="checkbox"/>	<input type="checkbox"/>	
		36 x 72"	TE3672	<input type="checkbox"/>	<input type="checkbox"/>	NCG	<input type="checkbox"/>	<input type="checkbox"/>	<input type="checkbox"/>	<input type="checkbox"/>	<input type="checkbox"/>	
			A	B	C	D	E	F	G	H	I	

HOW TO ORDER

Indicate the following information on order form:

1. Quantity of each item.
2. Model number, including options. See "How To Build a Model Number".
3. Any special service required.

Note: • The indicates that a choice is required.

- The absence of the indicates that no choice is required.
- Alpha-numeric characters in place of indicate that no other alternatives are available.

HOW TO BUILD A MODEL NUMBER

A Select basic model.

B Select edge style.

Knife edge (KN) adds 2" to the depth of the desk. KN is not recommended in L-Shaped configurations.

74P	- 74P edge
KN	- Knife edge
34S	- 3/8" Wood band edge
VN	- Wood edge veneer

C Select end panel.

S - Two full end panels only
Price included in desk price.

D Select desk center grommet option.

NCG - No center grommet

E Select surface grommet color.

Refer to color addendum at ki.com or KI Fabrics & Finishes binder.

F Select surface finish.

Refer to color addendum at ki.com or KI Fabrics & Finishes binder.

Surface finish offerings are based on edge style selections. With 74P edge (74P), knife edge (KN), and wood band edge laminate (34S), select from laminates. With wood edge veneer (VN), select from veneers.

G Select edge color.

Refer to color addendum at ki.com or KI Fabrics & Finishes binder.

Edge color offerings are based on edge style selections. With 74P edge (74P) and knife edge (KN), select from 74P/knife colors. With wood edge veneer (VN), no edge color selection required. With wood band edge laminate (34S), select wood edge colors.

H Select frame grommet color.

Refer to color addendum at ki.com or KI Fabrics & Finishes binder.

I Select desk color.

Refer to color addendum at ki.com or KI Fabrics & Finishes binder.

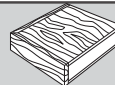
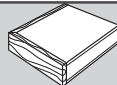
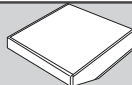
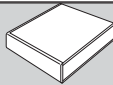

Approx. Packaged Weight	74P Edge (74P)	Knife Edge (KN)	3/8" Wood Band Edge (34S)	Wood Edge Veneer (VN)
134.0#	\$ 1751	\$ 1926	\$ 2242	\$ 2421
143.0#	1809	1989	2312	2498
151.0#	1915	2105	2449	2645
153.0#	2009	2211	2572	2775
163.0#	2078	2286	2659	2874
172.0#	2173	2392	2782	3005

FINISH INFORMATION

Additional Laminate Offering

Additional laminates beyond KI standard offering, are available with two weeks extended leadtime. To specify additional laminates, use these designators followed by the supplier's color/pattern code:

- Formica - LF/supplier's color pattern code
- Nevamar - LN/supplier's color pattern code
- Wilsonart - LW/supplier's color pattern code

KI's standard finish is the supplier's recommended finish for that color/pattern.

Note: Nonstandard laminates from these suppliers (example: textured laminates), require an upcharge and additional leadtime. Contact KI.

SPECIAL SERVICES

Special Carton Marking

With specially marked information N/C

Shipping

Delivered. Shipped k.d. freight prepaid f.o.b. **Pembroke, Ontario K8A 0E1** factory. Freight class #70.

Specifications and prices are subject to change without prior notice.

True[®] Desking System

Corner Desk

	D x W-LEFT x W-RIGHT x D	MODEL NUMBER								
		Basic Model	Edge Style	End Panel	Center Grom.	Surface Grom. Color	Surface Finish	Edge Color	Frame Grom. Color	Desk Color
TRUE Corner Desk with Full Modesty Panel/ Full Modesty Panel	24 x 42 x 42 x 24"	TC24424224/FF	<input type="checkbox"/> <input type="checkbox"/> <input type="checkbox"/>	<input type="checkbox"/>	NCG	<input type="checkbox"/> <input type="checkbox"/>	<input type="checkbox"/> <input type="checkbox"/> <input type="checkbox"/>	<input type="checkbox"/> <input type="checkbox"/>	<input type="checkbox"/> <input type="checkbox"/>	<input type="checkbox"/> <input type="checkbox"/>
	24 x 48 x 48 x 24"	TC24484824/FF	<input type="checkbox"/> <input type="checkbox"/> <input type="checkbox"/>	<input type="checkbox"/>	NCG	<input type="checkbox"/> <input type="checkbox"/>	<input type="checkbox"/> <input type="checkbox"/> <input type="checkbox"/>	<input type="checkbox"/> <input type="checkbox"/>	<input type="checkbox"/> <input type="checkbox"/>	<input type="checkbox"/> <input type="checkbox"/>
	30 x 48 x 48 x 30"	TC30484830/FF	<input type="checkbox"/> <input type="checkbox"/> <input type="checkbox"/>	<input type="checkbox"/>	NCG	<input type="checkbox"/> <input type="checkbox"/>	<input type="checkbox"/> <input type="checkbox"/> <input type="checkbox"/>	<input type="checkbox"/> <input type="checkbox"/>	<input type="checkbox"/> <input type="checkbox"/>	<input type="checkbox"/> <input type="checkbox"/>
<ul style="list-style-type: none"> • See images below • Consists of top, three legs, two modesty panels, two filler panels (full modesty panel), two end panels (optional transitional size), ganging plates, and all required assembly hardware • Each leg has two cable access grommet locations • Top has three cable access grommets above the legs • Top grommets allow for attachment of overhead storage units • Modesty panel allows for optional 10-wire electrical system (see Electrical section) • Pricing is for two transitional end panels, see "HOW TO BUILD A MODEL NUMBER" below for more options 										
A B C D E F G H I										

HOW TO ORDER

Indicate the following information on order form:

1. Quantity of each item.
2. Model number, including options. See "How To Build a Model Number".
3. Any special service required.

Note: • The indicates that a choice is required.

- The absence of the indicates that no choice is required.
- Alpha-numeric characters in place of indicate that no other alternatives are available.

HOW TO BUILD A MODEL NUMBER

- A** Select basic model.
- B** Select edge style.
 Knife edge (KN) adds 2" to the depth of the desk on the user's side.
74P - 74P edge
KN - Knife edge
34S - 3/8" Wood band edge
VN - Wood edge veneer
- C** Select transition end panels.
B - Two transitional end panels
L - Left transitional end panel;
 add \$55
R - Right transitional end panel;
 add \$55
S - Two full end panels; add \$108
- D** Select desk center grommet option.
NCG - No center grommet
- E** Select surface grommet color.
 Refer to color addendum at ki.com or KI

Fabrics & Finishes binder.

- F** Select surface finish.
 Refer to color addendum at ki.com or KI Fabrics & Finishes binder.
 Surface finish offerings are based on edge style selections. With 74P edge (74P), knife edge (KN), and wood band edge laminate (34S), select from laminates. With wood edge veneer (VN), select from veneers.
- G** Select edge color.
 Refer to color addendum at ki.com or KI Fabrics & Finishes binder.
 Edge color offerings are based on edge style selections. With 74P edge (74P) and knife edge (KN), select from 74P/knife colors. With wood edge veneer (VN), no edge color selection required. With wood band edge laminate (34S), select wood edge colors.
- H** Select frame grommet color.
 Refer to color addendum at ki.com or KI

Fabrics & Finishes binder.

- I** Select desk color.
 Refer to color addendum at ki.com or KI Fabrics & Finishes binder.

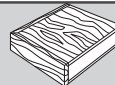
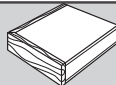
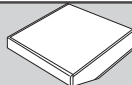
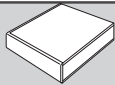

Approx. Packaged Weight	74P Edge (74P)	Knife Edge (KN)	3/8" Wood Band Edge (34S)	Wood Edge Veneer (VN)
142.0#	\$ 1725	\$ 1858	\$ 2098	\$ 2231
156.0#	1932	2078	2339	2487
171.0#	1967	2119	2388	2538

FINISH INFORMATION

Additional Laminate Offering

Additional laminates beyond KI standard offering, are available with two weeks extended leadtime. To specify additional laminates, use these designators followed by the supplier's color/pattern code:

- Formica - LF/supplier's color pattern code
- Nevamar - LN/supplier's color pattern code
- Wilsonart - LW/supplier's color pattern code

KI's standard finish is the supplier's recommended finish for that color/pattern.

Note: Nonstandard laminates from these suppliers (example: textured laminates), require an upcharge and additional leadtime. Contact KI.

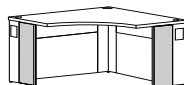

(B) Both transitional

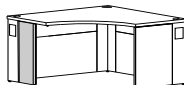

(L) Left transitional

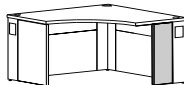

(R) Right transitional

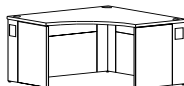

(S) Two full end panels

SPECIAL SERVICES

Special Carton Marking

With specially marked information N/C

Shipping

Delivered. Shipped k.d. freight prepaid f.o.b. **Pembroke, Ontario K8A 0E1** factory. Freight class #70.

Specifications and prices are subject to change without prior notice.

True[®] Desking System

Corner Desk

	D x W-LEFT x W-RIGHT x D	MODEL NUMBER									
		Basic Model	Edge Style	End Panel	Center Grom.	Surface Grom. Color	Surface Finish	Edge Color	Frame Grom. Color	Desk Color	
TRUE Corner Desk with Full Modesty Panel/ Partial Modesty Panel	24 x 42 x 42 x 24"	TC24424224/FP	<input type="checkbox"/> <input type="checkbox"/> <input type="checkbox"/>	<input type="checkbox"/>	NCG	<input type="checkbox"/> <input type="checkbox"/>	<input type="checkbox"/> <input type="checkbox"/> <input type="checkbox"/>	<input type="checkbox"/> <input type="checkbox"/>	<input type="checkbox"/> <input type="checkbox"/>	<input type="checkbox"/> <input type="checkbox"/>	
	24 x 48 x 48 x 24"	TC24484824/FP	<input type="checkbox"/> <input type="checkbox"/> <input type="checkbox"/>	<input type="checkbox"/>	NCG	<input type="checkbox"/> <input type="checkbox"/>	<input type="checkbox"/> <input type="checkbox"/> <input type="checkbox"/>	<input type="checkbox"/> <input type="checkbox"/>	<input type="checkbox"/> <input type="checkbox"/>	<input type="checkbox"/> <input type="checkbox"/>	
	30 x 48 x 48 x 30"	TC30484830/FP	<input type="checkbox"/> <input type="checkbox"/> <input type="checkbox"/>	<input type="checkbox"/>	NCG	<input type="checkbox"/> <input type="checkbox"/>	<input type="checkbox"/> <input type="checkbox"/> <input type="checkbox"/>	<input type="checkbox"/> <input type="checkbox"/>	<input type="checkbox"/> <input type="checkbox"/>	<input type="checkbox"/> <input type="checkbox"/>	
• See images below											
• Consists of top, three legs, two modesty panels, one filler panel (full modesty panel), two end panels (optional transitional size), ganging plates, and all required assembly hardware											
• Each leg has two cable access grommet locations											
• Top has three cable access grommets above the legs											
• Top grommets allow for attachment of overhead storage units											
• Modesty panel allows for optional 10-wire electrical system (see Electrical section)											
• Pricing is for two transitional end panels, see "HOW TO BUILD A MODEL NUMBER" below for more options											
			A	B	C	D	E	F	G	H	I

HOW TO ORDER

Indicate the following information on order form:

- Quantity of each item.
- Model number, including options. See "How To Build a Model Number".
- Any special service required.

Note: • The indicates that a choice is required.

- The absence of the indicates that no choice is required.
- Alpha-numeric characters in place of indicate that no other alternatives are available.

HOW TO BUILD A MODEL NUMBER

A Select basic model.

B Select edge style.

Knife edge (KN) adds 2" to the depth of the desk on the user's side.

74P	- 74P edge
KN	- Knife edge
34S	- 3/8" Wood band edge
VN	- Wood edge veneer

C Select transition end panels.

B	- Two transitional end panels
L	- Left transitional end panel; add \$55
R	- Right transitional end panel; add \$55
S	- Two full end panels; add \$108

D Select desk center grommet option.

NCG - No center grommet

E Select surface grommet color.

Refer to color addendum at ki.com or KI

Fabrics & Finishes binder.

F Select surface finish.

Refer to color addendum at ki.com or KI Fabrics & Finishes binder. Surface finish offerings are based on edge style selections. With 74P edge (74P), knife edge (KN), and wood band edge laminate (34S), select from laminates. With wood edge veneer (VN), select from veneers.

G Select edge color.

Refer to color addendum at ki.com or KI Fabrics & Finishes binder. Edge color offerings are based on edge style selections. With 74P edge (74P) and knife edge (KN), select from 74P/knife colors. With wood edge veneer (VN), no edge color selection required. With wood band edge laminate (34S), select wood edge colors.

H Select frame grommet color.

Refer to color addendum at ki.com or KI

Fabrics & Finishes binder.

I Select desk color.

Refer to color addendum at ki.com or KI Fabrics & Finishes binder.

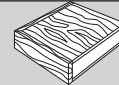
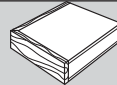
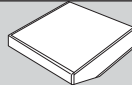
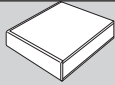

Approx. Packaged Weight	74P Edge (74P)	Knife Edge (KN)	3/8" Wood Band Edge (34S)	Wood Edge Veneer (VN)
133.0#	\$ 1526	\$ 1659	\$ 1899	\$ 2035
146.0#	1692	1838	2100	2252
161.0#	1729	1878	2145	2300

FINISH INFORMATION

Additional Laminate Offering

Additional laminates beyond KI standard offering, are available with two weeks extended leadtime. To specify additional laminates, use these designators followed by the supplier's color/pattern code:

- Formica - LF/supplier's color pattern code
- Nevamar - LN/supplier's color pattern code
- Wilsonart - LW/supplier's color pattern code

KI's standard finish is the supplier's recommended finish for that color/pattern.

Note: Nonstandard laminates from these suppliers (example: textured laminates), require an upcharge and additional leadtime. Contact KI.

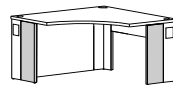

(B) Both transitional

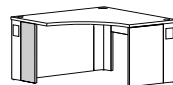

(L) Left transitional

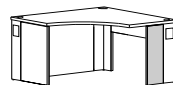

(R) Right transitional

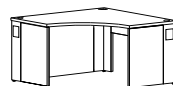

(S) Two full end panels

SPECIAL SERVICES

Special Carton Marking

With specially marked information N/C

Shipping

Delivered. Shipped k.d. freight prepaid f.o.b. **Pembroke, Ontario K8A 0E1** factory. Freight class #70.

Specifications and prices are subject to change without prior notice.

True[®] Desking System

Corner Desk

	D x W-LEFT x W-RIGHT x D	MODEL NUMBER									
		Basic Model	Edge Style	End Panel	Center Grom.	Surface Grom. Color	Surface Finish	Edge Color	Frame Grom. Color	Desk Color	
TRUE Corner Desk with Partial Modesty Panel/Full Modesty Panel	24 x 42 x 42 x 24"	TC24424224/PF	<input type="checkbox"/> <input type="checkbox"/> <input type="checkbox"/>	<input type="checkbox"/>	NCG	<input type="checkbox"/> <input type="checkbox"/>	<input type="checkbox"/> <input type="checkbox"/> <input type="checkbox"/>	<input type="checkbox"/> <input type="checkbox"/>	<input type="checkbox"/> <input type="checkbox"/>	<input type="checkbox"/> <input type="checkbox"/>	
	24 x 48 x 48 x 24"	TC24484824/PF	<input type="checkbox"/> <input type="checkbox"/> <input type="checkbox"/>	<input type="checkbox"/>	NCG	<input type="checkbox"/> <input type="checkbox"/>	<input type="checkbox"/> <input type="checkbox"/> <input type="checkbox"/>	<input type="checkbox"/> <input type="checkbox"/>	<input type="checkbox"/> <input type="checkbox"/>	<input type="checkbox"/> <input type="checkbox"/>	
	30 x 48 x 48 x 30"	TC30484830/PF	<input type="checkbox"/> <input type="checkbox"/> <input type="checkbox"/>	<input type="checkbox"/>	NCG	<input type="checkbox"/> <input type="checkbox"/>	<input type="checkbox"/> <input type="checkbox"/> <input type="checkbox"/>	<input type="checkbox"/> <input type="checkbox"/>	<input type="checkbox"/> <input type="checkbox"/>	<input type="checkbox"/> <input type="checkbox"/>	
<ul style="list-style-type: none"> • See images below • Consists of top, three legs, two modesty panels, one filler panel (full modesty panel), two end panels (optional transitional size), ganging plates, and all required assembly hardware • Each leg has two cable access grommet locations • Top has three cable access grommets above the legs • Top grommets allow for attachment of overhead storage units • Modesty panel allows for optional 10-wire electrical system (see Electrical section) • Pricing is for two transitional end panels, see "HOW TO BUILD A MODEL NUMBER" below for more options 											
			A	B	C	D	E	F	G	H	I

HOW TO ORDER

Indicate the following information on order form:

1. Quantity of each item.
2. Model number, including options. See "How To Build a Model Number".
3. Any special service required.

Note: • The indicates that a choice is required.

- The absence of the indicates that no choice is required.
- Alpha-numeric characters in place of indicate that no other alternatives are available.

HOW TO BUILD A MODEL NUMBER

A Select basic model.

B Select edge style.
Knife edge (KN) adds 2" to the depth of the desk on the user's side.

74P	- 74P edge
KN	- Knife edge
34S	- 3/8" Wood band edge
VN	- Wood edge veneer

C Select transition end panels.

B	- Two transitional end panels
L	- Left transitional end panel; add \$55
R	- Right transitional end panel; add \$55
S	- Two full end panels; add \$108

D Select desk center grommet option.

NCG - No center grommet

E Select surface grommet color.

Refer to color addendum at ki.com or KI

Fabrics & Finishes binder.

F Select surface finish.

Refer to color addendum at ki.com or KI Fabrics & Finishes binder.
Surface finish offerings are based on edge style selections. With 74P edge (74P), knife edge (KN), and wood band edge laminate (34S), select from laminates. With wood edge veneer (VN), select from veneers.

G Select edge color.

Refer to color addendum at ki.com or KI Fabrics & Finishes binder.
Edge color offerings are based on edge style selections. With 74P edge (74P) and knife edge (KN), select from 74P/knife colors. With wood edge veneer (VN), no edge color selection required. With wood band edge laminate (34S), select wood edge colors.

H Select frame grommet color.

Refer to color addendum at ki.com or KI

Fabrics & Finishes binder.

I Select desk color.

Refer to color addendum at ki.com or KI Fabrics & Finishes binder.

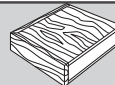
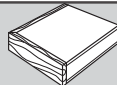
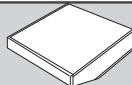
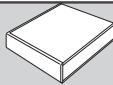

Approx. Packaged Weight	74P Edge (74P)	Knife Edge (KN)	3/8" Wood Band Edge (34S)	Wood Edge Veneer (VN)
133.0#	\$ 1526	\$ 1659	\$ 1899	\$ 2035
146.0#	1692	1838	2100	2252
161.0#	1729	1878	2145	2300

FINISH INFORMATION

Additional Laminate Offering

Additional laminates beyond KI standard offering, are available with two weeks extended leadtime. To specify additional laminates, use these designators followed by the supplier's color/pattern code:

- Formica - LF/supplier's color pattern code
- Nevamar - LN/supplier's color pattern code
- Wilsonart - LW/supplier's color pattern code

KI's standard finish is the supplier's recommended finish for that color/pattern.

Note: Nonstandard laminates from these suppliers (example: textured laminates), require an upcharge and additional leadtime. Contact KI.

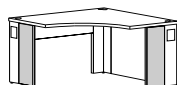

(B) Both transitional

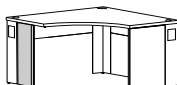

(L) Left transitional

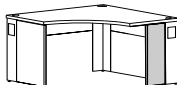

(R) Right transitional

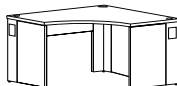

(S) Two full end panels

SPECIAL SERVICES

Special Carton Marking

With specially marked information N/C

Shipping

Delivered. Shipped k.d. freight prepaid f.o.b. **Pembroke, Ontario K8A 0E1** factory. Freight class #70.

Specifications and prices are subject to change without prior notice.

True[®] Desking System

Corner Desk

	D x W-LEFT x W-RIGHT x D	MODEL NUMBER									
		Basic Model	Edge Style	End Panel	Center Grom.	Surface Grom. Color	Surface Finish	Edge Color	Frame Grom. Color	Desk Color	
TRUE Corner Desk with Partial Modesty Panel/Partial Modesty Panel	24 x 42 x 42 x 24"	TC24424224/PP	<input type="checkbox"/> <input type="checkbox"/> <input type="checkbox"/>	<input type="checkbox"/>	NCG	<input type="checkbox"/> <input type="checkbox"/>	<input type="checkbox"/> <input type="checkbox"/> <input type="checkbox"/>	<input type="checkbox"/> <input type="checkbox"/>	<input type="checkbox"/> <input type="checkbox"/>	<input type="checkbox"/> <input type="checkbox"/>	
	24 x 48 x 48 x 24"	TC24484824/PP	<input type="checkbox"/> <input type="checkbox"/> <input type="checkbox"/>	<input type="checkbox"/>	NCG	<input type="checkbox"/> <input type="checkbox"/>	<input type="checkbox"/> <input type="checkbox"/> <input type="checkbox"/>	<input type="checkbox"/> <input type="checkbox"/>	<input type="checkbox"/> <input type="checkbox"/>	<input type="checkbox"/> <input type="checkbox"/>	
	30 x 48 x 48 x 30"	TC30484830/PP	<input type="checkbox"/> <input type="checkbox"/> <input type="checkbox"/>	<input type="checkbox"/>	NCG	<input type="checkbox"/> <input type="checkbox"/>	<input type="checkbox"/> <input type="checkbox"/> <input type="checkbox"/>	<input type="checkbox"/> <input type="checkbox"/>	<input type="checkbox"/> <input type="checkbox"/>	<input type="checkbox"/> <input type="checkbox"/>	
• See images below											
• Consists of top, three legs, two modesty panels, two end panels (optional transitional size), ganging plates, and all required assembly hardware											
• Each leg has two cable access grommet locations											
• Top has three cable access grommets above the legs											
• Top grommets allow for attachment of overhead storage units											
• Modesty panel allows for optional 10-wire electrical system (see Electrical section)											
• Pricing is for two transitional end panels, see "HOW TO BUILD A MODEL NUMBER" below for more options											
			A	B	C	D	E	F	G	H	I

HOW TO ORDER

Indicate the following information on order form:

- Quantity of each item.
- Model number, including options. See "How To Build a Model Number".
- Any special service required.

Note: • The indicates that a choice is required.

- The absence of the indicates that no choice is required.
- Alpha-numeric characters in place of indicate that no other alternatives are available.

HOW TO BUILD A MODEL NUMBER

A Select basic model.

B Select edge style.
Knife edge (KN) adds 2" to the depth of the desk on the user's side.

74P	- 74P edge
KN	- Knife edge
34S	- 3/8" Wood band edge
VN	- Wood edge veneer

C Select transition end panels.

B	- Two transitional end panels
L	- Left transitional end panel; add \$55
R	- Right transitional end panel; add \$55
S	- Two full end panels; add \$108

D Select desk center grommet option.

NCG - No center grommet

E Select surface grommet color.

Refer to color addendum at ki.com or KI

Fabrics & Finishes binder.

F Select surface finish.

Refer to color addendum at ki.com or KI Fabrics & Finishes binder.
Surface finish offerings are based on edge style selections. With 74P edge (74P), knife edge (KN), and wood band edge laminate (34S), select from laminates. With wood edge veneer (VN), select from veneers.

G Select edge color.

Refer to color addendum at ki.com or KI Fabrics & Finishes binder.
Edge color offerings are based on edge style selections. With 74P edge (74P) and knife edge (KN), select from 74P/knife colors. With wood edge veneer (VN), no edge color selection required. With wood band edge laminate (34S), select wood edge colors.

H Select frame grommet color.

Refer to color addendum at ki.com or KI

Fabrics & Finishes binder.

I Select desk color.

Refer to color addendum at ki.com or KI Fabrics & Finishes binder.

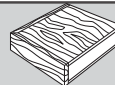
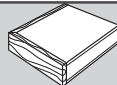
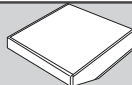
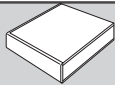

Approx. Packaged Weight	74P Edge (74P)	Knife Edge (KN)	3/8" Wood Band Edge (34S)	Wood Edge Veneer (VN)
124.0#	\$ 1329	\$ 1462	\$ 1700	\$ 1835
135.0#	1454	1598	1862	2010
150.0#	1490	1640	1906	2057

FINISH INFORMATION

Additional Laminate Offering

Additional laminates beyond KI standard offering, are available with two weeks extended leadtime. To specify additional laminates, use these designators followed by the supplier's color/pattern code:

- Formica - LF/supplier's color pattern code
- Nevamar - LN/supplier's color pattern code
- Wilsonart - LW/supplier's color pattern code

KI's standard finish is the supplier's recommended finish for that color/pattern.

Note: Nonstandard laminates from these suppliers (example: textured laminates), require an upcharge and additional leadtime. Contact KI.

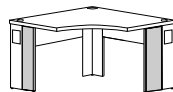

(B) Both transitional

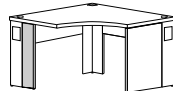

(L) Left transitional

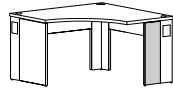

(R) Right transitional

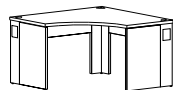

(S) Two full end panels

SPECIAL SERVICES

Special Carton Marking

With specially marked information N/C

Shipping

Delivered. Shipped **k.d. freight prepaid f.o.b. Pembroke, Ontario K8A 0E1** factory. Freight class #70.

Specifications and prices are subject to change without prior notice.

True[®] Desking System

Square Shoe Desk

	D x W-LEFT x W-RIGHT x D	MODEL NUMBER								
		Basic Model	Edge Style	End Panel	Center Grom.	Surface Grom. Color	Surface Finish	Edge Color	Frame Grom. Color	Desk Color
TRUE Square Shoe Desk with Full Modesty Panel/Full Modesty Panel <ul style="list-style-type: none"> • See images below • Consists of top, three legs, two modesty panels, two filler panels (full modesty panel), two end panels (optional transitional size), ganging plates, and all required assembly hardware • Each leg has two cable access grommet locations • Top has three cable access grommets above the legs (66" and 72" wide have an optional fourth middle grommet used for mounting stanchions and not intended for routing cables) • Top grommets allow for attachment of overhead storage units • Modesty panel allows for optional 10-wire electrical system (see Electrical section) • Pricing is for two transitional end panels, see "HOW TO BUILD A MODEL NUMBER" below for more options 	24 x 48 x 60 x 24"	TS24486024/F/FS	<input type="checkbox"/> <input type="checkbox"/> <input type="checkbox"/>	<input type="checkbox"/>	NCG	<input type="checkbox"/> <input type="checkbox"/>	<input type="checkbox"/> <input type="checkbox"/> <input type="checkbox"/>	<input type="checkbox"/> <input type="checkbox"/>	<input type="checkbox"/> <input type="checkbox"/>	<input type="checkbox"/> <input type="checkbox"/>
	24 x 48 x 66 x 24"	TS24486624/F/FS	<input type="checkbox"/> <input type="checkbox"/> <input type="checkbox"/>	<input type="checkbox"/>	<input type="checkbox"/> <input type="checkbox"/> <input type="checkbox"/>	<input type="checkbox"/> <input type="checkbox"/>	<input type="checkbox"/> <input type="checkbox"/> <input type="checkbox"/>	<input type="checkbox"/> <input type="checkbox"/>	<input type="checkbox"/> <input type="checkbox"/>	<input type="checkbox"/> <input type="checkbox"/>
	24 x 48 x 72 x 24"	TS24487224/F/FS	<input type="checkbox"/> <input type="checkbox"/> <input type="checkbox"/>	<input type="checkbox"/>	<input type="checkbox"/> <input type="checkbox"/> <input type="checkbox"/>	<input type="checkbox"/> <input type="checkbox"/>	<input type="checkbox"/> <input type="checkbox"/> <input type="checkbox"/>	<input type="checkbox"/> <input type="checkbox"/>	<input type="checkbox"/> <input type="checkbox"/>	<input type="checkbox"/> <input type="checkbox"/>
	24 x 60 x 48 x 24"	TS24604824/F/FS	<input type="checkbox"/> <input type="checkbox"/> <input type="checkbox"/>	<input type="checkbox"/>	NCG	<input type="checkbox"/> <input type="checkbox"/>	<input type="checkbox"/> <input type="checkbox"/> <input type="checkbox"/>	<input type="checkbox"/> <input type="checkbox"/>	<input type="checkbox"/> <input type="checkbox"/>	<input type="checkbox"/> <input type="checkbox"/>
	24 x 66 x 48 x 24"	TS24664824/F/FS	<input type="checkbox"/> <input type="checkbox"/> <input type="checkbox"/>	<input type="checkbox"/>	<input type="checkbox"/> <input type="checkbox"/> <input type="checkbox"/>	<input type="checkbox"/> <input type="checkbox"/>	<input type="checkbox"/> <input type="checkbox"/> <input type="checkbox"/>	<input type="checkbox"/> <input type="checkbox"/>	<input type="checkbox"/> <input type="checkbox"/>	<input type="checkbox"/> <input type="checkbox"/>
	24 x 72 x 48 x 24"	TS24724824/F/FS	<input type="checkbox"/> <input type="checkbox"/> <input type="checkbox"/>	<input type="checkbox"/>	<input type="checkbox"/> <input type="checkbox"/> <input type="checkbox"/>	<input type="checkbox"/> <input type="checkbox"/>	<input type="checkbox"/> <input type="checkbox"/> <input type="checkbox"/>	<input type="checkbox"/> <input type="checkbox"/>	<input type="checkbox"/> <input type="checkbox"/>	<input type="checkbox"/> <input type="checkbox"/>
	30 x 48 x 60 x 30"	TS30486030/F/FS	<input type="checkbox"/> <input type="checkbox"/> <input type="checkbox"/>	<input type="checkbox"/>	NCG	<input type="checkbox"/> <input type="checkbox"/>	<input type="checkbox"/> <input type="checkbox"/> <input type="checkbox"/>	<input type="checkbox"/> <input type="checkbox"/>	<input type="checkbox"/> <input type="checkbox"/>	<input type="checkbox"/> <input type="checkbox"/>
	30 x 48 x 66 x 30"	TS30486630/F/FS	<input type="checkbox"/> <input type="checkbox"/> <input type="checkbox"/>	<input type="checkbox"/>	<input type="checkbox"/> <input type="checkbox"/> <input type="checkbox"/>	<input type="checkbox"/> <input type="checkbox"/>	<input type="checkbox"/> <input type="checkbox"/> <input type="checkbox"/>	<input type="checkbox"/> <input type="checkbox"/>	<input type="checkbox"/> <input type="checkbox"/>	<input type="checkbox"/> <input type="checkbox"/>
	30 x 48 x 72 x 30"	TS30487230/F/FS	<input type="checkbox"/> <input type="checkbox"/> <input type="checkbox"/>	<input type="checkbox"/>	<input type="checkbox"/> <input type="checkbox"/> <input type="checkbox"/>	<input type="checkbox"/> <input type="checkbox"/>	<input type="checkbox"/> <input type="checkbox"/> <input type="checkbox"/>	<input type="checkbox"/> <input type="checkbox"/>	<input type="checkbox"/> <input type="checkbox"/>	<input type="checkbox"/> <input type="checkbox"/>
	30 x 60 x 48 x 30"	TS30604830/F/FS	<input type="checkbox"/> <input type="checkbox"/> <input type="checkbox"/>	<input type="checkbox"/>	NCG	<input type="checkbox"/> <input type="checkbox"/>	<input type="checkbox"/> <input type="checkbox"/> <input type="checkbox"/>	<input type="checkbox"/> <input type="checkbox"/>	<input type="checkbox"/> <input type="checkbox"/>	<input type="checkbox"/> <input type="checkbox"/>
	30 x 66 x 48 x 30"	TS30664830/F/FS	<input type="checkbox"/> <input type="checkbox"/> <input type="checkbox"/>	<input type="checkbox"/>	<input type="checkbox"/> <input type="checkbox"/> <input type="checkbox"/>	<input type="checkbox"/> <input type="checkbox"/>	<input type="checkbox"/> <input type="checkbox"/> <input type="checkbox"/>	<input type="checkbox"/> <input type="checkbox"/>	<input type="checkbox"/> <input type="checkbox"/>	<input type="checkbox"/> <input type="checkbox"/>
	30 x 72 x 48 x 30"	TS30724830/F/FS	<input type="checkbox"/> <input type="checkbox"/> <input type="checkbox"/>	<input type="checkbox"/>	<input type="checkbox"/> <input type="checkbox"/> <input type="checkbox"/>	<input type="checkbox"/> <input type="checkbox"/>	<input type="checkbox"/> <input type="checkbox"/> <input type="checkbox"/>	<input type="checkbox"/> <input type="checkbox"/>	<input type="checkbox"/> <input type="checkbox"/>	<input type="checkbox"/> <input type="checkbox"/>

A **B** **C** **D** **E** **F** **G** **H** **I**

HOW TO ORDER

Indicate the following information on order form:

1. Quantity of each item.
2. Model number, including options. See "How To Build a Model Number".
3. Any special service required.

Note: • The indicates that a choice is required.

- The absence of the indicates that no choice is required.
- Alpha-numeric characters in place of indicate that no other alternatives are available.

HOW TO BUILD A MODEL NUMBER

- A** Select basic model.
- B** Select edge style.
 Knife edge (KN) adds 2" to the depth of the desk on the user's side.
74P - 74P edge
KN - Knife edge
34S - 3/8" Wood band edge
VN - Wood edge veneer
 With 74P, KN and 34S edges, select from laminates for surface finish (Lxx). For edge color, 74P and KN, select from Exx colors and for 34S, select Mxx colors. For VN, select from Mxx for surface finish and do not select an edge color.
- C** Select transition end panels.
B - Two transitional end panels
L - Left transitional end panel; add \$55
R - Right transitional end panel; add \$55
S - Two full end panels; add \$108

- D** Select desk center grommet option.
NCG - No center grommet
YCG - Yes center grommet
 "YCG" option only available on 66" and 72" wide desks. "YCG" is needed to mount overheads, transaction surfaces or stanchion mounted privacy screens.
- E** Select surface grommet color.
 Refer to color addendum at ki.com or KI Fabrics & Finishes binder.
- F** Select surface finish.
 Refer to color addendum at ki.com or KI Fabrics & Finishes binder.
 Surface finish offerings are based on edge style selections.
- G** Select edge color.
 Refer to color addendum at ki.com or KI Fabrics & Finishes binder.
 Edge color offerings are based on edge style selections.
- H** Select frame grommet color.
 Refer to color addendum at ki.com or KI Fabrics & Finishes binder.
- I** Select desk color.
 Refer to color addendum at ki.com or KI Fabrics & Finishes binder.

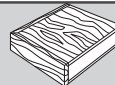
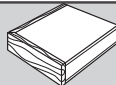
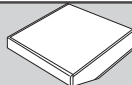
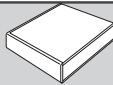

Approx. Packaged Weight	74P Edge (74P)	Knife Edge (KN)	3/8" Wood Band Edge (34S)	Wood Edge Veneer (VN)
177.0#	\$ 2237	\$ 2409	\$ 2632	\$ 2715
186.0#	2320	2496	2725	2814
193.0#	2405	2588	2824	2914
177.0#	2237	2409	2632	2715
186.0#	2320	2496	2725	2814
193.0#	2405	2588	2824	2914
195.0#	2435	2624	2874	2966
205.0#	2531	2723	2985	3079
211.0#	2648	2854	3122	3224
195.0#	2435	2624	2874	2966
205.0#	2531	2723	2985	3079
211.0#	2648	2854	3122	3224

FINISH INFORMATION

Additional Laminate Offering

Additional laminates beyond KI standard offering, are available with two weeks extended leadtime. To specify additional laminates, use these designators followed by the supplier's color/pattern code:

- Formica - LF/supplier's color pattern code
- Nevamar - LN/supplier's color pattern code
- Wilsonart - LW/supplier's color pattern code

KI's standard finish is the supplier's recommended finish for that color/pattern.

Note: Nonstandard laminates from these suppliers (example: textured laminates), require an upcharge and additional leadtime. Contact KI.

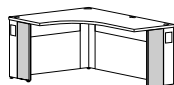

(B) Both transitional

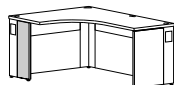

(L) Left transitional

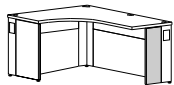

(R) Right transitional

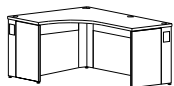

(S) Two full end panels

SPECIAL SERVICES

Special Carton Marking

With specially marked information N/C

Shipping

Delivered. Shipped **k.d. freight prepaid f.o.b. Pembroke, Ontario K8A 0E1** factory. Freight class #70.

Specifications and prices are subject to change without prior notice.

True® Desking System

Square Shoe Desk

	D x W-LEFT x W-RIGHT x D	MODEL NUMBER								
		Basic Model	Edge Style	End Panel	Center Grom.	Surface Grom. Color	Surface Finish	Edge Color	Frame Grom. Color	Desk Color
TRUE Square Shoe Desk with Full Modesty Panel/Partial Modesty Panel <ul style="list-style-type: none"> • See images below • Full modesty panel attached on short (48") side • Consists of top, three legs, two modesty panels, one filler panel (full modesty panel), two end panels (optional transitional size), ganging plates, and all required assembly hardware • Each leg has two cable access grommet locations • Top has three cable access grommets above the legs (66" and 72" wide have an optional fourth middle grommet used for mounting stanchions and not intended for routing cables) • Top grommets allow for attachment of overhead storage units • Modesty panel allows for optional 10-wire electrical system (see Electrical section) • Pricing is for two transitional end panels, see "HOW TO BUILD A MODEL NUMBER" below for more options 	24 x 48 x 60 x 24"	TS24486024/F/PS	<input type="checkbox"/> <input type="checkbox"/> <input type="checkbox"/>	<input type="checkbox"/>	NGC	<input type="checkbox"/>	<input type="checkbox"/> <input type="checkbox"/> <input type="checkbox"/>	<input type="checkbox"/>	<input type="checkbox"/>	<input type="checkbox"/>
	24 x 48 x 66 x 24"	TS24486624/F/PS	<input type="checkbox"/> <input type="checkbox"/> <input type="checkbox"/>	<input type="checkbox"/>	<input type="checkbox"/> <input type="checkbox"/> <input type="checkbox"/>	<input type="checkbox"/>	<input type="checkbox"/> <input type="checkbox"/> <input type="checkbox"/>	<input type="checkbox"/>	<input type="checkbox"/>	<input type="checkbox"/>
	24 x 48 x 72 x 24"	TS24487224/F/PS	<input type="checkbox"/> <input type="checkbox"/> <input type="checkbox"/>	<input type="checkbox"/>	<input type="checkbox"/> <input type="checkbox"/> <input type="checkbox"/>	<input type="checkbox"/>	<input type="checkbox"/> <input type="checkbox"/> <input type="checkbox"/>	<input type="checkbox"/>	<input type="checkbox"/>	<input type="checkbox"/>
	24 x 60 x 48 x 24"	TS24604824/F/PS	<input type="checkbox"/> <input type="checkbox"/> <input type="checkbox"/>	<input type="checkbox"/>	NGC	<input type="checkbox"/>	<input type="checkbox"/> <input type="checkbox"/> <input type="checkbox"/>	<input type="checkbox"/>	<input type="checkbox"/>	<input type="checkbox"/>
	24 x 66 x 48 x 24"	TS24664824/F/PS	<input type="checkbox"/> <input type="checkbox"/> <input type="checkbox"/>	<input type="checkbox"/>	<input type="checkbox"/> <input type="checkbox"/> <input type="checkbox"/>	<input type="checkbox"/>	<input type="checkbox"/> <input type="checkbox"/> <input type="checkbox"/>	<input type="checkbox"/>	<input type="checkbox"/>	<input type="checkbox"/>
	24 x 72 x 48 x 24"	TS24724824/F/PS	<input type="checkbox"/> <input type="checkbox"/> <input type="checkbox"/>	<input type="checkbox"/>	<input type="checkbox"/> <input type="checkbox"/> <input type="checkbox"/>	<input type="checkbox"/>	<input type="checkbox"/> <input type="checkbox"/> <input type="checkbox"/>	<input type="checkbox"/>	<input type="checkbox"/>	<input type="checkbox"/>
	30 x 48 x 60 x 30"	TS30486030/F/PS	<input type="checkbox"/> <input type="checkbox"/> <input type="checkbox"/>	<input type="checkbox"/>	NGC	<input type="checkbox"/>	<input type="checkbox"/> <input type="checkbox"/> <input type="checkbox"/>	<input type="checkbox"/>	<input type="checkbox"/>	<input type="checkbox"/>
	30 x 48 x 66 x 30"	TS30486630/F/PS	<input type="checkbox"/> <input type="checkbox"/> <input type="checkbox"/>	<input type="checkbox"/>	<input type="checkbox"/> <input type="checkbox"/> <input type="checkbox"/>	<input type="checkbox"/>	<input type="checkbox"/> <input type="checkbox"/> <input type="checkbox"/>	<input type="checkbox"/>	<input type="checkbox"/>	<input type="checkbox"/>
	30 x 48 x 72 x 30"	TS30487230/F/PS	<input type="checkbox"/> <input type="checkbox"/> <input type="checkbox"/>	<input type="checkbox"/>	<input type="checkbox"/> <input type="checkbox"/> <input type="checkbox"/>	<input type="checkbox"/>	<input type="checkbox"/> <input type="checkbox"/> <input type="checkbox"/>	<input type="checkbox"/>	<input type="checkbox"/>	<input type="checkbox"/>
	30 x 60 x 48 x 30"	TS30604830/F/PS	<input type="checkbox"/> <input type="checkbox"/> <input type="checkbox"/>	<input type="checkbox"/>	NGC	<input type="checkbox"/>	<input type="checkbox"/> <input type="checkbox"/> <input type="checkbox"/>	<input type="checkbox"/>	<input type="checkbox"/>	<input type="checkbox"/>
	30 x 66 x 48 x 30"	TS30664830/F/PS	<input type="checkbox"/> <input type="checkbox"/> <input type="checkbox"/>	<input type="checkbox"/>	<input type="checkbox"/> <input type="checkbox"/> <input type="checkbox"/>	<input type="checkbox"/>	<input type="checkbox"/> <input type="checkbox"/> <input type="checkbox"/>	<input type="checkbox"/>	<input type="checkbox"/>	<input type="checkbox"/>
	30 x 72 x 48 x 30"	TS30724830/F/PS	<input type="checkbox"/> <input type="checkbox"/> <input type="checkbox"/>	<input type="checkbox"/>	<input type="checkbox"/> <input type="checkbox"/> <input type="checkbox"/>	<input type="checkbox"/>	<input type="checkbox"/> <input type="checkbox"/> <input type="checkbox"/>	<input type="checkbox"/>	<input type="checkbox"/>	<input type="checkbox"/>

A

B

C

D

E

F

G

H

I

HOW TO ORDER

Indicate the following information on order form:

- Quantity of each item.
- Model number, including options. See "How To Build a Model Number".
- Any special service required.

Note: • The indicates that a choice is required.

- The absence of the indicates that no choice is required.
- Alpha-numeric characters in place of indicate that no other alternatives are available.

HOW TO BUILD A MODEL NUMBER

A Select basic model.

B Select edge style.

Knife edge (KN) adds 2" to the depth of the desk on the user's side.

74P - 74P edge

KN - Knife edge

34S - 3/8" Wood band edge

VN - Wood edge veneer

With 74P, KN and 34S edges, select from laminates for surface finish (Lxx). For edge color, 74P and KN, select from Exx colors and for 34S, select Mxx colors. For VN, select from Mxx for surface finish and do not select an edge color.

C Select transition end panels.

B - Two transitional end panels

L - Left transitional end panel;

add \$55

R - Right transitional end panel;

add \$55

S - Two full end panels; add \$108

D Select desk center grommet option.

NGC - No center grommet

YCG - Yes center grommet

"YCG" option only available on 66" and 72" wide desks. "YCG" is needed to mount overheads, transaction surfaces or stanchion mounted privacy screens.

E Select surface grommet color.

Refer to color addendum at ki.com or KI Fabrics & Finishes binder.

F Select surface finish.

Refer to color addendum at ki.com or KI Fabrics & Finishes binder. Surface finish offerings are based on edge style selections.

G Select edge color.

Refer to color addendum at ki.com or KI Fabrics & Finishes binder.

Edge color offerings are based on edge style selections.

H Select frame grommet color.

Refer to color addendum at ki.com or KI Fabrics & Finishes binder.

I Select desk color.

Refer to color addendum at ki.com or KI Fabrics & Finishes binder.

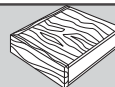
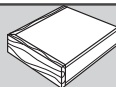
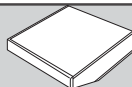
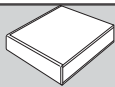

Approx. Packaged Weight	74P Edge (74P)	Knife Edge (KN)	3/8" Wood Band Edge (34S)	Wood Edge Veneer (VN)
163.0#	\$ 1942	\$ 2112	\$ 2334	\$ 2416
170.0#	2001	2178	2409	2494
176.0#	2051	2231	2470	2557
163.0#	1942	2112	2334	2416
170.0#	2001	2178	2409	2494
176.0#	2051	2231	2470	2557
181.0#	2135	2328	2575	2666
189.0#	2211	2406	2665	2761
194.0#	2292	2501	2767	2869
181.0#	2135	2328	2575	2666
189.0#	2211	2406	2665	2761
194.0#	2292	2501	2767	2869

FINISH INFORMATION

Additional Laminate Offering

Additional laminates beyond KI standard offering, are available with two weeks extended leadtime. To specify additional laminates, use these designators followed by the supplier's color/pattern code:

Formica - LF/supplier's color pattern code
Nevamar - LN/supplier's color pattern code
Wilsonart - LW/supplier's color pattern code

KI's standard finish is the supplier's recommended finish for that color/pattern.

Note: Nonstandard laminates from these suppliers (example: textured laminates), require an upcharge and additional leadtime. Contact KI.

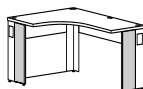

(B) Both transitional

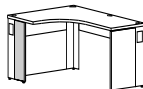

(L) Left transitional

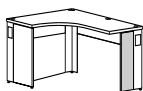

(R) Right transitional

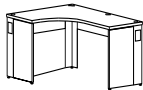

(S) Two full end panels

SPECIAL SERVICES

Special Carton Marking

With specially marked information N/C

Shipping

Delivered. Shipped k.d. freight prepaid f.o.b. Pembroke, Ontario K8A 0E1 factory. Freight class #70.

Specifications and prices are subject to change without prior notice.

True[®] Desking System

Square Shoe Desk

	D x W-LEFT x W-RIGHT x D	MODEL NUMBER								
		Basic Model	Edge Style	End Panel	Center Grom.	Surface Grom. Color	Surface Finish	Edge Color	Frame Grom. Color	Desk Color
TRUE Square Shoe Desk with Partial Modesty Panel/Full Modesty Panel <ul style="list-style-type: none"> • See images below • Full modesty panel attached on long (60", 66", or 72") side • Consists of top, three legs, two modesty panels, one filler panel (full modesty panel), two end panels (optional transitional size), ganging plates, and all required assembly hardware • Each leg has two cable access grommet locations • Top has three cable access grommets above the legs (66" and 72" wide have an optional fourth middle grommet used for mounting stanchions and not intended for routing cables) • Top grommets allow for attachment of overhead storage units • Modesty panel allows for optional 10-wire electrical system (see Electrical section) • Pricing is for two transitional end panels, see "HOW TO BUILD A MODEL NUMBER" below for more options 	24 x 48 x 60 x 24"	TS24486024/P/FS	<input type="checkbox"/> <input type="checkbox"/> <input type="checkbox"/>	<input type="checkbox"/>	NGC	<input type="checkbox"/>	<input type="checkbox"/> <input type="checkbox"/> <input type="checkbox"/>	<input type="checkbox"/>	<input type="checkbox"/>	<input type="checkbox"/>
	24 x 48 x 66 x 24"	TS24486624/P/FS	<input type="checkbox"/> <input type="checkbox"/> <input type="checkbox"/>	<input type="checkbox"/>	<input type="checkbox"/> <input type="checkbox"/> <input type="checkbox"/>	<input type="checkbox"/>	<input type="checkbox"/> <input type="checkbox"/> <input type="checkbox"/>	<input type="checkbox"/>	<input type="checkbox"/>	<input type="checkbox"/>
	24 x 48 x 72 x 24"	TS24487224/P/FS	<input type="checkbox"/> <input type="checkbox"/> <input type="checkbox"/>	<input type="checkbox"/>	<input type="checkbox"/> <input type="checkbox"/> <input type="checkbox"/>	<input type="checkbox"/>	<input type="checkbox"/> <input type="checkbox"/> <input type="checkbox"/>	<input type="checkbox"/>	<input type="checkbox"/>	<input type="checkbox"/>
	24 x 60 x 48 x 24"	TS24604824/P/FS	<input type="checkbox"/> <input type="checkbox"/> <input type="checkbox"/>	<input type="checkbox"/>	NGC	<input type="checkbox"/>	<input type="checkbox"/> <input type="checkbox"/> <input type="checkbox"/>	<input type="checkbox"/>	<input type="checkbox"/>	<input type="checkbox"/>
	24 x 66 x 48 x 24"	TS24664824/P/FS	<input type="checkbox"/> <input type="checkbox"/> <input type="checkbox"/>	<input type="checkbox"/>	<input type="checkbox"/> <input type="checkbox"/> <input type="checkbox"/>	<input type="checkbox"/>	<input type="checkbox"/> <input type="checkbox"/> <input type="checkbox"/>	<input type="checkbox"/>	<input type="checkbox"/>	<input type="checkbox"/>
	24 x 72 x 48 x 24"	TS24724824/P/FS	<input type="checkbox"/> <input type="checkbox"/> <input type="checkbox"/>	<input type="checkbox"/>	<input type="checkbox"/> <input type="checkbox"/> <input type="checkbox"/>	<input type="checkbox"/>	<input type="checkbox"/> <input type="checkbox"/> <input type="checkbox"/>	<input type="checkbox"/>	<input type="checkbox"/>	<input type="checkbox"/>
	30 x 48 x 60 x 30"	TS30486030/P/FS	<input type="checkbox"/> <input type="checkbox"/> <input type="checkbox"/>	<input type="checkbox"/>	NGC	<input type="checkbox"/>	<input type="checkbox"/> <input type="checkbox"/> <input type="checkbox"/>	<input type="checkbox"/>	<input type="checkbox"/>	<input type="checkbox"/>
	30 x 48 x 66 x 30"	TS30486630/P/FS	<input type="checkbox"/> <input type="checkbox"/> <input type="checkbox"/>	<input type="checkbox"/>	<input type="checkbox"/> <input type="checkbox"/> <input type="checkbox"/>	<input type="checkbox"/>	<input type="checkbox"/> <input type="checkbox"/> <input type="checkbox"/>	<input type="checkbox"/>	<input type="checkbox"/>	<input type="checkbox"/>
	30 x 48 x 72 x 30"	TS30487230/P/FS	<input type="checkbox"/> <input type="checkbox"/> <input type="checkbox"/>	<input type="checkbox"/>	<input type="checkbox"/> <input type="checkbox"/> <input type="checkbox"/>	<input type="checkbox"/>	<input type="checkbox"/> <input type="checkbox"/> <input type="checkbox"/>	<input type="checkbox"/>	<input type="checkbox"/>	<input type="checkbox"/>
	30 x 60 x 48 x 30"	TS30604830/P/FS	<input type="checkbox"/> <input type="checkbox"/> <input type="checkbox"/>	<input type="checkbox"/>	NGC	<input type="checkbox"/>	<input type="checkbox"/> <input type="checkbox"/> <input type="checkbox"/>	<input type="checkbox"/>	<input type="checkbox"/>	<input type="checkbox"/>
	30 x 66 x 48 x 30"	TS30664830/P/FS	<input type="checkbox"/> <input type="checkbox"/> <input type="checkbox"/>	<input type="checkbox"/>	<input type="checkbox"/> <input type="checkbox"/> <input type="checkbox"/>	<input type="checkbox"/>	<input type="checkbox"/> <input type="checkbox"/> <input type="checkbox"/>	<input type="checkbox"/>	<input type="checkbox"/>	<input type="checkbox"/>
	30 x 72 x 48 x 30"	TS30724830/P/FS	<input type="checkbox"/> <input type="checkbox"/> <input type="checkbox"/>	<input type="checkbox"/>	<input type="checkbox"/> <input type="checkbox"/> <input type="checkbox"/>	<input type="checkbox"/>	<input type="checkbox"/> <input type="checkbox"/> <input type="checkbox"/>	<input type="checkbox"/>	<input type="checkbox"/>	<input type="checkbox"/>

A **B** **C** **D** **E** **F** **G** **H** **I**

HOW TO ORDER

Indicate the following information on order form:

- Quantity of each item.
- Model number, including options. See "How To Build a Model Number".
- Any special service required.

Note: • The indicates that a choice is required.

- The absence of the indicates that no choice is required.
- Alpha-numeric characters in place of indicate that no other alternatives are available.

HOW TO BUILD A MODEL NUMBER

- A** Select basic model.
B Select edge style.
 Knife edge (KN) adds 2" to the depth of the desk on the user's side.
74P - 74P edge
KN - Knife edge
34S - 3/8" Wood band edge
VN - Wood edge veneer
 With 74P, KN and 34S edges, select from laminates for surface finish (Lxx). For edge color, 74P and KN, select from Exx colors and for 34S, select Mxx colors. For VN, select from Mxx for surface finish and do not select an edge color.
C Select transition end panels.
B - Two transitional end panels
L - Left transitional end panel; add \$55
R - Right transitional end panel; add \$55
S - Two full end panels; add \$108

- D** Select desk center grommet option.
NGC - No center grommet
YCG - Yes center grommet
 "YCG" option only available on 66" and 72" wide desks. "YCG" is needed to mount overheads, transaction surfaces or stanchion mounted privacy screens.
E Select surface grommet color.
 Refer to color addendum at ki.com or KI Fabrics & Finishes binder.
F Select surface finish.
 Refer to color addendum at ki.com or KI Fabrics & Finishes binder.
 Surface finish offerings are based on edge style selections.
G Select edge color.
 Refer to color addendum at ki.com or KI Fabrics & Finishes binder.
 Edge color offerings are based on edge style selections.
H Select frame grommet color.
 Refer to color addendum at ki.com or KI Fabrics & Finishes binder.
I Select desk color.
 Refer to color addendum at ki.com or KI Fabrics & Finishes binder.

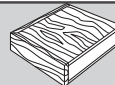
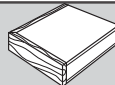
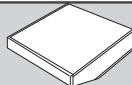
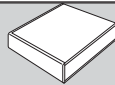

Approx. Packaged Weight	74P Edge (74P)	Knife Edge (KN)	3/8" Wood Band Edge (34S)	Wood Edge Veneer (VN)
166.0#	\$ 1997	\$ 2169	\$ 2393	\$ 2477
175.0#	2080	2257	2486	2574
182.0#	2167	2348	2586	2673
166.0#	1997	2169	2393	2477
175.0#	2080	2257	2486	2574
182.0#	2167	2348	2586	2673
184.0#	2195	2385	2633	2723
194.0#	2289	2485	2747	2839
200.0#	2409	2614	2884	2983
184.0#	2195	2385	2633	2723
194.0#	2289	2485	2747	2839
200.0#	2409	2614	2884	2983

FINISH INFORMATION

Additional Laminate Offering

Additional laminates beyond KI standard offering, are available with two weeks extended leadtime. To specify additional laminates, use these designators followed by the supplier's color/pattern code:

- Formica - LF/supplier's color pattern code
- Nevamar - LN/supplier's color pattern code
- Wilsonart - LW/supplier's color pattern code

KI's standard finish is the supplier's recommended finish for that color/pattern.

Note: Nonstandard laminates from these suppliers (example: textured laminates), require an upcharge and additional leadtime. Contact KI.

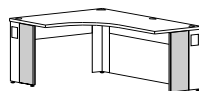

(B) Both transitional

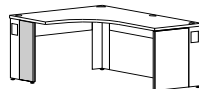

(L) Left transitional

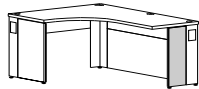

(R) Right transitional

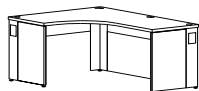

(S) Two full end panels

SPECIAL SERVICES

Special Carton Marking

With specially marked information N/C

Shipping

Delivered. Shipped k.d. freight prepaid f.o.b. **Pembroke, Ontario K8A 0E1** factory. Freight class #70.

Specifications and prices are subject to change without prior notice.

True[®] Desking System

Square Shoe Desk

	D x W-LEFT x W-RIGHT x D	MODEL NUMBER									
		Basic Model	Edge Style	End Panel	Center Grom.	Surface Grom. Color	Surface Finish	Edge Color	Frame Grom. Color	Desk Color	
TRUE	24 x 48 x 60 x 24"	TS24486024/P/PS	<input type="checkbox"/> <input type="checkbox"/> <input type="checkbox"/>	<input type="checkbox"/>		NGC	<input type="checkbox"/> <input type="checkbox"/>	<input type="checkbox"/> <input type="checkbox"/> <input type="checkbox"/>	<input type="checkbox"/> <input type="checkbox"/>	<input type="checkbox"/> <input type="checkbox"/>	
	24 x 48 x 66 x 24"	TS24486624/P/PS	<input type="checkbox"/> <input type="checkbox"/> <input type="checkbox"/>	<input type="checkbox"/>		<input type="checkbox"/> <input type="checkbox"/> <input type="checkbox"/>	<input type="checkbox"/> <input type="checkbox"/>	<input type="checkbox"/> <input type="checkbox"/> <input type="checkbox"/>	<input type="checkbox"/> <input type="checkbox"/>	<input type="checkbox"/> <input type="checkbox"/>	
Square Shoe Desk with Partial Modesty Panel/Partial Modesty Panel	24 x 48 x 72 x 24"	TS24487224/P/PS	<input type="checkbox"/> <input type="checkbox"/> <input type="checkbox"/>	<input type="checkbox"/>		<input type="checkbox"/> <input type="checkbox"/> <input type="checkbox"/>	<input type="checkbox"/> <input type="checkbox"/>	<input type="checkbox"/> <input type="checkbox"/> <input type="checkbox"/>	<input type="checkbox"/> <input type="checkbox"/>	<input type="checkbox"/> <input type="checkbox"/>	
	24 x 60 x 48 x 24"	TS24604824/P/PS	<input type="checkbox"/> <input type="checkbox"/> <input type="checkbox"/>	<input type="checkbox"/>		NGC	<input type="checkbox"/> <input type="checkbox"/>	<input type="checkbox"/> <input type="checkbox"/> <input type="checkbox"/>	<input type="checkbox"/> <input type="checkbox"/>	<input type="checkbox"/> <input type="checkbox"/>	
<ul style="list-style-type: none"> • See images below • Consists of top, three legs, two modesty panels, two end panels (optional transitional size), ganging plates, and all required assembly hardware • Each leg has two cable access grommet locations • Top has three cable access grommets above the legs (66" and 72" wide have an optional fourth middle grommet used for mounting stanchions and not intended for routing cables) • Top grommets allow for attachment of overhead storage units • Modesty panel allows for optional 10-wire electrical system (see Electrical section) • Pricing is for two transitional end panels, see "HOW TO BUILD A MODEL NUMBER" below for more options 	24 x 66 x 48 x 24"	TS24664824/P/PS	<input type="checkbox"/> <input type="checkbox"/> <input type="checkbox"/>	<input type="checkbox"/>		<input type="checkbox"/> <input type="checkbox"/> <input type="checkbox"/>	<input type="checkbox"/> <input type="checkbox"/>	<input type="checkbox"/> <input type="checkbox"/> <input type="checkbox"/>	<input type="checkbox"/> <input type="checkbox"/>	<input type="checkbox"/> <input type="checkbox"/>	
	24 x 72 x 48 x 24"	TS24724824/P/PS	<input type="checkbox"/> <input type="checkbox"/> <input type="checkbox"/>	<input type="checkbox"/>		<input type="checkbox"/> <input type="checkbox"/> <input type="checkbox"/>	<input type="checkbox"/> <input type="checkbox"/>	<input type="checkbox"/> <input type="checkbox"/> <input type="checkbox"/>	<input type="checkbox"/> <input type="checkbox"/>	<input type="checkbox"/> <input type="checkbox"/>	
	30 x 48 x 60 x 30"	TS30486030/P/PS	<input type="checkbox"/> <input type="checkbox"/> <input type="checkbox"/>	<input type="checkbox"/>		NGC	<input type="checkbox"/> <input type="checkbox"/>	<input type="checkbox"/> <input type="checkbox"/> <input type="checkbox"/>	<input type="checkbox"/> <input type="checkbox"/>	<input type="checkbox"/> <input type="checkbox"/>	
	30 x 48 x 66 x 30"	TS30486630/P/PS	<input type="checkbox"/> <input type="checkbox"/> <input type="checkbox"/>	<input type="checkbox"/>		<input type="checkbox"/> <input type="checkbox"/> <input type="checkbox"/>	<input type="checkbox"/> <input type="checkbox"/>	<input type="checkbox"/> <input type="checkbox"/> <input type="checkbox"/>	<input type="checkbox"/> <input type="checkbox"/>	<input type="checkbox"/> <input type="checkbox"/>	
	30 x 48 x 72 x 30"	TS30487230/P/PS	<input type="checkbox"/> <input type="checkbox"/> <input type="checkbox"/>	<input type="checkbox"/>		<input type="checkbox"/> <input type="checkbox"/> <input type="checkbox"/>	<input type="checkbox"/> <input type="checkbox"/>	<input type="checkbox"/> <input type="checkbox"/> <input type="checkbox"/>	<input type="checkbox"/> <input type="checkbox"/>	<input type="checkbox"/> <input type="checkbox"/>	
	30 x 60 x 48 x 30"	TS30604830/P/PS	<input type="checkbox"/> <input type="checkbox"/> <input type="checkbox"/>	<input type="checkbox"/>		NGC	<input type="checkbox"/> <input type="checkbox"/>	<input type="checkbox"/> <input type="checkbox"/> <input type="checkbox"/>	<input type="checkbox"/> <input type="checkbox"/>	<input type="checkbox"/> <input type="checkbox"/>	
	30 x 66 x 48 x 30"	TS30664830/P/PS	<input type="checkbox"/> <input type="checkbox"/> <input type="checkbox"/>	<input type="checkbox"/>		<input type="checkbox"/> <input type="checkbox"/> <input type="checkbox"/>	<input type="checkbox"/> <input type="checkbox"/>	<input type="checkbox"/> <input type="checkbox"/> <input type="checkbox"/>	<input type="checkbox"/> <input type="checkbox"/>	<input type="checkbox"/> <input type="checkbox"/>	
	30 x 72 x 48 x 30"	TS30724830/P/PS	<input type="checkbox"/> <input type="checkbox"/> <input type="checkbox"/>	<input type="checkbox"/>		<input type="checkbox"/> <input type="checkbox"/> <input type="checkbox"/>	<input type="checkbox"/> <input type="checkbox"/>	<input type="checkbox"/> <input type="checkbox"/> <input type="checkbox"/>	<input type="checkbox"/> <input type="checkbox"/>	<input type="checkbox"/> <input type="checkbox"/>	

A **B** **C** **D** **E** **F** **G** **H** **I**

HOW TO ORDER

Indicate the following information on order form:

- Quantity of each item.
- Model number, including options. See "How To Build a Model Number".
- Any special service required.

Note: • The indicates that a choice is required.

- The absence of the indicates that no choice is required.
- Alpha-numeric characters in place of indicate that no other alternatives are available.

HOW TO BUILD A MODEL NUMBER

- A** Select basic model.
B Select edge style.
 Knife edge (KN) adds 2" to the depth of the desk on the user's side.
74P - 74P edge
KN - Knife edge
34S - 3/8" Wood band edge
VN - Wood edge veneer
 With 74P, KN and 34S edges, select from laminates for surface finish (Lxx). For edge color, 74P and KN, select from Exx colors and for 34S, select Mxx colors. For VN, select from Mxx for surface finish and do not select an edge color.
- C** Select transition end panels.
B - Two transitional end panels
L - Left transitional end panel; add \$55
R - Right transitional end panel; add \$55
S - Two full end panels; add \$108

- D** Select desk center grommet option.
NGC - No center grommet
YCG - Yes center grommet
 "YCG" option only available on 66" and 72" wide desks. "YCG" is needed to mount overheads, transaction surfaces or stanchion mounted privacy screens.
- E** Select surface grommet color.
 Refer to color addendum at ki.com or KI Fabrics & Finishes binder.
- F** Select surface finish.
 Refer to color addendum at ki.com or KI Fabrics & Finishes binder.
 Surface finish offerings are based on edge style selections.
- G** Select edge color.
 Refer to color addendum at ki.com or KI Fabrics & Finishes binder.
 Edge color offerings are based on edge style selections.
- H** Select frame grommet color.
 Refer to color addendum at ki.com or KI Fabrics & Finishes binder.
- I** Select desk color.
 Refer to color addendum at ki.com or KI Fabrics & Finishes binder.

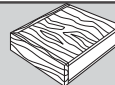
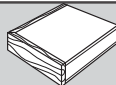
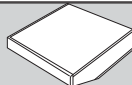
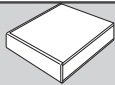

Approx. Packaged Weight	74P Edge (74P)	Knife Edge (KN)	3/8" Wood Band Edge (34S)	Wood Edge Veneer (VN)
152.0#	\$ 1701	\$ 1873	\$ 2095	\$ 2178
159.0#	1764	1939	2169	2256
165.0#	1813	1993	2229	2318
152.0#	1701	1873	2095	2178
159.0#	1764	1939	2169	2256
165.0#	1813	1993	2229	2318
170.0#	1898	2087	2335	2429
178.0#	1968	2168	2428	2521
183.0#	2053	2260	2531	2630
170.0#	1898	2087	2335	2429
178.0#	1968	2168	2428	2521
183.0#	2053	2260	2531	2630

FINISH INFORMATION

Additional Laminate Offering

Additional laminates beyond KI standard offering, are available with two weeks extended leadtime. To specify additional laminates, use these designators followed by the supplier's color/pattern code:

Formica - LF/supplier's color pattern code
Nevamar - LN/supplier's color pattern code
Wilsonart - LW/supplier's color pattern code

KI's standard finish is the supplier's recommended finish for that color/pattern.
Note: Nonstandard laminates from these suppliers (example: textured laminates), require an upcharge and additional leadtime. Contact KI.

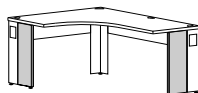

(B) Both transitional

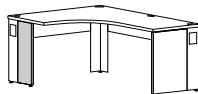

(L) Left transitional

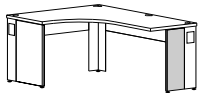

(R) Right transitional

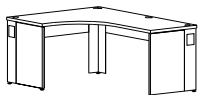

(S) Two full end panels

SPECIAL SERVICES

Special Carton Marking

With specially marked information N/C

Shipping

Delivered. Shipped k.d. freight prepaid f.o.b. **Pembroke, Ontario K8A 0E1** factory. Freight class #70.

Specifications and prices are subject to change without prior notice.

True® Desking System

D-Shaped Desk

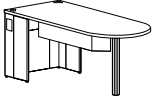
MODEL	D x W	MODEL NUMBER							Approx. Packaged Weight	
		Basic Model	Edge Style	Surface Grom. Color	Surface Finish	Edge Color	Frame Grom. Color	Desk Color		
 <p>TRUE</p> <p>D-Shaped Desk with Full Modesty Panel/ Partial Guest Modesty Panel</p> <ul style="list-style-type: none"> Consists of top, two legs, modesty panel, filler panel (full modesty panel on 24", 30" or 36" side), two transitional size end panels, ganging plates, one round leg, one 9" tall steel guest modesty panel along the long side, and all required assembly hardware Each leg has two cable access grommet locations Top has two cable access grommets above the corner legs Top grommets allow for attachment of overhead storage units Modesty panel allows for optional 10-wire electrical system (see Electrical section) 	24 x 48"	TD2448/F/G	<input type="checkbox"/> <input type="checkbox"/> <input type="checkbox"/>	<input type="checkbox"/>	<input type="checkbox"/> <input type="checkbox"/> <input type="checkbox"/>	<input type="checkbox"/>	<input type="checkbox"/>	<input type="checkbox"/>	<input type="checkbox"/>	92.0#
	24 x 54"	TD2454/F/G	<input type="checkbox"/> <input type="checkbox"/> <input type="checkbox"/>	<input type="checkbox"/>	<input type="checkbox"/> <input type="checkbox"/> <input type="checkbox"/>	<input type="checkbox"/>	<input type="checkbox"/>	<input type="checkbox"/>	<input type="checkbox"/>	98.0#
	24 x 60"	TD2460/F/G	<input type="checkbox"/> <input type="checkbox"/> <input type="checkbox"/>	<input type="checkbox"/>	<input type="checkbox"/> <input type="checkbox"/> <input type="checkbox"/>	<input type="checkbox"/>	<input type="checkbox"/>	<input type="checkbox"/>	<input type="checkbox"/>	104.0#
	24 x 66"	TD2466/F/G	<input type="checkbox"/> <input type="checkbox"/> <input type="checkbox"/>	<input type="checkbox"/>	<input type="checkbox"/> <input type="checkbox"/> <input type="checkbox"/>	<input type="checkbox"/>	<input type="checkbox"/>	<input type="checkbox"/>	<input type="checkbox"/>	110.0#
	24 x 72"	TD2472/F/G	<input type="checkbox"/> <input type="checkbox"/> <input type="checkbox"/>	<input type="checkbox"/>	<input type="checkbox"/> <input type="checkbox"/> <input type="checkbox"/>	<input type="checkbox"/>	<input type="checkbox"/>	<input type="checkbox"/>	<input type="checkbox"/>	116.0#
	30 x 48"	TD3048/F/G	<input type="checkbox"/> <input type="checkbox"/> <input type="checkbox"/>	<input type="checkbox"/>	<input type="checkbox"/> <input type="checkbox"/> <input type="checkbox"/>	<input type="checkbox"/>	<input type="checkbox"/>	<input type="checkbox"/>	<input type="checkbox"/>	103.0#
	30 x 54"	TD3054/F/G	<input type="checkbox"/> <input type="checkbox"/> <input type="checkbox"/>	<input type="checkbox"/>	<input type="checkbox"/> <input type="checkbox"/> <input type="checkbox"/>	<input type="checkbox"/>	<input type="checkbox"/>	<input type="checkbox"/>	<input type="checkbox"/>	110.0#
	30 x 60"	TD3060/F/G	<input type="checkbox"/> <input type="checkbox"/> <input type="checkbox"/>	<input type="checkbox"/>	<input type="checkbox"/> <input type="checkbox"/> <input type="checkbox"/>	<input type="checkbox"/>	<input type="checkbox"/>	<input type="checkbox"/>	<input type="checkbox"/>	117.0#
	30 x 66"	TD3066/F/G	<input type="checkbox"/> <input type="checkbox"/> <input type="checkbox"/>	<input type="checkbox"/>	<input type="checkbox"/> <input type="checkbox"/> <input type="checkbox"/>	<input type="checkbox"/>	<input type="checkbox"/>	<input type="checkbox"/>	<input type="checkbox"/>	125.0#
	30 x 72"	TD3072/F/G	<input type="checkbox"/> <input type="checkbox"/> <input type="checkbox"/>	<input type="checkbox"/>	<input type="checkbox"/> <input type="checkbox"/> <input type="checkbox"/>	<input type="checkbox"/>	<input type="checkbox"/>	<input type="checkbox"/>	<input type="checkbox"/>	132.0#
	36 x 48"	TD3648/F/G	<input type="checkbox"/> <input type="checkbox"/> <input type="checkbox"/>	<input type="checkbox"/>	<input type="checkbox"/> <input type="checkbox"/> <input type="checkbox"/>	<input type="checkbox"/>	<input type="checkbox"/>	<input type="checkbox"/>	<input type="checkbox"/>	115.0#
	36 x 54"	TD3654/F/G	<input type="checkbox"/> <input type="checkbox"/> <input type="checkbox"/>	<input type="checkbox"/>	<input type="checkbox"/> <input type="checkbox"/> <input type="checkbox"/>	<input type="checkbox"/>	<input type="checkbox"/>	<input type="checkbox"/>	<input type="checkbox"/>	123.0#
	36 x 60"	TD3660/F/G	<input type="checkbox"/> <input type="checkbox"/> <input type="checkbox"/>	<input type="checkbox"/>	<input type="checkbox"/> <input type="checkbox"/> <input type="checkbox"/>	<input type="checkbox"/>	<input type="checkbox"/>	<input type="checkbox"/>	<input type="checkbox"/>	132.0#
	36 x 66"	TD3666/F/G	<input type="checkbox"/> <input type="checkbox"/> <input type="checkbox"/>	<input type="checkbox"/>	<input type="checkbox"/> <input type="checkbox"/> <input type="checkbox"/>	<input type="checkbox"/>	<input type="checkbox"/>	<input type="checkbox"/>	<input type="checkbox"/>	140.0#
	36 x 72"	TD3672/F/G	<input type="checkbox"/> <input type="checkbox"/> <input type="checkbox"/>	<input type="checkbox"/>	<input type="checkbox"/> <input type="checkbox"/> <input type="checkbox"/>	<input type="checkbox"/>	<input type="checkbox"/>	<input type="checkbox"/>	<input type="checkbox"/>	149.0#

A **B** **C** **D** **E** **F** **G**

HOW TO ORDER

Indicate the following information on order form:

- Quantity of each item.
- Model number, including options. See "How To Build a Model Number".
- Any special service required.

Note:

- The indicates that a choice is required.
- The absence of the indicates that no choice is required.
- Alpha-numeric characters in place of indicate that no other alternatives are available.

HOW TO BUILD A MODEL NUMBER

- A** Select basic model.

74P	- 74P edge
34S	- 3/8" Wood band edge
VN	- Wood edge veneer
- B** Select edge style.
- C** Select surface grommet color. Refer to color addendum at ki.com or KI Fabrics & Finishes binder.
- D** Select surface finish. Refer to color addendum at ki.com or KI Fabrics & Finishes binder. Surface finish offerings are based on edge style selections. With 74P edge (74P) and wood band edge (34S), select from laminates. With wood edge veneer (VN), select from veneers.
- E** Select edge color. Refer to color addendum at ki.com or KI Fabrics & Finishes binder.

Edge color offerings are based on edge style selections. With 74P edge (74P), select from 74P colors. With wood edge veneer (VN), no edge color selection required. With wood band edge (34S), select wood edge colors.

- F** Select frame grommet color. Refer to color addendum at ki.com or KI Fabrics & Finishes binder.
- G** Select desk color. Refer to color addendum at ki.com or KI Fabrics & Finishes binder.

FINISH INFORMATION

Additional Laminate Offering

Additional laminates beyond KI standard offering, are available with two weeks extended leadtime. To specify additional laminates, use these designators followed by the supplier's color/pattern code:

Formica - LF/supplier's color pattern code
 Nevamar - LN/supplier's color pattern code
 Wilsonart - LW/supplier's color pattern code

KI's standard finish is the supplier's recommended finish for that color/pattern. Note: Nonstandard laminates from these suppliers (example: textured laminates), require an upcharge and additional leadtime. Contact KI.



True® Desking System
D-Shaped Desk

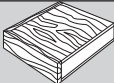
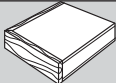
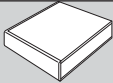

74P Edge
(74P)

3/8" Wood
Band Edge
(34S)

Wood Edge Veneer
(VN)

\$ 1654	\$ 1939	\$ 2072
1690	1989	2123
1726	2037	2173
1765	2084	2226
1798	2134	2279
1790	1955	2092
1826	2006	2142
1864	2054	2195
1900	2102	2246
1938	2154	2300
1926	1976	2110
1963	2023	2163
2000	2075	2216
2038	2122	2266
2075	2169	2315

SPECIAL SERVICES

Special Carton Marking

With specially marked information N/C

Shipping

Delivered. Shipped k.d. freight prepaid f.o.b. **Pembroke, Ontario K8A 0E1** factory. Freight class #70.

Specifications and prices are subject to change without prior notice.

True[®] Desking System

D-Shaped Desk

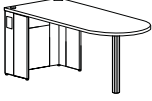
MODEL	D x W	MODEL NUMBER							Approx. Packaged Weight
		Basic Model	Edge Style	Surface Grom. Color	Surface Finish	Edge Color	Frame Grom. Color	Desk Color	
 <p>D-Shaped Desk with Full Modesty Panel/ No Partial Guest Modesty Panel</p> <ul style="list-style-type: none"> Consists of top, two legs, modesty panel, filler panel (full modesty panel on the 24", 30" or 36" side), two transitional size end panels, ganging plates, one round leg, and all required assembly hardware Each leg has two cable access grommet locations Top has two cable access grommets above the corner legs Top grommets allow for attachment of overhead storage units Modesty panel allows for optional 10-wire electrical system (see Electrical section) 	24 x 48"	TD2448/F/A	<input type="checkbox"/> <input type="checkbox"/> <input type="checkbox"/>	<input type="checkbox"/>	<input type="checkbox"/> <input type="checkbox"/> <input type="checkbox"/>	<input type="checkbox"/>	<input type="checkbox"/> <input type="checkbox"/> <input type="checkbox"/>	<input type="checkbox"/> <input type="checkbox"/> <input type="checkbox"/>	87.0#
	24 x 54"	TD2454/F/A	<input type="checkbox"/> <input type="checkbox"/> <input type="checkbox"/>	<input type="checkbox"/>	<input type="checkbox"/> <input type="checkbox"/> <input type="checkbox"/>	<input type="checkbox"/>	<input type="checkbox"/> <input type="checkbox"/> <input type="checkbox"/>	<input type="checkbox"/> <input type="checkbox"/> <input type="checkbox"/>	92.0#
	24 x 60"	TD2460/F/A	<input type="checkbox"/> <input type="checkbox"/> <input type="checkbox"/>	<input type="checkbox"/>	<input type="checkbox"/> <input type="checkbox"/> <input type="checkbox"/>	<input type="checkbox"/>	<input type="checkbox"/> <input type="checkbox"/> <input type="checkbox"/>	<input type="checkbox"/> <input type="checkbox"/> <input type="checkbox"/>	97.0#
	24 x 66"	TD2466/F/A	<input type="checkbox"/> <input type="checkbox"/> <input type="checkbox"/>	<input type="checkbox"/>	<input type="checkbox"/> <input type="checkbox"/> <input type="checkbox"/>	<input type="checkbox"/>	<input type="checkbox"/> <input type="checkbox"/> <input type="checkbox"/>	<input type="checkbox"/> <input type="checkbox"/> <input type="checkbox"/>	102.0#
	24 x 72"	TD2472/F/A	<input type="checkbox"/> <input type="checkbox"/> <input type="checkbox"/>	<input type="checkbox"/>	<input type="checkbox"/> <input type="checkbox"/> <input type="checkbox"/>	<input type="checkbox"/>	<input type="checkbox"/> <input type="checkbox"/> <input type="checkbox"/>	<input type="checkbox"/> <input type="checkbox"/> <input type="checkbox"/>	107.0#
	30 x 48"	TD3048/F/A	<input type="checkbox"/> <input type="checkbox"/> <input type="checkbox"/>	<input type="checkbox"/>	<input type="checkbox"/> <input type="checkbox"/> <input type="checkbox"/>	<input type="checkbox"/>	<input type="checkbox"/> <input type="checkbox"/> <input type="checkbox"/>	<input type="checkbox"/> <input type="checkbox"/> <input type="checkbox"/>	98.0#
	30 x 54"	TD3054/F/A	<input type="checkbox"/> <input type="checkbox"/> <input type="checkbox"/>	<input type="checkbox"/>	<input type="checkbox"/> <input type="checkbox"/> <input type="checkbox"/>	<input type="checkbox"/>	<input type="checkbox"/> <input type="checkbox"/> <input type="checkbox"/>	<input type="checkbox"/> <input type="checkbox"/> <input type="checkbox"/>	104.0#
	30 x 60"	TD3060/F/A	<input type="checkbox"/> <input type="checkbox"/> <input type="checkbox"/>	<input type="checkbox"/>	<input type="checkbox"/> <input type="checkbox"/> <input type="checkbox"/>	<input type="checkbox"/>	<input type="checkbox"/> <input type="checkbox"/> <input type="checkbox"/>	<input type="checkbox"/> <input type="checkbox"/> <input type="checkbox"/>	110.0#
	30 x 66"	TD3066/F/A	<input type="checkbox"/> <input type="checkbox"/> <input type="checkbox"/>	<input type="checkbox"/>	<input type="checkbox"/> <input type="checkbox"/> <input type="checkbox"/>	<input type="checkbox"/>	<input type="checkbox"/> <input type="checkbox"/> <input type="checkbox"/>	<input type="checkbox"/> <input type="checkbox"/> <input type="checkbox"/>	117.0#
	30 x 72"	TD3072/F/A	<input type="checkbox"/> <input type="checkbox"/> <input type="checkbox"/>	<input type="checkbox"/>	<input type="checkbox"/> <input type="checkbox"/> <input type="checkbox"/>	<input type="checkbox"/>	<input type="checkbox"/> <input type="checkbox"/> <input type="checkbox"/>	<input type="checkbox"/> <input type="checkbox"/> <input type="checkbox"/>	123.0#
	36 x 48"	TD3648/F/A	<input type="checkbox"/> <input type="checkbox"/> <input type="checkbox"/>	<input type="checkbox"/>	<input type="checkbox"/> <input type="checkbox"/> <input type="checkbox"/>	<input type="checkbox"/>	<input type="checkbox"/> <input type="checkbox"/> <input type="checkbox"/>	<input type="checkbox"/> <input type="checkbox"/> <input type="checkbox"/>	110.0#
	36 x 54"	TD3654/F/A	<input type="checkbox"/> <input type="checkbox"/> <input type="checkbox"/>	<input type="checkbox"/>	<input type="checkbox"/> <input type="checkbox"/> <input type="checkbox"/>	<input type="checkbox"/>	<input type="checkbox"/> <input type="checkbox"/> <input type="checkbox"/>	<input type="checkbox"/> <input type="checkbox"/> <input type="checkbox"/>	117.0#
	36 x 60"	TD3660/F/A	<input type="checkbox"/> <input type="checkbox"/> <input type="checkbox"/>	<input type="checkbox"/>	<input type="checkbox"/> <input type="checkbox"/> <input type="checkbox"/>	<input type="checkbox"/>	<input type="checkbox"/> <input type="checkbox"/> <input type="checkbox"/>	<input type="checkbox"/> <input type="checkbox"/> <input type="checkbox"/>	125.0#
	36 x 66"	TD3666/F/A	<input type="checkbox"/> <input type="checkbox"/> <input type="checkbox"/>	<input type="checkbox"/>	<input type="checkbox"/> <input type="checkbox"/> <input type="checkbox"/>	<input type="checkbox"/>	<input type="checkbox"/> <input type="checkbox"/> <input type="checkbox"/>	<input type="checkbox"/> <input type="checkbox"/> <input type="checkbox"/>	132.0#
	36 x 72"	TD3672/F/A	<input type="checkbox"/> <input type="checkbox"/> <input type="checkbox"/>	<input type="checkbox"/>	<input type="checkbox"/> <input type="checkbox"/> <input type="checkbox"/>	<input type="checkbox"/>	<input type="checkbox"/> <input type="checkbox"/> <input type="checkbox"/>	<input type="checkbox"/> <input type="checkbox"/> <input type="checkbox"/>	140.0#

A **B** **C** **D** **E** **F** **G**

HOW TO ORDER

Indicate the following information on order form:

- Quantity of each item.
- Model number, including options. See "How To Build a Model Number".
- Any special service required.

Note:

- The indicates that a choice is required.
- The absence of the indicates that no choice is required.
- Alpha-numeric characters in place of indicate that no other alternatives are available.

HOW TO BUILD A MODEL NUMBER

- A** Select basic model.
- B** Select edge style.

74P	- 74P edge
34S	- 3/8" Wood band edge
VN	- Wood edge veneer
- C** Select surface grommet color. Refer to color addendum at ki.com or KI Fabrics & Finishes binder.
- D** Select surface finish. Refer to color addendum at ki.com or KI Fabrics & Finishes binder. Surface finish offerings are based on edge style selections. With 74P edge (74P) and wood band edge (34S), select from laminates. With wood edge veneer (VN), select from veneers.
- E** Select edge color. Refer to color addendum at ki.com or KI Fabrics & Finishes binder.

Edge color offerings are based on edge style selections. With 74P edge (74P), select from 74P colors. With wood edge veneer (VN), no edge color selection required. With wood band edge (34S), select wood edge colors.

- F** Select frame grommet color. Refer to color addendum at ki.com or KI Fabrics & Finishes binder.
- G** Select desk color. Refer to color addendum at ki.com or KI Fabrics & Finishes binder.

FINISH INFORMATION

Additional Laminate Offering

Additional laminates beyond KI standard offering, are available with two weeks extended leadtime. To specify additional laminates, use these designators followed by the supplier's color/pattern code:

Formica - LF/supplier's color pattern code
 Nevamar - LN/supplier's color pattern code
 Wilsonart - LW/supplier's color pattern code

KI's standard finish is the supplier's recommended finish for that color/pattern. Note: Nonstandard laminates from these suppliers (example: textured laminates), require an upcharge and additional leadtime. Contact KI.



True® Desking System

D-Shaped Desk

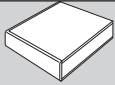

74P Edge
(74P)

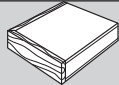

3/8" Wood
Band Edge
(34S)

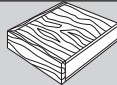

Wood Edge Veneer
(VN)

\$ 1531	\$ 1816	\$ 1949
1557	1855	1991
1585	1895	2031
1612	1932	2074
1638	1971	2119
1667	1834	1966
1693	1874	2010
1722	1914	2052
1747	1951	2094
1775	1991	2135
1805	1853	1989
1830	1891	2030
1858	1932	2074
1884	1967	2113
1914	2007	2156

SPECIAL SERVICES

Special Carton Marking

With specially marked information N/C

Shipping

Delivered. Shipped k.d. **freight prepaid**
f.o.b. **Pembroke, Ontario K8A 0E1** factory.
Freight class #70.

Specifications and prices are subject to
change without prior notice.

True[®] Desking System

D-Shaped Desk

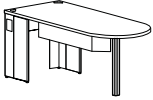
MODEL	D x W	MODEL NUMBER							Approx. Packaged Weight	
		Basic Model	Edge Style	Surface Grom. Color	Surface Finish	Edge Color	Frame Grom. Color	Desk Color		
 <p>TRUE</p> <p>D-Shaped Desk with Partial Modesty Panel/Partial Guest Modesty Panel</p> <ul style="list-style-type: none"> Consists of top, two legs, modesty panel, two transitional size end panels, ganging plates, one round leg, one 9" tall steel guest modesty panel along the long side, and all required assembly hardware Each leg has two cable access grommet locations Top has two cable access grommets above the corner legs Top grommets allow for attachment of overhead storage units Modesty panel allows for optional 10-wire electrical system (see Electrical section) 	24 x 48"	TD2448/P/G	<input type="checkbox"/> <input type="checkbox"/> <input type="checkbox"/>	<input type="checkbox"/>	<input type="checkbox"/> <input type="checkbox"/> <input type="checkbox"/>	<input type="checkbox"/>	<input type="checkbox"/>	<input type="checkbox"/>	<input type="checkbox"/>	87.0#
	24 x 54"	TD2454/P/G	<input type="checkbox"/> <input type="checkbox"/> <input type="checkbox"/>	<input type="checkbox"/>	<input type="checkbox"/> <input type="checkbox"/> <input type="checkbox"/>	<input type="checkbox"/>	<input type="checkbox"/>	<input type="checkbox"/>	<input type="checkbox"/>	93.0#
	24 x 60"	TD2460/P/G	<input type="checkbox"/> <input type="checkbox"/> <input type="checkbox"/>	<input type="checkbox"/>	<input type="checkbox"/> <input type="checkbox"/> <input type="checkbox"/>	<input type="checkbox"/>	<input type="checkbox"/>	<input type="checkbox"/>	<input type="checkbox"/>	99.0#
	24 x 66"	TD2466/P/G	<input type="checkbox"/> <input type="checkbox"/> <input type="checkbox"/>	<input type="checkbox"/>	<input type="checkbox"/> <input type="checkbox"/> <input type="checkbox"/>	<input type="checkbox"/>	<input type="checkbox"/>	<input type="checkbox"/>	<input type="checkbox"/>	105.0#
	24 x 72"	TD2472/P/G	<input type="checkbox"/> <input type="checkbox"/> <input type="checkbox"/>	<input type="checkbox"/>	<input type="checkbox"/> <input type="checkbox"/> <input type="checkbox"/>	<input type="checkbox"/>	<input type="checkbox"/>	<input type="checkbox"/>	<input type="checkbox"/>	111.0#
	30 x 48"	TD3048/P/G	<input type="checkbox"/> <input type="checkbox"/> <input type="checkbox"/>	<input type="checkbox"/>	<input type="checkbox"/> <input type="checkbox"/> <input type="checkbox"/>	<input type="checkbox"/>	<input type="checkbox"/>	<input type="checkbox"/>	<input type="checkbox"/>	97.0#
	30 x 54"	TD3054/P/G	<input type="checkbox"/> <input type="checkbox"/> <input type="checkbox"/>	<input type="checkbox"/>	<input type="checkbox"/> <input type="checkbox"/> <input type="checkbox"/>	<input type="checkbox"/>	<input type="checkbox"/>	<input type="checkbox"/>	<input type="checkbox"/>	104.0#
	30 x 60"	TD3060/P/G	<input type="checkbox"/> <input type="checkbox"/> <input type="checkbox"/>	<input type="checkbox"/>	<input type="checkbox"/> <input type="checkbox"/> <input type="checkbox"/>	<input type="checkbox"/>	<input type="checkbox"/>	<input type="checkbox"/>	<input type="checkbox"/>	111.0#
	30 x 66"	TD3066/P/G	<input type="checkbox"/> <input type="checkbox"/> <input type="checkbox"/>	<input type="checkbox"/>	<input type="checkbox"/> <input type="checkbox"/> <input type="checkbox"/>	<input type="checkbox"/>	<input type="checkbox"/>	<input type="checkbox"/>	<input type="checkbox"/>	119.0#
	30 x 72"	TD3072/P/G	<input type="checkbox"/> <input type="checkbox"/> <input type="checkbox"/>	<input type="checkbox"/>	<input type="checkbox"/> <input type="checkbox"/> <input type="checkbox"/>	<input type="checkbox"/>	<input type="checkbox"/>	<input type="checkbox"/>	<input type="checkbox"/>	126.0#
	36 x 48"	TD3648/P/G	<input type="checkbox"/> <input type="checkbox"/> <input type="checkbox"/>	<input type="checkbox"/>	<input type="checkbox"/> <input type="checkbox"/> <input type="checkbox"/>	<input type="checkbox"/>	<input type="checkbox"/>	<input type="checkbox"/>	<input type="checkbox"/>	107.0#
	36 x 54"	TD3654/P/G	<input type="checkbox"/> <input type="checkbox"/> <input type="checkbox"/>	<input type="checkbox"/>	<input type="checkbox"/> <input type="checkbox"/> <input type="checkbox"/>	<input type="checkbox"/>	<input type="checkbox"/>	<input type="checkbox"/>	<input type="checkbox"/>	115.0#
	36 x 60"	TD3660/P/G	<input type="checkbox"/> <input type="checkbox"/> <input type="checkbox"/>	<input type="checkbox"/>	<input type="checkbox"/> <input type="checkbox"/> <input type="checkbox"/>	<input type="checkbox"/>	<input type="checkbox"/>	<input type="checkbox"/>	<input type="checkbox"/>	124.0#
	36 x 66"	TD3666/P/G	<input type="checkbox"/> <input type="checkbox"/> <input type="checkbox"/>	<input type="checkbox"/>	<input type="checkbox"/> <input type="checkbox"/> <input type="checkbox"/>	<input type="checkbox"/>	<input type="checkbox"/>	<input type="checkbox"/>	<input type="checkbox"/>	132.0#
	36 x 72"	TD3672/P/G	<input type="checkbox"/> <input type="checkbox"/> <input type="checkbox"/>	<input type="checkbox"/>	<input type="checkbox"/> <input type="checkbox"/> <input type="checkbox"/>	<input type="checkbox"/>	<input type="checkbox"/>	<input type="checkbox"/>	<input type="checkbox"/>	141.0#

A

B

C

D

E

F

G

HOW TO ORDER

Indicate the following information on order form:

- Quantity of each item.
- Model number, including options. See "How To Build a Model Number".
- Any special service required.

Note: • The indicates that a choice is required.

- The absence of the indicates that no choice is required.
- Alpha-numeric characters in place of indicate that no other alternatives are available.

HOW TO BUILD A MODEL NUMBER

A Select basic model.

B Select edge style.

74P	- 74P edge
34S	- 3/8" Wood band edge
VN	- Wood edge veneer

C Select surface grommet color.

Refer to color addendum at ki.com or KI Fabrics & Finishes binder.

D Select surface finish.

Refer to color addendum at ki.com or KI Fabrics & Finishes binder.
Surface finish offerings are based on edge style selections. With 74P edge (74P) and wood band edge (34S), select from laminates. With wood edge veneer (VN), select from veneers.

E Select edge color.

Refer to color addendum at ki.com or KI Fabrics & Finishes binder.

Edge color offerings are based on edge style selections. With 74P edge (74P), select from 74P colors. With wood edge veneer (VN), no edge color selection required. With wood band edge (34S), select wood edge colors.

F Select frame grommet color.
Refer to color addendum at ki.com or KI Fabrics & Finishes binder.

G Select desk color.
Refer to color addendum at ki.com or KI Fabrics & Finishes binder.

FINISH INFORMATION

Additional Laminate Offering

Additional laminates beyond KI standard offering, are available with two weeks extended leadtime. To specify additional laminates, use these designators followed by the supplier's color/pattern code:

Formica - LF/supplier's color pattern code
Nevamar - LN/supplier's color pattern code
Wilsonart - LW/supplier's color pattern code

KI's standard finish is the supplier's recommended finish for that color/pattern.

Note: Nonstandard laminates from these suppliers (example: textured laminates), require an upcharge and additional leadtime. Contact KI.



True[®] Desking System

D-Shaped Desk

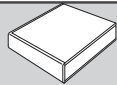

74P Edge
(74P)

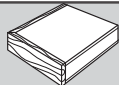

3/8" Wood
Band Edge
(34S)

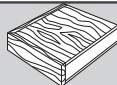

Wood Edge Veneer
(VN)

\$ 1489	\$ 1773	\$ 1904
1525	1823	1957
1561	1872	2009
1598	1921	2058
1635	1968	2117
1624	1791	1925
1661	1840	1979
1698	1890	2030
1736	1939	2080
1772	1989	2133
1764	1811	1946
1798	1861	1996
1835	1909	2051
1873	1955	2100
1909	2005	2154

SPECIAL SERVICES

Special Carton Marking

With specially marked information N/C

Shipping

Delivered. Shipped k.d. freight prepaid f.o.b. **Pembroke, Ontario K8A 0E1** factory. Freight class #70.

Specifications and prices are subject to change without prior notice.

True® Desking System

D-Shaped Desk

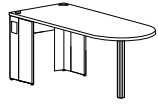

TRUE

MODEL	D x W	MODEL NUMBER							Approx. Packaged Weight	
		Basic Model	Edge Style	Surface Grom. Color	Surface Finish	Edge Color	Frame Grom. Color	Desk Color		
D-Shaped Desk w/Partial Modesty Panel/ No Partial Guest Modesty Panel <ul style="list-style-type: none"> Consists of top, two legs, modesty panel, two transitional size end panels, ganging plates, one round leg, and all required assembly hardware Each leg has two cable access grommet locations Top has two cable access grommets above the corner legs Top grommets allow for attachment of overhead storage units Modesty panel allows for optional 10-wire electrical system (see Electrical section) 	24 x 48"	TD2448/P/A	<input type="checkbox"/> <input type="checkbox"/> <input type="checkbox"/>	<input type="checkbox"/>	<input type="checkbox"/> <input type="checkbox"/> <input type="checkbox"/>	<input type="checkbox"/>	<input type="checkbox"/>	<input type="checkbox"/>	<input type="checkbox"/>	82.0#
	24 x 54"	TD2454/P/A	<input type="checkbox"/> <input type="checkbox"/> <input type="checkbox"/>	<input type="checkbox"/>	<input type="checkbox"/> <input type="checkbox"/> <input type="checkbox"/>	<input type="checkbox"/>	<input type="checkbox"/>	<input type="checkbox"/>	<input type="checkbox"/>	87.0#
	24 x 60"	TD2460/P/A	<input type="checkbox"/> <input type="checkbox"/> <input type="checkbox"/>	<input type="checkbox"/>	<input type="checkbox"/> <input type="checkbox"/> <input type="checkbox"/>	<input type="checkbox"/>	<input type="checkbox"/>	<input type="checkbox"/>	<input type="checkbox"/>	92.0#
	24 x 66"	TD2466/P/A	<input type="checkbox"/> <input type="checkbox"/> <input type="checkbox"/>	<input type="checkbox"/>	<input type="checkbox"/> <input type="checkbox"/> <input type="checkbox"/>	<input type="checkbox"/>	<input type="checkbox"/>	<input type="checkbox"/>	<input type="checkbox"/>	97.0#
	24 x 72"	TD2472/P/A	<input type="checkbox"/> <input type="checkbox"/> <input type="checkbox"/>	<input type="checkbox"/>	<input type="checkbox"/> <input type="checkbox"/> <input type="checkbox"/>	<input type="checkbox"/>	<input type="checkbox"/>	<input type="checkbox"/>	<input type="checkbox"/>	102.0#
	30 x 48"	TD3048/P/A	<input type="checkbox"/> <input type="checkbox"/> <input type="checkbox"/>	<input type="checkbox"/>	<input type="checkbox"/> <input type="checkbox"/> <input type="checkbox"/>	<input type="checkbox"/>	<input type="checkbox"/>	<input type="checkbox"/>	<input type="checkbox"/>	92.0#
	30 x 54"	TD3054/P/A	<input type="checkbox"/> <input type="checkbox"/> <input type="checkbox"/>	<input type="checkbox"/>	<input type="checkbox"/> <input type="checkbox"/> <input type="checkbox"/>	<input type="checkbox"/>	<input type="checkbox"/>	<input type="checkbox"/>	<input type="checkbox"/>	98.0#
	30 x 60"	TD3060/P/A	<input type="checkbox"/> <input type="checkbox"/> <input type="checkbox"/>	<input type="checkbox"/>	<input type="checkbox"/> <input type="checkbox"/> <input type="checkbox"/>	<input type="checkbox"/>	<input type="checkbox"/>	<input type="checkbox"/>	<input type="checkbox"/>	104.0#
	30 x 66"	TD3066/P/A	<input type="checkbox"/> <input type="checkbox"/> <input type="checkbox"/>	<input type="checkbox"/>	<input type="checkbox"/> <input type="checkbox"/> <input type="checkbox"/>	<input type="checkbox"/>	<input type="checkbox"/>	<input type="checkbox"/>	<input type="checkbox"/>	111.0#
	30 x 72"	TD3072/P/A	<input type="checkbox"/> <input type="checkbox"/> <input type="checkbox"/>	<input type="checkbox"/>	<input type="checkbox"/> <input type="checkbox"/> <input type="checkbox"/>	<input type="checkbox"/>	<input type="checkbox"/>	<input type="checkbox"/>	<input type="checkbox"/>	117.0#
	36 x 48"	TD3648/P/A	<input type="checkbox"/> <input type="checkbox"/> <input type="checkbox"/>	<input type="checkbox"/>	<input type="checkbox"/> <input type="checkbox"/> <input type="checkbox"/>	<input type="checkbox"/>	<input type="checkbox"/>	<input type="checkbox"/>	<input type="checkbox"/>	102.0#
	36 x 54"	TD3654/P/A	<input type="checkbox"/> <input type="checkbox"/> <input type="checkbox"/>	<input type="checkbox"/>	<input type="checkbox"/> <input type="checkbox"/> <input type="checkbox"/>	<input type="checkbox"/>	<input type="checkbox"/>	<input type="checkbox"/>	<input type="checkbox"/>	109.0#
	36 x 60"	TD3660/P/A	<input type="checkbox"/> <input type="checkbox"/> <input type="checkbox"/>	<input type="checkbox"/>	<input type="checkbox"/> <input type="checkbox"/> <input type="checkbox"/>	<input type="checkbox"/>	<input type="checkbox"/>	<input type="checkbox"/>	<input type="checkbox"/>	117.0#
	36 x 66"	TD3666/P/A	<input type="checkbox"/> <input type="checkbox"/> <input type="checkbox"/>	<input type="checkbox"/>	<input type="checkbox"/> <input type="checkbox"/> <input type="checkbox"/>	<input type="checkbox"/>	<input type="checkbox"/>	<input type="checkbox"/>	<input type="checkbox"/>	124.0#
	36 x 72"	TD3672/P/A	<input type="checkbox"/> <input type="checkbox"/> <input type="checkbox"/>	<input type="checkbox"/>	<input type="checkbox"/> <input type="checkbox"/> <input type="checkbox"/>	<input type="checkbox"/>	<input type="checkbox"/>	<input type="checkbox"/>	<input type="checkbox"/>	132.0#

A

B

C

D

E

F

G

HOW TO ORDER

Indicate the following information on order form:

- Quantity of each item.
- Model number, including options. See "How To Build a Model Number".
- Any special service required.

Note:

- The indicates that a choice is required.
- The absence of the indicates that no choice is required.
- Alpha-numeric characters in place of indicate that no other alternatives are available.

HOW TO BUILD A MODEL NUMBER

A Select basic model.

B Select edge style.

74P	- 74P edge
34S	- 3/8" Wood band edge
VN	- Wood edge veneer

C Select surface grommet color.

Refer to color addendum at ki.com or KI Fabrics & Finishes binder.

D Select surface finish.

Refer to color addendum at ki.com or KI Fabrics & Finishes binder. Surface finish offerings are based on edge style selections. With 74P edge (74P) and wood band edge (34S), select from laminates. With wood edge veneer (VN), select from veneers.

E Select edge color.

Refer to color addendum at ki.com or KI Fabrics & Finishes binder.

Edge color offerings are based on edge style selections. With 74P edge (74P), select from 74P colors. With wood edge veneer (VN), no edge color selection required. With wood band edge (34S), select wood edge colors.

F Select frame grommet color. Refer to color addendum at ki.com or KI Fabrics & Finishes binder.

G Select desk color. Refer to color addendum at ki.com or KI Fabrics & Finishes binder.

FINISH INFORMATION

Additional Laminate Offering

Additional laminates beyond KI standard offering, are available with two weeks extended leadtime. To specify additional laminates, use these designators followed by the supplier's color/pattern code:

Formica - LF/supplier's color pattern code
 Nevamar - LN/supplier's color pattern code
 Wilsonart - LW/supplier's color pattern code

KI's standard finish is the supplier's recommended finish for that color/pattern. Note: Nonstandard laminates from these suppliers (example: textured laminates), require an upcharge and additional leadtime. Contact KI.



True® Desking System

D-Shaped Desk

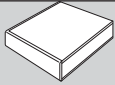

74P Edge
(74P)

\$ 1366

1391

1418

1446

1471

1505

1529

1556

1584

1610

1640

1666

1692

1721

1747

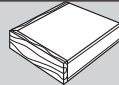

3/8" Wood
Band Edge
(34S)

\$ 1649

1690

1727

1769

1810

1669

1709

1747

1785

1825

1688

1726

1769

1805

1842

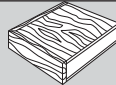

Wood Edge Veneer
(VN)

\$ 1783

1825

1867

1907

1953

1801

1844

1887

1928

1970

1823

1865

1907

1949

1991

SPECIAL SERVICES

Special Carton Marking

With specially marked information N/C

Shipping

Delivered. Shipped k.d. freight prepaid
f.o.b. **Pembroke, Ontario K8A 0E1** factory.
Freight class #70.

Specifications and prices are subject to
change without prior notice.

True® Desking System

P-Shaped Desk

MODEL	Dir.	D x W x L	MODEL NUMBER							
			Basic Model	Edge Style	End Panel	Surface Grom. Color	Surface Finish	Edge Color	Frame Grom. Color	Desk Color
P-Shaped Desk with Full Modesty Panel/ Partial Guest Modesty Panel <ul style="list-style-type: none"> Consists of top, two legs, modesty panel, filler panel (full modesty panel on the 48" side), two transitional size end panels, ganging plates, one round leg, one 9" tall steel guest modesty panel along the long side, and all required assembly hardware Each leg has two cable access grommet locations Top has two cable access grommets above the corner legs Top grommets allow for attachment of overhead storage units Modesty panel allows for optional 10-wire electrical system (see Electrical section) P-end is 18" radius 	Right	24 x 48 x 60"	TP244860/F/G	<input type="checkbox"/> <input type="checkbox"/> <input type="checkbox"/>	<input type="checkbox"/>	<input type="checkbox"/>	<input type="checkbox"/> <input type="checkbox"/> <input type="checkbox"/>	<input type="checkbox"/>	<input type="checkbox"/>	<input type="checkbox"/>
	Right	24 x 48 x 66"	TP244866/F/G	<input type="checkbox"/> <input type="checkbox"/> <input type="checkbox"/>	<input type="checkbox"/>	<input type="checkbox"/>	<input type="checkbox"/> <input type="checkbox"/> <input type="checkbox"/>	<input type="checkbox"/>	<input type="checkbox"/>	<input type="checkbox"/>
	Right	24 x 48 x 72"	TP244872/F/G	<input type="checkbox"/> <input type="checkbox"/> <input type="checkbox"/>	<input type="checkbox"/>	<input type="checkbox"/>	<input type="checkbox"/> <input type="checkbox"/> <input type="checkbox"/>	<input type="checkbox"/>	<input type="checkbox"/>	<input type="checkbox"/>
	Right	30 x 48 x 66"	TP304866/F/G	<input type="checkbox"/> <input type="checkbox"/> <input type="checkbox"/>	<input type="checkbox"/>	<input type="checkbox"/>	<input type="checkbox"/> <input type="checkbox"/> <input type="checkbox"/>	<input type="checkbox"/>	<input type="checkbox"/>	<input type="checkbox"/>
	Right	30 x 48 x 72"	TP304872/F/G	<input type="checkbox"/> <input type="checkbox"/> <input type="checkbox"/>	<input type="checkbox"/>	<input type="checkbox"/>	<input type="checkbox"/> <input type="checkbox"/> <input type="checkbox"/>	<input type="checkbox"/>	<input type="checkbox"/>	<input type="checkbox"/>
	Left	24 x 48 x 60"	TP604824/F/G	<input type="checkbox"/> <input type="checkbox"/> <input type="checkbox"/>	<input type="checkbox"/>	<input type="checkbox"/>	<input type="checkbox"/> <input type="checkbox"/> <input type="checkbox"/>	<input type="checkbox"/>	<input type="checkbox"/>	<input type="checkbox"/>
	Left	24 x 48 x 66"	TP664824/F/G	<input type="checkbox"/> <input type="checkbox"/> <input type="checkbox"/>	<input type="checkbox"/>	<input type="checkbox"/>	<input type="checkbox"/> <input type="checkbox"/> <input type="checkbox"/>	<input type="checkbox"/>	<input type="checkbox"/>	<input type="checkbox"/>
	Left	24 x 48 x 72"	TP724824/F/G	<input type="checkbox"/> <input type="checkbox"/> <input type="checkbox"/>	<input type="checkbox"/>	<input type="checkbox"/>	<input type="checkbox"/> <input type="checkbox"/> <input type="checkbox"/>	<input type="checkbox"/>	<input type="checkbox"/>	<input type="checkbox"/>
	Left	30 x 48 x 66"	TP664830/F/G	<input type="checkbox"/> <input type="checkbox"/> <input type="checkbox"/>	<input type="checkbox"/>	<input type="checkbox"/>	<input type="checkbox"/> <input type="checkbox"/> <input type="checkbox"/>	<input type="checkbox"/>	<input type="checkbox"/>	<input type="checkbox"/>
	Left	30 x 48 x 72"	TP724830/F/G	<input type="checkbox"/> <input type="checkbox"/> <input type="checkbox"/>	<input type="checkbox"/>	<input type="checkbox"/>	<input type="checkbox"/> <input type="checkbox"/> <input type="checkbox"/>	<input type="checkbox"/>	<input type="checkbox"/>	<input type="checkbox"/>

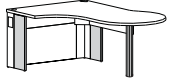

(B) Both transitional (Right)

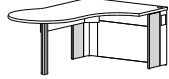

(B) Both transitional (Left)

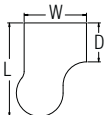

(Left)

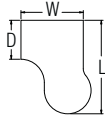

(Right)

P-Shaped Desk top view

TRUE

A B C D E F G H

HOW TO ORDER

Indicate the following information on order form:

- Quantity of each item.
- Model number, including options. See "How To Build a Model Number".
- Any special service required.

Note: • The indicates that a choice is required.

- The absence of the indicates that no choice is required.
- Alpha-numeric characters in place of indicate that no other alternatives are available.

HOW TO BUILD A MODEL NUMBER

- A** Select basic model.
- B** Select edge style.

74P	- 74P edge
KN	- Knife edge
34S	- 3/8" Wood band edge
VN	- Wood edge veneer
- C** Select transition end panels.

B	- Both
---	--------
- D** Select surface grommet color. Refer to color addendum at ki.com or KI Fabrics & Finishes binder.
- E** Select surface finish. Refer to color addendum at ki.com or KI Fabrics & Finishes binder. Surface finish offerings are based on edge style selections. With 74P edge (74P), knife edge (KN), and wood band edge

(34S), select from laminates. With wood edge veneer (VN), select from veneers.

- F** Select edge color. Refer to color addendum at ki.com or KI Fabrics & Finishes binder. Edge color offerings are based on edge style selections. With 74P edge (74P) and knife edge (KN), select from 74P/knife colors. With wood edge veneer (VN), no edge color selection required. With wood band edge (34S), select wood edge colors.
- G** Select frame grommet color. Refer to color addendum at ki.com or KI Fabrics & Finishes binder.
- H** Select desk color. Refer to color addendum at ki.com or KI Fabrics & Finishes binder.

FINISH INFORMATION

Additional Laminate Offering

Additional laminates beyond KI standard offering, are available with two weeks extended leadtime. To specify additional laminates, use these designators followed by the supplier's color/pattern code:

Formica - LF/supplier's color pattern code
 Nevamar - LN/supplier's color pattern code
 Wilsonart - LW/supplier's color pattern code

KI's standard finish is the supplier's recommended finish for that color/pattern. Note: Nonstandard laminates from these suppliers (example: textured laminates), require an upcharge and additional leadtime. Contact KI.



True® Desking System

P-Shaped Desk

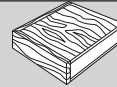
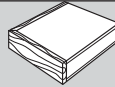
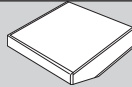
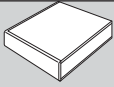

Approx. Packaged Weight	74P Edge (74P)	Knife Edge (KN)	3/8" Wood Band Edge (34S)	Wood Edge Veneer (VN)
155.0#	\$ 2287	\$ 2478	\$ 2820	\$ 3017
162.0#	2336	2533	2881	3081
168.0#	2402	2602	2964	3169
172.0#	2436	2641	3008	3218
179.0#	2494	2706	3081	3295
155.0#	2287	2478	2820	3017
162.0#	2336	2533	2881	3081
168.0#	2402	2602	2964	3169
172.0#	2436	2641	3008	3218
179.0#	2494	2706	3081	3295

SPECIAL SERVICES

Special Carton Marking

With specially marked information N/C

Shipping

Delivered. Shipped k.d. freight prepaid f.o.b. Pembroke, Ontario K8A 0E1 factory. Freight class #70.

Specifications and prices are subject to change without prior notice.

True® Desking System

P-Shaped Desk

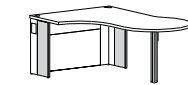
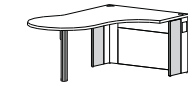
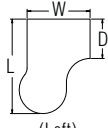
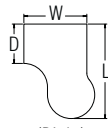
MODEL	Dir.	D x W x L	MODEL NUMBER								
			Basic Model	Edge Style	End Panel	Surface Grom. Color	Surface Finish	Edge Color	Frame Grom. Color	Desk Color	
 <p>(B) Both transitional (Right)</p>  <p>(B) Both transitional (Left)</p>  <p>(Left)</p>  <p>(Right)</p> <p>P-Shaped Desk top view</p>	Right	24 x 48 x 60"	TP244860/F/A	<input type="checkbox"/>	<input type="checkbox"/>	<input type="checkbox"/>	<input type="checkbox"/>	<input type="checkbox"/>	<input type="checkbox"/>		
	Right	24 x 48 x 66"	TP244866/F/A	<input type="checkbox"/>	<input type="checkbox"/>	<input type="checkbox"/>	<input type="checkbox"/>	<input type="checkbox"/>	<input type="checkbox"/>		
	Right	24 x 48 x 72"	TP244872/F/A	<input type="checkbox"/>	<input type="checkbox"/>	<input type="checkbox"/>	<input type="checkbox"/>	<input type="checkbox"/>	<input type="checkbox"/>		
	Right	30 x 48 x 66"	TP304866/F/A	<input type="checkbox"/>	<input type="checkbox"/>	<input type="checkbox"/>	<input type="checkbox"/>	<input type="checkbox"/>	<input type="checkbox"/>		
	Right	30 x 48 x 72"	TP304872/F/A	<input type="checkbox"/>	<input type="checkbox"/>	<input type="checkbox"/>	<input type="checkbox"/>	<input type="checkbox"/>	<input type="checkbox"/>		
	Left	24 x 48 x 60"	TP604824/F/A	<input type="checkbox"/>	<input type="checkbox"/>	<input type="checkbox"/>	<input type="checkbox"/>	<input type="checkbox"/>	<input type="checkbox"/>		
	Left	24 x 48 x 66"	TP664824/F/A	<input type="checkbox"/>	<input type="checkbox"/>	<input type="checkbox"/>	<input type="checkbox"/>	<input type="checkbox"/>	<input type="checkbox"/>		
	Left	24 x 48 x 72"	TP724824/F/A	<input type="checkbox"/>	<input type="checkbox"/>	<input type="checkbox"/>	<input type="checkbox"/>	<input type="checkbox"/>	<input type="checkbox"/>		
	Left	30 x 48 x 66"	TP664830/F/A	<input type="checkbox"/>	<input type="checkbox"/>	<input type="checkbox"/>	<input type="checkbox"/>	<input type="checkbox"/>	<input type="checkbox"/>		
	Left	30 x 48 x 72"	TP724830/F/A	<input type="checkbox"/>	<input type="checkbox"/>	<input type="checkbox"/>	<input type="checkbox"/>	<input type="checkbox"/>	<input type="checkbox"/>		

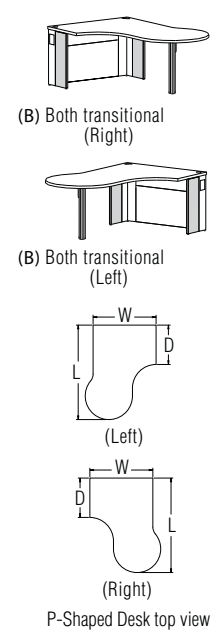

TRUE

HOW TO ORDER

Indicate the following information on order form:

- Quantity of each item.
- Model number, including options. See "How To Build a Model Number".
- Any special service required.

Note: • The indicates that a choice is required.
 • The absence of the indicates that no choice is required.
 • Alpha-numeric characters in place of indicate that no other alternatives are available.

HOW TO BUILD A MODEL NUMBER

- A** Select basic model.
- B** Select edge style.
 Knife edge (KN) adds 2" to the depth of the desk on the user's side.

74P	- 74P edge
KN	- Knife edge
34S	- 3/8" Wood band edge
VN	- Wood edge veneer
- C** Select transition end panels.

B	- Both
---	--------
- D** Select surface grommet color.
 Refer to color addendum at ki.com or KI Fabrics & Finishes binder.
- E** Select surface finish.
 Refer to color addendum at ki.com or KI Fabrics & Finishes binder.
 Surface finish offerings are based on edge style selections. With 74P edge (74P), knife edge (KN), and wood edge

- (34S), select from laminates. With wood edge veneer (VN), select from veneers.
- F** Select edge color.
 Refer to color addendum at ki.com or KI Fabrics & Finishes binder.
 Edge color offerings are based on edge style selections. With 74P edge (74P) and knife edge (KN), select from 74P/knife colors. With wood edge veneer (VN), no edge color selection required. With wood band edge (34S), select wood edge colors.
- G** Select frame grommet color.
 Refer to color addendum at ki.com or KI Fabrics & Finishes binder.
- H** Select desk color.
 Refer to color addendum at ki.com or KI Fabrics & Finishes binder.

FINISH INFORMATION

Additional Laminate Offering
 Additional laminates beyond KI standard offering, are available with two weeks extended leadtime. To specify additional laminates, use these designators followed by the supplier's color/pattern code:

Formica - LF/supplier's color pattern code
 Nevamar - LN/supplier's color pattern code
 Wilsonart - LW/supplier's color pattern code

KI's standard finish is the supplier's recommended finish for that color/pattern.
 Note: Nonstandard laminates from these suppliers (example: textured laminates), require an upcharge and additional leadtime. Contact KI.



True® Desking System
P-Shaped Desk

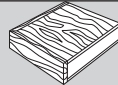
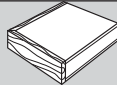
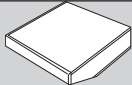
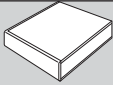

Approx. Packaged Weight	74P Edge (74P)	Knife Edge (KN)	3/8" Wood Band Edge (34S)	Wood Edge Veneer (VN)
149.0#	\$ 2143	\$ 2334	\$ 2680	\$ 2874
155.0#	2184	2378	2730	2929
160.0#	2238	2440	2802	3005
165.0#	2284	2486	2855	3065
171.0#	2333	2542	2920	3133
149.0#	2143	2334	2680	2874
155.0#	2184	2378	2730	2929
160.0#	2238	2440	2802	3005
165.0#	2284	2486	2855	3065
171.0#	2333	2542	2920	3133

SPECIAL SERVICES

Special Carton Marking

With specially marked information N/C

Shipping

Delivered. Shipped k.d. freight prepaid f.o.b. **Pembroke, Ontario K8A 0E1** factory. Freight class #70.

Specifications and prices are subject to change without prior notice.

True® Desking System

P-Shaped Desk

MODEL	Dir.	D x W x L	MODEL NUMBER								
			Basic Model	Edge Style	End Panel	Surface Grom. Color	Surface Finish	Edge Color	Frame Grom. Color	Desk Color	
P-Shaped Desk with Partial Modesty Panel/Partial Guest Modesty Panel • Consists of top, two legs, modesty panel, two transitional size end panels, ganging plates, one round leg, one 9" tall steel guest modesty panel along the long side, and all required assembly hardware • Each leg has two cable access grommet locations • Top has two cable access grommets above the corner legs • Top grommets allow for attachment of overhead storage units • Modesty panel allows for optional 10-wire electrical system (see Electrical section) • P-end is 18" radius	Right	24 x 48 x 60"	TP244860/P/G	<input type="checkbox"/> <input type="checkbox"/> <input type="checkbox"/>	<input type="checkbox"/>	<input type="checkbox"/>	<input type="checkbox"/> <input type="checkbox"/> <input type="checkbox"/>	<input type="checkbox"/>	<input type="checkbox"/>	<input type="checkbox"/>	<input type="checkbox"/>
	Right	24 x 48 x 66"	TP244866/P/G	<input type="checkbox"/> <input type="checkbox"/> <input type="checkbox"/>	<input type="checkbox"/>	<input type="checkbox"/>	<input type="checkbox"/> <input type="checkbox"/> <input type="checkbox"/>	<input type="checkbox"/>	<input type="checkbox"/>	<input type="checkbox"/>	<input type="checkbox"/>
	Right	24 x 48 x 72"	TP244872/P/G	<input type="checkbox"/> <input type="checkbox"/> <input type="checkbox"/>	<input type="checkbox"/>	<input type="checkbox"/>	<input type="checkbox"/> <input type="checkbox"/> <input type="checkbox"/>	<input type="checkbox"/>	<input type="checkbox"/>	<input type="checkbox"/>	<input type="checkbox"/>
	Right	30 x 48 x 66"	TP304866/P/G	<input type="checkbox"/> <input type="checkbox"/> <input type="checkbox"/>	<input type="checkbox"/>	<input type="checkbox"/>	<input type="checkbox"/> <input type="checkbox"/> <input type="checkbox"/>	<input type="checkbox"/>	<input type="checkbox"/>	<input type="checkbox"/>	<input type="checkbox"/>
	Right	30 x 48 x 72"	TP304872/P/G	<input type="checkbox"/> <input type="checkbox"/> <input type="checkbox"/>	<input type="checkbox"/>	<input type="checkbox"/>	<input type="checkbox"/> <input type="checkbox"/> <input type="checkbox"/>	<input type="checkbox"/>	<input type="checkbox"/>	<input type="checkbox"/>	<input type="checkbox"/>
	Left	24 x 48 x 60"	TP604824/P/G	<input type="checkbox"/> <input type="checkbox"/> <input type="checkbox"/>	<input type="checkbox"/>	<input type="checkbox"/>	<input type="checkbox"/> <input type="checkbox"/> <input type="checkbox"/>	<input type="checkbox"/>	<input type="checkbox"/>	<input type="checkbox"/>	<input type="checkbox"/>
	Left	24 x 48 x 66"	TP664824/P/G	<input type="checkbox"/> <input type="checkbox"/> <input type="checkbox"/>	<input type="checkbox"/>	<input type="checkbox"/>	<input type="checkbox"/> <input type="checkbox"/> <input type="checkbox"/>	<input type="checkbox"/>	<input type="checkbox"/>	<input type="checkbox"/>	<input type="checkbox"/>
	Left	24 x 48 x 72"	TP724824/P/G	<input type="checkbox"/> <input type="checkbox"/> <input type="checkbox"/>	<input type="checkbox"/>	<input type="checkbox"/>	<input type="checkbox"/> <input type="checkbox"/> <input type="checkbox"/>	<input type="checkbox"/>	<input type="checkbox"/>	<input type="checkbox"/>	<input type="checkbox"/>
	Left	30 x 48 x 66"	TP664830/P/G	<input type="checkbox"/> <input type="checkbox"/> <input type="checkbox"/>	<input type="checkbox"/>	<input type="checkbox"/>	<input type="checkbox"/> <input type="checkbox"/> <input type="checkbox"/>	<input type="checkbox"/>	<input type="checkbox"/>	<input type="checkbox"/>	<input type="checkbox"/>
	Left	30 x 48 x 72"	TP724830/P/G	<input type="checkbox"/> <input type="checkbox"/> <input type="checkbox"/>	<input type="checkbox"/>	<input type="checkbox"/>	<input type="checkbox"/> <input type="checkbox"/> <input type="checkbox"/>	<input type="checkbox"/>	<input type="checkbox"/>	<input type="checkbox"/>	<input type="checkbox"/>

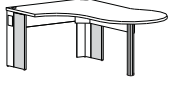

(B) Both transitional (Right)

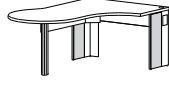

(B) Both transitional (Left)

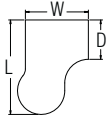

(Left)

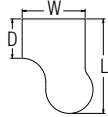

(Right)

P-Shaped Desk top view

TRUE

A B C D E F G H

HOW TO ORDER

Indicate the following information on order form:

- Quantity of each item.
- Model number, including options. See "How To Build a Model Number".
- Any special service required.

Note: • The indicates that a choice is required.

- The absence of the indicates that no choice is required.
- Alpha-numeric characters in place of indicate that no other alternatives are available.

HOW TO BUILD A MODEL NUMBER

- A** Select basic model.
- B** Select edge style.
Knife edge (KN) adds 2" to the depth of the desk on the user's side.

74P	- 74P edge
KN	- Knife edge
34S	- 3/8" Wood band edge
VN	- Wood edge veneer
- C** Select transition end panels.
B - Both
- D** Select surface grommet color.
Refer to color addendum at ki.com or KI Fabrics & Finishes binder.
- E** Select surface finish.
Refer to color addendum at ki.com or KI Fabrics & Finishes binder.
Surface finish offerings are based on edge style selections. With 74P edge (74P), knife edge (KN), and wood band edge

(34S), select from laminates. With wood edge veneer (VN), select from veneers.

- F** Select edge color.
Refer to color addendum at ki.com or KI Fabrics & Finishes binder.
Edge color offerings are based on edge style selections. With 74P edge (74P) and knife edge (KN), select from 74P/knife colors. With wood edge veneer (VN), no edge color selection required. With wood band edge (34S), select wood edge colors.
- G** Select frame grommet color.
Refer to color addendum at ki.com or KI Fabrics & Finishes binder.
- H** Select desk color.
Refer to color addendum at ki.com or KI Fabrics & Finishes binder.

FINISH INFORMATION

Additional Laminate Offering

Additional laminates beyond KI standard offering, are available with two weeks extended leadtime. To specify additional laminates, use these designators followed by the supplier's color/pattern code:

Formica - LF/supplier's color pattern code
 Nevamar - LN/supplier's color pattern code
 Wilsonart - LW/supplier's color pattern code

KI's standard finish is the supplier's recommended finish for that color/pattern.
 Note: Nonstandard laminates from these suppliers (example: textured laminates), require an upcharge and additional leadtime. Contact KI.



True[®] Desking System

P-Shaped Desk

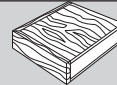
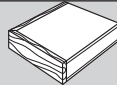
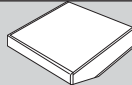
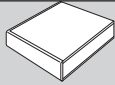

Approx. Packaged Weight	74P Edge (74P)	Knife Edge (KN)	3/8" Wood Band Edge (34S)	Wood Edge Veneer (VN)
144.0#	\$ 2048	\$ 2235	\$ 2580	\$ 2774
151.0#	2098	2291	2643	2842
157.0#	2163	2362	2721	2928
161.0#	2197	2400	2767	2977
168.0#	2256	2466	2842	3055
144.0#	2048	2235	2580	2774
151.0#	2098	2291	2643	2842
157.0#	2163	2362	2721	2928
161.0#	2197	2400	2767	2977
168.0#	2256	2466	2842	3055

SPECIAL SERVICES

Special Carton Marking

With specially marked information N/C

Shipping

Delivered. Shipped k.d. freight prepaid f.o.b. **Pembroke, Ontario K8A 0E1** factory. Freight class #70.

Specifications and prices are subject to change without prior notice.

True® Desking System

P-Shaped Desk

MODEL	Dir.	D x W x L	MODEL NUMBER								
			Basic Model	Edge Style	End Panel	Surface Grom. Color	Surface Finish	Edge Color	Frame Grom. Color	Desk Color	
P-Shaped Desk w/Partial Modesty Panel/ No Partial Guest Modesty Panel <ul style="list-style-type: none"> Consists of top, two legs, modesty panel, two transitional size end panels, ganging plates, one round leg, and all required assembly hardware Each leg has two cable access grommet locations Top has two cable access grommets above the corner legs Top grommets allow for attachment of overhead storage units Modesty panel allows for optional 10-wire electrical system (see Electrical section) P-end is 18" radius 	Right	24 x 48 x 60"	TP244860/P/A	<input type="checkbox"/> <input type="checkbox"/> <input type="checkbox"/>	<input type="checkbox"/>	<input type="checkbox"/>	<input type="checkbox"/> <input type="checkbox"/> <input type="checkbox"/>	<input type="checkbox"/>	<input type="checkbox"/>	<input type="checkbox"/>	
	Right	24 x 48 x 66"	TP244866/P/A	<input type="checkbox"/> <input type="checkbox"/> <input type="checkbox"/>	<input type="checkbox"/>	<input type="checkbox"/>	<input type="checkbox"/> <input type="checkbox"/> <input type="checkbox"/>	<input type="checkbox"/>	<input type="checkbox"/>	<input type="checkbox"/>	
	Right	24 x 48 x 72"	TP244872/P/A	<input type="checkbox"/> <input type="checkbox"/> <input type="checkbox"/>	<input type="checkbox"/>	<input type="checkbox"/>	<input type="checkbox"/> <input type="checkbox"/> <input type="checkbox"/>	<input type="checkbox"/>	<input type="checkbox"/>	<input type="checkbox"/>	
	Right	30 x 48 x 66"	TP304866/P/A	<input type="checkbox"/> <input type="checkbox"/> <input type="checkbox"/>	<input type="checkbox"/>	<input type="checkbox"/>	<input type="checkbox"/> <input type="checkbox"/> <input type="checkbox"/>	<input type="checkbox"/>	<input type="checkbox"/>	<input type="checkbox"/>	
	Right	30 x 48 x 72"	TP304872/P/A	<input type="checkbox"/> <input type="checkbox"/> <input type="checkbox"/>	<input type="checkbox"/>	<input type="checkbox"/>	<input type="checkbox"/> <input type="checkbox"/> <input type="checkbox"/>	<input type="checkbox"/>	<input type="checkbox"/>	<input type="checkbox"/>	
	Left	24 x 48 x 60"	TP604824/P/A	<input type="checkbox"/> <input type="checkbox"/> <input type="checkbox"/>	<input type="checkbox"/>	<input type="checkbox"/>	<input type="checkbox"/> <input type="checkbox"/> <input type="checkbox"/>	<input type="checkbox"/>	<input type="checkbox"/>	<input type="checkbox"/>	
	Left	24 x 48 x 66"	TP664824/P/A	<input type="checkbox"/> <input type="checkbox"/> <input type="checkbox"/>	<input type="checkbox"/>	<input type="checkbox"/>	<input type="checkbox"/> <input type="checkbox"/> <input type="checkbox"/>	<input type="checkbox"/>	<input type="checkbox"/>	<input type="checkbox"/>	
	Left	24 x 48 x 72"	TP724824/P/A	<input type="checkbox"/> <input type="checkbox"/> <input type="checkbox"/>	<input type="checkbox"/>	<input type="checkbox"/>	<input type="checkbox"/> <input type="checkbox"/> <input type="checkbox"/>	<input type="checkbox"/>	<input type="checkbox"/>	<input type="checkbox"/>	
	Left	30 x 48 x 66"	TP664830/P/A	<input type="checkbox"/> <input type="checkbox"/> <input type="checkbox"/>	<input type="checkbox"/>	<input type="checkbox"/>	<input type="checkbox"/> <input type="checkbox"/> <input type="checkbox"/>	<input type="checkbox"/>	<input type="checkbox"/>	<input type="checkbox"/>	
	Left	30 x 48 x 72"	TP724830/P/A	<input type="checkbox"/> <input type="checkbox"/> <input type="checkbox"/>	<input type="checkbox"/>	<input type="checkbox"/>	<input type="checkbox"/> <input type="checkbox"/> <input type="checkbox"/>	<input type="checkbox"/>	<input type="checkbox"/>	<input type="checkbox"/>	

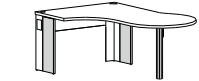

(B) Both transitional (Right)

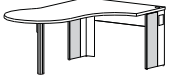

(B) Both transitional (Left)

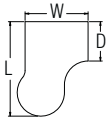

(Left)

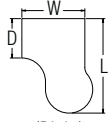

(Right)

P-Shaped Desk top view

TRUE

A B C D E F G H

HOW TO ORDER

Indicate the following information on order form:

- Quantity of each item.
- Model number, including options. See "How To Build a Model Number".
- Any special service required.

Note: • The indicates that a choice is required.

- The absence of the indicates that no choice is required.
- Alpha-numeric characters in place of indicate that no other alternatives are available.

HOW TO BUILD A MODEL NUMBER

- A** Select basic model.
- B** Select edge style.
Knife edge (KN) adds 2" to the depth of the desk on the user's side.

74P	- 74P edge
KN	- Knife edge
34S	- 3/8" Wood band edge
VN	- Wood edge veneer
- C** Select transition end panels.
B - Both
- D** Select surface grommet color.
Refer to color addendum at ki.com or KI Fabrics & Finishes binder.
- E** Select surface finish.
Refer to color addendum at ki.com or KI Fabrics & Finishes binder.
Surface finish offerings are based on edge style selections. With 74P edge (74P), knife edge (KN), and wood band edge

(34S), select from laminates. With wood edge veneer (VN), select from veneers.

- F** Select edge color.
Refer to color addendum at ki.com or KI Fabrics & Finishes binder.
Edge color offerings are based on edge style selections. With 74P edge (74P) and knife edge (KN), select from 74P/knife colors. With wood edge veneer (VN), no edge color selection required. With wood band edge (34S), select wood edge colors.
- G** Select frame grommet color.
Refer to color addendum at ki.com or KI Fabrics & Finishes binder.
- H** Select desk color.
Refer to color addendum at ki.com or KI Fabrics & Finishes binder.

FINISH INFORMATION

Additional Laminate Offering

Additional laminates beyond KI standard offering, are available with two weeks extended leadtime. To specify additional laminates, use these designators followed by the supplier's color/pattern code:

Formica - LF/supplier's color pattern code
Nevamar - LN/supplier's color pattern code
Wilsonart - LW/supplier's color pattern code

KI's standard finish is the supplier's recommended finish for that color/pattern.
Note: Nonstandard laminates from these suppliers (example: textured laminates), require an upcharge and additional leadtime. Contact KI.



True® Desking System
P-Shaped Desk

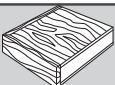
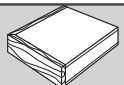
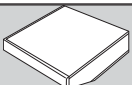
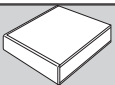

Approx. Packaged Weight	74P Edge (74P)	Knife Edge (KN)	3/8" Wood Band Edge (34S)	Wood Edge Veneer (VN)
138.0#	\$ 1903	\$ 2095	\$ 2439	\$ 2633
144.0#	1946	2138	2488	2689
149.0#	2000	2200	2563	2765
154.0#	2046	2248	2616	2824
160.0#	2094	2304	2681	2893
138.0#	1903	2095	2439	2633
144.0#	1946	2138	2488	2689
149.0#	2000	2200	2563	2765
154.0#	2046	2248	2616	2824
160.0#	2094	2304	2681	2893

SPECIAL SERVICES

Special Carton Marking

With specially marked information N/C

Shipping

Delivered. Shipped k.d. freight prepaid f.o.b. **Pembroke, Ontario K8A 0E1** factory. Freight class #70.

Specifications and prices are subject to change without prior notice.

True® Desking System

Piano Desk

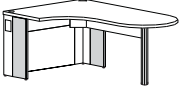
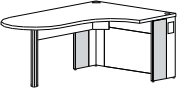
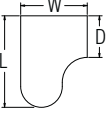
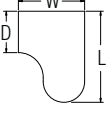
MODEL	Dir.	D x W x L	MODEL NUMBER									
			Basic Model	Edge Style	End Panel	Surface Grom. Color	Surface Finish	Edge Color	Frame Grom. Color	Desk Color		
 <p>(B) Both transitional (Right)</p>  <p>(B) Both transitional (Left)</p>  <p>(Left)</p>  <p>(Right)</p> <p>Piano Desk top view</p>	Right	24 x 48 x 60"	TI244860/F/G	<input type="checkbox"/> <input type="checkbox"/> <input type="checkbox"/>	<input type="checkbox"/>	<input type="checkbox"/>	<input type="checkbox"/> <input type="checkbox"/> <input type="checkbox"/>	<input type="checkbox"/>	<input type="checkbox"/>	<input type="checkbox"/>	<input type="checkbox"/>	
	Right	24 x 48 x 66"	TI244866/F/G	<input type="checkbox"/> <input type="checkbox"/> <input type="checkbox"/>	<input type="checkbox"/>	<input type="checkbox"/>	<input type="checkbox"/> <input type="checkbox"/> <input type="checkbox"/>	<input type="checkbox"/>	<input type="checkbox"/>	<input type="checkbox"/>	<input type="checkbox"/>	
	Right	24 x 48 x 72"	TI244872/F/G	<input type="checkbox"/> <input type="checkbox"/> <input type="checkbox"/>	<input type="checkbox"/>	<input type="checkbox"/>	<input type="checkbox"/> <input type="checkbox"/> <input type="checkbox"/>	<input type="checkbox"/>	<input type="checkbox"/>	<input type="checkbox"/>	<input type="checkbox"/>	
	Right	30 x 48 x 66"	TI304866/F/G	<input type="checkbox"/> <input type="checkbox"/> <input type="checkbox"/>	<input type="checkbox"/>	<input type="checkbox"/>	<input type="checkbox"/> <input type="checkbox"/> <input type="checkbox"/>	<input type="checkbox"/>	<input type="checkbox"/>	<input type="checkbox"/>	<input type="checkbox"/>	
	Right	30 x 48 x 72"	TI304872/F/G	<input type="checkbox"/> <input type="checkbox"/> <input type="checkbox"/>	<input type="checkbox"/>	<input type="checkbox"/>	<input type="checkbox"/> <input type="checkbox"/> <input type="checkbox"/>	<input type="checkbox"/>	<input type="checkbox"/>	<input type="checkbox"/>	<input type="checkbox"/>	
	Left	24 x 48 x 60"	TI604824/F/G	<input type="checkbox"/> <input type="checkbox"/> <input type="checkbox"/>	<input type="checkbox"/>	<input type="checkbox"/>	<input type="checkbox"/> <input type="checkbox"/> <input type="checkbox"/>	<input type="checkbox"/>	<input type="checkbox"/>	<input type="checkbox"/>	<input type="checkbox"/>	
	Left	24 x 48 x 66"	TI664824/F/G	<input type="checkbox"/> <input type="checkbox"/> <input type="checkbox"/>	<input type="checkbox"/>	<input type="checkbox"/>	<input type="checkbox"/> <input type="checkbox"/> <input type="checkbox"/>	<input type="checkbox"/>	<input type="checkbox"/>	<input type="checkbox"/>	<input type="checkbox"/>	
	Left	24 x 48 x 72"	TI724824/F/G	<input type="checkbox"/> <input type="checkbox"/> <input type="checkbox"/>	<input type="checkbox"/>	<input type="checkbox"/>	<input type="checkbox"/> <input type="checkbox"/> <input type="checkbox"/>	<input type="checkbox"/>	<input type="checkbox"/>	<input type="checkbox"/>	<input type="checkbox"/>	
	Left	30 x 48 x 66"	TI664830/F/G	<input type="checkbox"/> <input type="checkbox"/> <input type="checkbox"/>	<input type="checkbox"/>	<input type="checkbox"/>	<input type="checkbox"/> <input type="checkbox"/> <input type="checkbox"/>	<input type="checkbox"/>	<input type="checkbox"/>	<input type="checkbox"/>	<input type="checkbox"/>	
	Left	30 x 48 x 72"	TI724830/F/G	<input type="checkbox"/> <input type="checkbox"/> <input type="checkbox"/>	<input type="checkbox"/>	<input type="checkbox"/>	<input type="checkbox"/> <input type="checkbox"/> <input type="checkbox"/>	<input type="checkbox"/>	<input type="checkbox"/>	<input type="checkbox"/>	<input type="checkbox"/>	

TRUE

A B C D E F G H

HOW TO ORDER

- Indicate the following information on order form:
- Quantity of each item.
 - Model number, including options. See "How To Build a Model Number".
 - Any special service required.

Note: • The indicates that a choice is required.

- The absence of the indicates that no choice is required.
- Alpha-numeric characters in place of indicate that no other alternatives are available.

HOW TO BUILD A MODEL NUMBER

- A** Select basic model.
- B** Select edge style.

74P	- 74P edge
KN	- Knife edge
34S	- 3/8" Wood band edge
VN	- Wood edge veneer
- C** Select transition end panels.

B	- Both
----------	--------
- D** Select surface grommet color. Refer to color addendum at ki.com or KI Fabrics & Finishes binder.
- E** Select surface finish. Refer to color addendum at ki.com or KI Fabrics & Finishes binder. Surface finish offerings are based on edge style selections. With 74P edge (74P), knife edge (KN), and wood edge

- (34S), select from laminates. With wood edge veneer (VN), select from veneers.
- F** Select edge color. Refer to color addendum at ki.com or KI Fabrics & Finishes binder. Edge color offerings are based on edge style selections. With 74P edge (74P) and knife edge (KN), select from 74P/knife colors. With wood edge veneer (VN), no edge color selection required. With wood band edge (34S), select wood edge colors.
- G** Select frame grommet color. Refer to color addendum at ki.com or KI Fabrics & Finishes binder.
- H** Select desk color. Refer to color addendum at ki.com or KI Fabrics & Finishes binder.

FINISH INFORMATION

Additional Laminate Offering
 Additional laminates beyond KI standard offering, are available with two weeks extended leadtime. To specify additional laminates, use these designators followed by the supplier's color/pattern code:

Formica - LF/supplier's color pattern code
 Nevamar - LN/supplier's color pattern code
 Wilsonart - LW/supplier's color pattern code

KI's standard finish is the supplier's recommended finish for that color/pattern. Note: Nonstandard laminates from these suppliers (example: textured laminates), require an upcharge and additional leadtime. Contact KI.



True® Desking System
Piano Desk

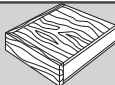
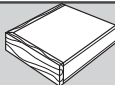
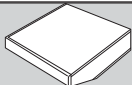
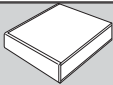

Approx. Packaged Weight	74P Edge (74P)	Knife Edge (KN)	3/8" Wood Band Edge (34S)	Wood Edge Veneer (VN)
165.0#	\$ 2143	\$ 2320	\$ 2637	\$ 2818
173.0#	2229	2414	2747	2936
180.0#	2291	2481	2822	3017
183.0#	2326	2517	2864	3062
190.0#	2378	2578	2933	3135
165.0#	2143	2320	2637	2818
173.0#	2229	2414	2747	2936
180.0#	2291	2481	2822	3017
183.0#	2326	2517	2864	3062
190.0#	2378	2578	2933	3135

SPECIAL SERVICES

Special Carton Marking

With specially marked information N/C

Shipping

Delivered. Shipped k.d. freight prepaid f.o.b. **Pembroke, Ontario K8A 0E1** factory. Freight class #70.

Specifications and prices are subject to change without prior notice.

True[®] Desking System

Piano Desk

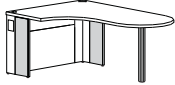
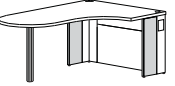
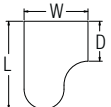
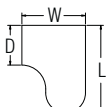
MODEL	Dir.	D x W x L	MODEL NUMBER								
			Basic Model	Edge Style	End Panel	Surface Grom. Color	Surface Finish	Edge Color	Frame Grom. Color	Desk Color	
 <p>(B) Both transitional (Right)</p>  <p>(B) Both transitional (Left)</p>  <p>(Left)</p>  <p>(Right)</p> <p>Piano Desk top view</p>	Right	24 x 48 x 60"	TI244860/F/A	<input type="checkbox"/>	<input type="checkbox"/>	<input type="checkbox"/>	<input type="checkbox"/>	<input type="checkbox"/>			
	Right	24 x 48 x 66"	TI244866/F/A	<input type="checkbox"/>	<input type="checkbox"/>	<input type="checkbox"/>	<input type="checkbox"/>	<input type="checkbox"/>			
	Right	24 x 48 x 72"	TI244872/F/A	<input type="checkbox"/>	<input type="checkbox"/>	<input type="checkbox"/>	<input type="checkbox"/>	<input type="checkbox"/>			
	Right	30 x 48 x 66"	TI304866/F/A	<input type="checkbox"/>	<input type="checkbox"/>	<input type="checkbox"/>	<input type="checkbox"/>	<input type="checkbox"/>			
	Right	30 x 48 x 72"	TI304872/F/A	<input type="checkbox"/>	<input type="checkbox"/>	<input type="checkbox"/>	<input type="checkbox"/>	<input type="checkbox"/>			
	Left	24 x 48 x 60"	TI604824/F/A	<input type="checkbox"/>	<input type="checkbox"/>	<input type="checkbox"/>	<input type="checkbox"/>	<input type="checkbox"/>			
	Left	24 x 48 x 66"	TI664824/F/A	<input type="checkbox"/>	<input type="checkbox"/>	<input type="checkbox"/>	<input type="checkbox"/>	<input type="checkbox"/>			
	Left	24 x 48 x 72"	TI724824/F/A	<input type="checkbox"/>	<input type="checkbox"/>	<input type="checkbox"/>	<input type="checkbox"/>	<input type="checkbox"/>			
	Left	30 x 48 x 66"	TI664830/F/A	<input type="checkbox"/>	<input type="checkbox"/>	<input type="checkbox"/>	<input type="checkbox"/>	<input type="checkbox"/>			
	Left	30 x 48 x 72"	TI724830/F/A	<input type="checkbox"/>	<input type="checkbox"/>	<input type="checkbox"/>	<input type="checkbox"/>	<input type="checkbox"/>			

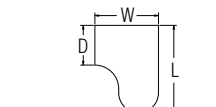
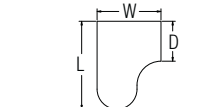
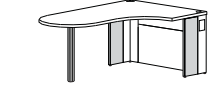
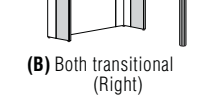

Piano Desk top view

TRUE

A B C D E F G H

HOW TO ORDER

- Indicate the following information on order form:
- Quantity of each item.
 - Model number, including options. See "How To Build a Model Number".
 - Any special service required.

Note: • The indicates that a choice is required.
 • The absence of the indicates that no choice is required.
 • Alpha-numeric characters in place of indicate that no other alternatives are available.

HOW TO BUILD A MODEL NUMBER

- A** Select basic model.
- B** Select edge style.
 Knife edge (KN) adds 2" to the depth of the desk on the user's side.

74P	- 74P edge
KN	- Knife edge
34S	- 3/8" Wood band edge
VN	- Wood edge veneer
- C** Select transition end panels.

B	- Both
----------	--------
- D** Select surface grommet color.
 Refer to color addendum at ki.com or KI Fabrics & Finishes binder.
- E** Select surface finish.
 Refer to color addendum at ki.com or KI Fabrics & Finishes binder.
 Surface finish offerings are based on edge style selections. With 74P edge (74P), knife edge (KN), and wood band edge

- (34S), select from laminates. With wood edge veneer (VN), select from veneers.
- F** Select edge color.
 Refer to color addendum at ki.com or KI Fabrics & Finishes binder.
 Edge color offerings are based on edge style selections. With 74P edge (74P) and knife edge (KN), select from 74P/knife colors. With wood edge veneer (VN), no edge color selection required. With wood band edge (34S), select wood edge colors.
- G** Select frame grommet color.
 Refer to color addendum at ki.com or KI Fabrics & Finishes binder.
- H** Select desk color.
 Refer to color addendum at ki.com or KI Fabrics & Finishes binder.

FINISH INFORMATION

Additional Laminate Offering
 Additional laminates beyond KI standard offering, are available with two weeks extended leadtime. To specify additional laminates, use these designators followed by the supplier's color/pattern code:

Formica - LF/supplier's color pattern code
 Nevamar - LN/supplier's color pattern code
 Wilsonart - LW/supplier's color pattern code

KI's standard finish is the supplier's recommended finish for that color/pattern.
 Note: Nonstandard laminates from these suppliers (example: textured laminates), require an upcharge and additional leadtime. Contact KI.



True[®] Desking System

Piano Desk

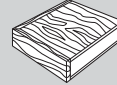
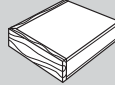
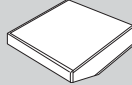
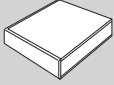

Approx. Packaged Weight	74P Edge (74P)	Knife Edge (KN)	3/8" Wood Band Edge (34S)	Wood Edge Veneer (VN)
158.0#	\$ 2001	\$ 2178	\$ 2494	\$ 2674
165.0#	2078	2262	2593	2782
172.0#	2130	2318	2659	2852
175.0#	2172	2364	2712	2910
182.0#	2220	2415	2770	2975
158.0#	2001	2178	2494	2674
165.0#	2078	2262	2593	2782
172.0#	2130	2318	2659	2852
175.0#	2172	2364	2712	2910
182.0#	2220	2415	2770	2975

SPECIAL SERVICES

Special Carton Marking

With specially marked information N/C

Shipping

Delivered. Shipped k.d. freight prepaid f.o.b. **Pembroke, Ontario K8A 0E1** factory. Freight class #70.

Specifications and prices are subject to change without prior notice.

True® Desking System

Piano Desk

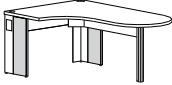
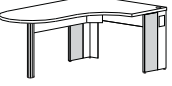
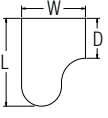
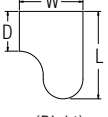
MODEL	Dir.	D x W x L	MODEL NUMBER									
			Basic Model	Edge Style	End Panel	Surface Grom. Color	Surface Finish	Edge Color	Frame Grom. Color	Desk Color		
 <p>(B) Both transitional (Right)</p>  <p>(B) Both transitional (Left)</p>  <p>(Left)</p>  <p>(Right)</p> <p>Piano Desk top view</p>	Right	24 x 48 x 60"	TI244860/P/G	<input type="checkbox"/> <input type="checkbox"/> <input type="checkbox"/> <input type="checkbox"/>	<input type="checkbox"/>	<input type="checkbox"/> <input type="checkbox"/>	<input type="checkbox"/> <input type="checkbox"/> <input type="checkbox"/> <input type="checkbox"/>	<input type="checkbox"/> <input type="checkbox"/>	<input type="checkbox"/> <input type="checkbox"/>	<input type="checkbox"/> <input type="checkbox"/>	<input type="checkbox"/> <input type="checkbox"/>	
	Right	24 x 48 x 66"	TI244866/P/G	<input type="checkbox"/> <input type="checkbox"/> <input type="checkbox"/> <input type="checkbox"/>	<input type="checkbox"/>	<input type="checkbox"/> <input type="checkbox"/>	<input type="checkbox"/> <input type="checkbox"/> <input type="checkbox"/> <input type="checkbox"/>	<input type="checkbox"/> <input type="checkbox"/>	<input type="checkbox"/> <input type="checkbox"/>	<input type="checkbox"/> <input type="checkbox"/>	<input type="checkbox"/> <input type="checkbox"/>	
	Right	24 x 48 x 72"	TI244872/P/G	<input type="checkbox"/> <input type="checkbox"/> <input type="checkbox"/> <input type="checkbox"/>	<input type="checkbox"/>	<input type="checkbox"/> <input type="checkbox"/>	<input type="checkbox"/> <input type="checkbox"/> <input type="checkbox"/> <input type="checkbox"/>	<input type="checkbox"/> <input type="checkbox"/>	<input type="checkbox"/> <input type="checkbox"/>	<input type="checkbox"/> <input type="checkbox"/>	<input type="checkbox"/> <input type="checkbox"/>	
	Right	30 x 48 x 66"	TI304866/P/G	<input type="checkbox"/> <input type="checkbox"/> <input type="checkbox"/> <input type="checkbox"/>	<input type="checkbox"/>	<input type="checkbox"/> <input type="checkbox"/>	<input type="checkbox"/> <input type="checkbox"/> <input type="checkbox"/> <input type="checkbox"/>	<input type="checkbox"/> <input type="checkbox"/>	<input type="checkbox"/> <input type="checkbox"/>	<input type="checkbox"/> <input type="checkbox"/>	<input type="checkbox"/> <input type="checkbox"/>	
	Right	30 x 48 x 72"	TI304872/P/G	<input type="checkbox"/> <input type="checkbox"/> <input type="checkbox"/> <input type="checkbox"/>	<input type="checkbox"/>	<input type="checkbox"/> <input type="checkbox"/>	<input type="checkbox"/> <input type="checkbox"/> <input type="checkbox"/> <input type="checkbox"/>	<input type="checkbox"/> <input type="checkbox"/>	<input type="checkbox"/> <input type="checkbox"/>	<input type="checkbox"/> <input type="checkbox"/>	<input type="checkbox"/> <input type="checkbox"/>	
	Left	24 x 48 x 60"	TI604824/P/G	<input type="checkbox"/> <input type="checkbox"/> <input type="checkbox"/> <input type="checkbox"/>	<input type="checkbox"/>	<input type="checkbox"/> <input type="checkbox"/>	<input type="checkbox"/> <input type="checkbox"/> <input type="checkbox"/> <input type="checkbox"/>	<input type="checkbox"/> <input type="checkbox"/>	<input type="checkbox"/> <input type="checkbox"/>	<input type="checkbox"/> <input type="checkbox"/>	<input type="checkbox"/> <input type="checkbox"/>	
	Left	24 x 48 x 66"	TI664824/P/G	<input type="checkbox"/> <input type="checkbox"/> <input type="checkbox"/> <input type="checkbox"/>	<input type="checkbox"/>	<input type="checkbox"/> <input type="checkbox"/>	<input type="checkbox"/> <input type="checkbox"/> <input type="checkbox"/> <input type="checkbox"/>	<input type="checkbox"/> <input type="checkbox"/>	<input type="checkbox"/> <input type="checkbox"/>	<input type="checkbox"/> <input type="checkbox"/>	<input type="checkbox"/> <input type="checkbox"/>	
	Left	24 x 48 x 72"	TI724824/P/G	<input type="checkbox"/> <input type="checkbox"/> <input type="checkbox"/> <input type="checkbox"/>	<input type="checkbox"/>	<input type="checkbox"/> <input type="checkbox"/>	<input type="checkbox"/> <input type="checkbox"/> <input type="checkbox"/> <input type="checkbox"/>	<input type="checkbox"/> <input type="checkbox"/>	<input type="checkbox"/> <input type="checkbox"/>	<input type="checkbox"/> <input type="checkbox"/>	<input type="checkbox"/> <input type="checkbox"/>	
	Left	30 x 48 x 66"	TI664830/P/G	<input type="checkbox"/> <input type="checkbox"/> <input type="checkbox"/> <input type="checkbox"/>	<input type="checkbox"/>	<input type="checkbox"/> <input type="checkbox"/>	<input type="checkbox"/> <input type="checkbox"/> <input type="checkbox"/> <input type="checkbox"/>	<input type="checkbox"/> <input type="checkbox"/>	<input type="checkbox"/> <input type="checkbox"/>	<input type="checkbox"/> <input type="checkbox"/>	<input type="checkbox"/> <input type="checkbox"/>	
	Left	30 x 48 x 72"	TI724830/P/G	<input type="checkbox"/> <input type="checkbox"/> <input type="checkbox"/> <input type="checkbox"/>	<input type="checkbox"/>	<input type="checkbox"/> <input type="checkbox"/>	<input type="checkbox"/> <input type="checkbox"/> <input type="checkbox"/> <input type="checkbox"/>	<input type="checkbox"/> <input type="checkbox"/>	<input type="checkbox"/> <input type="checkbox"/>	<input type="checkbox"/> <input type="checkbox"/>	<input type="checkbox"/> <input type="checkbox"/>	

A **B** **C** **D** **E** **F** **G** **H**

TRUE

HOW TO ORDER

Indicate the following information on order form:

- Quantity of each item.
- Model number, including options. See "How To Build a Model Number".
- Any special service required.

Note: • The indicates that a choice is required.

- The absence of the indicates that no choice is required.
- Alpha-numeric characters in place of indicate that no other alternatives are available.

HOW TO BUILD A MODEL NUMBER

- A** Select basic model.
- B** Select edge style.
Knife edge (KN) adds 2" to the depth of the desk on the user's side.

74P	- 74P edge
KN	- Knife edge
34S	- 3/8" Wood band edge
VN	- Wood edge veneer
- C** Select transition end panels.
B - Both
- D** Select surface grommet color.
Refer to color addendum at ki.com or KI Fabrics & Finishes binder.
- E** Select surface finish.
Refer to color addendum at ki.com or KI Fabrics & Finishes binder.
Surface finish offerings are based on edge style selections. With 74P edge (74P), knife edge (KN), and wood band edge

(34S), select from laminates. With wood edge veneer (VN), select from veneers.

- F** Select edge color.
Refer to color addendum at ki.com or KI Fabrics & Finishes binder.
Edge color offerings are based on edge style selections. With 74P edge (74P) and knife edge (KN), select from 74P/knife colors. With wood edge veneer (VN), no edge color selection required. With wood band edge (34S), select wood edge colors.
- G** Select frame grommet color.
Refer to color addendum at ki.com or KI Fabrics & Finishes binder.
- H** Select desk color.
Refer to color addendum at ki.com or KI Fabrics & Finishes binder.

FINISH INFORMATION

Additional Laminate Offering

Additional laminates beyond KI standard offering, are available with two weeks extended leadtime. To specify additional laminates, use these designators followed by the supplier's color/pattern code:

Formica - LF/supplier's color pattern code
Nevamar - LN/supplier's color pattern code
Wilsonart - LW/supplier's color pattern code

KI's standard finish is the supplier's recommended finish for that color/pattern.
Note: Nonstandard laminates from these suppliers (example: textured laminates), require an upcharge and additional leadtime. Contact KI.



True[®] Desking System

Piano Desk

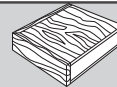
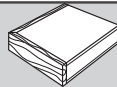
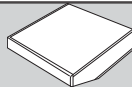
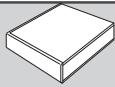

Approx. Packaged Weight	74P Edge (74P)	Knife Edge (KN)	3/8" Wood Band Edge (34S)	Wood Edge Veneer (VN)
154.0#	\$ 1903	\$ 2080	\$ 2398	\$ 2578
162.0#	1991	2175	2507	2696
169.0#	2052	2240	2582	2774
172.0#	2084	2276	2624	2822
179.0#	2138	2338	2693	2896
154.0#	1903	2080	2398	2578
162.0#	1991	2175	2507	2696
169.0#	2052	2240	2582	2774
172.0#	2084	2276	2624	2822
179.0#	2138	2338	2693	2896

SPECIAL SERVICES

Special Carton Marking

With specially marked information N/C

Shipping

Delivered. Shipped k.d. freight prepaid f.o.b. **Pembroke, Ontario K8A 0E1** factory. Freight class #70.

Specifications and prices are subject to change without prior notice.

True® Desking System

Piano Desk

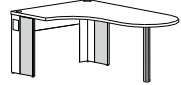
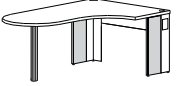
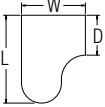
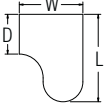
MODEL	Dir.	D x W x L	MODEL NUMBER									
			Basic Model	Edge Style	End Panel	Surface Grom. Color	Surface Finish	Edge Color	Frame Grom. Color	Desk Color		
 <p>(B) Both transitional (Right)</p>  <p>(B) Both transitional (Left)</p>  <p>(Left)</p>  <p>(Right)</p> <p>Piano Desk top view</p>	Right	24 x 48 x 60"	TI244860/P/A	<input type="checkbox"/> <input type="checkbox"/> <input type="checkbox"/>	<input type="checkbox"/>	<input type="checkbox"/>	<input type="checkbox"/> <input type="checkbox"/> <input type="checkbox"/>	<input type="checkbox"/>	<input type="checkbox"/>	<input type="checkbox"/>	<input type="checkbox"/>	
	Right	24 x 48 x 66"	TI244866/P/A	<input type="checkbox"/> <input type="checkbox"/> <input type="checkbox"/>	<input type="checkbox"/>	<input type="checkbox"/>	<input type="checkbox"/> <input type="checkbox"/> <input type="checkbox"/>	<input type="checkbox"/>	<input type="checkbox"/>	<input type="checkbox"/>	<input type="checkbox"/>	
	Right	24 x 48 x 72"	TI244872/P/A	<input type="checkbox"/> <input type="checkbox"/> <input type="checkbox"/>	<input type="checkbox"/>	<input type="checkbox"/>	<input type="checkbox"/> <input type="checkbox"/> <input type="checkbox"/>	<input type="checkbox"/>	<input type="checkbox"/>	<input type="checkbox"/>	<input type="checkbox"/>	
	Right	30 x 48 x 66"	TI304866/P/A	<input type="checkbox"/> <input type="checkbox"/> <input type="checkbox"/>	<input type="checkbox"/>	<input type="checkbox"/>	<input type="checkbox"/> <input type="checkbox"/> <input type="checkbox"/>	<input type="checkbox"/>	<input type="checkbox"/>	<input type="checkbox"/>	<input type="checkbox"/>	
	Right	30 x 48 x 72"	TI304872/P/A	<input type="checkbox"/> <input type="checkbox"/> <input type="checkbox"/>	<input type="checkbox"/>	<input type="checkbox"/>	<input type="checkbox"/> <input type="checkbox"/> <input type="checkbox"/>	<input type="checkbox"/>	<input type="checkbox"/>	<input type="checkbox"/>	<input type="checkbox"/>	
	Left	24 x 48 x 60"	TI604824/P/A	<input type="checkbox"/> <input type="checkbox"/> <input type="checkbox"/>	<input type="checkbox"/>	<input type="checkbox"/>	<input type="checkbox"/> <input type="checkbox"/> <input type="checkbox"/>	<input type="checkbox"/>	<input type="checkbox"/>	<input type="checkbox"/>	<input type="checkbox"/>	
	Left	24 x 48 x 66"	TI664824/P/A	<input type="checkbox"/> <input type="checkbox"/> <input type="checkbox"/>	<input type="checkbox"/>	<input type="checkbox"/>	<input type="checkbox"/> <input type="checkbox"/> <input type="checkbox"/>	<input type="checkbox"/>	<input type="checkbox"/>	<input type="checkbox"/>	<input type="checkbox"/>	
	Left	24 x 48 x 72"	TI724824/P/A	<input type="checkbox"/> <input type="checkbox"/> <input type="checkbox"/>	<input type="checkbox"/>	<input type="checkbox"/>	<input type="checkbox"/> <input type="checkbox"/> <input type="checkbox"/>	<input type="checkbox"/>	<input type="checkbox"/>	<input type="checkbox"/>	<input type="checkbox"/>	
	Left	30 x 48 x 66"	TI664830/P/A	<input type="checkbox"/> <input type="checkbox"/> <input type="checkbox"/>	<input type="checkbox"/>	<input type="checkbox"/>	<input type="checkbox"/> <input type="checkbox"/> <input type="checkbox"/>	<input type="checkbox"/>	<input type="checkbox"/>	<input type="checkbox"/>	<input type="checkbox"/>	
	Left	30 x 48 x 72"	TI724830/P/A	<input type="checkbox"/> <input type="checkbox"/> <input type="checkbox"/>	<input type="checkbox"/>	<input type="checkbox"/>	<input type="checkbox"/> <input type="checkbox"/> <input type="checkbox"/>	<input type="checkbox"/>	<input type="checkbox"/>	<input type="checkbox"/>	<input type="checkbox"/>	

A B C D E F G H

TRUE

HOW TO ORDER

Indicate the following information on order form:

- Quantity of each item.
- Model number, including options. See "How To Build a Model Number".
- Any special service required.

Note: • The indicates that a choice is required.

- The absence of the indicates that no choice is required.
- Alpha-numeric characters in place of indicate that no other alternatives are available.

HOW TO BUILD A MODEL NUMBER

- A** Select basic model.
- B** Select edge style.
Knife edge (KN) adds 2" to the depth of the desk on the user's side.

74P	- 74P edge
KN	- Knife edge
34S	- 3/8" Wood band edge
VN	- Wood edge veneer
- C** Select transition end panels.
B - Both
- D** Select surface grommet color.
Refer to color addendum at ki.com or KI Fabrics & Finishes binder.
- E** Select surface finish.
Refer to color addendum at ki.com or KI Fabrics & Finishes binder.
Surface finish offerings are based on edge style selections. With 74P edge (74P), knife edge (KN), and wood edge

(34S), select from laminates. With wood edge veneer (VN), select from veneers.

- F** Select edge color.
Refer to color addendum at ki.com or KI Fabrics & Finishes binder.
Edge color offerings are based on edge style selections. With 74P edge (74P) and knife edge (KN), select from 74P/knife colors. With wood edge veneer (VN), no edge color selection required. With wood band edge (34S), select wood edge colors.
- G** Select frame grommet color.
Refer to color addendum at ki.com or KI Fabrics & Finishes binder.
- H** Select desk color.
Refer to color addendum at ki.com or KI Fabrics & Finishes binder.

FINISH INFORMATION

Additional Laminate Offering

Additional laminates beyond KI standard offering, are available with two weeks extended leadtime. To specify additional laminates, use these designators followed by the supplier's color/pattern code:

Formica - LF/supplier's color pattern code
Nevamar - LN/supplier's color pattern code
Wilsonart - LW/supplier's color pattern code

KI's standard finish is the supplier's recommended finish for that color/pattern.

Note: Nonstandard laminates from these suppliers (example: textured laminates), require an upcharge and additional leadtime. Contact KI.

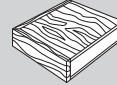
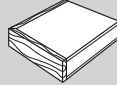
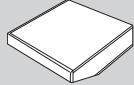
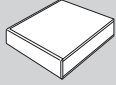

Approx. Packaged Weight	74P Edge (74P)	Knife Edge (KN)	3/8" Wood Band Edge (34S)	Wood Edge Veneer (VN)
147.0#	\$ 1764	\$ 1939	\$ 2256	\$ 2436
154.0#	1838	2022	2356	2542
161.0#	1890	2079	2419	2613
164.0#	1932	2125	2473	2668
171.0#	1979	2176	2533	2734
147.0#	1764	1939	2256	2436
154.0#	1838	2022	2356	2542
161.0#	1890	2079	2419	2613
164.0#	1932	2125	2473	2668
171.0#	1979	2176	2533	2734

SPECIAL SERVICES

Special Carton Marking

With specially marked information N/C

Shipping

Delivered. Shipped k.d. freight prepaid f.o.b. **Pembroke, Ontario K8A 0E1** factory. Freight class #70.

Specifications and prices are subject to change without prior notice.

True[®] Desking System

Transitional Desk

MODEL	D x W x D	MODEL NUMBER									
		Basic Model	Edge Style	End Panel	Center Grom.	Surface Grom. Color	Surface Finish	Edge Color	Frame Grom. Color	Desk Color	
TRUE	Transitional Desk with Full Modesty Panel • See images below • Desk reduces size from 30" on one end to 24" on opposite end • Consists of top, two legs, modesty panel, filler panel (full modesty panel), two end panels (optional transitional size), ganging plates, and all required assembly hardware. • Each leg has two cable access grommet locations • Top has two cable access grommets above the legs (66" and 72" wide have an optional third middle grommet used for mounting stanchions and not intended for routing cables) • Top grommets allow for attachment of overhead storage units • Modesty panel allows for optional 10-wire electrical system (see Electrical section)	24 x 42 x 30"	TTR244230/F	<input type="checkbox"/> <input type="checkbox"/> <input type="checkbox"/>	<input type="checkbox"/>	NCG	<input type="checkbox"/> <input type="checkbox"/>	<input type="checkbox"/> <input type="checkbox"/> <input type="checkbox"/>	<input type="checkbox"/> <input type="checkbox"/>	<input type="checkbox"/> <input type="checkbox"/>	<input type="checkbox"/> <input type="checkbox"/>
		24 x 48 x 30"	TTR244830/F	<input type="checkbox"/> <input type="checkbox"/> <input type="checkbox"/>	<input type="checkbox"/>	NCG	<input type="checkbox"/> <input type="checkbox"/>	<input type="checkbox"/> <input type="checkbox"/> <input type="checkbox"/>	<input type="checkbox"/> <input type="checkbox"/>	<input type="checkbox"/> <input type="checkbox"/>	<input type="checkbox"/> <input type="checkbox"/>
		24 x 54 x 30"	TTR245430/F	<input type="checkbox"/> <input type="checkbox"/> <input type="checkbox"/>	<input type="checkbox"/>	NCG	<input type="checkbox"/> <input type="checkbox"/>	<input type="checkbox"/> <input type="checkbox"/> <input type="checkbox"/>	<input type="checkbox"/> <input type="checkbox"/>	<input type="checkbox"/> <input type="checkbox"/>	<input type="checkbox"/> <input type="checkbox"/>
		24 x 60 x 30"	TTR246030/F	<input type="checkbox"/> <input type="checkbox"/> <input type="checkbox"/>	<input type="checkbox"/>	NCG	<input type="checkbox"/> <input type="checkbox"/>	<input type="checkbox"/> <input type="checkbox"/> <input type="checkbox"/>	<input type="checkbox"/> <input type="checkbox"/>	<input type="checkbox"/> <input type="checkbox"/>	<input type="checkbox"/> <input type="checkbox"/>
		24 x 66 x 30"	TTR246630/F	<input type="checkbox"/> <input type="checkbox"/> <input type="checkbox"/>	<input type="checkbox"/>	<input type="checkbox"/> <input type="checkbox"/> <input type="checkbox"/>	<input type="checkbox"/> <input type="checkbox"/>	<input type="checkbox"/> <input type="checkbox"/> <input type="checkbox"/>	<input type="checkbox"/> <input type="checkbox"/>	<input type="checkbox"/> <input type="checkbox"/>	<input type="checkbox"/> <input type="checkbox"/>
		24 x 72 x 30"	TTR247230/F	<input type="checkbox"/> <input type="checkbox"/> <input type="checkbox"/>	<input type="checkbox"/>	<input type="checkbox"/> <input type="checkbox"/> <input type="checkbox"/>	<input type="checkbox"/> <input type="checkbox"/>	<input type="checkbox"/> <input type="checkbox"/> <input type="checkbox"/>	<input type="checkbox"/> <input type="checkbox"/>	<input type="checkbox"/> <input type="checkbox"/>	<input type="checkbox"/> <input type="checkbox"/>
		30 x 42 x 24"	TTR304224/F	<input type="checkbox"/> <input type="checkbox"/> <input type="checkbox"/>	<input type="checkbox"/>	NCG	<input type="checkbox"/> <input type="checkbox"/>	<input type="checkbox"/> <input type="checkbox"/> <input type="checkbox"/>	<input type="checkbox"/> <input type="checkbox"/>	<input type="checkbox"/> <input type="checkbox"/>	<input type="checkbox"/> <input type="checkbox"/>
		30 x 48 x 24"	TTR304824/F	<input type="checkbox"/> <input type="checkbox"/> <input type="checkbox"/>	<input type="checkbox"/>	NCG	<input type="checkbox"/> <input type="checkbox"/>	<input type="checkbox"/> <input type="checkbox"/> <input type="checkbox"/>	<input type="checkbox"/> <input type="checkbox"/>	<input type="checkbox"/> <input type="checkbox"/>	<input type="checkbox"/> <input type="checkbox"/>
		30 x 54 x 24"	TTR305424/F	<input type="checkbox"/> <input type="checkbox"/> <input type="checkbox"/>	<input type="checkbox"/>	NCG	<input type="checkbox"/> <input type="checkbox"/>	<input type="checkbox"/> <input type="checkbox"/> <input type="checkbox"/>	<input type="checkbox"/> <input type="checkbox"/>	<input type="checkbox"/> <input type="checkbox"/>	<input type="checkbox"/> <input type="checkbox"/>
		30 x 60 x 24"	TTR306024/F	<input type="checkbox"/> <input type="checkbox"/> <input type="checkbox"/>	<input type="checkbox"/>	NCG	<input type="checkbox"/> <input type="checkbox"/>	<input type="checkbox"/> <input type="checkbox"/> <input type="checkbox"/>	<input type="checkbox"/> <input type="checkbox"/>	<input type="checkbox"/> <input type="checkbox"/>	<input type="checkbox"/> <input type="checkbox"/>
		30 x 66 x 24"	TTR306624/F	<input type="checkbox"/> <input type="checkbox"/> <input type="checkbox"/>	<input type="checkbox"/>	<input type="checkbox"/> <input type="checkbox"/> <input type="checkbox"/>	<input type="checkbox"/> <input type="checkbox"/>	<input type="checkbox"/> <input type="checkbox"/> <input type="checkbox"/>	<input type="checkbox"/> <input type="checkbox"/>	<input type="checkbox"/> <input type="checkbox"/>	<input type="checkbox"/> <input type="checkbox"/>
		30 x 72 x 24"	TTR307224/F	<input type="checkbox"/> <input type="checkbox"/> <input type="checkbox"/>	<input type="checkbox"/>	<input type="checkbox"/> <input type="checkbox"/> <input type="checkbox"/>	<input type="checkbox"/> <input type="checkbox"/>	<input type="checkbox"/> <input type="checkbox"/> <input type="checkbox"/>	<input type="checkbox"/> <input type="checkbox"/>	<input type="checkbox"/> <input type="checkbox"/>	<input type="checkbox"/> <input type="checkbox"/>

A

B

C

D

E

F

G

H

I

HOW TO ORDER

Indicate the following information on order form:

- Quantity of each item.
- Model number, including options. See "How To Build a Model Number".
- Any special service required.

Note: • The indicates that a choice is required.

- The absence of the indicates that no choice is required.
- Alpha-numeric characters in place of indicate that no other alternatives are available.

HOW TO BUILD A MODEL NUMBER

A Select basic model.

B Select edge style.

KN is not recommended in L-Shaped configurations.

74P - 74P edge
KN - Knife edge
34S - 3/8" Wood band edge
VN - Wood edge veneer

With 74P, KN and 34S edges, select from laminates for surface finish (Lxx). For edge color, 74P and KN, select from Exx colors and for 34S, select Mxx colors. For VN, select from Mxx for surface finish and do not select an edge color.

C Select transition end panels.

B - Two transitional end panels
L - Left transitional end panel; add \$55
R - Right transitional end panel; add \$55
S - Two full end panels; add \$108

D Select desk center grommet option.

NCG - No center grommet
YCG - Yes center grommet

"YCG" option only available on 66" and 72" wide desks. "YCG" is needed to mount overheads, transaction surfaces or stanchion mounted privacy screens.

E Select surface grommet color.

Refer to color addendum at ki.com or KI Fabrics & Finishes binder.

F Select surface finish.

Refer to color addendum at ki.com or KI Fabrics & Finishes binder. Surface finish offerings are based on edge style selections.

G Select edge color.

Refer to color addendum at ki.com or KI Fabrics & Finishes binder. Edge color offerings are based on edge style selections.

H Select frame grommet color.

Refer to color addendum at ki.com or KI Fabrics & Finishes binder.

I Select desk color.

Refer to color addendum at ki.com or KI Fabrics & Finishes binder.

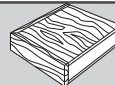
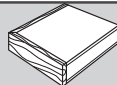
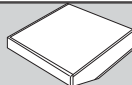
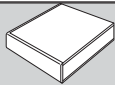

Approx. Packaged Weight	74P Edge (74P)	Knife Edge (KN)	3/8" Wood Band Edge (34S)	Wood Edge Veneer (VN)
108.0#	\$ 1413	\$ 1534	\$ 1753	\$ 1877
116.0#	1488	1613	1836	1964
124.0#	1543	1672	1902	2035
137.0#	1620	1751	1991	2125
146.0#	1678	1814	2056	2198
154.0#	1784	1926	2184	2332
108.0#	1413	1534	1753	1877
116.0#	1488	1613	1836	1964
124.0#	1543	1672	1902	2035
137.0#	1620	1751	1991	2125
146.0#	1678	1814	2056	2198
154.0#	1784	1926	2184	2332

FINISH INFORMATION

Additional Laminate Offering

Additional laminates beyond KI standard offering, are available with two weeks extended leadtime. To specify additional laminates, use these designators followed by the supplier's color/pattern code:

Formica - LF/supplier's color pattern code
Nevamar - LN/supplier's color pattern code
Wilsonart - LW/supplier's color pattern code

KI's standard finish is the supplier's recommended finish for that color/pattern.

Note: Nonstandard laminates from these suppliers (example: textured laminates), require an upcharge and additional leadtime. Contact KI.

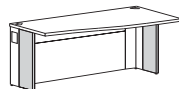

(B) Both transitional

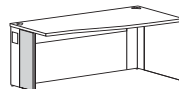

(L) Left transitional

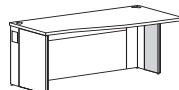

(R) Right transitional

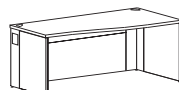

(S) Two full end panels

SPECIAL SERVICES

Special Carton Marking

With specially marked information N/C

Shipping

Delivered. Shipped k.d. freight prepaid f.o.b. **Pembroke, Ontario K8A 0E1** factory. Freight class #70.

Specifications and prices are subject to change without prior notice.

True® Desking System

Transitional Desk

MODEL		D x W x D	MODEL NUMBER								
			Basic Model	Edge Style	End Panel	Center Grom.	Surface Grom. Color	Surface Finish	Edge Color	Frame Grom. Color	Desk Color
TRUE	Transitional Desk with Partial Modesty Panel • See images below • Desk reduces size from 30" on one end to 24" on opposite end • Consists of top, two legs, modesty panel, two end panels (optional transitional size), ganging plates, and all required assembly hardware. • Each leg has two cable access grommet locations • Top has two cable access grommets above the legs (66" and 72" wide have an optional third middle grommet used for mounting stanchions and not intended for routing cables) • Top grommets allow for attachment of overhead storage units • Modesty panel allows for optional 10-wire electrical system (see Electrical section)	24 x 42 x 30"	TTR244230/P	□□□	□	NCG	□□	□□□	□□	□□	□□
		24 x 48 x 30"	TTR244830/P	□□□	□	NCG	□□	□□□	□□	□□	□□
		24 x 54 x 30"	TTR245430/P	□□□	□	NCG	□□	□□□	□□	□□	□□
		24 x 60 x 30"	TTR246030/P	□□□	□	NCG	□□	□□□	□□	□□	□□
		24 x 66 x 30"	TTR246630/P	□□□	□	□□□	□□	□□□	□□	□□	□□
		24 x 72 x 30"	TTR247230/P	□□□	□	□□□	□□	□□□	□□	□□	□□
		30 x 42 x 24"	TTR304224/P	□□□	□	NCG	□□	□□□	□□	□□	□□
		30 x 48 x 24"	TTR304824/P	□□□	□	NCG	□□	□□□	□□	□□	□□
		30 x 54 x 24"	TTR305424/P	□□□	□	NCG	□□	□□□	□□	□□	□□
		30 x 60 x 24"	TTR306024/P	□□□	□	NCG	□□	□□□	□□	□□	□□
		30 x 66 x 24"	TTR306624/P	□□□	□	□□□	□□	□□□	□□	□□	□□
		30 x 72 x 24"	TTR307224/P	□□□	□	□□□	□□	□□□	□□	□□	□□

A B C D E F G H I

HOW TO ORDER

Indicate the following information on order form:

- Quantity of each item.
- Model number, including options. See "How To Build a Model Number".
- Any special service required.

Note: • The □ indicates that a choice is required.

- The absence of the □ indicates that no choice is required.
- Alpha-numeric characters in place of □ indicate that no other alternatives are available.

HOW TO BUILD A MODEL NUMBER

- A** Select basic model.

KN - Knife edge
34S - 3/8" Wood band edge
VN - Wood edge veneer
 With 74P, KN and 34S edges, select from laminates for surface finish (Lxx). For edge color, 74P and KN, select from Exx colors and for 34S, select Mxx colors. For VN, select from Mxx for surface finish and do not select an edge color.
- B** Select edge style.
 KN is not recommended in L-Shaped configurations.

74P - 74P edge
KN - Knife edge
34S - 3/8" Wood band edge
VN - Wood edge veneer
 With 74P, KN and 34S edges, select from laminates for surface finish (Lxx). For edge color, 74P and KN, select from Exx colors and for 34S, select Mxx colors. For VN, select from Mxx for surface finish and do not select an edge color.
- C** Select transition end panels.

B - Two transitional end panels
L - Left transitional end panel; add \$55
R - Right transitional end panel; add \$55
S - Two full end panels; add \$108

- D** Select desk center grommet option.

NCG - No center grommet
YCG - Yes center grommet
 "YCG" option only available on 66" and 72" wide desks. "YCG" is needed to mount overheads, transaction surfaces or stanchion mounted privacy screens.
- E** Select surface grommet color.
 Refer to color addendum at ki.com or KI Fabrics & Finishes binder.
- F** Select surface finish.
 Refer to color addendum at ki.com or KI Fabrics & Finishes binder.
 Surface finish offerings are based on edge style selections.
- G** Select edge color.
 Refer to color addendum at ki.com or KI Fabrics & Finishes binder.
 Edge color offerings are based on edge style selections.
- H** Select frame grommet color.
 Refer to color addendum at ki.com or KI Fabrics & Finishes binder.
- I** Select desk color.
 Refer to color addendum at ki.com or KI Fabrics & Finishes binder.

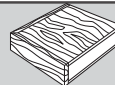
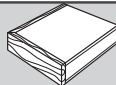
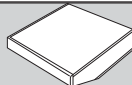
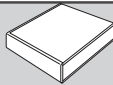

Approx. Packaged Weight	74P Edge (74P)	Knife Edge (KN)	3/8" Wood Band Edge (34S)	Wood Edge Veneer (VN)
99.0#	\$ 1213	\$ 1337	\$ 1555	\$ 1681
105.0#	1247	1374	1597	1725
112.0#	1284	1412	1643	1775
123.0#	1321	1455	1692	1828
130.0#	1359	1495	1739	1878
137.0#	1429	1570	1829	1978
99.0#	1213	1337	1555	1681
105.0#	1247	1374	1597	1725
112.0#	1284	1412	1643	1775
123.0#	1321	1455	1692	1828
130.0#	1359	1495	1739	1878
137.0#	1429	1570	1829	1978

FINISH INFORMATION

Additional Laminate Offering

Additional laminates beyond KI standard offering, are available with two weeks extended leadtime. To specify additional laminates, use these designators followed by the supplier's color/pattern code:

Formica - LF/supplier's color pattern code
Nevamar - LN/supplier's color pattern code
Wilsonart - LW/supplier's color pattern code

KI's standard finish is the supplier's recommended finish for that color/pattern.

Note: Nonstandard laminates from these suppliers (example: textured laminates), require an upcharge and additional leadtime. Contact KI.

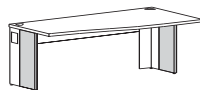

(B) Both transitional

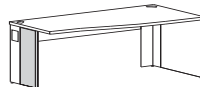

(L) Left transitional

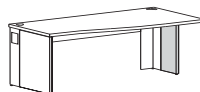

(R) Right transitional

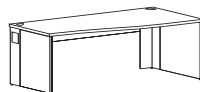

(S) Two full end panels

SPECIAL SERVICES

Special Carton Marking

With specially marked information N/C



Shipping

Delivered. Shipped k.d. freight prepaid f.o.b. **Pembroke, Ontario K8A 0E1** factory. Freight class #70.

Specifications and prices are subject to change without prior notice.

True® Desking System

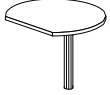
Add-On Worksurfaces

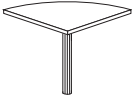
	MODEL	DIA x W	MODEL NUMBER					Approx. Packaged Weight
			Basic Model	Edge Style	Surface Finish	Edge Color	Desk Color	
 TRUE	Round Add-On Worksurface • Consists of top, 36" or 42" diameter, leg, ganging plates for attaching to existing desks, and all required assembly hardware • Knife edge (KN) on curve with 74P on flat edge	36 x 24"	TAR24	<input type="checkbox"/> <input type="checkbox"/> <input type="checkbox"/>	<input type="checkbox"/> <input type="checkbox"/> <input type="checkbox"/>	<input type="checkbox"/> <input type="checkbox"/> <input type="checkbox"/>	<input type="checkbox"/> <input type="checkbox"/> <input type="checkbox"/>	45.0#
		42 x 30"	TAR30	<input type="checkbox"/> <input type="checkbox"/> <input type="checkbox"/>	<input type="checkbox"/> <input type="checkbox"/> <input type="checkbox"/>	<input type="checkbox"/> <input type="checkbox"/> <input type="checkbox"/>	<input type="checkbox"/> <input type="checkbox"/> <input type="checkbox"/>	<input type="checkbox"/> <input type="checkbox"/> <input type="checkbox"/>
 TRUE	Half Round Add-On Worksurface • Consists of top, 24" or 30" radius, leg, ganging plates for attaching to existing desks, and all required assembly hardware • Knife edge (KN) on curve with 74P on flat edge	48 x 24"	THR4824	<input type="checkbox"/> <input type="checkbox"/> <input type="checkbox"/>	<input type="checkbox"/> <input type="checkbox"/> <input type="checkbox"/>	<input type="checkbox"/> <input type="checkbox"/> <input type="checkbox"/>	<input type="checkbox"/> <input type="checkbox"/> <input type="checkbox"/>	46.0#
		60 x 30"	THR6030	<input type="checkbox"/> <input type="checkbox"/> <input type="checkbox"/>	<input type="checkbox"/> <input type="checkbox"/> <input type="checkbox"/>	<input type="checkbox"/> <input type="checkbox"/> <input type="checkbox"/>	<input type="checkbox"/> <input type="checkbox"/> <input type="checkbox"/>	<input type="checkbox"/> <input type="checkbox"/> <input type="checkbox"/>
 TRUE	Quarter Round Add-On Worksurface • Consists of top, 24" or 30" radius, leg, ganging plates for attaching to existing desks, and all required assembly hardware • Knife edge (KN) on curve with 74P on flat edges	24"	TQR24	<input type="checkbox"/> <input type="checkbox"/> <input type="checkbox"/>	<input type="checkbox"/> <input type="checkbox"/> <input type="checkbox"/>	<input type="checkbox"/> <input type="checkbox"/> <input type="checkbox"/>	<input type="checkbox"/> <input type="checkbox"/> <input type="checkbox"/>	29.0#
		30"	TQR30	<input type="checkbox"/> <input type="checkbox"/> <input type="checkbox"/>	<input type="checkbox"/> <input type="checkbox"/> <input type="checkbox"/>	<input type="checkbox"/> <input type="checkbox"/> <input type="checkbox"/>	<input type="checkbox"/> <input type="checkbox"/> <input type="checkbox"/>	<input type="checkbox"/> <input type="checkbox"/> <input type="checkbox"/>

A **B** **C** **D** **E**

HOW TO ORDER

Indicate the following information on order form:

- Quantity of each item.
- Model number, including options. See "How To Build a Model Number".
- Any special service required.

Note: • The indicates that a choice is required.

- The absence of the indicates that no choice is required.
- Alpha-numeric characters in place of indicate that no other alternatives are available.

HOW TO BUILD A MODEL NUMBER

- A** Select basic model.
- B** Select edge style.
 Knife edge (KN) adds 2" to the depth of the worksurface.
- | | |
|------------|-----------------------|
| 74P | - 74P edge |
| KN | - Knife edge |
| 34S | - 3/8" Wood band edge |
| VN | - Wood edge veneer |
- C** Select surface finish.
 Refer to color addendum at ki.com or KI Fabrics & Finishes binder.
 Surface finish offerings are based on edge style selections. With 74P edge (74P), knife edge (KN), and wood band edge (34S), select from laminates. With wood edge veneer (VN), select from veneers.
- D** Select edge color.
 Refer to color addendum at ki.com or KI Fabrics & Finishes binder.
 Edge color offerings are based on edge

style selections. With 74P edge (74P) and knife edge (KN), select from 74P/ knife colors. With wood edge veneer (VN), no edge color selection required. With wood band edge (34S), select wood edge colors.

- E** Select desk color.
 Refer to color addendum at ki.com or KI Fabrics & Finishes binder.

FINISH INFORMATION

Additional Laminate Offering

Additional laminates beyond KI standard offering, are available with two weeks extended leadtime. To specify additional laminates, use these designators followed by the supplier's color/pattern code:

Formica - LF/supplier's color pattern code
 Nevamar - LN/supplier's color pattern code
 Wilsonart - LW/supplier's color pattern code

KI's standard finish is the supplier's recommended finish for that color/pattern.

Note: Nonstandard laminates from these suppliers (example: textured laminates), require an upcharge and additional leadtime. Contact KI.



True® Desking System
Add-On Worksurfaces

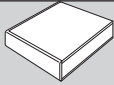

74P Edge
(74P)

\$ 999
1173

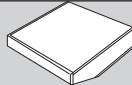

Knife Edge
(KN)

N/A
N/A

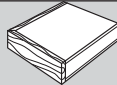

3/8" Wood
Band Edge
(34S)

\$ 1280
1505

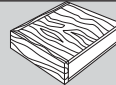

Wood Edge Veneer
(VN)

\$ 1383
1622

\$ 531
625

\$ 585
686

\$ 682
800

\$ 739
862

\$ 345
406

\$ 381
448

\$ 441
521

\$ 480
563

SPECIAL SERVICES

Special Carton Marking

With specially marked information N/C

Shipping

Delivered. Shipped k.d. freight prepaid f.o.b. **Pembroke, Ontario K8A 0E1** factory. Freight class #70.

Specifications and prices are subject to change without prior notice.

True[®] Desking System

Transaction Worksurfaces

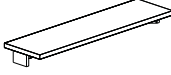
	MODEL	W	MODEL NUMBER						Approx. Packaged Weight	
			Basic Model	Edge Style	Trim Color	Surface Finish	Edge Color	Desk Color		
 <p>TRUE</p>	Standard Height Transaction Counter Straight <ul style="list-style-type: none"> Consists of top, two stanchions, steel privacy panel, and all required assembly hardware Top of transaction surface is approximately 42" from floor Space below transaction surface is 11-1/2" Worksurface is 16" deep and overhangs 4" on guest side Can mount transaction surface task lights underneath the surface ("TLT5" models) Knife edge (KN) will have the knife edge only on the user side, the approach side will just have the standard 74P edge just like the approach side of the primary desk surface 	24"	TSS24	<input type="checkbox"/>	<input type="checkbox"/>	<input type="checkbox"/>	25.0#			
		30"	TSS30	<input type="checkbox"/>	<input type="checkbox"/>	<input type="checkbox"/>	29.0#			
		36"	TSS36	<input type="checkbox"/>	<input type="checkbox"/>	<input type="checkbox"/>	33.0#			
		42"	TSS42	<input type="checkbox"/>	<input type="checkbox"/>	<input type="checkbox"/>	38.0#			
		48"	TSS48	<input type="checkbox"/>	<input type="checkbox"/>	<input type="checkbox"/>	42.0#			
		54"	TSS54	<input type="checkbox"/>	<input type="checkbox"/>	<input type="checkbox"/>	46.0#			
		60"	TSS60	<input type="checkbox"/>	<input type="checkbox"/>	<input type="checkbox"/>	50.0#			
		66"	TSS66	<input type="checkbox"/>	<input type="checkbox"/>	<input type="checkbox"/>	54.0#			
		72"	TSS72	<input type="checkbox"/>	<input type="checkbox"/>	<input type="checkbox"/>	59.0#			
		 <p>TRUE</p>	Low Height Transaction Counter Straight <ul style="list-style-type: none"> Consists of top, two stanchions, steel privacy panel, and all required assembly hardware Top of transaction surface is approximately 34" from floor Space below transaction surface is 3-3/4" Worksurface is 16" deep and overhangs 4" on guest side Cannot mount task lights underneath the low transaction surface Knife edge (KN) will have the knife edge only on the user side, the approach side will just have the standard 74P edge just like the approach side of the primary desk surface 	24"	TLS24	<input type="checkbox"/>	<input type="checkbox"/>	<input type="checkbox"/>	18.0#	
				30"	TLS30	<input type="checkbox"/>	<input type="checkbox"/>	<input type="checkbox"/>	22.0#	
36"	TLS36			<input type="checkbox"/>	<input type="checkbox"/>	<input type="checkbox"/>	25.0#			
42"	TLS42			<input type="checkbox"/>	<input type="checkbox"/>	<input type="checkbox"/>	29.0#			
48"	TLS48			<input type="checkbox"/>	<input type="checkbox"/>	<input type="checkbox"/>	33.0#			
54"	TLS54			<input type="checkbox"/>	<input type="checkbox"/>	<input type="checkbox"/>	36.0#			
60"	TLS60			<input type="checkbox"/>	<input type="checkbox"/>	<input type="checkbox"/>	40.0#			
66"	TLS66			<input type="checkbox"/>	<input type="checkbox"/>	<input type="checkbox"/>	43.0#			
72"	TLS72			<input type="checkbox"/>	<input type="checkbox"/>	<input type="checkbox"/>	47.0#			

A **B** **C** **D** **E** **F**

HOW TO ORDER

Indicate the following information on order form:

- Quantity of each item.
- Model number, including options. See "How To Build a Model Number".
- Any special service required.

Note:

- The indicates that a choice is required.
- The absence of the indicates that no choice is required.
- Alpha-numeric characters in place of indicate that no other alternatives are available.

HOW TO BUILD A MODEL NUMBER

- A** Select basic model.
- B** Select edge style.
- | | |
|------------|-----------------------|
| 74P | - 74P edge |
| KN | - Knife edge |
| 34S | - 3/8" Wood band edge |
| VN | - Wood edge veneer |
- C** Select trim/extrusion color.
Refer to color addendum at ki.com or KI Fabrics & Finishes binder.
- D** Select surface finish.
Refer to color addendum at ki.com or KI Fabrics & Finishes binder.
Surface finish offerings are based on edge style selections. With 74P edge (74P), knife edge (KN), and wood band edge (34S), select from laminates. With wood edge veneer (VN), select from veneers.
- E** Select edge color.
Refer to color addendum at ki.com or KI

Fabrics & Finishes binder.
Edge color offerings are based on edge style selections. With 74P edge (74P) and knife edge (KN), select from 74P/knife colors. With wood edge veneer (VN), no edge color selection required. With wood band edge (34S), select wood edge colors.

- F** Select desk color.
Refer to color addendum at ki.com or KI Fabrics & Finishes binder.

FINISH INFORMATION

Additional Laminate Offering

Additional laminates beyond KI standard offering, are available with two weeks extended leadtime. To specify additional laminates, use these designators followed by the supplier's color/pattern code:

Formica - LF/supplier's color pattern code
Nevamar - LN/supplier's color pattern code
Wilsonart - LW/supplier's color pattern code

KI's standard finish is the supplier's recommended finish for that color/pattern.

Note: Nonstandard laminates from these suppliers (example: textured laminates), require an upcharge and additional leadtime. Contact KI.

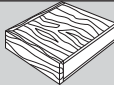
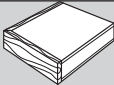
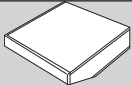
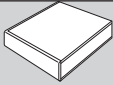

74P Edge
(74P)

Knife Edge
(KN)

3/8" Wood
Band Edge
(34S)

Wood Edge Veneer
(VN)

\$ 457
471
484
490
516
520
527
541
564

\$ 503
519
531
540
564
572
580
593
621

\$ 586
605
618
627
657
664
673
695
720

\$ 633
651
667
677
710
716
727
749
778

\$ 549
560
576
593
605
633
640
665
684

\$ 617
637
663
691
686
727
749
785
803

\$ 749
788
834
953
956
996
998
1095
1096

\$ 661
621
662
698
733
775
813
863
898

SPECIAL SERVICES

Special Carton Marking

With specially marked information N/C

Shipping

Delivered. Shipped k.d. freight prepaid f.o.b. **Pembroke, Ontario K8A 0E1** factory. Freight class #70.

Specifications and prices are subject to change without prior notice.

True[®] Desking System

Transaction Worksurfaces

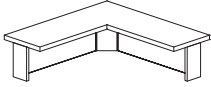
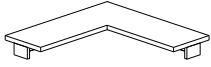
	MODEL	W-LEFT x W-RIGHT	MODEL NUMBER						Approx. Packaged Weight
			Basic Model	Edge Style	Trim Color	Surface Finish	Edge Color	Desk Color	
 <p>TRUE</p>	Standard Height Transaction Counter Corner <ul style="list-style-type: none"> Consists of top, three stanchions, steel privacy panels, and all required assembly hardware Top of transaction surface is approximately 42" from floor Space below transaction surface is 11-1/2" Worksurface is 16" deep and overhangs 4" on guest side Can mount transaction surface task lights underneath the surface ("TLT5" models) Knife edge (KN) will have the knife edge only on the user side, the approach side will just have the standard 74P edge just like the approach side of the primary desk surface 	42 x 42"	THC4242	<input type="checkbox"/>	<input type="checkbox"/>	<input type="checkbox"/>	<input type="checkbox"/>	66.0#	
		48 x 48"	THC4848	<input type="checkbox"/>	<input type="checkbox"/>	<input type="checkbox"/>	<input type="checkbox"/>	74.0#	
		48 x 60"	THC4860	<input type="checkbox"/>	<input type="checkbox"/>	<input type="checkbox"/>	<input type="checkbox"/>	83.0#	
		48 x 66"	THC4866	<input type="checkbox"/>	<input type="checkbox"/>	<input type="checkbox"/>	<input type="checkbox"/>	87.0#	
		48 x 72"	THC4872	<input type="checkbox"/>	<input type="checkbox"/>	<input type="checkbox"/>	<input type="checkbox"/>	91.0#	
		60 x 48"	THC6048	<input type="checkbox"/>	<input type="checkbox"/>	<input type="checkbox"/>	<input type="checkbox"/>	83.0#	
		66 x 48"	THC6648	<input type="checkbox"/>	<input type="checkbox"/>	<input type="checkbox"/>	<input type="checkbox"/>	87.0#	
		72 x 48"	THC7248	<input type="checkbox"/>	<input type="checkbox"/>	<input type="checkbox"/>	<input type="checkbox"/>	91.0#	
 <p>TRUE</p>	Low Height Transaction Counter Corner <ul style="list-style-type: none"> Consists of top, three stanchions, steel privacy panels, and all required assembly hardware Top of transaction surface is approximately 34" from floor Space below transaction surface is 3-3/4" Worksurface is 16" deep and overhangs 4" on guest side Cannot mount task lights underneath the low transaction surface Knife edge (KN) will have the knife edge only on the user side, the approach side will just have the standard 74P edge just like the approach side of the primary desk surface 	42 x 42"	TLC4242	<input type="checkbox"/>	<input type="checkbox"/>	<input type="checkbox"/>	<input type="checkbox"/>	51.0#	
		48 x 48"	TLC4848	<input type="checkbox"/>	<input type="checkbox"/>	<input type="checkbox"/>	<input type="checkbox"/>	59.0#	
		48 x 60"	TLC4860	<input type="checkbox"/>	<input type="checkbox"/>	<input type="checkbox"/>	<input type="checkbox"/>	66.0#	
		48 x 66"	TLC4866	<input type="checkbox"/>	<input type="checkbox"/>	<input type="checkbox"/>	<input type="checkbox"/>	70.0#	
		48 x 72"	TLC4872	<input type="checkbox"/>	<input type="checkbox"/>	<input type="checkbox"/>	<input type="checkbox"/>	73.0#	
		60 x 48"	TLC6048	<input type="checkbox"/>	<input type="checkbox"/>	<input type="checkbox"/>	<input type="checkbox"/>	66.0#	
		66 x 48"	TLC6648	<input type="checkbox"/>	<input type="checkbox"/>	<input type="checkbox"/>	<input type="checkbox"/>	70.0#	
		72 x 48"	TLC7248	<input type="checkbox"/>	<input type="checkbox"/>	<input type="checkbox"/>	<input type="checkbox"/>	73.0#	

A **B** **C** **D** **E** **F**

HOW TO ORDER

Indicate the following information on order form:

- Quantity of each item.
- Model number, including options. See "How To Build a Model Number".
- Any special service required.

Note:

- The indicates that a choice is required.
- The absence of the indicates that no choice is required.
- Alpha-numeric characters in place of indicate that no other alternatives are available.

HOW TO BUILD A MODEL NUMBER

- A** Select basic model.
- B** Select edge style.
- | | |
|------------|-----------------------|
| 74P | - 74P edge |
| KN | - Knife edge |
| 34S | - 3/8" Wood band edge |
| VN | - Wood edge veneer |
- C** Select trim/extrusion color.
Refer to color addendum at ki.com or KI Fabrics & Finishes binder.
- D** Select surface finish.
Refer to color addendum at ki.com or KI Fabrics & Finishes binder.
Surface finish offerings are based on edge style selections. With 74P edge (74P), knife edge (KN), and wood band edge (34S), select from laminates. With wood edge veneer (VN), select from veneers.
- E** Select edge color.
Refer to color addendum at ki.com or KI

Fabrics & Finishes binder.
Edge color offerings are based on edge style selections. With 74P edge (74P) and knife edge (KN), select from 74P/knife colors. With wood edge veneer (VN), no edge color selection required. With wood band edge (34S), select wood edge colors.

- F** Select desk color.
Refer to color addendum at ki.com or KI Fabrics & Finishes binder.

FINISH INFORMATION

Additional Laminate Offering

Additional laminates beyond KI standard offering, are available with two weeks extended leadtime. To specify additional laminates, use these designators followed by the supplier's color/pattern code:

Formica - LF/supplier's color pattern code
Nevamar - LN/supplier's color pattern code
Wilsonart - LW/supplier's color pattern code

KI's standard finish is the supplier's recommended finish for that color/pattern.

Note: Nonstandard laminates from these suppliers (example: textured laminates), require an upcharge and additional leadtime. Contact KI.



True[®] Desking System

Transaction Worksurfaces

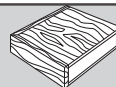
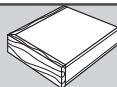
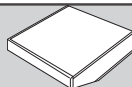
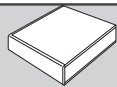

74P Edge
(74P)

Knife Edge
(KN)

3/8" Wood
Band Edge
(34S)

Wood Edge Veneer
(VN)

\$ 803	\$ 884	\$ 1030	\$ 1109
847	930	1083	1171
879	967	1124	1212
904	995	1159	1250
949	1042	1212	1310
879	967	1124	1212
904	995	1159	1250
949	1042	1212	1310

\$ 839	\$ 879	\$ 1211	\$ 1445
867	905	1299	1638
918	955	1408	1879
955	992	1506	2002
971	1010	1506	2114
918	955	1408	1879
955	992	1506	2002
971	1010	1506	2114

SPECIAL SERVICES

Special Carton Marking

With specially marked information N/C

Shipping

Delivered. Shipped k.d. freight prepaid f.o.b. **Pembroke, Ontario K8A 0E1** factory. Freight class #70.

Specifications and prices are subject to change without prior notice.

True[®] Desking System Components

Privacy Screens - Exposed Frame

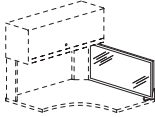
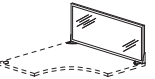
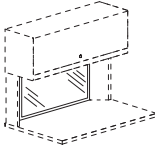
	MODEL	Features	W	MODEL NUMBER				Approx. Packaged Weight
				Basic Model	Dir.	Paint Color	Insert Finish	
 <p>TRSC</p>	Single Desk Privacy Screen, stanchion/end mount <ul style="list-style-type: none"> Exposed frame (core is translucent, frame painted) Available in 18" height only Attached to the desk with one stanchion support and one single grommet mounted bracket Includes screen and all required mounting hardware except stanchion 	Desk Width 24"	18"	TWSE24/E	<input type="checkbox"/>	<input type="checkbox"/> <input type="checkbox"/> <input type="checkbox"/>	<input type="checkbox"/> <input type="checkbox"/> <input type="checkbox"/>	7.0#
		Desk Width 30"	24"	TWSE30/E	<input type="checkbox"/>	<input type="checkbox"/> <input type="checkbox"/> <input type="checkbox"/>	<input type="checkbox"/> <input type="checkbox"/> <input type="checkbox"/>	8.0#
		Desk Width 36"	30"	TWSE36/E	<input type="checkbox"/>	<input type="checkbox"/> <input type="checkbox"/> <input type="checkbox"/>	<input type="checkbox"/> <input type="checkbox"/> <input type="checkbox"/>	9.0#
		Desk Width 42"	36"	TWSE42/E	<input type="checkbox"/>	<input type="checkbox"/> <input type="checkbox"/> <input type="checkbox"/>	<input type="checkbox"/> <input type="checkbox"/> <input type="checkbox"/>	11.0#
		Desk Width 48"	42"	TWSE48/E	<input type="checkbox"/>	<input type="checkbox"/> <input type="checkbox"/> <input type="checkbox"/>	<input type="checkbox"/> <input type="checkbox"/> <input type="checkbox"/>	12.0#
		Desk Width 54"	48"	TWSE54/E	<input type="checkbox"/>	<input type="checkbox"/> <input type="checkbox"/> <input type="checkbox"/>	<input type="checkbox"/> <input type="checkbox"/> <input type="checkbox"/>	13.0#
		Desk Width 60"	54"	TWSE60/E	<input type="checkbox"/>	<input type="checkbox"/> <input type="checkbox"/> <input type="checkbox"/>	<input type="checkbox"/> <input type="checkbox"/> <input type="checkbox"/>	14.0#
		Desk Width 66"	60"	TWSE66/E	<input type="checkbox"/>	<input type="checkbox"/> <input type="checkbox"/> <input type="checkbox"/>	<input type="checkbox"/> <input type="checkbox"/> <input type="checkbox"/>	16.0#
		Desk Width 72"	66"	TWSE72/E	<input type="checkbox"/>	<input type="checkbox"/> <input type="checkbox"/> <input type="checkbox"/>	<input type="checkbox"/> <input type="checkbox"/> <input type="checkbox"/>	17.0#
		 <p>TRSC</p>	Single Desk Privacy Screen, end mount/end mount <ul style="list-style-type: none"> Exposed frame (core is translucent, frame painted) Available in 18" height only Attached to the desk with two single grommet mounted brackets Includes screen and all required mounting hardware 	Desk Width 24"	24"	TWEE24/E	<input type="checkbox"/>	<input type="checkbox"/> <input type="checkbox"/> <input type="checkbox"/>
Desk Width 30"	30"			TWEE30/E	<input type="checkbox"/>	<input type="checkbox"/> <input type="checkbox"/> <input type="checkbox"/>	<input type="checkbox"/> <input type="checkbox"/> <input type="checkbox"/>	9.0#
Desk Width 36"	36"			TWEE36/E	<input type="checkbox"/>	<input type="checkbox"/> <input type="checkbox"/> <input type="checkbox"/>	<input type="checkbox"/> <input type="checkbox"/> <input type="checkbox"/>	10.0#
Desk Width 42"	42"			TWEE42/E	<input type="checkbox"/>	<input type="checkbox"/> <input type="checkbox"/> <input type="checkbox"/>	<input type="checkbox"/> <input type="checkbox"/> <input type="checkbox"/>	11.0#
Desk Width 48"	48"			TWEE48/E	<input type="checkbox"/>	<input type="checkbox"/> <input type="checkbox"/> <input type="checkbox"/>	<input type="checkbox"/> <input type="checkbox"/> <input type="checkbox"/>	13.0#
Desk Width 54"	54"			TWEE54/E	<input type="checkbox"/>	<input type="checkbox"/> <input type="checkbox"/> <input type="checkbox"/>	<input type="checkbox"/> <input type="checkbox"/> <input type="checkbox"/>	14.0#
Desk Width 60"	60"			TWEE60/E	<input type="checkbox"/>	<input type="checkbox"/> <input type="checkbox"/> <input type="checkbox"/>	<input type="checkbox"/> <input type="checkbox"/> <input type="checkbox"/>	15.0#
Desk Width 66"	66"			TWEE66/E	<input type="checkbox"/>	<input type="checkbox"/> <input type="checkbox"/> <input type="checkbox"/>	<input type="checkbox"/> <input type="checkbox"/> <input type="checkbox"/>	17.0#
Desk Width 72"	72"			TWEE72/E	<input type="checkbox"/>	<input type="checkbox"/> <input type="checkbox"/> <input type="checkbox"/>	<input type="checkbox"/> <input type="checkbox"/> <input type="checkbox"/>	18.0#
 <p>TRSC</p>	Single Desk Privacy Screen, between stanchions <ul style="list-style-type: none"> Exposed frame (core is translucent, frame painted) Available in 18" height only Attached between two stanchion supports Includes screen and all required mounting hardware except stanchion CANNOT be used simultaneously with Tool Rail (TATR) 			Desk Width 24"	12"	TBS24/E	<input type="checkbox"/>	<input type="checkbox"/> <input type="checkbox"/> <input type="checkbox"/>
		Desk Width 30"	18"	TBS30/E	<input type="checkbox"/>	<input type="checkbox"/> <input type="checkbox"/> <input type="checkbox"/>	<input type="checkbox"/> <input type="checkbox"/> <input type="checkbox"/>	6.0#
		Desk Width 36"	24"	TBS36/E	<input type="checkbox"/>	<input type="checkbox"/> <input type="checkbox"/> <input type="checkbox"/>	<input type="checkbox"/> <input type="checkbox"/> <input type="checkbox"/>	7.0#
		Desk Width 42"	30"	TBS42/E	<input type="checkbox"/>	<input type="checkbox"/> <input type="checkbox"/> <input type="checkbox"/>	<input type="checkbox"/> <input type="checkbox"/> <input type="checkbox"/>	9.0#
		Desk Width 48"	36"	TBS48/E	<input type="checkbox"/>	<input type="checkbox"/> <input type="checkbox"/> <input type="checkbox"/>	<input type="checkbox"/> <input type="checkbox"/> <input type="checkbox"/>	10.0#
		Desk Width 54"	42"	TBS54/E	<input type="checkbox"/>	<input type="checkbox"/> <input type="checkbox"/> <input type="checkbox"/>	<input type="checkbox"/> <input type="checkbox"/> <input type="checkbox"/>	11.0#
		Desk Width 60"	48"	TBS60/E	<input type="checkbox"/>	<input type="checkbox"/> <input type="checkbox"/> <input type="checkbox"/>	<input type="checkbox"/> <input type="checkbox"/> <input type="checkbox"/>	13.0#
		Desk Width 66"	54"	TBS66/E	<input type="checkbox"/>	<input type="checkbox"/> <input type="checkbox"/> <input type="checkbox"/>	<input type="checkbox"/> <input type="checkbox"/> <input type="checkbox"/>	14.0#
		Desk Width 72"	60"	TBS72/E	<input type="checkbox"/>	<input type="checkbox"/> <input type="checkbox"/> <input type="checkbox"/>	<input type="checkbox"/> <input type="checkbox"/> <input type="checkbox"/>	15.0#

A **B** **C** **D**

HOW TO ORDER

Indicate the following information on order form:

- Quantity of each item.
- Model number, including options. See "How To Build a Model Number".
- Any special service required.

Note: • The indicates that a choice is required.

- The absence of the indicates that no choice is required.
- Alpha-numeric characters in place of indicate that no other alternatives are available.

HOW TO BUILD A MODEL NUMBER

A Select basic model.

B Select direction.

L - Left
R - Right

C Select paint color.

Refer to color addendum at ki.com or KI Fabrics & Finishes binder.

D Select insert finish.

Refer to color addendum at ki.com or KI Fabrics & Finishes binder.



True[®] Desking System Components

Privacy Screens - Exposed Frame

Delivered Pricing
\$ 214
238
295
350
401
454
490
542
595
\$ 221
248
303
358
408
461
496
547
605
\$ 209
232
285
343
390
448
484
537
588

SPECIAL SERVICES

Special Carton Marking

With specially marked information N/C



Shipping

Delivered. Shipped k.d. freight prepaid f.o.b. **Pembroke, Ontario K8A 0E1** factory. Freight class #70.

Specifications and prices are subject to change without prior notice.

True® Desking System Components

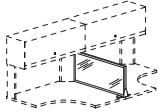
Privacy Screens - Exposed Frame

	MODEL	Features	W	MODEL NUMBER			Approx. Packaged Weight
				Basic Model	Paint Color	Insert Finish	
 <p>TRSC</p>	Shared Privacy Screen, stanchion/end mount <ul style="list-style-type: none"> Exposed frame (core is translucent, frame painted) Available in 18" height only Attached to the desk with one stanchion support and one double grommet mounted bracket Includes screen and all required mounting hardware except stanchion 	Desk Width 24"	18"	TSE24/E	<input type="checkbox"/>	<input type="checkbox"/>	6.0#
		Desk Width 30"	24"	TSE30/E	<input type="checkbox"/>	<input type="checkbox"/>	7.0#
		Desk Width 36"	30"	TSE36/E	<input type="checkbox"/>	<input type="checkbox"/>	8.0#
		Desk Width 42"	36"	TSE42/E	<input type="checkbox"/>	<input type="checkbox"/>	10.0#
		Desk Width 48"	42"	TSE48/E	<input type="checkbox"/>	<input type="checkbox"/>	11.0#
		Desk Width 54"	48"	TSE54/E	<input type="checkbox"/>	<input type="checkbox"/>	13.0#
		Desk Width 60"	54"	TSE60/E	<input type="checkbox"/>	<input type="checkbox"/>	14.0#
		Desk Width 66"	60"	TSE66/E	<input type="checkbox"/>	<input type="checkbox"/>	15.0#
		Desk Width 72"	66"	TSE72/E	<input type="checkbox"/>	<input type="checkbox"/>	17.0#
		 <p>TRSC</p>	Shared Privacy Screen, end mount/end mount <ul style="list-style-type: none"> Exposed frame (core is translucent, frame painted) Available in 18" height only Mounts to the desk with two double grommet mounted brackets Includes screen and all required mounting hardware 	Desk Width 24"	24"	TEE24/E	<input type="checkbox"/>
Desk Width 30"	30"			TEE30/E	<input type="checkbox"/>	<input type="checkbox"/>	9.0#
Desk Width 36"	36"			TEE36/E	<input type="checkbox"/>	<input type="checkbox"/>	10.0#
Desk Width 42"	42"			TEE42/E	<input type="checkbox"/>	<input type="checkbox"/>	11.0#
Desk Width 48"	48"			TEE48/E	<input type="checkbox"/>	<input type="checkbox"/>	13.0#
Desk Width 54"	54"			TEE54/E	<input type="checkbox"/>	<input type="checkbox"/>	14.0#
Desk Width 60"	60"			TEE60/E	<input type="checkbox"/>	<input type="checkbox"/>	15.0#
Desk Width 66"	66"			TEE66/E	<input type="checkbox"/>	<input type="checkbox"/>	17.0#
Desk Width 72"	72"			TEE72/E	<input type="checkbox"/>	<input type="checkbox"/>	18.0#

A **B** **C**

HOW TO ORDER

Indicate the following information on order form:

- Quantity of each item.
- Model number, including options. See "How To Build a Model Number".
- Any special service required.

Note: • The indicates that a choice is required.

- The absence of the indicates that no choice is required.
- Alpha-numeric characters in place of indicate that no other alternatives are available.

HOW TO BUILD A MODEL NUMBER

- A** Select basic model.
- B** Select paint color.
Refer to color addendum at ki.com or KI Fabrics & Finishes binder.
- C** Select insert finish.
Refer to color addendum at ki.com or KI Fabrics & Finishes binder.



True[®] Desking System Components

Privacy Screens - Exposed Frame

Delivered Pricing
\$ 214
238
295
350
401
454
490
542
595
\$ 221
248
303
358
408
461
496
547
605

SPECIAL SERVICES

Special Carton Marking

With specially marked information N/C

Shipping

Delivered. Shipped k.d. freight prepaid f.o.b. **Pembroke, Ontario K8A 0E1** factory. Freight class #70.

Specifications and prices are subject to change without prior notice.

True® Desking System Components

Privacy Screens - Upholstered

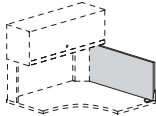
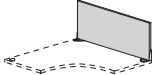
	MODEL	Features	W	MODEL NUMBER				Approx. Packaged Weight		
				Basic Model	Dir.	Paint Color	Fabric Color			
 <p>TRSC</p>	Single Desk Privacy Screen, stanchion/end mount <ul style="list-style-type: none"> Upholstered (upholstered frame) fully tackable Available in 18" height only Attached to the desk with one stanchion support and one single grommet mounted bracket 72" consists of two screens ganged together Includes screen and all required mounting hardware except stanchion 	Desk Width 24"	18"	TWSE24/U	<input type="checkbox"/>	<input type="checkbox"/>	<input type="checkbox"/>	<input type="checkbox"/>	7.0#	
		Desk Width 30"	24"	TWSE30/U	<input type="checkbox"/>	<input type="checkbox"/>	<input type="checkbox"/>	<input type="checkbox"/>	8.0#	
		Desk Width 36"	30"	TWSE36/U	<input type="checkbox"/>	<input type="checkbox"/>	<input type="checkbox"/>	<input type="checkbox"/>	9.0#	
		Desk Width 42"	36"	TWSE42/U	<input type="checkbox"/>	<input type="checkbox"/>	<input type="checkbox"/>	<input type="checkbox"/>	11.0#	
		Desk Width 48"	42"	TWSE48/U	<input type="checkbox"/>	<input type="checkbox"/>	<input type="checkbox"/>	<input type="checkbox"/>	12.0#	
		Desk Width 54"	48"	TWSE54/U	<input type="checkbox"/>	<input type="checkbox"/>	<input type="checkbox"/>	<input type="checkbox"/>	13.0#	
		Desk Width 60"	54"	TWSE60/U	<input type="checkbox"/>	<input type="checkbox"/>	<input type="checkbox"/>	<input type="checkbox"/>	15.0#	
		Desk Width 66"	60"	TWSE66/U	<input type="checkbox"/>	<input type="checkbox"/>	<input type="checkbox"/>	<input type="checkbox"/>	16.0#	
		Desk Width 72"	66"	TWSE72/U	<input type="checkbox"/>	<input type="checkbox"/>	<input type="checkbox"/>	<input type="checkbox"/>	18.0#	
 <p>TRSC</p>	Single Desk Privacy Screen, end mount/end mount <ul style="list-style-type: none"> Upholstered (upholstered frame) fully tackable Available in 18" height only Attached to the desk with two single grommet mounted brackets 66" and 72" size consists of two screens ganged together Includes screen and all required mounting hardware 	Desk Width 24"	24"	TWEE24/U		<input type="checkbox"/>	<input type="checkbox"/>	<input type="checkbox"/>	<input type="checkbox"/>	7.0#
		Desk Width 30"	30"	TWEE30/U		<input type="checkbox"/>	<input type="checkbox"/>	<input type="checkbox"/>	<input type="checkbox"/>	9.0#
		Desk Width 36"	36"	TWEE36/U		<input type="checkbox"/>	<input type="checkbox"/>	<input type="checkbox"/>	<input type="checkbox"/>	10.0#
		Desk Width 42"	42"	TWEE42/U		<input type="checkbox"/>	<input type="checkbox"/>	<input type="checkbox"/>	<input type="checkbox"/>	11.0#
		Desk Width 48"	48"	TWEE48/U		<input type="checkbox"/>	<input type="checkbox"/>	<input type="checkbox"/>	<input type="checkbox"/>	13.0#
		Desk Width 54"	54"	TWEE54/U		<input type="checkbox"/>	<input type="checkbox"/>	<input type="checkbox"/>	<input type="checkbox"/>	14.0#
		Desk Width 60"	60"	TWEE60/U		<input type="checkbox"/>	<input type="checkbox"/>	<input type="checkbox"/>	<input type="checkbox"/>	16.0#
		Desk Width 66"	66"	TWEE66/U		<input type="checkbox"/>	<input type="checkbox"/>	<input type="checkbox"/>	<input type="checkbox"/>	18.0#
		Desk Width 72"	72"	TWEE72/U		<input type="checkbox"/>	<input type="checkbox"/>	<input type="checkbox"/>	<input type="checkbox"/>	19.0#

A **B** **C** **D**

HOW TO ORDER

Indicate the following information on order form:

- Quantity of each item.
- Model number, including options. See "How To Build a Model Number".
- Any special service required.

Note: • The indicates that a choice is required.

- The absence of the indicates that no choice is required.
- Alpha-numeric characters in place of indicate that no other alternatives are available.

HOW TO BUILD A MODEL NUMBER

A Select basic model.

B Select direction.

L - Left
R - Right

C Select paint color.

Refer to color addendum at ki.com or KI Fabrics & Finishes binder.

D Select fabric color.

Refer to color addendum at ki.com or in KI Fabrics & Finishes binder.



True® Desking System Components

Privacy Screens - Upholstered

Delivered Pricing Fabric Grade 1 & C.O.M.	Delivered Pricing Fabric Grade 2	Delivered Pricing Fabric Grade 3 & Pallas Vertical Fabric Grade PV	Delivered Pricing Pallas Vertical Fabric Grade PV1	Delivered Pricing Pallas Vertical Fabric Grade PV2
\$ 208	\$ 214	\$ 222	\$ 235	\$ 247
231	238	251	266	277
282	294	307	324	339
339	350	365	388	403
386	401	415	439	458
436	454	472	497	521
472	490	510	541	563
522	542	564	597	623
575	595	621	656	683
<hr/>				
\$ 213	\$ 220	\$ 231	\$ 241	\$ 254
236	247	256	272	282
289	302	314	333	345
344	358	370	394	410
392	408	425	450	469
445	461	481	510	527
481	497	521	549	575
528	549	575	607	631
581	605	629	665	694

SPECIAL SERVICES

Special Carton Marking

With specially marked information N/C

Shipping

Delivered. Shipped k.d. freight prepaid
f.o.b. **Pembroke, Ontario K8A 0E1** factory.
Freight class #70.

Specifications and prices are subject to
change without prior notice.

True[®] Desking System Components

Privacy Screens - Upholstered

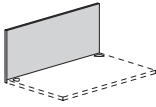
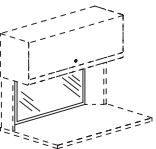
	MODEL	Features	W	MODEL NUMBER			Approx. Packaged Weight
				Basic Model	Paint Color	Fabric Color	
 <p>TRSC</p> <p>Single Desk Privacy Screen, mounted behind worksurface</p> <ul style="list-style-type: none"> Upholstered (upholstered frame) fully tackable Available in two heights: 20" matches the height of the stanchion mounted screen; 38" matches the height of an overhead storage unit Mounts behind the back edge of the worksurface on brackets that attach to the underside of the worksurface Adds 1" to overall depth of work station 66" and 72" size consists of two screens ganged together Includes screen and all required mounting hardware 	Single Desk Privacy Screen, mounted behind worksurface	Desk Width 24"	20"	TBW2024	<input type="checkbox"/>	<input type="checkbox"/>	9.0#
	Desk Width 30"	20"	TBW2030	<input type="checkbox"/>	<input type="checkbox"/>	11.0#	
	Desk Width 36"	20"	TBW2036	<input type="checkbox"/>	<input type="checkbox"/>	12.0#	
	Desk Width 42"	20"	TBW2042	<input type="checkbox"/>	<input type="checkbox"/>	14.0#	
	Desk Width 48"	20"	TBW2048	<input type="checkbox"/>	<input type="checkbox"/>	15.0#	
	Desk Width 54"	20"	TBW2054	<input type="checkbox"/>	<input type="checkbox"/>	18.0#	
	Desk Width 60"	20"	TBW2060	<input type="checkbox"/>	<input type="checkbox"/>	20.0#	
	Desk Width 66"	20"	TBW2066	<input type="checkbox"/>	<input type="checkbox"/>	22.0#	
	Desk Width 72"	20"	TBW2072	<input type="checkbox"/>	<input type="checkbox"/>	24.0#	
	Desk Width 24"	38"	TBW3824	<input type="checkbox"/>	<input type="checkbox"/>	17.0#	
	Desk Width 30"	38"	TBW3830	<input type="checkbox"/>	<input type="checkbox"/>	20.0#	
	Desk Width 36"	38"	TBW3836	<input type="checkbox"/>	<input type="checkbox"/>	23.0#	
	Desk Width 42"	38"	TBW3842	<input type="checkbox"/>	<input type="checkbox"/>	25.0#	
	Desk Width 48"	38"	TBW3848	<input type="checkbox"/>	<input type="checkbox"/>	28.0#	
	Desk Width 54"	38"	TBW3854	<input type="checkbox"/>	<input type="checkbox"/>	34.0#	
	Desk Width 60"	38"	TBW3860	<input type="checkbox"/>	<input type="checkbox"/>	36.0#	
Desk Width 66"	38"	TBW3866	<input type="checkbox"/>	<input type="checkbox"/>	42.0#		
Desk Width 72"	38"	TBW3872	<input type="checkbox"/>	<input type="checkbox"/>	45.0#		
 <p>TRSC</p> <p>Single Desk Privacy Screen, between stanchions</p> <ul style="list-style-type: none"> Upholstered (upholstered frame) fully tackable Available in 18" height only Attached between two stanchion supports Includes screen and all required mounting hardware except stanchion CANNOT be used simultaneously with Tool Rail (TATR) 	Single Desk Privacy Screen, between stanchions	Desk Width 24"	12"	TBS24/U	<input type="checkbox"/>	<input type="checkbox"/>	5.0#
	Desk Width 30"	18"	TBS30/U	<input type="checkbox"/>	<input type="checkbox"/>	6.0#	
	Desk Width 36"	24"	TBS36/U	<input type="checkbox"/>	<input type="checkbox"/>	8.0#	
	Desk Width 42"	30"	TBS42/U	<input type="checkbox"/>	<input type="checkbox"/>	9.0#	
	Desk Width 48"	36"	TBS48/U	<input type="checkbox"/>	<input type="checkbox"/>	11.0#	
	Desk Width 54"	42"	TBS54/U	<input type="checkbox"/>	<input type="checkbox"/>	12.0#	
	Desk Width 60"	48"	TBS60/U	<input type="checkbox"/>	<input type="checkbox"/>	13.0#	
	Desk Width 66"	54"	TBS66/U	<input type="checkbox"/>	<input type="checkbox"/>	15.0#	
	Desk Width 72"	60"	TBS72/U	<input type="checkbox"/>	<input type="checkbox"/>	16.0#	
					A	B	C

HOW TO ORDER

Indicate the following information on order form:

- Quantity of each item.
- Model number, including options. See "How To Build a Model Number".
- Any special service required.

Note: • The indicates that a choice is required.

- The absence of the indicates that no choice is required.
- Alpha-numeric characters in place of indicate that no other alternatives are available.

HOW TO BUILD A MODEL NUMBER

- A** Select basic model.
- B** Select paint color.
Refer to color addendum at ki.com or KI Fabrics & Finishes binder.
- C** Select fabric color.
Refer to color addendum at ki.com or in KI Fabrics & Finishes binder.



True® Desking System Components

Privacy Screens - Upholstered

Delivered Pricing Fabric Grade 1 & C.O.M.	Delivered Pricing Fabric Grade 2	Delivered Pricing Fabric Grade 3 & Pallas Vertical Fabric Grade PV	Delivered Pricing Pallas Vertical Fabric Grade PV1	Delivered Pricing Pallas Vertical Fabric Grade PV2
\$ 213	\$ 220	\$ 231	\$ 241	\$ 254
236	247	256	272	282
289	302	314	333	345
344	358	370	394	410
392	408	425	450	469
445	461	481	510	527
481	497	521	549	575
528	549	575	607	631
581	605	629	665	694
374	392	406	431	449
416	434	451	479	495
512	533	553	587	611
606	630	655	695	721
691	716	747	791	821
781	812	844	893	929
844	878	914	968	1006
929	967	1006	1065	1106
1021	1064	1104	1171	1217
\$ 198	\$ 209	\$ 215	\$ 228	\$ 236
222	232	239	255	267
277	285	300	316	329
329	343	357	376	393
373	390	404	430	446
431	448	464	492	516
464	484	502	533	553
517	537	557	589	613
569	588	612	650	673

SPECIAL SERVICES

Special Carton Marking

With specially marked information N/C

Shipping

Delivered. Shipped k.d. freight prepaid f.o.b. **Pembroke, Ontario K8A 0E1** factory. Freight class #70.

Specifications and prices are subject to change without prior notice.

True[®] Desking System Components

Privacy Screens - Upholstered

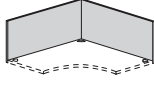
MODEL	H x W-LEFT x W-RIGHT	MODEL NUMBER			Approx. Packaged Weight
		Basic Model	Paint Color	Fabric Color	
 <p>TRSC</p> <p>Single Desk Corner Privacy Screen, mounted behind worksurface</p> <ul style="list-style-type: none"> Upholstered (upholstered frame) fully tackable Available in two heights: 20" matches the height of the stanchion mounted screen; 38" matches the height of an overhead storage unit Mounts behind the back edge of the worksurface on brackets that attach to the underside of the worksurface Adds 1" to overall depth of workstation 66" and 72" size consists of two screens ganged together Includes screen and all required mounting hardware 	20 x 42 x 42"	BWSC204242	<input type="checkbox"/>	<input type="checkbox"/>	28.0#
	20 x 48 x 48"	BWSC204848	<input type="checkbox"/>	<input type="checkbox"/>	30.0#
	20 x 48 x 60"	BWSC204860	<input type="checkbox"/>	<input type="checkbox"/>	35.0#
	20 x 48 x 66"	BWSC204866	<input type="checkbox"/>	<input type="checkbox"/>	37.0#
	20 x 48 x 72"	BWSC204872	<input type="checkbox"/>	<input type="checkbox"/>	39.0#
	20 x 60 x 48"	BWSC206048	<input type="checkbox"/>	<input type="checkbox"/>	35.0#
	20 x 66 x 48"	BWSC206648	<input type="checkbox"/>	<input type="checkbox"/>	37.0#
	20 x 72 x 48"	BWSC207248	<input type="checkbox"/>	<input type="checkbox"/>	39.0#
	38 x 42 x 42"	BWSC384242	<input type="checkbox"/>	<input type="checkbox"/>	50.0#
	38 x 48 x 48"	BWSC384848	<input type="checkbox"/>	<input type="checkbox"/>	56.0#
	38 x 48 x 60"	BWSC384860	<input type="checkbox"/>	<input type="checkbox"/>	64.0#
	38 x 48 x 66"	BWSC384866	<input type="checkbox"/>	<input type="checkbox"/>	70.0#
	38 x 48 x 72"	BWSC384872	<input type="checkbox"/>	<input type="checkbox"/>	73.0#
	38 x 60 x 48"	BWSC386048	<input type="checkbox"/>	<input type="checkbox"/>	64.0#
	38 x 66 x 48"	BWSC386648	<input type="checkbox"/>	<input type="checkbox"/>	70.0#
	38 x 72 x 48"	BWSC387248	<input type="checkbox"/>	<input type="checkbox"/>	73.0#

A

B

C

HOW TO ORDER

Indicate the following information on order form:

- Quantity of each item.
- Model number, including options. See "How To Build a Model Number".
- Any special service required.

Note: • The indicates that a choice is required.

- The absence of the indicates that no choice is required.
- Alpha-numeric characters in place of indicate that no other alternatives are available.

HOW TO BUILD A MODEL NUMBER

- A** Select basic model.
- B** Select paint color.
Refer to color addendum at ki.com or KI Fabrics & Finishes binder.
- C** Select fabric color.
Refer to color addendum at ki.com or in KI Fabrics & Finishes binder.



True® Desking System Components

Privacy Screens - Upholstered

Delivered Pricing Fabric Grade 1 & C.O.M.	Delivered Pricing Fabric Grade 2	Delivered Pricing Fabric Grade 3 & Pallas Vertical Fabric Grade PV	Delivered Pricing Pallas Vertical Fabric Grade PV1	Delivered Pricing Pallas Vertical Fabric Grade PV2
\$ 688	\$ 715	\$ 745	\$ 790	\$ 819
785	815	849	899	935
871	905	943	999	1039
922	956	996	1058	1099
974	1011	1052	1117	1160
871	905	943	999	1039
922	956	996	1058	1099
974	1011	1052	1117	1160
1209	1257	1306	1386	1444
1378	1435	1491	1583	1643
1532	1593	1657	1757	1826
1620	1685	1749	1857	1929
1711	1780	1851	1961	2041
1532	1593	1657	1757	1826
1620	1685	1749	1857	1929
1711	1780	1851	1961	2041

SPECIAL SERVICES

Special Carton Marking

With specially marked information N/C

Shipping

Delivered. Shipped k.d. freight prepaid
f.o.b. **Pembroke, Ontario K8A 0E1** factory.
Freight class #70.

Specifications and prices are subject to
change without prior notice.

True® Desking System Components

Privacy Screens - Upholstered

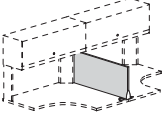
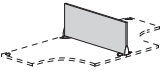
	MODEL	Features	W	MODEL NUMBER			Approx. Packaged Weight
				Basic Model	Paint Color	Fabric Color	
 <p>TRSC</p>	Shared Privacy Screen, stanchion/end mount <ul style="list-style-type: none"> Upholstered (upholstered frame) fully tackable Available in 18" height only Attached to the desk with one stanchion support and one double grommet mounted bracket 72" size consists of two screens ganged together Includes screen and all required mounting hardware except stanchion 	Desk Width 24"	18"	TSE24/U	<input type="checkbox"/>	<input type="checkbox"/>	6.0#
		Desk Width 30"	24"	TSE30/U	<input type="checkbox"/>	<input type="checkbox"/>	7.0#
		Desk Width 36"	30"	TSE36/U	<input type="checkbox"/>	<input type="checkbox"/>	9.0#
		Desk Width 42"	36"	TSE42/U	<input type="checkbox"/>	<input type="checkbox"/>	10.0#
		Desk Width 48"	42"	TSE48/U	<input type="checkbox"/>	<input type="checkbox"/>	11.0#
		Desk Width 54"	48"	TSE54/U	<input type="checkbox"/>	<input type="checkbox"/>	13.0#
		Desk Width 60"	54"	TSE60/U	<input type="checkbox"/>	<input type="checkbox"/>	14.0#
		Desk Width 66"	60"	TSE66/U	<input type="checkbox"/>	<input type="checkbox"/>	16.0#
		Desk Width 72"	66"	TSE72/U	<input type="checkbox"/>	<input type="checkbox"/>	18.0#
 <p>TRSC</p>	Shared Privacy Screen, end mount/end mount <ul style="list-style-type: none"> Upholstered (upholstered frame) fully tackable Available in 18" height only Mounts to the desk with two double grommet mounted brackets 66" and 72" size consists of two screens ganged together Includes screen and all required mounting hardware 	Desk Width 24"	24"	TEE24/U	<input type="checkbox"/>	<input type="checkbox"/>	7.0#
		Desk Width 30"	30"	TEE30/U	<input type="checkbox"/>	<input type="checkbox"/>	8.0#
		Desk Width 36"	36"	TEE36/U	<input type="checkbox"/>	<input type="checkbox"/>	10.0#
		Desk Width 42"	42"	TEE42/U	<input type="checkbox"/>	<input type="checkbox"/>	11.0#
		Desk Width 48"	48"	TEE48/U	<input type="checkbox"/>	<input type="checkbox"/>	13.0#
		Desk Width 54"	54"	TEE54/U	<input type="checkbox"/>	<input type="checkbox"/>	14.0#
		Desk Width 60"	60"	TEE60/U	<input type="checkbox"/>	<input type="checkbox"/>	15.0#
		Desk Width 66"	66"	TEE66/U	<input type="checkbox"/>	<input type="checkbox"/>	17.0#
		Desk Width 72"	72"	TEE72/U	<input type="checkbox"/>	<input type="checkbox"/>	19.0#

A

B

C

HOW TO ORDER

Indicate the following information on order form:

- Quantity of each item.
- Model number, including options. See "How To Build a Model Number".
- Any special service required.

Note: • The indicates that a choice is required.

- The absence of the indicates that no choice is required.
- Alpha-numeric characters in place of indicate that no other alternatives are available.

HOW TO BUILD A MODEL NUMBER

- A** Select basic model.
- B** Select frame paint color.
Refer to color addendum at ki.com or KI Fabrics & Finishes binder.
- C** Select fabric color.
Refer to color addendum at ki.com or in KI Fabrics & Finishes binder.



True[®] Desking System Components

Privacy Screens - Upholstered

Delivered Pricing Fabric Grade 1 & C.O.M.	Delivered Pricing Fabric Grade 2	Delivered Pricing Fabric Grade 3 & Pallas Vertical Fabric Grade PV	Delivered Pricing Pallas Vertical Fabric Grade PV1	Delivered Pricing Pallas Vertical Fabric Grade PV2
\$ 208	\$ 214	\$ 222	\$ 235	\$ 247
231	238	251	266	277
282	295	307	324	339
339	350	365	388	403
386	401	415	439	458
436	454	472	497	521
472	490	510	541	563
522	542	564	597	623
575	595	621	656	683
\$ 213	\$ 220	\$ 231	\$ 241	\$ 254
236	247	256	272	282
289	302	314	333	345
344	358	370	394	410
392	408	425	450	469
445	461	481	510	527
481	497	521	549	575
528	549	575	607	631
581	605	629	665	694

SPECIAL SERVICES

Special Carton Marking

With specially marked information N/C

Shipping

Delivered. Shipped k.d. freight prepaid
f.o.b. Pembroke, Ontario K8A 0E1 factory.
Freight class #70.

Specifications and prices are subject to
change without prior notice.

True® Desking System Components

Tool Rails

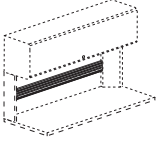
	MODEL	Features	W	MODEL NUMBER		Approx. Packaged Weight
				Basic Model	Paint Color	
 <p>TRAC</p> <p>Tool Rail, stanchion/stanchion mounted</p> <ul style="list-style-type: none"> • Accommodates paper management components • Mounts between stanchions • Field installable • Painted aluminum construction • Consists of four slots to accept components • Actual length is 12" shorter than work-surface • Stanchions ordered with overhead or individually (TST19 and TST11) • CANNOT be used simultaneously with stanchion mounted Privacy Screen (TBS) 	Desk width 24"	12"	TATR24/SS	<input type="checkbox"/>	3.0#	
	Desk width 30"	18"	TATR30/SS	<input type="checkbox"/>	3.0#	
	Desk width 36"	24"	TATR36/SS	<input type="checkbox"/>	3.0#	
	Desk width 42"	30"	TATR42/SS	<input type="checkbox"/>	4.0#	
	Desk width 48"	36"	TATR48/SS	<input type="checkbox"/>	5.0#	
	Desk width 54"	42"	TATR54/SS	<input type="checkbox"/>	5.0#	
	Desk width 60"	48"	TATR60/SS	<input type="checkbox"/>	6.0#	
	Desk width 66"	54"	TATR66/SS	<input type="checkbox"/>	7.0#	
	Desk width 72"	60"	TATR72/SS	<input type="checkbox"/>	8.0#	

A

B

HOW TO ORDER

Indicate the following information on order form:

1. Quantity of each item.
2. Model number, including options. See "How To Build a Model Number".
3. Any special service required.

Note: • The indicates that a choice is required.

- The absence of the indicates that no choice is required.
- Alpha-numeric characters in place of indicate that no other alternatives are available.

HOW TO BUILD A MODEL NUMBER

A Select basic model.

B Select paint color.
Refer to color addendum at ki.com or KI Fabrics & Finishes binder.



True® Desking System Components

Tool Rails

Delivered
Pricing

\$ 121
125
131
137
145
166
183
193
204

SPECIAL SERVICES

Special Carton Marking

With specially marked information N/C

Shipping

Delivered. Shipped k.d. freight prepaid f.o.b. **Pembroke, Ontario K8A 0E1** factory. Freight class #70.

Specifications and prices are subject to change without prior notice.

True® Desking System Components

Paper Management

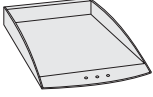
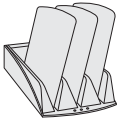
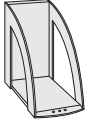
	MODEL	H x W x D	MODEL NUMBER		Approx. Packaged Weight
			Basic Model	Accessory Color	
 HRDPT	Paper Tray <ul style="list-style-type: none"> • Plastic construction • Stores letter or legal size documents • Suspends from tool rail • Suitable for free-standing worksurface or overhead location 	2 x 9-1/2 x 14"	PPLL	<input type="checkbox"/> <input type="checkbox"/>	1.0#
 HRDPT	Diagonal Storage <ul style="list-style-type: none"> • Plastic construction • Suspends only from tool rail • Suitable for free-standing worksurface or overhead location • Three slanted partitions per unit • Dividers in black only 	2-1/2 x 7 x 12-1/2"	PPDS	<input type="checkbox"/> <input type="checkbox"/>	4.0#
 HRDPT	Vertical Storage <ul style="list-style-type: none"> • Injection molded plastic construction • Suspends only from tool rail • Suitable for free-standing worksurface or overhead location • Stores binders, phone books or periodicals 	9 x 5 x 10-1/2"	PPVS	<input type="checkbox"/> <input type="checkbox"/>	1.0#

A

B

HOW TO ORDER

Indicate the following information on order form:

1. Quantity of each item.
2. Model number, including options. See "How To Build a Model Number".
3. Any special service required.

Note: • The indicates that a choice is required.

- The absence of the indicates that no choice is required.
- Alpha-numeric characters in place of indicate that no other alternatives are available.

HOW TO BUILD A MODEL NUMBER

- A** Select basic model.
- B** Select accessory color.
Refer to color addendum at ki.com or KI Fabrics & Finishes binder.



True[®] Desking System Components

Paper Management

Delivered
Pricing
\$ 38

\$ 38

\$ 36

SPECIAL SERVICES

Special Carton Marking

With specially marked information N/C



Shipping

Shipped k.d. freight prepaid f.o.b. Manitowoc, Wisconsin 54220 factory. Freight class #70.

Specifications and prices are subject to change without prior notice.

True[®] Desking System Components

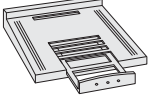
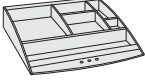
Paper Management

	MODEL	H x W x D	MODEL NUMBER		Approx. Packaged Weight
			Basic Model	Accessory Color	
 HRDPT	Telephone Caddy • Plastic construction • Holds telephone up to 8-1/2" wide and 9-1/2" deep • Suspends from tool rail	2 x 8 1/2 x 9 1/2"	PPTC	<input type="checkbox"/> <input type="checkbox"/>	0.8#
 HRDPT	Accessory Tray • Injection molded plastic • Stores stamps, tape dispenser, post-it pads and paper clips • Suspends from tool rail	2 x 9 1/2 x 10"	PPAT	<input type="checkbox"/> <input type="checkbox"/>	6.0#
 HRDPT	Pencil Cup • Injection molded plastic construction • Suspends from tool rail	4 x 4 x 3 1/2"	PPPC	<input type="checkbox"/> <input type="checkbox"/>	0.3#

A

B

HOW TO ORDER

Indicate the following information on order form:

1. Quantity of each item.
2. Model number, including options. See "How To Build a Model Number".
3. Any special service required.

Note: • The indicates that a choice is required.

- The absence of the indicates that no choice is required.
- Alpha-numeric characters in place of indicate that no other alternatives are available.

HOW TO BUILD A MODEL NUMBER

- A** Select basic model.
- B** Select accessory color.
Refer to color addendum at ki.com or KI Fabrics & Finishes binder.



True[®] Desking System Components

Paper Management

Delivered
Pricing

\$ 46

\$ 32

\$ 32

SPECIAL SERVICES

Special Carton Marking

With specially marked information N/C

Shipping

Shipped **k.d. freight prepaid f.o.b. Manitowoc, Wisconsin 54220** factory. Freight class #70.

Specifications and prices are subject to change without prior notice.

True® Desking System Components

Balance® Overhead Storage

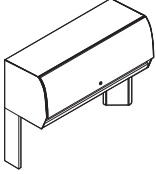
MODEL	W	MODEL NUMBER					Approx. Packaged Weight
		Basic Model	Cabinet Paint Color	Upper Door Solid Color	Stanchion Door Color	Lock Option	
 <p>BOH</p> <p>Solid Color Upper Door</p> <ul style="list-style-type: none"> Stanchions and mounting brackets included The KI Balance® Overhead allows users the option to interchange from a True® Desk mount solution to a KI office panel system Colored or translucent extruded door Painted cabinet and lower door Shelf dividers available separately Cabinet is fully assembled 	30"	BLCS30/TR	<input type="checkbox"/>	<input type="checkbox"/>	<input type="checkbox"/>	<input type="checkbox"/>	52.0#
	36"	BLCS36/TR	<input type="checkbox"/>	<input type="checkbox"/>	<input type="checkbox"/>	<input type="checkbox"/>	58.0#
	42"	BLCS42/TR	<input type="checkbox"/>	<input type="checkbox"/>	<input type="checkbox"/>	<input type="checkbox"/>	58.0#
	48"	BLCS48/TR	<input type="checkbox"/>	<input type="checkbox"/>	<input type="checkbox"/>	<input type="checkbox"/>	64.0#
	54"	BLCS54/TR	<input type="checkbox"/>	<input type="checkbox"/>	<input type="checkbox"/>	<input type="checkbox"/>	70.0#
	60"	BLCS60/TR	<input type="checkbox"/>	<input type="checkbox"/>	<input type="checkbox"/>	<input type="checkbox"/>	78.0#
	66"	BLCS66D/TR	<input type="checkbox"/>	<input type="checkbox"/>	<input type="checkbox"/>	<input type="checkbox"/>	92.0#
	72"	BLCS72D/TR	<input type="checkbox"/>	<input type="checkbox"/>	<input type="checkbox"/>	<input type="checkbox"/>	116.0#
			A	B	C	D	E

HOW TO ORDER

Indicate the following information on order form:

- Quantity of each item.
- Model number, including options. See "How To Build a Model Number".
- Any special service required.

Note: • The indicates that a choice is required.

- The absence of the indicates that no choice is required.
- Alpha-numeric characters in place of indicate that no other alternatives are available.

HOW TO BUILD A MODEL NUMBER

- A** Select basic model.
- B** Select cabinet paint color. Refer to color addendum at ki.com or KI Fabrics & Finishes binder.
- C** Select upper door solid color. Refer to color addendum at ki.com or KI Fabrics & Finishes binder.
- D** Select stanchion door color. Refer to color addendum at ki.com or KI Fabrics & Finishes binder.
- E** Select lock option.
 - KS** - Key standard
 - NLC** - No lock core
 - KA** - Key alike

BLCS, BLCL, BLSF

	30"	36"	42"	48"	54"	60"	66"	72"
Over-head Width	30"	36"	42"	48"	54"	60"	66"	72"
Door Over-hang in Open Position	3"	3"	3"	3"	3"	3"	3"	3"
No. of Doors	1	1	1	1	1	1	2	2
Inside Width of Over-head	27-3/4"	33-3/4"	39-3/4"	45-3/4"	51-3/4"	57-3/4"	63-3/4"	69-3/4"
Dimension Between Sets at Work-stations	18"	24"	30"	36"	42"	48"	54"	60"



True[®] Desking System Components

Balance[®] Overhead Storage

Delivered
Pricing

\$ 1234
1261
1289
1351
1435
1454
2287
2342

SPECIAL SERVICES

Special Carton Marking

With specially marked information N/C

Shipping

Shipped **assembled freight prepaid**
f.o.b. Manitowoc, Wisconsin 54220 factory.
Freight class #77.5

Specifications and prices are subject to
change without prior notice.

True® Desking System Components

Balance® Overhead Storage

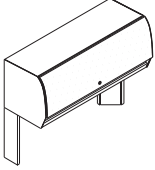
MODEL	W	MODEL NUMBER						Approx. Packaged Weight
		Basic Model	Cabinet Paint Color	Upper Door Laminate	Stanchion Door Color	Laminate Door Edge Color	Lock Option	
 <p>Laminate Upper Door</p> <ul style="list-style-type: none"> Stanchions and mounting brackets included The KI Balance® Overhead allows users the option to interchange from a True® Desk mount solution to a KI office panel system Laminate covered upper door Painted cabinet and lower door Shelf dividers available separately Cabinet is fully assembled 	30"	BLCL30/TR	<input type="checkbox"/>	<input type="checkbox"/>	<input type="checkbox"/>	<input type="checkbox"/>	<input type="checkbox"/>	52.0#
	36"	BLCL36/TR	<input type="checkbox"/>	<input type="checkbox"/>	<input type="checkbox"/>	<input type="checkbox"/>	<input type="checkbox"/>	52.0#
	42"	BLCL42/TR	<input type="checkbox"/>	<input type="checkbox"/>	<input type="checkbox"/>	<input type="checkbox"/>	<input type="checkbox"/>	58.0#
	48"	BLCL48/TR	<input type="checkbox"/>	<input type="checkbox"/>	<input type="checkbox"/>	<input type="checkbox"/>	<input type="checkbox"/>	64.0#
	54"	BLCL54/TR	<input type="checkbox"/>	<input type="checkbox"/>	<input type="checkbox"/>	<input type="checkbox"/>	<input type="checkbox"/>	64.0#
	60"	BLCL60/TR	<input type="checkbox"/>	<input type="checkbox"/>	<input type="checkbox"/>	<input type="checkbox"/>	<input type="checkbox"/>	78.0#
	66"	BLCL66D/TR	<input type="checkbox"/>	<input type="checkbox"/>	<input type="checkbox"/>	<input type="checkbox"/>	<input type="checkbox"/>	91.0#
	72"	BLCL72D/TR	<input type="checkbox"/>	<input type="checkbox"/>	<input type="checkbox"/>	<input type="checkbox"/>	<input type="checkbox"/>	104.0#
			A	B	C	D	E	F

HOW TO ORDER

Indicate the following information on order form:

- Quantity of each item.
- Model number, including options. See "How To Build a Model Number".
- Any special service required.

Note: • The indicates that a choice is required.

- The absence of the indicates that no choice is required.
- Alpha-numeric characters in place of indicate that no other alternatives are available.

HOW TO BUILD A MODEL NUMBER

- A** Select basic model.
- B** Select cabinet paint color.
Refer to color addendum at ki.com or KI Fabrics & Finishes binder.
- C** Select upper door laminate color.
Refer to color addendum at ki.com or KI Fabrics & Finishes binder.
- D** Select stanchion door color.
Refer to color addendum at ki.com or KI Fabrics & Finishes binder.
- E** Select laminate door edge color.
Refer to color addendum at ki.com or KI Fabrics & Finishes binder.
- F** Select lock option.
- | | |
|------------|----------------|
| KS | - Key standard |
| NLC | - No lock core |
| KA | - Key alike |

BLCS, BLCL, BLSF

	30"	36"	42"	48"	54"	60"	66"	72"
Over-head Width	30"	36"	42"	48"	54"	60"	66"	72"
Door Over-hang in Open Position	3"	3"	3"	3"	3"	3"	3"	3"
No. of Doors	1	1	1	1	1	1	2	2
Inside Width of Over-head	27-3/4"	33-3/4"	39-3/4"	45-3/4"	51-3/4"	57-3/4"	63-3/4"	69-3/4"
Dimension Between Sets at Work-stations	18"	24"	30"	36"	42"	48"	54"	60"



Delivered Pricing

\$ 1463
1516
1572
1646
1781
1809
2765
2879

FINISH INFORMATION

Additional Laminate Offering

Additional laminates beyond KI standard offering, are available with two weeks extended leadtime. To specify additional laminates, use these designators followed by the supplier's color/pattern code:

- Formica - LF/supplier's color pattern code
- Nevamar - LN/supplier's color pattern code
- Wilsonart - LW/supplier's color pattern code

KI's standard finish is the supplier's recommended finish for that color/pattern.

Note: Nonstandard laminates from these suppliers (example: textured laminates), require an upcharge and additional leadtime. Contact KI.

SPECIAL SERVICES

Special Carton Marking

With specially marked information N/C

Shipping

Shipped **assembled freight prepaid f.o.b. Manitowoc, Wisconsin 54220** factory. Freight class #77.5

Specifications and prices are subject to change without prior notice.

True® Desking System Components

Balance® Overhead Storage

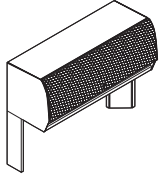

BOH

MODEL

Fabric Upper Door

- Stanchions and mounting brackets included
- The KI Balance® Overhead allows users the option to interchange from a True® Desk mount solution to a KI office panel system
- Fabric covered upper door
- Painted cabinet and lower door
- Shelf dividers available separately
- Cabinet is fully assembled

MODEL	W	MODEL NUMBER					Approx. Packaged Weight
		Basic Model	Cabinet Paint Color	Fabric Color	Stanchion Door Color	Lock Option	
	30"	BLCF30/TR	<input type="checkbox"/>	<input type="checkbox"/>	<input type="checkbox"/>	<input type="checkbox"/>	46.0#
	36"	BLCF36/TR	<input type="checkbox"/>	<input type="checkbox"/>	<input type="checkbox"/>	<input type="checkbox"/>	52.0#
	42"	BLCF42/TR	<input type="checkbox"/>	<input type="checkbox"/>	<input type="checkbox"/>	<input type="checkbox"/>	58.0#
	48"	BLCF48/TR	<input type="checkbox"/>	<input type="checkbox"/>	<input type="checkbox"/>	<input type="checkbox"/>	64.0#
	54"	BLCF54/TR	<input type="checkbox"/>	<input type="checkbox"/>	<input type="checkbox"/>	<input type="checkbox"/>	70.0#
	60"	BLCF60/TR	<input type="checkbox"/>	<input type="checkbox"/>	<input type="checkbox"/>	<input type="checkbox"/>	78.0#
	66"	BLCF66D/TR	<input type="checkbox"/>	<input type="checkbox"/>	<input type="checkbox"/>	<input type="checkbox"/>	91.0#
	72"	BLCF72D/TR	<input type="checkbox"/>	<input type="checkbox"/>	<input type="checkbox"/>	<input type="checkbox"/>	104.0#

A **B** **C** **D** **E**

HOW TO ORDER

Indicate the following information on order form:

1. Quantity of each item.
2. Model number, including options. See "How To Build a Model Number".
3. Any special service required.

Note: • The indicates that a choice is required.

- The absence of the indicates that no choice is required.
- Alpha-numeric characters in place of indicate that no other alternatives are available.

HOW TO BUILD A MODEL NUMBER

- A** Select basic model.
- B** Select cabinet paint color. Refer to color addendum at ki.com or KI Fabrics & Finishes binder.
- C** Select upper door fabric color. Refer to color addendum at ki.com or in KI Fabrics & Finishes binder.
- D** Select stanchion door color. Refer to color addendum at ki.com or KI Fabrics & Finishes binder.
- E** Select lock option.
 - KS** - Key standard
 - NLC** - No lock core
 - KA** - Key alike

BLCS, BLCL, BLSF

Over-head Width	30"	36"	42"	48"	54"	60"	66"	72"
Door Over-hang in Open Position	3"	3"	3"	3"	3"	3"	3"	3"
No. of Doors	1	1	1	1	1	1	2	2
Inside Width of Over-head	27-3/4"	33-3/4"	39-3/4"	45-3/4"	51-3/4"	57-3/4"	63-3/4"	69-3/4"
Dimension Between Sets at Work-stations	18"	24"	30"	36"	42"	48"	54"	60"



True[®] Desking System Components

Balance[®] Overhead Storage

Delivered Pricing Fabric Grade 1 & C.O.M.	Delivered Pricing Fabric Grade 2	Delivered Pricing Fabric Grade 3 & Pallas Vertical Fabric Grade PV	Delivered Pricing Pallas Vertical Fabric Grade PV1	Delivered Pricing Pallas Vertical Fabric Grade PV2
\$ 1324	\$ 1334	\$ 1350	\$ 1372	\$ 1391
1350	1359	1381	1402	1420
1380	1388	1411	1430	1452
1443	1454	1474	1498	1519
1543	1553	1579	1600	1626
1560	1570	1594	1621	1645
2461	2480	2519	2561	2598
2518	2539	2577	2619	2656

SPECIAL SERVICES

Special Carton Marking

With specially marked information N/C

Shipping

Shipped **assembled freight prepaid** f.o.b. **Manitowoc, Wisconsin 54220** factory. Freight class #77.5

Specifications and prices are subject to change without prior notice.

True® Desking System Components

Balance® Task Lights

MODEL	W	MODEL NUMBER		Approx. Packaged Weight
		Basic Model		
Balance® Task Lights • Electronic ballast	24"	BTLT5.24		3.9#
	36"	BTLT5.36		5.3#
	48"	BTLT5.48		6.7#

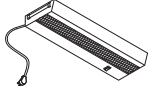

HRDPT

A

HOW TO ORDER

Indicate the following information on order form:

1. Quantity of each item.
2. Model number, including options. See "How To Build a Model Number".
3. Any special service required.

Note: • The indicates that a choice is required.

- The absence of the indicates that no choice is required.

- Alpha-numeric characters in place of indicate that no other alternatives are available.

HOW TO BUILD A MODEL NUMBER

A Select basic model.

INFORMATION

TASK LIGHT CABINET WIDTH

Cabinet Width	Light Width
24"	18"
30"	24"
36"	24"
42"	36"
48"	36"
54"	48"
60"	48"
66"	(2)24"
72"	(2)24"



True[®] Desking System Components

Balance[®] Task Lights

Delivered
Pricing

\$ 102
112
117

SPECIAL SERVICES

Special Carton Marking

With specially marked information N/C

Shipping

Shipped **assembled freight prepaid f.o.b. Manitowoc, Wisconsin 54220** factory.
Freight class #100.

Specifications and prices are subject to change without prior notice.

True® Desking System Components

Universal Overhead Storage

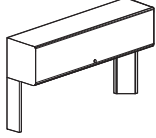
MODEL	W	MODEL NUMBER					Approx. Packaged Weight
		Basic Model	Cabinet Paint Color	Handle Color	Stanchion Door Color	Lock Option	
 <p>VUOS</p> <p>Steel Overhead Cabinet</p> <ul style="list-style-type: none"> Includes support stanchions The KI Universal Overhead allows users the option to interchange from a True® Desk mount solution to a KI office panel system Steel end panels, bottom, top shelf, and door with powder-coated finish Steel door Double-bit lock is included with key alike option Door stores recessed with handle exposed Shelf depth is 13-1/4" Must order 66" and 72" worksurfaces with optional center grommet 66" overhead consists of 30" and 36" cabinets supported at juncture of cabinets by support stanchion 72" overhead consist of two 36" cabinets supported at juncture of cabinets by support stanchion Accepts shelf divider 	24"	PRDS24/TR	<input type="checkbox"/>	<input type="checkbox"/>	<input type="checkbox"/>	<input type="checkbox"/>	34.0#
	30"	PRDS30/TR	<input type="checkbox"/>	<input type="checkbox"/>	<input type="checkbox"/>	<input type="checkbox"/>	39.0#
	36"	PRDS36/TR	<input type="checkbox"/>	<input type="checkbox"/>	<input type="checkbox"/>	<input type="checkbox"/>	44.0#
	42"	PRDS42/TR	<input type="checkbox"/>	<input type="checkbox"/>	<input type="checkbox"/>	<input type="checkbox"/>	49.0#
	48"	PRDS48/TR	<input type="checkbox"/>	<input type="checkbox"/>	<input type="checkbox"/>	<input type="checkbox"/>	54.0#
	54"	PRDS54/TR	<input type="checkbox"/>	<input type="checkbox"/>	<input type="checkbox"/>	<input type="checkbox"/>	60.0#
	60"	PRDS60/TR	<input type="checkbox"/>	<input type="checkbox"/>	<input type="checkbox"/>	<input type="checkbox"/>	64.0#
	66"	PRDS66/TR	<input type="checkbox"/>	<input type="checkbox"/>	<input type="checkbox"/>	<input type="checkbox"/>	61.0#
	72"	PRDS72/TR	<input type="checkbox"/>	<input type="checkbox"/>	<input type="checkbox"/>	<input type="checkbox"/>	65.0#

A **B** **C** **D** **E**

HOW TO ORDER

Indicate the following information on order form:

- Quantity of each item.
- Model number, including options. See "How To Build a Model Number".
- Any special service required.

Note: • The indicates that a choice is required.

- The absence of the indicates that no choice is required.
- Alpha-numeric characters in place of indicate that no other alternatives are available.

HOW TO BUILD A MODEL NUMBER

- A** Select basic model.
- B** Select cabinet paint color. Refer to color addendum at ki.com or KI Fabrics & Finishes binder.
- C** Select door handle trim color. Refer to color addendum at ki.com or KI Fabrics & Finishes binder.
- D** Select stanchion door color. Refer to color addendum at ki.com or KI Fabrics & Finishes binder.
- E** Select lock option.
 - KS** - Key standard
 - NLC** - No lock core
 - KA** - Key alike

PRDS, PRDF, PRDL, PRDV

	30"	36"	42"	48"	54"	60"	66"	72"
Over-head Width	30"	36"	42"	48"	54"	60"	66"	72"
Door Over-hang in Open Position	4"	4"	4"	4"	4"	4"	4"	4"
No. of Doors	1	1	1	1	1	1	2	2
Inside Width of Over-head	29-1/2"	35-1/2"	41-1/2"	47-1/2"	53-1/2"	59-1/2"	29-3/4" & 35-1/2"	2 x 35-1/2"
Dimension Between Sets at Work-stations	18"	24"	30"	36"	42"	48"	19-3/4" & 25-3/4"	2 x 25-3/4"



True[®] Desking System Components

Universal Overhead Storage

Delivered
Pricing

\$ 817
828
848
874
935
957
1033
1467
1561

SPECIAL SERVICES

Special Carton Marking

With specially marked information N/C

Shipping

Shipped k.d. freight prepaid f.o.b. Manitowoc, Wisconsin 54220 factory. Freight class #70.

Specifications and prices are subject to change without prior notice.

True® Desking System Components

Universal Overhead Storage

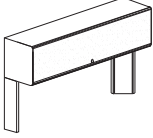
MODEL	W	MODEL NUMBER						Approx. Packaged Weight
		Basic Model	Cabinet Paint Color	Handle Color	Stanchion Door Color	Fabric Color	Lock Option	
 <p>VUOF</p> <p>Fabric Overhead Cabinet</p> <ul style="list-style-type: none"> Includes support stanchions The KI Universal Overhead allows users the option to interchange from a True® Desk mount solution to a KI office panel system Steel end panels, bottom, top shelf, and door with powder-coated finish Fabric-covered door Double-bit lock is included with key alike option Door stores recessed with handle exposed Shelf depth is 13-1/4" Must order 66" and 72" worksurfaces with optional center grommet 66" overhead consists of 30" and 36" cabinets supported at juncture of cabinets by support stanchion 72" overhead consist of two 36" cabinets supported at juncture of cabinets by support stanchion Accepts shelf divider 	24"	PRDF24/TR	<input type="checkbox"/>	<input type="checkbox"/>	<input type="checkbox"/>	<input type="checkbox"/>	<input type="checkbox"/>	32.0#
	30"	PRDF30/TR	<input type="checkbox"/>	<input type="checkbox"/>	<input type="checkbox"/>	<input type="checkbox"/>	<input type="checkbox"/>	36.0#
	36"	PRDF36/TR	<input type="checkbox"/>	<input type="checkbox"/>	<input type="checkbox"/>	<input type="checkbox"/>	<input type="checkbox"/>	40.0#
	42"	PRDF42/TR	<input type="checkbox"/>	<input type="checkbox"/>	<input type="checkbox"/>	<input type="checkbox"/>	<input type="checkbox"/>	44.0#
	48"	PRDF48/TR	<input type="checkbox"/>	<input type="checkbox"/>	<input type="checkbox"/>	<input type="checkbox"/>	<input type="checkbox"/>	49.0#
	54"	PRDF54/TR	<input type="checkbox"/>	<input type="checkbox"/>	<input type="checkbox"/>	<input type="checkbox"/>	<input type="checkbox"/>	53.0#
	60"	PRDF60/TR	<input type="checkbox"/>	<input type="checkbox"/>	<input type="checkbox"/>	<input type="checkbox"/>	<input type="checkbox"/>	57.0#
	66"	PRDF66/TR	<input type="checkbox"/>	<input type="checkbox"/>	<input type="checkbox"/>	<input type="checkbox"/>	<input type="checkbox"/>	61.0#
	72"	PRDF72/TR	<input type="checkbox"/>	<input type="checkbox"/>	<input type="checkbox"/>	<input type="checkbox"/>	<input type="checkbox"/>	65.0#

A **B** **C** **D** **E** **F**

HOW TO ORDER

Indicate the following information on order form:

- Quantity of each item.
- Model number, including options. See "How To Build a Model Number".
- Any special service required.

Note: • The indicates that a choice is required.

- The absence of the indicates that no choice is required.
- Alpha-numeric characters in place of indicate that no other alternatives are available.

HOW TO BUILD A MODEL NUMBER

- A** Select basic model.
- B** Select cabinet paint color. Refer to color addendum at ki.com or KI Fabrics & Finishes binder.
- C** Select door handle trim color. Refer to color addendum at ki.com or KI Fabrics & Finishes binder.
- D** Select stanchion door color. Refer to color addendum at ki.com or KI Fabrics & Finishes binder.
- E** Select fabric. Refer to color addendum at ki.com or in KI Fabrics & Finishes binder.
- F** Select lock option.

KS	- Key standard
NLC	- No lock core
KA	- Key alike

PRDS, PRDF, PRDL, PRDV

	30"	36"	42"	48"	54"	60"	66"	72"
Over-head Width	30"	36"	42"	48"	54"	60"	66"	72"
Door Over-hang in Open Position	4"	4"	4"	4"	4"	4"	4"	4"
No. of Doors	1	1	1	1	1	1	2	2
Inside Width of Over-head	29-1/2"	35-1/2"	41-1/2"	47-1/2"	53-1/2"	59-1/2"	29-3/4" & 35-1/2"	2 x 35-1/2"
Dimension Between Sets at Work-stations	18"	24"	30"	36"	42"	48"	19-3/4" & 25-3/4"	2 x 25-3/4"



True[®] Desking System Components

Universal Overhead Storage

Delivered Pricing Fabric Grade 1 & C.O.M.	Delivered Pricing Fabric Grade 2	Delivered Pricing Fabric Grade 3 & Pallas Vertical Fabric Grade PV	Delivered Pricing Pallas Vertical Fabric Grade PV1	Delivered Pricing Pallas Vertical Fabric Grade PV2
\$ 862	\$ 868	\$ 881	\$ 889	\$ 899
889	895	907	919	929
918	922	933	946	957
935	942	956	967	980
961	968	981	991	1006
1074	1083	1098	1112	1128
1124	1130	1144	1162	1177
1612	1624	1646	1670	1691
1657	1671	1692	1718	1740

SPECIAL SERVICES

Special Carton Marking

With specially marked information N/C

Shipping

Shipped k.d. freight prepaid f.o.b. Manitowoc, Wisconsin 54220 factory. Freight class #70.

Specifications and prices are subject to change without prior notice.

True® Desking System Components

Universal Overhead Storage

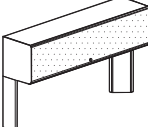
MODEL	W	MODEL NUMBER						Approx. Packaged Weight
		Basic Model	Cabinet Paint Color	Handle Color	Stanchion Door Color	Laminate Color	Lock Option	
 <p>VUOL</p> <p>Laminate Overhead Cabinet</p> <ul style="list-style-type: none"> Includes support stanchions The KI Universal Overhead allows users the option to interchange from a True® Desk mount solution to a KI office panel system Steel end panels, bottom, top shelf, and door with powder-coated finish High-pressure laminate on particleboard door Double-bit lock is included with key alike option Door stores recessed with handle exposed Shelf depth is 13-1/4" Must order 66" and 72" worksurfaces with optional center grommet 66" overhead consists of 30" and 36" cabinets supported at juncture of cabinets by support stanchion 72" overhead consist of two 36" cabinets supported at juncture of cabinets by support stanchion Accepts shelf divider 	24"	PRDL24/TR	<input type="checkbox"/>	<input type="checkbox"/>	<input type="checkbox"/>	<input type="checkbox"/>	<input type="checkbox"/>	32.0#
	30"	PRDL30/TR	<input type="checkbox"/>	<input type="checkbox"/>	<input type="checkbox"/>	<input type="checkbox"/>	<input type="checkbox"/>	36.0#
	36"	PRDL36/TR	<input type="checkbox"/>	<input type="checkbox"/>	<input type="checkbox"/>	<input type="checkbox"/>	<input type="checkbox"/>	40.0#
	42"	PRDL42/TR	<input type="checkbox"/>	<input type="checkbox"/>	<input type="checkbox"/>	<input type="checkbox"/>	<input type="checkbox"/>	44.0#
	48"	PRDL48/TR	<input type="checkbox"/>	<input type="checkbox"/>	<input type="checkbox"/>	<input type="checkbox"/>	<input type="checkbox"/>	48.0#
	54"	PRDL54/TR	<input type="checkbox"/>	<input type="checkbox"/>	<input type="checkbox"/>	<input type="checkbox"/>	<input type="checkbox"/>	53.0#
	60"	PRDL60/TR	<input type="checkbox"/>	<input type="checkbox"/>	<input type="checkbox"/>	<input type="checkbox"/>	<input type="checkbox"/>	57.0#
	66"	PRDL66/TR	<input type="checkbox"/>	<input type="checkbox"/>	<input type="checkbox"/>	<input type="checkbox"/>	<input type="checkbox"/>	61.0#
	72"	PRDL72/TR	<input type="checkbox"/>	<input type="checkbox"/>	<input type="checkbox"/>	<input type="checkbox"/>	<input type="checkbox"/>	65.0#

A **B** **C** **D** **E** **F**

HOW TO ORDER

Indicate the following information on order form:

- Quantity of each item.
- Model number, including options. See "How To Build a Model Number".
- Any special service required.

Note: • The indicates that a choice is required.

- The absence of the indicates that no choice is required.
- Alpha-numeric characters in place of indicate that no other alternatives are available.

HOW TO BUILD A MODEL NUMBER

- A** Select basic model.
- B** Select cabinet paint color. Refer to color addendum at ki.com or KI Fabrics & Finishes binder.
- C** Select door handle trim color. Refer to color addendum at ki.com or KI Fabrics & Finishes binder.
- D** Select stanchion door color. Refer to color addendum at ki.com or KI Fabrics & Finishes binder.
- E** Select laminate surface. Refer to color addendum at ki.com or KI Fabrics & Finishes binder.
- F** Select lock option.

KS	- Key standard
NLC	- No lock core
KA	- Key alike

PRDS, PRDF, PRDL, PRDV

	30"	36"	42"	48"	54"	60"	66"	72"
Over-head Width	30"	36"	42"	48"	54"	60"	66"	72"
Door Over-hang in Open Position	4"	4"	4"	4"	4"	4"	4"	4"
No. of Doors	1	1	1	1	1	1	2	2
Inside Width of Over-head	29-1/2"	35-1/2"	41-1/2"	47-1/2"	53-1/2"	59-1/2"	29-1/2" & 35-1/2"	2 x 35-1/2"
Dimension Between Sets at Work-stations	18"	24"	30"	36"	42"	48"	19-3/4" & 25-3/4"	2 x 25-3/4"



Delivered Pricing

\$ 881
 882
 921
 957
 991
 1091
 1141
 1607
 1683

FINISH INFORMATION

Additional Laminate Offering

Additional laminates beyond KI standard offering, are available with two weeks extended leadtime. To specify additional laminates, use these designators followed by the supplier's color/pattern code:

- Formica - LF/supplier's color pattern code
- Nevamar - LN/supplier's color pattern code
- Wilsonart - LW/supplier's color pattern code

KI's standard finish is the supplier's recommended finish for that color/pattern.

Note: Nonstandard laminates from these suppliers (example: textured laminates), require an upcharge and additional leadtime. Contact KI.

SPECIAL SERVICES

Special Carton Marking

With specially marked information N/C

Shipping

Shipped k.d. freight prepaid f.o.b. Manitowoc, Wisconsin 54220 factory. Freight class #70.

Specifications and prices are subject to change without prior notice.

True® Desking System Components

Universal Overhead Storage

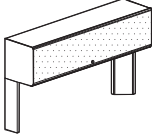
MODEL	W	MODEL NUMBER						Approx. Packaged Weight
		Basic Model	Cabinet Paint Color	Handle Color	Stanchion Door Color	Veneer Color	Lock Option	
 <p>VUOV</p> <p>Veneer Overhead Cabinet</p> <ul style="list-style-type: none"> Includes support stanchions The KI Universal Overhead allows users the option to interchange from a True® Desk mount solution to a KI office panel system Steel end panels, bottom and top shelf with powder-coated finish Veneer covered door Double-bit lock is included with key alike option Door stores recessed with handle exposed Shelf depth is 13-1/4" Must order 66" and 72" worksurfaces with optional center grommet 66" overhead consists of 30" and 36" cabinets supported at juncture of cabinets by support stanchion 72" overhead consist of two 36" cabinets supported at juncture of cabinets by support stanchion Accepts shelf divider 	24"	PRDV24/TR	<input type="checkbox"/>	<input type="checkbox"/>	<input type="checkbox"/>	<input type="checkbox"/>	<input type="checkbox"/>	32.0#
	30"	PRDV30/TR	<input type="checkbox"/>	<input type="checkbox"/>	<input type="checkbox"/>	<input type="checkbox"/>	<input type="checkbox"/>	36.0#
	36"	PRDV36/TR	<input type="checkbox"/>	<input type="checkbox"/>	<input type="checkbox"/>	<input type="checkbox"/>	<input type="checkbox"/>	40.0#
	42"	PRDV42/TR	<input type="checkbox"/>	<input type="checkbox"/>	<input type="checkbox"/>	<input type="checkbox"/>	<input type="checkbox"/>	44.0#
	48"	PRDV48/TR	<input type="checkbox"/>	<input type="checkbox"/>	<input type="checkbox"/>	<input type="checkbox"/>	<input type="checkbox"/>	48.0#
	54"	PRDV54/TR	<input type="checkbox"/>	<input type="checkbox"/>	<input type="checkbox"/>	<input type="checkbox"/>	<input type="checkbox"/>	53.0#
	60"	PRDV60/TR	<input type="checkbox"/>	<input type="checkbox"/>	<input type="checkbox"/>	<input type="checkbox"/>	<input type="checkbox"/>	57.0#
	66"	PRDV66/TR	<input type="checkbox"/>	<input type="checkbox"/>	<input type="checkbox"/>	<input type="checkbox"/>	<input type="checkbox"/>	57.0#
	72"	PRDV72/TR	<input type="checkbox"/>	<input type="checkbox"/>	<input type="checkbox"/>	<input type="checkbox"/>	<input type="checkbox"/>	57.0#

A **B** **C** **D** **E** **F**

HOW TO ORDER

Indicate the following information on order form:

- Quantity of each item.
- Model number, including options. See "How To Build a Model Number".
- Any special service required.

Note: • The indicates that a choice is required.

- The absence of the indicates that no choice is required.
- Alpha-numeric characters in place of indicate that no other alternatives are available.

HOW TO BUILD A MODEL NUMBER

- A** Select basic model.
- B** Select cabinet paint color. Refer to color addendum at ki.com or KI Fabrics & Finishes binder.
- C** Select door handle trim color. Refer to color addendum at ki.com or KI Fabrics & Finishes binder.
- D** Select stanchion door color. Refer to color addendum at ki.com or KI Fabrics & Finishes binder.
- E** Select veneer surface color. Refer to color addendum at ki.com or KI Fabrics & Finishes binder.
- F** Select lock option.

KS	- Key standard
NLC	- No lock core
KA	- Key alike

PRDS, PRDF, PRDL, PRDV

	30"	36"	42"	48"	54"	60"	66"	72"
Over-head Width	30"	36"	42"	48"	54"	60"	66"	72"
Door Over-hang in Open Position	4"	4"	4"	4"	4"	4"	4"	4"
No. of Doors	1	1	1	1	1	1	2	2
Inside Width of Over-head	29-1/2"	35-1/2"	41-1/2"	47-1/2"	53-1/2"	59-1/2"	29-1/2" & 35-1/2"	2 x 35-1/2"
Dimension Between Sets at Work-stations	18"	24"	30"	36"	42"	48"	19-3/4" & 25-3/4"	2 x 25-3/4"



True[®] Desking System Components

Universal Overhead Storage

Delivered
Pricing

\$ 1364
1384
1437
1491
1549
1788
1886
2629
2734

SPECIAL SERVICES

Special Carton Marking

With specially marked information N/C



Shipping

Shipped k.d. freight prepaid f.o.b. Manitowoc, Wisconsin 54220 factory. Freight class #70.

Specifications and prices are subject to change without prior notice.

True[®] Desking System Components

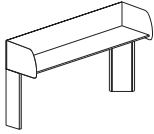
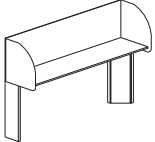
Universal Overhead Shelves and Divider

	MODEL	W x H	MODEL NUMBER			Approx. Packaged Weight
			Basic Model	Shelf Paint Color	Stanchion Door Color	
 <p>VULS</p>	Low Shelf	24"	ULSR24/TR	<input type="checkbox"/>	<input type="checkbox"/>	14.0#
	• Includes support stanchions	30"	ULSR30/TR	<input type="checkbox"/>	<input type="checkbox"/>	16.0#
	• Accepts shelf dividers	36"	ULSR36/TR	<input type="checkbox"/>	<input type="checkbox"/>	17.0#
	• Includes full back	42"	ULSR42/TR	<input type="checkbox"/>	<input type="checkbox"/>	19.0#
	• 66" shelf consists of one 36" and one 30"; 72" shelf consists of two 36" shelves supported by middle upright	48"	ULSR48/TR	<input type="checkbox"/>	<input type="checkbox"/>	20.0#
	• Shelves are shipped unassembled	54"	ULSR54/TR	<input type="checkbox"/>	<input type="checkbox"/>	22.0#
		60"	ULSR60/TR	<input type="checkbox"/>	<input type="checkbox"/>	24.0#
		66"	ULSR66/TR	<input type="checkbox"/>	<input type="checkbox"/>	29.0#
		72"	ULSR72/TR	<input type="checkbox"/>	<input type="checkbox"/>	30.0#
 <p>VURS</p>	Regular Shelf	24"	URSR24/TR	<input type="checkbox"/>	<input type="checkbox"/>	19.0#
	• Includes support stanchions	30"	URSR30/TR	<input type="checkbox"/>	<input type="checkbox"/>	20.0#
	• Accepts shelf dividers	36"	URSR36/TR	<input type="checkbox"/>	<input type="checkbox"/>	22.0#
	• Includes full back	42"	URSR42/TR	<input type="checkbox"/>	<input type="checkbox"/>	23.0#
	• 66" shelf consists of one 36" and one 30"; 72" shelf consists of two 36" shelves supported by middle upright	48"	URSR48/TR	<input type="checkbox"/>	<input type="checkbox"/>	25.0#
	• Shelves are shipped unassembled	54"	URSR54/TR	<input type="checkbox"/>	<input type="checkbox"/>	27.0#
		60"	URSR60/TR	<input type="checkbox"/>	<input type="checkbox"/>	28.0#
		66"	URSR66/TR	<input type="checkbox"/>	<input type="checkbox"/>	29.0#
		72"	URSR72/TR	<input type="checkbox"/>	<input type="checkbox"/>	30.0#
 <p>HRDPT</p>	Shelf Divider	7-1/4 x 11-1/2"	NSD	<input type="checkbox"/>		1.0#
	• Steel shelf dividers with powder-coated finish					
	• Fits shelves and overheads					

A

B

C

HOW TO ORDER

Indicate the following information on order form:

- Quantity of each item.
- Model number, including options. See "How To Build a Model Number".
- Any special service required.

Note: • The indicates that a choice is required.

- The absence of the indicates that no choice is required.
- Alpha-numeric characters in place of indicate that no other alternatives are available.

HOW TO BUILD A MODEL NUMBER

- A** Select basic model.
- B** Select shelf paint color.
Refer to color addendum at ki.com or KI Fabrics & Finishes binder.
- C** Select stanchion door color.
Refer to color addendum at ki.com or KI Fabrics & Finishes binder.



True[®] Desking System Components

Universal Overhead Shelves and Divider

Delivered Pricing

\$ 559
560
574
581
590
611
644
940
960
\$ 582
584
595
607
617
646
663
985
1010
\$ 26

SPECIAL SERVICES

Special Carton Marking

With specially marked information N/C

Shipping

Shipped k.d. freight prepaid f.o.b. Manitowoc, Wisconsin 54220 factory. Freight class #70.

Specifications and prices are subject to change without prior notice.

True® Desking System Components

Universal Overhead and Shelves Task Lights

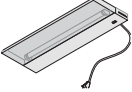
MODEL	W	MODEL NUMBER		Approx. Packaged Weight
			Basic Model	
 <p>Universal Overhead and Shelves Task Lights</p> <ul style="list-style-type: none"> • Electronic ballast 	24"		TLT5.24	3.9#
	36"		TLT5.36	5.3#
	48"		TLT5.48	6.7#

HRDPT

A

HOW TO ORDER

Indicate the following information on order form:

1. Quantity of each item.
2. Model number, including options. See "How To Build a Model Number".
3. Any special service required.

Note: • The indicates that a choice is required.

- The absence of the indicates that no choice is required.
- Alpha-numeric characters in place of indicate that no other alternatives are available.

HOW TO BUILD A MODEL NUMBER

A Select basic model.

INFORMATION

TASK LIGHT CABINET WIDTH

Cabinet Width	Light Width
24"	18"
30"	24"
36"	24"
42"	36"
48"	36"
54"	48"
60"	48"
66"	(2)24"
72"	(2)24"



True[®] Desking System Components

Universal Overhead and Shelves Task Lights

Delivered
Pricing

\$ 76
83
91

SPECIAL SERVICES

Special Carton Marking

With specially marked information N/C

Shipping

Shipped k.d. freight prepaid f.o.b. Manitowoc, Wisconsin 54220 factory. Freight class #100.

Specifications and prices are subject to change without prior notice.

True® Desking System Accessories

Center Drawer

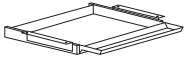

7DACU

MODEL

Center Drawer
 • Steel painted tray

W x D x H

17 x 18-1/4 x 1-5/8"

17 x 18-1/4 x 1-5/8"

MODEL NUMBER

Basic Model

Paint Color

Approx. Packaged Weight

7D/18CD

13.0#

7D/18CDL

13.0#

A

B

HOW TO ORDER

Indicate the following information on order form:

1. Quantity of each item.
2. Model number, including options. See "How To Build a Model Number".
3. Any special service required.

Note: • The indicates that a choice is required.

- The absence of the indicates that no choice is required.
- Alpha-numeric characters in place of indicate that no other alternatives are available.

HOW TO BUILD A MODEL NUMBER

- A** Select basic model.
- B** Select paint color. Refer to color addendum at ki.com or KI Fabrics & Finishes binder.



True[®] Desking System Accessories

Center Drawer

Delivered
Pricing

\$ 168

210

SPECIAL SERVICES

Special Carton Marking

With specially marked information N/C





Shipping

Delivered. Shipped **k.d. freight prepaid**
f.o.b. Pembroke, Ontario K8A 0E1 factory.
Freight class #70.

Specifications and prices are subject to
change without prior notice.

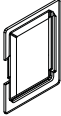
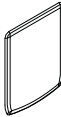
True® Desking System Accessories

Grommets

MODEL	MODEL NUMBER		Approx. Packaged Weight
	Basic Model	Surface Grom. Color	
 Standard Leg Grommet Frame • Standard on desks • Use for replacement HRDPT	TSLG	<input type="checkbox"/> <input type="checkbox"/>	0.2#
 Upper Leg Grommet Cover • Standard on desks • Use for replacement HRDPT	TULGC	<input type="checkbox"/> <input type="checkbox"/>	0.2#
 Lower Leg Grommet Cover • Standard on Corner Power Infeed Leg HRDPT	TLLGC	<input type="checkbox"/> <input type="checkbox"/>	0.2#
 Worksurface Grommet • Standard on desks • Use for replacement HRDPT	TWSG	<input type="checkbox"/> <input type="checkbox"/>	0.2#
 Worksurface Grommet Cover • Standard on desks • Use for replacement HRDPT	TWSGC	<input type="checkbox"/> <input type="checkbox"/>	0.2#

A **B**

HOW TO ORDER

Indicate the following information on order form:

1. Quantity of each item.
2. Model number, including options. See "How To Build a Model Number".
3. Any special service required.

Note:

- The indicates that a choice is required.
- The absence of the indicates that no choice is required.
- Alpha-numeric characters in place of indicate that no other alternatives are available.

HOW TO BUILD A MODEL NUMBER

- A** Select basic model.
- B** Select grommet color.
Refer to color addendum at ki.com or KI Fabrics & Finishes binder.



True[®] Desking System Accessories

Grommets

Delivered
Pricing

\$ 3

\$ 3

\$ 3

\$ 3

\$ 3

SPECIAL SERVICES

Special Carton Marking

With specially marked information N/C

Shipping

Delivered. Shipped k.d. freight prepaid f.o.b. **Pembroke, Ontario K8A 0E1** factory. Freight class #70.

Specifications and prices are subject to change without prior notice.

True® Desking System Accessories

Corner Power Infeed Leg

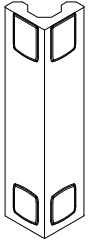

TRAC

MODEL

Corner Power Infeed Leg

- Used in place of standard leg when floor-mounted power monument falls outside footprint of the desk
- Includes upper and lower leg grommet

MODEL NUMBER			Approx. Packaged Weight
Basic Model	Trim Color	Paint Color	
TCLBG	<input type="checkbox"/> <input type="checkbox"/> <input type="checkbox"/>	<input type="checkbox"/> <input type="checkbox"/>	10.0#

A **B** **C**

HOW TO ORDER

Indicate the following information on order form:

1. Quantity of each item.
2. Model number, including options. See "How To Build a Model Number".
3. Any special service required.

- Note:
- The indicates that a choice is required.
 - The absence of the indicates that no choice is required.
 - Alpha-numeric characters in place of indicate that no other alternatives are available.

HOW TO BUILD A MODEL NUMBER

- A** Select basic model.
- B** Select trim color. Refer to color addendum at ki.com or KI Fabrics & Finishes binder.
- C** Select paint color. Refer to color addendum at ki.com or KI Fabrics & Finishes binder.



True[®] Desking System Accessories

Corner Power Infeed Leg

Delivered
Pricing

\$ 68

SPECIAL SERVICES

Special Carton Marking

With specially marked information N/C

Shipping

Delivered. Shipped **k.d. freight prepaid**
f.o.b. Pembroke, Ontario K8A 0E1 factory.
Freight class #70.

Specifications and prices are subject to
change without prior notice.

True® Desking System Accessories

Modesty Panel Inserts

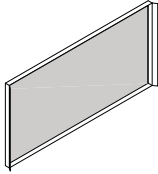
MODEL	W	MODEL NUMBER		Approx. Packaged Weight
		Basic Model	Paint Color	
 <p>TRAC</p> <p>Full Modesty Panel Insert</p> <ul style="list-style-type: none"> Used to change a desk from partial modesty panel into one with a full modesty panel Can be added or removed without disruption to other desks or electrical parts 	24"	TAFMP24	<input type="checkbox"/>	5.0#
	30"	TAFMP30	<input type="checkbox"/>	6.0#
	36"	TAFMP36	<input type="checkbox"/>	8.0#
	42"	TAFMP42	<input type="checkbox"/>	9.0#
	48"	TAFMP48	<input type="checkbox"/>	11.0#
	54"	TAFMP54	<input type="checkbox"/>	12.0#
	60"	TAFMP60	<input type="checkbox"/>	14.0#
	66"	TAFMP66	<input type="checkbox"/>	16.0#
	72"	TAFMP72	<input type="checkbox"/>	17.0#

A

B

HOW TO ORDER

Indicate the following information on order form:

- Quantity of each item.
- Model number, including options. See "How To Build a Model Number".
- Any special service required.

- Note:
- The indicates that a choice is required.
 - The absence of the indicates that no choice is required.
 - Alpha-numeric characters in place of indicate that no other alternatives are available.

HOW TO BUILD A MODEL NUMBER

- A** Select basic model.
- B** Select paint color.
Refer to color addendum at ki.com or KI Fabrics & Finishes binder.



True[®] Desking System Accessories

Modesty Panel Inserts

Delivered
Pricing

\$ 166
166
177
198
238
259
299
317
355

SPECIAL SERVICES

Special Carton Marking

With specially marked information N/C

Shipping

Delivered. Shipped k.d. freight prepaid
f.o.b. **Pembroke, Ontario K8A 0E1** factory.
Freight class #70.

Specifications and prices are subject to
change without prior notice.

True® Desking System Accessories

Worksurface Accessories

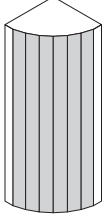
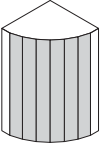
	MODEL	W	MODEL NUMBER			Approx. Packaged Weight	
			Basic Model	Paint Color	Stanchion Door Color		
 <p>TRAC</p>	Freestanding Stanchion Large • 19-1/2" tall (4 openings) • Stanchion door and top cap included • Used to provide worksurface power and data location • Included when ordering overheads with / TR suffix	19"	TST19	<input type="checkbox"/>	<input type="checkbox"/>	8.0#	
 <p>TRAC</p>	Freestanding Stanchion Short • 11-1/2" tall (2 openings) • Stanchion door and top cap included • Used to provide worksurface power and data location	11"	TST11	<input type="checkbox"/>	<input type="checkbox"/>	5.0#	

A **B** **C**

HOW TO ORDER

Indicate the following information on order form:

- Quantity of each item.
- Model number, including options. See "How To Build a Model Number".
- Any special service required.

Note: • The indicates that a choice is required.

- The absence of the indicates that no choice is required.
- Alpha-numeric characters in place of indicate that no other alternatives are available.

HOW TO BUILD A MODEL NUMBER

- A** Select basic model.
- B** Select paint color.
Refer to color addendum at ki.com or KI Fabrics & Finishes binder.
- C** Select stanchion door color.
Refer to color addendum at ki.com or KI Fabrics & Finishes binder.



True[®] Desking System Accessories

Worksurface Accessories

Delivered
Pricing
\$ 402

\$ 281

SPECIAL SERVICES

Special Carton Marking

With specially marked information N/C

Shipping

Delivered. Shipped k.d. freight prepaid f.o.b. **Pembroke, Ontario K8A 0E1** factory. Freight class #70.

Specifications and prices are subject to change without prior notice.

True® Desking System Data/Comm.

Accessories

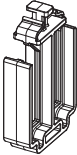
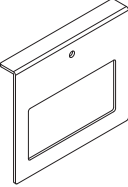
	MODEL	W	MODEL NUMBER			Approx. Packaged Weight
			Basic Model	Trim Color	Paint Color	
 <p>Communication Pole</p> <ul style="list-style-type: none"> Used to route communication cables through top grommet in worksurface to ceiling Includes pole, cover, and ceiling trim Pole has two separated channels 	10"	TCOMP10	<input type="checkbox"/> <input type="checkbox"/> <input type="checkbox"/>	<input type="checkbox"/> <input type="checkbox"/>	9.0#	
	7"	TCOMP7	<input type="checkbox"/> <input type="checkbox"/> <input type="checkbox"/>	<input type="checkbox"/> <input type="checkbox"/>	6.0#	
TRAC						
 <p>Cable Support</p> <ul style="list-style-type: none"> TCOMCS=single TCOMPK=8 pack 		TCOMCS			0.1#	
		TCOMPSPK			1.0#	
HRDPT						
 <p>Face Plate Bracket</p>		TCOMFP		<input type="checkbox"/> <input type="checkbox"/>	0.2#	
	TRAC					

A **B** **C**

HOW TO ORDER

Indicate the following information on order form:

- Quantity of each item.
- Model number, including options. See "How To Build a Model Number".
- Any special service required.

Note: • The indicates that a choice is required.

- The absence of the indicates that no choice is required.
- Alpha-numeric characters in place of indicate that no other alternatives are available.

HOW TO BUILD A MODEL NUMBER

- A** Select basic model.
- B** Select trim color.
Refer to color addendum at ki.com or KI Fabrics & Finishes binder.
- C** Select paint color.
Refer to color addendum at ki.com or KI Fabrics & Finishes binder.



Delivered
Pricing

\$ 163

113

\$ 5

44

\$ 24

SPECIAL SERVICES

Special Carton Marking

With specially marked information N/C

Shipping

Delivered. Shipped k.d. freight prepaid
f.o.b. **Pembroke, Ontario K8A 0E1** factory.
Freight class #70.

Specifications and prices are subject to
change without prior notice.

True® Desking System Electrical

Electrical

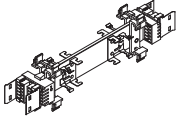
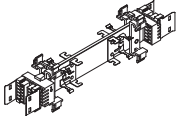
	MODEL	Features	MODEL NUMBER		Approx. Packaged Weight
			Basic Model	Paint Color	
 <p>TRAC</p>	Rigid Wireway 4-4-2 <ul style="list-style-type: none"> Includes rigid wireway electrical harness, steel wireway cover, and all required attachment hardware Available in two 10-wire styles. Note: 10-wire styles must match on all electrical parts Allows two duplex receptacles (ordered separately) to be mounted below the desk worksurface Size must match the desk length. Note: the 72D (dual) provides four possible receptacle locations 	Desk width 30"	TRWW4R30	<input type="checkbox"/>	4.0#
		Desk width 36"	TRWW4R36	<input type="checkbox"/>	5.0#
		Desk width 42"	TRWW4R42	<input type="checkbox"/>	5.0#
		Desk width 48"	TRWW4R48	<input type="checkbox"/>	8.0#
		Desk width 54"	TRWW4R54	<input type="checkbox"/>	8.0#
		Desk width 60"	TRWW4R60	<input type="checkbox"/>	11.0#
		Desk width 66"	TRWW4R66	<input type="checkbox"/>	11.0#
		Desk width 72"	TRWW4R72	<input type="checkbox"/>	12.0#
		Desk width 72"	TRWW4R72D	<input type="checkbox"/>	12.0#
 <p>TRAC</p>	Rigid Wireway 6-2-2 <ul style="list-style-type: none"> Includes rigid wireway electrical harness, steel wireway cover, and all required attachment hardware Available in two 10-wire styles. Note: 10-wire styles must match on all electrical parts Allows two duplex receptacles (ordered separately) to be mounted below the desk worksurface Size must match the desk length. Note: the 72D (dual) provides four possible receptacle locations 	Desk width 30"	TRWW6R30	<input type="checkbox"/>	4.0#
		Desk width 36"	TRWW6R36	<input type="checkbox"/>	5.0#
		Desk width 42"	TRWW6R42	<input type="checkbox"/>	6.0#
		Desk width 48"	TRWW6R48	<input type="checkbox"/>	8.0#
		Desk width 54"	TRWW6R54	<input type="checkbox"/>	9.0#
		Desk width 60"	TRWW6R60	<input type="checkbox"/>	10.0#
		Desk width 66"	TRWW6R66	<input type="checkbox"/>	11.0#
		Desk width 72"	TRWW6R72	<input type="checkbox"/>	12.0#
		Desk width 72"	TRWW6R72D	<input type="checkbox"/>	13.0#

A

B

HOW TO ORDER

Indicate the following information on order form:

- Quantity of each item.
- Model number, including options. See "How To Build a Model Number".
- Any special service required.

- Note:
- The indicates that a choice is required.
 - The absence of the indicates that no choice is required.
 - Alpha-numeric characters in place of indicate that no other alternatives are available.

HOW TO BUILD A MODEL NUMBER

- A** Select basic model.
- B** Select paint color. Refer to color addendum at ki.com or KI Fabrics & Finishes binder.



Delivered Pricing

\$ 121
134
150
170
233
299
363
420
420

\$ 121
134
150
170
233
299
363
420
420

SPECIAL SERVICES

Special Carton Marking

With specially marked information N/C

Shipping

Delivered. Shipped k.d. freight prepaid f.o.b. **Pembroke, Ontario K8A 0E1** factory. Freight class #70.

Specifications and prices are subject to change without prior notice.

True[®] Desking System Electrical

Electrical

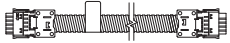
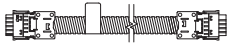
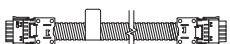
MODEL	Features	W	MODEL NUMBER		Approx. Packaged Weight
			Basic Model		
 HRDPT	Rigid Wireway Standard Desk Jumper 4-4-2 <ul style="list-style-type: none"> Includes jumper harness to make the electrical connection between adjacent desks Available in two 10-wire styles. Note: 10-wire styles must match on all electrical parts 	28"	TRDJ4ST		2.0#
 HRDPT	Rigid Wireway Standard Desk Jumper 6-2-2 <ul style="list-style-type: none"> Includes jumper harness to make the electrical connection between adjacent desks Available in two 10-wire styles. Note: 10-wire styles must match on all electrical parts 	28"	TRDJ6ST		2.0#
 HRDPT	Rigid Wireway Power Pass Through 4-4-2 <ul style="list-style-type: none"> Includes the power pass through harness that allows power to continue through one side of a desk between two rigid wireway equipped desks Available in two 10-wire styles. Note: 10-wire styles must match on all electrical parts Order length according to the desk width it is passing through 	Desk width 24"	TRE4PP24		3.0#
		Desk width 30"	TRE4PP30		3.0#
		Desk width 36"	TRE4PP36		3.0#
		Desk width 42"	TRE4PP42		3.0#
		Desk width 48"	TRE4PP48		3.0#
		Desk width 54"	TRE4PP54		3.0#
		Desk width 60"	TRE4PP60		3.0#
		Desk width 66"	TRE4PP66		3.0#
		Desk width 72"	TRE4PP72		4.0#
		 HRDPT	Rigid Wireway Power Pass Through 6-2-2 <ul style="list-style-type: none"> Includes the power pass through harness that allows power to continue through one side of a desk between two rigid wireway equipped desks Available in two 10-wire styles. Note: 10-wire styles must match on all electrical parts Order length according to the desk width it is passing through 	Desk width 24"	TRE6PP24
Desk width 30"	TRE6PP30				3.0#
Desk width 36"	TRE6PP36				3.0#
Desk width 42"	TRE6PP42				3.0#
Desk width 48"	TRE6PP48				4.0#
Desk width 54"	TRE6PP54				4.0#
Desk width 60"	TRE6PP60				4.0#
Desk width 66"	TRE6PP66				4.0#
Desk width 72"	TRE6PP72				4.0#



HOW TO ORDER

Indicate the following information on order form:

- Quantity of each item.
- Model number, including options. See "How To Build a Model Number".
- Any special service required.

- Note:
- The indicates that a choice is required.
 - The absence of the indicates that no choice is required.
 - Alpha-numeric characters in place of indicate that no other alternatives are available.

HOW TO BUILD A MODEL NUMBER

- A** Select basic model.



Delivered
Pricing
\$ 109

\$ 109

\$ 111
114
117
121
126
131
136
143
148

\$ 111
114
117
121
126
131
136
143
148

SPECIAL SERVICES

Special Carton Marking

With specially marked information N/C



Shipping

Delivered. Shipped k.d. freight prepaid
f.o.b. Pembroke, Ontario K8A 0E1 factory.
Freight class #70.

Specifications and prices are subject to
change without prior notice.

True® Desking System Electrical

Electrical

	MODEL	W	MODEL NUMBER		Approx. Packaged Weight
			Basic Model	Paint Color	
 TRAC	Rigid Wireway End Panel Trough/Desk Jumper 4-4-2 <ul style="list-style-type: none"> Includes jumper harness to make the electrical connection between adjacent desks See specifications for length that must be specified Available in two 10-wire styles. Note: 10-wire styles must match on all electrical parts 	24"	TEPT424	<input type="checkbox"/>	4.0#
		30"	TEPT430	<input type="checkbox"/>	5.0#
 TRAC	Rigid Wireway End Panel Trough/ Desk Jumper 6-2-2 <ul style="list-style-type: none"> Includes jumper harness to make the electrical connection between adjacent desks See specifications for length that must be specified Available in two 10-wire styles. Note: 10-wire styles must match on all electrical parts 	24"	TEPT624	<input type="checkbox"/>	4.0#
		30"	TEPT630	<input type="checkbox"/>	5.0#

A

B

HOW TO ORDER

Indicate the following information on order form:

- Quantity of each item.
- Model number, including options. See "How To Build a Model Number".
- Any special service required.

Note:

- The indicates that a choice is required.
- The absence of the indicates that no choice is required.
- Alpha-numeric characters in place of indicate that no other alternatives are available.

HOW TO BUILD A MODEL NUMBER

- A** Select basic model.
- B** Select paint color. Refer to color addendum at ki.com or KI Fabrics & Finishes binder.



Delivered
Pricing

\$ 180

197

\$ 180

197

SPECIAL SERVICES

Special Carton Marking

With specially marked information N/C

Shipping

Delivered. Shipped k.d. freight prepaid
f.o.b. **Pembroke, Ontario K8A 0E1** factory.
Freight class #70.

Specifications and prices are subject to
change without prior notice.

True® Desking System Electrical

Electrical

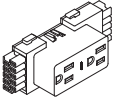
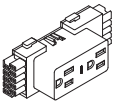
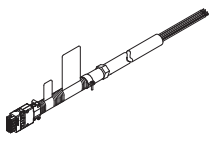
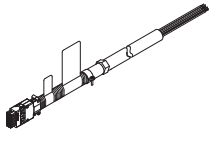
	MODEL	Features	L	MODEL NUMBER		Approx. Packaged Weight
				Basic Model	Accessory Color	
 <p>HRDPT</p>	Rigid Wireway Receptacles 4-4-2 • Includes the modular duplex 15 amp receptacle that snaps onto a rigid wireway • Available in two 10-wire styles. Note: 10-wire styles must match on all electrical parts			TRER4RC1	<input type="checkbox"/>	0.2#
				TRER4RC2	<input type="checkbox"/>	0.2#
				TRER4RC3I		0.2#
				TRER4RC4I		0.2#
 <p>HRDPT</p>	Rigid Wireway Receptacles 6-2-2 • Includes the modular duplex 15 amp receptacle that snaps onto a rigid wireway • Available in two 10-wire styles. Note: 10-wire styles must match on all electrical parts			TRER6RC1	<input type="checkbox"/>	0.2#
				TRER6RC2	<input type="checkbox"/>	0.2#
				TRER6RC3	<input type="checkbox"/>	0.2#
				TRER6RC4I		0.2#
				TRER6RC5I		0.2#
				TRER6RC6I		0.2#
 <p>HRDPT</p>	Rigid Wireway Base Feed 4-4-2 • Includes base feed harness with 6' of colored liquidtite conduit covering; used to feed power from a hard wired J-box or floor monument to the rigid wireway on a desk • Available in two 10-wire styles. Note: 10-wire styles must match on all electrical parts • Building connection hardware must be supplied by customer		72"	TEBI4BF6	<input type="checkbox"/>	7.0#
 <p>HRDPT</p>	Rigid Wireway Base Feed 6-2-2 • Includes base feed harness with 6' of colored liquidtite conduit covering; used to feed power from a hard wired J-box or floor monument to the rigid wireway on a desk • Available in two 10-wire styles. Note: 10-wire styles must match on all electrical parts • Building connection hardware must be supplied by customer		72"	TEBI6BF6	<input type="checkbox"/>	7.0#

A

B

HOW TO ORDER

Indicate the following information on order form:

1. Quantity of each item.
2. Model number, including options. See "How To Build a Model Number".
3. Any special service required.

Note:

- The indicates that a choice is required.
- The absence of the indicates that no choice is required.
- Alpha-numeric characters in place of indicate that no other alternatives are available.

HOW TO BUILD A MODEL NUMBER

- A** Select basic model.
- B** Select accessory color. Refer to color addendum at ki.com or KI Fabrics & Finishes binder.



Delivered
Pricing

\$ 36
36
36
36

\$ 36
36
36
36
36
36

\$ 232

\$ 232

SPECIAL SERVICES

Special Carton Marking

With specially marked information N/C



Shipping

Delivered. Shipped k.d. freight prepaid
f.o.b. **Pembroke, Ontario K8A 0E1** factory.
Freight class #70.

Specifications and prices are subject to
change without prior notice.

True® Desking System Electrical

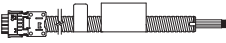
Electrical

	MODEL	H	MODEL NUMBER			Approx. Packaged Weight
			Basic Model	Trim Color	Paint Color	
 <p>TRAC</p>	Rigid Wireway Top Feed 6-2-2 • Includes electrical harness (144" or 216"), aluminum 2-channel power pole (7' or 10' respectively) and ceiling trim • Used to feed power from a hard wired J-box above a false ceiling to the rigid wireway or a desk • Attaches to the desk at a corner grommet location • Available in two 10-wire styles. Note: 10-wire styles must match on all electrical parts • Building connection hardware must be supplied by customer	144"	TE6TF144	<input type="checkbox"/> <input type="checkbox"/> <input type="checkbox"/>	<input type="checkbox"/> <input type="checkbox"/>	14.0#
		216"	TE6TF216	<input type="checkbox"/> <input type="checkbox"/> <input type="checkbox"/>	<input type="checkbox"/> <input type="checkbox"/>	19.0#
 <p>TRAC</p>	Rigid Wireway Top Feed 4-4-2 • Includes electrical harness (144" or 216"), aluminum 2-channel power pole (7' or 10' respectively) and ceiling trim • Used to feed power from a hard wired J-box above a false ceiling to the rigid wireway or a desk • Attaches to the desk at a corner grommet location • Available in two 10-wire styles. Note: 10-wire styles must match on all electrical parts • Building connection hardware must be supplied by customer	144"	TE4TF144	<input type="checkbox"/> <input type="checkbox"/> <input type="checkbox"/>	<input type="checkbox"/> <input type="checkbox"/>	13.0#
		216"	TE4TF216	<input type="checkbox"/> <input type="checkbox"/> <input type="checkbox"/>	<input type="checkbox"/> <input type="checkbox"/>	19.0#
 <p>HRDPT</p>	Stanchion Power Tap • Provides a duplex 15 amp receptacle that is located behind a desk stanchion door • Circuit number will be determined by the receptacle it is plugged into • Two cord lengths available: 36" and 96"	36"	TRESR36			0.5#
		96"	TRESR96			1.0#

A **B** **C**

HOW TO ORDER

Indicate the following information on order form:

- Quantity of each item.
- Model number, including options. See "How To Build a Model Number".
- Any special service required.

Note:

- The indicates that a choice is required.
- The absence of the indicates that no choice is required.
- Alpha-numeric characters in place of indicate that no other alternatives are available.

HOW TO BUILD A MODEL NUMBER

- A** Select basic model.
- B** Select paint color. Refer to color addendum at ki.com or KI Fabrics & Finishes binder.



Delivered
Pricing

\$ 171
227

\$ 171
227

\$ 105
126

SPECIAL SERVICES

Special Carton Marking

With specially marked information N/C

Shipping

Delivered. Shipped k.d. freight prepaid
f.o.b. **Pembroke, Ontario K8A 0E1** factory.
Freight class #70.

Specifications and prices are subject to
change without prior notice.

Index

Model No.	Description	Page	Model No.	Description	Page
7D/18CD	Center Drawer: Center Drawer	100	THC4242	Transaction Worksurfaces: Standard Height Transaction Counter Corner	60
BLCF30/TR	Balance® Overhead Storage: Fabric Upper Door	84	THR4824	Add-On Worksurfaces: Half Round Add-On Worksurface	56
BLCL30/TR	Balance® Overhead Storage: Laminate Upper Door	82	TI244860/F/A	Piano Desk: Piano Desk with Full Modesty Panel/No Partial Guest Modesty Panel	46
BLCS30/TR	Balance® Overhead Storage: Solid Color Upper Door	80	TI244860/F/G	Piano Desk: Piano Desk with Full Modesty Panel/Partial Guest Modesty Panel	44
BTLT5.24	Balance® Task Lights: Balance® Task Lights	86	TI244860/P/A	Piano Desk: Piano Desk with Partial Modesty Panel/No Partial Guest Modesty Panel	50
BWSC204242	Privacy Screens - Upholstered: Single Desk Corner Privacy Screen, mounted behind worksurface	70	TI244860/P/G	Piano Desk: Piano Desk with Partial Modesty Panel/Partial Guest Modesty Panel	48
NSD	Universal Overhead Shelves and Divider: Shelf Divider	96	TLC4242	Transaction Worksurfaces: Low Height Transaction Counter Corner	60
PPAT	Paper Management: Accessory Tray	78	TLLGC	Grommets: Lower Leg Grommet Cover	102
PPDS	Paper Management: Diagonal Storage	76	TLS24	Transaction Worksurfaces: Low Height Transaction Counter Straight	58
PPLL	Paper Management: Paper Tray	76	TLT5.24	Universal Overhead and Shelves Task Lights: Universal Overhead and Shelves Task Lights	98
PPPC	Paper Management: Pencil Cup	78	TP244860/F/A	P-Shaped Desk: P-Shaped Desk with Full Modesty Panel/No Partial Guest Modesty Panel	38
PPTC	Paper Management: Telephone Caddy	78	TP244860/F/G	P-Shaped Desk: P-Shaped Desk with Full Modesty Panel/Partial Guest Modesty Panel	36
PPVS	Paper Management: Vertical Storage	76	TP244860/P/A	P-Shaped Desk: P-Shaped Desk w/Partial Modesty Panel/No Partial Guest Modesty Panel	42
PRDF24/TR	Universal Overhead Storage: Fabric Overhead Cabinet	90	TP244860/P/G	P-Shaped Desk: P-Shaped Desk with Partial Modesty Panel/Partial Guest Modesty Panel	40
PRDL24/TR	Universal Overhead Storage: Laminate Overhead Cabinet	92	TQR24	Add-On Worksurfaces: Quarter Round Add-On Worksurface	56
PRDS24/TR	Universal Overhead Storage: Steel Overhead Cabinet	88	TR2424/F	Rectangular Desk: Rectangular Desk with Full Modesty Panel	6
PRDV24/TR	Universal Overhead Storage: Veneer Overhead Cabinet	94	TR2424/P	Rectangular Desk: Rectangular Desk with Partial Modesty Panel	8
TAFMP24	Modesty Panel Inserts: Full Modesty Panel Insert	106	TRDJ4ST	Electrical: Rigid Wireway Standard Desk Jumper 4-4-2	114
TAR24	Add-On Worksurfaces: Round Add-On Worksurface	56	TRDJ6ST	Electrical: Rigid Wireway Standard Desk Jumper 6-2-2	114
TATR24/SS	Tool Rails: Tool Rail, stanchion/stanchion mounted	74	TRE4PP24	Electrical: Rigid Wireway Power Pass Through 4-4-2	114
TBS24/E	Privacy Screens - Exposed Frame: Single Desk Privacy Screen, between stanchions	62	TRE6PP24	Electrical: Rigid Wireway Power Pass Through 6-2-2	114
TBS24/U	Privacy Screens - Upholstered: Single Desk Privacy Screen, between stanchions	68	TRER4RC1	Electrical: Rigid Wireway Receptacles 4-4-2	118
TBW2024	Privacy Screens - Upholstered: Single Desk Privacy Screen, mounted behind worksurface	68	TRER6RC1	Electrical: Rigid Wireway Receptacles 6-2-2	118
TC24424224/FF	Corner Desk: Corner Desk with Full Modesty Panel/Full Modesty Panel	12	TRESR36	Electrical: Stanchion Power Tap	120
TC24424224/FP	Corner Desk: Corner Desk with Full Modesty Panel/Partial Modesty Panel	14	TRWW4R30	Electrical: Rigid Wireway 4-4-2	112
TC24424224/PF	Corner Desk: Corner Desk with Partial Modesty Panel/Full Modesty Panel	16	TRWW6R30	Electrical: Rigid Wireway 6-2-2	112
TC24424224/PP	Corner Desk: Corner Desk with Partial Modesty Panel/Partial Modesty Panel	18	TS24486024/F/FS	Square Shoe Desk: Square Shoe Desk with Full Modesty Panel/Full Modesty Panel	20
TCLBG	Corner Power Infeed Leg: Corner Power Infeed Leg	104	TS24486024/F/PS	Square Shoe Desk: Square Shoe Desk with Full Modesty Panel/Partial Modesty Panel	22
TCOMCS	Accessories: Cable Support	110	TS24486024/P/FS	Square Shoe Desk: Square Shoe Desk with Partial Modesty Panel/Full Modesty Panel	24
TCOMFP	Accessories: Face Plate Bracket	110	TS24486024/P/PS	Square Shoe Desk: Square Shoe Desk with Partial Modesty Panel/Partial Modesty Panel	26
TCOMP10	Accessories: Communication Pole	110	TSE24/E	Privacy Screens - Exposed Frame: Shared Privacy Screen, stanchion/end mount	64
TD2448/F/A	D-Shaped Desk: D-Shaped Desk with Full Modesty Panel/No Partial Guest Modesty Panel	30	TSE24/U	Privacy Screens - Upholstered: Shared Privacy Screen, stanchion/end mount	72
TD2448/F/G	D-Shaped Desk: D-Shaped Desk with Full Modesty Panel/Partial Guest Modesty Panel	28	TSLG	Grommets: Standard Leg Grommet Frame	102
TD2448/P/A	D-Shaped Desk: D-Shaped Desk w/Partial Modesty Panel/No Partial Guest Modesty Panel	34	TSS24	Transaction Worksurfaces: Standard Height Transaction Counter Straight	58
TD2448/P/G	D-Shaped Desk: D-Shaped Desk with Partial Modesty Panel/Partial Guest Modesty Panel	32	TST11	Worksurface Accessories: Freestanding Stanchion Short	108
TE3060	Bow Front Desk: Bow Front Desk with Full Modesty Panel	10	TST19	Worksurface Accessories: Freestanding Stanchion Large	108
TE4TF144	Electrical: Rigid Wireway Top Feed 4-4-2	120	TTR244230/F	Transitional Desk: Transitional Desk with Full Modesty Panel	52
TE6TF144	Electrical: Rigid Wireway Top Feed 6-2-2	120			
TEB14BF6	Electrical: Rigid Wireway Base Feed 4-4-2	118			
TEB16BF6	Electrical: Rigid Wireway Base Feed 6-2-2	118			
TEE24/E	Privacy Screens - Exposed Frame: Shared Privacy Screen, end mount/end mount	64			
TEE24/U	Privacy Screens - Upholstered: Shared Privacy Screen, end mount/end mount	72			
TEPT424	Electrical: Rigid Wireway End Panel Trough/Desk Jumper 4-4-2	116			
TEPT624	Electrical: Rigid Wireway End Panel Trough/ Desk Jumper 6-2-2	116			



Model No.	Description	Page
TTR244230/P	Transitional Desk: Transitional Desk with Partial Modesty Panel	54
TULGC	Grommets: Upper Leg Grommet Cover	102
TWEE24/E	Privacy Screens - Exposed Frame: Single Desk Privacy Screen, end mount/end mount	62
TWEE24/U	Privacy Screens - Upholstered: Single Desk Privacy Screen, end mount/end mount	66
TWSE24/E	Privacy Screens - Exposed Frame: Single Desk Privacy Screen, stanchion/ end mount	62
TWSE24/U	Privacy Screens - Upholstered: Single Desk Privacy Screen, stanchion/end mount	66
TWSG	Grommets: Worksurface Grommet	102
TWSGC	Grommets: Worksurface Grommet Cover	102
ULSR24/TR	Universal Overhead Shelves and Divider: Low Shelf	96
URSR24/TR	Universal Overhead Shelves and Divider: Regular Shelf	96



KI
1330 Bellevue Street
P.O. Box 8100
Green Bay, Wisconsin 54308-8100
1-800-424-2432
www.ki.com

KI and Furnishing Knowledge
are registered trademarks
of Krueger International, Inc.

© 2011 KI
All Rights Reserved.
Litho in USA.
Code KI-11348R3/KI/VL/211

Printed using only water-based inks,
including metallics. Please recycle.