

October 6, 2010  
Updated January 2, 2017  
800-424-2432





<b>Unite® System</b>	General Information	4
<b>Preconfigured Monolithic Fabric Panel</b>		
	Standard Base Raceway	6
	Elevated Base	10
	Tile-to-Floor One Side; Standard Base Raceway One Side	12
<b>Preconfigured Monolithic Fabric Panel (Beltway Power)</b>		
	Standard Base Raceway	18
	Elevated Base	22
	Tile-to-Floor One Side; Standard Base Raceway One Side	26
<b>Preconfigured Monolithic Steel Panels</b>		
	Standard Base Raceway	30
	Elevated Base	32
	Tile-to-Floor One Side; Standard Base Raceway One Side	34
<b>Preconfigured Monolithic Steel Panels (Beltway Power)</b>		
	Standard Base Raceway	36
	Elevated Base	38
	Tile-to-Floor One Side; Standard Base Raceway One Side	40
<b>Preconfigured Monolithic Open Panels</b>		
	Standard Base Raceway	42
	Elevated Base	44
<b>Preconfigured Segmented Fabric Panel</b>		
	Standard Base Raceway	46
	Elevated Base	50
	Tile-to-Floor One Side; Standard Base Raceway One Side	54
<b>Preconfigured Segmented Fabric Panel w/Beltway Power</b>		
	Standard Base Raceway	58
	Elevated Base	62
	Tile-to-Floor One Side; Standard Base Raceway One Side	66
<b>Preconfigured Segmented Steel Panels w/Fabric Top Tiles</b>		
	Standard Base Raceway	70
	Elevated Base	74
	Tile-to-Floor One Side; Standard Base Raceway One Side	78
<b>Preconfigured Segmented Steel Panels w/Fabric Top Tiles Beltway/Power</b>		
	Standard Base Raceway	82
	Elevated Base	86
	Tile-to-Floor One Side; Standard Base Raceway One Side	90
<b>Preconfigured Segmented Open Panels w/Fabric Top Tiles</b>		
	Standard Base Raceway	94
	Elevated Base	98
<b>Preconfigured Segmented Fabric Panel w/Glass Top</b>		
	Standard Base Raceway	102
	Elevated Base	106
	Tile-to-Floor One Side; Standard Base Raceway One Side	110
<b>Preconfigured Segmented Fabric Panel w/Markerboard on One Side</b>		
	Standard Base Raceway	114
	Elevated Base	116
	Tile-to-Floor One Side; Standard Base Raceway One Side	118
<b>Preconfigured Segmented Fabric Panel w/Markerboard on Both Sides</b>		
	Standard Base Raceway	120
	Elevated Base	122
<b>Preconfigured Segmented Fabric Panel w/Perforated Steel Top</b>		
	Standard Base Raceway	124
	Elevated Base	128
	Tile-to-Floor One Side; Standard Base Raceway One Side	132
<b>Preconfigured Segmented Fabric Panel w/Slat Wall on One Side</b>		
	Standard Base Raceway	136
	Elevated Base	140
	Tile-to-Floor One Side; Standard Base Raceway One Side	144

<b>Preconfigured Segmented Fabric Panel w/Slat Wall on Two Sides</b>		
	Standard Base Raceway	148
	Elevated Base	152
<b>Stacking Panel</b>		
	Fabric	156
	Solid Steel	158
	Glass	160
	Perforated Steel	162
	Markerboard on One Side	164
	Markerboard on Both Sides	166
	Slat Wall on One Side	168
	Slat Wall on Two Sides	170
<b>Preconfigured Intersections</b>		
	2-Way 90° "L" Corner	172
	2-Way 180°	174
	3-Way 90°	176
	4-Way 90°	182
	2-Way 120°	190
	3-Way 120°	192
<b>End-of-Run Trim</b>		196
<b>Preconfigured Intersections</b>		
	Adjustable Wall Mount Start	198
	Perpendicular Start for Genius® Wall	200
	Universal Start for Genius® Wall	202
	Wall Track	204
<b>Preconfigured Stackable Intersections</b>		
	90° 1-Way, 2-Way, 3-Way and 4-Way	206
	2-Way 180° In-Line Spacer	208
	120° 1-Way, 2-Way, 3-Way and 4-Way	210
<b>Stacking End-of-Run Trim</b>		212
<b>Unite® Rolling Door</b>		
	General Information	214
	Thresholds	224
<b>Electrical</b>		
	10-Wire System 6 Circuit "810"	228
	10-Wire System 6 Circuit "810"/with Bezel for Raceway Use	234
	10-Wire System 6 Circuit "810"/for Beltway Use	236
	10-Wire System 6 Circuit "810"	238
	10-Wire System 4 Circuit "810"	242
	10-Wire System 4 Circuit "810"/with Bezel for Raceway Use	246
	10-Wire System 4 Circuit "810"/for Beltway Use	248
	10-Wire System 4 Circuit "810"	250
	New York Power - 10-Wire System 6 or 4 Circuit "810"	254
<b>Worksurfaces</b>		
	Rectangular	256
	Diagonal 90° Corner	260
	Extended Corner	262
	Extended Corner Reductions	266
	Conference End	270
	Tapered	272
	Peninsula	274
	120° End Corner	278
	120° End Corner/60° End Corner	280
	U-Series® Underhead	282
	Transaction Countertops	284
	Freestanding Tables	288
<b>Worksurface Support</b>		290
	Post Leg	294
<b>Support Leg</b>		
	Non-Panel Mounted, Open	296
	Non-Panel Mounted, Insert	298
	Panel Mounted, Open	300
	Panel Mounted, Insert	302
	Panel Mounted, Center	304

# Contents

Refer to KI Terms & Conditions document or visit [ki.com](http://ki.com).

<b>Universal Storage and Accessories</b>	
Overhead Storage	306
Overhead Accessories	316
Shelf/Cabinet Task Light	320
<b>Balance® Storage and Accessories</b>	
Overhead Storage	322
Overhead Accessories	328
Overhead Task Lights	332
<b>U-Series® Pedestals</b>	
Mobile	334
Freestanding	336
Worksurface Supporting	338
<b>U-Series® Double Pedestals</b>	
	340
<b>U-Series® Credenzas</b>	
Freestanding Credenzas	342
Laminate Tops	344
<b>U-Series® Wardrobe Towers</b>	
48" High Cabinet	346
64" High Cabinet	348
48" High Side Access Bookcase	350
64" High Side Access Bookcase	352
<b>U-Series® Overheads</b>	
	354
<b>U-Series® Underhead Storage</b>	
	356
<b>U-Series® Storage and Accessories</b>	
Overhead Accessories	358
Task Lights	360
<b>U-Series® Accessories</b>	
Pedestal Accessories	362
<b>Accessories</b>	
Acoustic Septum Kits	370
Glass Divider Screen	372
Frameless Modesty Panel with Acrylic Insert	374
Continuous Top Cap/Carpet Gripper/Alum Grommet	376
Power Modules	378
Bracket Assembly Kit/Receptacle Kit	380
Markerboards	382
Tackboard	384
Brackets	386
Paper Management	388
Desktop Accessories	390
<b>Unite® C.O.M. Yardage Requirements</b>	
	392
<b>Index</b>	
	394



# Contents

Refer to KI Terms & Conditions document or visit [ki.com](http://ki.com).

---

# Unite System

## General Information

### GENERAL INFORMATION

#### Overview

Unite is the unifying element that brings together architecture and furniture to create highly effective work environments that are both engaging and productive. As a comprehensive Systems offering, Unite features preconfigured panels, worksurfaces, storage elements and accessories, which together allow for dynamic solutions to current and future needs. Yet, Unite also brings a degree of simplicity to Systems furniture that other systems lack. Uncomplicated, but by no means boring, Unite simplifies the entire Systems furniture process—from planning and specifying, to ordering and installing—so more time is spent appreciating the end result and less time is spent worrying about the details.

#### Panels

Preconfigured monolithic and segmented Unite panels are available. All panels ship knockdown with panel frame, tiles, base components, top caps, adjustable glides, and panel-to-panel connection hardware. Panels may be specified without top caps to allow for attachment of spanning top caps or divider screens. All Unite panels meet the flame spread and smoke generation criteria defined in the UL 1286 safety standard for office furnishings.

Preconfigured panels are 3.5" thick to facilitate integration with KI Genius walls, and are available in the following dimensions:

- Widths: 24", 30", 36", 42", 48", 60" 72" (split tile on 72")
- Heights: 32", 40", 48", 56", 64"

Three base styles allow for functional and aesthetic planning flexibility:

- Standard base
- Elevated base
- Tile-to-floor base

Insert tiles are interchangeable among standard, elevated, and the standard base side of tile-to-floor panels. The tile height of the tile-to-floor tile is unique and not interchangeable. All tiles are hand-placed, requiring no tools for attachment to Unite frames. Standard and elevated base styles support future reconfiguration that substitutes either base style for the other.

Standard bases allow for distribution of power and data at the base of the panel. Elevated bases improve air circulation and lighten overall scale of the panel. Tile-to-floor panels feature a base raceway on the user side and no base raceway on the opposite side. Above worksurface bellline power is available regardless of preferred base style.

Preconfigured monolithic panels feature either fabric or steel tile inserts. Fabric tiles feature a wide variety of vertical fabrics adhered to acoustical fiberglass boards. Fab-

ric wraps around the board on all sides to minimize end fraying. Laminate and veneer tiles are also available as special finishes.

Preconfigured segmented panels are available in a variety of substrate and finish options. Segmented panels universally feature a 32" segmentation height, with specified upper and lower, and front and back tiles. Preconfigured substrates vary by configuration and may include:

- Fabric—upper and lower
- Powdercoated solid steel—lower
- Powdercoated perforated steel—upper
- Single pane glass—upper
- Steel laminated markerboard—upper
- Slat wall—upper

Slat wall tiles feature extruded slat wall on the lowest 8" of the tile, with fabric covering any area above the extrusion.

Preconfigured stacking sections add 16" to any Unite panel, and are retrofittable to existing installations. All parts and hardware are included. Preconfigured models are available with inserts of the following tiles:

- Fabric
- Powdercoated solid steel
- Powdercoated perforated steel
- Single pane glass
- Steel laminated markerboard
- Slat wall/fabric

#### Fabric Disclaimer:

"Fabric will be applied as swatched by the fabric manufacturer. Fabric that is required to be applied differently than is swatched will need a Special Cost Request written specifying the direction the fabric is to be applied. The posted standard lead time will apply to the Special Cost Request."

#### Connectors and Trim

All Unite panels include necessary panel connector blocks and light blocks. Connectors are universal and allow panel-to-panel connections of same or varied heights, as well as all panel-to-post and top cap connections.

Unite panels also include trim wherever possible. Trim included with panels consists of top cap, bottom trim channel or tile-to-floor trim, base raceway cover and foot shroud. Side/end trim and spanning top caps, along with their respective hardware, are specified separately. All Unite trim is powdercoated metal.

#### Electrical

Unite's electrical planning is simple and easy to specify. All Unite panels of 30" and greater widths feature two knockouts per side which accept duplex receptacles (24" panels feature a single knockout) for base or beltway power distribution. Elevated bases may be specified with power distribution at beltway height only. Tile-to-floor tiles do not feature cutouts, but may run pass-through cabling. Ten-wire electrical is available in

standard format, as well as Chicago- and New York-specific kits. Specifiable grommet locations ensure convenient access to power sources. All electrical components are specified separately and field installed.

#### Worksurfaces

Unite offers a variety of worksurface shapes designed to complement flexible workstation planning. All are available in a wide range of sizes. Edges and grommet locations may be specified. General worksurface styles include:

- Rectangle
- Corner
- Extended corner
- Extended corner reduction
- Conference end
- Tapered
- Peninsula
- Credenza and underhead tops
- 120 degree

#### Worksurface Support

Unite showcases a dynamic approach to planning through the use of multiple support options in a given workstation. All supports feature powdercoated steel. Powdercoated perforated steel inserts add design flair and added privacy.

Worksurface supporting legs are offered in two styles:

- Panel Supporting includes both open and insert styles. The frame ties the worksurface to an adjacent panel in place of a traditional return panel.
- Non-Panel Supporting legs are not tied to a panel, but offer a consistent aesthetic with the panel supporting frames.

Post legs may be used in place of frames for less foot restriction, or may be used in conjunction with panels or frames to support peninsula worksurfaces.

Cantilever brackets are also offered for more traditional planning. Standard and upscale versions are both offered.

#### Storage

Unite is designed to support all KI storage lines, but in particular complements U-Series storage. Integrated and freestanding storage is offered, including pedestals, laterals, over/under heads, credenzas, and towers. All work together to make efficient use of a user's valuable time and space.



# Preconfigured Monolithic Fabric Panel

Standard Base Raceway

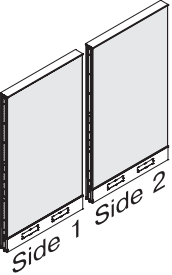
MODEL	W x H	MODEL NUMBER						Approx. Packaged Weight	
		Basic Model	Top Cap Style	Electrical Code	Trim Color	Fabric Side 1	Fabric Side 2		
 <p>UMFR</p> <p><b>Monolithic Fabric Panel - 32" H</b></p> <ul style="list-style-type: none"> <li>Standard base raceway on both sides accepts power and data cable distribution</li> <li>Includes monolithic fabric tiles for both sides</li> <li>Panel assembly includes frame, trim, and panel-to-panel connectors</li> <li>Trim is metal and includes top cap, bottom trim channel, and base raceway</li> <li>Side 1 and side 2 finishes are specified separately</li> <li>30-72" wide panels feature two power knockouts per side</li> <li>24" wide panels feature one power knockout per side</li> <li>72" wide panels feature split tiles</li> <li>Electrical components are specified separately</li> </ul>	24 x 32	UMFR2432	<input type="checkbox"/>	<input type="checkbox"/>	<input type="checkbox"/>	<input type="checkbox"/>	<input type="checkbox"/>	34.6#	
	30 x 32	UMFR3032	<input type="checkbox"/>	<input type="checkbox"/>	<input type="checkbox"/>	<input type="checkbox"/>	<input type="checkbox"/>	39.4#	
	36 x 32	UMFR3632	<input type="checkbox"/>	<input type="checkbox"/>	<input type="checkbox"/>	<input type="checkbox"/>	<input type="checkbox"/>	44.3#	
	42 x 32	UMFR4232	<input type="checkbox"/>	<input type="checkbox"/>	<input type="checkbox"/>	<input type="checkbox"/>	<input type="checkbox"/>	49.2#	
	48 x 32	UMFR4832	<input type="checkbox"/>	<input type="checkbox"/>	<input type="checkbox"/>	<input type="checkbox"/>	<input type="checkbox"/>	54.1#	
	60 x 32	UMFR6032	<input type="checkbox"/>	<input type="checkbox"/>	<input type="checkbox"/>	<input type="checkbox"/>	<input type="checkbox"/>	63.8#	
	72 x 32	UMFR7232	<input type="checkbox"/>	<input type="checkbox"/>	<input type="checkbox"/>	<input type="checkbox"/>	<input type="checkbox"/>	77.4#	
UMFR	<b>Monolithic Fabric Panel - 40" H</b>	24 x 40	UMFR2440	<input type="checkbox"/>	<input type="checkbox"/>	<input type="checkbox"/>	<input type="checkbox"/>	<input type="checkbox"/>	39.4#
	30 x 40	UMFR3040	<input type="checkbox"/>	<input type="checkbox"/>	<input type="checkbox"/>	<input type="checkbox"/>	<input type="checkbox"/>	44.7#	
	36 x 40	UMFR3640	<input type="checkbox"/>	<input type="checkbox"/>	<input type="checkbox"/>	<input type="checkbox"/>	<input type="checkbox"/>	50.1#	
	42 x 40	UMFR4240	<input type="checkbox"/>	<input type="checkbox"/>	<input type="checkbox"/>	<input type="checkbox"/>	<input type="checkbox"/>	55.6#	
	48 x 40	UMFR4840	<input type="checkbox"/>	<input type="checkbox"/>	<input type="checkbox"/>	<input type="checkbox"/>	<input type="checkbox"/>	61.0#	
	60 x 40	UMFR6040	<input type="checkbox"/>	<input type="checkbox"/>	<input type="checkbox"/>	<input type="checkbox"/>	<input type="checkbox"/>	71.8#	
	72 x 40	UMFR7240	<input type="checkbox"/>	<input type="checkbox"/>	<input type="checkbox"/>	<input type="checkbox"/>	<input type="checkbox"/>	87.6#	
UMFR	<b>Monolithic Fabric Panel - 48" H</b>	24 x 48	UMFR2448	<input type="checkbox"/>	<input type="checkbox"/>	<input type="checkbox"/>	<input type="checkbox"/>	<input type="checkbox"/>	44.3#
	30 x 48	UMFR3048	<input type="checkbox"/>	<input type="checkbox"/>	<input type="checkbox"/>	<input type="checkbox"/>	<input type="checkbox"/>	50.2#	
	36 x 48	UMFR3648	<input type="checkbox"/>	<input type="checkbox"/>	<input type="checkbox"/>	<input type="checkbox"/>	<input type="checkbox"/>	56.1#	
	42 x 48	UMFR4248	<input type="checkbox"/>	<input type="checkbox"/>	<input type="checkbox"/>	<input type="checkbox"/>	<input type="checkbox"/>	62.1#	
	48 x 48	UMFR4848	<input type="checkbox"/>	<input type="checkbox"/>	<input type="checkbox"/>	<input type="checkbox"/>	<input type="checkbox"/>	68.0#	
	60 x 48	UMFR6048	<input type="checkbox"/>	<input type="checkbox"/>	<input type="checkbox"/>	<input type="checkbox"/>	<input type="checkbox"/>	79.8#	
	72 x 48	UMFR7248	<input type="checkbox"/>	<input type="checkbox"/>	<input type="checkbox"/>	<input type="checkbox"/>	<input type="checkbox"/>	90.0#	

**A**   **B**   **C**   **D**   **E**   **F**

## HOW TO ORDER

Indicate the following information on order form:

- Quantity of each item.
- Model number, including options. See "How To Build a Model Number".
- Any special service required.

Note: • The  indicates that a choice is required.

- The absence of the  indicates that no choice is required.
- Alpha-numeric characters in place of

indicate that no other alternatives are available.

## HOW TO BUILD A MODEL NUMBER

- A** Select basic model.
- B** Select top cap style.
 

<b>F</b>	- Flat trim (std)
<b>N</b>	- No topcap
- C** Select electrical code.
 

<b>CP</b>	- Chicago - with cutouts
<b>DN</b>	- Domestic - no cutouts
<b>DP</b>	- Domestic - with cutouts
<b>C1</b>	- Chicago, 1 side w/cutouts
<b>D1</b>	- Domestic, 1 side w/cutouts
- D** Select trim color.  
Refer to color addendum at ki.com or KI Fabrics & Finishes binder.
- E** Select fabric side 1.  
Refer to color addendum at ki.com or in KI Fabrics & Finishes binder.
- F** Select fabric side 2.  
Refer to color addendum at ki.com or in KI Fabrics & Finishes binder.





# Preconfigured Monolithic Fabric Panel

Standard Base Raceway

Delivered Pricing Fabric Grade 1 & C.O.M.	Delivered Pricing Fabric Grade 2	Delivered Pricing Fabric Grade 3 & Pallas Vertical Fabric Grade PV	Delivered Pricing Pallas Vertical Fabric Grade PV1	Delivered Pricing Pallas Vertical Fabric Grade PV2
\$ 312	\$ 328	\$ 339	\$ 347	\$ 371
355	372	385	394	421
386	404	418	428	457
414	432	447	459	488
435	455	471	482	514
541	565	586	599	640
689	721	746	765	816
\$ 337	\$ 353	\$ 365	\$ 374	\$ 399
381	399	413	423	451
431	450	468	478	510
472	492	511	523	558
488	512	529	543	579
582	609	629	646	689
768	804	832	853	908
\$ 369	\$ 385	\$ 399	\$ 410	\$ 436
418	438	453	465	495
478	502	519	530	567
553	577	596	613	652
569	595	616	632	675
672	701	727	745	793
862	902	934	957	1021

## SPECIAL SERVICES

### Special Carton Marking

With specially marked information N/C

### Shipping

Delivered. Shipped k.d. freight prepaid f.o.b. Manitowoc, Wisconsin 54220 factory. Freight class #70.

Specifications and prices are subject to change without prior notice.

# Preconfigured Monolithic Fabric Panel

Standard Base Raceway

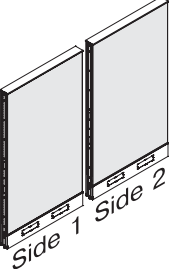
	MODEL	W x H	MODEL NUMBER						Approx. Packaged Weight
			Basic Model	Top Cap Style	Electrical Code	Trim Color	Fabric Side 1	Fabric Side 2	
 <p>UMFR</p>	<b>Monolithic Fabric Panel - 56" H</b>	24 x 56	UMFR2456	<input type="checkbox"/>	<input type="checkbox"/>	<input type="checkbox"/>	<input type="checkbox"/>	<input type="checkbox"/>	49.2#
	<ul style="list-style-type: none"> <li>Standard base raceway on both sides accepts power and data cable distribution</li> <li>Includes monolithic fabric tiles for both sides</li> <li>Panel assembly includes frame, trim, and panel-to-panel connectors</li> <li>Trim is metal and includes top cap, bottom trim channel, and base raceway</li> <li>Side 1 and side 2 finishes are specified separately</li> <li>30-72" wide panels feature two power knockouts per side</li> <li>24" wide panels feature one power knockout per side</li> <li>72" wide panels feature split tiles</li> <li>Electrical components are specified separately</li> </ul>	30 x 56	UMFR3056	<input type="checkbox"/>	<input type="checkbox"/>	<input type="checkbox"/>	<input type="checkbox"/>	<input type="checkbox"/>	55.6#
		36 x 56	UMFR3656	<input type="checkbox"/>	<input type="checkbox"/>	<input type="checkbox"/>	<input type="checkbox"/>	<input type="checkbox"/>	62.1#
		42 x 56	UMFR4256	<input type="checkbox"/>	<input type="checkbox"/>	<input type="checkbox"/>	<input type="checkbox"/>	<input type="checkbox"/>	68.6#
		48 x 56	UMFR4856	<input type="checkbox"/>	<input type="checkbox"/>	<input type="checkbox"/>	<input type="checkbox"/>	<input type="checkbox"/>	75.0#
		60 x 56	UMFR6056	<input type="checkbox"/>	<input type="checkbox"/>	<input type="checkbox"/>	<input type="checkbox"/>	<input type="checkbox"/>	87.9#
		72 x 56	UMFR7256	<input type="checkbox"/>	<input type="checkbox"/>	<input type="checkbox"/>	<input type="checkbox"/>	<input type="checkbox"/>	108.4#
UMFR	<b>Monolithic Fabric Panel - 64" H</b>	24 x 64	UMFR2464	<input type="checkbox"/>	<input type="checkbox"/>	<input type="checkbox"/>	<input type="checkbox"/>	<input type="checkbox"/>	53.6#
		30 x 64	UMFR3064	<input type="checkbox"/>	<input type="checkbox"/>	<input type="checkbox"/>	<input type="checkbox"/>	<input type="checkbox"/>	60.5#
		36 x 64	UMFR3664	<input type="checkbox"/>	<input type="checkbox"/>	<input type="checkbox"/>	<input type="checkbox"/>	<input type="checkbox"/>	67.5#
		42 x 64	UMFR4264	<input type="checkbox"/>	<input type="checkbox"/>	<input type="checkbox"/>	<input type="checkbox"/>	<input type="checkbox"/>	74.5#
		48 x 64	UMFR4864	<input type="checkbox"/>	<input type="checkbox"/>	<input type="checkbox"/>	<input type="checkbox"/>	<input type="checkbox"/>	81.5#
		60 x 64	UMFR6064	<input type="checkbox"/>	<input type="checkbox"/>	<input type="checkbox"/>	<input type="checkbox"/>	<input type="checkbox"/>	95.4#
		72 x 64	UMFR7264	<input type="checkbox"/>	<input type="checkbox"/>	<input type="checkbox"/>	<input type="checkbox"/>	<input type="checkbox"/>	118.2#
				<b>A</b>	<b>B</b>	<b>C</b>	<b>D</b>	<b>E</b>	<b>F</b>

## HOW TO ORDER

Indicate the following information on order form:

- Quantity of each item.
- Model number, including options. See "How To Build a Model Number".
- Any special service required.

Note: • The  indicates that a choice is required.

- The absence of the  indicates that no choice is required.
- Alpha-numeric characters in place of  indicate that no other alternatives are available.

## HOW TO BUILD A MODEL NUMBER

**A** Select basic model.

**B** Select top cap style.

- F** - Flat trim (std)  
**N** - No topcap

**C** Select electrical code.

- CP** - Chicago - with cutouts  
**DN** - Domestic - no cutouts  
**DP** - Domestic - with cutouts  
**C1** - Chicago, 1 side w/cutouts  
**D1** - Domestic, 1 side w/cutouts

**D** Select trim color.

Refer to color addendum at ki.com or KI Fabrics & Finishes binder.

**E** Select fabric side 1.

Refer to color addendum at ki.com or in KI Fabrics & Finishes binder.

**F** Select fabric side 2.

Refer to color addendum at ki.com or in KI Fabrics & Finishes binder.



# Preconfigured Monolithic Fabric Panel

Elevated Base

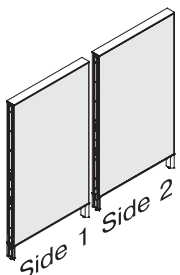
MODEL	W x H	MODEL NUMBER					Approx. Packaged Weight
		Basic Model	Top Cap Style	Trim Color	Fabric Side 1	Fabric Side 2	
 <p><b>Monolithic Fabric Panel - 32" H</b></p> <ul style="list-style-type: none"> <li>Elevated base does not accept cable distribution</li> <li>Includes monolithic fabric tiles for both sides</li> <li>Panel assembly includes frame, trim, and panel-to-panel connectors</li> <li>Trim is metal and includes top cap, bottom trim channel, and foot shroud</li> <li>Side 1 and side 2 finishes are specified separately</li> <li>72" wide panels feature split tiles</li> </ul>	24 x 32	UMFL2432	<input type="checkbox"/>	<input type="checkbox"/>	<input type="checkbox"/>	<input type="checkbox"/>	32.4#
	30 x 32	UMFL3032	<input type="checkbox"/>	<input type="checkbox"/>	<input type="checkbox"/>	<input type="checkbox"/>	36.5#
	36 x 32	UMFL3632	<input type="checkbox"/>	<input type="checkbox"/>	<input type="checkbox"/>	<input type="checkbox"/>	40.5#
	42 x 32	UMFL4232	<input type="checkbox"/>	<input type="checkbox"/>	<input type="checkbox"/>	<input type="checkbox"/>	44.6#
	48 x 32	UMFL4832	<input type="checkbox"/>	<input type="checkbox"/>	<input type="checkbox"/>	<input type="checkbox"/>	48.7#
	60 x 32	UMFL6032	<input type="checkbox"/>	<input type="checkbox"/>	<input type="checkbox"/>	<input type="checkbox"/>	56.8#
	72 x 32	UMFL7232	<input type="checkbox"/>	<input type="checkbox"/>	<input type="checkbox"/>	<input type="checkbox"/>	68.8#
UMFL							
<p><b>Monolithic Fabric Panel - 40" H</b></p>	24 x 40	UMFL2440	<input type="checkbox"/>	<input type="checkbox"/>	<input type="checkbox"/>	<input type="checkbox"/>	37.2#
	30 x 40	UMFL3040	<input type="checkbox"/>	<input type="checkbox"/>	<input type="checkbox"/>	<input type="checkbox"/>	41.8#
	36 x 40	UMFL3640	<input type="checkbox"/>	<input type="checkbox"/>	<input type="checkbox"/>	<input type="checkbox"/>	46.4#
	42 x 40	UMFL4240	<input type="checkbox"/>	<input type="checkbox"/>	<input type="checkbox"/>	<input type="checkbox"/>	51.0#
	48 x 40	UMFL4840	<input type="checkbox"/>	<input type="checkbox"/>	<input type="checkbox"/>	<input type="checkbox"/>	55.6#
	60 x 40	UMFL6040	<input type="checkbox"/>	<input type="checkbox"/>	<input type="checkbox"/>	<input type="checkbox"/>	64.8#
	72 x 40	UMFL7240	<input type="checkbox"/>	<input type="checkbox"/>	<input type="checkbox"/>	<input type="checkbox"/>	79.0#
UMFL							
<p><b>Monolithic Fabric Panel - 48" H</b></p>	24 x 48	UMFL2448	<input type="checkbox"/>	<input type="checkbox"/>	<input type="checkbox"/>	<input type="checkbox"/>	42.1#
	30 x 48	UMFL3048	<input type="checkbox"/>	<input type="checkbox"/>	<input type="checkbox"/>	<input type="checkbox"/>	47.2#
	36 x 48	UMFL3648	<input type="checkbox"/>	<input type="checkbox"/>	<input type="checkbox"/>	<input type="checkbox"/>	52.3#
	42 x 48	UMFL4248	<input type="checkbox"/>	<input type="checkbox"/>	<input type="checkbox"/>	<input type="checkbox"/>	57.5#
	48 x 48	UMFL4848	<input type="checkbox"/>	<input type="checkbox"/>	<input type="checkbox"/>	<input type="checkbox"/>	62.6#
	60 x 48	UMFL6048	<input type="checkbox"/>	<input type="checkbox"/>	<input type="checkbox"/>	<input type="checkbox"/>	72.9#
	72 x 48	UMFL7248	<input type="checkbox"/>	<input type="checkbox"/>	<input type="checkbox"/>	<input type="checkbox"/>	89.4#
UMFL							

**A**   **B**   **C**   **D**   **E**

## HOW TO ORDER

Indicate the following information on order form:

- Quantity of each item.
- Model number, including options. See "How To Build a Model Number".
- Any special service required.

Note: • The  indicates that a choice is required.

- The absence of the  indicates that no choice is required.
- Alpha-numeric characters in place of  indicate that no other alternatives are available.

## HOW TO BUILD A MODEL NUMBER

- A** Select basic model.
- B** Select top cap style.
 

<b>F</b>	- Flat trim (std)
<b>N</b>	- No topcap
- C** Select trim color. Refer to color addendum at [ki.com](http://ki.com) or KI Fabrics & Finishes binder.
- D** Select fabric side 1. Refer to color addendum at [ki.com](http://ki.com) or in KI Fabrics & Finishes binder.
- E** Select fabric side 2. Refer to color addendum at [ki.com](http://ki.com) or in KI Fabrics & Finishes binder.



# Preconfigured Monolithic Fabric Panel

Elevated Base

Delivered Pricing Fabric Grade 1 & C.O.M.	Delivered Pricing Fabric Grade 2	Delivered Pricing Fabric Grade 3 & Pallas Vertical Fabric Grade PV	Delivered Pricing Pallas Vertical Fabric Grade PV1	Delivered Pricing Pallas Vertical Fabric Grade PV2
\$ 312	\$ 328	\$ 339	\$ 347	\$ 371
355	372	385	394	421
386	404	418	428	457
414	432	447	459	488
435	455	471	482	514
541	565	586	599	640
689	721	746	765	816
\$ 337	\$ 353	\$ 365	\$ 374	\$ 399
381	399	413	423	451
431	450	468	478	510
472	492	511	523	558
488	512	529	543	579
582	609	629	646	689
768	804	832	853	908
\$ 369	\$ 385	\$ 399	\$ 410	\$ 436
418	438	453	465	495
478	502	519	530	567
553	577	596	613	652
569	595	616	632	675
672	701	727	745	793
862	902	934	957	1021

# Preconfigured Monolithic Fabric Panel

Elevated Base

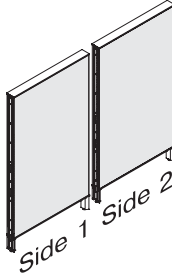
MODEL	W x H	MODEL NUMBER					Approx. Packaged Weight
		Basic Model	Top Cap Style	Trim Color	Fabric Side 1	Fabric Side 2	
 <p><b>Monolithic Fabric Panel - 56" H</b></p> <ul style="list-style-type: none"> <li>Elevated base does not accept cable distribution</li> <li>Includes monolithic fabric tiles for both sides</li> <li>Panel assembly includes frame, trim, and panel-to-panel connectors</li> <li>Trim is metal and includes top cap, bottom trim channel, and foot shroud</li> <li>Side 1 and side 2 finishes are specified separately</li> <li>72" wide panels feature split tiles</li> </ul>	24 x 56	UMFL2456	<input type="checkbox"/>	<input type="checkbox"/>	<input type="checkbox"/>	<input type="checkbox"/>	47.0#
	30 x 56	UMFL3056	<input type="checkbox"/>	<input type="checkbox"/>	<input type="checkbox"/>	<input type="checkbox"/>	52.7#
	36 x 56	UMFL3656	<input type="checkbox"/>	<input type="checkbox"/>	<input type="checkbox"/>	<input type="checkbox"/>	58.3#
	42 x 56	UMFL4256	<input type="checkbox"/>	<input type="checkbox"/>	<input type="checkbox"/>	<input type="checkbox"/>	64.0#
	48 x 56	UMFL4856	<input type="checkbox"/>	<input type="checkbox"/>	<input type="checkbox"/>	<input type="checkbox"/>	69.7#
	60 x 56	UMFL6056	<input type="checkbox"/>	<input type="checkbox"/>	<input type="checkbox"/>	<input type="checkbox"/>	81.0#
	72 x 56	UMFL7256	<input type="checkbox"/>	<input type="checkbox"/>	<input type="checkbox"/>	<input type="checkbox"/>	99.8#
	UMFL						
<p><b>Monolithic Fabric Panel - 64" H</b></p>	24 x 64	UMFL2464	<input type="checkbox"/>	<input type="checkbox"/>	<input type="checkbox"/>	<input type="checkbox"/>	51.4#
	30 x 64	UMFL3064	<input type="checkbox"/>	<input type="checkbox"/>	<input type="checkbox"/>	<input type="checkbox"/>	57.5#
	36 x 64	UMFL3664	<input type="checkbox"/>	<input type="checkbox"/>	<input type="checkbox"/>	<input type="checkbox"/>	63.7#
	42 x 64	UMFL4264	<input type="checkbox"/>	<input type="checkbox"/>	<input type="checkbox"/>	<input type="checkbox"/>	69.9#
	48 x 64	UMFL4864	<input type="checkbox"/>	<input type="checkbox"/>	<input type="checkbox"/>	<input type="checkbox"/>	76.1#
	60 x 64	UMFL6064	<input type="checkbox"/>	<input type="checkbox"/>	<input type="checkbox"/>	<input type="checkbox"/>	88.5#
	72 x 64	UMFL7264	<input type="checkbox"/>	<input type="checkbox"/>	<input type="checkbox"/>	<input type="checkbox"/>	109.6#
	UMFL						

**A**   **B**   **C**   **D**   **E**

## HOW TO ORDER

Indicate the following information on order form:

- Quantity of each item.
- Model number, including options. See "How To Build a Model Number".
- Any special service required.

Note: • The  indicates that a choice is required.

- The absence of the  indicates that no choice is required.
- Alpha-numeric characters in place of  indicate that no other alternatives are available.

## HOW TO BUILD A MODEL NUMBER

- A** Select basic model.
- B** Select top cap style.
 

<b>F</b>	- Flat trim (std)
<b>N</b>	- No topcap
- C** Select trim color.  
Refer to color addendum at [ki.com](http://ki.com) or KI Fabrics & Finishes binder.
- D** Select fabric side 1.  
Refer to color addendum at [ki.com](http://ki.com) or in KI Fabrics & Finishes binder.
- E** Select fabric side 2.  
Refer to color addendum at [ki.com](http://ki.com) or in KI Fabrics & Finishes binder.



# Preconfigured Monolithic Fabric Panel

Elevated Base

Delivered Pricing Fabric Grade 1 & C.O.M.	Delivered Pricing Fabric Grade 2	Delivered Pricing Fabric Grade 3 & Pallas Vertical Fabric Grade PV	Delivered Pricing Pallas Vertical Fabric Grade PV1	Delivered Pricing Pallas Vertical Fabric Grade PV2
\$ 403	\$ 421	\$ 436	\$ 447	\$ 477
479	502	519	531	567
522	545	564	579	617
572	598	619	636	678
617	645	668	685	730
760	794	823	845	900
945	988	1023	1048	1118
\$ 421	\$ 440	\$ 456	\$ 468	\$ 500
492	516	534	548	584
537	562	583	596	637
590	617	639	654	697
634	663	687	703	750
778	813	843	863	921
982	1027	1062	1089	1160

## SPECIAL SERVICES

### Special Carton Marking

With specially marked information N/C

### Shipping

Shipped k.d. freight prepaid f.o.b. Manitowoc, Wisconsin 54220 factory. Freight class #70.

Specifications and prices are subject to change without prior notice.

# Preconfigured Monolithic Fabric Panel

Tile-to-Floor One Side; Standard Base Raceway One Side

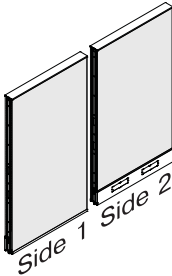
	MODEL	W x H	MODEL NUMBER						Approx. Packaged Weight
			Basic Model	Top Cap Style	Electrical Code	Trim Color	Fabric Side 1	Fabric Side 2	
 <p>UMFT</p>	<b>Monolithic Fabric Panel - 32" H</b>	24 x 32	UMFT2432	<input type="checkbox"/>	<input type="checkbox"/>	<input type="checkbox"/>	<input type="checkbox"/>	<input type="checkbox"/>	33.6#
	• Side 1: tile-to-floor base does not accept cable distribution	30 x 32	UMFT3032	<input type="checkbox"/>	<input type="checkbox"/>	<input type="checkbox"/>	<input type="checkbox"/>	<input type="checkbox"/>	38.1#
	• Side 2: standard base raceway accepts power and data cable distribution	36 x 32	UMFT3632	<input type="checkbox"/>	<input type="checkbox"/>	<input type="checkbox"/>	<input type="checkbox"/>	<input type="checkbox"/>	42.7#
	• Includes monolithic fabric tiles for both sides	42 x 32	UMFT4232	<input type="checkbox"/>	<input type="checkbox"/>	<input type="checkbox"/>	<input type="checkbox"/>	<input type="checkbox"/>	47.3#
	• Panel assembly includes frame, trim, and panel-to-panel connectors	48 x 32	UMFT4832	<input type="checkbox"/>	<input type="checkbox"/>	<input type="checkbox"/>	<input type="checkbox"/>	<input type="checkbox"/>	51.9#
	• Trim is metal and includes top cap, bottom trim channel, and base raceway	60 x 32	UMFT6032	<input type="checkbox"/>	<input type="checkbox"/>	<input type="checkbox"/>	<input type="checkbox"/>	<input type="checkbox"/>	61.0#
	• Side 1 and side 2 finishes are specified separately	72 x 32	UMFT7232	<input type="checkbox"/>	<input type="checkbox"/>	<input type="checkbox"/>	<input type="checkbox"/>	<input type="checkbox"/>	74.0#
• 30-72" wide tiles feature two power knockouts on side 2									
• 24" wide tiles feature one power knockout on side 2									
• 72" wide panels feature split tiles									
• Electrical components are specified separately									
UMFT	<b>Monolithic Fabric Panel - 40" H</b>	24 x 40	UMFT2440	<input type="checkbox"/>	<input type="checkbox"/>	<input type="checkbox"/>	<input type="checkbox"/>	<input type="checkbox"/>	38.4#
		30 x 40	UMFT3040	<input type="checkbox"/>	<input type="checkbox"/>	<input type="checkbox"/>	<input type="checkbox"/>	<input type="checkbox"/>	43.4#
		36 x 40	UMFT3640	<input type="checkbox"/>	<input type="checkbox"/>	<input type="checkbox"/>	<input type="checkbox"/>	<input type="checkbox"/>	48.5#
		42 x 40	UMFT4240	<input type="checkbox"/>	<input type="checkbox"/>	<input type="checkbox"/>	<input type="checkbox"/>	<input type="checkbox"/>	53.7#
		48 x 40	UMFT4840	<input type="checkbox"/>	<input type="checkbox"/>	<input type="checkbox"/>	<input type="checkbox"/>	<input type="checkbox"/>	58.8#
		60 x 40	UMFT6040	<input type="checkbox"/>	<input type="checkbox"/>	<input type="checkbox"/>	<input type="checkbox"/>	<input type="checkbox"/>	69.0#
		72 x 40	UMFT7240	<input type="checkbox"/>	<input type="checkbox"/>	<input type="checkbox"/>	<input type="checkbox"/>	<input type="checkbox"/>	84.2#
UMFT	<b>Monolithic Fabric Panel - 48" H</b>	24 x 48	UMFT2448	<input type="checkbox"/>	<input type="checkbox"/>	<input type="checkbox"/>	<input type="checkbox"/>	<input type="checkbox"/>	43.3#
		30 x 48	UMFT3048	<input type="checkbox"/>	<input type="checkbox"/>	<input type="checkbox"/>	<input type="checkbox"/>	<input type="checkbox"/>	48.9#
		36 x 48	UMFT3648	<input type="checkbox"/>	<input type="checkbox"/>	<input type="checkbox"/>	<input type="checkbox"/>	<input type="checkbox"/>	54.5#
		42 x 48	UMFT4248	<input type="checkbox"/>	<input type="checkbox"/>	<input type="checkbox"/>	<input type="checkbox"/>	<input type="checkbox"/>	60.2#
		48 x 48	UMFT4848	<input type="checkbox"/>	<input type="checkbox"/>	<input type="checkbox"/>	<input type="checkbox"/>	<input type="checkbox"/>	65.8#
		60 x 48	UMFT6048	<input type="checkbox"/>	<input type="checkbox"/>	<input type="checkbox"/>	<input type="checkbox"/>	<input type="checkbox"/>	77.1#
		72 x 48	UMFT7248	<input type="checkbox"/>	<input type="checkbox"/>	<input type="checkbox"/>	<input type="checkbox"/>	<input type="checkbox"/>	94.6#

**A**   **B**   **C**   **D**   **E**   **F**

## HOW TO ORDER

Indicate the following information on order form:

- Quantity of each item.
- Model number, including options. See "How To Build a Model Number".
- Any special service required.

Note: • The  indicates that a choice is required.

- The absence of the  indicates that no choice is required.
- Alpha-numeric characters in place of  indicate that no other alternatives are available.

## HOW TO BUILD A MODEL NUMBER

- A** Select basic model.
- B** Select top cap style.
 

<b>F</b>	- Flat trim (std)
<b>N</b>	- No topcap
- C** Select electrical code.
 

<b>CP</b>	- Chicago - with cutouts
<b>DN</b>	- Domestic - no cutouts
<b>DP</b>	- Domestic - with cutouts
- D** Select trim color.  
Refer to color addendum at ki.com or KI Fabrics & Finishes binder.
- E** Select fabric side 1.  
Refer to color addendum at ki.com or in KI Fabrics & Finishes binder.
- F** Select fabric side 2.  
Refer to color addendum at ki.com or in KI Fabrics & Finishes binder.





# Preconfigured Monolithic Fabric Panel

Tile-to-Floor One Side; Standard Base Raceway One Side

Delivered Pricing Fabric Grade 1 & C.O.M.	Delivered Pricing Fabric Grade 2	Delivered Pricing Fabric Grade 3 & Pallas Vertical Fabric Grade PV	Delivered Pricing Pallas Vertical Fabric Grade PV1	Delivered Pricing Pallas Vertical Fabric Grade PV2
\$ 312	\$ 328	\$ 339	\$ 347	\$ 371
355	372	385	394	421
386	404	418	428	457
414	432	447	459	488
435	455	471	482	514
541	565	586	599	640
689	721	746	765	816
\$ 337	\$ 353	\$ 365	\$ 374	\$ 399
381	399	413	423	451
431	450	468	478	510
472	492	511	523	558
488	512	529	543	579
582	609	629	646	689
768	804	832	853	908
\$ 369	\$ 385	\$ 399	\$ 410	\$ 436
418	438	453	465	495
478	502	519	530	567
553	577	596	613	652
569	595	616	632	675
672	701	727	745	793
862	902	934	957	1021

# Preconfigured Monolithic Fabric Panel

Tile-to-Floor One Side; Standard Base Raceway One Side

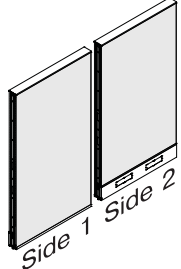
	MODEL	W x H	MODEL NUMBER						Approx. Packaged Weight	
			Basic Model	Top Cap Style	Electrical Code	Trim Color	Fabric Side 1	Fabric Side 2		
 <p>UMFT</p>	<b>Monolithic Fabric Panel - 56" H</b>	24 x 56	UMFT2456	<input type="checkbox"/>	<input type="checkbox"/>	<input type="checkbox"/>	<input type="checkbox"/>	<input type="checkbox"/>	<input type="checkbox"/>	48.2#
	<ul style="list-style-type: none"> <li>Side 1: tile-to-floor base does not accept cable distribution</li> </ul>	30 x 56	UMFT3056	<input type="checkbox"/>	<input type="checkbox"/>	<input type="checkbox"/>	<input type="checkbox"/>	<input type="checkbox"/>	<input type="checkbox"/>	54.3#
	<ul style="list-style-type: none"> <li>Side 2: standard base raceway accepts power and data cable distribution</li> </ul>	36 x 56	UMFT3656	<input type="checkbox"/>	<input type="checkbox"/>	<input type="checkbox"/>	<input type="checkbox"/>	<input type="checkbox"/>	<input type="checkbox"/>	60.5#
	<ul style="list-style-type: none"> <li>Includes monolithic fabric tiles for both sides</li> </ul>	42 x 56	UMFT4256	<input type="checkbox"/>	<input type="checkbox"/>	<input type="checkbox"/>	<input type="checkbox"/>	<input type="checkbox"/>	<input type="checkbox"/>	66.7#
	<ul style="list-style-type: none"> <li>Panel assembly includes frame, trim, and panel-to-panel connectors</li> </ul>	48 x 56	UMFT4856	<input type="checkbox"/>	<input type="checkbox"/>	<input type="checkbox"/>	<input type="checkbox"/>	<input type="checkbox"/>	<input type="checkbox"/>	72.8#
	<ul style="list-style-type: none"> <li>Trim is metal and includes top cap, bottom trim channel, and base raceway</li> </ul>	60 x 56	UMFT6056	<input type="checkbox"/>	<input type="checkbox"/>	<input type="checkbox"/>	<input type="checkbox"/>	<input type="checkbox"/>	<input type="checkbox"/>	85.2#
	<ul style="list-style-type: none"> <li>Side 1 and side 2 finishes are specified separately</li> </ul>	72 x 56	UMFT7256	<input type="checkbox"/>	<input type="checkbox"/>	<input type="checkbox"/>	<input type="checkbox"/>	<input type="checkbox"/>	<input type="checkbox"/>	105.0#
UMFT	<b>Monolithic Fabric Panel - 64" H</b>	24 x 64	UMFT2464	<input type="checkbox"/>	<input type="checkbox"/>	<input type="checkbox"/>	<input type="checkbox"/>	<input type="checkbox"/>	<input type="checkbox"/>	52.5#
		30 x 64	UMFT3064	<input type="checkbox"/>	<input type="checkbox"/>	<input type="checkbox"/>	<input type="checkbox"/>	<input type="checkbox"/>	<input type="checkbox"/>	59.2#
		36 x 64	UMFT3664	<input type="checkbox"/>	<input type="checkbox"/>	<input type="checkbox"/>	<input type="checkbox"/>	<input type="checkbox"/>	<input type="checkbox"/>	65.9#
		42 x 64	UMFT4264	<input type="checkbox"/>	<input type="checkbox"/>	<input type="checkbox"/>	<input type="checkbox"/>	<input type="checkbox"/>	<input type="checkbox"/>	72.6#
		48 x 64	UMFT4864	<input type="checkbox"/>	<input type="checkbox"/>	<input type="checkbox"/>	<input type="checkbox"/>	<input type="checkbox"/>	<input type="checkbox"/>	79.3#
		60 x 64	UMFT6064	<input type="checkbox"/>	<input type="checkbox"/>	<input type="checkbox"/>	<input type="checkbox"/>	<input type="checkbox"/>	<input type="checkbox"/>	92.7#
		72 x 64	UMFT7264	<input type="checkbox"/>	<input type="checkbox"/>	<input type="checkbox"/>	<input type="checkbox"/>	<input type="checkbox"/>	<input type="checkbox"/>	114.8#
			<b>A</b>	<b>B</b>	<b>C</b>	<b>D</b>	<b>E</b>	<b>F</b>		

## HOW TO ORDER

Indicate the following information on order form:

- Quantity of each item.
- Model number, including options. See "How To Build a Model Number".
- Any special service required.

Note: • The  indicates that a choice is required.

- The absence of the  indicates that no choice is required.
- Alpha-numeric characters in place of  indicate that no other alternatives are available.

## HOW TO BUILD A MODEL NUMBER

- A** Select basic model.
- B** Select top cap style.
- |          |                   |
|----------|-------------------|
| <b>F</b> | - Flat trim (std) |
| <b>N</b> | - No topcap       |
- C** Select electrical code.
- |           |                           |
|-----------|---------------------------|
| <b>CP</b> | - Chicago - with cutouts  |
| <b>DN</b> | - Domestic - no cutouts   |
| <b>DP</b> | - Domestic - with cutouts |
- D** Select trim color.  
Refer to color addendum at ki.com or KI Fabrics & Finishes binder.
- E** Select fabric side 1.  
Refer to color addendum at ki.com or in KI Fabrics & Finishes binder.
- F** Select fabric side 2.  
Refer to color addendum at ki.com or in KI Fabrics & Finishes binder.



# Preconfigured Monolithic Fabric Panel

Tile-to-Floor One Side; Standard Base Raceway One Side

Delivered Pricing Fabric Grade 1 & C.O.M.	Delivered Pricing Fabric Grade 2	Delivered Pricing Fabric Grade 3 & Pallas Vertical Fabric Grade PV	Delivered Pricing Pallas Vertical Fabric Grade PV1	Delivered Pricing Pallas Vertical Fabric Grade PV2
\$ 403	\$ 421	\$ 436	\$ 447	\$ 477
479	502	519	531	567
522	545	564	579	617
572	598	619	636	678
617	645	668	685	730
760	794	823	845	900
945	988	1023	1048	1118
\$ 421	\$ 440	\$ 456	\$ 468	\$ 500
492	516	534	548	584
537	562	583	596	637
590	617	639	654	697
634	663	687	703	750
778	813	843	863	921
982	1027	1062	1089	1160

**SPECIAL SERVICES**  
**Special Carton Marking**

With specially marked information N/C

**Shipping**  
Shipped **k.d. freight prepaid f.o.b. Manitowoc, Wisconsin 54220** factory. Freight class #70.

Specifications and prices are subject to change without prior notice.

# Preconfigured Monolithic Fabric Panel (Beltway Power)

Standard Base Raceway

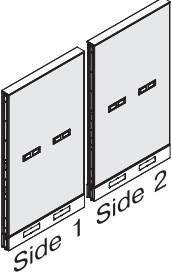
MODEL		W x H	MODEL NUMBER						Approx. Packaged Weight	
			Basic Model	Top Cap Style	Electrical Code	Bezel Color	Trim Color	Fabric Side 1		Fabric Side 2
 <p>UMFR</p>	<b>Monolithic Fabric Panel - 40" H</b>	24 x 40	UMFRBW2440	<input type="checkbox"/>	<input type="checkbox"/>	<input type="checkbox"/>	<input type="checkbox"/>	<input type="checkbox"/>	<input type="checkbox"/>	39.4#
	<ul style="list-style-type: none"> <li>Standard base raceway on both sides accepts power and data cable distribution</li> <li>Above worksurface beltway accepts power and data cable distribution</li> <li>Includes monolithic fabric tiles for both sides</li> <li>Panel assembly includes frame, trim, and panel-to-panel connectors</li> <li>Trim is metal and includes top cap, bottom trim channel, and base raceway</li> <li>Side 1 and side 2 finishes are specified separately</li> <li>30-72" wide panels feature two power knockouts at base and two knockouts with bezels at beltway per side</li> <li>24" wide panels each feature one power knockout and one at beltway per side</li> <li>72" wide panels feature split tiles</li> <li>Electrical components are specified separately</li> </ul>	30 x 40	UMFRBW3040	<input type="checkbox"/>	<input type="checkbox"/>	<input type="checkbox"/>	<input type="checkbox"/>	<input type="checkbox"/>	<input type="checkbox"/>	44.7#
		36 x 40	UMFRBW3640	<input type="checkbox"/>	<input type="checkbox"/>	<input type="checkbox"/>	<input type="checkbox"/>	<input type="checkbox"/>	<input type="checkbox"/>	50.1#
		42 x 40	UMFRBW4240	<input type="checkbox"/>	<input type="checkbox"/>	<input type="checkbox"/>	<input type="checkbox"/>	<input type="checkbox"/>	<input type="checkbox"/>	55.6#
		48 x 40	UMFRBW4840	<input type="checkbox"/>	<input type="checkbox"/>	<input type="checkbox"/>	<input type="checkbox"/>	<input type="checkbox"/>	<input type="checkbox"/>	61.0#
		60 x 40	UMFRBW6040	<input type="checkbox"/>	<input type="checkbox"/>	<input type="checkbox"/>	<input type="checkbox"/>	<input type="checkbox"/>	<input type="checkbox"/>	71.8#
		72 x 40	UMFRBW7240	<input type="checkbox"/>	<input type="checkbox"/>	<input type="checkbox"/>	<input type="checkbox"/>	<input type="checkbox"/>	<input type="checkbox"/>	87.6#
UMFR	<b>Monolithic Fabric Panel - 48" H</b>	24 x 48	UMFRBW2448	<input type="checkbox"/>	<input type="checkbox"/>	<input type="checkbox"/>	<input type="checkbox"/>	<input type="checkbox"/>	<input type="checkbox"/>	44.3#
		30 x 48	UMFRBW3048	<input type="checkbox"/>	<input type="checkbox"/>	<input type="checkbox"/>	<input type="checkbox"/>	<input type="checkbox"/>	<input type="checkbox"/>	50.2#
		36 x 48	UMFRBW3648	<input type="checkbox"/>	<input type="checkbox"/>	<input type="checkbox"/>	<input type="checkbox"/>	<input type="checkbox"/>	<input type="checkbox"/>	56.1#
		42 x 48	UMFRBW4248	<input type="checkbox"/>	<input type="checkbox"/>	<input type="checkbox"/>	<input type="checkbox"/>	<input type="checkbox"/>	<input type="checkbox"/>	62.1#
		48 x 48	UMFRBW4848	<input type="checkbox"/>	<input type="checkbox"/>	<input type="checkbox"/>	<input type="checkbox"/>	<input type="checkbox"/>	<input type="checkbox"/>	68.0#
		60 x 48	UMFRBW6048	<input type="checkbox"/>	<input type="checkbox"/>	<input type="checkbox"/>	<input type="checkbox"/>	<input type="checkbox"/>	<input type="checkbox"/>	79.8#
UMFR	<b>Monolithic Fabric Panel - 56" H</b>	24 x 56	UMFRBW2456	<input type="checkbox"/>	<input type="checkbox"/>	<input type="checkbox"/>	<input type="checkbox"/>	<input type="checkbox"/>	<input type="checkbox"/>	49.2#
		30 x 56	UMFRBW3056	<input type="checkbox"/>	<input type="checkbox"/>	<input type="checkbox"/>	<input type="checkbox"/>	<input type="checkbox"/>	<input type="checkbox"/>	55.6#
		36 x 56	UMFRBW3656	<input type="checkbox"/>	<input type="checkbox"/>	<input type="checkbox"/>	<input type="checkbox"/>	<input type="checkbox"/>	<input type="checkbox"/>	62.1#
		42 x 56	UMFRBW4256	<input type="checkbox"/>	<input type="checkbox"/>	<input type="checkbox"/>	<input type="checkbox"/>	<input type="checkbox"/>	<input type="checkbox"/>	68.6#
		48 x 56	UMFRBW4856	<input type="checkbox"/>	<input type="checkbox"/>	<input type="checkbox"/>	<input type="checkbox"/>	<input type="checkbox"/>	<input type="checkbox"/>	75.0#
		60 x 56	UMFRBW6056	<input type="checkbox"/>	<input type="checkbox"/>	<input type="checkbox"/>	<input type="checkbox"/>	<input type="checkbox"/>	<input type="checkbox"/>	87.9#
	72 x 56	UMFRBW7256	<input type="checkbox"/>	<input type="checkbox"/>	<input type="checkbox"/>	<input type="checkbox"/>	<input type="checkbox"/>	<input type="checkbox"/>	108.4#	

**A**      **B**      **C**      **D**      **E**      **F**      **G**

## HOW TO ORDER

Indicate the following information on order form:

- Quantity of each item.
- Model number, including options. See "How To Build a Model Number".
- Any special service required.

Note: • The  indicates that a choice is required.

- The absence of the  indicates that no choice is required.
- Alpha-numeric characters in place of  indicate that no other alternatives are available.

## HOW TO BUILD A MODEL NUMBER

- A** Select basic model.
- B** Select top cap style.  

<b>F</b>	- Flat trim (std)
<b>N</b>	- No topcap
- C** Select electrical code.  

<b>DP</b>	- Domestic - with cutouts
<b>D1</b>	- Domestic, 1 side w/cutouts

- G** Select fabric side 2.  
Refer to color addendum at [ki.com](http://ki.com) or in KI Fabrics & Finishes binder.

- D** Select bezel color.  
Refer to color addendum at [ki.com](http://ki.com) or KI Fabrics & Finishes binder.
- E** Select trim color.  
Refer to color addendum at [ki.com](http://ki.com) or KI Fabrics & Finishes binder.
- F** Select fabric side 1.  
Refer to color addendum at [ki.com](http://ki.com) or in KI Fabrics & Finishes binder.



Preconfigured Monolithic Fabric Panel (Beltway Power)

Standard Base Raceway

Delivered Pricing Fabric Grade 1 & C.O.M.	Delivered Pricing Fabric Grade 2	Delivered Pricing Fabric Grade 3 & Pallas Vertical Fabric Grade PV	Delivered Pricing Pallas Vertical Fabric Grade PV1	Delivered Pricing Pallas Vertical Fabric Grade PV2
\$ 376	\$ 394	\$ 408	\$ 418	\$ 445
437	457	473	484	516
480	504	521	533	569
525	550	569	584	621
543	568	588	603	643
651	682	705	724	773
864	904	936	959	1025
\$ 405	\$ 423	\$ 439	\$ 450	\$ 479
471	492	510	523	557
533	557	577	591	631
607	634	654	654	718
620	648	673	689	734
729	763	789	810	862
967	1012	1046	1073	1145
\$ 448	\$ 469	\$ 484	\$ 497	\$ 529
529	555	573	588	627
582	609	629	645	688
648	678	701	720	767
687	720	744	763	813
827	864	895	917	980
1061	1109	1148	1176	1256

# Preconfigured Monolithic Fabric Panel (Beltway Power)

Standard Base Raceway

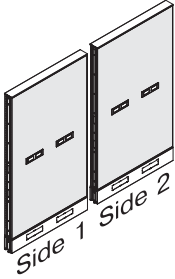

UMFR

**MODEL**

**W x H**

- **Monolithic Fabric Panel - 64" H**
- Standard base raceway on both sides accepts power and data cable distribution
- Above worksurface beltway accepts power and data cable distribution
- Includes monolithic fabric tiles for both sides
- Panel assembly includes frame, trim, and panel-to-panel connectors
- Trim is metal and includes top cap, bottom trim channel, and base raceway
- Side 1 and side 2 finishes are specified separately
- 30-72" wide panels feature two power knockouts at base and two knockouts with bezels at beltway per side
- 24" wide panels each feature one power knockout and one at beltway per side
- 72" wide panels feature split tiles
- Electrical components are specified separately

**MODEL NUMBER**

Basic Model	Top Cap Style	Electrical Code	Bezel Color	Trim Color	Fabric Side 1	Fabric Side 2
UMFRBW2464	<input type="checkbox"/>	<input type="checkbox"/>	<input type="checkbox"/>	<input type="checkbox"/>	<input type="checkbox"/>	<input type="checkbox"/>
UMFRBW3064	<input type="checkbox"/>	<input type="checkbox"/>	<input type="checkbox"/>	<input type="checkbox"/>	<input type="checkbox"/>	<input type="checkbox"/>
UMFRBW3664	<input type="checkbox"/>	<input type="checkbox"/>	<input type="checkbox"/>	<input type="checkbox"/>	<input type="checkbox"/>	<input type="checkbox"/>
UMFRBW4264	<input type="checkbox"/>	<input type="checkbox"/>	<input type="checkbox"/>	<input type="checkbox"/>	<input type="checkbox"/>	<input type="checkbox"/>
UMFRBW4864	<input type="checkbox"/>	<input type="checkbox"/>	<input type="checkbox"/>	<input type="checkbox"/>	<input type="checkbox"/>	<input type="checkbox"/>
UMFRBW6064	<input type="checkbox"/>	<input type="checkbox"/>	<input type="checkbox"/>	<input type="checkbox"/>	<input type="checkbox"/>	<input type="checkbox"/>
UMFRBW7264	<input type="checkbox"/>	<input type="checkbox"/>	<input type="checkbox"/>	<input type="checkbox"/>	<input type="checkbox"/>	<input type="checkbox"/>

Approx. Packaged Weight

53.6#  
60.5#  
67.5#  
74.5#  
81.5#  
95.4#  
118.2#

**A**   **B**   **C**   **D**   **E**   **F**   **G**

**HOW TO ORDER**

Indicate the following information on order form:

1. Quantity of each item.
2. Model number, including options. See "How To Build a Model Number".
3. Any special service required.

Note: • The  indicates that a choice is required.

- The absence of the  indicates that no choice is required.
- Alpha-numeric characters in place of  indicate that no other alternatives are available.

**HOW TO BUILD A MODEL NUMBER**

- A** Select basic model.
- B** Select top cap style.  

<b>F</b>	- Flat trim (std)
<b>N</b>	- No topcap
- C** Select electrical code.  

<b>DP</b>	- Domestic - with cutouts
<b>D1</b>	- Domestic, 1 side w/cutouts

- G** Select fabric side 2.  
Refer to color addendum at ki.com or in KI Fabrics & Finishes binder.

- D** Select bezel color.  
Refer to color addendum at ki.com or KI Fabrics & Finishes binder.
- E** Select trim color.  
Refer to color addendum at ki.com or KI Fabrics & Finishes binder.
- F** Select fabric side 1.  
Refer to color addendum at ki.com or in KI Fabrics & Finishes binder.



# Preconfigured Monolithic Fabric Panel (Beltway Power)

Standard Base Raceway

Delivered Pricing Fabric Grade 1 & C.O.M.	Delivered Pricing Fabric Grade 2	Delivered Pricing Fabric Grade 3 & Pallas Vertical Fabric Grade PV	Delivered Pricing Pallas Vertical Fabric Grade PV1	Delivered Pricing Pallas Vertical Fabric Grade PV2
\$ 476	\$ 500	\$ 515	\$ 528	\$ 563
562	588	609	623	665
614	642	664	681	726
670	698	724	743	790
717	749	776	794	848
871	911	943	966	1031
1118	1169	1209	1241	1323

**SPECIAL SERVICES**

**Special Carton Marking**

With specially marked information N/C

**Shipping**

Shipped k.d. freight prepaid f.o.b. Manitowoc, Wisconsin 54220 factory. Freight class #70.

Specifications and prices are subject to change without prior notice.

# Preconfigured Monolithic Fabric Panel (Beltway Power)

Elevated Base

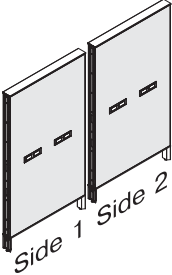
MODEL		W x H	MODEL NUMBER							Approx. Packaged Weight
			Basic Model	Top Cap Style	Electrical Code	Bezel Color	Trim Color	Fabric Side 1	Fabric Side 2	
 <p>UMFL</p>	<b>Monolithic Fabric Panel - 40" H</b>	24 x 40	UMFLBW2440	<input type="checkbox"/>	<input type="checkbox"/>	<input type="checkbox"/>	<input type="checkbox"/>	<input type="checkbox"/>	<input type="checkbox"/>	37.2#
	• 30-72" wide tiles each feature two power knockouts with bezels at above-worksurface beltway	30 x 40	UMFLBW3040	<input type="checkbox"/>	<input type="checkbox"/>	<input type="checkbox"/>	<input type="checkbox"/>	<input type="checkbox"/>	<input type="checkbox"/>	41.8#
	• 24" wide tiles each feature one power knockout with bezel at above-worksurface beltway	36 x 40	UMFLBW3640	<input type="checkbox"/>	<input type="checkbox"/>	<input type="checkbox"/>	<input type="checkbox"/>	<input type="checkbox"/>	<input type="checkbox"/>	46.4#
	• Raised base does not accept cable distribution	42 x 40	UMFLBW4240	<input type="checkbox"/>	<input type="checkbox"/>	<input type="checkbox"/>	<input type="checkbox"/>	<input type="checkbox"/>	<input type="checkbox"/>	51.0#
	• Includes monolithic fabric tiles for both sides	48 x 40	UMFLBW4840	<input type="checkbox"/>	<input type="checkbox"/>	<input type="checkbox"/>	<input type="checkbox"/>	<input type="checkbox"/>	<input type="checkbox"/>	55.6#
	• Panel assembly includes frame, trim, and panel-to-panel connectors	60 x 40	UMFLBW6040	<input type="checkbox"/>	<input type="checkbox"/>	<input type="checkbox"/>	<input type="checkbox"/>	<input type="checkbox"/>	<input type="checkbox"/>	64.8#
	• Trim is metal and includes top cap, bottom trim channel, and foot shroud	72 x 40	UMFLBW7240	<input type="checkbox"/>	<input type="checkbox"/>	<input type="checkbox"/>	<input type="checkbox"/>	<input type="checkbox"/>	<input type="checkbox"/>	79.0#
	• Side 1 and side 2 finishes are specified separately									
UMFL	<b>Monolithic Fabric Panel - 48" H</b>	24 x 48	UMFLBW2448	<input type="checkbox"/>	<input type="checkbox"/>	<input type="checkbox"/>	<input type="checkbox"/>	<input type="checkbox"/>	<input type="checkbox"/>	42.1#
		30 x 48	UMFLBW3048	<input type="checkbox"/>	<input type="checkbox"/>	<input type="checkbox"/>	<input type="checkbox"/>	<input type="checkbox"/>	<input type="checkbox"/>	47.2#
		36 x 48	UMFLBW3648	<input type="checkbox"/>	<input type="checkbox"/>	<input type="checkbox"/>	<input type="checkbox"/>	<input type="checkbox"/>	<input type="checkbox"/>	52.3#
		42 x 48	UMFLBW4248	<input type="checkbox"/>	<input type="checkbox"/>	<input type="checkbox"/>	<input type="checkbox"/>	<input type="checkbox"/>	<input type="checkbox"/>	57.5#
		48 x 48	UMFLBW4848	<input type="checkbox"/>	<input type="checkbox"/>	<input type="checkbox"/>	<input type="checkbox"/>	<input type="checkbox"/>	<input type="checkbox"/>	62.6#
		60 x 48	UMFLBW6048	<input type="checkbox"/>	<input type="checkbox"/>	<input type="checkbox"/>	<input type="checkbox"/>	<input type="checkbox"/>	<input type="checkbox"/>	72.9#
		72 x 48	UMFLBW7248	<input type="checkbox"/>	<input type="checkbox"/>	<input type="checkbox"/>	<input type="checkbox"/>	<input type="checkbox"/>	<input type="checkbox"/>	89.4#
UMFL	<b>Monolithic Fabric Panel - 56" H</b>	24 x 56	UMFLBW2456	<input type="checkbox"/>	<input type="checkbox"/>	<input type="checkbox"/>	<input type="checkbox"/>	<input type="checkbox"/>	<input type="checkbox"/>	47.0#
		30 x 56	UMFLBW3056	<input type="checkbox"/>	<input type="checkbox"/>	<input type="checkbox"/>	<input type="checkbox"/>	<input type="checkbox"/>	<input type="checkbox"/>	52.7#
		36 x 56	UMFLBW3656	<input type="checkbox"/>	<input type="checkbox"/>	<input type="checkbox"/>	<input type="checkbox"/>	<input type="checkbox"/>	<input type="checkbox"/>	58.3#
		42 x 56	UMFLBW4256	<input type="checkbox"/>	<input type="checkbox"/>	<input type="checkbox"/>	<input type="checkbox"/>	<input type="checkbox"/>	<input type="checkbox"/>	64.0#
		48 x 56	UMFLBW4856	<input type="checkbox"/>	<input type="checkbox"/>	<input type="checkbox"/>	<input type="checkbox"/>	<input type="checkbox"/>	<input type="checkbox"/>	69.7#
		60 x 56	UMFLBW6056	<input type="checkbox"/>	<input type="checkbox"/>	<input type="checkbox"/>	<input type="checkbox"/>	<input type="checkbox"/>	<input type="checkbox"/>	81.0#
		72 x 56	UMFLBW7256	<input type="checkbox"/>	<input type="checkbox"/>	<input type="checkbox"/>	<input type="checkbox"/>	<input type="checkbox"/>	<input type="checkbox"/>	99.8#

**A**      **B**      **C**      **D**      **E**      **F**      **G**

## HOW TO ORDER

Indicate the following information on order form:

- Quantity of each item.
- Model number, including options. See "How To Build a Model Number".
- Any special service required.

Note: • The  indicates that a choice is required.

- The absence of the  indicates that no choice is required.
- Alpha-numeric characters in place of  indicate that no other alternatives are available.

## HOW TO BUILD A MODEL NUMBER

- A** Select basic model.
- B** Select top cap style.
 

<b>F</b>	- Flat trim (std)
<b>N</b>	- No topcap
- C** Select electrical code.
 

<b>DP</b>	- Domestic - with cutouts
-----------	---------------------------
- D** Select bezel color. Refer to color addendum at ki.com or KI Fabrics & Finishes binder.
- E** Select trim color. Refer to color addendum at ki.com or KI Fabrics & Finishes binder.
- F** Select fabric side 1. Refer to color addendum at ki.com or in KI Fabrics & Finishes binder.
- G** Select fabric side 2. Refer to color addendum at ki.com or in KI Fabrics & Finishes binder.





# Preconfigured Monolithic Fabric Panel (Beltway Power)

Elevated Base

Delivered Pricing Fabric Grade 1 & C.O.M.	Delivered Pricing Fabric Grade 2	Delivered Pricing Fabric Grade 3 & Pallas Vertical Fabric Grade PV	Delivered Pricing Pallas Vertical Fabric Grade PV1	Delivered Pricing Pallas Vertical Fabric Grade PV2
\$ 376	\$ 394	\$ 408	\$ 418	\$ 445
437	457	473	484	516
480	504	521	533	569
525	550	569	584	621
543	568	588	603	643
651	682	705	724	773
864	904	936	959	1025
\$ 405	\$ 423	\$ 439	\$ 450	\$ 479
471	492	510	523	557
533	557	577	591	631
607	634	654	673	718
620	648	673	689	734
729	763	789	810	862
967	1012	1046	1073	1145
\$ 448	\$ 469	\$ 484	\$ 497	\$ 529
529	555	573	588	627
582	609	629	645	688
648	678	701	720	767
687	720	744	763	813
827	864	895	917	980
1061	1109	1148	1176	1256

# Preconfigured Monolithic Fabric Panel (Beltway Power)

Elevated Base

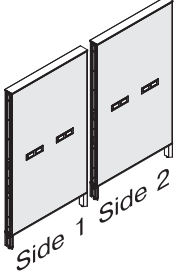
MODEL	W x H	MODEL NUMBER							Approx. Packaged Weight
		Basic Model	Top Cap Style	Electrical Code	Bezel Color	Trim Color	Fabric Side 1	Fabric Side 2	
 <p>UMFL</p> <p><b>Monolithic Fabric Panel - 64" H</b></p> <ul style="list-style-type: none"> <li>• 30-72" wide tiles each feature two power knockouts with bezels at above-worksurface beltway</li> <li>• 24" wide tiles each feature one power knockout with bezel at above-worksurface beltway</li> <li>• Raised base does not accept cable distribution</li> <li>• Includes monolithic fabric tiles for both sides</li> <li>• Panel assembly includes frame, trim, and panel-to-panel connectors</li> <li>• Trim is metal and includes top cap, bottom trim channel, and foot shroud</li> <li>• Side 1 and side 2 finishes are specified separately</li> <li>• 72" wide panels feature split tiles</li> <li>• Electrical components are specified separately</li> </ul>	24 x 64	UMFLBW2464	<input type="checkbox"/>	<input type="checkbox"/>	<input type="checkbox"/>	<input type="checkbox"/>	<input type="checkbox"/>	<input type="checkbox"/>	51.4#
	30 x 64	UMFLBW3064	<input type="checkbox"/>	<input type="checkbox"/>	<input type="checkbox"/>	<input type="checkbox"/>	<input type="checkbox"/>	<input type="checkbox"/>	57.5#
	36 x 64	UMFLBW3664	<input type="checkbox"/>	<input type="checkbox"/>	<input type="checkbox"/>	<input type="checkbox"/>	<input type="checkbox"/>	<input type="checkbox"/>	63.7#
	42 x 64	UMFLBW4264	<input type="checkbox"/>	<input type="checkbox"/>	<input type="checkbox"/>	<input type="checkbox"/>	<input type="checkbox"/>	<input type="checkbox"/>	69.9#
	48 x 64	UMFLBW4864	<input type="checkbox"/>	<input type="checkbox"/>	<input type="checkbox"/>	<input type="checkbox"/>	<input type="checkbox"/>	<input type="checkbox"/>	76.1#
	60 x 64	UMFLBW6064	<input type="checkbox"/>	<input type="checkbox"/>	<input type="checkbox"/>	<input type="checkbox"/>	<input type="checkbox"/>	<input type="checkbox"/>	88.5#
	72 x 64	UMFLBW7264	<input type="checkbox"/>	<input type="checkbox"/>	<input type="checkbox"/>	<input type="checkbox"/>	<input type="checkbox"/>	<input type="checkbox"/>	109.6#

**A** **B** **C** **D** **E** **F** **G**

## HOW TO ORDER

Indicate the following information on order form:

1. Quantity of each item.
2. Model number, including options. See "How To Build a Model Number".
3. Any special service required.

- Note:
- The  indicates that a choice is required.
  - The absence of the  indicates that no choice is required.
  - Alpha-numeric characters in place of  indicate that no other alternatives are available.

## HOW TO BUILD A MODEL NUMBER

- A** Select basic model.
- B** Select top cap style.  

<b>F</b>	- Flat trim (std)
<b>N</b>	- No topcap
- C** Select electrical code.  

<b>DP</b>	- Domestic - with cutouts
-----------	---------------------------
- D** Select bezel color.  
 Refer to color addendum at ki.com or KI Fabrics & Finishes binder.
- E** Select trim color.  
 Refer to color addendum at ki.com or KI Fabrics & Finishes binder.
- F** Select fabric side 1.  
 Refer to color addendum at ki.com or in KI Fabrics & Finishes binder.
- G** Select fabric side 2.  
 Refer to color addendum at ki.com or in KI Fabrics & Finishes binder.



# Preconfigured Monolithic Fabric Panel (Beltway Power)

Elevated Base

Delivered Pricing Fabric Grade 1 & C.O.M.	Delivered Pricing Fabric Grade 2	Delivered Pricing Fabric Grade 3 & Pallas Vertical Fabric Grade PV	Delivered Pricing Pallas Vertical Fabric Grade PV1	Delivered Pricing Pallas Vertical Fabric Grade PV2
\$ 476	\$ 500	\$ 515	\$ 528	\$ 563
562	588	609	623	665
614	642	664	681	726
670	698	724	743	790
717	749	776	794	848
871	911	943	966	1031
1118	1169	1209	1241	1323

**SPECIAL SERVICES**

**Special Carton Marking**

With specially marked information N/C

**Shipping**

Shipped k.d. freight prepaid f.o.b. Manitowoc, Wisconsin 54220 factory. Freight class #70.

Specifications and prices are subject to change without prior notice.

# Preconfigured Monolithic Fabric Panel (Beltway Power)

Tile-to-Floor One Side; Standard Base Raceway One Side

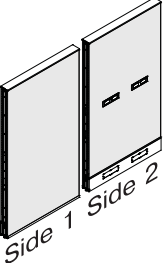
MODEL	W x H	MODEL NUMBER							Approx. Packaged Weight	
		Basic Model	Top Cap Style	Electrical Code	Bezel Color	Trim Color	Fabric Side 1	Fabric Side 2		
 <p>UMFT</p> <p><b>Monolithic Fabric Panel - 40" H</b></p> <ul style="list-style-type: none"> <li>Side 1: tile-to-floor base does not accept cable distribution at base or beltway</li> <li>Side 2: standard base raceway and above-worksurface beltway accept cable distribution</li> <li>Includes monolithic fabric tiles for both sides</li> <li>Panel assembly includes frame, trim, and panel-to-panel connectors</li> <li>Trim is metal and includes top cap, bottom trim channel, and base raceway</li> <li>Side 1 and side 2 finishes are specified separately</li> <li>Side 2: 30-72" wide tiles feature two base and two beltway power knockouts</li> <li>Side 2: 24" wide tiles feature one base and one beltway power knockout</li> <li>72" wide panels feature split tiles</li> <li>Electrical components are specified separately</li> </ul>	24 x 40	UMFTBW2440	<input type="checkbox"/>	<input type="checkbox"/>	<input type="checkbox"/>	<input type="checkbox"/>	<input type="checkbox"/>	<input type="checkbox"/>	38.4#	
	30 x 40	UMFTBW3040	<input type="checkbox"/>	<input type="checkbox"/>	<input type="checkbox"/>	<input type="checkbox"/>	<input type="checkbox"/>	<input type="checkbox"/>	43.4#	
	36 x 40	UMFTBW3640	<input type="checkbox"/>	<input type="checkbox"/>	<input type="checkbox"/>	<input type="checkbox"/>	<input type="checkbox"/>	<input type="checkbox"/>	48.5#	
	42 x 40	UMFTBW4240	<input type="checkbox"/>	<input type="checkbox"/>	<input type="checkbox"/>	<input type="checkbox"/>	<input type="checkbox"/>	<input type="checkbox"/>	53.7#	
	48 x 40	UMFTBW4840	<input type="checkbox"/>	<input type="checkbox"/>	<input type="checkbox"/>	<input type="checkbox"/>	<input type="checkbox"/>	<input type="checkbox"/>	58.8#	
	60 x 40	UMFTBW6040	<input type="checkbox"/>	<input type="checkbox"/>	<input type="checkbox"/>	<input type="checkbox"/>	<input type="checkbox"/>	<input type="checkbox"/>	69.0#	
	72 x 40	UMFTBW7240	<input type="checkbox"/>	<input type="checkbox"/>	<input type="checkbox"/>	<input type="checkbox"/>	<input type="checkbox"/>	<input type="checkbox"/>	84.2#	
UMFT	<b>Monolithic Fabric Panel - 48" H</b>	24 x 48	UMFTBW2448	<input type="checkbox"/>	<input type="checkbox"/>	<input type="checkbox"/>	<input type="checkbox"/>	<input type="checkbox"/>	<input type="checkbox"/>	43.3#
		30 x 48	UMFTBW3048	<input type="checkbox"/>	<input type="checkbox"/>	<input type="checkbox"/>	<input type="checkbox"/>	<input type="checkbox"/>	<input type="checkbox"/>	48.9#
		36 x 48	UMFTBW3648	<input type="checkbox"/>	<input type="checkbox"/>	<input type="checkbox"/>	<input type="checkbox"/>	<input type="checkbox"/>	<input type="checkbox"/>	54.5#
		42 x 48	UMFTBW4248	<input type="checkbox"/>	<input type="checkbox"/>	<input type="checkbox"/>	<input type="checkbox"/>	<input type="checkbox"/>	<input type="checkbox"/>	60.2#
		48 x 48	UMFTBW4848	<input type="checkbox"/>	<input type="checkbox"/>	<input type="checkbox"/>	<input type="checkbox"/>	<input type="checkbox"/>	<input type="checkbox"/>	65.8#
		60 x 48	UMFTBW6048	<input type="checkbox"/>	<input type="checkbox"/>	<input type="checkbox"/>	<input type="checkbox"/>	<input type="checkbox"/>	<input type="checkbox"/>	77.1#
UMFT	<b>Monolithic Fabric Panel - 56" H</b>	24 x 56	UMFTBW2456	<input type="checkbox"/>	<input type="checkbox"/>	<input type="checkbox"/>	<input type="checkbox"/>	<input type="checkbox"/>	<input type="checkbox"/>	48.2#
		30 x 56	UMFTBW3056	<input type="checkbox"/>	<input type="checkbox"/>	<input type="checkbox"/>	<input type="checkbox"/>	<input type="checkbox"/>	<input type="checkbox"/>	54.3#
		36 x 56	UMFTBW3656	<input type="checkbox"/>	<input type="checkbox"/>	<input type="checkbox"/>	<input type="checkbox"/>	<input type="checkbox"/>	<input type="checkbox"/>	60.5#
		42 x 56	UMFTBW4256	<input type="checkbox"/>	<input type="checkbox"/>	<input type="checkbox"/>	<input type="checkbox"/>	<input type="checkbox"/>	<input type="checkbox"/>	66.7#
		48 x 56	UMFTBW4856	<input type="checkbox"/>	<input type="checkbox"/>	<input type="checkbox"/>	<input type="checkbox"/>	<input type="checkbox"/>	<input type="checkbox"/>	72.8#
		60 x 56	UMFTBW6056	<input type="checkbox"/>	<input type="checkbox"/>	<input type="checkbox"/>	<input type="checkbox"/>	<input type="checkbox"/>	<input type="checkbox"/>	85.2#
	72 x 56	UMFTBW7256	<input type="checkbox"/>	<input type="checkbox"/>	<input type="checkbox"/>	<input type="checkbox"/>	<input type="checkbox"/>	<input type="checkbox"/>	105.0#	

**A B C D E F G**

## HOW TO ORDER

Indicate the following information on order form:

- Quantity of each item.
- Model number, including options. See "How To Build a Model Number".
- Any special service required.

Note: • The  indicates that a choice is required.

- The absence of the  indicates that no choice is required.
- Alpha-numeric characters in place of  indicate that no other alternatives are available.

## HOW TO BUILD A MODEL NUMBER

- A** Select basic model.
- B** Select top cap style.
 

F	- Flat trim (std)
N	- No topcap
- C** Select electrical code.
 

DP	- Domestic - with cutouts
----	---------------------------
- D** Select bezel color. Refer to color addendum at ki.com or KI Fabrics & Finishes binder.
- E** Select trim color. Refer to color addendum at ki.com or KI Fabrics & Finishes binder.
- F** Select fabric side 1. Refer to color addendum at ki.com or in KI Fabrics & Finishes binder.
- G** Select fabric side 2. Refer to color addendum at ki.com or in KI Fabrics & Finishes binder.



# Preconfigured Monolithic Fabric Panel (Beltway Power)

Tile-to-Floor One Side; Standard Base Raceway One Side

Delivered Pricing Fabric Grade 1 & C.O.M.	Delivered Pricing Fabric Grade 2	Delivered Pricing Fabric Grade 3 & Pallas Vertical Fabric Grade PV	Delivered Pricing Pallas Vertical Fabric Grade PV1	Delivered Pricing Pallas Vertical Fabric Grade PV2
\$ 376	\$ 394	\$ 408	\$ 418	\$ 445
437	457	473	484	516
480	504	521	533	569
525	550	569	584	621
543	568	588	603	643
651	682	705	724	773
864	904	936	959	1025

\$ 405	\$ 423	\$ 439	\$ 450	\$ 479
471	492	510	523	557
533	557	577	591	631
607	634	654	673	718
620	648	673	689	734
729	763	789	810	862
967	1012	1046	1073	1145
\$ 448	\$ 469	\$ 484	\$ 497	\$ 529
529	555	573	588	627
582	609	629	645	688
648	678	701	720	767
687	720	744	763	813
827	864	895	917	980
1061	1109	1148	1176	1256

# Preconfigured Monolithic Fabric Panel (Beltway Power)

Tile-to-Floor One Side; Standard Base Raceway One Side

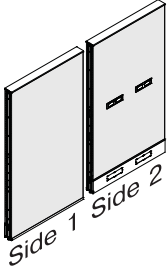

UMFT

**MODEL**

**W x H**

- Monolithic Fabric Panel - 64" H**
- Side 1: tile-to-floor base does not accept cable distribution at base or beltway
  - Side 2: standard base raceway and above-worksurface beltway accept cable distribution
  - Includes monolithic fabric tiles for both sides
  - Panel assembly includes frame, trim, and panel-to-panel connectors
  - Trim is metal and includes top cap, bottom trim channel, and base raceway
  - Side 1 and side 2 finishes are specified separately
  - Side 2: 30-72" wide tiles feature two base and two beltway power knockouts
  - Side 2: 24" wide tiles feature one base and one beltway power knockout
  - 72" wide panels feature split tiles
  - Electrical components are specified separately

**MODEL NUMBER**

Basic Model	Top Cap Style	Electrical Code	Bezel Color	Trim Color	Fabric Side 1	Fabric Side 2
UMFTBW2464	<input type="checkbox"/>	<input type="checkbox"/>	<input type="checkbox"/>	<input type="checkbox"/>	<input type="checkbox"/>	<input type="checkbox"/>
UMFTBW3064	<input type="checkbox"/>	<input type="checkbox"/>	<input type="checkbox"/>	<input type="checkbox"/>	<input type="checkbox"/>	<input type="checkbox"/>
UMFTBW3664	<input type="checkbox"/>	<input type="checkbox"/>	<input type="checkbox"/>	<input type="checkbox"/>	<input type="checkbox"/>	<input type="checkbox"/>
UMFTBW4264	<input type="checkbox"/>	<input type="checkbox"/>	<input type="checkbox"/>	<input type="checkbox"/>	<input type="checkbox"/>	<input type="checkbox"/>
UMFTBW4864	<input type="checkbox"/>	<input type="checkbox"/>	<input type="checkbox"/>	<input type="checkbox"/>	<input type="checkbox"/>	<input type="checkbox"/>
UMFTBW6064	<input type="checkbox"/>	<input type="checkbox"/>	<input type="checkbox"/>	<input type="checkbox"/>	<input type="checkbox"/>	<input type="checkbox"/>
UMFTBW7264	<input type="checkbox"/>	<input type="checkbox"/>	<input type="checkbox"/>	<input type="checkbox"/>	<input type="checkbox"/>	<input type="checkbox"/>

**Approx. Packaged Weight**

52.5#  
59.2#  
65.9#  
72.6#  
79.3#  
92.7#  
114.8#

**A B C D E F G**

**HOW TO ORDER**

Indicate the following information on order form:

1. Quantity of each item.
2. Model number, including options. See "How To Build a Model Number".
3. Any special service required.

- Note:
- The  indicates that a choice is required.
  - The absence of the  indicates that no choice is required.
  - Alpha-numeric characters in place of  indicate that no other alternatives are available.

**HOW TO BUILD A MODEL NUMBER**

- A** Select basic model.
- B** Select top cap style.
  - F** - Flat trim (std)
  - N** - No topcap
- C** Select electrical code.
  - DP** - Domestic - with cutouts
- D** Select bezel color. Refer to color addendum at ki.com or KI Fabrics & Finishes binder.
- E** Select trim color. Refer to color addendum at ki.com or KI Fabrics & Finishes binder.
- F** Select fabric side 1. Refer to color addendum at ki.com or in KI Fabrics & Finishes binder.
- G** Select fabric side 2. Refer to color addendum at ki.com or in KI Fabrics & Finishes binder.



# Preconfigured Monolithic Fabric Panel (Beltway Power)

Tile-to-Floor One Side; Standard Base Raceway One Side

Delivered Pricing Fabric Grade 1 & C.O.M.	Delivered Pricing Fabric Grade 2	Delivered Pricing Fabric Grade 3 & Pallas Vertical Fabric Grade PV	Delivered Pricing Pallas Vertical Fabric Grade PV1	Delivered Pricing Pallas Vertical Fabric Grade PV2
\$ 476	\$ 500	\$ 515	\$ 528	\$ 563
562	588	609	623	665
614	642	664	681	726
670	698	724	743	790
717	749	776	794	848
871	911	943	966	1031
1118	1169	1209	1241	1323

**SPECIAL SERVICES**

**Special Carton Marking**

With specially marked information N/C

**Shipping**

Shipped k.d. freight prepaid f.o.b. Manitowoc, Wisconsin 54220 factory. Freight class #70.

Specifications and prices are subject to change without prior notice.

# Preconfigured Monolithic Steel Panels

Standard Base Raceway

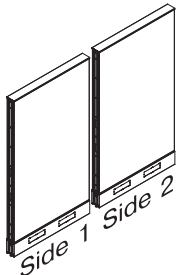
	MODEL	W x H	MODEL NUMBER						Approx. Packaged Weight
			Basic Model	Top Cap Style	Electrical Code	Trim Color	Paint Color Side 1	Paint Color Side 2	
 <p>UMSR</p>	<b>Monolithic Steel Panel - 32"H</b> <ul style="list-style-type: none"> <li>Standard base raceway on both sides accepts power and data cable distribution</li> <li>Includes monolithic steel tiles with mounting bars for both sides</li> <li>Panel assembly includes frame, trim, and panel-to-panel connectors</li> <li>Trim is metal and includes top cap, bottom trim channel, and base raceway</li> <li>Side 1 and side 2 finishes are specified separately</li> <li>30-72" wide panels feature two power knockouts per side</li> <li>24" wide panels feature one power knockout per side</li> <li>72" wide panels feature split tiles</li> <li>Electrical components are specified separately</li> </ul>	24 x 32	UMSR2432	<input type="checkbox"/>	<input type="checkbox"/>	<input type="checkbox"/>	<input type="checkbox"/>	<input type="checkbox"/>	39.7#
		30 x 32	UMSR3032	<input type="checkbox"/>	<input type="checkbox"/>	<input type="checkbox"/>	<input type="checkbox"/>	<input type="checkbox"/>	45.7#
		36 x 32	UMSR3632	<input type="checkbox"/>	<input type="checkbox"/>	<input type="checkbox"/>	<input type="checkbox"/>	<input type="checkbox"/>	51.8#
		42 x 32	UMSR4232	<input type="checkbox"/>	<input type="checkbox"/>	<input type="checkbox"/>	<input type="checkbox"/>	<input type="checkbox"/>	57.9#
		48 x 32	UMSR4832	<input type="checkbox"/>	<input type="checkbox"/>	<input type="checkbox"/>	<input type="checkbox"/>	<input type="checkbox"/>	64.0#
		60 x 32	UMSR6032	<input type="checkbox"/>	<input type="checkbox"/>	<input type="checkbox"/>	<input type="checkbox"/>	<input type="checkbox"/>	76.2#
		72 x 32	UMSR7232	<input type="checkbox"/>	<input type="checkbox"/>	<input type="checkbox"/>	<input type="checkbox"/>	<input type="checkbox"/>	94.5#
UMSR	<b>Monolithic Steel Panel - 40"H</b>	24 x 40	UMSR2440	<input type="checkbox"/>	<input type="checkbox"/>	<input type="checkbox"/>	<input type="checkbox"/>	<input type="checkbox"/>	44.8#
		30 x 40	UMSR3040	<input type="checkbox"/>	<input type="checkbox"/>	<input type="checkbox"/>	<input type="checkbox"/>	<input type="checkbox"/>	51.6#
		36 x 40	UMSR3640	<input type="checkbox"/>	<input type="checkbox"/>	<input type="checkbox"/>	<input type="checkbox"/>	<input type="checkbox"/>	58.5#
		42 x 40	UMSR4240	<input type="checkbox"/>	<input type="checkbox"/>	<input type="checkbox"/>	<input type="checkbox"/>	<input type="checkbox"/>	65.4#
		48 x 40	UMSR4840	<input type="checkbox"/>	<input type="checkbox"/>	<input type="checkbox"/>	<input type="checkbox"/>	<input type="checkbox"/>	72.3#
		60 x 40	UMSR6040	<input type="checkbox"/>	<input type="checkbox"/>	<input type="checkbox"/>	<input type="checkbox"/>	<input type="checkbox"/>	86.1#
		72 x 40	UMSR7240	<input type="checkbox"/>	<input type="checkbox"/>	<input type="checkbox"/>	<input type="checkbox"/>	<input type="checkbox"/>	107.5#
UMSR	<b>Monolithic Steel Panel - 48"H</b>	24 x 48	UMSR2448	<input type="checkbox"/>	<input type="checkbox"/>	<input type="checkbox"/>	<input type="checkbox"/>	<input type="checkbox"/>	49.9#
		30 x 48	UMSR3048	<input type="checkbox"/>	<input type="checkbox"/>	<input type="checkbox"/>	<input type="checkbox"/>	<input type="checkbox"/>	57.5#
		36 x 48	UMSR3648	<input type="checkbox"/>	<input type="checkbox"/>	<input type="checkbox"/>	<input type="checkbox"/>	<input type="checkbox"/>	65.2#
UMSR	<b>Monolithic Steel Panel - 56"H</b>	24 x 56	UMSR2456	<input type="checkbox"/>	<input type="checkbox"/>	<input type="checkbox"/>	<input type="checkbox"/>	<input type="checkbox"/>	55.1#
		30 x 56	UMSR3056	<input type="checkbox"/>	<input type="checkbox"/>	<input type="checkbox"/>	<input type="checkbox"/>	<input type="checkbox"/>	63.5#
		36 x 56	UMSR3656	<input type="checkbox"/>	<input type="checkbox"/>	<input type="checkbox"/>	<input type="checkbox"/>	<input type="checkbox"/>	72.0#
UMSR	<b>Monolithic Steel Panel - 64"H</b>	24 x 64	UMSR2464	<input type="checkbox"/>	<input type="checkbox"/>	<input type="checkbox"/>	<input type="checkbox"/>	<input type="checkbox"/>	60.2#
		30 x 64	UMSR3064	<input type="checkbox"/>	<input type="checkbox"/>	<input type="checkbox"/>	<input type="checkbox"/>	<input type="checkbox"/>	69.5#
		36 x 64	UMSR3664	<input type="checkbox"/>	<input type="checkbox"/>	<input type="checkbox"/>	<input type="checkbox"/>	<input type="checkbox"/>	78.8#

A

B

C

D

E

F

## HOW TO ORDER

Indicate the following information on order form:

- Quantity of each item.
- Model number, including options. See "How To Build a Model Number".
- Any special service required.

Note: • The  indicates that a choice is required.

- The absence of the  indicates that no choice is required.
- Alpha-numeric characters in place of  indicate that no other alternatives are available.

## HOW TO BUILD A MODEL NUMBER

**A** Select basic model.

**B** Select top cap style.

- |   |                   |
|---|-------------------|
| F | - Flat trim (std) |
| N | - No topcap       |

**C** Select electrical code.

- |    |                              |
|----|------------------------------|
| CP | - Chicago - with cutouts     |
| DN | - Domestic - no cutouts      |
| DP | - Domestic - with cutouts    |
| C1 | - Chicago, 1 side w/cutouts  |
| D1 | - Domestic, 1 side w/cutouts |

**D** Select trim color.

Refer to color addendum at ki.com or KI Fabrics & Finishes binder.

**E** Select paint color side 1.

Refer to color addendum at ki.com or KI Fabrics & Finishes binder.

**F** Select paint color side 2.

Refer to color addendum at ki.com or KI Fabrics & Finishes binder.





# Preconfigured Monolithic Steel Panels

Standard Base Raceway

Delivered Pricing

\$ 423  
455  
482  
495  
553  
739  
888

\$ 432  
473  
511  
530  
587  
775  
933

\$ 483  
511  
554

\$ 506  
555  
594

\$ 603  
648  
694

### SPECIAL SERVICES

#### Special Carton Marking

With specially marked information N/C

#### Shipping

Delivered. Shipped **k.d. freight prepaid f.o.b. Manitowoc, Wisconsin 54220** factory. Freight class #70.

Specifications and prices are subject to change without prior notice.

# Preconfigured Monolithic Steel Panels

Elevated Base

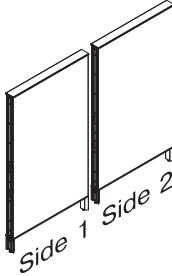
	MODEL	W x H	MODEL NUMBER					Approx. Packaged Weight
			Basic Model	Top Cap Style	Trim Color	Paint Color Side 1	Paint Color Side 2	
	<b>Monolithic Steel Panel - 32"H</b>	24 x 32	UMSL2432	<input type="checkbox"/>	<input type="checkbox"/>	<input type="checkbox"/>	<input type="checkbox"/>	37.1#
	• Raised base does not accept cable distribution	30 x 32	UMSL3032	<input type="checkbox"/>	<input type="checkbox"/>	<input type="checkbox"/>	<input type="checkbox"/>	42.4#
	• Includes monolithic steel tiles with mounting bars for both sides	36 x 32	UMSL3632	<input type="checkbox"/>	<input type="checkbox"/>	<input type="checkbox"/>	<input type="checkbox"/>	47.6#
	• Panel assembly includes frame, trim, and panel-to-panel connectors	42 x 32	UMSL4232	<input type="checkbox"/>	<input type="checkbox"/>	<input type="checkbox"/>	<input type="checkbox"/>	53.0#
	• Trim is metal and includes top cap, bottom trim channel, and foot shroud	48 x 32	UMSL4832	<input type="checkbox"/>	<input type="checkbox"/>	<input type="checkbox"/>	<input type="checkbox"/>	58.2#
	• Side 1 and side 2 finishes are specified separately	60 x 32	UMSL6032	<input type="checkbox"/>	<input type="checkbox"/>	<input type="checkbox"/>	<input type="checkbox"/>	68.8#
	• 72" wide panels feature split tiles	72 x 32	UMSL7232	<input type="checkbox"/>	<input type="checkbox"/>	<input type="checkbox"/>	<input type="checkbox"/>	85.5#
	UMSL							
UMSL	<b>Monolithic Steel Panel - 40"H</b>	24 x 40	UMSL2440	<input type="checkbox"/>	<input type="checkbox"/>	<input type="checkbox"/>	<input type="checkbox"/>	42.1#
		30 x 40	UMSL3040	<input type="checkbox"/>	<input type="checkbox"/>	<input type="checkbox"/>	<input type="checkbox"/>	48.2#
		36 x 40	UMSL3640	<input type="checkbox"/>	<input type="checkbox"/>	<input type="checkbox"/>	<input type="checkbox"/>	54.3#
		42 x 40	UMSL4240	<input type="checkbox"/>	<input type="checkbox"/>	<input type="checkbox"/>	<input type="checkbox"/>	60.5#
		48 x 40	UMSL4840	<input type="checkbox"/>	<input type="checkbox"/>	<input type="checkbox"/>	<input type="checkbox"/>	66.6#
		60 x 40	UMSL6040	<input type="checkbox"/>	<input type="checkbox"/>	<input type="checkbox"/>	<input type="checkbox"/>	78.7#
		72 x 40	UMSL7240	<input type="checkbox"/>	<input type="checkbox"/>	<input type="checkbox"/>	<input type="checkbox"/>	98.5#
UMSL	<b>Monolithic Steel Panel - 48"H</b>	24 x 48	UMSL2448	<input type="checkbox"/>	<input type="checkbox"/>	<input type="checkbox"/>	<input type="checkbox"/>	47.3#
		30 x 48	UMSL3048	<input type="checkbox"/>	<input type="checkbox"/>	<input type="checkbox"/>	<input type="checkbox"/>	54.2#
		36 x 48	UMSL3648	<input type="checkbox"/>	<input type="checkbox"/>	<input type="checkbox"/>	<input type="checkbox"/>	61.1#
UMSL	<b>Monolithic Steel Panel - 56"H</b>	24 x 56	UMSL2456	<input type="checkbox"/>	<input type="checkbox"/>	<input type="checkbox"/>	<input type="checkbox"/>	52.4#
		30 x 56	UMSL3056	<input type="checkbox"/>	<input type="checkbox"/>	<input type="checkbox"/>	<input type="checkbox"/>	60.2#
		36 x 56	UMSL3656	<input type="checkbox"/>	<input type="checkbox"/>	<input type="checkbox"/>	<input type="checkbox"/>	67.9#
UMSL	<b>Monolithic Steel Panel - 64"H</b>	24 x 64	UMSL2464	<input type="checkbox"/>	<input type="checkbox"/>	<input type="checkbox"/>	<input type="checkbox"/>	57.6#
		30 x 64	UMSL3064	<input type="checkbox"/>	<input type="checkbox"/>	<input type="checkbox"/>	<input type="checkbox"/>	66.1#
		36 x 64	UMSL3664	<input type="checkbox"/>	<input type="checkbox"/>	<input type="checkbox"/>	<input type="checkbox"/>	74.6#
			<b>A</b>	<b>B</b>	<b>C</b>	<b>D</b>	<b>E</b>	

## HOW TO ORDER

Indicate the following information on order form:

- Quantity of each item.
- Model number, including options. See "How To Build a Model Number".
- Any special service required.

Note: • The  indicates that a choice is required.

- The absence of the  indicates that no choice is required.
- Alpha-numeric characters in place of  indicate that no other alternatives are available.

## HOW TO BUILD A MODEL NUMBER

- A** Select basic model.
- B** Select top cap style.  

F	- Flat trim (std)
N	- No topcap
- C** Select trim color.  
Refer to color addendum at [ki.com](http://ki.com) or KI Fabrics & Finishes binder.
- D** Select paint color side 1.  
Refer to color addendum at [ki.com](http://ki.com) or KI Fabrics & Finishes binder.
- E** Select paint color side 2.  
Refer to color addendum at [ki.com](http://ki.com) or KI Fabrics & Finishes binder.



# Preconfigured Monolithic Steel Panels

Elevated Base

Delivered Pricing

\$ 423  
455  
482  
495  
553  
739  
888

\$ 432  
473  
511  
530  
587  
775  
933

\$ 483  
511  
554

\$ 506  
555  
594

\$ 603  
648  
694

**SPECIAL SERVICES**

**Special Carton Marking**

With specially marked information N/C

**Shipping**

Delivered. Shipped **k.d. freight prepaid f.o.b. Manitowoc, Wisconsin 54220** factory. Freight class #70.

Specifications and prices are subject to change without prior notice.

# Preconfigured Monolithic Steel Panels

Tile-to-Floor One Side; Standard Base Raceway One Side

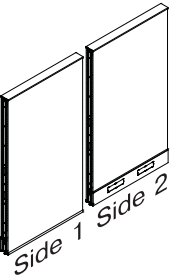
	MODEL	W x H	MODEL NUMBER						Approx. Packaged Weight
			Basic Model	Top Cap Style	Electrical Code	Trim Color	Paint Color Side 1	Paint Color Side 2	
 <p>UMST</p>	<b>Monolithic Steel Panel - 32"H</b>	24 x 32	UMST2432	<input type="checkbox"/>	<input type="checkbox"/>	<input type="checkbox"/>	<input type="checkbox"/>	<input type="checkbox"/>	38.9#
	<ul style="list-style-type: none"> <li>Side 1: tile-to-floor base does not accept cable distribution</li> </ul>	30 x 32	UMST3032	<input type="checkbox"/>	<input type="checkbox"/>	<input type="checkbox"/>	<input type="checkbox"/>	<input type="checkbox"/>	44.7#
	<ul style="list-style-type: none"> <li>Side 2: standard base raceway accepts power and data cable distribution</li> </ul>	36 x 32	UMST3632	<input type="checkbox"/>	<input type="checkbox"/>	<input type="checkbox"/>	<input type="checkbox"/>	<input type="checkbox"/>	50.5#
	<ul style="list-style-type: none"> <li>Includes monolithic steel tiles with mounting bars for both sides</li> </ul>	42 x 32	UMST4232	<input type="checkbox"/>	<input type="checkbox"/>	<input type="checkbox"/>	<input type="checkbox"/>	<input type="checkbox"/>	56.4#
	<ul style="list-style-type: none"> <li>Panel assembly includes frame, trim, and panel-to-panel connectors</li> </ul>	48 x 32	UMST4832	<input type="checkbox"/>	<input type="checkbox"/>	<input type="checkbox"/>	<input type="checkbox"/>	<input type="checkbox"/>	62.2#
	<ul style="list-style-type: none"> <li>Trim is metal and includes top cap, bottom trim channel, and base raceway</li> </ul>	60 x 32	UMST6032	<input type="checkbox"/>	<input type="checkbox"/>	<input type="checkbox"/>	<input type="checkbox"/>	<input type="checkbox"/>	73.9#
	<ul style="list-style-type: none"> <li>Side 1 and side 2 finishes are specified separately</li> </ul>	72 x 32	UMST7232	<input type="checkbox"/>	<input type="checkbox"/>	<input type="checkbox"/>	<input type="checkbox"/>	<input type="checkbox"/>	91.8#
	<ul style="list-style-type: none"> <li>Side 2: 30-72" wide panels feature two power knockouts</li> </ul>								
	<ul style="list-style-type: none"> <li>Side 2: 24" wide panels feature one power knockout</li> </ul>								
	<ul style="list-style-type: none"> <li>Electrical components are specified separately</li> <li>72" wide panels feature split tiles</li> </ul>								
UMST	<b>Monolithic Steel Panel - 40"H</b>	24 x 40	UMST2440	<input type="checkbox"/>	<input type="checkbox"/>	<input type="checkbox"/>	<input type="checkbox"/>	<input type="checkbox"/>	44.0#
		30 x 40	UMST3040	<input type="checkbox"/>	<input type="checkbox"/>	<input type="checkbox"/>	<input type="checkbox"/>	<input type="checkbox"/>	50.6#
		36 x 40	UMST3640	<input type="checkbox"/>	<input type="checkbox"/>	<input type="checkbox"/>	<input type="checkbox"/>	<input type="checkbox"/>	57.2#
		42 x 40	UMST4240	<input type="checkbox"/>	<input type="checkbox"/>	<input type="checkbox"/>	<input type="checkbox"/>	<input type="checkbox"/>	63.9#
		48 x 40	UMST4840	<input type="checkbox"/>	<input type="checkbox"/>	<input type="checkbox"/>	<input type="checkbox"/>	<input type="checkbox"/>	70.6#
		60 x 40	UMST6040	<input type="checkbox"/>	<input type="checkbox"/>	<input type="checkbox"/>	<input type="checkbox"/>	<input type="checkbox"/>	83.9#
		72 x 40	UMST7240	<input type="checkbox"/>	<input type="checkbox"/>	<input type="checkbox"/>	<input type="checkbox"/>	<input type="checkbox"/>	104.8#
UMST	<b>Monolithic Steel Panel - 48"H</b>	24 x 48	UMST2448	<input type="checkbox"/>	<input type="checkbox"/>	<input type="checkbox"/>	<input type="checkbox"/>	<input type="checkbox"/>	49.1#
		30 x 48	UMST3048	<input type="checkbox"/>	<input type="checkbox"/>	<input type="checkbox"/>	<input type="checkbox"/>	<input type="checkbox"/>	56.5#
		36 x 48	UMST3648	<input type="checkbox"/>	<input type="checkbox"/>	<input type="checkbox"/>	<input type="checkbox"/>	<input type="checkbox"/>	64.0#
UMST	<b>Monolithic Steel Panel - 56"H</b>	24 x 56	UMST2456	<input type="checkbox"/>	<input type="checkbox"/>	<input type="checkbox"/>	<input type="checkbox"/>	<input type="checkbox"/>	54.3#
		30 x 56	UMST3056	<input type="checkbox"/>	<input type="checkbox"/>	<input type="checkbox"/>	<input type="checkbox"/>	<input type="checkbox"/>	62.5#
		36 x 56	UMST3656	<input type="checkbox"/>	<input type="checkbox"/>	<input type="checkbox"/>	<input type="checkbox"/>	<input type="checkbox"/>	70.8#
UMST	<b>Monolithic Steel Panel - 64"H</b>	24 x 64	UMST2464	<input type="checkbox"/>	<input type="checkbox"/>	<input type="checkbox"/>	<input type="checkbox"/>	<input type="checkbox"/>	59.4#
		30 x 64	UMST3064	<input type="checkbox"/>	<input type="checkbox"/>	<input type="checkbox"/>	<input type="checkbox"/>	<input type="checkbox"/>	68.5#
		36 x 64	UMST3664	<input type="checkbox"/>	<input type="checkbox"/>	<input type="checkbox"/>	<input type="checkbox"/>	<input type="checkbox"/>	77.6#

**A**   **B**   **C**   **D**   **E**   **F**

## HOW TO ORDER

Indicate the following information on order form:

- Quantity of each item.
- Model number, including options. See "How To Build a Model Number".
- Any special service required.

Note: • The  indicates that a choice is required.

- The absence of the  indicates that no choice is required.
- Alpha-numeric characters in place of  indicate that no other alternatives are available.

## HOW TO BUILD A MODEL NUMBER

**A** Select basic model.

**B** Select top cap style.

**F** - Flat trim (std)  
**N** - No topcap

**C** Select electrical code.

**CP** - Chicago - with cutouts  
**DN** - Domestic - no cutouts  
**DP** - Domestic - with cutouts

**D** Select trim color.

Refer to color addendum at ki.com or KI Fabrics & Finishes binder.

**E** Select paint color side 1.

Refer to color addendum at ki.com or KI Fabrics & Finishes binder.

**F** Select paint color side 2.

Refer to color addendum at ki.com or KI Fabrics & Finishes binder.



# Preconfigured Monolithic Steel Panels

Tile-to-Floor One Side; Standard Base Raceway One Side

Delivered Pricing

\$ 423
455
482
495
553
739
888

\$ 432
473
511
530
587
775
933

\$ 483
511
554

\$ 506
555
594

\$ 603
648
694

### SPECIAL SERVICES

#### Special Carton Marking

With specially marked information N/C

#### Shipping

Delivered. Shipped **k.d. freight prepaid f.o.b. Manitowoc, Wisconsin 54220** factory. Freight class #70.

Specifications and prices are subject to change without prior notice.

# Preconfigured Monolithic Steel Panels (Beltway Power)

Standard Base Raceway

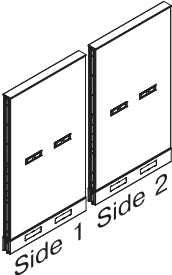
	MODEL	W x H	MODEL NUMBER						Approx. Packaged Weight	
			Basic Model	Top Cap Style	Electrical Code	Bezel Color	Trim Color	Paint Color Side 1		Paint Color Side 2
 <p>UMSR</p>	<b>Monolithic Steel Panel - 40"H</b>	24 x 40	UMSRBW2440	<input type="checkbox"/>	<input type="checkbox"/>	<input type="checkbox"/>	<input type="checkbox"/>	<input type="checkbox"/>	<input type="checkbox"/>	44.8#
	<ul style="list-style-type: none"> <li>Standard base raceway on both sides accepts power and data cable distribution</li> <li>Above worksurface beltway accepts power and data cable distribution</li> <li>Includes monolithic steel tiles with mounting bars for both sides</li> <li>Panel assembly includes frame, trim, and panel-to-panel connectors</li> <li>Trim is metal and includes top cap, bottom trim channel, and base raceway</li> <li>Side 1 and side 2 finishes are specified separately</li> <li>30-72" wide panels each feature two power knockouts at base and two knockouts with bezels at beltway per side</li> <li>24" wide panels each feature one power knockout and one at beltway per side</li> <li>72" wide panels feature split tiles</li> <li>Electrical components are specified separately</li> </ul>	30 x 40	UMSRBW3040	<input type="checkbox"/>	<input type="checkbox"/>	<input type="checkbox"/>	<input type="checkbox"/>	<input type="checkbox"/>	<input type="checkbox"/>	51.6#
		36 x 40	UMSRBW3640	<input type="checkbox"/>	<input type="checkbox"/>	<input type="checkbox"/>	<input type="checkbox"/>	<input type="checkbox"/>	<input type="checkbox"/>	58.5#
		42 x 40	UMSRBW4240	<input type="checkbox"/>	<input type="checkbox"/>	<input type="checkbox"/>	<input type="checkbox"/>	<input type="checkbox"/>	<input type="checkbox"/>	65.4#
		48 x 40	UMSRBW4840	<input type="checkbox"/>	<input type="checkbox"/>	<input type="checkbox"/>	<input type="checkbox"/>	<input type="checkbox"/>	<input type="checkbox"/>	72.3#
		60 x 40	UMSRBW6040	<input type="checkbox"/>	<input type="checkbox"/>	<input type="checkbox"/>	<input type="checkbox"/>	<input type="checkbox"/>	<input type="checkbox"/>	86.1#
		72 x 40	UMSRBW7240	<input type="checkbox"/>	<input type="checkbox"/>	<input type="checkbox"/>	<input type="checkbox"/>	<input type="checkbox"/>	<input type="checkbox"/>	107.5#
UMSR	<b>Monolithic Steel Panel - 48"H</b>	24 x 48	UMSRBW2448	<input type="checkbox"/>	<input type="checkbox"/>	<input type="checkbox"/>	<input type="checkbox"/>	<input type="checkbox"/>	<input type="checkbox"/>	49.9#
		30 x 48	UMSRBW3048	<input type="checkbox"/>	<input type="checkbox"/>	<input type="checkbox"/>	<input type="checkbox"/>	<input type="checkbox"/>	<input type="checkbox"/>	57.5#
		36 x 48	UMSRBW3648	<input type="checkbox"/>	<input type="checkbox"/>	<input type="checkbox"/>	<input type="checkbox"/>	<input type="checkbox"/>	<input type="checkbox"/>	65.2#
UMSR	<b>Monolithic Steel Panel - 56"H</b>	24 x 56	UMSRBW2456	<input type="checkbox"/>	<input type="checkbox"/>	<input type="checkbox"/>	<input type="checkbox"/>	<input type="checkbox"/>	<input type="checkbox"/>	55.1#
		30 x 56	UMSRBW3056	<input type="checkbox"/>	<input type="checkbox"/>	<input type="checkbox"/>	<input type="checkbox"/>	<input type="checkbox"/>	<input type="checkbox"/>	63.5#
		36 x 56	UMSRBW3656	<input type="checkbox"/>	<input type="checkbox"/>	<input type="checkbox"/>	<input type="checkbox"/>	<input type="checkbox"/>	<input type="checkbox"/>	72.0#
UMSR	<b>Monolithic Steel Panel - 64"H</b>	24 x 64	UMSRBW2464	<input type="checkbox"/>	<input type="checkbox"/>	<input type="checkbox"/>	<input type="checkbox"/>	<input type="checkbox"/>	<input type="checkbox"/>	60.2#
		30 x 64	UMSRBW3064	<input type="checkbox"/>	<input type="checkbox"/>	<input type="checkbox"/>	<input type="checkbox"/>	<input type="checkbox"/>	<input type="checkbox"/>	69.5#
		36 x 64	UMSRBW3664	<input type="checkbox"/>	<input type="checkbox"/>	<input type="checkbox"/>	<input type="checkbox"/>	<input type="checkbox"/>	<input type="checkbox"/>	78.8#

**A**      **B**      **C**      **D**      **E**      **F**      **G**

## HOW TO ORDER

Indicate the following information on order form:

- Quantity of each item.
- Model number, including options. See "How To Build a Model Number".
- Any special service required.

Note: • The  indicates that a choice is required.

- The absence of the  indicates that no choice is required.
- Alpha-numeric characters in place of  indicate that no other alternatives are available.

## HOW TO BUILD A MODEL NUMBER

- A** Select basic model.
- B** Select top cap style.  

<b>F</b>	- Flat trim (std)
<b>N</b>	- No topcap
- C** Select electrical code.  

<b>DP</b>	- Domestic - with cutouts
<b>D1</b>	- Domestic, 1 side w/cutouts

- G** Select paint color side 2.  
Refer to color addendum at [ki.com](http://ki.com) or KI Fabrics & Finishes binder.

- D** Select bezel color.  
Refer to color addendum at [ki.com](http://ki.com) or KI Fabrics & Finishes binder.

- E** Select trim color.  
Refer to color addendum at [ki.com](http://ki.com) or KI Fabrics & Finishes binder.

- F** Select paint color side 1.  
Refer to color addendum at [ki.com](http://ki.com) or KI Fabrics & Finishes binder.



# Preconfigured Monolithic Steel Panels (Beltway Power)

Standard Base Raceway

Delivered Pricing

\$ 444
493
531
554
609
795
976

\$ 496
531
575
\$ 517
576
617
\$ 614
672
717

**SPECIAL SERVICES**

**Special Carton Marking**

With specially marked information N/C

**Shipping**

Delivered. Shipped **k.d. freight prepaid f.o.b. Manitowoc, Wisconsin 54220** factory. Freight class #70.

Specifications and prices are subject to change without prior notice.

# Preconfigured Monolithic Steel Panels (Beltway Power)

Elevated Base

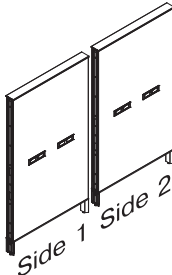
		MODEL NUMBER							Approx. Packaged Weight	
		Basic Model	Top Cap Style	Electrical Code	Bezel Color	Trim Color	Paint Color Side 1	Paint Color Side 2		
 <p>UMSL</p>	<b>Monolithic Steel Panel - 40"H</b>	24 x 40	UMSLBW2440	<input type="checkbox"/>	<input type="checkbox"/>	<input type="checkbox"/>	<input type="checkbox"/>	<input type="checkbox"/>	<input type="checkbox"/>	42.1#
	<ul style="list-style-type: none"> <li>Includes monolithic steel tiles with mounting bars for both sides</li> </ul>	30 x 40	UMSLBW3040	<input type="checkbox"/>	<input type="checkbox"/>	<input type="checkbox"/>	<input type="checkbox"/>	<input type="checkbox"/>	<input type="checkbox"/>	48.2#
	<ul style="list-style-type: none"> <li>30-72" wide tiles each feature two power knockouts with bezels at above-worksurface beltway</li> </ul>	36 x 40	UMSLBW3640	<input type="checkbox"/>	<input type="checkbox"/>	<input type="checkbox"/>	<input type="checkbox"/>	<input type="checkbox"/>	<input type="checkbox"/>	54.3#
	<ul style="list-style-type: none"> <li>24" wide tiles each feature one power knockout with bezel at above-worksurface beltway</li> </ul>	42 x 40	UMSLBW4240	<input type="checkbox"/>	<input type="checkbox"/>	<input type="checkbox"/>	<input type="checkbox"/>	<input type="checkbox"/>	<input type="checkbox"/>	60.5#
	<ul style="list-style-type: none"> <li>48" wide tiles each feature one power knockout with bezel at above-worksurface beltway</li> </ul>	48 x 40	UMSLBW4840	<input type="checkbox"/>	<input type="checkbox"/>	<input type="checkbox"/>	<input type="checkbox"/>	<input type="checkbox"/>	<input type="checkbox"/>	66.6#
	<ul style="list-style-type: none"> <li>60" wide tiles each feature one power knockout with bezel at above-worksurface beltway</li> </ul>	60 x 40	UMSLBW6040	<input type="checkbox"/>	<input type="checkbox"/>	<input type="checkbox"/>	<input type="checkbox"/>	<input type="checkbox"/>	<input type="checkbox"/>	78.7#
	<ul style="list-style-type: none"> <li>72" wide panels feature split tiles</li> </ul>	72 x 40	UMSLBW7240	<input type="checkbox"/>	<input type="checkbox"/>	<input type="checkbox"/>	<input type="checkbox"/>	<input type="checkbox"/>	<input type="checkbox"/>	98.5#
	<ul style="list-style-type: none"> <li>Raised base does not accept cable distribution</li> <li>Panel assembly includes frame, trim, and panel-to-panel connectors</li> <li>Trim is metal and includes top cap, bottom trim channel, and foot shroud</li> <li>Side 1 and side 2 finishes are specified separately</li> </ul>									
UMSL	<b>Monolithic Steel Panel - 48"H</b>	24 x 48	UMSLBW2448	<input type="checkbox"/>	<input type="checkbox"/>	<input type="checkbox"/>	<input type="checkbox"/>	<input type="checkbox"/>	<input type="checkbox"/>	47.3#
		30 x 48	UMSLBW3048	<input type="checkbox"/>	<input type="checkbox"/>	<input type="checkbox"/>	<input type="checkbox"/>	<input type="checkbox"/>	<input type="checkbox"/>	54.2#
		36 x 48	UMSLBW3648	<input type="checkbox"/>	<input type="checkbox"/>	<input type="checkbox"/>	<input type="checkbox"/>	<input type="checkbox"/>	<input type="checkbox"/>	61.1#
UMSL	<b>Monolithic Steel Panel - 56"H</b>	24 x 56	UMSLBW2456	<input type="checkbox"/>	<input type="checkbox"/>	<input type="checkbox"/>	<input type="checkbox"/>	<input type="checkbox"/>	<input type="checkbox"/>	52.4#
		30 x 56	UMSLBW3056	<input type="checkbox"/>	<input type="checkbox"/>	<input type="checkbox"/>	<input type="checkbox"/>	<input type="checkbox"/>	<input type="checkbox"/>	60.2#
		36 x 56	UMSLBW3656	<input type="checkbox"/>	<input type="checkbox"/>	<input type="checkbox"/>	<input type="checkbox"/>	<input type="checkbox"/>	<input type="checkbox"/>	67.9#
UMSL	<b>Monolithic Steel Panel - 64"H</b>	24 x 64	UMSLBW2464	<input type="checkbox"/>	<input type="checkbox"/>	<input type="checkbox"/>	<input type="checkbox"/>	<input type="checkbox"/>	<input type="checkbox"/>	57.6#
		30 x 64	UMSLBW3064	<input type="checkbox"/>	<input type="checkbox"/>	<input type="checkbox"/>	<input type="checkbox"/>	<input type="checkbox"/>	<input type="checkbox"/>	66.1#
		36 x 64	UMSLBW3664	<input type="checkbox"/>	<input type="checkbox"/>	<input type="checkbox"/>	<input type="checkbox"/>	<input type="checkbox"/>	<input type="checkbox"/>	74.6#

**A**   **B**   **C**   **D**   **E**   **F**   **G**

## HOW TO ORDER

Indicate the following information on order form:

- Quantity of each item.
- Model number, including options. See "How To Build a Model Number".
- Any special service required.

Note: • The  indicates that a choice is required.

- The absence of the  indicates that no choice is required.
- Alpha-numeric characters in place of  indicate that no other alternatives are available.

## HOW TO BUILD A MODEL NUMBER

- A** Select basic model.
- B** Select top cap style.
 

<b>F</b>	- Flat trim (std)
<b>N</b>	- No topcap
- C** Select electrical code.
 

<b>DP</b>	- Domestic - with cutouts
-----------	---------------------------
- D** Select bezel color. Refer to color addendum at ki.com or KI Fabrics & Finishes binder.
- E** Select trim color. Refer to color addendum at ki.com or KI Fabrics & Finishes binder.
- F** Select paint color side 1. Refer to color addendum at ki.com or KI Fabrics & Finishes binder.
- G** Select paint color side 2. Refer to color addendum at ki.com or KI Fabrics & Finishes binder.





# Preconfigured Monolithic Steel Panels (Beltway Power)

Elevated Base

Delivered Pricing	
\$	444
	493
	531
	554
	609
	795
	976
\$	496
	531
	575
\$	517
	576
	617
\$	614
	672
	717

**SPECIAL SERVICES**

**Special Carton Marking**

With specially marked information    N/C

**Shipping**

Delivered. Shipped **k.d. freight prepaid f.o.b. Manitowoc, Wisconsin 54220** factory. Freight class #70.

Specifications and prices are subject to change without prior notice.

# Preconfigured Monolithic Steel Panels (Beltway Power)

Tile-to-Floor One Side; Standard Base Raceway One Side

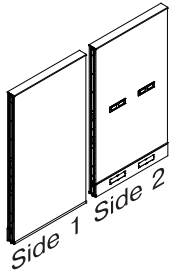

UMST

MODEL	W x H	MODEL NUMBER							Approx. Packaged Weight
		Basic Model	Top Cap Style	Electrical Code	Bezel Color	Trim Color	Paint Color Side 1	Paint Color Side 2	
<b>Monolithic Steel Panel - 40"H</b> • Side 1: tile-to-floor base does not accept cable distribution at base or beltway • Side 2: standard base raceway and above-worksurface beltway power accept cable distribution • Includes monolithic steel tiles with mounting bars for both sides • Panel assembly includes frame, trim, and panel-to-panel connectors • Trim is metal and includes top cap, bottom trim channel, and base raceway • Side 1 and side 2 finishes are specified separately • Side 2: 30-72" wide tiles feature two base knockouts and two beltway power knockouts with bezels • Side 2: 24" wide tiles feature one base power knockout and one beltway knockout with bezel • 72" wide panels feature split tiles • Electrical components are specified separately	24 x 40	UMSTBW2440	<input type="checkbox"/>	<input type="checkbox"/>	<input type="checkbox"/>	<input type="checkbox"/>	<input type="checkbox"/>	<input type="checkbox"/>	44.0#
	30 x 40	UMSTBW3040	<input type="checkbox"/>	<input type="checkbox"/>	<input type="checkbox"/>	<input type="checkbox"/>	<input type="checkbox"/>	<input type="checkbox"/>	50.6#
	36 x 40	UMSTBW3640	<input type="checkbox"/>	<input type="checkbox"/>	<input type="checkbox"/>	<input type="checkbox"/>	<input type="checkbox"/>	<input type="checkbox"/>	57.2#
	42 x 40	UMSTBW4240	<input type="checkbox"/>	<input type="checkbox"/>	<input type="checkbox"/>	<input type="checkbox"/>	<input type="checkbox"/>	<input type="checkbox"/>	63.9#
	48 x 40	UMSTBW4840	<input type="checkbox"/>	<input type="checkbox"/>	<input type="checkbox"/>	<input type="checkbox"/>	<input type="checkbox"/>	<input type="checkbox"/>	70.6#
	60 x 40	UMSTBW6040	<input type="checkbox"/>	<input type="checkbox"/>	<input type="checkbox"/>	<input type="checkbox"/>	<input type="checkbox"/>	<input type="checkbox"/>	83.9#
	72 x 40	UMSTBW7240	<input type="checkbox"/>	<input type="checkbox"/>	<input type="checkbox"/>	<input type="checkbox"/>	<input type="checkbox"/>	<input type="checkbox"/>	104.8#
UMST	<b>Monolithic Steel Panel - 48"H</b>	24 x 48	UMSTBW2448	<input type="checkbox"/>	<input type="checkbox"/>	<input type="checkbox"/>	<input type="checkbox"/>	<input type="checkbox"/>	49.1#
	30 x 48	UMSTBW3048	<input type="checkbox"/>	<input type="checkbox"/>	<input type="checkbox"/>	<input type="checkbox"/>	<input type="checkbox"/>	56.5#	
	36 x 48	UMSTBW3648	<input type="checkbox"/>	<input type="checkbox"/>	<input type="checkbox"/>	<input type="checkbox"/>	<input type="checkbox"/>	64.0#	
UMST	<b>Monolithic Steel Panel - 56"H</b>	24 x 56	UMSTBW2456	<input type="checkbox"/>	<input type="checkbox"/>	<input type="checkbox"/>	<input type="checkbox"/>	<input type="checkbox"/>	54.3#
	30 x 56	UMSTBW3056	<input type="checkbox"/>	<input type="checkbox"/>	<input type="checkbox"/>	<input type="checkbox"/>	<input type="checkbox"/>	62.5#	
	36 x 56	UMSTBW3656	<input type="checkbox"/>	<input type="checkbox"/>	<input type="checkbox"/>	<input type="checkbox"/>	<input type="checkbox"/>	70.8#	
UMST	<b>Monolithic Steel Panel - 64"H</b>	24 x 64	UMSTBW2464	<input type="checkbox"/>	<input type="checkbox"/>	<input type="checkbox"/>	<input type="checkbox"/>	<input type="checkbox"/>	59.4#
	30 x 64	UMSTBW3064	<input type="checkbox"/>	<input type="checkbox"/>	<input type="checkbox"/>	<input type="checkbox"/>	<input type="checkbox"/>	68.5#	
	36 x 64	UMSTBW3664	<input type="checkbox"/>	<input type="checkbox"/>	<input type="checkbox"/>	<input type="checkbox"/>	<input type="checkbox"/>	77.6#	

**A**      **B**      **C**      **D**      **E**      **F**      **G**

## HOW TO ORDER

Indicate the following information on order form:

- Quantity of each item.
- Model number, including options. See "How To Build a Model Number".
- Any special service required.

Note: • The  indicates that a choice is required.

- The absence of the  indicates that no choice is required.
- Alpha-numeric characters in place of  indicate that no other alternatives are available.

## HOW TO BUILD A MODEL NUMBER

- A** Select basic model.
- B** Select top cap style.  

<b>F</b>	- Flat trim (std)
<b>N</b>	- No topcap
- C** Select electrical code.  

<b>DP</b>	- Domestic - with cutouts
-----------	---------------------------
- D** Select bezel color.  
Refer to color addendum at ki.com or KI Fabrics & Finishes binder.
- E** Select trim color.  
Refer to color addendum at ki.com or KI Fabrics & Finishes binder.
- F** Select paint color side 1.  
Refer to color addendum at ki.com or KI Fabrics & Finishes binder.
- G** Select paint color side 2.  
Refer to color addendum at ki.com or KI Fabrics & Finishes binder.



# Preconfigured Monolithic Steel Panels (Beltway Power)

Tile-to-Floor One Side; Standard Base Raceway One Side

Delivered Pricing

\$ 444
493
531
554
609
795
976

\$ 496
531
575
\$ 517
576
617
\$ 614
672
717

**SPECIAL SERVICES**

**Special Carton Marking**

With specially marked information N/C

**Shipping**

Delivered. Shipped **k.d. freight prepaid f.o.b. Manitowoc, Wisconsin 54220** factory. Freight class #70.

Specifications and prices are subject to change without prior notice.

# Preconfigured Monolithic Open Panels

## Standard Base Raceway

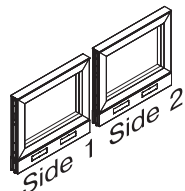

UMOR

**MODEL**

**W x H**

- Monolithic Open Panel - 32"H**
- Standard base raceway on both sides accepts power and data cable distribution
  - Aluminum powder coated open frame allows pass-through accessibility range of 8" to 29" from floor
  - Panel assembly includes frame, trim, and panel-to-panel connecting hardware
  - Trim is metal and includes top cap, bottom trim channel, and base raceway and open frame
  - 30-60" wide panels feature two power knockouts per side
  - 24" wide panels feature one power knockout per side
  - Electrical components are specified separately

**MODEL NUMBER**

**Basic Model**

**Top Cap Style**

**Electrical Code**

**Trim Color**

**Approx. Packaged Weight**

Basic Model	Top Cap Style	Electrical Code	Trim Color	Approx. Packaged Weight
UMOR2432	<input type="checkbox"/>	<input type="checkbox"/>	<input type="checkbox"/>	39.0#
UMOR3032	<input type="checkbox"/>	<input type="checkbox"/>	<input type="checkbox"/>	45.0#
UMOR3632	<input type="checkbox"/>	<input type="checkbox"/>	<input type="checkbox"/>	51.0#
UMOR4232	<input type="checkbox"/>	<input type="checkbox"/>	<input type="checkbox"/>	57.0#
UMOR4832	<input type="checkbox"/>	<input type="checkbox"/>	<input type="checkbox"/>	64.0#
UMOR6032	<input type="checkbox"/>	<input type="checkbox"/>	<input type="checkbox"/>	76.0#

**A**

**B**

**C**

**D**

### HOW TO ORDER

Indicate the following information on order form:

1. Quantity of each item.
2. Model number, including options. See "How To Build a Model Number".
3. Any special service required.

Note: • The  indicates that a choice is required.

- The absence of the  indicates that no choice is required.
- Alpha-numeric characters in place of  indicate that no other alternatives are available.

### HOW TO BUILD A MODEL NUMBER

- A** Select basic model.
- B** Select top cap style.
 

<b>F</b>	- Flat trim (std)
<b>N</b>	- No topcap
- C** Select electrical code.
 

<b>CP</b>	- Chicago - with cutouts
<b>DN</b>	- Domestic - no cutouts
<b>DP</b>	- Domestic - with cutouts
<b>C1</b>	- Chicago, 1 side w/cutouts
<b>D1</b>	- Domestic, 1 side w/cutouts
- D** Select trim color. Refer to color addendum at [ki.com](http://ki.com) or KI Fabrics & Finishes binder.



# Preconfigured Monolithic Open Panels

Standard Base Raceway

Delivered  
Pricing

\$ 544  
589  
612  
677  
699  
857

## SPECIAL SERVICES

### Special Carton Marking

With specially marked information N/C

### Shipping

Shipped **k.d. freight prepaid f.o.b. Manitowoc, Wisconsin 54220** factory. Freight class #70.

Specifications and prices are subject to change without prior notice.

# Preconfigured Monolithic Open Panels

Elevated Base

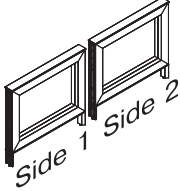
MODEL	W x H	MODEL NUMBER			Approx. Packaged Weight
		Basic Model	Top Cap Style	Trim Color	
 <p>UMOL</p> <p><b>Monolithic Open Panel - 32"H</b></p> <ul style="list-style-type: none"> <li>Elevated base is non-powered and does not accept cable distribution</li> <li>Features powder coated aluminum frame</li> <li>Open frame allows pass-through accessibility range of 8" to 29" from floor</li> <li>Panel assembly includes frame, trim, and panel-to-panel connecting hardware</li> <li>Trim is metal and includes top cap, bottom trim channel, and base raceway and open frame</li> </ul>	24 x 32	UMOL2432	<input type="checkbox"/>	<input type="checkbox"/>	37.0#
	30 x 32	UMOL3032	<input type="checkbox"/>	<input type="checkbox"/>	42.0#
	36 x 32	UMOL3632	<input type="checkbox"/>	<input type="checkbox"/>	47.0#
	42 x 32	UMOL4232	<input type="checkbox"/>	<input type="checkbox"/>	53.0#
	48 x 32	UMOL4832	<input type="checkbox"/>	<input type="checkbox"/>	58.0#
	60 x 32	UMOL6032	<input type="checkbox"/>	<input type="checkbox"/>	68.0#

A

B

C

## HOW TO ORDER

Indicate the following information on order form:

- Quantity of each item.
- Model number, including options. See "How To Build a Model Number".
- Any special service required.

Note: • The  indicates that a choice is required.

- The absence of the  indicates that no choice is required.
- Alpha-numeric characters in place of  indicate that no other alternatives are available.

## HOW TO BUILD A MODEL NUMBER

**A** Select basic model.

**B** Select top cap style.

**F** - Flat trim (std)

**N** - No topcap

**C** Select trim color.

Refer to color addendum at [ki.com](http://ki.com) or KI Fabrics & Finishes binder.



# Preconfigured Monolithic Open Panels

Elevated Base

Delivered  
Pricing

\$ 525
568
587
647
666
800

### SPECIAL SERVICES

#### Special Carton Marking

With specially marked information N/C

#### Shipping

Shipped k.d. freight prepaid f.o.b. Manitowoc, Wisconsin 54220 factory. Freight class #70.

Specifications and prices are subject to change without prior notice.

# Preconfigured Segmented Fabric Panel

Standard Base Raceway

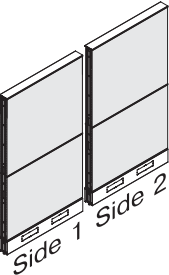
	MODEL	W x H	MODEL NUMBER						Approx. Packaged Weight
			Basic Model	Top Cap Style	Electrical Code	Trim Color	Fabric Side 1	Fabric Side 2	
 <p>USFR</p>	<b>Segmented Fabric Panel - 40"H</b>	24 x 40	USFR2440	<input type="checkbox"/>	<input type="checkbox"/>	<input type="checkbox"/>	<input type="checkbox"/>	<input type="checkbox"/>	39.0#
	• Includes upper and lower segmented fabric tiles for both sides	30 x 40	USFR3040	<input type="checkbox"/>	<input type="checkbox"/>	<input type="checkbox"/>	<input type="checkbox"/>	<input type="checkbox"/>	44.4#
	• Upper and lower segments must be identically specified	36 x 40	USFR3640	<input type="checkbox"/>	<input type="checkbox"/>	<input type="checkbox"/>	<input type="checkbox"/>	<input type="checkbox"/>	50.0#
	• Standard base raceway on both sides accepts power and data cable distribution	42 x 40	USFR4240	<input type="checkbox"/>	<input type="checkbox"/>	<input type="checkbox"/>	<input type="checkbox"/>	<input type="checkbox"/>	55.6#
	• Panel assembly includes frame, trim, and panel-to-panel connectors	48 x 40	USFR4840	<input type="checkbox"/>	<input type="checkbox"/>	<input type="checkbox"/>	<input type="checkbox"/>	<input type="checkbox"/>	61.2#
	• Trim is metal and includes top cap, bottom trim channel, base raceway, and segment channel	60 x 40	USFR6040	<input type="checkbox"/>	<input type="checkbox"/>	<input type="checkbox"/>	<input type="checkbox"/>	<input type="checkbox"/>	72.3#
	• Side 1 and side 2 finishes are specified separately	72 x 40	USFR7240	<input type="checkbox"/>	<input type="checkbox"/>	<input type="checkbox"/>	<input type="checkbox"/>	<input type="checkbox"/>	88.5#
	• 30-72" wide panels feature two power knockouts per side								
• 24" wide panels feature one power knockout per side									
• 72" wide panels feature split tiles									
• Electrical components are specified separately									
USFR	<b>Segmented Fabric Panel - 48"H</b>	24 x 48	USFR2448	<input type="checkbox"/>	<input type="checkbox"/>	<input type="checkbox"/>	<input type="checkbox"/>	<input type="checkbox"/>	44.3#
		30 x 48	USFR3048	<input type="checkbox"/>	<input type="checkbox"/>	<input type="checkbox"/>	<input type="checkbox"/>	<input type="checkbox"/>	50.3#
		36 x 48	USFR3648	<input type="checkbox"/>	<input type="checkbox"/>	<input type="checkbox"/>	<input type="checkbox"/>	<input type="checkbox"/>	56.4#
		42 x 48	USFR4248	<input type="checkbox"/>	<input type="checkbox"/>	<input type="checkbox"/>	<input type="checkbox"/>	<input type="checkbox"/>	62.5#
		48 x 48	USFR4848	<input type="checkbox"/>	<input type="checkbox"/>	<input type="checkbox"/>	<input type="checkbox"/>	<input type="checkbox"/>	68.6#
		60 x 48	USFR6048	<input type="checkbox"/>	<input type="checkbox"/>	<input type="checkbox"/>	<input type="checkbox"/>	<input type="checkbox"/>	80.8#
		72 x 48	USFR7248	<input type="checkbox"/>	<input type="checkbox"/>	<input type="checkbox"/>	<input type="checkbox"/>	<input type="checkbox"/>	99.3#
USFR	<b>Segmented Fabric Panel - 56"H</b>	24 x 56	USFR2456	<input type="checkbox"/>	<input type="checkbox"/>	<input type="checkbox"/>	<input type="checkbox"/>	<input type="checkbox"/>	48.6#
		30 x 56	USFR3056	<input type="checkbox"/>	<input type="checkbox"/>	<input type="checkbox"/>	<input type="checkbox"/>	<input type="checkbox"/>	55.2#
		36 x 56	USFR3656	<input type="checkbox"/>	<input type="checkbox"/>	<input type="checkbox"/>	<input type="checkbox"/>	<input type="checkbox"/>	61.8#
		42 x 56	USFR4256	<input type="checkbox"/>	<input type="checkbox"/>	<input type="checkbox"/>	<input type="checkbox"/>	<input type="checkbox"/>	68.5#
		48 x 56	USFR4856	<input type="checkbox"/>	<input type="checkbox"/>	<input type="checkbox"/>	<input type="checkbox"/>	<input type="checkbox"/>	75.1#
		60 x 56	USFR6056	<input type="checkbox"/>	<input type="checkbox"/>	<input type="checkbox"/>	<input type="checkbox"/>	<input type="checkbox"/>	88.3#
		72 x 56	USFR7256	<input type="checkbox"/>	<input type="checkbox"/>	<input type="checkbox"/>	<input type="checkbox"/>	<input type="checkbox"/>	109.1#

**A**   **B**   **C**   **D**   **E**   **F**

## HOW TO ORDER

Indicate the following information on order form:

- Quantity of each item.
- Model number, including options. See "How To Build a Model Number".
- Any special service required.

Note: • The  indicates that a choice is required.

- The absence of the  indicates that no choice is required.
- Alpha-numeric characters in place of  indicate that no other alternatives are available.

## HOW TO BUILD A MODEL NUMBER

**A** Select basic model.

**B** Select top cap style.

- F** - Flat trim (std)  
**N** - No topcap

**C** Select electrical code.

- CP** - Chicago - with cutouts  
**DN** - Domestic - no cutouts  
**DP** - Domestic - with cutouts  
**C1** - Chicago, 1 side w/cutouts  
**D1** - Domestic, 1 side w/cutouts

**D** Select trim color.

Refer to color addendum at [ki.com](http://ki.com) or KI Fabrics & Finishes binder.

**E** Select fabric side 1.

Refer to color addendum at [ki.com](http://ki.com) or in KI Fabrics & Finishes binder.

**F** Select fabric side 2.

Refer to color addendum at [ki.com](http://ki.com) or in KI Fabrics & Finishes binder.





# Preconfigured Segmented Fabric Panel

Standard Base Raceway

Delivered Pricing Fabric Grade 1 & C.O.M.	Delivered Pricing Fabric Grade 2	Delivered Pricing Fabric Grade 3 & Pallas Vertical Fabric Grade PV	Delivered Pricing Pallas Vertical Fabric Grade PV1	Delivered Pricing Pallas Vertical Fabric Grade PV2
\$ 403	\$ 421	\$ 436	\$ 447	\$ 477
457	478	495	508	541
496	519	536	550	587
542	568	587	603	642
559	585	607	620	662
675	705	730	748	799
903	946	980	1003	1069
<hr/>				
\$ 437	\$ 457	\$ 473	\$ 484	\$ 516
491	514	531	545	582
536	561	580	594	636
598	626	648	664	708
614	642	664	681	727
730	764	790	811	864
981	1026	1061	1088	1160
<hr/>				
\$ 458	\$ 479	\$ 496	\$ 509	\$ 542
524	549	568	583	620
577	603	623	640	682
646	676	698	718	765
662	692	718	734	783
749	784	811	832	888
1053	1101	1140	1169	1247

**SPECIAL SERVICES**

**Special Carton Marking**

With specially marked information    N/C

**Shipping**

Delivered. Shipped **k.d. freight prepaid f.o.b. Manitowoc, Wisconsin 54220** factory. Freight class #70.

Specifications and prices are subject to change without prior notice.

# Preconfigured Segmented Fabric Panel

Standard Base Raceway

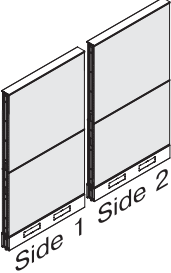
MODEL	W x H	MODEL NUMBER						Approx. Packaged Weight
		Basic Model	Top Cap Style	Electrical Code	Trim Color	Fabric Side 1	Fabric Side 2	
 <p>USFR</p> <p><b>Segmented Fabric Panel - 64"H</b></p> <ul style="list-style-type: none"> <li>Includes upper and lower segmented fabric tiles for both sides</li> <li>Upper and lower segments must be identically specified</li> <li>Standard base raceway on both sides accepts power and data cable distribution</li> <li>Panel assembly includes frame, trim, and panel-to-panel connectors</li> <li>Trim is metal and includes top cap, bottom trim channel, base raceway, and segment channel</li> <li>Side 1 and side 2 finishes are specified separately</li> <li>30-72" wide panels feature two power knockouts per side</li> <li>24" wide panels feature one power knockout per side</li> <li>72" wide panels feature split tiles</li> <li>Electrical components are specified separately</li> </ul>	24 x 64	USFR2464	<input type="checkbox"/>	<input type="checkbox"/>	<input type="checkbox"/>	<input type="checkbox"/>	<input type="checkbox"/>	53.0#
	30 x 64	USFR3064	<input type="checkbox"/>	<input type="checkbox"/>	<input type="checkbox"/>	<input type="checkbox"/>	<input type="checkbox"/>	60.0#
	36 x 64	USFR3664	<input type="checkbox"/>	<input type="checkbox"/>	<input type="checkbox"/>	<input type="checkbox"/>	<input type="checkbox"/>	67.2#
	42x 64	USFR4264	<input type="checkbox"/>	<input type="checkbox"/>	<input type="checkbox"/>	<input type="checkbox"/>	<input type="checkbox"/>	74.4#
	48 x 64	USFR4864	<input type="checkbox"/>	<input type="checkbox"/>	<input type="checkbox"/>	<input type="checkbox"/>	<input type="checkbox"/>	81.5#
	60 x 64	USFR6064	<input type="checkbox"/>	<input type="checkbox"/>	<input type="checkbox"/>	<input type="checkbox"/>	<input type="checkbox"/>	95.8#
	72 x 64	USFR7264	<input type="checkbox"/>	<input type="checkbox"/>	<input type="checkbox"/>	<input type="checkbox"/>	<input type="checkbox"/>	118.9#

**A** **B** **C** **D** **E** **F**

## HOW TO ORDER

Indicate the following information on order form:

- Quantity of each item.
- Model number, including options. See "How To Build a Model Number".
- Any special service required.

Note: • The  indicates that a choice is required.

- The absence of the  indicates that no choice is required.
- Alpha-numeric characters in place of  indicate that no other alternatives are available.

## HOW TO BUILD A MODEL NUMBER

- A** Select basic model.
- B** Select top cap style.  

<b>F</b>	- Flat trim (std)
<b>N</b>	- No topcap
- C** Select electrical code.  

<b>CP</b>	- Chicago - with cutouts
<b>DN</b>	- Domestic - no cutouts
<b>DP</b>	- Domestic - with cutouts
<b>C1</b>	- Chicago, 1 side w/cutouts
<b>D1</b>	- Domestic, 1 side w/cutouts
- D** Select trim color.  
Refer to color addendum at ki.com or KI Fabrics & Finishes binder.
- E** Select fabric side 1.  
Refer to color addendum at ki.com or in KI Fabrics & Finishes binder.
- F** Select fabric side 2.  
Refer to color addendum at ki.com or in KI Fabrics & Finishes binder.



# Preconfigured Segmented Fabric Panel

Standard Base Raceway

Delivered Pricing Fabric Grade 1 & C.O.M.	Delivered Pricing Fabric Grade 2	Delivered Pricing Fabric Grade 3 & Pallas Vertical Fabric Grade PV	Delivered Pricing Pallas Vertical Fabric Grade PV1	Delivered Pricing Pallas Vertical Fabric Grade PV2
\$ 493	\$ 517	\$ 535	\$ 549	\$ 585
584	611	632	647	691
650	680	702	722	769
692	724	749	768	819
716	747	775	792	846
834	872	902	927	987
1205	1261	1305	1338	1427

**SPECIAL SERVICES**

**Special Carton Marking**

With specially marked information N/C

**Shipping**

Shipped k.d. freight prepaid f.o.b. Manitowoc, Wisconsin 54220 factory. Freight class #70.

Specifications and prices are subject to change without prior notice.

# Preconfigured Segmented Fabric Panel

Elevated Base

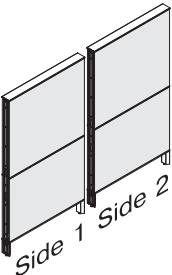
	MODEL	W x H	MODEL NUMBER					Approx. Packaged Weight	
			Basic Model	Top Cap Style	Trim Color	Fabric Side 1	Fabric Side 2		
 <p>Side 1 Side 2</p>	<b>Segmented Fabric Panel - 40"H</b>	24 x 40	USFL2440	<input type="checkbox"/>	<input type="checkbox"/>	<input type="checkbox"/>	<input type="checkbox"/>	36.7#	
	<ul style="list-style-type: none"> <li>Includes segmented fabric tiles for both sides</li> <li>Upper and lower segments must be identically specified</li> <li>Elevated base does not accept cable distribution</li> <li>Panel assembly includes frame, trim, and panel-to-panel connectors</li> <li>Trim is metal and includes top cap, bottom trim channel, and foot shroud</li> <li>Side 1 and side 2 finishes are specified separately</li> <li>72" wide panels feature split tiles</li> </ul>	30 x 40	USFL3040	<input type="checkbox"/>	<input type="checkbox"/>	<input type="checkbox"/>	<input type="checkbox"/>	41.5#	
		36 x 40	USFL3640	<input type="checkbox"/>	<input type="checkbox"/>	<input type="checkbox"/>	<input type="checkbox"/>	63.4#	
		42 x 40	USFL4240	<input type="checkbox"/>	<input type="checkbox"/>	<input type="checkbox"/>	<input type="checkbox"/>	51.1#	
		48 x 40	USFL4840	<input type="checkbox"/>	<input type="checkbox"/>	<input type="checkbox"/>	<input type="checkbox"/>	63.3#	
		60 x 40	USFL6040	<input type="checkbox"/>	<input type="checkbox"/>	<input type="checkbox"/>	<input type="checkbox"/>	65.3#	
		72 x 40	USFL7240	<input type="checkbox"/>	<input type="checkbox"/>	<input type="checkbox"/>	<input type="checkbox"/>	79.7#	
	USFL								
	USFL	<b>Segmented Fabric Panel - 48"H</b>	24 x 48	USFL2448	<input type="checkbox"/>	<input type="checkbox"/>	<input type="checkbox"/>	<input type="checkbox"/>	42.1#
			30 x 48	USFL3048	<input type="checkbox"/>	<input type="checkbox"/>	<input type="checkbox"/>	<input type="checkbox"/>	47.3#
		36 x 48	USFL3648	<input type="checkbox"/>	<input type="checkbox"/>	<input type="checkbox"/>	<input type="checkbox"/>	69.8#	
		42 x 48	USFL4248	<input type="checkbox"/>	<input type="checkbox"/>	<input type="checkbox"/>	<input type="checkbox"/>	58.0#	
		48 x 48	USFL4848	<input type="checkbox"/>	<input type="checkbox"/>	<input type="checkbox"/>	<input type="checkbox"/>	63.3#	
		60 x 48	USFL6048	<input type="checkbox"/>	<input type="checkbox"/>	<input type="checkbox"/>	<input type="checkbox"/>	73.8#	
		72 x 48	USFL7248	<input type="checkbox"/>	<input type="checkbox"/>	<input type="checkbox"/>	<input type="checkbox"/>	90.7#	
USFL	<b>Segmented Fabric Panel - 56"H</b>	24 x 56	USFL2456	<input type="checkbox"/>	<input type="checkbox"/>	<input type="checkbox"/>	<input type="checkbox"/>	46.4#	
		30 x 56	USFL3056	<input type="checkbox"/>	<input type="checkbox"/>	<input type="checkbox"/>	<input type="checkbox"/>	52.2#	
		36 x 56	USFL3656	<input type="checkbox"/>	<input type="checkbox"/>	<input type="checkbox"/>	<input type="checkbox"/>	58.0#	
		42 x 56	USFL4256	<input type="checkbox"/>	<input type="checkbox"/>	<input type="checkbox"/>	<input type="checkbox"/>	63.9#	
		48 x 56	USFL4856	<input type="checkbox"/>	<input type="checkbox"/>	<input type="checkbox"/>	<input type="checkbox"/>	69.7#	
		60 x 56	USFL6056	<input type="checkbox"/>	<input type="checkbox"/>	<input type="checkbox"/>	<input type="checkbox"/>	81.3#	
		72 x 56	USFL7256	<input type="checkbox"/>	<input type="checkbox"/>	<input type="checkbox"/>	<input type="checkbox"/>	100.5#	

**A**   **B**   **C**   **D**   **E**

## HOW TO ORDER

Indicate the following information on order form:

- Quantity of each item.
- Model number, including options. See "How To Build a Model Number".
- Any special service required.

Note: • The  indicates that a choice is required.

- The absence of the  indicates that no choice is required.
- Alpha-numeric characters in place of  indicate that no other alternatives are available.

## HOW TO BUILD A MODEL NUMBER

- A** Select basic model.
- B** Select top cap style.
 

<b>F</b>	- Flat trim (std)
<b>N</b>	- No topcap
- C** Select trim color. Refer to color addendum at [ki.com](http://ki.com) or KI Fabrics & Finishes binder.
- D** Select fabric side 1. Refer to color addendum at [ki.com](http://ki.com) or in KI Fabrics & Finishes binder.
- E** Select fabric side 2. Refer to color addendum at [ki.com](http://ki.com) or in KI Fabrics & Finishes binder.



# Preconfigured Segmented Fabric Panel

Elevated Base

Delivered Pricing Fabric Grade 1 & C.O.M.	Delivered Pricing Fabric Grade 2	Delivered Pricing Fabric Grade 3 & Pallas Vertical Fabric Grade PV	Delivered Pricing Pallas Vertical Fabric Grade PV1	Delivered Pricing Pallas Vertical Fabric Grade PV2
\$ 403	\$ 421	\$ 436	\$ 447	\$ 477
457	478	495	508	541
496	519	536	550	587
542	568	587	603	642
559	585	607	620	662
675	705	730	748	799
903	946	980	1003	1069
\$ 437	\$ 457	\$ 473	\$ 484	\$ 516
491	514	531	545	582
536	561	580	594	636
598	626	648	664	708
614	642	664	681	727
730	764	790	811	864
981	1026	1061	1088	1160
\$ 458	\$ 479	\$ 496	\$ 509	\$ 542
524	549	568	583	620
577	603	623	640	682
646	676	698	718	765
662	692	718	734	783
749	784	811	832	888
1053	1101	1140	1169	1247

**SPECIAL SERVICES**

**Special Carton Marking**

With specially marked information N/C

**Shipping**

Delivered. Shipped **k.d. freight prepaid f.o.b. Manitowoc, Wisconsin 54220** factory. Freight class #70.

Specifications and prices are subject to change without prior notice.

# Preconfigured Segmented Fabric Panel

Elevated Base

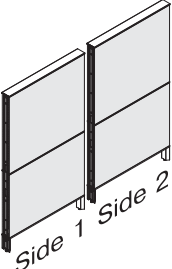
MODEL	W x H	MODEL NUMBER					Approx. Packaged Weight
		Basic Model	Top Cap Style	Trim Color	Fabric Side 1	Fabric Side 2	
 <p>USFL</p> <p><b>Segmented Fabric Panel - 64"H</b></p> <ul style="list-style-type: none"> <li>Includes segmented fabric tiles for both sides</li> <li>Upper and lower segments must be identically specified</li> <li>Elevated base does not accept cable distribution</li> <li>Panel assembly includes frame, trim, and panel-to-panel connectors</li> <li>Trim is metal and includes top cap, bottom trim channel, and foot shroud</li> <li>Side 1 and side 2 finishes are specified separately</li> <li>72" wide panels feature split tiles</li> </ul>	24 x 64	USFL2464	<input type="checkbox"/>	<input type="checkbox"/>	<input type="checkbox"/>	<input type="checkbox"/>	50.7#
	30 x 64	USFL3064	<input type="checkbox"/>	<input type="checkbox"/>	<input type="checkbox"/>	<input type="checkbox"/>	57.1#
	36 x 64	USFL3664	<input type="checkbox"/>	<input type="checkbox"/>	<input type="checkbox"/>	<input type="checkbox"/>	63.4#
	42 x 64	USFL4264	<input type="checkbox"/>	<input type="checkbox"/>	<input type="checkbox"/>	<input type="checkbox"/>	69.8#
	48 x 64	USFL4864	<input type="checkbox"/>	<input type="checkbox"/>	<input type="checkbox"/>	<input type="checkbox"/>	76.2#
	60 x 64	USFL6064	<input type="checkbox"/>	<input type="checkbox"/>	<input type="checkbox"/>	<input type="checkbox"/>	88.8#
	72 x 64	USFL7264	<input type="checkbox"/>	<input type="checkbox"/>	<input type="checkbox"/>	<input type="checkbox"/>	110.3#

**A**   **B**   **C**   **D**   **E**

## HOW TO ORDER

Indicate the following information on order form:

- Quantity of each item.
- Model number, including options. See "How To Build a Model Number".
- Any special service required.

Note: • The  indicates that a choice is required.

- The absence of the  indicates that no choice is required.
- Alpha-numeric characters in place of  indicate that no other alternatives are available.

## HOW TO BUILD A MODEL NUMBER

- A** Select basic model.
- B** Select top cap style.
- |   |                   |
|---|-------------------|
| F | - Flat trim (std) |
| N | - No topcap       |
- C** Select trim color.  
Refer to color addendum at [ki.com](http://ki.com) or KI Fabrics & Finishes binder.
- D** Select fabric side 1.  
Refer to color addendum at [ki.com](http://ki.com) or in KI Fabrics & Finishes binder.
- E** Select fabric side 2.  
Refer to color addendum at [ki.com](http://ki.com) or in KI Fabrics & Finishes binder.



# Preconfigured Segmented Fabric Panel

Elevated Base

Delivered Pricing Fabric Grade 1 & C.O.M.	Delivered Pricing Fabric Grade 2	Delivered Pricing Fabric Grade 3 & Pallas Vertical Fabric Grade PV	Delivered Pricing Pallas Vertical Fabric Grade PV1	Delivered Pricing Pallas Vertical Fabric Grade PV2
\$ 493	\$ 517	\$ 535	\$ 549	\$ 585
584	611	632	647	691
650	680	702	722	769
692	724	749	768	819
716	747	775	792	846
834	872	902	927	987
1205	1261	1305	1338	1427

**SPECIAL SERVICES**

**Special Carton Marking**

With specially marked information N/C

**Shipping**

Shipped k.d. freight prepaid f.o.b. Manitowoc, Wisconsin 54220 factory. Freight class #70.

Specifications and prices are subject to change without prior notice.

# Preconfigured Segmented Fabric Panel

Tile-to-Floor One Side; Standard Base Raceway One Side

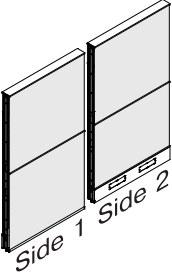
MODEL	W x H	MODEL NUMBER						Approx. Packaged Weight	
		Basic Model	Top Cap Style	Electrical Code	Trim Color	Fabric Side 1	Fabric Side 2		
 <p>USFT</p> <p><b>Segmented Fabric Panel - 40"H</b></p> <ul style="list-style-type: none"> <li>• Side 1: tile-to-floor base does not accept cable distribution</li> <li>• Side 2: standard base raceway accepts power and data cable distribution</li> <li>• Includes segmented fabric tiles for both sides</li> <li>• Upper and lower segments must be identically specified</li> <li>• Panel assembly includes frame, trim, and panel-to-panel connectors</li> <li>• Trim is metal and includes top cap, bottom trim channel, base raceway, and segment channel</li> <li>• Side 1 and side 2 finishes are specified separately</li> <li>• Side 2: 30-72" wide tiles feature two base power knockouts</li> <li>• Side 2: 24" wide tiles feature one power knockout</li> <li>• 72" wide panels feature split tiles</li> <li>• Electrical components are specified separately</li> </ul>	24 x 40	USFT2440	<input type="checkbox"/>	<input type="checkbox"/>	<input type="checkbox"/>	<input type="checkbox"/>	<input type="checkbox"/>	37.9#	
	30 x 40	USFT3040	<input type="checkbox"/>	<input type="checkbox"/>	<input type="checkbox"/>	<input type="checkbox"/>	<input type="checkbox"/>	43.1#	
	36 x 40	USFT3640	<input type="checkbox"/>	<input type="checkbox"/>	<input type="checkbox"/>	<input type="checkbox"/>	<input type="checkbox"/>	48.4#	
	42 x 40	USFT4240	<input type="checkbox"/>	<input type="checkbox"/>	<input type="checkbox"/>	<input type="checkbox"/>	<input type="checkbox"/>	53.7#	
	48 x 40	USFT4840	<input type="checkbox"/>	<input type="checkbox"/>	<input type="checkbox"/>	<input type="checkbox"/>	<input type="checkbox"/>	59.0#	
	60 x 40	USFT6040	<input type="checkbox"/>	<input type="checkbox"/>	<input type="checkbox"/>	<input type="checkbox"/>	<input type="checkbox"/>	69.5#	
	72 x 40	USFT7240	<input type="checkbox"/>	<input type="checkbox"/>	<input type="checkbox"/>	<input type="checkbox"/>	<input type="checkbox"/>	85.1#	
	USFT	24 x 48	USFT2448	<input type="checkbox"/>	<input type="checkbox"/>	<input type="checkbox"/>	<input type="checkbox"/>	<input type="checkbox"/>	43.2#
	USFT	30 x 48	USFT3048	<input type="checkbox"/>	<input type="checkbox"/>	<input type="checkbox"/>	<input type="checkbox"/>	<input type="checkbox"/>	49.0#
	USFT	36 x 48	USFT3648	<input type="checkbox"/>	<input type="checkbox"/>	<input type="checkbox"/>	<input type="checkbox"/>	<input type="checkbox"/>	54.8#
USFT	42 x 48	USFT4248	<input type="checkbox"/>	<input type="checkbox"/>	<input type="checkbox"/>	<input type="checkbox"/>	<input type="checkbox"/>	60.6#	
USFT	48 x 48	USFT4848	<input type="checkbox"/>	<input type="checkbox"/>	<input type="checkbox"/>	<input type="checkbox"/>	<input type="checkbox"/>	66.4#	
USFT	60 x 48	USFT6048	<input type="checkbox"/>	<input type="checkbox"/>	<input type="checkbox"/>	<input type="checkbox"/>	<input type="checkbox"/>	78.0#	
USFT	72 x 48	USFT7248	<input type="checkbox"/>	<input type="checkbox"/>	<input type="checkbox"/>	<input type="checkbox"/>	<input type="checkbox"/>	95.9#	
USFT	24 x 56	USFT2456	<input type="checkbox"/>	<input type="checkbox"/>	<input type="checkbox"/>	<input type="checkbox"/>	<input type="checkbox"/>	47.6#	
USFT	30 x 56	USFT3056	<input type="checkbox"/>	<input type="checkbox"/>	<input type="checkbox"/>	<input type="checkbox"/>	<input type="checkbox"/>	53.9#	
USFT	36 x 56	USFT3656	<input type="checkbox"/>	<input type="checkbox"/>	<input type="checkbox"/>	<input type="checkbox"/>	<input type="checkbox"/>	60.2#	
USFT	42 x 56	USFT4256	<input type="checkbox"/>	<input type="checkbox"/>	<input type="checkbox"/>	<input type="checkbox"/>	<input type="checkbox"/>	66.6#	
USFT	48 x 56	USFT4856	<input type="checkbox"/>	<input type="checkbox"/>	<input type="checkbox"/>	<input type="checkbox"/>	<input type="checkbox"/>	72.9#	
USFT	60 x 56	USFT6056	<input type="checkbox"/>	<input type="checkbox"/>	<input type="checkbox"/>	<input type="checkbox"/>	<input type="checkbox"/>	85.5#	
USFT	72 x 56	USFT7256	<input type="checkbox"/>	<input type="checkbox"/>	<input type="checkbox"/>	<input type="checkbox"/>	<input type="checkbox"/>	105.7#	

**A**   **B**   **C**   **D**   **E**   **F**

## HOW TO ORDER

Indicate the following information on order form:

1. Quantity of each item.
2. Model number, including options. See "How To Build a Model Number".
3. Any special service required.

Note: • The  indicates that a choice is required.

- The absence of the  indicates that no choice is required.
- Alpha-numeric characters in place of  indicate that no other alternatives are available.

## HOW TO BUILD A MODEL NUMBER

**A** Select basic model.

**B** Select top cap style.

- F** - Flat trim (std)  
**N** - No topcap

**C** Select electrical code.

- CP** - Chicago - with cutouts  
**DN** - Domestic - no cutouts  
**DP** - Domestic - with cutouts

**D** Select trim color.

Refer to color addendum at ki.com or KI Fabrics & Finishes binder.

**E** Select fabric side 1.

Refer to color addendum at ki.com or in KI Fabrics & Finishes binder.

**F** Select fabric side 2.

Refer to color addendum at ki.com or in KI Fabrics & Finishes binder.





# Preconfigured Segmented Fabric Panel

Tile-to-Floor One Side; Standard Base Raceway One Side

Delivered Pricing Fabric Grade 1 & C.O.M.	Delivered Pricing Fabric Grade 2	Delivered Pricing Fabric Grade 3 & Pallas Vertical Fabric Grade PV	Delivered Pricing Pallas Vertical Fabric Grade PV1	Delivered Pricing Pallas Vertical Fabric Grade PV2
\$ 403	\$ 421	\$ 436	\$ 447	\$ 477
457	478	495	508	541
496	519	536	550	587
542	568	587	603	642
559	585	607	620	662
675	705	730	748	799
903	946	980	1003	1069
<hr/>				
\$ 437	\$ 457	\$ 473	\$ 484	\$ 516
491	514	531	545	582
536	561	580	594	636
598	626	648	664	708
614	642	664	681	727
730	764	790	811	864
981	1026	1061	1088	1160
<hr/>				
\$ 458	\$ 479	\$ 496	\$ 509	\$ 542
524	549	568	583	620
577	603	623	640	682
646	676	698	718	765
662	692	718	734	783
749	784	811	832	888
1053	1101	1140	1169	1247

**SPECIAL SERVICES**

**Special Carton Marking**

With specially marked information      N/C

**Shipping**

Delivered. Shipped **k.d. freight prepaid f.o.b. Manitowoc, Wisconsin 54220** factory. Freight class #70.

Specifications and prices are subject to change without prior notice.

# Preconfigured Segmented Fabric Panel

Tile-to-Floor One Side; Standard Base Raceway One Side

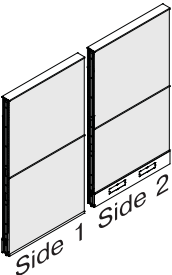
	MODEL	W x H	MODEL NUMBER						Approx. Packaged Weight		
			Basic Model	Top Cap Style	Electrical Code	Trim Color	Fabric Side 1	Fabric Side 2			
 <p>USFT</p>	<b>Segmented Fabric Panel - 64"H</b>	24 x 64	USFT2464	<input type="checkbox"/>	<input type="checkbox"/>	<input type="checkbox"/>	<input type="checkbox"/>	<input type="checkbox"/>	<input type="checkbox"/>	51.9#	
	<ul style="list-style-type: none"> <li>Side 1: tile-to-floor base does not accept cable distribution</li> </ul>	30 x 64	USFT3064	<input type="checkbox"/>	<input type="checkbox"/>	<input type="checkbox"/>	<input type="checkbox"/>	<input type="checkbox"/>	<input type="checkbox"/>	<input type="checkbox"/>	58.7#
	<ul style="list-style-type: none"> <li>Side 2: standard base raceway accepts power and data cable distribution</li> </ul>	36 x 64	USFT3664	<input type="checkbox"/>	<input type="checkbox"/>	<input type="checkbox"/>	<input type="checkbox"/>	<input type="checkbox"/>	<input type="checkbox"/>	<input type="checkbox"/>	65.6#
	<ul style="list-style-type: none"> <li>Includes segmented fabric tiles for both sides</li> </ul>	42x 64	USFT4264	<input type="checkbox"/>	<input type="checkbox"/>	<input type="checkbox"/>	<input type="checkbox"/>	<input type="checkbox"/>	<input type="checkbox"/>	<input type="checkbox"/>	72.5#
	<ul style="list-style-type: none"> <li>Upper and lower segments must be identically specified</li> </ul>	48 x 64	USFT4864	<input type="checkbox"/>	<input type="checkbox"/>	<input type="checkbox"/>	<input type="checkbox"/>	<input type="checkbox"/>	<input type="checkbox"/>	<input type="checkbox"/>	79.3#
	<ul style="list-style-type: none"> <li>Panel assembly includes frame, trim, and panel-to-panel connectors</li> </ul>	60 x 64	USFT6064	<input type="checkbox"/>	<input type="checkbox"/>	<input type="checkbox"/>	<input type="checkbox"/>	<input type="checkbox"/>	<input type="checkbox"/>	<input type="checkbox"/>	93.0#
	<ul style="list-style-type: none"> <li>Trim is metal and includes top cap, bottom trim channel, base raceway, and segment channel</li> </ul>	72 x 64	USFT7264	<input type="checkbox"/>	<input type="checkbox"/>	<input type="checkbox"/>	<input type="checkbox"/>	<input type="checkbox"/>	<input type="checkbox"/>	<input type="checkbox"/>	115.5#
<ul style="list-style-type: none"> <li>Side 1 and side 2 finishes are specified separately</li> </ul>											
<ul style="list-style-type: none"> <li>Side 2: 30-72" wide tiles feature two base power knockouts</li> </ul>											
<ul style="list-style-type: none"> <li>Side 2: 24" wide tiles feature one power knockout</li> </ul>											
<ul style="list-style-type: none"> <li>72" wide panels feature split tiles</li> </ul>											
<ul style="list-style-type: none"> <li>Electrical components are specified separately</li> </ul>											

**A      B      C      D      E      F**

## HOW TO ORDER

Indicate the following information on order form:

- Quantity of each item.
- Model number, including options. See "How To Build a Model Number".
- Any special service required.

Note: • The  indicates that a choice is required.

- The absence of the  indicates that no choice is required.
- Alpha-numeric characters in place of  indicate that no other alternatives are available.

## HOW TO BUILD A MODEL NUMBER

- A** Select basic model.
- B** Select top cap style.
- |          |                   |
|----------|-------------------|
| <b>F</b> | - Flat trim (std) |
| <b>N</b> | - No topcap       |
- C** Select electrical code.
- |           |                           |
|-----------|---------------------------|
| <b>CP</b> | - Chicago - with cutouts  |
| <b>DN</b> | - Domestic - no cutouts   |
| <b>DP</b> | - Domestic - with cutouts |
- D** Select trim color.  
Refer to color addendum at ki.com or KI Fabrics & Finishes binder.
- E** Select fabric side 1.  
Refer to color addendum at ki.com or in KI Fabrics & Finishes binder.
- F** Select fabric side 2.  
Refer to color addendum at ki.com or in KI Fabrics & Finishes binder.



# Preconfigured Segmented Fabric Panel

Tile-to-Floor One Side; Standard Base Raceway One Side

Delivered Pricing Fabric Grade 1 & C.O.M.	Delivered Pricing Fabric Grade 2	Delivered Pricing Fabric Grade 3 & Pallas Vertical Fabric Grade PV	Delivered Pricing Pallas Vertical Fabric Grade PV1	Delivered Pricing Pallas Vertical Fabric Grade PV2
\$ 493	\$ 517	\$ 535	\$ 549	\$ 585
584	611	632	647	691
650	680	702	722	769
692	724	749	768	819
716	747	775	792	846
834	872	902	927	987
1205	1261	1305	1338	1427

## SPECIAL SERVICES

### Special Carton Marking

With specially marked information N/C

### Shipping

Shipped k.d. freight prepaid f.o.b. Manitowoc, Wisconsin 54220 factory. Freight class #70.

Specifications and prices are subject to change without prior notice.

# Preconfigured Segmented Fabric Panel w/Beltway Power

Standard Base Raceway

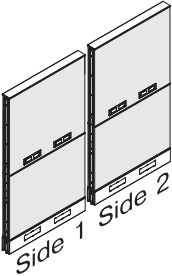
MODEL	W x H	MODEL NUMBER							Approx. Packaged Weight	
		Basic Model	Top Cap Style	Electrical Code	Bezel Color	Trim Color	Fabric Side 1	Fabric Side 2		
 <p>USFR</p> <p><b>Segmented Fabric Panel - 40"H</b></p> <ul style="list-style-type: none"> <li>Includes segmented fabric tiles for both sides</li> <li>Upper and lower segments must be identically specified</li> <li>Standard base raceway on both sides accepts power and data cable distribution</li> <li>Above worksurface beltway accepts power and data cable distribution</li> <li>Panel assembly includes frame, trim, and panel-to-panel connectors</li> <li>Trim is metal and includes top cap, bottom trim channel, base raceway, and segment channel</li> <li>Side 1 and side 2 finishes are specified separately</li> <li>30-72" wide panels each feature two power knockouts at base and two knockouts with bezels at beltway per side</li> <li>24" wide panels each feature one power knockout and one knockout with bezel at beltway per side</li> <li>72" wide panels feature split tiles</li> <li>Electrical components are specified separately</li> </ul>	24 x 40	USFRBW2440	<input type="checkbox"/>	<input type="checkbox"/>	<input type="checkbox"/>	<input type="checkbox"/>	<input type="checkbox"/>	<input type="checkbox"/>	39.0#	
	30 x 40	USFRBW3040	<input type="checkbox"/>	<input type="checkbox"/>	<input type="checkbox"/>	<input type="checkbox"/>	<input type="checkbox"/>	<input type="checkbox"/>	44.4#	
	36 x 40	USFRBW3640	<input type="checkbox"/>	<input type="checkbox"/>	<input type="checkbox"/>	<input type="checkbox"/>	<input type="checkbox"/>	<input type="checkbox"/>	50.0#	
	42 x 40	USFRBW4240	<input type="checkbox"/>	<input type="checkbox"/>	<input type="checkbox"/>	<input type="checkbox"/>	<input type="checkbox"/>	<input type="checkbox"/>	55.6#	
	48 x 40	USFRBW4840	<input type="checkbox"/>	<input type="checkbox"/>	<input type="checkbox"/>	<input type="checkbox"/>	<input type="checkbox"/>	<input type="checkbox"/>	61.2#	
	60 x 40	USFRBW6040	<input type="checkbox"/>	<input type="checkbox"/>	<input type="checkbox"/>	<input type="checkbox"/>	<input type="checkbox"/>	<input type="checkbox"/>	72.3#	
	72 x 40	USFRBW7240	<input type="checkbox"/>	<input type="checkbox"/>	<input type="checkbox"/>	<input type="checkbox"/>	<input type="checkbox"/>	<input type="checkbox"/>	88.5#	
USFR	<b>Segmented Fabric Panel - 48"H</b>		24 x 48	USFRBW2448	<input type="checkbox"/>	<input type="checkbox"/>	<input type="checkbox"/>	<input type="checkbox"/>	<input type="checkbox"/>	44.3#
	30 x 48	USFRBW3048	<input type="checkbox"/>	<input type="checkbox"/>	<input type="checkbox"/>	<input type="checkbox"/>	<input type="checkbox"/>	<input type="checkbox"/>	50.3#	
	36 x 48	USFRBW3648	<input type="checkbox"/>	<input type="checkbox"/>	<input type="checkbox"/>	<input type="checkbox"/>	<input type="checkbox"/>	<input type="checkbox"/>	56.4#	
	42 x 48	USFRBW4248	<input type="checkbox"/>	<input type="checkbox"/>	<input type="checkbox"/>	<input type="checkbox"/>	<input type="checkbox"/>	<input type="checkbox"/>	62.5#	
	48 x 48	USFRBW4848	<input type="checkbox"/>	<input type="checkbox"/>	<input type="checkbox"/>	<input type="checkbox"/>	<input type="checkbox"/>	<input type="checkbox"/>	68.6#	
	60 x 48	USFRBW6048	<input type="checkbox"/>	<input type="checkbox"/>	<input type="checkbox"/>	<input type="checkbox"/>	<input type="checkbox"/>	<input type="checkbox"/>	80.8#	
USFR	<b>Segmented Fabric Panel - 56"H</b>		24 x 56	USFRBW2456	<input type="checkbox"/>	<input type="checkbox"/>	<input type="checkbox"/>	<input type="checkbox"/>	<input type="checkbox"/>	48.6#
	30 x 56	USFRBW3056	<input type="checkbox"/>	<input type="checkbox"/>	<input type="checkbox"/>	<input type="checkbox"/>	<input type="checkbox"/>	<input type="checkbox"/>	55.2#	
	36 x 56	USFRBW3656	<input type="checkbox"/>	<input type="checkbox"/>	<input type="checkbox"/>	<input type="checkbox"/>	<input type="checkbox"/>	<input type="checkbox"/>	61.8#	
	42 x 56	USFRBW4256	<input type="checkbox"/>	<input type="checkbox"/>	<input type="checkbox"/>	<input type="checkbox"/>	<input type="checkbox"/>	<input type="checkbox"/>	68.5#	
	48 x 56	USFRBW4856	<input type="checkbox"/>	<input type="checkbox"/>	<input type="checkbox"/>	<input type="checkbox"/>	<input type="checkbox"/>	<input type="checkbox"/>	75.1#	
	60 x 56	USFRBW6056	<input type="checkbox"/>	<input type="checkbox"/>	<input type="checkbox"/>	<input type="checkbox"/>	<input type="checkbox"/>	<input type="checkbox"/>	88.3#	
72 x 56	USFRBW7256	<input type="checkbox"/>	<input type="checkbox"/>	<input type="checkbox"/>	<input type="checkbox"/>	<input type="checkbox"/>	<input type="checkbox"/>	109.1#		

**A**   **B**   **C**   **D**   **E**   **F**   **G**

## HOW TO ORDER

Indicate the following information on order form:

- Quantity of each item.
- Model number, including options. See "How To Build a Model Number".
- Any special service required.

Note: • The  indicates that a choice is required.

- The absence of the  indicates that no choice is required.
- Alpha-numeric characters in place of  indicate that no other alternatives are available.

## HOW TO BUILD A MODEL NUMBER

- A** Select basic model.
- B** Select top cap style.  

<b>F</b>	- Flat trim (std)
<b>N</b>	- No topcap
- C** Select electrical code.  

<b>DP</b>	- Domestic - with cutouts
<b>D1</b>	- Domestic, 1 side w/cutouts

- G** Select fabric side 2.  
Refer to color addendum at [ki.com](http://ki.com) or in KI Fabrics & Finishes binder.

- D** Select bezel color.  
Refer to color addendum at [ki.com](http://ki.com) or KI Fabrics & Finishes binder.
- E** Select trim color.  
Refer to color addendum at [ki.com](http://ki.com) or KI Fabrics & Finishes binder.
- F** Select fabric side 1.  
Refer to color addendum at [ki.com](http://ki.com) or in KI Fabrics & Finishes binder.



# Preconfigured Segmented Fabric Panel w/Beltway Power

Standard Base Raceway

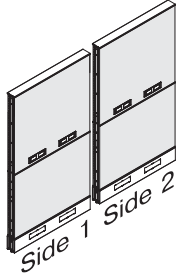

USFR

**MODEL**

**W x H**

**MODEL NUMBER**

Basic Model

Top Cap Style

Electrical Code

Bezel Color

Trim Color

Fabric Side 1

Fabric Side 2

Approx. Packaged Weight

**Segmented Fabric Panel - 64"H**

- Includes segmented fabric tiles for both sides
- Upper and lower segments must be identically specified
- Standard base raceway on both sides accepts power and data cable distribution
- Above worksurface beltway accepts power and data cable distribution
- Panel assembly includes frame, trim, and panel-to-panel connectors
- Trim is metal and includes top cap, bottom trim channel, base raceway, and segment channel
- Side 1 and side 2 finishes are specified separately
- 30-72" wide panels each feature two power knockouts at base and two knockouts with bezels at beltway per side
- 24" wide panels each feature one power knockout and one knockout with bezel at beltway per side
- 72" wide panels feature split tiles
- Electrical components are specified separately

24 x 64	USFRBW2464	<input type="checkbox"/>	<input type="checkbox"/>	<input type="checkbox"/>	<input type="checkbox"/>	<input type="checkbox"/>	<input type="checkbox"/>	<input type="checkbox"/>	53.0#
30 x 64	USFRBW3064	<input type="checkbox"/>	<input type="checkbox"/>	<input type="checkbox"/>	<input type="checkbox"/>	<input type="checkbox"/>	<input type="checkbox"/>	<input type="checkbox"/>	60.0#
36 x 64	USFRBW3664	<input type="checkbox"/>	<input type="checkbox"/>	<input type="checkbox"/>	<input type="checkbox"/>	<input type="checkbox"/>	<input type="checkbox"/>	<input type="checkbox"/>	67.2#
42 x 64	USFRBW4264	<input type="checkbox"/>	<input type="checkbox"/>	<input type="checkbox"/>	<input type="checkbox"/>	<input type="checkbox"/>	<input type="checkbox"/>	<input type="checkbox"/>	74.4#
48 x 64	USFRBW4864	<input type="checkbox"/>	<input type="checkbox"/>	<input type="checkbox"/>	<input type="checkbox"/>	<input type="checkbox"/>	<input type="checkbox"/>	<input type="checkbox"/>	81.5#
60 x 64	USFRBW6064	<input type="checkbox"/>	<input type="checkbox"/>	<input type="checkbox"/>	<input type="checkbox"/>	<input type="checkbox"/>	<input type="checkbox"/>	<input type="checkbox"/>	95.8#
72 x 64	USFRBW7264	<input type="checkbox"/>	<input type="checkbox"/>	<input type="checkbox"/>	<input type="checkbox"/>	<input type="checkbox"/>	<input type="checkbox"/>	<input type="checkbox"/>	118.9#

**A**    **B**    **C**    **D**    **E**    **F**    **G**

**HOW TO ORDER**

Indicate the following information on order form:

1. Quantity of each item.
2. Model number, including options. See "How To Build a Model Number".
3. Any special service required.

Note: • The  indicates that a choice is required.

- The absence of the  indicates that no choice is required.
- Alpha-numeric characters in place of  indicate that no other alternatives are available.

**HOW TO BUILD A MODEL NUMBER**

**A** Select basic model.

**B** Select top cap style.

- F**      - Flat trim (std)
- N**      - No topcap

**C** Select electrical code.

- DP**     - Domestic - with cutouts
- D1**     - Domestic, 1 side w/cutouts

**D** Select bezel color.

Refer to color addendum at ki.com or KI Fabrics & Finishes binder.

**E** Select trim color.

Refer to color addendum at ki.com or KI Fabrics & Finishes binder.

**F** Select fabric side 1.

Refer to color addendum at ki.com or in KI Fabrics & Finishes binder.

**G** Select fabric side 2.

Refer to color addendum at ki.com or in KI Fabrics & Finishes binder.



# Preconfigured Segmented Fabric Panel w/Beltway Power

Standard Base Raceway

Delivered Pricing Fabric Grade 1 & C.O.M.	Delivered Pricing Fabric Grade 2	Delivered Pricing Fabric Grade 3 & Pallas Vertical Fabric Grade PV	Delivered Pricing Pallas Vertical Fabric Grade PV1	Delivered Pricing Pallas Vertical Fabric Grade PV2
\$ 512	\$ 535	\$ 555	\$ 568	\$ 607
614	642	664	681	726
680	712	736	755	805
723	755	782	802	855
746	781	808	828	884
867	906	939	961	1027
1264	1323	1369	1405	1496

**SPECIAL SERVICES**

**Special Carton Marking**

With specially marked information N/C

**Shipping**

Shipped k.d. freight prepaid f.o.b. Manitowoc, Wisconsin 54220 factory. Freight class #70.

Specifications and prices are subject to change without prior notice.

# Preconfigured Segmented Fabric Panel w/Beltway Power

Elevated Base

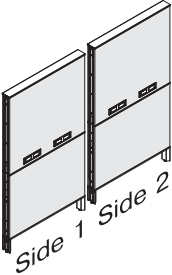
	MODEL	W x H	MODEL NUMBER							Approx. Packaged Weight		
			Basic Model	Top Cap Style	Electrical Code	Bezel Color	Trim Color	Fabric Side 1	Fabric Side 2			
 <p>USFL</p>	<b>Segmented Fabric Panel - 40"H</b>	24 x 40	USFLBW2440	<input type="checkbox"/>	<input type="checkbox"/>	<input type="checkbox"/>	<input type="checkbox"/>	<input type="checkbox"/>	<input type="checkbox"/>	<input type="checkbox"/>	36.7#	
	<ul style="list-style-type: none"> <li>Includes segmented fabric tiles for both sides</li> <li>Upper and lower segments must be identically specified</li> <li>30-72" wide tiles each feature two power knockouts with bezels at above-worksurface beltway</li> <li>24" wide tiles each feature one power knockout with bezel at above-worksurface beltway</li> <li>Elevated base does not accept cable distribution</li> <li>Panel assembly includes frame, trim, and panel-to-panel connectors</li> <li>Trim is metal and includes top cap, bottom trim channel, segment channel, and foot shroud</li> <li>Side 1 and side 2 finishes are specified separately</li> <li>72" wide panels feature split tiles</li> </ul>	30 x 40	USFLBW3040	<input type="checkbox"/>	<input type="checkbox"/>	<input type="checkbox"/>	<input type="checkbox"/>	<input type="checkbox"/>	<input type="checkbox"/>	<input type="checkbox"/>	<input type="checkbox"/>	41.5#
		36 x 40	USFLBW3640	<input type="checkbox"/>	<input type="checkbox"/>	<input type="checkbox"/>	<input type="checkbox"/>	<input type="checkbox"/>	<input type="checkbox"/>	<input type="checkbox"/>	<input type="checkbox"/>	46.3#
		42 x 40	USFLBW4240	<input type="checkbox"/>	<input type="checkbox"/>	<input type="checkbox"/>	<input type="checkbox"/>	<input type="checkbox"/>	<input type="checkbox"/>	<input type="checkbox"/>	<input type="checkbox"/>	51.1#
		48 x 40	USFLBW4840	<input type="checkbox"/>	<input type="checkbox"/>	<input type="checkbox"/>	<input type="checkbox"/>	<input type="checkbox"/>	<input type="checkbox"/>	<input type="checkbox"/>	<input type="checkbox"/>	55.8#
		60 x 40	USFLBW6040	<input type="checkbox"/>	<input type="checkbox"/>	<input type="checkbox"/>	<input type="checkbox"/>	<input type="checkbox"/>	<input type="checkbox"/>	<input type="checkbox"/>	<input type="checkbox"/>	65.3#
		72 x 40	USFLBW7240	<input type="checkbox"/>	<input type="checkbox"/>	<input type="checkbox"/>	<input type="checkbox"/>	<input type="checkbox"/>	<input type="checkbox"/>	<input type="checkbox"/>	<input type="checkbox"/>	79.7#
USFL	<b>Segmented Fabric Panel - 48"H</b>	24 x 48	USFLBW2448	<input type="checkbox"/>	<input type="checkbox"/>	<input type="checkbox"/>	<input type="checkbox"/>	<input type="checkbox"/>	<input type="checkbox"/>	<input type="checkbox"/>	42.1#	
		30 x 48	USFLBW3048	<input type="checkbox"/>	<input type="checkbox"/>	<input type="checkbox"/>	<input type="checkbox"/>	<input type="checkbox"/>	<input type="checkbox"/>	<input type="checkbox"/>	47.3#	
		36 x 48	USFLBW3648	<input type="checkbox"/>	<input type="checkbox"/>	<input type="checkbox"/>	<input type="checkbox"/>	<input type="checkbox"/>	<input type="checkbox"/>	<input type="checkbox"/>	52.6#	
		42 x 48	USFLBW4248	<input type="checkbox"/>	<input type="checkbox"/>	<input type="checkbox"/>	<input type="checkbox"/>	<input type="checkbox"/>	<input type="checkbox"/>	<input type="checkbox"/>	58.0#	
		48 x 48	USFLBW4848	<input type="checkbox"/>	<input type="checkbox"/>	<input type="checkbox"/>	<input type="checkbox"/>	<input type="checkbox"/>	<input type="checkbox"/>	<input type="checkbox"/>	63.3#	
		60 x 48	USFLBW6048	<input type="checkbox"/>	<input type="checkbox"/>	<input type="checkbox"/>	<input type="checkbox"/>	<input type="checkbox"/>	<input type="checkbox"/>	<input type="checkbox"/>	73.8#	
	72 x 48	USFLBW7248	<input type="checkbox"/>	<input type="checkbox"/>	<input type="checkbox"/>	<input type="checkbox"/>	<input type="checkbox"/>	<input type="checkbox"/>	<input type="checkbox"/>	90.7#		
USFL	<b>Segmented Fabric Panel - 56"H</b>	24 x 56	USFLBW2456	<input type="checkbox"/>	<input type="checkbox"/>	<input type="checkbox"/>	<input type="checkbox"/>	<input type="checkbox"/>	<input type="checkbox"/>	<input type="checkbox"/>	46.4#	
		30 x 56	USFLBW3056	<input type="checkbox"/>	<input type="checkbox"/>	<input type="checkbox"/>	<input type="checkbox"/>	<input type="checkbox"/>	<input type="checkbox"/>	<input type="checkbox"/>	52.2#	
		36 x 56	USFLBW3656	<input type="checkbox"/>	<input type="checkbox"/>	<input type="checkbox"/>	<input type="checkbox"/>	<input type="checkbox"/>	<input type="checkbox"/>	<input type="checkbox"/>	58.0#	
		42 x 56	USFLBW4256	<input type="checkbox"/>	<input type="checkbox"/>	<input type="checkbox"/>	<input type="checkbox"/>	<input type="checkbox"/>	<input type="checkbox"/>	<input type="checkbox"/>	63.9#	
		48 x 56	USFLBW4856	<input type="checkbox"/>	<input type="checkbox"/>	<input type="checkbox"/>	<input type="checkbox"/>	<input type="checkbox"/>	<input type="checkbox"/>	<input type="checkbox"/>	69.7#	
		60 x 56	USFLBW6056	<input type="checkbox"/>	<input type="checkbox"/>	<input type="checkbox"/>	<input type="checkbox"/>	<input type="checkbox"/>	<input type="checkbox"/>	<input type="checkbox"/>	81.3#	
	72 x 56	USFLBW7256	<input type="checkbox"/>	<input type="checkbox"/>	<input type="checkbox"/>	<input type="checkbox"/>	<input type="checkbox"/>	<input type="checkbox"/>	<input type="checkbox"/>	100.5#		

A

B

C

D

E

F

G

## HOW TO ORDER

Indicate the following information on order form:

- Quantity of each item.
- Model number, including options. See "How To Build a Model Number".
- Any special service required.

Note: • The  indicates that a choice is required.

- The absence of the  indicates that no choice is required.
- Alpha-numeric characters in place of  indicate that no other alternatives are available.

## HOW TO BUILD A MODEL NUMBER

**A** Select basic model.

**B** Select top cap style.

F - Flat trim (std)  
N - No topcap

**C** Select electrical code.

DP - Domestic - with cutouts

**D** Select bezel color.

Refer to color addendum at ki.com or KI Fabrics & Finishes binder.

**E** Select trim color.

Refer to color addendum at ki.com or KI Fabrics & Finishes binder.

**F** Select fabric side 1.

Refer to color addendum at ki.com or in KI Fabrics & Finishes binder.

**G** Select fabric side 2.

Refer to color addendum at ki.com or in KI Fabrics & Finishes binder.





# Preconfigured Segmented Fabric Panel w/Beltway Power Elevated Base

Delivered Pricing Fabric Grade 1 & C.O.M.	Delivered Pricing Fabric Grade 2	Delivered Pricing Fabric Grade 3 & Pallas Vertical Fabric Grade PV	Delivered Pricing Pallas Vertical Fabric Grade PV1	Delivered Pricing Pallas Vertical Fabric Grade PV2
\$ 419	\$ 438	\$ 454	\$ 466	\$ 496
486	510	527	541	577
526	550	569	584	622
572	598	620	637	678
589	616	639	653	697
703	736	763	782	833
962	1007	1042	1069	1140
\$ 449	\$ 471	\$ 485	\$ 500	\$ 531
521	545	564	579	617
567	592	613	628	671
628	657	681	697	744
644	674	697	716	763
763	797	825	846	901
1039	1088	1125	1154	1230
\$ 475	\$ 497	\$ 514	\$ 527	\$ 562
555	580	599	616	655
607	634	655	674	719
677	706	731	750	800
692	724	749	768	819
781	817	846	867	924
1112	1164	1204	1236	1317

## SPECIAL SERVICES

### Special Carton Marking

With specially marked information N/C

### Shipping

Delivered. Shipped **k.d. freight prepaid f.o.b. Manitowoc, Wisconsin 54220** factory. Freight class #70.

Specifications and prices are subject to change without prior notice.

# Preconfigured Segmented Fabric Panel w/Beltway Power

Elevated Base

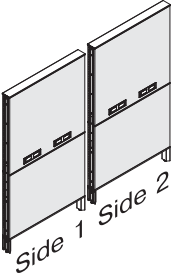
MODEL	W x H	MODEL NUMBER							Approx. Packaged Weight
		Basic Model	Top Cap Style	Electrical Code	Bezel Color	Trim Color	Fabric Side 1	Fabric Side 2	
 <p><b>Segmented Fabric Panel - 64"H</b></p> <ul style="list-style-type: none"> <li>Includes segmented fabric tiles for both sides</li> <li>Upper and lower segments must be identically specified</li> <li>30-72" wide tiles each feature two power knockouts with bezels at above-worksurface beltway</li> <li>24" wide tiles each feature one power knockout with bezel at above-worksurface beltway</li> <li>Elevated base does not accept cable distribution</li> <li>Panel assembly includes frame, trim, and panel-to-panel connectors</li> <li>Trim is metal and includes top cap, bottom trim channel, segment channel, and foot shroud</li> <li>Side 1 and side 2 finishes are specified separately</li> <li>72" wide panels feature split tiles</li> </ul>	24 x 64	USFLBW2464	<input type="checkbox"/>	<input type="checkbox"/>	<input type="checkbox"/>	<input type="checkbox"/>	<input type="checkbox"/>	<input type="checkbox"/>	50.7#
	30 x 64	USFLBW3064	<input type="checkbox"/>	<input type="checkbox"/>	<input type="checkbox"/>	<input type="checkbox"/>	<input type="checkbox"/>	<input type="checkbox"/>	57.1#
	36 x 64	USFLBW3664	<input type="checkbox"/>	<input type="checkbox"/>	<input type="checkbox"/>	<input type="checkbox"/>	<input type="checkbox"/>	<input type="checkbox"/>	63.4#
	42 x 64	USFLBW4264	<input type="checkbox"/>	<input type="checkbox"/>	<input type="checkbox"/>	<input type="checkbox"/>	<input type="checkbox"/>	<input type="checkbox"/>	69.8#
	48 x 64	USFLBW4864	<input type="checkbox"/>	<input type="checkbox"/>	<input type="checkbox"/>	<input type="checkbox"/>	<input type="checkbox"/>	<input type="checkbox"/>	76.2#
	60 x 64	USFLBW6064	<input type="checkbox"/>	<input type="checkbox"/>	<input type="checkbox"/>	<input type="checkbox"/>	<input type="checkbox"/>	<input type="checkbox"/>	88.8#
	72 x 64	USFLBW7264	<input type="checkbox"/>	<input type="checkbox"/>	<input type="checkbox"/>	<input type="checkbox"/>	<input type="checkbox"/>	<input type="checkbox"/>	110.3#

A

B

C

D

E

F

G

## HOW TO ORDER

Indicate the following information on order form:

- Quantity of each item.
- Model number, including options. See "How To Build a Model Number".
- Any special service required.

Note:

- The  indicates that a choice is required.
- The absence of the  indicates that no choice is required.
- Alpha-numeric characters in place of  indicate that no other alternatives are available.

## HOW TO BUILD A MODEL NUMBER

- A** Select basic model.
- B** Select top cap style.
- |          |                   |
|----------|-------------------|
| <b>F</b> | - Flat trim (std) |
| <b>N</b> | - No topcap       |
- C** Select electrical code.
- |           |                           |
|-----------|---------------------------|
| <b>DP</b> | - Domestic - with cutouts |
|-----------|---------------------------|
- D** Select bezel color.  
Refer to color addendum at ki.com or KI Fabrics & Finishes binder.
- E** Select trim color.  
Refer to color addendum at ki.com or KI Fabrics & Finishes binder.
- F** Select fabric side 1.  
Refer to color addendum at ki.com or in KI Fabrics & Finishes binder.
- G** Select fabric side 2.  
Refer to color addendum at ki.com or in KI Fabrics & Finishes binder.



# Preconfigured Segmented Fabric Panel w/Beltway Power

Elevated Base

Delivered Pricing Fabric Grade 1 & C.O.M.	Delivered Pricing Fabric Grade 2	Delivered Pricing Fabric Grade 3 & Pallas Vertical Fabric Grade PV	Delivered Pricing Pallas Vertical Fabric Grade PV1	Delivered Pricing Pallas Vertical Fabric Grade PV2
\$ 512	\$ 535	\$ 555	\$ 568	\$ 607
614	642	664	681	726
680	712	736	755	805
723	755	782	802	855
746	781	808	828	884
867	906	939	961	1027
1264	1323	1369	1405	1496

**SPECIAL SERVICES**

**Special Carton Marking**

With specially marked information N/C

**Shipping**

Shipped k.d. freight prepaid f.o.b. Manitowoc, Wisconsin 54220 factory. Freight class #70.

Specifications and prices are subject to change without prior notice.

# Preconfigured Segmented Fabric Panel w/Beltway Power

Tile-to-Floor One Side; Standard Base Raceway One Side

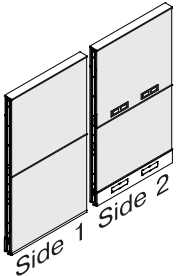
	MODEL	W x H	MODEL NUMBER						Approx. Packaged Weight			
			Basic Model	Top Cap Style	Electrical Code	Bezel Color	Trim Color	Fabric Side 1		Fabric Side 2		
 <p>USFT</p>	<b>Segmented Fabric Panel - 40"H</b>	24 x 40	USFTBW2440	<input type="checkbox"/>	<input type="checkbox"/>	<input type="checkbox"/>	<input type="checkbox"/>	<input type="checkbox"/>	<input type="checkbox"/>	<input type="checkbox"/>	37.9#	
	• Side 1: tile-to-floor base does not accept cable distribution at base or beltway	30 x 40	USFTBW3040	<input type="checkbox"/>	<input type="checkbox"/>	<input type="checkbox"/>	<input type="checkbox"/>	<input type="checkbox"/>	<input type="checkbox"/>	<input type="checkbox"/>	<input type="checkbox"/>	43.1#
	• Side 2: standard base raceway and above-worksurface beltway accept cable distribution	36 x 40	USFTBW3640	<input type="checkbox"/>	<input type="checkbox"/>	<input type="checkbox"/>	<input type="checkbox"/>	<input type="checkbox"/>	<input type="checkbox"/>	<input type="checkbox"/>	<input type="checkbox"/>	48.4#
	• Includes segmented fabric tiles for both sides	42 x 40	USFTBW4240	<input type="checkbox"/>	<input type="checkbox"/>	<input type="checkbox"/>	<input type="checkbox"/>	<input type="checkbox"/>	<input type="checkbox"/>	<input type="checkbox"/>	<input type="checkbox"/>	53.7#
	• Upper and lower segments must be identically specified	48 x 40	USFTBW4840	<input type="checkbox"/>	<input type="checkbox"/>	<input type="checkbox"/>	<input type="checkbox"/>	<input type="checkbox"/>	<input type="checkbox"/>	<input type="checkbox"/>	<input type="checkbox"/>	59.0#
	• Panel assembly includes frame, trim, and panel-to-panel connectors	60 x 40	USFTBW6040	<input type="checkbox"/>	<input type="checkbox"/>	<input type="checkbox"/>	<input type="checkbox"/>	<input type="checkbox"/>	<input type="checkbox"/>	<input type="checkbox"/>	<input type="checkbox"/>	69.5#
	• Trim is metal and includes top cap, bottom trim channel, base raceway, and segment channel	72 x 40	USFTBW7240	<input type="checkbox"/>	<input type="checkbox"/>	<input type="checkbox"/>	<input type="checkbox"/>	<input type="checkbox"/>	<input type="checkbox"/>	<input type="checkbox"/>	<input type="checkbox"/>	85.1#
	• Side 1 and side 2 finishes are specified separately											
• Side 2: 30-72" wide tiles feature two base power knockouts and two beltway power knockouts with bezels												
• Side 2: 24" wide tiles feature one base and one beltway power knockout with bezel												
• 72" wide panels feature split tiles												
• Electrical components are specified separately												
USFT	<b>Segmented Fabric Panel - 48"H</b>	24 x 48	USFTBW2448	<input type="checkbox"/>	<input type="checkbox"/>	<input type="checkbox"/>	<input type="checkbox"/>	<input type="checkbox"/>	<input type="checkbox"/>	<input type="checkbox"/>	<input type="checkbox"/>	43.2#
		30 x 48	USFTBW3048	<input type="checkbox"/>	<input type="checkbox"/>	<input type="checkbox"/>	<input type="checkbox"/>	<input type="checkbox"/>	<input type="checkbox"/>	<input type="checkbox"/>	<input type="checkbox"/>	49.0#
		36 x 48	USFTBW3648	<input type="checkbox"/>	<input type="checkbox"/>	<input type="checkbox"/>	<input type="checkbox"/>	<input type="checkbox"/>	<input type="checkbox"/>	<input type="checkbox"/>	<input type="checkbox"/>	54.8#
		42 x 48	USFTBW4248	<input type="checkbox"/>	<input type="checkbox"/>	<input type="checkbox"/>	<input type="checkbox"/>	<input type="checkbox"/>	<input type="checkbox"/>	<input type="checkbox"/>	<input type="checkbox"/>	60.6#
		48 x 48	USFTBW4848	<input type="checkbox"/>	<input type="checkbox"/>	<input type="checkbox"/>	<input type="checkbox"/>	<input type="checkbox"/>	<input type="checkbox"/>	<input type="checkbox"/>	<input type="checkbox"/>	66.4#
		60 x 48	USFTBW6048	<input type="checkbox"/>	<input type="checkbox"/>	<input type="checkbox"/>	<input type="checkbox"/>	<input type="checkbox"/>	<input type="checkbox"/>	<input type="checkbox"/>	<input type="checkbox"/>	78.0#
		72 x 48	USFTBW7248	<input type="checkbox"/>	<input type="checkbox"/>	<input type="checkbox"/>	<input type="checkbox"/>	<input type="checkbox"/>	<input type="checkbox"/>	<input type="checkbox"/>	<input type="checkbox"/>	95.9#
USFT	<b>Segmented Fabric Panel - 56"H</b>	24 x 56	USFTBW2456	<input type="checkbox"/>	<input type="checkbox"/>	<input type="checkbox"/>	<input type="checkbox"/>	<input type="checkbox"/>	<input type="checkbox"/>	<input type="checkbox"/>	<input type="checkbox"/>	47.6#
		30 x 56	USFTBW3056	<input type="checkbox"/>	<input type="checkbox"/>	<input type="checkbox"/>	<input type="checkbox"/>	<input type="checkbox"/>	<input type="checkbox"/>	<input type="checkbox"/>	<input type="checkbox"/>	53.9#
		36 x 56	USFTBW3656	<input type="checkbox"/>	<input type="checkbox"/>	<input type="checkbox"/>	<input type="checkbox"/>	<input type="checkbox"/>	<input type="checkbox"/>	<input type="checkbox"/>	<input type="checkbox"/>	60.2#
		42 x 56	USFTBW4256	<input type="checkbox"/>	<input type="checkbox"/>	<input type="checkbox"/>	<input type="checkbox"/>	<input type="checkbox"/>	<input type="checkbox"/>	<input type="checkbox"/>	<input type="checkbox"/>	66.6#
		48 x 56	USFTBW4856	<input type="checkbox"/>	<input type="checkbox"/>	<input type="checkbox"/>	<input type="checkbox"/>	<input type="checkbox"/>	<input type="checkbox"/>	<input type="checkbox"/>	<input type="checkbox"/>	72.9#
		60 x 56	USFTBW6056	<input type="checkbox"/>	<input type="checkbox"/>	<input type="checkbox"/>	<input type="checkbox"/>	<input type="checkbox"/>	<input type="checkbox"/>	<input type="checkbox"/>	<input type="checkbox"/>	85.5#
		72 x 56	USFTBW7256	<input type="checkbox"/>	<input type="checkbox"/>	<input type="checkbox"/>	<input type="checkbox"/>	<input type="checkbox"/>	<input type="checkbox"/>	<input type="checkbox"/>	<input type="checkbox"/>	105.7#

**A B C D E F G**

## HOW TO ORDER

Indicate the following information on order form:

- Quantity of each item.
- Model number, including options. See "How To Build a Model Number".
- Any special service required.

Note: • The  indicates that a choice is required.

- The absence of the  indicates that no choice is required.
- Alpha-numeric characters in place of  indicate that no other alternatives are available.

## HOW TO BUILD A MODEL NUMBER

**A** Select basic model.

**B** Select top cap style.

**F** - Flat trim (std)  
**N** - No topcap

**C** Select electrical code.

**DP** - Domestic - with cutouts

**D** Select bezel color.

Refer to color addendum at ki.com or KI Fabrics & Finishes binder.

**E** Select trim color.

Refer to color addendum at ki.com or KI Fabrics & Finishes binder.

**F** Select fabric side 1.

Refer to color addendum at ki.com or in KI Fabrics & Finishes binder.

**G** Select fabric side 2.

Refer to color addendum at ki.com or in KI Fabrics & Finishes binder.



# Preconfigured Segmented Fabric Panel w/Beltway Power

Tile-to-Floor One Side; Standard Base Raceway One Side

Delivered Pricing Fabric Grade 1 & C.O.M.	Delivered Pricing Fabric Grade 2	Delivered Pricing Fabric Grade 3 & Pallas Vertical Fabric Grade PV	Delivered Pricing Pallas Vertical Fabric Grade PV1	Delivered Pricing Pallas Vertical Fabric Grade PV2
\$ 419	\$ 438	\$ 454	\$ 466	\$ 496
486	510	527	541	577
526	550	569	584	622
572	598	620	637	678
589	616	639	653	697
703	736	763	782	833
962	1007	1042	1069	1140

\$ 449	\$ 471	\$ 485	\$ 500	\$ 531
521	545	564	579	617
567	592	613	628	671
628	657	681	697	744
644	674	697	716	763
763	797	825	846	901
1039	1088	1125	1154	1230
\$ 475	\$ 497	\$ 514	\$ 527	\$ 562
555	580	599	616	655
607	634	655	674	719
677	706	731	750	800
692	724	749	768	819
781	817	846	867	924
1112	1164	1204	1236	1317

## SPECIAL SERVICES

### Special Carton Marking

With specially marked information N/C

### Shipping

Delivered. Shipped **k.d. freight prepaid f.o.b. Manitowoc, Wisconsin 54220** factory. Freight class #70.

Specifications and prices are subject to change without prior notice.

# Preconfigured Segmented Fabric Panel w/Beltway Power

Tile-to-Floor One Side; Standard Base Raceway One Side

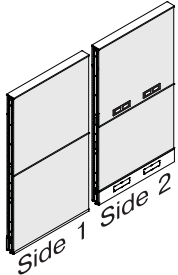

USFT

**MODEL**

**W x H**

**MODEL NUMBER**

Basic Model	Top Cap Style	Electrical Code	Bezel Color	Trim Color	Fabric Side 1	Fabric Side 2
USFTBW2464	<input type="checkbox"/>	<input type="checkbox"/>	<input type="checkbox"/>	<input type="checkbox"/>	<input type="checkbox"/>	<input type="checkbox"/>
USFTBW3064	<input type="checkbox"/>	<input type="checkbox"/>	<input type="checkbox"/>	<input type="checkbox"/>	<input type="checkbox"/>	<input type="checkbox"/>
USFTBW3664	<input type="checkbox"/>	<input type="checkbox"/>	<input type="checkbox"/>	<input type="checkbox"/>	<input type="checkbox"/>	<input type="checkbox"/>
USFTBW4264	<input type="checkbox"/>	<input type="checkbox"/>	<input type="checkbox"/>	<input type="checkbox"/>	<input type="checkbox"/>	<input type="checkbox"/>
USFTBW4864	<input type="checkbox"/>	<input type="checkbox"/>	<input type="checkbox"/>	<input type="checkbox"/>	<input type="checkbox"/>	<input type="checkbox"/>
USFTBW6064	<input type="checkbox"/>	<input type="checkbox"/>	<input type="checkbox"/>	<input type="checkbox"/>	<input type="checkbox"/>	<input type="checkbox"/>
USFTBW7264	<input type="checkbox"/>	<input type="checkbox"/>	<input type="checkbox"/>	<input type="checkbox"/>	<input type="checkbox"/>	<input type="checkbox"/>

Approx. Packaged Weight

- Segmented Fabric Panel - 64"H**
- Side 1: tile-to-floor base does not accept cable distribution at base or beltway
  - Side 2: standard base raceway and above-worksurface beltway accept cable distribution
  - Includes segmented fabric tiles for both sides
  - Upper and lower segments must be identically specified
  - Panel assembly includes frame, trim, and panel-to-panel connectors
  - Trim is metal and includes top cap, bottom trim channel, base raceway, and segment channel
  - Side 1 and side 2 finishes are specified separately
  - Side 2: 30-72" wide tiles feature two base power knockouts and two beltway power knockouts with bezels
  - Side 2: 24" wide tiles feature one base and one beltway power knockout with bezel
  - 72" wide panels feature split tiles
  - Electrical components are specified separately

**A B C D E F G**

**HOW TO ORDER**

Indicate the following information on order form:

1. Quantity of each item.
2. Model number, including options. See "How To Build a Model Number".
3. Any special service required.

Note: • The  indicates that a choice is required.

- The absence of the  indicates that no choice is required.
- Alpha-numeric characters in place of  indicate that no other alternatives are available.

**HOW TO BUILD A MODEL NUMBER**

- A** Select basic model.
- B** Select top cap style.  

F	- Flat trim (std)
N	- No topcap
- C** Select electrical code.  

DP	- Domestic - with cutouts
----	---------------------------
- D** Select bezel color.  
Refer to color addendum at ki.com or KI Fabrics & Finishes binder.
- E** Select trim color.  
Refer to color addendum at ki.com or KI Fabrics & Finishes binder.
- F** Select fabric side 1.  
Refer to color addendum at ki.com or in KI Fabrics & Finishes binder.
- G** Select fabric side 2.  
Refer to color addendum at ki.com or in KI Fabrics & Finishes binder.



# Preconfigured Segmented Fabric Panel w/Beltway Power

Tile-to-Floor One Side; Standard Base Raceway One Side

Delivered Pricing Fabric Grade 1 & C.O.M.	Delivered Pricing Fabric Grade 2	Delivered Pricing Fabric Grade 3 & Pallas Vertical Fabric Grade PV	Delivered Pricing Pallas Vertical Fabric Grade PV1	Delivered Pricing Pallas Vertical Fabric Grade PV2
\$ 512	\$ 535	\$ 555	\$ 568	\$ 607
614	642	664	681	726
680	712	736	755	805
723	755	782	802	855
746	781	808	828	884
867	906	939	961	1027
1264	1323	1369	1405	1496

### SPECIAL SERVICES

#### Special Carton Marking

With specially marked information N/C

#### Shipping

Shipped k.d. freight prepaid f.o.b. Manitowoc, Wisconsin 54220 factory. Freight class #70.

Specifications and prices are subject to change without prior notice.

# Preconfigured Segmented Steel Panels w/Fabric Top Tiles

Standard Base Raceway

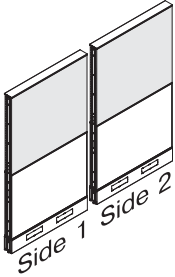

USFR

MODEL	W x H	MODEL NUMBER							
		Basic Model	Top Cap Style	Electrical Code	Trim Color	Steel Color Side 1	Fabric Side 1	Steel Color Side 2	Fabric Side 2
<b>Segmented Steel Panel - 40"H</b> • Includes segmented tiles with steel lower and fabric upper segments for both sides • Standard base raceway on both sides accepts power and data cable distribution • Panel assembly includes frame, trim, and panel-to-panel connectors • Trim is metal and includes top cap, bottom trim channel, base raceway, and segment channel • Side 1 and side 2 finishes are specified separately • 30-72" wide panels feature two power knockouts per side • 24" wide panels feature one power knockout per side • 72" wide panels feature split tiles • Electrical components are specified separately	24 x 40	USSFR2440	<input type="checkbox"/>	<input type="checkbox"/>	<input type="checkbox"/>	<input type="checkbox"/>	<input type="checkbox"/>	<input type="checkbox"/>	<input type="checkbox"/>
	30 x 40	USSFR3040	<input type="checkbox"/>	<input type="checkbox"/>	<input type="checkbox"/>	<input type="checkbox"/>	<input type="checkbox"/>	<input type="checkbox"/>	<input type="checkbox"/>
	36 x 40	USSFR3640	<input type="checkbox"/>	<input type="checkbox"/>	<input type="checkbox"/>	<input type="checkbox"/>	<input type="checkbox"/>	<input type="checkbox"/>	<input type="checkbox"/>
	42 x 40	USSFR4240	<input type="checkbox"/>	<input type="checkbox"/>	<input type="checkbox"/>	<input type="checkbox"/>	<input type="checkbox"/>	<input type="checkbox"/>	<input type="checkbox"/>
	48 x 40	USSFR4840	<input type="checkbox"/>	<input type="checkbox"/>	<input type="checkbox"/>	<input type="checkbox"/>	<input type="checkbox"/>	<input type="checkbox"/>	<input type="checkbox"/>
	60 x 40	USSFR6040	<input type="checkbox"/>	<input type="checkbox"/>	<input type="checkbox"/>	<input type="checkbox"/>	<input type="checkbox"/>	<input type="checkbox"/>	<input type="checkbox"/>
	72 x 40	USSFR7240	<input type="checkbox"/>	<input type="checkbox"/>	<input type="checkbox"/>	<input type="checkbox"/>	<input type="checkbox"/>	<input type="checkbox"/>	<input type="checkbox"/>
<b>Segmented Steel Panel - 48"H</b>	24 x 48	USSFR2448	<input type="checkbox"/>	<input type="checkbox"/>	<input type="checkbox"/>	<input type="checkbox"/>	<input type="checkbox"/>	<input type="checkbox"/>	<input type="checkbox"/>
	30 x 48	USSFR3048	<input type="checkbox"/>	<input type="checkbox"/>	<input type="checkbox"/>	<input type="checkbox"/>	<input type="checkbox"/>	<input type="checkbox"/>	<input type="checkbox"/>
	36 x 48	USSFR3648	<input type="checkbox"/>	<input type="checkbox"/>	<input type="checkbox"/>	<input type="checkbox"/>	<input type="checkbox"/>	<input type="checkbox"/>	<input type="checkbox"/>
	42 x 48	USSFR4248	<input type="checkbox"/>	<input type="checkbox"/>	<input type="checkbox"/>	<input type="checkbox"/>	<input type="checkbox"/>	<input type="checkbox"/>	<input type="checkbox"/>
	48 x 48	USSFR4848	<input type="checkbox"/>	<input type="checkbox"/>	<input type="checkbox"/>	<input type="checkbox"/>	<input type="checkbox"/>	<input type="checkbox"/>	<input type="checkbox"/>
	60 x 48	USSFR6048	<input type="checkbox"/>	<input type="checkbox"/>	<input type="checkbox"/>	<input type="checkbox"/>	<input type="checkbox"/>	<input type="checkbox"/>	<input type="checkbox"/>
	72 x 48	USSFR7248	<input type="checkbox"/>	<input type="checkbox"/>	<input type="checkbox"/>	<input type="checkbox"/>	<input type="checkbox"/>	<input type="checkbox"/>	<input type="checkbox"/>
<b>Segmented Steel Panel - 56"H</b>	24 x 56	USSFR2456	<input type="checkbox"/>	<input type="checkbox"/>	<input type="checkbox"/>	<input type="checkbox"/>	<input type="checkbox"/>	<input type="checkbox"/>	<input type="checkbox"/>
	30 x 56	USSFR3056	<input type="checkbox"/>	<input type="checkbox"/>	<input type="checkbox"/>	<input type="checkbox"/>	<input type="checkbox"/>	<input type="checkbox"/>	<input type="checkbox"/>
	36 x 56	USSFR3656	<input type="checkbox"/>	<input type="checkbox"/>	<input type="checkbox"/>	<input type="checkbox"/>	<input type="checkbox"/>	<input type="checkbox"/>	<input type="checkbox"/>
	42 x 56	USSFR4256	<input type="checkbox"/>	<input type="checkbox"/>	<input type="checkbox"/>	<input type="checkbox"/>	<input type="checkbox"/>	<input type="checkbox"/>	<input type="checkbox"/>
	48 x 56	USSFR4856	<input type="checkbox"/>	<input type="checkbox"/>	<input type="checkbox"/>	<input type="checkbox"/>	<input type="checkbox"/>	<input type="checkbox"/>	<input type="checkbox"/>
	60 x 56	USSFR6056	<input type="checkbox"/>	<input type="checkbox"/>	<input type="checkbox"/>	<input type="checkbox"/>	<input type="checkbox"/>	<input type="checkbox"/>	<input type="checkbox"/>
	72 x 56	USSFR7256	<input type="checkbox"/>	<input type="checkbox"/>	<input type="checkbox"/>	<input type="checkbox"/>	<input type="checkbox"/>	<input type="checkbox"/>	<input type="checkbox"/>

**A**   **B**   **C**   **D**   **E**   **F**   **G**   **H**

## HOW TO ORDER

Indicate the following information on order form:

- Quantity of each item.
- Model number, including options. See "How To Build a Model Number".
- Any special service required.

Note: • The  indicates that a choice is required.

- The absence of the  indicates that no choice is required.
- Alpha-numeric characters in place of

indicate that no other alternatives are available.

## HOW TO BUILD A MODEL NUMBER

**A** Select basic model.

**B** Select top cap style.

**F** - Flat trim (std)

**N** - No topcap

**C** Select electrical code.

**CP** - Chicago - with cutouts

**DN** - Domestic - no cutouts

**DP** - Domestic - with cutouts

**C1** - Chicago, 1 side w/cutouts

**D1** - Domestic, 1 side w/cutouts

**D** Select trim color.

Refer to color addendum at ki.com or KI Fabrics & Finishes binder.

**E** Select steel bottom color side 1.

Refer to color addendum at ki.com or KI Fabrics & Finishes binder.

**F** Select fabric side 1.

Refer to color addendum at ki.com or in KI Fabrics & Finishes binder.

**G** Select steel bottom color side 2.

Refer to color addendum at ki.com or KI Fabrics & Finishes binder.

**H** Select fabric side 2.

Refer to color addendum at ki.com or in KI Fabrics & Finishes binder.





# Preconfigured Segmented Steel Panels w/Fabric Top Tiles

Standard Base Raceway

Approx. Packaged Weight	Delivered Pricing Fabric Grade 1 & C.O.M.	Delivered Pricing Fabric Grade 2	Delivered Pricing Fabric Grade 3 & Pallas Vertical Fabric Grade PV	Delivered Pricing Pallas Vertical Fabric Grade PV1	Delivered Pricing Pallas Vertical Fabric Grade PV2
43.7#	\$ 504	\$ 517	\$ 526	\$ 545	\$ 565
50.4#	544	560	570	591	612
57.1#	583	597	610	632	653
64.0#	610	627	639	662	685
70.7#	663	682	694	721	746
84.3#	847	870	888	920	951
105.3#	1072	1103	1123	1165	1205
49.0#	\$ 537	\$ 554	\$ 563	\$ 585	\$ 606
56.2#	580	596	609	629	651
63.5#	620	639	650	675	697
70.8#	664	682	695	721	746
78.1#	717	736	750	778	804
92.8#	905	932	950	985	1018
116.1#	1149	1180	1204	1248	1292
53.3#	\$ 560	\$ 576	\$ 587	\$ 609	\$ 629
61.1#	612	629	641	641	688
68.9#	660	679	691	717	741
76.8#	716	734	749	777	803
84.6#	765	786	801	830	859
100.3#	924	951	967	1003	1038
126.0#	1225	1260	1283	1329	1376

**SPECIAL SERVICES****Special Carton Marking**

With specially marked information N/C

**Shipping**

Delivered. Shipped **k.d. freight prepaid**  
**f.o.b. Manitowoc, Wisconsin 54220**  
 factory. Freight class #70.

Specifications and prices are subject to  
 change without prior notice.

# Preconfigured Segmented Steel Panels w/Fabric Top Tiles

Standard Base Raceway

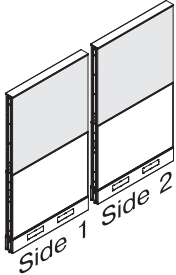

USFR

**MODEL**

**W x H**

- Segmented Steel Panel - 64"H**
- Includes segmented tiles with steel lower and fabric upper segments for both sides
  - Standard base raceway on both sides accepts power and data cable distribution
  - Panel assembly includes frame, trim, and panel-to-panel connectors
  - Trim is metal and includes top cap, bottom trim channel, base raceway, and segment channel
  - Side 1 and side 2 finishes are specified separately
  - 30-72" wide panels feature two power knockouts per side
  - 24" wide panels feature one power knockout per side
  - 72" wide panels feature split tiles
  - Electrical components are specified separately

**MODEL NUMBER**

Basic Model	Top Cap Style	Electrical Code	Trim Color	Steel Color Side 1	Fabric Side 1	Steel Color Side 2	Fabric Side 2
USSFR2464	<input type="checkbox"/>	<input type="checkbox"/>	<input type="checkbox"/>	<input type="checkbox"/>	<input type="checkbox"/>	<input type="checkbox"/>	<input type="checkbox"/>
USSFR3064	<input type="checkbox"/>	<input type="checkbox"/>	<input type="checkbox"/>	<input type="checkbox"/>	<input type="checkbox"/>	<input type="checkbox"/>	<input type="checkbox"/>
USSFR3664	<input type="checkbox"/>	<input type="checkbox"/>	<input type="checkbox"/>	<input type="checkbox"/>	<input type="checkbox"/>	<input type="checkbox"/>	<input type="checkbox"/>
USSFR4264	<input type="checkbox"/>	<input type="checkbox"/>	<input type="checkbox"/>	<input type="checkbox"/>	<input type="checkbox"/>	<input type="checkbox"/>	<input type="checkbox"/>
USSFR4864	<input type="checkbox"/>	<input type="checkbox"/>	<input type="checkbox"/>	<input type="checkbox"/>	<input type="checkbox"/>	<input type="checkbox"/>	<input type="checkbox"/>
USSFR6064	<input type="checkbox"/>	<input type="checkbox"/>	<input type="checkbox"/>	<input type="checkbox"/>	<input type="checkbox"/>	<input type="checkbox"/>	<input type="checkbox"/>
USSFR7264	<input type="checkbox"/>	<input type="checkbox"/>	<input type="checkbox"/>	<input type="checkbox"/>	<input type="checkbox"/>	<input type="checkbox"/>	<input type="checkbox"/>

**A B C D E F G H**

**HOW TO ORDER**

Indicate the following information on order form:

- Quantity of each item.
- Model number, including options. See "How To Build a Model Number".
- Any special service required.

Note:

- The  indicates that a choice is required.
- The absence of the  indicates that no choice is required.
- Alpha-numeric characters in place of  indicate that no other alternatives are available.

**HOW TO BUILD A MODEL NUMBER**

- A** Select basic model.
- B** Select top cap style.
  - F** - Flat trim (std)
  - N** - No topcap
- C** Select electrical code.
  - CP** - Chicago - with cutouts
  - DN** - Domestic - no cutouts
  - DP** - Domestic - with cutouts
  - C1** - Chicago, 1 side w/cutouts
  - D1** - Domestic, 1 side w/cutouts
- D** Select trim color. Refer to color addendum at ki.com or KI Fabrics & Finishes binder.
- E** Select steel bottom color side 1. Refer to color addendum at ki.com or KI Fabrics & Finishes binder.
- F** Select fabric side 1. Refer to color addendum at ki.com or in KI Fabrics & Finishes binder.
- G** Select steel bottom color side 2. Refer to color addendum at ki.com or KI Fabrics & Finishes binder.
- H** Select fabric side 2. Refer to color addendum at ki.com or in KI Fabrics & Finishes binder.



# Preconfigured Segmented Steel Panels w/Fabric Top Tiles

Standard Base Raceway

Approx. Packaged Weight	Delivered Pricing Fabric Grade 1 & C.O.M.	Delivered Pricing Fabric Grade 2	Delivered Pricing Fabric Grade 3 & Pallas Vertical Fabric Grade PV	Delivered Pricing Pallas Vertical Fabric Grade PV1	Delivered Pricing Pallas Vertical Fabric Grade PV2
57.7#	\$ 596	\$ 615	\$ 626	\$ 648	\$ 673
66.0#	675	694	706	732	758
74.3#	735	757	773	800	828
82.7#	762	784	799	828	857
91.1#	936	843	858	889	920
107.8#	1005	1056	1054	1092	1130
135.8#	1377	1417	1443	1495	1547

### SPECIAL SERVICES

#### Special Carton Marking

With specially marked information N/C

#### Shipping

Shipped k.d. freight prepaid f.o.b. Manitowoc, Wisconsin 54220 factory. Freight class #70.

Specifications and prices are subject to change without prior notice.

# Preconfigured Segmented Steel Panels w/Fabric Top Tiles

Elevated Base

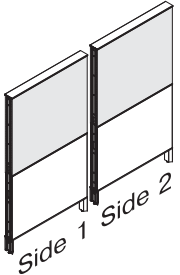
	MODEL	W x H	MODEL NUMBER							Approx. Packaged Weight
			Basic Model	Top Cap Style	Trim Color	Steel Color Side 1	Fabric Side 1	Steel Color Side 2	Fabric Side 2	
	<b>Segmented Steel Panel - 40"H</b>	24 x 40	USSFL2440	<input type="checkbox"/>	<input type="checkbox"/>	<input type="checkbox"/>	<input type="checkbox"/>	<input type="checkbox"/>	<input type="checkbox"/>	41.4#
	• Includes segmented tiles with steel lower and fabric upper segments for both sides	30 x 40	USSFL3040	<input type="checkbox"/>	<input type="checkbox"/>	<input type="checkbox"/>	<input type="checkbox"/>	<input type="checkbox"/>	<input type="checkbox"/>	47.4#
	• Elevated base does not accept cable distribution	36 x 40	USSFL3640	<input type="checkbox"/>	<input type="checkbox"/>	<input type="checkbox"/>	<input type="checkbox"/>	<input type="checkbox"/>	<input type="checkbox"/>	53.4#
	• Panel assembly includes frame, trim, and panel-to-panel connectors	42 x 40	USSFL4240	<input type="checkbox"/>	<input type="checkbox"/>	<input type="checkbox"/>	<input type="checkbox"/>	<input type="checkbox"/>	<input type="checkbox"/>	59.4#
	• Trim is metal and includes top cap, bottom trim channel, segment channel, and foot shroud	48 x 40	USSFL4840	<input type="checkbox"/>	<input type="checkbox"/>	<input type="checkbox"/>	<input type="checkbox"/>	<input type="checkbox"/>	<input type="checkbox"/>	65.3#
	• Side 1 and side 2 finishes are specified separately	60 x 40	USSFL6040	<input type="checkbox"/>	<input type="checkbox"/>	<input type="checkbox"/>	<input type="checkbox"/>	<input type="checkbox"/>	<input type="checkbox"/>	77.3#
	• 72" wide panels feature split tiles	72 x 40	USSFL7240	<input type="checkbox"/>	<input type="checkbox"/>	<input type="checkbox"/>	<input type="checkbox"/>	<input type="checkbox"/>	<input type="checkbox"/>	96.7#
	USFL									
USFL	<b>Segmented Steel Panel - 48"H</b>	24 x 48	USSFL2448	<input type="checkbox"/>	<input type="checkbox"/>	<input type="checkbox"/>	<input type="checkbox"/>	<input type="checkbox"/>	<input type="checkbox"/>	46.7#
		30 x 48	USSFL3048	<input type="checkbox"/>	<input type="checkbox"/>	<input type="checkbox"/>	<input type="checkbox"/>	<input type="checkbox"/>	<input type="checkbox"/>	53.2#
		36 x 48	USSFL3648	<input type="checkbox"/>	<input type="checkbox"/>	<input type="checkbox"/>	<input type="checkbox"/>	<input type="checkbox"/>	<input type="checkbox"/>	59.7#
		42 x 48	USSFL4248	<input type="checkbox"/>	<input type="checkbox"/>	<input type="checkbox"/>	<input type="checkbox"/>	<input type="checkbox"/>	<input type="checkbox"/>	66.3#
		48 x 48	USSFL4848	<input type="checkbox"/>	<input type="checkbox"/>	<input type="checkbox"/>	<input type="checkbox"/>	<input type="checkbox"/>	<input type="checkbox"/>	72.8#
		60 x 48	USSFL6048	<input type="checkbox"/>	<input type="checkbox"/>	<input type="checkbox"/>	<input type="checkbox"/>	<input type="checkbox"/>	<input type="checkbox"/>	85.8#
		72 x 48	USSFL7248	<input type="checkbox"/>	<input type="checkbox"/>	<input type="checkbox"/>	<input type="checkbox"/>	<input type="checkbox"/>	<input type="checkbox"/>	107.6#
USFL	<b>Segmented Steel Panel - 56"H</b>	24 x 56	USSFL2456	<input type="checkbox"/>	<input type="checkbox"/>	<input type="checkbox"/>	<input type="checkbox"/>	<input type="checkbox"/>	<input type="checkbox"/>	51.1#
		30 x 56	USSFL3056	<input type="checkbox"/>	<input type="checkbox"/>	<input type="checkbox"/>	<input type="checkbox"/>	<input type="checkbox"/>	<input type="checkbox"/>	58.1#
		36 x 56	USSFL3656	<input type="checkbox"/>	<input type="checkbox"/>	<input type="checkbox"/>	<input type="checkbox"/>	<input type="checkbox"/>	<input type="checkbox"/>	65.1#
		42 x 56	USSFL4256	<input type="checkbox"/>	<input type="checkbox"/>	<input type="checkbox"/>	<input type="checkbox"/>	<input type="checkbox"/>	<input type="checkbox"/>	72.2#
		48 x 56	USSFL4856	<input type="checkbox"/>	<input type="checkbox"/>	<input type="checkbox"/>	<input type="checkbox"/>	<input type="checkbox"/>	<input type="checkbox"/>	79.2#
		60 x 56	USSFL6056	<input type="checkbox"/>	<input type="checkbox"/>	<input type="checkbox"/>	<input type="checkbox"/>	<input type="checkbox"/>	<input type="checkbox"/>	93.3#
		72 x 56	USSFL7256	<input type="checkbox"/>	<input type="checkbox"/>	<input type="checkbox"/>	<input type="checkbox"/>	<input type="checkbox"/>	<input type="checkbox"/>	117.4#

A

B

C

D

E

F

G

## HOW TO ORDER

Indicate the following information on order form:

- Quantity of each item.
- Model number, including options. See "How To Build a Model Number".
- Any special service required.

Note: • The  indicates that a choice is required.

- The absence of the  indicates that no choice is required.
- Alpha-numeric characters in place of  indicate that no other alternatives are available.

## HOW TO BUILD A MODEL NUMBER

**A** Select basic model.

**B** Select top cap style.

F \_\_\_\_\_ - Flat trim (std)

N \_\_\_\_\_ - No topcap

**C** Select trim color.

Refer to color addendum at ki.com or KI Fabrics & Finishes binder.

**D** Select steel bottom color side 1.

Refer to color addendum at ki.com or KI Fabrics & Finishes binder.

**E** Select fabric side 1.

Refer to color addendum at ki.com or in KI Fabrics & Finishes binder.

**F** Select steel bottom color side 2.

Refer to color addendum at ki.com or KI Fabrics & Finishes binder.

**G** Select fabric side 2.

Refer to color addendum at ki.com or in KI Fabrics & Finishes binder.



# Preconfigured Segmented Steel Panels w/Fabric Top Tiles

Elevated Base

Delivered Pricing Fabric Grade 1 & C.O.M.	Delivered Pricing Fabric Grade 2	Delivered Pricing Fabric Grade 3 & Pallas Vertical Fabric Grade PV	Delivered Pricing Pallas Vertical Fabric Grade PV1	Delivered Pricing Pallas Vertical Fabric Grade PV2
\$ 504	\$ 517	\$ 526	\$ 545	\$ 565
544	560	570	591	612
583	597	610	632	653
610	627	639	662	685
663	682	694	721	746
847	870	888	920	951
1072	1103	1123	1165	1205
<hr/>				
\$ 537	\$ 554	\$ 563	\$ 585	\$ 606
580	596	609	629	651
620	639	650	675	697
664	682	695	721	746
717	736	750	778	804
905	932	950	985	1018
1149	1180	1204	1248	1292
<hr/>				
\$ 560	\$ 576	\$ 587	\$ 609	\$ 629
612	629	641	664	688
660	679	691	717	741
716	734	749	787	803
765	786	801	830	859
924	951	967	1003	1038
1225	1260	1283	1329	1376

**SPECIAL SERVICES**

**Special Carton Marking**

With specially marked information N/C

**Shipping**

Delivered. Shipped **k.d. freight prepaid f.o.b. Manitowoc, Wisconsin 54220** factory. Freight class #70.

Specifications and prices are subject to change without prior notice.

# Preconfigured Segmented Steel Panels w/Fabric Top Tiles

Elevated Base

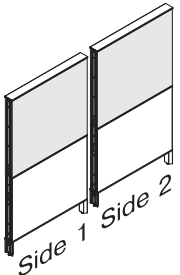
			MODEL NUMBER							Approx. Packaged Weight
MODEL	W x H	Basic Model	Top Cap Style	Trim Color	Steel Color Side 1	Fabric Side 1	Steel Color Side 2	Fabric Side 2		
			A	B	C	D	E	F	G	
 <p><b>Segmented Steel Panel - 64"H</b></p> <ul style="list-style-type: none"> <li>Includes segmented tiles with steel lower and fabric upper segments for both sides</li> <li>Elevated base does not accept cable distribution</li> <li>Panel assembly includes frame, trim, and panel-to-panel connectors</li> <li>Trim is metal and includes top cap, bottom trim channel, segment channel, and foot shroud</li> <li>Side 1 and side 2 finishes are specified separately</li> <li>72" wide panels feature split tiles</li> </ul>	24 x 64	USSFL2464	<input type="checkbox"/>	<input type="checkbox"/>	<input type="checkbox"/>	<input type="checkbox"/>	<input type="checkbox"/>	<input type="checkbox"/>	55.4#	
	30 x 64	USSFL3064	<input type="checkbox"/>	<input type="checkbox"/>	<input type="checkbox"/>	<input type="checkbox"/>	<input type="checkbox"/>	<input type="checkbox"/>	63.0#	
	36 x 64	USSFL3664	<input type="checkbox"/>	<input type="checkbox"/>	<input type="checkbox"/>	<input type="checkbox"/>	<input type="checkbox"/>	<input type="checkbox"/>	70.5#	
	42 x 64	USSFL4264	<input type="checkbox"/>	<input type="checkbox"/>	<input type="checkbox"/>	<input type="checkbox"/>	<input type="checkbox"/>	<input type="checkbox"/>	78.1#	
	48 x 64	USSFL4864	<input type="checkbox"/>	<input type="checkbox"/>	<input type="checkbox"/>	<input type="checkbox"/>	<input type="checkbox"/>	<input type="checkbox"/>	85.7#	
	60 x 64	USSFL6064	<input type="checkbox"/>	<input type="checkbox"/>	<input type="checkbox"/>	<input type="checkbox"/>	<input type="checkbox"/>	<input type="checkbox"/>	100.8#	
	72 x 64	USSFL7264	<input type="checkbox"/>	<input type="checkbox"/>	<input type="checkbox"/>	<input type="checkbox"/>	<input type="checkbox"/>	<input type="checkbox"/>	127.2#	

USFL

## HOW TO ORDER

Indicate the following information on order form:

- Quantity of each item.
- Model number, including options. See "How To Build a Model Number".
- Any special service required.

Note: • The  indicates that a choice is required.

- The absence of the  indicates that no choice is required.
- Alpha-numeric characters in place of  indicate that no other alternatives are available.

## HOW TO BUILD A MODEL NUMBER

- A** Select basic model.
- B** Select top cap style.
 

<b>F</b>	- Flat trim (std)
<b>N</b>	- No topcap
- C** Select trim color. Refer to color addendum at ki.com or KI Fabrics & Finishes binder.
- D** Select steel bottom color side 1. Refer to color addendum at ki.com or KI Fabrics & Finishes binder.
- E** Select fabric side 1. Refer to color addendum at ki.com or in KI Fabrics & Finishes binder.
- F** Select steel bottom color side 2. Refer to color addendum at ki.com or KI Fabrics & Finishes binder.

- G** Select fabric side 2. Refer to color addendum at ki.com or in KI Fabrics & Finishes binder.



# Preconfigured Segmented Steel Panels w/Fabric Top Tiles

Elevated Base

Delivered Pricing Fabric Grade 1 & C.O.M.	Delivered Pricing Fabric Grade 2	Delivered Pricing Fabric Grade 3 & Pallas Vertical Fabric Grade PV	Delivered Pricing Pallas Vertical Fabric Grade PV1	Delivered Pricing Pallas Vertical Fabric Grade PV2
\$ 596	\$ 615	\$ 626	\$ 648	\$ 673
675	694	706	732	758
735	757	773	800	828
762	784	799	828	857
819	843	858	889	920
1005	1035	1054	1092	1130
1377	1417	1443	1495	1547

**SPECIAL SERVICES**

**Special Carton Marking**

With specially marked information N/C

**Shipping**

Shipped k.d. freight prepaid f.o.b. Manitowoc, Wisconsin 54220 factory. Freight class #70.

Specifications and prices are subject to change without prior notice.

# Preconfigured Segmented Steel Panels w/Fabric Top Tiles

Tile-to-Floor One Side; Standard Base Raceway One Side

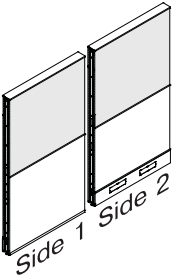
	MODEL	W x H	MODEL NUMBER								
			Basic Model	Top Cap Style	Electrical Code	Trim Color	Steel Color Side 1	Fabric Side 1	Steel Color Side 2	Fabric Side 2	
 <p>USFT</p>	<b>Segmented Steel Panel - 40"H</b>	24 x 40	USSFT2440	<input type="checkbox"/>	<input type="checkbox"/>	<input type="checkbox"/>	<input type="checkbox"/>	<input type="checkbox"/>	<input type="checkbox"/>	<input type="checkbox"/>	<input type="checkbox"/>
	• Side 1: tile-to-floor base does not accept cable distribution	30 x 40	USSFT3040	<input type="checkbox"/>	<input type="checkbox"/>	<input type="checkbox"/>	<input type="checkbox"/>	<input type="checkbox"/>	<input type="checkbox"/>	<input type="checkbox"/>	<input type="checkbox"/>
	• Side 2: standard base raceway accepts power and data cable distribution	36 x 40	USSFT3640	<input type="checkbox"/>	<input type="checkbox"/>	<input type="checkbox"/>	<input type="checkbox"/>	<input type="checkbox"/>	<input type="checkbox"/>	<input type="checkbox"/>	<input type="checkbox"/>
	• Includes segmented tiles with steel lower and fabric upper segments for both sides	42 x 40	USSFT4240	<input type="checkbox"/>	<input type="checkbox"/>	<input type="checkbox"/>	<input type="checkbox"/>	<input type="checkbox"/>	<input type="checkbox"/>	<input type="checkbox"/>	<input type="checkbox"/>
	• Panel assembly includes frame, trim, and panel-to-panel connectors	48 x 40	USSFT4840	<input type="checkbox"/>	<input type="checkbox"/>	<input type="checkbox"/>	<input type="checkbox"/>	<input type="checkbox"/>	<input type="checkbox"/>	<input type="checkbox"/>	<input type="checkbox"/>
	• Trim is metal and includes top cap, bottom trim channel, base raceway, and segment channel	60 x 40	USSFT6040	<input type="checkbox"/>	<input type="checkbox"/>	<input type="checkbox"/>	<input type="checkbox"/>	<input type="checkbox"/>	<input type="checkbox"/>	<input type="checkbox"/>	<input type="checkbox"/>
	• Side 1 and side 2 finishes are specified separately	72 x 40	USSFT7240	<input type="checkbox"/>	<input type="checkbox"/>	<input type="checkbox"/>	<input type="checkbox"/>	<input type="checkbox"/>	<input type="checkbox"/>	<input type="checkbox"/>	<input type="checkbox"/>
USFT	<b>Segmented Steel Panel - 48"H</b>	24 x 48	USSFT2448	<input type="checkbox"/>	<input type="checkbox"/>	<input type="checkbox"/>	<input type="checkbox"/>	<input type="checkbox"/>	<input type="checkbox"/>	<input type="checkbox"/>	<input type="checkbox"/>
		30 x 48	USSFT3048	<input type="checkbox"/>	<input type="checkbox"/>	<input type="checkbox"/>	<input type="checkbox"/>	<input type="checkbox"/>	<input type="checkbox"/>	<input type="checkbox"/>	<input type="checkbox"/>
		36 x 48	USSFT3648	<input type="checkbox"/>	<input type="checkbox"/>	<input type="checkbox"/>	<input type="checkbox"/>	<input type="checkbox"/>	<input type="checkbox"/>	<input type="checkbox"/>	<input type="checkbox"/>
		42 x 48	USSFT4248	<input type="checkbox"/>	<input type="checkbox"/>	<input type="checkbox"/>	<input type="checkbox"/>	<input type="checkbox"/>	<input type="checkbox"/>	<input type="checkbox"/>	<input type="checkbox"/>
		48 x 48	USSFT4848	<input type="checkbox"/>	<input type="checkbox"/>	<input type="checkbox"/>	<input type="checkbox"/>	<input type="checkbox"/>	<input type="checkbox"/>	<input type="checkbox"/>	<input type="checkbox"/>
		60 x 48	USSFT6048	<input type="checkbox"/>	<input type="checkbox"/>	<input type="checkbox"/>	<input type="checkbox"/>	<input type="checkbox"/>	<input type="checkbox"/>	<input type="checkbox"/>	<input type="checkbox"/>
		72 x 48	USSFT7248	<input type="checkbox"/>	<input type="checkbox"/>	<input type="checkbox"/>	<input type="checkbox"/>	<input type="checkbox"/>	<input type="checkbox"/>	<input type="checkbox"/>	<input type="checkbox"/>
USFT	<b>Segmented Steel Panel - 56"H</b>	24 x 56	USSFT2456	<input type="checkbox"/>	<input type="checkbox"/>	<input type="checkbox"/>	<input type="checkbox"/>	<input type="checkbox"/>	<input type="checkbox"/>	<input type="checkbox"/>	<input type="checkbox"/>
		30 x 56	USSFT3056	<input type="checkbox"/>	<input type="checkbox"/>	<input type="checkbox"/>	<input type="checkbox"/>	<input type="checkbox"/>	<input type="checkbox"/>	<input type="checkbox"/>	<input type="checkbox"/>
		36 x 56	USSFT3656	<input type="checkbox"/>	<input type="checkbox"/>	<input type="checkbox"/>	<input type="checkbox"/>	<input type="checkbox"/>	<input type="checkbox"/>	<input type="checkbox"/>	<input type="checkbox"/>
		42 x 56	USSFT4256	<input type="checkbox"/>	<input type="checkbox"/>	<input type="checkbox"/>	<input type="checkbox"/>	<input type="checkbox"/>	<input type="checkbox"/>	<input type="checkbox"/>	<input type="checkbox"/>
		48 x 56	USSFT4856	<input type="checkbox"/>	<input type="checkbox"/>	<input type="checkbox"/>	<input type="checkbox"/>	<input type="checkbox"/>	<input type="checkbox"/>	<input type="checkbox"/>	<input type="checkbox"/>
		60 x 56	USSFT6056	<input type="checkbox"/>	<input type="checkbox"/>	<input type="checkbox"/>	<input type="checkbox"/>	<input type="checkbox"/>	<input type="checkbox"/>	<input type="checkbox"/>	<input type="checkbox"/>
		72 x 56	USSFT7256	<input type="checkbox"/>	<input type="checkbox"/>	<input type="checkbox"/>	<input type="checkbox"/>	<input type="checkbox"/>	<input type="checkbox"/>	<input type="checkbox"/>	<input type="checkbox"/>

**A**   **B**   **C**   **D**   **E**   **F**   **G**   **H**

## HOW TO ORDER

Indicate the following information on order form:

- Quantity of each item.
- Model number, including options. See "How To Build a Model Number".
- Any special service required.

Note: • The  indicates that a choice is required.

- The absence of the  indicates that no choice is required.
- Alpha-numeric characters in place of  indicate that no other alternatives are available.

## HOW TO BUILD A MODEL NUMBER

**A** Select basic model.

**B** Select top cap style.

**F** - Flat trim (std)

**N** - No topcap

**C** Select electrical code.

**CP** - Chicago - with cutouts

**DN** - Domestic - no cutouts

**DP** - Domestic - with cutouts

**D** Select trim color.

Refer to color addendum at ki.com or KI Fabrics & Finishes binder.

**E** Select steel bottom color side 1.

Refer to color addendum at ki.com or KI Fabrics & Finishes binder.

**F** Select fabric side 1.

Refer to color addendum at ki.com or in KI Fabrics & Finishes binder.

**G** Select steel bottom color side 2.

Refer to color addendum at ki.com or KI Fabrics & Finishes binder.

**H** Select fabric side 2.

Refer to color addendum at ki.com or in KI Fabrics & Finishes binder.





# Preconfigured Segmented Steel Panels w/Fabric Top Tiles

Tile-to-Floor One Side; Standard Base Raceway One Side

Approx. Packaged Weight	Delivered Pricing Fabric Grade 1 & C.O.M.	Delivered Pricing Fabric Grade 2	Delivered Pricing Fabric Grade 3 & Pallas Vertical Fabric Grade PV	Delivered Pricing Pallas Vertical Fabric Grade PV1	Delivered Pricing Pallas Vertical Fabric Grade PV2
42.9#	\$ 504	\$ 517	\$ 526	\$ 545	\$ 565
49.4#	544	560	570	591	612
55.9#	583	597	610	632	653
62.5#	610	627	639	662	685
69.0#	663	682	694	721	746
82.1#	847	870	888	920	951
102.7#	1072	1103	1123	1165	1205
48.2#	\$ 537	\$ 554	\$ 563	\$ 585	\$ 606
55.2#	580	596	609	629	651
62.3#	620	639	650	675	697
69.4#	664	682	695	721	746
76.4#	717	736	750	778	804
90.6#	905	932	950	985	1018
113.5#	1149	1180	1204	1248	1292
52.5#	\$ 560	\$ 576	\$ 587	\$ 609	\$ 629
60.1#	612	629	641	664	688
67.7#	660	679	691	717	741
75.3#	716	734	749	777	803
82.9#	765	786	801	830	859
98.1#	924	951	967	1003	1038
123.4#	1225	1260	1283	1329	1376

## SPECIAL SERVICES

### Special Carton Marking

With specially marked information N/C

### Shipping

Delivered. Shipped **k.d. freight prepaid f.o.b. Manitowoc, Wisconsin 54220** factory. Freight class #70.

Specifications and prices are subject to change without prior notice.

# Preconfigured Segmented Steel Panels w/Fabric Top Tiles

Tile-to-Floor One Side; Standard Base Raceway One Side

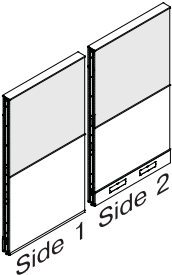
MODEL	W x H	MODEL NUMBER							
		Basic Model	Top Cap Style	Electrical Code	Trim Color	Steel Color Side 1	Fabric Side 1	Steel Color Side 2	Fabric Side 2
 <p>USFT</p> <p><b>Segmented Steel Panel - 64"H</b></p> <ul style="list-style-type: none"> <li>Side 1: tile-to-floor base does not accept cable distribution</li> <li>Side 2: standard base raceway accepts power and data cable distribution</li> <li>Includes segmented tiles with steel lower and fabric upper segments for both sides</li> <li>Panel assembly includes frame, trim, and panel-to-panel connectors</li> <li>Trim is metal and includes top cap, bottom trim channel, base raceway, and segment channel</li> <li>Side 1 and side 2 finishes are specified separately</li> <li>Side 2: 30-72" wide tiles feature two base and two beltway power knockouts</li> <li>Side 2: 24" wide tiles feature one base and one beltway power knockout</li> <li>72" wide panels feature split tiles</li> <li>Electrical components are specified separately</li> </ul>	24 x 64	USSFT2464	<input type="checkbox"/>	<input type="checkbox"/>	<input type="checkbox"/>	<input type="checkbox"/>	<input type="checkbox"/>	<input type="checkbox"/>	<input type="checkbox"/>
	30 x 64	USSFT3064	<input type="checkbox"/>	<input type="checkbox"/>	<input type="checkbox"/>	<input type="checkbox"/>	<input type="checkbox"/>	<input type="checkbox"/>	<input type="checkbox"/>
	36 x 64	USSFT3664	<input type="checkbox"/>	<input type="checkbox"/>	<input type="checkbox"/>	<input type="checkbox"/>	<input type="checkbox"/>	<input type="checkbox"/>	<input type="checkbox"/>
	42 x 64	USSFT4264	<input type="checkbox"/>	<input type="checkbox"/>	<input type="checkbox"/>	<input type="checkbox"/>	<input type="checkbox"/>	<input type="checkbox"/>	<input type="checkbox"/>
	48 x 64	USSFT4864	<input type="checkbox"/>	<input type="checkbox"/>	<input type="checkbox"/>	<input type="checkbox"/>	<input type="checkbox"/>	<input type="checkbox"/>	<input type="checkbox"/>
	60 x 64	USSFT6064	<input type="checkbox"/>	<input type="checkbox"/>	<input type="checkbox"/>	<input type="checkbox"/>	<input type="checkbox"/>	<input type="checkbox"/>	<input type="checkbox"/>
	72 x 64	USSFT7264	<input type="checkbox"/>	<input type="checkbox"/>	<input type="checkbox"/>	<input type="checkbox"/>	<input type="checkbox"/>	<input type="checkbox"/>	<input type="checkbox"/>

**A**   **B**   **C**   **D**   **E**   **F**   **G**   **H**

## HOW TO ORDER

Indicate the following information on order form:

- Quantity of each item.
- Model number, including options. See "How To Build a Model Number".
- Any special service required.

Note: • The  indicates that a choice is required.

- The absence of the  indicates that no choice is required.
- Alpha-numeric characters in place of  indicate that no other alternatives are available.

## HOW TO BUILD A MODEL NUMBER

**A** Select basic model.

**B** Select top cap style.

**F** - Flat trim (std)

**N** - No topcap

**C** Select electrical code.

**CP** - Chicago - with cutouts

**DN** - Domestic - no cutouts

**DP** - Domestic - with cutouts

**D** Select trim color.

Refer to color addendum at ki.com or KI Fabrics & Finishes binder.

**E** Select steel bottom color side 1.

Refer to color addendum at ki.com or KI Fabrics & Finishes binder.

**F** Select fabric side 1.

Refer to color addendum at ki.com or in KI Fabrics & Finishes binder.

**G** Select steel bottom color side 2.

Refer to color addendum at ki.com or KI Fabrics & Finishes binder.

**H** Select fabric side 2.

Refer to color addendum at ki.com or in KI Fabrics & Finishes binder.



# Preconfigured Segmented Steel Panels w/Fabric Top Tiles

Tile-to-Floor One Side; Standard Base Raceway One Side

Approx. Packaged Weight	Delivered Pricing Fabric Grade 1 & C.O.M.	Delivered Pricing Fabric Grade 2	Delivered Pricing Fabric Grade 3 & Pallas Vertical Fabric Grade PV	Delivered Pricing Pallas Vertical Fabric Grade PV1	Delivered Pricing Pallas Vertical Fabric Grade PV2
56.9#	\$ 596	\$ 615	\$ 626	\$ 648	\$ 673
65.0#	675	694	706	732	758
73.1#	735	757	773	800	828
81.2#	762	784	799	828	857
89.3#	819	843	858	889	920
105.6#	1005	1035	1054	1092	1130
133.2#	1377	1417	1443	1495	1547

**SPECIAL SERVICES**

**Special Carton Marking**

With specially marked information N/C

**Shipping**

Shipped k.d. freight prepaid f.o.b. Manitowoc, Wisconsin 54220 factory. Freight class #70.

Specifications and prices are subject to change without prior notice.

# Preconfigured Segmented Steel Panels w/Fabric Top Tiles Beltway/Power

Standard Base Raceway

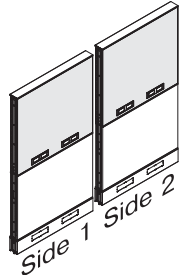

USFR

**MODEL**

**W x H**

- Segmented Steel Panel - 40"H**
- Includes segmented tiles with steel lower and fabric upper segments for both sides
  - Standard base raceway on both sides accepts power and data cable distribution
  - Above worksurface beltway on both sides accepts power and data cable distribution
  - Panel assembly includes frame, trim, and panel-to-panel connectors
  - Trim is metal and includes top cap, bottom trim channel, base raceway, and segment channel
  - Side 1 and side 2 finishes are specified separately
  - 30-72" wide panels each feature two power knockouts at base and two knockouts with bezels at beltway per side
  - 24" wide panels each feature one power knockout and one knockout with bezel at beltway per side
  - 72" wide panels feature split tiles
  - Electrical components are specified separately

**MODEL NUMBER**

Basic Model	Top Cap Style	Electrical Code	Bezel Color	Trim Color	Steel Color Side 1	Fabric Side 1	Steel Color Side 2	Fabric Side 2
USSFRBW2440	<input type="checkbox"/>	<input type="checkbox"/>	<input type="checkbox"/>	<input type="checkbox"/>	<input type="checkbox"/>	<input type="checkbox"/>	<input type="checkbox"/>	<input type="checkbox"/>
USSFRBW3040	<input type="checkbox"/>	<input type="checkbox"/>	<input type="checkbox"/>	<input type="checkbox"/>	<input type="checkbox"/>	<input type="checkbox"/>	<input type="checkbox"/>	<input type="checkbox"/>
USSFRBW3640	<input type="checkbox"/>	<input type="checkbox"/>	<input type="checkbox"/>	<input type="checkbox"/>	<input type="checkbox"/>	<input type="checkbox"/>	<input type="checkbox"/>	<input type="checkbox"/>
USSFRBW4240	<input type="checkbox"/>	<input type="checkbox"/>	<input type="checkbox"/>	<input type="checkbox"/>	<input type="checkbox"/>	<input type="checkbox"/>	<input type="checkbox"/>	<input type="checkbox"/>
USSFRBW4840	<input type="checkbox"/>	<input type="checkbox"/>	<input type="checkbox"/>	<input type="checkbox"/>	<input type="checkbox"/>	<input type="checkbox"/>	<input type="checkbox"/>	<input type="checkbox"/>
USSFRBW6040	<input type="checkbox"/>	<input type="checkbox"/>	<input type="checkbox"/>	<input type="checkbox"/>	<input type="checkbox"/>	<input type="checkbox"/>	<input type="checkbox"/>	<input type="checkbox"/>
USSFRBW7240	<input type="checkbox"/>	<input type="checkbox"/>	<input type="checkbox"/>	<input type="checkbox"/>	<input type="checkbox"/>	<input type="checkbox"/>	<input type="checkbox"/>	<input type="checkbox"/>

**A B C D E F G H I**

**HOW TO ORDER**

Indicate the following information on order form:

1. Quantity of each item.
2. Model number, including options. See "How To Build a Model Number".
3. Any special service required.

Note: • The  indicates that a choice is required.

- The absence of the  indicates that no choice is required.
- Alpha-numeric characters in place of  indicate that no other alternatives are available.

**HOW TO BUILD A MODEL NUMBER**

**A** Select basic model.

**B** Select top cap style.  
**F** - Flat trim (std)  
**N** - No topcap

**C** Select electrical code.  
**DP** - Domestic - with cutouts  
**DT** - Domestic, 1 side w/cutouts

**D** Select bezel color.  
 Refer to color addendum at ki.com or KI Fabrics & Finishes binder.

**E** Select trim color.  
 Refer to color addendum at ki.com or KI Fabrics & Finishes binder.

**F** Select steel bottom color side 1.  
 Refer to color addendum at ki.com or KI Fabrics & Finishes binder.

**G** Select fabric side 1.  
 Refer to color addendum at ki.com or in KI Fabrics & Finishes binder.

**H** Select steel bottom color side 2.  
 Refer to color addendum at ki.com or KI Fabrics & Finishes binder.

**I** Select fabric side 2.  
 Refer to color addendum at ki.com or in KI Fabrics & Finishes binder.

# Preconfigured Segmented Steel Panels w/Fabric Top Tiles Beltway/Power

Standard Base Raceway

Approx. Packaged Weight	Delivered Pricing Fabric Grade 1 & C.O.M.	Delivered Pricing Fabric Grade 2	Delivered Pricing Fabric Grade 3 & Pallas Vertical Fabric Grade PV	Delivered Pricing Pallas Vertical Fabric Grade PV1	Delivered Pricing Pallas Vertical Fabric Grade PV2
43.7#	\$ 524	\$ 539	\$ 549	\$ 569	\$ 589
50.4#	587	605	615	638	660
57.1#	621	640	650	675	697
64.0#	648	668	680	703	729
70.7#	699	721	733	760	786
84.3#	890	914	931	964	999
105.3#	1155	1188	1209	1254	1297

## SPECIAL SERVICES

### Special Carton Marking

With specially marked information N/C

### Shipping

Delivered. Shipped **k.d. freight prepaid f.o.b. Manitowoc, Wisconsin 54220** factory. Freight class #70.

Specifications and prices are subject to change without prior notice.

# Preconfigured Segmented Steel Panels w/Fabric Top Tiles Beltway/Power

Standard Base Raceway

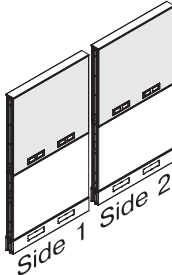
MODEL	W x H	MODEL NUMBER									
		Basic Model	Top Cap Style	Electrical Code	Bezel Color	Trim Color	Steel Color Side 1	Fabric Side 1	Steel Color Side 2	Fabric Side 2	
	<b>Segmented Steel Panel - 48"H</b>										
	24 x 48	USSFRBW2448	<input type="checkbox"/>	<input type="checkbox"/>	<input type="checkbox"/>	<input type="checkbox"/>	<input type="checkbox"/>	<input type="checkbox"/>	<input type="checkbox"/>	<input type="checkbox"/>	<input type="checkbox"/>
	30 x 48	USSFRBW3048	<input type="checkbox"/>	<input type="checkbox"/>	<input type="checkbox"/>	<input type="checkbox"/>	<input type="checkbox"/>	<input type="checkbox"/>	<input type="checkbox"/>	<input type="checkbox"/>	<input type="checkbox"/>
	36 x 48	USSFRBW3648	<input type="checkbox"/>	<input type="checkbox"/>	<input type="checkbox"/>	<input type="checkbox"/>	<input type="checkbox"/>	<input type="checkbox"/>	<input type="checkbox"/>	<input type="checkbox"/>	<input type="checkbox"/>
	42 x 48	USSFRBW4248	<input type="checkbox"/>	<input type="checkbox"/>	<input type="checkbox"/>	<input type="checkbox"/>	<input type="checkbox"/>	<input type="checkbox"/>	<input type="checkbox"/>	<input type="checkbox"/>	<input type="checkbox"/>
	48 x 48	USSFRBW4848	<input type="checkbox"/>	<input type="checkbox"/>	<input type="checkbox"/>	<input type="checkbox"/>	<input type="checkbox"/>	<input type="checkbox"/>	<input type="checkbox"/>	<input type="checkbox"/>	<input type="checkbox"/>
	60 x 48	USSFRBW6048	<input type="checkbox"/>	<input type="checkbox"/>	<input type="checkbox"/>	<input type="checkbox"/>	<input type="checkbox"/>	<input type="checkbox"/>	<input type="checkbox"/>	<input type="checkbox"/>	<input type="checkbox"/>
72 x 48	USSFRBW7248	<input type="checkbox"/>	<input type="checkbox"/>	<input type="checkbox"/>	<input type="checkbox"/>	<input type="checkbox"/>	<input type="checkbox"/>	<input type="checkbox"/>	<input type="checkbox"/>	<input type="checkbox"/>	
USFR											
USFR	<b>Segmented Steel Panel - 56"H</b>										
	24 x 56	USSFRBW2456	<input type="checkbox"/>	<input type="checkbox"/>	<input type="checkbox"/>	<input type="checkbox"/>	<input type="checkbox"/>	<input type="checkbox"/>	<input type="checkbox"/>	<input type="checkbox"/>	<input type="checkbox"/>
	30 x 56	USSFRBW3056	<input type="checkbox"/>	<input type="checkbox"/>	<input type="checkbox"/>	<input type="checkbox"/>	<input type="checkbox"/>	<input type="checkbox"/>	<input type="checkbox"/>	<input type="checkbox"/>	<input type="checkbox"/>
	36 x 56	USSFRBW3656	<input type="checkbox"/>	<input type="checkbox"/>	<input type="checkbox"/>	<input type="checkbox"/>	<input type="checkbox"/>	<input type="checkbox"/>	<input type="checkbox"/>	<input type="checkbox"/>	<input type="checkbox"/>
	42 x 56	USSFRBW4256	<input type="checkbox"/>	<input type="checkbox"/>	<input type="checkbox"/>	<input type="checkbox"/>	<input type="checkbox"/>	<input type="checkbox"/>	<input type="checkbox"/>	<input type="checkbox"/>	<input type="checkbox"/>
	48 x 56	USSFRBW4856	<input type="checkbox"/>	<input type="checkbox"/>	<input type="checkbox"/>	<input type="checkbox"/>	<input type="checkbox"/>	<input type="checkbox"/>	<input type="checkbox"/>	<input type="checkbox"/>	<input type="checkbox"/>
	60 x 56	USSFRBW6056	<input type="checkbox"/>	<input type="checkbox"/>	<input type="checkbox"/>	<input type="checkbox"/>	<input type="checkbox"/>	<input type="checkbox"/>	<input type="checkbox"/>	<input type="checkbox"/>	<input type="checkbox"/>
72 x 56	USSFRBW7256	<input type="checkbox"/>	<input type="checkbox"/>	<input type="checkbox"/>	<input type="checkbox"/>	<input type="checkbox"/>	<input type="checkbox"/>	<input type="checkbox"/>	<input type="checkbox"/>	<input type="checkbox"/>	
USFR	<b>Segmented Steel Panel - 64"H</b>										
	24 x 64	USSFRBW2464	<input type="checkbox"/>	<input type="checkbox"/>	<input type="checkbox"/>	<input type="checkbox"/>	<input type="checkbox"/>	<input type="checkbox"/>	<input type="checkbox"/>	<input type="checkbox"/>	<input type="checkbox"/>
	30 x 64	USSFRBW3064	<input type="checkbox"/>	<input type="checkbox"/>	<input type="checkbox"/>	<input type="checkbox"/>	<input type="checkbox"/>	<input type="checkbox"/>	<input type="checkbox"/>	<input type="checkbox"/>	<input type="checkbox"/>
	36 x 64	USSFRBW3664	<input type="checkbox"/>	<input type="checkbox"/>	<input type="checkbox"/>	<input type="checkbox"/>	<input type="checkbox"/>	<input type="checkbox"/>	<input type="checkbox"/>	<input type="checkbox"/>	<input type="checkbox"/>
	42 x 64	USSFRBW4264	<input type="checkbox"/>	<input type="checkbox"/>	<input type="checkbox"/>	<input type="checkbox"/>	<input type="checkbox"/>	<input type="checkbox"/>	<input type="checkbox"/>	<input type="checkbox"/>	<input type="checkbox"/>
	48 x 64	USSFRBW4864	<input type="checkbox"/>	<input type="checkbox"/>	<input type="checkbox"/>	<input type="checkbox"/>	<input type="checkbox"/>	<input type="checkbox"/>	<input type="checkbox"/>	<input type="checkbox"/>	<input type="checkbox"/>
	60 x 64	USSFRBW6064	<input type="checkbox"/>	<input type="checkbox"/>	<input type="checkbox"/>	<input type="checkbox"/>	<input type="checkbox"/>	<input type="checkbox"/>	<input type="checkbox"/>	<input type="checkbox"/>	<input type="checkbox"/>
72 x 64	USSFRBW7264	<input type="checkbox"/>	<input type="checkbox"/>	<input type="checkbox"/>	<input type="checkbox"/>	<input type="checkbox"/>	<input type="checkbox"/>	<input type="checkbox"/>	<input type="checkbox"/>	<input type="checkbox"/>	

**A**   **B**   **C**   **D**   **E**   **F**   **G**   **H**   **I**

## HOW TO ORDER

Indicate the following information on order form:

- Quantity of each item.
- Model number, including options. See "How To Build a Model Number".
- Any special service required.

Note: • The  indicates that a choice is required.

- The absence of the  indicates that no choice is required.
- Alpha-numeric characters in place of  indicate that no other alternatives are available.

## HOW TO BUILD A MODEL NUMBER

**A** Select basic model.

**B** Select top cap style.

**F** - Flat trim (std)

**N** - No topcap

**C** Select electrical code.

**DP** - Domestic - with cutouts

**D1** - Domestic, 1 side w/cutouts

**D** Select bezel color.

Refer to color addendum at ki.com or KI Fabrics & Finishes binder.

**E** Select trim color.

Refer to color addendum at ki.com or KI Fabrics & Finishes binder.

**F** Select steel bottom color side 1.

Refer to color addendum at ki.com or KI Fabrics & Finishes binder.

**G** Select fabric side 1.

Refer to color addendum at ki.com or in KI Fabrics & Finishes binder.

**H** Select steel bottom color side 2.

Refer to color addendum at ki.com or KI Fabrics & Finishes binder.

**I** Select fabric side 2.

Refer to color addendum at ki.com or in KI Fabrics & Finishes binder.



# Preconfigured Segmented Steel Panels w/Fabric Top Tiles Beltway/Power

Standard Base Raceway

Approx. Packaged Weight	Delivered Pricing Fabric Grade 1 & C.O.M.	Delivered Pricing Fabric Grade 2	Delivered Pricing Fabric Grade 3 & Pallas Vertical Fabric Grade PV	Delivered Pricing Pallas Vertical Fabric Grade PV1	Delivered Pricing Pallas Vertical Fabric Grade PV2
49.0#	\$ 554	\$ 569	\$ 580	\$ 599	\$ 621
56.2#	619	638	648	674	696
63.5#	660	679	691	718	741
70.8#	705	726	739	766	792
78.1#	755	778	791	820	849
92.8#	948	975	992	1029	1064
116.1#	1228	1263	1285	1333	1379
53.3#	\$ 582	\$ 597	\$ 610	\$ 631	\$ 652
61.1#	651	671	682	707	732
68.9#	700	722	734	762	788
76.8#	754	777	789	819	848
84.6#	808	830	846	876	906
100.3#	964	992	1010	1046	1085
126.0#	1304	1341	1366	1416	1465
57.7#	\$ 619	\$ 637	\$ 648	\$ 673	\$ 695
66.0#	716	734	748	776	802
74.3#	777	797	812	843	871
82.7#	802	824	840	870	900
91.1#	859	885	900	933	964
107.8#	1051	1082	1101	1142	1180
135.8#	1456	1498	1524	1580	1636

**SPECIAL SERVICES**

**Special Carton Marking**

With specially marked information N/C

**Shipping**

Shipped k.d. freight prepaid f.o.b. Manitowoc, Wisconsin 54220 factory. Freight class #70.

Specifications and prices are subject to change without prior notice.

# Preconfigured Segmented Steel Panels w/Fabric Top Tiles Beltway/Power

Elevated Base

MODEL	W x H	MODEL NUMBER									
		Basic Model	Top Cap Style	Electrical Code	Bezel Color	Trim Color	Steel Color Side 1	Fabric Side 1	Steel Color Side 2	Fabric Side 2	
<b>Segmented Steel Panel - 40"H</b> • Includes segmented tiles with steel lower and fabric upper segments for both sides • 30-72" wide tiles each feature two power knockouts with bezels at above-worksurface beltway • 24" wide tiles each feature one power knockout with bezel at above-worksurface beltway • Elevated base does not accept cable distribution • Panel assembly includes frame, trim, and panel-to-panel connectors • Trim is metal and includes top cap, bottom trim channel, segment channel and foot shroud • Side 1 and side 2 finishes are specified separately • 72" wide panels feature split tiles	24 x 40	USSFLBW2440	<input type="checkbox"/>	<input type="checkbox"/>	<input type="checkbox"/>	<input type="checkbox"/>	<input type="checkbox"/>	<input type="checkbox"/>	<input type="checkbox"/>	<input type="checkbox"/>	<input type="checkbox"/>
	30 x 40	USSFLBW3040	<input type="checkbox"/>	<input type="checkbox"/>	<input type="checkbox"/>	<input type="checkbox"/>	<input type="checkbox"/>	<input type="checkbox"/>	<input type="checkbox"/>	<input type="checkbox"/>	<input type="checkbox"/>
	36 x 40	USSFLBW3640	<input type="checkbox"/>	<input type="checkbox"/>	<input type="checkbox"/>	<input type="checkbox"/>	<input type="checkbox"/>	<input type="checkbox"/>	<input type="checkbox"/>	<input type="checkbox"/>	<input type="checkbox"/>
	42 x 40	USSFLBW4240	<input type="checkbox"/>	<input type="checkbox"/>	<input type="checkbox"/>	<input type="checkbox"/>	<input type="checkbox"/>	<input type="checkbox"/>	<input type="checkbox"/>	<input type="checkbox"/>	<input type="checkbox"/>
	48 x 40	USSFLBW4840	<input type="checkbox"/>	<input type="checkbox"/>	<input type="checkbox"/>	<input type="checkbox"/>	<input type="checkbox"/>	<input type="checkbox"/>	<input type="checkbox"/>	<input type="checkbox"/>	<input type="checkbox"/>
	60 x 40	USSFLBW6040	<input type="checkbox"/>	<input type="checkbox"/>	<input type="checkbox"/>	<input type="checkbox"/>	<input type="checkbox"/>	<input type="checkbox"/>	<input type="checkbox"/>	<input type="checkbox"/>	<input type="checkbox"/>
	72 x 40	USSFLBW7240	<input type="checkbox"/>	<input type="checkbox"/>	<input type="checkbox"/>	<input type="checkbox"/>	<input type="checkbox"/>	<input type="checkbox"/>	<input type="checkbox"/>	<input type="checkbox"/>	<input type="checkbox"/>

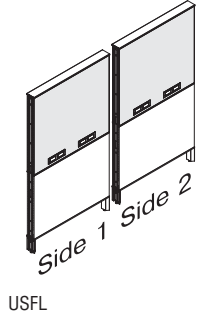

**A**   **B**   **C**   **D**   **E**   **F**   **G**   **H**   **I**

## HOW TO ORDER

Indicate the following information on order form:

1. Quantity of each item.
2. Model number, including options. See "How To Build a Model Number".
3. Any special service required.

Note: • The  indicates that a choice is required.

- The absence of the  indicates that no choice is required.
- Alpha-numeric characters in place of  indicate that no other alternatives are available.

## HOW TO BUILD A MODEL NUMBER

- A** Select basic model.
- B** Select top cap style.  

<b>F</b> _____	- Flat trim (std)
<b>N</b> _____	- No topcap
- C** Select electrical code.  

<b>DP</b> _____	- Domestic - with cutouts
-----------------	---------------------------
- D** Select bezel color.  
Refer to color addendum at ki.com or KI Fabrics & Finishes binder.
- E** Select trim color.  
Refer to color addendum at ki.com or KI Fabrics & Finishes binder.
- F** Select steel bottom color side 1.  
Refer to color addendum at ki.com or KI Fabrics & Finishes binder.
- G** Select fabric side 1.  
Refer to color addendum at ki.com or in KI Fabrics & Finishes binder.
- H** Select steel bottom color side 2.  
Refer to color addendum at ki.com or KI Fabrics & Finishes binder.
- I** Select fabric side 2.  
Refer to color addendum at ki.com or in KI Fabrics & Finishes binder.



# KI Preconfigured Segmented Steel Panels w/Fabric Top Tiles Beltway/Power

Elevated Base

Approx. Packaged Weight	Delivered Pricing Fabric Grade 1 & C.O.M.	Delivered Pricing Fabric Grade 2	Delivered Pricing Fabric Grade 3 & Pallas Vertical Fabric Grade PV	Delivered Pricing Pallas Vertical Fabric Grade PV1	Delivered Pricing Pallas Vertical Fabric Grade PV2
41.4#	\$ 524	\$ 539	\$ 549	\$ 569	\$ 589
47.4#	587	605	615	638	660
53.4#	621	640	650	675	697
59.4#	648	668	680	703	729
65.4#	699	721	733	760	786
77.3#	890	914	931	964	999
96.7#	1155	1188	1209	1254	1297

### SPECIAL SERVICES

#### Special Carton Marking

With specially marked information N/C

#### Shipping

Delivered. Shipped **k.d. freight prepaid f.o.b. Manitowoc, Wisconsin 54220** factory. Freight class #70.

Specifications and prices are subject to change without prior notice.

# Preconfigured Segmented Steel Panels w/Fabric Top Tiles Beltway/Power

Elevated Base

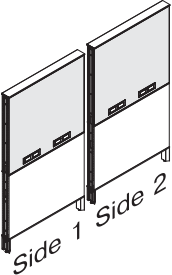
MODEL	W x H	MODEL NUMBER											
		Basic Model	Top Cap Style	Electrical Code	Bezel Color	Trim Color	Steel Color Side 1	Fabric Side 1	Steel Color Side 2	Fabric Side 2			
	<b>Segmented Steel Panel - 48"H</b>		24 x 48	USSFLBW2448	<input type="checkbox"/>	<input type="checkbox"/>	<input type="checkbox"/>	<input type="checkbox"/>	<input type="checkbox"/>	<input type="checkbox"/>	<input type="checkbox"/>	<input type="checkbox"/>	<input type="checkbox"/>
	30 x 48	USSFLBW3048	<input type="checkbox"/>	<input type="checkbox"/>	<input type="checkbox"/>	<input type="checkbox"/>	<input type="checkbox"/>	<input type="checkbox"/>	<input type="checkbox"/>	<input type="checkbox"/>	<input type="checkbox"/>	<input type="checkbox"/>	<input type="checkbox"/>
	36 x 48	USSFLBW3648	<input type="checkbox"/>	<input type="checkbox"/>	<input type="checkbox"/>	<input type="checkbox"/>	<input type="checkbox"/>	<input type="checkbox"/>	<input type="checkbox"/>	<input type="checkbox"/>	<input type="checkbox"/>	<input type="checkbox"/>	<input type="checkbox"/>
	42 x 48	USSFLBW4248	<input type="checkbox"/>	<input type="checkbox"/>	<input type="checkbox"/>	<input type="checkbox"/>	<input type="checkbox"/>	<input type="checkbox"/>	<input type="checkbox"/>	<input type="checkbox"/>	<input type="checkbox"/>	<input type="checkbox"/>	<input type="checkbox"/>
	48 x 48	USSFLBW4848	<input type="checkbox"/>	<input type="checkbox"/>	<input type="checkbox"/>	<input type="checkbox"/>	<input type="checkbox"/>	<input type="checkbox"/>	<input type="checkbox"/>	<input type="checkbox"/>	<input type="checkbox"/>	<input type="checkbox"/>	<input type="checkbox"/>
	60 x 48	USSFLBW6048	<input type="checkbox"/>	<input type="checkbox"/>	<input type="checkbox"/>	<input type="checkbox"/>	<input type="checkbox"/>	<input type="checkbox"/>	<input type="checkbox"/>	<input type="checkbox"/>	<input type="checkbox"/>	<input type="checkbox"/>	<input type="checkbox"/>
	72 x 48	USSFLBW7248	<input type="checkbox"/>	<input type="checkbox"/>	<input type="checkbox"/>	<input type="checkbox"/>	<input type="checkbox"/>	<input type="checkbox"/>	<input type="checkbox"/>	<input type="checkbox"/>	<input type="checkbox"/>	<input type="checkbox"/>	<input type="checkbox"/>
	USFL												
USFL	<b>Segmented Steel Panel - 56"H</b>		24 x 56	USSFLBW2456	<input type="checkbox"/>	<input type="checkbox"/>	<input type="checkbox"/>	<input type="checkbox"/>	<input type="checkbox"/>	<input type="checkbox"/>	<input type="checkbox"/>	<input type="checkbox"/>	<input type="checkbox"/>
	30 x 56	USSFLBW3056	<input type="checkbox"/>	<input type="checkbox"/>	<input type="checkbox"/>	<input type="checkbox"/>	<input type="checkbox"/>	<input type="checkbox"/>	<input type="checkbox"/>	<input type="checkbox"/>	<input type="checkbox"/>	<input type="checkbox"/>	<input type="checkbox"/>
	36 x 56	USSFLBW3656	<input type="checkbox"/>	<input type="checkbox"/>	<input type="checkbox"/>	<input type="checkbox"/>	<input type="checkbox"/>	<input type="checkbox"/>	<input type="checkbox"/>	<input type="checkbox"/>	<input type="checkbox"/>	<input type="checkbox"/>	<input type="checkbox"/>
	42 x 56	USSFLBW4256	<input type="checkbox"/>	<input type="checkbox"/>	<input type="checkbox"/>	<input type="checkbox"/>	<input type="checkbox"/>	<input type="checkbox"/>	<input type="checkbox"/>	<input type="checkbox"/>	<input type="checkbox"/>	<input type="checkbox"/>	<input type="checkbox"/>
	48 x 56	USSFLBW4856	<input type="checkbox"/>	<input type="checkbox"/>	<input type="checkbox"/>	<input type="checkbox"/>	<input type="checkbox"/>	<input type="checkbox"/>	<input type="checkbox"/>	<input type="checkbox"/>	<input type="checkbox"/>	<input type="checkbox"/>	<input type="checkbox"/>
	60 x 56	USSFLBW6056	<input type="checkbox"/>	<input type="checkbox"/>	<input type="checkbox"/>	<input type="checkbox"/>	<input type="checkbox"/>	<input type="checkbox"/>	<input type="checkbox"/>	<input type="checkbox"/>	<input type="checkbox"/>	<input type="checkbox"/>	<input type="checkbox"/>
	72 x 56	USSFLBW7256	<input type="checkbox"/>	<input type="checkbox"/>	<input type="checkbox"/>	<input type="checkbox"/>	<input type="checkbox"/>	<input type="checkbox"/>	<input type="checkbox"/>	<input type="checkbox"/>	<input type="checkbox"/>	<input type="checkbox"/>	<input type="checkbox"/>
	USFL												
USFL	<b>Segmented Steel Panel - 64"H</b>		24 x 64	USSFLBW2464	<input type="checkbox"/>	<input type="checkbox"/>	<input type="checkbox"/>	<input type="checkbox"/>	<input type="checkbox"/>	<input type="checkbox"/>	<input type="checkbox"/>	<input type="checkbox"/>	<input type="checkbox"/>
	30 x 64	USSFLBW3064	<input type="checkbox"/>	<input type="checkbox"/>	<input type="checkbox"/>	<input type="checkbox"/>	<input type="checkbox"/>	<input type="checkbox"/>	<input type="checkbox"/>	<input type="checkbox"/>	<input type="checkbox"/>	<input type="checkbox"/>	<input type="checkbox"/>
	36 x 64	USSFLBW3664	<input type="checkbox"/>	<input type="checkbox"/>	<input type="checkbox"/>	<input type="checkbox"/>	<input type="checkbox"/>	<input type="checkbox"/>	<input type="checkbox"/>	<input type="checkbox"/>	<input type="checkbox"/>	<input type="checkbox"/>	<input type="checkbox"/>
	42 x 64	USSFLBW4264	<input type="checkbox"/>	<input type="checkbox"/>	<input type="checkbox"/>	<input type="checkbox"/>	<input type="checkbox"/>	<input type="checkbox"/>	<input type="checkbox"/>	<input type="checkbox"/>	<input type="checkbox"/>	<input type="checkbox"/>	<input type="checkbox"/>
	48 x 64	USSFLBW4864	<input type="checkbox"/>	<input type="checkbox"/>	<input type="checkbox"/>	<input type="checkbox"/>	<input type="checkbox"/>	<input type="checkbox"/>	<input type="checkbox"/>	<input type="checkbox"/>	<input type="checkbox"/>	<input type="checkbox"/>	<input type="checkbox"/>
	60 x 64	USSFLBW6064	<input type="checkbox"/>	<input type="checkbox"/>	<input type="checkbox"/>	<input type="checkbox"/>	<input type="checkbox"/>	<input type="checkbox"/>	<input type="checkbox"/>	<input type="checkbox"/>	<input type="checkbox"/>	<input type="checkbox"/>	<input type="checkbox"/>
	72 x 64	USSFLBW7264	<input type="checkbox"/>	<input type="checkbox"/>	<input type="checkbox"/>	<input type="checkbox"/>	<input type="checkbox"/>	<input type="checkbox"/>	<input type="checkbox"/>	<input type="checkbox"/>	<input type="checkbox"/>	<input type="checkbox"/>	<input type="checkbox"/>

**A**   **B**   **C**   **D**   **E**   **F**   **G**   **H**   **I**

## HOW TO ORDER

Indicate the following information on order form:

- Quantity of each item.
- Model number, including options. See "How To Build a Model Number".
- Any special service required.

Note: • The  indicates that a choice is required.

- The absence of the  indicates that no choice is required.
- Alpha-numeric characters in place of  indicate that no other alternatives are available.

## HOW TO BUILD A MODEL NUMBER

- A** Select basic model.
- B** Select top cap style.  

<b>F</b>	- Flat trim (std)
<b>N</b>	- No topcap
- C** Select electrical code.  

<b>DP</b>	- Domestic - with cutouts
-----------	---------------------------
- D** Select bezel color.  
Refer to color addendum at ki.com or KI Fabrics & Finishes binder.
- E** Select trim color.  
Refer to color addendum at ki.com or KI Fabrics & Finishes binder.
- F** Select steel bottom color side 1.  
Refer to color addendum at ki.com or KI Fabrics & Finishes binder.
- G** Select fabric side 1.  
Refer to color addendum at ki.com or in KI Fabrics & Finishes binder.
- H** Select steel bottom color side 2.  
Refer to color addendum at ki.com or KI Fabrics & Finishes binder.
- I** Select fabric side 2.  
Refer to color addendum at ki.com or in KI Fabrics & Finishes binder.

# Preconfigured Segmented Steel Panels w/Fabric Top Tiles Beltway/Power

Elevated Base

Approx. Packaged Weight	Delivered Pricing Fabric Grade 1 & C.O.M.	Delivered Pricing Fabric Grade 2	Delivered Pricing Fabric Grade 3 & Pallas Vertical Fabric Grade PV	Delivered Pricing Pallas Vertical Fabric Grade PV1	Delivered Pricing Pallas Vertical Fabric Grade PV2
46.7#	\$ 554	\$ 569	\$ 580	\$ 599	\$ 621
53.3#	619	638	648	674	696
59.7#	660	679	691	718	741
66.3#	705	726	739	766	792
72.8#	755	778	791	820	849
85.8#	948	975	992	1029	1064
107.6#	1228	1263	1285	1333	1379
51.1#	\$ 582	\$ 597	\$ 610	\$ 631	\$ 652
58.1#	651	671	682	707	732
65.1#	700	722	734	762	788
72.2#	754	777	789	819	848
79.2#	808	830	846	876	906
93.3#	964	992	1010	1046	1085
117.4#	1304	1341	1366	1416	1465
55.4#	\$ 619	\$ 637	\$ 648	\$ 673	\$ 695
63.0#	716	734	748	776	802
70.5#	777	797	812	843	871
78.1#	802	824	840	870	900
85.7#	859	885	900	933	964
100.8#	1051	1082	1101	1142	1180
127.2#	1456	1498	1524	1580	1636

## SPECIAL SERVICES

### Special Carton Marking

With specially marked information N/C

### Shipping

Shipped k.d. freight prepaid f.o.b. Manitowoc, Wisconsin 54220 factory. Freight class #70.

Specifications and prices are subject to change without prior notice.

# Preconfigured Segmented Steel Panels w/Fabric Top Tiles Beltway/Power

Tile-to-Floor One Side; Standard Base Raceway One Side

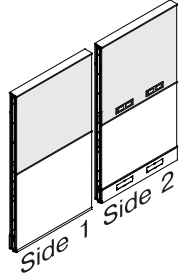

USFT

**MODEL**

**W x H**

- Segmented Steel Panel - 40"H**
- Side 1: tile-to-floor base does not accept cable distribution at base or beltway
  - Side 2: standard base raceway and above-worksurface beltway power accept cable distribution
  - Includes segmented tiles with steel lower and fabric upper segments for both sides
  - Panel assembly includes frame, trim, and panel-to-panel connectors
  - Trim is metal and includes top cap, bottom trim channel, base raceway, and segment channel
  - Side 1 and side 2 finishes are specified separately
  - Side 2: 30-72" wide tiles feature two base and two beltway power knockouts
  - Side 2: 24" wide tiles feature one base and one beltway power knockout
  - 72" wide panels feature split tiles
  - Electrical components are specified separately

**MODEL NUMBER**

Basic Model	Top Cap Style	Electrical Code	Bezel Color	Trim Color	Steel Color Side 1	Fabric Side 1	Steel Color Side 2	Fabric Side 2
USSFTBW2440	<input type="checkbox"/>	<input type="checkbox"/>	<input type="checkbox"/>	<input type="checkbox"/>	<input type="checkbox"/>	<input type="checkbox"/>	<input type="checkbox"/>	<input type="checkbox"/>
USSFTBW3040	<input type="checkbox"/>	<input type="checkbox"/>	<input type="checkbox"/>	<input type="checkbox"/>	<input type="checkbox"/>	<input type="checkbox"/>	<input type="checkbox"/>	<input type="checkbox"/>
USSFTBW3640	<input type="checkbox"/>	<input type="checkbox"/>	<input type="checkbox"/>	<input type="checkbox"/>	<input type="checkbox"/>	<input type="checkbox"/>	<input type="checkbox"/>	<input type="checkbox"/>
USSFTBW4240	<input type="checkbox"/>	<input type="checkbox"/>	<input type="checkbox"/>	<input type="checkbox"/>	<input type="checkbox"/>	<input type="checkbox"/>	<input type="checkbox"/>	<input type="checkbox"/>
USSFTBW4840	<input type="checkbox"/>	<input type="checkbox"/>	<input type="checkbox"/>	<input type="checkbox"/>	<input type="checkbox"/>	<input type="checkbox"/>	<input type="checkbox"/>	<input type="checkbox"/>
USSFTBW6040	<input type="checkbox"/>	<input type="checkbox"/>	<input type="checkbox"/>	<input type="checkbox"/>	<input type="checkbox"/>	<input type="checkbox"/>	<input type="checkbox"/>	<input type="checkbox"/>
USSFTBW7240	<input type="checkbox"/>	<input type="checkbox"/>	<input type="checkbox"/>	<input type="checkbox"/>	<input type="checkbox"/>	<input type="checkbox"/>	<input type="checkbox"/>	<input type="checkbox"/>

**A B C D E F G H I**

**HOW TO ORDER**

Indicate the following information on order form:

- Quantity of each item.
- Model number, including options. See "How To Build a Model Number".
- Any special service required.

Note: • The  indicates that a choice is required.  
 • The absence of the  indicates that no choice is required.  
 • Alpha-numeric characters in place of  indicate that no other alternatives are available.

**HOW TO BUILD A MODEL NUMBER**

- A** Select basic model.
- B** Select top cap style.  
 F - Flat trim (std)  
 N - No topcap
- C** Select electrical code.  
 DP - Domestic - with cutouts
- D** Select bezel color.  
 Refer to color addendum at ki.com or KI Fabrics & Finishes binder.
- E** Select trim color.  
 Refer to color addendum at ki.com or KI Fabrics & Finishes binder.
- F** Select steel bottom color side 1.  
 Refer to color addendum at ki.com or KI Fabrics & Finishes binder.
- G** Select fabric side 1.  
 Refer to color addendum at ki.com or in KI Fabrics & Finishes binder.
- H** Select steel bottom color side 2.  
 Refer to color addendum at ki.com or KI Fabrics & Finishes binder.
- I** Select fabric side 2.  
 Refer to color addendum at ki.com or in KI Fabrics & Finishes binder.



# Preconfigured Segmented Steel Panels w/Fabric Top Tiles Beltway/Power

Tile-to-Floor One Side; Standard Base Raceway One Side

Approx. Packaged Weight	Delivered Pricing Fabric Grade 1 & C.O.M.	Delivered Pricing Fabric Grade 2	Delivered Pricing Fabric Grade 3 & Pallas Vertical Fabric Grade PV	Delivered Pricing Pallas Vertical Fabric Grade PV1	Delivered Pricing Pallas Vertical Fabric Grade PV2
42.9#	\$ 524	\$ 539	\$ 549	\$ 569	\$ 589
49.4#	587	605	615	638	660
55.9#	621	640	650	675	697
62.5#	648	668	680	703	729
69.0#	699	721	733	760	786
82.1#	890	914	931	964	999
102.7#	1155	1188	1209	1254	1297

**SPECIAL SERVICES**

**Special Carton Marking**

With specially marked information N/C

**Shipping**

Delivered. Shipped **k.d. freight prepaid f.o.b. Manitowoc, Wisconsin 54220** factory. Freight class #70.

Specifications and prices are subject to change without prior notice.

# Preconfigured Segmented Steel Panels w/Fabric Top Tiles Beltway/Power

Tile-to-Floor One Side; Standard Base Raceway One Side

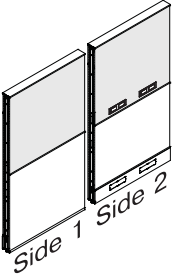
MODEL		W x H	MODEL NUMBER										
			Basic Model	Top Cap Style	Electrical Code	Bezel Color	Trim Color	Steel Color Side 1	Fabric Side 1	Steel Color Side 2	Fabric Side 2		
	<b>Segmented Steel Panel - 48"H</b>	24 x 48	USSFTBW2448	<input type="checkbox"/>	<input type="checkbox"/>	<input type="checkbox"/>	<input type="checkbox"/>	<input type="checkbox"/>	<input type="checkbox"/>	<input type="checkbox"/>	<input type="checkbox"/>	<input type="checkbox"/>	<input type="checkbox"/>
		30 x 48	USSFTBW3048	<input type="checkbox"/>	<input type="checkbox"/>	<input type="checkbox"/>	<input type="checkbox"/>	<input type="checkbox"/>	<input type="checkbox"/>	<input type="checkbox"/>	<input type="checkbox"/>	<input type="checkbox"/>	<input type="checkbox"/>
		36 x 48	USSFTBW3648	<input type="checkbox"/>	<input type="checkbox"/>	<input type="checkbox"/>	<input type="checkbox"/>	<input type="checkbox"/>	<input type="checkbox"/>	<input type="checkbox"/>	<input type="checkbox"/>	<input type="checkbox"/>	<input type="checkbox"/>
		42 x 48	USSFTBW4248	<input type="checkbox"/>	<input type="checkbox"/>	<input type="checkbox"/>	<input type="checkbox"/>	<input type="checkbox"/>	<input type="checkbox"/>	<input type="checkbox"/>	<input type="checkbox"/>	<input type="checkbox"/>	<input type="checkbox"/>
		48 x 48	USSFTBW4848	<input type="checkbox"/>	<input type="checkbox"/>	<input type="checkbox"/>	<input type="checkbox"/>	<input type="checkbox"/>	<input type="checkbox"/>	<input type="checkbox"/>	<input type="checkbox"/>	<input type="checkbox"/>	<input type="checkbox"/>
		60 x 48	USSFTBW6048	<input type="checkbox"/>	<input type="checkbox"/>	<input type="checkbox"/>	<input type="checkbox"/>	<input type="checkbox"/>	<input type="checkbox"/>	<input type="checkbox"/>	<input type="checkbox"/>	<input type="checkbox"/>	<input type="checkbox"/>
		72 x 48	USSFTBW7248	<input type="checkbox"/>	<input type="checkbox"/>	<input type="checkbox"/>	<input type="checkbox"/>	<input type="checkbox"/>	<input type="checkbox"/>	<input type="checkbox"/>	<input type="checkbox"/>	<input type="checkbox"/>	<input type="checkbox"/>
USFT													
USFT	<b>Segmented Steel Panel - 56"H</b>	24 x 56	USSFTBW2456	<input type="checkbox"/>	<input type="checkbox"/>	<input type="checkbox"/>	<input type="checkbox"/>	<input type="checkbox"/>	<input type="checkbox"/>	<input type="checkbox"/>	<input type="checkbox"/>	<input type="checkbox"/>	<input type="checkbox"/>
		30 x 56	USSFTBW3056	<input type="checkbox"/>	<input type="checkbox"/>	<input type="checkbox"/>	<input type="checkbox"/>	<input type="checkbox"/>	<input type="checkbox"/>	<input type="checkbox"/>	<input type="checkbox"/>	<input type="checkbox"/>	<input type="checkbox"/>
		36 x 56	USSFTBW3656	<input type="checkbox"/>	<input type="checkbox"/>	<input type="checkbox"/>	<input type="checkbox"/>	<input type="checkbox"/>	<input type="checkbox"/>	<input type="checkbox"/>	<input type="checkbox"/>	<input type="checkbox"/>	<input type="checkbox"/>
		42 x 56	USSFTBW4256	<input type="checkbox"/>	<input type="checkbox"/>	<input type="checkbox"/>	<input type="checkbox"/>	<input type="checkbox"/>	<input type="checkbox"/>	<input type="checkbox"/>	<input type="checkbox"/>	<input type="checkbox"/>	<input type="checkbox"/>
		48 x 56	USSFTBW4856	<input type="checkbox"/>	<input type="checkbox"/>	<input type="checkbox"/>	<input type="checkbox"/>	<input type="checkbox"/>	<input type="checkbox"/>	<input type="checkbox"/>	<input type="checkbox"/>	<input type="checkbox"/>	<input type="checkbox"/>
		60 x 56	USSFTBW6056	<input type="checkbox"/>	<input type="checkbox"/>	<input type="checkbox"/>	<input type="checkbox"/>	<input type="checkbox"/>	<input type="checkbox"/>	<input type="checkbox"/>	<input type="checkbox"/>	<input type="checkbox"/>	<input type="checkbox"/>
		72 x 56	USSFTBW7256	<input type="checkbox"/>	<input type="checkbox"/>	<input type="checkbox"/>	<input type="checkbox"/>	<input type="checkbox"/>	<input type="checkbox"/>	<input type="checkbox"/>	<input type="checkbox"/>	<input type="checkbox"/>	<input type="checkbox"/>
USFT	<b>Segmented Steel Panel - 64"H</b>	24 x 64	USSFTBW2464	<input type="checkbox"/>	<input type="checkbox"/>	<input type="checkbox"/>	<input type="checkbox"/>	<input type="checkbox"/>	<input type="checkbox"/>	<input type="checkbox"/>	<input type="checkbox"/>	<input type="checkbox"/>	<input type="checkbox"/>
		30 x 64	USSFTBW3064	<input type="checkbox"/>	<input type="checkbox"/>	<input type="checkbox"/>	<input type="checkbox"/>	<input type="checkbox"/>	<input type="checkbox"/>	<input type="checkbox"/>	<input type="checkbox"/>	<input type="checkbox"/>	<input type="checkbox"/>
		36 x 64	USSFTBW3664	<input type="checkbox"/>	<input type="checkbox"/>	<input type="checkbox"/>	<input type="checkbox"/>	<input type="checkbox"/>	<input type="checkbox"/>	<input type="checkbox"/>	<input type="checkbox"/>	<input type="checkbox"/>	<input type="checkbox"/>
		42 x 64	USSFTBW4264	<input type="checkbox"/>	<input type="checkbox"/>	<input type="checkbox"/>	<input type="checkbox"/>	<input type="checkbox"/>	<input type="checkbox"/>	<input type="checkbox"/>	<input type="checkbox"/>	<input type="checkbox"/>	<input type="checkbox"/>
		48 x 64	USSFTBW4864	<input type="checkbox"/>	<input type="checkbox"/>	<input type="checkbox"/>	<input type="checkbox"/>	<input type="checkbox"/>	<input type="checkbox"/>	<input type="checkbox"/>	<input type="checkbox"/>	<input type="checkbox"/>	<input type="checkbox"/>
		60 x 64	USSFTBW6064	<input type="checkbox"/>	<input type="checkbox"/>	<input type="checkbox"/>	<input type="checkbox"/>	<input type="checkbox"/>	<input type="checkbox"/>	<input type="checkbox"/>	<input type="checkbox"/>	<input type="checkbox"/>	<input type="checkbox"/>
		72 x 64	USSFTBW7264	<input type="checkbox"/>	<input type="checkbox"/>	<input type="checkbox"/>	<input type="checkbox"/>	<input type="checkbox"/>	<input type="checkbox"/>	<input type="checkbox"/>	<input type="checkbox"/>	<input type="checkbox"/>	<input type="checkbox"/>

**A**   **B**   **C**   **D**   **E**   **F**   **G**   **H**   **I**

## HOW TO ORDER

Indicate the following information on order form:

- Quantity of each item.
- Model number, including options. See "How To Build a Model Number".
- Any special service required.

Note: • The  indicates that a choice is required.

- The absence of the  indicates that no choice is required.
- Alpha-numeric characters in place of  indicate that no other alternatives are available.

## HOW TO BUILD A MODEL NUMBER

- A** Select basic model.
- B** Select top cap style.  

<b>F</b>	- Flat trim (std)
<b>N</b>	- No topcap
- C** Select electrical code.  

<b>DP</b>	- Domestic - with cutouts
-----------	---------------------------
- D** Select bezel color.  
Refer to color addendum at ki.com or KI Fabrics & Finishes binder.
- E** Select trim color.  
Refer to color addendum at ki.com or KI Fabrics & Finishes binder.
- F** Select steel bottom color side 1.  
Refer to color addendum at ki.com or KI Fabrics & Finishes binder.
- G** Select fabric side 1.  
Refer to color addendum at ki.com or in KI Fabrics & Finishes binder.
- H** Select steel bottom color side 2.  
Refer to color addendum at ki.com or KI Fabrics & Finishes binder.
- I** Select fabric side 2.  
Refer to color addendum at ki.com or in KI Fabrics & Finishes binder.



# Preconfigured Segmented Steel Panels w/Fabric Top Tiles Beltway/Power

Tile-to-Floor One Side; Standard Base Raceway One Side

Approx. Packaged Weight	Delivered Pricing Fabric Grade 1 & C.O.M.	Delivered Pricing Fabric Grade 2	Delivered Pricing Fabric Grade 3 & Pallas Vertical Fabric Grade PV	Delivered Pricing Pallas Vertical Fabric Grade PV1	Delivered Pricing Pallas Vertical Fabric Grade PV2
48.2#	\$ 554	\$ 569	\$ 580	\$ 599	\$ 621
55.2#	619	638	648	674	696
62.3#	660	679	691	718	741
69.4#	705	726	739	766	792
76.4#	755	778	791	820	849
90.6#	948	975	992	1029	1064
113.5#	1228	1263	1285	1333	1379
52.5#	\$ 582	\$ 597	\$ 610	\$ 631	\$ 652
60.1#	651	671	682	707	732
67.7#	700	722	734	762	788
75.3#	754	777	789	819	848
82.9#	808	830	846	876	906
98.1#	964	992	1010	1046	1085
123.4#	1304	1341	1366	1416	1465
56.9#	\$ 619	\$ 637	\$ 648	\$ 673	\$ 695
65.0#	716	734	748	776	802
73.1#	777	797	812	843	871
81.2#	802	824	840	870	900
89.3#	859	885	900	933	964
105.6#	1051	1082	1101	1142	1180
133.2#	1456	1498	1524	1580	1636

**SPECIAL SERVICES**

**Special Carton Marking**

With specially marked information N/C

**Shipping**

Shipped k.d. freight prepaid f.o.b. Manitowoc, Wisconsin 54220 factory. Freight class #70.

Specifications and prices are subject to change without prior notice.

# Preconfigured Segmented Open Panels w/Fabric Top Tiles

Standard Base Raceway

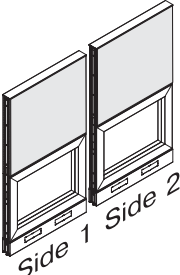
MODEL	W x H	MODEL NUMBER						Approx. Packaged Weight	
		Basic Model	Top Cap Style	Electrical Code	Trim Color	Fabric Side 1	Fabric Side 2		
 <p>USFR</p>	<b>Segmented Open Panel - 40"H</b>	24 x 40	USOR2440	<input type="checkbox"/>	<input type="checkbox"/>	<input type="checkbox"/>	<input type="checkbox"/>	<input type="checkbox"/>	43.0#
	• Segmented panel features open powder coated aluminum frame lower segment and fabric upper segment	30 x 40	USOR3040	<input type="checkbox"/>	<input type="checkbox"/>	<input type="checkbox"/>	<input type="checkbox"/>	<input type="checkbox"/>	50.0#
	• Standard base raceway on both sides accepts power and data cable distribution	36 x 40	USOR3640	<input type="checkbox"/>	<input type="checkbox"/>	<input type="checkbox"/>	<input type="checkbox"/>	<input type="checkbox"/>	57.0#
	• Open frame allows pass-through accessibility range of 8" to 29" from floor	42 x 40	USOR4240	<input type="checkbox"/>	<input type="checkbox"/>	<input type="checkbox"/>	<input type="checkbox"/>	<input type="checkbox"/>	64.0#
	• Panel assembly includes frame, trim, and panel-to-panel connecting hardware	48 x 40	USOR4840	<input type="checkbox"/>	<input type="checkbox"/>	<input type="checkbox"/>	<input type="checkbox"/>	<input type="checkbox"/>	70.0#
	• Trim is metal and includes top cap, bottom trim channel, base raceway, and open frame	60 x 40	USOR6040	<input type="checkbox"/>	<input type="checkbox"/>	<input type="checkbox"/>	<input type="checkbox"/>	<input type="checkbox"/>	84.0#
• Side 1 and side 2 fabric finishes are specified separately									
• 30-60" wide panels feature two power knockouts per side									
• 24" wide panels feature one power knockout per side									
• Electrical components are specified separately									
USFR	<b>Segmented Open Panel - 48"H</b>	24 x 48	USOR2448	<input type="checkbox"/>	<input type="checkbox"/>	<input type="checkbox"/>	<input type="checkbox"/>	<input type="checkbox"/>	49.0#
		30 x 48	USOR3048	<input type="checkbox"/>	<input type="checkbox"/>	<input type="checkbox"/>	<input type="checkbox"/>	<input type="checkbox"/>	56.0#
		36 x 48	USOR3648	<input type="checkbox"/>	<input type="checkbox"/>	<input type="checkbox"/>	<input type="checkbox"/>	<input type="checkbox"/>	63.0#
		42 x 48	USOR4248	<input type="checkbox"/>	<input type="checkbox"/>	<input type="checkbox"/>	<input type="checkbox"/>	<input type="checkbox"/>	70.0#
		48 x 48	USOR4848	<input type="checkbox"/>	<input type="checkbox"/>	<input type="checkbox"/>	<input type="checkbox"/>	<input type="checkbox"/>	78.0#
		60 x 48	USOR6048	<input type="checkbox"/>	<input type="checkbox"/>	<input type="checkbox"/>	<input type="checkbox"/>	<input type="checkbox"/>	92.0#
USFR	<b>Segmented Open Panel - 56"H</b>	24 x 56	USOR2456	<input type="checkbox"/>	<input type="checkbox"/>	<input type="checkbox"/>	<input type="checkbox"/>	<input type="checkbox"/>	53.0#
		30 x 56	USOR3056	<input type="checkbox"/>	<input type="checkbox"/>	<input type="checkbox"/>	<input type="checkbox"/>	<input type="checkbox"/>	61.0#
		36 x 56	USOR3656	<input type="checkbox"/>	<input type="checkbox"/>	<input type="checkbox"/>	<input type="checkbox"/>	<input type="checkbox"/>	68.0#
		42 x 56	USOR4256	<input type="checkbox"/>	<input type="checkbox"/>	<input type="checkbox"/>	<input type="checkbox"/>	<input type="checkbox"/>	76.0#
		48 x 56	USOR4856	<input type="checkbox"/>	<input type="checkbox"/>	<input type="checkbox"/>	<input type="checkbox"/>	<input type="checkbox"/>	84.0#
		60 x 56	USOR6056	<input type="checkbox"/>	<input type="checkbox"/>	<input type="checkbox"/>	<input type="checkbox"/>	<input type="checkbox"/>	100.0#
			<b>A</b>	<b>B</b>	<b>C</b>	<b>D</b>	<b>E</b>	<b>F</b>	

## HOW TO ORDER

Indicate the following information on order form:

- Quantity of each item.
- Model number, including options. See "How To Build a Model Number".
- Any special service required.

Note: • The  indicates that a choice is required.

- The absence of the  indicates that no choice is required.
- Alpha-numeric characters in place of

indicate that no other alternatives are available.

## HOW TO BUILD A MODEL NUMBER

**A** Select basic model.

**B** Select top cap style.

- F** - Flat trim (std)  
**N** - No topcap

**C** Select electrical code.

- CP** - Chicago - with cutouts  
**DN** - Domestic - no cutouts  
**DP** - Domestic - with cutouts  
**C1** - Chicago, 1 side w/cutouts  
**D1** - Domestic, 1 side w/cutouts

**D** Select trim color.

Refer to color addendum at ki.com or KI Fabrics & Finishes binder.

**E** Select fabric side 1.

Refer to color addendum at ki.com or in KI Fabrics & Finishes binder.

**F** Select fabric side 2.

Refer to color addendum at ki.com or in KI Fabrics & Finishes binder.





# Preconfigured Segmented Open Panels w/Fabric Top Tiles

Standard Base Raceway

Delivered Pricing Fabric Grade 1 & C.O.M.	Delivered Pricing Fabric Grade 2	Delivered Pricing Fabric Grade 3 & Pallas Vertical Fabric Grade PV	Delivered Pricing Pallas Vertical Fabric Grade PV1	Delivered Pricing Pallas Vertical Fabric Grade PV2
\$ 605	\$ 618	\$ 628	\$ 646	\$ 666
658	675	684	684	726
691	706	719	741	763
769	786	798	822	845
787	805	819	845	870
933	956	974	1005	1037

\$ 639	\$ 654	\$ 664	\$ 686	\$ 706
694	712	723	743	766
729	747	759	783	806
824	842	855	880	905
840	860	874	901	929
992	1018	1036	1070	1104
\$ 661	\$ 678	\$ 688	\$ 710	\$ 730
726	743	755	755	802
769	787	800	825	850
874	894	908	936	962
889	909	925	954	984
1009	1037	1054	1090	1124

## SPECIAL SERVICES

### Special Carton Marking

With specially marked information N/C

### Shipping

Specifications and prices are subject to change without prior notice.

# Preconfigured Segmented Open Panels w/Fabric Top Tiles

Standard Base Raceway

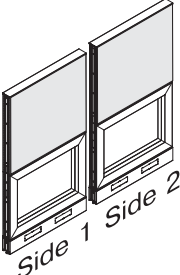
MODEL	W x H	MODEL NUMBER						Approx. Packaged Weight
		Basic Model	Top Cap Style	Electrical Code	Trim Color	Fabric Side 1	Fabric Side 2	
 <p>USFR</p> <p><b>Segmented Open Panel - 64"H</b></p> <ul style="list-style-type: none"> <li>Segmented panel features open powder coated aluminum frame lower segment and fabric upper segment</li> <li>Standard base raceway on both sides accepts power and data cable distribution</li> <li>Open frame allows pass-through accessibility range of 8" to 29" from floor</li> <li>Panel assembly includes frame, trim, and panel-to-panel connecting hardware</li> <li>Trim is metal and includes top cap, bottom trim channel, base raceway, and open frame</li> <li>Side 1 and side 2 fabric finishes are specified separately</li> <li>30-60" wide panels feature two power knockouts per side</li> <li>24" wide panels feature one power knockout per side</li> <li>Electrical components are specified separately</li> </ul>	24 x 64	USOR2464	<input type="checkbox"/>	<input type="checkbox"/>	<input type="checkbox"/>	<input type="checkbox"/>	<input type="checkbox"/>	57.0#
	30 x 64	USOR3064	<input type="checkbox"/>	<input type="checkbox"/>	<input type="checkbox"/>	<input type="checkbox"/>	<input type="checkbox"/>	66.0#
	36 x 64	USOR3664	<input type="checkbox"/>	<input type="checkbox"/>	<input type="checkbox"/>	<input type="checkbox"/>	<input type="checkbox"/>	74.0#
	42 x 64	USOR4264	<input type="checkbox"/>	<input type="checkbox"/>	<input type="checkbox"/>	<input type="checkbox"/>	<input type="checkbox"/>	82.0#
	48 x 64	USOR4864	<input type="checkbox"/>	<input type="checkbox"/>	<input type="checkbox"/>	<input type="checkbox"/>	<input type="checkbox"/>	91.0#
	60 x 64	USOR6064	<input type="checkbox"/>	<input type="checkbox"/>	<input type="checkbox"/>	<input type="checkbox"/>	<input type="checkbox"/>	107.0#

**A**   **B**   **C**   **D**   **E**   **F**

## HOW TO ORDER

Indicate the following information on order form:

- Quantity of each item.
- Model number, including options. See "How To Build a Model Number".
- Any special service required.

Note: • The  indicates that a choice is required.

- The absence of the  indicates that no choice is required.
- Alpha-numeric characters in place of

indicate that no other alternatives are available.

## HOW TO BUILD A MODEL NUMBER

- A** Select basic model.
- B** Select top cap style.
 

<b>F</b>	- Flat trim (std)
<b>N</b>	- No topcap
- C** Select electrical code.
 

<b>CP</b>	- Chicago - with cutouts
<b>DN</b>	- Domestic - no cutouts
<b>DP</b>	- Domestic - with cutouts
<b>C1</b>	- Chicago, 1 side w/cutouts
<b>D1</b>	- Domestic, 1 side w/cutouts
- D** Select trim color.  
Refer to color addendum at ki.com or KI Fabrics & Finishes binder.
- E** Select fabric side 1.  
Refer to color addendum at ki.com or in KI Fabrics & Finishes binder.
- F** Select fabric side 2.  
Refer to color addendum at ki.com or in KI Fabrics & Finishes binder.



# Preconfigured Segmented Open Panels w/Fabric Top Tiles

Standard Base Raceway

Delivered Pricing Fabric Grade 1 & C.O.M.	Delivered Pricing Fabric Grade 2	Delivered Pricing Fabric Grade 3 & Pallas Vertical Fabric Grade PV	Delivered Pricing Pallas Vertical Fabric Grade PV1	Delivered Pricing Pallas Vertical Fabric Grade PV2
\$ 697	\$ 717	\$ 727	\$ 749	\$ 774
788	809	821	847	872
845	865	881	908	937
921	943	958	988	1017
952	965	983	1012	1043
1092	1142	1142	1177	1215

## SPECIAL SERVICES

### Special Carton Marking

With specially marked information N/C

### Shipping

Shipped **k.d. freight prepaid f.o.b. Manitowoc, Wisconsin 54220** factory. Freight class #70.

Specifications and prices are subject to change without prior notice.

# Preconfigured Segmented Open Panels w/Fabric Top Tiles

Elevated Base

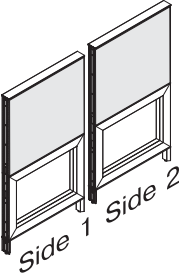
MODEL	W x H	MODEL NUMBER					Approx. Packaged Weight	
		Basic Model	Top Cap Style	Trim Color	Fabric Side 1	Fabric Side 2		
 <p>USFL</p>	<b>Segmented Open Panel - 40"H</b>	24 x 40	USOL2440	<input type="checkbox"/>	<input type="checkbox"/>	<input type="checkbox"/>	<input type="checkbox"/>	41.0#
	• Segmented panel features open powder coated aluminum frame lower segment and fabric upper segment	30 x 40	USOL3040	<input type="checkbox"/>	<input type="checkbox"/>	<input type="checkbox"/>	<input type="checkbox"/>	47.0#
	• Elevated base is non-powered and does not accept cable distribution	36 x 40	USOL3640	<input type="checkbox"/>	<input type="checkbox"/>	<input type="checkbox"/>	<input type="checkbox"/>	53.0#
	• Open frame allows pass-through accessibility range of 8" to 29" from floor	42 x 40	USOL4240	<input type="checkbox"/>	<input type="checkbox"/>	<input type="checkbox"/>	<input type="checkbox"/>	59.0#
	• Panel assembly includes frame, trim, and panel-to-panel connecting hardware	48 x 40	USOL4840	<input type="checkbox"/>	<input type="checkbox"/>	<input type="checkbox"/>	<input type="checkbox"/>	65.0#
	• Trim is metal and includes top cap, bottom trim channel, foot shroud, and open frame	60 x 40	USOL6040	<input type="checkbox"/>	<input type="checkbox"/>	<input type="checkbox"/>	<input type="checkbox"/>	77.0#
• Side 1 and side 2 fabric finishes are specified separately								
USFL	<b>Segmented Open Panel - 48"H</b>	24 x 48	USOL2448	<input type="checkbox"/>	<input type="checkbox"/>	<input type="checkbox"/>	<input type="checkbox"/>	46.0#
		30 x 48	USOL3048	<input type="checkbox"/>	<input type="checkbox"/>	<input type="checkbox"/>	<input type="checkbox"/>	53.0#
		36 x 48	USOL3648	<input type="checkbox"/>	<input type="checkbox"/>	<input type="checkbox"/>	<input type="checkbox"/>	59.0#
		42 x 48	USOL4248	<input type="checkbox"/>	<input type="checkbox"/>	<input type="checkbox"/>	<input type="checkbox"/>	66.0#
		48 x 48	USOL4848	<input type="checkbox"/>	<input type="checkbox"/>	<input type="checkbox"/>	<input type="checkbox"/>	72.0#
		60 x 48	USOL6048	<input type="checkbox"/>	<input type="checkbox"/>	<input type="checkbox"/>	<input type="checkbox"/>	85.0#
USFL	<b>Segmented Open Panel - 56"H</b>	24 x 56	USOL2456	<input type="checkbox"/>	<input type="checkbox"/>	<input type="checkbox"/>	<input type="checkbox"/>	51.0#
		30 x 56	USOL3056	<input type="checkbox"/>	<input type="checkbox"/>	<input type="checkbox"/>	<input type="checkbox"/>	58.0#
		36 x 56	USOL3656	<input type="checkbox"/>	<input type="checkbox"/>	<input type="checkbox"/>	<input type="checkbox"/>	65.0#
		42 x 56	USOL4256	<input type="checkbox"/>	<input type="checkbox"/>	<input type="checkbox"/>	<input type="checkbox"/>	72.0#
		48 x 56	USOL4856	<input type="checkbox"/>	<input type="checkbox"/>	<input type="checkbox"/>	<input type="checkbox"/>	79.0#
		60 x 56	USOL6056	<input type="checkbox"/>	<input type="checkbox"/>	<input type="checkbox"/>	<input type="checkbox"/>	93.0#

A

B

C

D

E

## HOW TO ORDER

Indicate the following information on order form:

- Quantity of each item.
- Model number, including options. See "How To Build a Model Number".
- Any special service required.

Note: • The  indicates that a choice is required.

- The absence of the  indicates that no choice is required.
- Alpha-numeric characters in place of  indicate that no other alternatives are available.

## HOW TO BUILD A MODEL NUMBER

**A** Select basic model.

**B** Select top cap style.

F - Flat trim (std)

N - No topcap

**C** Select trim color.

Refer to color addendum at [ki.com](http://ki.com) or KI Fabrics & Finishes binder.

**D** Select fabric side 1.

Refer to color addendum at [ki.com](http://ki.com) or in KI Fabrics & Finishes binder.

**E** Select fabric side 2.

Refer to color addendum at [ki.com](http://ki.com) or in KI Fabrics & Finishes binder.



# Preconfigured Segmented Open Panels w/Fabric Top Tiles

Elevated Base

Delivered Pricing Fabric Grade 1 & C.O.M.	Delivered Pricing Fabric Grade 2	Delivered Pricing Fabric Grade 3 & Pallas Vertical Fabric Grade PV	Delivered Pricing Pallas Vertical Fabric Grade PV1	Delivered Pricing Pallas Vertical Fabric Grade PV2
\$ 605	\$ 618	\$ 628	\$ 646	\$ 666
658	675	684	684	726
691	706	719	741	763
769	786	798	822	845
787	805	819	845	870
933	956	974	1005	1037
\$ 639	\$ 654	\$ 664	\$ 686	\$ 706
694	712	723	743	766
729	747	759	783	806
824	842	855	880	905
840	860	874	901	929
992	1018	1036	1070	1104
\$ 661	\$ 678	\$ 688	\$ 710	\$ 730
726	743	755	755	802
769	787	800	825	850
874	894	908	936	962
889	909	925	954	984
1009	1037	1054	1090	1124

## SPECIAL SERVICES

### Special Carton Marking

With specially marked information N/C

### Shipping

Shipped k.d. freight prepaid f.o.b. Manitowoc, Wisconsin 54220 factory. Freight class #70.

Specifications and prices are subject to change without prior notice.

# Preconfigured Segmented Open Panels w/Fabric Top Tiles

Elevated Base

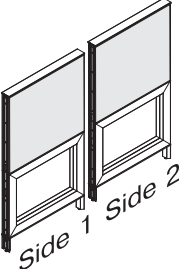
MODEL	W x H	MODEL NUMBER					Approx. Packaged Weight
		Basic Model	Top Cap Style	Trim Color	Fabric Side 1	Fabric Side 2	
 <p>USFL</p> <p><b>Segmented Open Panel - 64"H</b></p> <ul style="list-style-type: none"> <li>Segmented panel features open powder coated aluminum frame lower segment and fabric upper segment</li> <li>Elevated base is non-powered and does not accept cable distribution</li> <li>Open frame allows pass-through accessibility range of 8" to 29" from floor</li> <li>Panel assembly includes frame, trim, and panel-to-panel connecting hardware</li> <li>Trim is metal and includes top cap, bottom trim channel, foot shroud, and open frame</li> <li>Side 1 and side 2 fabric finishes are specified separately</li> </ul>	24 x 64	USOL2464	<input type="checkbox"/>	<input type="checkbox"/>	<input type="checkbox"/>	<input type="checkbox"/>	55.0#
	30 x 64	USOL3064	<input type="checkbox"/>	<input type="checkbox"/>	<input type="checkbox"/>	<input type="checkbox"/>	63.0#
	36 x 64	USOL3664	<input type="checkbox"/>	<input type="checkbox"/>	<input type="checkbox"/>	<input type="checkbox"/>	70.0#
	42 x 64	USOL4264	<input type="checkbox"/>	<input type="checkbox"/>	<input type="checkbox"/>	<input type="checkbox"/>	78.0#
	48 x 64	USOL4864	<input type="checkbox"/>	<input type="checkbox"/>	<input type="checkbox"/>	<input type="checkbox"/>	85.0#
	60 x 64	USOL6064	<input type="checkbox"/>	<input type="checkbox"/>	<input type="checkbox"/>	<input type="checkbox"/>	100.0#
			<b>A</b>	<b>B</b>	<b>C</b>	<b>D</b>	<b>E</b>

## HOW TO ORDER

Indicate the following information on order form:

- Quantity of each item.
- Model number, including options. See "How To Build a Model Number".
- Any special service required.

Note: • The  indicates that a choice is required.

- The absence of the  indicates that no choice is required.
- Alpha-numeric characters in place of  indicate that no other alternatives are available.

## HOW TO BUILD A MODEL NUMBER

- A** Select basic model.
- B** Select top cap style.
 

<b>F</b>	- Flat trim (std)
<b>N</b>	- No topcap
- C** Select trim color.  
Refer to color addendum at [ki.com](http://ki.com) or KI Fabrics & Finishes binder.
- D** Select fabric side 1.  
Refer to color addendum at [ki.com](http://ki.com) or in KI Fabrics & Finishes binder.
- E** Select fabric side 2.  
Refer to color addendum at [ki.com](http://ki.com) or in KI Fabrics & Finishes binder.



# Preconfigured Segmented Open Panels w/Fabric Top Tiles

Elevated Base

Delivered Pricing Fabric Grade 1 & C.O.M.	Delivered Pricing Fabric Grade 2	Delivered Pricing Fabric Grade 3 & Pallas Vertical Fabric Grade PV	Delivered Pricing Pallas Vertical Fabric Grade PV1	Delivered Pricing Pallas Vertical Fabric Grade PV2
\$ 697	\$ 717	\$ 727	\$ 749	\$ 774
788	809	821	847	872
845	865	881	908	937
921	943	958	988	1017
952	965	983	1012	1043
1092	1142	1142	1177	1215

## SPECIAL SERVICES

### Special Carton Marking

With specially marked information N/C

### Shipping

Shipped k.d. freight prepaid f.o.b. Manitowoc, Wisconsin 54220 factory. Freight class #70.

Specifications and prices are subject to change without prior notice.

# Preconfigured Segmented Fabric Panel w/Glass Top

Standard Base Raceway

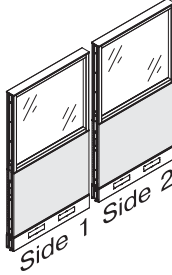
MODEL	W x H	MODEL NUMBER							Approx. Packaged Weight	
		Basic Model	Top Cap Style	Electrical Code	Trim Color	Glass Color	Fabric Side 1	Fabric Side 2		
 <p>USFR</p> <p><b>Segmented Fabric Panel - 40"H</b></p> <ul style="list-style-type: none"> <li>Lower segment includes fabric tiles for both sides, specified separately</li> <li>Upper segment features single piece of glass captured in frame</li> <li>Upper frame finish matches trim</li> <li>Standard base raceway on both sides accepts power and data cable distribution</li> <li>Panel assembly includes frame, trim, and panel-to-panel connectors</li> <li>Trim is metal and includes top cap, bottom trim channel, base raceway, and segment channel</li> <li>30-72" wide panels feature two power knockouts per side</li> <li>24" wide panels feature one power knockout per side</li> <li>72" wide panels feature split tiles</li> <li>Electrical components are specified separately</li> </ul>	24 x 40	USGR2440	<input type="checkbox"/>	<input type="checkbox"/>	<input type="checkbox"/>	<input type="checkbox"/>	<input type="checkbox"/>	<input type="checkbox"/>	46.5#	
	30 x 40	USGR3040	<input type="checkbox"/>	<input type="checkbox"/>	<input type="checkbox"/>	<input type="checkbox"/>	<input type="checkbox"/>	<input type="checkbox"/>	53.2#	
	36 x 40	USGR3640	<input type="checkbox"/>	<input type="checkbox"/>	<input type="checkbox"/>	<input type="checkbox"/>	<input type="checkbox"/>	<input type="checkbox"/>	60.0#	
	42 x 40	USGR4240	<input type="checkbox"/>	<input type="checkbox"/>	<input type="checkbox"/>	<input type="checkbox"/>	<input type="checkbox"/>	<input type="checkbox"/>	66.8#	
	48 x 40	USGR4840	<input type="checkbox"/>	<input type="checkbox"/>	<input type="checkbox"/>	<input type="checkbox"/>	<input type="checkbox"/>	<input type="checkbox"/>	73.6#	
	60 x 40	USGR6040	<input type="checkbox"/>	<input type="checkbox"/>	<input type="checkbox"/>	<input type="checkbox"/>	<input type="checkbox"/>	<input type="checkbox"/>	87.2#	
	72 x 40	USGR7240	<input type="checkbox"/>	<input type="checkbox"/>	<input type="checkbox"/>	<input type="checkbox"/>	<input type="checkbox"/>	<input type="checkbox"/>	105.8#	
USFR	<b>Segmented Fabric Panel - 48"H</b>	24 x 48	USGR2448	<input type="checkbox"/>	<input type="checkbox"/>	<input type="checkbox"/>	<input type="checkbox"/>	<input type="checkbox"/>	<input type="checkbox"/>	54.7#
	30 x 48	USGR3048	<input type="checkbox"/>	<input type="checkbox"/>	<input type="checkbox"/>	<input type="checkbox"/>	<input type="checkbox"/>	<input type="checkbox"/>	62.6#	
	36 x 48	USGR3648	<input type="checkbox"/>	<input type="checkbox"/>	<input type="checkbox"/>	<input type="checkbox"/>	<input type="checkbox"/>	<input type="checkbox"/>	70.5#	
	42 x 48	USGR4248	<input type="checkbox"/>	<input type="checkbox"/>	<input type="checkbox"/>	<input type="checkbox"/>	<input type="checkbox"/>	<input type="checkbox"/>	78.5#	
	48 x 48	USGR4848	<input type="checkbox"/>	<input type="checkbox"/>	<input type="checkbox"/>	<input type="checkbox"/>	<input type="checkbox"/>	<input type="checkbox"/>	86.4#	
	60 x 48	USGR6048	<input type="checkbox"/>	<input type="checkbox"/>	<input type="checkbox"/>	<input type="checkbox"/>	<input type="checkbox"/>	<input type="checkbox"/>	102.2#	
USFR	<b>Segmented Fabric Panel - 56"H</b>	24 x 56	USGR2456	<input type="checkbox"/>	<input type="checkbox"/>	<input type="checkbox"/>	<input type="checkbox"/>	<input type="checkbox"/>	<input type="checkbox"/>	62.9#
	30 x 56	USGR3056	<input type="checkbox"/>	<input type="checkbox"/>	<input type="checkbox"/>	<input type="checkbox"/>	<input type="checkbox"/>	<input type="checkbox"/>	71.9#	
	36 x 56	USGR3656	<input type="checkbox"/>	<input type="checkbox"/>	<input type="checkbox"/>	<input type="checkbox"/>	<input type="checkbox"/>	<input type="checkbox"/>	81.0#	
	42 x 56	USGR4256	<input type="checkbox"/>	<input type="checkbox"/>	<input type="checkbox"/>	<input type="checkbox"/>	<input type="checkbox"/>	<input type="checkbox"/>	90.1#	
	48 x 56	USGR4856	<input type="checkbox"/>	<input type="checkbox"/>	<input type="checkbox"/>	<input type="checkbox"/>	<input type="checkbox"/>	<input type="checkbox"/>	99.1#	
	60 x 56	USGR6056	<input type="checkbox"/>	<input type="checkbox"/>	<input type="checkbox"/>	<input type="checkbox"/>	<input type="checkbox"/>	<input type="checkbox"/>	117.2#	
72 x 56	USGR7256	<input type="checkbox"/>	<input type="checkbox"/>	<input type="checkbox"/>	<input type="checkbox"/>	<input type="checkbox"/>	<input type="checkbox"/>	142.9#		

**A**   **B**   **C**   **D**   **E**   **F**   **G**

## HOW TO ORDER

Indicate the following information on order form:

- Quantity of each item.
- Model number, including options. See "How To Build a Model Number".
- Any special service required.

Note: • The  indicates that a choice is required.

- The absence of the  indicates that no choice is required.
- Alpha-numeric characters in place of

indicate that no other alternatives are available.

## HOW TO BUILD A MODEL NUMBER

**A** Select basic model.

**B** Select top cap style.

**F** - Flat trim (std)

**N** - No topcap

**C** Select electrical code.

**CP** - Chicago - with cutouts

**DN** - Domestic - no cutouts

**DP** - Domestic - with cutouts

**C1** - Chicago, 1 side w/cutouts

**D1** - Domestic, 1 side w/cutouts

**D** Select trim color.

Refer to color addendum at ki.com or KI Fabrics & Finishes binder.

**E** Select glass color.

**GLA** - Clear (std)

**GLC** - White laminate

**GLV** - Satin etch one side

See pricing column for glass upcharge.

**F** Select fabric side 1.

Refer to color addendum at ki.com or in KI Fabrics & Finishes binder.

**G** Select fabric side 2.

Refer to color addendum at ki.com or in KI Fabrics & Finishes binder.





# Preconfigured Segmented Fabric Panel w/Glass Top

Standard Base Raceway

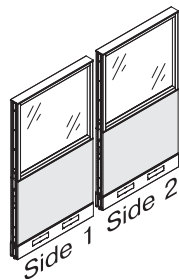

USFR

**MODEL**

**Segmented Fabric Panel - 64"H**

- Lower segment includes fabric tiles for both sides, specified separately
- Upper segment features single piece of glass captured in frame
- Upper frame finish matches trim
- Standard base raceway on both sides accepts power and data cable distribution
- Panel assembly includes frame, trim, and panel-to-panel connectors
- Trim is metal and includes top cap, bottom trim channel, base raceway, and segment channel
- 30-72" wide panels feature two power knockouts per side
- 24" wide panels feature one power knockout per side
- 72" wide panels feature split tiles
- Electrical components are specified separately

**W x H**

**MODEL NUMBER**

Basic Model	Top Cap Style	Electrical Code	Trim Color	Glass Color	Fabric Side 1	Fabric Side 2
USGR2464	<input type="checkbox"/>	<input type="checkbox"/>	<input type="checkbox"/>	<input type="checkbox"/>	<input type="checkbox"/>	<input type="checkbox"/>
USGR3064	<input type="checkbox"/>	<input type="checkbox"/>	<input type="checkbox"/>	<input type="checkbox"/>	<input type="checkbox"/>	<input type="checkbox"/>
USGR3664	<input type="checkbox"/>	<input type="checkbox"/>	<input type="checkbox"/>	<input type="checkbox"/>	<input type="checkbox"/>	<input type="checkbox"/>
USGR4264	<input type="checkbox"/>	<input type="checkbox"/>	<input type="checkbox"/>	<input type="checkbox"/>	<input type="checkbox"/>	<input type="checkbox"/>
USGR4864	<input type="checkbox"/>	<input type="checkbox"/>	<input type="checkbox"/>	<input type="checkbox"/>	<input type="checkbox"/>	<input type="checkbox"/>
USGR6064	<input type="checkbox"/>	<input type="checkbox"/>	<input type="checkbox"/>	<input type="checkbox"/>	<input type="checkbox"/>	<input type="checkbox"/>
USGR7264	<input type="checkbox"/>	<input type="checkbox"/>	<input type="checkbox"/>	<input type="checkbox"/>	<input type="checkbox"/>	<input type="checkbox"/>

**A**     **B**     **C**     **D**     **E**     **F**     **G**

**Approx. Packaged Weight**

71.1#  
81.2#  
91.4#  
101.7#  
111.9#  
132.3#  
161.5#

**HOW TO ORDER**

Indicate the following information on order form:

1. Quantity of each item.
2. Model number, including options. See "How To Build a Model Number".
3. Any special service required.

Note: • The  indicates that a choice is required.  
• The absence of the  indicates that no choice is required.  
• Alpha-numeric characters in place of  indicate that no other alternatives are available.

**HOW TO BUILD A MODEL NUMBER**

- A** Select basic model.  
\_\_\_\_\_
- B** Select top cap style.  
**F** \_\_\_\_\_ - Flat trim (std)  
**N** \_\_\_\_\_ - No topcap
- C** Select electrical code.  
**CP** \_\_\_\_\_ - Chicago - with cutouts  
**DN** \_\_\_\_\_ - Domestic - no cutouts  
**DP** \_\_\_\_\_ - Domestic - with cutouts  
**C1** \_\_\_\_\_ - Chicago, 1 side w/cutouts  
**D1** \_\_\_\_\_ - Domestic, 1 side w/cutouts
- D** Select trim color.  
Refer to color addendum at ki.com or KI Fabrics & Finishes binder.
- E** Select glass color.  
**GLA** \_\_\_\_\_ - Clear (std)  
**GLC** \_\_\_\_\_ - White laminate  
**GLV** \_\_\_\_\_ - Satin etch one side  
See pricing column for glass upcharge.

- F** Select fabric side 1.  
Refer to color addendum at ki.com or in KI Fabrics & Finishes binder.
- G** Select fabric side 2.  
Refer to color addendum at ki.com or in KI Fabrics & Finishes binder.



# Preconfigured Segmented Fabric Panel w/Glass Top

Standard Base Raceway

Delivered Pricing Fabric Grade 1 & C.O.M.	Delivered Pricing Fabric Grade 2	Delivered Pricing Fabric Grade 3 & Pallas Vertical Fabric Grade PV	Delivered Pricing Pallas Vertical Fabric Grade PV1	Delivered Pricing Pallas Vertical Fabric Grade PV2	White Laminate Upcharge	Satin Etch One Side Upcharge
\$ 703	\$ 749	\$ 793	\$ 840	\$ 872	\$ 63	\$ 135
780	830	880	930	964	63	135
830	884	936	989	1028	94	193
897	955	1012	1069	1111	125	255
951	1010	1072	1133	1176	152	309
1082	1151	1220	1290	1338	170	359
1397	1486	1576	1666	1730	202	421

**SPECIAL SERVICES**

**Special Carton Marking**

With specially marked information N/C

**Shipping**

Shipped k.d. freight prepaid f.o.b. Manitowoc, Wisconsin 54220 factory. Freight class #70.

Specifications and prices are subject to change without prior notice.

# Preconfigured Segmented Fabric Panel w/Glass Top

Elevated Base

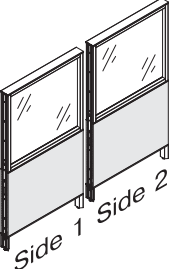
MODEL	W x H	MODEL NUMBER						Approx. Packaged Weight
		Basic Model	Top Cap Style	Trim Color	Glass Color	Fabric Side 1	Fabric Side 2	
 <p><b>Segmented Fabric Panel - 40"H</b></p> <ul style="list-style-type: none"> <li>Lower segment includes fabric tiles for both sides, specified separately</li> <li>Upper segment features single piece of glass captured in frame</li> <li>Upper frame finish matches trim</li> <li>Elevated base does not accept cable distribution</li> <li>Panel assembly includes frame, trim, and panel-to-panel connectors</li> <li>Trim is metal and includes top cap, bottom trim channel, segment channel, and foot shroud</li> <li>72" wide panels feature split tiles</li> </ul>	24 x 40	USGL2440	<input type="checkbox"/>	<input type="checkbox"/>	<input type="checkbox"/>	<input type="checkbox"/>	<input type="checkbox"/>	44.3#
	30 x 40	USGL3040	<input type="checkbox"/>	<input type="checkbox"/>	<input type="checkbox"/>	<input type="checkbox"/>	<input type="checkbox"/>	50.3#
	36 x 40	USGL3640	<input type="checkbox"/>	<input type="checkbox"/>	<input type="checkbox"/>	<input type="checkbox"/>	<input type="checkbox"/>	56.3#
	42 x 40	USGL4240	<input type="checkbox"/>	<input type="checkbox"/>	<input type="checkbox"/>	<input type="checkbox"/>	<input type="checkbox"/>	62.3#
	48 x 40	USGL4840	<input type="checkbox"/>	<input type="checkbox"/>	<input type="checkbox"/>	<input type="checkbox"/>	<input type="checkbox"/>	68.3#
	60 x 40	USGL6040	<input type="checkbox"/>	<input type="checkbox"/>	<input type="checkbox"/>	<input type="checkbox"/>	<input type="checkbox"/>	80.2#
	72 x 40	USGL7240	<input type="checkbox"/>	<input type="checkbox"/>	<input type="checkbox"/>	<input type="checkbox"/>	<input type="checkbox"/>	97.2#
USFL								
<p><b>Segmented Fabric Panel - 48"H</b></p>	24 x 48	USGL2448	<input type="checkbox"/>	<input type="checkbox"/>	<input type="checkbox"/>	<input type="checkbox"/>	<input type="checkbox"/>	52.5#
	30 x 48	USGL3048	<input type="checkbox"/>	<input type="checkbox"/>	<input type="checkbox"/>	<input type="checkbox"/>	<input type="checkbox"/>	59.6#
	36 x 48	USGL3648	<input type="checkbox"/>	<input type="checkbox"/>	<input type="checkbox"/>	<input type="checkbox"/>	<input type="checkbox"/>	66.7#
	42 x 48	USGL4248	<input type="checkbox"/>	<input type="checkbox"/>	<input type="checkbox"/>	<input type="checkbox"/>	<input type="checkbox"/>	73.9#
	48 x 48	USGL4848	<input type="checkbox"/>	<input type="checkbox"/>	<input type="checkbox"/>	<input type="checkbox"/>	<input type="checkbox"/>	81.0#
	60 x 48	USGL6048	<input type="checkbox"/>	<input type="checkbox"/>	<input type="checkbox"/>	<input type="checkbox"/>	<input type="checkbox"/>	95.2#
	72 x 48	USGL7248	<input type="checkbox"/>	<input type="checkbox"/>	<input type="checkbox"/>	<input type="checkbox"/>	<input type="checkbox"/>	115.7#
USFL								
<p><b>Segmented Fabric Panel - 56"H</b></p>	24 x 56	USGL2456	<input type="checkbox"/>	<input type="checkbox"/>	<input type="checkbox"/>	<input type="checkbox"/>	<input type="checkbox"/>	60.7#
	30 x 56	USGL3056	<input type="checkbox"/>	<input type="checkbox"/>	<input type="checkbox"/>	<input type="checkbox"/>	<input type="checkbox"/>	68.9#
	36 x 56	USGL3656	<input type="checkbox"/>	<input type="checkbox"/>	<input type="checkbox"/>	<input type="checkbox"/>	<input type="checkbox"/>	77.2#
	42 x 56	USGL4256	<input type="checkbox"/>	<input type="checkbox"/>	<input type="checkbox"/>	<input type="checkbox"/>	<input type="checkbox"/>	85.5#
	48 x 56	USGL4856	<input type="checkbox"/>	<input type="checkbox"/>	<input type="checkbox"/>	<input type="checkbox"/>	<input type="checkbox"/>	93.8#
	60 x 56	USGL6056	<input type="checkbox"/>	<input type="checkbox"/>	<input type="checkbox"/>	<input type="checkbox"/>	<input type="checkbox"/>	110.3#
	72 x 56	USGL7256	<input type="checkbox"/>	<input type="checkbox"/>	<input type="checkbox"/>	<input type="checkbox"/>	<input type="checkbox"/>	134.3#

**A**   **B**   **C**   **D**   **E**   **F**

## HOW TO ORDER

Indicate the following information on order form:

- Quantity of each item.
- Model number, including options. See "How To Build a Model Number".
- Any special service required.

Note: • The  indicates that a choice is required.

- The absence of the  indicates that no choice is required.
- Alpha-numeric characters in place of  indicate that no other alternatives are available.

## HOW TO BUILD A MODEL NUMBER

- A** Select basic model.
- B** Select top cap style.
 

<b>F</b>	- Flat trim (std)
<b>N</b>	- No topcap
- C** Select trim color. Refer to color addendum at ki.com or KI Fabrics & Finishes binder.
- D** Select glass color.
 

<b>GLA</b>	- Clear (std)
<b>GLC</b>	- White laminate
<b>GLV</b>	- Satin etch one side

 See pricing column for glass upcharge.
- E** Select fabric side 1. Refer to color addendum at ki.com or in KI Fabrics & Finishes binder.
- F** Select fabric side 2. Refer to color addendum at ki.com or in KI Fabrics & Finishes binder.



# Preconfigured Segmented Fabric Panel w/Glass Top

Elevated Base

Delivered Pricing Fabric Grade 1 & C.O.M.	Delivered Pricing Fabric Grade 2	Delivered Pricing Fabric Grade 3 & Pallas Vertical Fabric Grade PV	Delivered Pricing Pallas Vertical Fabric Grade PV1	Delivered Pricing Pallas Vertical Fabric Grade PV2	White Laminate Upcharge	Satin Etch One Side Upcharge
\$ 614	\$ 652	\$ 692	\$ 731	\$ 759	\$ 45	\$ 91
672	716	757	801	831	45	91
724	771	817	863	897	45	91
776	824	874	924	959	45	91
824	877	930	984	1020	57	114
947	1006	1067	1127	1171	57	114
1240	1319	1399	1478	1536	57	114
\$ 639	\$ 680	\$ 722	\$ 762	\$ 790	\$ 45	\$ 91
696	741	786	831	862	45	91
750	799	847	895	930	45	91
808	859	911	962	1000	54	108
858	913	967	1025	1063	63	135
988	1052	1114	1177	1223	80	164
1289	1371	1454	1537	1595	94	193
\$ 668	\$ 710	\$ 752	\$ 795	\$ 827	\$ 63	\$ 135
728	775	821	868	901	63	135
787	837	889	939	975	63	135
851	904	959	1015	1054	63	135
902	960	1019	1075	1118	94	193
1030	1096	1163	1229	1276	125	255
1338	1423	1510	1595	1657	152	309

## SPECIAL SERVICES

### Special Carton Marking

With specially marked information N/C

### Shipping

Delivered. Shipped **k.d. freight prepaid**  
**f.o.b. Manitowoc, Wisconsin 54220**  
factory. Freight class #70.

Specifications and prices are subject to  
change without prior notice.

# Preconfigured Segmented Fabric Panel w/Glass Top

Elevated Base

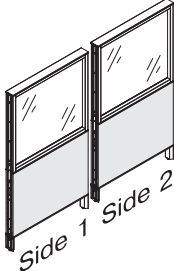
MODEL	W x H	MODEL NUMBER						Approx. Packaged Weight
		Basic Model	Top Cap Style	Trim Color	Glass Color	Fabric Side 1	Fabric Side 2	
 <p>Side 1 Side 2</p> <p>USFL</p> <p><b>Segmented Fabric Panel - 64"H</b></p> <ul style="list-style-type: none"> <li>Lower segment includes fabric tiles for both sides, specified separately</li> <li>Upper segment features single piece of glass captured in frame</li> <li>Upper frame finish matches trim</li> <li>Elevated base does not accept cable distribution</li> <li>Panel assembly includes frame, trim, and panel-to-panel connectors</li> <li>Trim is metal and includes top cap, bottom trim channel, segment channel, and foot shroud</li> <li>72" wide panels feature split tiles</li> </ul>	24 x 64	USGL2464	<input type="checkbox"/>	<input type="checkbox"/>	<input type="checkbox"/>	<input type="checkbox"/>	<input type="checkbox"/>	68.9#
	30 x 64	USGL3064	<input type="checkbox"/>	<input type="checkbox"/>	<input type="checkbox"/>	<input type="checkbox"/>	<input type="checkbox"/>	78.3#
	36 x 64	USGL3664	<input type="checkbox"/>	<input type="checkbox"/>	<input type="checkbox"/>	<input type="checkbox"/>	<input type="checkbox"/>	87.7#
	42 x 64	USGL4264	<input type="checkbox"/>	<input type="checkbox"/>	<input type="checkbox"/>	<input type="checkbox"/>	<input type="checkbox"/>	97.1#
	48 x 64	USGL4864	<input type="checkbox"/>	<input type="checkbox"/>	<input type="checkbox"/>	<input type="checkbox"/>	<input type="checkbox"/>	106.5#
	60 x 64	USGL6064	<input type="checkbox"/>	<input type="checkbox"/>	<input type="checkbox"/>	<input type="checkbox"/>	<input type="checkbox"/>	125.3#
	72 x 64	USGL7264	<input type="checkbox"/>	<input type="checkbox"/>	<input type="checkbox"/>	<input type="checkbox"/>	<input type="checkbox"/>	152.9#

**A B C D E F**

## HOW TO ORDER

Indicate the following information on order form:

- Quantity of each item.
- Model number, including options. See "How To Build a Model Number".
- Any special service required.

Note: • The  indicates that a choice is required.

- The absence of the  indicates that no choice is required.
- Alpha-numeric characters in place of  indicate that no other alternatives are available.

## HOW TO BUILD A MODEL NUMBER

- A** Select basic model.
- B** Select top cap style.
 

F	- Flat trim (std)
N	- No topcap
- C** Select trim color. Refer to color addendum at [ki.com](http://ki.com) or KI Fabrics & Finishes binder.
- D** Select glass color.
 

GLA	- Clear (std)
GLC	- White laminate
GLV	- Satin etch one side

See pricing column for glass upcharge.
- E** Select fabric side 1. Refer to color addendum at [ki.com](http://ki.com) or in KI Fabrics & Finishes binder.
- F** Select fabric side 2. Refer to color addendum at [ki.com](http://ki.com) or in KI Fabrics & Finishes binder.



# Preconfigured Segmented Fabric Panel w/Glass Top

Elevated Base

Delivered Pricing Fabric Grade 1 & C.O.M.	Delivered Pricing Fabric Grade 2	Delivered Pricing Fabric Grade 3 & Pallas Vertical Fabric Grade PV	Delivered Pricing Pallas Vertical Fabric Grade PV1	Delivered Pricing Pallas Vertical Fabric Grade PV2	White Laminate Upcharge	Satin Etch One Side Upcharge
\$ 703	\$ 749	\$ 793	\$ 840	\$ 872	\$ 63	\$ 135
780	830	880	930	964	63	135
830	884	936	989	1028	94	193
897	955	1012	1069	1111	125	255
951	1010	1072	1133	1176	152	309
1082	1151	1220	1290	1338	170	359
1397	1486	1576	1666	1730	202	421

## SPECIAL SERVICES

### Special Carton Marking

With specially marked information N/C

### Shipping

Shipped k.d. freight prepaid f.o.b. Manitowoc, Wisconsin 54220 factory. Freight class #70.

Specifications and prices are subject to change without prior notice.

# Preconfigured Segmented Fabric Panel w/Glass Top

Tile-to-Floor One Side; Standard Base Raceway One Side

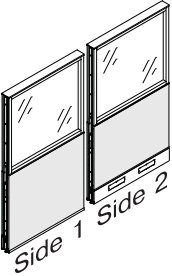
MODEL	W x H	MODEL NUMBER							Approx. Packaged Weight		
		Basic Model	Top Cap Style	Electrical Code	Trim Color	Glass Color	Fabric Side 1	Fabric Side 2			
 <p>USFT</p> <p><b>Segmented Fabric Panel - 40"H</b></p> <ul style="list-style-type: none"> <li>• Side 1: tile to floor base does not accept cable distribution</li> <li>• Side 2: standard base raceway accepts power and data cable distribution</li> <li>• Lower segment includes fabric tiles for both sides, specified separately</li> <li>• Upper segment features single piece of glass captured in frame</li> <li>• Upper frame finish matches trim includes segmented fabric tiles for both sides</li> <li>• Panel assembly includes frame, trim, and panel-to-panel connectors</li> <li>• Trim is metal and includes top cap, bottom trim channel, base raceway, and segment channel</li> <li>• Side 2: 30-72" wide panels feature two power knockouts</li> <li>• Side 2: 24" wide tiles feature one base power knockout</li> <li>• 72" wide panels feature split tiles</li> <li>• Electrical components are specified separately</li> </ul>	24 x 40	USGT2440	<input type="checkbox"/>	<input type="checkbox"/>	<input type="checkbox"/>	<input type="checkbox"/>	<input type="checkbox"/>	<input type="checkbox"/>	45.5#		
	30 x 40	USGT3040	<input type="checkbox"/>	<input type="checkbox"/>	<input type="checkbox"/>	<input type="checkbox"/>	<input type="checkbox"/>	<input type="checkbox"/>	51.9#		
	36 x 40	USGT3640	<input type="checkbox"/>	<input type="checkbox"/>	<input type="checkbox"/>	<input type="checkbox"/>	<input type="checkbox"/>	<input type="checkbox"/>	58.4#		
	42 x 40	USGT4240	<input type="checkbox"/>	<input type="checkbox"/>	<input type="checkbox"/>	<input type="checkbox"/>	<input type="checkbox"/>	<input type="checkbox"/>	64.9#		
	48 x 40	USGT4840	<input type="checkbox"/>	<input type="checkbox"/>	<input type="checkbox"/>	<input type="checkbox"/>	<input type="checkbox"/>	<input type="checkbox"/>	71.4#		
	60 x 40	USGT6040	<input type="checkbox"/>	<input type="checkbox"/>	<input type="checkbox"/>	<input type="checkbox"/>	<input type="checkbox"/>	<input type="checkbox"/>	84.4#		
	72 x 40	USGT7240	<input type="checkbox"/>	<input type="checkbox"/>	<input type="checkbox"/>	<input type="checkbox"/>	<input type="checkbox"/>	<input type="checkbox"/>	102.4#		
	USFT	<b>Segmented Fabric Panel - 48"H</b>									
		24 x 48	USGT2448	<input type="checkbox"/>	<input type="checkbox"/>	<input type="checkbox"/>	<input type="checkbox"/>	<input type="checkbox"/>	<input type="checkbox"/>	<input type="checkbox"/>	53.7#
30 x 48		USGT3048	<input type="checkbox"/>	<input type="checkbox"/>	<input type="checkbox"/>	<input type="checkbox"/>	<input type="checkbox"/>	<input type="checkbox"/>	<input type="checkbox"/>	61.3#	
36 x 48		USGT3648	<input type="checkbox"/>	<input type="checkbox"/>	<input type="checkbox"/>	<input type="checkbox"/>	<input type="checkbox"/>	<input type="checkbox"/>	<input type="checkbox"/>	68.9#	
42 x 48		USGT4248	<input type="checkbox"/>	<input type="checkbox"/>	<input type="checkbox"/>	<input type="checkbox"/>	<input type="checkbox"/>	<input type="checkbox"/>	<input type="checkbox"/>	76.6#	
48 x 48		USGT4848	<input type="checkbox"/>	<input type="checkbox"/>	<input type="checkbox"/>	<input type="checkbox"/>	<input type="checkbox"/>	<input type="checkbox"/>	<input type="checkbox"/>	84.2#	
60 x 48		USGT6048	<input type="checkbox"/>	<input type="checkbox"/>	<input type="checkbox"/>	<input type="checkbox"/>	<input type="checkbox"/>	<input type="checkbox"/>	<input type="checkbox"/>	99.4#	
72 x 48	USGT7248	<input type="checkbox"/>	<input type="checkbox"/>	<input type="checkbox"/>	<input type="checkbox"/>	<input type="checkbox"/>	<input type="checkbox"/>	<input type="checkbox"/>	121.0#		
USFT	<b>Segmented Fabric Panel - 56"H</b>										
	24 x 56	USGT2456	<input type="checkbox"/>	<input type="checkbox"/>	<input type="checkbox"/>	<input type="checkbox"/>	<input type="checkbox"/>	<input type="checkbox"/>	<input type="checkbox"/>	61.9#	
	30 x 56	USGT3056	<input type="checkbox"/>	<input type="checkbox"/>	<input type="checkbox"/>	<input type="checkbox"/>	<input type="checkbox"/>	<input type="checkbox"/>	<input type="checkbox"/>	70.6#	
	36 x 56	USGT3656	<input type="checkbox"/>	<input type="checkbox"/>	<input type="checkbox"/>	<input type="checkbox"/>	<input type="checkbox"/>	<input type="checkbox"/>	<input type="checkbox"/>	79.4#	
	42 x 56	USGT4256	<input type="checkbox"/>	<input type="checkbox"/>	<input type="checkbox"/>	<input type="checkbox"/>	<input type="checkbox"/>	<input type="checkbox"/>	<input type="checkbox"/>	88.2#	
	48 x 56	USGT4856	<input type="checkbox"/>	<input type="checkbox"/>	<input type="checkbox"/>	<input type="checkbox"/>	<input type="checkbox"/>	<input type="checkbox"/>	<input type="checkbox"/>	96.9#	
	60 x 56	USGT6056	<input type="checkbox"/>	<input type="checkbox"/>	<input type="checkbox"/>	<input type="checkbox"/>	<input type="checkbox"/>	<input type="checkbox"/>	<input type="checkbox"/>	114.5#	
72 x 56	USGT7256	<input type="checkbox"/>	<input type="checkbox"/>	<input type="checkbox"/>	<input type="checkbox"/>	<input type="checkbox"/>	<input type="checkbox"/>	<input type="checkbox"/>	139.5#		

**A**   **B**   **C**   **D**   **E**   **F**   **G**

## HOW TO ORDER

Indicate the following information on order form:

1. Quantity of each item.
2. Model number, including options. See "How To Build a Model Number".
3. Any special service required.

Note: • The  indicates that a choice is required.

- The absence of the  indicates that no choice is required.
- Alpha-numeric characters in place of  indicate that no other alternatives are available.

## HOW TO BUILD A MODEL NUMBER

**A** Select basic model.

**B** Select top cap style.

**F** \_\_\_\_\_ - Flat trim (std)

**N** \_\_\_\_\_ - No topcap

**C** Select electrical code.

**CP** \_\_\_\_\_ - Chicago - with cutouts

**DN** \_\_\_\_\_ - Domestic - no cutouts

**DP** \_\_\_\_\_ - Domestic - with cutouts

**D** Select trim color.

Refer to color addendum at ki.com or KI Fabrics & Finishes binder.

**E** Select glass color.

**GLA** \_\_\_\_\_ - Clear (std)

**GLC** \_\_\_\_\_ - White laminate

**GLV** \_\_\_\_\_ - Satin etch one side

See pricing column for glass upcharge.

**F** Select fabric side 1.

Refer to color addendum at ki.com or in KI Fabrics & Finishes binder.

**G** Select fabric side 2.

Refer to color addendum at ki.com or in KI Fabrics & Finishes binder.





# Preconfigured Segmented Fabric Panel w/Glass Top

Tile-to-Floor One Side; Standard Base Raceway One Side

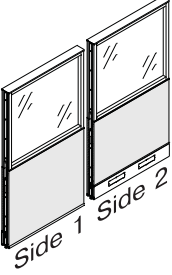
MODEL	W x H	MODEL NUMBER							Approx. Packaged Weight
		Basic Model	Top Cap Style	Electrical Code	Trim Color	Glass Color	Fabric Side 1	Fabric Side 2	
 <p>USFT</p> <p><b>Segmented Fabric Panel - 64"H</b></p> <ul style="list-style-type: none"> <li>Side 1: tile to floor base does not accept cable distribution</li> <li>Side 2: standard base raceway accepts power and data cable distribution</li> <li>Lower segment includes fabric tiles for both sides, specified separately</li> <li>Upper segment features single piece of glass captured in frame</li> <li>Upper frame finish matches trim includes segmented fabric tiles for both sides</li> <li>Panel assembly includes frame, trim, and panel-to-panel connectors</li> <li>Trim is metal and includes top cap, bottom trim channel, base raceway, and segment channel</li> <li>Side 2: 30-72" wide panels feature two power knockouts</li> <li>Side 2: 24" wide tiles feature one base power knockout</li> <li>72" wide panels feature split tiles</li> <li>Electrical components are specified separately</li> </ul>	24 x 64	USGT2464	<input type="checkbox"/>	<input type="checkbox"/>	<input type="checkbox"/>	<input type="checkbox"/>	<input type="checkbox"/>	<input type="checkbox"/>	70.1#
	30 x 64	USGT3064	<input type="checkbox"/>	<input type="checkbox"/>	<input type="checkbox"/>	<input type="checkbox"/>	<input type="checkbox"/>	<input type="checkbox"/>	79.9#
	36 x 64	USGT3664	<input type="checkbox"/>	<input type="checkbox"/>	<input type="checkbox"/>	<input type="checkbox"/>	<input type="checkbox"/>	<input type="checkbox"/>	89.8#
	42 x 64	USGT4264	<input type="checkbox"/>	<input type="checkbox"/>	<input type="checkbox"/>	<input type="checkbox"/>	<input type="checkbox"/>	<input type="checkbox"/>	99.8#
	48 x 64	USGT4864	<input type="checkbox"/>	<input type="checkbox"/>	<input type="checkbox"/>	<input type="checkbox"/>	<input type="checkbox"/>	<input type="checkbox"/>	109.7#
	60 x 64	USGT6064	<input type="checkbox"/>	<input type="checkbox"/>	<input type="checkbox"/>	<input type="checkbox"/>	<input type="checkbox"/>	<input type="checkbox"/>	129.5#
	72 x 64	USGT7264	<input type="checkbox"/>	<input type="checkbox"/>	<input type="checkbox"/>	<input type="checkbox"/>	<input type="checkbox"/>	<input type="checkbox"/>	158.1#

**A**   **B**   **C**   **D**   **E**   **F**   **G**

## HOW TO ORDER

Indicate the following information on order form:

- Quantity of each item.
- Model number, including options. See "How To Build a Model Number".
- Any special service required.

Note: • The  indicates that a choice is required.

- The absence of the  indicates that no choice is required.
- Alpha-numeric characters in place of  indicate that no other alternatives are available.

## HOW TO BUILD A MODEL NUMBER

- A** Select basic model.
- B** Select top cap style.
  - F** - Flat trim (std)
  - N** - No topcap
- C** Select electrical code.
  - CP** - Chicago - with cutouts
  - DN** - Domestic - no cutouts
  - DP** - Domestic - with cutouts
- D** Select trim color. Refer to color addendum at ki.com or KI Fabrics & Finishes binder.
- E** Select glass color.
  - GLA** - Clear (std)
  - GLC** - White laminate
  - GLV** - Satin etch one side

See pricing column for glass upcharge.
- F** Select fabric side 1. Refer to color addendum at ki.com or in KI Fabrics & Finishes binder.
- G** Select fabric side 2. Refer to color addendum at ki.com or in KI Fabrics & Finishes binder.



# Preconfigured Segmented Fabric Panel w/Glass Top

Tile-to-Floor One Side; Standard Base Raceway One Side

Delivered Pricing Fabric Grade 1 & C.O.M.	Delivered Pricing Fabric Grade 2	Delivered Pricing Fabric Grade 3 & Pallas Vertical Fabric Grade PV	Delivered Pricing Pallas Vertical Fabric Grade PV1	Delivered Pricing Pallas Vertical Fabric Grade PV2	White Laminate Upcharge	Satin Etch One Side Upcharge
\$ 703	\$ 749	\$ 793	\$ 840	\$ 872	\$ 63	\$ 135
780	830	880	930	964	63	135
830	884	936	989	1028	94	193
897	955	1012	1069	1111	125	255
951	1010	1072	1133	1176	152	309
1082	1151	1220	1290	1338	170	359
1397	1486	1576	1666	1730	202	421

## SPECIAL SERVICES

### Special Carton Marking

With specially marked information N/C

### Shipping

Shipped k.d. freight prepaid f.o.b. Manitowoc, Wisconsin 54220 factory. Freight class #70.

Specifications and prices are subject to change without prior notice.

# Preconfigured Segmented Fabric Panel w/Markerboard on One Side

Standard Base Raceway

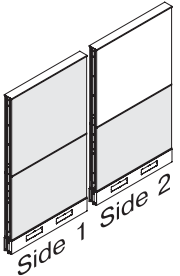
	MODEL	W x H	MODEL NUMBER						Approx. Packaged Weight
			Basic Model	Top Cap Style	Electrical Code	Trim Color	Fabric Side 1	Fabric Side 2	
 <p>USFR</p>	<b>Segmented Fabric Panel - 48"H</b>	24 x 48	USMB1R2448	<input type="checkbox"/>	<input type="checkbox"/>	<input type="checkbox"/>	<input type="checkbox"/>	<input type="checkbox"/>	46.2#
	• Side 1: includes segmented tiles with identically specified fabric lower and upper segments	30 x 48	USMB1R3048	<input type="checkbox"/>	<input type="checkbox"/>	<input type="checkbox"/>	<input type="checkbox"/>	<input type="checkbox"/>	52.7#
	• Side 2: includes segmented tiles with fabric lower and steel markerboard upper segment	36 x 48	USMB1R3648	<input type="checkbox"/>	<input type="checkbox"/>	<input type="checkbox"/>	<input type="checkbox"/>	<input type="checkbox"/>	59.1#
	• Standard base raceway on both sides accepts power and data cable distribution	42 x 48	USMB1R4248	<input type="checkbox"/>	<input type="checkbox"/>	<input type="checkbox"/>	<input type="checkbox"/>	<input type="checkbox"/>	68.7#
	• Panel assembly includes frame, trim, and panel-to-panel connectors	48 x 48	USMB1R4848	<input type="checkbox"/>	<input type="checkbox"/>	<input type="checkbox"/>	<input type="checkbox"/>	<input type="checkbox"/>	72.2#
	• Trim is metal and includes top cap, bottom trim channel, base raceway, and segment channel	60 x 48	USMB1R6048	<input type="checkbox"/>	<input type="checkbox"/>	<input type="checkbox"/>	<input type="checkbox"/>	<input type="checkbox"/>	85.2#
	• Side 1 and side 2 finishes are specified separately	72 x 48	USMB1R7248	<input type="checkbox"/>	<input type="checkbox"/>	<input type="checkbox"/>	<input type="checkbox"/>	<input type="checkbox"/>	106.3#
	• Upper and lower fabric finishes on side 1 must be identically specified								
	• 30-72" wide panels feature two power knockouts per side								
	• 24" wide panels feature one power knockout per side								
• 72" wide panels feature split tiles									
• Electrical components are specified separately									
USFR	<b>Segmented Fabric Panel - 56"H</b>	24 x 56	USMB1R2456	<input type="checkbox"/>	<input type="checkbox"/>	<input type="checkbox"/>	<input type="checkbox"/>	<input type="checkbox"/>	51.0#
		30 x 56	USMB1R3056	<input type="checkbox"/>	<input type="checkbox"/>	<input type="checkbox"/>	<input type="checkbox"/>	<input type="checkbox"/>	58.1#
		36 x 56	USMB1R3656	<input type="checkbox"/>	<input type="checkbox"/>	<input type="checkbox"/>	<input type="checkbox"/>	<input type="checkbox"/>	65.2#
		42 x 56	USMB1R4256	<input type="checkbox"/>	<input type="checkbox"/>	<input type="checkbox"/>	<input type="checkbox"/>	<input type="checkbox"/>	73.4#
		48 x 56	USMB1R4856	<input type="checkbox"/>	<input type="checkbox"/>	<input type="checkbox"/>	<input type="checkbox"/>	<input type="checkbox"/>	79.6#
		60 x 56	USMB1R6056	<input type="checkbox"/>	<input type="checkbox"/>	<input type="checkbox"/>	<input type="checkbox"/>	<input type="checkbox"/>	94.0#
		72 x 56	USMB1R7256	<input type="checkbox"/>	<input type="checkbox"/>	<input type="checkbox"/>	<input type="checkbox"/>	<input type="checkbox"/>	118.1#
USFR	<b>Segmented Fabric Panel - 64"H</b>	24 x 64	USMB1R2464	<input type="checkbox"/>	<input type="checkbox"/>	<input type="checkbox"/>	<input type="checkbox"/>	<input type="checkbox"/>	55.7#
		30 x 64	USMB1R3064	<input type="checkbox"/>	<input type="checkbox"/>	<input type="checkbox"/>	<input type="checkbox"/>	<input type="checkbox"/>	63.5#
		36 x 64	USMB1R3664	<input type="checkbox"/>	<input type="checkbox"/>	<input type="checkbox"/>	<input type="checkbox"/>	<input type="checkbox"/>	71.4#
		42 x 64	USMB1R4264	<input type="checkbox"/>	<input type="checkbox"/>	<input type="checkbox"/>	<input type="checkbox"/>	<input type="checkbox"/>	80.1#
		48 x 64	USMB1R4864	<input type="checkbox"/>	<input type="checkbox"/>	<input type="checkbox"/>	<input type="checkbox"/>	<input type="checkbox"/>	87.1#
		60 x 64	USMB1R6064	<input type="checkbox"/>	<input type="checkbox"/>	<input type="checkbox"/>	<input type="checkbox"/>	<input type="checkbox"/>	102.7#
		72 x 64	USMB1R7264	<input type="checkbox"/>	<input type="checkbox"/>	<input type="checkbox"/>	<input type="checkbox"/>	<input type="checkbox"/>	129.1#

**A**   **B**   **C**   **D**   **E**   **F**

## HOW TO ORDER

Indicate the following information on order form:

- Quantity of each item.
- Model number, including options. See "How To Build a Model Number".
- Any special service required.

Note: • The  indicates that a choice is required.

- The absence of the  indicates that no choice is required.
- Alpha-numeric characters in place of  indicate that no other alternatives are available.

## HOW TO BUILD A MODEL NUMBER

- A** Select basic model.
- B** Select top cap style.
 

<b>F</b>	- Flat trim (std)
<b>N</b>	- No topcap
- C** Select electrical code.
 

<b>CP</b>	- Chicago - with cutouts
<b>DN</b>	- Domestic - no cutouts
<b>DP</b>	- Domestic - with cutouts
<b>C1</b>	- Chicago, 1 side w/cutouts
<b>D1</b>	- Domestic, 1 side w/cutouts
- D** Select trim color. Refer to color addendum at ki.com or KI Fabrics & Finishes binder.
- E** Select fabric side 1. Refer to color addendum at ki.com or in KI Fabrics & Finishes binder.
- F** Select fabric side 2. Refer to color addendum at ki.com or in KI Fabrics & Finishes binder.



# Preconfigured Segmented Fabric Panel w/Markerboard on One Side

Standard Base Raceway

Delivered Pricing Fabric Grade 1 & C.O.M.	Delivered Pricing Fabric Grade 2	Delivered Pricing Fabric Grade 3 & Pallas Vertical Fabric Grade PV	Delivered Pricing Pallas Vertical Fabric Grade PV1	Delivered Pricing Pallas Vertical Fabric Grade PV2
\$ 512	\$ 544	\$ 577	\$ 611	\$ 634
580	618	654	692	720
622	662	701	743	771
689	733	778	822	853
724	771	817	863	896
943	1004	1065	1125	1168
1149	1223	1297	1371	1423
<hr/>				
\$ 573	\$ 610	\$ 646	\$ 683	\$ 710
632	673	713	754	783
679	723	766	810	842
736	785	832	879	914
844	897	951	1005	1043
1139	1211	1284	1360	1410
1255	1335	1416	1496	1553
<hr/>				
\$ 596	\$ 637	\$ 675	\$ 713	\$ 740
696	741	786	831	863
750	799	847	895	930
791	844	894	946	982
873	930	986	1042	1083
1183	1260	1336	1412	1467
1399	1488	1579	1670	1732

## SPECIAL SERVICES

### Special Carton Marking

With specially marked information N/C

### Shipping

Delivered. Shipped k.d. freight prepaid f.o.b. Manitowoc, Wisconsin 54220 factory. Freight class #70.

Specifications and prices are subject to change without prior notice.

# Preconfigured Segmented Fabric Panel w/Markerboard on One Side

Elevated Base

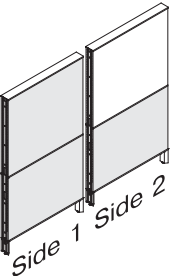
	MODEL	W x H	MODEL NUMBER					Approx. Packaged Weight
			Basic Model	Top Cap Style	Trim Color	Fabric Side 1	Fabric Side 2	
 <p>USFL</p>	<b>Segmented Fabric Panel - 48"H</b>	24 x 48	USMB1L2448	<input type="checkbox"/>	<input type="checkbox"/>	<input type="checkbox"/>	<input type="checkbox"/>	44.0#
	• Side 1: includes segmented tiles with identically specified fabric lower and upper segments	30 x 48	USMB1L3048	<input type="checkbox"/>	<input type="checkbox"/>	<input type="checkbox"/>	<input type="checkbox"/>	49.7#
	• Side 2: includes segmented tiles with fabric lower segments and steel markerboard upper segments	36 x 48	USMB1L3648	<input type="checkbox"/>	<input type="checkbox"/>	<input type="checkbox"/>	<input type="checkbox"/>	55.4#
	• Elevated base does not accept cable distribution	42 x 48	USMB1L4248	<input type="checkbox"/>	<input type="checkbox"/>	<input type="checkbox"/>	<input type="checkbox"/>	64.1#
	• Panel assembly includes frame, trim, and panel-to-panel connectors	48 x 48	USMB1L4848	<input type="checkbox"/>	<input type="checkbox"/>	<input type="checkbox"/>	<input type="checkbox"/>	66.8#
	• Trim is metal and includes top cap, bottom trim channel, segment channel, and foot shroud	60 x 48	USMB1L6048	<input type="checkbox"/>	<input type="checkbox"/>	<input type="checkbox"/>	<input type="checkbox"/>	78.2#
	• Side 1 and side 2 finishes are specified separately	72 x 48	USMB1L7248	<input type="checkbox"/>	<input type="checkbox"/>	<input type="checkbox"/>	<input type="checkbox"/>	97.8#
	• 72" wide panels feature split tiles							
USFL	<b>Segmented Fabric Panel - 56"H</b>	24 x 56	USMB1L2456	<input type="checkbox"/>	<input type="checkbox"/>	<input type="checkbox"/>	<input type="checkbox"/>	48.8#
		30 x 56	USMB1L3056	<input type="checkbox"/>	<input type="checkbox"/>	<input type="checkbox"/>	<input type="checkbox"/>	55.1#
		36 x 56	USMB1L3656	<input type="checkbox"/>	<input type="checkbox"/>	<input type="checkbox"/>	<input type="checkbox"/>	61.5#
		42 x 56	USMB1L4256	<input type="checkbox"/>	<input type="checkbox"/>	<input type="checkbox"/>	<input type="checkbox"/>	68.8#
		48 x 56	USMB1L4856	<input type="checkbox"/>	<input type="checkbox"/>	<input type="checkbox"/>	<input type="checkbox"/>	74.3#
		60 x 56	USMB1L6056	<input type="checkbox"/>	<input type="checkbox"/>	<input type="checkbox"/>	<input type="checkbox"/>	87.0#
		72 x 56	USMB1L7256	<input type="checkbox"/>	<input type="checkbox"/>	<input type="checkbox"/>	<input type="checkbox"/>	109.5#
USFL	<b>Segmented Fabric Panel - 64"H</b>	24 x 64	USMB1L2464	<input type="checkbox"/>	<input type="checkbox"/>	<input type="checkbox"/>	<input type="checkbox"/>	53.5#
		30 x 64	USMB1L3064	<input type="checkbox"/>	<input type="checkbox"/>	<input type="checkbox"/>	<input type="checkbox"/>	60.5#
		36 x 64	USMB1L3664	<input type="checkbox"/>	<input type="checkbox"/>	<input type="checkbox"/>	<input type="checkbox"/>	67.6#
		42 x 64	USMB1L4264	<input type="checkbox"/>	<input type="checkbox"/>	<input type="checkbox"/>	<input type="checkbox"/>	75.6#
		48 x 64	USMB1L4864	<input type="checkbox"/>	<input type="checkbox"/>	<input type="checkbox"/>	<input type="checkbox"/>	81.7#
		60 x 64	USMB1L6064	<input type="checkbox"/>	<input type="checkbox"/>	<input type="checkbox"/>	<input type="checkbox"/>	95.8#
		72 x 64	USMB1L7264	<input type="checkbox"/>	<input type="checkbox"/>	<input type="checkbox"/>	<input type="checkbox"/>	121.3#

**A**   **B**   **C**   **D**   **E**

## HOW TO ORDER

Indicate the following information on order form:

- Quantity of each item.
- Model number, including options. See "How To Build a Model Number".
- Any special service required.

Note: • The  indicates that a choice is required.

- The absence of the  indicates that no choice is required.
- Alpha-numeric characters in place of  indicate that no other alternatives are available.

## HOW TO BUILD A MODEL NUMBER

- A** Select basic model.
- B** Select top cap style.
 

<b>F</b>	- Flat trim (std)
<b>N</b>	- No topcap
- C** Select trim color. Refer to color addendum at [ki.com](http://ki.com) or KI Fabrics & Finishes binder.
- D** Select fabric side 1. Refer to color addendum at [ki.com](http://ki.com) or in KI Fabrics & Finishes binder.
- E** Select fabric side 2. Refer to color addendum at [ki.com](http://ki.com) or in KI Fabrics & Finishes binder.



Preconfigured Segmented Fabric Panel w/Markerboard on One Side

Elevated Base

Delivered Pricing Fabric Grade 1 & C.O.M.	Delivered Pricing Fabric Grade 2	Delivered Pricing Fabric Grade 3 & Pallas Vertical Fabric Grade PV	Delivered Pricing Pallas Vertical Fabric Grade PV1	Delivered Pricing Pallas Vertical Fabric Grade PV2
\$ 512	\$ 544	\$ 577	\$ 611	\$ 634
580	618	654	692	720
622	662	701	743	771
689	733	778	822	853
724	771	817	863	896
943	1004	1065	1125	1168
1149	1223	1297	1371	1423
\$ 573	\$ 610	\$ 646	\$ 683	\$ 710
632	673	713	754	783
679	723	766	810	842
736	785	832	879	914
844	897	951	1005	1043
1139	1211	1284	1360	1410
1255	1335	1416	1496	1553
\$ 596	\$ 637	\$ 675	\$ 713	\$ 740
696	741	786	831	863
750	799	847	895	930
791	844	894	946	982
873	930	986	1042	1083
1183	1260	1336	1412	1467
1399	1488	1579	1670	1732

**SPECIAL SERVICES**

**Special Carton Marking**

With specially marked information N/C

**Shipping**

Delivered. Shipped k.d. freight prepaid f.o.b. Manitowoc, Wisconsin 54220 factory. Freight class #70.

Specifications and prices are subject to change without prior notice.

# Preconfigured Segmented Fabric Panel w/Markerboard on One Side

Tile-to-Floor One Side; Standard Base Raceway One Side

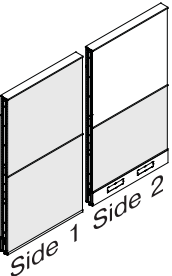
MODEL	W x H	MODEL NUMBER						Approx. Packaged Weight		
		Basic Model	Top Cap Style	Electrical Code	Trim Color	Fabric Side 1	Fabric Side 2			
 <p>USFT</p> <p><b>Segmented Fabric Panel - 48"H</b></p> <ul style="list-style-type: none"> <li>Side 1: includes tile-to-floor segmented tile with identically specified fabric upper and lower segments</li> <li>Side 2: includes segmented tiles with fabric lower and steel markerboard upper segment; standard base raceway accepts power and data cable distribution</li> <li>Panel assembly includes frame, trim, and panel-to-panel connectors</li> <li>Trim is metal and includes top cap, bottom trim channel, base raceway, and segment channel</li> <li>Side 1 and side 2 finishes are specified separately</li> <li>Upper and lower fabric finishes on side 1 must be identically specified</li> <li>Side 2: 30-72" wide tiles feature two power knockouts</li> <li>Side 2: 24" wide tiles feature one power knockout</li> <li>All 72" wide panels feature split tiles</li> <li>Electrical components are specified separately</li> </ul>	24 x 48	USMB1T2448	<input type="checkbox"/>	<input type="checkbox"/>	<input type="checkbox"/>	<input type="checkbox"/>	<input type="checkbox"/>	45.2#		
	30 x 48	USMB1T3048	<input type="checkbox"/>	<input type="checkbox"/>	<input type="checkbox"/>	<input type="checkbox"/>	<input type="checkbox"/>	51.3#		
	36 x 48	USMB1T3648	<input type="checkbox"/>	<input type="checkbox"/>	<input type="checkbox"/>	<input type="checkbox"/>	<input type="checkbox"/>	57.6#		
	42 x 48	USMB1T4248	<input type="checkbox"/>	<input type="checkbox"/>	<input type="checkbox"/>	<input type="checkbox"/>	<input type="checkbox"/>	66.8#		
	48 x 48	USMB1T4848	<input type="checkbox"/>	<input type="checkbox"/>	<input type="checkbox"/>	<input type="checkbox"/>	<input type="checkbox"/>	70.0#		
	60 x 48	USMB1T6048	<input type="checkbox"/>	<input type="checkbox"/>	<input type="checkbox"/>	<input type="checkbox"/>	<input type="checkbox"/>	82.4#		
	72 x 48	USMB1T7248	<input type="checkbox"/>	<input type="checkbox"/>	<input type="checkbox"/>	<input type="checkbox"/>	<input type="checkbox"/>	103.0#		
USFT	<b>Segmented Fabric Panel - 56"H</b>		24 x 56	USMB1T2456	<input type="checkbox"/>	<input type="checkbox"/>	<input type="checkbox"/>	<input type="checkbox"/>	<input type="checkbox"/>	49.9#
	30 x 56	USMB1T3056	<input type="checkbox"/>	<input type="checkbox"/>	<input type="checkbox"/>	<input type="checkbox"/>	<input type="checkbox"/>	56.8#		
	36 x 56	USMB1T3656	<input type="checkbox"/>	<input type="checkbox"/>	<input type="checkbox"/>	<input type="checkbox"/>	<input type="checkbox"/>	63.6#		
	42 x 56	USMB1T4256	<input type="checkbox"/>	<input type="checkbox"/>	<input type="checkbox"/>	<input type="checkbox"/>	<input type="checkbox"/>	71.5#		
	48 x 56	USMB1T4856	<input type="checkbox"/>	<input type="checkbox"/>	<input type="checkbox"/>	<input type="checkbox"/>	<input type="checkbox"/>	77.4#		
	60 x 56	USMB1T6056	<input type="checkbox"/>	<input type="checkbox"/>	<input type="checkbox"/>	<input type="checkbox"/>	<input type="checkbox"/>	91.2#		
	72 x 56	USMB1T7256	<input type="checkbox"/>	<input type="checkbox"/>	<input type="checkbox"/>	<input type="checkbox"/>	<input type="checkbox"/>	114.7#		
USFT	<b>Segmented Fabric Panel - 64"H</b>		24 x 64	USMB1T2464	<input type="checkbox"/>	<input type="checkbox"/>	<input type="checkbox"/>	<input type="checkbox"/>	<input type="checkbox"/>	54.7#
	30 x 64	USMB1T3064	<input type="checkbox"/>	<input type="checkbox"/>	<input type="checkbox"/>	<input type="checkbox"/>	<input type="checkbox"/>	62.2#		
	36 x 64	USMB1T3664	<input type="checkbox"/>	<input type="checkbox"/>	<input type="checkbox"/>	<input type="checkbox"/>	<input type="checkbox"/>	69.7#		
	42 x 64	USMB1T4264	<input type="checkbox"/>	<input type="checkbox"/>	<input type="checkbox"/>	<input type="checkbox"/>	<input type="checkbox"/>	78.2#		
	48 x 64	USMB1T4864	<input type="checkbox"/>	<input type="checkbox"/>	<input type="checkbox"/>	<input type="checkbox"/>	<input type="checkbox"/>	84.9#		
	60 x 64	USMB1T6064	<input type="checkbox"/>	<input type="checkbox"/>	<input type="checkbox"/>	<input type="checkbox"/>	<input type="checkbox"/>	100.0#		
	72 x 64	USMB1T7264	<input type="checkbox"/>	<input type="checkbox"/>	<input type="checkbox"/>	<input type="checkbox"/>	<input type="checkbox"/>	126.5#		

**A**   **B**   **C**   **D**   **E**   **F**

## HOW TO ORDER

Indicate the following information on order form:

- Quantity of each item.
- Model number, including options. See "How To Build a Model Number".
- Any special service required.

Note: • The  indicates that a choice is required.

- The absence of the  indicates that no choice is required.
- Alpha-numeric characters in place of  indicate that no other alternatives are available.

## HOW TO BUILD A MODEL NUMBER

- A** Select basic model.
- B** Select top cap style.
 

<b>F</b>	- Flat trim (std)
<b>N</b>	- No topcap
- C** Select electrical code.
 

<b>CP</b>	- Chicago - with cutouts
<b>DN</b>	- Domestic - no cutouts
<b>DP</b>	- Domestic - with cutouts
- D** Select trim color.  
Refer to color addendum at ki.com or KI Fabrics & Finishes binder.
- E** Select fabric side 1.  
Refer to color addendum at ki.com or in KI Fabrics & Finishes binder.
- F** Select fabric side 2.  
Refer to color addendum at ki.com or in KI Fabrics & Finishes binder.





# Preconfigured Segmented Fabric Panel w/Markerboard on One Side

Tile-to-Floor One Side; Standard Base Raceway One Side

Delivered Pricing Fabric Grade 1 & C.O.M.	Delivered Pricing Fabric Grade 2	Delivered Pricing Fabric Grade 3 & Pallas Vertical Fabric Grade PV	Delivered Pricing Pallas Vertical Fabric Grade PV1	Delivered Pricing Pallas Vertical Fabric Grade PV2
\$ 512	\$ 544	\$ 577	\$ 611	\$ 634
580	618	654	692	720
622	662	701	743	771
689	733	778	822	853
724	771	817	863	896
943	1004	1065	1125	1168
1149	1223	1297	1371	1423

\$ 573	\$ 610	\$ 646	\$ 683	\$ 710
632	673	713	754	783
679	723	766	810	842
736	785	832	879	914
844	897	951	1005	1043
1139	1211	1284	1360	1410
1255	1335	1416	1496	1553
\$ 596	\$ 637	\$ 675	\$ 713	\$ 740
696	741	786	831	863
750	799	847	895	930
791	844	894	946	982
873	930	986	1042	1083
1183	1260	1336	1412	1467
1399	1488	1579	1670	1732

### SPECIAL SERVICES

#### Special Carton Marking

With specially marked information     N/C

#### Shipping

Delivered. Shipped k.d. freight prepaid f.o.b. Manitowoc, Wisconsin 54220 factory. Freight class #70.

Specifications and prices are subject to change without prior notice.

# Preconfigured Segmented Fabric Panel w/Markerboard on Both Sides

Standard Base Raceway

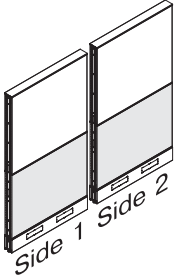
MODEL	W x H	MODEL NUMBER						Approx. Packaged Weight
		Basic Model	Top Cap Style	Electrical Code	Trim Color	Fabric Side 1	Fabric Side 2	
 <p>USFR</p>	<b>Segmented Fabric Panel - 48"H</b>							
	24 x 48	USMB2R2448	<input type="checkbox"/>	<input type="checkbox"/>	<input type="checkbox"/>	<input type="checkbox"/>	<input type="checkbox"/>	48.2#
	30 x 48	USMB2R3048	<input type="checkbox"/>	<input type="checkbox"/>	<input type="checkbox"/>	<input type="checkbox"/>	<input type="checkbox"/>	55.0#
	36 x 48	USMB2R3648	<input type="checkbox"/>	<input type="checkbox"/>	<input type="checkbox"/>	<input type="checkbox"/>	<input type="checkbox"/>	61.9#
	42 x 48	USMB2R4248	<input type="checkbox"/>	<input type="checkbox"/>	<input type="checkbox"/>	<input type="checkbox"/>	<input type="checkbox"/>	68.9#
	48 x 48	USMB2R4848	<input type="checkbox"/>	<input type="checkbox"/>	<input type="checkbox"/>	<input type="checkbox"/>	<input type="checkbox"/>	75.8#
	60 x 48	USMB2R6048	<input type="checkbox"/>	<input type="checkbox"/>	<input type="checkbox"/>	<input type="checkbox"/>	<input type="checkbox"/>	89.6#
72 x 48	USMB2R7248	<input type="checkbox"/>	<input type="checkbox"/>	<input type="checkbox"/>	<input type="checkbox"/>	<input type="checkbox"/>	111.9#	
USFR	<b>Segmented Fabric Panel - 56"H</b>							
	24 x 56	USMB2R2456	<input type="checkbox"/>	<input type="checkbox"/>	<input type="checkbox"/>	<input type="checkbox"/>	<input type="checkbox"/>	53.4#
	30 x 56	USMB2R3056	<input type="checkbox"/>	<input type="checkbox"/>	<input type="checkbox"/>	<input type="checkbox"/>	<input type="checkbox"/>	61.0#
	36 x 56	USMB2R3656	<input type="checkbox"/>	<input type="checkbox"/>	<input type="checkbox"/>	<input type="checkbox"/>	<input type="checkbox"/>	68.7#
	42 x 56	USMB2R4256	<input type="checkbox"/>	<input type="checkbox"/>	<input type="checkbox"/>	<input type="checkbox"/>	<input type="checkbox"/>	76.5#
	48 x 56	USMB2R4856	<input type="checkbox"/>	<input type="checkbox"/>	<input type="checkbox"/>	<input type="checkbox"/>	<input type="checkbox"/>	84.2#
	60 x 56	USMB2R6056	<input type="checkbox"/>	<input type="checkbox"/>	<input type="checkbox"/>	<input type="checkbox"/>	<input type="checkbox"/>	99.6#
72 x 56	USMB2R7256	<input type="checkbox"/>	<input type="checkbox"/>	<input type="checkbox"/>	<input type="checkbox"/>	<input type="checkbox"/>	125.0#	
USFR	<b>Segmented Fabric Panel - 64"H</b>							
	24 x 64	USMB2R2464	<input type="checkbox"/>	<input type="checkbox"/>	<input type="checkbox"/>	<input type="checkbox"/>	<input type="checkbox"/>	58.5#
	30 x 64	USMB2R3064	<input type="checkbox"/>	<input type="checkbox"/>	<input type="checkbox"/>	<input type="checkbox"/>	<input type="checkbox"/>	66.9#
	36 x 64	USMB2R3664	<input type="checkbox"/>	<input type="checkbox"/>	<input type="checkbox"/>	<input type="checkbox"/>	<input type="checkbox"/>	75.5#
	42 x 64	USMB2R4264	<input type="checkbox"/>	<input type="checkbox"/>	<input type="checkbox"/>	<input type="checkbox"/>	<input type="checkbox"/>	84.0#
	48 x 64	USMB2R4864	<input type="checkbox"/>	<input type="checkbox"/>	<input type="checkbox"/>	<input type="checkbox"/>	<input type="checkbox"/>	92.6#
	60 x 64	USMB2R6064	<input type="checkbox"/>	<input type="checkbox"/>	<input type="checkbox"/>	<input type="checkbox"/>	<input type="checkbox"/>	109.6#
72 x 64	USMB2R7264	<input type="checkbox"/>	<input type="checkbox"/>	<input type="checkbox"/>	<input type="checkbox"/>	<input type="checkbox"/>	138.1#	

**A**   **B**   **C**   **D**   **E**   **F**

## HOW TO ORDER

Indicate the following information on order form:

- Quantity of each item.
- Model number, including options. See "How To Build a Model Number".
- Any special service required.

Note: • The  indicates that a choice is required.

- The absence of the  indicates that no choice is required.
- Alpha-numeric characters in place of

indicate that no other alternatives are available.

## HOW TO BUILD A MODEL NUMBER

- A** Select basic model.
- B** Select top cap style.
 

<b>F</b>	- Flat trim (std)
<b>N</b>	- No topcap
- C** Select electrical code.
 

<b>CP</b>	- Chicago - with cutouts
<b>DN</b>	- Domestic - no cutouts
<b>DP</b>	- Domestic - with cutouts
<b>C1</b>	- Chicago, 1 side w/cutouts
<b>D1</b>	- Domestic, 1 side w/cutouts
- D** Select trim color. Refer to color addendum at ki.com or KI Fabrics & Finishes binder.
- E** Select fabric side 1. Refer to color addendum at ki.com or in KI Fabrics & Finishes binder.
- F** Select fabric side 2. Refer to color addendum at ki.com or in KI Fabrics & Finishes binder.



# Preconfigured Segmented Fabric Panel w/Markerboard on Both Sides

Standard Base Raceway

Delivered Pricing Fabric Grade 1 & C.O.M.	Delivered Pricing Fabric Grade 2	Delivered Pricing Fabric Grade 3 & Pallas Vertical Fabric Grade PV	Delivered Pricing Pallas Vertical Fabric Grade PV1	Delivered Pricing Pallas Vertical Fabric Grade PV2
\$ 569	\$ 607	\$ 643	\$ 679	\$ 705
648	690	732	775	803
688	731	777	820	851
752	801	849	897	932
806	858	908	961	999
1123	1197	1267	1340	1391
1273	1354	1436	1518	1577
\$ 671	\$ 713	\$ 756	\$ 799	\$ 830
716	760	806	852	887
757	806	855	902	937
799	850	901	953	990
998	1062	1125	1190	1236
1401	1489	1579	1670	1736
1411	1503	1592	1683	1748
\$ 674	\$ 718	\$ 759	\$ 803	\$ 834
781	831	880	931	966
821	873	927	980	1017
862	918	974	1029	1068
1003	1067	1132	1197	1243
1503	1598	1694	1791	1859
1537	1635	1733	1832	1902

## SPECIAL SERVICES

### Special Carton Marking

With specially marked information N/C

### Shipping

Delivered. Shipped **k.d. freight prepaid f.o.b. Manitowoc, Wisconsin 54220** factory. Freight class #70.

Specifications and prices are subject to change without prior notice.

# Preconfigured Segmented Fabric Panel w/Markerboard on Both Sides

Elevated Base

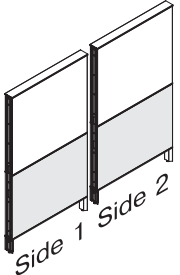
MODEL	W x H	MODEL NUMBER					Approx. Packaged Weight
		Basic Model	Top Cap Style	Trim Color	Fabric Side 1	Fabric Side 2	
 <p><b>Segmented Fabric Panel - 48"H</b></p> <ul style="list-style-type: none"> <li>Lower segment includes fabric tiles for both sides, specified separately</li> <li>Upper segments both feature steel markerboard</li> <li>Elevated base does not accept cable distribution</li> <li>Panel assembly includes frame, trim, and panel-to-panel connectors</li> <li>Trim is metal and includes top cap, bottom trim channel, segment channel, and foot shroud</li> <li>72" wide panels feature split tiles</li> </ul>	24 x 48	USMB2L2448	<input type="checkbox"/>	<input type="checkbox"/>	<input type="checkbox"/>	<input type="checkbox"/>	46.0#
	30 x 48	USMB2L3048	<input type="checkbox"/>	<input type="checkbox"/>	<input type="checkbox"/>	<input type="checkbox"/>	52.1#
	36 x 48	USMB2L3648	<input type="checkbox"/>	<input type="checkbox"/>	<input type="checkbox"/>	<input type="checkbox"/>	58.2#
	42 x 48	USMB2L4248	<input type="checkbox"/>	<input type="checkbox"/>	<input type="checkbox"/>	<input type="checkbox"/>	64.3#
	48 x 48	USMB2L4848	<input type="checkbox"/>	<input type="checkbox"/>	<input type="checkbox"/>	<input type="checkbox"/>	70.4#
	60 x 48	USMB2L6048	<input type="checkbox"/>	<input type="checkbox"/>	<input type="checkbox"/>	<input type="checkbox"/>	82.6#
	72 x 48	USMB2L7248	<input type="checkbox"/>	<input type="checkbox"/>	<input type="checkbox"/>	<input type="checkbox"/>	103.3#
USFL							
USFL	<b>Segmented Fabric Panel - 56"H</b>						
	24 x 56	USMB2L2456	<input type="checkbox"/>	<input type="checkbox"/>	<input type="checkbox"/>	<input type="checkbox"/>	51.1#
	30 x 56	USMB2L3056	<input type="checkbox"/>	<input type="checkbox"/>	<input type="checkbox"/>	<input type="checkbox"/>	58.0#
	36 x 56	USMB2L3656	<input type="checkbox"/>	<input type="checkbox"/>	<input type="checkbox"/>	<input type="checkbox"/>	64.9#
	42 x 56	USMB2L4256	<input type="checkbox"/>	<input type="checkbox"/>	<input type="checkbox"/>	<input type="checkbox"/>	71.9#
	48 x 56	USMB2L4856	<input type="checkbox"/>	<input type="checkbox"/>	<input type="checkbox"/>	<input type="checkbox"/>	78.8#
	60 x 56	USMB2L6056	<input type="checkbox"/>	<input type="checkbox"/>	<input type="checkbox"/>	<input type="checkbox"/>	92.6#
72 x 56	USMB2L7256	<input type="checkbox"/>	<input type="checkbox"/>	<input type="checkbox"/>	<input type="checkbox"/>	116.4#	
USFL	<b>Segmented Fabric Panel - 64"H</b>						
	24 x 64	USMB2L2464	<input type="checkbox"/>	<input type="checkbox"/>	<input type="checkbox"/>	<input type="checkbox"/>	56.3#
	30 x 64	USMB2L3064	<input type="checkbox"/>	<input type="checkbox"/>	<input type="checkbox"/>	<input type="checkbox"/>	64.0#
	36 x 64	USMB2L3664	<input type="checkbox"/>	<input type="checkbox"/>	<input type="checkbox"/>	<input type="checkbox"/>	71.7#
	42x 64	USMB2L4264	<input type="checkbox"/>	<input type="checkbox"/>	<input type="checkbox"/>	<input type="checkbox"/>	79.5#
	48 x 64	USMB2L4864	<input type="checkbox"/>	<input type="checkbox"/>	<input type="checkbox"/>	<input type="checkbox"/>	87.2#
	60 x 64	USMB2L6064	<input type="checkbox"/>	<input type="checkbox"/>	<input type="checkbox"/>	<input type="checkbox"/>	102.7#
72 x 64	USMB2L7264	<input type="checkbox"/>	<input type="checkbox"/>	<input type="checkbox"/>	<input type="checkbox"/>	129.6#	
			<b>A</b>	<b>B</b>	<b>C</b>	<b>D</b>	<b>E</b>

## HOW TO ORDER

Indicate the following information on order form:

- Quantity of each item.
- Model number, including options. See "How To Build a Model Number".
- Any special service required.

Note: • The  indicates that a choice is required.

- The absence of the  indicates that no choice is required.
- Alpha-numeric characters in place of  indicate that no other alternatives are available.

## HOW TO BUILD A MODEL NUMBER

- A** Select basic model.
- B** Select top cap style.
 

F	- Flat trim (std)
N	- No topcap
- C** Select trim color. Refer to color addendum at [ki.com](http://ki.com) or KI Fabrics & Finishes binder.
- D** Select fabric side 1. Refer to color addendum at [ki.com](http://ki.com) or in KI Fabrics & Finishes binder.
- E** Select fabric side 2. Refer to color addendum at [ki.com](http://ki.com) or in KI Fabrics & Finishes binder.



# Preconfigured Segmented Fabric Panel w/Markerboard on Both Sides

Elevated Base

Delivered Pricing Fabric Grade 1 & C.O.M.	Delivered Pricing Fabric Grade 2	Delivered Pricing Fabric Grade 3 & Pallas Vertical Fabric Grade PV	Delivered Pricing Pallas Vertical Fabric Grade PV1	Delivered Pricing Pallas Vertical Fabric Grade PV2
\$ 569	\$ 607	\$ 643	\$ 679	\$ 705
648	690	732	775	803
688	731	777	820	851
752	801	849	897	932
806	858	908	961	999
1123	1197	1267	1340	1391
1273	1354	1436	1518	1577
\$ 671	\$ 713	\$ 756	\$ 799	\$ 830
716	760	806	852	887
757	806	855	902	937
799	850	901	953	990
998	1062	1125	1190	1236
1401	1489	1579	1670	1736
1411	1503	1592	1683	1748
\$ 674	\$ 718	\$ 759	\$ 803	\$ 834
781	831	880	931	966
821	873	927	980	1017
862	918	974	1029	1068
1003	1067	1132	1197	1243
1503	1598	1694	1791	1859
1537	1635	1733	1832	1902

## SPECIAL SERVICES

### Special Carton Marking

With specially marked information N/C

### Shipping

Delivered. Shipped **k.d. freight prepaid f.o.b. Manitowoc, Wisconsin 54220** factory. Freight class #70.

Specifications and prices are subject to change without prior notice.

# Preconfigured Segmented Fabric Panel w/Perforated Steel Top

Standard Base Raceway

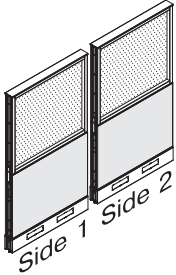

USFR

- Segmented Fabric Panel - 40"H**
- Lower segment includes fabric tiles for both sides, specified separately
  - Upper segment features single piece of perforated steel captured in frame
  - Perforated steel insert paint color is specified separately from trim, side 1 and side 2 are identical
  - Upper frame finish matches trim
  - Standard base raceway on both sides accepts power and data cable distribution
  - Panel assembly includes frame, trim, and panel-to-panel connectors
  - Trim is metal and includes top cap, bottom trim channel, base raceway, and segment channel
  - 30-72" wide panels feature two power knockouts per side
  - 24" wide panels feature one power knockout per side
  - 72" wide panels feature split tiles
  - Electrical components are specified separately

MODEL	W x H	MODEL NUMBER							Approx. Packaged Weight
		Basic Model	Top Cap Style	Electrical Code	Trim Color	Paint Color	Fabric Side 1	Fabric Side 2	
USFR	24 x 40	USFPR2440	<input type="checkbox"/>	<input type="checkbox"/>	<input type="checkbox"/>	<input type="checkbox"/>	<input type="checkbox"/>	<input type="checkbox"/>	46.5#
	30 x 40	USFPR3040	<input type="checkbox"/>	<input type="checkbox"/>	<input type="checkbox"/>	<input type="checkbox"/>	<input type="checkbox"/>	<input type="checkbox"/>	53.2#
	36 x 40	USFPR3640	<input type="checkbox"/>	<input type="checkbox"/>	<input type="checkbox"/>	<input type="checkbox"/>	<input type="checkbox"/>	<input type="checkbox"/>	60.0#
	42 x 40	USFPR4240	<input type="checkbox"/>	<input type="checkbox"/>	<input type="checkbox"/>	<input type="checkbox"/>	<input type="checkbox"/>	<input type="checkbox"/>	66.8#
	48 x 40	USFPR4840	<input type="checkbox"/>	<input type="checkbox"/>	<input type="checkbox"/>	<input type="checkbox"/>	<input type="checkbox"/>	<input type="checkbox"/>	73.6#
	60 x 40	USFPR6040	<input type="checkbox"/>	<input type="checkbox"/>	<input type="checkbox"/>	<input type="checkbox"/>	<input type="checkbox"/>	<input type="checkbox"/>	87.2#
	72 x 40	USFPR7240	<input type="checkbox"/>	<input type="checkbox"/>	<input type="checkbox"/>	<input type="checkbox"/>	<input type="checkbox"/>	<input type="checkbox"/>	105.8#
USFR	24 x 48	USFPR2448	<input type="checkbox"/>	<input type="checkbox"/>	<input type="checkbox"/>	<input type="checkbox"/>	<input type="checkbox"/>	<input type="checkbox"/>	54.7#
	30 x 48	USFPR3048	<input type="checkbox"/>	<input type="checkbox"/>	<input type="checkbox"/>	<input type="checkbox"/>	<input type="checkbox"/>	<input type="checkbox"/>	62.6#
	36 x 48	USFPR3648	<input type="checkbox"/>	<input type="checkbox"/>	<input type="checkbox"/>	<input type="checkbox"/>	<input type="checkbox"/>	<input type="checkbox"/>	70.5#
	42 x 48	USFPR4248	<input type="checkbox"/>	<input type="checkbox"/>	<input type="checkbox"/>	<input type="checkbox"/>	<input type="checkbox"/>	<input type="checkbox"/>	78.5#
	48 x 48	USFPR4848	<input type="checkbox"/>	<input type="checkbox"/>	<input type="checkbox"/>	<input type="checkbox"/>	<input type="checkbox"/>	<input type="checkbox"/>	86.4#
	60 x 48	USFPR6048	<input type="checkbox"/>	<input type="checkbox"/>	<input type="checkbox"/>	<input type="checkbox"/>	<input type="checkbox"/>	<input type="checkbox"/>	102.2#
	72 x 48	USFPR7248	<input type="checkbox"/>	<input type="checkbox"/>	<input type="checkbox"/>	<input type="checkbox"/>	<input type="checkbox"/>	<input type="checkbox"/>	124.3#
USFR	24 x 56	USFPR2456	<input type="checkbox"/>	<input type="checkbox"/>	<input type="checkbox"/>	<input type="checkbox"/>	<input type="checkbox"/>	<input type="checkbox"/>	62.9#
	30 x 56	USFPR3056	<input type="checkbox"/>	<input type="checkbox"/>	<input type="checkbox"/>	<input type="checkbox"/>	<input type="checkbox"/>	<input type="checkbox"/>	71.9#
	36 x 56	USFPR3656	<input type="checkbox"/>	<input type="checkbox"/>	<input type="checkbox"/>	<input type="checkbox"/>	<input type="checkbox"/>	<input type="checkbox"/>	81.0#
	42 x 56	USFPR4256	<input type="checkbox"/>	<input type="checkbox"/>	<input type="checkbox"/>	<input type="checkbox"/>	<input type="checkbox"/>	<input type="checkbox"/>	90.1#
	48 x 56	USFPR4856	<input type="checkbox"/>	<input type="checkbox"/>	<input type="checkbox"/>	<input type="checkbox"/>	<input type="checkbox"/>	<input type="checkbox"/>	99.1#
	60 x 56	USFPR6056	<input type="checkbox"/>	<input type="checkbox"/>	<input type="checkbox"/>	<input type="checkbox"/>	<input type="checkbox"/>	<input type="checkbox"/>	117.2#
	72 x 56	USFPR7256	<input type="checkbox"/>	<input type="checkbox"/>	<input type="checkbox"/>	<input type="checkbox"/>	<input type="checkbox"/>	<input type="checkbox"/>	142.9#

**A**   **B**   **C**   **D**   **E**   **F**   **G**

## HOW TO ORDER

Indicate the following information on order form:

1. Quantity of each item.
2. Model number, including options. See "How To Build a Model Number".
3. Any special service required.

Note: • The  indicates that a choice is required.

- The absence of the  indicates that no choice is required.
- Alpha-numeric characters in place of  indicate that no other alternatives are available.

## HOW TO BUILD A MODEL NUMBER

**A** Select basic model.

**B** Select top cap style.

- F** - Flat trim (std)
- N** - No topcap

**C** Select electrical code.

- CP** - Chicago - with cutouts
- DN** - Domestic - no cutouts
- DP** - Domestic - with cutouts
- C1** - Chicago, 1 side w/cutouts
- D1** - Domestic, 1 side w/cutouts

**D** Select trim and frame color.

Refer to color addendum at ki.com or KI Fabrics & Finishes binder.

**E** Select perforated steel paint color.

Refer to color addendum at ki.com or KI Fabrics & Finishes binder.

**F** Select fabric side 1.

Refer to color addendum at ki.com or in KI Fabrics & Finishes binder.

**G** Select fabric side 2.

Refer to color addendum at ki.com or in KI Fabrics & Finishes binder.



# Preconfigured Segmented Fabric Panel w/Perforated Steel Top

Standard Base Raceway

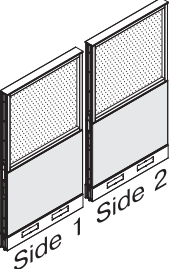
MODEL	W x H	Basic Model	MODEL NUMBER						Approx. Packaged Weight
			Top Cap Style	Electrical Code	Trim Color	Paint Color	Fabric Side 1	Fabric Side 2	
 USFR <ul style="list-style-type: none"> <li>Segmented Fabric Panel - 64"H</li> <li>Lower segment includes fabric tiles for both sides, specified separately</li> <li>Upper segment features single piece of perforated steel captured in frame</li> <li>Perforated steel insert paint color is specified separately from trim, side 1 and side 2 are identical</li> <li>Upper frame finish matches trim</li> <li>Standard base raceway on both sides accepts power and data cable distribution</li> <li>Panel assembly includes frame, trim, and panel-to-panel connectors</li> <li>Trim is metal and includes top cap, bottom trim channel, base raceway, and segment channel</li> <li>30-72" wide panels feature two power knockouts per side</li> <li>24" wide panels feature one power knockout per side</li> <li>72" wide panels feature split tiles</li> <li>Electrical components are specified separately</li> </ul>	24 x 64	USFPR2464	<input type="checkbox"/>	<input type="checkbox"/>	<input type="checkbox"/>	<input type="checkbox"/>	<input type="checkbox"/>	<input type="checkbox"/>	71.1#
	30 x 64	USFPR3064	<input type="checkbox"/>	<input type="checkbox"/>	<input type="checkbox"/>	<input type="checkbox"/>	<input type="checkbox"/>	<input type="checkbox"/>	81.2#
	36 x 64	USFPR3664	<input type="checkbox"/>	<input type="checkbox"/>	<input type="checkbox"/>	<input type="checkbox"/>	<input type="checkbox"/>	<input type="checkbox"/>	91.4#
	42 x 64	USFPR4264	<input type="checkbox"/>	<input type="checkbox"/>	<input type="checkbox"/>	<input type="checkbox"/>	<input type="checkbox"/>	<input type="checkbox"/>	101.7#
	48 x 64	USFPR4864	<input type="checkbox"/>	<input type="checkbox"/>	<input type="checkbox"/>	<input type="checkbox"/>	<input type="checkbox"/>	<input type="checkbox"/>	111.9#
	60 x 64	USFPR6064	<input type="checkbox"/>	<input type="checkbox"/>	<input type="checkbox"/>	<input type="checkbox"/>	<input type="checkbox"/>	<input type="checkbox"/>	132.3#
	72 x 64	USFPR7264	<input type="checkbox"/>	<input type="checkbox"/>	<input type="checkbox"/>	<input type="checkbox"/>	<input type="checkbox"/>	<input type="checkbox"/>	161.5#
			<b>A</b>	<b>B</b>	<b>C</b>	<b>D</b>	<b>E</b>	<b>F</b>	<b>G</b>

## HOW TO ORDER

Indicate the following information on order form:

- Quantity of each item.
- Model number, including options. See "How To Build a Model Number".
- Any special service required.

Note:

- The  indicates that a choice is required.
- The absence of the  indicates that no choice is required.
- Alpha-numeric characters in place of  indicate that no other alternatives are available.

## HOW TO BUILD A MODEL NUMBER

**A** Select basic model.

**B** Select top cap style.

**F** - Flat trim (std)

**N** - No topcap

**C** Select electrical code.

**CP** - Chicago - with cutouts

**DN** - Domestic - no cutouts

**DP** - Domestic - with cutouts

**C1** - Chicago, 1 side w/cutouts

**D1** - Domestic, 1 side w/cutouts

**D** Select trim and frame color.

Refer to color addendum at ki.com or KI Fabrics & Finishes binder.

**E** Select perforated steel paint color.

Refer to color addendum at ki.com or KI Fabrics & Finishes binder.

**F** Select fabric side 1.

Refer to color addendum at ki.com or in KI Fabrics & Finishes binder.

**G** Select fabric side 2.

Refer to color addendum at ki.com or in KI Fabrics & Finishes binder.





# Preconfigured Segmented Fabric Panel w/Perforated Steel Top

Standard Base Raceway

Delivered Pricing Fabric Grade 1 & C.O.M.	Delivered Pricing Fabric Grade 2	Delivered Pricing Fabric Grade 3 & Pallas Vertical Fabric Grade PV	Delivered Pricing Pallas Vertical Fabric Grade PV1	Delivered Pricing Pallas Vertical Fabric Grade PV2
\$ 824	\$ 878	\$ 931	\$ 984	\$ 1021
932	991	1051	1111	1154
1041	1109	1175	1243	1291
1104	1174	1245	1317	1368
1166	1240	1315	1389	1445
1479	1575	1671	1764	1832
1803	1921	2035	2152	2234

**SPECIAL SERVICES**

**Special Carton Marking**

With specially marked information N/C

**Shipping**

Shipped k.d. freight prepaid f.o.b. Manitowoc, Wisconsin 54220 factory. Freight class #70.

Specifications and prices are subject to change without prior notice.

# Preconfigured Segmented Fabric Panel w/Perforated Steel Top

Elevated Base

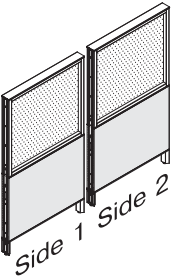
MODEL	W x H	MODEL NUMBER						Approx. Packaged Weight	
		Basic Model	Top Cap Style	Trim Color	Paint Color	Fabric Side 1	Fabric Side 2		
 <p>USFL</p> <p><b>Segmented Fabric Panel - 40"H</b></p> <ul style="list-style-type: none"> <li>Lower segment includes fabric tiles for both sides, specified separately</li> <li>Upper segment features single piece of perforated steel captured in frame</li> <li>Perforated steel insert paint color is specified separately from trim, side 1 and side 2 are identical</li> <li>Upper frame finish matches trim</li> <li>Elevated base does not accept cable distribution</li> <li>Panel assembly includes frame, trim, and panel-to-panel connectors</li> <li>Trim is metal and includes top cap, bottom trim channel, segment channel, and foot shroud</li> <li>72" wide panels feature split tiles</li> </ul>	24 x 40	USFPL2440	<input type="checkbox"/>	<input type="checkbox"/>	<input type="checkbox"/>	<input type="checkbox"/>	<input type="checkbox"/>	44.3#	
	30 x 40	USFPL3040	<input type="checkbox"/>	<input type="checkbox"/>	<input type="checkbox"/>	<input type="checkbox"/>	<input type="checkbox"/>	50.3#	
	36 x 40	USFPL3640	<input type="checkbox"/>	<input type="checkbox"/>	<input type="checkbox"/>	<input type="checkbox"/>	<input type="checkbox"/>	56.3#	
	42 x 40	USFPL4240	<input type="checkbox"/>	<input type="checkbox"/>	<input type="checkbox"/>	<input type="checkbox"/>	<input type="checkbox"/>	62.3#	
	48 x 40	USFPL4840	<input type="checkbox"/>	<input type="checkbox"/>	<input type="checkbox"/>	<input type="checkbox"/>	<input type="checkbox"/>	68.3#	
	60 x 40	USFPL6040	<input type="checkbox"/>	<input type="checkbox"/>	<input type="checkbox"/>	<input type="checkbox"/>	<input type="checkbox"/>	80.2#	
	72 x 40	USFPL7240	<input type="checkbox"/>	<input type="checkbox"/>	<input type="checkbox"/>	<input type="checkbox"/>	<input type="checkbox"/>	97.2#	
USFL	<b>Segmented Fabric Panel - 48"H</b>	24 x 48	USFPL2448	<input type="checkbox"/>	<input type="checkbox"/>	<input type="checkbox"/>	<input type="checkbox"/>	<input type="checkbox"/>	52.5#
	30 x 48	USFPL3048	<input type="checkbox"/>	<input type="checkbox"/>	<input type="checkbox"/>	<input type="checkbox"/>	<input type="checkbox"/>	59.6#	
	36 x 48	USFPL3648	<input type="checkbox"/>	<input type="checkbox"/>	<input type="checkbox"/>	<input type="checkbox"/>	<input type="checkbox"/>	66.7#	
	42 x 48	USFPL4248	<input type="checkbox"/>	<input type="checkbox"/>	<input type="checkbox"/>	<input type="checkbox"/>	<input type="checkbox"/>	73.9#	
	48 x 48	USFPL4848	<input type="checkbox"/>	<input type="checkbox"/>	<input type="checkbox"/>	<input type="checkbox"/>	<input type="checkbox"/>	81.0#	
	60 x 48	USFPL6048	<input type="checkbox"/>	<input type="checkbox"/>	<input type="checkbox"/>	<input type="checkbox"/>	<input type="checkbox"/>	95.2#	
USFL	<b>Segmented Fabric Panel - 56"H</b>	24 x 56	USFPL2456	<input type="checkbox"/>	<input type="checkbox"/>	<input type="checkbox"/>	<input type="checkbox"/>	<input type="checkbox"/>	60.7#
	30 x 56	USFPL3056	<input type="checkbox"/>	<input type="checkbox"/>	<input type="checkbox"/>	<input type="checkbox"/>	<input type="checkbox"/>	68.9#	
	36 x 56	USFPL3656	<input type="checkbox"/>	<input type="checkbox"/>	<input type="checkbox"/>	<input type="checkbox"/>	<input type="checkbox"/>	77.2#	
	42 x 56	USFPL4256	<input type="checkbox"/>	<input type="checkbox"/>	<input type="checkbox"/>	<input type="checkbox"/>	<input type="checkbox"/>	85.5#	
	48 x 56	USFPL4856	<input type="checkbox"/>	<input type="checkbox"/>	<input type="checkbox"/>	<input type="checkbox"/>	<input type="checkbox"/>	93.8#	
	60 x 56	USFPL6056	<input type="checkbox"/>	<input type="checkbox"/>	<input type="checkbox"/>	<input type="checkbox"/>	<input type="checkbox"/>	110.3#	
	72 x 56	USFPL7256	<input type="checkbox"/>	<input type="checkbox"/>	<input type="checkbox"/>	<input type="checkbox"/>	<input type="checkbox"/>	134.3#	

**A**   **B**   **C**   **D**   **E**   **F**

## HOW TO ORDER

Indicate the following information on order form:

- Quantity of each item.
- Model number, including options. See "How To Build a Model Number".
- Any special service required.

Note: • The  indicates that a choice is required.

- The absence of the  indicates that no choice is required.
- Alpha-numeric characters in place of  indicate that no other alternatives are available.

## HOW TO BUILD A MODEL NUMBER

- A** Select basic model.
- B** Select top cap style.
 

<b>F</b>	- Flat trim (std)
<b>N</b>	- No topcap
- C** Select trim and frame color. Refer to color addendum at ki.com or KI Fabrics & Finishes binder.
- D** Select perforated steel paint color. Refer to color addendum at ki.com or KI Fabrics & Finishes binder.
- E** Select fabric side 1. Refer to color addendum at ki.com or in KI Fabrics & Finishes binder.
- F** Select fabric side 2. Refer to color addendum at ki.com or in KI Fabrics & Finishes binder.



# Preconfigured Segmented Fabric Panel w/Perforated Steel Top

Elevated Base

Delivered Pricing Fabric Grade 1 & C.O.M.	Delivered Pricing Fabric Grade 2	Delivered Pricing Fabric Grade 3 & Pallas Vertical Fabric Grade PV	Delivered Pricing Pallas Vertical Fabric Grade PV1	Delivered Pricing Pallas Vertical Fabric Grade PV2
\$ 642	\$ 683	\$ 725	\$ 766	\$ 794
703	750	794	840	872
792	844	895	946	983
845	899	953	1006	1045
900	957	1016	1073	1115
1042	1110	1176	1244	1292
1366	1454	1541	1628	1690
\$ 691	\$ 735	\$ 780	\$ 824	\$ 856
759	808	857	904	940
844	897	952	1005	1044
897	954	1010	1069	1110
986	1049	1112	1175	1221
1144	1216	1292	1365	1417
1464	1558	1651	1746	1814
\$ 743	\$ 789	\$ 837	\$ 886	\$ 920
815	867	920	972	1008
911	969	1028	1086	1127
973	1035	1096	1159	1204
1028	1093	1159	1225	1272
1243	1324	1404	1482	1540
1570	1672	1772	1873	1944

**SPECIAL SERVICES**

**Special Carton Marking**

With specially marked information N/C

**Shipping**

Delivered. Shipped k.d. freight prepaid f.o.b. Manitowoc, Wisconsin 54220 factory. Freight class #70.

Specifications and prices are subject to change without prior notice.

# Preconfigured Segmented Fabric Panel w/Perforated Steel Top

Elevated Base

MODEL	W x H	MODEL NUMBER						Approx. Packaged Weight
		Basic Model	Top Cap Style	Trim Color	Paint Color	Fabric Side 1	Fabric Side 2	
<b>Segmented Fabric Panel - 64"H</b> <ul style="list-style-type: none"> <li>Lower segment includes fabric tiles for both sides, specified separately</li> <li>Upper segment features single piece of perforated steel captured in frame</li> <li>Perforated steel insert paint color is specified separately from trim, side 1 and side 2 are identical</li> <li>Upper frame finish matches trim</li> <li>Elevated base does not accept cable distribution</li> <li>Panel assembly includes frame, trim, and panel-to-panel connectors</li> <li>Trim is metal and includes top cap, bottom trim channel, segment channel, and foot shroud</li> <li>72" wide panels feature split tiles</li> </ul>	24 x 64	USFPL2464	<input type="checkbox"/>	<input type="checkbox"/>	<input type="checkbox"/>	<input type="checkbox"/>	<input type="checkbox"/>	68.9#
	30 x 64	USFPL3064	<input type="checkbox"/>	<input type="checkbox"/>	<input type="checkbox"/>	<input type="checkbox"/>	<input type="checkbox"/>	78.3#
	36 x 64	USFPL3664	<input type="checkbox"/>	<input type="checkbox"/>	<input type="checkbox"/>	<input type="checkbox"/>	<input type="checkbox"/>	87.7#
	42 x 64	USFPL4264	<input type="checkbox"/>	<input type="checkbox"/>	<input type="checkbox"/>	<input type="checkbox"/>	<input type="checkbox"/>	97.1#
	48 x 64	USFPL4864	<input type="checkbox"/>	<input type="checkbox"/>	<input type="checkbox"/>	<input type="checkbox"/>	<input type="checkbox"/>	106.5#
	60 x 64	USFPL6064	<input type="checkbox"/>	<input type="checkbox"/>	<input type="checkbox"/>	<input type="checkbox"/>	<input type="checkbox"/>	125.3#
	72 x 64	USFPL7264	<input type="checkbox"/>	<input type="checkbox"/>	<input type="checkbox"/>	<input type="checkbox"/>	<input type="checkbox"/>	152.9#

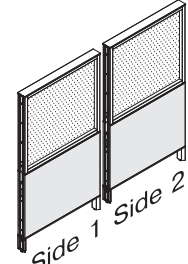

USFL

- A**
- B**
- C**
- D**
- E**
- F**

### HOW TO ORDER

- Indicate the following information on order form:
- Quantity of each item.
  - Model number, including options. See "How To Build a Model Number".
  - Any special service required.

Note:

- The  indicates that a choice is required.
- The absence of the  indicates that no choice is required.
- Alpha-numeric characters in place of  indicate that no other alternatives are available.

### HOW TO BUILD A MODEL NUMBER

- A** Select basic model.
- B** Select top cap style.
 

<b>F</b>	- Flat trim (std)
<b>N</b>	- No topcap
- C** Select trim and frame color. Refer to color addendum at ki.com or KI Fabrics & Finishes binder.
- D** Select perforated steel paint color. Refer to color addendum at ki.com or KI Fabrics & Finishes binder.
- E** Select fabric side 1. Refer to color addendum at ki.com or in KI Fabrics & Finishes binder.
- F** Select fabric side 2. Refer to color addendum at ki.com or in KI Fabrics & Finishes binder.



# Preconfigured Segmented Fabric Panel w/Perforated Steel Top

Elevated Base

Delivered Pricing Fabric Grade 1 & C.O.M.	Delivered Pricing Fabric Grade 2	Delivered Pricing Fabric Grade 3 & Pallas Vertical Fabric Grade PV	Delivered Pricing Pallas Vertical Fabric Grade PV1	Delivered Pricing Pallas Vertical Fabric Grade PV2
\$ 824	\$ 878	\$ 931	\$ 984	\$ 1021
932	991	1051	1111	1154
1041	1109	1175	1243	1291
1104	1174	1245	1317	1368
1166	1240	1315	1389	1445
1479	1575	1671	1764	1832
1803	1921	2035	2152	2234

**SPECIAL SERVICES**

**Special Carton Marking**

With specially marked information N/C

**Shipping**

Shipped k.d. freight prepaid f.o.b. Manitowoc, Wisconsin 54220 factory. Freight class #70.

Specifications and prices are subject to change without prior notice.

# Preconfigured Segmented Fabric Panel w/Perforated Steel Top

Tile-to-Floor One Side; Standard Base Raceway One Side

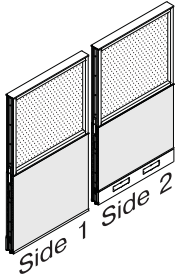

USFT

MODEL	W x H	MODEL NUMBER							Approx. Packaged Weight
		Basic Model	Top Cap Style	Electrical Code	Trim Color	Paint Color	Fabric Side 1	Fabric Side 2	
<b>Segmented Fabric Panel - 40"H</b> • Side 1: tile-to-floor base does not accept cable distribution • Side 2: standard base raceway accepts power and cable distribution • Lower segment includes fabric tiles for both sides, specified separately • Upper segment features single piece of perforated steel captured in frame • Perforated steel insert paint color is specified separately from trim, side 1 and side 2 are identical • Upper frame finish matches trim • Panel assembly includes frame, trim, and panel-to-panel connectors • Trim is metal and includes top cap, bottom trim channel, base raceway, and segment channel • Side 2: 30-72" wide tiles feature two power knockouts • Side 2: 24" wide tiles feature one base power knockout • 72" wide panels feature split tiles • Electrical components are specified separately	24 x 40	USFPT2440	<input type="checkbox"/>	<input type="checkbox"/>	<input type="checkbox"/>	<input type="checkbox"/>	<input type="checkbox"/>	<input type="checkbox"/>	45.5#
	30 x 40	USFPT3040	<input type="checkbox"/>	<input type="checkbox"/>	<input type="checkbox"/>	<input type="checkbox"/>	<input type="checkbox"/>	<input type="checkbox"/>	51.9#
	36 x 40	USFPT3640	<input type="checkbox"/>	<input type="checkbox"/>	<input type="checkbox"/>	<input type="checkbox"/>	<input type="checkbox"/>	<input type="checkbox"/>	58.4#
	42 x 40	USFPT4240	<input type="checkbox"/>	<input type="checkbox"/>	<input type="checkbox"/>	<input type="checkbox"/>	<input type="checkbox"/>	<input type="checkbox"/>	64.9#
	48 x 40	USFPT4840	<input type="checkbox"/>	<input type="checkbox"/>	<input type="checkbox"/>	<input type="checkbox"/>	<input type="checkbox"/>	<input type="checkbox"/>	71.4#
	60 x 40	USFPT6040	<input type="checkbox"/>	<input type="checkbox"/>	<input type="checkbox"/>	<input type="checkbox"/>	<input type="checkbox"/>	<input type="checkbox"/>	84.4#
	72 x 40	USFPT7240	<input type="checkbox"/>	<input type="checkbox"/>	<input type="checkbox"/>	<input type="checkbox"/>	<input type="checkbox"/>	<input type="checkbox"/>	102.4#
<b>Segmented Fabric Panel - 48"H</b>	24 x 48	USFPT2448	<input type="checkbox"/>	<input type="checkbox"/>	<input type="checkbox"/>	<input type="checkbox"/>	<input type="checkbox"/>	<input type="checkbox"/>	53.7#
	30 x 48	USFPT3048	<input type="checkbox"/>	<input type="checkbox"/>	<input type="checkbox"/>	<input type="checkbox"/>	<input type="checkbox"/>	<input type="checkbox"/>	61.3#
	36 x 48	USFPT3648	<input type="checkbox"/>	<input type="checkbox"/>	<input type="checkbox"/>	<input type="checkbox"/>	<input type="checkbox"/>	<input type="checkbox"/>	68.9#
	42 x 48	USFPT4248	<input type="checkbox"/>	<input type="checkbox"/>	<input type="checkbox"/>	<input type="checkbox"/>	<input type="checkbox"/>	<input type="checkbox"/>	76.6#
	48 x 48	USFPT4848	<input type="checkbox"/>	<input type="checkbox"/>	<input type="checkbox"/>	<input type="checkbox"/>	<input type="checkbox"/>	<input type="checkbox"/>	84.2#
	60 x 48	USFPT6048	<input type="checkbox"/>	<input type="checkbox"/>	<input type="checkbox"/>	<input type="checkbox"/>	<input type="checkbox"/>	<input type="checkbox"/>	99.4#
	72 x 48	USFPT7248	<input type="checkbox"/>	<input type="checkbox"/>	<input type="checkbox"/>	<input type="checkbox"/>	<input type="checkbox"/>	<input type="checkbox"/>	121.0#
<b>Segmented Fabric Panel - 56"H</b>	24 x 56	USFPT2456	<input type="checkbox"/>	<input type="checkbox"/>	<input type="checkbox"/>	<input type="checkbox"/>	<input type="checkbox"/>	<input type="checkbox"/>	61.9#
	30 x 56	USFPT3056	<input type="checkbox"/>	<input type="checkbox"/>	<input type="checkbox"/>	<input type="checkbox"/>	<input type="checkbox"/>	<input type="checkbox"/>	70.6#
	36 x 56	USFPT3656	<input type="checkbox"/>	<input type="checkbox"/>	<input type="checkbox"/>	<input type="checkbox"/>	<input type="checkbox"/>	<input type="checkbox"/>	79.4#
	42 x 56	USFPT4256	<input type="checkbox"/>	<input type="checkbox"/>	<input type="checkbox"/>	<input type="checkbox"/>	<input type="checkbox"/>	<input type="checkbox"/>	88.2#
	48 x 56	USFPT4856	<input type="checkbox"/>	<input type="checkbox"/>	<input type="checkbox"/>	<input type="checkbox"/>	<input type="checkbox"/>	<input type="checkbox"/>	96.9#
	60 x 56	USFPT6056	<input type="checkbox"/>	<input type="checkbox"/>	<input type="checkbox"/>	<input type="checkbox"/>	<input type="checkbox"/>	<input type="checkbox"/>	114.5#
	72 x 56	USFPT7256	<input type="checkbox"/>	<input type="checkbox"/>	<input type="checkbox"/>	<input type="checkbox"/>	<input type="checkbox"/>	<input type="checkbox"/>	139.5#

**A**   **B**   **C**   **D**   **E**   **F**   **G**

## HOW TO ORDER

Indicate the following information on order form:

- Quantity of each item.
- Model number, including options. See "How To Build a Model Number".
- Any special service required.

Note: • The  indicates that a choice is required.

- The absence of the  indicates that no choice is required.
- Alpha-numeric characters in place of  indicate that no other alternatives are available.

## HOW TO BUILD A MODEL NUMBER

**A** Select basic model.

**B** Select top cap style.

- F** - Flat trim (std)
- N** - No topcap

**C** Select electrical code.

- CP** - Chicago - with cutouts
- DN** - Domestic - no cutouts
- DP** - Domestic - with cutouts

**D** Select trim and frame color.

Refer to color addendum at ki.com or KI Fabrics & Finishes binder.

**E** Select perforated steel paint color.

Refer to color addendum at ki.com or KI Fabrics & Finishes binder.

**F** Select fabric side 1.

Refer to color addendum at ki.com or in KI Fabrics & Finishes binder.

**G** Select fabric side 2.

Refer to color addendum at ki.com or in KI Fabrics & Finishes binder.



# Preconfigured Segmented Fabric Panel w/Perforated Steel Top

Tile-to-Floor One Side; Standard Base Raceway One Side

Delivered Pricing Fabric Grade 1 & C.O.M.	Delivered Pricing Fabric Grade 2	Delivered Pricing Fabric Grade 3 & Pallas Vertical Fabric Grade PV	Delivered Pricing Pallas Vertical Fabric Grade PV1	Delivered Pricing Pallas Vertical Fabric Grade PV2
\$ 642	\$ 683	\$ 725	\$ 766	\$ 794
703	750	794	840	872
792	844	895	946	983
845	899	953	1006	1045
900	957	1016	1073	1115
1042	1110	1176	1244	1292
1366	1454	1541	1628	1690
<hr/>				
\$ 691	\$ 735	\$ 780	\$ 824	\$ 856
759	808	857	904	940
844	897	952	1005	1044
897	954	1010	1069	1110
986	1049	1112	1175	1221
1144	1216	1292	1365	1417
1464	1558	1651	1746	1814
<hr/>				
\$ 743	\$ 789	\$ 837	\$ 886	\$ 920
815	867	920	972	1008
911	969	1028	1086	1127
973	1035	1096	1159	1204
1028	1093	1159	1225	1272
1243	1324	1404	1482	1540
1570	1672	1772	1873	1944

**SPECIAL SERVICES**

**Special Carton Marking**

With specially marked information N/C

**Shipping**

Delivered. Shipped **k.d. freight prepaid f.o.b. Manitowoc, Wisconsin 54220** factory. Freight class #70.

Specifications and prices are subject to change without prior notice.

# Preconfigured Segmented Fabric Panel w/Perforated Steel Top

Tile-to-Floor One Side; Standard Base Raceway One Side

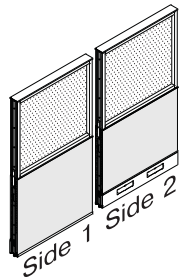

USFT

**MODEL**

**W x H**

- Segmented Fabric Panel - 64"H**
- Side 1: tile-to-floor base does not accept cable distribution
  - Side 2: standard base raceway accepts power and cable distribution
  - Lower segment includes fabric tiles for both sides, specified separately
  - Upper segment features single piece of perforated steel captured in frame
  - Perforated steel insert paint color is specified separately from trim, side 1 and side 2 are identical
  - Upper frame finish matches trim
  - Panel assembly includes frame, trim, and panel-to-panel connectors
  - Trim is metal and includes top cap, bottom trim channel, base raceway, and segment channel
  - Side 2: 30-72" wide tiles feature two power knockouts
  - Side 2: 24" wide tiles feature one base power knockout
  - 72" wide panels feature split tiles
  - Electrical components are specified separately

**MODEL NUMBER**

Basic Model	Top Cap Style	Electrical Code	Trim Color	Paint Color	Fabric Side 1	Fabric Side 2
USFPT2464	<input type="checkbox"/>	<input type="checkbox"/>	<input type="checkbox"/>	<input type="checkbox"/>	<input type="checkbox"/>	<input type="checkbox"/>
USFPT3064	<input type="checkbox"/>	<input type="checkbox"/>	<input type="checkbox"/>	<input type="checkbox"/>	<input type="checkbox"/>	<input type="checkbox"/>
USFPT3664	<input type="checkbox"/>	<input type="checkbox"/>	<input type="checkbox"/>	<input type="checkbox"/>	<input type="checkbox"/>	<input type="checkbox"/>
USFPT4264	<input type="checkbox"/>	<input type="checkbox"/>	<input type="checkbox"/>	<input type="checkbox"/>	<input type="checkbox"/>	<input type="checkbox"/>
USFPT4864	<input type="checkbox"/>	<input type="checkbox"/>	<input type="checkbox"/>	<input type="checkbox"/>	<input type="checkbox"/>	<input type="checkbox"/>
USFPT6064	<input type="checkbox"/>	<input type="checkbox"/>	<input type="checkbox"/>	<input type="checkbox"/>	<input type="checkbox"/>	<input type="checkbox"/>
USFPT7264	<input type="checkbox"/>	<input type="checkbox"/>	<input type="checkbox"/>	<input type="checkbox"/>	<input type="checkbox"/>	<input type="checkbox"/>

Approx. Packaged Weight

**A B C D E F G**

**HOW TO ORDER**

Indicate the following information on order form:

1. Quantity of each item.
2. Model number, including options. See "How To Build a Model Number".
3. Any special service required.

- Note:
- The  indicates that a choice is required.
  - The absence of the  indicates that no choice is required.
  - Alpha-numeric characters in place of  indicate that no other alternatives are available.

**HOW TO BUILD A MODEL NUMBER**

- A** Select basic model.
- B** Select top cap style.  

<b>F</b> _____	- Flat trim (std)
<b>N</b> _____	- No topcap
- C** Select electrical code.  

<b>CP</b> _____	- Chicago - with cutouts
<b>DN</b> _____	- Domestic - no cutouts
<b>DP</b> _____	- Domestic - with cutouts
- D** Select trim and frame color.  
 Refer to color addendum at ki.com or KI Fabrics & Finishes binder.
- E** Select perforated steel paint color.  
 Refer to color addendum at ki.com or KI Fabrics & Finishes binder.
- F** Select fabric side 1.  
 Refer to color addendum at ki.com or in KI Fabrics & Finishes binder.
- G** Select fabric side 2.  
 Refer to color addendum at ki.com or in KI Fabrics & Finishes binder.





# Preconfigured Segmented Fabric Panel w/Perforated Steel Top

Tile-to-Floor One Side; Standard Base Raceway One Side

Delivered Pricing Fabric Grade 1 & C.O.M.	Delivered Pricing Fabric Grade 2	Delivered Pricing Fabric Grade 3 & Pallas Vertical Fabric Grade PV	Delivered Pricing Pallas Vertical Fabric Grade PV1	Delivered Pricing Pallas Vertical Fabric Grade PV2
\$ 824	\$ 878	\$ 931	\$ 984	\$ 1021
932	991	1051	1111	1154
1041	1109	1175	1243	1291
1104	1174	1245	1317	1368
1166	1240	1315	1389	1445
1479	1575	1671	1764	1832
1803	1921	2035	2152	2234

## SPECIAL SERVICES

### Special Carton Marking

With specially marked information N/C

### Shipping

Shipped **k.d. freight prepaid f.o.b. Manitowoc, Wisconsin 54220** factory. Freight class #70.

Specifications and prices are subject to change without prior notice.

# Preconfigured Segmented Fabric Panel w/Slat Wall on One Side

Standard Base Raceway

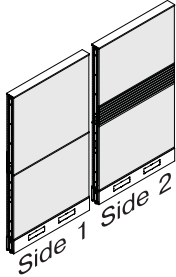

USFR

MODEL	W x H	MODEL NUMBER							Approx. Packaged Weight	
		Basic Model	Top Cap Style	Electrical Code	Trim Color	Slat Wall Finish	Fabric Side 1	Fabric Side 2		
<b>Segmented Fabric Panel - 40"H</b> • Lower segment includes fabric tiles for both sides, specified separately • Upper segment features slatwall on lowest 8" of tile, and fabric on remaining segment height • Upper and lower fabric segments on each side must be identically specified • Slatwall paint finish is specified • Standard base raceway on both sides accepts power and data cable distribution • Panel assembly includes frame, trim, and panel-to-panel connectors • Trim is metal and includes top cap, bottom trim channel, base raceway, and segment channel • 30-72" wide panels feature two power knockouts per side • 24" wide panels feature one power knockout per side • 72" wide panels feature split tiles • Electrical components are specified separately	24 x 40	USSW1R2440	<input type="checkbox"/>	<input type="checkbox"/>	<input type="checkbox"/>	<input type="checkbox"/>	<input type="checkbox"/>	<input type="checkbox"/>	42.8#	
	30 x 40	USSW1R3040	<input type="checkbox"/>	<input type="checkbox"/>	<input type="checkbox"/>	<input type="checkbox"/>	<input type="checkbox"/>	<input type="checkbox"/>	49.0#	
	36 x 40	USSW1R3640	<input type="checkbox"/>	<input type="checkbox"/>	<input type="checkbox"/>	<input type="checkbox"/>	<input type="checkbox"/>	<input type="checkbox"/>	55.3#	
	42 x 40	USSW1R4240	<input type="checkbox"/>	<input type="checkbox"/>	<input type="checkbox"/>	<input type="checkbox"/>	<input type="checkbox"/>	<input type="checkbox"/>	61.7#	
	48 x 40	USSW1R4840	<input type="checkbox"/>	<input type="checkbox"/>	<input type="checkbox"/>	<input type="checkbox"/>	<input type="checkbox"/>	<input type="checkbox"/>	68.0#	
	60 x 40	USSW1R6040	<input type="checkbox"/>	<input type="checkbox"/>	<input type="checkbox"/>	<input type="checkbox"/>	<input type="checkbox"/>	<input type="checkbox"/>	80.6#	
	72 x 40	USSW1R7240	<input type="checkbox"/>	<input type="checkbox"/>	<input type="checkbox"/>	<input type="checkbox"/>	<input type="checkbox"/>	<input type="checkbox"/>	99.1#	
USFR	<b>Segmented Fabric Panel - 48"H</b>		24 x 48	USSW1R2448	<input type="checkbox"/>	<input type="checkbox"/>	<input type="checkbox"/>	<input type="checkbox"/>	<input type="checkbox"/>	47.4#
			30 x 48	USSW1R3048	<input type="checkbox"/>	<input type="checkbox"/>	<input type="checkbox"/>	<input type="checkbox"/>	<input type="checkbox"/>	54.1#
			36 x 48	USSW1R3648	<input type="checkbox"/>	<input type="checkbox"/>	<input type="checkbox"/>	<input type="checkbox"/>	<input type="checkbox"/>	60.9#
			42 x 48	USSW1R4248	<input type="checkbox"/>	<input type="checkbox"/>	<input type="checkbox"/>	<input type="checkbox"/>	<input type="checkbox"/>	67.8#
			48 x 48	USSW1R4848	<input type="checkbox"/>	<input type="checkbox"/>	<input type="checkbox"/>	<input type="checkbox"/>	<input type="checkbox"/>	74.7#
			60 x 48	USSW1R6048	<input type="checkbox"/>	<input type="checkbox"/>	<input type="checkbox"/>	<input type="checkbox"/>	<input type="checkbox"/>	88.4#
			72 x 48	USSW1R7248	<input type="checkbox"/>	<input type="checkbox"/>	<input type="checkbox"/>	<input type="checkbox"/>	<input type="checkbox"/>	109.9#
USFR	<b>Segmented Fabric Panel - 56"H</b>		24 x 56	USSW1R2456	<input type="checkbox"/>	<input type="checkbox"/>	<input type="checkbox"/>	<input type="checkbox"/>	<input type="checkbox"/>	52.2#
			30 x 56	USSW1R3056	<input type="checkbox"/>	<input type="checkbox"/>	<input type="checkbox"/>	<input type="checkbox"/>	<input type="checkbox"/>	59.5#
			36 x 56	USSW1R3656	<input type="checkbox"/>	<input type="checkbox"/>	<input type="checkbox"/>	<input type="checkbox"/>	<input type="checkbox"/>	66.8#
			42 x 56	USSW1R4256	<input type="checkbox"/>	<input type="checkbox"/>	<input type="checkbox"/>	<input type="checkbox"/>	<input type="checkbox"/>	74.2#
			48 x 56	USSW1R4856	<input type="checkbox"/>	<input type="checkbox"/>	<input type="checkbox"/>	<input type="checkbox"/>	<input type="checkbox"/>	81.6#
			60 x 56	USSW1R6056	<input type="checkbox"/>	<input type="checkbox"/>	<input type="checkbox"/>	<input type="checkbox"/>	<input type="checkbox"/>	96.4#
			72 x 56	USSW1R7256	<input type="checkbox"/>	<input type="checkbox"/>	<input type="checkbox"/>	<input type="checkbox"/>	<input type="checkbox"/>	121.3#

**A** **B** **C** **D** **E** **F** **G**

## HOW TO ORDER

Indicate the following information on order form:

- Quantity of each item.
- Model number, including options. See "How To Build a Model Number".
- Any special service required.

Note: • The  indicates that a choice is required.

- The absence of the  indicates that no choice is required.
- Alpha-numeric characters in place of

indicate that no other alternatives are available.

## HOW TO BUILD A MODEL NUMBER

**A** Select basic model.

**B** Select top cap style.

- F** - Flat trim (std)
- N** - No topcap

**C** Select electrical code.

- CP** - Chicago - with cutouts
- DN** - Domestic - no cutouts
- DP** - Domestic - with cutouts
- C1** - Chicago, 1 side w/cutouts
- D1** - Domestic, 1 side w/cutouts

**D** Select trim color.

Refer to color addendum at ki.com or KI Fabrics & Finishes binder.

**E** Select paint finish for slat wall section.

Refer to color addendum at ki.com or KI Fabrics & Finishes binder.

**F** Select fabric side 1.

Refer to color addendum at ki.com or in KI Fabrics & Finishes binder.

**G** Select fabric side 2.

Refer to color addendum at ki.com or in KI Fabrics & Finishes binder.



# Preconfigured Segmented Fabric Panel w/Slat Wall on One Side

Standard Base Raceway

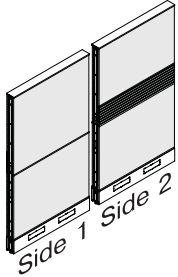

USFR

**MODEL**

**W x H**

- Segmented Fabric Panel - 64"H**
- Lower segment includes fabric tiles for both sides, specified separately
  - Upper segment features slatwall on lowest 8" of tile, and fabric on remaining segment height
  - Upper and lower fabric segments on each side must be identically specified
  - Slatwall paint finish is specified
  - Standard base raceway on both sides accepts power and data cable distribution
  - Panel assembly includes frame, trim, and panel-to-panel connectors
  - Trim is metal and includes top cap, bottom trim channel, base raceway, and segment channel
  - 30-72" wide panels feature two power knockouts per side
  - 24" wide panels feature one power knockout per side
  - 72" wide panels feature split tiles
  - Electrical components are specified separately

**MODEL NUMBER**

Basic Model	Top Cap Style	Electrical Code	Trim Color	Slat Wall Finish	Fabric Side 1	Fabric Side 2
USSW1R2464	<input type="checkbox"/>	<input type="checkbox"/>	<input type="checkbox"/>	<input type="checkbox"/>	<input type="checkbox"/>	<input type="checkbox"/>
USSW1R3064	<input type="checkbox"/>	<input type="checkbox"/>	<input type="checkbox"/>	<input type="checkbox"/>	<input type="checkbox"/>	<input type="checkbox"/>
USSW1R3664	<input type="checkbox"/>	<input type="checkbox"/>	<input type="checkbox"/>	<input type="checkbox"/>	<input type="checkbox"/>	<input type="checkbox"/>
USSW1R4264	<input type="checkbox"/>	<input type="checkbox"/>	<input type="checkbox"/>	<input type="checkbox"/>	<input type="checkbox"/>	<input type="checkbox"/>
USSW1R4864	<input type="checkbox"/>	<input type="checkbox"/>	<input type="checkbox"/>	<input type="checkbox"/>	<input type="checkbox"/>	<input type="checkbox"/>
USSW1R6064	<input type="checkbox"/>	<input type="checkbox"/>	<input type="checkbox"/>	<input type="checkbox"/>	<input type="checkbox"/>	<input type="checkbox"/>
USSW1R7264	<input type="checkbox"/>	<input type="checkbox"/>	<input type="checkbox"/>	<input type="checkbox"/>	<input type="checkbox"/>	<input type="checkbox"/>

Approx. Packaged Weight

**A** **B** **C** **D** **E** **F** **G**

**HOW TO ORDER**

Indicate the following information on order form:

1. Quantity of each item.
2. Model number, including options. See "How To Build a Model Number".
3. Any special service required.

Note: • The  indicates that a choice is required.  
 • The absence of the  indicates that no choice is required.  
 • Alpha-numeric characters in place of  indicate that no other alternatives are available.

**HOW TO BUILD A MODEL NUMBER**

- A** Select basic model.
- B** Select top cap style.  
 F - Flat trim (std)  
 N - No topcap
- C** Select electrical code.  
 CP - Chicago - with cutouts  
 DN - Domestic - no cutouts  
 DP - Domestic - with cutouts  
 C1 - Chicago, 1 side w/cutouts  
 D1 - Domestic, 1 side w/cutouts
- D** Select trim color.  
 Refer to color addendum at ki.com or KI Fabrics & Finishes binder.
- E** Select paint finish for slat wall section.  
 Refer to color addendum at ki.com or KI Fabrics & Finishes binder.
- F** Select fabric side 1.  
 Refer to color addendum at ki.com or in KI Fabrics & Finishes binder.

**G** Select fabric side 2.  
 Refer to color addendum at ki.com or in KI Fabrics & Finishes binder.



# Preconfigured Segmented Fabric Panel w/Slat Wall on One Side

Standard Base Raceway

Delivered Pricing Fabric Grade 1 & C.O.M.	Delivered Pricing Fabric Grade 2	Delivered Pricing Fabric Grade 3 & Pallas Vertical Fabric Grade PV	Delivered Pricing Pallas Vertical Fabric Grade PV1	Delivered Pricing Pallas Vertical Fabric Grade PV2
\$ 640	\$ 680	\$ 722	\$ 764	\$ 791
733	780	828	874	907
809	861	913	963	1002
892	950	1006	1064	1105
924	984	1041	1101	1144
1039	1105	1172	1240	1288
1510	1606	1704	1800	1870

**SPECIAL SERVICES**

**Special Carton Marking**

With specially marked information N/C

**Shipping**

Shipped k.d. freight prepaid f.o.b. Manitowoc, Wisconsin 54220 factory. Freight class #70.

Specifications and prices are subject to change without prior notice.

# Preconfigured Segmented Fabric Panel w/Slat Wall on One Side

Elevated Base

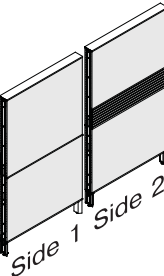
	MODEL	W x H	MODEL NUMBER						Approx. Packaged Weight	
			Basic Model	Top Cap Style	Trim Color	Slat Wall Finish	Fabric Side 1	Fabric Side 2		
 <p>USFL</p>	<b>Segmented Fabric Panel - 40"H</b>	24 x 40	USSW1L2440	<input type="checkbox"/>	<input type="checkbox"/>	<input type="checkbox"/>	<input type="checkbox"/>	<input type="checkbox"/>	<input type="checkbox"/>	40.6#
	• Lower segment includes fabric tiles for both sides, specified separately	30 x 40	USSW1L3040	<input type="checkbox"/>	<input type="checkbox"/>	<input type="checkbox"/>	<input type="checkbox"/>	<input type="checkbox"/>	<input type="checkbox"/>	46.1#
	• Upper segment features slatwall on lowest 8" of tile, and fabric on remaining segment height	36 x 40	USSW1L3640	<input type="checkbox"/>	<input type="checkbox"/>	<input type="checkbox"/>	<input type="checkbox"/>	<input type="checkbox"/>	<input type="checkbox"/>	51.6#
	• Upper and lower fabric segments on each side must be identically specified	42 x 40	USSW1L4240	<input type="checkbox"/>	<input type="checkbox"/>	<input type="checkbox"/>	<input type="checkbox"/>	<input type="checkbox"/>	<input type="checkbox"/>	57.1#
	• Slatwall paint finish is specified	48 x 40	USSW1L4840	<input type="checkbox"/>	<input type="checkbox"/>	<input type="checkbox"/>	<input type="checkbox"/>	<input type="checkbox"/>	<input type="checkbox"/>	62.7#
	• Elevated base does not accept cable distribution	60 x 40	USSW1L6040	<input type="checkbox"/>	<input type="checkbox"/>	<input type="checkbox"/>	<input type="checkbox"/>	<input type="checkbox"/>	<input type="checkbox"/>	73.7#
	• Panel assembly includes frame, trim, and panel-to-panel connectors	72 x 40	USSW1L7240	<input type="checkbox"/>	<input type="checkbox"/>	<input type="checkbox"/>	<input type="checkbox"/>	<input type="checkbox"/>	<input type="checkbox"/>	90.5#
• Trim is metal and includes top cap, bottom trim channel, segment channel, and foot shroud										
• 72" wide panels feature split tiles										
USFL	<b>Segmented Fabric Panel - 48"H</b>	24 x 48	USSW1L2448	<input type="checkbox"/>	<input type="checkbox"/>	<input type="checkbox"/>	<input type="checkbox"/>	<input type="checkbox"/>	<input type="checkbox"/>	45.1#
		30 x 48	USSW1L3048	<input type="checkbox"/>	<input type="checkbox"/>	<input type="checkbox"/>	<input type="checkbox"/>	<input type="checkbox"/>	<input type="checkbox"/>	51.2#
		36 x 48	USSW1L3648	<input type="checkbox"/>	<input type="checkbox"/>	<input type="checkbox"/>	<input type="checkbox"/>	<input type="checkbox"/>	<input type="checkbox"/>	57.2#
		42 x 48	USSW1L4248	<input type="checkbox"/>	<input type="checkbox"/>	<input type="checkbox"/>	<input type="checkbox"/>	<input type="checkbox"/>	<input type="checkbox"/>	63.3#
		48 x 48	USSW1L4848	<input type="checkbox"/>	<input type="checkbox"/>	<input type="checkbox"/>	<input type="checkbox"/>	<input type="checkbox"/>	<input type="checkbox"/>	69.3#
		60 x 48	USSW1L6048	<input type="checkbox"/>	<input type="checkbox"/>	<input type="checkbox"/>	<input type="checkbox"/>	<input type="checkbox"/>	<input type="checkbox"/>	81.4#
USFL	<b>Segmented Fabric Panel - 56"H</b>	24 x 56	USSW1L2456	<input type="checkbox"/>	<input type="checkbox"/>	<input type="checkbox"/>	<input type="checkbox"/>	<input type="checkbox"/>	<input type="checkbox"/>	50.0#
		30 x 56	USSW1L3056	<input type="checkbox"/>	<input type="checkbox"/>	<input type="checkbox"/>	<input type="checkbox"/>	<input type="checkbox"/>	<input type="checkbox"/>	56.5#
		36 x 56	USSW1L3656	<input type="checkbox"/>	<input type="checkbox"/>	<input type="checkbox"/>	<input type="checkbox"/>	<input type="checkbox"/>	<input type="checkbox"/>	63.1#
		42 x 56	USSW1L4256	<input type="checkbox"/>	<input type="checkbox"/>	<input type="checkbox"/>	<input type="checkbox"/>	<input type="checkbox"/>	<input type="checkbox"/>	69.7#
		48 x 56	USSW1L4856	<input type="checkbox"/>	<input type="checkbox"/>	<input type="checkbox"/>	<input type="checkbox"/>	<input type="checkbox"/>	<input type="checkbox"/>	76.3#
		60 x 56	USSW1L6056	<input type="checkbox"/>	<input type="checkbox"/>	<input type="checkbox"/>	<input type="checkbox"/>	<input type="checkbox"/>	<input type="checkbox"/>	89.4#
		72 x 56	USSW1L7256	<input type="checkbox"/>	<input type="checkbox"/>	<input type="checkbox"/>	<input type="checkbox"/>	<input type="checkbox"/>	<input type="checkbox"/>	112.7#

**A**   **B**   **C**   **D**   **E**   **F**

## HOW TO ORDER

Indicate the following information on order form:

- Quantity of each item.
- Model number, including options. See "How To Build a Model Number".
- Any special service required.

Note: • The  indicates that a choice is required.

- The absence of the  indicates that no choice is required.
- Alpha-numeric characters in place of  indicate that no other alternatives are available.

## HOW TO BUILD A MODEL NUMBER

- A** Select basic model.
- B** Select top cap style.
 

<b>F</b>	- Flat trim (std)
<b>N</b>	- No topcap
- C** Select trim color. Refer to color addendum at [ki.com](http://ki.com) or KI Fabrics & Finishes binder.
- D** Select paint finish for slat wall section. Refer to color addendum at [ki.com](http://ki.com) or KI Fabrics & Finishes binder.
- E** Select fabric side 1. Refer to color addendum at [ki.com](http://ki.com) or in KI Fabrics & Finishes binder.
- F** Select fabric side 2. Refer to color addendum at [ki.com](http://ki.com) or in KI Fabrics & Finishes binder.



Preconfigured Segmented Fabric Panel w/Slat Wall on One Side  
Elevated Base

Delivered Pricing Fabric Grade 1 & C.O.M.	Delivered Pricing Fabric Grade 2	Delivered Pricing Fabric Grade 3 & Pallas Vertical Fabric Grade PV	Delivered Pricing Pallas Vertical Fabric Grade PV1	Delivered Pricing Pallas Vertical Fabric Grade PV2
\$ 510	\$ 542	\$ 575	\$ 609	\$ 631
571	609	645	681	707
620	660	699	740	769
684	728	773	816	847
713	758	804	850	884
838	893	947	1001	1039
1144	1216	1291	1365	1417
\$ 576	\$ 613	\$ 649	\$ 687	\$ 714
646	688	729	771	799
702	748	792	837	870
784	833	886	934	970
810	861	913	964	1002
941	1001	1062	1121	1165
1300	1382	1467	1550	1609
\$ 612	\$ 650	\$ 690	\$ 729	\$ 757
685	729	774	818	849
747	793	843	891	925
840	894	949	1002	1041
869	925	982	1036	1075
983	1044	1108	1171	1216
1386	1476	1565	1653	1717

**SPECIAL SERVICES**

**Special Carton Marking**

With specially marked information N/C

**Shipping**

Shipped **k.d. freight prepaid f.o.b. Manitowoc, Wisconsin 54220** factory. Freight class #70.

Specifications and prices are subject to change without prior notice.

# Preconfigured Segmented Fabric Panel w/Slat Wall on One Side

Elevated Base

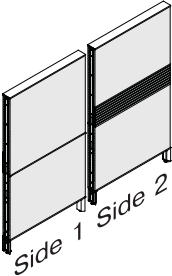
MODEL	W x H	MODEL NUMBER						Approx. Packaged Weight
		Basic Model	Top Cap Style	Trim Color	Slat Wall Finish	Fabric Side 1	Fabric Side 2	
 <p>USFL</p> <p><b>Segmented Fabric Panel - 64"H</b></p> <ul style="list-style-type: none"> <li>Lower segment includes fabric tiles for both sides, specified separately</li> <li>Upper segment features slatwall on lowest 8" of tile, and fabric on remaining segment height</li> <li>Upper and lower fabric segments on each side must be identically specified</li> <li>Slatwall paint finish is specified</li> <li>Elevated base does not accept cable distribution</li> <li>Panel assembly includes frame, trim, and panel-to-panel connectors</li> <li>Trim is metal and includes top cap, bottom trim channel, segment channel, and foot shroud</li> <li>72" wide panels feature split tiles</li> </ul>	24 x 64	USSW1L2464	<input type="checkbox"/>	<input type="checkbox"/>	<input type="checkbox"/>	<input type="checkbox"/>	<input type="checkbox"/>	54.3#
	30 x 64	USSW1L3064	<input type="checkbox"/>	<input type="checkbox"/>	<input type="checkbox"/>	<input type="checkbox"/>	<input type="checkbox"/>	61.4#
	36 x 64	USSW1L3664	<input type="checkbox"/>	<input type="checkbox"/>	<input type="checkbox"/>	<input type="checkbox"/>	<input type="checkbox"/>	68.5#
	42 x 64	USSW1L4264	<input type="checkbox"/>	<input type="checkbox"/>	<input type="checkbox"/>	<input type="checkbox"/>	<input type="checkbox"/>	75.6#
	48 x 64	USSW1L4864	<input type="checkbox"/>	<input type="checkbox"/>	<input type="checkbox"/>	<input type="checkbox"/>	<input type="checkbox"/>	82.7#
	60 x 64	USSW1L6064	<input type="checkbox"/>	<input type="checkbox"/>	<input type="checkbox"/>	<input type="checkbox"/>	<input type="checkbox"/>	96.9#
	72 x 64	USSW1L7264	<input type="checkbox"/>	<input type="checkbox"/>	<input type="checkbox"/>	<input type="checkbox"/>	<input type="checkbox"/>	123.1#

**A**   **B**   **C**   **D**   **E**   **F**

## HOW TO ORDER

Indicate the following information on order form:

- Quantity of each item.
- Model number, including options. See "How To Build a Model Number".
- Any special service required.

Note: • The  indicates that a choice is required.

- The absence of the  indicates that no choice is required.
- Alpha-numeric characters in place of  indicate that no other alternatives are available.

## HOW TO BUILD A MODEL NUMBER

- A** Select basic model.
- B** Select top cap style.
 

<b>F</b>	- Flat trim (std)
<b>N</b>	- No topcap
- C** Select trim color.  
Refer to color addendum at ki.com or KI Fabrics & Finishes binder.
- D** Select paint finish for slat wall section.  
Refer to color addendum at ki.com or KI Fabrics & Finishes binder.
- E** Select fabric side 1.  
Refer to color addendum at ki.com or in KI Fabrics & Finishes binder.
- F** Select fabric side 2.  
Refer to color addendum at ki.com or in KI Fabrics & Finishes binder.





# Preconfigured Segmented Fabric Panel w/Slat Wall on One Side

Elevated Base

Delivered Pricing Fabric Grade 1 & C.O.M.	Delivered Pricing Fabric Grade 2	Delivered Pricing Fabric Grade 3 & Pallas Vertical Fabric Grade PV	Delivered Pricing Pallas Vertical Fabric Grade PV1	Delivered Pricing Pallas Vertical Fabric Grade PV2
\$ 640	\$ 680	\$ 722	\$ 764	\$ 791
733	780	828	874	907
809	861	913	963	1002
892	950	1006	1064	1105
924	984	1041	1101	1144
1039	1105	1172	1240	1288
1510	1606	1704	1800	1870

## SPECIAL SERVICES

### Special Carton Marking

With specially marked information N/C

### Shipping

Shipped k.d. freight prepaid f.o.b. Manitowoc, Wisconsin 54220 factory. Freight class #70.

Specifications and prices are subject to change without prior notice.

# Preconfigured Segmented Fabric Panel w/Slat Wall on One Side

Tile-to-Floor One Side; Standard Base Raceway One Side

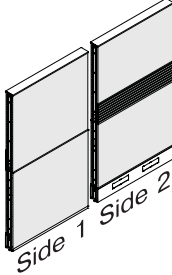
MODEL	W x H	MODEL NUMBER							Approx. Packaged Weight		
		Basic Model	Top Cap Style	Electrical Code	Trim Color	Slat Wall Finish	Fabric Side 1	Fabric Side 2			
 <p>USFT</p> <p><b>Segmented Fabric Panel - 40"H</b></p> <ul style="list-style-type: none"> <li>• Side 1: tile to floor base does not accept cable distribution</li> <li>• Side 2: standard base raceway accepts power and data cable distribution</li> <li>• Upper segment features slatwall on lowest 8" of tile, and fabric on remaining segment height</li> <li>• Upper and lower fabric segments on each side must be identically specified</li> <li>• Slatwall paint finish is specified</li> <li>• Panel assembly includes frame, trim, and panel-to-panel connectors</li> <li>• Trim is metal and includes top cap, bottom trim channel, base raceway, and segment channel</li> <li>• Side 2: 30-72" wide panels feature two power knockouts</li> <li>• Side 2: 24" wide tiles feature one power knockout</li> <li>• 72" wide panels feature split tiles</li> <li>• Electrical components are specified separately</li> </ul>	24 x 40	USSW1T2440	<input type="checkbox"/>	<input type="checkbox"/>	<input type="checkbox"/>	<input type="checkbox"/>	<input type="checkbox"/>	<input type="checkbox"/>	41.8#		
	30 x 40	USSW1T3040	<input type="checkbox"/>	<input type="checkbox"/>	<input type="checkbox"/>	<input type="checkbox"/>	<input type="checkbox"/>	<input type="checkbox"/>	47.7#		
	36 x 40	USSW1T3640	<input type="checkbox"/>	<input type="checkbox"/>	<input type="checkbox"/>	<input type="checkbox"/>	<input type="checkbox"/>	<input type="checkbox"/>	53.7#		
	42 x 40	USSW1T4240	<input type="checkbox"/>	<input type="checkbox"/>	<input type="checkbox"/>	<input type="checkbox"/>	<input type="checkbox"/>	<input type="checkbox"/>	59.8#		
	48 x 40	USSW1T4840	<input type="checkbox"/>	<input type="checkbox"/>	<input type="checkbox"/>	<input type="checkbox"/>	<input type="checkbox"/>	<input type="checkbox"/>	65.8#		
	60 x 40	USSW1T6040	<input type="checkbox"/>	<input type="checkbox"/>	<input type="checkbox"/>	<input type="checkbox"/>	<input type="checkbox"/>	<input type="checkbox"/>	77.9#		
	72 x 40	USSW1T7240	<input type="checkbox"/>	<input type="checkbox"/>	<input type="checkbox"/>	<input type="checkbox"/>	<input type="checkbox"/>	<input type="checkbox"/>	95.7#		
USFT	<b>Segmented Fabric Panel - 48"H</b>		24 x 48	USSW1T2448	<input type="checkbox"/>	<input type="checkbox"/>	<input type="checkbox"/>	<input type="checkbox"/>	<input type="checkbox"/>	<input type="checkbox"/>	46.3#
	30 x 48	USSW1T3048	<input type="checkbox"/>	<input type="checkbox"/>	<input type="checkbox"/>	<input type="checkbox"/>	<input type="checkbox"/>	<input type="checkbox"/>	52.8#		
	36 x 48	USSW1T3648	<input type="checkbox"/>	<input type="checkbox"/>	<input type="checkbox"/>	<input type="checkbox"/>	<input type="checkbox"/>	<input type="checkbox"/>	59.3#		
	42 x 48	USSW1T4248	<input type="checkbox"/>	<input type="checkbox"/>	<input type="checkbox"/>	<input type="checkbox"/>	<input type="checkbox"/>	<input type="checkbox"/>	65.9#		
	48 x 48	USSW1T4848	<input type="checkbox"/>	<input type="checkbox"/>	<input type="checkbox"/>	<input type="checkbox"/>	<input type="checkbox"/>	<input type="checkbox"/>	72.5#		
	60 x 48	USSW1T6048	<input type="checkbox"/>	<input type="checkbox"/>	<input type="checkbox"/>	<input type="checkbox"/>	<input type="checkbox"/>	<input type="checkbox"/>	85.6#		
USFT	<b>Segmented Fabric Panel - 56"H</b>		24 x 56	USSW1T2456	<input type="checkbox"/>	<input type="checkbox"/>	<input type="checkbox"/>	<input type="checkbox"/>	<input type="checkbox"/>	<input type="checkbox"/>	51.1#
	30 x 56	USSW1T3056	<input type="checkbox"/>	<input type="checkbox"/>	<input type="checkbox"/>	<input type="checkbox"/>	<input type="checkbox"/>	<input type="checkbox"/>	58.2#		
	36 x 56	USSW1T3656	<input type="checkbox"/>	<input type="checkbox"/>	<input type="checkbox"/>	<input type="checkbox"/>	<input type="checkbox"/>	<input type="checkbox"/>	65.2#		
	42 x 56	USSW1T4256	<input type="checkbox"/>	<input type="checkbox"/>	<input type="checkbox"/>	<input type="checkbox"/>	<input type="checkbox"/>	<input type="checkbox"/>	72.3#		
	48 x 56	USSW1T4856	<input type="checkbox"/>	<input type="checkbox"/>	<input type="checkbox"/>	<input type="checkbox"/>	<input type="checkbox"/>	<input type="checkbox"/>	79.4#		
	60 x 56	USSW1T6056	<input type="checkbox"/>	<input type="checkbox"/>	<input type="checkbox"/>	<input type="checkbox"/>	<input type="checkbox"/>	<input type="checkbox"/>	93.6#		
72 x 56	USSW1T7256	<input type="checkbox"/>	<input type="checkbox"/>	<input type="checkbox"/>	<input type="checkbox"/>	<input type="checkbox"/>	<input type="checkbox"/>	117.9#			

**A**   **B**   **C**   **D**   **E**   **F**   **G**

## HOW TO ORDER

Indicate the following information on order form:

1. Quantity of each item.
2. Model number, including options. See "How To Build a Model Number".
3. Any special service required.

Note: • The  indicates that a choice is required.

- The absence of the  indicates that no choice is required.
- Alpha-numeric characters in place of  indicate that no other alternatives are available.

## HOW TO BUILD A MODEL NUMBER

**A** Select basic model.

**B** Select top cap style.

- F** - Flat trim (std)
- N** - No topcap

**C** Select electrical code.

- CP** - Chicago - with cutouts
- DN** - Domestic - no cutouts
- DP** - Domestic - with cutouts

**D** Select trim color.

Refer to color addendum at ki.com or KI Fabrics & Finishes binder.

**E** Select paint finish for slat wall section.

Refer to color addendum at ki.com or KI Fabrics & Finishes binder.

**F** Select fabric side 1.

Refer to color addendum at ki.com or in KI Fabrics & Finishes binder.

**G** Select fabric side 2.  
Refer to color addendum at ki.com or in KI Fabrics & Finishes binder.



# Preconfigured Segmented Fabric Panel w/Slat Wall on One Side

Tile-to-Floor One Side; Standard Base Raceway One Side

Delivered Pricing Fabric Grade 1 & C.O.M.	Delivered Pricing Fabric Grade 2	Delivered Pricing Fabric Grade 3 & Pallas Vertical Fabric Grade PV	Delivered Pricing Pallas Vertical Fabric Grade PV1	Delivered Pricing Pallas Vertical Fabric Grade PV2
\$ 510	\$ 542	\$ 575	\$ 609	\$ 631
571	609	645	681	707
620	660	699	740	769
684	728	773	816	847
713	758	804	850	884
838	893	947	1001	1039
1144	1216	1291	1365	1417
\$ 576	\$ 613	\$ 649	\$ 687	\$ 714
646	688	729	771	799
702	748	792	837	870
784	833	886	934	970
810	861	913	964	1002
941	1001	1062	1121	1165
1300	1382	1467	1550	1609
\$ 612	\$ 650	\$ 690	\$ 729	\$ 757
685	729	774	818	849
747	793	843	891	925
840	894	949	1002	1041
869	925	982	1036	1075
983	1044	1108	1171	1216
1386	1476	1565	1653	1717

**SPECIAL SERVICES**

**Special Carton Marking**

With specially marked information N/C

**Shipping**

Shipped **k.d. freight prepaid f.o.b. Manitowoc, Wisconsin 54220** factory. Freight class #70.

Specifications and prices are subject to change without prior notice.

# Preconfigured Segmented Fabric Panel w/Slat Wall on One Side

Tile-to-Floor One Side; Standard Base Raceway One Side

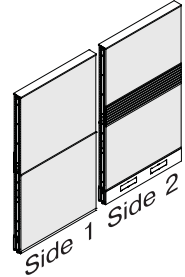

USFT

**MODEL**

**W x H**

**MODEL NUMBER**

Basic Model	Top Cap Style	Electrical Code	Trim Color	Slat Wall Finish	Fabric Side 1	Fabric Side 2
USSW1T2464	<input type="checkbox"/>	<input type="checkbox"/>	<input type="checkbox"/>	<input type="checkbox"/>	<input type="checkbox"/>	<input type="checkbox"/>
USSW1T3064	<input type="checkbox"/>	<input type="checkbox"/>	<input type="checkbox"/>	<input type="checkbox"/>	<input type="checkbox"/>	<input type="checkbox"/>
USSW1T3664	<input type="checkbox"/>	<input type="checkbox"/>	<input type="checkbox"/>	<input type="checkbox"/>	<input type="checkbox"/>	<input type="checkbox"/>
USSW1T4264	<input type="checkbox"/>	<input type="checkbox"/>	<input type="checkbox"/>	<input type="checkbox"/>	<input type="checkbox"/>	<input type="checkbox"/>
USSW1T4864	<input type="checkbox"/>	<input type="checkbox"/>	<input type="checkbox"/>	<input type="checkbox"/>	<input type="checkbox"/>	<input type="checkbox"/>
USSW1T6064	<input type="checkbox"/>	<input type="checkbox"/>	<input type="checkbox"/>	<input type="checkbox"/>	<input type="checkbox"/>	<input type="checkbox"/>
USSW1T7264	<input type="checkbox"/>	<input type="checkbox"/>	<input type="checkbox"/>	<input type="checkbox"/>	<input type="checkbox"/>	<input type="checkbox"/>

Approx. Packaged Weight

**Segmented Fabric Panel - 64"H**

- Side 1: tile to floor base does not accept cable distribution
- Side 2: standard base raceway accepts power and data cable distribution
- Upper segment features slatwall on lowest 8" of tile, and fabric on remaining segment height
- Upper and lower fabric segments on each side must be identically specified
- Slatwall paint finish is specified
- Panel assembly includes frame, trim, and panel-to-panel connectors
- Trim is metal and includes top cap, bottom trim channel, base raceway, and segment channel
- Side 2: 30-72" wide panels feature two power knockouts
- Side 2: 24" wide tiles feature one power knockout
- 72" wide panels feature split tiles
- Electrical components are specified separately

**A B C D E F G**

**HOW TO ORDER**

Indicate the following information on order form:

1. Quantity of each item.
2. Model number, including options. See "How To Build a Model Number".
3. Any special service required.

Note: • The  indicates that a choice is required.

- The absence of the  indicates that no choice is required.
- Alpha-numeric characters in place of  indicate that no other alternatives are available.

**HOW TO BUILD A MODEL NUMBER**

- A** Select basic model.
- B** Select top cap style.
  - F** \_\_\_\_\_ - Flat trim (std)
  - N** \_\_\_\_\_ - No topcap
- C** Select electrical code.
  - CP** \_\_\_\_\_ - Chicago - with cutouts
  - DN** \_\_\_\_\_ - Domestic - no cutouts
  - DP** \_\_\_\_\_ - Domestic - with cutouts
- D** Select trim color. Refer to color addendum at ki.com or KI Fabrics & Finishes binder.
- E** Select paint finish for slat wall section. Refer to color addendum at ki.com or KI Fabrics & Finishes binder.
- F** Select fabric side 1. Refer to color addendum at ki.com or in KI Fabrics & Finishes binder.
- G** Select fabric side 2. Refer to color addendum at ki.com or in KI Fabrics & Finishes binder.



# Preconfigured Segmented Fabric Panel w/Slat Wall on One Side

Tile-to-Floor One Side; Standard Base Raceway One Side

Delivered Pricing Fabric Grade 1 & C.O.M.	Delivered Pricing Fabric Grade 2	Delivered Pricing Fabric Grade 3 & Pallas Vertical Fabric Grade PV	Delivered Pricing Pallas Vertical Fabric Grade PV1	Delivered Pricing Pallas Vertical Fabric Grade PV2
\$ 640	\$ 680	\$ 722	\$ 764	\$ 791
733	780	828	874	907
809	861	913	963	1002
892	950	1006	1064	1105
924	984	1041	1101	1144
1039	1105	1172	1240	1288
1510	1606	1704	1800	1870

**SPECIAL SERVICES**

**Special Carton Marking**

With specially marked information N/C

**Shipping**

Shipped k.d. freight prepaid f.o.b. Manitowoc, Wisconsin 54220 factory. Freight class #70.

Specifications and prices are subject to change without prior notice.

# Preconfigured Segmented Fabric Panel w/Slat Wall on Two Sides

Standard Base Raceway

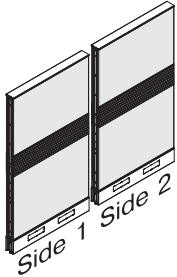

USFR

MODEL	W x H	MODEL NUMBER							
		Basic Model	Top Cap Style	Electrical Code	Trim Color	Slat Wall Finish Side 1	Fabric Side 1	Slat Wall Finish Side 2	Fabric Side 2
<b>Segmented Fabric Panel - 40"H</b> • Lower segment includes fabric tiles for both sides, specified separately • Upper segment features slat wall on lowest 8" of upper tile segment, and fabric on remaining segment height • Upper and lower fabric segments on each side must be identically specified • Slatwall paint finish is specified • Standard base raceway on both sides accepts power and data cable distribution • Panel assembly includes frame, trim, and panel-to-panel connectors • Trim is metal and includes top cap, bottom trim channel, base raceway, and segment channel • 30-72" wide panels feature two power knockouts per side • 24" wide panels feature one power knockout per side • 72" wide panels feature split tiles • Electrical components are specified separately	24 x 40	USSW2R2440	<input type="checkbox"/>	<input type="checkbox"/>	<input type="checkbox"/>	<input type="checkbox"/>	<input type="checkbox"/>	<input type="checkbox"/>	<input type="checkbox"/>
	30 x 40	USSW2R3040	<input type="checkbox"/>	<input type="checkbox"/>	<input type="checkbox"/>	<input type="checkbox"/>	<input type="checkbox"/>	<input type="checkbox"/>	<input type="checkbox"/>
	36 x 40	USSW2R3640	<input type="checkbox"/>	<input type="checkbox"/>	<input type="checkbox"/>	<input type="checkbox"/>	<input type="checkbox"/>	<input type="checkbox"/>	<input type="checkbox"/>
	42 x 40	USSW2R4240	<input type="checkbox"/>	<input type="checkbox"/>	<input type="checkbox"/>	<input type="checkbox"/>	<input type="checkbox"/>	<input type="checkbox"/>	<input type="checkbox"/>
	48 x 40	USSW2R4840	<input type="checkbox"/>	<input type="checkbox"/>	<input type="checkbox"/>	<input type="checkbox"/>	<input type="checkbox"/>	<input type="checkbox"/>	<input type="checkbox"/>
	60 x 40	USSW2R6040	<input type="checkbox"/>	<input type="checkbox"/>	<input type="checkbox"/>	<input type="checkbox"/>	<input type="checkbox"/>	<input type="checkbox"/>	<input type="checkbox"/>
	72 x 40	USSW2R7240	<input type="checkbox"/>	<input type="checkbox"/>	<input type="checkbox"/>	<input type="checkbox"/>	<input type="checkbox"/>	<input type="checkbox"/>	<input type="checkbox"/>
<b>Segmented Fabric Panel - 48"H</b>	24 x 48	USSW2R2448	<input type="checkbox"/>	<input type="checkbox"/>	<input type="checkbox"/>	<input type="checkbox"/>	<input type="checkbox"/>	<input type="checkbox"/>	<input type="checkbox"/>
	30 x 48	USSW2R3048	<input type="checkbox"/>	<input type="checkbox"/>	<input type="checkbox"/>	<input type="checkbox"/>	<input type="checkbox"/>	<input type="checkbox"/>	<input type="checkbox"/>
	36 x 48	USSW2R3648	<input type="checkbox"/>	<input type="checkbox"/>	<input type="checkbox"/>	<input type="checkbox"/>	<input type="checkbox"/>	<input type="checkbox"/>	<input type="checkbox"/>
	42 x 48	USSW2R4248	<input type="checkbox"/>	<input type="checkbox"/>	<input type="checkbox"/>	<input type="checkbox"/>	<input type="checkbox"/>	<input type="checkbox"/>	<input type="checkbox"/>
	48 x 48	USSW2R4848	<input type="checkbox"/>	<input type="checkbox"/>	<input type="checkbox"/>	<input type="checkbox"/>	<input type="checkbox"/>	<input type="checkbox"/>	<input type="checkbox"/>
	60 x 48	USSW2R6048	<input type="checkbox"/>	<input type="checkbox"/>	<input type="checkbox"/>	<input type="checkbox"/>	<input type="checkbox"/>	<input type="checkbox"/>	<input type="checkbox"/>
	72 x 48	USSW2R7248	<input type="checkbox"/>	<input type="checkbox"/>	<input type="checkbox"/>	<input type="checkbox"/>	<input type="checkbox"/>	<input type="checkbox"/>	<input type="checkbox"/>
<b>Segmented Fabric Panel - 56"H</b>	24 x 56	USSW2R2456	<input type="checkbox"/>	<input type="checkbox"/>	<input type="checkbox"/>	<input type="checkbox"/>	<input type="checkbox"/>	<input type="checkbox"/>	<input type="checkbox"/>
	30 x 56	USSW2R3056	<input type="checkbox"/>	<input type="checkbox"/>	<input type="checkbox"/>	<input type="checkbox"/>	<input type="checkbox"/>	<input type="checkbox"/>	<input type="checkbox"/>
	36 x 56	USSW2R3656	<input type="checkbox"/>	<input type="checkbox"/>	<input type="checkbox"/>	<input type="checkbox"/>	<input type="checkbox"/>	<input type="checkbox"/>	<input type="checkbox"/>
	42 x 56	USSW2R4256	<input type="checkbox"/>	<input type="checkbox"/>	<input type="checkbox"/>	<input type="checkbox"/>	<input type="checkbox"/>	<input type="checkbox"/>	<input type="checkbox"/>
	48 x 56	USSW2R4856	<input type="checkbox"/>	<input type="checkbox"/>	<input type="checkbox"/>	<input type="checkbox"/>	<input type="checkbox"/>	<input type="checkbox"/>	<input type="checkbox"/>
	60 x 56	USSW2R6056	<input type="checkbox"/>	<input type="checkbox"/>	<input type="checkbox"/>	<input type="checkbox"/>	<input type="checkbox"/>	<input type="checkbox"/>	<input type="checkbox"/>
	72 x 56	USSW2R7256	<input type="checkbox"/>	<input type="checkbox"/>	<input type="checkbox"/>	<input type="checkbox"/>	<input type="checkbox"/>	<input type="checkbox"/>	<input type="checkbox"/>

**A**   **B**   **C**   **D**   **E**   **F**   **G**   **H**

## HOW TO ORDER

Indicate the following information on order form:

- Quantity of each item.
- Model number, including options. See "How To Build a Model Number".
- Any special service required.

Note: • The  indicates that a choice is required.

- The absence of the  indicates that no choice is required.
- Alpha-numeric characters in place of  indicate that no other alternatives are available.

## HOW TO BUILD A MODEL NUMBER

- A** Select basic model.
- B** Select top cap style.  

<b>F</b>	- Flat trim (std)
<b>N</b>	- No topcap
- C** Select electrical code.  

<b>CP</b>	- Chicago - with cutouts
<b>DN</b>	- Domestic - no cutouts
<b>DP</b>	- Domestic - with cutouts
<b>C1</b>	- Chicago, 1 side w/cutouts
<b>D1</b>	- Domestic, 1 side w/cutouts

**D** Select trim color.  
Refer to color addendum at ki.com or KI Fabrics & Finishes binder.

**E** Select paint finish for slat wall section side 1.  
Refer to color addendum at ki.com or KI Fabrics & Finishes binder.

**F** Select fabric side 1.

Refer to color addendum at ki.com or in KI Fabrics & Finishes binder.

**G** Select paint finish for slat wall section side 2.

Refer to color addendum at ki.com or KI Fabrics & Finishes binder.

**H** Select fabric side 2.  
Refer to color addendum at ki.com or in KI Fabrics & Finishes binder.



# Preconfigured Segmented Fabric Panel w/Slat Wall on Two Sides

Standard Base Raceway

Approx. Packaged Weight	Delivered Pricing Fabric Grade 1 & C.O.M.	Delivered Pricing Fabric Grade 2	Delivered Pricing Fabric Grade 3 & Pallas Vertical Fabric Grade PV	Delivered Pricing Pallas Vertical Fabric Grade PV1	Delivered Pricing Pallas Vertical Fabric Grade PV2
44.4#	\$ 599	\$ 640	\$ 678	\$ 717	\$ 744
50.7#	666	708	752	793	825
56.9#	725	773	818	865	899
63.2#	810	861	913	963	1002
69.5#	846	899	953	1007	1046
82.0#	1021	1088	1154	1220	1265
101.2#	1346	1432	1518	1605	1669
48.2#	\$ 701	\$ 747	\$ 791	\$ 836	\$ 869
55.0#	781	830	880	930	964
61.8#	852	906	961	1017	1056
68.5#	947	1006	1067	1128	1172
75.4#	984	1046	1110	1173	1218
88.9#	1125	1198	1268	1342	1393
110.5#	1592	1694	1796	1898	1971
53.5#	\$ 746	\$ 792	\$ 842	\$ 890	\$ 924
60.8#	823	877	931	983	1019
68.1#	900	957	1016	1072	1115
75.4#	1014	1077	1144	1208	1255
82.8#	1053	1120	1189	1256	1304
97.4#	1193	1267	1345	1422	1477
122.8#	1685	1794	1901	2011	2088

**SPECIAL SERVICES**

**Special Carton Marking**

With specially marked information N/C

**Shipping**

Shipped k.d. freight prepaid f.o.b. Manitowoc, Wisconsin 54220 factory. Freight class #70.

Specifications and prices are subject to change without prior notice.

# Preconfigured Segmented Fabric Panel w/Slat Wall on Two Sides

Standard Base Raceway

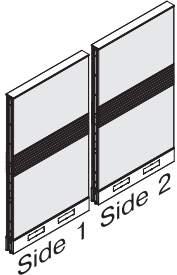

USFR

**MODEL**

**W x H**

- Segmented Fabric Panel - 64"H**
- Lower segment includes fabric tiles for both sides, specified separately
  - Upper segment features slat wall on lowest 8" of upper tile segment, and fabric on remaining segment height
  - Upper and lower fabric segments on each side must be identically specified
  - Slatwall paint finish is specified
  - Standard base raceway on both sides accepts power and data cable distribution
  - Panel assembly includes frame, trim, and panel-to-panel connectors
  - Trim is metal and includes top cap, bottom trim channel, base raceway, and segment channel
  - 30-72" wide panels feature two power knockouts per side
  - 24" wide panels feature one power knockout per side
  - 72" wide panels feature split tiles
  - Electrical components are specified separately

**MODEL NUMBER**

Basic Model	Top Cap Style	Electrical Code	Trim Color	Slat Wall Finish Side 1	Fabric Side 1	Slat Wall Finish Side 2	Fabric Side 2
USW2R2464	<input type="checkbox"/>	<input type="checkbox"/>	<input type="checkbox"/>	<input type="checkbox"/>	<input type="checkbox"/>	<input type="checkbox"/>	<input type="checkbox"/>
USW2R3064	<input type="checkbox"/>	<input type="checkbox"/>	<input type="checkbox"/>	<input type="checkbox"/>	<input type="checkbox"/>	<input type="checkbox"/>	<input type="checkbox"/>
USW2R3664	<input type="checkbox"/>	<input type="checkbox"/>	<input type="checkbox"/>	<input type="checkbox"/>	<input type="checkbox"/>	<input type="checkbox"/>	<input type="checkbox"/>
USW2R4264	<input type="checkbox"/>	<input type="checkbox"/>	<input type="checkbox"/>	<input type="checkbox"/>	<input type="checkbox"/>	<input type="checkbox"/>	<input type="checkbox"/>
USW2R4864	<input type="checkbox"/>	<input type="checkbox"/>	<input type="checkbox"/>	<input type="checkbox"/>	<input type="checkbox"/>	<input type="checkbox"/>	<input type="checkbox"/>
USW2R6064	<input type="checkbox"/>	<input type="checkbox"/>	<input type="checkbox"/>	<input type="checkbox"/>	<input type="checkbox"/>	<input type="checkbox"/>	<input type="checkbox"/>
USW2R7264	<input type="checkbox"/>	<input type="checkbox"/>	<input type="checkbox"/>	<input type="checkbox"/>	<input type="checkbox"/>	<input type="checkbox"/>	<input type="checkbox"/>

**A B C D E F G H**

**HOW TO ORDER**

Indicate the following information on order form:

1. Quantity of each item.
2. Model number, including options. See "How To Build a Model Number".
3. Any special service required.

Note:

- The  indicates that a choice is required.
- The absence of the  indicates that no choice is required.
- Alpha-numeric characters in place of  indicate that no other alternatives are available.

**HOW TO BUILD A MODEL NUMBER**

- A** Select basic model.
- B** Select top cap style.
  - F** - Flat trim (std)
  - N** - No topcap
- C** Select electrical code.
  - CP** - Chicago - with cutouts
  - DN** - Domestic - no cutouts
  - DP** - Domestic - with cutouts
  - C1** - Chicago, 1 side w/cutouts
  - D1** - Domestic, 1 side w/cutouts
- D** Select trim color. Refer to color addendum at ki.com or KI Fabrics & Finishes binder.
- E** Select paint finish for slat wall section side 1. Refer to color addendum at ki.com or KI Fabrics & Finishes binder.
- F** Select fabric side 1.

Refer to color addendum at ki.com or in KI Fabrics & Finishes binder.

- G** Select paint finish for slat wall section side 2. Refer to color addendum at ki.com or KI Fabrics & Finishes binder.
- H** Select fabric side 2. Refer to color addendum at ki.com or in KI Fabrics & Finishes binder.





# Preconfigured Segmented Fabric Panel w/Slat Wall on Two Sides

Standard Base Raceway

Approx. Packaged Weight	Delivered Pricing Fabric Grade 1 & C.O.M.	Delivered Pricing Fabric Grade 2	Delivered Pricing Fabric Grade 3 & Pallas Vertical Fabric Grade PV	Delivered Pricing Pallas Vertical Fabric Grade PV1	Delivered Pricing Pallas Vertical Fabric Grade PV2
57.9#	\$ 767	\$ 817	\$ 867	\$ 915	\$ 951
65.7#	858	914	969	1025	1063
73.5#	939	999	1060	1120	1163
81.4#	1066	1135	1203	1272	1321
89.3#	1108	1177	1250	1320	1371
105.0#	1210	1289	1367	1445	1501
133.2#	1767	1881	1995	2108	2190

## SPECIAL SERVICES

### Special Carton Marking

With specially marked information N/C

### Shipping

Shipped **k.d. freight prepaid f.o.b. Manitowoc, Wisconsin 54220** factory. Freight class #70.

Specifications and prices are subject to change without prior notice.

# Preconfigured Segmented Fabric Panel w/Slat Wall on Two Sides

Elevated Base

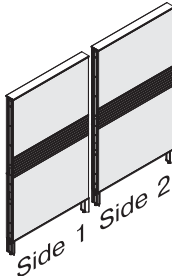
MODEL	W x H	MODEL NUMBER							Approx. Packaged Weight		
		Basic Model	Top Cap Style	Trim Color	Slat Wall Finish Side 1	Fabric Side 1	Slat Wall Finish Side 2	Fabric Side 2			
 <p>USFL</p> <p><b>Segmented Fabric Panel - 40"H</b></p> <ul style="list-style-type: none"> <li>Lower segment includes fabric tiles for both sides, specified separately</li> <li>Upper segment features slat wall on lowest 8" of upper tile segment, and fabric on remaining segment height</li> <li>Upper and lower fabric segments on each side must be identically specified</li> <li>Slatwall paint finish is specified</li> <li>Elevated base does not accept cable distribution</li> <li>Panel assembly includes frame, trim, and panel-to-panel connectors</li> <li>Trim is metal and includes top cap, bottom trim channel, segment channel, and foot shroud</li> <li>72" wide panels feature split tiles</li> </ul>	24 x 40	USSW2L2440	<input type="checkbox"/>	<input type="checkbox"/>	<input type="checkbox"/>	<input type="checkbox"/>	<input type="checkbox"/>	<input type="checkbox"/>	44.4#		
	30 x 40	USSW2L3040	<input type="checkbox"/>	<input type="checkbox"/>	<input type="checkbox"/>	<input type="checkbox"/>	<input type="checkbox"/>	<input type="checkbox"/>	50.7#		
	36 x 40	USSW2L3640	<input type="checkbox"/>	<input type="checkbox"/>	<input type="checkbox"/>	<input type="checkbox"/>	<input type="checkbox"/>	<input type="checkbox"/>	56.9#		
	42 x 40	USSW2L4240	<input type="checkbox"/>	<input type="checkbox"/>	<input type="checkbox"/>	<input type="checkbox"/>	<input type="checkbox"/>	<input type="checkbox"/>	63.2#		
	48 x 40	USSW2L4840	<input type="checkbox"/>	<input type="checkbox"/>	<input type="checkbox"/>	<input type="checkbox"/>	<input type="checkbox"/>	<input type="checkbox"/>	69.5#		
	60 x 40	USSW2L6040	<input type="checkbox"/>	<input type="checkbox"/>	<input type="checkbox"/>	<input type="checkbox"/>	<input type="checkbox"/>	<input type="checkbox"/>	82.0#		
	72 x 40	USSW2L7240	<input type="checkbox"/>	<input type="checkbox"/>	<input type="checkbox"/>	<input type="checkbox"/>	<input type="checkbox"/>	<input type="checkbox"/>	101.2#		
USFL	<b>Segmented Fabric Panel - 48"H</b>		24 x 48	USSW2L2448	<input type="checkbox"/>	<input type="checkbox"/>	<input type="checkbox"/>	<input type="checkbox"/>	<input type="checkbox"/>	<input type="checkbox"/>	48.2#
	30 x 48	USSW2L3048	<input type="checkbox"/>	<input type="checkbox"/>	<input type="checkbox"/>	<input type="checkbox"/>	<input type="checkbox"/>	<input type="checkbox"/>	<input type="checkbox"/>	55.0#	
	36 x 48	USSW2L3648	<input type="checkbox"/>	<input type="checkbox"/>	<input type="checkbox"/>	<input type="checkbox"/>	<input type="checkbox"/>	<input type="checkbox"/>	<input type="checkbox"/>	61.8#	
	42 x 48	USSW2L4248	<input type="checkbox"/>	<input type="checkbox"/>	<input type="checkbox"/>	<input type="checkbox"/>	<input type="checkbox"/>	<input type="checkbox"/>	<input type="checkbox"/>	68.5#	
	48 x 48	USSW2L4848	<input type="checkbox"/>	<input type="checkbox"/>	<input type="checkbox"/>	<input type="checkbox"/>	<input type="checkbox"/>	<input type="checkbox"/>	<input type="checkbox"/>	75.4#	
	60 x 48	USSW2L6048	<input type="checkbox"/>	<input type="checkbox"/>	<input type="checkbox"/>	<input type="checkbox"/>	<input type="checkbox"/>	<input type="checkbox"/>	<input type="checkbox"/>	88.9#	
USFL	<b>Segmented Fabric Panel - 56"H</b>		24 x 56	USSW2L2456	<input type="checkbox"/>	<input type="checkbox"/>	<input type="checkbox"/>	<input type="checkbox"/>	<input type="checkbox"/>	<input type="checkbox"/>	53.5#
	30 x 56	USSW2L3056	<input type="checkbox"/>	<input type="checkbox"/>	<input type="checkbox"/>	<input type="checkbox"/>	<input type="checkbox"/>	<input type="checkbox"/>	<input type="checkbox"/>	60.8#	
	36 x 56	USSW2L3656	<input type="checkbox"/>	<input type="checkbox"/>	<input type="checkbox"/>	<input type="checkbox"/>	<input type="checkbox"/>	<input type="checkbox"/>	<input type="checkbox"/>	68.1#	
	42 x 56	USSW2L4256	<input type="checkbox"/>	<input type="checkbox"/>	<input type="checkbox"/>	<input type="checkbox"/>	<input type="checkbox"/>	<input type="checkbox"/>	<input type="checkbox"/>	75.4#	
	48 x 56	USSW2L4856	<input type="checkbox"/>	<input type="checkbox"/>	<input type="checkbox"/>	<input type="checkbox"/>	<input type="checkbox"/>	<input type="checkbox"/>	<input type="checkbox"/>	82.8#	
	60 x 56	USSW2L6056	<input type="checkbox"/>	<input type="checkbox"/>	<input type="checkbox"/>	<input type="checkbox"/>	<input type="checkbox"/>	<input type="checkbox"/>	<input type="checkbox"/>	97.4#	
72 x 56	USSW2L7256	<input type="checkbox"/>	<input type="checkbox"/>	<input type="checkbox"/>	<input type="checkbox"/>	<input type="checkbox"/>	<input type="checkbox"/>	<input type="checkbox"/>	122.8#		

**A**   **B**   **C**   **D**   **E**   **F**   **G**

## HOW TO ORDER

Indicate the following information on order form:

- Quantity of each item.
- Model number, including options. See "How To Build a Model Number".
- Any special service required.

Note: • The  indicates that a choice is required.

- The absence of the  indicates that no choice is required.
- Alpha-numeric characters in place of  indicate that no other alternatives are available.

## HOW TO BUILD A MODEL NUMBER

**A** Select basic model.

**B** Select top cap style.  
**F** - Flat trim (std)  
**N** - No topcap

**C** Select trim color.  
Refer to color addendum at ki.com or KI Fabrics & Finishes binder.

**D** Select paint finish for slat wall section side 1.  
Refer to color addendum at ki.com or KI Fabrics & Finishes binder.

**E** Select fabric side 1.  
Refer to color addendum at ki.com or in KI Fabrics & Finishes binder.

**F** Select paint finish for slat wall section side 2.  
Refer to color addendum at ki.com or KI Fabrics & Finishes binder.

**G** Select fabric side 2.  
Refer to color addendum at ki.com or in KI Fabrics & Finishes binder.



# Preconfigured Segmented Fabric Panel w/Slat Wall on Two Sides

Elevated Base

Delivered Pricing Fabric Grade 1 & C.O.M.	Delivered Pricing Fabric Grade 2	Delivered Pricing Fabric Grade 3 & Pallas Vertical Fabric Grade PV	Delivered Pricing Pallas Vertical Fabric Grade PV1	Delivered Pricing Pallas Vertical Fabric Grade PV2
\$ 599	\$ 640	\$ 678	\$ 717	\$ 744
666	708	752	793	825
725	773	818	865	899
810	861	913	963	1002
846	899	953	1007	1046
1021	1088	1154	1220	1265
1346	1432	1518	1605	1669
<hr/>				
\$ 701	\$ 747	\$ 791	\$ 836	\$ 869
781	830	880	930	964
852	906	961	1017	1056
947	1006	1067	1128	1172
984	1046	1110	1173	1218
1125	1198	1268	1342	1393
1592	1694	1796	1898	1971
<hr/>				
\$ 746	\$ 792	\$ 842	\$ 890	\$ 924
823	877	929	983	1019
900	957	1016	1072	1115
1014	1077	1144	1208	1255
1053	1120	1189	1256	1304
1193	1267	1345	1422	1477
1685	1794	1901	2011	2088

## SPECIAL SERVICES

### Special Carton Marking

With specially marked information      N/C

### Shipping

Shipped **k.d. freight prepaid f.o.b. Manitowoc, Wisconsin 54220** factory. Freight class #70.

Specifications and prices are subject to change without prior notice.

# Preconfigured Segmented Fabric Panel w/Slat Wall on Two Sides

Elevated Base

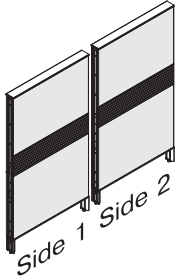
MODEL	W x H	MODEL NUMBER							Approx. Packaged Weight
		Basic Model	Top Cap Style	Trim Color	Slat Wall Finish Side 1	Fabric Side 1	Slat Wall Finish Side 2	Fabric Side 2	
 <p><b>Segmented Fabric Panel - 64"H</b></p> <ul style="list-style-type: none"> <li>Lower segment includes fabric tiles for both sides, specified separately</li> <li>Upper segment features slat wall on lowest 8" of upper tile segment, and fabric on remaining segment height</li> <li>Upper and lower fabric segments on each side must be identically specified</li> <li>Slatwall paint finish is specified</li> <li>Elevated base does not accept cable distribution</li> <li>Panel assembly includes frame, trim, and panel-to-panel connectors</li> <li>Trim is metal and includes top cap, bottom trim channel, segment channel, and foot shroud</li> <li>72" wide panels feature split tiles</li> </ul>	24 x 64	USSW2L2464	<input type="checkbox"/>	<input type="checkbox"/>	<input type="checkbox"/>	<input type="checkbox"/>	<input type="checkbox"/>	<input type="checkbox"/>	57.9#
	30 x 64	USSW2L3064	<input type="checkbox"/>	<input type="checkbox"/>	<input type="checkbox"/>	<input type="checkbox"/>	<input type="checkbox"/>	<input type="checkbox"/>	65.7#
	36 x 64	USSW2L3664	<input type="checkbox"/>	<input type="checkbox"/>	<input type="checkbox"/>	<input type="checkbox"/>	<input type="checkbox"/>	<input type="checkbox"/>	73.5#
	42 x 64	USSW2L4264	<input type="checkbox"/>	<input type="checkbox"/>	<input type="checkbox"/>	<input type="checkbox"/>	<input type="checkbox"/>	<input type="checkbox"/>	81.4#
	48 x 64	USSW2L4864	<input type="checkbox"/>	<input type="checkbox"/>	<input type="checkbox"/>	<input type="checkbox"/>	<input type="checkbox"/>	<input type="checkbox"/>	89.3#
	60 x 64	USSW2L6064	<input type="checkbox"/>	<input type="checkbox"/>	<input type="checkbox"/>	<input type="checkbox"/>	<input type="checkbox"/>	<input type="checkbox"/>	105.0#
	72 x 64	USSW2L7264	<input type="checkbox"/>	<input type="checkbox"/>	<input type="checkbox"/>	<input type="checkbox"/>	<input type="checkbox"/>	<input type="checkbox"/>	133.2#

**A**
**B**
**C**
**D**
**E**
**F**
**G**

USFL

## HOW TO ORDER

Indicate the following information on order form:

- Quantity of each item.
- Model number, including options. See "How To Build a Model Number".
- Any special service required.

Note: • The  indicates that a choice is required.

- The absence of the  indicates that no choice is required.
- Alpha-numeric characters in place of  indicate that no other alternatives are available.

## HOW TO BUILD A MODEL NUMBER

**A** Select basic model.

**B** Select top cap style.

F - Flat trim (std)

N - No topcap

**C** Select trim color.

Refer to color addendum at ki.com or KI Fabrics & Finishes binder.

**D** Select paint finish for slat wall section side 1.

Refer to color addendum at ki.com or KI Fabrics & Finishes binder.

**E** Select fabric side 1.

Refer to color addendum at ki.com or in KI Fabrics & Finishes binder.

**F** Select paint finish for slat wall section side 2.

Refer to color addendum at ki.com or KI Fabrics & Finishes binder.

**G** Select fabric side 2.

Refer to color addendum at ki.com or in KI Fabrics & Finishes binder.



# Preconfigured Segmented Fabric Panel w/Slat Wall on Two Sides

Elevated Base

Delivered Pricing Fabric Grade 1 & C.O.M.	Delivered Pricing Fabric Grade 2	Delivered Pricing Fabric Grade 3 & Pallas Vertical Fabric Grade PV	Delivered Pricing Pallas Vertical Fabric Grade PV1	Delivered Pricing Pallas Vertical Fabric Grade PV2
\$ 767	\$ 817	\$ 867	\$ 915	\$ 951
858	914	969	1025	1063
939	999	1060	1120	1163
1066	1135	1203	1272	1321
1108	1177	1250	1320	1371
1210	1289	1367	1445	1501
1767	1881	1995	2108	2190

## SPECIAL SERVICES

### Special Carton Marking

With specially marked information N/C

### Shipping

Shipped k.d. freight prepaid f.o.b. Manitowoc, Wisconsin 54220 factory. Freight class #70.

Specifications and prices are subject to change without prior notice.

# Stacking Panel

Fabric

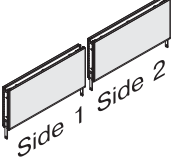
MODEL	W x H	MODEL NUMBER				Approx. Packaged Weight
		Basic Model	Trim Color	Fabric Side 1	Fabric Side 2	
 <p>USTF</p> <p><b>Fabric Stacking Panel - 16" H</b></p> <ul style="list-style-type: none"> <li>• Side 1 and side 2 fabrics are specified separately</li> <li>• All sizes stack above panels of equal widths</li> <li>• 48"-72" sizes may span multiple panels</li> <li>• Only one stacking section may be added to a frame</li> <li>• No power is available on stacking sections</li> <li>• No storage or accessories may be hung from stacking sections</li> <li>• Panel Assembly includes stacking frame, segment channel, tiles and panel-to-panel connectors</li> <li>• Trim is metal and includes segment channel</li> </ul>	24 x 16"	USTF2416	<input type="checkbox"/>	<input type="checkbox"/> <input type="checkbox"/> <input type="checkbox"/> <input type="checkbox"/>	<input type="checkbox"/> <input type="checkbox"/> <input type="checkbox"/> <input type="checkbox"/>	13.2#
	30 x 16"	USTF3016	<input type="checkbox"/>	<input type="checkbox"/> <input type="checkbox"/> <input type="checkbox"/> <input type="checkbox"/>	<input type="checkbox"/> <input type="checkbox"/> <input type="checkbox"/> <input type="checkbox"/>	14.8#
	36 x 16"	USTF3616	<input type="checkbox"/>	<input type="checkbox"/> <input type="checkbox"/> <input type="checkbox"/> <input type="checkbox"/>	<input type="checkbox"/> <input type="checkbox"/> <input type="checkbox"/> <input type="checkbox"/>	16.9#
	42 x 16"	USTF4216	<input type="checkbox"/>	<input type="checkbox"/> <input type="checkbox"/> <input type="checkbox"/> <input type="checkbox"/>	<input type="checkbox"/> <input type="checkbox"/> <input type="checkbox"/> <input type="checkbox"/>	18.5#
	48 x 16"	USTF4816	<input type="checkbox"/>	<input type="checkbox"/> <input type="checkbox"/> <input type="checkbox"/> <input type="checkbox"/>	<input type="checkbox"/> <input type="checkbox"/> <input type="checkbox"/> <input type="checkbox"/>	20.1#
	60 x 16"	USTF6016	<input type="checkbox"/>	<input type="checkbox"/> <input type="checkbox"/> <input type="checkbox"/> <input type="checkbox"/>	<input type="checkbox"/> <input type="checkbox"/> <input type="checkbox"/> <input type="checkbox"/>	23.7#
	72 x 16"	USTF7216	<input type="checkbox"/>	<input type="checkbox"/> <input type="checkbox"/> <input type="checkbox"/> <input type="checkbox"/>	<input type="checkbox"/> <input type="checkbox"/> <input type="checkbox"/> <input type="checkbox"/>	29.5#
			<b>A</b>	<b>B</b>	<b>C</b>	<b>D</b>

## HOW TO ORDER

Indicate the following information on order form:

1. Quantity of each item.
2. Model number, including options. See "How To Build a Model Number".
3. Any special service required.

Note: • The  indicates that a choice is required.

- The absence of the  indicates that no choice is required.
- Alpha-numeric characters in place of  indicate that no other alternatives are available.

## HOW TO BUILD A MODEL NUMBER

- A** Select basic model.
- B** Select trim color.  
Refer to color addendum at [ki.com](http://ki.com) or KI Fabrics & Finishes binder.
- C** Select fabric side 1.  
Refer to color addendum at [ki.com](http://ki.com) or in KI Fabrics & Finishes binder.
- D** Select fabric side 2.  
Refer to color addendum at [ki.com](http://ki.com) or in KI Fabrics & Finishes binder.



# Stacking Panel

Fabric

Delivered Pricing Fabric Grade 1 & C.O.M.	Delivered Pricing Fabric Grade 2	Delivered Pricing Fabric Grade 3 & Pallas Vertical Fabric Grade PV	Delivered Pricing Pallas Vertical Fabric Grade PV1	Delivered Pricing Pallas Vertical Fabric Grade PV2
\$ 303	\$ 315	\$ 328	\$ 335	\$ 357
325	339	352	361	384
353	370	382	391	418
388	407	421	431	460
396	414	427	439	469
443	465	480	492	525
590	618	640	655	698

**SPECIAL SERVICES**

**Special Carton Marking**

With specially marked information N/C

**Shipping**

Shipped k.d. freight prepaid f.o.b. Manitowoc, Wisconsin 54220 factory. Freight class #70.

Specifications and prices are subject to change without prior notice.

# Stacking Panel

Solid Steel

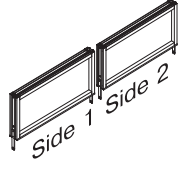

USTS

MODEL	W x H	MODEL NUMBER			Approx. Packaged Weight
		Basic Model	Trim Color	Insert Color	
<b>Solid Steel Stacking Panel - 16" H</b> <ul style="list-style-type: none"> <li>• Single steel section captured within aluminum frame</li> <li>• All sizes stack above panels of equal widths</li> <li>• 48"-72" sizes may span multiple panels</li> <li>• Only one stacking section may be added to a frame</li> <li>• No power is available on stacking sections</li> <li>• No storage or accessories may be hung from stacking sections</li> <li>• Steel insert paint color is specified separate from trim, side 1 and side 2 are identical</li> <li>• Frame matches trim finish</li> </ul>	24 x 16"	USTS2416	<input type="checkbox"/>	<input type="checkbox"/> <input type="checkbox"/> <input type="checkbox"/>	15.5#
	30 x 16"	USTS3016	<input type="checkbox"/>	<input type="checkbox"/> <input type="checkbox"/> <input type="checkbox"/>	17.7#
	36 x 16"	USTS3616	<input type="checkbox"/>	<input type="checkbox"/> <input type="checkbox"/> <input type="checkbox"/>	20.5#
	42 x 16"	USTS4216	<input type="checkbox"/>	<input type="checkbox"/> <input type="checkbox"/> <input type="checkbox"/>	22.7#
	48 x 16"	USTS4816	<input type="checkbox"/>	<input type="checkbox"/> <input type="checkbox"/> <input type="checkbox"/>	25.0#
	60 x 16"	USTS6016	<input type="checkbox"/>	<input type="checkbox"/> <input type="checkbox"/> <input type="checkbox"/>	29.8#
	72 x 16"	USTS7216	<input type="checkbox"/>	<input type="checkbox"/> <input type="checkbox"/> <input type="checkbox"/>	34.3#

**A**   **B**   **C**

## HOW TO ORDER

Indicate the following information on order form:

- Quantity of each item.
- Model number, including options. See "How To Build a Model Number".
- Any special service required.

Note: • The  indicates that a choice is required.

- The absence of the  indicates that no choice is required.
- Alpha-numeric characters in place of  indicate that no other alternatives are available.

## HOW TO BUILD A MODEL NUMBER

- A** Select basic model.
- B** Select trim color.  
Refer to color addendum at [ki.com](http://ki.com) or KI Fabrics & Finishes binder.
- C** Select insert color.  
Refer to color addendum at [ki.com](http://ki.com) or KI Fabrics & Finishes binder.





# Stacking Panel

Solid Steel

Delivered  
Pricing

\$ 383
402
435
456
508
521
718

### SPECIAL SERVICES

#### Special Carton Marking

With specially marked information N/C

#### Shipping

Shipped k.d. freight prepaid f.o.b. Manitowoc, Wisconsin 54220 factory. Freight class #70.

Specifications and prices are subject to change without prior notice.

# Stacking Panel

Glass

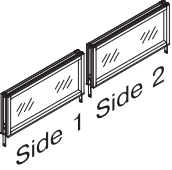
MODEL	W x H	MODEL NUMBER			Approx. Packaged Weight
		Basic Model	Trim Color	Glass Color	
 <p>USTS</p> <p><b>Glass Stacking Panel - 16" H</b></p> <ul style="list-style-type: none"> <li>• Single glass pane captured within aluminum frame</li> <li>• All sizes stack above panels of equal widths</li> <li>• 48"-72" sizes may span multiple panels</li> <li>• Only one stacking section may be added to a frame</li> <li>• No power is available on stacking sections</li> <li>• No storage or accessories may be hung from stacking sections</li> <li>• Frame matches trim finish</li> </ul>	24 x 16"	USTG2416	<input type="checkbox"/> <input type="checkbox"/>	<input type="checkbox"/> <input type="checkbox"/> <input type="checkbox"/>	18.4#
	30 x 16"	USTG3016	<input type="checkbox"/> <input type="checkbox"/>	<input type="checkbox"/> <input type="checkbox"/> <input type="checkbox"/>	21.5#
	36 x 16"	USTG3616	<input type="checkbox"/> <input type="checkbox"/>	<input type="checkbox"/> <input type="checkbox"/> <input type="checkbox"/>	25.0#
	42 x 16"	USTG4216	<input type="checkbox"/> <input type="checkbox"/>	<input type="checkbox"/> <input type="checkbox"/> <input type="checkbox"/>	28.1#
	48 x 16"	USTG4816	<input type="checkbox"/> <input type="checkbox"/>	<input type="checkbox"/> <input type="checkbox"/> <input type="checkbox"/>	31.1#
	60 x 16"	USTG6016	<input type="checkbox"/> <input type="checkbox"/>	<input type="checkbox"/> <input type="checkbox"/> <input type="checkbox"/>	37.7#
	72 x 16"	USTG7216	<input type="checkbox"/> <input type="checkbox"/>	<input type="checkbox"/> <input type="checkbox"/> <input type="checkbox"/>	43.8#

**A**      **B**      **C**

### HOW TO ORDER

Indicate the following information on order form:

1. Quantity of each item.
2. Model number, including options. See "How To Build a Model Number".
3. Any special service required.

- Note:
- The  indicates that a choice is required.
  - The absence of the  indicates that no choice is required.
  - Alpha-numeric characters in place of  indicate that no other alternatives are available.

### HOW TO BUILD A MODEL NUMBER

- A** Select basic model.
- B** Select trim color.  
Refer to color addendum at [ki.com](http://ki.com) or KI Fabrics & Finishes binder.
- C** Select glass color.
 

<b>GLA</b>	- Clear (std)
<b>GLC</b>	- White laminate
<b>GLV</b>	- Satin etch one side



# Stacking Panel

Glass

Clear (GLA)	White Laminate (GLC)	Satin Etch One Side (GLV)
\$ 349	\$ 394	\$ 440
362	407	453
384	428	475
407	460	514
444	509	579
461	541	625
613	706	805

**SPECIAL SERVICES**

**Special Carton Marking**

With specially marked information N/C

**Shipping**

Shipped k.d. freight prepaid f.o.b. Manitowoc, Wisconsin 54220 factory. Freight class #70.

Specifications and prices are subject to change without prior notice.

# Stacking Panel

Perforated Steel

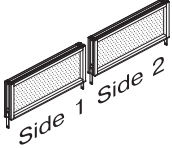
MODEL	W x H	MODEL NUMBER			Approx. Packaged Weight
		Basic Model	Trim Color	Insert Color	
 <p>USTS</p> <p><b>Perforated Steel Stacking Panel - 16" H</b></p> <ul style="list-style-type: none"> <li>• Single perforated steel section captured within aluminum frame</li> <li>• All sizes stack above panels of equal widths</li> <li>• 48"-72" sizes may span multiple panels</li> <li>• Only one stacking section may be added to a frame</li> <li>• No power is available on stacking sections</li> <li>• No storage or accessories may be hung from stacking sections</li> <li>• Steel insert paint color is specified separate from trim, side 1 and side 2 are identical</li> <li>• Frame matches trim finish</li> </ul>	24 x 16"	USTP2416	<input type="checkbox"/>	<input type="checkbox"/>	13.5#
	30 x 16"	USTP3016	<input type="checkbox"/>	<input type="checkbox"/>	15.1#
	36 x 16"	USTP3616	<input type="checkbox"/>	<input type="checkbox"/>	17.2#
	42 x 16"	USTP4216	<input type="checkbox"/>	<input type="checkbox"/>	19.0#
	48 x 16"	USTP4816	<input type="checkbox"/>	<input type="checkbox"/>	20.6#
	60 x 16"	USTP6016	<input type="checkbox"/>	<input type="checkbox"/>	24.4#
	72 x 16"	USTP7216	<input type="checkbox"/>	<input type="checkbox"/>	27.7#
			<b>A</b>	<b>B</b>	<b>C</b>

### HOW TO ORDER

Indicate the following information on order form:

1. Quantity of each item.
2. Model number, including options. See "How To Build a Model Number".
3. Any special service required.

Note: • The  indicates that a choice is required.

- The absence of the  indicates that no choice is required.
- Alpha-numeric characters in place of  indicate that no other alternatives are available.

### HOW TO BUILD A MODEL NUMBER

- A** Select basic model.
- B** Select trim color.  
Refer to color addendum at [ki.com](http://ki.com) or KI Fabrics & Finishes binder.
- C** Select insert color.  
Refer to color addendum at [ki.com](http://ki.com) or KI Fabrics & Finishes binder.



# Stacking Panel

Perforated Steel

Delivered  
Pricing

\$ 407
435
484
507
583
629
802

### SPECIAL SERVICES

#### Special Carton Marking

With specially marked information    N/C

#### Shipping

Shipped **k.d. freight prepaid f.o.b. Manitowoc, Wisconsin 54220** factory. Freight class #70.

Specifications and prices are subject to change without prior notice.

# Stacking Panel

Markerboard on One Side

MODEL	W x H	MODEL NUMBER			Approx. Packaged Weight
		Basic Model	Trim Color	Fabric Side 2	
<p>USTF</p> <p><b>Markerboard on One-Side Stacking Panel - 16" H</b></p> <ul style="list-style-type: none"> <li>• Side 1 is marker board; side 2 is fabric</li> <li>• All sizes stack above panels of equal widths</li> <li>• 48"-72" sizes may span multiple panels</li> <li>• Only one stacking section may be added to a frame</li> <li>• No power is available on stacking sections</li> <li>• No storage or accessories may be hung from stacking sections</li> </ul>	24 x 16"	USTM12416	<input type="checkbox"/>	<input type="checkbox"/> <input type="checkbox"/> <input type="checkbox"/> <input type="checkbox"/>	16.4#
	30 x 16"	USTM13016	<input type="checkbox"/>	<input type="checkbox"/> <input type="checkbox"/> <input type="checkbox"/> <input type="checkbox"/>	18.7#
	36 x 16"	USTM13616	<input type="checkbox"/>	<input type="checkbox"/> <input type="checkbox"/> <input type="checkbox"/> <input type="checkbox"/>	21.5#
	42 x 16"	USTM14216	<input type="checkbox"/>	<input type="checkbox"/> <input type="checkbox"/> <input type="checkbox"/> <input type="checkbox"/>	23.8#
	48 x 16"	USTM14816	<input type="checkbox"/>	<input type="checkbox"/> <input type="checkbox"/> <input type="checkbox"/> <input type="checkbox"/>	26.1#
	60 x 16"	USTM16016	<input type="checkbox"/>	<input type="checkbox"/> <input type="checkbox"/> <input type="checkbox"/> <input type="checkbox"/>	31.2#
	72 x 16"	USTM17216	<input type="checkbox"/>	<input type="checkbox"/> <input type="checkbox"/> <input type="checkbox"/> <input type="checkbox"/>	38.7#

**A**      **B**      **C**

### HOW TO ORDER

Indicate the following information on order form:

1. Quantity of each item.
2. Model number, including options. See "How To Build a Model Number".
3. Any special service required.

Note:

- The  indicates that a choice is required.
- The absence of the  indicates that no choice is required.
- Alpha-numeric characters in place of  indicate that no other alternatives are available.

### HOW TO BUILD A MODEL NUMBER

- A** Select basic model.
- B** Select trim color.  
Refer to color addendum at [ki.com](http://ki.com) or KI Fabrics & Finishes binder.
- C** Select fabric side 2.  
Refer to color addendum at [ki.com](http://ki.com) or in KI Fabrics & Finishes binder.



# Stacking Panel

Markerboard on One Side

Delivered Pricing Fabric Grade 1 & C.O.M.	Delivered Pricing Fabric Grade 2	Delivered Pricing Fabric Grade 3 & Pallas Vertical Fabric Grade PV	Delivered Pricing Pallas Vertical Fabric Grade PV1	Delivered Pricing Pallas Vertical Fabric Grade PV2
\$ 364	\$ 381	\$ 394	\$ 404	\$ 431
398	417	431	441	472
422	441	457	469	501
459	480	497	510	543
486	510	527	541	577
640	670	692	710	757
729	762	788	809	862

## SPECIAL SERVICES

### Special Carton Marking

With specially marked information N/C

### Shipping

Shipped k.d. freight prepaid f.o.b. Manitowoc, Wisconsin 54220 factory. Freight class #70.

Specifications and prices are subject to change without prior notice.

# Stacking Panel

Markerboard on Both Sides

MODEL	W x H	MODEL NUMBER		Approx. Packaged Weight
		Basic Model	Trim Color	
<b>Markerboard on Both-Sides Stacking Panel - 16" H</b> <ul style="list-style-type: none"> <li>Steel marker board on both sides</li> <li>All sizes stack above panels of equal widths</li> <li>48"-72" sizes may span multiple panels</li> <li>Only one stacking section may be added to a frame</li> <li>No power is available on stacking sections</li> <li>No storage or accessories may be hung from stacking sections</li> </ul>	24 x 16"	USTM22416	<input type="checkbox"/>	18.1#
	30 x 16"	USTM23016	<input type="checkbox"/>	21.1#
	36 x 16"	USTM23616	<input type="checkbox"/>	24.2#
	42 x 16"	USTM24216	<input type="checkbox"/>	27.2#
	48 x 16"	USTM24816	<input type="checkbox"/>	30.2#
	60 x 16"	USTM26016	<input type="checkbox"/>	36.2#
	72 x 16"	USTM27216	<input type="checkbox"/>	45.4#

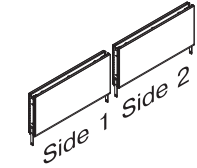

USTS

**A**

**B**

## HOW TO ORDER

Indicate the following information on order form:

- Quantity of each item.
- Model number, including options. See "How To Build a Model Number".
- Any special service required.

- Note:
- The  indicates that a choice is required.
  - The absence of the  indicates that no choice is required.
  - Alpha-numeric characters in place of  indicate that no other alternatives are available.

## HOW TO BUILD A MODEL NUMBER

- A** Select basic model.
- B** Select trim color. Refer to color addendum at [ki.com](http://ki.com) or KI Fabrics & Finishes binder.





# Stacking Panel

Markerboard on Both Sides

Delivered  
Pricing

\$ 411  
454  
473  
510  
557  
805  
834

## SPECIAL SERVICES

### Special Carton Marking

With specially marked information N/C

### Shipping

Shipped k.d. freight prepaid f.o.b. Manitowoc, Wisconsin 54220 factory. Freight class #70.

Specifications and prices are subject to change without prior notice.

# Stacking Panel

Slat Wall on One Side

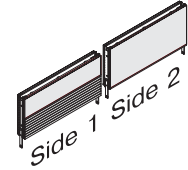
MODEL	W x H	MODEL NUMBER				Approx. Packaged Weight
		Basic Model	Trim Color	Fabric Side 1	Fabric Side 2	
 <p>USTF</p> <p><b>Slat Wall on One-Side Stacking Panel - 16" H</b></p> <ul style="list-style-type: none"> <li>• Side 1 features lower 8" section of slat wall and fabric on upper 8"; side 2 is fabric only</li> <li>• All sizes stack above panels of equal widths</li> <li>• 48"-72" sizes may span multiple panels</li> <li>• Only one stacking section may be added to a frame</li> <li>• No power is available on stacking sections</li> <li>• No storage or accessories may be hung from stacking sections</li> </ul>	24 x 16"	USTSW12416	<input type="checkbox"/>	<input type="checkbox"/> <input type="checkbox"/> <input type="checkbox"/> <input type="checkbox"/>	<input type="checkbox"/> <input type="checkbox"/> <input type="checkbox"/> <input type="checkbox"/>	15.1#
	30 x 16"	USTSW13016	<input type="checkbox"/>	<input type="checkbox"/> <input type="checkbox"/> <input type="checkbox"/> <input type="checkbox"/>	<input type="checkbox"/> <input type="checkbox"/> <input type="checkbox"/> <input type="checkbox"/>	17.5#
	36 x 16"	USTSW13616	<input type="checkbox"/>	<input type="checkbox"/> <input type="checkbox"/> <input type="checkbox"/> <input type="checkbox"/>	<input type="checkbox"/> <input type="checkbox"/> <input type="checkbox"/> <input type="checkbox"/>	19.9#
	42 x 16"	USTSW14216	<input type="checkbox"/>	<input type="checkbox"/> <input type="checkbox"/> <input type="checkbox"/> <input type="checkbox"/>	<input type="checkbox"/> <input type="checkbox"/> <input type="checkbox"/> <input type="checkbox"/>	22.3#
	48 x 16"	USTSW14816	<input type="checkbox"/>	<input type="checkbox"/> <input type="checkbox"/> <input type="checkbox"/> <input type="checkbox"/>	<input type="checkbox"/> <input type="checkbox"/> <input type="checkbox"/> <input type="checkbox"/>	24.7#
	60 x 16"	USTSW16016	<input type="checkbox"/>	<input type="checkbox"/> <input type="checkbox"/> <input type="checkbox"/> <input type="checkbox"/>	<input type="checkbox"/> <input type="checkbox"/> <input type="checkbox"/> <input type="checkbox"/>	29.5#
	72 x 16"	USTSW17216	<input type="checkbox"/>	<input type="checkbox"/> <input type="checkbox"/> <input type="checkbox"/> <input type="checkbox"/>	<input type="checkbox"/> <input type="checkbox"/> <input type="checkbox"/> <input type="checkbox"/>	36.9#

**A**      **B**      **C**      **D**

## HOW TO ORDER

Indicate the following information on order form:

1. Quantity of each item.
2. Model number, including options. See "How To Build a Model Number".
3. Any special service required.

Note: • The  indicates that a choice is required.

- The absence of the  indicates that no choice is required.
- Alpha-numeric characters in place of  indicate that no other alternatives are available.

## HOW TO BUILD A MODEL NUMBER

- A** Select basic model.
- B** Select trim color.  
Refer to color addendum at [ki.com](http://ki.com) or KI Fabrics & Finishes binder.
- C** Select fabric side 1.  
Refer to color addendum at [ki.com](http://ki.com) or in KI Fabrics & Finishes binder.
- D** Select fabric side 2.  
Refer to color addendum at [ki.com](http://ki.com) or in KI Fabrics & Finishes binder.



# Stacking Panel

Slat Wall on One Side

Delivered Pricing Fabric Grade 1 & C.O.M.	Delivered Pricing Fabric Grade 2	Delivered Pricing Fabric Grade 3 & Pallas Vertical Fabric Grade PV	Delivered Pricing Pallas Vertical Fabric Grade PV1	Delivered Pricing Pallas Vertical Fabric Grade PV2
\$ 460	\$ 481	\$ 501	\$ 512	\$ 544
493	517	534	550	586
539	563	583	597	638
592	619	642	657	700
612	640	662	679	725
670	699	725	743	790
943	986	1020	1045	1115

## SPECIAL SERVICES

### Special Carton Marking

With specially marked information N/C

### Shipping

Shipped k.d. freight prepaid f.o.b. Manitowoc, Wisconsin 54220 factory. Freight class #70.

Specifications and prices are subject to change without prior notice.

# Stacking Panel

Slat Wall on Two Sides

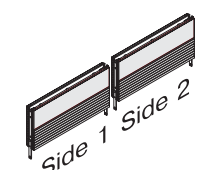
	MODEL	W x H	MODEL NUMBER				Approx. Packaged Weight
			Basic Model	Trim Color	Fabric Side 1	Fabric Side 2	
 <p>USTF</p> <p><b>Slat Wall on Two-Sides Stacking Panel - 16" H</b></p> <ul style="list-style-type: none"> <li>Both sides feature lower 8" section of slat wall and fabric on upper 8"</li> <li>Fabric on sides 1 and 2 is specified separately</li> <li>All sizes stack above panels of equal widths</li> <li>48"-72" sizes may span multiple panels</li> <li>Only one stacking section may be added to a frame</li> <li>No power is available on stacking sections</li> <li>No storage or accessories may be hung from stacking sections</li> </ul>		24 x 16"	USTSW22416	<input type="checkbox"/>	<input type="checkbox"/>	<input type="checkbox"/>	20.6#
		30 x 16"	USTSW23016	<input type="checkbox"/>	<input type="checkbox"/>	<input type="checkbox"/>	24.0#
		36 x 16"	USTSW23616	<input type="checkbox"/>	<input type="checkbox"/>	<input type="checkbox"/>	28.0#
		42 x 16"	USTSW24216	<input type="checkbox"/>	<input type="checkbox"/>	<input type="checkbox"/>	31.3#
		48 x 16"	USTSW24816	<input type="checkbox"/>	<input type="checkbox"/>	<input type="checkbox"/>	34.7#
		60 x 16"	USTSW26016	<input type="checkbox"/>	<input type="checkbox"/>	<input type="checkbox"/>	42.0#
		72 x 16"	USTSW27216	<input type="checkbox"/>	<input type="checkbox"/>	<input type="checkbox"/>	51.5#

**A**      **B**      **C**      **D**

### HOW TO ORDER

Indicate the following information on order form:

- Quantity of each item.
- Model number, including options. See "How To Build a Model Number".
- Any special service required.

Note: • The  indicates that a choice is required.

- The absence of the  indicates that no choice is required.
- Alpha-numeric characters in place of  indicate that no other alternatives are available.

### HOW TO BUILD A MODEL NUMBER

- A** Select basic model.
- B** Select trim color.  
Refer to color addendum at [ki.com](http://ki.com) or KI Fabrics & Finishes binder.
- C** Select fabric side 1.  
Refer to color addendum at [ki.com](http://ki.com) or in KI Fabrics & Finishes binder.
- D** Select fabric side 2.  
Refer to color addendum at [ki.com](http://ki.com) or in KI Fabrics & Finishes binder.



# Stacking Panel

Slat Wall on Two Sides

Delivered Pricing Fabric Grade 1 & C.O.M.	Delivered Pricing Fabric Grade 2	Delivered Pricing Fabric Grade 3 & Pallas Vertical Fabric Grade PV	Delivered Pricing Pallas Vertical Fabric Grade PV1	Delivered Pricing Pallas Vertical Fabric Grade PV2
\$ 610	\$ 638	\$ 660	\$ 677	\$ 722
653	684	707	726	774
710	743	769	788	842
784	820	849	870	928
817	853	885	904	964
878	918	951	975	1039
1279	1338	1384	1420	1513

## SPECIAL SERVICES

### Special Carton Marking

With specially marked information N/C

### Shipping

Shipped k.d. freight prepaid f.o.b. Manitowoc, Wisconsin 54220 factory. Freight class #70.

Specifications and prices are subject to change without prior notice.

# Preconfigured Intersections

## 2-Way 90° "L" Corner

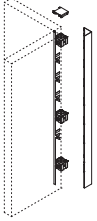
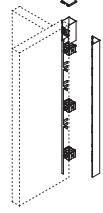
MODEL	A B B-A	MODEL NUMBER		Approx. Packaged Weight
		Basic Model	Trim Color	
 <p><b>2-Way 90°, "L" Corner, No Height Change</b></p> <ul style="list-style-type: none"> <li>Select for 90° corner intersections of two same-height panels</li> <li>Includes full height corner trim, 90° top cap, connecting blocks, light block and connecting hardware</li> </ul>	32"	U2W9032	<input type="checkbox"/>	7.3#
	40"	U2W9040	<input type="checkbox"/>	9.2#
	48"	U2W9048	<input type="checkbox"/>	10.3#
	56"	U2W9056	<input type="checkbox"/>	11.3#
	64"	U2W9064	<input type="checkbox"/>	12.4#
	72"	U2W9072	<input type="checkbox"/>	14.3#
	80"	U2W9080	<input type="checkbox"/>	15.4#
 <p><b>2-Way 90°, "L" Corner, with Height Change</b></p> <ul style="list-style-type: none"> <li>Select for 90° corner intersections of one taller and one lower panel</li> <li>Includes corner and change of height trim, top cap, connecting blocks, light blocks and connecting hardware</li> </ul>	32" 40" 8"	U2W901W3240	<input type="checkbox"/>	9.0#
	32" 48" 16"	U2W901W3248	<input type="checkbox"/>	10.4#
	32" 56" 24"	U2W901W3256	<input type="checkbox"/>	11.6#
	32" 64" 32"	U2W901W3264	<input type="checkbox"/>	12.7#
	32" 72" 40"	U2W901W3272	<input type="checkbox"/>	14.1#
	32" 80" 48"	U2W901W3280	<input type="checkbox"/>	15.3#
	40" 48" 8"	U2W901W4048	<input type="checkbox"/>	10.8#
	40" 56" 16"	U2W901W4056	<input type="checkbox"/>	12.2#
	40" 64" 24"	U2W901W4064	<input type="checkbox"/>	13.4#
	40" 72" 32"	U2W901W4072	<input type="checkbox"/>	14.6#
	40" 80" 40"	U2W901W4080	<input type="checkbox"/>	16.0#
	48" 56" 8"	U2W901W4856	<input type="checkbox"/>	11.9#
	48" 64" 24"	U2W901W4864	<input type="checkbox"/>	13.3#
	48" 72" 24"	U2W901W4872	<input type="checkbox"/>	14.3#
	48" 80" 32"	U2W901W4880	<input type="checkbox"/>	15.5#
	56" 64" 8"	U2W901W5664	<input type="checkbox"/>	13.0#
	56" 72" 16"	U2W901W5672	<input type="checkbox"/>	14.2#
	56" 80" 24"	U2W901W5680	<input type="checkbox"/>	15.4#
	64" 72" 8"	U2W901W6472	<input type="checkbox"/>	14.1#
	64" 80" 16"	U2W901W6480	<input type="checkbox"/>	15.3#
72" 80" 8"	U2W901W7280	<input type="checkbox"/>	15.9#	

A

B

### HOW TO ORDER

Indicate the following information on order form:

- Quantity of each item.
- Model number, including options. See "How To Build a Model Number".
- Any special service required.

Note: • The  indicates that a choice is required.

- The absence of the  indicates that no choice is required.
- Alpha-numeric characters in place of  indicate that no other alternatives are available.

### HOW TO BUILD A MODEL NUMBER

- A** Select basic model.
- B** Select trim color.  
Refer to color addendum at [ki.com](http://ki.com) or KI Fabrics & Finishes binder.



# Preconfigured Intersections

2-Way 90° "L" Corner

Delivered Pricing

\$ 113  
133  
137  
143  
161  
179  
190

\$ 193  
200  
205  
213  
222  
226  
214  
221  
227  
233  
246  
218  
226  
228  
235  
222  
230  
234  
243  
250  
260

**SPECIAL SERVICES**

**Special Carton Marking**

With specially marked information N/C

**Shipping**

Shipped k.d. freight prepaid f.o.b. Manitowoc, Wisconsin 54220 factory. Freight class #70.

Specifications and prices are subject to change without prior notice.

# Preconfigured Intersections

## 2-Way 180°

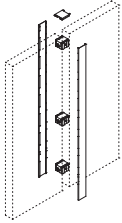
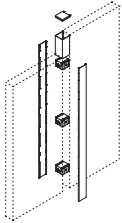
MODEL	A B B-A	MODEL NUMBER		Approx. Packaged Weight
		Basic Model	Trim Color	
 <p><b>2-Way 180°, In-Line Spacer Trim, No Height Change</b></p> <ul style="list-style-type: none"> <li>• Select for inline intersections of two same-height panels, with panel-width spacing between</li> <li>• Includes two full height flat trim pieces, 90° top cap, connecting blocks, and connecting hardware</li> </ul>	32"	U2W180IL32	<input type="checkbox"/>	8.4#
	40"	U2W180IL40	<input type="checkbox"/>	9.4#
	48"	U2W180IL48	<input type="checkbox"/>	10.4#
	56"	U2W180IL56	<input type="checkbox"/>	11.3#
	64"	U2W180IL64	<input type="checkbox"/>	12.3#
	72"	U2W180IL72	<input type="checkbox"/>	14.3#
	80"	U2W180IL80	<input type="checkbox"/>	15.2#
 <p><b>2-Way 180°, Trim One Side, with Height Change</b></p> <ul style="list-style-type: none"> <li>• Select for inline intersections of one taller and one lower panel, with panel-width spacing between</li> <li>• Includes two flat trim pieces, change of height 3-sided trim, top cap, connecting blocks, and connecting hardware</li> </ul>	32" 40" 8"	U2W1801W3240	<input type="checkbox"/>	9.0#
	32" 48" 16"	U2W1801W3248	<input type="checkbox"/>	10.4#
	32" 56" 24"	U2W1801W3256	<input type="checkbox"/>	11.6#
	32" 64" 32"	U2W1801W3264	<input type="checkbox"/>	12.7#
	32" 72" 40"	U2W1801W3272	<input type="checkbox"/>	14.1#
	32" 80" 48"	U2W1801W3280	<input type="checkbox"/>	15.3#
	40" 48" 8"	U2W1801W4048	<input type="checkbox"/>	10.9#
	40" 56" 16"	U2W1801W4056	<input type="checkbox"/>	12.3#
	40" 64" 24"	U2W1801W4064	<input type="checkbox"/>	13.5#
	40" 72" 32"	U2W1801W4072	<input type="checkbox"/>	14.7#
	40" 80" 40"	U2W1801W4080	<input type="checkbox"/>	16.1#
	48" 56" 8"	U2W1801W4856	<input type="checkbox"/>	11.9#
	48" 64" 16"	U2W1801W4864	<input type="checkbox"/>	13.3#
	48" 72" 24"	U2W1801W4872	<input type="checkbox"/>	14.5#
	48" 80" 32"	U2W1801W4880	<input type="checkbox"/>	15.7#
	56" 64" 8"	U2W1801W5664	<input type="checkbox"/>	12.9#
	56" 72" 16"	U2W1801W5672	<input type="checkbox"/>	14.3#
	56" 80" 24"	U2W1801W5680	<input type="checkbox"/>	15.5#
	64" 72" 8"	U2W1801W6472	<input type="checkbox"/>	13.9#
	64" 80" 16"	U2W1801W6480	<input type="checkbox"/>	15.3#
72" 80" 8"	U2W1801W7280	<input type="checkbox"/>	15.8#	

**A**

**B**

### HOW TO ORDER

Indicate the following information on order form:

1. Quantity of each item.
2. Model number, including options. See "How To Build a Model Number".
3. Any special service required.

Note: • The  indicates that a choice is required.

- The absence of the  indicates that no choice is required.
- Alpha-numeric characters in place of  indicate that no other alternatives are available.

### HOW TO BUILD A MODEL NUMBER

- A** Select basic model.
- B** Select trim color.  
Refer to color addendum at [ki.com](http://ki.com) or KI Fabrics & Finishes binder.





# Preconfigured Intersections

2-Way 180°

Delivered Pricing

\$ 139  
144  
145  
161  
179  
222  
228

\$ 214  
221  
226  
233  
246  
249  
244  
251  
256  
264  
274  
246  
253  
258  
265  
256  
261  
267  
274  
282  
319

**SPECIAL SERVICES**

**Special Carton Marking**

With specially marked information N/C

**Shipping**

Shipped k.d. freight prepaid f.o.b. Manitowoc, Wisconsin 54220 factory. Freight class #70.

Specifications and prices are subject to change without prior notice.

# Preconfigured Intersections

3-Way 90°

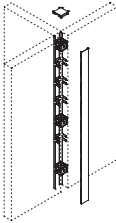
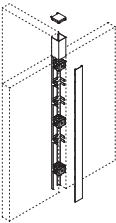
MODEL	A B B-A	MODEL NUMBER		Approx. Packaged Weight
		Basic Model	Trim Color	
 <p><b>3-Way 90°, "T" Corner, No Height Change</b></p> <ul style="list-style-type: none"> <li>Select for 90° intersections of three same-height panels</li> <li>Includes one full height trim piece, 90° top cap, connecting blocks, light blocks and connecting hardware</li> </ul>	32"	U3W9032	<input type="checkbox"/>	6.5#
	40"	U3W9040	<input type="checkbox"/>	8.3#
	48"	U3W9048	<input type="checkbox"/>	9.2#
	56"	U3W9056	<input type="checkbox"/>	10.0#
	64"	U3W9064	<input type="checkbox"/>	11.0#
	72"	U3W9072	<input type="checkbox"/>	12.9#
	80"	U3W9080	<input type="checkbox"/>	13.8#
 <p><b>3-Way 90°, Trim One Side "T" Corner, with Height Change</b></p> <ul style="list-style-type: none"> <li>Select for 90° three-way intersections of one taller and two lower panels</li> <li>Includes one flat trim piece, three-sided change of height trim, top cap, connecting blocks, light blocks, and connecting hardware</li> </ul>	32" 40" 8"	U3W901W3240	<input type="checkbox"/>	7.9#
	32" 48" 16"	U3W901W3248	<input type="checkbox"/>	9.4#
	32" 56" 24"	U3W901W3256	<input type="checkbox"/>	10.5#
	32" 64" 32"	U3W901W3264	<input type="checkbox"/>	11.7#
	32" 72" 40"	U3W901W3272	<input type="checkbox"/>	13.0#
	32" 80" 48"	U3W901W3280	<input type="checkbox"/>	14.3#
	40" 48" 8"	U3W901W4048	<input type="checkbox"/>	9.8#
	40" 56" 16"	U3W901W4056	<input type="checkbox"/>	11.2#
	40" 64" 24"	U3W901W4064	<input type="checkbox"/>	12.3#
	40" 72" 32"	U3W901W4072	<input type="checkbox"/>	13.5#
	40" 80" 40"	U3W901W4080	<input type="checkbox"/>	14.9#
	48" 56" 8"	U3W901W4856	<input type="checkbox"/>	10.7#
	48" 64" 16"	U3W901W4864	<input type="checkbox"/>	12.1#
	48" 72" 24"	U3W901W4872	<input type="checkbox"/>	13.2#
	48" 80" 32"	U3W901W4880	<input type="checkbox"/>	14.6#
	56" 64" 8"	U3W901W5664	<input type="checkbox"/>	11.6#
	56" 72" 16"	U3W901W5672	<input type="checkbox"/>	13.0#
	56" 80" 24"	U3W901W5680	<input type="checkbox"/>	14.2#
	64" 72" 8"	U3W901W6472	<input type="checkbox"/>	12.5#
	64" 80" 16"	U3W901W6480	<input type="checkbox"/>	13.9#
72" 80" 8"	U3W901W7280	<input type="checkbox"/>	14.7#	

A

B

## HOW TO ORDER

Indicate the following information on order form:

- Quantity of each item.
- Model number, including options. See "How To Build a Model Number".
- Any special service required.

Note: • The  indicates that a choice is required.

- The absence of the  indicates that no choice is required.
- Alpha-numeric characters in place of  indicate that no other alternatives are available.

## HOW TO BUILD A MODEL NUMBER

**A** Select basic model.

**B** Select trim color.  
Refer to color addendum at [ki.com](http://ki.com) or KI Fabrics & Finishes binder.



# Preconfigured Intersections

3-Way 90°

Delivered Pricing

\$ 114  
137  
142  
148  
161  
191  
197

\$ 198  
205  
211  
217  
228  
229  
219  
227  
229  
238  
251  
221  
229  
233  
243  
229  
235  
243  
244  
251  
273

**SPECIAL SERVICES**

**Special Carton Marking**

With specially marked information N/C

**Shipping**

Shipped k.d. freight prepaid f.o.b. Manitowoc, Wisconsin 54220 factory. Freight class #70.

Specifications and prices are subject to change without prior notice.

# Preconfigured Intersections

3-Way 90°

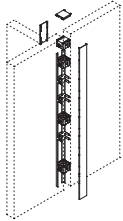
MODEL	A B B-A	MODEL NUMBER		Approx. Packaged Weight
		Basic Model	Trim Color	
 <p><b>3-Way 90°, In-Line "T" Corner, with Height Change</b></p> <ul style="list-style-type: none"> <li>• Select for 90° three-way intersections of two taller inline panels and one lower perpendicular panel</li> <li>• Includes one full height flat trim piece, one change-of-height flat trim piece, 90° top cap, connecting blocks, light blocks, and connecting hardware</li> </ul>	32" 40" 8"	U3W90IL3240	<input type="checkbox"/>	8.9#
	32" 48" 16"	U3W90IL3248	<input type="checkbox"/>	10.8#
	32" 56" 24"	U3W90IL3256	<input type="checkbox"/>	11.8#
	32" 64" 32"	U3W90IL3264	<input type="checkbox"/>	12.8#
	32" 72" 40"	U3W90IL3272	<input type="checkbox"/>	14.7#
	32" 80" 48"	U3W90IL3280	<input type="checkbox"/>	15.7#
	40" 48" 8"	U3W90IL4048	<input type="checkbox"/>	10.7#
	40" 56" 16"	U3W90IL4056	<input type="checkbox"/>	11.7#
	40" 64" 24"	U3W90IL4064	<input type="checkbox"/>	13.6#
	40" 72" 32"	U3W90IL4072	<input type="checkbox"/>	14.6#
	40" 80" 40"	U3W90IL4080	<input type="checkbox"/>	16.5#
	48" 56" 8"	U3W90IL4856	<input type="checkbox"/>	11.6#
	48" 64" 16"	U3W90IL4864	<input type="checkbox"/>	13.5#
	48" 72" 24"	U3W90IL4872	<input type="checkbox"/>	15.5#
	48" 80" 32"	U3W90IL4880	<input type="checkbox"/>	15.5#
	56" 64" 8"	U3W90IL5664	<input type="checkbox"/>	12.5#
	56" 72" 16"	U3W90IL5672	<input type="checkbox"/>	15.3#
	56" 80" 24"	U3W90IL5680	<input type="checkbox"/>	16.4#
	64" 72" 8"	U3W90IL6472	<input type="checkbox"/>	13.4#
	64" 80" 16"	U3W90IL6480	<input type="checkbox"/>	15.4#
72" 80" 8"	U3W90IL7280	<input type="checkbox"/>	15.2#	

**A**

**B**

## HOW TO ORDER

Indicate the following information on order form:

1. Quantity of each item.
2. Model number, including options. See "How To Build a Model Number".
3. Any special service required.

Note: • The  indicates that a choice is required.

- The absence of the  indicates that no choice is required.
- Alpha-numeric characters in place of  indicate that no other alternatives are available.

## HOW TO BUILD A MODEL NUMBER

**A** Select basic model.

**B** Select trim color.  
Refer to color addendum at [ki.com](http://ki.com) or KI Fabrics & Finishes binder.



# Preconfigured Intersections

3-Way 90°

Delivered  
Pricing

\$ 149
174
179
193
229
234
167
198
206
222
251
174
207
221
228
188
221
227
203
228
221

## SPECIAL SERVICES

### Special Carton Marking

With specially marked information N/C

### Shipping

Shipped k.d. freight prepaid f.o.b. Manitowoc, Wisconsin 54220 factory. Freight class #70.

Specifications and prices are subject to change without prior notice.

# Preconfigured Intersections

3-Way 90°

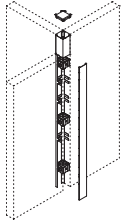
MODEL	A B B-A	MODEL NUMBER		Approx. Packaged Weight
		Basic Model	Trim Color	
 <p><b>3-Way 90°, Trim Two Sides "T" Corner, with Height Change</b></p> <ul style="list-style-type: none"> <li>• Select for 90° three-way intersections of one taller and one lower inline panels and one perpendicular taller panel</li> <li>• Includes one flat trim piece, two-sided change of height trim, top cap, connecting blocks, light blocks, and connecting hardware</li> </ul>	32" 40" 8"	U3W902W3240	<input type="checkbox"/>	8.7#
	32" 48" 16"	U3W902W3248	<input type="checkbox"/>	10.6#
	32" 56" 24"	U3W902W3256	<input type="checkbox"/>	11.6#
	32" 64" 32"	U3W902W3264	<input type="checkbox"/>	12.7#
	32" 72" 40"	U3W902W3272	<input type="checkbox"/>	14.6#
	32" 80" 48"	U3W902W3280	<input type="checkbox"/>	15.6#
	40" 48" 8"	U3W902W4048	<input type="checkbox"/>	10.5#
	40" 56" 16"	U3W902W4056	<input type="checkbox"/>	12.4#
	40" 64" 24"	U3W902W4064	<input type="checkbox"/>	13.4#
	40" 72" 32"	U3W902W4072	<input type="checkbox"/>	14.5#
	40" 80" 40"	U3W902W4080	<input type="checkbox"/>	16.4#
	48" 56" 8"	U3W902W4856	<input type="checkbox"/>	11.4#
	48" 64" 16"	U3W902W4864	<input type="checkbox"/>	13.3#
	48" 72" 24"	U3W902W4872	<input type="checkbox"/>	14.3#
	48" 80" 32"	U3W902W4880	<input type="checkbox"/>	15.4#
	56" 64" 8"	U3W902W5664	<input type="checkbox"/>	12.3#
	56" 72" 16"	U3W902W5672	<input type="checkbox"/>	14.2#
	56" 80" 24"	U3W902W5680	<input type="checkbox"/>	15.3#
	64" 72" 8"	U3W902W6472	<input type="checkbox"/>	13.2#
	64" 80" 16"	U3W902W6480	<input type="checkbox"/>	16.0#
72" 80" 8"	U3W902W7280	<input type="checkbox"/>	15.0#	

**A**

**B**

## HOW TO ORDER

Indicate the following information on order form:

1. Quantity of each item.
2. Model number, including options. See "How To Build a Model Number".
3. Any special service required.

Note: • The  indicates that a choice is required.

- The absence of the  indicates that no choice is required.
- Alpha-numeric characters in place of  indicate that no other alternatives are available.

## HOW TO BUILD A MODEL NUMBER

**A** Select basic model.

**B** Select trim color.  
Refer to color addendum at [ki.com](http://ki.com) or KI Fabrics & Finishes binder.



# Preconfigured Intersections

3-Way 90°

Delivered  
Pricing

\$ 161
176
182
191
209
214
182
200
205
212
219
185
202
207
215
193
209
215
206
222
248

## SPECIAL SERVICES

### Special Carton Marking

With specially marked information N/C

### Shipping

Shipped k.d. freight prepaid f.o.b. Manitowoc, Wisconsin 54220 factory. Freight class #70.

Specifications and prices are subject to change without prior notice.

# Preconfigured Intersections

4-Way 90°

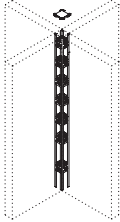
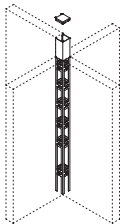
	MODEL	A	B	B-A	MODEL NUMBER		Approx. Packaged Weight
					Basic Model	Trim Color	
	<b>4-Way 90°, "X", No Height Change</b>	32"			U4W9032	<input type="checkbox"/>	6.3#
	<ul style="list-style-type: none"> <li>Select for 90° intersections of four same-height panels</li> <li>Includes 90° top cap, connecting blocks, light blocks, and connecting hardware</li> </ul>	40"			U4W9040	<input type="checkbox"/>	8.1#
		48"			U4W9048	<input type="checkbox"/>	9.0#
		56"			U4W9056	<input type="checkbox"/>	9.9#
		64"			U4W9064	<input type="checkbox"/>	10.7#
		72"			U4W9072	<input type="checkbox"/>	12.6#
		80"			U4W9080	<input type="checkbox"/>	13.4#
UTN							
	<b>4-Way 90°, "X" Trim One Side, with Height Change</b>	32"	40"	8"	U4W901W3240	<input type="checkbox"/>	7.8#
	<ul style="list-style-type: none"> <li>Select for 90° four-way intersections of one taller and three lower panels</li> <li>Includes three-sided change of height trim, top cap, connecting blocks, light blocks, and connecting hardware</li> </ul>	32"	48"	16"	U4W901W3248	<input type="checkbox"/>	9.2#
		32"	56"	24"	U4W901W3256	<input type="checkbox"/>	10.4#
		32"	64"	32"	U4W901W3264	<input type="checkbox"/>	11.6#
		32"	72"	40"	U4W901W3272	<input type="checkbox"/>	12.9#
		32"	80"	48"	U4W901W3280	<input type="checkbox"/>	14.1#
		40"	48"	8"	U4W901W4048	<input type="checkbox"/>	8.7#
		40"	56"	16"	U4W901W4056	<input type="checkbox"/>	10.1#
		40"	64"	24"	U4W901W4064	<input type="checkbox"/>	11.2#
		40"	72"	32"	U4W901W4072	<input type="checkbox"/>	13.6#
		40"	80"	40"	U4W901W4080	<input type="checkbox"/>	13.6#
		48"	56"	8"	U4W901W4856	<input type="checkbox"/>	10.5#
		48"	64"	16"	U4W901W4864	<input type="checkbox"/>	11.9#
		48"	72"	24"	U4W901W4872	<input type="checkbox"/>	13.1#
		48"	80"	32"	U4W901W4880	<input type="checkbox"/>	14.2#
		56"	64"	8"	U4W901W5664	<input type="checkbox"/>	11.4#
		56"	72"	16"	U4W901W5672	<input type="checkbox"/>	12.8#
		56"	80"	24"	U4W901W5680	<input type="checkbox"/>	13.9#
	64"	72"	8"	U4W901W6472	<input type="checkbox"/>	12.2#	
	64"	80"	16"	U4W901W6480	<input type="checkbox"/>	14.8#	
	72"	80"	8"	U4W901W7280	<input type="checkbox"/>	14.0#	

A

B

## HOW TO ORDER

Indicate the following information on order form:

- Quantity of each item.
- Model number, including options. See "How To Build a Model Number".
- Any special service required.

Note: • The  indicates that a choice is required.

- The absence of the  indicates that no choice is required.
- Alpha-numeric characters in place of  indicate that no other alternatives are available.

## HOW TO BUILD A MODEL NUMBER

- A** Select basic model.
- B** Select trim color.  
Refer to color addendum at [ki.com](http://ki.com) or KI Fabrics & Finishes binder.





# Preconfigured Intersections

4-Way 90°

Delivered Pricing

\$ 112  
132  
138  
143  
149  
169  
175

\$ 195  
204  
206  
214  
227  
228  
218  
226  
228  
234  
250  
220  
228  
233  
240  
227  
234  
238  
233  
241  
251

**SPECIAL SERVICES**

**Special Carton Marking**

With specially marked information N/C

**Shipping**

Shipped k.d. freight prepaid f.o.b. Manitowoc, Wisconsin 54220 factory. Freight class #70.

Specifications and prices are subject to change without prior notice.

# Preconfigured Intersections

4-Way 90°

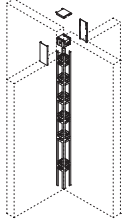

UTN

**MODEL**

**4-Way 90°, "X" In-Line Intersection, with Height Change**

- Select for 90° four-way intersections of two taller inline panels and two lower perpendicular panels
- Includes two change-of-height flat trim pieces, 90° top cap, connecting blocks, light blocks and connecting hardware

**A B B-A**

**MODEL NUMBER**

Basic Model

Trim Color

Approx. Packaged Weight

32" 40" 8"	U4W90IL3240	<input type="checkbox"/>	8.7#
32" 48" 16"	U4W90IL3248	<input type="checkbox"/>	10.7#
32" 56" 24"	U4W90IL3256	<input type="checkbox"/>	11.6#
32" 64" 32"	U4W90IL3264	<input type="checkbox"/>	12.6#
32" 72" 40"	U4W90IL3272	<input type="checkbox"/>	14.6#
32" 80" 48"	U4W90IL3280	<input type="checkbox"/>	15.5#
40" 48" 8"	U4W90IL4048	<input type="checkbox"/>	10.6#
40" 56" 16"	U4W90IL4056	<input type="checkbox"/>	12.5#
40" 64" 24"	U4W90IL4064	<input type="checkbox"/>	13.5#
40" 72" 32"	U4W90IL4072	<input type="checkbox"/>	14.5#
40" 80" 40"	U4W90IL4080	<input type="checkbox"/>	16.4#
48" 56" 8"	U4W90IL4856	<input type="checkbox"/>	11.4#
48" 64" 16"	U4W90IL4864	<input type="checkbox"/>	13.4#
48" 72" 24"	U4W90IL4872	<input type="checkbox"/>	14.3#
48" 80" 32"	U4W90IL4880	<input type="checkbox"/>	16.3#
56" 64" 8"	U4W90IL5664	<input type="checkbox"/>	12.3#
56" 72" 16"	U4W90IL5672	<input type="checkbox"/>	15.2#
56" 80" 24"	U4W90IL5680	<input type="checkbox"/>	15.2#
64" 72" 8"	U4W90IL6472	<input type="checkbox"/>	13.1#
64" 80" 16"	U4W90IL6480	<input type="checkbox"/>	15.1#
72" 80" 8"	U4W90IL7280	<input type="checkbox"/>	15.0#

**A**

**B**

## HOW TO ORDER

Indicate the following information on order form:

1. Quantity of each item.
2. Model number, including options. See "How To Build a Model Number".
3. Any special service required.

Note: • The  indicates that a choice is required.

- The absence of the  indicates that no choice is required.
- Alpha-numeric characters in place of  indicate that no other alternatives are available.

## HOW TO BUILD A MODEL NUMBER

- A** Select basic model.
- B** Select trim color. Refer to color addendum at [ki.com](http://ki.com) or KI Fabrics & Finishes binder.



# Preconfigured Intersections

4-Way 90°

Delivered  
Pricing

\$ 171
201
208
224
256
283
191
221
232
249
265
197
228
235
252
201
231
244
209
240
228

## SPECIAL SERVICES

### Special Carton Marking

With specially marked information N/C

### Shipping

Shipped **k.d. freight prepaid f.o.b. Manitowoc, Wisconsin 54220** factory. Freight class #70.

Specifications and prices are subject to change without prior notice.

# Preconfigured Intersections

4-Way 90°

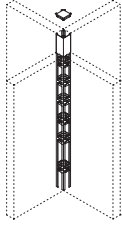
MODEL	A B B-A	MODEL NUMBER		Approx. Packaged Weight
		Basic Model	Trim Color	
 <p>UTN</p> <p><b>4-Way 90°, "X" Trim Two Sides, with Height Change</b></p> <ul style="list-style-type: none"> <li>• Select for 90° three-way intersections of two perpendicular taller panels and two perpendicular lower panels</li> <li>• Includes two-sided change of height trim, top cap, connecting blocks, light blocks, and connecting hardware</li> </ul>	32" 40" 8"	U4W902W3240	<input type="checkbox"/>	8.2#
	32" 48" 16"	U4W902W3248	<input type="checkbox"/>	10.0#
	32" 56" 24"	U4W902W3256	<input type="checkbox"/>	11.2#
	32" 64" 32"	U4W902W3264	<input type="checkbox"/>	12.2#
	32" 72" 40"	U4W902W3272	<input type="checkbox"/>	14.0#
	32" 80" 48"	U4W902W3280	<input type="checkbox"/>	15.2#
	40" 48" 8"	U4W902W4048	<input type="checkbox"/>	10.1#
	40" 56" 16"	U4W902W4056	<input type="checkbox"/>	11.9#
	40" 64" 24"	U4W902W4064	<input type="checkbox"/>	13.0#
	40" 72" 32"	U4W902W4072	<input type="checkbox"/>	14.1#
	40" 80" 40"	U4W902W4080	<input type="checkbox"/>	15.9#
	48" 56" 8"	U4W902W4856	<input type="checkbox"/>	10.9#
	48" 64" 16"	U4W902W4864	<input type="checkbox"/>	12.8#
	48" 72" 24"	U4W902W4872	<input type="checkbox"/>	13.9#
	48" 80" 32"	U4W902W4880	<input type="checkbox"/>	14.9#
	56" 64" 8"	U4W902W5664	<input type="checkbox"/>	11.8#
	56" 72" 16"	U4W902W5672	<input type="checkbox"/>	13.6#
	56" 80" 24"	U4W902W5680	<input type="checkbox"/>	14.7#
	64" 72" 8"	U4W902W6472	<input type="checkbox"/>	13.4#
	64" 80" 24"	U4W902W6480	<input type="checkbox"/>	14.5#
72" 80" 8"	U4W902W7280	<input type="checkbox"/>	14.5#	

A

B

## HOW TO ORDER

Indicate the following information on order form:

1. Quantity of each item.
2. Model number, including options. See "How To Build a Model Number".
3. Any special service required.

Note: • The  indicates that a choice is required.

- The absence of the  indicates that no choice is required.
- Alpha-numeric characters in place of  indicate that no other alternatives are available.

## HOW TO BUILD A MODEL NUMBER

- A** Select basic model.
- B** Select trim color.  
Refer to color addendum at [ki.com](http://ki.com) or KI Fabrics & Finishes binder.



# Preconfigured Intersections

4-Way 90°

Delivered  
Pricing

\$ 160
175
177
186
208
213
177
199
201
208
229
184
202
206
214
191
208
213
198
214
219

## SPECIAL SERVICES

### Special Carton Marking

With specially marked information N/C

### Shipping

Shipped k.d. freight prepaid f.o.b. Manitowoc, Wisconsin 54220 factory. Freight class #70.

Specifications and prices are subject to change without prior notice.

# Preconfigured Intersections

4-Way 90°

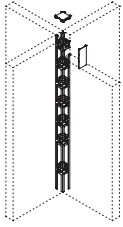

UTN

**MODEL**

- 4-Way 90°, "X" Trim Three Sides, with Height Change**
- Select for 90° X four-way intersections of three taller panels and one lower panel
  - Includes one change-of-height flat trim piece, top cap, connecting blocks, light blocks, and connecting hardware

A	B	B-A	MODEL NUMBER		Approx. Packaged Weight
			Basic Model	Trim Color	
32"	40"	8"	U4W903W3240	<input type="checkbox"/>	8.0#
32"	48"	16"	U4W903W3248	<input type="checkbox"/>	9.9#
32"	56"	24"	U4W903W3256	<input type="checkbox"/>	10.9#
32"	64"	32"	U4W903W3264	<input type="checkbox"/>	11.8#
32"	72"	40"	U4W903W3272	<input type="checkbox"/>	13.6#
32"	80"	48"	U4W903W3280	<input type="checkbox"/>	14.5#
40"	48"	8"	U4W903W4048	<input type="checkbox"/>	10.0#
40"	56"	16"	U4W903W4056	<input type="checkbox"/>	11.8#
40"	64"	24"	U4W903W4064	<input type="checkbox"/>	12.7#
40"	72"	32"	U4W903W4072	<input type="checkbox"/>	13.6#
40"	80"	40"	U4W903W4080	<input type="checkbox"/>	15.4#
48"	56"	8"	U4W903W4856	<input type="checkbox"/>	10.8#
48"	64"	16"	U4W903W4864	<input type="checkbox"/>	12.6#
48"	72"	24"	U4W903W4872	<input type="checkbox"/>	13.6#
48"	80"	32"	U4W903W4880	<input type="checkbox"/>	14.5#
56"	64"	8"	U4W903W5664	<input type="checkbox"/>	11.7#
56"	72"	16"	U4W903W5672	<input type="checkbox"/>	14.5#
56"	80"	24"	U4W903W5680	<input type="checkbox"/>	14.4#
64"	72"	8"	U4W903W6472	<input type="checkbox"/>	12.6#
64"	80"	16"	U4W903W6480	<input type="checkbox"/>	14.4#
72"	80"	8"	U4W903W7280	<input type="checkbox"/>	14.4#

**A**

**B**

## HOW TO ORDER

Indicate the following information on order form:

1. Quantity of each item.
2. Model number, including options. See "How To Build a Model Number".
3. Any special service required.

Note: • The  indicates that a choice is required.

- The absence of the  indicates that no choice is required.
- Alpha-numeric characters in place of  indicate that no other alternatives are available.

## HOW TO BUILD A MODEL NUMBER

- A** Select basic model.
- B** Select trim color. Refer to color addendum at [ki.com](http://ki.com) or KI Fabrics & Finishes binder.



# Preconfigured Intersections

4-Way 90°

Delivered Pricing

- \$ 152
- 186
- 192
- 199
- 205
- 207
- 173
- 190
- 198
- 205
- 227
- 176
- 199
- 201
- 208
- 184
- 205
- 211
- 191
- 208
- 209

**SPECIAL SERVICES**

**Special Carton Marking**

With specially marked information    N/C

**Shipping**

Shipped **k.d. freight prepaid f.o.b. Manitowoc, Wisconsin 54220** factory. Freight class #70.

Specifications and prices are subject to change without prior notice.

# Preconfigured Intersections

## 2-Way 120°

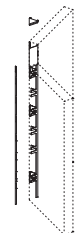
MODEL	A B B-A	MODEL NUMBER		Approx. Packaged Weight
		Basic Model	Trim Color	
 <p><b>2-Way 120°, "V" Corner, No Height Change</b></p> <ul style="list-style-type: none"> <li>Select for 120° angled intersections of two same-height panels</li> <li>Includes 2-sided angle trim, 120° top cap, connecting blocks, light block and connecting hardware</li> </ul>	32"	U2W12032	<input type="checkbox"/>	4.7#
	40"	U2W12040	<input type="checkbox"/>	5.9#
	48"	U2W12048	<input type="checkbox"/>	6.6#
	56"	U2W12056	<input type="checkbox"/>	7.4#
	64"	U2W12064	<input type="checkbox"/>	8.0#
	72"	U2W12072	<input type="checkbox"/>	9.3#
	80"	U2W12080	<input type="checkbox"/>	10.0#
 <p><b>2-Way 120°, "V" Corner, with Height Change</b></p> <ul style="list-style-type: none"> <li>Select for 120° angled intersections of one taller and one lower panel</li> <li>Includes corner and change of height trim, 120° top cap, connecting blocks, light block, and connecting hardware</li> </ul>	32" 40" 8"	U2W1201W3240	<input type="checkbox"/>	4.5#
	32" 48" 16"	U2W1201W3248	<input type="checkbox"/>	4.5#
	32" 56" 24"	U2W1201W3256	<input type="checkbox"/>	4.5#
	32" 64" 32"	U2W1201W3264	<input type="checkbox"/>	4.5#
	32" 72" 40"	U2W1201W3272	<input type="checkbox"/>	4.5#
	32" 80" 48"	U2W1201W3280	<input type="checkbox"/>	4.5#
	40" 48" 8"	U2W1201W4048	<input type="checkbox"/>	5.7#
	40" 56" 16"	U2W1201W4056	<input type="checkbox"/>	5.7#
	40" 64" 24"	U2W1201W4064	<input type="checkbox"/>	5.7#
	40" 72" 32"	U2W1201W4072	<input type="checkbox"/>	5.7#
	40" 80" 40"	U2W1201W4080	<input type="checkbox"/>	6.1#
	48" 56" 8"	U2W1201W4856	<input type="checkbox"/>	6.4#
	48" 64" 16"	U2W1201W4864	<input type="checkbox"/>	6.4#
	48" 72" 24"	U2W1201W4872	<input type="checkbox"/>	6.4#
	48" 80" 32"	U2W1201W4880	<input type="checkbox"/>	6.4#
	56" 64" 8"	U2W1201W5664	<input type="checkbox"/>	7.1#
	56" 72" 16"	U2W1201W5672	<input type="checkbox"/>	7.1#
	56" 80" 24"	U2W1201W5680	<input type="checkbox"/>	7.1#
	64" 72" 8"	U2W1201W6472	<input type="checkbox"/>	7.9#
	64" 80" 16"	U2W1201W6480	<input type="checkbox"/>	7.9#
72" 80" 8"	U2W1201W7280	<input type="checkbox"/>	9.0#	

**A**

**B**

### HOW TO ORDER

- Indicate the following information on order form:
- Quantity of each item.
  - Model number, including options. See "How To Build a Model Number".
  - Any special service required.

Note:

- The  indicates that a choice is required.
- The absence of the  indicates that no choice is required.
- Alpha-numeric characters in place of  indicate that no other alternatives are available.

### HOW TO BUILD A MODEL NUMBER

- A** Select basic model.
- B** Select trim color. Refer to color addendum at [ki.com](http://ki.com) or KI Fabrics & Finishes binder.





# Preconfigured Intersections

2-Way 120°

Delivered Pricing

\$ 298
369
373
382
397
466
473

\$ 312
318
319
328
335
336
387
392
396
401
478
389
396
397
403
401
405
410
416
419
482

### SPECIAL SERVICES

#### Special Carton Marking

With specially marked information N/C

#### Shipping

Shipped k.d. freight prepaid f.o.b. Manitowoc, Wisconsin 54220 factory. Freight class #70.

Specifications and prices are subject to change without prior notice.

# Preconfigured Intersections

## 3-Way 120°

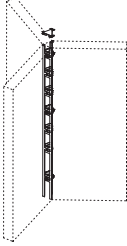
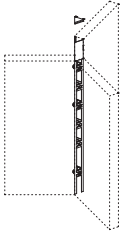
MODEL	A B B-A	MODEL NUMBER		Approx. Packaged Weight
		Basic Model	Trim Color	
 <p><b>3-Way 120° Corner, No Height Change</b></p> <ul style="list-style-type: none"> <li>Select for 120° intersections of three same-height panels</li> <li>Includes 120° top cap, connecting blocks, light blocks and connecting hardware</li> </ul>	32"	U3W12032	<input type="checkbox"/>	4.6#
	40"	U3W12040	<input type="checkbox"/>	5.8#
	48"	U3W12048	<input type="checkbox"/>	6.4#
	56"	U3W12056	<input type="checkbox"/>	7.0#
	64"	U3W12064	<input type="checkbox"/>	7.7#
	72"	U3W12072	<input type="checkbox"/>	8.9#
	80"	U3W12080	<input type="checkbox"/>	9.5#
 <p><b>3-Way 120° Corner, Trim One Side, with Height Change</b></p> <ul style="list-style-type: none"> <li>Select for 120° three-way intersections of one taller and two lower panels</li> <li>Includes one flat trim piece, angled change of height trim, top cap, connecting blocks, light blocks, and connecting hardware</li> </ul>	32" 40" 8"	U3W1201W3240	<input type="checkbox"/>	4.4#
	32" 48" 16"	U3W1201W3248	<input type="checkbox"/>	4.4#
	32" 56" 24"	U3W1201W3256	<input type="checkbox"/>	4.4#
	32" 64" 32"	U3W1201W3264	<input type="checkbox"/>	4.4#
	32" 72" 40"	U3W1201W3272	<input type="checkbox"/>	4.4#
	32" 80" 48"	U3W1201W3280	<input type="checkbox"/>	4.4#
	40" 48" 8"	U3W1201W4048	<input type="checkbox"/>	5.6#
	40" 56" 16"	U3W1201W4056	<input type="checkbox"/>	5.6#
	40" 64" 24"	U3W1201W4064	<input type="checkbox"/>	5.6#
	40" 72" 32"	U3W1201W4072	<input type="checkbox"/>	5.6#
	40" 80" 40"	U3W1201W4080	<input type="checkbox"/>	5.6#
	48" 56" 8"	U3W1201W4856	<input type="checkbox"/>	6.2#
	48" 64" 16"	U3W1201W4864	<input type="checkbox"/>	6.2#
	48" 72" 24"	U3W1201W4872	<input type="checkbox"/>	6.2#
	48" 80" 32"	U3W1201W4880	<input type="checkbox"/>	6.2#
	56" 64" 8"	U3W1201W5664	<input type="checkbox"/>	6.9#
	56" 72" 16"	U3W1201W5672	<input type="checkbox"/>	6.9#
	56" 80" 24"	U3W1201W5680	<input type="checkbox"/>	6.9#
	64" 72" 8"	U3W1201W6472	<input type="checkbox"/>	7.5#
	64" 80" 16"	U3W1201W6480	<input type="checkbox"/>	7.5#
72" 80" 8"	U3W1201W7280	<input type="checkbox"/>	8.7#	

**A**

**B**

### HOW TO ORDER

Indicate the following information on order form:

- Quantity of each item.
- Model number, including options. See "How To Build a Model Number".
- Any special service required.

Note: • The  indicates that a choice is required.

- The absence of the  indicates that no choice is required.
- Alpha-numeric characters in place of  indicate that no other alternatives are available.

### HOW TO BUILD A MODEL NUMBER

- A** Select basic model.
- B** Select trim color. Refer to color addendum at [ki.com](http://ki.com) or KI Fabrics & Finishes binder.



# Preconfigured Intersections

3-Way 120°

Delivered Pricing

\$ 287
363
365
367
373
444
450

\$ 300
306
309
313
320
325
374
380
381
387
458
376
382
386
391
381
386
388
387
390
397

**SPECIAL SERVICES**

**Special Carton Marking**

With specially marked information N/C

**Shipping**

Shipped k.d. freight prepaid f.o.b. Manitowoc, Wisconsin 54220 factory. Freight class #70.

Specifications and prices are subject to change without prior notice.

# Preconfigured Intersections

## 3-Way 120°

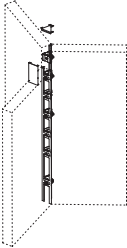
MODEL	A B B-A	MODEL NUMBER		Approx. Packaged Weight
		Basic Model	Trim Color	
 <p><b>3-Way 120° Corner, Trim Two Sides, with Height Change</b></p> <ul style="list-style-type: none"> <li>• Select for 120° three-way intersections of two taller panels and one lower panel</li> <li>• Includes one flat trim piece, top cap, connecting blocks, light blocks, and connecting hardware</li> </ul>	32" 40" 8"	U3W1202W3240	<input type="checkbox"/>	5.5#
	32" 48" 16"	U3W1202W3248	<input type="checkbox"/>	6.6#
	32" 56" 24"	U3W1202W3256	<input type="checkbox"/>	7.3#
	32" 64" 32"	U3W1202W3264	<input type="checkbox"/>	8.0#
	32" 72" 40"	U3W1202W3272	<input type="checkbox"/>	9.1#
	32" 80" 48"	U3W1202W3280	<input type="checkbox"/>	9.9#
	40" 48" 8"	U3W1202W4048	<input type="checkbox"/>	6.7#
	40" 56" 16"	U3W1202W4056	<input type="checkbox"/>	7.8#
	40" 64" 24"	U3W1202W4064	<input type="checkbox"/>	8.5#
	40" 72" 32"	U3W1202W4072	<input type="checkbox"/>	9.2#
	40" 80" 40"	U3W1202W4080	<input type="checkbox"/>	10.3#
	48" 56" 8"	U3W1202W4856	<input type="checkbox"/>	7.3#
	48" 64" 16"	U3W1202W4864	<input type="checkbox"/>	8.4#
	48" 72" 24"	U3W1202W4872	<input type="checkbox"/>	9.1#
	48" 80" 32"	U3W1202W4880	<input type="checkbox"/>	9.8#
	56" 64" 8"	U3W1202W5664	<input type="checkbox"/>	8.0#
	56" 72" 16"	U3W1202W5672	<input type="checkbox"/>	9.1#
	56" 80" 24"	U3W1202W5680	<input type="checkbox"/>	9.8#
	64" 72" 8"	U3W1202W6472	<input type="checkbox"/>	8.6#
	64" 80" 16"	U3W1202W6480	<input type="checkbox"/>	9.7#
72" 80" 8"	U3W1202W7280	<input type="checkbox"/>	10.2#	

**A**

**B**

### HOW TO ORDER

Indicate the following information on order form:

1. Quantity of each item.
2. Model number, including options. See "How To Build a Model Number".
3. Any special service required.

Note: • The  indicates that a choice is required.

- The absence of the  indicates that no choice is required.
- Alpha-numeric characters in place of  indicate that no other alternatives are available.

### HOW TO BUILD A MODEL NUMBER

**A** Select basic model.

**B** Select trim color.  
Refer to color addendum at [ki.com](http://ki.com) or KI Fabrics & Finishes binder.



# Preconfigured Intersections

3-Way 120°

Delivered  
Pricing

\$ 382
453
459
466
536
542
456
527
533
540
612
526
531
539
542
472
534
541
468
541
605

## SPECIAL SERVICES

### Special Carton Marking

With specially marked information N/C

### Shipping

Shipped k.d. freight prepaid f.o.b. Manitowoc, Wisconsin 54220 factory. Freight class #70.

Specifications and prices are subject to change without prior notice.

# End-of-Run Trim

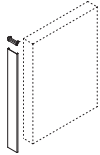
	MODEL	H	MODEL NUMBER		Approx. Packaged Weight
			Basic Model	Trim Color	
	<b>End-of-Run Trim for Full Panel Height Conditions</b> <ul style="list-style-type: none"> <li>Select by height for single panel</li> <li>For seamless end trim when stacking sections are used, specify by combined height of panel and stacker</li> <li>Includes trim endcap and hardware</li> </ul>	32"	UEOR32	<input type="checkbox"/>	3.6#
		40"	UEOR40	<input type="checkbox"/>	4.2#
		48"	UEOR48	<input type="checkbox"/>	4.7#
		56"	UEOR56	<input type="checkbox"/>	5.5#
		64"	UEOR64	<input type="checkbox"/>	6.0#
		72"	UEOR72	<input type="checkbox"/>	7.0#
		80"	UEOR80	<input type="checkbox"/>	7.4#
		UTN			
UTN UST	<b>End-of-Run Trim for Change of Height Conditions</b> <ul style="list-style-type: none"> <li>Height listed is the 'height differential'</li> <li>Specify the distance between the upper panel height and the lower panel height</li> <li>Includes trim endcap and hardware</li> </ul>	8"	UEORV08	<input type="checkbox"/>	1.8#
		16"	UEORV16	<input type="checkbox"/>	2.5#
		24"	UEORV24	<input type="checkbox"/>	3.0#
		32"	UEORV32	<input type="checkbox"/>	3.5#
		40"	UEORV40	<input type="checkbox"/>	4.2#
		48"	UEORV48	<input type="checkbox"/>	4.7#

**A**

**B**

## HOW TO ORDER

Indicate the following information on order form:

- Quantity of each item.
- Model number, including options. See "How To Build a Model Number".
- Any special service required.

Note: • The  indicates that a choice is required.

- The absence of the  indicates that no choice is required.
- Alpha-numeric characters in place of  indicate that no other alternatives are available.

## HOW TO BUILD A MODEL NUMBER

- A** Select basic model.
- B** Select trim color.  
Refer to color addendum at [ki.com](http://ki.com) or KI Fabrics & Finishes binder.  
Metallic finish not available.

Delivered  
Pricing

\$ 48
54
55
59
69
85
88

\$ 34
38
39
44
49
50

**SPECIAL SERVICES****Special Carton Marking**

With specially marked information N/C

**Shipping**

Shipped k.d. freight prepaid f.o.b. Manitowoc, Wisconsin 54220 factory. Freight class #70.

Specifications and prices are subject to change without prior notice.

# Preconfigured Intersections

## Adjustable Wall Mount Start

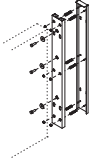
MODEL	MODEL NUMBER		Approx. Packaged Weight
	Basic Model	Trim Color	
 <p><b>Adjustable Wall Mount Start</b></p> <ul style="list-style-type: none"> <li>• Attaches panel to a wall at the start of a run</li> <li>• Includes mounting plate</li> <li>• Steel construction with painted finish</li> <li>• Adjustable for up to 3/4" of wall deflection</li> <li>• Appropriate wall anchor to drywall must be provided by contractor</li> </ul>	UNWM16		6.0#
	UNWM32		11.0#
	UNWM40		14.0#
	UNWM48		17.0#
	UNWM56		20.0#
	UNWM64		22.0#
	UNWM72		25.0#
	UNWM80		28.0#

A

B

### HOW TO ORDER

Indicate the following information on order form:

1. Quantity of each item.
2. Model number, including options. See "How To Build a Model Number".
3. Any special service required.

Note: • The  indicates that a choice is required.

- The absence of the  indicates that no choice is required.
- Alpha-numeric characters in place of  indicate that no other alternatives are available.

### HOW TO BUILD A MODEL NUMBER

**A** Select basic model.

**B** Select trim color.  
Refer to color addendum at [ki.com](http://ki.com) or KI Fabrics & Finishes binder.





# Preconfigured Intersections

Adjustable Wall Mount Start

Delivered  
Pricing

\$ 112
134
141
148
157
173
221
254

## SPECIAL SERVICES

### Special Carton Marking

With specially marked information N/C

### Shipping

Shipped **k.d. freight prepaid f.o.b. Manitowoc, Wisconsin 54220** factory. Freight class #70.

Specifications and prices are subject to change without prior notice.

# Preconfigured Intersections

Perpendicular Start for Genius® Wall

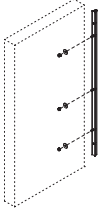
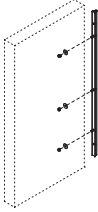
		MODEL NUMBER		Approx. Packaged Weight
MODEL	H	Basic Model		
 <p>UNS</p>	<b>Perpendicular Start - 32" H</b>	32"	UNGPS32	1.4#
	<ul style="list-style-type: none"> <li>Attaches Unite® perpendicularly between two Genius® Wall sections</li> <li>Includes aluminum mounting track</li> <li>Hardware for attachment is included</li> <li>Specify UNGPS32 for all heights of segmented panels with glass, steel or perforated steel (with Aluminum frame) upper segments</li> <li>Specify all other panel models by finished height (without Aluminum frame)</li> <li>Stacking sections are allowed and do not require wall attachment</li> </ul>			
 <p>UNS</p>	<b>Perpendicular Start - 40", 48", 56", 64" H</b>	40"	UNGPS40	1.6#
	<ul style="list-style-type: none"> <li>Attaches Unite® perpendicularly between two Genius® Wall sections</li> <li>Includes aluminum mounting track</li> <li>Hardware for attachment is included</li> <li>Specify by finished monolithic or segmented panel height for all fabric, markerboard or slat wall (unframed) upper segments</li> <li>Stacking sections are allowed and do not require wall attachment</li> </ul>			
		48"	UNGPS48	1.7#
		56"	UNGPS56	1.9#
		64"	UNGPS64	2.1#

**A**

## HOW TO ORDER

Indicate the following information on order form:

- Quantity of each item.
- Model number, including options. See "How To Build a Model Number".
- Any special service required.

Note:

- The  indicates that a choice is required.
- The absence of the  indicates that no choice is required.
- Alpha-numeric characters in place of  indicate that no other alternatives are available.

## HOW TO BUILD A MODEL NUMBER

**A** Select basic model.



# Preconfigured Intersections

Perpendicular Start for Genius® Wall

Delivered  
Pricing  
\$ 66

\$ 71  
80  
80  
80

**SPECIAL SERVICES**

**Special Carton Marking**

With specially marked information N/C

**Shipping**

Shipped k.d. freight prepaid f.o.b. Manitowoc, Wisconsin 54220 factory. Freight class #70.

Specifications and prices are subject to change without prior notice.

# Preconfigured Intersections

Universal Start for Genius® Wall

	MODEL	MODEL NUMBER	
		Basic Model	Approx. Packaged Weight
 <p>HRDPT</p>	<p><b>Universal Start</b></p> <ul style="list-style-type: none"> <li>• Attaches Unite® at a corner, inline, or 3-Way condition of a Genius® Wall section</li> <li>• Includes all hardware necessary for attachment</li> <li>• Universal Start is drilled directly into, and permanently alters, Genius® trim</li> <li>• Wall start does not impact or require any additional Genius® specification</li> <li>• Retrofittable to most standard Genius® trim sections</li> <li>• For use with unloaded panels only</li> </ul>	UNGUS	1.0#

**A**

## HOW TO ORDER

Indicate the following information on order form:

1. Quantity of each item.
2. Model number, including options. See "How To Build a Model Number".
3. Any special service required.

Note:

- The  indicates that a choice is required.
- The absence of the  indicates that no choice is required.
- Alpha-numeric characters in place of  indicate that no other alternatives are available.

## HOW TO BUILD A MODEL NUMBER

**A** Select basic model.



# Preconfigured Intersections

Universal Start for Genius® Wall

Delivered  
Pricing  
\$ 18

**SPECIAL SERVICES**

**Special Carton Marking**

With specially marked information N/C

**Shipping**

Shipped k.d. freight prepaid f.o.b. Manitowoc, Wisconsin 54220 factory. Freight class #70.

Specifications and prices are subject to change without prior notice.

# Preconfigured Intersections

## Wall Track

MODEL	W x H x D	MODEL NUMBER		Approx. Packaged Weight
		Basic Model	Trim Color	
<b>Wall Track</b> • Double slotted track accommodates wall mounting of overhead components and worksurfaces • Steel construction with painted finish • Appropriate wall anchor to drywall must be provided by contractor	1-1/4 x 30 x 1"	UNWT30	<input type="checkbox"/>	3.0#
	1-1/4 x 64 x 1"	UNWT64	<input type="checkbox"/>	5.0#



HRDPT

**A**

**B**

### HOW TO ORDER

Indicate the following information on order form:

1. Quantity of each item.
2. Model number, including options. See "How To Build a Model Number".
3. Any special service required.

- Note:
- The  indicates that a choice is required.
  - The absence of the  indicates that no choice is required.
  - Alpha-numeric characters in place of  indicate that no other alternatives are available.

### HOW TO BUILD A MODEL NUMBER

- A** Select basic model.
- B** Select trim color. Refer to color addendum at [ki.com](http://ki.com) or KI Fabrics & Finishes binder.



# Preconfigured Intersections

Wall Track

Delivered  
Pricing

\$ 28  
39

**SPECIAL SERVICES**

**Special Carton Marking**

With specially marked information N/C

**Shipping**

Shipped **k.d. freight prepaid f.o.b. Manitowoc, Wisconsin 54220** factory. Freight class #70.

Specifications and prices are subject to change without prior notice.

# Preconfigured Stackable Intersections

90° 1-Way, 2-Way, 3-Way and 4-Way

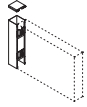
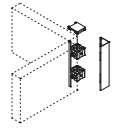
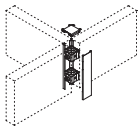
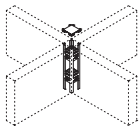
	MODEL	H	MODEL NUMBER			Approx. Packaged Weight
			Basic Model	Top Cap Style	Trim Color	
 <p>UST</p>	<b>90° 1-Way End</b> • Includes top cap and connecting hardware and light block • Only used in 90° intersections when stacking one panel	16	U1W90S16	F	<input type="checkbox"/> <input type="checkbox"/>	4.6#
 <p>UST</p>	<b>90° 2-Way Corner</b> • Includes top cap and connecting hardware and light block	16	U2W90S16	F	<input type="checkbox"/> <input type="checkbox"/>	5.0#
 <p>UST</p>	<b>90° 3-Way Intersection</b> • Includes top cap and connecting hardware and light blocks	16	U3W90S16	F	<input type="checkbox"/> <input type="checkbox"/>	4.8#
 <p>UST</p>	<b>90° 4-Way Intersection</b> • Includes top cap and connecting hardware and light blocks	16	U4W90S16	F	<input type="checkbox"/> <input type="checkbox"/>	4.9#

**A**   **B**   **C**

## HOW TO ORDER

Indicate the following information on order form:

- Quantity of each item.
- Model number, including options. See "How To Build a Model Number".
- Any special service required.

Note:

- The  indicates that a choice is required.
- The absence of the  indicates that no choice is required.
- Alpha-numeric characters in place of  indicate that no other alternatives are available.

## HOW TO BUILD A MODEL NUMBER

- A** Select basic model.
- B** Select top cap style.  
F - Flat trim (std)
- C** Select trim color.  
Refer to color addendum at [ki.com](http://ki.com) or KI Fabrics & Finishes binder.





# Preconfigured Stackable Intersections

90° 1-Way, 2-Way, 3-Way and 4-Way

Delivered Pricing

\$ 115

\$ 99

\$ 100

\$ 97

### SPECIAL SERVICES

#### Special Carton Marking

With specially marked information N/C

#### Shipping

Shipped k.d. freight prepaid f.o.b. Manitowoc, Wisconsin 54220 factory. Freight class #70.

Specifications and prices are subject to change without prior notice.

# Preconfigured Stackable Intersections

2-Way 180° In-Line Spacer

MODEL	H	MODEL NUMBER			Approx. Packaged Weight
		Basic Model	Top Cap Style	Trim Color	
<b>180° 2-Way In-Line Spacer</b> • Includes two flat trim pieces, top cap and connecting hardware and light block	16	U2W180S16	<input type="checkbox"/>	<input type="checkbox"/>	5.5#

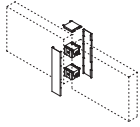

UST

**A**      **B**      **C**

## HOW TO ORDER

Indicate the following information on order form:

1. Quantity of each item.
2. Model number, including options. See "How To Build a Model Number".
3. Any special service required.

- Note:
- The  indicates that a choice is required.
  - The absence of the  indicates that no choice is required.
  - Alpha-numeric characters in place of  indicate that no other alternatives are available.

## HOW TO BUILD A MODEL NUMBER

- A** Select basic model.
- B** Select top cap style.  
F - Flat trim (std)
- C** Select trim color.  
Refer to color addendum at [ki.com](http://ki.com) or KI Fabrics & Finishes binder.



# Preconfigured Stackable Intersections

2-Way 180° In-Line Spacer

Delivered  
Pricing

\$ 102

**SPECIAL SERVICES**

**Special Carton Marking**

With specially marked information N/C

**Shipping**

Shipped **k.d. freight prepaid f.o.b. Manitowoc, Wisconsin 54220** factory. Freight class #70.

Specifications and prices are subject to change without prior notice.

# Preconfigured Stackable Intersections

120° 1-Way, 2-Way, 3-Way and 4-Way

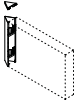
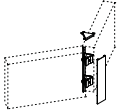
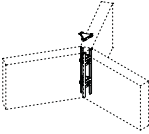
	MODEL	H	MODEL NUMBER			Approx. Packaged Weight
			Basic Model	Top Cap Style	Trim Color	
 <p>UST</p>	<b>120° 1-Way End</b> • Includes top cap and connecting hardware • Only used in 120° intersections when stacking one panel	16	U1W120S16	<input type="checkbox"/>	<input type="checkbox"/>	3.3#
 <p>UST</p>	<b>120° 2-Way Corner</b> • Includes top cap and connecting hardware and light block	16	U2W120S16	<input type="checkbox"/>	<input type="checkbox"/>	3.4#
 <p>UST</p>	<b>120° 3-Way Intersection</b> • Includes top cap and connecting hardware and light blocks	16	U3W120S16	<input type="checkbox"/>	<input type="checkbox"/>	3.5#

**A**      **B**      **C**

## HOW TO ORDER

Indicate the following information on order form:

- Quantity of each item.
- Model number, including options. See "How To Build a Model Number".
- Any special service required.

Note:

- The  indicates that a choice is required.
- The absence of the  indicates that no choice is required.
- Alpha-numeric characters in place of  indicate that no other alternatives are available.

## HOW TO BUILD A MODEL NUMBER

- A** Select basic model.
- B** Select top cap style.  
F - Flat trim (std)
- C** Select trim color.  
Refer to color addendum at [ki.com](http://ki.com) or KI Fabrics & Finishes binder.



# Preconfigured Stackable Intersections

120° 1-Way, 2-Way, 3-Way and 4-Way

Delivered Pricing
\$ 127

\$ 282
--------

\$ 274
--------

**SPECIAL SERVICES**

**Special Carton Marking**

With specially marked information N/C

**Shipping**

Shipped k.d. freight prepaid f.o.b. Manitowoc, Wisconsin 54220 factory. Freight class #70.

Specifications and prices are subject to change without prior notice.

# Stacking End-of-Run Trim

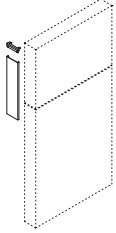
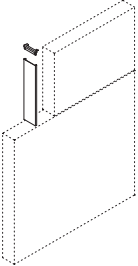
	MODEL	H	MODEL NUMBER		Approx. Packaged Weight	
			Basic Model	Trim Color		
 <p>UST</p>	<b>End-of-Run Trim - Stacking Section</b> <ul style="list-style-type: none"> <li>• Additive vertical trim portion for placement directly above a lower section of end of run trim</li> <li>• Includes end cap</li> </ul>	16"	UEORS16	<input type="checkbox"/>	2.5#	
 <p>UST</p>	<b>End-of-Run Trim - Stacking Section at Variable Height Condition</b> <ul style="list-style-type: none"> <li>• Additive stacking vertical trim for placement at end of run stacking section placed at a change of height location</li> <li>• Trim is 1/2" shorter than end of run trim for stacking section (above), and rests on top of horizontal trim</li> </ul>	16"	UEORV16	<input type="checkbox"/>	2.5#	

**A**      **B**

## HOW TO ORDER

Indicate the following information on order form:

1. Quantity of each item.
2. Model number, including options. See "How To Build a Model Number".
3. Any special service required.

Note:

- The  indicates that a choice is required.
- The absence of the  indicates that no choice is required.
- Alpha-numeric characters in place of  indicate that no other alternatives are available.

## HOW TO BUILD A MODEL NUMBER

- A** Select basic model.
- B** Select trim color. Refer to color addendum at [ki.com](http://ki.com) or KI Fabrics & Finishes binder. Metallic finish not available.



# Stacking End-of-Run Trim

Delivered Pricing

\$ 38

\$ 38

**SPECIAL SERVICES**

**Special Carton Marking**

With specially marked information N/C

**Shipping**

Shipped k.d. freight prepaid f.o.b. Manitowoc, Wisconsin 54220 factory. Freight class #70.

Specifications and prices are subject to change without prior notice.

# Unite® Rolling Door

## General Information

### Plan View of Rolling Door Applications

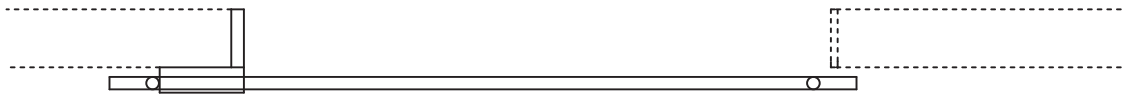

No Jamb Condition (URDNJ)

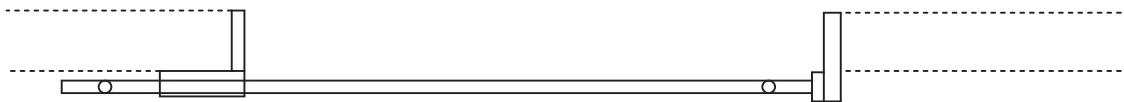

180° Inline Condition (URD180)



90° Intersection Condition (URD90)

#### GENERAL INFORMATION

Unite Rolling Doors allow for simple privacy in workstation, and are offered with or without a jamb closure. Doors without a closing jamb simply overlap the external corner of the closing panel intersection condition. Doors with jambs are shipped with a jamb post and a jamb rail (a receiver where the door can nest there by providing additional privacy).

#### Sizes

Rolling Doors are offered in the following sizes:

36" w X 64" h (monolithic door core)

36" w X 80" h (segmented door core)

42" w X 64" h (monolithic door core)

42" w X 80" h (segmented door core)

The width dimension provided indicates the nominal opening width that the door will span, and the actual door is oversized to allow for panel overlap.

64" high doors are constructed with a single aluminum frame. 80" high doors have a 16" high segmented top section to correspond

to a 16" high Unite® stacking section.

#### Panel Attachment and Specification

The panel to which a Rolling Door is attached must be specified the same width or wider than the nominal Rolling Door model (i.e. 36" w door with 36" or wider attach panel). The "No Jamb" model (URDNJ) must be specified with a 6" or wider attaching panel (i.e. 36" w model with 42" w or wider attaching panel). This prevents the door from extending open into an adjacent walkway. This rule is not required if the attaching panel is a member of a panel run.

#### Door Height Options

80" high Rolling Doors feature a 16" segmented top frame. The top segment of the door is consistent with a 16" panel stacking section on the Unite® panel. 64" Rolling Door models are monolithic and do not feature any segmentation.

#### Cores

Rolling doors are available with two optional

core inserts that are designated as "clear" and "opal". The insert material is the same and complements KI All Terrain® screens. The insert material is a horizontally fluted Polycarbonate sheet. Both cores are semi-transparent and provide basic privacy while allowing light to penetrate into the office space. The opal core is less transparent than the clear.

#### Handedness of Models

All Rolling Door models are "non-handed". Wheel assemblies are packaged separately from the door for unilateral application. Jamb post assemblies are reversible for right or left side assembly.

#### Planning Options

Rolling doors can be ordered after a job site has been installed (reconfiguration) or space planned in advance of job site installation. If planned in advance, standard Unite® intersections will be replaced with jamb post intersections. If a job site is reconfigured after installation, standard intersections must

be removed and replaced with the appropriate jamb post assembly. The exception is with the "no-jamb" condition which does not require a closing jamb intersection.





### Plan View of Rolling Door Applications



Dead End Condition (URDDE)

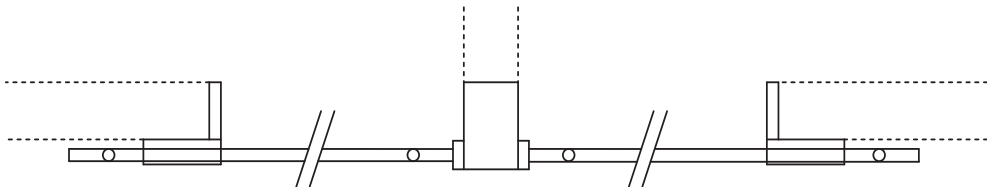

Double Dead End Condition (URDDDE)



Building Wall Condition (URDBW)

**INFORMATION**

**Warranty**  
Refer to KI Terms & Conditions document  
or visit [ki.com](http://ki.com)

# Unite® Rolling Door

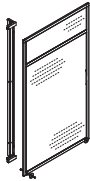
MODEL	W x H	MODEL NUMBER			Approx. Packaged Weight
		Basic Model	Core Insert	Trim Color	
 <p>URD</p> <p><b>Rolling Door-No Jamb Condition</b></p> <ul style="list-style-type: none"> <li>Includes door and attachment post</li> <li>Door extends beyond opening and overlaps Unite® panel edge without jamb closure</li> <li>Door is non-handed and may be used in either right or left position</li> <li>64" models are monolithic; 80" models (shown at left) feature segmentation with trim at 64"</li> <li>Polycarbonate core inserts feature horizontal fluting pattern</li> <li>Non-locking</li> <li>Actual door dimension extends 8" beyond its nominal door opening width</li> <li>Panel to which door attaches must be at least 6" wider than nominal width of door; see Planning Guide for more details</li> <li>See General Information preceding these pages for all conditions in plan view</li> </ul>	44-3/8 x 63-15/16"	URDNJ3664	<input type="checkbox"/>	<input type="checkbox"/>	20.0#
	44-3/8 x 79-15/16"	URDNJ3680	<input type="checkbox"/>	<input type="checkbox"/>	26.0#
	50-3/8 x 63-15/16"	URDNJ4264	<input type="checkbox"/>	<input type="checkbox"/>	22.0#
	50-3/8 x 79-15/16"	URDNJ4280	<input type="checkbox"/>	<input type="checkbox"/>	27.0#
			<b>A</b>	<b>B</b>	<b>C</b>

## HOW TO ORDER

Indicate the following information on order form:

- Quantity of each item.
- Model number, including options. See "How To Build a Model Number".
- Any special service required.

Note:

- The  indicates that a choice is required.
- The absence of the  indicates that no choice is required.
- Alpha-numeric characters in place of  indicate that no other alternatives are available.

## HOW TO BUILD A MODEL NUMBER

- A** Select basic model.
- B** Select core type (plastic fluted core insert).
  - CP** - Fluted Clear Plastic Core
  - OP** - Fluted Opal Plastic Core; add \$158
- C** Select trim color. Refer to color addendum at ki.com or KI Fabrics & Finishes binder.



Delivered Pricing

\$ 1351
1601
1401
1676

**SPECIAL SERVICES**

**Special Carton Marking**

With specially marked information N/C

**Shipping**

Shipped k.d. freight prepaid f.o.b. Manitowoc, Wisconsin 54220 factory. Freight class #70.

Specifications and prices are subject to change without prior notice.

# Unite® Rolling Door

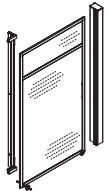
	MODEL	W x H	MODEL NUMBER			Approx. Packaged Weight
			Basic Model	Core Insert	Trim Color	
 <p>URD</p>	<b>Rolling Door-180° Inline Condition</b> <ul style="list-style-type: none"> <li>Includes door, attachment post, and inline door jamb</li> <li>Door is non-handed and may be used in either right or left position</li> <li>64" models are monolithic; 80" models (shown at left) feature segmentation with trim at 64"</li> <li>Polycarbonate core inserts feature horizontal fluting pattern</li> <li>Non-locking</li> <li>Actual door dimension extends 10-3/4" beyond its nominal door opening width</li> <li>Panel to which door attaches must be the same width or wider than the nominal width of door, see Planning Guide for more details</li> <li>See General Information preceding these pages for all conditions in plan view</li> </ul>	44-3/8 x 63-15/16"	URD1803664	<input type="checkbox"/>	<input type="checkbox"/>	34.0#
		44-3/8 x 79-15/16"	URD1803680	<input type="checkbox"/>	<input type="checkbox"/>	44.0#
		50-3/8 x 63-15/16"	URD1804264	<input type="checkbox"/>	<input type="checkbox"/>	36.0#
		50-3/8 x 79-15/16"	URD1804280	<input type="checkbox"/>	<input type="checkbox"/>	45.0#
 <p>URD</p>	<b>Rolling Door-90° Intersection Condition</b> <ul style="list-style-type: none"> <li>Includes door, attachment post, and 90° intersection trim with jamb</li> <li>Door is non-handed and may be used in either right or left position</li> <li>64" models are monolithic; 80" models (shown at left) feature segmentation with trim at 64"</li> <li>Polycarbonate core inserts feature horizontal fluting pattern</li> <li>Non-locking</li> <li>Actual door dimension extends 10-3/4" beyond its nominal door opening width</li> <li>Panel to which door attaches must be the same width or wider than the nominal width of door, see Planning Guide for more details</li> <li>See General Information preceding these pages for all conditions in plan view</li> </ul>	44-3/8 x 63-15/16"	URD903664	<input type="checkbox"/>	<input type="checkbox"/>	42.0#
		44-3/8 x 79-15/16"	URD903680	<input type="checkbox"/>	<input type="checkbox"/>	54.0#
		50-3/8 x 63-15/16"	URD904264	<input type="checkbox"/>	<input type="checkbox"/>	44.0#
		50-3/8 x 79-15/16"	URD904280	<input type="checkbox"/>	<input type="checkbox"/>	55.0#

**A**      **B**      **C**

## HOW TO ORDER

Indicate the following information on order form:

- Quantity of each item.
- Model number, including options. See "How To Build a Model Number".
- Any special service required.

Note:

- The  indicates that a choice is required.
- The absence of the  indicates that no choice is required.
- Alpha-numeric characters in place of  indicate that no other alternatives are available.

## HOW TO BUILD A MODEL NUMBER

- A** Select basic model.
- B** Select core type (plastic fluted core insert).
  - CP** - Fluted Clear Plastic Core
  - OP** - Fluted Opal Plastic Core; add \$158
- C** Select trim color. Refer to color addendum at ki.com or KI Fabrics & Finishes binder.



Delivered Pricing

\$ 1751
2076
1800
2152

\$ 1877
2201
1926
2276

**SPECIAL SERVICES**

**Special Carton Marking**

With specially marked information N/C

**Shipping**

Shipped k.d. freight prepaid f.o.b. Manitowoc, Wisconsin 54220 factory. Freight class #70.

Specifications and prices are subject to change without prior notice.

# Unite® Rolling Door

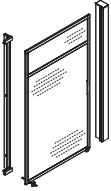
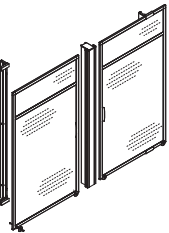
	MODEL	W x H	MODEL NUMBER			Approx. Packaged Weight
			Basic Model	Core Insert	Trim Color	
 <p>URD</p>	<b>Rolling Door-Dead End Condition</b> <ul style="list-style-type: none"> <li>Includes door, attachment post and 90° dead end jamb</li> <li>Door is non-handed and may be used in either right or left position</li> <li>64" models are monolithic; 80" models (shown at left) feature segmentation with trim at 64"</li> <li>Polycarbonate core inserts feature horizontal fluting pattern</li> <li>Non-locking</li> <li>Actual door dimension extends 10-3/4" beyond its nominal door opening width</li> <li>Panel to which door attaches must be the same width or wider than the nominal width of door, see Planning Guide for more details</li> <li>See General Information preceding these pages for all conditions in plan view</li> </ul>	44-3/8 x 63-15/16"	URDDE3664	<input type="checkbox"/>	<input type="checkbox"/>	43.0#
		44-3/8 x 79-15/16"	URDDE3680	<input type="checkbox"/>	<input type="checkbox"/>	53.0#
		50-3/8 x 63-15/16"	URDDE4264	<input type="checkbox"/>	<input type="checkbox"/>	45.0#
		50-3/8 x 79-15/16"	URDDE4280	<input type="checkbox"/>	<input type="checkbox"/>	54.0#
 <p>URD</p>	<b>Rolling Door-Double Dead End Condition</b> <ul style="list-style-type: none"> <li>Includes two doors, two attachment posts and double-sided center jamb post</li> <li>64" models are monolithic; 80" models (shown at left) feature segmentation with trim at 64"</li> <li>Polycarbonate core inserts feature horizontal fluting pattern</li> <li>Non-locking</li> <li>Actual door dimension extends 10-3/4" beyond its nominal door opening width</li> <li>Panel to which door attaches must be the same width or wider than the nominal width of door, see Planning Guide for more details</li> <li>See General Information preceding these pages for all conditions in plan view</li> </ul>	44-3/8 x 63-15/16"	URDDDE3664	<input type="checkbox"/>	<input type="checkbox"/>	65.0#
		44-3/8 x 79-15/16"	URDDDE3680	<input type="checkbox"/>	<input type="checkbox"/>	83.0#
		50-3/8 x 63-15/16"	URDDDE4264	<input type="checkbox"/>	<input type="checkbox"/>	69.0#
		50-3/8 x 79-15/16"	URDDDE4280	<input type="checkbox"/>	<input type="checkbox"/>	86.0#
			<b>A</b>	<b>B</b>	<b>C</b>	

## HOW TO ORDER

Indicate the following information on order form:

- Quantity of each item.
- Model number, including options. See "How To Build a Model Number".
- Any special service required.

Note:

- The  indicates that a choice is required.
- The absence of the  indicates that no choice is required.
- Alpha-numeric characters in place of  indicate that no other alternatives are available.

## HOW TO BUILD A MODEL NUMBER

- A** Select basic model.
- B** Select core type (plastic fluted core insert).
  - CP** - Fluted Clear Plastic Core
  - OP** - Fluted Opal Plastic Core; add \$158
- C** Select trim color. Refer to color addendum at ki.com or KI Fabrics & Finishes binder.



Delivered Pricing

\$ 1851
2175
1901
2252

\$ 3327
3927
3402
4027

**SPECIAL SERVICES**

**Special Carton Marking**

With specially marked information N/C

**Shipping**

Shipped k.d. freight prepaid f.o.b. Manitowoc, Wisconsin 54220 factory. Freight class #70.

Specifications and prices are subject to change without prior notice.

# Unite® Rolling Door

MODEL	W x H	MODEL NUMBER			Approx. Packaged Weight	
		Basic Model	Core Insert	Trim Color		
 URD	<b>Rolling Door-Building Wall Condition</b>	44-3/8 x 63-15/16"	URDBW3664	<input type="checkbox"/>	<input type="checkbox"/>	24.0#
	• Includes door, attachment post and jamb rail	44-3/8 x 79-15/16"	URDBW3680	<input type="checkbox"/>	<input type="checkbox"/>	31.0#
	• Jamb rail attaches to building wall	50-3/8 x 63-15/16"	URDBW4264	<input type="checkbox"/>	<input type="checkbox"/>	26.0#
	• Door is non-handed and may be used in either right or left position	50-3/8 x 79-15/16"	URDBW4280	<input type="checkbox"/>	<input type="checkbox"/>	32.0#
• 64" models are monolithic; 80" models (shown at left) feature segmentation with trim at 64"						
• Polycarbonate core inserts feature horizontal fluting pattern						
• Non-locking						
• Actual door dimension extends 10-3/4" beyond its nominal door opening width						
• Panel to which door attaches must be the same width or wider than the nominal width of door, see Planning Guide for more details						
• See General Information preceding these pages for all conditions in plan view						

**A          B          C**

## HOW TO ORDER

Indicate the following information on order form:

- Quantity of each item.
- Model number, including options. See "How To Build a Model Number".
- Any special service required.

Note:

- The  indicates that a choice is required.
- The absence of the  indicates that no choice is required.
- Alpha-numeric characters in place of  indicate that no other alternatives are available.

## HOW TO BUILD A MODEL NUMBER

- A** Select basic model.
- B** Select core type (plastic fluted core insert).
  - CP** - Fluted Clear Plastic Core
  - OP** - Fluted Opal Plastic Core; add \$158
- C** Select trim color. Refer to color addendum at ki.com or KI Fabrics & Finishes binder.





Delivered Pricing

\$ 1476
1776
1525
1826

**SPECIAL SERVICES**

**Special Carton Marking**

With specially marked information N/C

**Shipping**

Shipped k.d. freight prepaid f.o.b. Manitowoc, Wisconsin 54220 factory. Freight class #70.

Specifications and prices are subject to change without prior notice.

# Unite® Rolling Door Thresholds

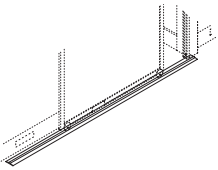
MODEL	L	MODEL NUMBER		Approx. Packaged Weight
		Basic Model	Finish	
 <p>HRDPT</p> <p><b>Rolling Door-Threshold for use with Jamb Conditions</b></p> <ul style="list-style-type: none"> <li>• Thresholds are an accessory, designed as an option to assist door tracking</li> <li>• Non-handed threshold model are specified by nominal door opening</li> <li>• Thresholds extend across the door opening and in front of the attachment panel</li> <li>• Length listed reflects attached endcaps, and corresponds to roughly twice the width of the door opening</li> <li>• Threshold kits include two types of floor attachment - (1) adhesive back hook pads that are effective on a variety of carpets or (2) double back foam tape pads that are effective on hard floors or hard pile carpet</li> <li>• Includes two aluminum end caps</li> <li>• Thresholds are extruded aluminum with either black or clear silver anodize color option</li> </ul>	77-1/4"	URDT36	<input type="checkbox"/>	5.0#
	89-1/4"	URDT42	<input type="checkbox"/>	5.0#

**A**      **B**

### HOW TO ORDER

Indicate the following information on order form:

1. Quantity of each item.
2. Model number, including options. See "How To Build a Model Number".
3. Any special service required.

Note:

- The  indicates that a choice is required.
- The absence of the  indicates that no choice is required.
- Alpha-numeric characters in place of  indicate that no other alternatives are available.

### HOW TO BUILD A MODEL NUMBER

- A** Select basic model.
- B** Select finish.  
Refer to color addendum at [ki.com](http://ki.com) or KI Fabrics & Finishes binder.



Delivered  
Pricing

\$ 202  
202

**SPECIAL SERVICES**

**Special Carton Marking**

With specially marked information N/C

**Shipping**

Shipped k.d. freight prepaid f.o.b. Manitowoc, Wisconsin 54220 factory. Freight class #70.

Specifications and prices are subject to change without prior notice.

# Unite® Rolling Door Thresholds

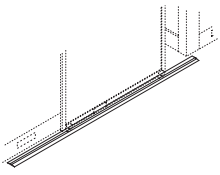
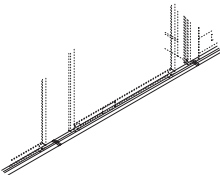
MODEL	L	MODEL NUMBER		Approx. Packaged Weight
		Basic Model	Finish	
 <p>HRDPT</p> <p><b>Rolling Door-Threshold for use with No-Jamb Conditions</b></p> <ul style="list-style-type: none"> <li>• Thresholds are an accessory, designed as an option to assist door tracking</li> <li>• Non-handed threshold model are specified by nominal door opening for rolling door in "no jamb" conditions that require wider doors and longer thresholds</li> <li>• Thresholds extend across the door opening and in front of the attachment panel</li> <li>• Length listed reflects attached endcaps, and corresponds to roughly twice the width of the door opening</li> <li>• Threshold kits include two types of floor attachment - (1) adhesive back hook pads that are effective on a variety of carpets or (2) double back foam tape pads that are effective on hard floors or hard pile carpet</li> <li>• Includes two aluminum end caps</li> <li>• Thresholds are extruded aluminum with either black or clear silver anodize color option</li> </ul>	83-1/4"	URDTNJ36	<input type="checkbox"/>	5.0#
	95-1/4"	URDTNJ42	<input type="checkbox"/>	5.0#
 <p>HRDPT</p> <p><b>Rolling Door-Continuous Threshold</b></p> <ul style="list-style-type: none"> <li>• Thresholds are an accessory, designed as an option to assist door tracking</li> <li>• Continuous Threshold models are designed to be installed end to end</li> <li>• Consult space plan for the required linear feet</li> <li>• Threshold kits include two types of floor attachment - (1) adhesive back hook pads that are effective on a variety of carpets or (2) double back foam tape pads that are effective on hard floors or hard pile carpet</li> <li>• Includes one threshold and one aluminum end cap. End caps are not required at joints so only one end cap is included per model</li> <li>• Threshold is extruded aluminum with either black or clear silver anodize color option</li> </ul>	96-1/4"	URDTC	<input type="checkbox"/>	5.0#

**A**      **B**

### HOW TO ORDER

Indicate the following information on order form:

1. Quantity of each item.
2. Model number, including options. See "How To Build a Model Number".
3. Any special service required.

- Note:
- The  indicates that a choice is required.
  - The absence of the  indicates that no choice is required.
  - Alpha-numeric characters in place of  indicate that no other alternatives are available.

### HOW TO BUILD A MODEL NUMBER

- A** Select basic model.
- B** Select finish.  
Refer to color addendum at [ki.com](http://ki.com) or KI Fabrics & Finishes binder.



Delivered  
Pricing

\$ 202  
202

\$ 135

**SPECIAL SERVICES**

**Special Carton Marking**

With specially marked information N/C

**Shipping**

Shipped k.d. freight prepaid f.o.b. Manitowoc, Wisconsin 54220 factory. Freight class #70.

Specifications and prices are subject to change without prior notice.

# Electrical

## 10-Wire System 6 Circuit "810"

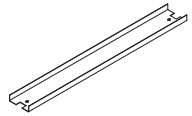
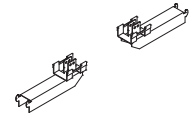
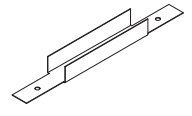
		MODEL NUMBER		Approx. Packaged Weight
MODEL	PANEL WIDTH	Basic Model		
 <p>HRDPT</p>	<b>Rigid Wireway - 6 Circuit</b>	24"	UET6WW.24	2.0#
	<ul style="list-style-type: none"> <li>Distributes 10-wire power and allows receptacle mounting</li> <li>Non-directional</li> <li>Wireway can be mounted inside the base raceway or at beltway behind tile</li> <li>Accommodates two duplex receptacles per side; maximum of four per wireway</li> <li>Receptacles are purchased separately</li> <li>Beltway power requires UETBWM for mounting</li> </ul>	30"	UET6WW.30	2.0#
		36"	UET6WW.36	3.0#
		42"	UET6WW.42	3.0#
		48"	UET6WW.48	3.0#
		60"	UET6WW.60	4.0#
		72"	UET6WW.72	4.0#
 <p>HRDPT</p>	<b>Raceway Cable Trough - 6 Circuit</b>	24"	UETRT.24	0.9#
	<ul style="list-style-type: none"> <li>Steel trough manages cords at raceway</li> </ul>	30"	UETRT.30	1.1#
		36"	UETRT.36	1.3#
		42"	UETRT.42	1.4#
		48"	UETRT.48	1.6#
		60"	UETRT.60	2.0#
		72"	UETRT.72	2.3#
 <p>HRDPT</p>	<b>Beltway-Height Harness Mounting Kit - 6 Circuit</b>		UETBWM	1.3#
	<ul style="list-style-type: none"> <li>Allows harness to mount at beltway height</li> <li>Includes mounting brackets and hardware</li> </ul>			
 <p>HRDPT</p>	<b>Beltway Cable Trough - 6 Circuit</b>	24"	UETBT.24	0.6#
	<ul style="list-style-type: none"> <li>Steel trough manages cords at beltway</li> <li>Requires UETBWM for mounting</li> </ul>	30"	UETBT.30	0.8#
		36"	UETBT.36	0.9#
		42"	UETBT.42	1.1#
		48"	UETBT.48	1.3#
		60"	UETBT.60	1.6#
		72"	UETBT.72	1.9#

**A**

### HOW TO ORDER

Indicate the following information on order form:

- Quantity of each item.
- Model number, including options. See "How To Build a Model Number".
- Any special service required.

Note: • The  indicates that a choice is required.

- The absence of the  indicates that no choice is required.
- Alpha-numeric characters in place of  indicate that no other alternatives are available.

### HOW TO BUILD A MODEL NUMBER

- A** Select basic model.



# Electrical

10-Wire System 6 Circuit "810"

Delivered Pricing

\$ 95
99
102
106
111
121
121

\$ 11
12
14
15
16
20
24

\$ 36

\$ 11
12
14
15
16
20
24

**SPECIAL SERVICES**

**Special Carton Marking**

With specially marked information N/C

**Shipping**

Shipped k.d. freight prepaid f.o.b. Manitowoc, Wisconsin 54220 factory. Freight class #70.

Specifications and prices are subject to change without prior notice.

# Electrical

## 10-Wire System 6 Circuit "810"

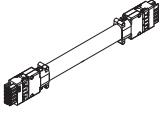
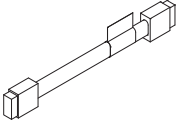
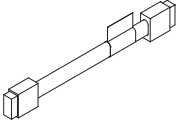
		MODEL NUMBER		Approx. Packaged Weight
MODEL	PANEL WIDTH	Basic Model		
 <p>HRDPT</p>	<b>Harness/Power Pass Through - 6 Circuit</b> <ul style="list-style-type: none"> <li>• Distributes 10-wire power</li> <li>• Non-directional</li> <li>• Connects to adjacent rigid wireway or another harness/pass through</li> <li>• Receptacle access is not provided</li> <li>• Length is same as corresponding rigid wireway</li> <li>• Pass through requires panel-to-panel jumpers (ordered separately)</li> </ul>	24"	UET6PP.24	1.0#
		30"	UET6PP.30	2.0#
		36"	UET6PP.36	2.0#
		42"	UET6PP.42	2.0#
		48"	UET6PP.48	2.0#
		60"	UET6PP.60	3.0#
		72"	UET6PP.72	3.0#
 <p>HRDPT</p>	<b>In-Line Panel Jumper - 6 Circuit</b> <ul style="list-style-type: none"> <li>• Used for in-line intersections</li> <li>• Non-directional</li> </ul>	12" Length	UET6PJNL	1.0#
 <p>HRDPT</p>	<b>Intersection Panel Jumper - 6 Circuit</b> <ul style="list-style-type: none"> <li>• Used for intersections</li> <li>• Non-directional</li> </ul>	15-1/2" Length	UET6PJINT	1.0#

**A**

### HOW TO ORDER

Indicate the following information on order form:

1. Quantity of each item.
2. Model number, including options. See "How To Build a Model Number".
3. Any special service required.

- Note:
- The  indicates that a choice is required.
  - The absence of the  indicates that no choice is required.
  - Alpha-numeric characters in place of  indicate that no other alternatives are available.

### HOW TO BUILD A MODEL NUMBER

- A** Select basic model.





# Electrical

10-Wire System 6 Circuit "810"

Delivered Pricing

\$ 110
116
116
116
121
121
121

\$ 48

\$ 54

### SPECIAL SERVICES

#### Special Carton Marking

With specially marked information N/C



#### Shipping

Shipped k.d. freight prepaid f.o.b. Manitowoc, Wisconsin 54220 factory. Freight class #70.

Specifications and prices are subject to change without prior notice.

# Electrical

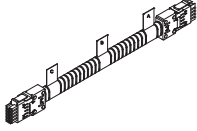
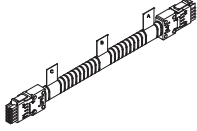
10-Wire System 6 Circuit "810"

		MODEL NUMBER		Approx. Packaged Weight	
MODEL	L	Basic Model			
 HRDPT	<b>Genius In-Line Panel Jumper - 6 Circuit</b> <ul style="list-style-type: none"> <li>Used to connect Genius® (UL 183) to Unite (UL 1286) in in-line conditions</li> <li>Jumper is non-directional; however electrical system must originate from Genius® wall and terminate in Unite® panel</li> <li>Electrical system cannot alternate between Genius® and Unite®</li> <li>Steel corrugated sheathing and steel shielded connectors</li> </ul>	18-1/2" Length	SET6PJINL	1.0#	
 HRDPT	<b>Genius Intersection Panel Jumper - 6 Circuit</b> <ul style="list-style-type: none"> <li>Used to connect Genius® (UL 183) to Unite (UL 1286) at 90 degree intersection conditions</li> <li>Jumper is non-directional; however electrical system must originate from Genius® wall and terminate in Unite panel</li> <li>Electrical system cannot alternate between Genius® and Unite</li> <li>Steel corrugated sheathing and steel shielded connectors</li> </ul>	17-1/2" Length	SET6PJINT	1.0#	
 HRDPT	<b>Vertical Jumper - 6 Circuit</b> <ul style="list-style-type: none"> <li>Jumps power from base raceway to beltway</li> <li>Non-directional</li> </ul>	38-1/2" Length	UET6VJ	2.0#	

**A**

## HOW TO ORDER

Indicate the following information on order form:

- Quantity of each item.
- Model number, including options. See "How To Build a Model Number".
- Any special service required.

Note:

- The  indicates that a choice is required.
- The absence of the  indicates that no choice is required.
- Alpha-numeric characters in place of  indicate that no other alternatives are available.

## HOW TO BUILD A MODEL NUMBER

**A** Select basic model.



# Electrical

10-Wire System 6 Circuit "810"

Delivered  
Pricing

\$ 81

\$ 81

\$ 84

### SPECIAL SERVICES

#### Special Carton Marking

With specially marked information N/C

#### Shipping

Shipped **k.d. freight prepaid f.o.b. Manitowoc, Wisconsin 54220** factory. Freight class #70.

Specifications and prices are subject to change without prior notice.

# Electrical

10-Wire System 6 Circuit "810"/with Bezel for Raceway Use

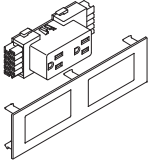
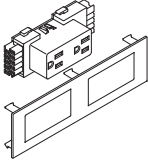
MODEL	Features	MODEL NUMBER		Approx. Packaged Weight
		Basic Model	Trim Color	
 <p>HRDPT</p> <p><b>15 Amp Duplex Receptacle with Bezel for Raceway Use - 6 Circuit</b></p> <ul style="list-style-type: none"> <li>• Snaps to wireways of powered panels</li> <li>• Includes bezel with filler plate which can be removed to accept standard "modular furniture knockouts" or data plates</li> <li>• Receptacle color matches bezel color for circuits 1,2 and 3</li> <li>• 4I, 5I and 6I circuit receptacles are stamped with orange triangle</li> </ul>	Circuit 1	UET6RRC.1	<input type="checkbox"/>	1.0#
	Circuit 2	UET6RRC.2	<input type="checkbox"/>	1.0#
	Circuit 3	UET6RRC.3	<input type="checkbox"/>	1.0#
	Circuit 4	UET6RRC.4I	<input type="checkbox"/>	1.0#
	Circuit 5	UET6RRC.5I	<input type="checkbox"/>	1.0#
	Circuit 6	UET6RRC.6I	<input type="checkbox"/>	1.0#
 <p>HRDPT</p> <p><b>20 Amp Receptacle with Bezel for Raceway Use - 6 Circuit</b></p> <ul style="list-style-type: none"> <li>• Snaps to wireways of powered panels</li> <li>• Receptacle includes one 20 amp simplex and one 15 amp simplex</li> <li>• Occupies space of one duplex receptacle</li> <li>• Includes bezel with filler plate which can be removed to accept standard "modular furniture knockouts" or data plates</li> <li>• Receptacle color matches bezel color for circuits 1,2 and 3</li> <li>• 4I, 5I and 6I circuit receptacles are stamped with orange triangle</li> </ul>	Circuit 1	UET6R20R.1	<input type="checkbox"/>	1.0#
	Circuit 2	UET6R20R.2	<input type="checkbox"/>	1.0#
	Circuit 3	UET6R20R.3	<input type="checkbox"/>	1.0#
	Circuit 4	UET6R20R.4I	<input type="checkbox"/>	1.0#
	Circuit 5	UET6R20R.5I	<input type="checkbox"/>	1.0#
	Circuit 6	UET6R20R.6I	<input type="checkbox"/>	1.0#

**A**      **B**

## HOW TO ORDER

Indicate the following information on order form:

1. Quantity of each item.
2. Model number, including options. See "How To Build a Model Number".
3. Any special service required.

Note:

- The  indicates that a choice is required.
- The absence of the  indicates that no choice is required.
- Alpha-numeric characters in place of  indicate that no other alternatives are available.

## HOW TO BUILD A MODEL NUMBER

- A** Select basic model.
- B** Select trim color.  
Refer to color addendum at [ki.com](http://ki.com) or KI Fabrics & Finishes binder.  
Metallic finish not available.



# Electrical

10-Wire System 6 Circuit "810"/with Bezel for Raceway Use

Delivered Pricing

\$	28
	28
	28
	28
	28
	28

\$	41
	41
	41
	41
	41
	41

### SPECIAL SERVICES

#### Special Carton Marking

With specially marked information N/C



#### Shipping

Shipped k.d. freight prepaid f.o.b. Manitowoc, Wisconsin 54220 factory. Freight class #70.

Specifications and prices are subject to change without prior notice.

# Electrical

10-Wire System 6 Circuit "810"/for Beltway Use

		MODEL	Features	MODEL NUMBER		Approx. Packaged Weight
				Basic Model	Trim Color	
 HRDPT	<b>15 Amp Duplex Receptacle for Beltway Use - 6 Circuit</b> <ul style="list-style-type: none"> <li>• Snaps to wireways of powered panels</li> <li>• Receptacle color is specified only for circuits 1,2 and 3</li> <li>• 4I, 5I and 6I circuit receptacles are stamped with orange triangle</li> <li>• Bezel is pre-specified within beltway tile</li> <li>• For use at beltway only: raceway receptacles are listed separately</li> </ul>	Circuit 1	UET6BRC.1	<input type="checkbox"/>	1.0#	
		Circuit 2	UET6BRC.2	<input type="checkbox"/>	1.0#	
		Circuit 3	UET6BRC.3	<input type="checkbox"/>	1.0#	
		Circuit 4	UET6BRC.4I	<input type="checkbox"/>	1.0#	
		Circuit 5	UET6BRC.5I	<input type="checkbox"/>	1.0#	
		Circuit 6	UET6BRC.6I	<input type="checkbox"/>	1.0#	
 HRDPT	<b>20 Amp Receptacle for Beltway Use - 6 Circuit</b> <ul style="list-style-type: none"> <li>• Snaps to wireways of powered panels</li> <li>• Receptacle includes one 20-amp simplex and one 15-amp simplex</li> <li>• 4I, 5I and 6I circuit receptacles are stamped with orange triangle</li> <li>• Bezel is pre-specified within beltway tile</li> <li>• For use at beltway only: raceway receptacles are listed separately</li> </ul>	Circuit 1	UET6B20R.1	<input type="checkbox"/>	1.0#	
		Circuit 2	UET6B20R.2	<input type="checkbox"/>	1.0#	
		Circuit 3	UET6B20R.3	<input type="checkbox"/>	1.0#	
		Circuit 4	UET6B20R.4I	<input type="checkbox"/>	1.0#	
		Circuit 5	UET6B20R.5I	<input type="checkbox"/>	1.0#	
		Circuit 6	UET6B20R.6I	<input type="checkbox"/>	1.0#	

**A**

**B**

## HOW TO ORDER

Indicate the following information on order form:

1. Quantity of each item.
2. Model number, including options. See "How To Build a Model Number".
3. Any special service required.

- Note:
- The  indicates that a choice is required.
  - The absence of the  indicates that no choice is required.
  - Alpha-numeric characters in place of  indicate that no other alternatives are available.

## HOW TO BUILD A MODEL NUMBER

- A** Select basic model.
- B** Select trim color. Refer to color addendum at [ki.com](http://ki.com) or KI Fabrics & Finishes binder. Metallic finish not available.



# Electrical

10-Wire System 6 Circuit "810"/for Beltway Use

Delivered Pricing

\$ 24
24
24
24
24
24

\$ 38
38
38
38
38
38

### SPECIAL SERVICES

#### Special Carton Marking

With specially marked information N/C

#### Shipping

Shipped k.d. freight prepaid f.o.b. Manitowoc, Wisconsin 54220 factory. Freight class #70.

Specifications and prices are subject to change without prior notice.

# Electrical

## 10-Wire System 6 Circuit "810"

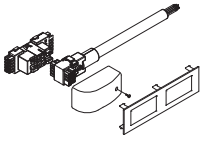
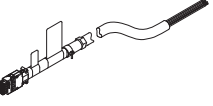
MODEL	L	MODEL NUMBER		Approx. Packaged Weight
		Basic Model	Trim Color	
 <p><b>Base Infeed with Bezel for Raceway Base - 6 Circuit</b></p> <ul style="list-style-type: none"> <li>Infeed is non-handed</li> <li>Includes bezel with filler plate which can be removed to accept "modular furniture knockouts" for data plates</li> <li>For use with standard or tile to floor bases only</li> </ul>	72"	UET6RBFU		7.0#
 <p><b>Base Infeed for Elevated Base - 6 Circuit</b></p> <ul style="list-style-type: none"> <li>Infeed is non-handed</li> <li>For use with elevated base only</li> <li>Infeed connects to rigid wireway at beltway</li> </ul>	72"	UET6LBFU		7.0#

**A**      **B**

### HOW TO ORDER

Indicate the following information on order form:

- Quantity of each item.
- Model number, including options. See "How To Build a Model Number".
- Any special service required.

Note:

- The  indicates that a choice is required.
- The absence of the  indicates that no choice is required.
- Alpha-numeric characters in place of  indicate that no other alternatives are available.

### HOW TO BUILD A MODEL NUMBER

- A** Select basic model.
- B** Select trim color. Refer to color addendum at [ki.com](http://ki.com) or KI Fabrics & Finishes binder. Metallic finish not available.





# Electrical

10-Wire System 6 Circuit "810"

Delivered  
Pricing

\$ 151

\$ 151

### SPECIAL SERVICES

#### Special Carton Marking

With specially marked information N/C

#### Shipping

Shipped **k.d. freight prepaid f.o.b. Manitowoc, Wisconsin 54220** factory. Freight class #70.

Specifications and prices are subject to change without prior notice.

# Electrical

10-Wire System 6 Circuit "810"

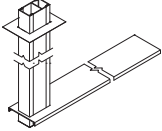
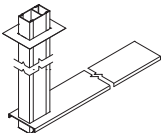
	MODEL	PANEL WIDTH	MODEL NUMBER			Approx. Packaged Weight
			Basic Model	Power Option	Trim Color	
 <p>UETF</p>	<b>Top Feed with 7-Foot Pole and Top Cap - 6 Circuit</b> <ul style="list-style-type: none"> <li>• Topfeed must be specified by length of top cap</li> <li>• For use at top of panel only</li> <li>• When powered, infeed connects to either end of rigid wireway at base or beltway</li> <li>• Does not occupy space for duplex receptacles</li> <li>• Includes aluminum topfeed power pole, ceiling trim, top cap, and infeed when powered</li> <li>• Infeed length 144" adds 14lbs to ship weight</li> </ul>	24"	UETF0724	<input type="checkbox"/>	<input type="checkbox"/>	7.3#
		30"	UETF0730	<input type="checkbox"/>	<input type="checkbox"/>	7.4#
		36"	UETF0736	<input type="checkbox"/>	<input type="checkbox"/>	7.6#
		42"	UETF0742	<input type="checkbox"/>	<input type="checkbox"/>	7.8#
		48"	UETF0748	<input type="checkbox"/>	<input type="checkbox"/>	8.0#
		60"	UETF0760	<input type="checkbox"/>	<input type="checkbox"/>	7.4#
		72"	UETF0772	<input type="checkbox"/>	<input type="checkbox"/>	8.8#
 <p>UETF</p>	<b>Top Feed with 10-foot Pole and Top Cap - 6 Circuit</b> <ul style="list-style-type: none"> <li>• Topfeed must be specified by length of top cap</li> <li>• For use at top of panel only</li> <li>• When powered, infeed connects to either end of rigid wireway at base or beltway</li> <li>• Does not occupy space for duplex receptacles</li> <li>• Includes aluminum topfeed power pole, ceiling trim, top cap, and infeed when powered</li> <li>• Infeed length 216" adds 19lbs to ship weight</li> </ul>	24"	UETF1024	<input type="checkbox"/>	<input type="checkbox"/>	9.6#
		30"	UETF1030	<input type="checkbox"/>	<input type="checkbox"/>	9.8#
		36"	UETF1036	<input type="checkbox"/>	<input type="checkbox"/>	10.0#
		42"	UETF1042	<input type="checkbox"/>	<input type="checkbox"/>	10.2#
		48"	UETF1048	<input type="checkbox"/>	<input type="checkbox"/>	10.4#
		60"	UETF1060	<input type="checkbox"/>	<input type="checkbox"/>	10.8#
		72"	UETF1072	<input type="checkbox"/>	<input type="checkbox"/>	11.2#

**A**   **B**   **C**

## HOW TO ORDER

Indicate the following information on order form:

1. Quantity of each item.
2. Model number, including options. See "How To Build a Model Number".
3. Any special service required.

- Note:
- The  indicates that a choice is required.
  - The absence of the  indicates that no choice is required.
  - Alpha-numeric characters in place of  indicate that no other alternatives are available.

## HOW TO BUILD A MODEL NUMBER

- A** Select basic model.
- B** Select power.
- |          |                               |
|----------|-------------------------------|
| <b>N</b> | - No Power                    |
| <b>4</b> | - 442 power infeed; add \$151 |
| <b>6</b> | - 622 power infeed; add \$151 |
- Note: For Chicago and New York electrical requirements, contact your Customer Service Representative.
- C** Select trim color.  
Refer to color addendum at ki.com or KI Fabrics & Finishes binder.  
Metallic finish not available.



# Electrical

10-Wire System 6 Circuit "810"

Delivered Pricing

\$ 294
306
308
315
317
320
338

\$ 375
387
390
399
400
403
421

**SPECIAL SERVICES**

**Special Carton Marking**

With specially marked information N/C

**Shipping**

Shipped k.d. freight prepaid f.o.b. Manitowoc, Wisconsin 54220 factory. Freight class #70.

Specifications and prices are subject to change without prior notice.

# Electrical

## 10-Wire System 4 Circuit "810"

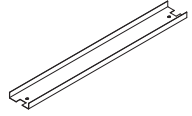
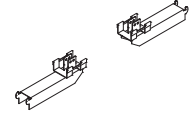
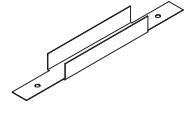
	MODEL	PANEL WIDTH	MODEL NUMBER	Approx. Packaged Weight
			Basic Model	
 HRDPT	<b>Rigid Wireway - 4 Circuit</b> <ul style="list-style-type: none"> <li>Distributes 10-wire power and allows receptacle mounting</li> <li>Non-directional</li> <li>Wireway can be mounted inside the base raceway or at beltway behind tile</li> <li>Accommodates two duplex receptacles per side. Maximum of four per wireway</li> <li>Receptacles purchased separately</li> <li>Beltway power requires UETBWM for mounting</li> </ul>	24"	UET4WW.24	2.0#
		30"	UET4WW.30	2.0#
		36"	UET4WW.36	3.0#
		42"	UET4WW.42	3.0#
		48"	UET4WW.48	3.0#
		60"	UET4WW.60	4.0#
		72"	UET4WW.72	4.0#
 HRDPT	<b>Raceway Cable Trough - 4 Circuit</b> <ul style="list-style-type: none"> <li>Steel trough manages cords at raceway</li> </ul>	24"	UETRT.24	0.9#
		30"	UETRT.30	1.1#
		36"	UETRT.36	1.3#
		42"	UETRT.42	1.4#
		48"	UETRT.48	1.6#
		60"	UETRT.60	2.0#
		72"	UETRT.72	2.3#
 HRDPT	<b>Beltway-Height Harness Mounting Kit - 4 Circuit</b> <ul style="list-style-type: none"> <li>Allows harness to mount at beltway height</li> <li>Includes mounting brackets and hardware</li> </ul>		UETBWM	1.3#
 HRDPT	<b>Beltway Cable Trough - 4 Circuit</b> <ul style="list-style-type: none"> <li>Steel trough manages cords at beltway</li> <li>Requires UETBWM for mounting</li> </ul>	24"	UETBT.24	0.6#
		30"	UETBT.30	0.8#
		36"	UETBT.36	0.9#
		42"	UETBT.42	1.1#
		48"	UETBT.48	1.3#
		60"	UETBT.60	1.6#
		72"	UETBT.72	1.9#

**A**

### HOW TO ORDER

Indicate the following information on order form:

- Quantity of each item.
- Model number, including options. See "How To Build a Model Number".
- Any special service required.

Note: • The  indicates that a choice is required.

- The absence of the  indicates that no choice is required.
- Alpha-numeric characters in place of  indicate that no other alternatives are available.

### HOW TO BUILD A MODEL NUMBER

- A** Select basic model.



# Electrical

10-Wire System 4 Circuit "810"

Delivered Pricing

\$ 95
99
102
106
111
117
121

\$ 11
12
14
15
16
20
24

\$ 36

\$ 11
12
14
15
16
20
24

### SPECIAL SERVICES

#### Special Carton Marking

With specially marked information N/C



#### Shipping

Shipped k.d. freight prepaid f.o.b. Manitowoc, Wisconsin 54220 factory. Freight class #70.

Specifications and prices are subject to change without prior notice.

# Electrical

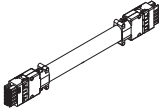
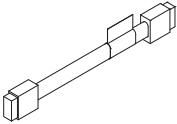
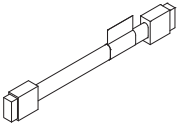
## 10-Wire System 4 Circuit "810"

		MODEL NUMBER		Approx. Packaged Weight	
MODEL	PANEL WIDTH	Basic Model			
 <p>HRDPT</p>	<b>Harness/Power Pass Through - 4 Circuit</b> <ul style="list-style-type: none"> <li>• Distributes 10-wire power</li> <li>• Non-directional</li> <li>• Connects to adjacent Rigid Wireway or or another Harness/Pass Through</li> <li>• Receptacle access is not provided</li> <li>• Length is same as corresponding Rigid Wireway</li> <li>• Pass through requires panel-to-panel jumpers (ordered separately)</li> </ul>	24"	UET4PP.24		1.0#
		30"	UET4PP.30		2.0#
		36"	UET4PP.36		2.0#
		42"	UET4PP.42		2.0#
		48"	UET4PP.48		2.0#
		60"	UET4PP.60		3.0#
		72"	UET4PP.72		3.0#
 <p>HRDPT</p>	<b>In-Line Panel Jumper - 4 Circuit</b> <ul style="list-style-type: none"> <li>• Used for in-line intersections</li> <li>• Non-directional</li> </ul>	12" Length	UET4PJINL		1.0#
 <p>HRDPT</p>	<b>Intersection Panel Jumper - 4 Circuit</b> <ul style="list-style-type: none"> <li>• Used for intersections</li> <li>• Non-directional</li> </ul>	15-1/2" Length	UET4PJINT		1.0#
 <p>HRDPT</p>	<b>Vertical Jumper - 4 Circuit</b> <ul style="list-style-type: none"> <li>• Jumps power from base raceway to beltway</li> <li>• Non-directional</li> </ul>	38-1/2" Length	UET4VJ		2.0#

**A**

### HOW TO ORDER

Indicate the following information on order form:

1. Quantity of each item.
2. Model number, including options. See "How To Build a Model Number".
3. Any special service required.

Note:

- The  indicates that a choice is required.
- The absence of the  indicates that no choice is required.
- Alpha-numeric characters in place of  indicate that no other alternatives are available.

### HOW TO BUILD A MODEL NUMBER

**A** Select basic model.



# Electrical

10-Wire System 4 Circuit "810"

Delivered Pricing

\$ 110
116
116
116
121
121
121

\$ 48

\$ 54

\$ 84

### SPECIAL SERVICES

#### Special Carton Marking

With specially marked information N/C

#### Shipping

Shipped k.d. freight prepaid f.o.b. Manitowoc, Wisconsin 54220 factory. Freight class #70.

Specifications and prices are subject to change without prior notice.

# Electrical

10-Wire System 4 Circuit "810"/with Bezel for Raceway Use

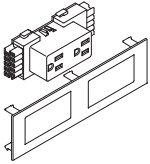
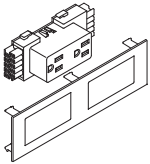
	MODEL	Features	MODEL NUMBER		Approx. Packaged Weight	
			Basic Model	Trim Color		
 <p>HRDPT</p>	<b>15-Amp Duplex Receptacle with Bezel for Raceway Use - 4 Circuit</b> <ul style="list-style-type: none"> <li>• Snaps to wireways of powered panels</li> <li>• Includes bezel with filler plate which can be removed to accept standard "modular furniture knockouts" or data plates</li> <li>• Receptacle color matches bezel color for circuits 1 and 2</li> <li>• 3I and 4I circuit receptacles are stamped with orange triangle</li> </ul>	Circuit 1	UET4RRC.1	<input type="checkbox"/>	1.0#	
		Circuit 2	UET4RRC.2	<input type="checkbox"/>	1.0#	
		Circuit 3	UET4RRC.3I	<input type="checkbox"/>	1.0#	
		Circuit 4	UET4RRC.4I	<input type="checkbox"/>	1.0#	
 <p>HRDPT</p>	<b>20-Amp Receptacle with Bezel for Raceway Use - 4 Circuit</b> <ul style="list-style-type: none"> <li>• Snaps to wireways of powered panels</li> <li>• Receptacle includes one 20 amp simplex and one 15 amp simplex</li> <li>• Occupies space of one duplex receptacle</li> <li>• Includes bezel with filler plate which can be removed to accept standard "modular furniture knockouts" or data plates</li> <li>• Receptacle color matches bezel color for circuits 1 and 2</li> <li>• 4I circuit receptacles are stamped with orange triangle</li> </ul>	Circuit 1	UET4R20R.1	<input type="checkbox"/>	1.0#	
		Circuit 2	UET4R20R.2	<input type="checkbox"/>	1.0#	
		Circuit 4	UET4R20R.4I	<input type="checkbox"/>	1.0#	

**A**      **B**

## HOW TO ORDER

Indicate the following information on order form:

1. Quantity of each item.
2. Model number, including options. See "How To Build a Model Number".
3. Any special service required.

- Note:
- The  indicates that a choice is required.
  - The absence of the  indicates that no choice is required.
  - Alpha-numeric characters in place of  indicate that no other alternatives are available.

## HOW TO BUILD A MODEL NUMBER

- A** Select basic model.
- B** Select trim color.  
Refer to color addendum at [ki.com](http://ki.com) or KI Fabrics & Finishes binder.  
Metallic finish not available.





# Electrical

10-Wire System 4 Circuit "810"/with Bezel for Raceway Use

Delivered  
Pricing

\$	28
	28
	28
	28

\$	41
	41
	41

### SPECIAL SERVICES

#### Special Carton Marking

With specially marked information N/C



#### Shipping

Shipped **k.d. freight prepaid f.o.b. Manitowoc, Wisconsin 54220** factory. Freight class #70.

Specifications and prices are subject to change without prior notice.

# Electrical

10-Wire System 4 Circuit "810"/for Beltway Use

			MODEL NUMBER		Approx. Packaged Weight
			Basic Model	Trim Color	
MODEL	Features				
 HRDPT	<b>15-Amp Duplex Receptacle for Beltway Use - 4 Circuit</b> <ul style="list-style-type: none"> <li>• Snaps to wireways of powered panels</li> <li>• Receptacle color is specified only for circuits 1, and 2</li> <li>• 3I and 4I circuit receptacles are stamped with orange triangle</li> <li>• Bezel is pre-specified within beltway tile</li> <li>• For use at beltway only; raceway receptacles are listed separately</li> </ul>	Circuit 1	UET4BRC.1	<input type="checkbox"/>	1.0#
		Circuit 2	UET4BRC.2	<input type="checkbox"/>	1.0#
		Circuit 3	UET4BRC.3I	<input type="checkbox"/>	1.0#
		Circuit 4	UET4BRC.4I	<input type="checkbox"/>	1.0#
 HRDPT	<b>20-Amp Receptacle for Beltway Use - 4 Circuit</b> <ul style="list-style-type: none"> <li>• Snaps to wireways of powered panels</li> <li>• Receptacle includes one 20-amp simplex and one 15-amp simplex</li> <li>• 4I circuit receptacle is stamped with orange triangle</li> <li>• Bezel is pre-specified within beltway tile</li> <li>• For use at beltway only; raceway receptacles are listed separately</li> </ul>	Circuit 1	UET4B20R.1	<input type="checkbox"/>	1.0#
		Circuit 2	UET4B20R.2	<input type="checkbox"/>	1.0#
		Circuit 4	UET4B20R.4I	<input type="checkbox"/>	1.0#

**A**      **B**

## HOW TO ORDER

Indicate the following information on order form:

1. Quantity of each item.
2. Model number, including options. See "How To Build a Model Number".
3. Any special service required.

Note:

- The  indicates that a choice is required.
- The absence of the  indicates that no choice is required.
- Alpha-numeric characters in place of  indicate that no other alternatives are available.

## HOW TO BUILD A MODEL NUMBER

- A** Select basic model.
- B** Select trim color. Refer to color addendum at [ki.com](http://ki.com) or KI Fabrics & Finishes binder. Metallic finish not available.



# Electrical

10-Wire System 4 Circuit "810"/for Beltway Use

Delivered Pricing

\$	24
	24
	24
	24

\$	38
	38
	38

### SPECIAL SERVICES

#### Special Carton Marking

With specially marked information N/C

#### Shipping

Shipped k.d. freight prepaid f.o.b. Manitowoc, Wisconsin 54220 factory. Freight class #70.

Specifications and prices are subject to change without prior notice.

# Electrical

## 10-Wire System 4 Circuit "810"

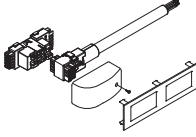
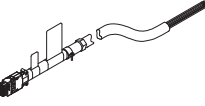
MODEL	L	MODEL NUMBER		Approx. Packaged Weight
		Basic Model	Trim Color	
 <p><b>Base Infeed with Bezel for Raceway Base - 4 Circuit</b></p> <ul style="list-style-type: none"> <li>• Infeed is non-handed</li> <li>• Includes bezel with filler plate which can be removed to accept "modular furniture knockouts" for data plates</li> <li>• For use with standard or tile to floor bases only</li> </ul>	72"	UET4RBFU		7.0#
	HRDPT			
 <p><b>Base Infeed for Elevated Base - 4 Circuit</b></p> <ul style="list-style-type: none"> <li>• Infeed is non-handed</li> <li>• For use with elevated base only</li> <li>• Infeed connects to rigid wireway at beltway</li> </ul>	72"	UET4LBFU		7.0#
	HRDPT			

**A**

**B**

### HOW TO ORDER

Indicate the following information on order form:

1. Quantity of each item.
2. Model number, including options. See "How To Build a Model Number".
3. Any special service required.

Note:

- The  indicates that a choice is required.
- The absence of the  indicates that no choice is required.
- Alpha-numeric characters in place of  indicate that no other alternatives are available.

### HOW TO BUILD A MODEL NUMBER

- A** Select basic model.
- B** Select trim color. Refer to color addendum at [ki.com](http://ki.com) or KI Fabrics & Finishes binder. Metallic finish not available.



# Electrical

10-Wire System 4 Circuit "810"

Delivered  
Pricing

\$ 151

\$ 151

### SPECIAL SERVICES

#### Special Carton Marking

With specially marked information N/C

#### Shipping

Shipped **k.d. freight prepaid f.o.b. Manitowoc, Wisconsin 54220** factory. Freight class #70.

Specifications and prices are subject to change without prior notice.

# Electrical

10-Wire System 4 Circuit "810"

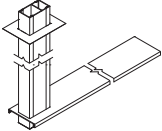
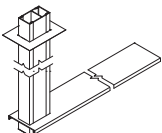
	MODEL	PANEL WIDTH	MODEL NUMBER			Approx. Packaged Weight
			Basic Model	Power Option	Trim Color	
 <p>UETF</p>	<b>Top Feed with 7-Foot Pole and Top Cap - 4 Circuit</b>	24"	UETF0724	<input type="checkbox"/>	<input type="checkbox"/>	7.3#
	<ul style="list-style-type: none"> <li>• Topfeed must be specified by length of top cap</li> <li>• For use at top of panel only</li> <li>• When powered, infeed connects to either end of rigid wireway at base or beltway</li> <li>• Does not occupy space for duplex receptacles</li> <li>• Includes aluminum topfeed power pole, ceiling trim, top cap, and infeed when powered</li> <li>• Infeed length 144" adds 14lbs to ship weight</li> </ul>	30"	UETF0730	<input type="checkbox"/>	<input type="checkbox"/>	7.4#
		36"	UETF0736	<input type="checkbox"/>	<input type="checkbox"/>	7.6#
		42"	UETF0742	<input type="checkbox"/>	<input type="checkbox"/>	7.8#
		48"	UETF0748	<input type="checkbox"/>	<input type="checkbox"/>	8.0#
		60"	UETF0760	<input type="checkbox"/>	<input type="checkbox"/>	7.4#
		72"	UETF0772	<input type="checkbox"/>	<input type="checkbox"/>	8.8#
 <p>UETF</p>	<b>Top Feed with 10-foot Pole and Top Cap - 4 Circuit</b>	24"	UETF1024	<input type="checkbox"/>	<input type="checkbox"/>	9.6#
	<ul style="list-style-type: none"> <li>• Topfeed must be specified by length of top cap</li> <li>• For use at top of panel only</li> <li>• When powered, infeed connects to either end of rigid wireway at base or beltway</li> <li>• Does not occupy space for duplex receptacles</li> <li>• Includes aluminum topfeed power pole, ceiling trim, top cap, and infeed when powered</li> <li>• Infeed length 216" adds 19lbs to ship weight</li> </ul>	30"	UETF1030	<input type="checkbox"/>	<input type="checkbox"/>	9.8#
		36"	UETF1036	<input type="checkbox"/>	<input type="checkbox"/>	10.0#
		42"	UETF1042	<input type="checkbox"/>	<input type="checkbox"/>	10.2#
		48"	UETF1048	<input type="checkbox"/>	<input type="checkbox"/>	10.4#
		60"	UETF1060	<input type="checkbox"/>	<input type="checkbox"/>	10.8#
		72"	UETF1072	<input type="checkbox"/>	<input type="checkbox"/>	11.2#

**A**      **B**      **C**

## HOW TO ORDER

Indicate the following information on order form:

1. Quantity of each item.
2. Model number, including options. See "How To Build a Model Number".
3. Any special service required.

- Note:
- The  indicates that a choice is required.
  - The absence of the  indicates that no choice is required.
  - Alpha-numeric characters in place of  indicate that no other alternatives are available.

## HOW TO BUILD A MODEL NUMBER

- A** Select basic model.
- B** Select power.
- |          |                               |
|----------|-------------------------------|
| <b>N</b> | - No Power                    |
| <b>4</b> | - 442 power infeed; add \$151 |
| <b>6</b> | - 622 power infeed; add \$151 |
- Note: For Chicago and New York electrical requirements, contact your Customer Service Representative.
- C** Select trim color.  
Refer to color addendum at ki.com or KI Fabrics & Finishes binder.  
Metallic finish not available.



# Electrical

10-Wire System 4 Circuit "810"

Delivered Pricing

\$ 294
306
308
315
317
320
338

\$ 375
387
390
399
400
403
421

**SPECIAL SERVICES**

**Special Carton Marking**

With specially marked information N/C

**Shipping**

Shipped k.d. freight prepaid f.o.b. Manitowoc, Wisconsin 54220 factory. Freight class #70.

Specifications and prices are subject to change without prior notice.

# Electrical

New York Power - 10-Wire System 6 or 4 Circuit "810"

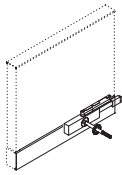
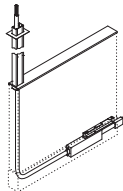
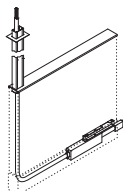
MODEL	MODEL NUMBER				Approx. Packaged Weight
	Basic Model	Power Option	Trim Color	Whip Color	
 <p>UENY</p> <p><b>New York Base Infeed with Race Way Cover</b></p> <ul style="list-style-type: none"> <li>• City of New York approved power entry box with panel to panel jumper</li> <li>• Infeed must be specified by width of panel</li> <li>• Infeed comes with painted steel raceway cover with entry hole and grommet for inlet</li> <li>• Can be used at base level only</li> <li>• 72" whip is color matched to trim</li> <li>• Entry box is mounted to bottom horizontal and inlet whip enters one side of the panel</li> <li>• Panel jumper is hard wired to infeed box and plugs into wireway of adjacent panel</li> <li>• Infeed compatible with the 10-Wire System "810". Specify either 6 or 4 circuit</li> </ul>	UETNYBF24	<input type="checkbox"/>	<input type="checkbox"/>	<input type="checkbox"/>	12.3#
	UETNYBF30	<input type="checkbox"/>	<input type="checkbox"/>	<input type="checkbox"/>	12.6#
	UETNYBF36	<input type="checkbox"/>	<input type="checkbox"/>	<input type="checkbox"/>	12.8#
	UETNYBF42	<input type="checkbox"/>	<input type="checkbox"/>	<input type="checkbox"/>	13.6#
	UETNYBF48	<input type="checkbox"/>	<input type="checkbox"/>	<input type="checkbox"/>	13.8#
	UETNYBF60	<input type="checkbox"/>	<input type="checkbox"/>	<input type="checkbox"/>	14.5#
	UETNYBF72	<input type="checkbox"/>	<input type="checkbox"/>	<input type="checkbox"/>	15.0#
 <p>UENY</p> <p><b>New York Power Top Feed with 7-foot Pole and Top Cap</b></p> <ul style="list-style-type: none"> <li>• Topfeed must be specified by length of top cap</li> <li>• For use at top of panel only</li> <li>• Infeed connects at base raceway</li> <li>• Includes aluminum topfeed power pole, ceiling trim and infeed</li> <li>• 216" of conduit provided</li> <li>• Top feed compatible with the 10-Wire System "810". Specify either 6 or 4 circuit</li> </ul>	UETNYTF0730	<input type="checkbox"/>	<input type="checkbox"/>		31.4#
	UETNYTF0736	<input type="checkbox"/>	<input type="checkbox"/>		31.6#
	UETNYTF0742	<input type="checkbox"/>	<input type="checkbox"/>		32.3#
	UETNYTF0748	<input type="checkbox"/>	<input type="checkbox"/>		32.5#
	UETNYTF0760	<input type="checkbox"/>	<input type="checkbox"/>		33.1#
	UETNYTF0772	<input type="checkbox"/>	<input type="checkbox"/>		33.5#
 <p>UENY</p> <p><b>New York Power Top Feed with 10-foot Pole and Top Cap</b></p> <ul style="list-style-type: none"> <li>• Topfeed must be specified by length of top cap</li> <li>• For use at top of panel only</li> <li>• Infeed connects at base raceway</li> <li>• Includes aluminum topfeed power pole, ceiling trim and infeed</li> <li>• 216" of conduit provided</li> <li>• Top feed compatible with the 10-Wire System "810". Specify either 6 or 4 circuit</li> </ul>	UETNYTF1030	<input type="checkbox"/>	<input type="checkbox"/>		33.8#
	UETNYTF1036	<input type="checkbox"/>	<input type="checkbox"/>		34.0#
	UETNYTF1042	<input type="checkbox"/>	<input type="checkbox"/>		34.7#
	UETNYTF1048	<input type="checkbox"/>	<input type="checkbox"/>		34.9#
	UETNYTF1060	<input type="checkbox"/>	<input type="checkbox"/>		35.5#
	UETNYTF1072	<input type="checkbox"/>	<input type="checkbox"/>		35.9#

**A**      **B**      **C**      **D**

## HOW TO ORDER

Indicate the following information on order form:

1. Quantity of each item.
2. Model number, including options. See "How To Build a Model Number".
3. Any special service required.

Note: • The  indicates that a choice is required.

- The absence of the  indicates that no choice is required.
- Alpha-numeric characters in place of  indicate that no other alternatives are available.

## HOW TO BUILD A MODEL NUMBER

- A** Select basic model.
- B** Select power.
 

4	- 4 Circuit
6	- 6 Circuit
- C** Select trim color.  
Refer to color addendum at ki.com or KI Fabrics & Finishes binder.
- D** Select whip color.  
Refer to color addendum at ki.com or KI Fabrics & Finishes binder.





# Electrical

New York Power - 10-Wire System 6 or 4 Circuit "810"

Delivered Pricing

\$ 431
433
436
438
440
443
447

\$ 584
587
594
595
596
613

\$ 612
614
616
625
627
644

**SPECIAL SERVICES**

**Special Carton Marking**

With specially marked information N/C

**Shipping**

Shipped k.d. freight prepaid f.o.b. Manitowoc, Wisconsin 54220 factory. Freight class #70.

Specifications and prices are subject to change without prior notice.

# Worksurfaces

## Rectangular

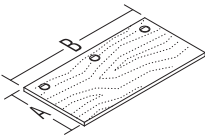
		MODEL NUMBER						Approx. Packaged Weight	
		Basic Model	Edge Style	Grommet Location	Surface Finish	Edge Color	Grommet Color		
 <p>UWR</p>	<b>Rectangular Worksurfaces - 18" D</b> • Brackets and/or supports are specified separately, two required for 24"-72" and three required for larger than 72" • 60" and larger worksurfaces are reinforced • Grommet locations are shown	18 x 24"	UWR1824	<input type="checkbox"/> <input type="checkbox"/>	<input type="checkbox"/> <input type="checkbox"/>	<input type="checkbox"/> <input type="checkbox"/>	<input type="checkbox"/> <input type="checkbox"/>	<input type="checkbox"/> <input type="checkbox"/>	17.0#
		18 x 30"	UWR1830	<input type="checkbox"/> <input type="checkbox"/>	<input type="checkbox"/> <input type="checkbox"/>	<input type="checkbox"/> <input type="checkbox"/>	<input type="checkbox"/> <input type="checkbox"/>	<input type="checkbox"/> <input type="checkbox"/>	20.0#
		18 x 36"	UWR1836	<input type="checkbox"/> <input type="checkbox"/>	<input type="checkbox"/> <input type="checkbox"/>	<input type="checkbox"/> <input type="checkbox"/>	<input type="checkbox"/> <input type="checkbox"/>	<input type="checkbox"/> <input type="checkbox"/>	24.0#
		18 x 42"	UWR1842	<input type="checkbox"/> <input type="checkbox"/>	<input type="checkbox"/> <input type="checkbox"/>	<input type="checkbox"/> <input type="checkbox"/>	<input type="checkbox"/> <input type="checkbox"/>	<input type="checkbox"/> <input type="checkbox"/>	27.0#
		18 x 48"	UWR1848	<input type="checkbox"/> <input type="checkbox"/>	<input type="checkbox"/> <input type="checkbox"/>	<input type="checkbox"/> <input type="checkbox"/>	<input type="checkbox"/> <input type="checkbox"/>	<input type="checkbox"/> <input type="checkbox"/>	30.0#
		18 x 54"	UWR1854	<input type="checkbox"/> <input type="checkbox"/>	<input type="checkbox"/> <input type="checkbox"/>	<input type="checkbox"/> <input type="checkbox"/>	<input type="checkbox"/> <input type="checkbox"/>	<input type="checkbox"/> <input type="checkbox"/>	33.0#
		18 x 60"	UWR1860	<input type="checkbox"/> <input type="checkbox"/>	<input type="checkbox"/> <input type="checkbox"/>	<input type="checkbox"/> <input type="checkbox"/>	<input type="checkbox"/> <input type="checkbox"/>	<input type="checkbox"/> <input type="checkbox"/>	38.0#
		18 x 66"	UWR1866	<input type="checkbox"/> <input type="checkbox"/>	<input type="checkbox"/> <input type="checkbox"/>	<input type="checkbox"/> <input type="checkbox"/>	<input type="checkbox"/> <input type="checkbox"/>	<input type="checkbox"/> <input type="checkbox"/>	41.0#
		18 x 72"	UWR1872	<input type="checkbox"/> <input type="checkbox"/>	<input type="checkbox"/> <input type="checkbox"/>	<input type="checkbox"/> <input type="checkbox"/>	<input type="checkbox"/> <input type="checkbox"/>	<input type="checkbox"/> <input type="checkbox"/>	44.0#
		UWR	<b>Rectangular Worksurfaces - 22" D</b> • 22" deep worksurfaces optimize alignment with U Series 22" storage elements • Brackets and/or supports are specified separately, two required for 24"-72" and three required for larger than 72" • 60" and larger worksurfaces are reinforced • Grommet locations are shown	22 x 24	UWR2224	<input type="checkbox"/> <input type="checkbox"/>	<input type="checkbox"/> <input type="checkbox"/>	<input type="checkbox"/> <input type="checkbox"/>	<input type="checkbox"/> <input type="checkbox"/>
22 x 30	UWR2230			<input type="checkbox"/> <input type="checkbox"/>	<input type="checkbox"/> <input type="checkbox"/>	<input type="checkbox"/> <input type="checkbox"/>	<input type="checkbox"/> <input type="checkbox"/>	<input type="checkbox"/> <input type="checkbox"/>	24.0#
22 x 36	UWR2236			<input type="checkbox"/> <input type="checkbox"/>	<input type="checkbox"/> <input type="checkbox"/>	<input type="checkbox"/> <input type="checkbox"/>	<input type="checkbox"/> <input type="checkbox"/>	<input type="checkbox"/> <input type="checkbox"/>	28.0#
22 x 42	UWR2242			<input type="checkbox"/> <input type="checkbox"/>	<input type="checkbox"/> <input type="checkbox"/>	<input type="checkbox"/> <input type="checkbox"/>	<input type="checkbox"/> <input type="checkbox"/>	<input type="checkbox"/> <input type="checkbox"/>	32.0#
22 x 48	UWR2248			<input type="checkbox"/> <input type="checkbox"/>	<input type="checkbox"/> <input type="checkbox"/>	<input type="checkbox"/> <input type="checkbox"/>	<input type="checkbox"/> <input type="checkbox"/>	<input type="checkbox"/> <input type="checkbox"/>	36.0#
22 x 54	UWR2254			<input type="checkbox"/> <input type="checkbox"/>	<input type="checkbox"/> <input type="checkbox"/>	<input type="checkbox"/> <input type="checkbox"/>	<input type="checkbox"/> <input type="checkbox"/>	<input type="checkbox"/> <input type="checkbox"/>	39.0#
22 x 60	UWR2260			<input type="checkbox"/> <input type="checkbox"/>	<input type="checkbox"/> <input type="checkbox"/>	<input type="checkbox"/> <input type="checkbox"/>	<input type="checkbox"/> <input type="checkbox"/>	<input type="checkbox"/> <input type="checkbox"/>	45.0#
22 x 66	UWR2266			<input type="checkbox"/> <input type="checkbox"/>	<input type="checkbox"/> <input type="checkbox"/>	<input type="checkbox"/> <input type="checkbox"/>	<input type="checkbox"/> <input type="checkbox"/>	<input type="checkbox"/> <input type="checkbox"/>	49.0#
22 x 72	UWR2272			<input type="checkbox"/> <input type="checkbox"/>	<input type="checkbox"/> <input type="checkbox"/>	<input type="checkbox"/> <input type="checkbox"/>	<input type="checkbox"/> <input type="checkbox"/>	<input type="checkbox"/> <input type="checkbox"/>	53.0#
22 x 84	UWR2284			<input type="checkbox"/> <input type="checkbox"/>	<input type="checkbox"/> <input type="checkbox"/>	<input type="checkbox"/> <input type="checkbox"/>	<input type="checkbox"/> <input type="checkbox"/>	<input type="checkbox"/> <input type="checkbox"/>	60.0#
UWR	<b>Rectangular Worksurfaces - 24" D</b> • Brackets and/or supports are specified separately, two required for 24"-72" and three required for larger than 72" • 60" and larger worksurfaces are reinforced • Grommet locations are shown	24 x 24	UWR2424	<input type="checkbox"/> <input type="checkbox"/>	<input type="checkbox"/> <input type="checkbox"/>	<input type="checkbox"/> <input type="checkbox"/>	<input type="checkbox"/> <input type="checkbox"/>	<input type="checkbox"/> <input type="checkbox"/>	21.0#
		24 x 30	UWR2430	<input type="checkbox"/> <input type="checkbox"/>	<input type="checkbox"/> <input type="checkbox"/>	<input type="checkbox"/> <input type="checkbox"/>	<input type="checkbox"/> <input type="checkbox"/>	<input type="checkbox"/> <input type="checkbox"/>	26.0#
		24 x 36	UWR2436	<input type="checkbox"/> <input type="checkbox"/>	<input type="checkbox"/> <input type="checkbox"/>	<input type="checkbox"/> <input type="checkbox"/>	<input type="checkbox"/> <input type="checkbox"/>	<input type="checkbox"/> <input type="checkbox"/>	30.0#
		24 x 42	UWR2442	<input type="checkbox"/> <input type="checkbox"/>	<input type="checkbox"/> <input type="checkbox"/>	<input type="checkbox"/> <input type="checkbox"/>	<input type="checkbox"/> <input type="checkbox"/>	<input type="checkbox"/> <input type="checkbox"/>	34.0#
		24 x 48	UWR2448	<input type="checkbox"/> <input type="checkbox"/>	<input type="checkbox"/> <input type="checkbox"/>	<input type="checkbox"/> <input type="checkbox"/>	<input type="checkbox"/> <input type="checkbox"/>	<input type="checkbox"/> <input type="checkbox"/>	38.0#
		24 x 54	UWR2454	<input type="checkbox"/> <input type="checkbox"/>	<input type="checkbox"/> <input type="checkbox"/>	<input type="checkbox"/> <input type="checkbox"/>	<input type="checkbox"/> <input type="checkbox"/>	<input type="checkbox"/> <input type="checkbox"/>	43.0#
		24 x 60	UWR2460	<input type="checkbox"/> <input type="checkbox"/>	<input type="checkbox"/> <input type="checkbox"/>	<input type="checkbox"/> <input type="checkbox"/>	<input type="checkbox"/> <input type="checkbox"/>	<input type="checkbox"/> <input type="checkbox"/>	48.0#
		24 x 66	UWR2466	<input type="checkbox"/> <input type="checkbox"/>	<input type="checkbox"/> <input type="checkbox"/>	<input type="checkbox"/> <input type="checkbox"/>	<input type="checkbox"/> <input type="checkbox"/>	<input type="checkbox"/> <input type="checkbox"/>	53.0#
		24 x 72	UWR2472	<input type="checkbox"/> <input type="checkbox"/>	<input type="checkbox"/> <input type="checkbox"/>	<input type="checkbox"/> <input type="checkbox"/>	<input type="checkbox"/> <input type="checkbox"/>	<input type="checkbox"/> <input type="checkbox"/>	57.0#
		24 x 84	UWR2484	<input type="checkbox"/> <input type="checkbox"/>	<input type="checkbox"/> <input type="checkbox"/>	<input type="checkbox"/> <input type="checkbox"/>	<input type="checkbox"/> <input type="checkbox"/>	<input type="checkbox"/> <input type="checkbox"/>	65.0#
		24 x 96	UWR2496	<input type="checkbox"/> <input type="checkbox"/>	<input type="checkbox"/> <input type="checkbox"/>	<input type="checkbox"/> <input type="checkbox"/>	<input type="checkbox"/> <input type="checkbox"/>	<input type="checkbox"/> <input type="checkbox"/>	74.0#

**A**   **B**   **C**   **D**   **E**   **F**

### HOW TO ORDER

Indicate the following information on order form:

- Quantity of each item.
- Model number, including options. See "How To Build a Model Number".
- Any special service required.

Note: • The  indicates that a choice is required.  
 • The absence of the  indicates that no choice is required.  
 • Alpha-numeric characters in place of  indicate that no other alternatives are available.

### HOW TO BUILD A MODEL NUMBER

- A** Select basic model.  
 \_\_\_\_\_  
**74P** - 74P edge  
**KN** - Knife edge
- B** Select edge style.  
 \_\_\_\_\_  
**74P** - 74P edge  
**KN** - Knife edge
- C** Select grommet location.  
 \_\_\_\_\_  
**N** - No grommet  
**L** - Grommet : Left; add \$23  
**C** - Grommet : Center; add \$23  
**R** - Grommet : Right; add \$23  
**LR** - Grommet : Left/right; add \$45  
**LC** - Grommet : Left /center; add \$45  
**CR** - Grommet : Center/right; add \$45  
**LCR** - Grommet : Left /center/right; add \$67
- D** Select surface finish.  
 Refer to color addendum at ki.com or KI Fabrics & Finishes binder.  
 Surface finish offerings are based on edge

- style selections.
- E** Select edge color.  
 Refer to color addendum at ki.com or KI Fabrics & Finishes binder.
- F** Select grommet color.  
 Refer to color addendum at ki.com or KI Fabrics & Finishes binder.



# Worksurfaces

Rectangular

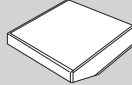
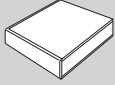

74P Edge  
(74P)

Knife Edge  
(KN)

\$ 176

\$ 203

196

221

211

241

247

280

265

303

277

316

287

329

299

339

303

345

\$ 179

\$ 206

200

227

217

248

256

293

277

316

293

334

304

346

313

357

318

364

340

388

353

402

\$ 179

\$ 206

200

227

217

248

256

293

277

316

293

334

304

346

313

357

318

364

340

388

353

402

**SPECIAL SERVICES**

**Special Carton Marking**

With specially marked information N/C

**Shipping**

Shipped k.d. freight prepaid f.o.b. Manitowoc, Wisconsin 54220 factory. Freight class #70.

Specifications and prices are subject to change without prior notice.

# Worksurfaces

Rectangular

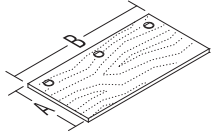

UWR

**MODEL**

**A x B**

- Rectangular Worksurfaces - 30" D**
- Brackets and/or supports are specified separately, two required for 24"-72" and three required for larger than 72"
  - 60" and larger worksurfaces are reinforced
  - Grommet locations are shown

**MODEL NUMBER**

Basic Model	Edge Style	Grommet Location	Surface Finish	Edge Color	Grommet Color
UWR3024	□□□	□□□	□□□	□□□	□□
UWR3030	□□□	□□□	□□□	□□□	□□
UWR3036	□□□	□□□	□□□	□□□	□□
UWR3042	□□□	□□□	□□□	□□□	□□
UWR3048	□□□	□□□	□□□	□□□	□□
UWR3054	□□□	□□□	□□□	□□□	□□
UWR3060	□□□	□□□	□□□	□□□	□□
UWR3066	□□□	□□□	□□□	□□□	□□
UWR3072	□□□	□□□	□□□	□□□	□□
UWR3084	□□□	□□□	□□□	□□□	□□
UWR3096	□□□	□□□	□□□	□□□	□□

Approx. Packaged Weight

30 x 24	26.0#
30 x 30	31.0#
30 x 36	36.0#
30 x 42	41.0#
30 x 48	47.0#
30 x 54	52.0#
30 x 60	59.0#
30 x 66	64.0#
30 x 72	69.0#
30 x 84	80.0#
30 x 96	90.0#

**A**   **B**   **C**   **D**   **E**   **F**

**HOW TO ORDER**

Indicate the following information on order form:

1. Quantity of each item.
2. Model number, including options. See "How To Build a Model Number".
3. Any special service required.

- Note:
- The □ indicates that a choice is required.
  - The absence of the □ indicates that no choice is required.
  - Alpha-numeric characters in place of □ indicate that no other alternatives are available.

**HOW TO BUILD A MODEL NUMBER**

- A** Select basic model.
- B** Select edge style.
  - 74P - 74P edge
  - KN - Knife edge
- C** Select grommet location.
  - N - No grommet
  - L - Grommet : Left; add \$23
  - C - Grommet : Center; add \$23
  - R - Grommet : Right; add \$23
  - LR - Grommet : Left/right; add \$45
  - LC - Grommet : Left /center; add \$45
  - CR - Grommet : Center/right; add \$45
  - LCR - Grommet : Left /center/right; add \$67
- D** Select surface finish. Refer to color addendum at ki.com or KI Fabrics & Finishes binder. Surface finish offerings are based on edge

- style selections.
- E** Select edge color. Refer to color addendum at ki.com or KI Fabrics & Finishes binder.
- F** Select grommet color. Refer to color addendum at ki.com or KI Fabrics & Finishes binder.



# Worksurfaces

Rectangular

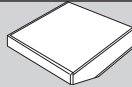
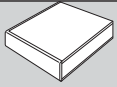

74P Edge  
(74P)

Knife Edge  
(KN)

\$ 200	\$ 227
217	248
238	271
272	310
299	339
308	352
319	365
334	381
339	386
386	440
403	459

**SPECIAL SERVICES**

**Special Carton Marking**

With specially marked information N/C

**Shipping**

Shipped k.d. freight prepaid f.o.b. Manitowoc, Wisconsin 54220 factory. Freight class #70.

Specifications and prices are subject to change without prior notice.

# Worksurfaces

## Diagonal 90° Corner

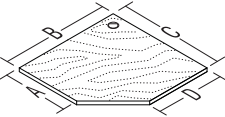
		MODEL NUMBER					
MODEL	A x B x C x D	Basic Model	Edge Style	Grommet Location	Surface Finish	Edge Color	Grommet Color
 <p>UWC</p>	<b>Diagonal 90° Corner - 18" D</b> • Brackets and/or supports are specified separately, three required • Grommet options are limited to center (corner) or no grommet	18 x 36 x 36 x 18	UWDC18363618	<input type="checkbox"/> <input type="checkbox"/> <input type="checkbox"/>	<input type="checkbox"/>	<input type="checkbox"/> <input type="checkbox"/> <input type="checkbox"/>	<input type="checkbox"/> <input type="checkbox"/> <input type="checkbox"/>
	18 x 42 x 42 x 18	UWDC18424218	<input type="checkbox"/> <input type="checkbox"/> <input type="checkbox"/>	<input type="checkbox"/>	<input type="checkbox"/> <input type="checkbox"/> <input type="checkbox"/>	<input type="checkbox"/> <input type="checkbox"/> <input type="checkbox"/>	<input type="checkbox"/> <input type="checkbox"/> <input type="checkbox"/>
	18 x 48 x 48 x 18	UWDC18484818	<input type="checkbox"/> <input type="checkbox"/> <input type="checkbox"/>	<input type="checkbox"/>	<input type="checkbox"/> <input type="checkbox"/> <input type="checkbox"/>	<input type="checkbox"/> <input type="checkbox"/> <input type="checkbox"/>	<input type="checkbox"/> <input type="checkbox"/> <input type="checkbox"/>
UWC	<b>Diagonal 90° Corner - 22" D</b> • Brackets and/or supports are specified separately, three required • Grommet options are limited to center (corner) or no grommet	22 x 36 x 36 x 22	UWDC22363622	<input type="checkbox"/> <input type="checkbox"/> <input type="checkbox"/>	<input type="checkbox"/>	<input type="checkbox"/> <input type="checkbox"/> <input type="checkbox"/>	<input type="checkbox"/> <input type="checkbox"/> <input type="checkbox"/>
UWC		22 x 42 x 42 x 22	UWDC22424222	<input type="checkbox"/> <input type="checkbox"/> <input type="checkbox"/>	<input type="checkbox"/>	<input type="checkbox"/> <input type="checkbox"/> <input type="checkbox"/>	<input type="checkbox"/> <input type="checkbox"/> <input type="checkbox"/>
UWC		22 x 48 x 48 x 22	UWDC22484822	<input type="checkbox"/> <input type="checkbox"/> <input type="checkbox"/>	<input type="checkbox"/>	<input type="checkbox"/> <input type="checkbox"/> <input type="checkbox"/>	<input type="checkbox"/> <input type="checkbox"/> <input type="checkbox"/>
UWC	<b>Diagonal 90° Corner - 24" D</b> • Brackets and/or supports are specified separately, three required • Grommet options are limited to center (corner) or no grommet	24 x 36 x 36 x 24	UWDC24363624	<input type="checkbox"/> <input type="checkbox"/> <input type="checkbox"/>	<input type="checkbox"/>	<input type="checkbox"/> <input type="checkbox"/> <input type="checkbox"/>	<input type="checkbox"/> <input type="checkbox"/> <input type="checkbox"/>
UWC		24 x 42 x 42 x 24	UWDC24424224	<input type="checkbox"/> <input type="checkbox"/> <input type="checkbox"/>	<input type="checkbox"/>	<input type="checkbox"/> <input type="checkbox"/> <input type="checkbox"/>	<input type="checkbox"/> <input type="checkbox"/> <input type="checkbox"/>
UWC		24 x 48 x 48 x 24	UWDC24484824	<input type="checkbox"/> <input type="checkbox"/> <input type="checkbox"/>	<input type="checkbox"/>	<input type="checkbox"/> <input type="checkbox"/> <input type="checkbox"/>	<input type="checkbox"/> <input type="checkbox"/> <input type="checkbox"/>

**A**      **B**      **C**      **D**      **E**      **F**

### HOW TO ORDER

Indicate the following information on order form:

- Quantity of each item.
- Model number, including options. See "How To Build a Model Number".
- Any special service required.

Note: • The  indicates that a choice is required.

- The absence of the  indicates that no choice is required.
- Alpha-numeric characters in place of  indicate that no other alternatives are available.

### HOW TO BUILD A MODEL NUMBER

- A** Select basic model.
- B** Select edge style.
 

<b>74P</b>	- 74P edge
<b>KN</b>	- Knife edge
- C** Select grommet location.
 

<b>N</b>	- No grommet
<b>C</b>	- Grommet : Center; add \$23
- D** Select surface finish.  
Refer to color addendum at ki.com or KI Fabrics & Finishes binder.  
Surface finish offerings are based on edge style selections.
- E** Select edge color.  
Refer to color addendum at ki.com or KI Fabrics & Finishes binder.
- F** Select grommet color.  
Refer to color addendum at ki.com or KI Fabrics & Finishes binder.



# Worksurfaces

Diagonal 90° Corner

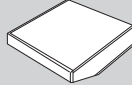
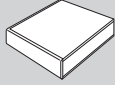

Approx. Packaged Weight	74P Edge (74P)	Knife Edge (KN)
34.0#	\$ 327	\$ 375
47.0#	351	403
62.0#	457	524

37.0#	\$ 327	\$ 375
50.0#	351	403
65.0#	457	524

39.0#	\$ 327	\$ 375
52.0#	351	403
67.0#	457	524

**SPECIAL SERVICES**

**Special Carton Marking**

With specially marked information N/C

**Shipping**

Shipped k.d. freight prepaid f.o.b. Manitowoc, Wisconsin 54220 factory. Freight class #70.

Specifications and prices are subject to change without prior notice.

# Worksurfaces

## Extended Corner

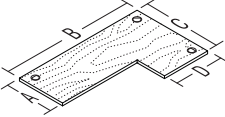
	MODEL	A x B x C x D	MODEL NUMBER						Approx. Packaged Weight
			Basic Model	Edge Style	Grommet Location	Surface Finish	Edge Color	Grommet Color	
	<b>Extended Corner - 22"</b> • Brackets and/or supports are specified separately, two required for 24"-72" and three required for larger than 72" • 60" and larger worksurfaces are reinforced • Grommet locations are shown	22 x 60 x 36 x 22	UWEC22603622	<input type="checkbox"/> <input type="checkbox"/>	<input type="checkbox"/> <input type="checkbox"/>	<input type="checkbox"/> <input type="checkbox"/>	<input type="checkbox"/> <input type="checkbox"/>	<input type="checkbox"/> <input type="checkbox"/>	53.0#
		22 x 72 x 36 x 22	UWEC22723622	<input type="checkbox"/> <input type="checkbox"/>	<input type="checkbox"/> <input type="checkbox"/>	<input type="checkbox"/> <input type="checkbox"/>	<input type="checkbox"/> <input type="checkbox"/>	<input type="checkbox"/> <input type="checkbox"/>	60.0#
UWC									
UWC	<b>Extended Corner - 24"</b> • Brackets and/or supports are specified separately, two required for 24"-72" and three required for larger than 72" • 60" and larger worksurfaces are reinforced • Grommet locations are shown	24 x 60 x 36 x 24	UWEC24603624	<input type="checkbox"/> <input type="checkbox"/>	<input type="checkbox"/> <input type="checkbox"/>	<input type="checkbox"/> <input type="checkbox"/>	<input type="checkbox"/> <input type="checkbox"/>	<input type="checkbox"/> <input type="checkbox"/>	55.0#
		24 x 72 x 36 x 24	UWEC24723624	<input type="checkbox"/> <input type="checkbox"/>	<input type="checkbox"/> <input type="checkbox"/>	<input type="checkbox"/> <input type="checkbox"/>	<input type="checkbox"/> <input type="checkbox"/>	<input type="checkbox"/> <input type="checkbox"/>	62.0#

**A**      **B**      **C**      **D**      **E**      **F**

### HOW TO ORDER

Indicate the following information on order form:

- Quantity of each item.
- Model number, including options. See "How To Build a Model Number".
- Any special service required.

Note: • The  indicates that a choice is required.  
 • The absence of the  indicates that no choice is required.  
 • Alpha-numeric characters in place of  indicate that no other alternatives are available.

### HOW TO BUILD A MODEL NUMBER

- A** Select basic model.
- B** Select edge style.  
 74P - 74P edge  
 KN - Knife edge
- C** Select grommet location.  
 N - No grommet  
 L - Grommet : Left; add \$23  
 C - Grommet : Center; add \$23  
 R - Grommet : Right; add \$23  
 LR - Grommet : Left/right; add \$45  
 LC - Grommet : Left /center; add \$45  
 CR - Grommet : Center/right; add \$45  
 LCR - Grommet : Left /center/right; add \$67
- D** Select surface finish.  
 Refer to color addendum at ki.com or KI Fabrics & Finishes binder.  
 Surface finish offerings are based on edge

- style selections.
- E** Select edge color.  
 Refer to color addendum at ki.com or KI Fabrics & Finishes binder.
- F** Select grommet color.  
 Refer to color addendum at ki.com or KI Fabrics & Finishes binder.



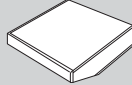
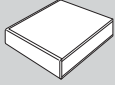

74P Edge  
(74P)

Knife Edge  
(KN)

\$ 593

\$ 677

683

779

\$ 593

\$ 677

683

779

**SPECIAL SERVICES**

**Special Carton Marking**

With specially marked information N/C

**Shipping**

Shipped k.d. freight prepaid f.o.b. Manitowoc, Wisconsin 54220 factory. Freight class #70.

Specifications and prices are subject to change without prior notice.

# Worksurfaces

## Extended Corner

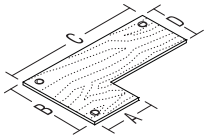
		MODEL NUMBER						Approx. Packaged Weight	
		Basic Model	Edge Style	Grommet Location	Surface Finish	Edge Color	Grommet Color		
	<b>MODEL</b>	<b>A x B x C x D</b>							
	<b>Extended Corner - 22"</b>	22 x 36 x 60 x 22	UWEC22366022	<input type="checkbox"/> <input type="checkbox"/>	<input type="checkbox"/> <input type="checkbox"/>	<input type="checkbox"/> <input type="checkbox"/>	<input type="checkbox"/> <input type="checkbox"/>	<input type="checkbox"/> <input type="checkbox"/>	53.0#
	<ul style="list-style-type: none"> <li>• Brackets and/or supports are specified separately, two required for 24"-72" and three required for larger than 72"</li> <li>• 60" and larger worksurfaces are reinforced</li> <li>• Grommet locations are shown</li> </ul>	22 x 36 x 72 x 22	UWEC22367222	<input type="checkbox"/> <input type="checkbox"/>	<input type="checkbox"/> <input type="checkbox"/>	<input type="checkbox"/> <input type="checkbox"/>	<input type="checkbox"/> <input type="checkbox"/>	<input type="checkbox"/> <input type="checkbox"/>	60.0#
UWC	<b>Extended Corner - 24"</b>	24 x 36 x 60 x 24	UWEC24366024	<input type="checkbox"/> <input type="checkbox"/>	<input type="checkbox"/> <input type="checkbox"/>	<input type="checkbox"/> <input type="checkbox"/>	<input type="checkbox"/> <input type="checkbox"/>	<input type="checkbox"/> <input type="checkbox"/>	55.0#
UWC		24 x 36 x 72 x 24	UWEC24367224	<input type="checkbox"/> <input type="checkbox"/>	<input type="checkbox"/> <input type="checkbox"/>	<input type="checkbox"/> <input type="checkbox"/>	<input type="checkbox"/> <input type="checkbox"/>	<input type="checkbox"/> <input type="checkbox"/>	62.0#
				<b>A</b>	<b>B</b>	<b>C</b>	<b>D</b>	<b>E</b>	<b>F</b>

### HOW TO ORDER

Indicate the following information on order form:

- Quantity of each item.
- Model number, including options. See "How To Build a Model Number".
- Any special service required.

- Note:
- The  indicates that a choice is required.
  - The absence of the  indicates that no choice is required.
  - Alpha-numeric characters in place of  indicate that no other alternatives are available.

### HOW TO BUILD A MODEL NUMBER

- A** Select basic model.
- B** Select edge style.
  - 74P - 74P edge
  - KN - Knife edge
- C** Select grommet location.
  - N - No grommet
  - L - Grommet : Left; add \$23
  - C - Grommet : Center; add \$23
  - R - Grommet : Right; add \$23
  - LR - Grommet : Left/right; add \$45
  - LC - Grommet : Left /center; add \$45
  - CR - Grommet : Center/right; add \$45
  - LCR - Grommet : Left /center/right; add \$67
- D** Select surface finish. Refer to color addendum at ki.com or KI Fabrics & Finishes binder. Surface finish offerings are based on edge

style selections.

- E** Select edge color. Refer to color addendum at ki.com or KI Fabrics & Finishes binder.
- F** Select grommet color. Refer to color addendum at ki.com or KI Fabrics & Finishes binder.

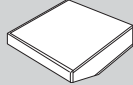
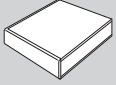

74P Edge  
(74P)

Knife Edge  
(KN)

\$ 593

\$ 677

683

779

\$ 593

\$ 677

683

779

### SPECIAL SERVICES

#### Special Carton Marking

With specially marked information N/C

#### Shipping

Shipped k.d. freight prepaid f.o.b. Manitowoc, Wisconsin 54220 factory. Freight class #70.

Specifications and prices are subject to change without prior notice.

# Worksurfaces

## Extended Corner Reductions

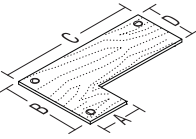

	MODEL	A x B x C x D	MODEL NUMBER						Approx. Packaged Weight
			Basic Model	Edge Style	Grommet Location	Surface Finish	Edge Color	Grommet Color	
UWC	<b>Extended Corner Reduction - 18"</b> • Brackets and/or supports are specified separately, three required • 60" and larger worksurfaces are reinforced • Grommet locations are shown	18 x 36 x 60 x 22	UWEC18366022	<input type="checkbox"/> <input type="checkbox"/> <input type="checkbox"/>	<input type="checkbox"/> <input type="checkbox"/> <input type="checkbox"/>	<input type="checkbox"/> <input type="checkbox"/> <input type="checkbox"/>	<input type="checkbox"/> <input type="checkbox"/> <input type="checkbox"/>	<input type="checkbox"/> <input type="checkbox"/>	51.0#
		18 x 36 x 60 x 24	UWEC18366024	<input type="checkbox"/> <input type="checkbox"/> <input type="checkbox"/>	<input type="checkbox"/> <input type="checkbox"/> <input type="checkbox"/>	<input type="checkbox"/> <input type="checkbox"/> <input type="checkbox"/>	<input type="checkbox"/> <input type="checkbox"/> <input type="checkbox"/>	<input type="checkbox"/> <input type="checkbox"/>	53.0#
		18 x 36 x 72 x 22	UWEC18367222	<input type="checkbox"/> <input type="checkbox"/> <input type="checkbox"/>	<input type="checkbox"/> <input type="checkbox"/> <input type="checkbox"/>	<input type="checkbox"/> <input type="checkbox"/> <input type="checkbox"/>	<input type="checkbox"/> <input type="checkbox"/> <input type="checkbox"/>	<input type="checkbox"/> <input type="checkbox"/>	58.0#
		18 x 36 x 72 x 24	UWEC18367224	<input type="checkbox"/> <input type="checkbox"/> <input type="checkbox"/>	<input type="checkbox"/> <input type="checkbox"/> <input type="checkbox"/>	<input type="checkbox"/> <input type="checkbox"/> <input type="checkbox"/>	<input type="checkbox"/> <input type="checkbox"/> <input type="checkbox"/>	<input type="checkbox"/> <input type="checkbox"/>	60.0#
UWC									
UWC	<b>Extended Corner Reduction - 22"</b> • Brackets and/or supports are specified separately, three required • Grommet locations are shown	22 x 36 x 60 x 18	UWEC22366018	<input type="checkbox"/> <input type="checkbox"/> <input type="checkbox"/>	<input type="checkbox"/> <input type="checkbox"/> <input type="checkbox"/>	<input type="checkbox"/> <input type="checkbox"/> <input type="checkbox"/>	<input type="checkbox"/> <input type="checkbox"/> <input type="checkbox"/>	<input type="checkbox"/> <input type="checkbox"/>	51.0#
		22 x 36 x 60 x 24	UWEC22366024	<input type="checkbox"/> <input type="checkbox"/> <input type="checkbox"/>	<input type="checkbox"/> <input type="checkbox"/> <input type="checkbox"/>	<input type="checkbox"/> <input type="checkbox"/> <input type="checkbox"/>	<input type="checkbox"/> <input type="checkbox"/> <input type="checkbox"/>	<input type="checkbox"/> <input type="checkbox"/>	51.0#
		22 x 36 x 72 x 18	UWEC22367218	<input type="checkbox"/> <input type="checkbox"/> <input type="checkbox"/>	<input type="checkbox"/> <input type="checkbox"/> <input type="checkbox"/>	<input type="checkbox"/> <input type="checkbox"/> <input type="checkbox"/>	<input type="checkbox"/> <input type="checkbox"/> <input type="checkbox"/>	<input type="checkbox"/> <input type="checkbox"/>	58.0#
		22 x 36 x 72 x 24	UWEC22367224	<input type="checkbox"/> <input type="checkbox"/> <input type="checkbox"/>	<input type="checkbox"/> <input type="checkbox"/> <input type="checkbox"/>	<input type="checkbox"/> <input type="checkbox"/> <input type="checkbox"/>	<input type="checkbox"/> <input type="checkbox"/> <input type="checkbox"/>	<input type="checkbox"/> <input type="checkbox"/>	53.0#
UWC	<b>Extended Corner Reduction - 24"</b> • Brackets and/or supports are specified separately, three required • 60" and larger worksurfaces are reinforced • Grommet locations are shown	24 x 36 x 60 x 18	UWEC24366018	<input type="checkbox"/> <input type="checkbox"/> <input type="checkbox"/>	<input type="checkbox"/> <input type="checkbox"/> <input type="checkbox"/>	<input type="checkbox"/> <input type="checkbox"/> <input type="checkbox"/>	<input type="checkbox"/> <input type="checkbox"/> <input type="checkbox"/>	<input type="checkbox"/> <input type="checkbox"/>	53.0#
		24 x 36 x 60 x 22	UWEC24366022	<input type="checkbox"/> <input type="checkbox"/> <input type="checkbox"/>	<input type="checkbox"/> <input type="checkbox"/> <input type="checkbox"/>	<input type="checkbox"/> <input type="checkbox"/> <input type="checkbox"/>	<input type="checkbox"/> <input type="checkbox"/> <input type="checkbox"/>	<input type="checkbox"/> <input type="checkbox"/>	55.0#
		24 x 36 x 72 x 18	UWEC24367218	<input type="checkbox"/> <input type="checkbox"/> <input type="checkbox"/>	<input type="checkbox"/> <input type="checkbox"/> <input type="checkbox"/>	<input type="checkbox"/> <input type="checkbox"/> <input type="checkbox"/>	<input type="checkbox"/> <input type="checkbox"/> <input type="checkbox"/>	<input type="checkbox"/> <input type="checkbox"/>	60.0#
		24 x 36 x 72 x 22	UWEC24367222	<input type="checkbox"/> <input type="checkbox"/> <input type="checkbox"/>	<input type="checkbox"/> <input type="checkbox"/> <input type="checkbox"/>	<input type="checkbox"/> <input type="checkbox"/> <input type="checkbox"/>	<input type="checkbox"/> <input type="checkbox"/> <input type="checkbox"/>	<input type="checkbox"/> <input type="checkbox"/>	62.0#

**A**      **B**      **C**      **D**      **E**      **F**

### HOW TO ORDER

Indicate the following information on order form:

- Quantity of each item.
- Model number, including options. See "How To Build a Model Number".
- Any special service required.

Note:

- The  indicates that a choice is required.
- The absence of the  indicates that no choice is required.
- Alpha-numeric characters in place of  indicate that no other alternatives are available.

### HOW TO BUILD A MODEL NUMBER

- A** Select basic model.
- B** Select edge style.  
74P - 74P edge  
KN - Knife edge
- C** Select grommet location.  
N - No grommet  
L - Grommet : Left; add \$23  
C - Grommet : Center; add \$23  
R - Grommet : Right; add \$23  
LR - Grommet : Left/right; add \$45  
LC - Grommet : Left /center; add \$45  
CR - Grommet : Center/right; add \$45  
LCR - Grommet : Left /center/right; add \$67
- D** Select surface finish.  
Refer to color addendum at ki.com or KI Fabrics & Finishes binder.  
Surface finish offerings are based on edge

- style selections.
- E** Select edge color.  
Refer to color addendum at ki.com or KI Fabrics & Finishes binder.
- F** Select grommet color.  
Refer to color addendum at ki.com or KI Fabrics & Finishes binder.

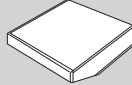
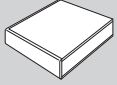

74P Edge  
(74P)

Knife Edge  
(KN)

\$ 593  
593  
683  
683

\$ 677  
677  
779  
779

\$ 593  
593  
683  
683

\$ 677  
677  
779  
779

\$ 593  
593  
683  
683

\$ 677  
677  
779  
779

**SPECIAL SERVICES**

**Special Carton Marking**

With specially marked information N/C

**Shipping**

Shipped k.d. freight prepaid f.o.b. Manitowoc, Wisconsin 54220 factory. Freight class #70.

Specifications and prices are subject to change without prior notice.

# Worksurfaces

## Extended Corner Reductions

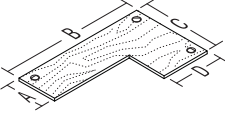

	MODEL	A x B x C x D	MODEL NUMBER						Approx. Packaged Weight
			Basic Model	Edge Style	Grommet Location	Surface Finish	Edge Color	Grommet Color	
UWC	<b>Extended Corner Reduction - 18"</b> • Brackets and/or supports are specified separately, three required • 60" and larger worksurfaces are reinforced • Grommet locations are shown	18 x 60 x 36 x 22	UWEC18603622	<input type="checkbox"/> <input type="checkbox"/> <input type="checkbox"/>	<input type="checkbox"/> <input type="checkbox"/> <input type="checkbox"/>	<input type="checkbox"/> <input type="checkbox"/> <input type="checkbox"/>	<input type="checkbox"/> <input type="checkbox"/> <input type="checkbox"/>	<input type="checkbox"/> <input type="checkbox"/>	51.0#
		18 x 60 x 36 x 24	UWEC18603624	<input type="checkbox"/> <input type="checkbox"/> <input type="checkbox"/>	<input type="checkbox"/> <input type="checkbox"/> <input type="checkbox"/>	<input type="checkbox"/> <input type="checkbox"/> <input type="checkbox"/>	<input type="checkbox"/> <input type="checkbox"/> <input type="checkbox"/>	<input type="checkbox"/> <input type="checkbox"/>	53.0#
		18 x 72 x 36 x 22	UWEC18723622	<input type="checkbox"/> <input type="checkbox"/> <input type="checkbox"/>	<input type="checkbox"/> <input type="checkbox"/> <input type="checkbox"/>	<input type="checkbox"/> <input type="checkbox"/> <input type="checkbox"/>	<input type="checkbox"/> <input type="checkbox"/> <input type="checkbox"/>	<input type="checkbox"/> <input type="checkbox"/>	58.0#
		18 x 72 x 36 x 24	UWEC18723624	<input type="checkbox"/> <input type="checkbox"/> <input type="checkbox"/>	<input type="checkbox"/> <input type="checkbox"/> <input type="checkbox"/>	<input type="checkbox"/> <input type="checkbox"/> <input type="checkbox"/>	<input type="checkbox"/> <input type="checkbox"/> <input type="checkbox"/>	<input type="checkbox"/> <input type="checkbox"/>	60.0#
UWC									
UWC	<b>Extended Corner Reduction - 22"</b> • Brackets and/or supports are specified separately, three required • Grommet locations are shown	22 x 60 x 36 x 18	UWEC22603618	<input type="checkbox"/> <input type="checkbox"/> <input type="checkbox"/>	<input type="checkbox"/> <input type="checkbox"/> <input type="checkbox"/>	<input type="checkbox"/> <input type="checkbox"/> <input type="checkbox"/>	<input type="checkbox"/> <input type="checkbox"/> <input type="checkbox"/>	<input type="checkbox"/> <input type="checkbox"/>	51.0#
		22 x 60 x 36 x 24	UWEC22603624	<input type="checkbox"/> <input type="checkbox"/> <input type="checkbox"/>	<input type="checkbox"/> <input type="checkbox"/> <input type="checkbox"/>	<input type="checkbox"/> <input type="checkbox"/> <input type="checkbox"/>	<input type="checkbox"/> <input type="checkbox"/> <input type="checkbox"/>	<input type="checkbox"/> <input type="checkbox"/>	58.0#
		22 x 72 x 36 x 18	UWEC22723618	<input type="checkbox"/> <input type="checkbox"/> <input type="checkbox"/>	<input type="checkbox"/> <input type="checkbox"/> <input type="checkbox"/>	<input type="checkbox"/> <input type="checkbox"/> <input type="checkbox"/>	<input type="checkbox"/> <input type="checkbox"/> <input type="checkbox"/>	<input type="checkbox"/> <input type="checkbox"/>	58.0#
		22 x 72 x 36 x 24	UWEC22723624	<input type="checkbox"/> <input type="checkbox"/> <input type="checkbox"/>	<input type="checkbox"/> <input type="checkbox"/> <input type="checkbox"/>	<input type="checkbox"/> <input type="checkbox"/> <input type="checkbox"/>	<input type="checkbox"/> <input type="checkbox"/> <input type="checkbox"/>	<input type="checkbox"/> <input type="checkbox"/>	60.0#
UWC	<b>Extended Corner Reduction - 24"</b> • Brackets and/or supports are specified separately, three required • 60" and larger worksurfaces are reinforced • Grommet locations are shown	24 x 60 x 36 x 18	UWEC24603618	<input type="checkbox"/> <input type="checkbox"/> <input type="checkbox"/>	<input type="checkbox"/> <input type="checkbox"/> <input type="checkbox"/>	<input type="checkbox"/> <input type="checkbox"/> <input type="checkbox"/>	<input type="checkbox"/> <input type="checkbox"/> <input type="checkbox"/>	<input type="checkbox"/> <input type="checkbox"/>	53.0#
		24 x 60 x 36 x 22	UWEC24603622	<input type="checkbox"/> <input type="checkbox"/> <input type="checkbox"/>	<input type="checkbox"/> <input type="checkbox"/> <input type="checkbox"/>	<input type="checkbox"/> <input type="checkbox"/> <input type="checkbox"/>	<input type="checkbox"/> <input type="checkbox"/> <input type="checkbox"/>	<input type="checkbox"/> <input type="checkbox"/>	55.0#
		24 x 72 x 36 x 18	UWEC24723618	<input type="checkbox"/> <input type="checkbox"/> <input type="checkbox"/>	<input type="checkbox"/> <input type="checkbox"/> <input type="checkbox"/>	<input type="checkbox"/> <input type="checkbox"/> <input type="checkbox"/>	<input type="checkbox"/> <input type="checkbox"/> <input type="checkbox"/>	<input type="checkbox"/> <input type="checkbox"/>	60.0#
		24 x 72 x 36 x 22	UWEC24723622	<input type="checkbox"/> <input type="checkbox"/> <input type="checkbox"/>	<input type="checkbox"/> <input type="checkbox"/> <input type="checkbox"/>	<input type="checkbox"/> <input type="checkbox"/> <input type="checkbox"/>	<input type="checkbox"/> <input type="checkbox"/> <input type="checkbox"/>	<input type="checkbox"/> <input type="checkbox"/>	62.0#

**A**      **B**      **C**      **D**      **E**      **F**

### HOW TO ORDER

Indicate the following information on order form:

- Quantity of each item.
- Model number, including options. See "How To Build a Model Number".
- Any special service required.

Note: • The  indicates that a choice is required.  
 • The absence of the  indicates that no choice is required.  
 • Alpha-numeric characters in place of  indicate that no other alternatives are available.

### HOW TO BUILD A MODEL NUMBER

- A** Select basic model.
- B** Select edge style.  
 74P - 74P edge  
 KN - Knife edge
- C** Select grommet location.  
 N - No grommet  
 L - Grommet : Left; add \$23  
 C - Grommet : Center; add \$23  
 R - Grommet : Right; add \$23  
 LR - Grommet : Left/right; add \$45  
 LC - Grommet : Left /center; add \$45  
 CR - Grommet : Center/right; add \$45  
 LCR - Grommet : Left /center/right; add \$67
- D** Select surface finish.  
 Refer to color addendum at ki.com or KI Fabrics & Finishes binder.  
 Surface finish offerings are based on edge

- style selections.
- E** Select edge color.  
 Refer to color addendum at ki.com or KI Fabrics & Finishes binder.
- F** Select grommet color.  
 Refer to color addendum at ki.com or KI Fabrics & Finishes binder.

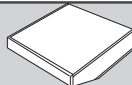
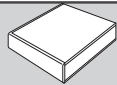

74P Edge  
(74P)

Knife Edge  
(KN)

\$ 593  
593  
683  
683

\$ 677  
677  
779  
779

\$ 593  
593  
683  
683  
\$ 593  
593  
683  
683

\$ 677  
677  
779  
779  
\$ 677  
677  
779  
779

**SPECIAL SERVICES**

**Special Carton Marking**

With specially marked information N/C

**Shipping**

Shipped k.d. freight prepaid f.o.b. Manitowoc, Wisconsin 54220 factory. Freight class #70.

Specifications and prices are subject to change without prior notice.

# Worksurfaces

Conference End

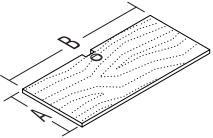
MODEL	A x B	MODEL NUMBER						Approx. Packaged Weight
		Basic Model	Edge Style	Grommet Location	Surface Finish	Edge Color	Grommet Color	
 <p>UWP</p> <p><b>Conference End</b></p> <ul style="list-style-type: none"> <li>• Brackets and/or supports are specified separately; requires two brackets and two post legs or two worksurface support legs</li> <li>• Grommet location is shown</li> </ul>	24 x 51	UWCE2451	<input type="checkbox"/> <input type="checkbox"/> <input type="checkbox"/>	<input type="checkbox"/>	<input type="checkbox"/> <input type="checkbox"/> <input type="checkbox"/>	<input type="checkbox"/> <input type="checkbox"/> <input type="checkbox"/>	<input type="checkbox"/> <input type="checkbox"/>	45.0#
	30 x 63	UWCE3063	<input type="checkbox"/> <input type="checkbox"/> <input type="checkbox"/>	<input type="checkbox"/>	<input type="checkbox"/> <input type="checkbox"/> <input type="checkbox"/>	<input type="checkbox"/> <input type="checkbox"/> <input type="checkbox"/>	<input type="checkbox"/> <input type="checkbox"/>	70.0#

**A**   **B**   **C**   **D**   **E**   **F**

## HOW TO ORDER

Indicate the following information on order form:

1. Quantity of each item.
2. Model number, including options. See "How To Build a Model Number".
3. Any special service required.

Note: • The  indicates that a choice is required.

- The absence of the  indicates that no choice is required.
- Alpha-numeric characters in place of  indicate that no other alternatives are available.

## HOW TO BUILD A MODEL NUMBER

- A** Select basic model.
- B** Select edge style.
 

<b>74P</b>	- 74P edge
<b>KN</b>	- Knife edge
- C** Select grommet location.
 

<b>N</b>	- No grommet
<b>C</b>	- Grommet : Center; add \$23
- D** Select surface finish. Refer to color addendum at ki.com or KI Fabrics & Finishes binder. Surface finish offerings are based on edge style selections.
- E** Select edge color. Refer to color addendum at ki.com or KI Fabrics & Finishes binder.
- F** Select grommet color. Refer to color addendum at ki.com or KI Fabrics & Finishes binder.



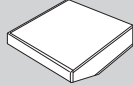
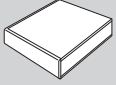

74P Edge  
(74P)

Knife Edge  
(KN)

\$ 293

\$ 334

334

381

**SPECIAL SERVICES**

**Special Carton Marking**

With specially marked information N/C

**Shipping**

Shipped k.d. freight prepaid f.o.b. Manitowoc, Wisconsin 54220 factory. Freight class #70.

Specifications and prices are subject to change without prior notice.

# Worksurfaces

Tapered

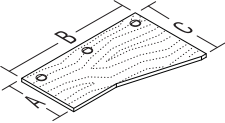
		MODEL NUMBER							Approx. Packaged Weight
		Basic Model	Edge Style	Grommet Location	Surface Finish	Edge Color	Grommet Color		
 <p>UWT</p>	<b>MODEL</b> <b>Tapered - 22"</b> • Tapered worksurfaces allow user to face out of the workstation • 22" tapered worksurfaces align with U-Series tower depths • Brackets and/or supports are specified separately, two required for 24"-72" and three required for larger than 72" • 60" and larger worksurfaces are reinforced • Grommet locations are shown	<b>A x B x C</b> 22 x 48 x 30 22 x 60 x 30 22 x 72 x 30 30 x 48 x 22 30 x 60 x 22 30 x 72 x 22	UWT224830 UWT226030 UWT227230 UWT304822 UWT306022 UWT307222	<input type="checkbox"/> <input type="checkbox"/> <input type="checkbox"/> <input type="checkbox"/> <input type="checkbox"/> <input type="checkbox"/> <input type="checkbox"/> <input type="checkbox"/> <input type="checkbox"/> <input type="checkbox"/> <input type="checkbox"/> <input type="checkbox"/> <input type="checkbox"/> <input type="checkbox"/> <input type="checkbox"/> <input type="checkbox"/> <input type="checkbox"/> <input type="checkbox"/>	<input type="checkbox"/> <input type="checkbox"/> <input type="checkbox"/> <input type="checkbox"/> <input type="checkbox"/> <input type="checkbox"/> <input type="checkbox"/> <input type="checkbox"/> <input type="checkbox"/> <input type="checkbox"/> <input type="checkbox"/> <input type="checkbox"/> <input type="checkbox"/> <input type="checkbox"/> <input type="checkbox"/> <input type="checkbox"/> <input type="checkbox"/> <input type="checkbox"/>	<input type="checkbox"/> <input type="checkbox"/> <input type="checkbox"/> <input type="checkbox"/> <input type="checkbox"/> <input type="checkbox"/> <input type="checkbox"/> <input type="checkbox"/> <input type="checkbox"/> <input type="checkbox"/> <input type="checkbox"/> <input type="checkbox"/> <input type="checkbox"/> <input type="checkbox"/> <input type="checkbox"/> <input type="checkbox"/> <input type="checkbox"/> <input type="checkbox"/>	<input type="checkbox"/> <input type="checkbox"/> <input type="checkbox"/> <input type="checkbox"/> <input type="checkbox"/> <input type="checkbox"/> <input type="checkbox"/> <input type="checkbox"/> <input type="checkbox"/> <input type="checkbox"/> <input type="checkbox"/> <input type="checkbox"/> <input type="checkbox"/> <input type="checkbox"/> <input type="checkbox"/> <input type="checkbox"/> <input type="checkbox"/> <input type="checkbox"/>	<input type="checkbox"/> <input type="checkbox"/> <input type="checkbox"/> <input type="checkbox"/> <input type="checkbox"/> <input type="checkbox"/> <input type="checkbox"/> <input type="checkbox"/> <input type="checkbox"/> <input type="checkbox"/> <input type="checkbox"/> <input type="checkbox"/>	39.0# 49.0# 58.0# 39.0# 49.0# 58.0#
	<p>UWT</p>	<b>Tapered - 24"</b> • Tapered worksurfaces allow user to face out of the workstation • Brackets and/or supports are specified separately, two required for 24"-72" and three required for larger than 72" • 60" and larger worksurfaces are reinforced • Grommet locations are shown	24 x 48 x 30 24 x 60 x 30 24 x 72 x 30 30 x 48 x 24 30 x 60 x 24 30 x 72 x 24	UWT244830 UWT246030 UWT247230 UWT304824 UWT306024 UWT307224	<input type="checkbox"/> <input type="checkbox"/> <input type="checkbox"/> <input type="checkbox"/> <input type="checkbox"/> <input type="checkbox"/> <input type="checkbox"/> <input type="checkbox"/> <input type="checkbox"/> <input type="checkbox"/> <input type="checkbox"/> <input type="checkbox"/> <input type="checkbox"/> <input type="checkbox"/> <input type="checkbox"/> <input type="checkbox"/> <input type="checkbox"/> <input type="checkbox"/>	<input type="checkbox"/> <input type="checkbox"/> <input type="checkbox"/> <input type="checkbox"/> <input type="checkbox"/> <input type="checkbox"/> <input type="checkbox"/> <input type="checkbox"/> <input type="checkbox"/> <input type="checkbox"/> <input type="checkbox"/> <input type="checkbox"/> <input type="checkbox"/> <input type="checkbox"/> <input type="checkbox"/> <input type="checkbox"/> <input type="checkbox"/> <input type="checkbox"/>	<input type="checkbox"/> <input type="checkbox"/> <input type="checkbox"/> <input type="checkbox"/> <input type="checkbox"/> <input type="checkbox"/> <input type="checkbox"/> <input type="checkbox"/> <input type="checkbox"/> <input type="checkbox"/> <input type="checkbox"/> <input type="checkbox"/> <input type="checkbox"/> <input type="checkbox"/> <input type="checkbox"/> <input type="checkbox"/> <input type="checkbox"/> <input type="checkbox"/>	<input type="checkbox"/> <input type="checkbox"/> <input type="checkbox"/> <input type="checkbox"/> <input type="checkbox"/> <input type="checkbox"/> <input type="checkbox"/> <input type="checkbox"/> <input type="checkbox"/> <input type="checkbox"/> <input type="checkbox"/> <input type="checkbox"/>	41.0# 51.0# 60.0# 41.0# 51.0# 61.0#

**A**      **B**      **C**      **D**      **E**      **F**

## HOW TO ORDER

Indicate the following information on order form:

- Quantity of each item.
- Model number, including options. See "How To Build a Model Number".
- Any special service required.

Note:

- The  indicates that a choice is required.
- The absence of the  indicates that no choice is required.
- Alpha-numeric characters in place of  indicate that no other alternatives are available.

## HOW TO BUILD A MODEL NUMBER

- A** Select basic model.
- B** Select edge style  
 74P - 74P edge  
 KN - Knife edge
- C** Select grommet location.  
 N - No grommet  
 L - Grommet : Left; add \$23  
 C - Grommet : Center; add \$23  
 R - Grommet : Right; add \$23  
 LR - Grommet : Left/right; add \$45  
 LC - Grommet : Left /center; add \$45  
 CR - Grommet : Center/right; add \$45  
 LCR - Grommet : Left /center/right; add \$67
- D** Select surface finish.  
 Refer to color addendum at ki.com or KI Fabrics & Finishes binder.  
 Surface finish offerings are based on edge

- style selections.
- E** Select edge color.  
 Refer to color addendum at ki.com or KI Fabrics & Finishes binder.
- F** Select grommet color.  
 Refer to color addendum at ki.com or KI Fabrics & Finishes binder.



# Worksurfaces

Tapered

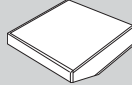
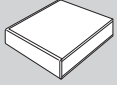

74P Edge  
(74P)

Knife Edge  
(KN)

\$ 478	\$ 549
523	599
568	650
478	549
523	599
568	650

\$ 478	\$ 549
523	599
568	650
478	549
523	599
568	650

**SPECIAL SERVICES**

**Special Carton Marking**

With specially marked information N/C

**Shipping**

Shipped k.d. freight prepaid f.o.b. Manitowoc, Wisconsin 54220 factory. Freight class #70.

Specifications and prices are subject to change without prior notice.

# Worksurfaces

## Peninsula

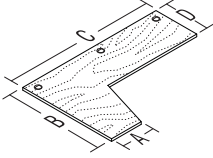
	MODEL	A x B x C x D	MODEL NUMBER						Approx. Packaged Weight
			Basic Model	Edge Style	Grommet Location	Surface Finish	Edge Color	Grommet Color	
 <p>UWP</p>	<b>Peninsula - 22" D</b> <ul style="list-style-type: none"> <li>Peninsula worksurfaces allow user to face out of the workstation</li> <li>22" worksurfaces align with U-Series tower depths</li> <li>Brackets and/or supports are specified separately, two required for 24"-72" and three required for larger than 72"</li> <li>60" and larger worksurfaces are reinforced</li> <li>Grommet locations are shown</li> </ul>	16 x 48 x 72 x 22	UWP16487222	<input type="checkbox"/>	<input type="checkbox"/>	<input type="checkbox"/>	<input type="checkbox"/>	<input type="checkbox"/>	71.0#
		16 x 54 x 72 x 22	UWP16547222	<input type="checkbox"/>	<input type="checkbox"/>	<input type="checkbox"/>	<input type="checkbox"/>	<input type="checkbox"/>	74.0#
		16 x 60 x 72 x 22	UWP16607222	<input type="checkbox"/>	<input type="checkbox"/>	<input type="checkbox"/>	<input type="checkbox"/>	<input type="checkbox"/>	78.0#
UWP	<b>Peninsula - 24" D</b> <ul style="list-style-type: none"> <li>Peninsula worksurfaces allow user to face out of the workstation</li> <li>22" worksurfaces align with U-Series tower depths</li> <li>Brackets and/or supports are specified separately, two required for 24"-72" and three required for larger than 72"</li> <li>60" and larger worksurfaces are reinforced</li> <li>Grommet locations are shown</li> </ul>	16 x 48 x 72 x 24	UWP16487224	<input type="checkbox"/>	<input type="checkbox"/>	<input type="checkbox"/>	<input type="checkbox"/>	<input type="checkbox"/>	75.0#
		16 x 54 x 72 x 24	UWP16547224	<input type="checkbox"/>	<input type="checkbox"/>	<input type="checkbox"/>	<input type="checkbox"/>	<input type="checkbox"/>	78.0#
		16 x 60 x 72 x 24	UWP16607224	<input type="checkbox"/>	<input type="checkbox"/>	<input type="checkbox"/>	<input type="checkbox"/>	<input type="checkbox"/>	82.0#

**A**   **B**   **C**   **D**   **E**   **F**

### HOW TO ORDER

Indicate the following information on order form:

- Quantity of each item.
- Model number, including options. See "How To Build a Model Number".
- Any special service required.

Note:

- The  indicates that a choice is required.
- The absence of the  indicates that no choice is required.
- Alpha-numeric characters in place of  indicate that no other alternatives are available.

### HOW TO BUILD A MODEL NUMBER

- A** Select basic model.
- B** Select edge style.
  - 74P** - 74P edge
  - KN** - Knife edge
- C** Select grommet location.
  - N** - No grommet
  - L** - Grommet : Left; add \$23
  - C** - Grommet : Center; add \$23
  - R** - Grommet : Right; add \$23
  - LR** - Grommet : Left/right; add \$45
  - LC** - Grommet : Left /center; add \$45
  - CR** - Grommet : Center/right; add \$45
  - LCR** - Grommet : Left /center/right; add \$67
- D** Select surface finish. Refer to color addendum at ki.com or KI Fabrics & Finishes binder. Surface finish offerings are based on edge

- style selections.
- E** Select edge color. Refer to color addendum at ki.com or KI Fabrics & Finishes binder.
- F** Select grommet color. Refer to color addendum at ki.com or KI Fabrics & Finishes binder.

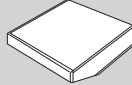
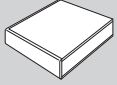

74P Edge  
(74P)

Knife Edge  
(KN)

\$ 599  
641  
662

\$ 651  
744  
767

\$ 599  
641  
662

\$ 651  
744  
767

**SPECIAL SERVICES**

**Special Carton Marking**

With specially marked information N/C

**Shipping**

Shipped k.d. freight prepaid f.o.b. Manitowoc, Wisconsin 54220 factory. Freight class #70.

Specifications and prices are subject to change without prior notice.

# Worksurfaces

## Peninsula

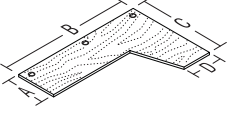
	MODEL	A x B x C x D	MODEL NUMBER						Approx. Packaged Weight
			Basic Model	Edge Style	Grommet Location	Surface Finish	Edge Color	Grommet Color	
 <p>UWP</p>	<b>Peninsula - 22" D</b> <ul style="list-style-type: none"> <li>Peninsula worksurfaces allow user to face out of the workstation</li> <li>22" worksurfaces align with U-Series tower depths</li> <li>Brackets and/or supports are specified separately, two required for 24"-72" and three required for larger than 72"</li> <li>60" and larger worksurfaces are reinforced</li> <li>Grommet locations are shown</li> </ul>	22 x 72 x 48 x 16	UWP22724816	<input type="checkbox"/> <input type="checkbox"/>	<input type="checkbox"/> <input type="checkbox"/>	<input type="checkbox"/> <input type="checkbox"/>	<input type="checkbox"/> <input type="checkbox"/>	<input type="checkbox"/> <input type="checkbox"/>	71.0#
		22 x 72 x 54 x 16	UWP22725416	<input type="checkbox"/> <input type="checkbox"/>	<input type="checkbox"/> <input type="checkbox"/>	<input type="checkbox"/> <input type="checkbox"/>	<input type="checkbox"/> <input type="checkbox"/>	<input type="checkbox"/> <input type="checkbox"/>	74.0#
		22 x 72 x 60 x 16	UWP22726016	<input type="checkbox"/> <input type="checkbox"/>	<input type="checkbox"/> <input type="checkbox"/>	<input type="checkbox"/> <input type="checkbox"/>	<input type="checkbox"/> <input type="checkbox"/>	<input type="checkbox"/> <input type="checkbox"/>	78.0#
<p>UWP</p>	<b>Peninsula - 24" D</b> <ul style="list-style-type: none"> <li>Peninsula worksurfaces allow user to face out of the workstation</li> <li>22" worksurfaces align with U-Series tower depths</li> <li>Brackets and/or supports are specified separately, two required for 24"-72" and three required for larger than 72"</li> <li>60" and larger worksurfaces are reinforced</li> <li>Grommet locations are shown</li> </ul>	24 x 72 x 48 x 16	UWP24724816	<input type="checkbox"/> <input type="checkbox"/>	<input type="checkbox"/> <input type="checkbox"/>	<input type="checkbox"/> <input type="checkbox"/>	<input type="checkbox"/> <input type="checkbox"/>	<input type="checkbox"/> <input type="checkbox"/>	75.0#
		24 x 72 x 54 x 16	UWP24725416	<input type="checkbox"/> <input type="checkbox"/>	<input type="checkbox"/> <input type="checkbox"/>	<input type="checkbox"/> <input type="checkbox"/>	<input type="checkbox"/> <input type="checkbox"/>	<input type="checkbox"/> <input type="checkbox"/>	78.0#
		24 x 72 x 60 x 16	UWP24726016	<input type="checkbox"/> <input type="checkbox"/>	<input type="checkbox"/> <input type="checkbox"/>	<input type="checkbox"/> <input type="checkbox"/>	<input type="checkbox"/> <input type="checkbox"/>	<input type="checkbox"/> <input type="checkbox"/>	82.0#

**A**      **B**      **C**      **D**      **E**      **F**

### HOW TO ORDER

Indicate the following information on order form:

- Quantity of each item.
- Model number, including options. See "How To Build a Model Number".
- Any special service required.

Note:

- The  indicates that a choice is required.
- The absence of the  indicates that no choice is required.
- Alpha-numeric characters in place of  indicate that no other alternatives are available.

### HOW TO BUILD A MODEL NUMBER

- A** Select basic model.
- B** Select edge style.
  - 74P** - 74P edge
  - KN** - Knife edge
- C** Select grommet location.
  - N** - No grommet
  - L** - Grommet : Left; add \$23
  - C** - Grommet : Center; add \$23
  - R** - Grommet : Right; add \$23
  - LR** - Grommet : Left/right; add \$45
  - LC** - Grommet : Left /center; add \$45
  - CR** - Grommet : Center/right; add \$45
  - LCR** - Grommet : Left /center/right; add \$67
- D** Select surface finish. Refer to color addendum at ki.com or KI Fabrics & Finishes binder. Surface finish offerings are based on edge

- style selections.
- E** Select edge color. Refer to color addendum at ki.com or KI Fabrics & Finishes binder.
- F** Select grommet color. Refer to color addendum at ki.com or KI Fabrics & Finishes binder.

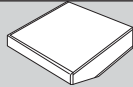
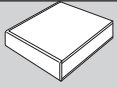

74P Edge  
(74P)

Knife Edge  
(KN)

\$ 599  
641  
662

\$ 651  
744  
767

\$ 599  
641  
662

\$ 651  
744  
767

**SPECIAL SERVICES**

**Special Carton Marking**

With specially marked information N/C

**Shipping**

Shipped k.d. freight prepaid f.o.b. Manitowoc, Wisconsin 54220 factory. Freight class #70.

Specifications and prices are subject to change without prior notice.

# Worksurfaces

120° End Corner

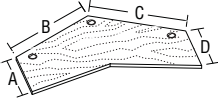
	MODEL	A x B x C x D	MODEL NUMBER						
			Basic Model	Edge Style	Grommet Location	Surface Finish	Edge Color	Grommet Color	
	<b>120° End Corner/60° User Edge - 22"</b> • Brackets and/or supports are specified separately, two required • Grommet locations are shown	22 x 36 x 36 x 22	UW12022363622	<input type="checkbox"/> <input type="checkbox"/> <input type="checkbox"/>	<input type="checkbox"/> <input type="checkbox"/> <input type="checkbox"/>	<input type="checkbox"/> <input type="checkbox"/> <input type="checkbox"/>	<input type="checkbox"/> <input type="checkbox"/> <input type="checkbox"/>	<input type="checkbox"/> <input type="checkbox"/>	
		22 x 42 x 42 x 22	UW12022424222	<input type="checkbox"/> <input type="checkbox"/> <input type="checkbox"/>	<input type="checkbox"/> <input type="checkbox"/> <input type="checkbox"/>	<input type="checkbox"/> <input type="checkbox"/> <input type="checkbox"/>	<input type="checkbox"/> <input type="checkbox"/> <input type="checkbox"/>	<input type="checkbox"/> <input type="checkbox"/>	
		22 x 48 x 48 x 22	UW12022484822	<input type="checkbox"/> <input type="checkbox"/> <input type="checkbox"/>	<input type="checkbox"/> <input type="checkbox"/> <input type="checkbox"/>	<input type="checkbox"/> <input type="checkbox"/> <input type="checkbox"/>	<input type="checkbox"/> <input type="checkbox"/> <input type="checkbox"/>	<input type="checkbox"/> <input type="checkbox"/>	
UWC									
UWC	<b>120° End Corner/60° User Edge - 24"</b> • Brackets and/or supports are specified separately, two required • Grommet locations are shown	24 x 36 x 36 x 24	UW12024363624	<input type="checkbox"/> <input type="checkbox"/> <input type="checkbox"/>	<input type="checkbox"/> <input type="checkbox"/> <input type="checkbox"/>	<input type="checkbox"/> <input type="checkbox"/> <input type="checkbox"/>	<input type="checkbox"/> <input type="checkbox"/> <input type="checkbox"/>	<input type="checkbox"/> <input type="checkbox"/>	
		24 x 42 x 42 x 24	UW12024424224	<input type="checkbox"/> <input type="checkbox"/> <input type="checkbox"/>	<input type="checkbox"/> <input type="checkbox"/> <input type="checkbox"/>	<input type="checkbox"/> <input type="checkbox"/> <input type="checkbox"/>	<input type="checkbox"/> <input type="checkbox"/> <input type="checkbox"/>	<input type="checkbox"/> <input type="checkbox"/>	
		24 x 48 x 48 x 24	UW12024484824	<input type="checkbox"/> <input type="checkbox"/> <input type="checkbox"/>	<input type="checkbox"/> <input type="checkbox"/> <input type="checkbox"/>	<input type="checkbox"/> <input type="checkbox"/> <input type="checkbox"/>	<input type="checkbox"/> <input type="checkbox"/> <input type="checkbox"/>	<input type="checkbox"/> <input type="checkbox"/>	
				<b>A</b>	<b>B</b>	<b>C</b>	<b>D</b>	<b>E</b>	<b>F</b>

## HOW TO ORDER

Indicate the following information on order form:

- Quantity of each item.
- Model number, including options. See "How To Build a Model Number".
- Any special service required.

Note:

- The  indicates that a choice is required.
- The absence of the  indicates that no choice is required.
- Alpha-numeric characters in place of  indicate that no other alternatives are available.

## HOW TO BUILD A MODEL NUMBER

- A** Select basic model.
- B** Select edge style.
  - 74P** - 74P edge
  - KN** - Knife edge
- C** Select grommet location.
  - N** - No grommet
  - L** - Grommet : Left; add \$23
  - C** - Grommet : Center; add \$23
  - R** - Grommet : Right; add \$23
  - LR** - Grommet : Left/right; add \$45
  - LC** - Grommet : Left /center; add \$45
  - CR** - Grommet : Center/right; add \$45
  - LCR** - Grommet : Left /center/right; add \$67
- D** Select surface finish. Refer to color addendum at [ki.com](http://ki.com) or KI Fabrics & Finishes binder. Surface finish offerings are based on edge

style selections.

- E** Select edge color. Refer to color addendum at [ki.com](http://ki.com) or KI Fabrics & Finishes binder.
- F** Select grommet color. Refer to color addendum at [ki.com](http://ki.com) or KI Fabrics & Finishes binder.



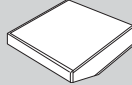
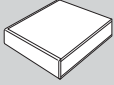

Approx. Packaged Weight	74P Edge (74P)	Knife Edge (KN)
43.0#	\$ 680	\$ 788
50.0#	836	972
58.0#	894	1037

45.0#	\$ 680	\$ 788
54.0#	836	972
62.0#	894	1037

**SPECIAL SERVICES**

**Special Carton Marking**

With specially marked information N/C

**Shipping**

Shipped k.d. freight prepaid f.o.b. Manitowoc, Wisconsin 54220 factory. Freight class #70.

Specifications and prices are subject to change without prior notice.

# Worksurfaces

120° End Corner/60° End Corner

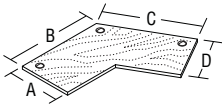
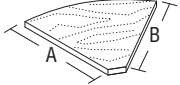
MODEL	A x B x C x D	MODEL NUMBER					
		Basic Model	Edge Style	Grommet Location	Surface Finish	Edge Color	Grommet Color
 <p><b>120° End Corner/90° User Edge - 22"</b></p> <ul style="list-style-type: none"> <li>• Brackets and/or supports are specified separately, two required</li> <li>• Grommet locations are shown</li> </ul>	22 x 36 x 36 x 22	UWIC12022363622	<input type="checkbox"/> <input type="checkbox"/>	<input type="checkbox"/> <input type="checkbox"/>	<input type="checkbox"/> <input type="checkbox"/>	<input type="checkbox"/> <input type="checkbox"/>	<input type="checkbox"/> <input type="checkbox"/>
	22 x 42 x 42 x 22	UWIC12022424222	<input type="checkbox"/> <input type="checkbox"/>	<input type="checkbox"/> <input type="checkbox"/>	<input type="checkbox"/> <input type="checkbox"/>	<input type="checkbox"/> <input type="checkbox"/>	<input type="checkbox"/> <input type="checkbox"/>
	22 x 48 x 48 x 22	UWIC12022484822	<input type="checkbox"/> <input type="checkbox"/>	<input type="checkbox"/> <input type="checkbox"/>	<input type="checkbox"/> <input type="checkbox"/>	<input type="checkbox"/> <input type="checkbox"/>	<input type="checkbox"/> <input type="checkbox"/>
UWC							
UWC	24 x 36 x 36 x 24	UWIC12024363624	<input type="checkbox"/> <input type="checkbox"/>	<input type="checkbox"/> <input type="checkbox"/>	<input type="checkbox"/> <input type="checkbox"/>	<input type="checkbox"/> <input type="checkbox"/>	<input type="checkbox"/> <input type="checkbox"/>
	24 x 42 x 42 x 24	UWIC12024424224	<input type="checkbox"/> <input type="checkbox"/>	<input type="checkbox"/> <input type="checkbox"/>	<input type="checkbox"/> <input type="checkbox"/>	<input type="checkbox"/> <input type="checkbox"/>	<input type="checkbox"/> <input type="checkbox"/>
	24 x 48 x 48 x 24	UWIC12024484824	<input type="checkbox"/> <input type="checkbox"/>	<input type="checkbox"/> <input type="checkbox"/>	<input type="checkbox"/> <input type="checkbox"/>	<input type="checkbox"/> <input type="checkbox"/>	<input type="checkbox"/> <input type="checkbox"/>
 <p><b>60° End Corner - 22 and 24"</b></p> <ul style="list-style-type: none"> <li>• Attaches to adjacent worksurface with splice plates (ordered separately)</li> <li>• Does not feature grommets</li> </ul>	22 x 22	UW1202260	<input type="checkbox"/> <input type="checkbox"/>		<input type="checkbox"/> <input type="checkbox"/>	<input type="checkbox"/> <input type="checkbox"/>	
	24 x 24	UW1202460	<input type="checkbox"/> <input type="checkbox"/>		<input type="checkbox"/> <input type="checkbox"/>	<input type="checkbox"/> <input type="checkbox"/>	

**A**      **B**      **C**      **D**      **E**      **F**

## HOW TO ORDER

Indicate the following information on order form:

1. Quantity of each item.
2. Model number, including options. See "How To Build a Model Number".
3. Any special service required.

Note: • The  indicates that a choice is required.  
 • The absence of the  indicates that no choice is required.  
 • Alpha-numeric characters in place of  indicate that no other alternatives are available.

## HOW TO BUILD A MODEL NUMBER

- A** Select basic model.
- B** Select edge style.  
 74P - 74P edge  
 KN - Knife edge
- C** Select grommet location.  
 N - Grommet : No grommet  
 L - Grommet : Left; add \$23  
 C - Grommet : Center; add \$23  
 R - Grommet : Right; add \$23  
 LR - Grommet : Left/right; add \$45  
 LC - Grommet : Left /center; add \$45  
 CR - Grommet : Center/right; add \$45  
 LCR - Grommet : Left /center/right; add \$67
- D** Select surface finish.  
 Refer to color addendum at ki.com or KI Fabrics & Finishes binder.  
 Surface finish offerings are based on edge

- style selections.
- E** Select edge color.  
 Refer to color addendum at ki.com or KI Fabrics & Finishes binder.
- F** Select grommet color.  
 Refer to color addendum at ki.com or KI Fabrics & Finishes binder.



# Worksurfaces

120° End Corner/60° End Corner

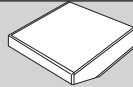
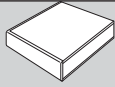

Approx. Packaged Weight	74P Edge (74P)	Knife Edge (KN)
43.0#	\$ 680	\$ 788
50.0#	836	972
58.0#	894	1037

45.0#	\$ 714	\$ 828
54.0#	836	972
62.0#	894	1037

17.0#	\$ 168	\$ 196
17.0#	168	196

**SPECIAL SERVICES**

**Special Carton Marking**

With specially marked information N/C

**Shipping**

Shipped k.d. freight prepaid f.o.b. Manitowoc, Wisconsin 54220 factory. Freight class #70.

Specifications and prices are subject to change without prior notice.

# Worksurfaces

U-Series Underhead

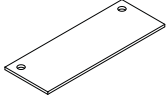

UHWR

- U-Series® Underhead Worksurface**
- Specify by width of underhead
  - Left and/or right grommets are offered
  - 15" is flush to edge of storage; other sizes are recessed to rear of worksurface
  - KN edge not offered on 15" deep tops

MODEL	D x W	MODEL NUMBER						Approx. Packaged Weight
		Basic Model	Edge Style	Grommet Location	Surface Finish	Edge Color	Grommet Color	
UHWR1536	15 x 36	□□□□	□□	□□	□□□□	□□□□	□□	18.0#
UHWR1542	15 x 42	□□□□	□□	□□	□□□□	□□□□	□□	21.0#
UHWR1548	15 x 48	□□□□	□□	□□	□□□□	□□□□	□□	24.0#
UHWR1560	15 x 60	□□□□	□□	□□	□□□□	□□□□	□□	30.0#
UHWR1572	15 x 72	□□□□	□□	□□	□□□□	□□□□	□□	35.0#
UHWR1836	18 x 36	□□□□	□□	□□	□□□□	□□□□	□□	24.0#
UHWR1842	18 x 42	□□□□	□□	□□	□□□□	□□□□	□□	27.0#
UHWR1848	18 x 48	□□□□	□□	□□	□□□□	□□□□	□□	30.0#
UHWR1860	18 x 60	□□□□	□□	□□	□□□□	□□□□	□□	38.0#
UHWR1872	18 x 72	□□□□	□□	□□	□□□□	□□□□	□□	44.0#
UHWR2236	22 x 36	□□□□	□□	□□	□□□□	□□□□	□□	28.0#
UHWR2242	22 x 42	□□□□	□□	□□	□□□□	□□□□	□□	32.0#
UHWR2248	22 x 48	□□□□	□□	□□	□□□□	□□□□	□□	36.0#
UHWR2260	22 x 60	□□□□	□□	□□	□□□□	□□□□	□□	45.0#
UHWR2272	22 x 72	□□□□	□□	□□	□□□□	□□□□	□□	53.0#
UHWR2436	24 x 36	□□□□	□□	□□	□□□□	□□□□	□□	30.0#
UHWR2442	24 x 42	□□□□	□□	□□	□□□□	□□□□	□□	34.0#
UHWR2448	24 x 48	□□□□	□□	□□	□□□□	□□□□	□□	38.0#
UHWR2460	24 x 60	□□□□	□□	□□	□□□□	□□□□	□□	48.0#
UHWR2472	24 x 72	□□□□	□□	□□	□□□□	□□□□	□□	57.0#

**A**   **B**   **C**   **D**   **E**   **F**

## HOW TO ORDER

Indicate the following information on order form:

1. Quantity of each item.
2. Model number, including options. See "How To Build a Model Number".
3. Any special service required.

- Note:
- The □ indicates that a choice is required.
  - The absence of the □ indicates that no choice is required.
  - Alpha-numeric characters in place of □ indicate that no other alternatives are available.

## HOW TO BUILD A MODEL NUMBER

- A** Select basic model.
- B** Select edge style.
  - 74P** - 74P edge
  - KN** - Knife edge
- C** Select grommet location.
  - N** - No grommet
  - L** - Grommet : Left; add \$23
  - R** - Grommet : Right; add \$23
  - LR** - Grommet : Left/right; add \$45
- D** Select surface finish.
 

Refer to color addendum at ki.com or KI Fabrics & Finishes binder. Surface finish offerings are based on edge style selections.
- E** Select edge color.
 

Refer to color addendum at ki.com or KI Fabrics & Finishes binder.
- F** Select grommet color.

Refer to color addendum at ki.com or KI Fabrics & Finishes binder.

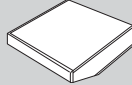
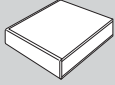

74P Edge  
(74P)

Knife Edge  
(KN)

\$ 200	N/A
234	N/A
254	N/A
267	N/A
276	N/A
211	241
247	280
265	303
287	329
303	345
217	248
256	293
277	316
304	346
318	364
217	248
256	293
277	316
304	346
318	364

**SPECIAL SERVICES**

**Special Carton Marking**

With specially marked information N/C

**Shipping**

Shipped k.d. freight prepaid f.o.b. Manitowoc, Wisconsin 54220 factory. Freight class #70.

Specifications and prices are subject to change without prior notice.

# Worksurfaces

## Transaction Countertops

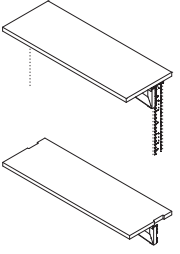
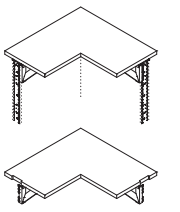
		MODEL NUMBER						Approx. Packaged Weight	
		Basic Model	Notch Location	Edge Style	Surface Finish	Edge Color	Bracket Finish		
 <p>Notch locations shown</p>	<b>Straight Countertops, Standard Height</b> • Includes cantilever support brackets and locking clips to prevent dislodgement • Notch is required when transaction counter is adjacent to end of run trim for change of height conditions • Countertops accept task lights • Transaction counters add 1-1/4" to finished panel heights	16 x 24	UWTR1624	<input type="checkbox"/>	<input type="checkbox"/>	<input type="checkbox"/>	<input type="checkbox"/>	<input type="checkbox"/>	15.7#
	16 x 30	UWTR1630	<input type="checkbox"/>	<input type="checkbox"/>	<input type="checkbox"/>	<input type="checkbox"/>	<input type="checkbox"/>	19.0#	
	16 x 36	UWTR1636	<input type="checkbox"/>	<input type="checkbox"/>	<input type="checkbox"/>	<input type="checkbox"/>	<input type="checkbox"/>	22.3#	
	16 x 42	UWTR1642	<input type="checkbox"/>	<input type="checkbox"/>	<input type="checkbox"/>	<input type="checkbox"/>	<input type="checkbox"/>	25.7#	
	16 x 48	UWTR1648	<input type="checkbox"/>	<input type="checkbox"/>	<input type="checkbox"/>	<input type="checkbox"/>	<input type="checkbox"/>	29.0#	
	16 x 54	UWTR1654	<input type="checkbox"/>	<input type="checkbox"/>	<input type="checkbox"/>	<input type="checkbox"/>	<input type="checkbox"/>	32.3#	
	16 x 60	UWTR1660	<input type="checkbox"/>	<input type="checkbox"/>	<input type="checkbox"/>	<input type="checkbox"/>	<input type="checkbox"/>	35.7#	
	16 x 66	UWTR1666	<input type="checkbox"/>	<input type="checkbox"/>	<input type="checkbox"/>	<input type="checkbox"/>	<input type="checkbox"/>	39.0#	
	16 x 72	UWTR1672	<input type="checkbox"/>	<input type="checkbox"/>	<input type="checkbox"/>	<input type="checkbox"/>	<input type="checkbox"/>	42.3#	
	16 x 78	UWTR1678	<input type="checkbox"/>	<input type="checkbox"/>	<input type="checkbox"/>	<input type="checkbox"/>	<input type="checkbox"/>	45.7#	
	16 x 84	UWTR1684	<input type="checkbox"/>	<input type="checkbox"/>	<input type="checkbox"/>	<input type="checkbox"/>	<input type="checkbox"/>	50.2#	
UWTR									
 <p>Notch locations shown</p>	<b>Corner Countertops, Standard Height</b> • Includes cantilever support brackets and locking clips to prevent dislodgement • Notch is required when transaction counter is adjacent to end of run trim for change of height conditions • Countertops accept task lights • Transaction counters add 1-1/4" to finished panel heights	16 x 24	UWTRC1624	<input type="checkbox"/>	<input type="checkbox"/>	<input type="checkbox"/>	<input type="checkbox"/>	<input type="checkbox"/>	21.1#
	16 x 30	UWTRC1630	<input type="checkbox"/>	<input type="checkbox"/>	<input type="checkbox"/>	<input type="checkbox"/>	<input type="checkbox"/>	27.8#	
	16 x 36	UWTRC1636	<input type="checkbox"/>	<input type="checkbox"/>	<input type="checkbox"/>	<input type="checkbox"/>	<input type="checkbox"/>	34.4#	
UWTR									

**A**      **B**      **C**      **D**      **E**      **F**

### HOW TO ORDER

Indicate the following information on order form:

- Quantity of each item.
- Model number, including options. See "How To Build a Model Number".
- Any special service required.

Note: • The  indicates that a choice is required.  
 • The absence of the  indicates that no choice is required.  
 • Alpha-numeric characters in place of  indicate that no other alternatives are available.

### HOW TO BUILD A MODEL NUMBER

Refer to color addendum at [ki.com](http://ki.com) or KI Fabrics & Finishes binder.

- A** Select basic model.  
 \_\_\_\_\_
- B** Select notch location.  
 NN - Standard  
 LN - Left; add \$38  
 RN - Right; add \$38  
 LRN - Both; add \$76  
 \_\_\_\_\_
- C** Select edge style.  
 74P - 74P edge  
 KN - Knife edge  
 \_\_\_\_\_
- D** Select surface finish.  
 Refer to color addendum at [ki.com](http://ki.com) or KI Fabrics & Finishes binder.  
 Surface finish offerings are based on edge style selections.
- E** Select edge color.  
 Refer to color addendum at [ki.com](http://ki.com) or KI Fabrics & Finishes binder.
- F** Select bracket finish.

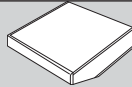
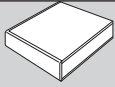

74P Edge  
(74P)

Knife Edge  
(KN)

\$ 294	\$ 334
314	362
345	400
375	438
394	461
410	479
473	542
526	611
598	683
682	801
732	851
\$ 688	\$ 793
746	868
783	915

**SPECIAL SERVICES**

**Special Carton Marking**

With specially marked information N/C

**Shipping**

Shipped k.d. freight prepaid f.o.b. Manitowoc, Wisconsin 54220 factory. Freight class #70.

Specifications and prices are subject to change without prior notice.

# Worksurfaces

## Transaction Countertops

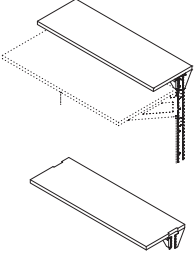
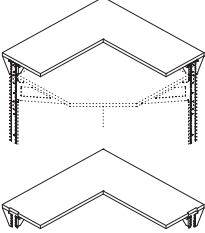
MODEL	D x W	MODEL NUMBER						Approx. Packaged Weight	
		Basic Model	Notch Location	Edge Style	Surface Finish	Edge Color	Bracket Finish		
 <p>Notch locations shown</p>	<b>Straight Countertops, 32" Height</b>								
	• Includes cantilever support brackets and locking clips to prevent dislodgement	16 x 24	UWTR321624	□□□	□□□	□□□	□□□	□□	15.3#
	• Notch is required when transaction counter is adjacent to end of run trim for change of height conditions	16 x 30	UWTR321630	□□□	□□□	□□□	□□□	□□	18.6#
	• Countertops accept task lights	16 x 36	UWTR321636	□□□	□□□	□□□	□□□	□□	21.9#
	• Transaction counters add 1-1/4" to finished panel heights	16 x 42	UWTR321642	□□□	□□□	□□□	□□□	□□	25.3#
		16 x 48	UWTR321648	□□□	□□□	□□□	□□□	□□	28.6#
		16 x 54	UWTR321654	□□□	□□□	□□□	□□□	□□	31.9#
		16 x 60	UWTR321660	□□□	□□□	□□□	□□□	□□	35.2#
		16 x 66	UWTR321666	□□□	□□□	□□□	□□□	□□	38.6#
		16 x 72	UWTR321672	□□□	□□□	□□□	□□□	□□	41.9#
		16 x 78	UWTR321678	□□□	□□□	□□□	□□□	□□	45.3#
	16 x 84	UWTR321684	□□□	□□□	□□□	□□□	□□	49.6#	
UWTR									
 <p>Notch locations shown</p>	<b>Corner Countertops, 32" Height</b>								
	• Includes cantilever support brackets and locking clips to prevent dislodgement	16 x 24	UWTRC321624	□□□	□□□	□□□	□□□	□□	20.7#
	• Notch is required when transaction counter is adjacent to end of run trim for change of height conditions	16 x 30	UWTRC321630	□□□	□□□	□□□	□□□	□□	27.4#
	• Countertops accept task lights	16 x 36	UWTRC321636	□□□	□□□	□□□	□□□	□□	34.0#
• Transaction counters add 1-1/4" to finished panel heights									
UWTR									
			<b>A</b>	<b>B</b>	<b>C</b>	<b>D</b>	<b>E</b>	<b>F</b>	

### HOW TO ORDER

Indicate the following information on order form:

- Quantity of each item.
- Model number, including options. See "How To Build a Model Number".
- Any special service required.

Note:

- The □ indicates that a choice is required.
- The absence of the □ indicates that no choice is required.
- Alpha-numeric characters in place of □ indicate that no other alternatives are available.

### HOW TO BUILD A MODEL NUMBER

- A** Select basic model.
- B** Select notch location.
  - NN - Standard
  - LN - Left; add \$38
  - RN - Right; add \$38
  - LRN - Both; add \$76
- C** Select edge style.
  - 74P - 74P edge
  - KN - Knife edge
- D** Select surface finish. Refer to color addendum at ki.com or KI Fabrics & Finishes binder. Surface finish offerings are based on edge style selections.
- E** Select edge color. Refer to color addendum at ki.com or KI Fabrics & Finishes binder.
- F** Select bracket finish.

Refer to color addendum at ki.com or KI Fabrics & Finishes binder.



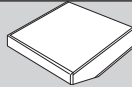
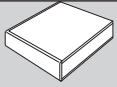

74P Edge  
(74P)

Knife Edge  
(KN)

\$ 267	\$ 307
287	335
318	373
348	412
368	435
382	453
445	516
456	548
501	584
654	775
693	812

\$ 666	\$ 773
725	847
762	894

**SPECIAL SERVICES**

**Special Carton Marking**

With specially marked information N/C

**Shipping**

Shipped k.d. freight prepaid f.o.b. Manitowoc, Wisconsin 54220 factory. Freight class #70.

Specifications and prices are subject to change without prior notice.

# Worksurfaces

## Freestanding Tables

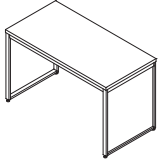
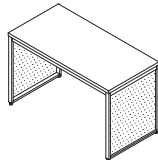
		MODEL NUMBER							Approx. Packaged Weight	
		Basic Model	Edge Style	Frame Color	Insert Type	Insert Color	Surface Finish	Edge Color		
	<b>Freestanding Tables - Open Leg</b> • Table includes base support and work-surface • Knife edge is featured on all four sides when specified • Support gusset extends 1-1/2" below work-surface on all sides • 29" high table provides 26-1/4" clearance under gusset	24 x 48"	UTBLO2448	<input type="checkbox"/> <input type="checkbox"/> <input type="checkbox"/>	<input type="checkbox"/>			<input type="checkbox"/> <input type="checkbox"/> <input type="checkbox"/>	<input type="checkbox"/> <input type="checkbox"/>	51.0#
		24 x 60"	UTBLO2460	<input type="checkbox"/> <input type="checkbox"/> <input type="checkbox"/>	<input type="checkbox"/>			<input type="checkbox"/> <input type="checkbox"/> <input type="checkbox"/>	<input type="checkbox"/> <input type="checkbox"/>	62.0#
		24 x 72"	UTBLO2472	<input type="checkbox"/> <input type="checkbox"/> <input type="checkbox"/>	<input type="checkbox"/>			<input type="checkbox"/> <input type="checkbox"/> <input type="checkbox"/>	<input type="checkbox"/> <input type="checkbox"/>	74.0#
		30 x 48"	UTBLO3048	<input type="checkbox"/> <input type="checkbox"/> <input type="checkbox"/>	<input type="checkbox"/>			<input type="checkbox"/> <input type="checkbox"/> <input type="checkbox"/>	<input type="checkbox"/> <input type="checkbox"/>	71.0#
		30 x 60"	UTBLO3060	<input type="checkbox"/> <input type="checkbox"/> <input type="checkbox"/>	<input type="checkbox"/>			<input type="checkbox"/> <input type="checkbox"/> <input type="checkbox"/>	<input type="checkbox"/> <input type="checkbox"/>	73.0#
		30 x 72"	UTBLO3072	<input type="checkbox"/> <input type="checkbox"/> <input type="checkbox"/>	<input type="checkbox"/>			<input type="checkbox"/> <input type="checkbox"/> <input type="checkbox"/>	<input type="checkbox"/> <input type="checkbox"/>	83.0#
UTBL										
	<b>Freestanding Tables - With Insert</b> • Table includes base support and work-surface • Knife edge is featured on all four sides when specified • Support gusset extends 1-1/2" below work-surface on all sides • 29" high table provides 26-1/4" clearance under gusset	24 x 48"	UTBLI2448	<input type="checkbox"/> <input type="checkbox"/> <input type="checkbox"/>	<input type="checkbox"/>	PS	<input type="checkbox"/> <input type="checkbox"/> <input type="checkbox"/>	<input type="checkbox"/> <input type="checkbox"/> <input type="checkbox"/>	<input type="checkbox"/> <input type="checkbox"/>	86.0#
		24 x 60"	UTBLI2460	<input type="checkbox"/> <input type="checkbox"/> <input type="checkbox"/>	<input type="checkbox"/>	PS	<input type="checkbox"/> <input type="checkbox"/> <input type="checkbox"/>	<input type="checkbox"/> <input type="checkbox"/> <input type="checkbox"/>	<input type="checkbox"/> <input type="checkbox"/>	97.0#
		24 x 72"	UTBLI2472	<input type="checkbox"/> <input type="checkbox"/> <input type="checkbox"/>	<input type="checkbox"/>	PS	<input type="checkbox"/> <input type="checkbox"/> <input type="checkbox"/>	<input type="checkbox"/> <input type="checkbox"/> <input type="checkbox"/>	<input type="checkbox"/> <input type="checkbox"/>	109.0#
		30 x 48"	UTBLI3048	<input type="checkbox"/> <input type="checkbox"/> <input type="checkbox"/>	<input type="checkbox"/>	PS	<input type="checkbox"/> <input type="checkbox"/> <input type="checkbox"/>	<input type="checkbox"/> <input type="checkbox"/> <input type="checkbox"/>	<input type="checkbox"/> <input type="checkbox"/>	97.0#
		30 x 60"	UTBLI3060	<input type="checkbox"/> <input type="checkbox"/> <input type="checkbox"/>	<input type="checkbox"/>	PS	<input type="checkbox"/> <input type="checkbox"/> <input type="checkbox"/>	<input type="checkbox"/> <input type="checkbox"/> <input type="checkbox"/>	<input type="checkbox"/> <input type="checkbox"/>	108.0#
		30 x 72"	UTBLI3072	<input type="checkbox"/> <input type="checkbox"/> <input type="checkbox"/>	<input type="checkbox"/>	PS	<input type="checkbox"/> <input type="checkbox"/> <input type="checkbox"/>	<input type="checkbox"/> <input type="checkbox"/> <input type="checkbox"/>	<input type="checkbox"/> <input type="checkbox"/>	118.0#
UTBL										
				A	B	C	D	E	F	G

### HOW TO ORDER

Indicate the following information on order form:

- Quantity of each item.
- Model number, including options. See "How To Build a Model Number".
- Any special service required.

Note: • The  indicates that a choice is required.

- The absence of the  indicates that no choice is required.
- Alpha-numeric characters in place of  indicate that no other alternatives are available.

### HOW TO BUILD A MODEL NUMBER

- A** Select basic model.  
 \_\_\_\_\_  
**74P** - 74P edge  
**KN** - Knife edge
- B** Select edge style.
- C** Select frame color.  
 Refer to color addendum at ki.com or KI Fabrics & Finishes binder.
- D** Select insert type.  
**PS** - Perforated Steel
- E** Select insert color.  
 Refer to color addendum at ki.com or KI Fabrics & Finishes binder.
- F** Select surface finish.  
 Refer to color addendum at ki.com or KI Fabrics & Finishes binder.  
 Surface finish offerings are based on edge style selections.

- G** Select edge color.  
 Refer to color addendum at ki.com or KI Fabrics & Finishes binder.



# Worksurfaces

Freestanding Tables

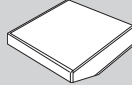
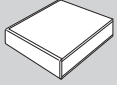

74P Edge  
(74P)

Knife Edge  
(KN)

\$ 638	\$ 678
737	845
748	898
718	763
819	903
815	1015

\$ 991	\$ 903
1048	1112
1105	1109
1049	1016
1131	1208
1190	1237

**SPECIAL SERVICES**

**Special Carton Marking**

With specially marked information N/C

**Shipping**

Shipped k.d. freight prepaid f.o.b. Manitowoc, Wisconsin 54220 factory. Freight class #70.

Specifications and prices are subject to change without prior notice.

# Worksurface Support

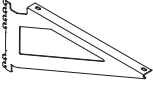
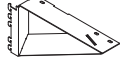
MODEL	MODEL NUMBER		Approx. Packaged Weight
	Basic Model	Trim Color	
 <p><b>Standard Cantilever Bracket</b>                      • Left orientation shown in image</p>	UCANTST.R	<input type="checkbox"/>	2.5#
	UCANTST.L	<input type="checkbox"/>	2.5#
 <p><b>Design Bracket - Worksurface Support Bracket</b>                      • For 18" deep worksurface support only; may not be used in conjunction with overheads                      • Left orientation shown in image</p>	UCANTD12.R	<input type="checkbox"/>	2.0#
	UCANTD12.L	<input type="checkbox"/>	2.0#

**A**

**B**

## HOW TO ORDER

Indicate the following information on order form:

1. Quantity of each item.
2. Model number, including options. See "How To Build a Model Number".
3. Any special service required.

- Note:
- The  indicates that a choice is required.
  - The absence of the  indicates that no choice is required.
  - Alpha-numeric characters in place of  indicate that no other alternatives are available.

## HOW TO BUILD A MODEL NUMBER

- A** Select basic model.
- B** Select trim color.  
 Refer to color addendum at [ki.com](http://ki.com) or KI Fabrics & Finishes binder.  
 Metallic finish not available.



Delivered Pricing	
\$ 27	
27	
\$ 54	
54	

**SPECIAL SERVICES**

**Special Carton Marking**

With specially marked information N/C

**Shipping**

Shipped k.d. freight prepaid f.o.b. Manitowoc, Wisconsin 54220 factory. Freight class #70.

Specifications and prices are subject to change without prior notice.

# Worksurface Support

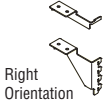
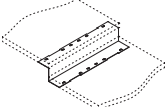
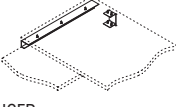
	MODEL	H	MODEL NUMBER			Approx. Packaged Weight
			Basic Model	Edge Style	Trim Color	
 Right Orientation HRDPT	<b>Worksurface Edge Support with Lock</b> • Optional support tying worksurface edge in to adjacent panel frame		UWSES.R	<input type="checkbox"/>	<input type="checkbox"/>	1.0#
			UWSES.L	<input type="checkbox"/>	<input type="checkbox"/>	1.0#
HRDPT	<b>Splice Plate</b> • For use with 24" and 30" deep worksurfaces		USPLPL			0.5#
HRDPT	<b>Splice Plate - 22" Worksurface</b> • For use with 22" deep worksurfaces		USPLPL.22			2.4#
HRDPT	<b>Add-on Peninsula Attachment Plate</b> • For use only with 74P worksurfaces		UPENPL24			3.8#
HRDPT			UPENPL30			4.6#
 UCFP	<b>Height Change Filler Plate for In-Line</b> • Use when adapting heights of in-line worksurface conditions • Specify by worksurface depth • Edge style refers to worksurface that support is being attached to • Filler plate is intended for use between 26" and 29" worksurface heights, resulting gap between surfaces is 1-7/8"	18"	UCFPI18	<input type="checkbox"/>	<input type="checkbox"/>	2.6#
		22"	UCFPI22	<input type="checkbox"/>	<input type="checkbox"/>	3.1#
		24"	UCFPI24	<input type="checkbox"/>	<input type="checkbox"/>	3.4#
		30"	UCFPI30	<input type="checkbox"/>	<input type="checkbox"/>	4.3#
 UCFP	<b>Height Change Filler Plate for Corner</b> • Use when adapting heights of corner worksurface conditions • Specify by worksurface depth • Edge style refers to worksurface that support is being attached to • Filler plate is intended for use between 26" and 29" worksurface heights, resulting gap between surfaces is 1-7/8"	18"	UCFPC18	<input type="checkbox"/>	<input type="checkbox"/>	2.7#
		22"	UCFPC22	<input type="checkbox"/>	<input type="checkbox"/>	3.3#
		24"	UCFPC24	<input type="checkbox"/>	<input type="checkbox"/>	3.5#
		30"	UCFPC30	<input type="checkbox"/>	<input type="checkbox"/>	4.3#
				<b>A</b>	<b>B</b>	<b>C</b>

## HOW TO ORDER

Indicate the following information on order form:

- Quantity of each item.
- Model number, including options. See "How To Build a Model Number".
- Any special service required.

Note: • The  indicates that a choice is required.  
 • The absence of the  indicates that no choice is required.  
 • Alpha-numeric characters in place of  indicate that no other alternatives are available.

## HOW TO BUILD A MODEL NUMBER

**A** Select basic model.

**B** Select edge style.

**74P** - 74P edge  
**KN** - Knife edge

**C** Select trim color.

Refer to color addendum at [ki.com](http://ki.com) or KI Fabrics & Finishes binder.  
 Metallic finish not available.



Delivered Pricing	
\$	29
	29
\$	7
\$	22
\$	19
	22
\$	35
	37
	37
	40
\$	35
	37
	37
	40

**SPECIAL SERVICES**

**Special Carton Marking**

With specially marked information    N/C

**Shipping**

Shipped **k.d. freight prepaid f.o.b. Manitowoc, Wisconsin 54220** factory. Freight class #70.

Specifications and prices are subject to change without prior notice.

# Worksurface Support

## Post Leg

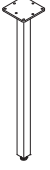
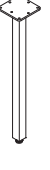
	MODEL	H	MODEL NUMBER		Approx. Packaged Weight	
			Basic Model	Frame Color		
 HRDPT	<b>Post Leg Assembly - 27-3/4" Height</b> • Supports standard 29" height worksurfaces	27-3/4"	UPL29	<input type="checkbox"/> <input type="checkbox"/>	5.5#	
 HRDPT	<b>Post Leg Assembly - 24-3/4" Height</b> • Supports 26" height worksurfaces	24-3/4"	UPL26	<input type="checkbox"/> <input type="checkbox"/>	5.0#	

**A**      **B**

### HOW TO ORDER

Indicate the following information on order form:

1. Quantity of each item.
2. Model number, including options. See "How To Build a Model Number".
3. Any special service required.

Note: • The  indicates that a choice is required.  
 • The absence of the  indicates that no choice is required.  
 • Alpha-numeric characters in place of  indicate that no other alternatives are available.

### HOW TO BUILD A MODEL NUMBER

- A** Select basic model.
- B** Select frame color.  
 Refer to color addendum at [ki.com](http://ki.com) or KI Fabrics & Finishes binder.  
 Metallic finish not available.





Delivered  
Pricing  
\$ 54

\$ 54

**SPECIAL SERVICES**

**Special Carton Marking**

With specially marked information N/C

**Shipping**

Shipped k.d. freight prepaid f.o.b. Manitowoc, Wisconsin 54220 factory. Freight class #70.

Specifications and prices are subject to change without prior notice.

# Support Leg

Non-Panel Mounted, Open

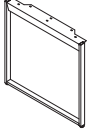
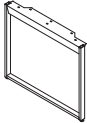
	MODEL	W x H	MODEL NUMBER			Approx. Packaged Weight
			Basic Model	Edge Style	Frame Color	
	<b>Open Leg - 27-3/4" Height</b> <ul style="list-style-type: none"> <li>Does not allow for panel attachment</li> <li>Supports standard 29" perpendicular worksurface</li> <li>Specify width by worksurface depth</li> <li>Edge style refers to worksurface that support is being attached to</li> </ul>	18 x 27-3/4"	UPNLO1829	<input type="checkbox"/> <input type="checkbox"/> <input type="checkbox"/>	<input type="checkbox"/>	12.5#
		22 x 27-3/4"	UPNLO2229	<input type="checkbox"/> <input type="checkbox"/> <input type="checkbox"/>	<input type="checkbox"/>	13.8#
		24 x 27-3/4"	UPNLO2429	<input type="checkbox"/> <input type="checkbox"/> <input type="checkbox"/>	<input type="checkbox"/>	14.4#
		30 x 27-3/4"	UPNLO3029	<input type="checkbox"/> <input type="checkbox"/> <input type="checkbox"/>	<input type="checkbox"/>	16.2#
USL						
	<b>Open Leg - 24-3/4" Height</b> <ul style="list-style-type: none"> <li>Does not allow for panel attachment</li> <li>Supports standard 26" perpendicular worksurface</li> <li>Specify width by worksurface depth</li> <li>Edge style refers to worksurface that support is being attached to</li> </ul>	18 x 24-3/4"	UPNLO1826	<input type="checkbox"/> <input type="checkbox"/> <input type="checkbox"/>	<input type="checkbox"/>	12.0#
		22 x 24-3/4"	UPNLO2226	<input type="checkbox"/> <input type="checkbox"/> <input type="checkbox"/>	<input type="checkbox"/>	13.2#
		24 x 24-3/4"	UPNLO2426	<input type="checkbox"/> <input type="checkbox"/> <input type="checkbox"/>	<input type="checkbox"/>	13.9#
		30 x 24-3/4"	UPNLO3026	<input type="checkbox"/> <input type="checkbox"/> <input type="checkbox"/>	<input type="checkbox"/>	15.7#
USL						

**A**

**B**

**C**

## HOW TO ORDER

Indicate the following information on order form:

- Quantity of each item.
- Model number, including options. See "How To Build a Model Number".
- Any special service required.

Note:

- The  indicates that a choice is required.
- The absence of the  indicates that no choice is required.
- Alpha-numeric characters in place of  indicate that no other alternatives are available.

## HOW TO BUILD A MODEL NUMBER

**A** Select basic model.

**B** Select edge style.

**74P** - 74P edge  
**KN** - Knife edge

**C** Select frame color.

Refer to color addendum at [ki.com](http://ki.com) or KI Fabrics & Finishes binder. Metallic finish not available.



# Support Leg

Non-Panel Mounted, Open

Delivered Pricing

\$ 174  
177  
182  
200

\$ 172  
175  
178  
197

**SPECIAL SERVICES**

**Special Carton Marking**

With specially marked information N/C

**Shipping**

Shipped k.d. freight prepaid f.o.b. Manitowoc, Wisconsin 54220 factory. Freight class #70.

Specifications and prices are subject to change without prior notice.

# Support Leg

Non-Panel Mounted, Insert

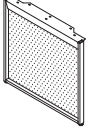
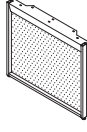
	MODEL	W x H	MODEL NUMBER					Approx. Packaged Weight
			Basic Model	Edge Style	Frame Color	Insert Type	Insert Color	
 <p>USL</p>	<b>Insert Leg - 27-3/4" Height</b> <ul style="list-style-type: none"> <li>Does not allow for panel attachment</li> <li>Supports standard 29" perpendicular worksurface</li> <li>Features perforated steel insert</li> <li>Specify width by worksurface depth</li> <li>Steel insert paint color is specified separately from frame color</li> <li>Edge style refers to worksurface that support is being attached to</li> </ul>	18 x 27-3/4"	UPNLI1829	<input type="checkbox"/> <input type="checkbox"/>	<input type="checkbox"/>	PS	<input type="checkbox"/> <input type="checkbox"/>	16.1#
		22 x 27-3/4"	UPNLI2229	<input type="checkbox"/> <input type="checkbox"/>	<input type="checkbox"/>	PS	<input type="checkbox"/> <input type="checkbox"/>	18.3#
		24 x 27-3/4"	UPNLI2429	<input type="checkbox"/> <input type="checkbox"/>	<input type="checkbox"/>	PS	<input type="checkbox"/> <input type="checkbox"/>	19.4#
		30 x 27-3/4"	UPNLI3029	<input type="checkbox"/> <input type="checkbox"/>	<input type="checkbox"/>	PS	<input type="checkbox"/> <input type="checkbox"/>	22.4#
 <p>USL</p>	<b>Insert Leg - 24-3/4" Height</b> <ul style="list-style-type: none"> <li>Does not allow for panel attachment</li> <li>Supports 26" perpendicular worksurface</li> <li>Features perforated steel insert</li> <li>Specify width by worksurface depth</li> <li>Steel insert paint color is specified separately from frame color</li> <li>Edge style refers to worksurface that support is being attached to</li> </ul>	18 x 24-3/4"	UPNLI1826	<input type="checkbox"/> <input type="checkbox"/>	<input type="checkbox"/>	PS	<input type="checkbox"/> <input type="checkbox"/>	15.3#
		22 x 24-3/4"	UPNLI2226	<input type="checkbox"/> <input type="checkbox"/>	<input type="checkbox"/>	PS	<input type="checkbox"/> <input type="checkbox"/>	17.4#
		24 x 24-3/4"	UPNLI2426	<input type="checkbox"/> <input type="checkbox"/>	<input type="checkbox"/>	PS	<input type="checkbox"/> <input type="checkbox"/>	18.4#
		30 x 24-3/4"	UPNLI3026	<input type="checkbox"/> <input type="checkbox"/>	<input type="checkbox"/>	PS	<input type="checkbox"/> <input type="checkbox"/>	21.3#

**A**   **B**   **C**   **D**   **E**

## HOW TO ORDER

Indicate the following information on order form:

- Quantity of each item.
- Model number, including options. See "How To Build a Model Number".
- Any special service required.

Note:

- The  indicates that a choice is required.
- The absence of the  indicates that no choice is required.
- Alpha-numeric characters in place of  indicate that no other alternatives are available.

## HOW TO BUILD A MODEL NUMBER

- A** Select basic model.
- B** Select edge style.
 

<b>74P</b>	- 74P edge
<b>KN</b>	- Knife edge
- C** Select frame color. Refer to color addendum at ki.com or KI Fabrics & Finishes binder. Metallic finish not available.
- D** Select insert type.
 

<b>PS</b>	- Perforated Steel
-----------	--------------------
- E** Select insert color. Refer to color addendum at ki.com or KI Fabrics & Finishes binder.



# Support Leg

Non-Panel Mounted, Insert

Delivered Pricing

\$ 271  
283  
297  
328

\$ 268  
281  
293  
324

**SPECIAL SERVICES**

**Special Carton Marking**

With specially marked information N/C

**Shipping**

Shipped **k.d. freight prepaid f.o.b. Manitowoc, Wisconsin 54220** factory. Freight class #70.

Specifications and prices are subject to change without prior notice.

# Support Leg

Panel Mounted, Open

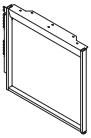
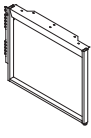
	MODEL	W x H	MODEL NUMBER				Approx. Packaged Weight
			Basic Model	Left or Right Side	Edge Style	Frame Color	
 USL	<b>Open Leg - 27-3/4" Height</b> <ul style="list-style-type: none"> <li>Features bracketry to attach to panel frame</li> <li>Left orientation shown in image</li> <li>Specify width by worksurface depth</li> <li>Edge style refers to worksurface that support is being attached to</li> </ul>	18 x 27-3/4"	UPSLO1829	<input type="checkbox"/>	<input type="checkbox"/> <input type="checkbox"/> <input type="checkbox"/>	<input type="checkbox"/>	13.1#
		22 x 27-3/4"	UPSLO2229	<input type="checkbox"/>	<input type="checkbox"/> <input type="checkbox"/> <input type="checkbox"/>	<input type="checkbox"/>	14.4#
		24 x 27-3/4"	UPSLO2429	<input type="checkbox"/>	<input type="checkbox"/> <input type="checkbox"/> <input type="checkbox"/>	<input type="checkbox"/>	15.0#
		30 x 27-3/4"	UPSLO3029	<input type="checkbox"/>	<input type="checkbox"/> <input type="checkbox"/> <input type="checkbox"/>	<input type="checkbox"/>	16.9#
		48 x 27-3/4"	UPSLO4829	<input type="checkbox"/>	<input type="checkbox"/> <input type="checkbox"/> <input type="checkbox"/>	<input type="checkbox"/>	25.2#
		54 x 27-3/4"	UPSLO5429	<input type="checkbox"/>	<input type="checkbox"/> <input type="checkbox"/> <input type="checkbox"/>	<input type="checkbox"/>	27.1#
		60 x 27-3/4"	UPSLO6029	<input type="checkbox"/>	<input type="checkbox"/> <input type="checkbox"/> <input type="checkbox"/>	<input type="checkbox"/>	29.0#
		72 x 27-3/4"	UPSLO7229	<input type="checkbox"/>	<input type="checkbox"/> <input type="checkbox"/> <input type="checkbox"/>	<input type="checkbox"/>	32.9#
 USL	<b>Open Leg - 24-3/4" Height</b> <ul style="list-style-type: none"> <li>Features bracketry to attach to panel frame</li> <li>Left orientation shown in image</li> <li>Specify width by worksurface depth</li> <li>Edge style refers to worksurface that support is being attached to</li> </ul>	18 x 24-3/4"	UPSLO1826	<input type="checkbox"/>	<input type="checkbox"/> <input type="checkbox"/> <input type="checkbox"/>	<input type="checkbox"/>	12.5#
		22 x 24-3/4"	UPSLO2226	<input type="checkbox"/>	<input type="checkbox"/> <input type="checkbox"/> <input type="checkbox"/>	<input type="checkbox"/>	13.8#
		24 x 24-3/4"	UPSLO2426	<input type="checkbox"/>	<input type="checkbox"/> <input type="checkbox"/> <input type="checkbox"/>	<input type="checkbox"/>	14.4#
		30 x 24-3/4"	UPSLO3026	<input type="checkbox"/>	<input type="checkbox"/> <input type="checkbox"/> <input type="checkbox"/>	<input type="checkbox"/>	16.3#
		48 x 24-3/4"	UPSLO4826	<input type="checkbox"/>	<input type="checkbox"/> <input type="checkbox"/> <input type="checkbox"/>	<input type="checkbox"/>	24.6#
		54 x 24-3/4"	UPSLO5426	<input type="checkbox"/>	<input type="checkbox"/> <input type="checkbox"/> <input type="checkbox"/>	<input type="checkbox"/>	25.2#
		60 x 24-3/4"	UPSLO6026	<input type="checkbox"/>	<input type="checkbox"/> <input type="checkbox"/> <input type="checkbox"/>	<input type="checkbox"/>	28.4#
		72 x 24-3/4"	UPSLO7226	<input type="checkbox"/>	<input type="checkbox"/> <input type="checkbox"/> <input type="checkbox"/>	<input type="checkbox"/>	32.3#

A

B

C

D

## HOW TO ORDER

Indicate the following information on order form:

- Quantity of each item.
- Model number, including options. See "How To Build a Model Number".
- Any special service required.

Note: • The  indicates that a choice is required.

- The absence of the  indicates that no choice is required.
- Alpha-numeric characters in place of  indicate that no other alternatives are available.

## HOW TO BUILD A MODEL NUMBER

**A** Select basic model.

**B** Select orientation.

L - Left  
R - Right

**C** Select edge style.

74P - 74P edge  
KN - Knife edge

**D** Select frame color.

Refer to color addendum at ki.com or KI Fabrics & Finishes binder.  
Metallic finish not available.



# Support Leg

Panel Mounted, Open

Delivered Pricing

\$ 177

182

186

203

302

303

310

337

\$ 175

178

184

201

300

301

308

335

**SPECIAL SERVICES**

**Special Carton Marking**

With specially marked information N/C

**Shipping**

Shipped k.d. freight prepaid f.o.b. Manitowoc, Wisconsin 54220 factory. Freight class #70.

Specifications and prices are subject to change without prior notice.

# Support Leg

Panel Mounted, Insert

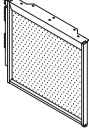
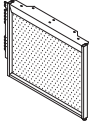
	MODEL	W x H	MODEL NUMBER						Approx. Packaged Weight
			Basic Model	Left or Right Side	Edge Style	Frame Color	Insert Type	Insert Color	
 USL	<b>Insert Leg - 27-3/4" Height</b> <ul style="list-style-type: none"> <li>Features bracketry to attach to panel frame</li> <li>Specify width by worksurface depth</li> <li>Left orientation shown in image</li> <li>Edge style refers to worksurface that support is being attached to</li> </ul>	18 x 27-3/4"	UPSLI1829	<input type="checkbox"/>	<input type="checkbox"/>	<input type="checkbox"/>	<input type="checkbox"/>	<input type="checkbox"/>	16.8#
		22 x 27-3/4"	UPSLI2229	<input type="checkbox"/>	<input type="checkbox"/>	<input type="checkbox"/>	<input type="checkbox"/>	<input type="checkbox"/>	18.9#
		24 x 27-3/4"	UPSLI2429	<input type="checkbox"/>	<input type="checkbox"/>	<input type="checkbox"/>	<input type="checkbox"/>	<input type="checkbox"/>	20.0#
		30 x 27-3/4"	UPSLI3029	<input type="checkbox"/>	<input type="checkbox"/>	<input type="checkbox"/>	<input type="checkbox"/>	<input type="checkbox"/>	23.0#
		48 x 27-3/4"	UPSLI4829	<input type="checkbox"/>	<input type="checkbox"/>	<input type="checkbox"/>	<input type="checkbox"/>	<input type="checkbox"/>	35.3#
		54 x 27-3/4"	UPSLI5429	<input type="checkbox"/>	<input type="checkbox"/>	<input type="checkbox"/>	<input type="checkbox"/>	<input type="checkbox"/>	38.6#
		60 x 27-3/4"	UPSLI6029	<input type="checkbox"/>	<input type="checkbox"/>	<input type="checkbox"/>	<input type="checkbox"/>	<input type="checkbox"/>	41.8#
		72 x 27-3/4"	UPSLI7229	<input type="checkbox"/>	<input type="checkbox"/>	<input type="checkbox"/>	<input type="checkbox"/>	<input type="checkbox"/>	48.3#
 USL	<b>Insert Leg - 24-3/4" Height</b> <ul style="list-style-type: none"> <li>Features bracketry to attach to panel frame</li> <li>Specify width by worksurface depth</li> <li>Left orientation shown in image</li> <li>Edge style refers to worksurface that support is being attached to</li> </ul>	18 x 24-3/4"	UPSLI1826	<input type="checkbox"/>	<input type="checkbox"/>	<input type="checkbox"/>	<input type="checkbox"/>	<input type="checkbox"/>	15.8#
		22 x 24-3/4"	UPSLI2226	<input type="checkbox"/>	<input type="checkbox"/>	<input type="checkbox"/>	<input type="checkbox"/>	<input type="checkbox"/>	17.9#
		24 x 24-3/4"	UPSLI2426	<input type="checkbox"/>	<input type="checkbox"/>	<input type="checkbox"/>	<input type="checkbox"/>	<input type="checkbox"/>	19.0#
		30 x 24-3/4"	UPSLI3026	<input type="checkbox"/>	<input type="checkbox"/>	<input type="checkbox"/>	<input type="checkbox"/>	<input type="checkbox"/>	21.9#
		48 x 24-3/4"	UPSLI4826	<input type="checkbox"/>	<input type="checkbox"/>	<input type="checkbox"/>	<input type="checkbox"/>	<input type="checkbox"/>	33.8#
		54 x 24-3/4"	UPSLI5426	<input type="checkbox"/>	<input type="checkbox"/>	<input type="checkbox"/>	<input type="checkbox"/>	<input type="checkbox"/>	35.6#
		60 x 24-3/4"	UPSLI6026	<input type="checkbox"/>	<input type="checkbox"/>	<input type="checkbox"/>	<input type="checkbox"/>	<input type="checkbox"/>	40.0#
		72 x 24-3/4"	UPSLI7226	<input type="checkbox"/>	<input type="checkbox"/>	<input type="checkbox"/>	<input type="checkbox"/>	<input type="checkbox"/>	46.2#

**A**      **B**      **C**      **D**      **E**      **F**

## HOW TO ORDER

Indicate the following information on order form:

- Quantity of each item.
- Model number, including options. See "How To Build a Model Number".
- Any special service required.

Note: • The  indicates that a choice is required.

- The absence of the  indicates that no choice is required.
- Alpha-numeric characters in place of  indicate that no other alternatives are available.

## HOW TO BUILD A MODEL NUMBER

- A** Select basic model.
- B** Select orientation.
- |   |         |
|---|---------|
| L | - Left  |
| R | - Right |
- C** Select edge style.
- |     |              |
|-----|--------------|
| 74P | - 74P edge   |
| KN  | - Knife edge |
- D** Select frame color.
- Refer to color addendum at ki.com or KI Fabrics & Finishes binder.  
Metallic finish not available.
- E** Select insert type.
- |    |                    |
|----|--------------------|
| PS | - Perforated Steel |
|----|--------------------|
- F** Select insert color.
- Refer to color addendum at ki.com or KI Fabrics & Finishes binder.





# Support Leg

Panel Mounted, Insert

Delivered  
Pricing

\$ 274
287
300
331
562
573
590
644
\$ 271
284
297
328
559
569
586
641

## SPECIAL SERVICES

### Special Carton Marking

With specially marked information N/C

### Shipping

Shipped k.d. freight prepaid f.o.b. Manitowoc, Wisconsin 54220 factory. Freight class #70.

Specifications and prices are subject to change without prior notice.

# Support Leg

Panel Mounted, Center

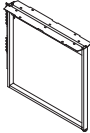
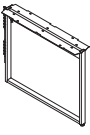
MODEL	W x H	MODEL NUMBER				Approx. Packaged Weight
		Basic Model	Left or Right Side	Edge Style	Frame Color	
 <p>USL</p> <p><b>Center Leg (Open) - 27-3/4" Height</b></p> <ul style="list-style-type: none"> <li>• Handedness of unit indicates placement of the visible portion of the locking plate</li> <li>• Leg is non-handed. Leg is centered between joining worksurfaces. Right and Left selection indicate location of the locking bracket for preferred installation access. Teeth engage one vertical row of bracket slots and cover the adjacent row</li> <li>• Attaches to panel frame to join two worksurfaces</li> <li>• Specify width by worksurface depth</li> <li>• Leg is non-handed, leg is centered between joining worksurfaces and connects to left hand panel slotting and also covers adjacent right hand slotting</li> <li>• Edge style refers to worksurface that support is being attached to</li> </ul>	18 x 27-3/4"	UPSLC1829	<input type="checkbox"/>	<input type="checkbox"/> <input type="checkbox"/> <input type="checkbox"/>	<input type="checkbox"/>	16.5#
	22 x 27-3/4"	UPSLC2229	<input type="checkbox"/>	<input type="checkbox"/> <input type="checkbox"/> <input type="checkbox"/>	<input type="checkbox"/>	18.5#
	24 x 27-3/4"	UPSLC2429	<input type="checkbox"/>	<input type="checkbox"/> <input type="checkbox"/> <input type="checkbox"/>	<input type="checkbox"/>	19.4#
	30 x 27-3/4"	UPSLC3029	<input type="checkbox"/>	<input type="checkbox"/> <input type="checkbox"/> <input type="checkbox"/>	<input type="checkbox"/>	22.2#
 <p>USL</p> <p><b>Center Leg (Open) - 24-3/4" Height</b></p> <ul style="list-style-type: none"> <li>• Handedness of unit indicates placement of the visible portion of the locking plate</li> <li>• Leg is non-handed. Leg is centered between joining worksurfaces. Right and Left selection indicate location of the locking bracket for preferred installation access. Teeth engage one vertical row of bracket slots and cover the adjacent row</li> <li>• Attaches to panel frame to join two worksurfaces</li> <li>• Specify width by worksurface depth</li> <li>• Edge style refers to worksurface that support is being attached to</li> </ul>	18 x 24-3/4"	UPSLC1826	<input type="checkbox"/>	<input type="checkbox"/> <input type="checkbox"/> <input type="checkbox"/>	<input type="checkbox"/>	15.9#
	22 x 24-3/4"	UPSLC2226	<input type="checkbox"/>	<input type="checkbox"/> <input type="checkbox"/> <input type="checkbox"/>	<input type="checkbox"/>	17.9#
	24 x 24-3/4"	UPSLC2426	<input type="checkbox"/>	<input type="checkbox"/> <input type="checkbox"/> <input type="checkbox"/>	<input type="checkbox"/>	18.8#
	30 x 24-3/4"	UPSLC3026	<input type="checkbox"/>	<input type="checkbox"/> <input type="checkbox"/> <input type="checkbox"/>	<input type="checkbox"/>	21.6#

**A**      **B**      **C**      **D**

## HOW TO ORDER

Indicate the following information on order form:

1. Quantity of each item.
2. Model number, including options. See "How To Build a Model Number".
3. Any special service required.

Note: • The  indicates that a choice is required.

- The absence of the  indicates that no choice is required.
- Alpha-numeric characters in place of  indicate that no other alternatives are available.

## HOW TO BUILD A MODEL NUMBER

- A** Select basic model.
- B** Select orientation.
 

L	- Left
R	- Right
- C** Select edge style.
 

74P	- 74P edge
KN	- Knife edge
- D** Select frame color. Refer to color addendum at ki.com or KI Fabrics & Finishes binder. Metallic finish not available.



# Support Leg

Panel Mounted, Center

Delivered Pricing

\$ 207  
212  
217  
233

\$ 204  
209  
213  
231

**SPECIAL SERVICES**

**Special Carton Marking**

With specially marked information N/C

**Shipping**

Shipped k.d. freight prepaid f.o.b. Manitowoc, Wisconsin 54220 factory. Freight class #70.

Specifications and prices are subject to change without prior notice.

# Universal Storage and Accessories

## Overhead Storage

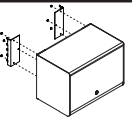
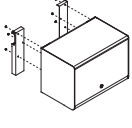
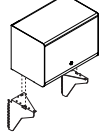
	MODEL	W x H x D	MODEL NUMBER				Approx. Packaged Weight
			Basic Model	Assembly	Paint Color	Key Option	
 <p>PRDS</p>	<b>Steel Door Overhead Cabinet-On-Module</b> <ul style="list-style-type: none"> <li>On-Module overheads (PM) mount into slots in vertical posts. Overheads must be the same width as panel mounted to</li> <li>Allows for vertical adjustment in 1" increments</li> </ul>	24 x 16-1/2 x 14-1/2"	PRDS24/UN/PM	<input type="checkbox"/>	<input type="checkbox"/>	<input type="checkbox"/>	32.0#
		30 x 16-1/2 x 14-1/2"	PRDS30/UN/PM	<input type="checkbox"/>	<input type="checkbox"/>	<input type="checkbox"/>	36.0#
		36 x 16-1/2 x 14-1/2"	PRDS36/UN/PM	<input type="checkbox"/>	<input type="checkbox"/>	<input type="checkbox"/>	40.0#
		42 x 16-1/2 x 14-1/2"	PRDS42/UN/PM	<input type="checkbox"/>	<input type="checkbox"/>	<input type="checkbox"/>	44.0#
		48 x 16-1/2 x 14-1/2"	PRDS48/UN/PM	<input type="checkbox"/>	<input type="checkbox"/>	<input type="checkbox"/>	49.0#
		60 x 16-1/2 x 14-1/2"	PRDS60/UN/PM	<input type="checkbox"/>	<input type="checkbox"/>	<input type="checkbox"/>	57.0#
 <p>PRDS</p>	<b>Steel Door Overhead Cabinet-Load Bar Mount</b> <ul style="list-style-type: none"> <li>Load Bar mount overheads (LB) hang from an externally mounted load bar</li> <li>Load Bar purchased separately</li> </ul>	24 x 16-1/2 x 14-1/2"	PRDS24/UN/LB	<input type="checkbox"/>	<input type="checkbox"/>	<input type="checkbox"/>	32.0#
		30 x 16-1/2 x 14-1/2"	PRDS30/UN/LB	<input type="checkbox"/>	<input type="checkbox"/>	<input type="checkbox"/>	36.0#
		36 x 16-1/2 x 14-1/2"	PRDS36/UN/LB	<input type="checkbox"/>	<input type="checkbox"/>	<input type="checkbox"/>	40.0#
		42 x 16-1/2 x 14-1/2"	PRDS42/UN/LB	<input type="checkbox"/>	<input type="checkbox"/>	<input type="checkbox"/>	44.0#
		48 x 16-1/2 x 14-1/2"	PRDS48/UN/LB	<input type="checkbox"/>	<input type="checkbox"/>	<input type="checkbox"/>	49.0#
		60 x 16-1/2 x 14-1/2"	PRDS60/UN/LB	<input type="checkbox"/>	<input type="checkbox"/>	<input type="checkbox"/>	57.0#
 <p>PRDS</p>	<b>Steel Door Overhead Cabinet-Upmount</b> <ul style="list-style-type: none"> <li>On a 48" panel, clearance between the Universal overhead and 29" high work-surface is 18.85"</li> <li>On a 56" panel, clearance between the Universal overhead and 29" high work-surface is 26.85"</li> </ul>	24 x 16-1/2 x 14-1/2"	PRDS24/UN/UM	<input type="checkbox"/>	<input type="checkbox"/>	<input type="checkbox"/>	32.0#
		30 x 16-1/2 x 14-1/2"	PRDS30/UN/UM	<input type="checkbox"/>	<input type="checkbox"/>	<input type="checkbox"/>	36.0#
		36 x 16-1/2 x 14-1/2"	PRDS36/UN/UM	<input type="checkbox"/>	<input type="checkbox"/>	<input type="checkbox"/>	40.0#
		42 x 16-1/2 x 14-1/2"	PRDS42/UN/UM	<input type="checkbox"/>	<input type="checkbox"/>	<input type="checkbox"/>	44.0#
		48 x 16-1/2 x 14-1/2"	PRDS48/UN/UM	<input type="checkbox"/>	<input type="checkbox"/>	<input type="checkbox"/>	49.0#
		60 x 16-1/2 x 14-1/2"	PRDS60/UN/UM	<input type="checkbox"/>	<input type="checkbox"/>	<input type="checkbox"/>	57.0#

A

B

C

D

### HOW TO ORDER

Indicate the following information on order form:

- Quantity of each item.
- Model number, including options. See "How To Build a Model Number".
- Any special service required.

Note:

- The  indicates that a choice is required.
- The absence of the  indicates that no choice is required.
- Alpha-numeric characters in place of  indicate that no other alternatives are available.

### HOW TO BUILD A MODEL NUMBER

- A** Select basic model.
- B** Select assembly.
- |   |                              |
|---|------------------------------|
| F | - Fully Assembled; add \$131 |
| U | - Unassembled                |
- C** Select paint color.  
Refer to color addendum at ki.com or KI Fabrics & Finishes binder.  
Metallic paint requires upcharge.
- D** Select key alike.
- |     |                |
|-----|----------------|
| KA  | - Key alike    |
| KS  | - Key standard |
| NLC | - No lock core |

### INFORMATION

Steel bottom, top shelf and end panels with powder-coated finish  
Accepts shelf divider  
Door stores recessed with handle exposed  
Double bit lock is included  
Shelf depth is 13-1/4"



# Universal Storage and Accessories

Overhead Storage

Delivered  
Pricing

\$ 437
481
488
521
551
673
\$ 518
557
565
599
631
753
\$ 557
600
607
640
671
796

## SPECIAL SERVICES

### Special Carton Marking

With specially marked information N/C

### Shipping

Delivered. Shipped **k.d. freight prepaid**  
**f.o.b. Manitowoc, Wisconsin 54220**  
factory. Freight class #70.

Specifications and prices are subject to  
change without prior notice.

# Universal Storage and Accessories

## Overhead Storage

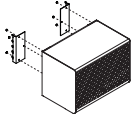
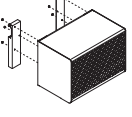
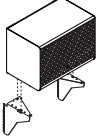
MODEL	W x H x D	MODEL NUMBER					Approx. Packaged Weight
		Basic Model	Assembly	Paint Color	Fabric Color	Key Option	
 <p><b>Fabric Door Overhead Cabinet-On-Module</b></p> <ul style="list-style-type: none"> <li>On-Module overheads (PM) mount into slots in vertical posts.</li> <li>Overheads must be same width as panel mounted to. Allows for vertical adjustment in 1" increments</li> </ul>	24 x 16-1/2 x 14-1/2"	PRDF24/UN/PM	<input type="checkbox"/>	<input type="checkbox"/>	<input type="checkbox"/>	<input type="checkbox"/>	32.0#
	30 x 16-1/2 x 14-1/2"	PRDF30/UN/PM	<input type="checkbox"/>	<input type="checkbox"/>	<input type="checkbox"/>	<input type="checkbox"/>	36.0#
	36 x 16-1/2 x 14-1/2"	PRDF36/UN/PM	<input type="checkbox"/>	<input type="checkbox"/>	<input type="checkbox"/>	<input type="checkbox"/>	40.0#
	42 x 16-1/2 x 14-1/2"	PRDF42/UN/PM	<input type="checkbox"/>	<input type="checkbox"/>	<input type="checkbox"/>	<input type="checkbox"/>	44.0#
	48 x 16-1/2 x 14-1/2"	PRDF48/UN/PM	<input type="checkbox"/>	<input type="checkbox"/>	<input type="checkbox"/>	<input type="checkbox"/>	49.0#
	60 x 16-1/2 x 14-1/2"	PRDF60/UN/PM	<input type="checkbox"/>	<input type="checkbox"/>	<input type="checkbox"/>	<input type="checkbox"/>	57.0#
 <p><b>Fabric Door Overhead Cabinet-Load Bar Mount</b></p> <ul style="list-style-type: none"> <li>Load Bar mount overheads (LB) hang from an externally mounted load bar</li> <li>Load Bar purchased separately</li> </ul>	24 x 16-1/2 x 14-1/2"	PRDF24/UN/LB	<input type="checkbox"/>	<input type="checkbox"/>	<input type="checkbox"/>	<input type="checkbox"/>	32.0#
	30 x 16-1/2 x 14-1/2"	PRDF30/UN/LB	<input type="checkbox"/>	<input type="checkbox"/>	<input type="checkbox"/>	<input type="checkbox"/>	36.0#
	36 x 16-1/2 x 14-1/2"	PRDF36/UN/LB	<input type="checkbox"/>	<input type="checkbox"/>	<input type="checkbox"/>	<input type="checkbox"/>	40.0#
	42 x 16-1/2 x 14-1/2"	PRDF42/UN/LB	<input type="checkbox"/>	<input type="checkbox"/>	<input type="checkbox"/>	<input type="checkbox"/>	44.0#
	48 x 16-1/2 x 14-1/2"	PRDF48/UN/LB	<input type="checkbox"/>	<input type="checkbox"/>	<input type="checkbox"/>	<input type="checkbox"/>	49.0#
	60 x 16-1/2 x 14-1/2"	PRDF60/UN/LB	<input type="checkbox"/>	<input type="checkbox"/>	<input type="checkbox"/>	<input type="checkbox"/>	57.0#
 <p><b>Fabric Door Overhead Cabinet-Upmount</b></p> <ul style="list-style-type: none"> <li>On a 48" panel, clearance between the Universal overhead and 29" high work-surface is 18.85"</li> <li>On a 56" panel, clearance between the Universal overhead and 29" high work-surface is 26.85"</li> </ul>	24 x 16-1/2 x 14-1/2"	PRDF24/UN/UM	<input type="checkbox"/>	<input type="checkbox"/>	<input type="checkbox"/>	<input type="checkbox"/>	32.0#
	30 x 16-1/2 x 14-1/2"	PRDF30/UN/UM	<input type="checkbox"/>	<input type="checkbox"/>	<input type="checkbox"/>	<input type="checkbox"/>	36.0#
	36 x 16-1/2 x 14-1/2"	PRDF36/UN/UM	<input type="checkbox"/>	<input type="checkbox"/>	<input type="checkbox"/>	<input type="checkbox"/>	40.0#
	42 x 16-1/2 x 14-1/2"	PRDF42/UN/UM	<input type="checkbox"/>	<input type="checkbox"/>	<input type="checkbox"/>	<input type="checkbox"/>	44.0#
	48 x 16-1/2 x 14-1/2"	PRDF48/UN/UM	<input type="checkbox"/>	<input type="checkbox"/>	<input type="checkbox"/>	<input type="checkbox"/>	49.0#
	60 x 16-1/2 x 14-1/2"	PRDF60/UN/UM	<input type="checkbox"/>	<input type="checkbox"/>	<input type="checkbox"/>	<input type="checkbox"/>	57.0#

**A**      **B**      **C**      **D**      **E**

### HOW TO ORDER

Indicate the following information on order form:

- Quantity of each item.
- Model number, including options. See "How To Build a Model Number".
- Any special service required.

Note:

- The  indicates that a choice is required.
- The absence of the  indicates that no choice is required.
- Alpha-numeric characters in place of  indicate that no other alternatives are available.

### HOW TO BUILD A MODEL NUMBER

- A** Select basic model.
- B** Select assembly.
 

<b>F</b>	- Fully Assembled; add \$131
<b>U</b>	- Unassembled
- C** Select paint color. Refer to color addendum at ki.com or KI Fabrics & Finishes binder. Metallic paint requires upcharge.
- D** Select fabric color. Refer to color addendum at ki.com or in KI Fabrics & Finishes binder.
- E** Select key alike.
 

<b>KA</b>	- Key alike
<b>NL</b>	- No Lock
<b>NLC</b>	- No lock core

### INFORMATION

Steel bottom, top shelf and end panels with powder-coated finish  
 Accepts shelf divider  
 Door stores recessed with handle exposed  
 Double bit lock is included  
 Shelf depth is 13-1/4"



# Universal Storage and Accessories

Overhead Storage

Delivered Pricing Fabric Grade 1 & C.O.M.	Delivered Pricing Fabric Grade 2	Delivered Pricing Fabric Grade 3 & Pallas Vertical Fabric Grade PV	Delivered Pricing Pallas Vertical Fabric Grade PV1	Delivered Pricing Pallas Vertical Fabric Grade PV2
\$ 461	\$ 469	\$ 475	\$ 475	\$ 480
502	512	519	519	524
516	523	529	529	537
546	555	563	563	571
581	592	599	599	605
709	722	728	728	739
\$ 540	\$ 546	\$ 552	\$ 552	\$ 557
581	589	595	595	603
592	600	608	608	613
626	633	641	641	647
660	670	679	679	684
787	802	809	809	815
\$ 581	\$ 588	\$ 594	\$ 594	\$ 599
624	631	637	637	644
634	642	651	651	657
666	674	684	684	691
701	712	718	718	723
828	843	849	849	857

## SPECIAL SERVICES

### Special Carton Marking

With specially marked information N/C

### Shipping

Delivered. Shipped **k.d. freight prepaid f.o.b. Manitowoc, Wisconsin 54220** factory. Freight class #70.

Specifications and prices are subject to change without prior notice.

# Universal Storage and Accessories

## Overhead Storage

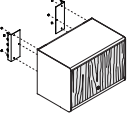
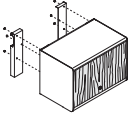
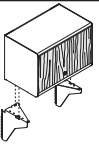
	MODEL	W x H x D	MODEL NUMBER					Approx. Packaged Weight
			Basic Model	Assembly	Paint Color	Laminate Color	Key Option	
 PRDL	<b>Laminate Door Overhead Cabinet-On-Module (PM)</b> • On-Module overheads mount into slots in vertical posts. Overheads must be same width as panel mounted to. Allows for vertical adjustment in 1" increments	24 x 16-1/2 x 14-1/2"	PRDL24/UN/PM	<input type="checkbox"/>	<input type="checkbox"/>	<input type="checkbox"/>	<input type="checkbox"/>	32.0#
		30 x 16-1/2 x 14-1/2"	PRDL30/UN/PM	<input type="checkbox"/>	<input type="checkbox"/>	<input type="checkbox"/>	<input type="checkbox"/>	36.0#
		36 x 16-1/2 x 14-1/2"	PRDL36/UN/PM	<input type="checkbox"/>	<input type="checkbox"/>	<input type="checkbox"/>	<input type="checkbox"/>	40.0#
		42 x 16-1/2 x 14-1/2"	PRDL42/UN/PM	<input type="checkbox"/>	<input type="checkbox"/>	<input type="checkbox"/>	<input type="checkbox"/>	44.0#
		48 x 16-1/2 x 14-1/2"	PRDL48/UN/PM	<input type="checkbox"/>	<input type="checkbox"/>	<input type="checkbox"/>	<input type="checkbox"/>	48.0#
		60 x 16-1/2 x 14-1/2"	PRDL60/UN/PM	<input type="checkbox"/>	<input type="checkbox"/>	<input type="checkbox"/>	<input type="checkbox"/>	57.0#
 PRDL	<b>Laminate Door Overhead Cabinet-Load Bar Mount (LB)</b> • Load Bar mount overheads (LB) hang from an externally mounted load bar • Load Bar purchased separately	24 x 16-1/2 x 14-1/2"	PRDL24/UN/LB	<input type="checkbox"/>	<input type="checkbox"/>	<input type="checkbox"/>	<input type="checkbox"/>	32.0#
		30 x 16-1/2 x 14-1/2"	PRDL30/UN/LB	<input type="checkbox"/>	<input type="checkbox"/>	<input type="checkbox"/>	<input type="checkbox"/>	36.0#
		36 x 16-1/2 x 14-1/2"	PRDL36/UN/LB	<input type="checkbox"/>	<input type="checkbox"/>	<input type="checkbox"/>	<input type="checkbox"/>	40.0#
		42 x 16-1/2 x 14-1/2"	PRDL42/UN/LB	<input type="checkbox"/>	<input type="checkbox"/>	<input type="checkbox"/>	<input type="checkbox"/>	44.0#
		48 x 16-1/2 x 14-1/2"	PRDL48/UN/LB	<input type="checkbox"/>	<input type="checkbox"/>	<input type="checkbox"/>	<input type="checkbox"/>	48.0#
		60 x 16-1/2 x 14-1/2"	PRDL60/UN/LB	<input type="checkbox"/>	<input type="checkbox"/>	<input type="checkbox"/>	<input type="checkbox"/>	57.0#
 PRDL	<b>Laminate Door Overhead Cabinet-Upmount</b> • On a 48" panel, clearance between the Universal overhead and 29" high work-surface is 18.85" • On a 56" panel, clearance between the Universal overhead and 29" high work-surface is 26.85"	24 x 16-1/2 x 14-1/2"	PRDL24/UN/UM	<input type="checkbox"/>	<input type="checkbox"/>	<input type="checkbox"/>	<input type="checkbox"/>	32.0#
		30 x 16-1/2 x 14-1/2"	PRDL30/UN/UM	<input type="checkbox"/>	<input type="checkbox"/>	<input type="checkbox"/>	<input type="checkbox"/>	36.0#
		36 x 16-1/2 x 14-1/2"	PRDL36/UN/UM	<input type="checkbox"/>	<input type="checkbox"/>	<input type="checkbox"/>	<input type="checkbox"/>	40.0#
		42 x 16-1/2 x 14-1/2"	PRDL42/UN/UM	<input type="checkbox"/>	<input type="checkbox"/>	<input type="checkbox"/>	<input type="checkbox"/>	44.0#
		48 x 16-1/2 x 14-1/2"	PRDL48/UN/UM	<input type="checkbox"/>	<input type="checkbox"/>	<input type="checkbox"/>	<input type="checkbox"/>	48.0#
		60 x 16-1/2 x 14-1/2"	PRDL60/UN/UM	<input type="checkbox"/>	<input type="checkbox"/>	<input type="checkbox"/>	<input type="checkbox"/>	57.0#
			<b>A</b>	<b>B</b>	<b>C</b>	<b>D</b>	<b>E</b>	

### HOW TO ORDER

Indicate the following information on order form:

- Quantity of each item.
- Model number, including options. See "How To Build a Model Number".
- Any special service required.

Note: • The  indicates that a choice is required.  
 • The absence of the  indicates that no choice is required.  
 • Alpha-numeric characters in place of  indicate that no other alternatives are available.

### HOW TO BUILD A MODEL NUMBER

- A** Select basic model.
- B** Select assembly.
- |          |                              |
|----------|------------------------------|
| <b>F</b> | - Fully Assembled; add \$131 |
| <b>U</b> | - Unassembled                |
- C** Select paint color.  
 Refer to color addendum at ki.com or KI Fabrics & Finishes binder.  
 Metallic paint requires upcharge.
- D** Select laminate color.  
 Refer to color addendum at ki.com or KI Fabrics & Finishes binder.
- E** Select key alike.
- |            |                |
|------------|----------------|
| <b>KA</b>  | - Key alike    |
| <b>KS</b>  | - Key standard |
| <b>NLC</b> | - No lock core |

### INFORMATION

Steel bottom, top shelf and end panels with powder-coated finish  
 Accepts shelf divider  
 Door stores recessed with handle exposed  
 Double bit lock is included  
 Shelf depth is 13-1/4"

### FINISH INFORMATION

#### Additional Laminate Offering

Additional laminates beyond KI standard offering, are available with two weeks extended leadtime. To specify additional laminates, use these designators followed by the supplier's color/pattern code:

Formica - LF/supplier's color pattern code  
 Nevamar - LN/supplier's color pattern code  
 Wilsonart - LW/supplier's color pattern code

KI's standard finish is the supplier's recommended finish for that color/pattern.

Note: Nonstandard laminates from these suppliers (example: textured laminates), require an upcharge and additional leadtime. Contact KI.





# Universal Storage and Accessories

Overhead Storage

## Delivered Pricing

\$ 590
647
660
702
746
914
\$ 668
724
740
781
824
989
\$ 711
767
779
823
865
1032

### SPECIAL SERVICES

#### Special Carton Marking

With specially marked information N/C

#### Shipping

Delivered. Shipped **k.d. freight prepaid f.o.b. Manitowoc, Wisconsin 54220** factory. Freight class #70.

Specifications and prices are subject to change without prior notice.

# Universal Storage and Accessories

## Overhead Storage

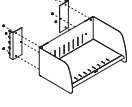
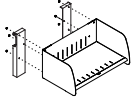
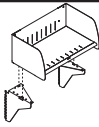
	MODEL	W x H x D	MODEL NUMBER		Approx. Packaged Weight
			Basic Model	Paint Color	
 ULSR	<b>Low Shelf-On-Module</b> • On-Module shelves (PM) mount into slots in vertical posts. Shelves must be same width as panel mounted to. Allows for vertical adjustment in 1" increments	24 x 10-1/2 x 13-1/4"	ULSR24/UN/PM	<input type="checkbox"/>	14.0#
		30 x 10-1/2 x 13-1/4"	ULSR30/UN/PM	<input type="checkbox"/>	16.0#
		36 x 10-1/2 x 13-1/4"	ULSR36/UN/PM	<input type="checkbox"/>	17.0#
		42 x 10-1/2 x 13-1/4"	ULSR42/UN/PM	<input type="checkbox"/>	19.0#
		48 x 10-1/2 x 13-1/4"	ULSR48/UN/PM	<input type="checkbox"/>	20.0#
		60 x 10-1/2 x 13-1/4"	ULSR60/UN/PM	<input type="checkbox"/>	24.0#
 ULSR	<b>Low Shelf-Load Bar Mount</b> • Load Bar mount overheads (LB) hang from an externally mounted load bar • Load Bar purchased separately	24 x 10-1/2 x 13-1/4"	ULSR24/UN/LB	<input type="checkbox"/>	14.0#
		30 x 10-1/2 x 13-1/4"	ULSR30/UN/LB	<input type="checkbox"/>	16.0#
		36 x 10-1/2 x 13-1/4"	ULSR36/UN/LB	<input type="checkbox"/>	17.0#
		42 x 10-1/2 x 13-1/4"	ULSR42/UN/LB	<input type="checkbox"/>	19.0#
		48 x 10-1/2 x 13-1/4"	ULSR48/UN/LB	<input type="checkbox"/>	20.0#
		60 x 10-1/2 x 13-1/4"	ULSR60/UN/LB	<input type="checkbox"/>	24.0#
 ULSR	<b>Low Shelf-Upmount</b> • On a 48" panel, clearance between the Universal overhead and 29" high work-surface is 18.85" • On a 56" panel, clearance between the Universal overhead and 29" high work-surface is 26.85"	24 x 10-1/2 x 13-1/4"	ULSR24/UN/UM	<input type="checkbox"/>	14.0#
		30 x 10-1/2 x 13-1/4"	ULSR30/UN/UM	<input type="checkbox"/>	16.0#
		36 x 10-1/2 x 13-1/4"	ULSR36/UN/UM	<input type="checkbox"/>	17.0#
		42 x 10-1/2 x 13-1/4"	ULSR42/UN/UM	<input type="checkbox"/>	19.0#
		48 x 10-1/2 x 13-1/4"	ULSR48/UN/UM	<input type="checkbox"/>	20.0#
		60 x 10-1/2 x 13-1/4"	ULSR60/UN/UM	<input type="checkbox"/>	24.0#

A

B

### HOW TO ORDER

Indicate the following information on order form:

- Quantity of each item.
- Model number, including options. See "How To Build a Model Number".
- Any special service required.

Note: • The  indicates that a choice is required.

- The absence of the  indicates that no choice is required.
- Alpha-numeric characters in place of  indicate that no other alternatives are available.

### HOW TO BUILD A MODEL NUMBER

- A** Select basic model.
- B** Select paint color.  
Refer to color addendum at [ki.com](http://ki.com) or KI Fabrics & Finishes binder.  
Metallic paint requires upcharge.

### INFORMATION

Includes 10-1/2" high back  
Accepts shelf dividers  
Shelves shipped assembled



# Universal Storage and Accessories

Overhead Storage

Delivered Pricing	Metallic Paint add to list price
\$ 190	\$ 74
197	82
208	83
215	90
219	95
241	115
\$ 268	\$ 74
276	82
284	83
294	90
298	95
319	115
\$ 309	\$ 74
316	82
327	83
337	90
340	95
363	115

## SPECIAL SERVICES

### Special Carton Marking

With specially marked information N/C

### Shipping

Delivered. Shipped **k.d. freight prepaid f.o.b. Manitowoc, Wisconsin 54220** factory. Freight class #70.

Specifications and prices are subject to change without prior notice.

# Universal Storage and Accessories

## Overhead Storage

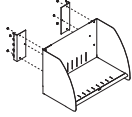
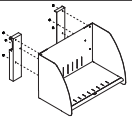
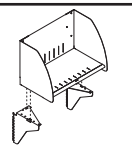
MODEL	W x H x D	MODEL NUMBER		Approx. Packaged Weight
		Basic Model	Paint Color	
 <p><b>Regular Shelf-On-Module</b></p> <ul style="list-style-type: none"> <li>On-Module shelves mount into slots in vertical posts. Shelves must be same width as panel mounted to. Allows for vertical adjustment in 1" increments</li> </ul>	24 x 16-1/2 x 13-1/4"	URSR24/UN/PM	<input type="checkbox"/>	19.0#
	30 x 16-1/2 x 13-1/4"	URSR30/UN/PM	<input type="checkbox"/>	20.0#
	36 x 16-1/2 x 13-1/4"	URSR36/UN/PM	<input type="checkbox"/>	22.0#
	42 x 16-1/2 x 13-1/4"	URSR42/UN/PM	<input type="checkbox"/>	23.0#
	48 x 16-1/2 x 13-1/4"	URSR48/UN/PM	<input type="checkbox"/>	25.0#
	60 x 16-1/2 x 13-1/4"	URSR60/UN/PM	<input type="checkbox"/>	28.0#
 <p><b>Regular Shelf-Load Bar Mount</b></p> <ul style="list-style-type: none"> <li>Load Bar mount overheads (LB) hang from an externally mounted load bar</li> <li>Load Bar purchased separately</li> </ul>	24 x 16-1/2 x 13-1/4"	URSR24/UN/LB	<input type="checkbox"/>	19.0#
	30 x 16-1/2 x 13-1/4"	URSR30/UN/LB	<input type="checkbox"/>	20.0#
	36 x 16-1/2 x 13-1/4"	URSR36/UN/LB	<input type="checkbox"/>	22.0#
	42 x 16-1/2 x 13-1/4"	URSR42/UN/LB	<input type="checkbox"/>	23.0#
	48 x 16-1/2 x 13-1/4"	URSR48/UN/LB	<input type="checkbox"/>	25.0#
	60 x 16-1/2 x 13-1/4"	URSR60/UN/LB	<input type="checkbox"/>	28.0#
 <p><b>Regular Shelf-Upmount</b></p> <ul style="list-style-type: none"> <li>On a 48" panel, clearance between the Universal overhead and 29" high work-surface is 18.85"</li> <li>On a 56" panel, clearance between the Universal overhead and 29" high work-surface is 26.85"</li> </ul>	24 x 16-1/2 x 13-1/4"	URSR24/UN/UM	<input type="checkbox"/>	19.0#
	30 x 16-1/2 x 13-1/4"	URSR30/UN/UM	<input type="checkbox"/>	20.0#
	36 x 16-1/2 x 13-1/4"	URSR36/UN/UM	<input type="checkbox"/>	22.0#
	42 x 16-1/2 x 13-1/4"	URSR42/UN/UM	<input type="checkbox"/>	23.0#
	48 x 16-1/2 x 13-1/4"	URSR48/UN/UM	<input type="checkbox"/>	25.0#
	60 x 16-1/2 x 13-1/4"	URSR60/UN/UM	<input type="checkbox"/>	28.0#

A

B

### HOW TO ORDER

Indicate the following information on order form:

- Quantity of each item.
- Model number, including options. See "How To Build a Model Number".
- Any special service required.

Note: • The  indicates that a choice is required.

- The absence of the  indicates that no choice is required.
- Alpha-numeric characters in place of  indicate that no other alternatives are available.

### HOW TO BUILD A MODEL NUMBER

- A** Select basic model.
- B** Select paint color.  
Refer to color addendum at [ki.com](http://ki.com) or KI Fabrics & Finishes binder.  
Metallic paint requires upcharge.

### INFORMATION

Includes full back  
Accepts shelf dividers  
Shelves shipped assembled



# Universal Storage and Accessories

Overhead Storage

Delivered Pricing	Metallic Paint add to list price
\$ 205	\$ 74
213	82
219	83
226	90
236	95
255	115
\$ 282	\$ 74
291	82
298	83
306	90
313	95
335	115
\$ 324	\$ 74
334	82
340	83
346	90
355	95
375	115

## SPECIAL SERVICES

### Special Carton Marking

With specially marked information N/C

### Shipping

Delivered. Shipped **k.d. freight prepaid f.o.b. Manitowoc, Wisconsin 54220** factory. Freight class #70.

Specifications and prices are subject to change without prior notice.

# Universal Storage and Accessories

## Overhead Accessories

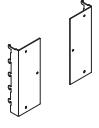
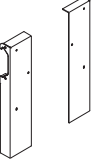
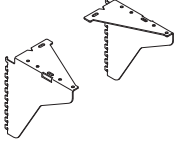
MODEL	MODEL NUMBER		Approx. Packaged Weight
	Basic Model	Trim Color	
 <p>HRDPT</p> <p><b>Universal Overhead On-Module Mounting Bracket</b></p> <ul style="list-style-type: none"> <li>• Sold in pairs / Black only</li> <li>• Mounts into slots in vertical posts</li> <li>• Allows for vertical adjustments in 1" increments</li> <li>• Only necessary to order if changing mounting style</li> </ul>	48.0261.SET		1.0#
 <p>HRDPT</p> <p><b>Load Bar Brackets</b></p> <ul style="list-style-type: none"> <li>• Load Bar mount overheads hang from an externally mounted load bar</li> <li>• Load Bar purchased separately, Sold in pairs</li> </ul>	46.2103	<input type="checkbox"/>	1.0#
 <p>HRDPT</p> <p><b>Upmount Brackets</b></p> <ul style="list-style-type: none"> <li>• On a 48" panel, clearance between the Universal overhead and 29" high work-surface is 18.85"</li> <li>• On a 56" panel, clearance between the Universal overhead and 29" high work-surface is 26.85"</li> <li>• Sold in pairs</li> </ul>	46.1234	<input type="checkbox"/>	1.0#

A

B

### HOW TO ORDER

Indicate the following information on order form:

1. Quantity of each item.
2. Model number, including options. See "How To Build a Model Number".
3. Any special service required.

Note: • The  indicates that a choice is required.

- The absence of the  indicates that no choice is required.
- Alpha-numeric characters in place of  indicate that no other alternatives are available.

### HOW TO BUILD A MODEL NUMBER

- A** Select basic model.
- B** Select trim color.  
Refer to color addendum at [ki.com](http://ki.com) or KI Fabrics & Finishes binder.  
Metallic finish not available.



# Universal Storage and Accessories

Overhead Accessories

Delivered  
Pricing  
\$ 38

\$ 117

\$ 145

### SPECIAL SERVICES

#### Special Carton Marking

With specially marked information N/C

#### Shipping

Delivered. Shipped **k.d. freight prepaid f.o.b. Manitowoc, Wisconsin 54220** factory. Freight class #70.

Specifications and prices are subject to change without prior notice.

# Universal Storage and Accessories

## Overhead Accessories

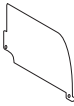
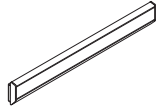
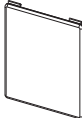
	MODEL	W x H	MODEL NUMBER				Approx. Packaged Weight
			Basic Model	Trim Color	Mounting	Fabric Color	
	<b>Universal Shelf Dividers</b> • Steel shelf dividers with powder-coated finish • Fits on all shelves and cabinets	7-1/4 x 11-1/2'	NSD	<input type="checkbox"/>			1.0#
HRDPT							
	<b>Wall Mounted Load Bar</b> • Supports overhead storage on drywall or other non-panel applications	24"	SWLB.24	<input type="checkbox"/>			5.0#
		30"	SWLB.30	<input type="checkbox"/>			6.0#
		36"	SWLB.36	<input type="checkbox"/>			7.0#
		42"	SWLB.42	<input type="checkbox"/>			8.0#
		48"	SWLB.48	<input type="checkbox"/>			10.0#
		60"	SWLB.60	<input type="checkbox"/>			12.0#
		66"	SWLB.66	<input type="checkbox"/>			13.0#
		72"	SWLB.72	<input type="checkbox"/>			14.0#
		84"	SWLB.84	<input type="checkbox"/>			17.0#
		96"	SWLB.96	<input type="checkbox"/>			19.0#
HRDPT							
	<b>Overhead Tackboard</b> • Hangs from bottom of flipper door cabinet or shelf • When hanging from Balance® overhead, specify attachment bar BMB (purchase separately) • Includes mounting brackets in black only	24 x 12"	PTB02412	<input type="checkbox"/>	<input type="checkbox"/>	<input type="checkbox"/>	3.0#
		30 x 12"	PTB03012	<input type="checkbox"/>	<input type="checkbox"/>	<input type="checkbox"/>	3.0#
		36 x 12"	PTB03612	<input type="checkbox"/>	<input type="checkbox"/>	<input type="checkbox"/>	3.0#
		42 x 12"	PTB04212	<input type="checkbox"/>	<input type="checkbox"/>	<input type="checkbox"/>	4.0#
		48 x 12"	PTB04812	<input type="checkbox"/>	<input type="checkbox"/>	<input type="checkbox"/>	4.0#
		60 x 12"	PTB06012	<input type="checkbox"/>	<input type="checkbox"/>	<input type="checkbox"/>	4.0#
PTBO							
			<b>A</b>	<b>B</b>	<b>C</b>	<b>D</b>	

### HOW TO ORDER

Indicate the following information on order form:

- Quantity of each item.
- Model number, including options. See "How To Build a Model Number".
- Any special service required.

Note: • The  indicates that a choice is required.

- The absence of the  indicates that no choice is required.
- Alpha-numeric characters in place of  indicate that no other alternatives are available.

### HOW TO BUILD A MODEL NUMBER

- A** Select basic model.
- B** Select trim color.  
Refer to color addendum at ki.com or KI Fabrics & Finishes binder.  
Metallic finish not available.
- C** Select mounting.  

<b>NLBM</b>	- Not load bar mounted
<b>YLBM</b>	- Load bar mounted
- D** Select fabric color.  
Refer to color addendum at ki.com or in KI Fabrics & Finishes binder.





# Universal Storage and Accessories

Overhead Accessories

Delivered Pricing	Delivered Pricing Fabric Grade 1 & C.O.M.	Delivered Pricing Fabric Grade 2	Delivered Pricing Fabric Grade 3 & Pallas Vertical Fabric Grade PV	Delivered Pricing Pallas Vertical Fabric Grade PV1	Delivered Pricing Pallas Vertical Fabric Grade PV2
\$ 26					
\$ 111					
119					
121					
133					
138					
164					
166					
173					
268					
280					
N/A	\$ 134	\$ 138	\$ 140	\$ 147	\$ 156
N/A	148	151	153	161	169
N/A	162	166	168	173	182
N/A	167	171	173	178	191
N/A	170	173	175	182	194
N/A	202	207	209	217	228

**SPECIAL SERVICES**

**Special Carton Marking**

With specially marked information N/C

**Shipping**

Delivered. Shipped **k.d. freight prepaid f.o.b. Manitowoc, Wisconsin 54220** factory. Freight class #70.

Specifications and prices are subject to change without prior notice.

# Universal Storage and Accessories

## Shelf/Cabinet Task Light

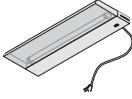
	MODEL	W	MODEL NUMBER		Approx. Packaged Weight
				Basic Model	
	<b>Shelf/Cabinet Task Light</b> • Electronic ballast	18"		TLT5.18	3.4#
		24"		TLT5.24	3.9#
		36"		TLT5.36	5.3#
		48"		TLT5.48	6.7#

HRDPT

**A**

### HOW TO ORDER

Indicate the following information on order form:

1. Quantity of each item.
2. Model number, including options. See "How To Build a Model Number".
3. Any special service required.

Note: • The  indicates that a choice is required.

- The absence of the  indicates that no choice is required.
- Alpha-numeric characters in place of  indicate that no other alternatives are available.

### HOW TO BUILD A MODEL NUMBER

**A** Select basic model.

### INFORMATION

#### TASK LIGHT CABINET WIDTH

Cabinet Width	Light Width
24"	18"
30"	24"
36"	24"
42"	36"
48"	36"
54"	48"
60"	48"



# Universal Storage and Accessories

Shelf/Cabinet Task Light

Delivered  
Pricing

\$	74
	76
	83
	91

### SPECIAL SERVICES

#### Special Carton Marking

With specially marked information    N/C

#### Shipping

Delivered. Shipped **k.d. freight prepaid f.o.b. Manitowoc, Wisconsin 54220** factory. Freight class #70.

Specifications and prices are subject to change without prior notice.

# Balance® Storage and Accessories

## Overhead Storage

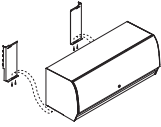
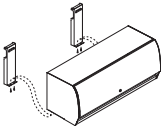
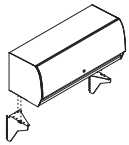
	MODEL	W x H x D	MODEL NUMBER				Approx. Packaged Weight
			Basic Model	Cabinet Paint Color	Upper Door Solid Color	Key Option	
 <p>BOH</p>	<b>Balance® Overhead Cabinet-Solid Color Upper Door-On Module (PM)</b> • Colored or translucent extruded polypropylene door • On-Module overheads mount into slots in vertical posts. Overheads must be same width as panel mounted to. Allows for vertical adjustment in 1" increments	30 x 17 x 19-1/4"	BLCS30/UN/PM	<input type="checkbox"/> <input type="checkbox"/> <input type="checkbox"/>	<input type="checkbox"/> <input type="checkbox"/> <input type="checkbox"/>	<input type="checkbox"/> <input type="checkbox"/> <input type="checkbox"/>	46.0#
		36 x 17 x 19-1/4"	BLCS36/UN/PM	<input type="checkbox"/> <input type="checkbox"/> <input type="checkbox"/>	<input type="checkbox"/> <input type="checkbox"/> <input type="checkbox"/>	<input type="checkbox"/> <input type="checkbox"/> <input type="checkbox"/>	52.0#
		42 x 17 x 19-1/4"	BLCS42/UN/PM	<input type="checkbox"/> <input type="checkbox"/> <input type="checkbox"/>	<input type="checkbox"/> <input type="checkbox"/> <input type="checkbox"/>	<input type="checkbox"/> <input type="checkbox"/> <input type="checkbox"/>	58.0#
		48 x 17 x 19-1/4"	BLCS48/UN/PM	<input type="checkbox"/> <input type="checkbox"/> <input type="checkbox"/>	<input type="checkbox"/> <input type="checkbox"/> <input type="checkbox"/>	<input type="checkbox"/> <input type="checkbox"/> <input type="checkbox"/>	64.0#
		60 x 17 x 19-1/4"	BLCS60/UN/PM	<input type="checkbox"/> <input type="checkbox"/> <input type="checkbox"/>	<input type="checkbox"/> <input type="checkbox"/> <input type="checkbox"/>	<input type="checkbox"/> <input type="checkbox"/> <input type="checkbox"/>	78.0#
 <p>BOH</p>	<b>Balance® Overhead Cabinet-Solid Color Upper Door-Load Bar Mount</b> • Colored or translucent extruded polypropylene door • Load Bar Mount overheads hang from an externally mounted load bar • Load Bar purchased separately	30 x 17 x 19-1/4"	BLCS30/UN/LB	<input type="checkbox"/> <input type="checkbox"/> <input type="checkbox"/>	<input type="checkbox"/> <input type="checkbox"/> <input type="checkbox"/>	<input type="checkbox"/> <input type="checkbox"/> <input type="checkbox"/>	46.0#
		36 x 17 x 19-1/4"	BLCS36/UN/LB	<input type="checkbox"/> <input type="checkbox"/> <input type="checkbox"/>	<input type="checkbox"/> <input type="checkbox"/> <input type="checkbox"/>	<input type="checkbox"/> <input type="checkbox"/> <input type="checkbox"/>	52.0#
		42 x 17 x 19-1/4"	BLCS42/UN/LB	<input type="checkbox"/> <input type="checkbox"/> <input type="checkbox"/>	<input type="checkbox"/> <input type="checkbox"/> <input type="checkbox"/>	<input type="checkbox"/> <input type="checkbox"/> <input type="checkbox"/>	58.0#
		48 x 17 x 19-1/4"	BLCS48/UN/LB	<input type="checkbox"/> <input type="checkbox"/> <input type="checkbox"/>	<input type="checkbox"/> <input type="checkbox"/> <input type="checkbox"/>	<input type="checkbox"/> <input type="checkbox"/> <input type="checkbox"/>	64.0#
		60 x 17 x 19-1/4"	BLCS60/UN/LB	<input type="checkbox"/> <input type="checkbox"/> <input type="checkbox"/>	<input type="checkbox"/> <input type="checkbox"/> <input type="checkbox"/>	<input type="checkbox"/> <input type="checkbox"/> <input type="checkbox"/>	78.0#
 <p>BOH</p>	<b>Balance® Overhead Cabinet-Solid Color Upper Door-Load Bar-Upmount</b> • Colored or translucent extruded polypropylene door • Upmount brackets raise the storage 12" • On a 48" panel, clearance between the Balance overhead and 29" high work surface is 18.85" • On a 56" panel, clearance between the Balance overhead and 29" high work surface is 26.85"	30 x 17 x 19-1/4"	BLCS30/UN/UM	<input type="checkbox"/> <input type="checkbox"/> <input type="checkbox"/>	<input type="checkbox"/> <input type="checkbox"/> <input type="checkbox"/>	<input type="checkbox"/> <input type="checkbox"/> <input type="checkbox"/>	46.0#
		36 x 17 x 19-1/4"	BLCS36/UN/UM	<input type="checkbox"/> <input type="checkbox"/> <input type="checkbox"/>	<input type="checkbox"/> <input type="checkbox"/> <input type="checkbox"/>	<input type="checkbox"/> <input type="checkbox"/> <input type="checkbox"/>	52.0#
		42 x 17 x 19-1/4"	BLCS42/UN/UM	<input type="checkbox"/> <input type="checkbox"/> <input type="checkbox"/>	<input type="checkbox"/> <input type="checkbox"/> <input type="checkbox"/>	<input type="checkbox"/> <input type="checkbox"/> <input type="checkbox"/>	58.0#
		48 x 17 x 19-1/4"	BLCS48/UN/UM	<input type="checkbox"/> <input type="checkbox"/> <input type="checkbox"/>	<input type="checkbox"/> <input type="checkbox"/> <input type="checkbox"/>	<input type="checkbox"/> <input type="checkbox"/> <input type="checkbox"/>	64.0#
		60 x 17 x 19-1/4"	BLCS60/UN/UM	<input type="checkbox"/> <input type="checkbox"/> <input type="checkbox"/>	<input type="checkbox"/> <input type="checkbox"/> <input type="checkbox"/>	<input type="checkbox"/> <input type="checkbox"/> <input type="checkbox"/>	78.0#
			<b>A</b>	<b>B</b>	<b>C</b>	<b>D</b>	

### HOW TO ORDER

Indicate the following information on order form:

- Quantity of each item.
- Model number, including options. See "How To Build a Model Number".
- Any special service required.

Note: • The  indicates that a choice is required.

- The absence of the  indicates that no choice is required.
- Alpha-numeric characters in place of  indicate that no other alternatives are available.

### HOW TO BUILD A MODEL NUMBER

- A** Select basic model.
- B** Select cabinet paint color.  
Refer to color addendum at ki.com or KI Fabrics & Finishes binder.
- C** Select upper door color.  
Refer to color addendum at ki.com or KI Fabrics & Finishes binder.
- D** Select key alike.
- |            |                |
|------------|----------------|
| <b>KA</b>  | - Key alike    |
| <b>KS</b>  | - Key standard |
| <b>NLC</b> | - No lock core |

### INFORMATION

Painted cabinet and lower door  
 Shelf dividers available separately  
 Cabinet is fully assembled  
 Door stores above top of cabinet  
 Will accept hanging tool rail and tackboards  
 (Attachment bar ordered separately)



# Balance® Storage and Accessories

Overhead Storage

Delivered  
Pricing

\$ 893  
951  
1001  
1035  
1154

\$ 1032  
1091  
1137  
1172  
1292

\$ 965  
1023  
1072  
1106  
1228

**SPECIAL SERVICES**

**Special Carton Marking**

With specially marked information N/C



**Shipping**

Shipped **assembled freight prepaid**  
**f.o.b. Manitowoc, Wisconsin 54220** factory.  
Freight class #77.5

Specifications and prices are subject to  
change without prior notice.

# Balance® Storage and Accessories

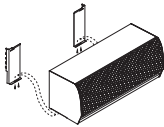
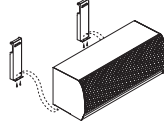
## Overhead Storage

	MODEL	W x H x D	MODEL NUMBER				Approx. Packaged Weight
			Basic Model	Cabinet Paint Color	Fabric Color	Key Option	
 <p>BOH</p>	<b>Balance® Overhead Cabinet-Fabric Upper Door-On-Module</b> • On-Module overheads (PM) mount into slots in vertical posts • Overheads must be same width as panel mounted to • Allows for vertical adjustment in 1" increments.	30 x 17 x 19-1/4"	BLCF30/UN/PM	<input type="checkbox"/> <input type="checkbox"/> <input type="checkbox"/>	<input type="checkbox"/> <input type="checkbox"/> <input type="checkbox"/> <input type="checkbox"/>	<input type="checkbox"/> <input type="checkbox"/> <input type="checkbox"/>	46.0#
		36 x 17 x 19-1/4"	BLCF36/UN/PM	<input type="checkbox"/> <input type="checkbox"/> <input type="checkbox"/>	<input type="checkbox"/> <input type="checkbox"/> <input type="checkbox"/> <input type="checkbox"/>	<input type="checkbox"/> <input type="checkbox"/> <input type="checkbox"/>	52.0#
		42 x 17 x 19-1/4"	BLCF42/UN/PM	<input type="checkbox"/> <input type="checkbox"/> <input type="checkbox"/>	<input type="checkbox"/> <input type="checkbox"/> <input type="checkbox"/> <input type="checkbox"/>	<input type="checkbox"/> <input type="checkbox"/> <input type="checkbox"/>	58.0#
		48 x 17 x 19-1/4"	BLCF48/UN/PM	<input type="checkbox"/> <input type="checkbox"/> <input type="checkbox"/>	<input type="checkbox"/> <input type="checkbox"/> <input type="checkbox"/> <input type="checkbox"/>	<input type="checkbox"/> <input type="checkbox"/> <input type="checkbox"/>	64.0#
		60 x 17 x 19-1/4"	BLCF60/UN/PM	<input type="checkbox"/> <input type="checkbox"/> <input type="checkbox"/>	<input type="checkbox"/> <input type="checkbox"/> <input type="checkbox"/> <input type="checkbox"/>	<input type="checkbox"/> <input type="checkbox"/> <input type="checkbox"/>	78.0#
 <p>BOH</p>	<b>Balance® Overhead Cabinet-Fabric Upper Door-Load Bar Mount</b> • Load Bar Mount overheads (LB) hang from an externally mounted load bar • Load Bar purchased separately	30 x 17 x 19-1/4"	BLCF30/UN/LB	<input type="checkbox"/> <input type="checkbox"/> <input type="checkbox"/>	<input type="checkbox"/> <input type="checkbox"/> <input type="checkbox"/> <input type="checkbox"/>	<input type="checkbox"/> <input type="checkbox"/> <input type="checkbox"/>	46.0#
		36 x 17 x 19-1/4"	BLCF36/UN/LB	<input type="checkbox"/> <input type="checkbox"/> <input type="checkbox"/>	<input type="checkbox"/> <input type="checkbox"/> <input type="checkbox"/> <input type="checkbox"/>	<input type="checkbox"/> <input type="checkbox"/> <input type="checkbox"/>	52.0#
		42 x 17 x 19-1/4"	BLCF42/UN/LB	<input type="checkbox"/> <input type="checkbox"/> <input type="checkbox"/>	<input type="checkbox"/> <input type="checkbox"/> <input type="checkbox"/> <input type="checkbox"/>	<input type="checkbox"/> <input type="checkbox"/> <input type="checkbox"/>	58.0#
		48 x 17 x 19-1/4"	BLCF48/UN/LB	<input type="checkbox"/> <input type="checkbox"/> <input type="checkbox"/>	<input type="checkbox"/> <input type="checkbox"/> <input type="checkbox"/> <input type="checkbox"/>	<input type="checkbox"/> <input type="checkbox"/> <input type="checkbox"/>	64.0#
		60 x 17 x 19-1/4"	BLCF60/UN/LB	<input type="checkbox"/> <input type="checkbox"/> <input type="checkbox"/>	<input type="checkbox"/> <input type="checkbox"/> <input type="checkbox"/> <input type="checkbox"/>	<input type="checkbox"/> <input type="checkbox"/> <input type="checkbox"/>	78.0#
 <p>BOH</p>	<b>Balance® Overhead Cabinet-Fabric Upper Door-Upmount</b> • Upmount brackets raise the storage component 12" • On a 48" panel, clearance between the Balance overhead and 29" high work surface is 18.85" • On a 56" panel, clearance between the Balance overhead and 29" high work surface is 26.85"	30 x 17 x 19-1/4"	BLCF30/UN/UM	<input type="checkbox"/> <input type="checkbox"/> <input type="checkbox"/>	<input type="checkbox"/> <input type="checkbox"/> <input type="checkbox"/> <input type="checkbox"/>	<input type="checkbox"/> <input type="checkbox"/> <input type="checkbox"/>	46.0#
		36 x 17 x 19-1/4"	BLCF36/UN/UM	<input type="checkbox"/> <input type="checkbox"/> <input type="checkbox"/>	<input type="checkbox"/> <input type="checkbox"/> <input type="checkbox"/> <input type="checkbox"/>	<input type="checkbox"/> <input type="checkbox"/> <input type="checkbox"/>	52.0#
		42 x 17 x 19-1/4"	BLCF42/UN/UM	<input type="checkbox"/> <input type="checkbox"/> <input type="checkbox"/>	<input type="checkbox"/> <input type="checkbox"/> <input type="checkbox"/> <input type="checkbox"/>	<input type="checkbox"/> <input type="checkbox"/> <input type="checkbox"/>	58.0#
		48 x 17 x 19-1/4"	BLCF48/UN/UM	<input type="checkbox"/> <input type="checkbox"/> <input type="checkbox"/>	<input type="checkbox"/> <input type="checkbox"/> <input type="checkbox"/> <input type="checkbox"/>	<input type="checkbox"/> <input type="checkbox"/> <input type="checkbox"/>	64.0#
		60 x 17 x 19-1/4"	BLCF60/UN/UM	<input type="checkbox"/> <input type="checkbox"/> <input type="checkbox"/>	<input type="checkbox"/> <input type="checkbox"/> <input type="checkbox"/> <input type="checkbox"/>	<input type="checkbox"/> <input type="checkbox"/> <input type="checkbox"/>	78.0#

**A**      **B**      **C**      **D**

### HOW TO ORDER

Indicate the following information on order form:

- Quantity of each item.
- Model number, including options. See "How To Build a Model Number".
- Any special service required.

Note: • The  indicates that a choice is required.

- The absence of the  indicates that no choice is required.
- Alpha-numeric characters in place of  indicate that no other alternatives are available.

### HOW TO BUILD A MODEL NUMBER

- A** Select basic model.
- B** Select cabinet paint color.  
Refer to color addendum at ki.com or KI Fabrics & Finishes binder.
- C** Select upper door color.  
Refer to color addendum at ki.com or in KI Fabrics & Finishes binder.
- D** Select key alike.
 

<b>KA</b>	- Key alike
<b>NL</b>	- No Lock
<b>NLC</b>	- No lock core

### INFORMATION

Painted cabinet and lower door  
 Shelf dividers available separately  
 Cabinet is fully assembled  
 Door stores above top of cabinet  
 Will accept hanging tool rail and tackboards  
 (Attachment bar ordered separately)



# Balance® Storage and Accessories

Overhead Storage

Delivered Pricing Fabric Grade 1 & C.O.M.	Delivered Pricing Fabric Grade 2	Delivered Pricing Fabric Grade 3 & Pallas Vertical Fabric Grade PV	Delivered Pricing Pallas Vertical Fabric Grade PV1	Delivered Pricing Pallas Vertical Fabric Grade PV2
\$ 964	\$ 973	\$ 984	\$ 984	\$ 988
1027	1036	1049	1049	1052
1077	1090	1101	1101	1105
1119	1127	1138	1138	1143
1246	1257	1272	1272	1278
<hr/>				
\$ 1101	\$ 1109	\$ 1123	\$ 1123	\$ 1126
1166	1174	1188	1188	1192
1217	1228	1242	1242	1245
1252	1263	1278	1278	1284
1384	1394	1410	1410	1415
<hr/>				
\$ 1038	\$ 1046	\$ 1059	\$ 1059	\$ 1063
1099	1107	1123	1123	1126
1153	1161	1174	1174	1179
1189	1200	1212	1212	1217
1316	1330	1343	1343	1348

**SPECIAL SERVICES**

**Special Carton Marking**

With specially marked information N/C

**Shipping**

Shipped **assembled freight prepaid**  
**f.o.b. Manitowoc, Wisconsin 54220** factory.  
 Freight class #77.5

Specifications and prices are subject to  
 change without prior notice.

# Balance® Storage and Accessories

## Overhead Storage

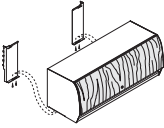
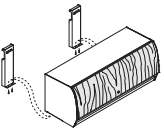
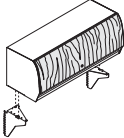
MODEL	W x H x D	MODEL NUMBER					Approx. Packaged Weight	
		Basic Model	Cabinet Paint Color	Laminate Color	Laminate Door Edge Color	Key Option		
 <p><b>Balance® Overhead Cabinet-Laminate Upper Door-On-Module</b></p> <ul style="list-style-type: none"> <li>On-Module overheads (PM) mount into slots in vertical posts. Overheads must be the same width as panel mounted to</li> <li>Allows for vertical adjustment in 1" increments.</li> </ul>	30 x 17 x 19-1/4"	BLCL30/UN/PM	<input type="checkbox"/>	<input type="checkbox"/>	<input type="checkbox"/>	<input type="checkbox"/>	46.0#	
	36 x 17 x 19-1/4"	BLCL36/UN/PM	<input type="checkbox"/>	<input type="checkbox"/>	<input type="checkbox"/>	<input type="checkbox"/>	52.0#	
	42 x 17 x 19-1/4"	BLCL42/UN/PM	<input type="checkbox"/>	<input type="checkbox"/>	<input type="checkbox"/>	<input type="checkbox"/>	58.0#	
	48 x 17 x 19-1/4"	BLCL48/UN/PM	<input type="checkbox"/>	<input type="checkbox"/>	<input type="checkbox"/>	<input type="checkbox"/>	64.0#	
	60 x 17 x 19-1/4"	BLCL60/UN/PM	<input type="checkbox"/>	<input type="checkbox"/>	<input type="checkbox"/>	<input type="checkbox"/>	78.0#	
BOH								
 <p><b>Balance® Overhead Cabinet-Laminate Upper Door-Load Bar Mount</b></p> <ul style="list-style-type: none"> <li>Load Bar Mount overheads (LB) hang from an externally mounted load bar</li> <li>Load Bar purchased separately</li> </ul>	30 x 17 x 19-1/4"	BLCL30/UN/LB	<input type="checkbox"/>	<input type="checkbox"/>	<input type="checkbox"/>	<input type="checkbox"/>	46.0#	
	36 x 17 x 19-1/4"	BLCL36/UN/LB	<input type="checkbox"/>	<input type="checkbox"/>	<input type="checkbox"/>	<input type="checkbox"/>	52.0#	
	42 x 17 x 19-1/4"	BLCL42/UN/LB	<input type="checkbox"/>	<input type="checkbox"/>	<input type="checkbox"/>	<input type="checkbox"/>	58.0#	
	48 x 17 x 19-1/4"	BLCL48/UN/LB	<input type="checkbox"/>	<input type="checkbox"/>	<input type="checkbox"/>	<input type="checkbox"/>	64.0#	
	60 x 17 x 19-1/4"	BLCL60/UN/LB	<input type="checkbox"/>	<input type="checkbox"/>	<input type="checkbox"/>	<input type="checkbox"/>	78.0#	
BOH								
 <p><b>Balance® Overhead Cabinet-Laminate Upper Door-Upmount</b></p> <ul style="list-style-type: none"> <li>Upmount brackets raise the storage component 12"</li> <li>On a 48" panel, clearance between the Balance overhead and 29" high work surface is 18.85"</li> <li>On a 56" panel, clearance between the Balance overhead and 29" high work surface is 26.85"</li> </ul>	30 x 17 x 19-1/4"	BLCL30/UN/UM	<input type="checkbox"/>	<input type="checkbox"/>	<input type="checkbox"/>	<input type="checkbox"/>	46.0#	
	36 x 17 x 19-1/4"	BLCL36/UN/UM	<input type="checkbox"/>	<input type="checkbox"/>	<input type="checkbox"/>	<input type="checkbox"/>	52.0#	
	42 x 17 x 19-1/4"	BLCL42/UN/UM	<input type="checkbox"/>	<input type="checkbox"/>	<input type="checkbox"/>	<input type="checkbox"/>	58.0#	
	48 x 17 x 19-1/4"	BLCL48/UN/UM	<input type="checkbox"/>	<input type="checkbox"/>	<input type="checkbox"/>	<input type="checkbox"/>	64.0#	
	60 x 17 x 19-1/4"	BLCL60/UN/UM	<input type="checkbox"/>	<input type="checkbox"/>	<input type="checkbox"/>	<input type="checkbox"/>	78.0#	
BOH								
			<b>A</b>	<b>B</b>	<b>C</b>	<b>D</b>	<b>E</b>	

### HOW TO ORDER

Indicate the following information on order form:

- Quantity of each item.
- Model number, including options. See "How To Build a Model Number".
- Any special service required.

Note: • The  indicates that a choice is required.

- The absence of the  indicates that no choice is required.
- Alpha-numeric characters in place of  indicate that no other alternatives are available.

### HOW TO BUILD A MODEL NUMBER

- A** Select basic model.
- B** Select cabinet paint color. Refer to color addendum at ki.com or KI Fabrics & Finishes binder.
- C** Select upper door laminate color. Refer to color addendum at ki.com or KI Fabrics & Finishes binder.
- D** Select laminate door edge color. Refer to color addendum at ki.com or KI Fabrics & Finishes binder.
- E** Select key alike.
 

<b>KA</b>	- Key alike
<b>KS</b>	- Key standard
<b>NLC</b>	- No lock core

### INFORMATION

Painted cabinet and lower door  
 Shelf dividers available separately  
 Cabinet is fully assembled  
 Door stores above top of cabinet  
 Will accept hanging tool rail and tackboards (Attachment bar ordered separately)

### FINISH INFORMATION

**Additional Laminate Offering**  
 Additional laminates beyond KI standard offering, are available with two weeks extended leadtime. To specify additional laminates, use these designators followed by the supplier's color/pattern code:

Formica - LF/supplier's color pattern code  
 Nevamar - LN/supplier's color pattern code  
 Wilsonart - LW/supplier's color pattern code

KI's standard finish is the supplier's recommended finish for that color/pattern.  
 Note: Nonstandard laminates from these suppliers (example: textured laminates), require an upcharge and additional leadtime. Contact KI.





# Balance® Storage and Accessories

Overhead Storage

Delivered  
Pricing

\$ 1096  
1127  
1202  
1286  
1447

\$ 1234  
1263  
1340  
1422  
1587

\$ 1170  
1201  
1276  
1358  
1521

## SPECIAL SERVICES

### Special Carton Marking

With specially marked information N/C

### Shipping

Shipped **assembled freight prepaid**  
**f.o.b. Manitowoc, Wisconsin 54220** factory.  
Freight class #77.5

Specifications and prices are subject to  
change without prior notice.

# Balance® Storage and Accessories

## Overhead Accessories

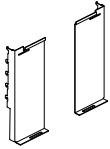
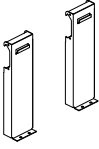
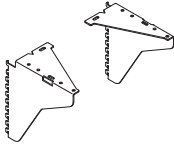
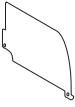
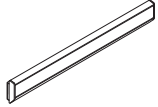
	MODEL	W	MODEL NUMBER		Approx. Packaged Weight	
			Basic Model	Paint Color		
 <p><b>Balance® Overhead On-Module Mounting Bracket</b></p> <ul style="list-style-type: none"> <li>Sold in pairs</li> <li>Mounts into slots in vertical posts</li> <li>Black only</li> </ul>			BOA/UN/PM	<input type="checkbox"/>	5.0#	
	BOA					
 <p><b>Load Bar Brackets</b></p> <ul style="list-style-type: none"> <li>Load Bar mount overhangs (LB) hang from an externally mounted load bar</li> <li>Load Bar purchased separately</li> <li>Sold in pairs</li> </ul>			BOA/UN/LB	<input type="checkbox"/>	5.0#	
	BOA					
 <p><b>Upmount Brackets</b></p> <ul style="list-style-type: none"> <li>On a 48" panel, clearance between the Balance® overhead and 29" high work-surface is 18.85"</li> <li>On a 56" panel, clearance between the Balance® overhead and 29" high work-surface is 26.85"</li> <li>Sold in pairs</li> </ul>			BOA/UN/UM	<input type="checkbox"/>	5.0#	
	BOA					
 <p><b>Shelf Dividers</b></p> <ul style="list-style-type: none"> <li>Steel shelf dividers with powder coat finish</li> <li>Fits on all shelves and cabinets</li> </ul>		7-1/4 x 11-1/2"	NSD	<input type="checkbox"/>	1.0#	
	HRDPT					
 <p><b>Wall Mounted Load Bar</b></p>		24"	SWLB.24	<input type="checkbox"/>	5.0#	
		30"	SWLB.30	<input type="checkbox"/>	6.0#	
		36"	SWLB.36	<input type="checkbox"/>	7.0#	
		42"	SWLB.42	<input type="checkbox"/>	8.0#	
		48"	SWLB.48	<input type="checkbox"/>	10.0#	
	HRDPT	60"	SWLB.60	<input type="checkbox"/>	12.0#	
		66"	SWLB.66	<input type="checkbox"/>	13.0#	
		72"	SWLB.72	<input type="checkbox"/>	14.0#	
		84"	SWLB.84	<input type="checkbox"/>	17.0#	
		96"	SWLB.96	<input type="checkbox"/>	19.0#	

A

B

### HOW TO ORDER

Indicate the following information on order form:

- Quantity of each item.
- Model number, including options. See "How To Build a Model Number".
- Any special service required.

Note: • The  indicates that a choice is required.

- The absence of the  indicates that no choice is required.
- Alpha-numeric characters in place of  indicate that no other alternatives are available.

### HOW TO BUILD A MODEL NUMBER

- A** Select basic model.
- B** Select paint color.  
Refer to color addendum at [ki.com](http://ki.com) or KI Fabrics & Finishes binder.  
Metallic finish not available.



# Balance® Storage and Accessories

Overhead Accessories

Delivered  
Pricing

\$ 152

\$ 190

\$ 233

\$ 26

\$ 111

119

121

133

138

164

166

173

268

280

### SPECIAL SERVICES

#### Special Carton Marking

With specially marked information N/C



#### Shipping

Shipped **assembled freight prepaid**  
**f.o.b. Manitowoc, Wisconsin 54220** factory.  
Freight class #70.

Specifications and prices are subject to  
change without prior notice.

# Balance® Storage and Accessories

## Overhead Accessories

	MODEL	W x H	MODEL NUMBER		Approx. Packaged Weight	Delivered Pricing
			Basic Model	Trim Color		
 PTBO	<b>Overhead Tackboard</b>	24 x 12"	PTB02412	<input type="checkbox"/>	3.0#	N/A
	• Hangs from bottom of flipper door cabinet or shelf	30 x 12"	PTB03012	<input type="checkbox"/>	3.0#	N/A
	• When hanging from Balance® overhead, specify attachment bar BMB (purchase separately)	36 x 12"	PTB03612	<input type="checkbox"/>	3.0#	N/A
		42 x 12"	PTB04212	<input type="checkbox"/>	4.0#	N/A
	• Includes mounting brackets in black only	48 x 12"	PTB04812	<input type="checkbox"/>	4.0#	N/A
		60 x 12"	PTB06012	<input type="checkbox"/>	4.0#	N/A
		24 x 16"	PTB02416	<input type="checkbox"/>	3.0#	N/A
		30 x 16"	PTB03016	<input type="checkbox"/>	4.0#	N/A
		36 x 16"	PTB03616	<input type="checkbox"/>	4.0#	N/A
		42 x 16"	PTB04216	<input type="checkbox"/>	5.0#	N/A
		48 x 16"	PTB04816	<input type="checkbox"/>	5.0#	N/A
		60 x 16"	PTB06016	<input type="checkbox"/>	6.0#	N/A
	 BOA	<b>Tackboard/Tool Rail Attachment Bar</b>	30"	BMB30	<input type="checkbox"/>	3.0#
• Attachment bracket that attaches to bottom of overhead to accept overhead tackboard		36"	BMB36	<input type="checkbox"/>	3.0#	37
		42"	BMB42	<input type="checkbox"/>	3.0#	38
• Order same size as overhead cabinet		48"	BMB48	<input type="checkbox"/>	4.0#	44
		60"	BMB60	<input type="checkbox"/>	4.0#	47
• 18-gauge steel						
• Black only						

A

B

### HOW TO ORDER

Indicate the following information on order form:

- Quantity of each item.
- Model number, including options. See "How To Build a Model Number".
- Any special service required.

Note: • The  indicates that a choice is required.

- The absence of the  indicates that no choice is required.
- Alpha-numeric characters in place of  indicate that no other alternatives are available.

### HOW TO BUILD A MODEL NUMBER

**A** Select basic model.

**B** Select trim color.

Refer to color addendum at [ki.com](http://ki.com) or KI Fabrics & Finishes binder. Metallic finish not available.



# Balance® Storage and Accessories

Overhead Accessories

Delivered Pricing Fabric Grade 1 & C.O.M.	Delivered Pricing Fabric Grade 2	Delivered Pricing Fabric Grade 3 & Pallas Vertical Fabric Grade PV	Delivered Pricing Pallas Vertical Fabric Grade PV1	Delivered Pricing Pallas Vertical Fabric Grade PV2
\$ 134	\$ 138	\$ 140	\$ 147	\$ 156
148	151	153	161	169
162	166	168	173	182
167	171	173	178	191
170	173	175	182	194
202	207	209	217	228
193	198	202	208	220
199	205	209	214	231
204	209	213	219	235
208	213	217	224	238
217	224	228	235	251
237	242	249	255	275

## SPECIAL SERVICES

### Special Carton Marking

With specially marked information N/C

### Shipping

Shipped **assembled freight prepaid**  
f.o.b. **Manitowoc, Wisconsin 54220** factory.  
Freight class #70.

Specifications and prices are subject to  
change without prior notice.

# Balance® Storage and Accessories

## Overhead Task Lights

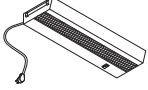
MODEL	W	MODEL NUMBER	Approx. Packaged Weight
		Basic Model	
 <p>Overhead Task Lights</p> <ul style="list-style-type: none"> <li>• Electronic ballast</li> </ul>	24"	BTLT5.24	3.9#
	36"	BTLT5.36	5.3#
	48"	BTLT5.48	6.7#

HRDPT

A

### HOW TO ORDER

Indicate the following information on order form:

1. Quantity of each item.
2. Model number, including options. See "How To Build a Model Number".
3. Any special service required.

Note: • The  indicates that a choice is required.

- The absence of the  indicates that no choice is required.
- Alpha-numeric characters in place of  indicate that no other alternatives are available.

### HOW TO BUILD A MODEL NUMBER

A Select basic model.

### INFORMATION

#### TASK LIGHT CABINET WIDTH

Cabinet Width	Light Width
24"	18"
30"	24"
36"	24"
42"	36"
48"	36"
54"	48"
60"	48"



<attrib a="167" l="10"  
o="685181" p="857972" s="90"  
status="1"/>

\$ 102  
112  
117

**SPECIAL SERVICES**

**Special Carton Marking**

With specially marked information N/C

**Shipping**

Shipped **assembled freight prepaid f.o.b. Manitowoc, Wisconsin 54220** factory. Freight class #100.

Specifications and prices are subject to change without prior notice.

# U-Series® Pedestals

Mobile

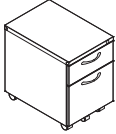
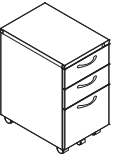
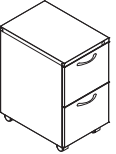
	MODEL	Features	W x D x H	MODEL NUMBER				Approx. Packaged Weight
				Basic Model	Unit Color	Lock Option	Pull Style	
	<b>Pedestal - MBF</b> • One 6" box drawer • One 12" file drawer • 5th wheel eliminates need for counterbalance weight • Optional dividers sold separately	Mobile	15 x 17-5/8" x 21-3/4"	ULP20MBF	<input type="checkbox"/>	<input type="checkbox"/>	<input type="checkbox"/>	38.0#
		Mobile	15 x 21-5/8" x 21-3/4"	ULP24MBF	<input type="checkbox"/>	<input type="checkbox"/>	<input type="checkbox"/>	42.0#
USLP								
	<b>Pedestal - BBF</b> • Two 6" box drawers • One 12" file drawer • 5th wheel eliminates need for counterbalance weight • Optional dividers sold separately	Mobile	15 x 17-5/8" x 27-5/8"	ULP20MBBF	<input type="checkbox"/>	<input type="checkbox"/>	<input type="checkbox"/>	49.0#
		Mobile	15 x 21-5/8" x 27-5/8"	ULP24MBBF	<input type="checkbox"/>	<input type="checkbox"/>	<input type="checkbox"/>	51.0#
USLP								
	<b>Pedestal - FF</b> • Two 12" file drawers • Counterbalance weight included • Optional dividers sold separately	Mobile	15 x 17-5/8" x 27-5/8"	ULP20MFF	<input type="checkbox"/>	<input type="checkbox"/>	<input type="checkbox"/>	79.0#
		Mobile	15 x 21-5/8" x 27-5/8"	ULP24MFF	<input type="checkbox"/>	<input type="checkbox"/>	<input type="checkbox"/>	71.0#
USLP								

**A**      **B**      **C**      **D**

## HOW TO ORDER

Indicate the following information on order form:

- Quantity of each item.
- Model number, including options. See "How To Build a Model Number".
- Any special service required.

Note: • The  indicates that a choice is required.

• The absence of the  indicates that no choice is required.

• Alpha-numeric characters in place of  indicate that no other alternatives are available.

## HOW TO BUILD A MODEL NUMBER

- A** Select basic model.
- B** Select unit and drawer color.  
Refer to color addendum at [ki.com](http://ki.com) or KI Fabrics & Finishes binder.
- C** Select key option.
 

<b>KS</b>	- Key standard
<b>NLC</b>	- No lock core
<b>KA</b>	- Key alike
- D** Select pull style.
 

<b>USP</b>	- U-Series Pull (Standard)
<b>CZP</b>	- Connection Zone Pull

## INFORMATION

**Height**  
Mobile pedestal include 2-5/16" allowance for casters.

**Accessories**  
See accessory section for accessories that can be ordered separately.

**Weights**  
Figures provided are approximate and reflect packaged product without additional accessories.





# U-Series® Pedestals

Mobile

Delivered Pricing	Whites & All Metallics Upcharge
\$ 316	\$ 58
334	58
\$ 378	\$ 58
396	58
\$ 452	\$ 58
456	58

**SPECIAL SERVICES**

**Special Carton Marking**

With specially marked information    N/C



**Shipping**

Shipped **assembled freight prepaid f.o.b. Pembroke, Ontario K8A 0E1** factory. Freight class #70.

Specifications and prices are subject to change without prior notice.

# U-Series® Pedestals

Freestanding

	MODEL	Features	W x D x H	MODEL NUMBER				Approx. Packaged Weight
				Basic Model	Unit Color	Lock Option	Pull Style	
	<b>Pedestal - BBF</b>	Freestanding	15 x 17-5/8" x 27-5/8"	ULP20FBBF	<input type="checkbox"/>	<input type="checkbox"/>	<input type="checkbox"/>	49.0#
	<ul style="list-style-type: none"> <li>• Features 2-5/8" non-adjustable glides</li> <li>• Two 6" box drawers</li> <li>• One 12" file drawer</li> <li>• Center caster eliminates need for counterbalance weight</li> <li>• Optional dividers sold separately</li> </ul>	Freestanding	15 x 21-5/8" x 27-5/8"	ULP24FBBF	<input type="checkbox"/>	<input type="checkbox"/>	<input type="checkbox"/>	51.0#
USLP								
	<b>Pedestal - FF</b>	Freestanding	15 x 17-5/8" x 27-5/8"	ULP20FFF	<input type="checkbox"/>	<input type="checkbox"/>	<input type="checkbox"/>	79.0#
	<ul style="list-style-type: none"> <li>• Features 2-5/8" non-adjustable glides</li> <li>• Two 12" file drawers</li> <li>• Counterbalance is included</li> <li>• Optional dividers sold separately</li> </ul>	Freestanding	15 x 21-5/8" x 27-5/8"	ULP24FFF	<input type="checkbox"/>	<input type="checkbox"/>	<input type="checkbox"/>	71.0#
USLP								

**A**   **B**   **C**   **D**

## HOW TO ORDER

Indicate the following information on order form:

1. Quantity of each item.
2. Model number, including options. See "How To Build a Model Number".
3. Any special service required.

Note: • The  indicates that a choice is required.

- The absence of the  indicates that no choice is required.
- Alpha-numeric characters in place of  indicate that no other alternatives are available.

## HOW TO BUILD A MODEL NUMBER

- A** Select basic model.
- B** Select unit and drawer color.  
Refer to color addendum at [ki.com](http://ki.com) or KI Fabrics & Finishes binder.
- C** Select key option.
 

<b>KS</b>	- Key standard
<b>NLC</b>	- No lock core
<b>KA</b>	- Key alike
- D** Select pull style.
 

<b>USP</b>	- U-Series Pull (Standard)
<b>CZP</b>	- Connection Zone Pull

## INFORMATION

**Height**  
All freestanding pedestals include 1/4" allowance for glides in recessed position.

**Accessories**  
See accessory section for accessories that can be ordered separately.

**Weights**  
Figures provided are approximate and reflect packaged product without additional accessories.



# U-Series® Pedestals

Freestanding

Delivered  
Pricing

\$ 401

427

Whites &  
All Metallics  
Upcharge

\$ 58

58

\$ 472

478

\$ 58

58

## SPECIAL SERVICES

### Special Carton Marking

With specially marked information N/C

### Shipping

Shipped **assembled freight prepaid f.o.b.**  
**Pembroke, Ontario K8A 0E1** factory.  
Freight class #70.

Specifications and prices are subject to  
change without prior notice.

# U-Series® Pedestals

Worksurface Supporting

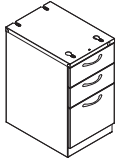
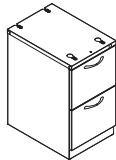
MODEL	Features	W x D x H	MODEL NUMBER				
			Basic Model	Unit Color	Bracket	Key Option	Pull Style
 <p><b>Pedestal - Box/Box/File</b></p> <ul style="list-style-type: none"> <li>• Two 6" box drawers</li> <li>• One 12" file drawer</li> <li>• Includes four leveling glides</li> <li>• Pedestal ships fully assembled</li> <li>• Bracket, if ordered, ships with unit</li> <li>• Optional dividers sold separately</li> </ul>	Worksurface Supporting	15 x 17-5/8 x 27-7/8"	ULP20WBBF	<input type="checkbox"/>	<input type="checkbox"/> <input type="checkbox"/> <input type="checkbox"/> <input type="checkbox"/>	<input type="checkbox"/> <input type="checkbox"/>	<input type="checkbox"/> <input type="checkbox"/>
	Worksurface Supporting	15 x 21-5/8 x 27-7/8"	ULP24WBBF	<input type="checkbox"/>	<input type="checkbox"/> <input type="checkbox"/> <input type="checkbox"/> <input type="checkbox"/>	<input type="checkbox"/> <input type="checkbox"/>	<input type="checkbox"/> <input type="checkbox"/>
 <p><b>Pedestal - File/File</b></p> <ul style="list-style-type: none"> <li>• Two 12" file drawers</li> <li>• Includes four leveling glides</li> <li>• Pedestal ships fully assembled</li> <li>• Bracket, if ordered, ships with unit</li> <li>• Optional dividers sold separately</li> </ul>	Worksurface Supporting	15 x 17-5/8 x 27-7/8"	ULP20WFF	<input type="checkbox"/>	<input type="checkbox"/> <input type="checkbox"/> <input type="checkbox"/> <input type="checkbox"/>	<input type="checkbox"/> <input type="checkbox"/>	<input type="checkbox"/> <input type="checkbox"/>
	Worksurface Supporting	15 x 21-5/8 x 27-7/8"	ULP24WFF	<input type="checkbox"/>	<input type="checkbox"/> <input type="checkbox"/> <input type="checkbox"/> <input type="checkbox"/>	<input type="checkbox"/> <input type="checkbox"/>	<input type="checkbox"/> <input type="checkbox"/>

**A**   **B**   **C**   **D**   **E**

## HOW TO ORDER

Indicate the following information on order form:

1. Quantity of each item.
2. Model number, including options. See "How To Build a Model Number".
3. Any special service required.

Note: • The  indicates that a choice is required.

- The absence of the  indicates that no choice is required.
- Alpha-numeric characters in place of  indicate that no other alternatives are available.

## HOW TO BUILD A MODEL NUMBER

- A** Select basic model.
- B** Select unit color.  
Refer to color addendum at ki.com or KI Fabrics & Finishes binder.  
All white and metallic paints require an upcharge. Please see upcharge column.
- C** Select bracket.
 

<b>NB</b>	- No Bracket
<b>3K24</b>	- 24" Worksurface; add \$74
<b>3K30</b>	- 30" Worksurface; add \$74
<b>SW24</b>	- 24" Worksurface; add \$74
<b>SW30</b>	- 30" Worksurface; add \$74
<b>UN22</b>	- 22" Worksurface; add \$74
<b>UN24</b>	- 24" Worksurface; add \$74
<b>UN24KN</b>	- 24" Worksurface w/knife edge; add \$74
<b>UN30</b>	- 30" Worksurface; add \$74
<b>UN30KN</b>	- 30" Worksurface w/knife edge; add \$74
<b>WW24</b>	- 24" Worksurface; add \$74
<b>WW30</b>	- 30" Worksurface; add \$74

When ordering:  
**3K** for System 3000  
**SW** for Studio Works  
**UN** for Unite  
**WW** for WireWorks  
 If ped is not replacing return, no bracket is required.

- D** Select key option.
 

<b>KS</b>	- Key standard
<b>NLC</b>	- No lock core
<b>KA</b>	- Key alike
- E** Select pull style.
 

<b>USP</b>	- U-Series Pull (Standard)
<b>CZP</b>	- Connection Zone Pull

## INFORMATION

**Accessories**  
 See accessory section for accessories that can be ordered separately.

**Weights**  
 Figures provided are approximate and reflect packaged product without additional accessories.



# U-Series® Pedestals

Worksurface Supporting

Approx. Packaged Weight	Delivered Pricing	Whites & All Metallics Upcharge
47.0#	\$ 392	\$ 58
52.0#	415	58
43.0#	\$ 351	\$ 58
48.0#	367	58

**SPECIAL SERVICES**

**Special Carton Marking**

With specially marked information N/C

**Shipping**

Shipped **assembled freight prepaid f.o.b. Pembroke, Ontario K8A 0E1** factory. Freight class #70.

Specifications and prices are subject to change without prior notice.

# U-Series® Double Pedestals

Worksurface Supporting

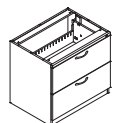

PUSP

MODEL	W x D x H	MODEL NUMBER					Approx. Packaged Weight
		Basic Model	Unit Color	Bracket	Key Option	Pull Style	
<b>30" Wide, 2 High</b> • Two 12" drawers with side-to-side hanging folder bars • For use within panel systems' planning only, may not be planned free standing	30 x 22 x 27-3/4"	UDP302D	<input type="checkbox"/>	<input type="checkbox"/>	<input type="checkbox"/>	<input type="checkbox"/>	88.0#

**A**   **B**   **C**   **D**   **E**

## HOW TO ORDER

Indicate the following information on order form:

- Quantity of each item.
- Model number, including options. See "How To Build a Model Number".
- Any special service required.

Note: • The  indicates that a choice is required.

- The absence of the  indicates that no choice is required.
- Alpha-numeric characters in place of  indicate that no other alternatives are available.

## HOW TO BUILD A MODEL NUMBER

- A** Select basic model.
- B** Select unit color.  
Refer to color addendum at ki.com or KI Fabrics & Finishes binder.  
All white and metallic paints require an upcharge. Please see upcharge column.
- C** Select bracket.
 

<b>NB</b>	- No Bracket
<b>3K24</b>	- 24" Worksurface; add \$74
<b>3K30</b>	- 30" Worksurface; add \$81
<b>SW24</b>	- 24" Worksurface; add \$96
<b>SW30</b>	- 30" Worksurface; add \$100
<b>UN22</b>	- 22" Worksurface; add \$74
<b>UN24</b>	- 24" Worksurface; add \$74
<b>UN24KN</b>	- 24" Worksurface w/knife edge; add \$74
<b>UN30</b>	- 30" Worksurface; add \$74
<b>UN30KN</b>	- 30" Worksurface w/knife edge; add \$74
<b>WW24</b>	- 24" Worksurface; add \$69
<b>WW30</b>	- 30" Worksurface; add \$73

When ordering:  
**3K** for System 3000  
**SW** for Studio Works  
**UN** for Unite  
**WW** for WireWorks  
 If ped is not replacing return, no bracket is required.

- D** Select key option.
 

<b>KS</b>	- Key standard
<b>NLC</b>	- No lock core
<b>KA</b>	- Key alike
- E** Select pull style.
 

<b>USP</b>	- U-Series Pull (Standard)
<b>CZP</b>	- Connection Zone Pull

## INFORMATION

**Accessories**  
See accessory section for accessories that can be ordered separately.

**Height**  
Height shown is with glides in fully recessed position. Maximum height is 28-1/2".

**Weights**  
Figures provided are approximate and reflect packaged product without additional accessories.

**Folder Bars**  
Files are configured for side-to-side media storage.h



# U-Series<sup>®</sup> Double Pedestals

Worksurface Supporting

Delivered  
Pricing

\$ 753

Whites &  
All Metallics  
Upcharge

\$ 58

## SPECIAL SERVICES

### Special Carton Marking

With specially marked information N/C

### Shipping

Shipped **assembled freight prepaid f.o.b.**  
**Pembroke, Ontario K8A 0E1** factory.  
Freight class #70.

Specifications and prices are subject to  
change without prior notice.

# U-Series® Credenzas

Freestanding Credenzas

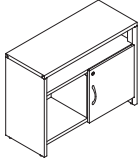
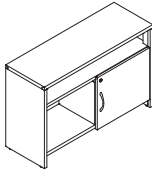
	MODEL	W x D x H	MODEL NUMBER				Approx. Packaged Weight
			Basic Model	Key Option	Unit Color	Pull Style	
 <p>PUSC</p>	<b>36" Wide</b> • Features sliding door with lock	36 x 15 x 27-3/4"	UC36	<input type="checkbox"/> <input type="checkbox"/> <input type="checkbox"/>	<input type="checkbox"/> <input type="checkbox"/>	<input type="checkbox"/> <input type="checkbox"/> <input type="checkbox"/>	45.0#
 <p>PUSC</p>	<b>42" Wide</b> • Features sliding door with lock	42 x 15 x 27-3/4"	UC42	<input type="checkbox"/> <input type="checkbox"/> <input type="checkbox"/>	<input type="checkbox"/> <input type="checkbox"/>	<input type="checkbox"/> <input type="checkbox"/> <input type="checkbox"/>	50.0#

**A**   **B**   **C**   **D**

### HOW TO ORDER

Indicate the following information on order form:

- Quantity of each item.
- Model number, including options. See "How To Build a Model Number".
- Any special service required.

Note: • The  indicates that a choice is required.  
 • The absence of the  indicates that no choice is required.  
 • Alpha-numeric characters in place of  indicate that no other alternatives are available.

### HOW TO BUILD A MODEL NUMBER

- A** Select basic model.
- B** Select key option.
 

<b>KS</b>	- Key standard
<b>NLC</b>	- No lock core
<b>KA</b>	- Key alike
- C** Select unit color.  
 Refer to color addendum at ki.com or KI Fabrics & Finishes binder.  
 All white and metallic paints require an upcharge. Please see upcharge column.
- D** Select pull style.
 

<b>USP</b>	- U-Series Pull (Standard)
<b>CZP</b>	- Connection Zone Pull

### INFORMATION

#### Accessories

See accessory section for accessories that can be ordered separately.

#### Weights

Figures provided are approximate and reflect packaged product without additional accessories.





# U-Series® Credenzas

Freestanding Credenzas

Delivered Pricing	Whites & All Metallics Upcharge
\$ 919	\$ 58
\$ 1060	\$ 58

### SPECIAL SERVICES

#### Special Carton Marking

With specially marked information N/C

#### Shipping

Shipped **assembled freight prepaid f.o.b. Pembroke, Ontario K8A 0E1** factory. Freight class #70.

Specifications and prices are subject to change without prior notice.

# U-Series® Credenzas

Laminate Tops

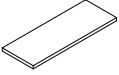
	MODEL	D x W	MODEL NUMBER				Approx. Packaged Weight
			Basic Model	Edge Style	Surface Finish	Edge Color	
 UWCT	<b>U-Series® Credenza-Laminate Tops</b> <ul style="list-style-type: none"> <li>• High pressure laminate with particle-board core</li> <li>• 74P edge only</li> <li>• Back-to-back credenzas should use single piece tops of appropriate depth</li> </ul>	15-1/8 x 36-1/8"	UWCT1536	74P	<input type="checkbox"/> <input type="checkbox"/> <input type="checkbox"/>	<input type="checkbox"/> <input type="checkbox"/> <input type="checkbox"/>	16.0#
		15-1/8 x 42-1/8"	UWCT1542	74P	<input type="checkbox"/> <input type="checkbox"/> <input type="checkbox"/>	<input type="checkbox"/> <input type="checkbox"/> <input type="checkbox"/>	19.0#
		30-1/8 x 36-1/8"	UWCT3036	74P	<input type="checkbox"/> <input type="checkbox"/> <input type="checkbox"/>	<input type="checkbox"/> <input type="checkbox"/> <input type="checkbox"/>	34.0#
		30-1/8 x 42-1/8"	UWCT3042	74P	<input type="checkbox"/> <input type="checkbox"/> <input type="checkbox"/>	<input type="checkbox"/> <input type="checkbox"/> <input type="checkbox"/>	40.0#
			<b>A</b>	<b>B</b>	<b>C</b>	<b>D</b>	

## HOW TO ORDER

Indicate the following information on order form:

1. Quantity of each item.
2. Model number, including options. See "How To Build a Model Number".
3. Any special service required.

Note: • The  indicates that a choice is required.  
 • The absence of the  indicates that no choice is required.  
 • Alpha-numeric characters in place of  indicate that no other alternatives are available.

## HOW TO BUILD A MODEL NUMBER

- A** Select basic model.
- B** Select edge style.  
**74P** - 74P edge
- C** Select surface finish.  
 Refer to color addendum at [ki.com](http://ki.com) or KI Fabrics & Finishes binder.  
 Surface finish offerings are based on edge style selections.
- D** Select edge color.  
 Refer to color addendum at [ki.com](http://ki.com) or KI Fabrics & Finishes binder.



# U-Series® Credenzas

Laminate Tops

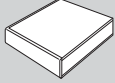

74P Edge  
(74P)

\$ 198

235

252

293

## SPECIAL SERVICES

### Special Carton Marking

With specially marked information N/C

### Shipping

Shipped **assembled freight prepaid f.o.b.**  
**Pembroke, Ontario K8A 0E1** factory.  
Freight class #70.

Specifications and prices are subject to  
change without prior notice.

# U-Series® Wardrobe Towers

48" High Cabinet

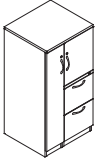
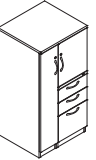
	MODEL	Features	W x D x H	MODEL NUMBER				Approx. Packaged Weight
				Basic Model	Unit Color	Key Option	Pull Style	
 <p>left shown</p>	<b>Wardrobe/Cabinet - File/File</b>	Left	24 x 22 x 48"	UWFFC48L	<input type="checkbox"/> <input type="checkbox"/>	<input type="checkbox"/> <input type="checkbox"/> <input type="checkbox"/> <input type="checkbox"/>	<input type="checkbox"/> <input type="checkbox"/> <input type="checkbox"/> <input type="checkbox"/>	122.0#
	<ul style="list-style-type: none"> <li>• Wardrobe and cabinet lock independently</li> <li>• Pedestal features two 12" drawers and locks independently of wardrobe</li> <li>• Includes four leveling glides</li> <li>• Cabinet features adjustable shelf</li> <li>• Units ship fully assembled</li> </ul>	Right	24 x 22 x 48"	UWFFC48R	<input type="checkbox"/> <input type="checkbox"/>	<input type="checkbox"/> <input type="checkbox"/> <input type="checkbox"/> <input type="checkbox"/>	<input type="checkbox"/> <input type="checkbox"/> <input type="checkbox"/> <input type="checkbox"/>	122.0#
PUSW								
 <p>left shown</p>	<b>Wardrobe/Cabinet - Box/Box/File</b>	Left	24 x 22 x 48"	UWBBFC48L	<input type="checkbox"/> <input type="checkbox"/>	<input type="checkbox"/> <input type="checkbox"/> <input type="checkbox"/> <input type="checkbox"/>	<input type="checkbox"/> <input type="checkbox"/> <input type="checkbox"/> <input type="checkbox"/>	127.0#
	<ul style="list-style-type: none"> <li>• Wardrobe and cabinet lock independently</li> <li>• Pedestal features two 6" box drawers and one 12" file drawer</li> <li>• Includes four leveling glides</li> <li>• Cabinet features adjustable shelf</li> <li>• Units ship fully assembled</li> </ul>	Right	24 x 22 x 48"	UWBBFC48R	<input type="checkbox"/> <input type="checkbox"/>	<input type="checkbox"/> <input type="checkbox"/> <input type="checkbox"/> <input type="checkbox"/>	<input type="checkbox"/> <input type="checkbox"/> <input type="checkbox"/> <input type="checkbox"/>	127.0#
PUSW								

**A**      **B**      **C**      **D**

## HOW TO ORDER

Indicate the following information on order form:

1. Quantity of each item.
2. Model number, including options. See "How To Build a Model Number".
3. Any special service required.

Note: • The  indicates that a choice is required.  
 • The absence of the  indicates that no choice is required.  
 • Alpha-numeric characters in place of  indicate that no other alternatives are available.

## HOW TO BUILD A MODEL NUMBER

- A** Select basic model.
- B** Select unit color.  
Refer to color addendum at [ki.com](http://ki.com) or KI Fabrics & Finishes binder.  
All white and metallic paints require an upcharge. Please see upcharge column.
- C** Select key option.
 

<b>KS</b>	- Key standard
<b>NLC</b>	- No lock core
<b>KA</b>	- Key alike
- D** Select pull style.
 

<b>USP</b>	- U-Series Pull (Standard)
<b>CZP</b>	- Connection Zone Pull

## INFORMATION

### Accessories

See accessory section for accessories that can be ordered separately.

### Weights

Figures provided are approximate and reflect packaged product without additional accessories.



# U-Series® Wardrobe Towers

48" High Cabinet

Delivered  
Pricing

Whites &  
All Metallics  
Upcharge

\$ 1402

\$ 94

1402

94

\$ 1460

\$ 94

1460

94

## SPECIAL SERVICES

### Special Carton Marking

With specially marked information N/C

### Shipping

Shipped **assembled freight prepaid f.o.b.**  
**Pembroke, Ontario K8A 0E1** factory.  
Freight class #70.

Specifications and prices are subject to  
change without prior notice.

# U-Series® Wardrobe Towers

64" High Cabinet

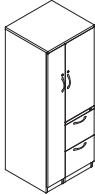
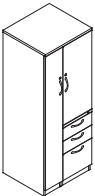
MODEL	Features	W x D x H	MODEL NUMBER				Approx. Packaged Weight
			Basic Model	Unit Color	Key Option	Pull Style	
 <p>left shown</p> <p><b>Wardrobe/Cabinet - File/File</b></p> <ul style="list-style-type: none"> <li>• Wardrobe and cabinet lock independently</li> <li>• Pedestal features two 12" drawers and locks independently of wardrobe</li> <li>• Includes four leveling glides</li> <li>• Cabinet features adjustable shelf</li> <li>• Units ship fully assembled</li> </ul>	Left	24 x 22 x 64"	UWFFC64L	<input type="checkbox"/> <input type="checkbox"/>	<input type="checkbox"/> <input type="checkbox"/> <input type="checkbox"/> <input type="checkbox"/>	<input type="checkbox"/> <input type="checkbox"/>	152.0#
	Right	24 x 22 x 64"	UWFFC64R	<input type="checkbox"/> <input type="checkbox"/>	<input type="checkbox"/> <input type="checkbox"/> <input type="checkbox"/> <input type="checkbox"/>	<input type="checkbox"/> <input type="checkbox"/>	152.0#
 <p>left shown</p> <p><b>Wardrobe/Cabinet - Box/Box/File</b></p> <ul style="list-style-type: none"> <li>• Wardrobe and cabinet lock independently</li> <li>• Pedestal features two 6" box drawers and one 12" file drawer</li> <li>• Includes four leveling glides</li> <li>• Cabinet features adjustable shelf</li> <li>• Units ship fully assembled</li> </ul>	Left	24 x 22 x 64"	UWBBFC64L	<input type="checkbox"/> <input type="checkbox"/>	<input type="checkbox"/> <input type="checkbox"/> <input type="checkbox"/> <input type="checkbox"/>	<input type="checkbox"/> <input type="checkbox"/>	157.0#
	Right	24 x 22 x 64"	UWBBFC64R	<input type="checkbox"/> <input type="checkbox"/>	<input type="checkbox"/> <input type="checkbox"/> <input type="checkbox"/> <input type="checkbox"/>	<input type="checkbox"/> <input type="checkbox"/>	157.0#

**A**   **B**   **C**   **D**

## HOW TO ORDER

Indicate the following information on order form:

1. Quantity of each item.
2. Model number, including options. See "How To Build a Model Number".
3. Any special service required.

Note: • The  indicates that a choice is required.  
 • The absence of the  indicates that no choice is required.  
 • Alpha-numeric characters in place of  indicate that no other alternatives are available.

## HOW TO BUILD A MODEL NUMBER

- A** Select basic model.
- B** Select unit color.  
Refer to color addendum at [ki.com](http://ki.com) or KI Fabrics & Finishes binder.  
All white and metallic paints require an upcharge. Please see upcharge column.
- C** Select key option.
 

<b>KS</b>	- Key standard
<b>NLC</b>	- No lock core
<b>KA</b>	- Key alike
- D** Select pull style.
 

<b>USP</b>	- U-Series Pull (Standard)
<b>CZP</b>	- Connection Zone Pull

## INFORMATION

**Accessories**  
See accessory section for accessories that can be ordered separately.

**Weights**  
Figures provided are approximate and reflect packaged product without additional accessories.



# U-Series® Wardrobe Towers

64" High Cabinet

Delivered  
Pricing

\$ 1471  
1471

Whites &  
All Metallics  
Upcharge

\$ 141  
141

\$ 1507  
1507

\$ 141  
141

## SPECIAL SERVICES

### Special Carton Marking

With specially marked information N/C

### Shipping

Shipped **assembled freight prepaid f.o.b. Pembroke, Ontario K8A 0E1** factory.  
Freight class #70.

Specifications and prices are subject to change without prior notice.

# U-Series® Wardrobe Towers

48" High Side Access Bookcase

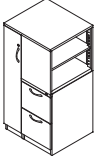
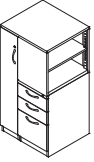
MODEL	Features	W x D x H	MODEL NUMBER				Approx. Packaged Weight
			Basic Model	Unit Color	Key Option	Pull Style	
 <p>left shown</p> <p><b>Wardrobe/Side Access Bookcase - File/File</b></p> <ul style="list-style-type: none"> <li>• Pedestal features two 12" drawers and locks independently of wardrobe</li> <li>• Includes four leveling glides</li> <li>• Cabinet features adjustable shelf</li> <li>• Units ship fully assembled</li> <li>• 48" Tower does not include adjustable shelf</li> </ul>	Left	24 x 22 x 48"	UWFFB48L	<input type="checkbox"/>	<input type="checkbox"/>	<input type="checkbox"/>	120.0#
	Right	24 x 22 x 48"	UWFFB48R	<input type="checkbox"/>	<input type="checkbox"/>	<input type="checkbox"/>	120.0#
PUSW							
 <p>left shown</p> <p><b>Wardrobe/Side Access Bookcase - Box/Box/File</b></p> <ul style="list-style-type: none"> <li>• Pedestal features two 6" box drawers and one 12" file drawer</li> <li>• Includes four leveling glides</li> <li>• Cabinet features adjustable shelf</li> <li>• Units ship fully assembled</li> <li>• 48" Tower does not include adjustable shelf</li> </ul>	Left	24 x 22 x 48"	UWBBFB48L	<input type="checkbox"/>	<input type="checkbox"/>	<input type="checkbox"/>	125.0#
	Right	24 x 22 x 48"	UWBBFB48R	<input type="checkbox"/>	<input type="checkbox"/>	<input type="checkbox"/>	125.0#
PUSW							

**A**   **B**   **C**   **D**

## HOW TO ORDER

Indicate the following information on order form:

1. Quantity of each item.
2. Model number, including options. See "How To Build a Model Number".
3. Any special service required.

Note: • The  indicates that a choice is required.  
 • The absence of the  indicates that no choice is required.  
 • Alpha-numeric characters in place of  indicate that no other alternatives are available.

## HOW TO BUILD A MODEL NUMBER

- A** Select basic model.
- B** Select unit color.  
Refer to color addendum at ki.com or KI Fabrics & Finishes binder.  
All white and metallic paints require an upcharge. Please see upcharge column.
- C** Select key option.
 

<b>KS</b>	- Key standard
<b>NLC</b>	- No lock core
<b>KA</b>	- Key alike
- D** Select pull style.
 

<b>USP</b>	- U-Series Pull (Standard)
<b>CZP</b>	- Connection Zone Pull

## INFORMATION

### Accessories

See accessory section for accessories that can be ordered separately.

### Weights

Figures provided are approximate and reflect packaged product without additional accessories.





U-Series® Wardrobe Towers  
48" High Side Access Bookcase

Delivered Pricing	Whites & All Metallics Upcharge
\$ 1365	\$ 94
1365	94
\$ 1383	\$ 94
1383	94

**SPECIAL SERVICES**

**Special Carton Marking**

With specially marked information N/C

**Shipping**

Shipped **assembled freight prepaid f.o.b. Pembroke, Ontario K8A 0E1** factory. Freight class #70.

Specifications and prices are subject to change without prior notice.

# U-Series® Wardrobe Towers

64" High Side Access Bookcase

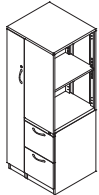
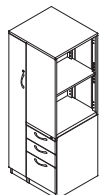
MODEL	Features	W x D x H	MODEL NUMBER				Approx. Packaged Weight
			Basic Model	Unit Color	Key Option	Pull Style	
 <p>left shown</p> <p><b>Wardrobe/Side Access Bookcase - File/File</b></p> <ul style="list-style-type: none"> <li>• Pedestal features two 12" drawers and locks independently of wardrobe</li> <li>• Includes four leveling glides</li> <li>• Cabinet features adjustable shelf</li> <li>• Units ship fully assembled</li> </ul>	Left	24 x 22 x 64"	UWFFB64L	<input type="checkbox"/> <input type="checkbox"/>	<input type="checkbox"/> <input type="checkbox"/> <input type="checkbox"/> <input type="checkbox"/>	<input type="checkbox"/> <input type="checkbox"/> <input type="checkbox"/> <input type="checkbox"/>	155.0#
	Right	24 x 22 x 64"	UWFFB64R	<input type="checkbox"/> <input type="checkbox"/>	<input type="checkbox"/> <input type="checkbox"/> <input type="checkbox"/> <input type="checkbox"/>	<input type="checkbox"/> <input type="checkbox"/> <input type="checkbox"/> <input type="checkbox"/>	155.0#
 <p>left shown</p> <p><b>Wardrobe/Side Access Bookcase - Box/Box/File</b></p> <ul style="list-style-type: none"> <li>• Pedestal features two 6" box drawers and one 12" file drawer</li> <li>• Includes four leveling glides</li> <li>• Cabinet features adjustable shelf</li> <li>• Units ship fully assembled</li> </ul>	Left	24 x 22 x 64"	UWBBFB64L	<input type="checkbox"/> <input type="checkbox"/>	<input type="checkbox"/> <input type="checkbox"/> <input type="checkbox"/> <input type="checkbox"/>	<input type="checkbox"/> <input type="checkbox"/> <input type="checkbox"/> <input type="checkbox"/>	160.0#
	Right	24 x 22 x 64"	UWBBFB64R	<input type="checkbox"/> <input type="checkbox"/>	<input type="checkbox"/> <input type="checkbox"/> <input type="checkbox"/> <input type="checkbox"/>	<input type="checkbox"/> <input type="checkbox"/> <input type="checkbox"/> <input type="checkbox"/>	160.0#

PUSW

PUSW

**A**   **B**   **C**   **D**

## HOW TO ORDER

Indicate the following information on order form:

1. Quantity of each item.
2. Model number, including options. See "How To Build a Model Number".
3. Any special service required.

Note: • The  indicates that a choice is required.  
 • The absence of the  indicates that no choice is required.  
 • Alpha-numeric characters in place of  indicate that no other alternatives are available.

## HOW TO BUILD A MODEL NUMBER

- A** Select basic model.
- B** Select unit color.  
Refer to color addendum at [ki.com](http://ki.com) or KI Fabrics & Finishes binder.  
All white and metallic paints require an upcharge. Please see upcharge column.
- C** Select key option.
 

<b>KS</b>	- Key standard
<b>NLC</b>	- No lock core
<b>KA</b>	- Key alike
- D** Select pull style.
 

<b>USP</b>	- U-Series Pull (Standard)
<b>CZP</b>	- Connection Zone Pull

## INFORMATION

**Accessories**  
See accessory section for accessories that can be ordered separately.

**Weights**  
Figures provided are approximate and reflect packaged product without additional accessories.



# U-Series® Wardrobe Towers

64" High Side Access Bookcase

Delivered  
Pricing

Whites &  
All Metallics  
Upcharge

\$ 1507

\$ 141

1507

141

\$ 1529

\$ 141

1529

141

## SPECIAL SERVICES

### Special Carton Marking

With specially marked information N/C

### Shipping

Shipped **assembled freight prepaid f.o.b.**  
**Pembroke, Ontario K8A 0E1** factory.  
Freight class #70.

Specifications and prices are subject to  
change without prior notice.

# U-Series® Overheads

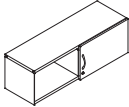
MODEL	W x D x H	MODEL NUMBER				Approx. Packaged Weight
		Basic Model	Bracket	Unit Color	Key Option	
 <p><b>Sliding Door Overhead</b></p> <ul style="list-style-type: none"> <li>• Lockable sliding door extends slightly beyond the center of overhead</li> <li>• Overhead accommodates standard binders</li> </ul>	35-3/4 x 14-3/8 x 14-7/16	USSDH36	<input type="checkbox"/> <input type="checkbox"/> <input type="checkbox"/> <input type="checkbox"/>	<input type="checkbox"/> <input type="checkbox"/>	<input type="checkbox"/> <input type="checkbox"/>	38.0#
	41-3/4 x 14-3/8 x 14-7/16	USSDH42	<input type="checkbox"/> <input type="checkbox"/> <input type="checkbox"/> <input type="checkbox"/>	<input type="checkbox"/> <input type="checkbox"/>	<input type="checkbox"/> <input type="checkbox"/>	42.0#
	47-3/4 x 14-3/8 x 14-7/16	USSDH48	<input type="checkbox"/> <input type="checkbox"/> <input type="checkbox"/> <input type="checkbox"/>	<input type="checkbox"/> <input type="checkbox"/>	<input type="checkbox"/> <input type="checkbox"/>	47.0#
	59-3/4 x 14-3/8 x 14-7/16	USSDH60	<input type="checkbox"/> <input type="checkbox"/> <input type="checkbox"/> <input type="checkbox"/>	<input type="checkbox"/> <input type="checkbox"/>	<input type="checkbox"/> <input type="checkbox"/>	57.0#
	71-3/4 x 14-3/8 x 14-7/16	USSDH72	<input type="checkbox"/> <input type="checkbox"/> <input type="checkbox"/> <input type="checkbox"/>	<input type="checkbox"/> <input type="checkbox"/>	<input type="checkbox"/> <input type="checkbox"/>	67.0#
			<b>A</b>	<b>B</b>	<b>C</b>	<b>D</b>

USSDO

## HOW TO ORDER

Indicate the following information on order form:

1. Quantity of each item.
2. Model number, including options. See "How To Build a Model Number".
3. Any special service required.

Note:

- The  indicates that a choice is required.
- The absence of the  indicates that no choice is required.
- Alpha-numeric characters in place of  indicate that no other alternatives are available.

## HOW TO BUILD A MODEL NUMBER

- A** Select basic model.
- B** Select bracket type.
 

<b>UN</b>	- Unite mounted
<b>UN/UM</b>	- Unite upmount
- C** Select unit color. Refer to color addendum at [ki.com](http://ki.com) or KI Fabrics & Finishes binder. All white and metallic paints require an upcharge. Please see upcharge column.
- D** Select key option.
 

<b>KS</b>	- Key standard
<b>NLC</b>	- No lock core
<b>KA</b>	- Key alike

## INFORMATION

### Weights

Figures provided are approximate and reflect packaged product without additional accessories.



# U-Series® Overheads

Delivered Pricing	Whites & All Metallics Upcharge
\$ 491	\$ 58
525	58
557	58
682	58
805	58

## SPECIAL SERVICES

### Special Carton Marking



With specially marked information N/C

### Shipping

Shipped **assembled freight prepaid**  
**f.o.b. Manitowoc, Wisconsin 54220** factory.  
 Freight class #70.

Specifications and prices are subject to  
 change without prior notice.

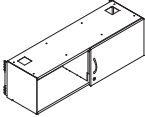
# U-Series® Underhead Storage

	MODEL	D x W x H	MODEL NUMBER				Approx. Packaged Weight	
			Basic Model	Direction	Unit Color	Key Option		
 <p>UHS</p>	<b>Underhead Storage</b> <ul style="list-style-type: none"> <li>Underhead storage units mount below worksurface</li> <li>Underhead accommodates standard binders</li> <li>Storage units include holes in top and bottom for cord drop in conjunction with grommets</li> <li>Includes brackets for attachment; legs may be specified separately if desired</li> <li>Lockable sliding door extends slightly beyond the center divider of storage unit</li> </ul>	35-3/4 x 14-3/8 x 14-7/8	UHS36		<input type="checkbox"/> <input type="checkbox"/>	<input type="checkbox"/> <input type="checkbox"/>	38.0#	
		41-3/4 x 14-3/8 x 14-7/8	UHS42		<input type="checkbox"/> <input type="checkbox"/>	<input type="checkbox"/> <input type="checkbox"/>	42.0#	
		47-3/4 x 14-3/8 x 14-7/8	UHS48		<input type="checkbox"/> <input type="checkbox"/>	<input type="checkbox"/> <input type="checkbox"/>	47.0#	
		59-3/4 x 14-3/8 x 14-7/8	UHS60		<input type="checkbox"/> <input type="checkbox"/>	<input type="checkbox"/> <input type="checkbox"/>	52.0#	
		71-3/4 x 14-3/8 x 14-7/8	UHS72		<input type="checkbox"/> <input type="checkbox"/>	<input type="checkbox"/> <input type="checkbox"/>	57.0#	
 <p>UHSL</p>	<b>Underhead Storage Support Leg</b> <ul style="list-style-type: none"> <li>May be used in place of return</li> <li>Size noted does not reflect attachment brackets</li> </ul>	1-1/2 x 13-7/8 x 13-5/16"	UHSL	<input type="checkbox"/>	<input type="checkbox"/> <input type="checkbox"/>		8.6#	

**A**   **B**   **C**   **D**

## HOW TO ORDER

Indicate the following information on order form:

- Quantity of each item.
- Model number, including options. See "How To Build a Model Number".
- Any special service required.

Note:

- The  indicates that a choice is required.
- The absence of the  indicates that no choice is required.
- Alpha-numeric characters in place of  indicate that no other alternatives are available.

## HOW TO BUILD A MODEL NUMBER

- A** Select basic model.
- B** Select placement of leg.
 

L	- Left
R	- Right
- C** Select unit color. Refer to color addendum at [ki.com](http://ki.com) or KI Fabrics & Finishes binder. All white and metallic paints require an upcharge. Please see upcharge column.
- D** Select key option.
 

KS	- Key standard
KA	- Key alike
NLC	- No lock core



# U-Series® Underhead Storage

Delivered Pricing	Whites & All Metallics Upcharge
\$ 491	\$ 58
525	58
557	58
638	58
682	58
<hr/>	
\$ 123	\$ 10
<hr/>	
<hr/>	
<hr/>	

**SPECIAL SERVICES**

**Special Carton Marking**

With specially marked information N/C

**Shipping**

Shipped **assembled freight prepaid f.o.b. Manitowoc, Wisconsin 54220** factory. Freight class #70.

Specifications and prices are subject to change without prior notice.

# U-Series® Storage and Accessories

## Overhead Accessories

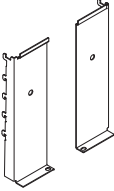
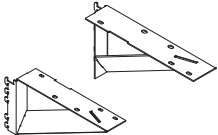
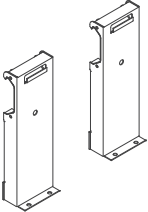
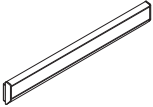
	MODEL	L	MODEL NUMBER		Approx. Packaged Weight
			Basic Model	Trim Color	
	<b>U-Series® Overhead On-Module Mounting Bracket for Unite</b> <ul style="list-style-type: none"> <li>Sold in pairs</li> <li>Mounts into slots in frame</li> <li>Black only</li> <li>Allows for vertical adjustment in 1" increment</li> </ul>		48.0222.SET		5.0#
HRDPT					
	<b>U-Series® Overhead Upmount Brackets for Unite</b> <ul style="list-style-type: none"> <li>Sold in pairs</li> <li>Mounts into slots in frame</li> <li>Uses 8" of slot space at top of panel</li> <li>Overhead extends 15" above top cap</li> <li>Fasteners and allen wrench included</li> </ul>		48.0236.12.S	<input type="checkbox"/>	7.0#
HRDPT					
	<b>U-Series® Overhead Load Bar Brackets for Unite</b> <ul style="list-style-type: none"> <li>Sold in pairs</li> <li>Load Bar Brackets attach to an externally mounted load bar</li> <li>Load Bar purchased separately</li> </ul>		46.8186.SET	<input type="checkbox"/>	5.0#
HRDPT					
	<b>Wall Mounted Load Bar for Unite</b> <ul style="list-style-type: none"> <li>Supports overhead storage on drywall or other non-panel application</li> <li>Requires Load Bar brackets to support storage unit-sold separately</li> </ul>	24"	SWLB.24	<input type="checkbox"/>	5.0#
		30"	SWLB.30	<input type="checkbox"/>	6.0#
		36"	SWLB.36	<input type="checkbox"/>	7.0#
		42"	SWLB.42	<input type="checkbox"/>	8.0#
		48"	SWLB.48	<input type="checkbox"/>	10.0#
		60"	SWLB.60	<input type="checkbox"/>	12.0#
		66"	SWLB.66	<input type="checkbox"/>	13.0#
		72"	SWLB.72	<input type="checkbox"/>	14.0#
		84"	SWLB.84	<input type="checkbox"/>	17.0#
		96"	SWLB.96	<input type="checkbox"/>	19.0#

**A**

**B**

### HOW TO ORDER

Indicate the following information on order form:

- Quantity of each item.
- Model number, including options. See "How To Build a Model Number".
- Any special service required.

Note:

- The  indicates that a choice is required.
- The absence of the  indicates that no choice is required.
- Alpha-numeric characters in place of  indicate that no other alternatives are available.

### HOW TO BUILD A MODEL NUMBER

- A** Select basic model.
- B** Select trim color.  
Refer to color addendum at [ki.com](http://ki.com) or KI Fabrics & Finishes binder.





# U-Series® Storage and Accessories

Overhead Accessories

Delivered  
Pricing  
\$ 152

\$ 254

\$ 190

\$ 111  
119  
121  
133  
138  
164  
166  
173  
268  
280

### SPECIAL SERVICES

#### Special Carton Marking

With specially marked information N/C

#### Shipping

Shipped **assembled freight prepaid**  
**f.o.b. Manitowoc, Wisconsin 54220** factory.  
Freight class #70.

Specifications and prices are subject to  
change without prior notice.

# U-Series® Storage and Accessories

## Task Lights

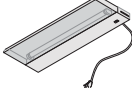
MODEL	MODEL NUMBER		Approx. Packaged Weight
	Basic Model		
 <p><b>Task Lights</b></p> <ul style="list-style-type: none"> <li>• For use under U-Series™ overheads on Unite® panels</li> <li>• Attachment straps included</li> </ul>	UTLT5.24	3.9#	
	UTLT5.36	5.3#	
	UTLT5.48	6.7#	

HRDPT

**A**

### HOW TO ORDER

Indicate the following information on order form:

1. Quantity of each item.
2. Model number, including options. See "How To Build a Model Number".
3. Any special service required.

- Note:
- The  indicates that a choice is required.
  - The absence of the  indicates that no choice is required.
  - Alpha-numeric characters in place of  indicate that no other alternatives are available.

### HOW TO BUILD A MODEL NUMBER

**A** Select basic model.

### INFORMATION

#### TASK LIGHT CABINET WIDTH

Cabinet Width	Light Width
24"	18"
30"	24"
36"	24"
42"	36"
48"	36"
54"	48"
60"	48"
72"	48"



# U-Series® Storage and Accessories

Task Lights

Delivered  
Pricing

\$ 75  
82  
88

## SPECIAL SERVICES

### Special Carton Marking

With specially marked information N/C

### Shipping

Shipped **assembled freight prepaid**  
**f.o.b. Manitowoc, Wisconsin 54220** factory.  
Freight class #70.

Specifications and prices are subject to  
change without prior notice.

# U-Series® Accessories

## Pedestal Accessories

MODEL	Features	MODEL NUMBER		Approx. Packaged Weight	
		Basic Model	Paint Color		
 <p>USPA</p> <p><b>Pedestal Bracket</b></p> <ul style="list-style-type: none"> <li>Graphic represents bracket used with a 24" deep pedestal on a 24" deep worksurface</li> <li>Bracket is intended to fill the space between back of pedestal and panel</li> <li>Bracket provides support for extended runs and screws with trim to outside back of pedestal for added support on extended panel runs</li> <li>Bracket depth varies by pedestal model                             <ul style="list-style-type: none"> <li>24" worksurface                                     <ul style="list-style-type: none"> <li>- 20" pedestal = approx. 6-1/4"</li> <li>- 24" pedestal = approx. 2-1/4"</li> </ul> </li> <li>30" worksurface                                     <ul style="list-style-type: none"> <li>- 20" pedestal = approx. 12-1/4"</li> <li>- 24" pedestal = approx. 6-1/4"</li> </ul> </li> </ul> </li> </ul>	System 3000® 24" deep worksurface	3K24	<input type="checkbox"/>	6.0#	
	System 3000® 30" deep worksurface	3K30	<input type="checkbox"/>	10.0#	
	StudioWorks® 24" deep worksurface	SW24	<input type="checkbox"/>	6.0#	
	StudioWorks® 30" deep worksurface	SW30	<input type="checkbox"/>	10.0#	
	Unite® 22" deep worksurface	UN22	<input type="checkbox"/>	6.0#	
	Unite® 24" deep worksurface	UN24	<input type="checkbox"/>	6.0#	
	Unite® 24" deep knife edge worksurface	UN24KN	<input type="checkbox"/>	10.0#	
	Unite® 30" deep worksurface	UN30	<input type="checkbox"/>	6.0#	
	Unite® 30" deep knife edge worksurface	UN30KN	<input type="checkbox"/>	10.0#	
	WireWorks® 24" deep worksurface	WW24	<input type="checkbox"/>	6.0#	
	WireWorks® 30" deep worksurface	WW30	<input type="checkbox"/>	10.0#	

**A**

**B**

### HOW TO ORDER

Indicate the following information on order form:

- Quantity of each item.
- Model number, including options. See "How To Build a Model Number".
- Any special service required.

Note: • The  indicates that a choice is required.

- The absence of the  indicates that no choice is required.
- Alpha-numeric characters in place of  indicate that no other alternatives are available.

### HOW TO BUILD A MODEL NUMBER

- A** Select basic model.
- B** Select paint color. Refer to color addendum at [ki.com](http://ki.com) or KI Fabrics & Finishes binder.



# U-Series® Accessories

Pedestal Accessories

Delivered Pricing

\$	74
	74
	74
	74
	74
	74
	74
	74
	74
	74
	74

**SPECIAL SERVICES**

**Special Carton Marking**

With specially marked information      N/C

**Shipping**

Delivered. Shipped **k.d. freight prepaid**  
**f.o.b. Pembroke, Ontario K8A 0E1** factory.  
Freight class #70.

Specifications and prices are subject to  
change without prior notice.

# U-Series® Accessories

## Pedestal Accessories

	MODEL	W x D x H	MODEL NUMBER			Approx. Packaged Weight	Delivered Pricing C.O.M.
			Basic Model	Trim Color	Upholstery Color		
 PDCU	<b>Cushioned Seat for Mobile Pedestal</b> <ul style="list-style-type: none"> <li>• 17" deep, used with 17-5/8" deep mobile pedestal</li> <li>• 20" deep, used with 21-5/8" deep mobile pedestal</li> <li>• Fabric runs side to side</li> <li>• Lip height is 3-1/4"</li> </ul>	15 x 17 x 1-7/8"	PDCU/17	<input type="checkbox"/> <input type="checkbox"/>	<input type="checkbox"/> <input type="checkbox"/> <input type="checkbox"/> <input type="checkbox"/>	5.0#	\$ 151
		15 x 20 x 1-7/8"	PDCU/20	<input type="checkbox"/> <input type="checkbox"/>	<input type="checkbox"/> <input type="checkbox"/> <input type="checkbox"/> <input type="checkbox"/>	6.0#	163

A

B

C

### HOW TO ORDER

Indicate the following information on order form:

1. Quantity of each item.
2. Model number, including options. See "How To Build a Model Number".
3. Any special service required.

Note: • The  indicates that a choice is required.

- The absence of the  indicates that no choice is required.
- Alpha-numeric characters in place of  indicate that no other alternatives are available.

### HOW TO BUILD A MODEL NUMBER

- A** Select basic model.
- B** Select trim color.  
Refer to color addendum at [ki.com](http://ki.com) or KI Fabrics & Finishes binder.
- C** Select upholstery color.  
Refer to color addendum at [ki.com](http://ki.com) or KI Fabrics & Finishes binder.  
For a listing of available fabric finishes, please refer to the Color Addendum. For specific fabric availability on cushioned seats, please refer to E-Spec.



# U-Series® Accessories

Pedestal Accessories

Delivered Pricing Fabric Grade 1	Delivered Pricing Fabric Grade 2	Delivered Pricing Fabric Grade 3	Delivered Pricing Pallas Fabric Group P0	Delivered Pricing Pallas Fabric Group P1	Delivered Pricing Pallas Fabric Group P2	Delivered Pricing Pallas Fabric Group P3	Delivered Pricing Pallas Fabric Group P4
\$ 151	\$ 172	\$ 181	\$ 190	\$ 201	\$ 212	\$ 236	\$ 242
163	180	193	200	210	221	247	253

## SPECIAL SERVICES

### Special Carton Marking

With specially marked information N/C





### Shipping

Shipped **assembled freight prepaid f.o.b.**  
**Green Bay, Wisconsin 54302** factory.  
Freight class #100.

Specifications and prices are subject to  
change without prior notice.

# U-Series® Accessories

Pedestal Accessories

				MODEL NUMBER		
MODEL	Features	W x D x H	Basic Model	Approx. Packaged Weight		
 USPA	<b>Counterbalance Weight</b> • Required for conversion for 24" deep mobile and freestanding to file/file units.	24"D Units 12-1/2 x 2 x 18"	USPCBW25	25.0#		
 USPA	<b>Counterbalance Weight</b> • Required for conversion for 20" deep mobile and freestanding to file/file units. • Two required, sold in pairs	For 20" D Units 7-1/2 x 3/4 x 16"	USPCBW36	36.0#		
 HRDPT	<b>P-Series Keys</b> • Extractor key used for core removal	Lock/Core Set	2.KP20522	0.4#		
			Master Key	2.KP20550	0.2#	
			Extractor Key	2.KP20551	0.2#	
			Key Blank	2.KP20552	0.2#	
			Cut Key	2.KP20557	0.2#	
 USPA	<b>Caster Kit</b> • Converts freestanding pedestals to mobile units • Finished height consistent with freestanding pedestal • File/file units require counterbalance weights • 4 casters and a 5th wheel per kit	2-5/8"	USPCK	1.0#		
 USPA	<b>Glide Kit</b> • Converts mobile pedestal to freestanding • File/file units require counterbalance weights • Finished height consistent with mobile pedestal • 4 glides and a center wheel per kit	2-5/8"	USPGK	1.0#		

**A**

## HOW TO ORDER

Indicate the following information on order form:

- Quantity of each item.
- Model number, including options. See "How To Build a Model Number".
- Any special service required.

Note: • The  indicates that a choice is required.

- The absence of the  indicates that no choice is required.
- Alpha-numeric characters in place of  indicate that no other alternatives are available.

## HOW TO BUILD A MODEL NUMBER

- A** Select basic model.





Delivered Pricing	
\$ 84	
\$ 166	
\$ 12	
9	
9	
3	
4	
\$ 65	
\$ 65	

**SPECIAL SERVICES**

**Special Carton Marking**

With specially marked information N/C



**Shipping**

Shipped assembled freight prepaid f.o.b. Pembroke, Ontario K8A 0E1 factory. Freight class #70.

Specifications and prices are subject to change without prior notice.

# U-Series® Accessories

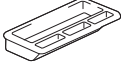
Pedestal Accessories

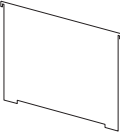
	MODEL	W x D x H	MODEL NUMBER		Approx. Packaged Weight
			Basic Model		
 PDACU	<b>Pencil Tray</b> • For 6" box drawers • Black finish only	12-1/8 x 4 x 1"	S7P/PENTRAY		1.0#
 PDACU	<b>6" Partition</b> • For 6" box drawers • Black finish only • Priced each	12-1/8 x 4-5/8"	S7P/D6		1.0#
 PDACU	<b>Hanging Folder Partition</b> • For 12" file drawers • Black finish only • Priced each	12-1/8 x 9-5/8"	S7P/D12		1.0#

**A**

## HOW TO ORDER

Indicate the following information on order form:

1. Quantity of each item.
2. Model number, including options. See "How To Build a Model Number".
3. Any special service required.

Note:

- The  indicates that a choice is required.
- The absence of the  indicates that no choice is required.
- Alpha-numeric characters in place of  indicate that no other alternatives are available.

## HOW TO BUILD A MODEL NUMBER

**A** Select basic model.



# U-Series® Accessories

Pedestal Accessories

Delivered  
Pricing

\$ 8

\$ 5

\$ 8

## SPECIAL SERVICES

### Special Carton Marking

With specially marked information N/C

### Shipping

Delivered. Shipped k.d. freight prepaid  
f.o.b. **Pembroke, Ontario K8A 0E1** factory.  
Freight class #70.

Specifications and prices are subject to  
change without prior notice.

# Accessories

## Acoustic Septum Kits

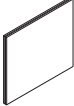
	MODEL	W x H	MODEL NUMBER		Approx. Packaged Weight
			Basic Model		
 HRDPT	<b>Acoustic Septum Kit</b>	24 x 32"	UNRC.2432		5.1#
	• 2" thick fiberglass sheet is field installed inside frame structure	30 x 32"	UNRC.3032		6.0#
	• When used with Unite® tiles, kit provides .70NRC / .70SAA per ASTM C423-09a	36 x 32"	UNRC.3632		6.9#
	• Acoustic septum kit may be specified with any Unite® base style	42 x 32"	UNRC.4232		7.8#
	• Specify by panel size (72" panels include 2-36" kits)	48 x 32"	UNRC.4832		8.8#
	• Septums may be field-trimmed to allow clearance for beltway power	60 x 32"	UNRC.6032		10.6#
		72 x 32"	UNRC.7232		11.6#
		24 x 40"	UNRC.2440		6.1#
		30 x 40"	UNRC.3040		7.4#
		36 x 40"	UNRC.3640		8.7#
		42 x 40"	UNRC.4240		10.0#
		48 x 40"	UNRC.4840		11.2#
		60 x 40"	UNRC.6040		13.8#
		72 x 40"	UNRC.7240		15.2#
		24 x 48"	UNRC.2448		7.2#
		30 x 48"	UNRC.3048		8.8#
		36 x 48"	UNRC.3648		10.5#
		42 x 48"	UNRC.4248		12.1#
		48 x 48"	UNRC.4848		13.7#
		60 x 48"	UNRC.6048		17.0#
		72 x 48"	UNRC.7248		18.7#
		24 x 56"	UNRC.2456		8.3#
		30 x 56"	UNRC.3056		10.3#
		36 x 56"	UNRC.3656		12.2#
		42 x 56"	UNRC.4256		14.2#
		48 x 56"	UNRC.4856		16.2#
		60 x 56"	UNRC.6056		20.2#
		72 x 56"	UNRC.7256		22.3#
		24 x 64"	UNRC.2464		9.3#
		30 x 64"	UNRC.3064		11.7#
	36 x 64"	UNRC.3664		14.0#	
	42 x 64"	UNRC.4264		16.3#	
	48 x 64"	UNRC.4864		18.7#	
	60 x 64"	UNRC.6064		25.5#	
	72 x 64"	UNRC.7264		25.8#	

**A**

### HOW TO ORDER

Indicate the following information on order form:

1. Quantity of each item.
2. Model number, including options. See "How To Build a Model Number".
3. Any special service required.

Note: • The  indicates that a choice is required.

- The absence of the  indicates that no choice is required.
- Alpha-numeric characters in place of  indicate that no other alternatives are available.

### HOW TO BUILD A MODEL NUMBER

- A** Select basic model.



Delivered  
Pricing

\$ 48
57
83
95
113
113
165
82
83
161
161
161
161
316
62
95
161
187
187
187
316
95
121
161
187
240
240
319
95
141
161
187
240
277
319

**SPECIAL SERVICES**

**Special Carton Marking**

With specially marked information N/C

**Shipping**

Shipped k.d. freight prepaid f.o.b. Manitowoc, Wisconsin 54220 factory. Freight class #70.

Specifications and prices are subject to change without prior notice.

# Accessories

## Glass Divider Screen

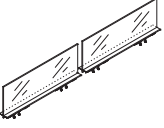
	MODEL	W x H	MODEL NUMBER			Approx. Packaged Weight
			Basic Model	Glass Color	Trim Color	
 <p>UNGD</p>	<b>Glass Divider Screen</b>	24 x 12"	UNGDS24	<input type="checkbox"/> <input type="checkbox"/> <input type="checkbox"/>	<input type="checkbox"/> <input type="checkbox"/>	20.0#
	• Unframed glass divider drops into panel top	30 x 12"	UNGDS30	<input type="checkbox"/> <input type="checkbox"/> <input type="checkbox"/>	<input type="checkbox"/> <input type="checkbox"/>	23.0#
	• Divider base takes place of top cap	36 x 12"	UNGDS36	<input type="checkbox"/> <input type="checkbox"/> <input type="checkbox"/>	<input type="checkbox"/> <input type="checkbox"/>	26.0#
	• May span two panels up to 72" wide maximum	42 x 12"	UNGDS42	<input type="checkbox"/> <input type="checkbox"/> <input type="checkbox"/>	<input type="checkbox"/> <input type="checkbox"/>	28.0#
	• May not be used over segmented glass or segmented perforated steel panels	48 x 12"	UNGDS48	<input type="checkbox"/> <input type="checkbox"/> <input type="checkbox"/>	<input type="checkbox"/> <input type="checkbox"/>	31.0#
	• May not be used over stacking sections or adjacent to trim UEORV	54 x 12"	UNGDS54	<input type="checkbox"/> <input type="checkbox"/> <input type="checkbox"/>	<input type="checkbox"/> <input type="checkbox"/>	35.0#
	• Glass features polished edge	60 x 12"	UNGDS60	<input type="checkbox"/> <input type="checkbox"/> <input type="checkbox"/>	<input type="checkbox"/> <input type="checkbox"/>	38.0#
		66 x 12"	UNGDS66	<input type="checkbox"/> <input type="checkbox"/> <input type="checkbox"/>	<input type="checkbox"/> <input type="checkbox"/>	40.0#
		72 x 12"	UNGDS72	<input type="checkbox"/> <input type="checkbox"/> <input type="checkbox"/>	<input type="checkbox"/> <input type="checkbox"/>	43.0#
				<b>A</b> <b>B</b> <b>C</b>		

### HOW TO ORDER

Indicate the following information on order form:

- Quantity of each item.
- Model number, including options. See "How To Build a Model Number".
- Any special service required.

Note: • The  indicates that a choice is required.

- The absence of the  indicates that no choice is required.
- Alpha-numeric characters in place of  indicate that no other alternatives are available.

### HOW TO BUILD A MODEL NUMBER

**A** Select basic model.

**B** Select glass color.

<b>GLA</b>	- Clear (std)
<b>GLV</b>	- Satin etch one side

**C** Select trim color.

Refer to color addendum at [ki.com](http://ki.com) or KI Fabrics & Finishes binder.  
Metallic finish not available.



# Accessories

Glass Divider Screen

Clear (GLA)	Satin Etch One Side (GLV)
\$ 226	\$ 268
234	277
258	308
293	352
306	372
317	392
332	415
398	476
440	540

## SPECIAL SERVICES

### Special Carton Marking

With specially marked information N/C

### Shipping

Shipped **k.d. freight prepaid f.o.b. Manitowoc, Wisconsin 54220** factory. Freight class #70.

Specifications and prices are subject to change without prior notice.

# Accessories

## Frameless Modesty Panel with Acrylic Insert

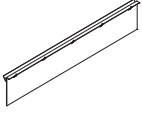
	MODEL	W x H	MODEL NUMBER		Approx. Packaged Weight
			Basic Model	Acrylic	
 <p>UMOD</p>	<b>Frameless Modesty Panel</b>	24 x 10	UMODA24	<input type="checkbox"/> <input type="checkbox"/>	7.0#
	<ul style="list-style-type: none"> <li>• Metal attachment to worksurface underside acrylic panel</li> <li>• Dimension listed refers to the worksurface width; actual width is approximately 6" undersized</li> </ul>	30 x 10	UMODA30	<input type="checkbox"/> <input type="checkbox"/>	8.0#
		36 x 10	UMODA36	<input type="checkbox"/> <input type="checkbox"/>	9.0#
		42 x 10	UMODA42	<input type="checkbox"/> <input type="checkbox"/>	11.0#
		48 x 10	UMODA48	<input type="checkbox"/> <input type="checkbox"/>	13.0#
		54 x 10	UMODA54	<input type="checkbox"/> <input type="checkbox"/>	14.0#
		60 x 10	UMODA60	<input type="checkbox"/> <input type="checkbox"/>	16.0#
		66 x 10	UMODA66	<input type="checkbox"/> <input type="checkbox"/>	18.0#
		72 x 10	UMODA72	<input type="checkbox"/> <input type="checkbox"/>	19.0#
				<b>A</b>	<b>B</b>

### HOW TO ORDER

Indicate the following information on order form:

1. Quantity of each item.
2. Model number, including options. See "How To Build a Model Number".
3. Any special service required.

Note: • The  indicates that a choice is required.

- The absence of the  indicates that no choice is required.
- Alpha-numeric characters in place of  indicate that no other alternatives are available.

### HOW TO BUILD A MODEL NUMBER

- A** Select basic model.
- B** Select acrylic color.  
Refer to color addendum at [ki.com](http://ki.com) or KI Fabrics & Finishes binder.





# Accessories

Frameless Modesty Panel with Acrylic Insert

Delivered  
Pricing

\$ 104  
130  
164  
186  
227  
234  
400  
405  
417

## SPECIAL SERVICES

### Special Carton Marking

With specially marked information N/C



### Shipping

Shipped k.d. freight prepaid f.o.b. Manitowoc, Wisconsin 54220 factory. Freight class #70.

Specifications and prices are subject to change without prior notice.

# Accessories

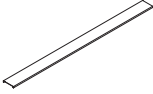
## Continuous Top Cap/Carpet Gripper/Alum Grommet

	MODEL	MODEL NUMBER		Approx. Packaged Weight
		Basic Model	Trim Color	
 HRDPT	<b>Continuous Top Cap</b> <ul style="list-style-type: none"> <li>Used in place of standard top cap for uninterrupted spans between intersections</li> <li>To specify, add together nominal panel widths</li> <li>Maximum span is 6 feet</li> </ul>	48.0717.48	<input type="checkbox"/>	2.7#
		48.0717.54	<input type="checkbox"/>	3.4#
		48.0717.60	<input type="checkbox"/>	3.6#
		48.0717.66	<input type="checkbox"/>	3.8#
		48.0717.72	<input type="checkbox"/>	3.8#
HRDPT	<b>Carpet Gripper</b> <ul style="list-style-type: none"> <li>Grippers snap into leveling glides to prevent panels from shifting on carpet</li> <li>Glide rotation is unaffected</li> <li>Black finish only</li> <li>Package of 10</li> </ul>	UNCG10		0.5#
HRDPT	 <b>Aluminum Grommet</b> <ul style="list-style-type: none"> <li>Molded grommet is specified in all powdercoat colors</li> </ul>	48.0399	<input type="checkbox"/>	0.5#

A

B

### HOW TO ORDER

Indicate the following information on order form:

- Quantity of each item.
- Model number, including options. See "How To Build a Model Number".
- Any special service required.

Note: • The  indicates that a choice is required.

- The absence of the  indicates that no choice is required.
- Alpha-numeric characters in place of  indicate that no other alternatives are available.

### HOW TO BUILD A MODEL NUMBER

- A** Select basic model.
- B** Select trim color.  
Refer to color addendum at [ki.com](http://ki.com) or KI Fabrics & Finishes binder.  
Metallic finish not available.



# Accessories

Continuous Top Cap/Carpet Gripper/Alum Grommet

Delivered Pricing

\$ 37

37

41

69

69

\$ 6

\$ 9

**SPECIAL SERVICES**

**Special Carton Marking**

With specially marked information N/C

**Shipping**

Shipped k.d. freight prepaid f.o.b. Manitowoc, Wisconsin 54220 factory. Freight class #70.

Specifications and prices are subject to change without prior notice.

# Accessories

## Power Modules

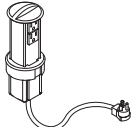
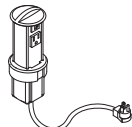
MODEL	MODEL NUMBER		Approx. Packaged Weight
	Basic Model		
 <p>HRDPT</p> <p><b>Round Power Module-Dual Receptacles</b></p> <ul style="list-style-type: none"> <li>• Round module with sleeves fits into Unite® grommet cutout</li> <li>• Provides two receptacles</li> <li>• Cord length is 6 feet</li> <li>• Black</li> </ul>	UNPWUP		2.0#
 <p>HRDPT</p> <p><b>Round Power Module-Receptacle and Data</b></p> <ul style="list-style-type: none"> <li>• Round module with sleeves fits into Unite® grommet cutout</li> <li>• Provides one receptacle and one data port</li> <li>• Black</li> </ul>	UNPWUD		2.0#

**A**

### HOW TO ORDER

Indicate the following information on order form:

1. Quantity of each item.
2. Model number, including options. See "How To Build a Model Number".
3. Any special service required.

- Note:
- The  indicates that a choice is required.
  - The absence of the  indicates that no choice is required.
  - Alpha-numeric characters in place of  indicate that no other alternatives are available.

### HOW TO BUILD A MODEL NUMBER

- A** Select basic model.



Delivered  
Pricing  
\$ 269

\$ 269

**SPECIAL SERVICES**

**Special Carton Marking**

With specially marked information N/C

**Shipping**

Shipped k.d. freight prepaid f.o.b. Manitowoc, Wisconsin 54220 factory. Freight class #70.

Specifications and prices are subject to change without prior notice.

# Accessories

## Bracket Assembly Kit/Receptacle Kit

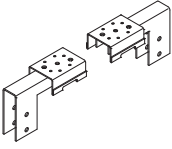
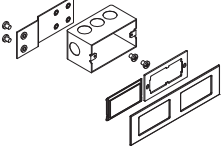
MODEL	MODEL NUMBER		Approx. Packaged Weight
	Basic Model	Bezel Color	
 <p>HRDPT</p> <p><b>Chicago Mounting Bracket Assembly Kit</b></p> <ul style="list-style-type: none"> <li>• Steel construction</li> <li>• Accepts Chicago Code Receptacle Kit (see below)</li> <li>• Specify one assembly per panel, for use on base raceway only</li> <li>• Associated panels must be specified with Chicago power option in order to accept assembly</li> <li>• Includes mounting hardware</li> <li>• Assembly is not size-specific or handed</li> </ul>	UCEM		1.5#
 <p>HRDPT</p> <p><b>Chicago Code Receptacle Kit</b></p> <ul style="list-style-type: none"> <li>• Includes all components required to mount one hardwired receptacle to a mounting bracket assembly (see below)</li> <li>• Receptacle is provided by customer</li> <li>• Up to two receptacles may be specified on a 24" panel, one per side; up to four receptacles may be mounted on all other panels, two per side</li> </ul>	URK.HW	<input type="checkbox"/>	1.4#

**A**

**B**

### HOW TO ORDER

Indicate the following information on order form:

1. Quantity of each item.
2. Model number, including options. See "How To Build a Model Number".
3. Any special service required.

- Note:
- The  indicates that a choice is required.
  - The absence of the  indicates that no choice is required.
  - Alpha-numeric characters in place of  indicate that no other alternatives are available.

### HOW TO BUILD A MODEL NUMBER

- A** Select basic model.
- B** Select bezel color. Refer to color addendum at [ki.com](http://ki.com) or KI Fabrics & Finishes binder.



# Accessories

Bracket Assembly Kit/Receptacle Kit

Delivered  
Pricing

\$ 72

\$ 72

### SPECIAL SERVICES

#### Special Carton Marking

With specially marked information N/C



#### Shipping

Shipped **k.d. freight prepaid f.o.b. Manitowoc, Wisconsin 54220** factory. Freight class #70.

Specifications and prices are subject to change without prior notice.

# Accessories

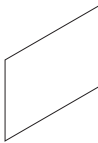
## Markerboards

				MODEL NUMBER	
MODEL	Features	W x H	Basic Model	Approx. Packaged Weight	
 HRDPT	<b>Markerboards - No Frame</b> <ul style="list-style-type: none"> <li>White "dry erase" painted steel</li> <li>"No frame" construction of 22 gauge steel with honeycomb core adhered to back of tile to dampen sound</li> <li>Includes magnetic removable 16" x 2-1/2" tray with markers and eraser</li> <li>Includes black mounting brackets</li> </ul>	On-Module 36 x 30"	UNDEMB.PM3630	25.0#	
		On-Module 42 x 30"	UNDEMB.PM4230	21.0#	
		On-Module 48 x 30"	UNDEMB.PM4830	23.0#	
		On-Module 60 x 30"	UNDEMB.PM6030	30.0#	
 HRDPT	<b>Markerboards</b> <ul style="list-style-type: none"> <li>White porcelain painted steel surface with matching white trim</li> <li>Includes magnetic removable 16" x 2-1/2" tray with markers and eraser</li> <li>Includes black mounting brackets</li> </ul>	On-Module 30 x 32"	UNMB.PM.3032	11.0#	
		On-Module 36 x 32"	UNMB.PM.3632	13.0#	
		On-Module 42 x 32"	UNMB.PM.4232	15.0#	
		On-Module 48 x 32"	UNMB.PM.4832	17.0#	
		On-Module 60 x 32"	UNMB.PM.6032	22.0#	
 HRDPT	<b>Magnetic Tray</b>	16 x 2-1/2"	MB.TRAY	1.0#	
HRDPT	<b>Tray/Eraser/4 Markers</b>		MB.MARKERKIT	1.0#	

**A**

### HOW TO ORDER

Indicate the following information on order form:

- Quantity of each item.
- Model number, including options. See "How To Build a Model Number".
- Any special service required.

Note: • The  indicates that a choice is required.

- The absence of the  indicates that no choice is required.
- Alpha-numeric characters in place of  indicate that no other alternatives are available.

### HOW TO BUILD A MODEL NUMBER

- A** Select basic model.





Delivered  
Pricing

\$ 271  
280  
291  
396

\$ 485  
508  
565  
578  
661

\$ 38

\$ 92

**SPECIAL SERVICES**

**Special Carton Marking**

With specially marked information N/C

**Shipping**

Shipped k.d. freight prepaid f.o.b. Manitowoc, Wisconsin 54220 factory. Freight class #70.

Specifications and prices are subject to change without prior notice.

# Accessories

## Tackboard

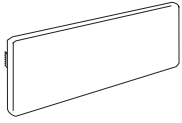

UTB

MODEL	Features	W x H	MODEL NUMBER		Approx. Packaged Weight
			Basic Model	Fabric Color	
<b>Tackboard</b>	On-Module	24 x 12"	UNTB2412/PM	<input type="checkbox"/> <input type="checkbox"/> <input type="checkbox"/> <input type="checkbox"/>	3.0#
• Tackboards are constructed of 3/4" tack-able core and covered with fabric	On-Module	30 x 12"	UNTB3012/PM	<input type="checkbox"/> <input type="checkbox"/> <input type="checkbox"/> <input type="checkbox"/>	3.0#
• Includes black mounting brackets	On-Module	36 x 12"	UNTB3612/PM	<input type="checkbox"/> <input type="checkbox"/> <input type="checkbox"/> <input type="checkbox"/>	4.0#
• Not available with countertops	On-Module	42 x 12"	UNTB4212/PM	<input type="checkbox"/> <input type="checkbox"/> <input type="checkbox"/> <input type="checkbox"/>	4.0#
	On-Module	48 x 12"	UNTB4812/PM	<input type="checkbox"/> <input type="checkbox"/> <input type="checkbox"/> <input type="checkbox"/>	5.0#
	On-Module	60 x 12"	UNTB6012/PM	<input type="checkbox"/> <input type="checkbox"/> <input type="checkbox"/> <input type="checkbox"/>	6.0#
	On-Module	24 x 16"	UNTB2416/PM	<input type="checkbox"/> <input type="checkbox"/> <input type="checkbox"/> <input type="checkbox"/>	4.0#
	On-Module	30 x 16"	UNTB3016/PM	<input type="checkbox"/> <input type="checkbox"/> <input type="checkbox"/> <input type="checkbox"/>	4.0#
	On-Module	36 x 16"	UNTB3616/PM	<input type="checkbox"/> <input type="checkbox"/> <input type="checkbox"/> <input type="checkbox"/>	5.0#
	On-Module	42 x 16"	UNTB4216/PM	<input type="checkbox"/> <input type="checkbox"/> <input type="checkbox"/> <input type="checkbox"/>	5.0#
	On-Module	48 x 16"	UNTB4816/PM	<input type="checkbox"/> <input type="checkbox"/> <input type="checkbox"/> <input type="checkbox"/>	6.0#
	On-Module	60 x 16"	UNTB6016/PM	<input type="checkbox"/> <input type="checkbox"/> <input type="checkbox"/> <input type="checkbox"/>	7.0#
	On-Module	24 x 20"	UNTB2420/PM	<input type="checkbox"/> <input type="checkbox"/> <input type="checkbox"/> <input type="checkbox"/>	4.0#
	On-Module	30 x 20"	UNTB3020/PM	<input type="checkbox"/> <input type="checkbox"/> <input type="checkbox"/> <input type="checkbox"/>	5.0#
	On-Module	36 x 20"	UNTB3620/PM	<input type="checkbox"/> <input type="checkbox"/> <input type="checkbox"/> <input type="checkbox"/>	6.0#
	On-Module	42 x 20"	UNTB4220/PM	<input type="checkbox"/> <input type="checkbox"/> <input type="checkbox"/> <input type="checkbox"/>	7.0#
	On-Module	48 x 20"	UNTB4820/PM	<input type="checkbox"/> <input type="checkbox"/> <input type="checkbox"/> <input type="checkbox"/>	8.0#
	On-Module	60 x 20"	UNTB6020/PM	<input type="checkbox"/> <input type="checkbox"/> <input type="checkbox"/> <input type="checkbox"/>	10.0#
	On-Module	24 x 30"	UNTB2430/PM	<input type="checkbox"/> <input type="checkbox"/> <input type="checkbox"/> <input type="checkbox"/>	6.0#
	On-Module	30 x 30"	UNTB3030/PM	<input type="checkbox"/> <input type="checkbox"/> <input type="checkbox"/> <input type="checkbox"/>	7.0#
	On-Module	36 x 30"	UNTB3630/PM	<input type="checkbox"/> <input type="checkbox"/> <input type="checkbox"/> <input type="checkbox"/>	8.0#
	On-Module	42 x 30"	UNTB4230/PM	<input type="checkbox"/> <input type="checkbox"/> <input type="checkbox"/> <input type="checkbox"/>	10.0#
	On-Module	48 x 30"	UNTB4830/PM	<input type="checkbox"/> <input type="checkbox"/> <input type="checkbox"/> <input type="checkbox"/>	11.0#
	On-Module	60 x 30"	UNTB6030/PM	<input type="checkbox"/> <input type="checkbox"/> <input type="checkbox"/> <input type="checkbox"/>	14.0#
	On-Module	24 x 48"	UNTB2448/PM	<input type="checkbox"/> <input type="checkbox"/> <input type="checkbox"/> <input type="checkbox"/>	9.0#
	On-Module	30 x 48"	UNTB3048/PM	<input type="checkbox"/> <input type="checkbox"/> <input type="checkbox"/> <input type="checkbox"/>	11.0#
	On-Module	36 x 48"	UNTB3648/PM	<input type="checkbox"/> <input type="checkbox"/> <input type="checkbox"/> <input type="checkbox"/>	13.0#
	On-Module	42 x 48"	UNTB4248/PM	<input type="checkbox"/> <input type="checkbox"/> <input type="checkbox"/> <input type="checkbox"/>	15.0#
	On-Module	48 x 48"	UNTB4848/PM	<input type="checkbox"/> <input type="checkbox"/> <input type="checkbox"/> <input type="checkbox"/>	17.0#

A

B

### HOW TO ORDER

Indicate the following information on order form:

1. Quantity of each item.
2. Model number, including options. See "How To Build a Model Number".
3. Any special service required.

Note: • The  indicates that a choice is required.

- The absence of the  indicates that no choice is required.
- Alpha-numeric characters in place of  indicate that no other alternatives are available.

### HOW TO BUILD A MODEL NUMBER

**A** Select basic model.

**B** Select fabric color.  
Refer to color addendum at [ki.com](http://ki.com) or in KI Fabrics & Finishes binder.



Delivered Pricing Fabric Grade 1 & C.O.M.	Delivered Pricing Fabric Grade 2	Delivered Pricing Fabric Grade 3 & Pallas Vertical Fabric Grade PV	Delivered Pricing Pallas Vertical Fabric Grade PV1	Delivered Pricing Pallas Vertical Fabric Grade PV2
\$ 128	\$ 132	\$ 134	\$ 137	\$ 147
141	144	146	151	161
152	158	160	165	174
159	163	165	170	180
162	165	167	173	185
192	197	199	206	217
132	134	137	141	151
141	144	146	151	161
143	146	148	153	163
160	164	166	173	182
166	169	173	179	190
203	207	211	220	230
193	200	202	207	220
207	214	217	225	235
221	227	231	240	252
228	233	240	247	260
272	280	285	294	310
278	289	294	303	317
209	216	221	227	242
260	267	272	280	297
274	281	289	299	313
291	300	307	314	332
307	313	320	331	348
333	344	349	359	380
268	274	281	290	306
309	315	324	333	352
352	362	371	380	400
362	373	383	390	413
385	398	405	417	439

## SPECIAL SERVICES

### Special Carton Marking

With specially marked information N/C

### Shipping

Shipped k.d. freight prepaid f.o.b. Manitowoc, Wisconsin 54220 factory. Freight class #70.

Specifications and prices are subject to change without prior notice.

# Accessories

## Brackets

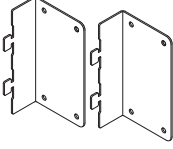
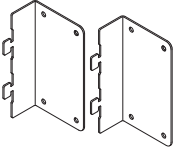
	MODEL	MODEL NUMBER		Approx. Packaged Weight
		Basic Model	Trim Color	
 <p>HRDPT</p>	<b>Tackboard On-Module Bracket</b> <ul style="list-style-type: none"> <li>• Order one kit for 12" and 16" high tackboards</li> <li>• Order two kits for 20" and 30" high tackboards</li> <li>• Order three kits for 48" high tackboards</li> <li>• Not used on Overhead Tackboards</li> <li>• Only necessary to order if changing mounting style</li> <li>• Black only</li> </ul>	48.0262.TB.KIT	<input type="checkbox"/>	1.0#
			<input type="checkbox"/>	
			<input type="checkbox"/>	
			<input type="checkbox"/>	
			<input type="checkbox"/>	
 <p>HRDPT</p>	<b>Markerboard On-Module Bracket</b> <ul style="list-style-type: none"> <li>• Pair of brackets</li> <li>• Order one kit for all heights</li> <li>• Includes mounting hardware</li> <li>• Only necessary to order if changing mounting style</li> <li>• Black only</li> </ul>	48.0262.MB.KIT	<input type="checkbox"/>	1.0#
			<input type="checkbox"/>	
			<input type="checkbox"/>	
			<input type="checkbox"/>	
			<input type="checkbox"/>	

A

B

### HOW TO ORDER

Indicate the following information on order form:

1. Quantity of each item.
2. Model number, including options. See "How To Build a Model Number".
3. Any special service required.

Note:

- The  indicates that a choice is required.
- The absence of the  indicates that no choice is required.
- Alpha-numeric characters in place of  indicate that no other alternatives are available.

### HOW TO BUILD A MODEL NUMBER

- A** Select basic model.
- B** Select trim color.  
Refer to color addendum at [ki.com](http://ki.com) or KI Fabrics & Finishes binder.  
Metallic finish not available.



Delivered  
Pricing  
\$ 27

\$ 45

**SPECIAL SERVICES**

**Special Carton Marking**

With specially marked information N/C



**Shipping**

Shipped k.d. freight prepaid f.o.b. Manitowoc, Wisconsin 54220 factory. Freight class #70.

Specifications and prices are subject to change without prior notice.

# Accessories

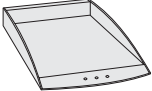
## Paper Management

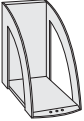
	MODEL	H x W x D	MODEL NUMBER		Approx. Packaged Weight
			Basic Model	Trim Color	
 UTR	<b>On-Module Tool Rail</b> • Accommodates paper management components • Attaches to panels "on" module • Field installable • Painted aluminum construction • Consists of four slots to accept components	24 x 4-1/2"	UPMTR24	<input type="checkbox"/>	3.0#
		30 x 4-1/2"	UPMTR30	<input type="checkbox"/>	4.0#
		36 x 4-1/2"	UPMTR36	<input type="checkbox"/>	5.0#
		42 x 4-1/2"	UPMTR42	<input type="checkbox"/>	6.0#
		48 x 4-1/2"	UPMTR48	<input type="checkbox"/>	6.0#
		60 x 4-1/2"	UPMTR60	<input type="checkbox"/>	7.0#
		72 x 4-1/2"	UPMTR72	<input type="checkbox"/>	8.0#
 HRDPT	<b>Plastic Paper Tray Unit</b> • Plastic construction • Accepts letter and legal-size paper • Suspends from Tool Rail	2 x 9-1/2 x 14"	PPLL	<input type="checkbox"/>	1.0#
 HRDPT	<b>Plastic Diagonal Storage Unit</b> • Plastic construction • Three slanted partitions per unit with dividers • Suspends from Tool Rail	2-1/2 x 7 x 12-1/2"	PPDS	<input type="checkbox"/>	4.0#
 HRDPT	<b>Plastic Vertical Storage Unit</b> • Injection-molded plastic construction • Stores binders and books • Suspends from Tool Rail	9 x 5 x 10-1/2"	PPVS	<input type="checkbox"/>	1.0#

**A**

**B**

### HOW TO ORDER

Indicate the following information on order form:

1. Quantity of each item.
2. Model number, including options. See "How To Build a Model Number".
3. Any special service required.

Note: • The  indicates that a choice is required.

- The absence of the  indicates that no choice is required.
- Alpha-numeric characters in place of  indicate that no other alternatives are available.

### HOW TO BUILD A MODEL NUMBER

- A** Select basic model.
- B** Select trim color. Refer to color addendum at [ki.com](http://ki.com) or KI Fabrics & Finishes binder.



Delivered  
Pricing

\$ 105
111
116
122
129
164
180
\$ 38

\$ 38

\$ 36

**SPECIAL SERVICES**

**Special Carton Marking**

With specially marked information N/C



**Shipping**

Shipped k.d. freight prepaid f.o.b. Manitowoc, Wisconsin 54220 factory. Freight class #70.

Specifications and prices are subject to change without prior notice.

# Accessories

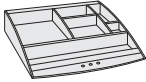
## Desktop Accessories

	MODEL	H x W x D	MODEL NUMBER		Approx. Packaged Weight
			Basic Model	Trim Color	
 HRDPT	<b>Telephone Caddy</b> • Plastic construction • Suspends from Tool Rail	2 x 8 1/2 x 9 1/2"	PPTC	<input type="checkbox"/>	0.8#
 HRDPT	<b>Accessory Tray</b> • Injection-molded plastic • Stores stamps, tape dispenser, post-it pads and paper clips • Suspends from Tool Rail	2 x 9 1/2 x 10"	PPAT	<input type="checkbox"/>	6.0#
 HRDPT	<b>Pencil Cup</b> • Injection-molded plastic • Suspends from Tool Rail	4 x 4 x 3 1/2"	PPPC	<input type="checkbox"/>	0.3#

A

B

### HOW TO ORDER

Indicate the following information on order form:

- Quantity of each item.
- Model number, including options. See "How To Build a Model Number".
- Any special service required.

Note: • The  indicates that a choice is required.

- The absence of the  indicates that no choice is required.
- Alpha-numeric characters in place of  indicate that no other alternatives are available.

### HOW TO BUILD A MODEL NUMBER

- A** Select basic model.
- B** Select trim color.  
Refer to color addendum at [ki.com](http://ki.com) or KI Fabrics & Finishes binder.  
Metallic finish not available.





Delivered  
Pricing

\$ 46

\$ 32

\$ 32

**SPECIAL SERVICES**

**Special Carton Marking**

With specially marked information N/C

**Shipping**

Shipped **k.d. freight prepaid f.o.b. Manitowoc, Wisconsin 54220** factory. Freight class #70.

Specifications and prices are subject to change without prior notice.

# Unite® C.O.M. Yardage Requirements

Width	Height	Actual Cut size	54" Non Directional	54" Directional	66" Non Directional	66" Non Directional	Width	Height	Actual Cut size	54" Non Directional	54" Directional	66" Non Directional	66" Non Directional
24	8	28 x 13	0.361	0.361	0.181	0.181	42	8	46 x 13	0.361	0.361	0.361	0.361
24	16	28 x 21	0.583	0.583	0.292	0.292	42	16	46 x 21	0.583	0.583	0.583	0.583
24	24	28 x 29	0.806	0.806	0.403	0.403	42	24	46 x 29	0.806	0.806	0.806	0.806
24	26	28 x 31	0.861	0.861	0.431	0.431	42	26	46 x 31	0.861	0.861	0.861	0.861
24	32	28 x 37	1.028	1.028	0.514	0.514	42	32	46 x 37	1.028	1.028	1.028	1.028
24	34	28 x 39	1.083	1.083	0.542	0.542	42	34	46 x 39	1.083	1.083	1.083	1.083
24	40	28 x 45	1.250	1.250	0.625	0.625	42	40	46 x 45	1.250	1.250	1.250	1.250
24	42	28 x 47	1.306	1.306	0.653	0.653	42	42	46 x 47	1.306	1.306	1.306	1.306
24	48	28 x 53	1.472	1.472	0.736	0.736	42	48	46 x 53	1.472	1.472	1.472	1.472
24	50	28 x 55	1.528	1.528	0.764	0.764	42	50	46 x 55	1.528	1.528	1.528	1.528
24	56	28 x 61	1.694	1.694	0.847	0.847	42	56	46 x 61	1.694	1.694	1.694	1.694
24	58	28 x 63	1.750	1.750	0.875	0.875	42	58	46 x 63	1.750	1.750	1.750	1.750
24	64	28 x 69	1.917	1.917	0.958	0.958	42	64	46 x 69	1.917	1.917	1.917	1.917
30	8	34 x 13	0.361	0.361	0.361	0.361	48	8	52 x 13	0.361	0.361	0.361	0.361
30	16	34 x 21	0.583	0.583	0.583	0.583	48	16	52 x 21	0.583	0.583	0.583	0.583
30	24	34 x 29	0.806	0.806	0.806	0.806	48	24	52 x 29	0.806	0.806	0.806	0.806
30	26	34 x 31	0.861	0.861	0.861	0.861	48	26	52 x 31	0.861	0.861	0.861	0.861
30	32	34 x 37	1.028	1.028	1.028	1.028	48	32	52 x 37	1.028	1.028	1.028	1.028
30	34	34 x 39	1.083	1.083	1.083	1.083	48	34	52 x 39	1.083	1.083	1.083	1.083
30	40	34 x 45	1.250	1.250	1.250	1.250	48	40	52 x 45	1.250	1.250	1.250	1.250
30	42	34 x 47	1.306	1.306	1.306	1.306	48	42	52 x 47	1.306	1.306	1.306	1.306
30	48	34 x 53	1.472	1.472	1.472	1.472	48	48	52 x 53	1.472	1.472	1.472	1.472
30	50	34 x 55	1.528	1.528	1.528	1.528	48	50	52 x 55	1.528	1.528	1.528	1.528
30	56	34 x 61	1.694	1.694	1.694	1.694	48	56	52 x 61	1.694	1.694	1.694	1.694
30	58	34 x 63	1.750	1.750	1.750	1.750	48	58	52 x 63	1.750	1.750	1.750	1.750
30	64	34 x 69	1.917	1.917	1.917	1.917	48	64	52 x 69	1.917	1.917	1.917	1.917
36	8	40 x 13	0.361	0.361	0.361	0.361	60	8	64 x 13			0.361	0.361
36	16	40 x 21	0.583	0.583	0.583	0.583	60	16	64 x 21			0.583	0.583
36	24	40 x 29	0.806	0.806	0.806	0.806	60	24	64 x 29			0.806	0.806
36	26	40 x 31	0.861	0.861	0.861	0.861	60	26	64 x 31			0.861	0.861
36	32	40 x 37	1.028	1.028	1.028	1.028	60	32	64 x 37			1.028	1.028
36	34	40 x 39	1.083	1.083	1.083	1.083	60	34	64 x 39			1.083	1.083
36	40	40 x 45	1.250	1.250	1.250	1.250	60	40	64 x 45			1.250	1.250
36	42	40 x 47	1.306	1.306	1.306	1.306	60	42	64 x 47			1.306	1.306
36	48	40 x 53	1.472	1.472	1.472	1.472	60	48	64 x 53			1.472	1.472
36	50	40 x 55	1.528	1.528	1.528	1.528	60	50	64 x 55			1.528	1.528
36	56	40 x 61	1.694	1.694	1.694	1.694	60	56	64 x 61			1.694	1.694
36	58	40 x 63	1.750	1.750	1.750	1.750	60	58	64 x 63			1.750	1.750
36	64	40 x 69	1.917	1.917	1.917	1.917	60	64	64 x 69			1.917	1.917

Yardage requirements are "per panel side"  
(multiply times 2 for a complete panel).



## How to Specify C.O.M. Upholstery

Textile designs often have intricate patterns. Not all individuals will interpret fabric direction in the same manner.

As a standard procedure, KI cuts fabrics off the roll in a horizontal fashion as shown in Diagram A at the right. By cutting in this fashion, most waste is eliminated. Our requirements for yardage in this book are based on this type of cutting. When directional or patterned fabrics are used, they often require more yardage than solid colors.

By providing KI with a completely filled-out copy of the form on this page, we will be able to expedite your order. We find it particularly helpful with directional or patterned upholstery material. It is critical that copies of this form accompany test quantities as well as production quantities of C.O.M.

C.O.M. must be supplied in continuous yardage.

### C.O.M. Testing

KI will require six yards of actual fabric to be submitted for testing. The test will be completed on panels, tackboards, and overheads. For products shipped from Manitowoc, WI facility, ship upholstery material to:

**KI Manitowoc**  
**1400 South 41st Street**  
**Manitowoc, WI 54220**  
**Attn: Fabric Testing**

### C.O.M. Production

Customer's fabrics must be approved prior to acceptance for production. KI assumes no responsibility for wear, defects, or performance of customer's own materials. C.O.M. orders are available on a deferred delivery basis.

Orders for production of C.O.M. upholstered products are not scheduled for processing until upholstery material is received. Upon receipt, KI will provide an acknowledgement and an estimated shipping date.

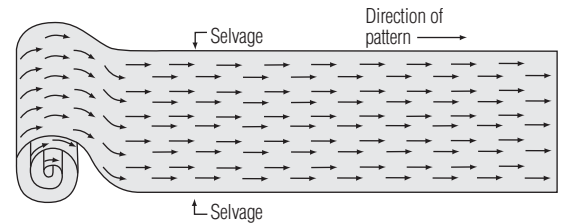

Diagram A

### Excess Upholstery Material

KI will dispose of excess upholstery material at the time of shipment unless expressly requested to return it with the product shipment.

### Cancelled or Changed Orders

KI assumes no responsibility for extra C.O.M. material due to a change of upholstery or cancellation of an order. It is the customer's responsibility to arrange for return of this material.

### Yardage Specification

The chart on the following page details the yardage requirements for each upholstered item in the price list. To accommodate flaws, wrinkles, and other imperfections, calculate the total yardage and add the appropriate percentage shown below:

**1 to 25 yards — Add 5 yards**  
**25 + yards — Add 10% over requirements (5 yard minimum)**

## Index

Model No.	Description	Page	Model No.	Description	Page
2.KP20522	Pedestal Accessories: P-Series Keys	366		Upmount	310
3K24	Pedestal Accessories: Pedestal Bracket	362	PRDS24/UN/LB	Overhead Storage: Steel Door Overhead Cabinet-Load Bar Mount	306
46.1234	Overhead Accessories: Upmount Brackets	316	PRDS24/UN/PM	Overhead Storage: Steel Door Overhead Cabinet-On-Module	306
46.2103	Overhead Accessories: Load Bar Brackets	316	PRDS24/UN/UM	Overhead Storage: Steel Door Overhead Cabinet-Upmount	306
46.8186.SET	Overhead Accessories: U-Series® Overhead Load Bar Brackets for Unite	358	PTB02412	Overhead Accessories: Overhead Tackboard	318
48.0222.SET	Overhead Accessories: U-Series® Overhead On-Module Mounting Bracket for Unite	358	S7P/D12	Pedestal Accessories: Hanging Folder Partition	368
48.0236.12.S	Overhead Accessories: U-Series® Overhead Upmount Brackets for Unite	358	S7P/D6	Pedestal Accessories: 6" Partition	368
48.0261.SET	Overhead Accessories: Universal Overhead On-Module Mounting Bracket	316	S7P/PENTRAY	Pedestal Accessories: Pencil Tray	368
48.0262.MB.KIT	Brackets: Markerboard On-Module Bracket	386	SET6PJINL	10-Wire System 6 Circuit "810": Genius In-Line Panel Jumper - 6 Circuit	232
48.0262.TB.KIT	Brackets: Tackboard On-Module Bracket	386	SET6PJINT	10-Wire System 6 Circuit "810": Genius Intersection Panel Jumper - 6 Circuit	232
48.0399	Continuous Top Cap/Carpet Gripper/Alum Grommet: Aluminum Grommet	376	SWLB.24	Overhead Accessories: Wall Mounted Load Bar	318
48.0717.48	Continuous Top Cap/Carpet Gripper/Alum Grommet: Continuous Top Cap	376	TLT5.18	Shelf/Cabinet Task Light: Shelf/Cabinet Task Light	320
BLCF30/UN/LB	Overhead Storage: Balance® Overhead Cabinet-Fabric Upper Door-Load Bar Mount	324	U1W120S16	120° 1-Way, 2-Way, 3-Way and 4-Way: 120° 1-Way End	210
BLCF30/UN/PM	Overhead Storage: Balance® Overhead Cabinet-Fabric Upper Door-On-Module	324	U1W90S16	90° 1-Way, 2-Way, 3-Way and 4-Way: 90° 1-Way End	206
BLCF30/UN/UM	Overhead Storage: Balance® Overhead Cabinet-Fabric Upper Door-Upmount	324	U2W1201W3240	2-Way 120°: 2-Way 120°, "V" Corner, with Height Change	190
BLCL30/UN/LB	Overhead Storage: Balance® Overhead Cabinet-Laminate Upper Door-Load Bar Mount	326	U2W12032	2-Way 120°: 2-Way 120°, "V" Corner, No Height Change	190
BLCL30/UN/PM	Overhead Storage: Balance® Overhead Cabinet-Laminate Upper Door-On-Module	326	U2W120S16	120° 1-Way, 2-Way, 3-Way and 4-Way: 120° 2-Way Corner	210
BLCL30/UN/UM	Overhead Storage: Balance® Overhead Cabinet-Laminate Upper Door-Upmount	326	U2W1801W3240	2-Way 180°: 2-Way 180°, Trim One Side, with Height Change	174
BLCS30/UN/LB	Overhead Storage: Balance® Overhead Cabinet-Solid Color Upper Door-Load Bar Mount	322	U2W180IL32	2-Way 180°: 2-Way 180°, In-Line Spacer Trim, No Height Change	174
BLCS30/UN/PM	Overhead Storage: Balance® Overhead Cabinet-Solid Color Upper Door-On Module (PM)	322	U2W180S16	2-Way 180° In-Line Spacer: 180° 2-Way In-Line Spacer	208
BLCS30/UN/UM	Overhead Storage: Balance® Overhead Cabinet-Solid Color Upper Door-Load Bar-Upmount	322	U2W901W3240	2-Way 90° "L" Corner: 2-Way 90°, "L" Corner, with Height Change	172
BMB30	Overhead Accessories: Tackboard/Tool Rail Attachment Bar	330	U2W9032	2-Way 90° "L" Corner: 2-Way 90°, "L" Corner, No Height Change	172
BOA/UN/LB	Overhead Accessories: Load Bar Brackets	328	U2W90S16	90° 1-Way, 2-Way, 3-Way and 4-Way: 90° 2-Way Corner	206
BOA/UN/PM	Overhead Accessories: Balance® Overhead On-Module Mounting Bracket	328	U3W1201W3240	3-Way 120°: 3-Way 120° Corner, Trim One Side, with Height Change	192
BOA/UN/UM	Overhead Accessories: Upmount Brackets	328	U3W1202W3240	3-Way 120°: 3-Way 120° Corner, Trim Two Sides, with Height Change	194
BTLT5.24	Overhead Task Lights: Overhead Task Lights	332	U3W12032	3-Way 120°: 3-Way 120° Corner, No Height Change	192
MB.MARKERKIT	Markerboards: Tray/Eraser/4 Markers	382	U3W120S16	120° 1-Way, 2-Way, 3-Way and 4-Way: 120° 3-Way Intersection	210
MB.TRAY	Markerboards: Magnetic Tray	382	U3W901W3240	3-Way 90°: 3-Way 90°, Trim One Side "T" Corner, with Height Change	176
NSD	Overhead Accessories: Universal Shelf Dividers	318	U3W902W3240	3-Way 90°: 3-Way 90°, Trim Two Sides "T" Corner, with Height Change	180
PDCU/17	Pedestal Accessories: Cushioned Seat for Mobile Pedestal	364	U3W9032	3-Way 90°: 3-Way 90°, "T" Corner, No Height Change	176
PPAT	Desktop Accessories: Accessory Tray	390	U3W90IL3240	3-Way 90°: 3-Way 90°, In-Line "T" Corner, with Height Change	178
PPDS	Paper Management: Plastic Diagonal Storage Unit	388	U3W90S16	90° 1-Way, 2-Way, 3-Way and 4-Way: 90° 3-Way Intersection	206
PPLL	Paper Management: Plastic Paper Tray Unit	388	U4W901W3240	4-Way 90°: 4-Way 90°, "X" Trim One Side, with Height Change	182
PPPC	Desktop Accessories: Pencil Cup	390	U4W902W3240	4-Way 90°: 4-Way 90°, "X" Trim Two Sides, with Height Change	186
PPTC	Desktop Accessories: Telephone Caddy	390	U4W9032	4-Way 90°: 4-Way 90°, "X", No Height Change	182
PPVS	Paper Management: Plastic Vertical Storage Unit	388	U4W903W3240	4-Way 90°: 4-Way 90°, "X" Trim Three Sides, with Height Change	188
PRDF24/UN/LB	Overhead Storage: Fabric Door Overhead Cabinet-Load Bar Mount	308	U4W90IL3240	4-Way 90°: 4-Way 90°, "X" In-Line Intersection, with Height Change	184
PRDF24/UN/PM	Overhead Storage: Fabric Door Overhead Cabinet-On-Module	308	U4W90S16	90° 1-Way, 2-Way, 3-Way and 4-Way: 90° 4-Way Intersection	206
PRDF24/UN/UM	Overhead Storage: Fabric Door Overhead Cabinet-Upmount	308	UC36	Freestanding Credenzas: 36" Wide	342
PRDL24/UN/LB	Overhead Storage: Laminate Door Overhead Cabinet-Load Bar Mount (LB)	310			
PRDL24/UN/PM	Overhead Storage: Laminate Door Overhead Cabinet-On-Module (PM)	310			
PRDL24/UN/UM	Overhead Storage: Laminate Door Overhead Cabinet-				



Model No.	Description	Page	Model No.	Description	Page
UC42	Freestanding Credenzas: 42" Wide	342		Pole and Top Cap - 6 Circuit	240
UCANTD12.R	Design Bracket - Worksurface Support Bracket	290	UETF1024	10-Wire System 6 Circuit "810": Top Feed with 10-foot Pole and Top Cap - 6 Circuit	240
UCANTST.R	Standard Cantilever Bracket	290			
UCEM	Bracket Assembly Kit/Receptacle Kit: Chicago Mounting Bracket Assembly Kit	380	UETNYBF24	New York Power - 10-Wire System 6 or 4 Circuit "810": New York Base Infeed with Race Way Cover	254
UCFPC18	Height Change Filler Plate for Corner	292	UETNYTF0730	New York Power - 10-Wire System 6 or 4 Circuit "810": New York Power Top Feed with 7-foot Pole and Top Cap	254
UCFPI18	Height Change Filler Plate for In-Line	292			
UDP302D	Worksurface Supporting: 30" Wide, 2 High	340	UETNYTF1030	New York Power - 10-Wire System 6 or 4 Circuit "810": New York Power Top Feed with 10-foot Pole and Top Cap	254
UEOR32	End-of-Run Trim for Full Panel Height Conditions	196			
UEORS16	End-of-Run Trim - Stacking Section	212	UETRT.24	10-Wire System 6 Circuit "810": Raceway Cable Trough - 6 Circuit	228
UEORV08	End-of-Run Trim for Change of Height Conditions	196			
UEORV16	End-of-Run Trim for Change of Height Conditions	196	UHS36	Underhead Storage	356
UET4B20R.1	10-Wire System 4 Circuit "810"/for Beltway Use: 20-Amp Receptacle for Beltway Use - 4 Circuit	248	UHSL	Underhead Storage Support Leg	356
UET4BRC.1	10-Wire System 4 Circuit "810"/for Beltway Use: 15-Amp Duplex Receptacle for Beltway Use - 4 Circuit	248	UHWR1536	U-Series® Underhead: U-Series® Underhead Worksurface	282
UET4LBFU	10-Wire System 4 Circuit "810": Base Infeed for Elevated Base - 4 Circuit	250	ULP20FBBF	Freestanding: Pedestal - BBF	336
UET4PJINL	10-Wire System 4 Circuit "810": In-Line Panel Jumper - 4 Circuit	244	ULP20FFF	Freestanding: Pedestal - FF	336
UET4PJINT	10-Wire System 4 Circuit "810": Intersection Panel Jumper - 4 Circuit	244	ULP20MBBF	Mobile: Pedestal - BBF	334
UET4PP.24	10-Wire System 4 Circuit "810": Harness/Power Pass Through - 4 Circuit	244	ULP20MBF	Mobile: Pedestal - MBF	334
UET4R20R.1	10-Wire System 4 Circuit "810"/with Bezel for Raceway Use: 20-Amp Receptacle with Bezel for Raceway Use - 4 Circuit	244	ULP20MFF	Mobile: Pedestal - FF	334
UET4RBFU	10-Wire System 4 Circuit "810": Base Infeed with Bezel for Raceway Base - 4 Circuit	246	ULP20WBBF	Worksurface Supporting: Pedestal - Box/Box/File	338
UET4RRC.1	10-Wire System 4 Circuit "810"/with Bezel for Raceway Use: 15-Amp Duplex Receptacle with Bezel for Raceway Use - 4 Circuit	250	ULP20WFF	Worksurface Supporting: Pedestal - File/File	338
UET4VJ	10-Wire System 4 Circuit "810": Vertical Jumper - 4 Circuit	244	ULSR24/UN/LB	Overhead Storage: Low Shelf-Load Bar Mount	312
UET4WW.24	10-Wire System 4 Circuit "810": Rigid Wireway - 4 Circuit	242	ULSR24/UN/PM	Overhead Storage: Low Shelf-On-Module	312
UET6B20R.1	10-Wire System 6 Circuit "810"/for Beltway Use: 20 Amp Receptacle for Beltway Use - 6 Circuit	236	ULSR24/UN/UM	Overhead Storage: Low Shelf-Upmount	312
UET6BRC.1	10-Wire System 6 Circuit "810"/for Beltway Use: 15 Amp Duplex Receptacle for Beltway Use - 6 Circuit	236	UMFL2432	Elevated Base: Monolithic Fabric Panel - 32" H	10
UET6LBFU	10-Wire System 6 Circuit "810": Base Infeed for Elevated Base - 6 Circuit	238	UMFL2440	Elevated Base: Monolithic Fabric Panel - 40" H	10
UET6PJINL	10-Wire System 6 Circuit "810": In-Line Panel Jumper - 6 Circuit	230	UMFL2448	Elevated Base: Monolithic Fabric Panel - 48" H	10
UET6PJINT	10-Wire System 6 Circuit "810": Intersection Panel Jumper - 6 Circuit	230	UMFL2456	Elevated Base: Monolithic Fabric Panel - 56" H	12
UET6PP.24	10-Wire System 6 Circuit "810": Harness/Power Pass Through - 6 Circuit	230	UMFL2464	Elevated Base: Monolithic Fabric Panel - 64" H	12
UET6R20R.1	10-Wire System 6 Circuit "810"/with Bezel for Raceway Use: 20 Amp Receptacle with Bezel for Raceway Use - 6 Circuit	234	UMFLBW2440	Elevated Base: Monolithic Fabric Panel - 40" H	22
UET6RBFU	10-Wire System 6 Circuit "810": Base Infeed with Bezel for Raceway Base - 6 Circuit	238	UMFLBW2448	Elevated Base: Monolithic Fabric Panel - 48" H	22
UET6RRC.1	10-Wire System 6 Circuit "810"/with Bezel for Raceway Use: 15 Amp Duplex Receptacle with Bezel for Raceway Use - 6 Circuit	234	UMFLBW2456	Elevated Base: Monolithic Fabric Panel - 56" H	22
UET6VJ	10-Wire System 6 Circuit "810": Vertical Jumper - 6 Circuit	232	UMFLBW2464	Elevated Base: Monolithic Fabric Panel - 64" H	24
UET6WW.24	10-Wire System 6 Circuit "810": Rigid Wireway - 6 Circuit	228	UMFR2432	Standard Base Raceway: Monolithic Fabric Panel - 32" H	6
UETBT.24	10-Wire System 6 Circuit "810": Beltway Cable Trough - 6 Circuit	228	UMFR2440	Standard Base Raceway: Monolithic Fabric Panel - 40" H	6
UETBWM	10-Wire System 6 Circuit "810": Beltway-Height Harness Mounting Kit - 6 Circuit	228	UMFR2448	Standard Base Raceway: Monolithic Fabric Panel - 48" H	6
UETF0724	10-Wire System 6 Circuit "810": Top Feed with 7-Foot Pole and Top Cap - 6 Circuit	240	UMFR2456	Standard Base Raceway: Monolithic Fabric Panel - 56" H	8
			UMFR2464	Standard Base Raceway: Monolithic Fabric Panel - 64" H	8
			UMFRBW2440	Standard Base Raceway: Monolithic Fabric Panel - 40" H	18
			UMFRBW2448	Standard Base Raceway: Monolithic Fabric Panel - 48" H	18
			UMFRBW2456	Standard Base Raceway: Monolithic Fabric Panel - 56" H	18
			UMFRBW2464	Standard Base Raceway: Monolithic Fabric Panel - 64" H	20
			UMFT2432	Tile-to-Floor One Side; Standard Base Raceway One Side: Monolithic Fabric Panel - 32" H	12
			UMFT2440	Tile-to-Floor One Side; Standard Base Raceway One Side: Monolithic Fabric Panel - 40" H	12
			UMFT2448	Tile-to-Floor One Side; Standard Base Raceway One Side: Monolithic Fabric Panel - 48" H	12
			UMFT2456	Tile-to-Floor One Side; Standard Base Raceway One Side: Monolithic Fabric Panel - 56" H	16
			UMFT2464	Tile-to-Floor One Side; Standard Base Raceway One Side: Monolithic Fabric Panel - 64" H	16
			UMFTBW2440	Tile-to-Floor One Side; Standard Base Raceway One Side: Monolithic Fabric Panel - 40" H	26
			UMFTBW2448	Tile-to-Floor One Side; Standard Base Raceway One Side: Monolithic Fabric Panel - 48" H	26
			UMFTBW2456	Tile-to-Floor One Side; Standard Base Raceway One Side: Monolithic Fabric Panel - 56" H	26
			UMFTBW2464	Tile-to-Floor One Side; Standard Base Raceway One Side: Monolithic Fabric Panel - 64" H	26

## Index

Model No.	Description	Page	Model No.	Description	Page
	Side: Monolithic Fabric Panel - 64" H	28	UPMTR24	Paper Management: On-Module Tool Rail	388
UMODA24	Frameless Modesty Panel with Acrylic Insert: Frameless Modesty Panel	374	UPNLI1826	Non-Panel Mounted, Insert: Insert Leg - 24-3/4" Height	298
UMOL2432	Elevated Base: Monolithic Open Panel - 32"H	44	UPNLI1829	Non-Panel Mounted, Insert: Insert Leg - 27-3/4" Height	298
UMOR2432	Standard Base Raceway: Monolithic Open Panel - 32"H	42	UPNLO1826	Non-Panel Mounted, Open: Open Leg - 24-3/4" Height	296
UMSL2432	Elevated Base: Monolithic Steel Panel - 32"H	32	UPNLO1829	Non-Panel Mounted, Open: Open Leg - 27-3/4" Height	296
UMSL2440	Elevated Base: Monolithic Steel Panel - 40"H	32	UPSLC1826	Panel Mounted, Center: Center Leg (Open) - 24-3/4" Height	304
UMSL2448	Elevated Base: Monolithic Steel Panel - 48"H	32	UPSLC1829	Panel Mounted, Center: Center Leg (Open) - 27-3/4" Height	304
UMSL2456	Elevated Base: Monolithic Steel Panel - 56"H	32	UPSLI1826	Panel Mounted, Insert: Insert Leg - 24-3/4" Height	302
UMSL2464	Elevated Base: Monolithic Steel Panel - 64"H	32	UPSLI1829	Panel Mounted, Insert: Insert Leg - 27-3/4" Height	302
UMSLBW2440	Elevated Base: Monolithic Steel Panel - 40"H	38	UPSL01826	Panel Mounted, Open: Open Leg - 24-3/4" Height	300
UMSLBW2448	Elevated Base: Monolithic Steel Panel - 48"H	38	UPSL01829	Panel Mounted, Open: Open Leg - 27-3/4" Height	300
UMSLBW2456	Elevated Base: Monolithic Steel Panel - 56"H	38	URD1803664	Rolling Door-180° Inline Condition	218
UMSLBW2464	Elevated Base: Monolithic Steel Panel - 64"H	38	URD903664	Rolling Door-90° Intersection Condition	218
UMSR2432	Standard Base Raceway: Monolithic Steel Panel - 32"H	30	URDBW3664	Rolling Door-Building Wall Condition	222
UMSR2440	Standard Base Raceway: Monolithic Steel Panel - 40"H	30	URDDDE3664	Rolling Door-Double Dead End Condition	220
UMSR2448	Standard Base Raceway: Monolithic Steel Panel - 48"H	30	URDDE3664	Rolling Door-Dead End Condition	220
UMSR2456	Standard Base Raceway: Monolithic Steel Panel - 56"H	30	URDNJ3664	Rolling Door-No Jamb Condition	216
UMSR2464	Standard Base Raceway: Monolithic Steel Panel - 64"H	30	URDT36	Thresholds: Rolling Door-Threshold for use with Jamb Conditions	224
UMSRBW2440	Standard Base Raceway: Monolithic Steel Panel - 40"H	36	URDTC	Thresholds: Rolling Door-Continuous Threshold	226
UMSRBW2448	Standard Base Raceway: Monolithic Steel Panel - 48"H	36	URDTNJ36	Thresholds: Rolling Door-Threshold for use with No-Jamb Conditions	226
UMSRBW2456	Standard Base Raceway: Monolithic Steel Panel - 56"H	36	URK.HW	Bracket Assembly Kit/Receptacle Kit: Chicago Code Receptacle Kit	380
UMSRBW2464	Standard Base Raceway: Monolithic Steel Panel - 64"H	36	URSR24/UN/LB	Overhead Storage: Regular Shelf-Load Bar Mount	314
UMST2432	Tile-to-Floor One Side; Standard Base Raceway One Side: Monolithic Steel Panel - 32"H	34	URSR24/UN/PM	Overhead Storage: Regular Shelf-On-Module	314
UMST2440	Tile-to-Floor One Side; Standard Base Raceway One Side: Monolithic Steel Panel - 40"H	34	URSR24/UN/UM	Overhead Storage: Regular Shelf-Upmount	314
UMST2448	Tile-to-Floor One Side; Standard Base Raceway One Side: Monolithic Steel Panel - 48"H	34	USFL2440	Elevated Base: Segmented Fabric Panel - 40"H	50
UMST2456	Tile-to-Floor One Side; Standard Base Raceway One Side: Monolithic Steel Panel - 56"H	34	USFL2448	Elevated Base: Segmented Fabric Panel - 48"H	50
UMST2464	Tile-to-Floor One Side; Standard Base Raceway One Side: Monolithic Steel Panel - 64"H	34	USFL2456	Elevated Base: Segmented Fabric Panel - 56"H	50
UMSTBW2440	Tile-to-Floor One Side; Standard Base Raceway One Side: Monolithic Steel Panel - 40"H	40	USFL2464	Elevated Base: Segmented Fabric Panel - 64"H	52
UMSTBW2448	Tile-to-Floor One Side; Standard Base Raceway One Side: Monolithic Steel Panel - 48"H	40	USFLBW2440	Elevated Base: Segmented Fabric Panel - 40"H	62
UMSTBW2456	Tile-to-Floor One Side; Standard Base Raceway One Side: Monolithic Steel Panel - 56"H	40	USFLBW2448	Elevated Base: Segmented Fabric Panel - 48"H	62
UMSTBW2464	Tile-to-Floor One Side; Standard Base Raceway One Side: Monolithic Steel Panel - 64"H	40	USFLBW2456	Elevated Base: Segmented Fabric Panel - 56"H	62
UNCG10	Continuous Top Cap/Carpet Gripper/Alum Grommet: Carpet Gripper	376	USFLBW2464	Elevated Base: Segmented Fabric Panel - 64"H	64
UNDEMB.PM3630	Markerboards: Markerboards - No Frame	382	USFPL2440	Elevated Base: Segmented Fabric Panel - 40"H	128
UNGDS24	Glass Divider Screen: Glass Divider Screen	372	USFPL2448	Elevated Base: Segmented Fabric Panel - 48"H	128
UNGPS32	Perpendicular Start for Genius® Wall: Perpendicular Start - 32" H	200	USFPL2456	Elevated Base: Segmented Fabric Panel - 56"H	128
UNGPS40	Perpendicular Start for Genius® Wall: Perpendicular Start - 40",48",56", 64" H	200	USFPL2464	Elevated Base: Segmented Fabric Panel - 64"H	130
UNGUS	Universal Start for Genius® Wall: Universal Start	202	USFPR2440	Standard Base Raceway: Segmented Fabric Panel - 40"H	124
UNMB.PM.3032	Markerboards: Markerboards	382	USFPR2448	Standard Base Raceway: Segmented Fabric Panel - 48"H	124
UNPWUD	Power Modules: Round Power Module-Receptacle and Data	378	USFPR2456	Standard Base Raceway: Segmented Fabric Panel - 56"H	124
UNPWUP	Power Modules: Round Power Module-Dual Receptacles	378	USFPR2464	Standard Base Raceway: Segmented Fabric Panel - 64"H	126
UNRC.2432	Acoustic Septum Kits: Acoustic Septum Kit	370	USFPT2440	Tile-to-Floor One Side; Standard Base Raceway One Side: Segmented Fabric Panel - 40"H	132
UNTB2412/PM	Tackboard: Tackboard	384	USFPT2448	Tile-to-Floor One Side; Standard Base Raceway One Side: Segmented Fabric Panel - 48"H	132
UNWM16	Adjustable Wall Mount Start: Adjustable Wall Mount Start	198	USFPT2456	Tile-to-Floor One Side; Standard Base Raceway One Side: Segmented Fabric Panel - 56"H	132
UNWT30	Wall Track: Wall Track	204	USFPT2464	Tile-to-Floor One Side; Standard Base Raceway One Side: Segmented Fabric Panel - 64"H	134
UPENPL24	Add-on Peninsula Attachment Plate	292	USFR2440	Standard Base Raceway: Segmented Fabric Panel - 40"H	46
UPL26	Post Leg: Post Leg Assembly - 24-3/4" Height	294	USFR2448	Standard Base Raceway: Segmented Fabric Panel - 48"H	46
UPL29	Post Leg: Post Leg Assembly - 27-3/4" Height	294	USFR2456	Standard Base Raceway: Segmented Fabric Panel - 56"H	46
			USFR2464	Standard Base Raceway: Segmented Fabric Panel - 64"H	48
			USFRBW2440	Standard Base Raceway: Segmented Fabric Panel - 40"H	58
			USFRBW2448	Standard Base Raceway: Segmented Fabric Panel - 48"H	58
			USFRBW2456	Standard Base Raceway: Segmented Fabric Panel - 56"H	58
			USFRBW2464	Standard Base Raceway: Segmented Fabric Panel - 64"H	60
			USFT2440	Tile-to-Floor One Side; Standard Base Raceway One Side: Segmented Fabric Panel - 40"H	54



Model No.	Description	Page	Model No.	Description	Page
USFT2448	Tile-to-Floor One Side; Standard Base Raceway One Side: Segmented Fabric Panel - 48"H	54	USPLPL22	Splice Plate - 22" Worksurface	292
USFT2456	Tile-to-Floor One Side; Standard Base Raceway One Side: Segmented Fabric Panel - 56"H	54	USSDH36	Sliding Door Overhead	354
USFT2464	Tile-to-Floor One Side; Standard Base Raceway One Side: Segmented Fabric Panel - 64"H	56	USSFL2440	Elevated Base: Segmented Steel Panel - 40"H	74
USFTBW2440	Tile-to-Floor One Side; Standard Base Raceway One Side: Segmented Fabric Panel - 40"H	66	USSFL2448	Elevated Base: Segmented Steel Panel - 48"H	74
USFTBW2448	Tile-to-Floor One Side; Standard Base Raceway One Side: Segmented Fabric Panel - 48"H	66	USSFL2456	Elevated Base: Segmented Steel Panel - 56"H	74
USFTBW2456	Tile-to-Floor One Side; Standard Base Raceway One Side: Segmented Fabric Panel - 56"H	66	USSFL2464	Elevated Base: Segmented Steel Panel - 64"H	76
USFTBW2464	Tile-to-Floor One Side; Standard Base Raceway One Side: Segmented Fabric Panel - 64"H	68	USSFLBW2440	Elevated Base: Segmented Steel Panel - 40"H	86
USGL2440	Elevated Base: Segmented Fabric Panel - 40"H	106	USSFLBW2448	Elevated Base: Segmented Steel Panel - 48"H	88
USGL2448	Elevated Base: Segmented Fabric Panel - 48"H	106	USSFLBW2456	Elevated Base: Segmented Steel Panel - 56"H	88
USGL2456	Elevated Base: Segmented Fabric Panel - 56"H	106	USSFLBW2464	Elevated Base: Segmented Steel Panel - 64"H	88
USGL2464	Elevated Base: Segmented Fabric Panel - 64"H	108	USSFR2440	Standard Base Raceway: Segmented Steel Panel - 40"H	70
USGR2440	Standard Base Raceway: Segmented Fabric Panel - 40"H	102	USSFR2448	Standard Base Raceway: Segmented Steel Panel - 48"H	70
USGR2448	Standard Base Raceway: Segmented Fabric Panel - 48"H	102	USSFR2456	Standard Base Raceway: Segmented Steel Panel - 56"H	70
USGR2456	Standard Base Raceway: Segmented Fabric Panel - 56"H	102	USSFR2464	Standard Base Raceway: Segmented Steel Panel - 64"H	72
USGR2464	Standard Base Raceway: Segmented Fabric Panel - 64"H	104	USSFRBW2440	Standard Base Raceway: Segmented Steel Panel - 40"H	82
USGT2440	Tile-to-Floor One Side; Standard Base Raceway One Side: Segmented Fabric Panel - 40"H	110	USSFRBW2448	Standard Base Raceway: Segmented Steel Panel - 48"H	84
USGT2448	Tile-to-Floor One Side; Standard Base Raceway One Side: Segmented Fabric Panel - 48"H	110	USSFRBW2456	Standard Base Raceway: Segmented Steel Panel - 56"H	84
USGT2456	Tile-to-Floor One Side; Standard Base Raceway One Side: Segmented Fabric Panel - 56"H	110	USSFRBW2464	Standard Base Raceway: Segmented Steel Panel - 64"H	84
USGT2464	Tile-to-Floor One Side; Standard Base Raceway One Side: Segmented Fabric Panel - 64"H	112	USSFT2440	Tile-to-Floor One Side; Standard Base Raceway One Side: Segmented Steel Panel - 40"H	78
USMB1L2448	Elevated Base: Segmented Fabric Panel - 48"H	116	USSFT2448	Tile-to-Floor One Side; Standard Base Raceway One Side: Segmented Steel Panel - 48"H	78
USMB1L2456	Elevated Base: Segmented Fabric Panel - 56"H	116	USSFT2456	Tile-to-Floor One Side; Standard Base Raceway One Side: Segmented Steel Panel - 56"H	78
USMB1L2464	Elevated Base: Segmented Fabric Panel - 64"H	116	USSFT2464	Tile-to-Floor One Side; Standard Base Raceway One Side: Segmented Steel Panel - 64"H	80
USMB1R2448	Standard Base Raceway: Segmented Fabric Panel - 48"H	114	USSFTBW2440	Tile-to-Floor One Side; Standard Base Raceway One Side: Segmented Steel Panel - 40"H	90
USMB1R2456	Standard Base Raceway: Segmented Fabric Panel - 56"H	114	USSFTBW2448	Tile-to-Floor One Side; Standard Base Raceway One Side: Segmented Steel Panel - 48"H	92
USMB1R2464	Standard Base Raceway: Segmented Fabric Panel - 64"H	114	USSFTBW2456	Tile-to-Floor One Side; Standard Base Raceway One Side: Segmented Steel Panel - 56"H	92
USMB1T2448	Tile-to-Floor One Side; Standard Base Raceway One Side: Segmented Fabric Panel - 48"H	118	USSFTBW2464	Tile-to-Floor One Side; Standard Base Raceway One Side: Segmented Steel Panel - 64"H	92
USMB1T2456	Tile-to-Floor One Side; Standard Base Raceway One Side: Segmented Fabric Panel - 56"H	118	USSW1L2440	Elevated Base: Segmented Fabric Panel - 40"H	140
USMB1T2464	Tile-to-Floor One Side; Standard Base Raceway One Side: Segmented Fabric Panel - 64"H	118	USSW1L2448	Elevated Base: Segmented Fabric Panel - 48"H	140
USMB2L2448	Elevated Base: Segmented Fabric Panel - 48"H	122	USSW1L2456	Elevated Base: Segmented Fabric Panel - 56"H	140
USMB2L2456	Elevated Base: Segmented Fabric Panel - 56"H	122	USSW1L2464	Elevated Base: Segmented Fabric Panel - 64"H	142
USMB2L2464	Elevated Base: Segmented Fabric Panel - 64"H	122	USSW1R2440	Standard Base Raceway: Segmented Fabric Panel - 40"H	136
USMB2R2448	Standard Base Raceway: Segmented Fabric Panel - 48"H	120	USSW1R2448	Standard Base Raceway: Segmented Fabric Panel - 48"H	136
USMB2R2456	Standard Base Raceway: Segmented Fabric Panel - 56"H	120	USSW1R2456	Standard Base Raceway: Segmented Fabric Panel - 56"H	136
USMB2R2464	Standard Base Raceway: Segmented Fabric Panel - 64"H	120	USSW1R2464	Standard Base Raceway: Segmented Fabric Panel - 64"H	138
USOL2440	Elevated Base: Segmented Open Panel - 40"H	98	USSW1T2440	Tile-to-Floor One Side; Standard Base Raceway One Side: Segmented Fabric Panel - 40"H	144
USOL2448	Elevated Base: Segmented Open Panel - 48"H	98	USSW1T2448	Tile-to-Floor One Side; Standard Base Raceway One Side: Segmented Fabric Panel - 48"H	144
USOL2456	Elevated Base: Segmented Open Panel - 56"H	98	USSW1T2456	Tile-to-Floor One Side; Standard Base Raceway One Side: Segmented Fabric Panel - 56"H	144
USOL2464	Elevated Base: Segmented Open Panel - 64"H	100	USSW1T2464	Tile-to-Floor One Side; Standard Base Raceway One Side: Segmented Fabric Panel - 64"H	146
USOR2440	Standard Base Raceway: Segmented Open Panel - 40"H	94	USSW2L2440	Elevated Base: Segmented Fabric Panel - 40"H	152
USOR2448	Standard Base Raceway: Segmented Open Panel - 48"H	94	USSW2L2448	Elevated Base: Segmented Fabric Panel - 48"H	152
USOR2456	Standard Base Raceway: Segmented Open Panel - 56"H	94	USSW2L2456	Elevated Base: Segmented Fabric Panel - 56"H	152
USOR2464	Standard Base Raceway: Segmented Open Panel - 64"H	96	USSW2L2464	Elevated Base: Segmented Fabric Panel - 64"H	154
USPCBW25	Pedestal Accessories: Counterbalance Weight	366	USSW2R2440	Standard Base Raceway: Segmented Fabric Panel - 40"H	148
USPCBW36	Pedestal Accessories: Counterbalance Weight	366	USSW2R2448	Standard Base Raceway: Segmented Fabric Panel - 48"H	148
USPCK	Pedestal Accessories: Caster Kit	366	USSW2R2456	Standard Base Raceway: Segmented Fabric Panel - 56"H	148
USPGK	Pedestal Accessories: Glide Kit	366	USSW2R2464	Standard Base Raceway: Segmented Fabric Panel - 64"H	150
USPLPL	Splice Plate	292	USTF2416	Fabric : Fabric Stacking Panel - 16" H	156
			USTG2416	Glass: Glass Stacking Panel - 16" H	160
			USTM12416	Markerboard on One Side: Markerboard on One-Side	

# Index

Model No.	Description	Page	Model No.	Description	Page
	Stacking Panel - 16" H	164	UWR1824	Rectangular: Rectangular Worksurfaces - 18" D	256
USTM22416	Markerboard on Both Sides : Markerboard on Both-Sides Stacking Panel - 16" H	166	UWR2224	Rectangular: Rectangular Worksurfaces - 22" D	256
USTP2416	Perforated Steel: Perforated Steel Stacking Panel - 16" H	162	UWR2424	Rectangular: Rectangular Worksurfaces - 24" D	256
USTS2416	Solid Steel : Solid Steel Stacking Panel - 16" H	158	UWR3024	Rectangular: Rectangular Worksurfaces - 30" D	258
USTSW12416	Slat Wall on One Side : Slat Wall on One-Side Stacking Panel - 16" H	168	UWSES.R	Worksurface Edge Support with Lock	292
USTSW22416	Slat Wall on Two Sides : Slat Wall on Two-Sides Stacking Panel - 16" H	170	UWT224830	Tapered: Tapered - 22"	272
UTBLI2448	Freestanding Tables: Freestanding Tables - With Insert	288	UWT244830	Tapered: Tapered - 24"	272
UTBLO2448	Freestanding Tables: Freestanding Tables - Open Leg	288	UWTR1624	Transaction Countertops: Straight Countertops, Standard Height	284
UTLT5.24	Task Lights: Task Lights	360	UWTR321624	Transaction Countertops: Straight Countertops, 32" Height	286
UW12022363622	120° End Corner: 120° End Corner/60° User Edge - 22"	278	UWTRC1624	Transaction Countertops: Corner Countertops, Standard Height	284
UW1202260	120° End Corner/60° End Corner: 60° End Corner - 22 and 24"	280	UWTRC321624	Transaction Countertops: Corner Countertops, 32" Height	286
UW12024363624	120° End Corner: 120° End Corner/60° User Edge - 24"	278			
UWBBFB48L	48" High Side Access Bookcase: Wardrobe/Side Access Bookcase - Box/Box/File	350			
UWBBFB64L	64" High Side Access Bookcase: Wardrobe/Side Access Bookcase - Box/Box/File	352			
UWBBFC48L	48" High Cabinet: Wardrobe/Cabinet - Box/Box/File	346			
UWBBFC64L	64" High Cabinet: Wardrobe/Cabinet - Box/Box/File	348			
UWCE2451	Conference End: Conference End	270			
UWCT1536	Laminate Tops: U-Series® Credenza-Laminate Tops	344			
UWDC18363618	Diagonal 90° Corner: Diagonal 90° Corner - 18" D	260			
UWDC22363622	Diagonal 90° Corner: Diagonal 90° Corner - 22" D	260			
UWDC24363624	Diagonal 90° Corner: Diagonal 90° Corner - 24" D	260			
UWEC18366022	Extended Corner Reductions: Extended Corner Reduction - 18"	266			
UWEC18603622	Extended Corner Reductions: Extended Corner Reduction - 18"	268			
UWEC22366018	Extended Corner Reductions: Extended Corner Reduction - 22"	266			
UWEC22366022	Extended Corner: Extended Corner - 22"	264			
UWEC22603618	Extended Corner Reductions: Extended Corner Reduction - 22"	268			
UWEC22603622	Extended Corner: Extended Corner - 22"	262			
UWEC24366018	Extended Corner Reductions: Extended Corner Reduction - 24"	266			
UWEC24366024	Extended Corner: Extended Corner - 24"	264			
UWEC24603618	Extended Corner Reductions: Extended Corner Reduction - 24"	268			
UWEC24603624	Extended Corner: Extended Corner - 24"	262			
UWFFB48L	48" High Side Access Bookcase: Wardrobe/Side Access Bookcase - File/File	350			
UWFFB64L	64" High Side Access Bookcase: Wardrobe/Side Access Bookcase - File/File	352			
UWFFC48L	48" High Cabinet: Wardrobe/Cabinet - File/File	346			
UWFFC64L	64" High Cabinet: Wardrobe/Cabinet - File/File	348			
UWIC12022363622	120° End Corner/60° End Corner: 120° End Corner/90° User Edge - 22"	280			
UWIC12024363624	120° End Corner/60° End Corner: 120° End Corner/90° User Edge - 24"	280			
UWP16487222	Peninsula: Peninsula - 22" D	274			
UWP16487224	Peninsula: Peninsula - 24" D	274			
UWP22724816	Peninsula: Peninsula - 22" D	276			
UWP24724816	Peninsula: Peninsula - 24" D	276			







KI  
1330 Bellevue Street  
P.O. Box 8100  
Green Bay, Wisconsin 54308-8100  
1-800-424-2432  
[www.ki.com](http://www.ki.com)

KI and Furnishing Knowledge  
are registered trademarks of  
Krueger International, Inc.

© 2010 KI  
All Rights Reserved.  
Litho in USA.  
Code KI-11557/KI/PDF/1010