

July 3, 2011

Updated January 2, 2017

800-424-2432



Darwin®	General Information	2
Darwin®	Desks and Desk Shells	10
	Table Desks	12
	Corner Desks	20
	Corner Table Desks	22
	Corner Desks	24
	Executive Return Shells	30
	Bridges	32
	Extended Corners	34
	Credenzas	36
	Reception Desks	38
	Reception Returns	40
	Reception - Bridge/Credenza	42
	PT Edge Mitered Desks	44
	PT Edge Mitered Table Desks	48
	PT Edge Mitered Returns	60
	PT Edge Mitered Bridges	62
	PT Edge Mitered Credenzas	64
	Hutches	66
	Storage Units	70
	Sub-Surface Storage-No Tops	76
	Sub-Surface Storage	78
	Freestanding and Mobile Pedestals with Tops	80
	Storage - with Top	82
	Storage Units - Veneer Doors	84
	Bookcases - 16" Deep	92
	Storage	94
	Lateral Files	98
Storage Accessories		100
Darwin® Conference Room Tables		
	Round/Rectangular Tables	102
	Elliptical Tables	104
	Racetrack Tables	106
	Round/Rectangular Tables with CD Edge only	108
	Elliptical/Triangular Tables with CD Edge only	110
	Racetrack/Boat Shape Tables with CD Edge only	112
Darwin®	Accessories	108
	Accessories/Replacement Parts	116
	Accessories	118
	Accessories/Darwin® Tackboards	120
Index		122

Darwin®

General Information



Quarter Round Edge (BO)

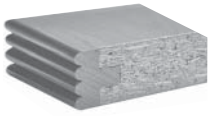

Reed Edge (CR)



Square Edge (EB)

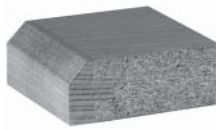

Pyramid Edge (PD)



Cove Edge (CV)



Knife Edge (CD)

BO, CR, EB, PD

-- Edge all around

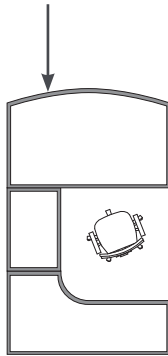

CV Cove

-- Desk edges on user and visitor sides
-- Bridges, corners and credenzas on users sides and on connecting sides

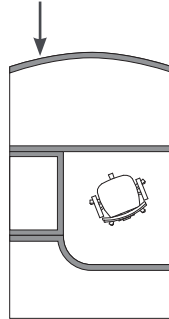

CD Knife

-- Desk edges on user and visitor sides
-- Mitered bridges
-- Bridges and credenzas edges on user sides

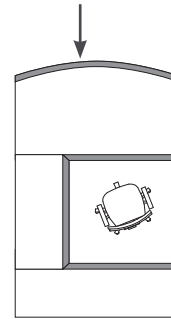

SPECIFICATIONS

Worksurfaces and sides are 1-1/4" particle-board or MDF. Particle board is used with solid wood edges, MDF with knife edge. Modesty panels are 3/4" (19mm) MDF. Pedestals (desks and credenzas) are not attached nor handed. They can be installed either on left or right.

Furniture is assembled using Minifix quick connectors.

Levellers are accessible at the bottom and allow up to a 3/4" height adjustment.

Approximate weights and dimensions are for cartoned items and are indicated for shipping purposes only.

Veneer

Genuine veneers are selectively book matched on all surfaces to provide proper consistency.

Desks and Tables

4" Round steel leg are submitted to a phosphatization process before being finished with a sterling color, electrostatic powder

paint dried at high temperature.

Pedestals

All pedestals are available separately. They can be used independently or to complete a desk, credenza, return, etc.

Drawer construction

Drawers are built of 1/2" (12mm) 3-ply maple for the sides and 1/4" (6mm) for the bottom, with a natural finish, and sealed. Drawer fronts are veneered and finished to match the furniture tone.

File Drawers

File drawers are equipped with heavy-duty full-extension ball bearing slides for smooth operation. 150-lb (68 kg) load capacity. Drawers accommodate legal-size suspended file folders for front-to-back filing, and letter-size suspended file folders for side-to-side filing (hanging bar included).

Drawer Suspension

File drawers utilize a heavy duty full exten-

sion metal ball bearing slide for smooth operation. Box drawers operate on full extension slides allowing total access to the drawer.

Finish color matching

Different wood species offer unique texture and grain. Minor variations in finish color may occur due to the natural characteristics of wood. We carefully select all material used in every product insuring an excellent color and finish.

Locks

Locks are factory installed in pre-determined positions. (Glass doors do not allow locks)

Finish Color Matching

Different wood species offer unique texture and grain. Minor variations in finish color may occur due to the natural characteristics of wood.

Darwin's 7-step catalyzed varnish utilizes the latest in technology. The superior strength of the finish provides enhanced stain and

mar resistance for lasting beauty and easy maintenance.



6 - Metal Pull - Black



7 - Metal Pull - Satin



8 - Metal Pull - Chrome



0 - Curved Pull - Black



4 - Curved Pull - Champagne



11 - Arc Pull - Satin



12 - Arc Pull - Black



13 - Arc Pull - Chrome



21 - Straight Pull - Chrome



22 - Straight Pull - Black



41 - Corinto Pull - Black



42 - Corinto Pull - Satin



45 - Flat Pull - Satin

Typical 1

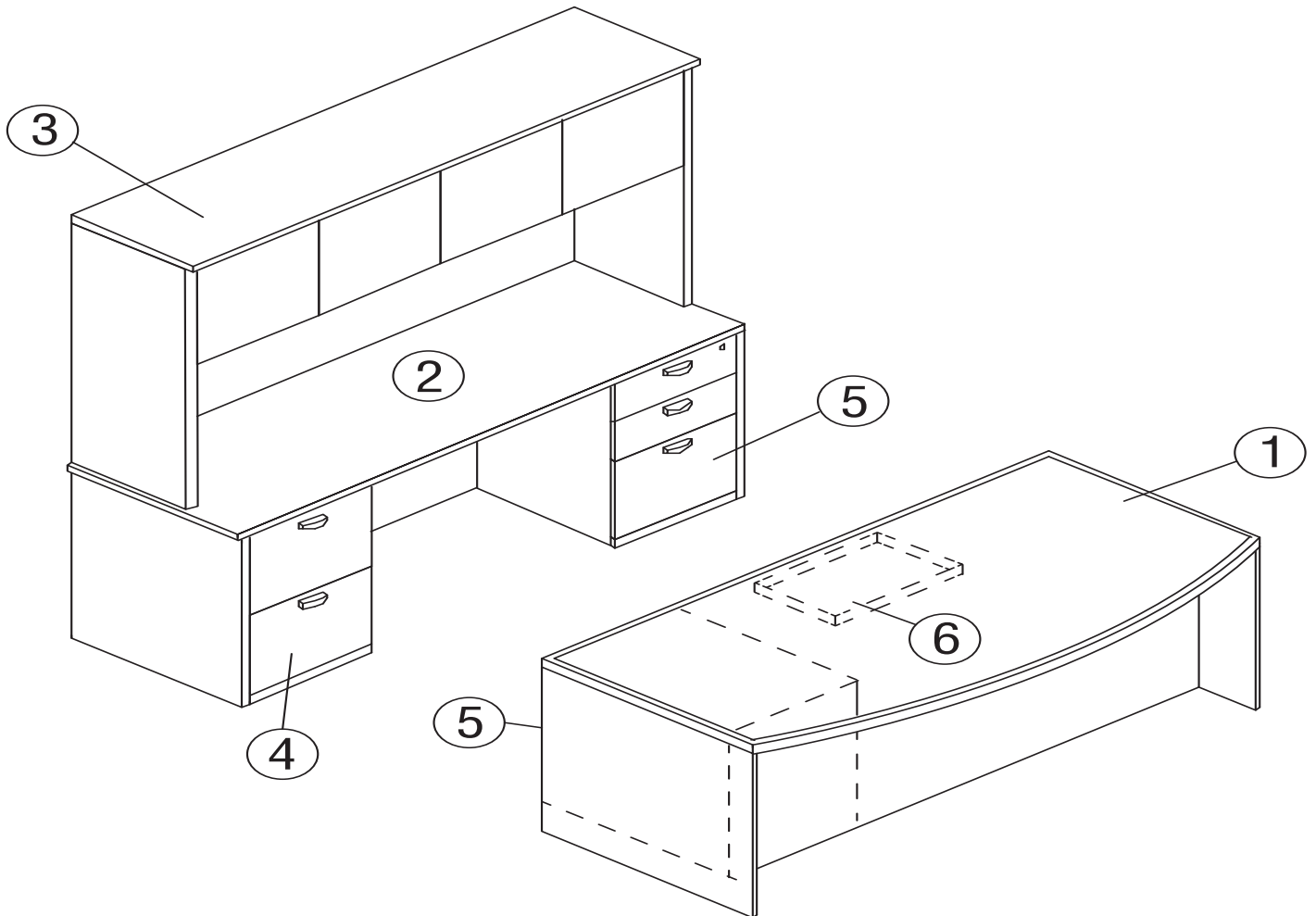

ITEM	MODEL#	QTY	DESCRIPTION
1	KAT40023672/PD	1	Bow front, desk shell, without grommets
2	KAT45112472/PD	1	Credenza shell, without grommets
3	KAT60011771/PD	1	Hutch unit, veneer doors, no lock
4	KAT70072017	1	File pedestal, two file drawers
5	KAT70082017	2	Utility pedestal, two box and one file drawer
6	KAT78041613	1	Pencil tray

Typical 2

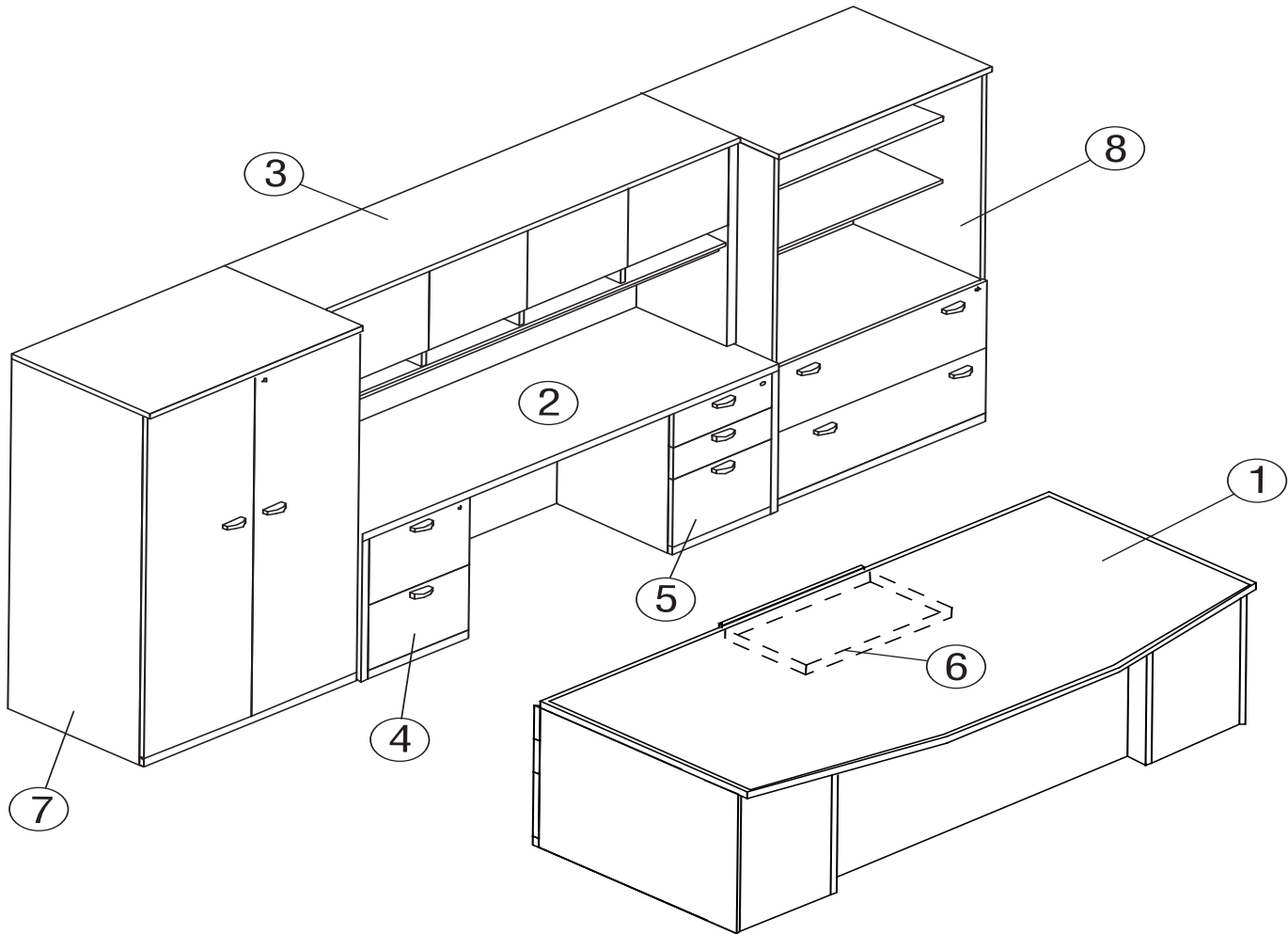

ITEM	MODEL#	QTY	DESCRIPTION
1	KAT40014288/PD	1	Bow front, double pedestal desk
2	KAT45112472/PD	1	Credenza shell, without grommets
3	KAT60111771/PD	1	Hutch unit with pigeonholes, veneer doors, no lock
4	KAT70072017	1	File pedestal (sub-surface storage), two file drawers
5	KAT70082017	1	Utility pedestal (sub-surface storage), two box and one file drawer
6	KAT78042421	1	Pencil tray
7	KAT77113670/PD	1	Bookcase with doors
8	KAT76123670/PD	1	File/bookcase unit, with lock

Typical 3

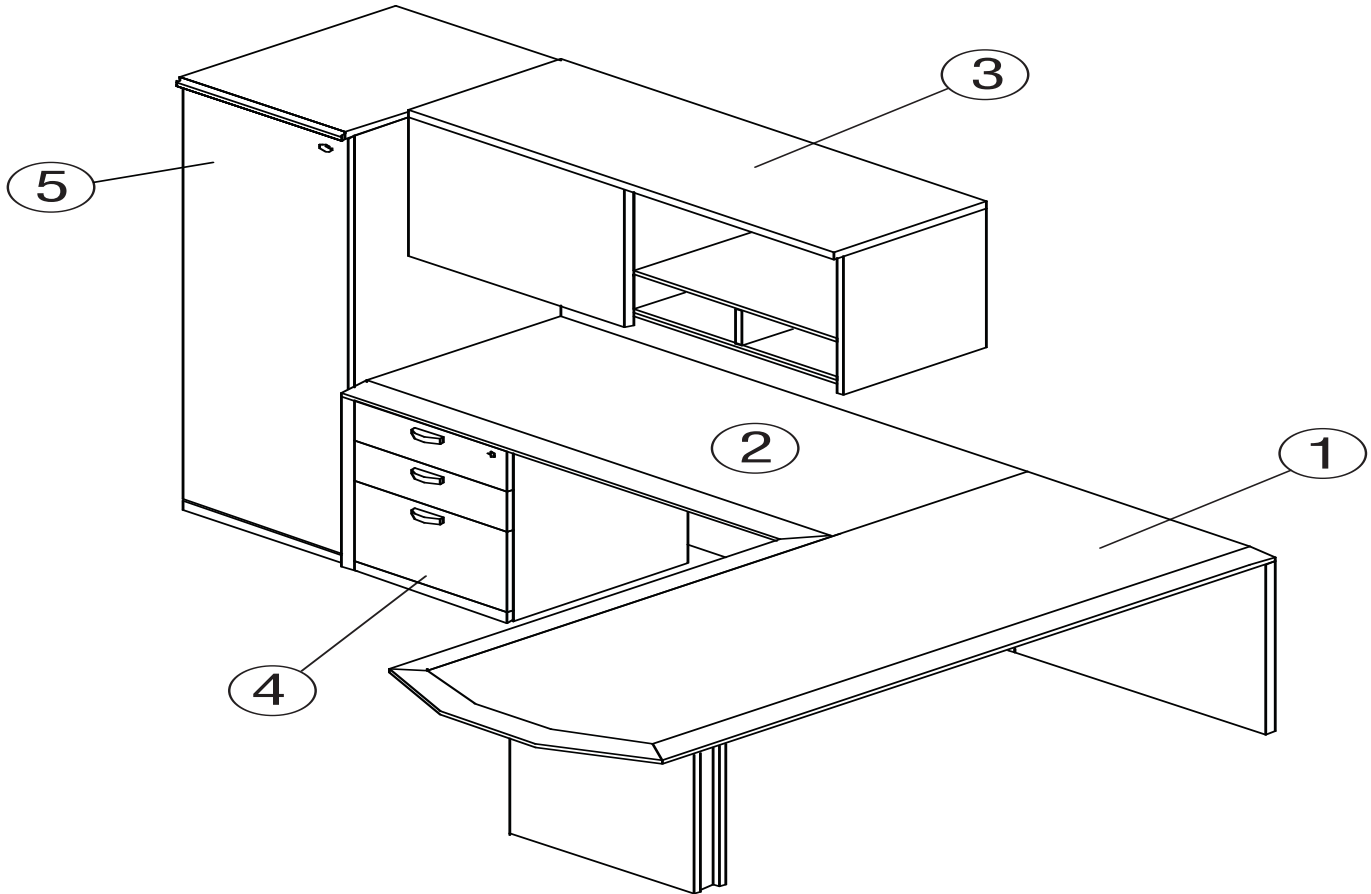

ITEM	MODEL#	QTY	DESCRIPTION
1	KAT40443072/CD	1	Mitered rectangular desk, right, 3/4 modesty panel
2	KAT43032472/CD	1	Mitered executive return, left, without grommets
3	KAT65152448/CD	1	Wall mount unit with pigeonholes, sliding veneer door
4	KAT70082017	1	Utility pedestal (sub-surface storage), two box and one file drawer
5	KAT75021870/CD	1	Storage tower, left

Typical 4

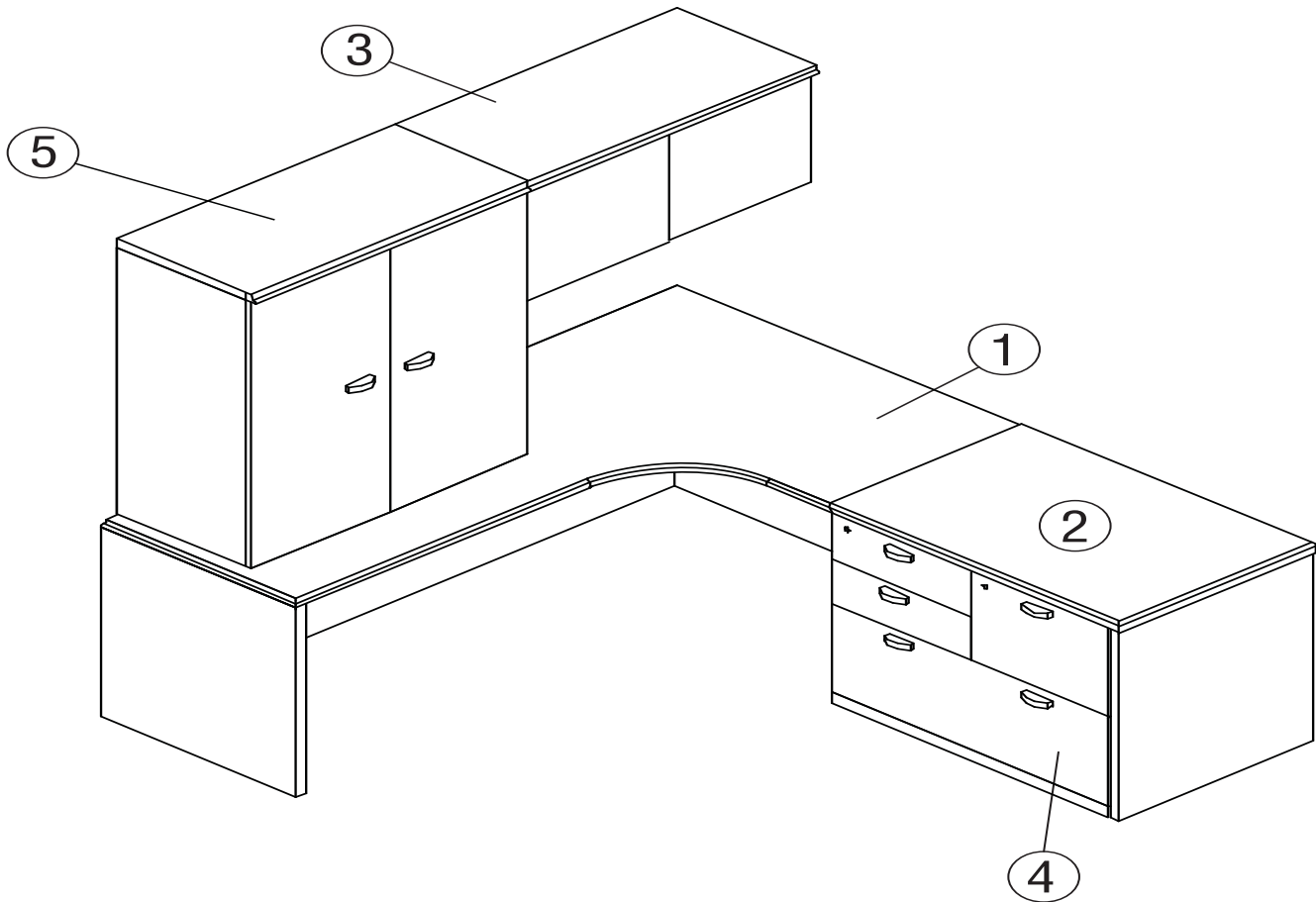

ITEM	MODEL#	QTY	DESCRIPTION
1	KAT42114272/PD	1	Extended corner, left, without grommets
2	KAT43022436/PD	1	Executive return shell, right, without grommets
3	KAT65011636/PD	1	Wall mount storage unit, no lock
4	KAT70152034	1	Multi-file, right (sub-surface storage)
5	KAT77213441/PD	1	Bookcase with doors

Typical 5

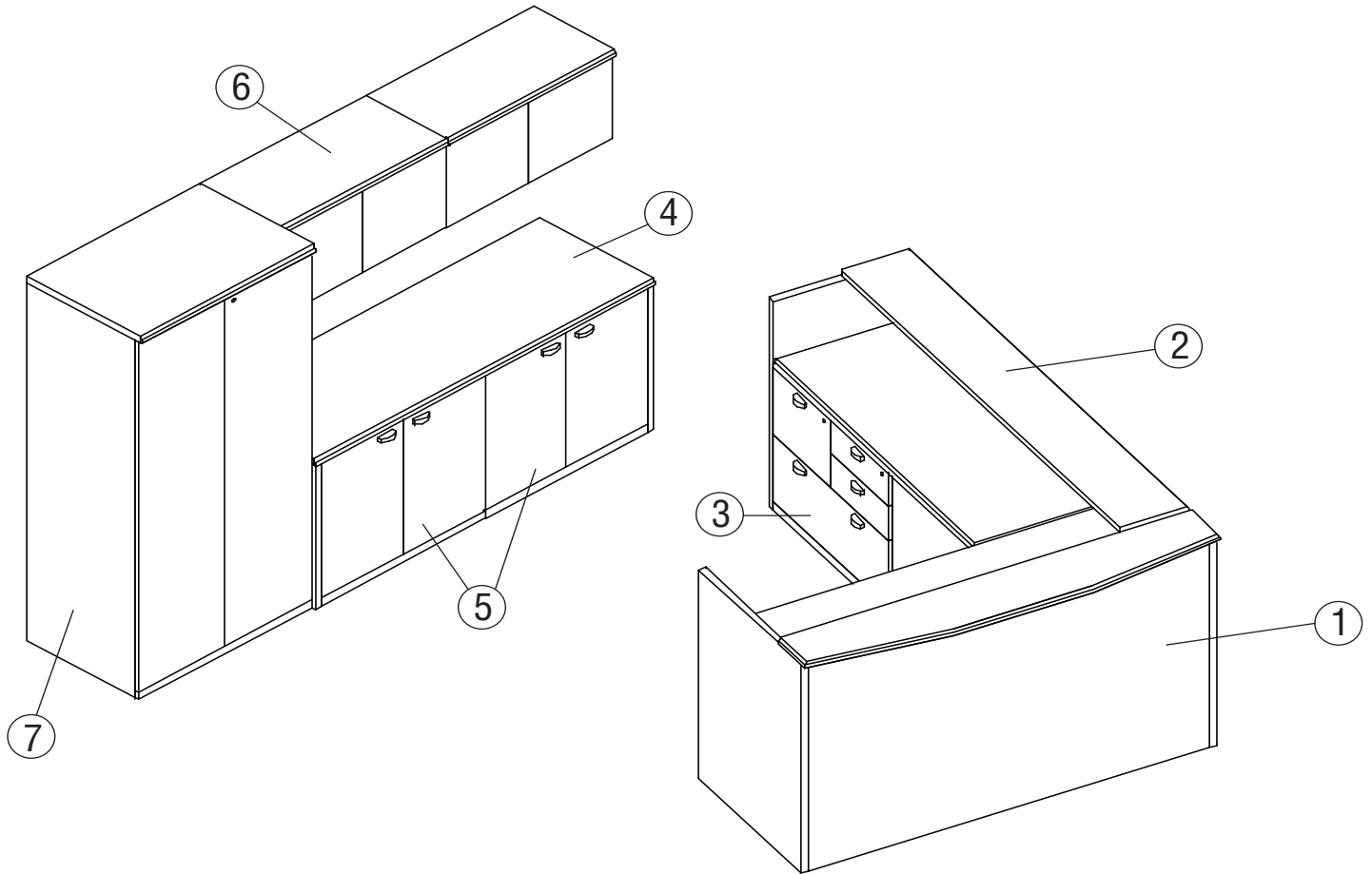

ITEM	MODEL#	QTY	DESCRIPTION
1	KAT55013072/CV	1	Reception desk, bow shaped transaction top
2	KAT55113060/CV	1	Return, left
3	KAT70192034	1	Multi-file, left (sub-surface storage)
4	KAT45112472/CV	1	Credenza shell, without grommets
5	KAT70112034	2	Bookcase unit, no lock
6	KAT65011636/CV	1	Wall mount storage unit, no lock
7	KAT76033670/CV	i	Storage / wardrobe unit

Darwin®

Desks and Desk Shells

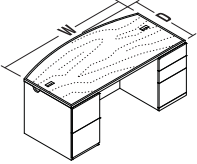
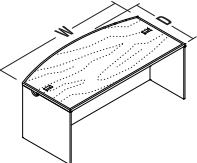
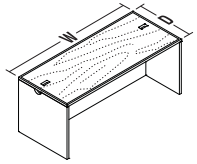
MODEL	Features	D x W x H	MODEL NUMBER						
			Basic Model	Edge Style	Wood Finish	Pull Option	Grommets	Lock Option	
 <p>Bow Front Desk, Double Pedestal</p> <ul style="list-style-type: none"> • Box-box-file pedestal • File-file pedestal • Locks included, front locking • Flush sides • Full height panel is recessed 8" • 36" deep models accommodate 19" pedestals • 42" deep models accommodate 19" or 26" pedestals 	36" Deep	36 x 70-3/4 x 29-1/4"	KAT40013672	<input type="checkbox"/>	<input type="checkbox"/>	<input type="checkbox"/>	<input type="checkbox"/>	<input type="checkbox"/>	<input type="checkbox"/>
	36" Deep	36 x 82-3/4 x 29-1/4"	KAT40013684	<input type="checkbox"/>	<input type="checkbox"/>	<input type="checkbox"/>	<input type="checkbox"/>	<input type="checkbox"/>	<input type="checkbox"/>
	36" Deep	36 x 87 x 29-1/4"	KAT40013688	<input type="checkbox"/>	<input type="checkbox"/>	<input type="checkbox"/>	<input type="checkbox"/>	<input type="checkbox"/>	<input type="checkbox"/>
	42" Deep	42 x 70-3/4 x 29-1/4"	KAT40014272	<input type="checkbox"/>	<input type="checkbox"/>	<input type="checkbox"/>	<input type="checkbox"/>	<input type="checkbox"/>	<input type="checkbox"/>
	42" Deep	42 x 82-3/4 x 29-1/4"	KAT40014284	<input type="checkbox"/>	<input type="checkbox"/>	<input type="checkbox"/>	<input type="checkbox"/>	<input type="checkbox"/>	<input type="checkbox"/>
	42" Deep	42 x 87 x 29-1/4"	KAT40014288	<input type="checkbox"/>	<input type="checkbox"/>	<input type="checkbox"/>	<input type="checkbox"/>	<input type="checkbox"/>	<input type="checkbox"/>
 <p>Bow Front Desk - Shell</p> <ul style="list-style-type: none"> • Inside dimension is 4" less than nominal width (example=72" is 68" inside) • Flush sides • Full height panel is recessed 8" • 36" deep models accommodate 19" pedestals • 42" deep models accommodate 19" or 26" pedestals 	36" Deep	36 x 70-3/4 x 29-1/4"	KAT40023672	<input type="checkbox"/>	<input type="checkbox"/>		<input type="checkbox"/>		
	36" Deep	36 x 82-3/4 x 29-1/4"	KAT40023684	<input type="checkbox"/>	<input type="checkbox"/>		<input type="checkbox"/>		
	36" Deep	36 x 87 x 29-1/4"	KAT40023688	<input type="checkbox"/>	<input type="checkbox"/>		<input type="checkbox"/>		
	42" Deep	42 x 70-3/4 x 29-1/4"	KAT40024272	<input type="checkbox"/>	<input type="checkbox"/>		<input type="checkbox"/>		
	42" Deep	42 x 82-3/4 x 29-1/4"	KAT40024284	<input type="checkbox"/>	<input type="checkbox"/>		<input type="checkbox"/>		
	42" Deep	42 x 87 x 29-1/4"	KAT40024288	<input type="checkbox"/>	<input type="checkbox"/>		<input type="checkbox"/>		
 <p>Desk - Shell</p> <ul style="list-style-type: none"> • Inside dimension is 4" less than nominal width (example=72" is 68" inside) • Flush sides • Full height panel is recessed 8" • 30" models accommodate 19" pedestals only • 36" and 42" deep models accommodate 19" or 26" pedestals 	30" Deep	30 x 58-3/4 x 29-1/4"	KAT40123060	<input type="checkbox"/>	<input type="checkbox"/>		<input type="checkbox"/>		
	30" Deep	30 x 64-3/4 x 29-1/4"	KAT40123066	<input type="checkbox"/>	<input type="checkbox"/>		<input type="checkbox"/>		
	30" Deep	30 x 70-3/4 x 29-1/4"	KAT40123072	<input type="checkbox"/>	<input type="checkbox"/>		<input type="checkbox"/>		
	30" Deep	30 x 82-3/4 x 29-1/4"	KAT40123084	<input type="checkbox"/>	<input type="checkbox"/>		<input type="checkbox"/>		
	30" Deep	30 x 87 x 29-1/4"	KAT40123088	<input type="checkbox"/>	<input type="checkbox"/>		<input type="checkbox"/>		
	36" Deep	36 x 58-3/4 x 29-1/4"	KAT40123660	<input type="checkbox"/>	<input type="checkbox"/>		<input type="checkbox"/>		
	36" Deep	36 x 64-3/4 x 29-1/4"	KAT40123666	<input type="checkbox"/>	<input type="checkbox"/>		<input type="checkbox"/>		
	36" Deep	36 x 70-3/4 x 29-1/4"	KAT40123672	<input type="checkbox"/>	<input type="checkbox"/>		<input type="checkbox"/>		
	36" Deep	36 x 82-3/4 x 29-1/4"	KAT40123684	<input type="checkbox"/>	<input type="checkbox"/>		<input type="checkbox"/>		
	36" Deep	36 x 87 x 29-1/4"	KAT40123688	<input type="checkbox"/>	<input type="checkbox"/>		<input type="checkbox"/>		

A **B** **C** **D** **E** **F**

HOW TO ORDER

Indicate the following information on order form:

1. Quantity of each item.
2. Model number, including options. See "How To Build a Model Number".
3. Any special service required.

Note: • The indicates that a choice is required.

- The absence of the indicates that no choice is required.
- Alpha-numeric characters in place of indicate that no other alternatives are available.

HOW TO BUILD A MODEL NUMBER

A Select basic model.

B Select edge style.

- BO** - Quarter round edge
- CR** - Reed edge
- CV** - Cove edge
- EB** - Square edge
- PD** - Pyramid edge

C Select wood finish color.
Refer to color addendum at ki.com or KI Fabrics & Finishes binder.

D Select pull option.

- 6** - Metal pull - black
- 7** - Metal pull - satin
- 8** - Metal pull - chrome
- 0** - Curved pull - black
- 4** - Curved pull - champagne
- 11** - Arc pull - satin
- 12** - Arc pull - black
- 13** - Arc pull - chrome
- 21** - Straight pull - chrome

- 22** - Straight pull - black
- 41** - Corinto pull - black
- 42** - Corinto pull - satin
- 45** - Flat pull - satin

E Select grommet.

- NA** - No grommet
 - EG** - Rectangular grommet
- Grommets are factory installed.

F Select key option.

- KS** - Key standard
- KA** - Key alike



Approx. Packaged Weight	Delivered Pricing
400.0#	\$ 4416
410.0#	4619
420.0#	4695
450.0#	5062
460.0#	5283
475.0#	5362

230.0#	\$ 2600
245.0#	2886
260.0#	2991
270.0#	2831
275.0#	3181
280.0#	3290

208.0#	\$ 1412
238.0#	1555
270.0#	1635
290.0#	1886
300.0#	1951
220.0#	1695
250.0#	1767
266.0#	1832
299.0#	2102
310.0#	2171

SPECIAL SERVICES

Special Carton Marking

With specially marked information N/C

Shipping

Shipped **assembled freight prepaid f.o.b. Mexico City, MX 11000** factory. Freight class #125.

Specifications and prices are subject to change without prior notice.

Darwin®

Table Desks

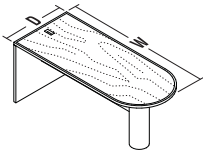
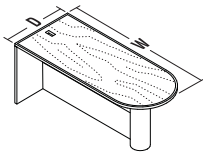
MODEL	Features	D x W x H	MODEL NUMBER				Approx. Packaged Weight
			Basic Model	Edge Style	Wood Finish	Grommets	
 <p>Bullet Desk - 3/4 Modesty Panel</p> <ul style="list-style-type: none"> • 4" diameter steel leg (black only) • 14-3/4" modesty height <p>DTDK</p>	30" Deep	30 x 59-1/4 x 29-1/4"	KAT40223060	<input type="checkbox"/>	<input type="checkbox"/>	<input type="checkbox"/>	144.0#
	30" Deep	30 x 65-1/4 x 29-1/4"	KAT40223066	<input type="checkbox"/>	<input type="checkbox"/>	<input type="checkbox"/>	152.0#
	30" Deep	30 x 71-1/2 x 29-1/4"	KAT40223072	<input type="checkbox"/>	<input type="checkbox"/>	<input type="checkbox"/>	168.0#
	30" Deep	30 x 83-1/2 x 29-1/4"	KAT40223084	<input type="checkbox"/>	<input type="checkbox"/>	<input type="checkbox"/>	185.0#
	30" Deep	30 x 87-1/2 x 29-1/4"	KAT40223088	<input type="checkbox"/>	<input type="checkbox"/>	<input type="checkbox"/>	194.0#
	36" Deep	36 x 59-1/4 x 29-1/4"	KAT40223660	<input type="checkbox"/>	<input type="checkbox"/>	<input type="checkbox"/>	205.0#
	36" Deep	36 x 65-1/4 x 29-1/4"	KAT40223666	<input type="checkbox"/>	<input type="checkbox"/>	<input type="checkbox"/>	210.0#
	36" Deep	36 x 71-1/2 x 29-1/4"	KAT40223672	<input type="checkbox"/>	<input type="checkbox"/>	<input type="checkbox"/>	220.0#
	36" Deep	36 x 83-1/2 x 29-1/4"	KAT40223684	<input type="checkbox"/>	<input type="checkbox"/>	<input type="checkbox"/>	235.0#
	36" Deep	36 x 87-1/2 x 29-1/4"	KAT40223688	<input type="checkbox"/>	<input type="checkbox"/>	<input type="checkbox"/>	247.0#
 <p>Bullet Desk - Full Modesty Panel</p> <ul style="list-style-type: none"> • 4" diameter steel leg (black only) <p>DTDK</p>	30" Deep	30 x 59-1/4 x 29-1/4"	KAT40273060	<input type="checkbox"/>	<input type="checkbox"/>	<input type="checkbox"/>	144.0#
	30" Deep	30 x 65-1/4 x 29-1/4"	KAT40273066	<input type="checkbox"/>	<input type="checkbox"/>	<input type="checkbox"/>	152.0#
	30" Deep	30 x 71-1/2 x 29-1/4"	KAT40273072	<input type="checkbox"/>	<input type="checkbox"/>	<input type="checkbox"/>	168.0#
	30" Deep	30 x 83-1/2 x 29-1/4"	KAT40273084	<input type="checkbox"/>	<input type="checkbox"/>	<input type="checkbox"/>	185.0#
	30" Deep	30 x 87-1/2 x 29-1/4"	KAT40273088	<input type="checkbox"/>	<input type="checkbox"/>	<input type="checkbox"/>	194.0#
	36" Deep	36 x 59-1/4 x 29-1/4"	KAT40273660	<input type="checkbox"/>	<input type="checkbox"/>	<input type="checkbox"/>	205.0#
	36" Deep	36 x 65-1/4 x 29-1/4"	KAT40273666	<input type="checkbox"/>	<input type="checkbox"/>	<input type="checkbox"/>	210.0#
	36" Deep	36 x 71-1/2 x 29-1/4"	KAT40273672	<input type="checkbox"/>	<input type="checkbox"/>	<input type="checkbox"/>	220.0#
	36" Deep	36 x 83-1/2 x 29-1/4"	KAT40273684	<input type="checkbox"/>	<input type="checkbox"/>	<input type="checkbox"/>	235.0#
	36" Deep	36 x 87-1/2 x 29-1/4"	KAT40273688	<input type="checkbox"/>	<input type="checkbox"/>	<input type="checkbox"/>	247.0#

A **B** **C** **D**

HOW TO ORDER

Indicate the following information on order form:

1. Quantity of each item.
2. Model number, including options. See "How To Build a Model Number".
3. Any special service required.

Note: • The indicates that a choice is required.

- The absence of the indicates that no choice is required.
- Alpha-numeric characters in place of

indicate that no other alternatives are available.

HOW TO BUILD A MODEL NUMBER

A Select basic model.

B Select edge style.

- BO** - Quarter round edge
- CR** - Reed edge
- CV** - Cove edge
- EB** - Square edge
- PD** - Pyramid edge

C Select wood finish color. Refer to color addendum at ki.com or KI Fabrics & Finishes binder.

D Select grommet.

- NA** - No grommet
 - EG** - Rectangular grommet
- Grommets are factory installed.



Delivered
Pricing

\$ 2286
2486
2691
3092
3126
2777
2926
2978
3246
3538
\$ 2682
2859
3036
3393
3520
3006
3199
3401
3786
3925

SPECIAL SERVICES

Special Carton Marking

With specially marked information N/C

Shipping

Shipped **assembled freight prepaid f.o.b. Mexico City, MX 11000** factory. Freight class #125.

Specifications and prices are subject to change without prior notice.

Darwin®

Table Desks

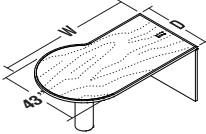
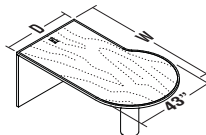
MODEL	Features	D x W x H	MODEL NUMBER				Approx. Packaged Weight
			Basic Model	Edge Style	Wood Finish	Grommets	
 <p>P-Shaped Desk - Left - 3/4 Modesty Panel</p> <ul style="list-style-type: none"> • 4" diameter steel leg (black only) • 14-3/4" modesty panel • 43" at fullest depth <p>DTDK</p>	30" Deep	30 x 59-1/4 x 29-1/4"	KAT40313060	<input type="checkbox"/>	<input type="checkbox"/>	<input type="checkbox"/>	165.0#
	30" Deep	30 x 65-1/4 x 29-1/4"	KAT40313066	<input type="checkbox"/>	<input type="checkbox"/>	<input type="checkbox"/>	172.0#
	30" Deep	30 x 71-1/2 x 29-1/4"	KAT40313072	<input type="checkbox"/>	<input type="checkbox"/>	<input type="checkbox"/>	180.0#
	30" Deep	30 x 83-1/2 x 29-1/4"	KAT40313084	<input type="checkbox"/>	<input type="checkbox"/>	<input type="checkbox"/>	195.0#
	30" Deep	30 x 87-1/2 x 29-1/4"	KAT40313088	<input type="checkbox"/>	<input type="checkbox"/>	<input type="checkbox"/>	199.0#
	36" Deep	36 x 59-1/4 x 29-1/4"	KAT40313660	<input type="checkbox"/>	<input type="checkbox"/>	<input type="checkbox"/>	232.0#
	36" Deep	36 x 65-1/4 x 29-1/4"	KAT40313666	<input type="checkbox"/>	<input type="checkbox"/>	<input type="checkbox"/>	240.0#
	36" Deep	36 x 71-1/2 x 29-1/4"	KAT40313672	<input type="checkbox"/>	<input type="checkbox"/>	<input type="checkbox"/>	254.0#
	36" Deep	36 x 83-1/2 x 29-1/4"	KAT40313684	<input type="checkbox"/>	<input type="checkbox"/>	<input type="checkbox"/>	260.0#
	36" Deep	36 x 87-1/2 x 29-1/4"	KAT40313688	<input type="checkbox"/>	<input type="checkbox"/>	<input type="checkbox"/>	265.0#
 <p>P-Shaped Desk - Right - 3/4 Modesty Panel</p> <ul style="list-style-type: none"> • 4" diameter steel leg (black only) • 14-3/4" modesty panel • 43" at fullest depth <p>DTDK</p>	30" Deep	30 x 59-1/4 x 29-1/4"	KAT40323060	<input type="checkbox"/>	<input type="checkbox"/>	<input type="checkbox"/>	165.0#
	30" Deep	30 x 65-1/4 x 29-1/4"	KAT40323066	<input type="checkbox"/>	<input type="checkbox"/>	<input type="checkbox"/>	172.0#
	30" Deep	30 x 71-1/2 x 29-1/4"	KAT40323072	<input type="checkbox"/>	<input type="checkbox"/>	<input type="checkbox"/>	180.0#
	30" Deep	30 x 83-1/2 x 29-1/4"	KAT40323084	<input type="checkbox"/>	<input type="checkbox"/>	<input type="checkbox"/>	195.0#
	30" Deep	30 x 87-1/2 x 29-1/4"	KAT40323088	<input type="checkbox"/>	<input type="checkbox"/>	<input type="checkbox"/>	199.0#
	36" Deep	36 x 59-1/4 x 29-1/4"	KAT40323660	<input type="checkbox"/>	<input type="checkbox"/>	<input type="checkbox"/>	232.0#
	36" Deep	36 x 65-1/4 x 29-1/4"	KAT40323666	<input type="checkbox"/>	<input type="checkbox"/>	<input type="checkbox"/>	240.0#
	36" Deep	36 x 71-1/2 x 29-1/4"	KAT40323672	<input type="checkbox"/>	<input type="checkbox"/>	<input type="checkbox"/>	254.0#
	36" Deep	36 x 83-1/2 x 29-1/4"	KAT40323684	<input type="checkbox"/>	<input type="checkbox"/>	<input type="checkbox"/>	260.0#
	36" Deep	36 x 87-1/2 x 29-1/4"	KAT40323688	<input type="checkbox"/>	<input type="checkbox"/>	<input type="checkbox"/>	265.0#

A

B

C

D

HOW TO ORDER

Indicate the following information on order form:

1. Quantity of each item.
2. Model number, including options. See "How To Build a Model Number".
3. Any special service required.

Note: • The indicates that a choice is required.

- The absence of the indicates that no choice is required.

- Alpha-numeric characters in place of indicate that no other alternatives are available.

HOW TO BUILD A MODEL NUMBER

- A** Select basic model.

- B** Select edge style.

BO	- Quarter round edge
CR	- Reed edge
CV	- Cove edge
EB	- Square edge
PD	- Pyramid edge

- C** Select wood finish color.
Refer to color addendum at ki.com or KI Fabrics & Finishes binder.

- D** Select grommet.

NA	- No grommet
EG	- Rectangular grommet

Grommets are factory installed.

 Delivered
 Pricing

\$ 3726
3927
4044
4507
4659
3726
3927
4044
4507
4659
\$ 3726
3927
4044
4507
4659
3726
3927
4044
4507
4659

SPECIAL SERVICES
Special Carton Marking

With specially marked information N/C

Shipping

 Shipped **assembled freight prepaid f.o.b. Mexico City, MX 11000** factory. Freight class #125.

Specifications and prices are subject to change without prior notice.

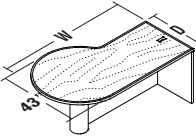
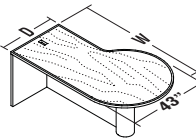
	MODEL	Features	D x W x H	MODEL NUMBER				Approx. Packaged Weight
				Basic Model	Edge Style	Wood Finish	Grommets	
 <p>DTDK</p>	P-Shaped Desk - Left - Full Modesty Panel • 4" diameter steel leg (black only) • 43" at fullest depth	30" Deep	30 x 59-1/4 x 29-1/4"	KAT40363060	<input type="checkbox"/>	<input type="checkbox"/>	<input type="checkbox"/>	165.0#
		30" Deep	30 x 65-1/4 x 29-1/4"	KAT40363066	<input type="checkbox"/>	<input type="checkbox"/>	<input type="checkbox"/>	172.0#
		30" Deep	30 x 71-1/2 x 29-1/4"	KAT40363072	<input type="checkbox"/>	<input type="checkbox"/>	<input type="checkbox"/>	180.0#
		30" Deep	30 x 83-1/2 x 29-1/4"	KAT40363084	<input type="checkbox"/>	<input type="checkbox"/>	<input type="checkbox"/>	195.0#
		30" Deep	30 x 87-1/2 x 29-1/4"	KAT40363088	<input type="checkbox"/>	<input type="checkbox"/>	<input type="checkbox"/>	199.0#
		36" Deep	36 x 59-1/4 x 29-1/4"	KAT40363660	<input type="checkbox"/>	<input type="checkbox"/>	<input type="checkbox"/>	232.0#
		36" Deep	36 x 65-1/4 x 29-1/4"	KAT40363666	<input type="checkbox"/>	<input type="checkbox"/>	<input type="checkbox"/>	240.0#
		36" Deep	36 x 71-1/2 x 29-1/4"	KAT40363672	<input type="checkbox"/>	<input type="checkbox"/>	<input type="checkbox"/>	254.0#
		36" Deep	36 x 83-1/2 x 29-1/4"	KAT40363684	<input type="checkbox"/>	<input type="checkbox"/>	<input type="checkbox"/>	260.0#
		36" Deep	36 x 87-1/2 x 29-1/4"	KAT40363688	<input type="checkbox"/>	<input type="checkbox"/>	<input type="checkbox"/>	265.0#
 <p>DTDK</p>	P-Shaped Desk - Right - Full Modesty Panel • 4" diameter steel leg (black only) • 43" at fullest depth	30" Deep	30 x 59-1/4 x 29-1/4"	KAT40373060	<input type="checkbox"/>	<input type="checkbox"/>	<input type="checkbox"/>	165.0#
		30" Deep	30 x 65-1/4 x 29-1/4"	KAT40373066	<input type="checkbox"/>	<input type="checkbox"/>	<input type="checkbox"/>	172.0#
		30" Deep	30 x 71-1/2 x 29-1/4"	KAT40373072	<input type="checkbox"/>	<input type="checkbox"/>	<input type="checkbox"/>	180.0#
		30" Deep	30 x 83-1/2 x 29-1/4"	KAT40373084	<input type="checkbox"/>	<input type="checkbox"/>	<input type="checkbox"/>	195.0#
		30" Deep	30 x 87-1/2 x 29-1/4"	KAT40373088	<input type="checkbox"/>	<input type="checkbox"/>	<input type="checkbox"/>	199.0#
		36" Deep	36 x 59-1/4 x 29-1/4"	KAT40373660	<input type="checkbox"/>	<input type="checkbox"/>	<input type="checkbox"/>	232.0#
		36" Deep	36 x 65-1/4 x 29-1/4"	KAT40373666	<input type="checkbox"/>	<input type="checkbox"/>	<input type="checkbox"/>	240.0#
		36" Deep	36 x 71-1/2 x 29-1/4"	KAT40373672	<input type="checkbox"/>	<input type="checkbox"/>	<input type="checkbox"/>	254.0#
		36" Deep	36 x 83-1/2 x 29-1/4"	KAT40373684	<input type="checkbox"/>	<input type="checkbox"/>	<input type="checkbox"/>	260.0#
		36" Deep	36 x 87-1/2 x 29-1/4"	KAT40373688	<input type="checkbox"/>	<input type="checkbox"/>	<input type="checkbox"/>	265.0#

A

B

C

D

HOW TO ORDER

Indicate the following information on order form:

- Quantity of each item.
- Model number, including options. See "How To Build a Model Number".
- Any special service required.

Note: • The indicates that a choice is required.

- The absence of the indicates that no choice is required.
- Alpha-numeric characters in place of indicate that no other alternatives are available.

HOW TO BUILD A MODEL NUMBER

A Select basic model.

B Select edge style.

BO - Quarter round edge

CR - Reed edge

CV - Cove edge

EB - Square edge

PD - Pyramid edge

C Select wood finish color.
Refer to color addendum at ki.com or KI Fabrics & Finishes binder.

D Select grommet.

NA - No grommet

EG - Rectangular grommet

Grommets are factory installed.

 Delivered
 Pricing

\$ 3927

4169

4389

4866

5024

3927

4169

4389

4866

5024

\$ 3927

4169

4389

4866

5024

3927

4169

4389

4866

5024

SPECIAL SERVICES
Special Carton Marking

With specially marked information N/C

Shipping

 Shipped **assembled freight prepaid f.o.b. Mexico City, MX 11000** factory. Freight class #125.

Specifications and prices are subject to change without prior notice.

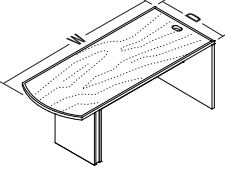
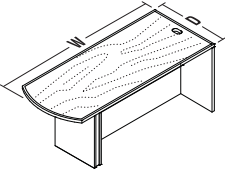
MODEL	Features	D x W x H	MODEL NUMBER				Approx. Packaged Weight
			Basic Model	Edge Style	Wood Finish	Grommets	
 <p>D-Shaped Rectangular Desk - Straight Leg - 3/4 Modesty Panel • 15-3/4" modesty panel</p> <p>DTDK</p>	30" Deep	30 x 59-1/4 x 29-1/4"	KAT40413060	<input type="checkbox"/>	<input type="checkbox"/>	<input type="checkbox"/>	194.0#
	30" Deep	30 x 65-1/4 x 29-1/4"	KAT40413066	<input type="checkbox"/>	<input type="checkbox"/>	<input type="checkbox"/>	210.0#
	30" Deep	30 x 71-1/2 x 29-1/4"	KAT40413072	<input type="checkbox"/>	<input type="checkbox"/>	<input type="checkbox"/>	222.0#
	30" Deep	30 x 83-1/2 x 29-1/4"	KAT40413084	<input type="checkbox"/>	<input type="checkbox"/>	<input type="checkbox"/>	234.0#
	30" Deep	30 x 87-1/2 x 29-1/4"	KAT40413088	<input type="checkbox"/>	<input type="checkbox"/>	<input type="checkbox"/>	245.0#
	36" Deep	36 x 59-1/4 x 29-1/4"	KAT40413660	<input type="checkbox"/>	<input type="checkbox"/>	<input type="checkbox"/>	232.0#
	36" Deep	36 x 65-1/4 x 29-1/4"	KAT40413666	<input type="checkbox"/>	<input type="checkbox"/>	<input type="checkbox"/>	240.0#
	36" Deep	36 x 71-1/2 x 29-1/4"	KAT40413672	<input type="checkbox"/>	<input type="checkbox"/>	<input type="checkbox"/>	251.0#
	36" Deep	36 x 83-1/2 x 29-1/4"	KAT40413684	<input type="checkbox"/>	<input type="checkbox"/>	<input type="checkbox"/>	288.0#
	36" Deep	36 x 87-1/2 x 29-1/4"	KAT40413688	<input type="checkbox"/>	<input type="checkbox"/>	<input type="checkbox"/>	295.0#
 <p>D-Shaped Rectangular Desk - Straight Leg - Full Modesty Panel • 15-3/4" modesty panel</p> <p>DTDK</p>	30" Deep	30 x 59-1/4 x 29-1/4"	KAT40423060	<input type="checkbox"/>	<input type="checkbox"/>	<input type="checkbox"/>	194.0#
	30" Deep	30 x 65-1/4 x 29-1/4"	KAT40423066	<input type="checkbox"/>	<input type="checkbox"/>	<input type="checkbox"/>	210.0#
	30" Deep	30 x 71-1/2 x 29-1/4"	KAT40423072	<input type="checkbox"/>	<input type="checkbox"/>	<input type="checkbox"/>	222.0#
	30" Deep	30 x 83-1/2 x 29-1/4"	KAT40423084	<input type="checkbox"/>	<input type="checkbox"/>	<input type="checkbox"/>	234.0#
	30" Deep	30 x 87-1/2 x 29-1/4"	KAT40423088	<input type="checkbox"/>	<input type="checkbox"/>	<input type="checkbox"/>	245.0#
	36" Deep	36 x 59-1/4 x 29-1/4"	KAT40423660	<input type="checkbox"/>	<input type="checkbox"/>	<input type="checkbox"/>	232.0#
	36" Deep	36 x 65-1/4 x 29-1/4"	KAT40423666	<input type="checkbox"/>	<input type="checkbox"/>	<input type="checkbox"/>	240.0#
	36" Deep	36 x 71-1/2 x 29-1/4"	KAT40423672	<input type="checkbox"/>	<input type="checkbox"/>	<input type="checkbox"/>	251.0#
	36" Deep	36 x 83-1/2 x 29-1/4"	KAT40423684	<input type="checkbox"/>	<input type="checkbox"/>	<input type="checkbox"/>	288.0#
	36" Deep	36 x 87-1/2 x 29-1/4"	KAT40423688	<input type="checkbox"/>	<input type="checkbox"/>	<input type="checkbox"/>	295.0#

A

B

C

D

HOW TO ORDER

Indicate the following information on order form:

- Quantity of each item.
- Model number, including options. See "How To Build a Model Number".
- Any special service required.

Note: • The indicates that a choice is required.

- The absence of the indicates that no choice is required.
- Alpha-numeric characters in place of indicate that no other alternatives are available.

HOW TO BUILD A MODEL NUMBER

A Select basic model.

B Select edge style.

BO	- Quarter round edge
CR	- Reed edge
CV	- Cove edge
EB	- Square edge
PD	- Pyramid edge

C Select wood finish color.
Refer to color addendum at ki.com or KI Fabrics & Finishes binder.

D Select grommet.

NA	- No grommet
EG	- Rectangular grommet

Grommets are factory installed.

 Delivered
 Pricing

\$ 2814
2968
3110
3406
3501
3178
3337
3501
3824
3939
\$ 3036
3214
3401
3751
3880
3401
3597
3786
4170
4306

SPECIAL SERVICES
Special Carton Marking

With specially marked information N/C

Shipping

 Shipped **assembled freight prepaid f.o.b. Mexico City, MX 11000** factory. Freight class #125.

Specifications and prices are subject to change without prior notice.

Darwin®

Corner Desks

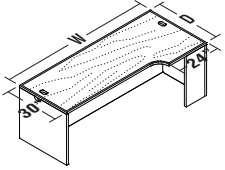
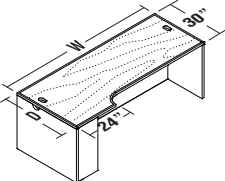
MODEL	Features	D x W x H	MODEL NUMBER				Approx. Packaged Weight
			Basic Model	Edge Style	Wood Finish	Grommets	
 <p>J-Shaped Corner Desk - Left - Full Modesty Panel</p> <ul style="list-style-type: none"> specify with 24" bridge/return located to user's right <p>DCDK</p>	36" Deep	36 x 59-1/4 x 29-1/4"	KAT40533660	<input type="checkbox"/>	<input type="checkbox"/>	<input type="checkbox"/>	266.0#
	36" Deep	36 x 65-1/4 x 29-1/4"	KAT40533666	<input type="checkbox"/>	<input type="checkbox"/>	<input type="checkbox"/>	284.0#
	36" Deep	36 x 71-1/2 x 29-1/4"	KAT40533672	<input type="checkbox"/>	<input type="checkbox"/>	<input type="checkbox"/>	302.0#
	36" Deep	36 x 83-1/2 x 29-1/4"	KAT40533684	<input type="checkbox"/>	<input type="checkbox"/>	<input type="checkbox"/>	321.0#
	36" Deep	36 x 87-1/2 x 29-1/4"	KAT40533688	<input type="checkbox"/>	<input type="checkbox"/>	<input type="checkbox"/>	338.0#
	42" Deep	42 x 59-1/4 x 29-1/4"	KAT40534260	<input type="checkbox"/>	<input type="checkbox"/>	<input type="checkbox"/>	291.0#
	42" Deep	42 x 65-1/4 x 29-1/4"	KAT40534266	<input type="checkbox"/>	<input type="checkbox"/>	<input type="checkbox"/>	310.0#
	42" Deep	42 x 71-1/2 x 29-1/4"	KAT40534272	<input type="checkbox"/>	<input type="checkbox"/>	<input type="checkbox"/>	331.0#
	42" Deep	42 x 83-1/2 x 29-1/4"	KAT40534284	<input type="checkbox"/>	<input type="checkbox"/>	<input type="checkbox"/>	351.0#
	42" Deep	42 x 87-1/2 x 29-1/4"	KAT40534288	<input type="checkbox"/>	<input type="checkbox"/>	<input type="checkbox"/>	370.0#
	48" Deep	48 x 59-1/4 x 29-1/4"	KAT40534860	<input type="checkbox"/>	<input type="checkbox"/>	<input type="checkbox"/>	316.0#
	48" Deep	48 x 65-1/4 x 29-1/4"	KAT40534866	<input type="checkbox"/>	<input type="checkbox"/>	<input type="checkbox"/>	336.0#
	48" Deep	48 x 71-1/2 x 29-1/4"	KAT40534872	<input type="checkbox"/>	<input type="checkbox"/>	<input type="checkbox"/>	359.0#
	48" Deep	48 x 83-1/2 x 29-1/4"	KAT40534884	<input type="checkbox"/>	<input type="checkbox"/>	<input type="checkbox"/>	379.0#
48" Deep	48 x 87-1/2 x 29-1/4"	KAT40534888	<input type="checkbox"/>	<input type="checkbox"/>	<input type="checkbox"/>	402.0#	
 <p>J-Shaped Corner Desk - Right - Full Modesty Panel</p> <ul style="list-style-type: none"> specify with 24" bridge/return located to user's left <p>DCDK</p>	36" Deep	36 x 59-1/4 x 29-1/4"	KAT40543660	<input type="checkbox"/>	<input type="checkbox"/>	<input type="checkbox"/>	266.0#
	36" Deep	36 x 65-1/4 x 29-1/4"	KAT40543666	<input type="checkbox"/>	<input type="checkbox"/>	<input type="checkbox"/>	284.0#
	36" Deep	36 x 71-1/2 x 29-1/4"	KAT40543672	<input type="checkbox"/>	<input type="checkbox"/>	<input type="checkbox"/>	302.0#
	36" Deep	36 x 83-1/2 x 29-1/4"	KAT40543684	<input type="checkbox"/>	<input type="checkbox"/>	<input type="checkbox"/>	321.0#
	36" Deep	36 x 87-1/2 x 29-1/4"	KAT40543688	<input type="checkbox"/>	<input type="checkbox"/>	<input type="checkbox"/>	338.0#
	42" Deep	42 x 59-1/4 x 29-1/4"	KAT40544260	<input type="checkbox"/>	<input type="checkbox"/>	<input type="checkbox"/>	291.0#
	42" Deep	42 x 65-1/4 x 29-1/4"	KAT40544266	<input type="checkbox"/>	<input type="checkbox"/>	<input type="checkbox"/>	310.0#
	42" Deep	42 x 71-1/2 x 29-1/4"	KAT40544272	<input type="checkbox"/>	<input type="checkbox"/>	<input type="checkbox"/>	331.0#
	42" Deep	42 x 83-1/2 x 29-1/4"	KAT40544284	<input type="checkbox"/>	<input type="checkbox"/>	<input type="checkbox"/>	351.0#
	42" Deep	42 x 87-1/2 x 29-1/4"	KAT40544288	<input type="checkbox"/>	<input type="checkbox"/>	<input type="checkbox"/>	370.0#
	48" Deep	48 x 59-1/4 x 29-1/4"	KAT40544860	<input type="checkbox"/>	<input type="checkbox"/>	<input type="checkbox"/>	316.0#
	48" Deep	48 x 65-1/4 x 29-1/4"	KAT40544866	<input type="checkbox"/>	<input type="checkbox"/>	<input type="checkbox"/>	336.0#
	48" Deep	48 x 71-1/2 x 29-1/4"	KAT40544872	<input type="checkbox"/>	<input type="checkbox"/>	<input type="checkbox"/>	359.0#
	48" Deep	48 x 83-1/2 x 29-1/4"	KAT40544884	<input type="checkbox"/>	<input type="checkbox"/>	<input type="checkbox"/>	379.0#
48" Deep	48 x 87-1/2 x 29-1/4"	KAT40544888	<input type="checkbox"/>	<input type="checkbox"/>	<input type="checkbox"/>	402.0#	

A **B** **C** **D**

HOW TO ORDER

Indicate the following information on order form:

- Quantity of each item.
- Model number, including options. See "How To Build a Model Number".
- Any special service required.

Note: • The indicates that a choice is required.

- The absence of the indicates that no choice is required.
- Alpha-numeric characters in place of indicate that no other alternatives are available.

HOW TO BUILD A MODEL NUMBER

- A** Select basic model.
- B** Select edge style.

BO	- Quarter round edge
CR	- Reed edge
CV	- Cove edge
EB	- Square edge
PD	- Pyramid edge
- C** Select wood finish color. Refer to color addendum at ki.com or KI Fabrics & Finishes binder.
- D** Select grommet.

NA	- No grommet
EG	- Rectangular grommet

Grommets are factory installed.



Delivered
Pricing

\$ 1746
1847
1945
2153
2217
1880
1988
2102
2325
2399
2015
2133
2254
2490
2561
\$ 1746
1847
1945
2153
2217
1880
1988
2102
2325
2399
2015
2133
2254
2490
2561

SPECIAL SERVICES

Special Carton Marking

With specially marked information N/C

Shipping

Shipped **assembled freight prepaid f.o.b. Mexico City, MX 11000** factory. Freight class #125.

Specifications and prices are subject to change without prior notice.

Darwin®

Corner Table Desks

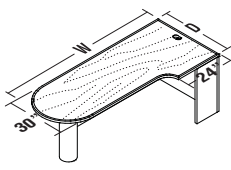
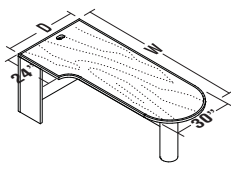
MODEL	Features	D x W x H	MODEL NUMBER				Approx. Packaged Weight
			Basic Model	Edge Style	Wood Finish	Grommets	
 <p>Bullet Corner Table - 30" - Left - 3/4 Modesty Panel</p> <ul style="list-style-type: none"> 4" diameter steel leg (black only) 14-3/4" modesty panel specify with 24" bridge/return located to user's right <p>DCDK</p>	36" Deep	36 x 59-1/4 x 29-1/4"	KAT40613660	<input type="checkbox"/>	<input type="checkbox"/>	<input type="checkbox"/>	266.0#
	36" Deep	36 x 65-1/4 x 29-1/4"	KAT40613666	<input type="checkbox"/>	<input type="checkbox"/>	<input type="checkbox"/>	284.0#
	36" Deep	36 x 71-1/2 x 29-1/4"	KAT40613672	<input type="checkbox"/>	<input type="checkbox"/>	<input type="checkbox"/>	302.0#
	36" Deep	36 x 83-1/2 x 29-1/4"	KAT40613684	<input type="checkbox"/>	<input type="checkbox"/>	<input type="checkbox"/>	321.0#
	36" Deep	36 x 87-1/2 x 29-1/4"	KAT40613688	<input type="checkbox"/>	<input type="checkbox"/>	<input type="checkbox"/>	338.0#
	42" Deep	42 x 59-1/4 x 29-1/4"	KAT40614260	<input type="checkbox"/>	<input type="checkbox"/>	<input type="checkbox"/>	291.0#
	42" Deep	42 x 65-1/4 x 29-1/4"	KAT40614266	<input type="checkbox"/>	<input type="checkbox"/>	<input type="checkbox"/>	310.0#
	42" Deep	42 x 71-1/2 x 29-1/4"	KAT40614272	<input type="checkbox"/>	<input type="checkbox"/>	<input type="checkbox"/>	331.0#
	42" Deep	42 x 83-1/2 x 29-1/4"	KAT40614284	<input type="checkbox"/>	<input type="checkbox"/>	<input type="checkbox"/>	351.0#
	42" Deep	42 x 87-1/2 x 29-1/4"	KAT40614288	<input type="checkbox"/>	<input type="checkbox"/>	<input type="checkbox"/>	370.0#
	48" Deep	48 x 59-1/4 x 29-1/4"	KAT40614860	<input type="checkbox"/>	<input type="checkbox"/>	<input type="checkbox"/>	316.0#
	48" Deep	48 x 65-1/4 x 29-1/4"	KAT40614866	<input type="checkbox"/>	<input type="checkbox"/>	<input type="checkbox"/>	336.0#
	48" Deep	48 x 71-1/2 x 29-1/4"	KAT40614872	<input type="checkbox"/>	<input type="checkbox"/>	<input type="checkbox"/>	359.0#
	48" Deep	48 x 83-1/2 x 29-1/4"	KAT40614884	<input type="checkbox"/>	<input type="checkbox"/>	<input type="checkbox"/>	379.0#
48" Deep	48 x 87-1/2 x 29-1/4"	KAT40614888	<input type="checkbox"/>	<input type="checkbox"/>	<input type="checkbox"/>	402.0#	
 <p>Bullet Corner Table - 30" - Right - 3/4 Modesty Panel</p> <ul style="list-style-type: none"> 4" diameter steel leg (black only) 14-3/4" modesty panel specify with 24" bridge/return located to user's left <p>DCDK</p>	36" Deep	36 x 59-1/4 x 29-1/4"	KAT40623660	<input type="checkbox"/>	<input type="checkbox"/>	<input type="checkbox"/>	266.0#
	36" Deep	36 x 65-1/4 x 29-1/4"	KAT40623666	<input type="checkbox"/>	<input type="checkbox"/>	<input type="checkbox"/>	284.0#
	36" Deep	36 x 71-1/2 x 29-1/4"	KAT40623672	<input type="checkbox"/>	<input type="checkbox"/>	<input type="checkbox"/>	302.0#
	36" Deep	36 x 83-1/2 x 29-1/4"	KAT40623684	<input type="checkbox"/>	<input type="checkbox"/>	<input type="checkbox"/>	321.0#
	36" Deep	36 x 87-1/2 x 29-1/4"	KAT40623688	<input type="checkbox"/>	<input type="checkbox"/>	<input type="checkbox"/>	338.0#
	42" Deep	42 x 59-1/4 x 29-1/4"	KAT40624260	<input type="checkbox"/>	<input type="checkbox"/>	<input type="checkbox"/>	291.0#
	42" Deep	42 x 65-1/4 x 29-1/4"	KAT40624266	<input type="checkbox"/>	<input type="checkbox"/>	<input type="checkbox"/>	310.0#
	42" Deep	42 x 71-1/2 x 29-1/4"	KAT40624272	<input type="checkbox"/>	<input type="checkbox"/>	<input type="checkbox"/>	331.0#
	42" Deep	42 x 83-1/2 x 29-1/4"	KAT40624284	<input type="checkbox"/>	<input type="checkbox"/>	<input type="checkbox"/>	351.0#
	42" Deep	42 x 87-1/2 x 29-1/4"	KAT40624288	<input type="checkbox"/>	<input type="checkbox"/>	<input type="checkbox"/>	370.0#
	48" Deep	48 x 59-1/4 x 29-1/4"	KAT40624860	<input type="checkbox"/>	<input type="checkbox"/>	<input type="checkbox"/>	316.0#
	48" Deep	48 x 65-1/4 x 29-1/4"	KAT40624866	<input type="checkbox"/>	<input type="checkbox"/>	<input type="checkbox"/>	336.0#
	48" Deep	48 x 71-1/2 x 29-1/4"	KAT40624872	<input type="checkbox"/>	<input type="checkbox"/>	<input type="checkbox"/>	359.0#
	48" Deep	48 x 83-1/2 x 29-1/4"	KAT40624884	<input type="checkbox"/>	<input type="checkbox"/>	<input type="checkbox"/>	379.0#
48" Deep	48 x 87-1/2 x 29-1/4"	KAT40624888	<input type="checkbox"/>	<input type="checkbox"/>	<input type="checkbox"/>	402.0#	

A **B** **C** **D**

HOW TO ORDER

Indicate the following information on order form:

- Quantity of each item.
- Model number, including options. See "How To Build a Model Number".
- Any special service required.

Note:

- The indicates that a choice is required.
- The absence of the indicates that no choice is required.
- Alpha-numeric characters in place of indicate that no other alternatives are available.

HOW TO BUILD A MODEL NUMBER

- A** Select basic model.
- B** Select edge style.

BO	- Quarter round edge
CR	- Reed edge
CV	- Cove edge
EB	- Square edge
PD	- Pyramid edge
- C** Select wood finish color. Refer to color addendum at ki.com or KI Fabrics & Finishes binder.
- D** Select grommet.

NA	- No grommet
EG	- Rectangular grommet

 Grommets are factory installed.



Delivered
Pricing

\$ 2839
2999
3155
3470
3597
3098
3272
3442
3785
3905
3337
3547
3687
4039
4266
\$ 2839
2999
3155
3470
3597
3098
3272
3442
3785
3905
3337
3547
3687
4039
4266

SPECIAL SERVICES

Special Carton Marking

With specially marked information N/C

Shipping

Shipped **assembled freight prepaid f.o.b. Mexico City, MX 11000** factory. Freight class #125.

Specifications and prices are subject to change without prior notice.

Darwin®

Corner Desks

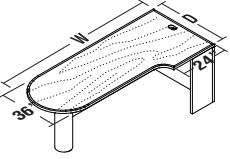
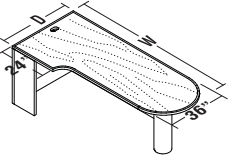
MODEL	Features	D x W x H	MODEL NUMBER				Approx. Packaged Weight
			Basic Model	Edge Style	Wood Finish	Grommets	
 <p>Bullet Corner Table - 36" - Left - 3/4 Modesty Panel</p> <ul style="list-style-type: none"> • 4" diameter steel leg (black only) • 14-3/4" modesty panel • specify with 24" bridge/return located to user's right <p>DCDK</p>	42" Deep	42 x 59-1/4 x 29-1/4"	KAT40634260	<input type="checkbox"/>	<input type="checkbox"/>	<input type="checkbox"/>	291.0#
	42" Deep	42 x 65-1/4 x 29-1/4"	KAT40634266	<input type="checkbox"/>	<input type="checkbox"/>	<input type="checkbox"/>	310.0#
	42" Deep	42 x 71-1/2 x 29-1/4"	KAT40634272	<input type="checkbox"/>	<input type="checkbox"/>	<input type="checkbox"/>	331.0#
	42" Deep	42 x 83-1/2 x 29-1/4"	KAT40634284	<input type="checkbox"/>	<input type="checkbox"/>	<input type="checkbox"/>	351.0#
	42" Deep	42 x 87-1/2 x 29-1/4"	KAT40634288	<input type="checkbox"/>	<input type="checkbox"/>	<input type="checkbox"/>	370.0#
	48" Deep	48 x 59-1/4 x 29-1/4"	KAT40634860	<input type="checkbox"/>	<input type="checkbox"/>	<input type="checkbox"/>	316.0#
	48" Deep	48 x 65-1/4 x 29-1/4"	KAT40634866	<input type="checkbox"/>	<input type="checkbox"/>	<input type="checkbox"/>	336.0#
	48" Deep	48 x 71-1/2 x 29-1/4"	KAT40634872	<input type="checkbox"/>	<input type="checkbox"/>	<input type="checkbox"/>	359.0#
	48" Deep	48 x 83-1/2 x 29-1/4"	KAT40634884	<input type="checkbox"/>	<input type="checkbox"/>	<input type="checkbox"/>	379.0#
	48" Deep	48 x 87-1/2 x 29-1/4"	KAT40634888	<input type="checkbox"/>	<input type="checkbox"/>	<input type="checkbox"/>	402.0#
 <p>Bullet Corner Table - 36" - Right - 3/4 Modesty Panel</p> <ul style="list-style-type: none"> • 4" diameter steel leg (black only) • 14-3/4" modesty panel • specify with 24" bridge/return located to user's left <p>DCDK</p>	42" Deep	42 x 59-1/4 x 29-1/4"	KAT40644260	<input type="checkbox"/>	<input type="checkbox"/>	<input type="checkbox"/>	291.0#
	42" Deep	42 x 65-1/4 x 29-1/4"	KAT40644266	<input type="checkbox"/>	<input type="checkbox"/>	<input type="checkbox"/>	310.0#
	42" Deep	42 x 71-1/2 x 29-1/4"	KAT40644272	<input type="checkbox"/>	<input type="checkbox"/>	<input type="checkbox"/>	331.0#
	42" Deep	42 x 83-1/2 x 29-1/4"	KAT40644284	<input type="checkbox"/>	<input type="checkbox"/>	<input type="checkbox"/>	351.0#
	42" Deep	42 x 87-1/2 x 29-1/4"	KAT40644288	<input type="checkbox"/>	<input type="checkbox"/>	<input type="checkbox"/>	370.0#
	48" Deep	48 x 59-1/4 x 29-1/4"	KAT40644860	<input type="checkbox"/>	<input type="checkbox"/>	<input type="checkbox"/>	316.0#
	48" Deep	48 x 65-1/4 x 29-1/4"	KAT40644866	<input type="checkbox"/>	<input type="checkbox"/>	<input type="checkbox"/>	336.0#
	48" Deep	48 x 71-1/2 x 29-1/4"	KAT40644872	<input type="checkbox"/>	<input type="checkbox"/>	<input type="checkbox"/>	359.0#
	48" Deep	48 x 83-1/2 x 29-1/4"	KAT40644884	<input type="checkbox"/>	<input type="checkbox"/>	<input type="checkbox"/>	379.0#
	48" Deep	48 x 87-1/2 x 29-1/4"	KAT40644888	<input type="checkbox"/>	<input type="checkbox"/>	<input type="checkbox"/>	402.0#

A **B** **C** **D**

HOW TO ORDER

Indicate the following information on order form:

1. Quantity of each item.
2. Model number, including options. See "How To Build a Model Number".
3. Any special service required.

Note: • The indicates that a choice is required.
 • The absence of the indicates that no choice is required.
 • Alpha-numeric characters in place of indicate that no other alternatives are available.

HOW TO BUILD A MODEL NUMBER

- A** Select basic model.
- B** Select edge style.

BO	- Quarter round edge
CR	- Reed edge
CV	- Cove edge
EB	- Square edge
PD	- Pyramid edge
- C** Select wood finish color.
Refer to color addendum at ki.com or KI Fabrics & Finishes binder.
- D** Select grommet.

NA	- No grommet
EG	- Rectangular grommet

 Grommets are factory installed.



Delivered
Pricing

\$ 3142
3311
3486
3833
3946
3385
3577
3761
4140
4294
\$ 3142
3311
3486
3833
3946
3385
3577
3761
4140
4294

SPECIAL SERVICES

Special Carton Marking

With specially marked information N/C

Shipping

Shipped **assembled freight prepaid f.o.b. Mexico City, MX 11000** factory. Freight class #125.

Specifications and prices are subject to change without prior notice.

Darwin®

Corner Desks

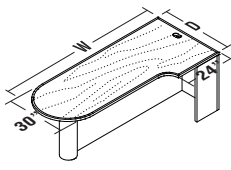
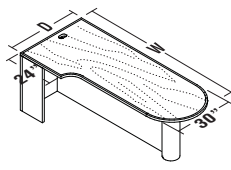
MODEL	Features	D x W x H	MODEL NUMBER				Approx. Packaged Weight
			Basic Model	Edge Style	Wood Finish	Grommets	
 <p>Bullet Corner Table - 30" - Left - Full Modesty Panel</p> <ul style="list-style-type: none"> 4" diameter steel leg (black only) specify with 24" connecting pieces to user's right <p>DCDK</p>	36" Deep	36 x 59-1/4 x 29-1/4"	KAT40653660	<input type="checkbox"/>	<input type="checkbox"/>	<input type="checkbox"/>	266.0#
	36" Deep	36 x 65-1/4 x 29-1/4"	KAT40653666	<input type="checkbox"/>	<input type="checkbox"/>	<input type="checkbox"/>	284.0#
	36" Deep	36 x 71-1/2 x 29-1/4"	KAT40653672	<input type="checkbox"/>	<input type="checkbox"/>	<input type="checkbox"/>	302.0#
	36" Deep	36 x 83-1/2 x 29-1/4"	KAT40653684	<input type="checkbox"/>	<input type="checkbox"/>	<input type="checkbox"/>	321.0#
	36" Deep	36 x 87-1/2 x 29-1/4"	KAT40653688	<input type="checkbox"/>	<input type="checkbox"/>	<input type="checkbox"/>	338.0#
	42" Deep	42 x 59-1/4 x 29-1/4"	KAT40654260	<input type="checkbox"/>	<input type="checkbox"/>	<input type="checkbox"/>	291.0#
	42" Deep	42 x 65-1/4 x 29-1/4"	KAT40654266	<input type="checkbox"/>	<input type="checkbox"/>	<input type="checkbox"/>	310.0#
	42" Deep	42 x 71-1/2 x 29-1/4"	KAT40654272	<input type="checkbox"/>	<input type="checkbox"/>	<input type="checkbox"/>	331.0#
	42" Deep	42 x 83-1/2 x 29-1/4"	KAT40654284	<input type="checkbox"/>	<input type="checkbox"/>	<input type="checkbox"/>	351.0#
	42" Deep	42 x 87-1/2 x 29-1/4"	KAT40654288	<input type="checkbox"/>	<input type="checkbox"/>	<input type="checkbox"/>	370.0#
	48" Deep	48 x 59-1/4 x 29-1/4"	KAT40654860	<input type="checkbox"/>	<input type="checkbox"/>	<input type="checkbox"/>	316.0#
	48" Deep	48 x 65-1/4 x 29-1/4"	KAT40654866	<input type="checkbox"/>	<input type="checkbox"/>	<input type="checkbox"/>	336.0#
	48" Deep	48 x 71-1/2 x 29-1/4"	KAT40654872	<input type="checkbox"/>	<input type="checkbox"/>	<input type="checkbox"/>	359.0#
	48" Deep	48 x 83-1/2 x 29-1/4"	KAT40654884	<input type="checkbox"/>	<input type="checkbox"/>	<input type="checkbox"/>	379.0#
	48" Deep	48 x 87-1/2 x 29-1/4"	KAT40654888	<input type="checkbox"/>	<input type="checkbox"/>	<input type="checkbox"/>	402.0#
 <p>Bullet Corner Table - 30" - Right - Full Modesty Panel</p> <ul style="list-style-type: none"> 4" diameter steel leg (black only) specify with 24" connecting pieces to user's left <p>DCDK</p>	36" Deep	36 x 59-1/4 x 29-1/4"	KAT40663660	<input type="checkbox"/>	<input type="checkbox"/>	<input type="checkbox"/>	266.0#
	36" Deep	36 x 65-1/4 x 29-1/4"	KAT40663666	<input type="checkbox"/>	<input type="checkbox"/>	<input type="checkbox"/>	284.0#
	36" Deep	36 x 71-1/2 x 29-1/4"	KAT40663672	<input type="checkbox"/>	<input type="checkbox"/>	<input type="checkbox"/>	302.0#
	36" Deep	36 x 83-1/2 x 29-1/4"	KAT40663684	<input type="checkbox"/>	<input type="checkbox"/>	<input type="checkbox"/>	321.0#
	36" Deep	36 x 87-1/2 x 29-1/4"	KAT40663688	<input type="checkbox"/>	<input type="checkbox"/>	<input type="checkbox"/>	338.0#
	42" Deep	42 x 59-1/4 x 29-1/4"	KAT40664260	<input type="checkbox"/>	<input type="checkbox"/>	<input type="checkbox"/>	291.0#
	42" Deep	42 x 65-1/4 x 29-1/4"	KAT40664266	<input type="checkbox"/>	<input type="checkbox"/>	<input type="checkbox"/>	310.0#
	42" Deep	42 x 71-1/2 x 29-1/4"	KAT40664272	<input type="checkbox"/>	<input type="checkbox"/>	<input type="checkbox"/>	331.0#
	42" Deep	42 x 83-1/2 x 29-1/4"	KAT40664284	<input type="checkbox"/>	<input type="checkbox"/>	<input type="checkbox"/>	351.0#
	42" Deep	42 x 87-1/2 x 29-1/4"	KAT40664288	<input type="checkbox"/>	<input type="checkbox"/>	<input type="checkbox"/>	370.0#
	48" Deep	48 x 59-1/4 x 29-1/4"	KAT40664860	<input type="checkbox"/>	<input type="checkbox"/>	<input type="checkbox"/>	316.0#
	48" Deep	48 x 65-1/4 x 29-1/4"	KAT40664866	<input type="checkbox"/>	<input type="checkbox"/>	<input type="checkbox"/>	336.0#
	48" Deep	48 x 71-1/2 x 29-1/4"	KAT40664872	<input type="checkbox"/>	<input type="checkbox"/>	<input type="checkbox"/>	359.0#
	48" Deep	48 x 83-1/2 x 29-1/4"	KAT40664884	<input type="checkbox"/>	<input type="checkbox"/>	<input type="checkbox"/>	379.0#
	48" Deep	48 x 87-1/2 x 29-1/4"	KAT40664888	<input type="checkbox"/>	<input type="checkbox"/>	<input type="checkbox"/>	402.0#

A **B** **C** **D**

HOW TO ORDER

Indicate the following information on order form:

- Quantity of each item.
- Model number, including options. See "How To Build a Model Number".
- Any special service required.

Note:

- The indicates that a choice is required.
- The absence of the indicates that no choice is required.
- Alpha-numeric characters in place of indicate that no other alternatives are available.

HOW TO BUILD A MODEL NUMBER

- A** Select basic model.

BO	- Quarter round edge
CR	- Reed edge
CV	- Cove edge
EB	- Square edge
PD	- Pyramid edge
- C** Select wood finish color. Refer to color addendum at ki.com or KI Fabrics & Finishes binder.
- D** Select grommet.

NA	- No grommet
EG	- Rectangular grommet

Grommets are factory installed.



Delivered
Pricing

- \$ 3050
 - 3243
 - 3426
 - 3800
 - 3951
 - 3305
 - 3509
 - 3718
 - 4112
 - 4255
 - 3573
 - 3788
 - 4008
 - 4430
 - 4590
-
- \$ 3050
 - 3243
 - 3426
 - 3800
 - 3951
 - 3305
 - 3509
 - 3718
 - 4112
 - 4255
 - 3573
 - 3788
 - 4008
 - 4430
 - 4590

SPECIAL SERVICES

Special Carton Marking

With specially marked information N/C

Shipping

Shipped **assembled freight prepaid f.o.b. Mexico City, MX 11000** factory. Freight class #125.

Specifications and prices are subject to change without prior notice.

Darwin®

Corner Desks

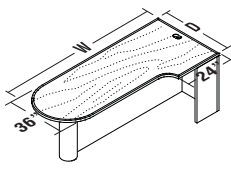
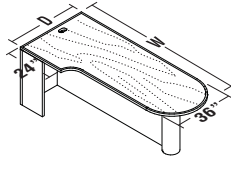
MODEL	Features	D x W x H	MODEL NUMBER				Approx. Packaged Weight
			Basic Model	Edge Style	Wood Finish	Grommets	
 <p>Bullet Corner Table - 36" - Left - Full Modesty Panel</p> <ul style="list-style-type: none"> 4" diameter steel leg (black only) specify with 24" connecting pieces to user's right <p>DCDK</p>	42" Deep	42 x 59-1/4 x 29-1/4"	KAT40674260	<input type="checkbox"/>	<input type="checkbox"/>	<input type="checkbox"/>	291.0#
	42" Deep	42 x 65-1/4 x 29-1/4"	KAT40674266	<input type="checkbox"/>	<input type="checkbox"/>	<input type="checkbox"/>	310.0#
	42" Deep	42 x 71-1/2 x 29-1/4"	KAT40674272	<input type="checkbox"/>	<input type="checkbox"/>	<input type="checkbox"/>	331.0#
	42" Deep	42 x 83-1/2 x 29-1/4"	KAT40674284	<input type="checkbox"/>	<input type="checkbox"/>	<input type="checkbox"/>	351.0#
	42" Deep	42 x 87-1/2 x 29-1/4"	KAT40674288	<input type="checkbox"/>	<input type="checkbox"/>	<input type="checkbox"/>	370.0#
	48" Deep	48 x 59-1/4 x 29-1/4"	KAT40674860	<input type="checkbox"/>	<input type="checkbox"/>	<input type="checkbox"/>	316.0#
	48" Deep	48 x 65-1/4 x 29-1/4"	KAT40674866	<input type="checkbox"/>	<input type="checkbox"/>	<input type="checkbox"/>	336.0#
	48" Deep	48 x 71-1/2 x 29-1/4"	KAT40674872	<input type="checkbox"/>	<input type="checkbox"/>	<input type="checkbox"/>	359.0#
	48" Deep	48 x 83-1/2 x 29-1/4"	KAT40674884	<input type="checkbox"/>	<input type="checkbox"/>	<input type="checkbox"/>	379.0#
	48" Deep	48 x 87-1/2 x 29-1/4"	KAT40674888	<input type="checkbox"/>	<input type="checkbox"/>	<input type="checkbox"/>	402.0#
 <p>Bullet Corner Table - 36" - Right - Full Modesty Panel</p> <ul style="list-style-type: none"> 4" diameter steel leg (black only) specify with 24" connecting pieces to user's left <p>DCDK</p>	42" Deep	42 x 59-1/4 x 29-1/4"	KAT40684260	<input type="checkbox"/>	<input type="checkbox"/>	<input type="checkbox"/>	291.0#
	42" Deep	42 x 65-1/4 x 29-1/4"	KAT40684266	<input type="checkbox"/>	<input type="checkbox"/>	<input type="checkbox"/>	310.0#
	42" Deep	42 x 71-1/2 x 29-1/4"	KAT40684272	<input type="checkbox"/>	<input type="checkbox"/>	<input type="checkbox"/>	331.0#
	42" Deep	42 x 83-1/2 x 29-1/4"	KAT40684284	<input type="checkbox"/>	<input type="checkbox"/>	<input type="checkbox"/>	351.0#
	42" Deep	42 x 87-1/2 x 29-1/4"	KAT40684288	<input type="checkbox"/>	<input type="checkbox"/>	<input type="checkbox"/>	370.0#
	48" Deep	48 x 59-1/4 x 29-1/4"	KAT40684860	<input type="checkbox"/>	<input type="checkbox"/>	<input type="checkbox"/>	316.0#
	48" Deep	48 x 65-1/4 x 29-1/4"	KAT40684866	<input type="checkbox"/>	<input type="checkbox"/>	<input type="checkbox"/>	336.0#
	48" Deep	48 x 71-1/2 x 29-1/4"	KAT40684872	<input type="checkbox"/>	<input type="checkbox"/>	<input type="checkbox"/>	359.0#
	48" Deep	48 x 83-1/2 x 29-1/4"	KAT40684884	<input type="checkbox"/>	<input type="checkbox"/>	<input type="checkbox"/>	379.0#
	48" Deep	48 x 87-1/2 x 29-1/4"	KAT40684888	<input type="checkbox"/>	<input type="checkbox"/>	<input type="checkbox"/>	402.0#

A **B** **C** **D**

HOW TO ORDER

Indicate the following information on order form:

- Quantity of each item.
- Model number, including options. See "How To Build a Model Number".
- Any special service required.

Note: • The indicates that a choice is required.

- The absence of the indicates that no choice is required.
- Alpha-numeric characters in place of indicate that no other alternatives are available.

HOW TO BUILD A MODEL NUMBER

- A** Select basic model.
- B** Select edge style.

BO	- Quarter round edge
CR	- Reed edge
CV	- Cove edge
EB	- Square edge
PD	- Pyramid edge
- C** Select wood finish color. Refer to color addendum at ki.com or KI Fabrics & Finishes binder.
- D** Select grommet.

NA	- No grommet
EG	- Rectangular grommet

Grommets are factory installed.



Delivered
Pricing

\$ 3335
3538
3747
4144
4286
3581
3800
4022
4445
4605
\$ 3335
3538
3747
4144
4286
3581
3800
4022
4445
4605

SPECIAL SERVICES

Special Carton Marking

With specially marked information N/C

Shipping

Shipped **assembled freight prepaid f.o.b. Mexico City, MX 11000** factory. Freight class #125.

Specifications and prices are subject to change without prior notice.

Darwin®

Executive Return Shells

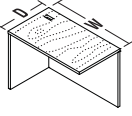
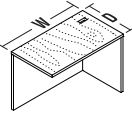
	MODEL	Features	D x W x H	MODEL NUMBER				Approx. Packaged Weight
				Basic Model	Edge Style	Wood Finish	Grommets	
 DRET	Executive Return Shell - Left • Accommodates 19" pedestal or 20" lateral	24" Deep	24 x 36 x 29-1/4"	KAT43012436	<input type="checkbox"/>	<input type="checkbox"/> <input type="checkbox"/> <input type="checkbox"/> <input type="checkbox"/>	<input type="checkbox"/>	91.0#
		24" Deep	24 x 42 x 29-1/4"	KAT43012442	<input type="checkbox"/>	<input type="checkbox"/> <input type="checkbox"/> <input type="checkbox"/> <input type="checkbox"/>	<input type="checkbox"/>	106.0#
		24" Deep	24 x 48 x 29-1/4"	KAT43012448	<input type="checkbox"/>	<input type="checkbox"/> <input type="checkbox"/> <input type="checkbox"/> <input type="checkbox"/>	<input type="checkbox"/>	121.0#
		24" Deep	24 x 60 x 29-1/4"	KAT43012460	<input type="checkbox"/>	<input type="checkbox"/> <input type="checkbox"/> <input type="checkbox"/> <input type="checkbox"/>	<input type="checkbox"/>	151.0#
		24" Deep	24 x 66 x 29-1/4"	KAT43012466	<input type="checkbox"/>	<input type="checkbox"/> <input type="checkbox"/> <input type="checkbox"/> <input type="checkbox"/>	<input type="checkbox"/>	164.0#
		24" Deep	24 x 72 x 29-1/4"	KAT43012472	<input type="checkbox"/>	<input type="checkbox"/> <input type="checkbox"/> <input type="checkbox"/> <input type="checkbox"/>	<input type="checkbox"/>	185.0#
 DRET	Executive Return Shell - Right • Accommodates 19" pedestal or 20" lateral	24" Deep	24 x 36 x 29-1/4"	KAT43022436	<input type="checkbox"/>	<input type="checkbox"/> <input type="checkbox"/> <input type="checkbox"/> <input type="checkbox"/>	<input type="checkbox"/>	91.0#
		24" Deep	24 x 42 x 29-1/4"	KAT43022442	<input type="checkbox"/>	<input type="checkbox"/> <input type="checkbox"/> <input type="checkbox"/> <input type="checkbox"/>	<input type="checkbox"/>	106.0#
		24" Deep	24 x 48 x 29-1/4"	KAT43022448	<input type="checkbox"/>	<input type="checkbox"/> <input type="checkbox"/> <input type="checkbox"/> <input type="checkbox"/>	<input type="checkbox"/>	121.0#
		24" Deep	24 x 60 x 29-1/4"	KAT43022460	<input type="checkbox"/>	<input type="checkbox"/> <input type="checkbox"/> <input type="checkbox"/> <input type="checkbox"/>	<input type="checkbox"/>	151.0#
		24" Deep	24 x 66 x 29-1/4"	KAT43022466	<input type="checkbox"/>	<input type="checkbox"/> <input type="checkbox"/> <input type="checkbox"/> <input type="checkbox"/>	<input type="checkbox"/>	164.0#
		24" Deep	24 x 72 x 29-1/4"	KAT43022472	<input type="checkbox"/>	<input type="checkbox"/> <input type="checkbox"/> <input type="checkbox"/> <input type="checkbox"/>	<input type="checkbox"/>	185.0#

A **B** **C** **D**

HOW TO ORDER

Indicate the following information on order form:

- Quantity of each item.
- Model number, including options. See "How To Build a Model Number".
- Any special service required.

Note: • The indicates that a choice is required.

- The absence of the indicates that no choice is required.
- Alpha-numeric characters in place of indicate that no other alternatives are available.

HOW TO BUILD A MODEL NUMBER

A Select basic model.

B Select edge style.

BO	- Quarter round edge
CR	- Reed edge
CV	- Cove edge
EB	- Square edge
PD	- Pyramid edge

C Select wood finish color.
Refer to color addendum at ki.com or KI Fabrics & Finishes binder.

D Select grommet.

NA	- No grommet
EG	- Rectangular grommet

Grommets are factory installed.



Delivered
Pricing

\$ 931
1050
1161
1395
1531
1636
\$ 931
1050
1161
1395
1531
1636

SPECIAL SERVICES

Special Carton Marking

With specially marked information N/C

Shipping

Shipped **assembled freight prepaid f.o.b. Mexico City, MX 11000** factory. Freight class #125.

Specifications and prices are subject to change without prior notice.

Darwin®

Bridges

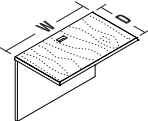
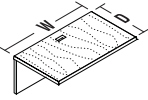
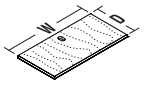
	MODEL	Features	D x W x H	MODEL NUMBER				Approx. Packaged Weight
				Basic Model	Edge Style	Wood Finish	Grommets	
 DBDG	Executive Bridge Unit - Full Modesty Panel • Ships K.D.	24" Deep	24 x 24 x 29-1/4"	KAT41012424	<input type="checkbox"/>	<input type="checkbox"/>	<input type="checkbox"/>	51.0#
		24" Deep	24 x 30 x 29-1/4"	KAT41012430	<input type="checkbox"/>	<input type="checkbox"/>	<input type="checkbox"/>	62.0#
		24" Deep	24 x 36 x 29-1/4"	KAT41012436	<input type="checkbox"/>	<input type="checkbox"/>	<input type="checkbox"/>	74.0#
		24" Deep	24 x 42 x 29-1/4"	KAT41012442	<input type="checkbox"/>	<input type="checkbox"/>	<input type="checkbox"/>	86.0#
		24" Deep	24 x 48 x 29-1/4"	KAT41012448	<input type="checkbox"/>	<input type="checkbox"/>	<input type="checkbox"/>	106.0#
		24" Deep	24 x 60 x 29-1/4"	KAT41012460	<input type="checkbox"/>	<input type="checkbox"/>	<input type="checkbox"/>	125.0#
		24" Deep	24 x 66 x 29-1/4"	KAT41012466	<input type="checkbox"/>	<input type="checkbox"/>	<input type="checkbox"/>	138.0#
		24" Deep	24 x 72 x 29-1/4"	KAT41012472	<input type="checkbox"/>	<input type="checkbox"/>	<input type="checkbox"/>	160.0#
 DBDG	Executive Bridge Unit - 3/4 Modesty Panel • Ships K.D. • 14-3/4" modesty	24" Deep	24 x 24 x 17"	KAT41022424	<input type="checkbox"/>	<input type="checkbox"/>	<input type="checkbox"/>	49.0#
		24" Deep	24 x 30 x 17"	KAT41022430	<input type="checkbox"/>	<input type="checkbox"/>	<input type="checkbox"/>	53.0#
		24" Deep	24 x 36 x 17"	KAT41022436	<input type="checkbox"/>	<input type="checkbox"/>	<input type="checkbox"/>	71.0#
		24" Deep	24 x 42 x 17"	KAT41022442	<input type="checkbox"/>	<input type="checkbox"/>	<input type="checkbox"/>	82.0#
		24" Deep	24 x 48 x 17"	KAT41022448	<input type="checkbox"/>	<input type="checkbox"/>	<input type="checkbox"/>	101.0#
		24" Deep	24 x 60 x 17"	KAT41022460	<input type="checkbox"/>	<input type="checkbox"/>	<input type="checkbox"/>	121.0#
		24" Deep	24 x 66 x 17"	KAT41022466	<input type="checkbox"/>	<input type="checkbox"/>	<input type="checkbox"/>	134.0#
		24" Deep	24 x 72 x 17"	KAT41022472	<input type="checkbox"/>	<input type="checkbox"/>	<input type="checkbox"/>	155.0#
 DBDG	Connecting Top	24" Deep	24 x 24 x 1-1/4"	KAT41032424	<input type="checkbox"/>	<input type="checkbox"/>	<input type="checkbox"/>	49.0#
		24" Deep	24 x 30 x 1-1/4"	KAT41032430	<input type="checkbox"/>	<input type="checkbox"/>	<input type="checkbox"/>	53.0#
		24" Deep	24 x 36 x 1-1/4"	KAT41032436	<input type="checkbox"/>	<input type="checkbox"/>	<input type="checkbox"/>	71.0#
		24" Deep	24 x 42 x 1-1/4"	KAT41032442	<input type="checkbox"/>	<input type="checkbox"/>	<input type="checkbox"/>	82.0#
		24" Deep	24 x 48 x 1-1/4"	KAT41032448	<input type="checkbox"/>	<input type="checkbox"/>	<input type="checkbox"/>	101.0#
		24" Deep	24 x 60 x 1-1/4"	KAT41032460	<input type="checkbox"/>	<input type="checkbox"/>	<input type="checkbox"/>	121.0#
		24" Deep	24 x 66 x 1-1/4"	KAT41032466	<input type="checkbox"/>	<input type="checkbox"/>	<input type="checkbox"/>	134.0#
		24" Deep	24 x 72 x 1-1/4"	KAT41032472	<input type="checkbox"/>	<input type="checkbox"/>	<input type="checkbox"/>	155.0#

A **B** **C** **D**

HOW TO ORDER

Indicate the following information on order form:

- Quantity of each item.
- Model number, including options. See "How To Build a Model Number".
- Any special service required.

Note: • The indicates that a choice is required.

- The absence of the indicates that no choice is required.

- Alpha-numeric characters in place of indicate that no other alternatives are available.

HOW TO BUILD A MODEL NUMBER

A Select basic model.

B Select edge style.

BO	- Quarter round edge
CR	- Reed edge
CV	- Cove edge
EB	- Square edge
PD	- Pyramid edge

C Select wood finish color.
Refer to color addendum at ki.com or KI Fabrics & Finishes binder.

D Select grommet.

NA	- No grommet
EG	- Rectangular grommet

Grommets are factory installed.



Delivered
Pricing

\$ 580

691

761

877

998

1240

1349

1464

\$ 519

613

681

777

877

1102

1200

1297

\$ 408

480

549

607

683

839

907

981

SPECIAL SERVICES

Special Carton Marking

With specially marked information N/C

Shipping

Shipped k.d. freight prepaid f.o.b. Mexico City, MX 11000 factory. Freight class #125.

Specifications and prices are subject to change without prior notice.

Darwin®

Extended Corners

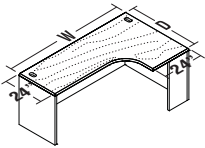
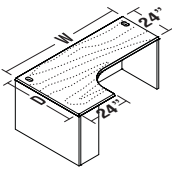
MODEL	Features	D x W x H	MODEL NUMBER				Approx. Packaged Weight	
			Basic Model	Edge Style	Wood Finish	Grommets		
 <p>DCRD</p>	Extended Corner - Left	36" Deep	36 x 58-3/4 x 29-1/4"	KAT42113660	<input type="checkbox"/>	<input type="checkbox"/>	<input type="checkbox"/>	266.0#
	36" Deep	36 x 70-3/4 x 29-1/4"	KAT42113672	<input type="checkbox"/>	<input type="checkbox"/>	<input type="checkbox"/>	302.0#	
	36" Deep	36 x 82-3/4 x 29-1/4"	KAT42113684	<input type="checkbox"/>	<input type="checkbox"/>	<input type="checkbox"/>	321.0#	
	36" Deep	36 x 87 x 29-1/4"	KAT42113688	<input type="checkbox"/>	<input type="checkbox"/>	<input type="checkbox"/>	338.0#	
	42" Deep	42 x 58-3/4 x 29-1/4"	KAT42114260	<input type="checkbox"/>	<input type="checkbox"/>	<input type="checkbox"/>	291.0#	
	42" Deep	42 x 70-3/4 x 29-1/4"	KAT42114272	<input type="checkbox"/>	<input type="checkbox"/>	<input type="checkbox"/>	331.0#	
	42" Deep	42 x 82-3/4 x 29-1/4"	KAT42114284	<input type="checkbox"/>	<input type="checkbox"/>	<input type="checkbox"/>	351.0#	
	42" Deep	42 x 87 x 29-1/4"	KAT42114288	<input type="checkbox"/>	<input type="checkbox"/>	<input type="checkbox"/>	370.0#	
	48" Deep	48 x 58-3/4 x 29-1/4"	KAT42114860	<input type="checkbox"/>	<input type="checkbox"/>	<input type="checkbox"/>	316.0#	
	48" Deep	48 x 70-3/4 x 29-1/4"	KAT42114872	<input type="checkbox"/>	<input type="checkbox"/>	<input type="checkbox"/>	359.0#	
	48" Deep	48 x 82-3/4 x 29-1/4"	KAT42114884	<input type="checkbox"/>	<input type="checkbox"/>	<input type="checkbox"/>	379.0#	
	48" Deep	48 x 87 x 29-1/4"	KAT42114888	<input type="checkbox"/>	<input type="checkbox"/>	<input type="checkbox"/>	402.0#	
 <p>DCRD</p>	Extended Corner - Right	36" Deep	36 x 58-3/4 x 29-1/4"	KAT42123660	<input type="checkbox"/>	<input type="checkbox"/>	<input type="checkbox"/>	266.0#
	36" Deep	36 x 70-3/4 x 29-1/4"	KAT42123672	<input type="checkbox"/>	<input type="checkbox"/>	<input type="checkbox"/>	302.0#	
	36" Deep	36 x 82-3/4 x 29-1/4"	KAT42123684	<input type="checkbox"/>	<input type="checkbox"/>	<input type="checkbox"/>	321.0#	
	36" Deep	36 x 87 x 29-1/4"	KAT42123688	<input type="checkbox"/>	<input type="checkbox"/>	<input type="checkbox"/>	338.0#	
	42" Deep	42 x 58-3/4 x 29-1/4"	KAT42124260	<input type="checkbox"/>	<input type="checkbox"/>	<input type="checkbox"/>	291.0#	
	42" Deep	42 x 70-3/4 x 29-1/4"	KAT42124272	<input type="checkbox"/>	<input type="checkbox"/>	<input type="checkbox"/>	331.0#	
	42" Deep	42 x 82-3/4 x 29-1/4"	KAT42124284	<input type="checkbox"/>	<input type="checkbox"/>	<input type="checkbox"/>	351.0#	
	42" Deep	42 x 87 x 29-1/4"	KAT42124288	<input type="checkbox"/>	<input type="checkbox"/>	<input type="checkbox"/>	370.0#	
	48" Deep	48 x 58-3/4 x 29-1/4"	KAT42124860	<input type="checkbox"/>	<input type="checkbox"/>	<input type="checkbox"/>	316.0#	
	48" Deep	48 x 70-3/4 x 29-1/4"	KAT42124872	<input type="checkbox"/>	<input type="checkbox"/>	<input type="checkbox"/>	359.0#	
	48" Deep	48 x 82-3/4 x 29-1/4"	KAT42124884	<input type="checkbox"/>	<input type="checkbox"/>	<input type="checkbox"/>	379.0#	
	48" Deep	48 x 87 x 29-1/4"	KAT42124888	<input type="checkbox"/>	<input type="checkbox"/>	<input type="checkbox"/>	402.0#	

A

B

C

D

HOW TO ORDER

Indicate the following information on order form:

- Quantity of each item.
- Model number, including options. See "How To Build a Model Number".
- Any special service required.

Note: • The indicates that a choice is required.

- The absence of the indicates that no choice is required.

- Alpha-numeric characters in place of indicate that no other alternatives are available.

HOW TO BUILD A MODEL NUMBER

A Select basic model.

B Select edge style.

BO	- Quarter round edge
CR	- Reed edge
CV	- Cove edge
EB	- Square edge
PD	- Pyramid edge

C Select wood finish color.
Refer to color addendum at ki.com or KI Fabrics & Finishes binder.

D Select grommet.

NA	- No grommet
EG	- Rectangular grommet

Grommets are factory installed.

 Delivered
 Pricing

\$ 2769

3066

3270

3363

2951

3276

3516

3597

3140

3484

3770

3827

\$ 2769

3066

3270

3363

2951

3276

3516

3597

3140

3484

3770

3827

SPECIAL SERVICES
Special Carton Marking

With specially marked information N/C

Shipping

 Shipped **assembled freight prepaid f.o.b. Mexico City, MX 11000** factory. Freight class #125.

Specifications and prices are subject to change without prior notice.

Darwin®

Credenzas

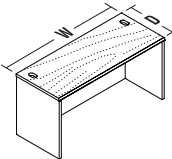
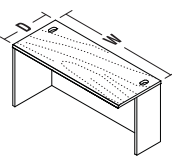
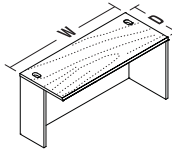
	MODEL	Features	D x W x H	MODEL NUMBER				Approx. Packaged Weight
				Basic Model	Edge Style	Wood Finish	Grommets	
 <p>DCRD</p>	Credenza Shell • Inside clearance is 4" less than nominal width (Example=72" is 68" inside) • Accommodates 19" pedestals or 20" laterals	24" Deep	24 x 34-3/4 x 29-1/4"	KAT45112436	<input type="checkbox"/>	<input type="checkbox"/>	<input type="checkbox"/>	120.0#
		24" Deep	24 x 40-3/4 x 29-1/4"	KAT45112442	<input type="checkbox"/>	<input type="checkbox"/>	<input type="checkbox"/>	140.0#
		24" Deep	24 x 46-3/4 x 29-1/4"	KAT45112448	<input type="checkbox"/>	<input type="checkbox"/>	<input type="checkbox"/>	155.0#
		24" Deep	24 x 58-3/4 x 29-1/4"	KAT45112460	<input type="checkbox"/>	<input type="checkbox"/>	<input type="checkbox"/>	170.0#
		24" Deep	24 x 64-3/4 x 29-1/4"	KAT45112466	<input type="checkbox"/>	<input type="checkbox"/>	<input type="checkbox"/>	180.0#
		24" Deep	24 x 70-3/4 x 29-1/4"	KAT45112472	<input type="checkbox"/>	<input type="checkbox"/>	<input type="checkbox"/>	190.0#
		24" Deep	24 x 82-3/4 x 29-1/4"	KAT45112484	<input type="checkbox"/>	<input type="checkbox"/>	<input type="checkbox"/>	205.0#
		24" Deep	24 x 87 x 29-1/4"	KAT45112488	<input type="checkbox"/>	<input type="checkbox"/>	<input type="checkbox"/>	230.0#
 <p>DCRD</p>	Credenza Shell - Left • Inside clearance is 4" less than nominal width (Example=72" is 68" inside) • Accommodates 19" pedestals or 20" laterals	24" Deep	24 x 34-3/4 x 29-1/4"	KAT45122436	<input type="checkbox"/>	<input type="checkbox"/>	<input type="checkbox"/>	120.0#
		24" Deep	24 x 40-3/4 x 29-1/4"	KAT45122442	<input type="checkbox"/>	<input type="checkbox"/>	<input type="checkbox"/>	140.0#
		24" Deep	24 x 46-3/4 x 29-1/4"	KAT45122448	<input type="checkbox"/>	<input type="checkbox"/>	<input type="checkbox"/>	155.0#
		24" Deep	24 x 58-3/4 x 29-1/4"	KAT45122460	<input type="checkbox"/>	<input type="checkbox"/>	<input type="checkbox"/>	170.0#
		24" Deep	24 x 64-3/4 x 29-1/4"	KAT45122466	<input type="checkbox"/>	<input type="checkbox"/>	<input type="checkbox"/>	180.0#
		24" Deep	24 x 70-3/4 x 29-1/4"	KAT45122472	<input type="checkbox"/>	<input type="checkbox"/>	<input type="checkbox"/>	190.0#
		24" Deep	24 x 82-3/4 x 29-1/4"	KAT45122484	<input type="checkbox"/>	<input type="checkbox"/>	<input type="checkbox"/>	205.0#
		24" Deep	24 x 87 x 29-1/4"	KAT45122488	<input type="checkbox"/>	<input type="checkbox"/>	<input type="checkbox"/>	230.0#
 <p>DCRD</p>	Credenza Shell - Right • Inside clearance is 4" less than nominal width (Example=72" is 68" inside) • Accommodates 19" pedestals or 20" laterals	24" Deep	24 x 34-3/4 x 29-1/4"	KAT45132436	<input type="checkbox"/>	<input type="checkbox"/>	<input type="checkbox"/>	120.0#
		24" Deep	24 x 40-3/4 x 29-1/4"	KAT45132442	<input type="checkbox"/>	<input type="checkbox"/>	<input type="checkbox"/>	140.0#
		24" Deep	24 x 46-3/4 x 29-1/4"	KAT45132448	<input type="checkbox"/>	<input type="checkbox"/>	<input type="checkbox"/>	155.0#
		24" Deep	24 x 58-3/4 x 29-1/4"	KAT45132460	<input type="checkbox"/>	<input type="checkbox"/>	<input type="checkbox"/>	170.0#
		24" Deep	24 x 64-3/4 x 29-1/4"	KAT45132466	<input type="checkbox"/>	<input type="checkbox"/>	<input type="checkbox"/>	180.0#
		24" Deep	24 x 70-3/4 x 29-1/4"	KAT45132472	<input type="checkbox"/>	<input type="checkbox"/>	<input type="checkbox"/>	190.0#
		24" Deep	24 x 82-3/4 x 29-1/4"	KAT45132484	<input type="checkbox"/>	<input type="checkbox"/>	<input type="checkbox"/>	205.0#
		24" Deep	24 x 87 x 29-1/4"	KAT45132488	<input type="checkbox"/>	<input type="checkbox"/>	<input type="checkbox"/>	230.0#

A

B

C

D

HOW TO ORDER

Indicate the following information on order form:

- Quantity of each item.
- Model number, including options. See "How To Build a Model Number".
- Any special service required.

Note: • The indicates that a choice is required.

- The absence of the indicates that no choice is required.
- Alpha-numeric characters in place of indicate that no other alternatives are available.

HOW TO BUILD A MODEL NUMBER

A Select basic model.

B Select edge style.

BO	- Quarter round edge
CR	- Reed edge
CV	- Cove edge
EB	- Square edge
PD	- Pyramid edge

C Select wood finish color.
Refer to color addendum at ki.com or KI Fabrics & Finishes binder.

D Select grommet.

NA	- No grommet
EG	- Rectangular grommet

Grommets are factory installed.



Delivered
Pricing

\$ 1050

1138

1230

1418

1497

1614

1769

1972

\$ 955

1044

1133

1328

1403

1521

1675

1740

\$ 955

1044

1133

1328

1403

1521

1675

1740

SPECIAL SERVICES

Special Carton Marking

With specially marked information N/C

Shipping

Shipped **assembled freight prepaid f.o.b. Mexico City, MX 11000** factory. Freight class #125.

Specifications and prices are subject to change without prior notice.

Darwin®

Reception Desks

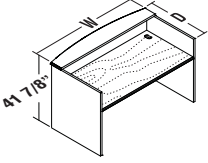
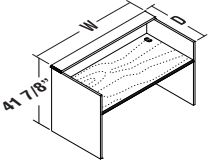
	MODEL	Features	D x W x H	MODEL NUMBER				Approx. Packaged Weight
				Basic Model	Edge Style	Wood Finish	Grommets	
 <p>DREC</p>	Reception Desk - Bow Shaped Transaction Top • Transaction counter is 12" deep at center • 30" deep units accommodate 19" pedestals only; 36" deep accommodate 19" or 26" pedestals	30" Deep	30 x 58-3/4 x 41-7/8"	KAT55013060	<input type="checkbox"/>	<input type="checkbox"/>	<input type="checkbox"/>	270.0#
		30" Deep	30 x 64-3/4 x 41-7/8"	KAT55013066	<input type="checkbox"/>	<input type="checkbox"/>	<input type="checkbox"/>	301.0#
		30" Deep	30 x 70-3/4 x 41-7/8"	KAT55013072	<input type="checkbox"/>	<input type="checkbox"/>	<input type="checkbox"/>	328.0#
		30" Deep	30 x 82-3/4 x 41-7/8"	KAT55013084	<input type="checkbox"/>	<input type="checkbox"/>	<input type="checkbox"/>	361.0#
		30" Deep	30 x 87 x 41-7/8"	KAT55013088	<input type="checkbox"/>	<input type="checkbox"/>	<input type="checkbox"/>	394.0#
		36" Deep	36 x 58-3/4 x 41-7/8"	KAT55013660	<input type="checkbox"/>	<input type="checkbox"/>	<input type="checkbox"/>	301.0#
		36" Deep	36 x 64-3/4 x 41-7/8"	KAT55013666	<input type="checkbox"/>	<input type="checkbox"/>	<input type="checkbox"/>	331.0#
		36" Deep	36 x 70-3/4 x 41-7/8"	KAT55013672	<input type="checkbox"/>	<input type="checkbox"/>	<input type="checkbox"/>	361.0#
		36" Deep	36 x 82-3/4 x 41-7/8"	KAT55013684	<input type="checkbox"/>	<input type="checkbox"/>	<input type="checkbox"/>	391.0#
		36" Deep	36 x 87 x 41-7/8"	KAT55013688	<input type="checkbox"/>	<input type="checkbox"/>	<input type="checkbox"/>	422.0#
 <p>DREC</p>	Reception Desk - Rectangular Transaction Top • Transaction counter is 12" deep • 30" deep units accommodate 19" pedestals only; 36" deep accommodate 19" or 26" pedestals	30" Deep	30 x 58-3/4 x 41-7/8"	KAT55033060	<input type="checkbox"/>	<input type="checkbox"/>	<input type="checkbox"/>	270.0#
		30" Deep	30 x 64-3/4 x 41-7/8"	KAT55033066	<input type="checkbox"/>	<input type="checkbox"/>	<input type="checkbox"/>	301.0#
		30" Deep	30 x 70-3/4 x 41-7/8"	KAT55033072	<input type="checkbox"/>	<input type="checkbox"/>	<input type="checkbox"/>	328.0#
		30" Deep	30 x 82-3/4 x 41-7/8"	KAT55033084	<input type="checkbox"/>	<input type="checkbox"/>	<input type="checkbox"/>	361.0#
		30" Deep	30 x 87 x 41-7/8"	KAT55033088	<input type="checkbox"/>	<input type="checkbox"/>	<input type="checkbox"/>	394.0#
		36" Deep	36 x 58-3/4 x 41-7/8"	KAT55033660	<input type="checkbox"/>	<input type="checkbox"/>	<input type="checkbox"/>	301.0#
		36" Deep	36 x 64-3/4 x 41-7/8"	KAT55033666	<input type="checkbox"/>	<input type="checkbox"/>	<input type="checkbox"/>	331.0#
		36" Deep	36 x 70-3/4 x 41-7/8"	KAT55033672	<input type="checkbox"/>	<input type="checkbox"/>	<input type="checkbox"/>	361.0#
		36" Deep	36 x 82-3/4 x 41-7/8"	KAT55033684	<input type="checkbox"/>	<input type="checkbox"/>	<input type="checkbox"/>	391.0#
		36" Deep	36 x 87 x 41-7/8"	KAT55033688	<input type="checkbox"/>	<input type="checkbox"/>	<input type="checkbox"/>	422.0#

A **B** **C** **D**

HOW TO ORDER

Indicate the following information on order form:

- Quantity of each item.
- Model number, including options. See "How To Build a Model Number".
- Any special service required.

Note: • The indicates that a choice is required.

- The absence of the indicates that no choice is required.
- Alpha-numeric characters in place of indicate that no other alternatives are available.

HOW TO BUILD A MODEL NUMBER

A Select basic model.

B Select edge style.

BO	- Quarter round edge
CR	- Reed edge
CV	- Cove edge
EB	- Square edge
PD	- Pyramid edge

C Select wood finish color.
Refer to color addendum at ki.com or KI Fabrics & Finishes binder.

D Select grommet.

NA	- No grommet
EG	- Rectangular grommet

Grommets are factory installed.



Delivered
Pricing

\$ 3459

3649

3881

4319

4475

3777

3894

4117

4649

4855

\$ 3459

3649

3881

4319

4475

3777

3894

4117

4649

4855

SPECIAL SERVICES

Special Carton Marking

With specially marked information N/C

Shipping

Shipped **assembled freight prepaid f.o.b. Mexico City, MX 11000** factory. Freight class #125.

Specifications and prices are subject to change without prior notice.

Darwin®

Reception Returns

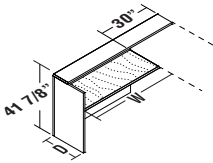
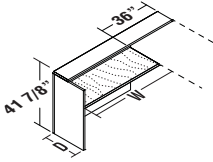
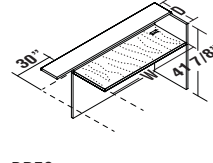
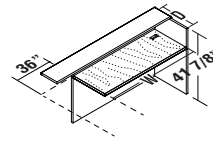
MODEL	Features	D x W x H	MODEL NUMBER				Approx. Packaged Weight
			Basic Model	Edge Style	Wood Finish	Grommets	
 <p>Reception Desk - Return - Left</p> <ul style="list-style-type: none"> • "D" length of transaction shelf fits on left side panel of Reception desk • Returns accommodate 19" pedestals only 	For 30" Dp Recep	24 x 36 x 41-7/8"	KAT55113036	<input type="checkbox"/>	<input type="checkbox"/>	<input type="checkbox"/>	139.0#
	For 30" Dp Recep	24 x 42 x 41-7/8"	KAT55113042	<input type="checkbox"/>	<input type="checkbox"/>	<input type="checkbox"/>	155.0#
	For 30" Dp Recep	24 x 48 x 41-7/8"	KAT55113048	<input type="checkbox"/>	<input type="checkbox"/>	<input type="checkbox"/>	174.0#
	For 30" Dp Recep	24 x 60 x 41-7/8"	KAT55113060	<input type="checkbox"/>	<input type="checkbox"/>	<input type="checkbox"/>	203.0#
DREC							
 <p>Reception Desk - Return - Left</p> <ul style="list-style-type: none"> • "D" length of transaction shelf fits on left side panel of Reception desk • Returns accommodate 19" pedestals only 	For 36" Dp Recep	24 x 36 x 41-7/8"	KAT55113636	<input type="checkbox"/>	<input type="checkbox"/>	<input type="checkbox"/>	145.0#
	For 36" Dp Recep	24 x 42 x 41-7/8"	KAT55113642	<input type="checkbox"/>	<input type="checkbox"/>	<input type="checkbox"/>	160.0#
	For 36" Dp Recep	24 x 48 x 41-7/8"	KAT55113648	<input type="checkbox"/>	<input type="checkbox"/>	<input type="checkbox"/>	180.0#
	For 36" Dp Recep	24 x 60 x 41-7/8"	KAT55113660	<input type="checkbox"/>	<input type="checkbox"/>	<input type="checkbox"/>	210.0#
DREC							
 <p>Reception Desk - Return - Right</p> <ul style="list-style-type: none"> • "D" length of transaction shelf fits on right side panel of Reception desk • Returns accommodate 19" pedestals only 	For 30" Dp Recep	24 x 36 x 41-7/8"	KAT55123036	<input type="checkbox"/>	<input type="checkbox"/>	<input type="checkbox"/>	139.0#
	For 30" Dp Recep	24 x 42 x 41-7/8"	KAT55123042	<input type="checkbox"/>	<input type="checkbox"/>	<input type="checkbox"/>	155.0#
	For 30" Dp Recep	24 x 48 x 41-7/8"	KAT55123048	<input type="checkbox"/>	<input type="checkbox"/>	<input type="checkbox"/>	174.0#
	For 30" Dp Recep	24 x 60 x 41-7/8"	KAT55123060	<input type="checkbox"/>	<input type="checkbox"/>	<input type="checkbox"/>	203.0#
DREC							
 <p>Reception Desk - Return - Right</p> <ul style="list-style-type: none"> • "D" length of transaction shelf fits on right side panel of Reception desk • Returns accommodate 19" pedestals only 	For 36" Dp Recep	24 x 36 x 41-7/8"	KAT55123636	<input type="checkbox"/>	<input type="checkbox"/>	<input type="checkbox"/>	145.0#
	For 36" Dp Recep	24 x 42 x 41-7/8"	KAT55123642	<input type="checkbox"/>	<input type="checkbox"/>	<input type="checkbox"/>	160.0#
	For 36" Dp Recep	24 x 48 x 41-7/8"	KAT55123648	<input type="checkbox"/>	<input type="checkbox"/>	<input type="checkbox"/>	180.0#
	For 36" Dp Recep	24 x 60 x 41-7/8"	KAT55123660	<input type="checkbox"/>	<input type="checkbox"/>	<input type="checkbox"/>	210.0#
DREC							

A **B** **C** **D**

HOW TO ORDER

Indicate the following information on order form:

1. Quantity of each item.
2. Model number, including options. See "How To Build a Model Number".
3. Any special service required.

Note: • The indicates that a choice is required.
 • The absence of the indicates that no choice is required.
 • Alpha-numeric characters in place of indicate that no other alternatives are available.

HOW TO BUILD A MODEL NUMBER

- A** Select basic model.
- B** Select edge style.

BO	- Quarter round edge
CR	- Reed edge
CV	- Cove edge
EB	- Square edge
PD	- Pyramid edge
- C** Select wood finish color.
Refer to color addendum at ki.com or KI Fabrics & Finishes binder.
- D** Select grommet.

NA	- No grommet
EG	- Rectangular grommet

Grommets are factory installed.



Delivered
Pricing

\$ 2169
2377
2585
2972

\$ 2243
2456
2665
3101

\$ 2169
2377
2585
2972

\$ 2243
2456
2665
3101

SPECIAL SERVICES

Special Carton Marking

With specially marked information N/C

Shipping

Shipped **assembled freight prepaid f.o.b. Mexico City, MX 11000** factory. Freight class #125.

Specifications and prices are subject to change without prior notice.

Darwin®

Reception - Bridge/Credenza

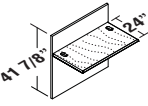
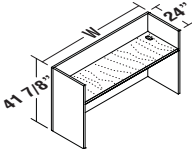
MODEL	Features	D x W x H	MODEL NUMBER				Approx. Packaged Weight
			Basic Model	Edge Style	Wood Finish	Grommets	
 <p>Reception - Bridge • Accommodates 19" pedestal or 20" lateral</p>	24" Deep	24 x 36 x 41-7/8"	KAT55182436	<input type="checkbox"/>	<input type="checkbox"/>	<input type="checkbox"/>	84.0#
	24" Deep	24 x 42 x 41-7/8"	KAT55182442	<input type="checkbox"/>	<input type="checkbox"/>	<input type="checkbox"/>	110.0#
	24" Deep	24 x 48 x 41-7/8"	KAT55182448	<input type="checkbox"/>	<input type="checkbox"/>	<input type="checkbox"/>	120.0#
 <p>Reception - Credenza • Accommodates 19" pedestal or 20" lateral</p>	24" Deep	24 x 66 x 41-7/8"	KAT55192466	<input type="checkbox"/>	<input type="checkbox"/>	<input type="checkbox"/>	195.0#
	24" Deep	24 x 72 x 41-7/8"	KAT55192472	<input type="checkbox"/>	<input type="checkbox"/>	<input type="checkbox"/>	202.0#
	24" Deep	24 x 84 x 41-7/8"	KAT55192484	<input type="checkbox"/>	<input type="checkbox"/>	<input type="checkbox"/>	220.0#
	24" Deep	24 x 88-1/4 x 41-7/8"	KAT55192488	<input type="checkbox"/>	<input type="checkbox"/>	<input type="checkbox"/>	260.0#

A **B** **C** **D**

HOW TO ORDER

Indicate the following information on order form:

- Quantity of each item.
- Model number, including options. See "How To Build a Model Number".
- Any special service required.

Note: • The indicates that a choice is required.
• The absence of the indicates that no choice is required.
• Alpha-numeric characters in place of indicate that no other alternatives are available.

HOW TO BUILD A MODEL NUMBER

- A** Select basic model.
- B** Select edge style.

BO	- Quarter round edge
CR	- Reed edge
CV	- Cove edge
EB	- Square edge
PD	- Pyramid edge
- C** Select wood finish color.
Refer to color addendum at ki.com or KI Fabrics & Finishes binder.
- D** Select grommet.

NA	- No grommet
EG	- Rectangular grommet

Grommets are factory installed.



Delivered
Pricing

\$ 906
1031
1159

\$ 2671
2835
3144
3253

SPECIAL SERVICES

Special Carton Marking

With specially marked information N/C

Shipping

Shipped **assembled freight prepaid f.o.b. Mexico City, MX 11000** factory. Freight class #125.

Specifications and prices are subject to change without prior notice.

Darwin®

Mitered Desks

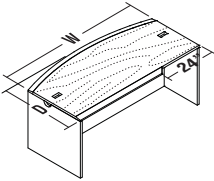
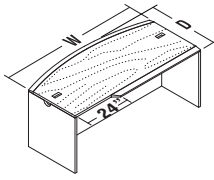
MODEL	Features	D x W x H	MODEL NUMBER				Approx. Packaged Weight
			Basic Model	Edge Style	Wood Finish	Grommets	
 <p>DDSK</p> <p>Mitered Bow Front Desk Shell - Left</p> <ul style="list-style-type: none"> • Inside dimension is 4" less than nominal width (Ex: 72" is 68" inside) • For use with mitered connecting top or mitered bridge • Flush sides • Full height panel is recessed 8" • 36" deep models accommodate 19" pedestals • 42" deep models accommodate 19" or 26" pedestals 	36" Deep	36 x 70-3/4 x 29-1/4"	KAT40033672	CD	<input type="checkbox"/> <input type="checkbox"/> <input type="checkbox"/> <input type="checkbox"/>	<input type="checkbox"/> <input type="checkbox"/>	230.0#
	36" Deep	36 x 82-3/4 x 29-1/4"	KAT40033684	CD	<input type="checkbox"/> <input type="checkbox"/> <input type="checkbox"/> <input type="checkbox"/>	<input type="checkbox"/> <input type="checkbox"/>	245.0#
	36" Deep	36 x 87 x 29-1/4"	KAT40033688	CD	<input type="checkbox"/> <input type="checkbox"/> <input type="checkbox"/> <input type="checkbox"/>	<input type="checkbox"/> <input type="checkbox"/>	260.0#
	42" Deep	42 x 70-3/4 x 29-1/4"	KAT40034272	CD	<input type="checkbox"/> <input type="checkbox"/> <input type="checkbox"/> <input type="checkbox"/>	<input type="checkbox"/> <input type="checkbox"/>	270.0#
	42" Deep	42 x 82-3/4 x 29-1/4"	KAT40034284	CD	<input type="checkbox"/> <input type="checkbox"/> <input type="checkbox"/> <input type="checkbox"/>	<input type="checkbox"/> <input type="checkbox"/>	275.0#
	42" Deep	42 x 87 x 29-1/4"	KAT40034288	CD	<input type="checkbox"/> <input type="checkbox"/> <input type="checkbox"/> <input type="checkbox"/>	<input type="checkbox"/> <input type="checkbox"/>	280.0#
 <p>DDSK</p> <p>Mitered Bow Front Desk Shell - Right</p> <ul style="list-style-type: none"> • Inside dimension is 4" less than nominal width (Ex: 72" is 68" inside) • For use with mitered connecting top or mitered bridge • Flush sides • Full height panel is recessed 8" • 36" deep models accommodate 19" pedestals • 42" deep models accommodate 19" or 26" pedestals 	36" Deep	36 x 70-3/4 x 29-1/4"	KAT40043672	CD	<input type="checkbox"/> <input type="checkbox"/> <input type="checkbox"/> <input type="checkbox"/>	<input type="checkbox"/> <input type="checkbox"/>	230.0#
	36" Deep	36 x 82-3/4 x 29-1/4"	KAT40043684	CD	<input type="checkbox"/> <input type="checkbox"/> <input type="checkbox"/> <input type="checkbox"/>	<input type="checkbox"/> <input type="checkbox"/>	245.0#
	36" Deep	36 x 87 x 29-1/4"	KAT40043688	CD	<input type="checkbox"/> <input type="checkbox"/> <input type="checkbox"/> <input type="checkbox"/>	<input type="checkbox"/> <input type="checkbox"/>	260.0#
	42" Deep	42 x 70-3/4 x 29-1/4"	KAT40044272	CD	<input type="checkbox"/> <input type="checkbox"/> <input type="checkbox"/> <input type="checkbox"/>	<input type="checkbox"/> <input type="checkbox"/>	270.0#
	42" Deep	42 x 82-3/4 x 29-1/4"	KAT40044284	CD	<input type="checkbox"/> <input type="checkbox"/> <input type="checkbox"/> <input type="checkbox"/>	<input type="checkbox"/> <input type="checkbox"/>	275.0#
	42" Deep	42 x 87 x 29-1/4"	KAT40044288	CD	<input type="checkbox"/> <input type="checkbox"/> <input type="checkbox"/> <input type="checkbox"/>	<input type="checkbox"/> <input type="checkbox"/>	280.0#

A **B** **C** **D**

HOW TO ORDER

Indicate the following information on order form:

1. Quantity of each item.
2. Model number, including options. See "How To Build a Model Number".
3. Any special service required.

Note:

- The indicates that a choice is required.
- The absence of the indicates that no choice is required.
- Alpha-numeric characters in place of indicate that no other alternatives are available.

HOW TO BUILD A MODEL NUMBER

- A** Select basic model.
- B** Select edge style.

CD	- Knife edge
-----------	--------------
- C** Select wood finish color.
 Refer to color addendum at ki.com or KI Fabrics & Finishes binder.
- D** Select grommet.

NA	- No grommet
EG	- Rectangular grommet

 Grommets are factory installed.



Delivered
Pricing

\$ 2600
2886
2991
2831
3181
3290

\$ 2600
2886
2991
2831
3181
3290

SPECIAL SERVICES

Special Carton Marking

With specially marked information N/C

Shipping

Shipped **assembled freight prepaid f.o.b. Mexico City, MX 11000** factory. Freight class #125.

Specifications and prices are subject to change without prior notice.

Darwin®

Mitered Desks

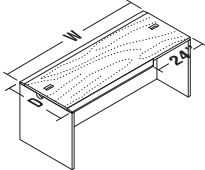
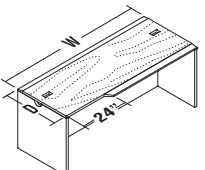
	MODEL	Features	D x W x H	MODEL NUMBER				Approx. Packaged Weight
				Basic Model	Edge Style	Wood Finish	Grommets	
 <p>DDSK</p>	Mitered Desk Shell - Left • Inside dimension is 4" less than nominal width (Ex: 72" is 68" inside) • For use with mitered connecting top or mitered bridge	30" Deep	30 x 58-3/4 x 29-1/4"	KAT40133060	CD	<input type="checkbox"/> <input type="checkbox"/> <input type="checkbox"/> <input type="checkbox"/>	<input type="checkbox"/> <input type="checkbox"/>	208.0#
		30" Deep	30 x 64-3/4 x 29-1/4"	KAT40133066	CD	<input type="checkbox"/> <input type="checkbox"/> <input type="checkbox"/> <input type="checkbox"/>	<input type="checkbox"/> <input type="checkbox"/>	238.0#
		30" Deep	30 x 70-3/4 x 29-1/4"	KAT40133072	CD	<input type="checkbox"/> <input type="checkbox"/> <input type="checkbox"/> <input type="checkbox"/>	<input type="checkbox"/> <input type="checkbox"/>	270.0#
		30" Deep	30 x 82-3/4 x 29-1/4"	KAT40133084	CD	<input type="checkbox"/> <input type="checkbox"/> <input type="checkbox"/> <input type="checkbox"/>	<input type="checkbox"/> <input type="checkbox"/>	290.0#
		30" Deep	30 x 87 x 29-1/4"	KAT40133088	CD	<input type="checkbox"/> <input type="checkbox"/> <input type="checkbox"/> <input type="checkbox"/>	<input type="checkbox"/> <input type="checkbox"/>	300.0#
		36" Deep	36 x 58-3/4 x 29-1/4"	KAT40133660	CD	<input type="checkbox"/> <input type="checkbox"/> <input type="checkbox"/> <input type="checkbox"/>	<input type="checkbox"/> <input type="checkbox"/>	220.0#
		36" Deep	36 x 64-3/4 x 29-1/4"	KAT40133666	CD	<input type="checkbox"/> <input type="checkbox"/> <input type="checkbox"/> <input type="checkbox"/>	<input type="checkbox"/> <input type="checkbox"/>	250.0#
		36" Deep	36 x 70-3/4 x 29-1/4"	KAT40133672	CD	<input type="checkbox"/> <input type="checkbox"/> <input type="checkbox"/> <input type="checkbox"/>	<input type="checkbox"/> <input type="checkbox"/>	266.0#
		36" Deep	36 x 82-3/4 x 29-1/4"	KAT40133684	CD	<input type="checkbox"/> <input type="checkbox"/> <input type="checkbox"/> <input type="checkbox"/>	<input type="checkbox"/> <input type="checkbox"/>	299.0#
		36" Deep	36 x 87 x 29-1/4"	KAT40133688	CD	<input type="checkbox"/> <input type="checkbox"/> <input type="checkbox"/> <input type="checkbox"/>	<input type="checkbox"/> <input type="checkbox"/>	310.0#
 <p>DDSK</p>	Mitered Desk Shell - Right • Inside dimension is 4" less than nominal width (Ex: 72" is 68" inside) • For use with mitered connecting top or mitered bridge	30" Deep	30 x 58-3/4 x 29-1/4"	KAT40143060	CD	<input type="checkbox"/> <input type="checkbox"/> <input type="checkbox"/> <input type="checkbox"/>	<input type="checkbox"/> <input type="checkbox"/>	208.0#
		30" Deep	30 x 64-3/4 x 29-1/4"	KAT40143066	CD	<input type="checkbox"/> <input type="checkbox"/> <input type="checkbox"/> <input type="checkbox"/>	<input type="checkbox"/> <input type="checkbox"/>	238.0#
		30" Deep	30 x 70-3/4 x 29-1/4"	KAT40143072	CD	<input type="checkbox"/> <input type="checkbox"/> <input type="checkbox"/> <input type="checkbox"/>	<input type="checkbox"/> <input type="checkbox"/>	270.0#
		30" Deep	30 x 82-3/4 x 29-1/4"	KAT40143084	CD	<input type="checkbox"/> <input type="checkbox"/> <input type="checkbox"/> <input type="checkbox"/>	<input type="checkbox"/> <input type="checkbox"/>	290.0#
		30" Deep	30 x 87 x 29-1/4"	KAT40143088	CD	<input type="checkbox"/> <input type="checkbox"/> <input type="checkbox"/> <input type="checkbox"/>	<input type="checkbox"/> <input type="checkbox"/>	300.0#
		36" Deep	36 x 58-3/4 x 29-1/4"	KAT40143660	CD	<input type="checkbox"/> <input type="checkbox"/> <input type="checkbox"/> <input type="checkbox"/>	<input type="checkbox"/> <input type="checkbox"/>	220.0#
		36" Deep	36 x 64-3/4 x 29-1/4"	KAT40143666	CD	<input type="checkbox"/> <input type="checkbox"/> <input type="checkbox"/> <input type="checkbox"/>	<input type="checkbox"/> <input type="checkbox"/>	250.0#
		36" Deep	36 x 70-3/4 x 29-1/4"	KAT40143672	CD	<input type="checkbox"/> <input type="checkbox"/> <input type="checkbox"/> <input type="checkbox"/>	<input type="checkbox"/> <input type="checkbox"/>	266.0#
		36" Deep	36 x 82-3/4 x 29-1/4"	KAT40143684	CD	<input type="checkbox"/> <input type="checkbox"/> <input type="checkbox"/> <input type="checkbox"/>	<input type="checkbox"/> <input type="checkbox"/>	299.0#
		36" Deep	36 x 87 x 29-1/4"	KAT40143688	CD	<input type="checkbox"/> <input type="checkbox"/> <input type="checkbox"/> <input type="checkbox"/>	<input type="checkbox"/> <input type="checkbox"/>	310.0#

A

B

C

D

HOW TO ORDER

Indicate the following information on order form:

- Quantity of each item.
- Model number, including options. See "How To Build a Model Number".
- Any special service required.

Note: • The indicates that a choice is required.

- The absence of the indicates that no choice is required.
- Alpha-numeric characters in place of indicate that no other alternatives are available.

HOW TO BUILD A MODEL NUMBER

A Select basic model.

B Select edge style.

CD - Knife edge

C Select wood finish color.

Refer to color addendum at ki.com or KI Fabrics & Finishes binder.

D Select grommet.

NA - No grommet

EG - Rectangular grommet

Grommets are factory installed.



Delivered Pricing

\$ 1412

1555

1635

1886

1951

1695

1767

1832

2102

2171

\$ 1412

1555

1635

1886

1951

1695

1767

1832

2102

2171

SPECIAL SERVICES

Special Carton Marking

With specially marked information N/C

Shipping

Shipped **assembled freight prepaid f.o.b. Mexico City, MX 11000** factory. Freight class #125.

Specifications and prices are subject to change without prior notice.

Darwin®

Mitered Table Desks

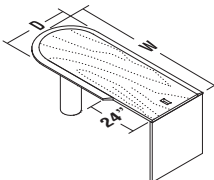
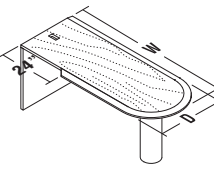
MODEL	Features	D x W x H	MODEL NUMBER				Approx. Packaged Weight
			Basic Model	Edge Style	Wood Finish	Grommets	
 <p>DTDK</p> <p>Mitered Bullet Desk - Left with 3/4 Modesty Panel</p> <ul style="list-style-type: none"> • 4" diameter steel leg (black only) • For use with mitered connecting top or mitered bridge • 14-3/4" modesty panel 	30" Deep	30 x 59-1/4 x 29-1/4"	KAT40233060	CD	<input type="checkbox"/> <input type="checkbox"/> <input type="checkbox"/> <input type="checkbox"/>	<input type="checkbox"/>	144.0#
	30" Deep	30 x 65-1/4 x 29-1/4"	KAT40233066	CD	<input type="checkbox"/> <input type="checkbox"/> <input type="checkbox"/> <input type="checkbox"/>	<input type="checkbox"/>	152.0#
	30" Deep	30 x 71-1/2 x 29-1/4"	KAT40233072	CD	<input type="checkbox"/> <input type="checkbox"/> <input type="checkbox"/> <input type="checkbox"/>	<input type="checkbox"/>	168.0#
	30" Deep	30 x 83-1/2 x 29-1/4"	KAT40233084	CD	<input type="checkbox"/> <input type="checkbox"/> <input type="checkbox"/> <input type="checkbox"/>	<input type="checkbox"/>	185.0#
	30" Deep	30 x 87-1/2 x 29-1/4"	KAT40233088	CD	<input type="checkbox"/> <input type="checkbox"/> <input type="checkbox"/> <input type="checkbox"/>	<input type="checkbox"/>	194.0#
	36" Deep	36 x 59-1/4 x 29-1/4"	KAT40233660	CD	<input type="checkbox"/> <input type="checkbox"/> <input type="checkbox"/> <input type="checkbox"/>	<input type="checkbox"/>	205.0#
	36" Deep	36 x 65-1/4 x 29-1/4"	KAT40233666	CD	<input type="checkbox"/> <input type="checkbox"/> <input type="checkbox"/> <input type="checkbox"/>	<input type="checkbox"/>	210.0#
	36" Deep	36 x 71-1/2 x 29-1/4"	KAT40233672	CD	<input type="checkbox"/> <input type="checkbox"/> <input type="checkbox"/> <input type="checkbox"/>	<input type="checkbox"/>	220.0#
	36" Deep	36 x 83-1/2 x 29-1/4"	KAT40233684	CD	<input type="checkbox"/> <input type="checkbox"/> <input type="checkbox"/> <input type="checkbox"/>	<input type="checkbox"/>	235.0#
	36" Deep	36 x 87-1/2 x 29-1/4"	KAT40233688	CD	<input type="checkbox"/> <input type="checkbox"/> <input type="checkbox"/> <input type="checkbox"/>	<input type="checkbox"/>	247.0#
 <p>DTDK</p> <p>Mitered Bullet Desk - Right with 3/4 Modesty Panel</p> <ul style="list-style-type: none"> • 4" diameter steel leg (black only) • For use with mitered connecting top or mitered bridge • 14-3/4" modesty panel 	30" Deep	30 x 59-1/4 x 29-1/4"	KAT40243060	CD	<input type="checkbox"/> <input type="checkbox"/> <input type="checkbox"/> <input type="checkbox"/>	<input type="checkbox"/>	144.0#
	30" Deep	30 x 65-1/4 x 29-1/4"	KAT40243066	CD	<input type="checkbox"/> <input type="checkbox"/> <input type="checkbox"/> <input type="checkbox"/>	<input type="checkbox"/>	152.0#
	30" Deep	30 x 71-1/2 x 29-1/4"	KAT40243072	CD	<input type="checkbox"/> <input type="checkbox"/> <input type="checkbox"/> <input type="checkbox"/>	<input type="checkbox"/>	168.0#
	30" Deep	30 x 83-1/2 x 29-1/4"	KAT40243084	CD	<input type="checkbox"/> <input type="checkbox"/> <input type="checkbox"/> <input type="checkbox"/>	<input type="checkbox"/>	185.0#
	30" Deep	30 x 87-1/2 x 29-1/4"	KAT40243088	CD	<input type="checkbox"/> <input type="checkbox"/> <input type="checkbox"/> <input type="checkbox"/>	<input type="checkbox"/>	194.0#
	36" Deep	36 x 59-1/4 x 29-1/4"	KAT40243660	CD	<input type="checkbox"/> <input type="checkbox"/> <input type="checkbox"/> <input type="checkbox"/>	<input type="checkbox"/>	205.0#
	36" Deep	36 x 65-1/4 x 29-1/4"	KAT40243666	CD	<input type="checkbox"/> <input type="checkbox"/> <input type="checkbox"/> <input type="checkbox"/>	<input type="checkbox"/>	210.0#
	36" Deep	36 x 71-1/2 x 29-1/4"	KAT40243672	CD	<input type="checkbox"/> <input type="checkbox"/> <input type="checkbox"/> <input type="checkbox"/>	<input type="checkbox"/>	220.0#
	36" Deep	36 x 83-1/2 x 29-1/4"	KAT40243684	CD	<input type="checkbox"/> <input type="checkbox"/> <input type="checkbox"/> <input type="checkbox"/>	<input type="checkbox"/>	235.0#
	36" Deep	36 x 87-1/2 x 29-1/4"	KAT40243688	CD	<input type="checkbox"/> <input type="checkbox"/> <input type="checkbox"/> <input type="checkbox"/>	<input type="checkbox"/>	247.0#

A **B** **C** **D**

HOW TO ORDER

Indicate the following information on order form:

1. Quantity of each item.
2. Model number, including options. See "How To Build a Model Number".
3. Any special service required.

Note: • The indicates that a choice is required.

- The absence of the indicates that no choice is required.
- Alpha-numeric characters in place of indicate that no other alternatives are available.

HOW TO BUILD A MODEL NUMBER

- A** Select basic model.

- B** Select edge style.
CD _____ - Knife edge
- C** Select wood finish color.
Refer to color addendum at ki.com or KI Fabrics & Finishes binder.

- D** Select grommet.
NA _____ - No grommet
EG _____ - Rectangular grommet
Grommets are factory installed.



Delivered
Pricing

\$ 2286
2486
2691
3092
3126
2777
2926
2978
3246
3538
\$ 2286
2486
2691
3092
3126
2777
2926
2978
3246
3538

SPECIAL SERVICES

Special Carton Marking

With specially marked information N/C

Shipping

Shipped **assembled freight prepaid f.o.b. Mexico City, MX 11000** factory. Freight class #125.

Specifications and prices are subject to change without prior notice.

Darwin®

Mitered Table Desks

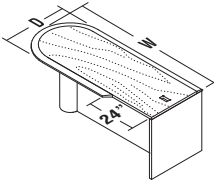
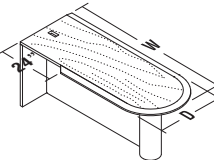
	MODEL	Features	D x W x H	MODEL NUMBER				Approx. Packaged Weight
				Basic Model	Edge Style	Wood Finish	Grommets	
 <p>DTDK</p>	Mitered Bullet Desk - Left with Full Modesty Panel <ul style="list-style-type: none"> 4" diameter steel leg (black only) For use with mitered connecting top or mitered bridge 	30" Deep	30 x 59-1/4 x 29-1/4"	KAT40283060	CD	<input type="checkbox"/> <input type="checkbox"/> <input type="checkbox"/> <input type="checkbox"/>	<input type="checkbox"/>	144.0#
		30" Deep	30 x 65-1/4 x 29-1/4"	KAT40283066	CD	<input type="checkbox"/> <input type="checkbox"/> <input type="checkbox"/> <input type="checkbox"/>	<input type="checkbox"/>	152.0#
		30" Deep	30 x 71-1/2 x 29-1/4"	KAT40283072	CD	<input type="checkbox"/> <input type="checkbox"/> <input type="checkbox"/> <input type="checkbox"/>	<input type="checkbox"/>	168.0#
		30" Deep	30 x 83-1/2 x 29-1/4"	KAT40283084	CD	<input type="checkbox"/> <input type="checkbox"/> <input type="checkbox"/> <input type="checkbox"/>	<input type="checkbox"/>	185.0#
		30" Deep	30 x 87-1/2 x 29-1/4"	KAT40283088	CD	<input type="checkbox"/> <input type="checkbox"/> <input type="checkbox"/> <input type="checkbox"/>	<input type="checkbox"/>	194.0#
		36" Deep	36 x 59-1/4 x 29-1/4"	KAT40283660	CD	<input type="checkbox"/> <input type="checkbox"/> <input type="checkbox"/> <input type="checkbox"/>	<input type="checkbox"/>	205.0#
		36" Deep	36 x 65-1/4 x 29-1/4"	KAT40283666	CD	<input type="checkbox"/> <input type="checkbox"/> <input type="checkbox"/> <input type="checkbox"/>	<input type="checkbox"/>	210.0#
		36" Deep	36 x 71-1/2 x 29-1/4"	KAT40283672	CD	<input type="checkbox"/> <input type="checkbox"/> <input type="checkbox"/> <input type="checkbox"/>	<input type="checkbox"/>	220.0#
		36" Deep	36 x 83-1/2 x 29-1/4"	KAT40283684	CD	<input type="checkbox"/> <input type="checkbox"/> <input type="checkbox"/> <input type="checkbox"/>	<input type="checkbox"/>	235.0#
		36" Deep	36 x 87-1/2 x 29-1/4"	KAT40283688	CD	<input type="checkbox"/> <input type="checkbox"/> <input type="checkbox"/> <input type="checkbox"/>	<input type="checkbox"/>	247.0#
 <p>DTDK</p>	Mitered Bullet Desk - Right with Full Modesty Panel <ul style="list-style-type: none"> 4" diameter steel leg (black only) For use with mitered connecting top or mitered bridge 	30" Deep	30 x 65-1/4 x 29-1/4"	KAT40293060	CD	<input type="checkbox"/> <input type="checkbox"/> <input type="checkbox"/> <input type="checkbox"/>	<input type="checkbox"/>	144.0#
		30" Deep	30 x 65-1/4 x 29-1/4"	KAT40293066	CD	<input type="checkbox"/> <input type="checkbox"/> <input type="checkbox"/> <input type="checkbox"/>	<input type="checkbox"/>	152.0#
		30" Deep	30 x 71-1/2 x 29-1/4"	KAT40293072	CD	<input type="checkbox"/> <input type="checkbox"/> <input type="checkbox"/> <input type="checkbox"/>	<input type="checkbox"/>	168.0#
		30" Deep	30 x 83-1/2 x 29-1/4"	KAT40293084	CD	<input type="checkbox"/> <input type="checkbox"/> <input type="checkbox"/> <input type="checkbox"/>	<input type="checkbox"/>	185.0#
		30" Deep	30 x 87-1/2 x 29-1/4"	KAT40293088	CD	<input type="checkbox"/> <input type="checkbox"/> <input type="checkbox"/> <input type="checkbox"/>	<input type="checkbox"/>	194.0#
		36" Deep	36 x 65-1/4 x 29-1/4"	KAT40293660	CD	<input type="checkbox"/> <input type="checkbox"/> <input type="checkbox"/> <input type="checkbox"/>	<input type="checkbox"/>	205.0#
		36" Deep	36 x 65-1/4 x 29-1/4"	KAT40293666	CD	<input type="checkbox"/> <input type="checkbox"/> <input type="checkbox"/> <input type="checkbox"/>	<input type="checkbox"/>	210.0#
		36" Deep	36 x 71-1/2 x 29-1/4"	KAT40293672	CD	<input type="checkbox"/> <input type="checkbox"/> <input type="checkbox"/> <input type="checkbox"/>	<input type="checkbox"/>	220.0#
		36" Deep	36 x 83-1/2 x 29-1/4"	KAT40293684	CD	<input type="checkbox"/> <input type="checkbox"/> <input type="checkbox"/> <input type="checkbox"/>	<input type="checkbox"/>	235.0#
		36" Deep	36 x 87-1/2 x 29-1/4"	KAT40293688	CD	<input type="checkbox"/> <input type="checkbox"/> <input type="checkbox"/> <input type="checkbox"/>	<input type="checkbox"/>	247.0#

A

B

C

D

HOW TO ORDER

Indicate the following information on order form:

- Quantity of each item.
- Model number, including options. See "How To Build a Model Number".
- Any special service required.

Note: • The indicates that a choice is required.

- The absence of the indicates that no choice is required.
- Alpha-numeric characters in place of indicate that no other alternatives are available.

HOW TO BUILD A MODEL NUMBER

A Select basic model.

B Select edge style.

CD - Knife edge

C Select wood finish color.

Refer to color addendum at ki.com or KI Fabrics & Finishes binder.

D Select grommet.

NA - No grommet

EG - Rectangular grommet

Grommets are factory installed.



Delivered
Pricing

\$ 2682
2859
3036
3393
3520
3006
3199
3401
3786
3925
\$ 2682
2859
3036
3393
3520
3006
3199
3401
3786
3925

SPECIAL SERVICES

Special Carton Marking

With specially marked information N/C

Shipping

Shipped **assembled freight prepaid f.o.b. Mexico City, MX 11000** factory. Freight class #125.

Specifications and prices are subject to change without prior notice.

Darwin®

Mitered Table Desks

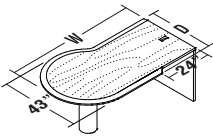
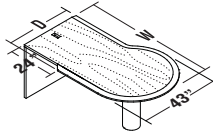
	MODEL	Features	D x W x H	MODEL NUMBER				Approx. Packaged Weight		
				Basic Model	Edge Style	Wood Finish	Grommets			
 <p>DTDK</p>	Mitered P-Shaped Table - Left with 3/4 Modesty Panel <ul style="list-style-type: none"> 4" diameter steel leg (black only) For use with mitered connecting top or mitered bridge 14-3/4" modesty panel 43° at widest depth 	30" Deep	30 x 59-1/4 x 29-1/4"	KAT40333060	CD	<input type="checkbox"/> <input type="checkbox"/> <input type="checkbox"/> <input type="checkbox"/>	<input type="checkbox"/>	165.0#		
		30" Deep	30 x 65-1/4 x 29-1/4"	KAT40333066	CD	<input type="checkbox"/> <input type="checkbox"/> <input type="checkbox"/> <input type="checkbox"/>	<input type="checkbox"/>	172.0#		
		30" Deep	30 x 71-1/2 x 29-1/4"	KAT40333072	CD	<input type="checkbox"/> <input type="checkbox"/> <input type="checkbox"/> <input type="checkbox"/>	<input type="checkbox"/>	180.0#		
		30" Deep	30 x 83-1/2 x 29-1/4"	KAT40333084	CD	<input type="checkbox"/> <input type="checkbox"/> <input type="checkbox"/> <input type="checkbox"/>	<input type="checkbox"/>	195.0#		
		30" Deep	30 x 87-1/2 x 29-1/4"	KAT40333088	CD	<input type="checkbox"/> <input type="checkbox"/> <input type="checkbox"/> <input type="checkbox"/>	<input type="checkbox"/>	199.0#		
		36" Deep	36 x 59-1/4 x 29-1/4"	KAT40333660	CD	<input type="checkbox"/> <input type="checkbox"/> <input type="checkbox"/> <input type="checkbox"/>	<input type="checkbox"/>	232.0#		
		36" Deep	36 x 65-1/4 x 29-1/4"	KAT40333666	CD	<input type="checkbox"/> <input type="checkbox"/> <input type="checkbox"/> <input type="checkbox"/>	<input type="checkbox"/>	240.0#		
		36" Deep	36 x 71-1/2 x 29-1/4"	KAT40333672	CD	<input type="checkbox"/> <input type="checkbox"/> <input type="checkbox"/> <input type="checkbox"/>	<input type="checkbox"/>	254.0#		
		36" Deep	36 x 83-1/2 x 29-1/4"	KAT40333684	CD	<input type="checkbox"/> <input type="checkbox"/> <input type="checkbox"/> <input type="checkbox"/>	<input type="checkbox"/>	260.0#		
		36" Deep	36 x 87-1/2 x 29-1/4"	KAT40333688	CD	<input type="checkbox"/> <input type="checkbox"/> <input type="checkbox"/> <input type="checkbox"/>	<input type="checkbox"/>	265.0#		
		 <p>DTDK</p>	Mitered P-Shaped Table - Right with 3/4 Modesty Panel <ul style="list-style-type: none"> 4" diameter steel leg (black only) For use with mitered connecting top or mitered bridge 14-3/4" modesty panel 43° at widest depth 	30" Deep	30 x 59-1/4 x 29-1/4"	KAT40343060	CD	<input type="checkbox"/> <input type="checkbox"/> <input type="checkbox"/> <input type="checkbox"/>	<input type="checkbox"/>	165.0#
				30" Deep	30 x 65-1/4 x 29-1/4"	KAT40343066	CD	<input type="checkbox"/> <input type="checkbox"/> <input type="checkbox"/> <input type="checkbox"/>	<input type="checkbox"/>	172.0#
30" Deep	30 x 71-1/2 x 29-1/4"			KAT40343072	CD	<input type="checkbox"/> <input type="checkbox"/> <input type="checkbox"/> <input type="checkbox"/>	<input type="checkbox"/>	180.0#		
30" Deep	30 x 83-1/2 x 29-1/4"			KAT40343084	CD	<input type="checkbox"/> <input type="checkbox"/> <input type="checkbox"/> <input type="checkbox"/>	<input type="checkbox"/>	195.0#		
30" Deep	30 x 87-1/2 x 29-1/4"			KAT40343088	CD	<input type="checkbox"/> <input type="checkbox"/> <input type="checkbox"/> <input type="checkbox"/>	<input type="checkbox"/>	199.0#		
36" Deep	36 x 59-1/4 x 29-1/4"			KAT40343660	CD	<input type="checkbox"/> <input type="checkbox"/> <input type="checkbox"/> <input type="checkbox"/>	<input type="checkbox"/>	232.0#		
36" Deep	36 x 65-1/4 x 29-1/4"			KAT40343666	CD	<input type="checkbox"/> <input type="checkbox"/> <input type="checkbox"/> <input type="checkbox"/>	<input type="checkbox"/>	240.0#		
36" Deep	36 x 71-1/2 x 29-1/4"			KAT40343672	CD	<input type="checkbox"/> <input type="checkbox"/> <input type="checkbox"/> <input type="checkbox"/>	<input type="checkbox"/>	254.0#		
36" Deep	36 x 83-1/2 x 29-1/4"			KAT40343684	CD	<input type="checkbox"/> <input type="checkbox"/> <input type="checkbox"/> <input type="checkbox"/>	<input type="checkbox"/>	260.0#		
36" Deep	36 x 87-1/2 x 29-1/4"			KAT40343688	CD	<input type="checkbox"/> <input type="checkbox"/> <input type="checkbox"/> <input type="checkbox"/>	<input type="checkbox"/>	265.0#		

A

B

C

D

HOW TO ORDER

Indicate the following information on order form:

- Quantity of each item.
- Model number, including options. See "How To Build a Model Number".
- Any special service required.

Note: • The indicates that a choice is required.

- The absence of the indicates that no choice is required.
- Alpha-numeric characters in place of indicate that no other alternatives are available.

HOW TO BUILD A MODEL NUMBER

- A** Select basic model.
- B** Select edge style.
CD - Knife edge
- C** Select wood finish color.
 Refer to color addendum at ki.com or KI Fabrics & Finishes binder.
- D** Select grommet.
NA - No grommet
EG - Rectangular grommet
 Grommets are factory installed.



Delivered
Pricing

\$ 3726
3927
4044
4507
4659
3726
3927
4044
4507
4659
\$ 3726
3927
4044
4507
4659
3726
3927
4044
4507
4659

SPECIAL SERVICES

Special Carton Marking

With specially marked information N/C

Shipping

Shipped **assembled freight prepaid f.o.b. Mexico City, MX 11000** factory. Freight class #125.

Specifications and prices are subject to change without prior notice.

Darwin®

Mitered Table Desks

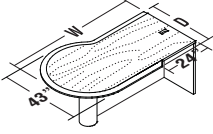
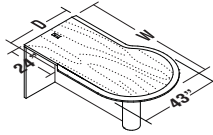
	MODEL	Features	D x W x H	MODEL NUMBER				Approx. Packaged Weight
				Basic Model	Edge Style	Wood Finish	Grommets	
 <p>DTDK</p>	Mitered P-Shaped Table - Left with Full Modesty Panel <ul style="list-style-type: none"> 4" diameter steel leg (black only) For use with mitered connecting top or mitered bridge 14-3/4" modesty panel 43" at widest depth 	30" Deep	30 x 59-1/4 x 29-1/4"	KAT40383060	CD	<input type="checkbox"/> <input type="checkbox"/> <input type="checkbox"/> <input type="checkbox"/>	<input type="checkbox"/>	165.0#
		30" Deep	30 x 65-1/4 x 29-1/4"	KAT40383066	CD	<input type="checkbox"/> <input type="checkbox"/> <input type="checkbox"/> <input type="checkbox"/>	<input type="checkbox"/>	172.0#
		30" Deep	30 x 71-1/2 x 29-1/4"	KAT40383072	CD	<input type="checkbox"/> <input type="checkbox"/> <input type="checkbox"/> <input type="checkbox"/>	<input type="checkbox"/>	180.0#
		30" Deep	30 x 83-1/2 x 29-1/4"	KAT40383084	CD	<input type="checkbox"/> <input type="checkbox"/> <input type="checkbox"/> <input type="checkbox"/>	<input type="checkbox"/>	195.0#
		30" Deep	30 x 87-1/2 x 29-1/4"	KAT40383088	CD	<input type="checkbox"/> <input type="checkbox"/> <input type="checkbox"/> <input type="checkbox"/>	<input type="checkbox"/>	199.0#
		36" Deep	36 x 59-1/4 x 29-1/4"	KAT40383660	CD	<input type="checkbox"/> <input type="checkbox"/> <input type="checkbox"/> <input type="checkbox"/>	<input type="checkbox"/>	232.0#
		36" Deep	36 x 65-1/4 x 29-1/4"	KAT40383666	CD	<input type="checkbox"/> <input type="checkbox"/> <input type="checkbox"/> <input type="checkbox"/>	<input type="checkbox"/>	240.0#
		36" Deep	36 x 71-1/2 x 29-1/4"	KAT40383672	CD	<input type="checkbox"/> <input type="checkbox"/> <input type="checkbox"/> <input type="checkbox"/>	<input type="checkbox"/>	254.0#
		36" Deep	36 x 83-1/2 x 29-1/4"	KAT40383684	CD	<input type="checkbox"/> <input type="checkbox"/> <input type="checkbox"/> <input type="checkbox"/>	<input type="checkbox"/>	260.0#
		36" Deep	36 x 87-1/2 x 29-1/4"	KAT40383688	CD	<input type="checkbox"/> <input type="checkbox"/> <input type="checkbox"/> <input type="checkbox"/>	<input type="checkbox"/>	265.0#
 <p>DTDK</p>	Mitered P-Shaped Table - Right with Full Modesty Panel <ul style="list-style-type: none"> 4" diameter steel leg (black only) For use with mitered connecting top or mitered bridge 14-3/4" modesty panel 43" at widest depth 	30" Deep	30 x 59-1/4 x 29-1/4"	KAT40393060	CD	<input type="checkbox"/> <input type="checkbox"/> <input type="checkbox"/> <input type="checkbox"/>	<input type="checkbox"/>	165.0#
		30" Deep	30 x 65-1/4 x 29-1/4"	KAT40393066	CD	<input type="checkbox"/> <input type="checkbox"/> <input type="checkbox"/> <input type="checkbox"/>	<input type="checkbox"/>	172.0#
		30" Deep	30 x 71-1/2 x 29-1/4"	KAT40393072	CD	<input type="checkbox"/> <input type="checkbox"/> <input type="checkbox"/> <input type="checkbox"/>	<input type="checkbox"/>	180.0#
		30" Deep	30 x 83-1/2 x 29-1/4"	KAT40393084	CD	<input type="checkbox"/> <input type="checkbox"/> <input type="checkbox"/> <input type="checkbox"/>	<input type="checkbox"/>	195.0#
		30" Deep	30 x 87-1/2 x 29-1/4"	KAT40393088	CD	<input type="checkbox"/> <input type="checkbox"/> <input type="checkbox"/> <input type="checkbox"/>	<input type="checkbox"/>	199.0#
		36" Deep	36 x 59-1/4 x 29-1/4"	KAT40393660	CD	<input type="checkbox"/> <input type="checkbox"/> <input type="checkbox"/> <input type="checkbox"/>	<input type="checkbox"/>	232.0#
		36" Deep	36 x 65-1/4 x 29-1/4"	KAT40393666	CD	<input type="checkbox"/> <input type="checkbox"/> <input type="checkbox"/> <input type="checkbox"/>	<input type="checkbox"/>	240.0#
		36" Deep	36 x 71-1/2 x 29-1/4"	KAT40393672	CD	<input type="checkbox"/> <input type="checkbox"/> <input type="checkbox"/> <input type="checkbox"/>	<input type="checkbox"/>	254.0#
		36" Deep	36 x 83-1/2 x 29-1/4"	KAT40393684	CD	<input type="checkbox"/> <input type="checkbox"/> <input type="checkbox"/> <input type="checkbox"/>	<input type="checkbox"/>	260.0#
		36" Deep	36 x 87-1/2 x 29-1/4"	KAT40393688	CD	<input type="checkbox"/> <input type="checkbox"/> <input type="checkbox"/> <input type="checkbox"/>	<input type="checkbox"/>	265.0#

A

B

C

D

HOW TO ORDER

Indicate the following information on order form:

- Quantity of each item.
- Model number, including options. See "How To Build a Model Number".
- Any special service required.

Note: • The indicates that a choice is required.

- The absence of the indicates that no choice is required.
- Alpha-numeric characters in place of indicate that no other alternatives are available.

HOW TO BUILD A MODEL NUMBER

A Select basic model.

B Select edge style.

CD - Knife edge

C Select wood finish color.

Refer to color addendum at ki.com or KI Fabrics & Finishes binder.

D Select grommet.

NA - No grommet

EG - Rectangular grommet

Grommets are factory installed.



Delivered
Pricing

\$ 3927

4169

4389

4866

5024

3927

4169

4389

4866

5024

\$ 3927

4169

4389

4866

5024

3927

4169

4389

4866

5024

SPECIAL SERVICES

Special Carton Marking

With specially marked information N/C

Shipping

Shipped **assembled freight prepaid f.o.b. Mexico City, MX 11000** factory. Freight class #125.

Specifications and prices are subject to change without prior notice.

Darwin®

Mitered Table Desks

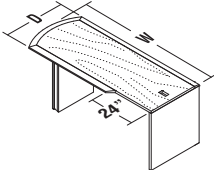
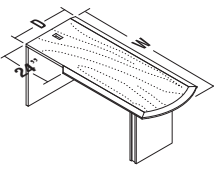
MODEL	Features	D x W x H	MODEL NUMBER				Approx. Packaged Weight
			Basic Model	Edge Style	Wood Finish	Grommets	
 <p>DTDK</p>	Mitered Rectangular Desk - Left with 3/4 Modesty Panel <ul style="list-style-type: none"> For use with mitered connecting top or mitered bridge 14-3/4" modesty panel 	30" Deep 30 x 59-1/4 x 29-1/4"	KAT40433060	CD	<input type="checkbox"/> <input type="checkbox"/> <input type="checkbox"/> <input type="checkbox"/>	<input type="checkbox"/> <input type="checkbox"/>	194.0#
	30" Deep 30 x 65-1/4 x 29-1/4"	KAT40433066	CD	<input type="checkbox"/> <input type="checkbox"/> <input type="checkbox"/> <input type="checkbox"/>	<input type="checkbox"/> <input type="checkbox"/>	210.0#	
	30" Deep 30 x 71-1/2 x 29-1/4"	KAT40433072	CD	<input type="checkbox"/> <input type="checkbox"/> <input type="checkbox"/> <input type="checkbox"/>	<input type="checkbox"/> <input type="checkbox"/>	222.0#	
	30" Deep 30 x 83-1/2 x 29-1/4"	KAT40433084	CD	<input type="checkbox"/> <input type="checkbox"/> <input type="checkbox"/> <input type="checkbox"/>	<input type="checkbox"/> <input type="checkbox"/>	234.0#	
	30" Deep 30 x 87-1/2 x 29-1/4"	KAT40433088	CD	<input type="checkbox"/> <input type="checkbox"/> <input type="checkbox"/> <input type="checkbox"/>	<input type="checkbox"/> <input type="checkbox"/>	245.0#	
	36" Deep 36 x 59-1/4 x 29-1/4"	KAT40433660	CD	<input type="checkbox"/> <input type="checkbox"/> <input type="checkbox"/> <input type="checkbox"/>	<input type="checkbox"/> <input type="checkbox"/>	232.0#	
	36" Deep 36 x 65-1/4 x 29-1/4"	KAT40433666	CD	<input type="checkbox"/> <input type="checkbox"/> <input type="checkbox"/> <input type="checkbox"/>	<input type="checkbox"/> <input type="checkbox"/>	240.0#	
	36" Deep 36 x 71-1/2 x 29-1/4"	KAT40433672	CD	<input type="checkbox"/> <input type="checkbox"/> <input type="checkbox"/> <input type="checkbox"/>	<input type="checkbox"/> <input type="checkbox"/>	251.0#	
	36" Deep 36 x 83-1/2 x 29-1/4"	KAT40433684	CD	<input type="checkbox"/> <input type="checkbox"/> <input type="checkbox"/> <input type="checkbox"/>	<input type="checkbox"/> <input type="checkbox"/>	288.0#	
	36" Deep 36 x 87-1/2 x 29-1/4"	KAT40433688	CD	<input type="checkbox"/> <input type="checkbox"/> <input type="checkbox"/> <input type="checkbox"/>	<input type="checkbox"/> <input type="checkbox"/>	295.0#	
 <p>DTDK</p>	Mitered Rectangular Desk - Right with 3/4 Modesty Panel <ul style="list-style-type: none"> For use with mitered connecting top or mitered bridge 14-3/4" modesty panel 	30" Deep 30 x 59-1/4 x 29-1/4"	KAT40443060	CD	<input type="checkbox"/> <input type="checkbox"/> <input type="checkbox"/> <input type="checkbox"/>	<input type="checkbox"/> <input type="checkbox"/>	194.0#
	30" Deep 30 x 65-1/4 x 29-1/4"	KAT40443066	CD	<input type="checkbox"/> <input type="checkbox"/> <input type="checkbox"/> <input type="checkbox"/>	<input type="checkbox"/> <input type="checkbox"/>	210.0#	
	30" Deep 30 x 71-1/2 x 29-1/4"	KAT40443072	CD	<input type="checkbox"/> <input type="checkbox"/> <input type="checkbox"/> <input type="checkbox"/>	<input type="checkbox"/> <input type="checkbox"/>	222.0#	
	30" Deep 30 x 83-1/2 x 29-1/4"	KAT40443084	CD	<input type="checkbox"/> <input type="checkbox"/> <input type="checkbox"/> <input type="checkbox"/>	<input type="checkbox"/> <input type="checkbox"/>	234.0#	
	30" Deep 30 x 87-1/2 x 29-1/4"	KAT40443088	CD	<input type="checkbox"/> <input type="checkbox"/> <input type="checkbox"/> <input type="checkbox"/>	<input type="checkbox"/> <input type="checkbox"/>	245.0#	
	36" Deep 36 x 59-1/4 x 29-1/4"	KAT40443660	CD	<input type="checkbox"/> <input type="checkbox"/> <input type="checkbox"/> <input type="checkbox"/>	<input type="checkbox"/> <input type="checkbox"/>	232.0#	
	36" Deep 36 x 65-1/4 x 29-1/4"	KAT40443666	CD	<input type="checkbox"/> <input type="checkbox"/> <input type="checkbox"/> <input type="checkbox"/>	<input type="checkbox"/> <input type="checkbox"/>	240.0#	
	36" Deep 36 x 71-1/2 x 29-1/4"	KAT40443672	CD	<input type="checkbox"/> <input type="checkbox"/> <input type="checkbox"/> <input type="checkbox"/>	<input type="checkbox"/> <input type="checkbox"/>	251.0#	
	36" Deep 36 x 83-1/2 x 29-1/4"	KAT40443684	CD	<input type="checkbox"/> <input type="checkbox"/> <input type="checkbox"/> <input type="checkbox"/>	<input type="checkbox"/> <input type="checkbox"/>	288.0#	
	36" Deep 36 x 87-1/2 x 29-1/4"	KAT40443688	CD	<input type="checkbox"/> <input type="checkbox"/> <input type="checkbox"/> <input type="checkbox"/>	<input type="checkbox"/> <input type="checkbox"/>	295.0#	

A **B** **C** **D**

HOW TO ORDER

Indicate the following information on order form:

- Quantity of each item.
- Model number, including options. See "How To Build a Model Number".
- Any special service required.

Note: • The indicates that a choice is required.

- The absence of the indicates that no choice is required.
- Alpha-numeric characters in place of indicate that no other alternatives are available.

HOW TO BUILD A MODEL NUMBER

- A** Select basic model.
CD - Knife edge
- B** Select edge style.
CD - Knife edge
- C** Select wood finish color.
Refer to color addendum at ki.com or KI Fabrics & Finishes binder.
- D** Select grommet.
NA - No grommet
EG - Rectangular grommet
Grommets are factory installed.



Delivered
Pricing

\$ 2814
2968
3110
3406
3501
3178
3337
3501
3824
3939
\$ 2814
2968
3110
3406
3501
3178
3337
3501
3824
3939

SPECIAL SERVICES

Special Carton Marking

With specially marked information N/C

Shipping

Shipped **assembled freight prepaid f.o.b. Mexico City, MX 11000** factory. Freight class #125.

Specifications and prices are subject to change without prior notice.

Darwin®

Mitered Table Desks

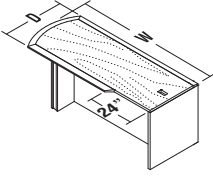
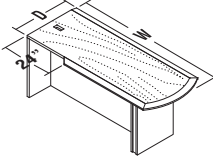
	MODEL	Features	D x W x H	MODEL NUMBER				Approx. Packaged Weight
				Basic Model	Edge Style	Wood Finish	Grommets	
 <p>DTDK</p>	Mitered Rectangular Desk - Left with Full Modesty Panel • For use with mitered connecting top or mitered bridge	30" Deep	30 x 59-1/4 x 29-1/4"	KAT40483060	CD	<input type="checkbox"/> <input type="checkbox"/> <input type="checkbox"/> <input type="checkbox"/>	<input type="checkbox"/>	194.0#
		30" Deep	30 x 65-1/4 x 29-1/4"	KAT40483066	CD	<input type="checkbox"/> <input type="checkbox"/> <input type="checkbox"/> <input type="checkbox"/>	<input type="checkbox"/>	210.0#
		30" Deep	30 x 71-1/2 x 29-1/4"	KAT40483072	CD	<input type="checkbox"/> <input type="checkbox"/> <input type="checkbox"/> <input type="checkbox"/>	<input type="checkbox"/>	222.0#
		30" Deep	30 x 83-1/2 x 29-1/4"	KAT40483084	CD	<input type="checkbox"/> <input type="checkbox"/> <input type="checkbox"/> <input type="checkbox"/>	<input type="checkbox"/>	234.0#
		30" Deep	30 x 87-1/2 x 29-1/4"	KAT40483088	CD	<input type="checkbox"/> <input type="checkbox"/> <input type="checkbox"/> <input type="checkbox"/>	<input type="checkbox"/>	245.0#
		36" Deep	36 x 59-1/4 x 29-1/4"	KAT40483660	CD	<input type="checkbox"/> <input type="checkbox"/> <input type="checkbox"/> <input type="checkbox"/>	<input type="checkbox"/>	232.0#
		36" Deep	36 x 65-1/4 x 29-1/4"	KAT40483666	CD	<input type="checkbox"/> <input type="checkbox"/> <input type="checkbox"/> <input type="checkbox"/>	<input type="checkbox"/>	240.0#
		36" Deep	36 x 71-1/2 x 29-1/4"	KAT40483672	CD	<input type="checkbox"/> <input type="checkbox"/> <input type="checkbox"/> <input type="checkbox"/>	<input type="checkbox"/>	251.0#
		36" Deep	36 x 83-1/2 x 29-1/4"	KAT40483684	CD	<input type="checkbox"/> <input type="checkbox"/> <input type="checkbox"/> <input type="checkbox"/>	<input type="checkbox"/>	288.0#
		36" Deep	36 x 87-1/2 x 29-1/4"	KAT40483688	CD	<input type="checkbox"/> <input type="checkbox"/> <input type="checkbox"/> <input type="checkbox"/>	<input type="checkbox"/>	295.0#
 <p>DTDK</p>	Mitered Rectangular Desk - Right with Full Modesty Panel • For use with mitered connecting top or mitered bridge	30" Deep	30 x 59-1/4 x 29-1/4"	KAT40493060	CD	<input type="checkbox"/> <input type="checkbox"/> <input type="checkbox"/> <input type="checkbox"/>	<input type="checkbox"/>	194.0#
		30" Deep	30 x 65-1/4 x 29-1/4"	KAT40493066	CD	<input type="checkbox"/> <input type="checkbox"/> <input type="checkbox"/> <input type="checkbox"/>	<input type="checkbox"/>	210.0#
		30" Deep	30 x 71-1/2 x 29-1/4"	KAT40493072	CD	<input type="checkbox"/> <input type="checkbox"/> <input type="checkbox"/> <input type="checkbox"/>	<input type="checkbox"/>	222.0#
		30" Deep	30 x 83-1/2 x 29-1/4"	KAT40493084	CD	<input type="checkbox"/> <input type="checkbox"/> <input type="checkbox"/> <input type="checkbox"/>	<input type="checkbox"/>	234.0#
		30" Deep	30 x 87-1/2 x 29-1/4"	KAT40493088	CD	<input type="checkbox"/> <input type="checkbox"/> <input type="checkbox"/> <input type="checkbox"/>	<input type="checkbox"/>	245.0#
		36" Deep	36 x 59-1/4 x 29-1/4"	KAT40493660	CD	<input type="checkbox"/> <input type="checkbox"/> <input type="checkbox"/> <input type="checkbox"/>	<input type="checkbox"/>	232.0#
		36" Deep	36 x 65-1/4 x 29-1/4"	KAT40493666	CD	<input type="checkbox"/> <input type="checkbox"/> <input type="checkbox"/> <input type="checkbox"/>	<input type="checkbox"/>	240.0#
		36" Deep	36 x 71-1/2 x 29-1/4"	KAT40493672	CD	<input type="checkbox"/> <input type="checkbox"/> <input type="checkbox"/> <input type="checkbox"/>	<input type="checkbox"/>	251.0#
		36" Deep	36 x 83-1/2 x 29-1/4"	KAT40493684	CD	<input type="checkbox"/> <input type="checkbox"/> <input type="checkbox"/> <input type="checkbox"/>	<input type="checkbox"/>	288.0#
		36" Deep	36 x 87-1/2 x 29-1/4"	KAT40493688	CD	<input type="checkbox"/> <input type="checkbox"/> <input type="checkbox"/> <input type="checkbox"/>	<input type="checkbox"/>	295.0#

A

B

C

D

HOW TO ORDER

Indicate the following information on order form:

- Quantity of each item.
- Model number, including options. See "How To Build a Model Number".
- Any special service required.

Note: • The indicates that a choice is required.

- The absence of the indicates that no choice is required.
- Alpha-numeric characters in place of indicate that no other alternatives are available.

HOW TO BUILD A MODEL NUMBER

A Select basic model.

B Select edge style.

CD - Knife edge

C Select wood finish color.

Refer to color addendum at ki.com or KI Fabrics & Finishes binder.

D Select grommet.

NA - No grommet

EG - Rectangular grommet

Grommets are factory installed.



Delivered
Pricing

\$ 3036
3214
3401
3751
3880
3401
3597
3786
4170
4306
\$ 3036
3214
3401
3751
3880
3401
3597
3786
4170
4306

SPECIAL SERVICES

Special Carton Marking

With specially marked information N/C

Shipping

Shipped **assembled freight prepaid f.o.b. Mexico City, MX 11000** factory. Freight class #125.

Specifications and prices are subject to change without prior notice.

Darwin®

Mitered Returns

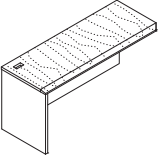
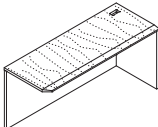
	MODEL	Features	D x W x H	MODEL NUMBER				Approx. Packaged Weight
				Basic Model	Edge Style	Wood Finish	Grommets	
	Mitered - Executive Return - Left • To be used with mitered desk • Accommodates 19" pedestal or 20" lateral	24" Deep	24 x 36 x 29-1/4"	KAT43032436	CD	<input type="checkbox"/> <input type="checkbox"/> <input type="checkbox"/> <input type="checkbox"/>	<input type="checkbox"/> <input type="checkbox"/>	91.0#
		24" Deep	24 x 42 x 29-1/4"	KAT43032442	CD	<input type="checkbox"/> <input type="checkbox"/> <input type="checkbox"/> <input type="checkbox"/>	<input type="checkbox"/> <input type="checkbox"/>	106.0#
		24" Deep	24 x 48 x 29-1/4"	KAT43032448	CD	<input type="checkbox"/> <input type="checkbox"/> <input type="checkbox"/> <input type="checkbox"/>	<input type="checkbox"/> <input type="checkbox"/>	121.0#
		24" Deep	24 x 60 x 29-1/4"	KAT43032460	CD	<input type="checkbox"/> <input type="checkbox"/> <input type="checkbox"/> <input type="checkbox"/>	<input type="checkbox"/> <input type="checkbox"/>	151.0#
		24" Deep	24 x 66 x 29-1/4"	KAT43032466	CD	<input type="checkbox"/> <input type="checkbox"/> <input type="checkbox"/> <input type="checkbox"/>	<input type="checkbox"/> <input type="checkbox"/>	164.0#
		24" Deep	24 x 72 x 29-1/4"	KAT43032472	CD	<input type="checkbox"/> <input type="checkbox"/> <input type="checkbox"/> <input type="checkbox"/>	<input type="checkbox"/> <input type="checkbox"/>	185.0#
DRET								
	Mitered - Executive Return - Right • To be used with mitered desk • Accommodates 19" pedestal or 20" lateral	24" Deep	24 x 36 x 29-1/4"	KAT43042436	CD	<input type="checkbox"/> <input type="checkbox"/> <input type="checkbox"/> <input type="checkbox"/>	<input type="checkbox"/> <input type="checkbox"/>	91.0#
		24" Deep	24 x 42 x 29-1/4"	KAT43042442	CD	<input type="checkbox"/> <input type="checkbox"/> <input type="checkbox"/> <input type="checkbox"/>	<input type="checkbox"/> <input type="checkbox"/>	106.0#
		24" Deep	24 x 48 x 29-1/4"	KAT43042448	CD	<input type="checkbox"/> <input type="checkbox"/> <input type="checkbox"/> <input type="checkbox"/>	<input type="checkbox"/> <input type="checkbox"/>	121.0#
		24" Deep	24 x 60 x 29-1/4"	KAT43042460	CD	<input type="checkbox"/> <input type="checkbox"/> <input type="checkbox"/> <input type="checkbox"/>	<input type="checkbox"/> <input type="checkbox"/>	151.0#
		24" Deep	24 x 66 x 29-1/4"	KAT43042466	CD	<input type="checkbox"/> <input type="checkbox"/> <input type="checkbox"/> <input type="checkbox"/>	<input type="checkbox"/> <input type="checkbox"/>	164.0#
		24" Deep	24 x 72 x 29-1/4"	KAT43042472	CD	<input type="checkbox"/> <input type="checkbox"/> <input type="checkbox"/> <input type="checkbox"/>	<input type="checkbox"/> <input type="checkbox"/>	185.0#
DRET								

A **B** **C** **D**

HOW TO ORDER

Indicate the following information on order form:

- Quantity of each item.
- Model number, including options. See "How To Build a Model Number".
- Any special service required.

Note: • The indicates that a choice is required.

- The absence of the indicates that no choice is required.
- Alpha-numeric characters in place of indicate that no other alternatives are available.

HOW TO BUILD A MODEL NUMBER

- A** Select basic model.
- B** Select edge style.
CD - Knife edge
- C** Select wood finish color.
 Refer to color addendum at ki.com or KI Fabrics & Finishes binder.
- D** Select grommet.
NA - No grommet
EG - Rectangular grommet
 Grommets are factory installed.



Delivered
Pricing

\$ 931
1050
1161
1395
1531
1636

\$ 931
1050
1161
1395
1531
1636

SPECIAL SERVICES

Special Carton Marking

With specially marked information N/C

Shipping

Shipped **assembled freight prepaid f.o.b. Mexico City, MX 11000** factory. Freight class #125.

Specifications and prices are subject to change without prior notice.

Darwin®

Mitered Bridges

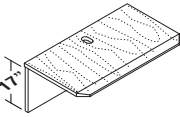
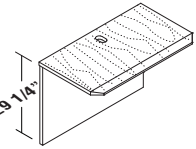
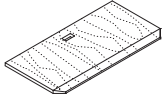
	MODEL	Features	D x W x H	MODEL NUMBER				Approx. Packaged Weight
				Basic Model	Edge Style	Wood Finish	Grommets	
 <p>DBDG</p>	Double Mitered Executive Bridge Unit - 3/4 Modesty Panel <ul style="list-style-type: none"> To be used with mitered desk and credenzas Accommodates 19" pedestal or 20" lateral Ships k.d. 	24" Deep	24 x 24 x 17"	KAT41112424	CD	<input type="checkbox"/> <input type="checkbox"/> <input type="checkbox"/> <input type="checkbox"/>	<input type="checkbox"/> <input type="checkbox"/>	49.0#
		24" Deep	24 x 30 x 17"	KAT41112430	CD	<input type="checkbox"/> <input type="checkbox"/> <input type="checkbox"/> <input type="checkbox"/>	<input type="checkbox"/> <input type="checkbox"/>	53.0#
		24" Deep	24 x 30 x 17"	KAT41112436	CD	<input type="checkbox"/> <input type="checkbox"/> <input type="checkbox"/> <input type="checkbox"/>	<input type="checkbox"/> <input type="checkbox"/>	71.0#
		24" Deep	24 x 42 x 17"	KAT41112442	CD	<input type="checkbox"/> <input type="checkbox"/> <input type="checkbox"/> <input type="checkbox"/>	<input type="checkbox"/> <input type="checkbox"/>	82.0#
		24" Deep	24 x 48 x 17"	KAT41112448	CD	<input type="checkbox"/> <input type="checkbox"/> <input type="checkbox"/> <input type="checkbox"/>	<input type="checkbox"/> <input type="checkbox"/>	101.0#
		24" Deep	24 x 60 x 17"	KAT41112460	CD	<input type="checkbox"/> <input type="checkbox"/> <input type="checkbox"/> <input type="checkbox"/>	<input type="checkbox"/> <input type="checkbox"/>	121.0#
		24" Deep	24 x 66 x 17"	KAT41112466	CD	<input type="checkbox"/> <input type="checkbox"/> <input type="checkbox"/> <input type="checkbox"/>	<input type="checkbox"/> <input type="checkbox"/>	134.0#
		24" Deep	24 x 72 x 17"	KAT41112472	CD	<input type="checkbox"/> <input type="checkbox"/> <input type="checkbox"/> <input type="checkbox"/>	<input type="checkbox"/> <input type="checkbox"/>	155.0#
 <p>DBDG</p>	Double Mitered Executive Bridge Unit - Full Modesty Panel <ul style="list-style-type: none"> To be used with mitered desk and credenzas Accommodates 19" pedestal or 20" lateral Ships k.d. 	24" Deep	24 x 24 x 29-1/4"	KAT41122424	CD	<input type="checkbox"/> <input type="checkbox"/> <input type="checkbox"/> <input type="checkbox"/>	<input type="checkbox"/> <input type="checkbox"/>	51.0#
		24" Deep	24 x 30 x 29-1/4"	KAT41122430	CD	<input type="checkbox"/> <input type="checkbox"/> <input type="checkbox"/> <input type="checkbox"/>	<input type="checkbox"/> <input type="checkbox"/>	62.0#
		24" Deep	24 x 36 x 29-1/4"	KAT41122436	CD	<input type="checkbox"/> <input type="checkbox"/> <input type="checkbox"/> <input type="checkbox"/>	<input type="checkbox"/> <input type="checkbox"/>	74.0#
		24" Deep	24 x 42 x 29-1/4"	KAT41122442	CD	<input type="checkbox"/> <input type="checkbox"/> <input type="checkbox"/> <input type="checkbox"/>	<input type="checkbox"/> <input type="checkbox"/>	86.0#
		24" Deep	24 x 48 x 29-1/4"	KAT41122448	CD	<input type="checkbox"/> <input type="checkbox"/> <input type="checkbox"/> <input type="checkbox"/>	<input type="checkbox"/> <input type="checkbox"/>	106.0#
		24" Deep	24 x 60 x 29-1/4"	KAT41122460	CD	<input type="checkbox"/> <input type="checkbox"/> <input type="checkbox"/> <input type="checkbox"/>	<input type="checkbox"/> <input type="checkbox"/>	125.0#
		24" Deep	24 x 66 x 29-1/4"	KAT41122466	CD	<input type="checkbox"/> <input type="checkbox"/> <input type="checkbox"/> <input type="checkbox"/>	<input type="checkbox"/> <input type="checkbox"/>	138.0#
		24" Deep	24 x 72 x 29-1/4"	KAT41122472	CD	<input type="checkbox"/> <input type="checkbox"/> <input type="checkbox"/> <input type="checkbox"/>	<input type="checkbox"/> <input type="checkbox"/>	160.0#
 <p>DBDG</p>	Double Mitered Connecting Top <ul style="list-style-type: none"> To be used with mitered desk and credenzas Accommodates 19" pedestal or 20" lateral 	24" Deep	24 x 24 x 1-1/4"	KAT41132424	CD	<input type="checkbox"/> <input type="checkbox"/> <input type="checkbox"/> <input type="checkbox"/>	<input type="checkbox"/> <input type="checkbox"/>	49.0#
		24" Deep	24 x 30 x 1-1/4"	KAT41132430	CD	<input type="checkbox"/> <input type="checkbox"/> <input type="checkbox"/> <input type="checkbox"/>	<input type="checkbox"/> <input type="checkbox"/>	53.0#
		24" Deep	24 x 36 x 1-1/4"	KAT41132436	CD	<input type="checkbox"/> <input type="checkbox"/> <input type="checkbox"/> <input type="checkbox"/>	<input type="checkbox"/> <input type="checkbox"/>	71.0#
		24" Deep	24 x 42 x 1-1/4"	KAT41132442	CD	<input type="checkbox"/> <input type="checkbox"/> <input type="checkbox"/> <input type="checkbox"/>	<input type="checkbox"/> <input type="checkbox"/>	82.0#
		24" Deep	24 x 48 x 1-1/4"	KAT41132448	CD	<input type="checkbox"/> <input type="checkbox"/> <input type="checkbox"/> <input type="checkbox"/>	<input type="checkbox"/> <input type="checkbox"/>	101.0#
		24" Deep	24 x 54 x 1-1/4"	KAT41132460	CD	<input type="checkbox"/> <input type="checkbox"/> <input type="checkbox"/> <input type="checkbox"/>	<input type="checkbox"/> <input type="checkbox"/>	121.0#
		24" Deep	24 x 60 x 1-1/4"	KAT41132466	CD	<input type="checkbox"/> <input type="checkbox"/> <input type="checkbox"/> <input type="checkbox"/>	<input type="checkbox"/> <input type="checkbox"/>	134.0#
		24" Deep	24 x 72 x 1-1/4"	KAT41132472	CD	<input type="checkbox"/> <input type="checkbox"/> <input type="checkbox"/> <input type="checkbox"/>	<input type="checkbox"/> <input type="checkbox"/>	155.0#

A **B** **C** **D**

HOW TO ORDER

Indicate the following information on order form:

- Quantity of each item.
- Model number, including options. See "How To Build a Model Number".
- Any special service required.

Note: • The indicates that a choice is required.

- The absence of the indicates that no choice is required.
- Alpha-numeric characters in place of indicate that no other alternatives are available.

HOW TO BUILD A MODEL NUMBER

- A** Select basic model.
B Select edge style.
CD - Knife edge
- C** Select wood finish color.
Refer to color addendum at ki.com or KI Fabrics & Finishes binder.
- D** Select grommet.
NA - No grommet
EG - Rectangular grommet
Grommets are factory installed.



Delivered
Pricing

\$ 519

613

681

777

877

1102

1200

1297

\$ 580

691

761

877

998

1240

1349

1464

\$ 408

480

549

607

683

839

907

981

SPECIAL SERVICES

Special Carton Marking

With specially marked information N/C

Shipping

Shipped **k.d. freight prepaid f.o.b. Mexico City, MX 11000** factory. Freight class #125.

Specifications and prices are subject to change without prior notice.

Darwin®

Mitered Credenzas

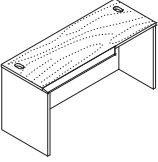
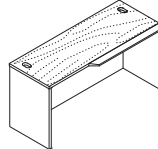
	MODEL	Features	D x W x H	MODEL NUMBER				Approx. Packaged Weight
				Basic Model	Edge Style	Wood Finish	Grommets	
 <p>DCRD</p>	Mitered Credenza Shell - Left • To be used with connecting bridge and connecting tops • Accommodates 19" pedestal or 20" lateral • Inside clearance is 4" less than nominal width (Ex.=72" is 68" inside)	24" Deep	24 x 46-3/4 x 29-1/4"	KAT45142448	CD	<input type="checkbox"/> <input type="checkbox"/> <input type="checkbox"/> <input type="checkbox"/>	<input type="checkbox"/> <input type="checkbox"/>	155.0#
		24" Deep	24 x 58-3/4 x 29-1/4"	KAT45142460	CD	<input type="checkbox"/> <input type="checkbox"/> <input type="checkbox"/> <input type="checkbox"/>	<input type="checkbox"/> <input type="checkbox"/>	170.0#
		24" Deep	24 x 64-3/4 x 29-1/4"	KAT45142466	CD	<input type="checkbox"/> <input type="checkbox"/> <input type="checkbox"/> <input type="checkbox"/>	<input type="checkbox"/> <input type="checkbox"/>	180.0#
		24" Deep	24 x 70-3/4 x 29-1/4"	KAT45142472	CD	<input type="checkbox"/> <input type="checkbox"/> <input type="checkbox"/> <input type="checkbox"/>	<input type="checkbox"/> <input type="checkbox"/>	190.0#
		24" Deep	24 x 82-3/4 x 29-1/4"	KAT45142484	CD	<input type="checkbox"/> <input type="checkbox"/> <input type="checkbox"/> <input type="checkbox"/>	<input type="checkbox"/> <input type="checkbox"/>	205.0#
		24" Deep	24 x 87 x 29-1/4"	KAT45142488	CD	<input type="checkbox"/> <input type="checkbox"/> <input type="checkbox"/> <input type="checkbox"/>	<input type="checkbox"/> <input type="checkbox"/>	230.0#
 <p>DCRD</p>	Mitered Credenza Shell - Right • To be used with connecting bridge and connecting tops • Accommodates 19" pedestal or 20" lateral • Inside clearance is 4" less than nominal width (Ex.=72" is 68" inside)	24" Deep	24 x 46-3/4 x 29-1/4"	KAT45152448	CD	<input type="checkbox"/> <input type="checkbox"/> <input type="checkbox"/> <input type="checkbox"/>	<input type="checkbox"/> <input type="checkbox"/>	155.0#
		24" Deep	24 x 58-3/4 x 29-1/4"	KAT45152460	CD	<input type="checkbox"/> <input type="checkbox"/> <input type="checkbox"/> <input type="checkbox"/>	<input type="checkbox"/> <input type="checkbox"/>	170.0#
		24" Deep	24 x 64-3/4 x 29-1/4"	KAT45152466	CD	<input type="checkbox"/> <input type="checkbox"/> <input type="checkbox"/> <input type="checkbox"/>	<input type="checkbox"/> <input type="checkbox"/>	180.0#
		24" Deep	24 x 70-3/4 x 29-1/4"	KAT45152472	CD	<input type="checkbox"/> <input type="checkbox"/> <input type="checkbox"/> <input type="checkbox"/>	<input type="checkbox"/> <input type="checkbox"/>	190.0#
		24" Deep	24 x 82-3/4 x 29-1/4"	KAT45152484	CD	<input type="checkbox"/> <input type="checkbox"/> <input type="checkbox"/> <input type="checkbox"/>	<input type="checkbox"/> <input type="checkbox"/>	205.0#
		24" Deep	24 x 87 x 29-1/4"	KAT45152488	CD	<input type="checkbox"/> <input type="checkbox"/> <input type="checkbox"/> <input type="checkbox"/>	<input type="checkbox"/> <input type="checkbox"/>	230.0#
				A	B	C	D	

HOW TO ORDER

Indicate the following information on order form:

- Quantity of each item.
- Model number, including options. See "How To Build a Model Number".
- Any special service required.

Note: • The indicates that a choice is required.

- The absence of the indicates that no choice is required.
- Alpha-numeric characters in place of indicate that no other alternatives are available.

HOW TO BUILD A MODEL NUMBER

- A** Select basic model.
- B** Select edge style.
CD - Knife edge
- C** Select wood finish color.
 Refer to color addendum at ki.com or KI Fabrics & Finishes binder.
- D** Select grommet.
NA - No grommet
EG - Rectangular grommet
 Grommets are factory installed.



Delivered
Pricing

\$ 1230
1418
1497
1614
1769
1972

\$ 1230
1418
1497
1614
1769
1972

SPECIAL SERVICES

Special Carton Marking

With specially marked information N/C

Shipping

Shipped **assembled freight prepaid f.o.b. Mexico City, MX 11000** factory. Freight class #125.

Specifications and prices are subject to change without prior notice.

Darwin®

Hutches

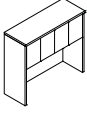
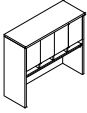
MODEL	Features	D x W x H	MODEL NUMBER				Approx. Packaged Weight
			Basic Model	Edge Style	Wood Finish	Lock Option	
 <p>DHTC</p> <p>Hutch Unit - Veneer Doors</p> <ul style="list-style-type: none"> • 24" clearance to bottom edge of doors 	No Lock	16-1/2 x 46-1/2 x 41-7/8"	KAT60011747	<input type="checkbox"/>	<input type="checkbox"/>		216.0#
	No Lock	16-1/2 x 58-1/2 x 41-7/8"	KAT60011759	<input type="checkbox"/>	<input type="checkbox"/>		254.0#
	No Lock	16-1/2 x 64-1/2 x 41-7/8"	KAT60011764	<input type="checkbox"/>	<input type="checkbox"/>		270.0#
	No Lock	16-1/2 x 70-1/2 x 41-7/8"	KAT60011771	<input type="checkbox"/>	<input type="checkbox"/>		297.0#
	No Lock	16-1/2 x 82-1/2 x 41-7/8"	KAT60011783	<input type="checkbox"/>	<input type="checkbox"/>		305.0#
	No Lock	16-1/2 x 86-3/4 x 41-7/8"	KAT60011787	<input type="checkbox"/>	<input type="checkbox"/>		342.0#
	No Lock	16-1/2 x 96 x 41-7/8"	KAT60011796	<input type="checkbox"/>	<input type="checkbox"/>		369.0#
	No Lock	16-1/2 x 102 x 41-7/8"	KAT600117102	<input type="checkbox"/>	<input type="checkbox"/>		410.0#
	No Lock	16-1/2 x 108 x 41-7/8"	KAT600117108	<input type="checkbox"/>	<input type="checkbox"/>		450.0#
	With Lock	16-1/2 x 46-1/2 x 41-7/8"	KAT60021747	<input type="checkbox"/>	<input type="checkbox"/>	<input type="checkbox"/>	216.0#
	With Lock	16-1/2 x 58-1/2 x 41-7/8"	KAT60021759	<input type="checkbox"/>	<input type="checkbox"/>	<input type="checkbox"/>	254.0#
	With Lock	16-1/2 x 64-1/2 x 41-7/8"	KAT60021764	<input type="checkbox"/>	<input type="checkbox"/>	<input type="checkbox"/>	270.0#
	With Lock	16-1/2 x 70-1/2 x 41-7/8"	KAT60021771	<input type="checkbox"/>	<input type="checkbox"/>	<input type="checkbox"/>	297.0#
	With Lock	16-1/2 x 82-1/2 x 41-7/8"	KAT60021783	<input type="checkbox"/>	<input type="checkbox"/>	<input type="checkbox"/>	305.0#
	With Lock	16-1/2 x 86-3/4 x 41-7/8"	KAT60021787	<input type="checkbox"/>	<input type="checkbox"/>	<input type="checkbox"/>	342.0#
	With Lock	16-1/2 x 96 x 41-7/8"	KAT60021796	<input type="checkbox"/>	<input type="checkbox"/>	<input type="checkbox"/>	369.0#
	With Lock	16-1/2 x 102 x 41-7/8"	KAT600217102	<input type="checkbox"/>	<input type="checkbox"/>	<input type="checkbox"/>	410.0#
	With Lock	16-1/2 x 108 x 41-7/8"	KAT600217108	<input type="checkbox"/>	<input type="checkbox"/>	<input type="checkbox"/>	450.0#
 <p>DHTC</p> <p>Hutch Unit with Pigeonholes - Veneer Doors</p> <ul style="list-style-type: none"> • 18" clearance to bottom of pigeon holes • Units do not feature center divider • Able to accept full-width task lights 	No Lock	16-1/2 x 46-1/2 x 41-7/8"	KAT60111747	<input type="checkbox"/>	<input type="checkbox"/>		216.0#
	No Lock	16-1/2 x 58-1/2 x 41-7/8"	KAT60111759	<input type="checkbox"/>	<input type="checkbox"/>		254.0#
	No Lock	16-1/2 x 64-1/2 x 41-7/8"	KAT60111764	<input type="checkbox"/>	<input type="checkbox"/>		270.0#
	No Lock	16-1/2 x 70-1/2 x 41-7/8"	KAT60111771	<input type="checkbox"/>	<input type="checkbox"/>		297.0#
	No Lock	16-1/2 x 82-1/2 x 41-7/8"	KAT60111783	<input type="checkbox"/>	<input type="checkbox"/>		305.0#
	No Lock	16-1/2 x 86-3/4 x 41-7/8"	KAT60111787	<input type="checkbox"/>	<input type="checkbox"/>		342.0#
	No Lock	16-1/2 x 96 x 41-7/8"	KAT60111796	<input type="checkbox"/>	<input type="checkbox"/>		369.0#
	No Lock	16-1/2 x 102 x 41-7/8"	KAT601117102	<input type="checkbox"/>	<input type="checkbox"/>		410.0#
	No Lock	16-1/2 x 108 x 41-7/8"	KAT601117108	<input type="checkbox"/>	<input type="checkbox"/>		450.0#
	With Lock	16-1/2 x 46-1/2 x 41-7/8"	KAT60121747	<input type="checkbox"/>	<input type="checkbox"/>	<input type="checkbox"/>	216.0#
	With Lock	16-1/2 x 58-1/2 x 41-7/8"	KAT60121759	<input type="checkbox"/>	<input type="checkbox"/>	<input type="checkbox"/>	254.0#
	With Lock	16-1/2 x 64-1/2 x 41-7/8"	KAT60121764	<input type="checkbox"/>	<input type="checkbox"/>	<input type="checkbox"/>	270.0#
	With Lock	16-1/2 x 70-1/2 x 41-7/8"	KAT60121771	<input type="checkbox"/>	<input type="checkbox"/>	<input type="checkbox"/>	297.0#
	With Lock	16-1/2 x 82-1/2 x 41-7/8"	KAT60121783	<input type="checkbox"/>	<input type="checkbox"/>	<input type="checkbox"/>	305.0#
	With Lock	16-1/2 x 86-3/4 x 41-7/8"	KAT60121787	<input type="checkbox"/>	<input type="checkbox"/>	<input type="checkbox"/>	342.0#
	With Lock	16-1/2 x 96 x 41-7/8"	KAT60121796	<input type="checkbox"/>	<input type="checkbox"/>	<input type="checkbox"/>	369.0#
	With Lock	16-1/2 x 102 x 41-7/8"	KAT601217102	<input type="checkbox"/>	<input type="checkbox"/>	<input type="checkbox"/>	410.0#
	With Lock	16-1/2 x 108 x 41-7/8"	KAT601217108	<input type="checkbox"/>	<input type="checkbox"/>	<input type="checkbox"/>	450.0#

A **B** **C** **D**

HOW TO ORDER

Indicate the following information on order form:

- Quantity of each item.
- Model number, including options. See "How To Build a Model Number".
- Any special service required.

Note: • The indicates that a choice is required.

- The absence of the indicates that no choice is required.
- Alpha-numeric characters in place of indicate that no other alternatives are available.

HOW TO BUILD A MODEL NUMBER

A Select basic model.

B Select edge style.

BO	- Quarter round edge
CR	- Reed edge
CV	- Cove edge
EB	- Square edge
PD	- Pyramid edge

C Select wood finish color.
Refer to color addendum at ki.com or KI Fabrics & Finishes binder.

D Select key option.

KS	- Key standard
KA	- Key alike

INFORMATION

Hutch Size	Tackboard Size
46-1/2" wide	44" wide
58-1/2" wide	56" wide
64-1/2" wide	62" wide (2 tackboards)
70-1/2" wide	68" wide (2 tackboards)
82-1/2" wide	80" wide (2 tackboards)
86-3/4" wide	84" wide (2 tackboards)
96" wide*	94" wide (2 tackboards)
102" wide*	99" wide (2 tackboards)
108" wide*	106" wide (2 tackboards)

*Hutches larger than 88" are for use with a combination of two desks



Delivered
Pricing

- \$ 2232
- 2797
- 3021
- 3168
- 3768
- 3799
- 4187
- 4374
- 4562
- 2484
- 3048
- 3236
- 3419
- 4083
- 4176
- 4507
- 4693
- 4880

- \$ 3064
- 3507
- 3658
- 3889
- 4611
- 4729
- 5118
- 5347
- 5576
- 3317
- 3757
- 3881
- 4125
- 4955
- 5106
- 5460
- 5690
- 5918

SPECIAL SERVICES

Special Carton Marking

With specially marked information N/C

Shipping

Shipped **assembled freight prepaid f.o.b. Mexico City, MX 11000** factory. Freight class #125.

Specifications and prices are subject to change without prior notice.

Darwin®

Hutches

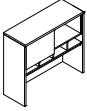
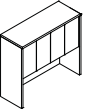
	MODEL	Features	D x W x H	MODEL NUMBER				Approx. Packaged Weight
				Basic Model	Edge Style	Wood Finish	Lock Option	
 DHTC	Hutch Unit - Sliding Wood Door - Pigeonholes • 18-1/8" clearance to bottom of pigeonholes • Units do not feature center divider • Able to accept full-width task lights	No Lock	16-1/2 x 58-1/2 x 41-7/8"	KAT60151759	<input type="checkbox"/>	<input type="checkbox"/>	<input type="checkbox"/>	254.0#
		No Lock	16-1/2 x 64-1/2 x 41-7/8"	KAT60151764	<input type="checkbox"/>	<input type="checkbox"/>	<input type="checkbox"/>	270.0#
		No Lock	16-1/2 x 70-1/2 x 41-7/8"	KAT60151771	<input type="checkbox"/>	<input type="checkbox"/>	<input type="checkbox"/>	297.0#
		No Lock	16-1/2 x 82-1/2 x 41-7/8"	KAT60151783	<input type="checkbox"/>	<input type="checkbox"/>	<input type="checkbox"/>	305.0#
		No Lock	16-1/2 x 86-3/4 x 41-7/8"	KAT60151787	<input type="checkbox"/>	<input type="checkbox"/>	<input type="checkbox"/>	342.0#
		No Lock	16-1/2 x 96 x 41-7/8"	KAT60151796	<input type="checkbox"/>	<input type="checkbox"/>	<input type="checkbox"/>	369.0#
		No Lock	16-1/2 x 102 x 41-7/8"	KAT601517102	<input type="checkbox"/>	<input type="checkbox"/>	<input type="checkbox"/>	410.0#
		No Lock	16-1/2 x 108 x 41-7/8"	KAT601517108	<input type="checkbox"/>	<input type="checkbox"/>	<input type="checkbox"/>	450.0#
 DHTC	Hutch Unit with Rectangular Veneer Doors - Concealed Pigeonholes • 18-1/8" clearance to bottom of pigeonholes • Units do not feature center divider • Able to accept full-width task lights	No Lock	16-1/2 x 46-1/2 x 41-7/8"	KAT60171747	<input type="checkbox"/>	<input type="checkbox"/>	<input type="checkbox"/>	216.0#
		No Lock	16-1/2 x 58-1/2 x 41-7/8"	KAT60171759	<input type="checkbox"/>	<input type="checkbox"/>	<input type="checkbox"/>	254.0#
		No Lock	16-1/2 x 64-1/2 x 41-7/8"	KAT60171764	<input type="checkbox"/>	<input type="checkbox"/>	<input type="checkbox"/>	270.0#
		No Lock	16-1/2 x 70-1/2 x 41-7/8"	KAT60171771	<input type="checkbox"/>	<input type="checkbox"/>	<input type="checkbox"/>	297.0#
		No Lock	16-1/2 x 82-1/2 x 41-7/8"	KAT60171783	<input type="checkbox"/>	<input type="checkbox"/>	<input type="checkbox"/>	305.0#
		No Lock	16-1/2 x 86-3/4 x 41-7/8"	KAT60171787	<input type="checkbox"/>	<input type="checkbox"/>	<input type="checkbox"/>	342.0#
		No Lock	16-1/2 x 96 x 41-7/8"	KAT60171796	<input type="checkbox"/>	<input type="checkbox"/>	<input type="checkbox"/>	369.0#
		No Lock	16-1/2 x 102 x 41-7/8"	KAT601717102	<input type="checkbox"/>	<input type="checkbox"/>	<input type="checkbox"/>	410.0#
		No Lock	16-1/2 x 108 x 41-7/8"	KAT601717108	<input type="checkbox"/>	<input type="checkbox"/>	<input type="checkbox"/>	450.0#
		With Lock	16-1/2 x 46-1/2 x 41-7/8"	KAT60181747	<input type="checkbox"/>	<input type="checkbox"/>	<input type="checkbox"/>	216.0#
		With Lock	16-1/2 x 58-1/2 x 41-7/8"	KAT60181759	<input type="checkbox"/>	<input type="checkbox"/>	<input type="checkbox"/>	254.0#
		With Lock	16-1/2 x 64-1/2 x 41-7/8"	KAT60181764	<input type="checkbox"/>	<input type="checkbox"/>	<input type="checkbox"/>	270.0#
		With Lock	16-1/2 x 70-1/2 x 41-7/8"	KAT60181771	<input type="checkbox"/>	<input type="checkbox"/>	<input type="checkbox"/>	297.0#
		With Lock	16-1/2 x 82-1/2 x 41-7/8"	KAT60181783	<input type="checkbox"/>	<input type="checkbox"/>	<input type="checkbox"/>	305.0#
		With Lock	16-1/2 x 86-3/4 x 41-7/8"	KAT60181787	<input type="checkbox"/>	<input type="checkbox"/>	<input type="checkbox"/>	342.0#
		With Lock	16-1/2 x 96 x 41-7/8"	KAT60181796	<input type="checkbox"/>	<input type="checkbox"/>	<input type="checkbox"/>	369.0#
		With Lock	16-1/2 x 102 x 41-7/8"	KAT601817102	<input type="checkbox"/>	<input type="checkbox"/>	<input type="checkbox"/>	410.0#
		With Lock	16-1/2 x 108 x 41-7/8"	KAT601817108	<input type="checkbox"/>	<input type="checkbox"/>	<input type="checkbox"/>	450.0#

A

B

C

D

HOW TO ORDER

Indicate the following information on order form:

- Quantity of each item.
- Model number, including options. See "How To Build a Model Number".
- Any special service required.

Note: • The indicates that a choice is required.

- The absence of the indicates that no choice is required.
- Alpha-numeric characters in place of indicate that no other alternatives are available.

HOW TO BUILD A MODEL NUMBER

A Select basic model.

B Select edge style.

BO	- Quarter round edge
CR	- Reed edge
CV	- Cove edge
EB	- Square edge
PD	- Pyramid edge

C Select wood finish color.
Refer to color addendum at ki.com or KI Fabrics & Finishes binder.

D Select key option.

KS	- Key standard
KA	- Key alike

INFORMATION

Hutch Size	Tackboard Size
46-1/2" wide	44" wide
58-1/2" wide	56" wide
64-1/2" wide	62" wide (2 tackboards)
70-1/2" wide	68" wide (2 tackboards)
82-1/2" wide	80" wide (2 tackboards)
86-3/4" wide	84" wide (2 tackboards)
96" wide*	94" wide (2 tackboards)
102" wide*	99" wide (2 tackboards)
108" wide*	106" wide (2 tackboards)

*Hutches larger than 88" are for use with a combination of two desks



Delivered
Pricing

\$ 3624
3842
4071
5129
5288
5645
5874
6113
\$ 3086
3544
3781
4016
4784
4951
5294
5531
5769
3315
3773
4009
4244
5129
5294
5635
5874
6113

SPECIAL SERVICES

Special Carton Marking

With specially marked information N/C



Shipping

Shipped **assembled freight prepaid f.o.b. Mexico City, MX 11000** factory. Freight class #125.

Specifications and prices are subject to change without prior notice.

Darwin®

Storage Units

	MODEL	Features	H x W x D	MODEL NUMBER				Approx. Packaged Weight
				Basic Model	Edge Style	Wood Finish	Lock Option	
 DWST	Wall Mount Storage Unit - Veneer Doors	No Lock	16 x 24 x 16-1/2"	KAT65011624	<input type="checkbox"/>	<input type="checkbox"/>	<input type="checkbox"/>	45.0#
		No Lock	16 x 30 x 16-1/2"	KAT65011630	<input type="checkbox"/>	<input type="checkbox"/>	<input type="checkbox"/>	52.0#
		No Lock	16 x 36 x 16-1/2"	KAT65011636	<input type="checkbox"/>	<input type="checkbox"/>	<input type="checkbox"/>	60.0#
		No Lock	16 x 42 x 16-1/2"	KAT65011642	<input type="checkbox"/>	<input type="checkbox"/>	<input type="checkbox"/>	68.0#
		No Lock	16 x 48 x 16-1/2"	KAT65011648	<input type="checkbox"/>	<input type="checkbox"/>	<input type="checkbox"/>	77.0#
		With Lock	16 x 24 x 16-1/2"	KAT65021624	<input type="checkbox"/>	<input type="checkbox"/>	<input type="checkbox"/>	45.0#
		With Lock	16 x 30 x 16-1/2"	KAT65021630	<input type="checkbox"/>	<input type="checkbox"/>	<input type="checkbox"/>	52.0#
		With Lock	16 x 36 x 16-1/2"	KAT65021636	<input type="checkbox"/>	<input type="checkbox"/>	<input type="checkbox"/>	60.0#
		With Lock	16 x 42 x 16-1/2"	KAT65021642	<input type="checkbox"/>	<input type="checkbox"/>	<input type="checkbox"/>	68.0#
		With Lock	16 x 48 x 16-1/2"	KAT65021648	<input type="checkbox"/>	<input type="checkbox"/>	<input type="checkbox"/>	77.0#
 DWST	Wall Mount Storage Unit - Concealed Pigeonholes - Veneer Doors	No Lock	24 x 24 x 16-1/2"	KAT65112424	<input type="checkbox"/>	<input type="checkbox"/>	<input type="checkbox"/>	45.0#
		No Lock	24 x 30 x 16-1/2"	KAT65112430	<input type="checkbox"/>	<input type="checkbox"/>	<input type="checkbox"/>	52.0#
		No Lock	24 x 36 x 16-1/2"	KAT65112436	<input type="checkbox"/>	<input type="checkbox"/>	<input type="checkbox"/>	60.0#
		No Lock	24 x 42 x 16-1/2"	KAT65112442	<input type="checkbox"/>	<input type="checkbox"/>	<input type="checkbox"/>	68.0#
		No Lock	24 x 48 x 16-1/2"	KAT65112448	<input type="checkbox"/>	<input type="checkbox"/>	<input type="checkbox"/>	77.0#
		With Lock	24 x 24 x 16-1/2"	KAT65122424	<input type="checkbox"/>	<input type="checkbox"/>	<input type="checkbox"/>	45.0#
		With Lock	24 x 30 x 16-1/2"	KAT65122430	<input type="checkbox"/>	<input type="checkbox"/>	<input type="checkbox"/>	52.0#
		With Lock	24 x 36 x 16-1/2"	KAT65122436	<input type="checkbox"/>	<input type="checkbox"/>	<input type="checkbox"/>	60.0#
		With Lock	24 x 42 x 16-1/2"	KAT65122442	<input type="checkbox"/>	<input type="checkbox"/>	<input type="checkbox"/>	68.0#
		With Lock	24 x 48 x 16-1/2"	KAT65122448	<input type="checkbox"/>	<input type="checkbox"/>	<input type="checkbox"/>	77.0#

A

B

C

D

HOW TO ORDER

Indicate the following information on order form:

- Quantity of each item.
- Model number, including options. See "How To Build a Model Number".
- Any special service required.

Note: • The indicates that a choice is required.

- The absence of the indicates that no choice is required.
- Alpha-numeric characters in place of indicate that no other alternatives are available.

HOW TO BUILD A MODEL NUMBER

A Select basic model.

B Select edge style.

BO - Quarter round edge

CR - Reed edge

CV - Cove edge

EB - Square edge

PD - Pyramid edge

C Select wood finish color.
Refer to color addendum at ki.com or KI Fabrics & Finishes binder.

D Select key option.

KS - Key standard

KA - Key alike



Delivered
Pricing

\$ 955
1090
1309
1387
1436
1054
1311
1436
1513
1540
\$ 1189
1273
1547
1710
2113
1281
1367
1639
1805
2208

SPECIAL SERVICES

Special Carton Marking

With specially marked information N/C



Shipping

Shipped **assembled freight prepaid f.o.b. Mexico City, MX 11000** factory. Freight class #125.

Specifications and prices are subject to change without prior notice.

Darwin®

Storage Units

	MODEL	H x W x D	MODEL NUMBER			Approx. Packaged Weight
			Basic Model	Edge Style	Wood Finish	
 DWST	Wall Mount Storage Unit - No Doors	16 x 24 x 16-1/2"	KAT65211624	<input type="checkbox"/>	<input type="checkbox"/>	60.0#
		16 x 30 x 16-1/2"	KAT65211630	<input type="checkbox"/>	<input type="checkbox"/>	68.0#
		16 x 36 x 16-1/2"	KAT65211636	<input type="checkbox"/>	<input type="checkbox"/>	77.0#
		16 x 42 x 16-1/2"	KAT65211642	<input type="checkbox"/>	<input type="checkbox"/>	80.0#
		16 x 48 x 16-1/2"	KAT65211648	<input type="checkbox"/>	<input type="checkbox"/>	84.0#
 DWST	Wall Mount Storage Unit - Pigeonholes - No Doors	24 x 24 x 16-1/2"	KAT65222424	<input type="checkbox"/>	<input type="checkbox"/>	60.0#
		24 x 30 x 16-1/2"	KAT65222430	<input type="checkbox"/>	<input type="checkbox"/>	68.0#
		24 x 36 x 16-1/2"	KAT65222436	<input type="checkbox"/>	<input type="checkbox"/>	77.0#
		24 x 42 x 16-1/2"	KAT65222442	<input type="checkbox"/>	<input type="checkbox"/>	80.0#
		24 x 48 x 16-1/2"	KAT65222448	<input type="checkbox"/>	<input type="checkbox"/>	84.0#

A

B

C

HOW TO ORDER

Indicate the following information on order form:

- Quantity of each item.
- Model number, including options. See "How To Build a Model Number".
- Any special service required.

Note: • The indicates that a choice is required.

- The absence of the indicates that no choice is required.
- Alpha-numeric characters in place of indicate that no other alternatives are available.

HOW TO BUILD A MODEL NUMBER

A Select basic model.

B Select edge style.

BO - Quarter round edge

CR - Reed edge

CV - Cove edge

EB - Square edge

PD - Pyramid edge

C Select wood finish color.
Refer to color addendum at ki.com or KI Fabrics & Finishes binder.



Delivered
Pricing

\$ 724
825
945
1044
1207
\$ 939
1068
1230
1351
1614

SPECIAL SERVICES

Special Carton Marking

With specially marked information N/C

Shipping

Shipped **assembled freight prepaid f.o.b. Mexico City, MX 11000** factory. Freight class #125.

Specifications and prices are subject to change without prior notice.

Darwin®

Storage Units

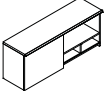
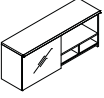
	MODEL	Features	H x W x D	MODEL NUMBER			Approx. Packaged Weight
				Basic Model	Edge Style	Wood Finish	
 DWST	Wall Mount Storage Unit - Pigeonholes - Sliding Veneer Doors	No Lock	24 x 36 x 16-1/2"	KAT65152436	<input type="checkbox"/>	<input type="checkbox"/> <input type="checkbox"/> <input type="checkbox"/> <input type="checkbox"/>	77.0#
		No Lock	24 x 42 x 16-1/2"	KAT65152442	<input type="checkbox"/>	<input type="checkbox"/> <input type="checkbox"/> <input type="checkbox"/> <input type="checkbox"/>	80.0#
		No Lock	24 x 48 x 16-1/2"	KAT65152448	<input type="checkbox"/>	<input type="checkbox"/> <input type="checkbox"/> <input type="checkbox"/> <input type="checkbox"/>	84.0#
		No Lock	24 x 60 x 16-1/2"	KAT65152460	<input type="checkbox"/>	<input type="checkbox"/> <input type="checkbox"/> <input type="checkbox"/> <input type="checkbox"/>	87.0#
		No Lock	24 x 66 x 16-1/2"	KAT65152466	<input type="checkbox"/>	<input type="checkbox"/> <input type="checkbox"/> <input type="checkbox"/> <input type="checkbox"/>	89.0#
		No Lock	24 x 72 x 16-1/2"	KAT65152472	<input type="checkbox"/>	<input type="checkbox"/> <input type="checkbox"/> <input type="checkbox"/> <input type="checkbox"/>	90.0#
 DWST	Wall Mount Storage Unit - Pigeonholes - Sliding Wood Door with White Overlaid Glass	No Lock	24 x 36 x 16-1/2"	KAT65162436	<input type="checkbox"/>	<input type="checkbox"/> <input type="checkbox"/> <input type="checkbox"/> <input type="checkbox"/>	77.0#
		No Lock	24 x 42 x 16-1/2"	KAT65162442	<input type="checkbox"/>	<input type="checkbox"/> <input type="checkbox"/> <input type="checkbox"/> <input type="checkbox"/>	80.0#
		No Lock	24 x 48 x 16-1/2"	KAT65162448	<input type="checkbox"/>	<input type="checkbox"/> <input type="checkbox"/> <input type="checkbox"/> <input type="checkbox"/>	84.0#
		No Lock	24 x 60 x 16-1/2"	KAT65162460	<input type="checkbox"/>	<input type="checkbox"/> <input type="checkbox"/> <input type="checkbox"/> <input type="checkbox"/>	87.0#
		No Lock	24 x 66 x 16-1/2"	KAT65162466	<input type="checkbox"/>	<input type="checkbox"/> <input type="checkbox"/> <input type="checkbox"/> <input type="checkbox"/>	89.0#
		No Lock	24 x 72 x 16-1/2"	KAT65162472	<input type="checkbox"/>	<input type="checkbox"/> <input type="checkbox"/> <input type="checkbox"/> <input type="checkbox"/>	90.0#

A **B** **C**

HOW TO ORDER

Indicate the following information on order form:

- Quantity of each item.
- Model number, including options. See "How To Build a Model Number".
- Any special service required.

Note: • The indicates that a choice is required.

- The absence of the indicates that no choice is required.
- Alpha-numeric characters in place of indicate that no other alternatives are available.

HOW TO BUILD A MODEL NUMBER

A Select basic model.

B Select edge style.

BO - Quarter round edge

CR - Reed edge

CV - Cove edge

EB - Square edge

PD - Pyramid edge

C Select wood finish color. Refer to color addendum at ki.com or KI Fabrics & Finishes binder.



Delivered
Pricing

\$ 1586
1769
2039
2272
2391
2836
\$ 1888
2048
2314
2699
2797
3102

SPECIAL SERVICES

Special Carton Marking

With specially marked information N/C



Shipping

Shipped **assembled freight prepaid f.o.b. Mexico City, MX 11000** factory. Freight class #125.

Specifications and prices are subject to change without prior notice.

Darwin®

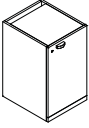
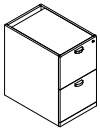
Sub-Surface Storage

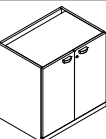
	MODEL	Features	D x W x H	MODEL NUMBER				Approx. Packaged Weight
				Basic Model	Pull Option	Wood Finish	Lock Option	
	Storage Unit with Door - Left and Right <ul style="list-style-type: none"> Lock included Unfinished top, no edge Units slide under shells but are not attached 	Left	19-3/4 x 17 x 28"	KAT70012017	<input type="checkbox"/>	<input type="checkbox"/> <input type="checkbox"/> <input type="checkbox"/> <input type="checkbox"/>	<input type="checkbox"/>	89.0#
		Right	19-3/4 x 17 x 28"	KAT70022017	<input type="checkbox"/>	<input type="checkbox"/> <input type="checkbox"/> <input type="checkbox"/> <input type="checkbox"/>	<input type="checkbox"/>	89.0#
DSST								
	File Pedestal <ul style="list-style-type: none"> Two file drawers Lock included Unfinished top, no edge Ships with legal filing bars standard on 26" depth models Units slide under shells but are not attached 		19-3/4 x 17 x 28"	KAT70072017	<input type="checkbox"/>	<input type="checkbox"/> <input type="checkbox"/> <input type="checkbox"/> <input type="checkbox"/>	<input type="checkbox"/>	89.0#
			25-3/4 x 17 x 28"	KAT70072617	<input type="checkbox"/>	<input type="checkbox"/> <input type="checkbox"/> <input type="checkbox"/> <input type="checkbox"/>	<input type="checkbox"/>	93.0#
DSST								
	Box/Box/File Pedestal <ul style="list-style-type: none"> Two box and one file drawer Lock included Unfinished top, no edge Ships with legal filing bars standard on 26" depth models Units slide under shells but are not attached 		19-3/4 x 17 x 28"	KAT70082017	<input type="checkbox"/>	<input type="checkbox"/> <input type="checkbox"/> <input type="checkbox"/> <input type="checkbox"/>	<input type="checkbox"/>	89.0#
			25-3/4 x 17 x 28"	KAT70082617	<input type="checkbox"/>	<input type="checkbox"/> <input type="checkbox"/> <input type="checkbox"/> <input type="checkbox"/>	<input type="checkbox"/>	93.0#
DSST								
	Bookcase Unit <ul style="list-style-type: none"> One adjustable shelf Unfinished top, no edge Units slide under shells but are not attached 	No Lock	19-3/4 x 28 x 28"	KAT70112028	<input type="checkbox"/>	<input type="checkbox"/> <input type="checkbox"/> <input type="checkbox"/> <input type="checkbox"/>		124.0#
		No Lock	19-3/4 x 34 x 28"	KAT70112034	<input type="checkbox"/>	<input type="checkbox"/> <input type="checkbox"/> <input type="checkbox"/> <input type="checkbox"/>		145.0#
		With Lock	19-3/4 x 28 x 28"	KAT70122028	<input type="checkbox"/>	<input type="checkbox"/> <input type="checkbox"/> <input type="checkbox"/> <input type="checkbox"/>	<input type="checkbox"/>	124.0#
		With Lock	19-3/4 x 34 x 28"	KAT70122034	<input type="checkbox"/>	<input type="checkbox"/> <input type="checkbox"/> <input type="checkbox"/> <input type="checkbox"/>	<input type="checkbox"/>	145.0#
DSST								

A **B** **C** **D**

HOW TO ORDER

Indicate the following information on order form:

- Quantity of each item.
- Model number, including options. See "How To Build a Model Number".
- Any special service required.

Note: • The indicates that a choice is required.

- The absence of the indicates that no choice is required.
- Alpha-numeric characters in place of indicate that no other alternatives are available.

HOW TO BUILD A MODEL NUMBER

A Select basic model.

B Select pull option.

6	- Metal pull - black
7	- Metal pull - satin
8	- Metal pull - chrome
0	- Curved pull - black
4	- Curved pull - champagne
11	- Arc pull - satin
12	- Arc pull - black
13	- Arc pull - chrome
21	- Straight pull - chrome
22	- Straight pull - black
41	- Corinto pull - black
42	- Corinto pull - satin
45	- Flat pull - satin

C Select wood finish color.

Refer to color addendum at ki.com or KI Fabrics & Finishes binder.

D Select key option.

KS	- Key standard
KA	- Key alike



Delivered
Pricing

\$ 728

728

\$ 1028

1077

\$ 1186

1196

\$ 1051

1132

1177

1258

SPECIAL SERVICES

Special Carton Marking

With specially marked information N/C

Shipping

Shipped **assembled freight prepaid f.o.b. Mexico City, MX 11000** factory. Freight class #125.

Specifications and prices are subject to change without prior notice.

Darwin®

Sub-Surface Storage

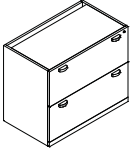
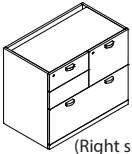
	MODEL	Features	D x W x H	MODEL NUMBER				Approx. Packaged Weight
				Basic Model	Pull Option	Wood Finish	Lock Option	
 DSST	Lateral File	<ul style="list-style-type: none"> Two drawers Lock included Unfinished top, no edge File bars for lateral files are front-to-back as standard/see Accessories section for side-to-side hanging bars Units slide under shells but are not attached 	19-3/4 x 28 x 28"	KAT70132028	<input type="checkbox"/> <input type="checkbox"/>	<input type="checkbox"/> <input type="checkbox"/> <input type="checkbox"/> <input type="checkbox"/>	<input type="checkbox"/> <input type="checkbox"/>	124.0#
			19-3/4 x 34 x 28"	KAT70132034	<input type="checkbox"/> <input type="checkbox"/>	<input type="checkbox"/> <input type="checkbox"/> <input type="checkbox"/> <input type="checkbox"/>	<input type="checkbox"/> <input type="checkbox"/>	145.0#
 (Right shown) DSST	Multifile - Left and Right	<ul style="list-style-type: none"> Two box drawers, one file drawer One lateral file Lock included Unfinished top, no edge File bars for lateral files are front-to-back as standard/see Accessories section for side-to-side hanging bars Units slide under shells but are not attached 	Left 19-3/4 x 34 x 28"	KAT70142034	<input type="checkbox"/> <input type="checkbox"/>	<input type="checkbox"/> <input type="checkbox"/> <input type="checkbox"/> <input type="checkbox"/>	<input type="checkbox"/> <input type="checkbox"/>	145.0#
			Right 19-3/4 x 34 x 28"	KAT70152034	<input type="checkbox"/> <input type="checkbox"/>	<input type="checkbox"/> <input type="checkbox"/> <input type="checkbox"/> <input type="checkbox"/>	<input type="checkbox"/> <input type="checkbox"/>	145.0#
				A	B	C	D	

HOW TO ORDER

Indicate the following information on order form:

- Quantity of each item.
- Model number, including options. See "How To Build a Model Number".
- Any special service required.

Note: • The indicates that a choice is required.

- The absence of the indicates that no choice is required.
- Alpha-numeric characters in place of indicate that no other alternatives are available.

HOW TO BUILD A MODEL NUMBER

A Select basic model.

B Select pull option.

6	- Metal pull - black
7	- Metal pull - satin
8	- Metal pull - chrome
0	- Curved pull - black
4	- Curved pull - champagne
11	- Arc pull - satin
12	- Arc pull - black
13	- Arc pull - chrome
21	- Straight pull - chrome
22	- Straight pull - black
41	- Corinto pull - black
42	- Corinto pull - satin
45	- Flat pull - satin

C Select wood finish color.

Refer to color addendum at ki.com or KI Fabrics & Finishes binder.

D Select key option.

KS	- Key standard
KA	- Key alike



Delivered
Pricing

\$ 1516

1625

\$ 2884

2884

SPECIAL SERVICES

Special Carton Marking

With specially marked information N/C



Shipping

Shipped **assembled freight prepaid f.o.b. Mexico City, MX 11000** factory. Freight class #125.

Specifications and prices are subject to change without prior notice.

Darwin®

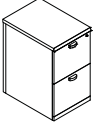
Freestanding and Mobile Pedestals with Tops

	MODEL	Features	D x W x H	MODEL NUMBER				
				Basic Model	Edge Style	Wood Finish	Pull Option	Lock Option
 DSST	File/File Pedestal • Lock included	Lock Included	24 x 17 x 29-1/4"	KAT70052417	<input type="checkbox"/>	<input type="checkbox"/>	<input type="checkbox"/>	<input type="checkbox"/>
					<input type="checkbox"/>	<input type="checkbox"/>	<input type="checkbox"/>	<input type="checkbox"/>
					<input type="checkbox"/>	<input type="checkbox"/>	<input type="checkbox"/>	<input type="checkbox"/>
					<input type="checkbox"/>	<input type="checkbox"/>	<input type="checkbox"/>	<input type="checkbox"/>
 DSST	Box/Box/File Pedestal • Lock included	Lock Included	24 x 17 x 29-1/4"	KAT70062417	<input type="checkbox"/>	<input type="checkbox"/>	<input type="checkbox"/>	<input type="checkbox"/>
					<input type="checkbox"/>	<input type="checkbox"/>	<input type="checkbox"/>	<input type="checkbox"/>
					<input type="checkbox"/>	<input type="checkbox"/>	<input type="checkbox"/>	<input type="checkbox"/>
					<input type="checkbox"/>	<input type="checkbox"/>	<input type="checkbox"/>	<input type="checkbox"/>
 DSST	Box/File Mobile Pedestal • Lock included	Lock Included	19-3/4 x 17 x 25-1/2"	KAT70261719	<input type="checkbox"/>	<input type="checkbox"/>	<input type="checkbox"/>	<input type="checkbox"/>
					<input type="checkbox"/>	<input type="checkbox"/>	<input type="checkbox"/>	<input type="checkbox"/>
					<input type="checkbox"/>	<input type="checkbox"/>	<input type="checkbox"/>	<input type="checkbox"/>
					<input type="checkbox"/>	<input type="checkbox"/>	<input type="checkbox"/>	<input type="checkbox"/>

A **B** **C** **D** **E**

HOW TO ORDER

Indicate the following information on order form:

- Quantity of each item.
- Model number, including options. See "How To Build a Model Number".
- Any special service required.

Note: • The indicates that a choice is required.

- The absence of the indicates that no choice is required.
- Alpha-numeric characters in place of indicate that no other alternatives are available.

HOW TO BUILD A MODEL NUMBER

A Select basic model.

B Select edge style.

- | | |
|-----------|----------------------|
| BO | - Quarter round edge |
| CD | - Knife edge |
| CR | - Reed edge |
| CV | - Cove edge |
| EB | - Square edge |
| PD | - Pyramid edge |

C Select wood finish color.

Refer to color addendum at ki.com or KI Fabrics & Finishes binder.

D Select pull option.

- | | |
|-----------|---------------------------|
| 6 | - Metal pull - black |
| 7 | - Metal pull - satin |
| 8 | - Metal pull - chrome |
| 0 | - Curved pull - black |
| 4 | - Curved pull - champagne |
| 11 | - Arc pull - satin |
| 12 | - Arc pull - black |
| 13 | - Arc pull - chrome |

21 - Straight pull - chrome

22 - Straight pull - black

41 - Corinto pull - black

42 - Corinto pull - satin

45 - Flat pull - satin

E Select key option.

KS - Key standard

KA - Key alike



Approx. Packaged Weight	Delivered Pricing
95.0#	\$ 1332

95.0#	\$ 1431
-------	---------

82.0#	\$ 964
-------	--------

SPECIAL SERVICES

Special Carton Marking

With specially marked information N/C

Shipping

Shipped **assembled freight prepaid f.o.b. Mexico City, MX 11000** factory. Freight class #125.

Specifications and prices are subject to change without prior notice.

Darwin®

Storage - with Top

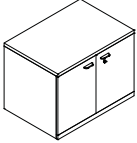
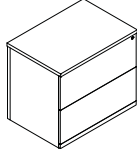
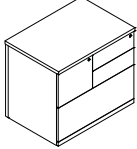
MODEL	Features	D x W x H	MODEL NUMBER					
			Basic Model	Edge Style	Wood Finish	Pull Option	Lock Option	
	No Lock	24 x 34 x 29-1/4"	KAT71112434	<input type="checkbox"/>	<input type="checkbox"/>	<input type="checkbox"/>	<input type="checkbox"/>	
	With Lock	24 x 34 x 29-1/4"	KAT71122434	<input type="checkbox"/>	<input type="checkbox"/>	<input type="checkbox"/>	<input type="checkbox"/>	<input type="checkbox"/>
DSST								
	Lock Included	24 x 34 x 29-1/4"	KAT71132434	<input type="checkbox"/>	<input type="checkbox"/>	<input type="checkbox"/>	<input type="checkbox"/>	<input type="checkbox"/>
	<ul style="list-style-type: none"> Lock included File bars for lateral files are front-to-back as standard/see Accessories section for side-to-side hanging bars 							
DSST								
	Left-Lock Included	24 x 34 x 29-1/4"	KAT71142434	<input type="checkbox"/>	<input type="checkbox"/>	<input type="checkbox"/>	<input type="checkbox"/>	<input type="checkbox"/>
	Right-Lock Included	24 x 34 x 29-1/4"	KAT71242434	<input type="checkbox"/>	<input type="checkbox"/>	<input type="checkbox"/>	<input type="checkbox"/>	<input type="checkbox"/>
DSST	<ul style="list-style-type: none"> Two box drawers, one file drawer One lateral file Lock included File bars for lateral files are front-to-back as standard/see Accessories section for side-to-side hanging bars 							
				A	B	C	D	E

HOW TO ORDER

Indicate the following information on order form:

- Quantity of each item.
- Model number, including options. See "How To Build a Model Number".
- Any special service required.

Note: • The indicates that a choice is required.

- The absence of the indicates that no choice is required.
- Alpha-numeric characters in place of indicate that no other alternatives are available.

HOW TO BUILD A MODEL NUMBER

A Select basic model.

B Select edge style.

- BO** - Quarter round edge
- CD** - Knife edge
- CR** - Reed edge
- CV** - Cove edge
- EB** - Square edge
- PD** - Pyramid edge

C Select wood finish color.

Refer to color addendum at ki.com or KI Fabrics & Finishes binder.

D Select pull option.

- 6** - Metal pull - black
- 7** - Metal pull - satin
- 8** - Metal pull - chrome
- 0** - Curved pull - black
- 4** - Curved pull - champagne
- 11** - Arc pull - satin
- 12** - Arc pull - black
- 13** - Arc pull - chrome

21 - Straight pull - chrome

22 - Straight pull - black

41 - Corinto pull - black

42 - Corinto pull - satin

45 - Flat pull - satin

E Select key option.

KS - Key standard

KA - Key alike



Approx. Packaged Weight	Delivered Pricing
155.0#	\$ 2427
155.0#	2549

155.0#	\$ 2673
--------	---------

155.0#	\$ 3768
155.0#	3768

SPECIAL SERVICES

Special Carton Marking

With specially marked information N/C

Shipping

Shipped **assembled freight prepaid f.o.b. Mexico City, MX 11000** factory. Freight class #125.

Specifications and prices are subject to change without prior notice.

Darwin®

Storage Units - Veneer Doors

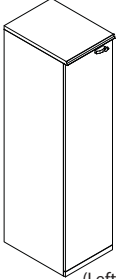
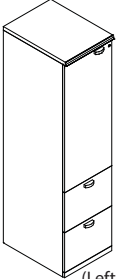
MODEL	Features	W x D x H	MODEL NUMBER					Approx. Packaged Weight
			Basic Model	Edge Style	Wood Finish	Pull Option	Lock Option	
 <p>(Left shown)</p> <p>Storage Tower - Left and Right</p> <ul style="list-style-type: none"> • One hinged door • One fixed shelf at 29° and (3) adjustable shelves • Grommet on back panel included • Lock included • Right or left designated by hinge location • Coat rod included 	Right	18 x 24 x 70"	KAT75011870	<input type="checkbox"/>	<input type="checkbox"/>	<input type="checkbox"/>	<input type="checkbox"/>	225.0#
	Left	18 x 24 x 70"	KAT75021870	<input type="checkbox"/>	<input type="checkbox"/>	<input type="checkbox"/>	<input type="checkbox"/>	225.0#
 <p>(Left shown)</p> <p>2 Drawer File/Storage Cabinet - Left and Right</p> <ul style="list-style-type: none"> • One hinged door • Two adjustable shelves • Two file drawers • Front to back letter, side to side legal • Lock included • Right or left designated by hinge location 	Right	18 x 24 x 70"	KAT75111870	<input type="checkbox"/>	<input type="checkbox"/>	<input type="checkbox"/>	<input type="checkbox"/>	245.0#
	Left	18 x 24 x 70"	KAT75121870	<input type="checkbox"/>	<input type="checkbox"/>	<input type="checkbox"/>	<input type="checkbox"/>	245.0#

A **B** **C** **D** **E**

HOW TO ORDER

Indicate the following information on order form:

1. Quantity of each item.
2. Model number, including options. See "How To Build a Model Number".
3. Any special service required.

Note: • The indicates that a choice is required.
 • The absence of the indicates that no choice is required.
 • Alpha-numeric characters in place of indicate that no other alternatives are available.

HOW TO BUILD A MODEL NUMBER

A Select basic model.

B Select edge style.

- BO** - Quarter round edge
- CR** - Reed edge
- CV** - Cove edge
- EB** - Square edge
- PD** - Pyramid edge

C Select wood finish color.
 Refer to color addendum at ki.com or KI Fabrics & Finishes binder.

D Select pull option.

- 6** - Metal pull - black
- 7** - Metal pull - satin
- 8** - Metal pull - chrome
- 0** - Curved pull - black
- 4** - Curved pull - champagne
- 11** - Arc pull - satin
- 12** - Arc pull - black
- 13** - Arc pull - chrome
- 21** - Straight pull - chrome

- 22** - Straight pull - black
- 41** - Corinto pull - black
- 42** - Corinto pull - satin
- 45** - Flat pull - satin

E Select key option.

- KS** - Key standard
- KA** - Key alike



Delivered
Pricing

\$ 2464

2464

\$ 3428

3428

SPECIAL SERVICES

Special Carton Marking

With specially marked information N/C

Shipping

Shipped **assembled freight prepaid f.o.b. Mexico City, MX 11000** factory. Freight class #125.

Specifications and prices are subject to change without prior notice.



Delivered
Pricing

\$ 3548

3548

SPECIAL SERVICES

Special Carton Marking

With specially marked information N/C

Shipping

Shipped **assembled freight prepaid f.o.b. Mexico City, MX 11000** factory. Freight class #125.

Specifications and prices are subject to change without prior notice.

Darwin®

Storage Units - Veneer Doors

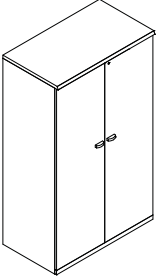
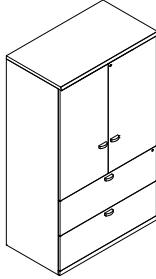
		MODEL NUMBER					Approx. Packaged Weight
		Basic Model	Edge Style	Wood Finish	Pull Option	Lock Option	
MODEL	W x D x H						
 <p>Storage/Wardrobe Unit</p> <ul style="list-style-type: none"> • Two hinged doors • Coat rod • One fixed shelf and three adjustable shelves • Grommet on back panel included • Lock included 	36 x 24 x 70"	KAT76033670	<input type="checkbox"/>	<input type="checkbox"/>	<input type="checkbox"/>	<input type="checkbox"/>	370.0#
	42 x 24 x 70"	KAT76034270	<input type="checkbox"/>	<input type="checkbox"/>	<input type="checkbox"/>	<input type="checkbox"/>	425.0#
 <p>Storage Cabinet with 2 File Drawers</p> <ul style="list-style-type: none"> • Two hinged doors • Two adjustable shelves • Two lateral file drawers • Grommet on back panel included • Lock included • File bars for lateral files are front-to-back as standard/see Accessories section for side-to-side hanging bars 	36 x 24 x 70"	KAT76053670	<input type="checkbox"/>	<input type="checkbox"/>	<input type="checkbox"/>	<input type="checkbox"/>	370.0#
	42 x 24 x 70"	KAT76054270	<input type="checkbox"/>	<input type="checkbox"/>	<input type="checkbox"/>	<input type="checkbox"/>	425.0#
			A	B	C	D	E

DSTW

DSTW

HOW TO ORDER

Indicate the following information on order form:

1. Quantity of each item.
2. Model number, including options. See "How To Build a Model Number".
3. Any special service required.

Note: • The indicates that a choice is required.

- The absence of the indicates that no choice is required.
- Alpha-numeric characters in place of indicate that no other alternatives are available.

HOW TO BUILD A MODEL NUMBER

A Select basic model.

B Select edge style.

- BO** - Quarter round edge
- CR** - Reed edge
- CV** - Cove edge
- EB** - Square edge
- PD** - Pyramid edge

C Select wood finish color. Refer to color addendum at ki.com or KI Fabrics & Finishes binder.

D Select pull option.

- 6** - Metal pull - black
- 7** - Metal pull - satin
- 8** - Metal pull - chrome
- 0** - Curved pull - black
- 4** - Curved pull - champagne
- 11** - Arc pull - satin
- 12** - Arc pull - black
- 13** - Arc pull - chrome
- 21** - Straight pull - chrome

- 22** - Straight pull - black
- 41** - Corinto pull - black
- 42** - Corinto pull - satin
- 45** - Flat pull - satin

E Select key option.

- KS** - Key standard
- KA** - Key alike



Delivered
Pricing

\$ 4562

4999

\$ 5496

5949

SPECIAL SERVICES

Special Carton Marking

With specially marked information N/C

Shipping

Shipped **assembled freight prepaid f.o.b. Mexico City, MX 11000** factory. Freight class #125.

Specifications and prices are subject to change without prior notice.

Darwin®

Storage Units - Veneer Doors

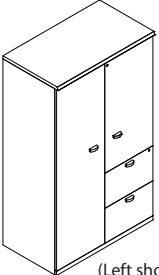
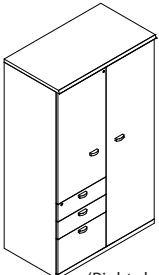
MODEL	Features	W x D x H	MODEL NUMBER					Approx. Packaged Weight
			Basic Model	Edge Style	Wood Finish	Pull Option	Lock Option	
 <p>(Left shown)</p>	Wardrobe Cabinet with File Drawers - Left and Right <ul style="list-style-type: none"> • Two hinged doors • Coat rod on wardrobe side • Two adjustable shelves • Two file drawers • Grommet on back panel included • Lock included • Left and right designate the full wardrobe location 	Left 36 x 24 x 70"	KAT76073670	<input type="checkbox"/>	<input type="checkbox"/>	<input type="checkbox"/>	<input type="checkbox"/>	370.0#
		Left 42 x 24 x 70"	KAT76074270	<input type="checkbox"/>	<input type="checkbox"/>	<input type="checkbox"/>	<input type="checkbox"/>	425.0#
		Right 36 x 24 x 70"	KAT76083670	<input type="checkbox"/>	<input type="checkbox"/>	<input type="checkbox"/>	<input type="checkbox"/>	370.0#
		Right 42 x 24 x 70"	KAT76084270	<input type="checkbox"/>	<input type="checkbox"/>	<input type="checkbox"/>	<input type="checkbox"/>	425.0#
 <p>(Right shown)</p>	Split Storage/Wardrobe Cabinet - Left and Right <ul style="list-style-type: none"> • Two hinged doors • Coat rod on wardrobe side • Two adjustable shelves • Two box drawers and one file drawer • Grommet on back panel included • Lock included • Left and right designate the full wardrobe location 	Left 36 x 24 x 70"	KAT76093670	<input type="checkbox"/>	<input type="checkbox"/>	<input type="checkbox"/>	<input type="checkbox"/>	370.0#
		Left 42 x 24 x 70"	KAT76094270	<input type="checkbox"/>	<input type="checkbox"/>	<input type="checkbox"/>	<input type="checkbox"/>	425.0#
		Right 36 x 24 x 70"	KAT76103670	<input type="checkbox"/>	<input type="checkbox"/>	<input type="checkbox"/>	<input type="checkbox"/>	370.0#
		Right 42 x 24 x 70"	KAT76104270	<input type="checkbox"/>	<input type="checkbox"/>	<input type="checkbox"/>	<input type="checkbox"/>	425.0#
			A	B	C	D	E	

DSTW

DSTW

HOW TO ORDER

Indicate the following information on order form:

1. Quantity of each item.
2. Model number, including options. See "How To Build a Model Number".
3. Any special service required.

Note: • The indicates that a choice is required.

- The absence of the indicates that no choice is required.
- Alpha-numeric characters in place of

indicate that no other alternatives are available.

HOW TO BUILD A MODEL NUMBER

A Select basic model.

B Select edge style.

- BO** - Quarter round edge
- CR** - Reed edge
- CV** - Cove edge
- EB** - Square edge
- PD** - Pyramid edge

C Select wood finish color.

Refer to color addendum at ki.com or KI Fabrics & Finishes binder.

D Select pull option.

- 6** - Metal pull - black
- 7** - Metal pull - satin
- 8** - Metal pull - chrome
- 0** - Curved pull - black
- 4** - Curved pull - champagne
- 11** - Arc pull - satin
- 12** - Arc pull - black
- 13** - Arc pull - chrome
- 21** - Straight pull - chrome

22 - Straight pull - black

41 - Corinto pull - black

42 - Corinto pull - satin

45 - Flat pull - satin

E Select key option.

KS - Key standard

KA - Key alike



Delivered
Pricing

\$ 5189

5611

5189

5611

\$ 5312

5734

5312

5734

SPECIAL SERVICES

Special Carton Marking

With specially marked information N/C

Shipping

Shipped **assembled freight prepaid f.o.b. Mexico City, MX 11000** factory. Freight class #125.

Specifications and prices are subject to change without prior notice.

Darwin®

Bookcases - 16" Deep

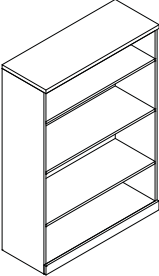
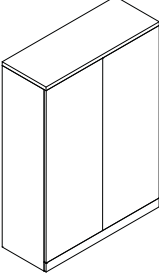
	MODEL	W x H x D	MODEL NUMBER					Approx. Packaged Weight	
			Basic Model	Edge Style	Wood Finish	Pull Option	Lock Option		
 <p>DBKC</p>	Open Bookcase <ul style="list-style-type: none"> All open bookcases must be placed with the rear of the bookcase located fully against a wall or other equal- or larger-sized furniture piece to ensure proper stability 28" units feature one adjustable shelf 48" units feature one fixed and one adjustable shelf 60" units feature one fixed and two adjustable shelves 70" units feature two fixed and two adjustable shelves 84" units feature two fixed and three adjustable shelves 	36 x 28 x 16"	KAT77103628	<input type="checkbox"/>	<input type="checkbox"/>	<input type="checkbox"/>	<input type="checkbox"/>	<input type="checkbox"/>	98.0#
		36 x 47-1/2 x 16"	KAT77103648	<input type="checkbox"/>	<input type="checkbox"/>	<input type="checkbox"/>	<input type="checkbox"/>	<input type="checkbox"/>	150.0#
		36 x 59-1/2 x 16"	KAT77103660	<input type="checkbox"/>	<input type="checkbox"/>	<input type="checkbox"/>	<input type="checkbox"/>	<input type="checkbox"/>	180.0#
		36 x 70 x 16"	KAT77103670	<input type="checkbox"/>	<input type="checkbox"/>	<input type="checkbox"/>	<input type="checkbox"/>	<input type="checkbox"/>	220.0#
		36 x 83-1/2 x 16"	KAT77103684	<input type="checkbox"/>	<input type="checkbox"/>	<input type="checkbox"/>	<input type="checkbox"/>	<input type="checkbox"/>	250.0#
		42 x 28 x 16"	KAT77104228	<input type="checkbox"/>	<input type="checkbox"/>	<input type="checkbox"/>	<input type="checkbox"/>	<input type="checkbox"/>	114.0#
		42 x 47-1/2 x 16"	KAT77104248	<input type="checkbox"/>	<input type="checkbox"/>	<input type="checkbox"/>	<input type="checkbox"/>	<input type="checkbox"/>	200.0#
		42 x 59-1/2 x 16"	KAT77104260	<input type="checkbox"/>	<input type="checkbox"/>	<input type="checkbox"/>	<input type="checkbox"/>	<input type="checkbox"/>	245.0#
		42 x 70 x 16"	KAT77104270	<input type="checkbox"/>	<input type="checkbox"/>	<input type="checkbox"/>	<input type="checkbox"/>	<input type="checkbox"/>	270.0#
		42 x 83-1/2 x 16"	KAT77104284	<input type="checkbox"/>	<input type="checkbox"/>	<input type="checkbox"/>	<input type="checkbox"/>	<input type="checkbox"/>	355.0#
		48 x 28 x 16"	KAT77104828	<input type="checkbox"/>	<input type="checkbox"/>	<input type="checkbox"/>	<input type="checkbox"/>	<input type="checkbox"/>	130.0#
		48 x 47-1/2 x 16"	KAT77104848	<input type="checkbox"/>	<input type="checkbox"/>	<input type="checkbox"/>	<input type="checkbox"/>	<input type="checkbox"/>	224.0#
		48 x 59-1/2 x 16"	KAT77104860	<input type="checkbox"/>	<input type="checkbox"/>	<input type="checkbox"/>	<input type="checkbox"/>	<input type="checkbox"/>	280.0#
48 x 70 x 16"	KAT77104870	<input type="checkbox"/>	<input type="checkbox"/>	<input type="checkbox"/>	<input type="checkbox"/>	<input type="checkbox"/>	326.0#		
48 x 83-1/2 x 16"	KAT77104884	<input type="checkbox"/>	<input type="checkbox"/>	<input type="checkbox"/>	<input type="checkbox"/>	<input type="checkbox"/>	406.0#		
 <p>DBKC</p>	Bookcase with Wood Doors <ul style="list-style-type: none"> Bookcases include two hinged doors All units are locking 28" units feature one adjustable shelf 48" units feature one fixed and one adjustable shelf 60" units feature one fixed and two adjustable shelves 70" units feature two fixed and two adjustable shelves 84" units feature two fixed and three adjustable shelves 	36 x 28 x 16"	KAT77113628	<input type="checkbox"/>	<input type="checkbox"/>	<input type="checkbox"/>	<input type="checkbox"/>	<input type="checkbox"/>	98.0#
		36 x 47-1/2 x 16"	KAT77113648	<input type="checkbox"/>	<input type="checkbox"/>	<input type="checkbox"/>	<input type="checkbox"/>	<input type="checkbox"/>	150.0#
		36 x 59-1/2 x 16"	KAT77113660	<input type="checkbox"/>	<input type="checkbox"/>	<input type="checkbox"/>	<input type="checkbox"/>	<input type="checkbox"/>	180.0#
		36 x 70 x 16"	KAT77113670	<input type="checkbox"/>	<input type="checkbox"/>	<input type="checkbox"/>	<input type="checkbox"/>	<input type="checkbox"/>	220.0#
		36 x 83-1/2 x 16"	KAT77113684	<input type="checkbox"/>	<input type="checkbox"/>	<input type="checkbox"/>	<input type="checkbox"/>	<input type="checkbox"/>	250.0#
		42 x 28 x 16"	KAT77114228	<input type="checkbox"/>	<input type="checkbox"/>	<input type="checkbox"/>	<input type="checkbox"/>	<input type="checkbox"/>	114.0#
		42 x 47-1/2 x 16"	KAT77114248	<input type="checkbox"/>	<input type="checkbox"/>	<input type="checkbox"/>	<input type="checkbox"/>	<input type="checkbox"/>	200.0#
		42 x 59-1/2 x 16"	KAT77114260	<input type="checkbox"/>	<input type="checkbox"/>	<input type="checkbox"/>	<input type="checkbox"/>	<input type="checkbox"/>	245.0#
		42 x 70 x 16"	KAT77114270	<input type="checkbox"/>	<input type="checkbox"/>	<input type="checkbox"/>	<input type="checkbox"/>	<input type="checkbox"/>	270.0#
		42 x 83-1/2 x 16"	KAT77114284	<input type="checkbox"/>	<input type="checkbox"/>	<input type="checkbox"/>	<input type="checkbox"/>	<input type="checkbox"/>	250.0#
		48 x 28 x 16"	KAT77114828	<input type="checkbox"/>	<input type="checkbox"/>	<input type="checkbox"/>	<input type="checkbox"/>	<input type="checkbox"/>	130.0#
		48 x 47-1/2 x 16"	KAT77114848	<input type="checkbox"/>	<input type="checkbox"/>	<input type="checkbox"/>	<input type="checkbox"/>	<input type="checkbox"/>	224.0#
		48 x 59-1/2 x 16"	KAT77114860	<input type="checkbox"/>	<input type="checkbox"/>	<input type="checkbox"/>	<input type="checkbox"/>	<input type="checkbox"/>	280.0#
48 x 70 x 16"	KAT77114870	<input type="checkbox"/>	<input type="checkbox"/>	<input type="checkbox"/>	<input type="checkbox"/>	<input type="checkbox"/>	326.0#		
48 x 83-1/2 x 16"	KAT77114884	<input type="checkbox"/>	<input type="checkbox"/>	<input type="checkbox"/>	<input type="checkbox"/>	<input type="checkbox"/>	406.0#		

A **B** **C** **D** **E**

HOW TO ORDER

Indicate the following information on order form:

- Quantity of each item.
- Model number, including options. See "How To Build a Model Number".
- Any special service required.

Note: • The indicates that a choice is required.

- The absence of the indicates that no choice is required.
- Alpha-numeric characters in place of

indicate that no other alternatives are available.

HOW TO BUILD A MODEL NUMBER

A Select basic model.

B Select edge style.

- | | |
|-----------|----------------------|
| BO | - Quarter round edge |
| CR | - Reed edge |
| CV | - Cove edge |
| EB | - Square edge |
| PD | - Pyramid edge |

C Select wood finish color.
Refer to color addendum at ki.com or KI Fabrics & Finishes binder.

D Select pull option.

- | | |
|-----------|---------------------------|
| 6 | - Metal pull - black |
| 7 | - Metal pull - satin |
| 8 | - Metal pull - chrome |
| 0 | - Curved pull - black |
| 4 | - Curved pull - champagne |
| 11 | - Arc pull - satin |
| 12 | - Arc pull - black |
| 13 | - Arc pull - chrome |
| 21 | - Straight pull - chrome |

- | | |
|-----------|-------------------------|
| 22 | - Straight pull - black |
| 41 | - Corinto pull - black |
| 42 | - Corinto pull - satin |
| 45 | - Flat pull - satin |

E Select key option.

- | | |
|-----------|----------------|
| KS | - Key standard |
| KA | - Key alike |



Delivered Pricing
\$ 1497
2103
2574
3036
3544
1844
2508
3030
3467
3715
2037
2785
3339
3880
4090
\$ 2470
3291
3886
4489
5285
2710
3618
4291
4958
5846
2944
3969
4703
5488
6429

SPECIAL SERVICES

Special Carton Marking

With specially marked information N/C

Shipping

Shipped **assembled freight prepaid f.o.b. Mexico City, MX 11000** factory. Freight class #125.

Specifications and prices are subject to change without prior notice.

Darwin®

Storage

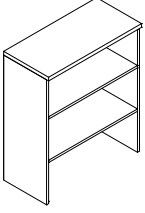
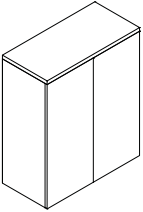
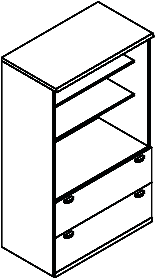
	MODEL	Features	W x H x D	MODEL NUMBER					Approx. Packaged Weight
				Basic Model	Edge Style	Wood Finish	Pull Option	Lock Option	
	Open Bookcase-Stack On Storage Unit • To stack on a credenza or a freestanding module • May not be used freestanding		28 x 40-3/4 x 16"	KAT77202841	<input type="checkbox"/>	<input type="checkbox"/>			160.0#
			34 x 40-3/4 x 16"	KAT77203441	<input type="checkbox"/>	<input type="checkbox"/>			160.0#
DBKC									
	Bookcase with Wood Doors-Stack On Storage Unit • To stack on a credenza or a freestanding module • May not be used freestanding		28 x 41 x 16"	KAT77212841	<input type="checkbox"/>	<input type="checkbox"/>	<input type="checkbox"/>		190.0#
			34 x 41 x 16"	KAT77213441	<input type="checkbox"/>	<input type="checkbox"/>	<input type="checkbox"/>		190.0#
DBKC									
	File/ Bookcase Storage Unit • Two adjustable shelves • Two lateral file drawers with lock • File bars for lateral files are front-to-back as standard/see Accessories section for side-to-side hanging bars	No Lock	36 x 70 x 24"	KAT76113670	<input type="checkbox"/>	<input type="checkbox"/>	<input type="checkbox"/>		370.0#
		No Lock	42 x 70 x 24"	KAT76114270	<input type="checkbox"/>	<input type="checkbox"/>	<input type="checkbox"/>		425.0#
		With Lock	36 x 70 x 24"	KAT76123670	<input type="checkbox"/>	<input type="checkbox"/>	<input type="checkbox"/>	<input type="checkbox"/>	370.0#
		With Lock	42 x 70 x 24"	KAT76124270	<input type="checkbox"/>	<input type="checkbox"/>	<input type="checkbox"/>	<input type="checkbox"/>	425.0#
DBKC									

A **B** **C** **D** **E**

HOW TO ORDER

Indicate the following information on order form:

- Quantity of each item.
- Model number, including options. See "How To Build a Model Number".
- Any special service required.

Note: • The indicates that a choice is required.

- The absence of the indicates that no choice is required.
- Alpha-numeric characters in place of indicate that no other alternatives are available.

HOW TO BUILD A MODEL NUMBER

A Select basic model.

B Select edge style.

- BO** - Quarter round edge
- CR** - Reed edge
- CV** - Cove edge
- EB** - Square edge
- PD** - Pyramid edge

C Select wood finish color.
Refer to color addendum at ki.com or KI Fabrics & Finishes binder.

D Select pull option.

- 6** - Metal pull - black
- 7** - Metal pull - satin
- 8** - Metal pull - chrome
- 0** - Curved pull - black
- 4** - Curved pull - champagne
- 11** - Arc pull - satin
- 12** - Arc pull - black
- 13** - Arc pull - chrome
- 21** - Straight pull - chrome

- 22** - Straight pull - black
- 41** - Corinto pull - black
- 42** - Corinto pull - satin
- 45** - Flat pull - satin

E Select key option.

- KS** - Key standard
- KA** - Key alike



Delivered
Pricing

\$ 1716

1996

\$ 2560

2929

\$ 4372

4783

4494

4908

SPECIAL SERVICES

Special Carton Marking

With specially marked information N/C

Shipping

Shipped **assembled freight prepaid f.o.b. Mexico City, MX 11000** factory. Freight class #125.

Specifications and prices are subject to change without prior notice.

Darwin®

Storage

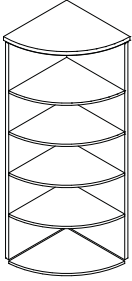
MODEL	W x H x D	MODEL NUMBER			Approx. Packaged Weight
		Basic Model	Edge Style	Wood Finish	
 <p>Corner Display Shelves</p> <ul style="list-style-type: none"> Fixed shelf at 29° and three adjustable shelves 	23-1/4 x 70 x 24"	KAT77052370	<input type="checkbox"/>	<input type="checkbox"/> <input type="checkbox"/> <input type="checkbox"/>	156.0#

DBKC

A **B** **C**

HOW TO ORDER

Indicate the following information on order form:

- Quantity of each item.
- Model number, including options. See "How To Build a Model Number".
- Any special service required.

Note:

- The indicates that a choice is required.
- The absence of the indicates that no choice is required.
- Alpha-numeric characters in place of indicate that no other alternatives are available.

HOW TO BUILD A MODEL NUMBER

- A** Select basic model.
- B** Select edge style.

BO	- Quarter round edge
CR	- Reed edge
CV	- Cove edge
EB	- Square edge
PD	- Pyramid edge
- C** Select wood finish color. Refer to color addendum at ki.com or KI Fabrics & Finishes binder.



Delivered
Pricing
\$ 2854

SPECIAL SERVICES

Special Carton Marking

With specially marked information N/C

Shipping

Shipped **assembled freight prepaid f.o.b. Mexico City, MX 11000** factory. Freight class #125.

Specifications and prices are subject to change without prior notice.

Darwin®

Lateral Files

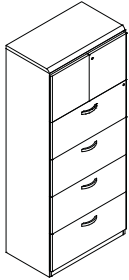
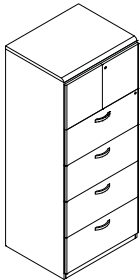
MODEL	W x H x D	MODEL NUMBER				Approx. Packaged Weight
		Basic Model	Edge Style	Wood Finish	Pull Option	
 <p>Wood Lateral Files - 18" Deep</p> <ul style="list-style-type: none"> 71" high (pictured) has cabinet doors at top, all other sizes have drawers only File bars for lateral files are front-to-back as standard/see Accessories section for side-to-side hanging bars 	30 x 28-3/4 x 18"	KAT79013029	<input type="checkbox"/>	<input type="checkbox"/>	<input type="checkbox"/>	90.0#
	30 x 42 x 18"	KAT79013042	<input type="checkbox"/>	<input type="checkbox"/>	<input type="checkbox"/>	130.0#
	30 x 55-1/4 x 18"	KAT79013055	<input type="checkbox"/>	<input type="checkbox"/>	<input type="checkbox"/>	175.0#
	30 x 71-1/4 x 18"	KAT79013071	<input type="checkbox"/>	<input type="checkbox"/>	<input type="checkbox"/>	221.0#
	36 x 28-3/4 x 18"	KAT79013629	<input type="checkbox"/>	<input type="checkbox"/>	<input type="checkbox"/>	104.0#
	36 x 42 x 18"	KAT79013642	<input type="checkbox"/>	<input type="checkbox"/>	<input type="checkbox"/>	145.0#
	36 x 55-1/4 x 18"	KAT79013655	<input type="checkbox"/>	<input type="checkbox"/>	<input type="checkbox"/>	192.0#
	36 x 71-1/4 x 18"	KAT79013671	<input type="checkbox"/>	<input type="checkbox"/>	<input type="checkbox"/>	235.0#
DLAT						
 <p>Wood Lateral Files - 24" Deep</p> <ul style="list-style-type: none"> 71" high (pictured) has cabinet doors at top, all other sizes have drawers only File bars for lateral files are front-to-back as standard/see Accessories section for side-to-side hanging bars 	30 x 28-3/4 x 24"	KAT79053029	<input type="checkbox"/>	<input type="checkbox"/>	<input type="checkbox"/>	90.0#
	30 x 42 x 24"	KAT79053042	<input type="checkbox"/>	<input type="checkbox"/>	<input type="checkbox"/>	130.0#
	30 x 55-1/4 x 24"	KAT79053055	<input type="checkbox"/>	<input type="checkbox"/>	<input type="checkbox"/>	175.0#
	30 x 71-1/4 x 24"	KAT79053071	<input type="checkbox"/>	<input type="checkbox"/>	<input type="checkbox"/>	221.0#
	36 x 28-3/4 x 24"	KAT79053629	<input type="checkbox"/>	<input type="checkbox"/>	<input type="checkbox"/>	104.0#
	36 x 42 x 24"	KAT79053642	<input type="checkbox"/>	<input type="checkbox"/>	<input type="checkbox"/>	145.0#
	36 x 55-1/4 x 24"	KAT79053655	<input type="checkbox"/>	<input type="checkbox"/>	<input type="checkbox"/>	192.0#
	36 x 71-1/4 x 24"	KAT79053671	<input type="checkbox"/>	<input type="checkbox"/>	<input type="checkbox"/>	235.0#
DLAT						
			A	B	C	D

HOW TO ORDER

Indicate the following information on order form:

- Quantity of each item.
- Model number, including options. See "How To Build a Model Number".
- Any special service required.

Note: • The indicates that a choice is required.

- The absence of the indicates that no choice is required.
- Alpha-numeric characters in place of indicate that no other alternatives are available.

HOW TO BUILD A MODEL NUMBER

A Select basic model.

- B** Select edge style.
- | | |
|-----------|----------------------|
| BO | - Quarter round edge |
| CR | - Reed edge |
| CV | - Cove edge |
| EB | - Square edge |
| PD | - Pyramid edge |

C Select wood finish color.
Refer to color addendum at ki.com or KI Fabrics & Finishes binder.

D Select pull option.

- | | |
|-----------|---------------------------|
| 6 | - Metal pull - black |
| 7 | - Metal pull - satin |
| 8 | - Metal pull - chrome |
| 0 | - Curved pull - black |
| 4 | - Curved pull - champagne |
| 11 | - Arc pull - satin |
| 12 | - Arc pull - black |
| 13 | - Arc pull - chrome |
| 21 | - Straight pull - chrome |

- | | |
|-----------|-------------------------|
| 22 | - Straight pull - black |
| 41 | - Corinto pull - black |
| 42 | - Corinto pull - satin |
| 45 | - Flat pull - satin |



Delivered
Pricing

\$ 2182
3021
3822
4689
2370
3282
4134
5053

\$ 2340
3217
3966
4980
2548
3489
4374
5367

SPECIAL SERVICES

Special Carton Marking

With specially marked information N/C

Shipping

Shipped **assembled freight prepaid f.o.b. Mexico City, MX 11000** factory. Freight class #125.

Specifications and prices are subject to change without prior notice.

Darwin® Conference Room Tables

Round/Rectangular Tables

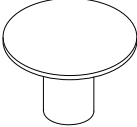
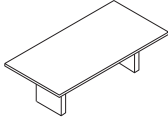
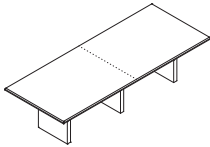
	MODEL	W x D x H	MODEL NUMBER			Approx. Packaged Weight
			Basic Model	Edge Style	Wood Finish	
 DRTBL	Round Table • One 20" diameter drum base included with 42" and 48" tables • One 24" diameter drum base included with 60" table • To prevent tipping, counterweights (supplied by the end-user or installer) should be added into the drum base prior to attaching the table top • Straight self-edge top	36" dia	KA70036	<input type="checkbox"/>	<input type="checkbox"/>	150.0#
		42" dia	KA70042	<input type="checkbox"/>	<input type="checkbox"/>	169.0#
		48" dia	KA70048	<input type="checkbox"/>	<input type="checkbox"/>	190.0#
		60" dia	KA70060	<input type="checkbox"/>	<input type="checkbox"/>	230.0#
 DRTBL	Rectangular Table • Panel base • 72" and 96" tops are one-piece	72 x 36 x 29-1/4"	KA74072	<input type="checkbox"/>	<input type="checkbox"/>	260.0#
		96 x 48 x 29-1/4"	KA74096	<input type="checkbox"/>	<input type="checkbox"/>	294.0#
 DRTBL	Rectangular Table • Panel base • 120" and 144" tops are two-piece, connected	120 x 48 x 29-1/4"	KA740120	<input type="checkbox"/>	<input type="checkbox"/>	406.0#
		144 x 48 x 29-1/4"	KA740144	<input type="checkbox"/>	<input type="checkbox"/>	433.0#

A **B** **C**

HOW TO ORDER

Indicate the following information on order form:

- Quantity of each item.
- Model number, including options. See "How To Build a Model Number".
- Any special service required.

Note:

- The indicates that a choice is required.
- The absence of the indicates that no choice is required.
- Alpha-numeric characters in place of indicate that no other alternatives are available.

HOW TO BUILD A MODEL NUMBER

- A** Select basic model.
- B** Select edge style.
- | | |
|-----------|----------------------|
| BO | - Quarter round edge |
| CR | - Reed edge |
| CV | - Cove edge |
| EB | - Square edge |
| PD | - Pyramid edge |
- C** Select wood finish.
Refer to color addendum at ki.com or KI Fabrics & Finishes binder.



Darwin® Conference Room Tables

Round/Rectangular Tables

Delivered Pricing

\$ 2143
2435
2693
3386

\$ 4069
6198

\$ 8315
10534

SPECIAL SERVICES

Special Carton Marking

With specially marked information N/C

Shipping

Shipped **assembled freight prepaid f.o.b. Mexico City, MX 11000** factory. Freight class #125.

Specifications and prices are subject to change without prior notice.

Darwin® Conference Room Tables

Elliptical Tables

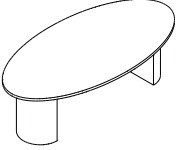
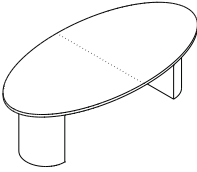
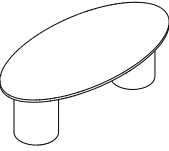
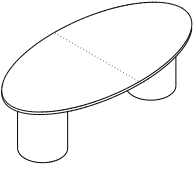
	MODEL	W x D x H	MODEL NUMBER			Approx. Packaged Weight
			Basic Model	Edge Style	Wood Finish	
 <p>Elliptical Table/Half Drum Bases</p> <ul style="list-style-type: none"> • Half drum bases with access door • 96" top is one-piece 		96 x 48 x 29-1/4"	KA72096	<input type="checkbox"/>	<input type="checkbox"/>	246.0#
DRTBL						
 <p>Elliptical Table/Half Drum Bases</p> <ul style="list-style-type: none"> • Half drum bases with access door • 120" top is two-piece, connected 		120 x 48 x 29-1/4"	KA720120	<input type="checkbox"/>	<input type="checkbox"/>	320.0#
DRTBL						
 <p>Elliptical Table/Full Drum Bases</p> <ul style="list-style-type: none"> • Full drum bases • To prevent tipping, counterweights (supplied by the end-user or installer) should be added into the drum base prior to attaching the table top • 96" top is one-piece 		96 x 48 x 29-1/4"	KA72296	<input type="checkbox"/>	<input type="checkbox"/>	246.0#
DRTBL						
 <p>Elliptical Table/Full Drum Bases</p> <ul style="list-style-type: none"> • Full drum bases • To prevent tipping, counterweights (supplied by the end-user or installer) should be added into the drum base prior to attaching the table top • 120" top is two-piece, connected 		120 x 48 x 29-1/4"	KA722120	<input type="checkbox"/>	<input type="checkbox"/>	320.0#
DRTBL						

A **B** **C**

HOW TO ORDER

Indicate the following information on order form:

1. Quantity of each item.
2. Model number, including options. See "How To Build a Model Number".
3. Any special service required.

Note:

- The indicates that a choice is required.
- The absence of the indicates that no choice is required.
- Alpha-numeric characters in place of indicate that no other alternatives are available.

HOW TO BUILD A MODEL NUMBER

- A** Select basic model.
- B** Select edge style.
- | | |
|-----------|----------------------|
| BO | - Quarter round edge |
| CR | - Reed edge |
| CV | - Cove edge |
| EB | - Square edge |
| PD | - Pyramid edge |
- C** Select wood finish.
Refer to color addendum at ki.com or KI Fabrics & Finishes binder.



Darwin® Conference Room Tables

Elliptical Tables

Delivered
Pricing

\$ 4520

\$ 7737

\$ 4742

\$ 8126

SPECIAL SERVICES

Special Carton Marking

With specially marked information N/C

Shipping

Shipped **assembled freight prepaid f.o.b. Mexico City, MX 11000** factory. Freight class #125.

Specifications and prices are subject to change without prior notice.

Darwin® Conference Room Tables

Racetrack Tables

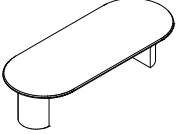
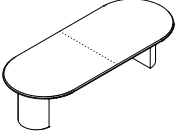
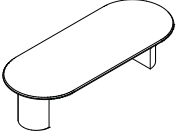
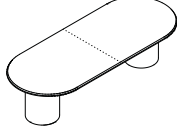
	MODEL	W x D x H	MODEL NUMBER			Approx. Packaged Weight
			Basic Model	Edge Style	Wood Finish	
 DRTBL	Racetrack Table/Half Drum Bases • Half drum bases with access door • 72" and 96" tops are one-piece	72 x 36 x 29-1/4"	KA73072	<input type="checkbox"/>	<input type="checkbox"/>	260.0#
		96 x 48 x 29-1/4"	KA73096	<input type="checkbox"/>	<input type="checkbox"/>	326.0#
 DRTBL	Racetrack Table/Half Drum Bases • Half drum bases with access door • 120" and 144" tops are two-piece, connected	120 x 48 x 29-1/4"	KA730120	<input type="checkbox"/>	<input type="checkbox"/>	351.0#
		144 x 48 x 29-1/4"	KA730144	<input type="checkbox"/>	<input type="checkbox"/>	395.0#
 DRTBL	Racetrack Table/Full Drum Bases • Half drum bases with access door • 72" and 96" tops are one-piece	72 x 36 x 29-1/4"	KA73272	<input type="checkbox"/>	<input type="checkbox"/>	260.0#
		96 x 48 x 29-1/4"	KA73296	<input type="checkbox"/>	<input type="checkbox"/>	326.0#
 DRTBL	Racetrack Table/Full Drum Bases • Half drum bases with access door • 120" and 144" tops are two-piece, connected	120 x 48 x 29-1/4"	KA732120	<input type="checkbox"/>	<input type="checkbox"/>	351.0#
		144 x 48 x 29-1/4"	KA732144	<input type="checkbox"/>	<input type="checkbox"/>	395.0#

A **B** **C**

HOW TO ORDER

Indicate the following information on order form:

- Quantity of each item.
- Model number, including options. See "How To Build a Model Number".
- Any special service required.

- Note:
- The indicates that a choice is required.
 - The absence of the indicates that no choice is required.
 - Alpha-numeric characters in place of indicate that no other alternatives are available.

HOW TO BUILD A MODEL NUMBER

- A** Select basic model.
- B** Select edge style.
- | | |
|-----------|----------------------|
| BO | - Quarter round edge |
| CR | - Reed edge |
| CV | - Cove edge |
| EB | - Square edge |
| PD | - Pyramid edge |
- C** Select wood finish.
Refer to color addendum at ki.com or KI Fabrics & Finishes binder.



Darwin® Conference Room Tables

Racetrack Tables

Delivered
Pricing

\$ 4027
4520

\$ 6315
8886

\$ 4231
4742

\$ 6632
9954

SPECIAL SERVICES

Special Carton Marking

With specially marked information N/C

Shipping

Shipped **assembled freight prepaid f.o.b. Mexico City, MX 11000** factory. Freight class #125.

Specifications and prices are subject to change without prior notice.

Darwin® Conference Room Tables

Round/Rectangular Tables with CD Edge only

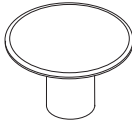
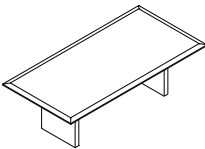
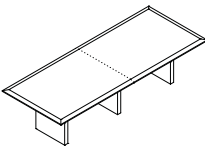
	MODEL	W x D x H	MODEL NUMBER		Approx. Packaged Weight
			Basic Model	Wood Finish	
 <p>DVTBL</p>	Round Table • CD edge all around • Drum base, to prevent tipping, counterweights (supplied by the end-user or installer) should be added into the drum base prior to attaching the table top	48" dia	KACD70048CD	<input type="checkbox"/> <input type="checkbox"/> <input type="checkbox"/> <input type="checkbox"/>	190.0#
		60" dia	KACD70060CD	<input type="checkbox"/> <input type="checkbox"/> <input type="checkbox"/> <input type="checkbox"/>	230.0#
 <p>DVTBL</p>	Rectangular Table • CD edge all around • Panel base • One-piece top	96 x 48 x 29-1/4"	KACD74096CD	<input type="checkbox"/> <input type="checkbox"/> <input type="checkbox"/> <input type="checkbox"/>	350.0#
 <p>DVTBL</p>	Rectangular Table • CD edge all around • Panel base • Two-piece top, connected	120 x 48 x 29-1/4"	KACD740120CD	<input type="checkbox"/> <input type="checkbox"/> <input type="checkbox"/> <input type="checkbox"/>	406.0#
		144 x 48 x 29-1/4"	KACD740144CD	<input type="checkbox"/> <input type="checkbox"/> <input type="checkbox"/> <input type="checkbox"/>	433.0#

A

B

HOW TO ORDER

Indicate the following information on order form:

- Quantity of each item.
- Model number, including options. See "How To Build a Model Number".
- Any special service required.

- Note:
- The indicates that a choice is required.
 - The absence of the indicates that no choice is required.
 - Alpha-numeric characters in place of indicate that no other alternatives are available.

HOW TO BUILD A MODEL NUMBER

- A** Select basic model.
- B** Select wood finish.
Refer to color addendum at ki.com or KI Fabrics & Finishes binder.



Darwin® Conference Room Tables

Round/Rectangular Tables with CD Edge only

Delivered
Pricing

\$ 2826

3552

\$ 6509

\$ 8731

11061

SPECIAL SERVICES

Special Carton Marking

With specially marked information N/C

Shipping

Shipped **assembled freight prepaid f.o.b. Mexico City, MX 11000** factory. Freight class #125.

Specifications and prices are subject to change without prior notice.

Darwin® Conference Room Tables

Elliptical/Triangular Tables with CD Edge only

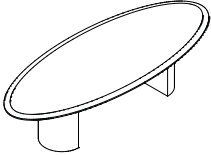
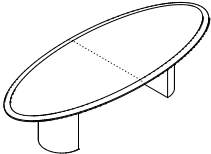
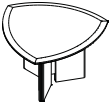
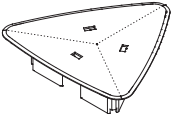
	MODEL	W x D x H	MODEL NUMBER		Approx. Packaged Weight
			Basic Model	Wood Finish	
 DVTBL	Elliptical Table/Half Drum Bases • CD edge all around • Half drum bases with access door • 96" top is one-piece	96 x 48 x 29-1/4"	KACD72096CD	<input type="checkbox"/> <input type="checkbox"/> <input type="checkbox"/> <input type="checkbox"/>	246.0#
 DVTBL	Elliptical Table/Half Drum Bases • CD edge all around • Half drum bases with access door • 120" top is two-piece, connected	120 x 48 x 29-1/4"	KACD720120CD	<input type="checkbox"/> <input type="checkbox"/> <input type="checkbox"/> <input type="checkbox"/>	320.0#
 DVTBL	Triangular Table • CD edge all around • Panel base • 48" top is one-piece	48 x 48 x 48"	KACD48TRCD	<input type="checkbox"/> <input type="checkbox"/> <input type="checkbox"/> <input type="checkbox"/>	200.0#
 DVTBL	Triangular Table • CD edge all around • Panel base • 126" top is three-piece, connected • Cutout on each section of three-piece top is predrilled and may not be modified or removed	126 x 126 x 126"	KACD116126TRCD	<input type="checkbox"/> <input type="checkbox"/> <input type="checkbox"/> <input type="checkbox"/>	1500.0#

A

B

HOW TO ORDER

Indicate the following information on order form:

1. Quantity of each item.
2. Model number, including options. See "How To Build a Model Number".
3. Any special service required.

Note:

- The indicates that a choice is required.
- The absence of the indicates that no choice is required.
- Alpha-numeric characters in place of indicate that no other alternatives are available.

HOW TO BUILD A MODEL NUMBER

- A** Select basic model.
- B** Select wood finish.
Refer to color addendum at ki.com or KI Fabrics & Finishes binder.



Darwin® Conference Room Tables

Elliptical/Triangular Tables with CD Edge only

Delivered
Pricing
\$ 4743

\$ 8124

\$ 2859

\$ 14005

SPECIAL SERVICES

Special Carton Marking

With specially marked information N/C

Shipping

Shipped **assembled freight prepaid f.o.b. Mexico City, MX 11000** factory. Freight class #125.

Specifications and prices are subject to change without prior notice.

Darwin® Conference Room Tables

Racetrack/Boat Shape Tables with CD Edge only

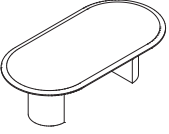
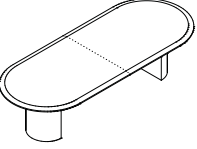
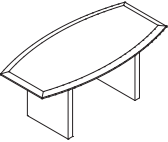
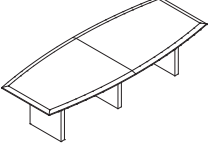
	MODEL	W x D x H	MODEL NUMBER		Approx. Packaged Weight
			Basic Model	Wood Finish	
 DVTBL	Racetrack Table/Half Drum Bases • CD edge all around • Half drum bases with access door • One-piece top	96 x 48 x 29-1/4"	KACD73096CD	<input type="checkbox"/> <input type="checkbox"/> <input type="checkbox"/> <input type="checkbox"/>	326.0#
 DVTBL	Racetrack Table/Half Drum Bases • CD edge all around • Half drum bases with access door • Two-piece top, connected	120 x 48 x 29-1/4"	KACD730120CD	<input type="checkbox"/> <input type="checkbox"/> <input type="checkbox"/> <input type="checkbox"/>	351.0#
		144 x 48 x 29-1/4"	KACD730144CD	<input type="checkbox"/> <input type="checkbox"/> <input type="checkbox"/> <input type="checkbox"/>	395.0#
 DVTBL	Boat Shape Table • CD edge all around • Panel base • One-piece top	72 x 36 x 29-1/4"	KACD3672BTCD	<input type="checkbox"/> <input type="checkbox"/> <input type="checkbox"/> <input type="checkbox"/>	280.0#
		96 x 48 x 29-1/4"	KACD4896BTCD	<input type="checkbox"/> <input type="checkbox"/> <input type="checkbox"/> <input type="checkbox"/>	310.0#
 DVTBL	Boat Shape Table • CD edge all around • Panel base • Two-piece top, connected	120 x 48 x 29-1/4"	KACD48120BTCD	<input type="checkbox"/> <input type="checkbox"/> <input type="checkbox"/> <input type="checkbox"/>	420.0#
		144 x 48 x 29-1/4"	KACD48144BTCD	<input type="checkbox"/> <input type="checkbox"/> <input type="checkbox"/> <input type="checkbox"/>	450.0#

A

B

HOW TO ORDER

Indicate the following information on order form:

- Quantity of each item.
- Model number, including options. See "How To Build a Model Number".
- Any special service required.

Note:

- The indicates that a choice is required.
- The absence of the indicates that no choice is required.
- Alpha-numeric characters in place of indicate that no other alternatives are available.

HOW TO BUILD A MODEL NUMBER

- A** Select basic model.
- B** Select wood finish.
Refer to color addendum at ki.com or KI Fabrics & Finishes binder.



Darwin® Conference Room Tables

Racetrack/Boat Shape Tables with CD Edge only

Delivered
Pricing

\$ 4743

\$ 6632

9332

\$ 3087

4314

\$ 5893

6632

SPECIAL SERVICES

Special Carton Marking

With specially marked information N/C

Shipping

Shipped **assembled freight prepaid f.o.b. Mexico City, MX 11000** factory. Freight class #125.

Specifications and prices are subject to change without prior notice.

Darwin®

Accessories

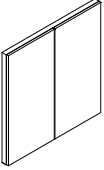
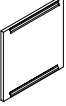
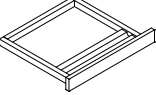
	MODEL	W x H x D	MODEL NUMBER			Approx. Packaged Weight	
			Basic Model	Edge Style	Wood Finish		
 <p>DACC</p>	Visual Board • Two hinged doors • Porcelain writing surface • Hardware included	48 x 48"	KAT78014848	<input type="checkbox"/> <input type="checkbox"/>	<input type="checkbox"/> <input type="checkbox"/> <input type="checkbox"/> <input type="checkbox"/>	120.0#	
 <p>DACC</p>	Wire Access	18 x 18"	KAT78031818		<input type="checkbox"/> <input type="checkbox"/> <input type="checkbox"/> <input type="checkbox"/>	10.0#	
 <p>DACC</p>	Pencil Tray • Front of drawer is angled for thinner profile and greater knee clearance	16 x 13"	KAT78041613		<input type="checkbox"/> <input type="checkbox"/> <input type="checkbox"/> <input type="checkbox"/>	5.0#	
		24 x 21"	KAT78042421		<input type="checkbox"/> <input type="checkbox"/> <input type="checkbox"/> <input type="checkbox"/>	7.0#	

A **B** **C**

HOW TO ORDER

Indicate the following information on order form:

- Quantity of each item.
- Model number, including options. See "How To Build a Model Number".
- Any special service required.

Note:

- The indicates that a choice is required.
- The absence of the indicates that no choice is required.
- Alpha-numeric characters in place of indicate that no other alternatives are available.

HOW TO BUILD A MODEL NUMBER

- A** Select basic model.
- B** Select edge style.

BO	- Quarter round edge
CR	- Reed edge
CV	- Cove edge
EB	- Square edge
PD	- Pyramid edge
- C** Select wood finish color. Refer to color addendum at ki.com or KI Fabrics & Finishes binder.



Delivered
Pricing
\$ 3294

\$ 192

\$ 483
699

SPECIAL SERVICES

Special Carton Marking

With specially marked information N/C



Shipping

Shipped **assembled freight prepaid f.o.b. Mexico City, MX 11000** factory. Freight class #125.

Specifications and prices are subject to change without prior notice.

Darwin®

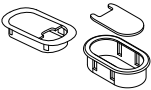
Accessories/Replacement Parts

	MODEL	W x D x H	MODEL NUMBER	
			Basic Model	Approx. Packaged Weight
 HRDPT	Cable Access Panel • Provides easy access to wall outlets behind any desk or credenza with a modesty panel blocking the wall • Includes access panel and Z-brackets • Modesty panel not included • Field install		KE02871.Z203	2.0#
			KE02871.Z204	2.0#
			KE02871.Z213	2.0#
			KE02871.Z214	2.0#
			KE02871.Z220	2.0#
 HRDPT	Oval Grommet Kit for Worksurface • Replacement part • Black	3-7/8 x 2-1/4"	KLA542	0.5#
HRDPT	Round Grommet Kit for Worksurface • Replacement part • Black	3 x 3"	KLA544	0.5#
 HRDPT	Half-Moon Grommet Kit for Side/Back • Replacement part • Black	3-7/8 x 2-1/4"	KLA543	0.5#
HRDPT	Rectangular Grommet • Replacement part • Black	3-7/8 x 2-1/4"	K1094705	0.5#

A

HOW TO ORDER

Indicate the following information on order form:

- Quantity of each item.
- Model number, including options. See "How To Build a Model Number".
- Any special service required.

Note:

- The indicates that a choice is required.
- The absence of the indicates that no choice is required.
- Alpha-numeric characters in place of indicate that no other alternatives are available.

HOW TO BUILD A MODEL NUMBER

A Select basic model.



Delivered Pricing
\$ 613
613
613
613
613
\$ 29
\$ 24
\$ 29
\$ 23

SPECIAL SERVICES

Special Carton Marking

With specially marked information N/C

Shipping

Shipped **assembled freight prepaid f.o.b. Mexico City, MX 11000** factory. Freight class #125.

Specifications and prices are subject to change without prior notice.

Darwin®

Accessories

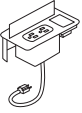
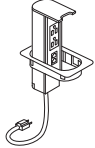
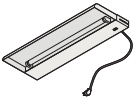
	MODEL	W x D	MODEL NUMBER		
			Basic Model	Approx. Packaged Weight	
 HRDPT	Power/Communication Module <ul style="list-style-type: none"> • For conference tables • Factory installed • Specify quantity and supply sketch of position • Black 	6 x 2-1/4"	KLA540	2.0#	
 HRDPT	Pop-up Receptacle <ul style="list-style-type: none"> • With openings which accommodate power and communication jacks • Takes the place of a factory installed oval grommet • Black 	3-7/8 x 2-1/4"	KLA541	2.0#	
 HRDPT	Magnetic Ballast, Normal Power Factor Task Light <ul style="list-style-type: none"> • Magnetic high-power factor ballast with rapid start cool white lamp • UL listed • Includes 9' cord • Cords can be routed down overhead uprights • Black 	48"	TLT5.48	6.7#	
HRDPT	Keys <ul style="list-style-type: none"> • KY.100 = set of keys • KY.300 = set of cores/keys • KY.500 = core removal key 		KY.100	0.5#	
			KY.300	0.5#	
			KY.500	0.5#	



HOW TO ORDER

Indicate the following information on order form:

1. Quantity of each item.
2. Model number, including options. See "How To Build a Model Number".
3. Any special service required.

- Note:
- The indicates that a choice is required.
 - The absence of the indicates that no choice is required.
 - Alpha-numeric characters in place of indicate that no other alternatives are available.

HOW TO BUILD A MODEL NUMBER

- A** Select basic model.



Delivered
Pricing
\$ 379

\$ 321

\$ 91

\$ 42
31
50

SPECIAL SERVICES

Special Carton Marking

With specially marked information N/C

Shipping

Shipped **assembled freight prepaid f.o.b. Mexico City, MX 11000** factory. Freight class #125.

Specifications and prices are subject to change without prior notice.

Darwin®

Accessories/Darwin® Tackboards

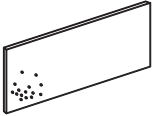
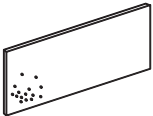
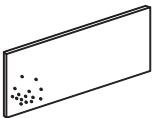
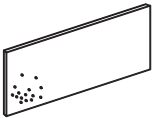
MODEL	W x H	MODEL NUMBER		Approx. Packaged Weight	
		Basic Model	Fabric Color		
 DRTBD	Tackboard for Darwin® Hutch Unit	44 x 23"	KAT78104423	<input type="checkbox"/> <input type="checkbox"/> <input type="checkbox"/> <input type="checkbox"/>	18.0#
	56 x 23"	KAT78105623	<input type="checkbox"/> <input type="checkbox"/> <input type="checkbox"/> <input type="checkbox"/>	22.0#	
	62 x 23"	KAT78106223	<input type="checkbox"/> <input type="checkbox"/> <input type="checkbox"/> <input type="checkbox"/>	24.0#	
	68 x 23"	KAT78106823	<input type="checkbox"/> <input type="checkbox"/> <input type="checkbox"/> <input type="checkbox"/>	27.0#	
	80 x 23"	KAT78108023	<input type="checkbox"/> <input type="checkbox"/> <input type="checkbox"/> <input type="checkbox"/>	28.0#	
	84 x 23"	KAT78108423	<input type="checkbox"/> <input type="checkbox"/> <input type="checkbox"/> <input type="checkbox"/>	34.0#	
	92.7 x 23"	KAT78109423	<input type="checkbox"/> <input type="checkbox"/> <input type="checkbox"/> <input type="checkbox"/>	39.0#	
	98.7 x 23"	KAT78109923	<input type="checkbox"/> <input type="checkbox"/> <input type="checkbox"/> <input type="checkbox"/>	45.0#	
	104.7 x 23"	KAT781010623	<input type="checkbox"/> <input type="checkbox"/> <input type="checkbox"/> <input type="checkbox"/>	47.0#	
 DRTBD	Tackboard for Darwin® Hutch Unit with Pigeonholes	44 x 17"	KAT78114417	<input type="checkbox"/> <input type="checkbox"/> <input type="checkbox"/> <input type="checkbox"/>	18.0#
	56 x 17"	KAT78115617	<input type="checkbox"/> <input type="checkbox"/> <input type="checkbox"/> <input type="checkbox"/>	22.0#	
	62 x 17"	KAT78116217	<input type="checkbox"/> <input type="checkbox"/> <input type="checkbox"/> <input type="checkbox"/>	24.0#	
	68 x 17"	KAT78116817	<input type="checkbox"/> <input type="checkbox"/> <input type="checkbox"/> <input type="checkbox"/>	27.0#	
	80 x 17"	KAT78118017	<input type="checkbox"/> <input type="checkbox"/> <input type="checkbox"/> <input type="checkbox"/>	28.0#	
	84 x 17"	KAT78118417	<input type="checkbox"/> <input type="checkbox"/> <input type="checkbox"/> <input type="checkbox"/>	34.0#	
	92.7 x 17"	KAT78119417	<input type="checkbox"/> <input type="checkbox"/> <input type="checkbox"/> <input type="checkbox"/>	39.0#	
	98.7 x 17"	KAT78119917	<input type="checkbox"/> <input type="checkbox"/> <input type="checkbox"/> <input type="checkbox"/>	45.0#	
	104.7 x 17"	KAT781110617	<input type="checkbox"/> <input type="checkbox"/> <input type="checkbox"/> <input type="checkbox"/>	47.0#	
 DRTBD	Tackboard for Darwin® Wall Mounted Storage Unit	24 x 23"	KAT78122423	<input type="checkbox"/> <input type="checkbox"/> <input type="checkbox"/> <input type="checkbox"/>	15.0#
	30 x 23"	KAT78123023	<input type="checkbox"/> <input type="checkbox"/> <input type="checkbox"/> <input type="checkbox"/>	16.0#	
	36 x 23"	KAT78123623	<input type="checkbox"/> <input type="checkbox"/> <input type="checkbox"/> <input type="checkbox"/>	18.0#	
	42 x 23"	KAT78124223	<input type="checkbox"/> <input type="checkbox"/> <input type="checkbox"/> <input type="checkbox"/>	22.0#	
	48 x 23"	KAT78124823	<input type="checkbox"/> <input type="checkbox"/> <input type="checkbox"/> <input type="checkbox"/>	24.0#	
	60 x 23"	KAT78126023	<input type="checkbox"/> <input type="checkbox"/> <input type="checkbox"/> <input type="checkbox"/>	25.0#	
	66 x 23"	KAT78126623	<input type="checkbox"/> <input type="checkbox"/> <input type="checkbox"/> <input type="checkbox"/>	26.0#	
	72 x 23"	KAT78127223	<input type="checkbox"/> <input type="checkbox"/> <input type="checkbox"/> <input type="checkbox"/>	27.0#	
	 DRTBD	Tackboard for Darwin® Wall Mounted Storage Unit with Pigeonholes	24 x 17"	KAT78132417	<input type="checkbox"/> <input type="checkbox"/> <input type="checkbox"/> <input type="checkbox"/>
30 x 17"		KAT78133017	<input type="checkbox"/> <input type="checkbox"/> <input type="checkbox"/> <input type="checkbox"/>	16.0#	
36 x 17"		KAT78133617	<input type="checkbox"/> <input type="checkbox"/> <input type="checkbox"/> <input type="checkbox"/>	18.0#	
42 x 17"		KAT78134217	<input type="checkbox"/> <input type="checkbox"/> <input type="checkbox"/> <input type="checkbox"/>	22.0#	
48 x 17"		KAT78134817	<input type="checkbox"/> <input type="checkbox"/> <input type="checkbox"/> <input type="checkbox"/>	24.0#	
60 x 17"		KAT78136017	<input type="checkbox"/> <input type="checkbox"/> <input type="checkbox"/> <input type="checkbox"/>	25.0#	
66 x 17"		KAT78136617	<input type="checkbox"/> <input type="checkbox"/> <input type="checkbox"/> <input type="checkbox"/>	26.0#	
72 x 17"		KAT78137217	<input type="checkbox"/> <input type="checkbox"/> <input type="checkbox"/> <input type="checkbox"/>	27.0#	

A

B

HOW TO ORDER

Indicate the following information on order form:

- Quantity of each item.
- Model number, including options. See "How To Build a Model Number".
- Any special service required.

Note: • The indicates that a choice is required.

- The absence of the indicates that no choice is required.
- Alpha-numeric characters in place of indicate that no other alternatives are available.

HOW TO BUILD A MODEL NUMBER

- A** Select basic model.
B Select fabric color.
 Refer to color addendum at ki.com or in KI Fabrics & Finishes binder.

INFORMATION

Hutch Size	Tackboard Size
46-1/2" wide	44" wide
58-1/2" wide	56" wide
64-1/2" wide	62" wide (2 tackboards)
70-1/2" wide	68" wide (2 tackboards)
82-1/2" wide	80" wide (2 tackboards)
86-3/4" wide	84" wide (2 tackboards)
96" wide*	92.7" wide (2 tackboards)
102" wide*	98.7" wide (2 tackboards)
108" wide*	104.7" wide (2 tackboards)

*Hutches larger than 88" are for use with a combination of two desks



Delivered Pricing Fabric Grade 1 & C.O.M.	Delivered Pricing Fabric Grade 2	Delivered Pricing Fabric Grade 3 & Pallas Vertical Fabric Grade PV	Delivered Pricing Pallas Vertical Fabric Grade PV1	Delivered Pricing Pallas Vertical Fabric Grade PV2
\$ 190	\$ 198	\$ 202	\$ 211	\$ 227
239	251	255	269	288
245	255	259	276	294
254	267	270	284	307
276	286	290	308	330
288	295	299	308	335
322	329	334	341	357
341	347	350	362	375
365	372	376	383	403
\$ 190	\$ 198	\$ 202	\$ 211	\$ 227
239	251	255	269	288
245	255	259	276	294
254	267	270	284	307
276	286	290	308	330
288	295	299	308	335
322	329	334	341	357
341	347	350	362	375
365	372	376	383	403
\$ 156	\$ 164	\$ 166	\$ 176	\$ 190
168	174	177	190	201
178	184	191	203	213
190	198	202	211	227
239	251	255	269	288
245	255	259	276	294
266	273	281	291	302
282	290	302	313	324
\$ 156	\$ 164	\$ 166	\$ 176	\$ 190
168	174	177	190	201
178	184	191	203	213
190	198	202	211	227
239	251	255	269	288
245	255	259	276	294
266	273	281	291	302
282	290	302	313	324

SPECIAL SERVICES

Special Carton Marking

With specially marked information N/C

Shipping

Shipped k.d. freight prepaid f.o.b. Manitowoc, Wisconsin 54220 factory. Freight class #70.

Specifications and prices are subject to change without prior notice.

Index

Model No.	Description	Page	Model No.	Description	Page
K1094705	Accessories/Replacement Parts: Rectangular Grommet	116	KAT40373060	Table Desks: P-Shaped Desk - Right - Full Modesty Panel	16
KA.901.28.S	File Bars - Side-to-Side	100	KAT40383060	PT Edge Mitered Table Desks: Mitered P-Shaped Table	
KA.903.28.S	File Bars - Front-to-Back	100		- Left with Full Modesty Panel	54
KA70036	Round/Rectangular Tables: Round Table	102	KAT40393060	PT Edge Mitered Table Desks: Mitered P-Shaped Table	
KA720120	Elliptical Tables: Elliptical Table/Half Drum Bases	104		- Right with Full Modesty Panel	54
KA72096	Elliptical Tables: Elliptical Table/Half Drum Bases	104	KAT40413060	Table Desks: D-Shaped Rectangular Desk - Straight	
KA722120	Elliptical Tables: Elliptical Table/Full Drum Bases	104		Leg - 3/4 Modesty Panel	18
KA72296	Elliptical Tables: Elliptical Table/Full Drum Bases	104	KAT40423060	Table Desks: D-Shaped Rectangular Desk - Straight	
KA730120	Racetrack Tables: Racetrack Table/Half Drum Bases	106		Leg - Full Modesty Panel	18
KA73072	Racetrack Tables: Racetrack Table/Half Drum Bases	106	KAT40433060	PT Edge Mitered Table Desks: Mitered Rectangular	
KA732120	Racetrack Tables: Racetrack Table/Full Drum Bases	106		Desk - Left with 3/4 Modesty Panel	56
KA73272	Racetrack Tables: Racetrack Table/Full Drum Bases	106	KAT40443060	PT Edge Mitered Table Desks: Mitered Rectangular	
KA740120	Round/Rectangular Tables: Rectangular Table	102		Desk - Right with 3/4 Modesty Panel	56
KA74072	Round/Rectangular Tables: Rectangular Table	102	KAT40483060	PT Edge Mitered Table Desks: Mitered Rectangular	
KACD116126TRCD				Desk - Left with Full Modesty Panel	58
	Elliptical/Triangular Tables with CD Edge only: Triangu-		KAT40493060	PT Edge Mitered Table Desks: Mitered Rectangular	
	lar Table	110		Desk - Right with Full Modesty Panel	58
KACD3672BTCD	Racetrack/Boat Shape Tables with CD Edge only: Boat		KAT40533660	Corner Desks: J-Shaped Corner Desk - Left - Full	
	Shape Table	112		Modesty Panel	20
KACD48120BTCD			KAT40543660	Corner Desks: J-Shaped Corner Desk - Right - Full	
	Racetrack/Boat Shape Tables with CD Edge only: Boat			Modesty Panel	20
	Shape Table	112	KAT40613660	Corner Table Desks: Bullet Corner Table - 30" - Left -	
KACD48TRCD	Elliptical/Triangular Tables with CD Edge only: Triangu-			3/4 Modesty Panel	22
	lar Table	110	KAT40623660	Corner Table Desks: Bullet Corner Table - 30" - Right -	
KACD70048CD	Round/Rectangular Tables with CD Edge only: Round Table	108		3/4 Modesty Panel	22
KACD720120CD	Elliptical/Triangular Tables with CD Edge only: Elliptical		KAT40634260	Corner Desks: Bullet Corner Table - 36" - Left - 3/4	
	Table/Half Drum Bases	110		Modesty Panel	24
KACD72096CD	Elliptical/Triangular Tables with CD Edge only: Elliptical		KAT40644260	Corner Desks: Bullet Corner Table - 36" - Right - 3/4	
	Table/Half Drum Bases	110		Modesty Panel	24
KACD730120CD	Racetrack/Boat Shape Tables with CD Edge only:		KAT40653660	Corner Desks: Bullet Corner Table - 30" - Left - Full	
	Racetrack Table/Half Drum Bases	112		Modesty Panel	26
KACD73096CD	Racetrack/Boat Shape Tables with CD Edge only:		KAT40663660	Corner Desks: Bullet Corner Table - 30" - Right - Full	
	Racetrack Table/Half Drum Bases	112		Modesty Panel	26
KACD740120CD	Round/Rectangular Tables with CD Edge only: Rectan-		KAT40674260	Corner Desks: Bullet Corner Table - 36" - Left - Full	
	gular Table	108		Modesty Panel	28
KACD74096CD	Round/Rectangular Tables with CD Edge only: Rectan-		KAT40684260	Corner Desks: Bullet Corner Table - 36" - Right - Full	
	gular Table	108		Modesty Panel	28
KAT40013672	Desks and Desk Shells: Bow Front Desk, Double Pedestal	10	KAT41012424	Bridges: Executive Bridge Unit - Full Modesty Panel	32
KAT40023672	Desks and Desk Shells: Bow Front Desk - Shell	10	KAT41022424	Bridges: Executive Bridge Unit - 3/4 Modesty Panel	32
KAT40033672	PT Edge Mitered Desks: Mitered Bow Front Desk Shell - Left	44	KAT41032424	Bridges: Connecting Top	32
KAT40043672	PT Edge Mitered Desks: Mitered Bow Front Desk Shell - Right	44	KAT41112424	PT Edge Mitered Bridges: Double Mitered Executive	
KAT40123060	Desks and Desk Shells: Desk - Shell	10		Bridge Unit - 3/4 Modesty Panel	62
KAT40133060	PT Edge Mitered Desks: Mitered Desk Shell - Left	46	KAT41122424	PT Edge Mitered Bridges: Double Mitered Executive	
KAT40143060	PT Edge Mitered Desks: Mitered Desk Shell - Right	46		Bridge Unit - Full Modesty Panel	62
KAT40223060	Table Desks: Bullet Desk - 3/4 Modesty Panel	12	KAT41132424	PT Edge Mitered Bridges: Double Mitered Connecting Top	62
KAT40233060	PT Edge Mitered Table Desks: Mitered Bullet Desk -		KAT42113660	Extended Corners: Extended Corner - Left	34
	Left with 3/4 Modesty Panel	48	KAT42123660	Extended Corners: Extended Corner - Right	34
KAT40243060	PT Edge Mitered Table Desks: Mitered Bullet Desk -		KAT43012436	Executive Return Shells: Executive Return Shell - Left	30
	Right with 3/4 Modesty Panel	48	KAT43022436	Executive Return Shells: Executive Return Shell - Right	30
KAT40273060	Table Desks: Bullet Desk - Full Modesty Panel	12	KAT43032436	PT Edge Mitered Returns: Mitered - Executive Return - Left	60
KAT40283060	PT Edge Mitered Table Desks: Mitered Bullet Desk -		KAT43042436	PT Edge Mitered Returns: Mitered - Executive Return - Right	60
	Left with Full Modesty Panel	50	KAT45112436	Credenzas: Credenza Shell	36
KAT40293060	PT Edge Mitered Table Desks: Mitered Bullet Desk -		KAT45122436	Credenzas: Credenza Shell - Left	36
	Right with Full Modesty Panel	50	KAT45132436	Credenzas: Credenza Shell - Right	36
KAT40313060	Table Desks: P-Shaped Desk - Left - 3/4 Modesty Panel	14	KAT45142448	PT Edge Mitered Credenzas: Mitered Credenza Shell - Left	64
KAT40323060	Table Desks: P-Shaped Desk - Right - 3/4 Modesty Panel	14	KAT45152448	PT Edge Mitered Credenzas: Mitered Credenza Shell - Right	64
KAT40333060	PT Edge Mitered Table Desks: Mitered P-Shaped Table		KAT55013060	Reception Desks: Reception Desk - Bow Shaped	
	- Left with 3/4 Modesty Panel	52		Transaction Top	38
KAT40343060	PT Edge Mitered Table Desks: Mitered P-Shaped Table		KAT55033060	Reception Desks: Reception Desk - Rectangular Trans-	
	- Right with 3/4 Modesty Panel	52		action Top	38
KAT40363060	Table Desks: P-Shaped Desk - Left - Full Modesty Panel	16	KAT55113036	Reception Returns: Reception Desk - Return - Left	40



Model No.	Description	Page	Model No.	Description	Page
KAT55113636	Reception Returns: Reception Desk - Return - Left	40	KAT78122423	Accessories/Darwin® Tackboards: Tackboard for Darwin® Wall Mounted Storage Unit	120
KAT55123036	Reception Returns: Reception Desk - Return - Right	40			
KAT55123636	Reception Returns: Reception Desk - Return - Right	40	KAT78132417	Accessories/Darwin® Tackboards: Tackboard for Darwin® Wall Mounted Storage Unit with Pigeonholes	120
KAT55182436	Reception - Bridge/Credenza: Reception - Bridge	42			
KAT55192466	Reception - Bridge/Credenza: Reception - Credenza	42	KAT79013029	Lateral Files: Wood Lateral Files - 18" Deep	98
KAT60011747	Hutches: Hutch Unit - Veneer Doors	66	KAT79053029	Lateral Files: Wood Lateral Files - 24" Deep	98
KAT60111747	Hutches: Hutch Unit with Pigeonholes - Veneer Doors	66	KE02871.Z203	Accessories/Replacement Parts: Cable Access Panel	116
KAT60151759	Hutches: Hutch Unit - Sliding Wood Door - Pigeonholes	68	KLA540	Accessories: Power/Communication Module	118
KAT60171747	Hutches: Hutch Unit with Rectangular Veneer Doors - Concealed Pigeonholes	68	KLA541	Accessories: Pop-up Receptacle	118
			KLA542	Accessories/Replacement Parts: Oval Grommet Kit for Worksurface	116
KAT65011624	Storage Units: Wall Mount Storage Unit - Veneer Doors	70			
KAT65112424	Storage Units: Wall Mount Storage Unit - Concealed Pigeonholes - Veneer Doors	70	KLA543	Accessories/Replacement Parts: Half-Moon Grommet Kit for Side/Back	116
KAT65152436	Storage Units: Wall Mount Storage Unit - Pigeonholes - Sliding Veneer Doors	74	KLA544	Accessories/Replacement Parts: Round Grommet Kit for Worksurface	116
KAT65162436	Storage Units: Wall Mount Storage Unit - Pigeonholes - Sliding Wood Door with White Overlaid Glass	74	KY.100	Accessories: Keys	118
KAT65211624	Storage Units: Wall Mount Storage Unit - No Doors	72	TLT5.48	Accessories: Magnetic Ballast, Normal Power Factor Task Light	118
KAT65222424	Storage Units: Wall Mount Storage Unit - Pigeonholes - No Doors	72			
KAT70012017	Sub-Surface Storage-No Tops: Storage Unit with Door - Left and Right	76			
KAT70052417	Freestanding and Mobile Pedestals with Tops: File/File Pedestal	80			
KAT70062417	Freestanding and Mobile Pedestals with Tops: Box/Box/File Pedestal	80			
KAT70072017	Sub-Surface Storage-No Tops: File Pedestal	76			
KAT70082017	Sub-Surface Storage-No Tops: Box/Box/File Pedestal	76			
KAT70112028	Sub-Surface Storage-No Tops: Bookcase Unit	76			
KAT70132028	Sub-Surface Storage: Lateral File	78			
KAT70142034	Sub-Surface Storage: Multiframe - Left and Right	78			
KAT70261719	Freestanding and Mobile Pedestals with Tops: Box/File Mobile Pedestal	80			
KAT71112434	Storage - with Top: Bookcase Unit	82			
KAT71132434	Storage - with Top: Lateral File	82			
KAT71142434	Storage - with Top: Multiframe - Left and Right	82			
KAT75011870	Storage Units - Veneer Doors: Storage Tower - Left and Right	84			
KAT75111870	Storage Units - Veneer Doors: 2 Drawer File/Storage Cabinet - Left and Right	84			
KAT75211870	Storage Units - Veneer Doors: Mixed Drawers/Storage Cabinet - Left and Right	86			
KAT76033670	Storage Units - Veneer Doors: Storage/Wardrobe Unit	88			
KAT76053670	Storage Units - Veneer Doors: Storage Cabinet with 2 File Drawers	88			
KAT76073670	Storage Units - Veneer Doors: Wardrobe Cabinet with File Drawers - Left and Right	90			
KAT76093670	Storage Units - Veneer Doors: Split Storage/Wardrobe Cabinet - Left and Right	90			
KAT76113670	Storage: File/ Bookcase Storage Unit	94			
KAT77052370	Storage: Corner Display Shelves	96			
KAT77103628	Bookcases - 16" Deep: Open Bookcase	92			
KAT77113628	Bookcases - 16" Deep: Bookcase with Wood Doors	92			
KAT77202841	Storage: Open Bookcase-Stack On Storage Unit	94			
KAT77212841	Storage: Bookcase with Wood Doors-Stack On Storage Unit	94			
KAT78014848	Accessories: Visual Board	114			
KAT78031818	Accessories: Wire Access	114			
KAT78041613	Accessories: Pencil Tray	114			
KAT78104423	Accessories/Darwin® Tackboards: Tackboard for Darwin® Hutch Unit	120			
KAT78114417	Accessories/Darwin® Tackboards: Tackboard for Darwin® Hutch Unit with Pigeonholes	120			



KI
1330 Bellevue Street
P.O. Box 8100
Green Bay, Wisconsin 54308-8100
1-800-424-2432
www.ki.com

KI and Furnishing Knowledge
are registered trademarks
of Krueger International, Inc.

© 2011 KI
All Rights Reserved.
Litho in USA.
Code KI-11577/KI/PDF/711

Printed using only water-based inks,
including metallics. Please recycle.