

January 3, 2011

Updated January 2, 2017

800-424-2432





<b>Fabric Panel - Tackable Acoustic - 3/8" Thick Tiles</b>		
Face Styles		2
Half Segmented/Half Segmented Panel		6
Monolithic/Half Segmented Panel		14
<b>Glass/Fabric Panel - Acoustic - 3/8" Thick Tiles</b>		
Monolithic/Glass/Monolithic/Glass Panel		22
<b>Fabric Panel - Tackable Acoustic - 3/4" Thick Tiles</b>		
Face Styles		26
<b>Fabric Panel - Tackable Acoustic - 3/4" Thick Tiles</b>		
Monolithic Panel		30
Monolithic/Half Segmented Panel		34
Monolithic/Fully Segmented Panel		38
Half Segmented/Half Segmented Panel		42
Half Segmented/Fully Segmented Panel		46
Fully Segmented/Fully Segmented Panel		50
<b>Glass Panel</b>		
Face Styles		54
Full Glass Panel		56
<b>Glass/Fabric Panel - Acoustic - 3/4" Thick Tiles</b>		
Monolithic/Monolithic/Glass Panel		58
Monolithic/Fully Segmented/Glass Panel		60
Fully Segmented/Fully Segmented/Glass Panel		64
<b>Open Panel</b>		
Face Styles		68
Full Open Panel		70
<b>Open/Fabric Panel - Acoustic - 3/4" Thick Tiles</b>		
Open/Monolithic/Monolithic Panel		74
Monolithic/Monolithic/Open Panel		78
<b>Fabric Stackable Section - Acoustic - 3/4" Tiles</b>		
		82
<b>Glass Stackable Section</b>		84
<b>Open Stackable Section</b>		86
<b>Doors</b>		88
<b>Preconfigured Intersection Conditions</b>		
90° 2-Way and End-of-Run		90
90° 2-Way		92
Off-Module Post		100
Adjustable Wall Mount		102
180° 2-Way		104
3-Way		112
4-Way		126
<b>Preconfigured Stackable Intersection Conditions</b>		
180° 2-Way and End-of-Run		140
2-Way and 3-Way		142
2-Way, 3-Way and 4-Way		144
<b>Electrical</b>		
10-Wire System 6 Circuit "810"		146
10-Wire System 4 Circuit "810"		158
8-Wire System		170
<b>Cable Management</b>		180
<b>Worksurfaces</b>		
Rectangular		184
"P" Shaped Peninsula/Piano Peninsula		186
Square Shoe/Conference End		188
"D" Shaped Peninsula		190
Dual Curvilinear/Diag/Curvilinear 90° Corner		192
Countertops		194
Mobile Teardrop/Mobile Semi-Circle		196
Worksurface Support Panel		200
<b>Worksurface Accessories</b>		
Worksurface Accessories		204
<b>Universal Storage and Accessories</b>		
Overhead Storage		206
Overhead Accessories		220
Shelf/Cabinet Task Light		224
<b>Balance® Storage and Accessories</b>		
General Information		226
Overhead Storage		228
Overhead Accessories		240
Overhead Task Lights		246
<b>Accessories</b>		
Panel Mount Task Light		248
Markerboards		250
Tackboard		252
Brackets		258
Paper Management		260
Desktop Accessories		262
<b>120° Intersections</b>		
2-Way		264
3-Way		270
2-Way and 3-Way Stackable		280
<b>120° Worksurfaces</b>		
Corner Worksurfaces		282
<b>120° Build Your Own Components</b>		284
<b>Tech Preconfigured Intersection Conditions</b>		
90° 2-Way and End-of-Run		288
90° 2-Way		290
180° 2-Way		298
3-Way		304
4-Way		310
Tech Panel Components		316
<b>Pedestals - Worksurface Supporting</b>		
700 Series® Pedestals with Filler Bracket		318
<b>WireWorks® C.O.M. Yardage Requirements</b>		320
<b>Index</b>		322





# Fabric Panel -Tackable Acoustic (3/8" Thick Tiles)

## Face Styles

### Face Style: Monolithic/Glass/ Monolithic/Glass

### Basic Model: PMMGB

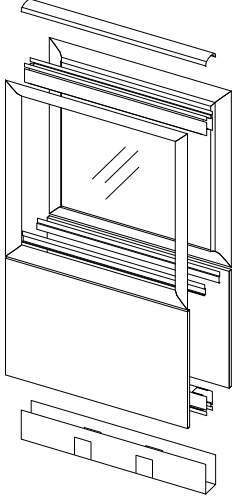

Monolithic/Glass/Monolithic/Glass panels consist of the following: 24" fabric tile on bottom; Remainder of panel consists of one glass tile utilizing a single pane of 1/4" thick tempered glass. Base is 6". Panel thickness: 3 1/2".

The 3/8" Tackable/Acoustic tile consists of one piece of 3/8" thick fiberglass board. Each tile has two steel rails, positioned near top and bottom of tile, to provide increased strength. Fabric is glued to the face, edges and back of the fiberglass board.

### STANDARD PANEL SIZES

	12" W	18" W	24" W	30" W	36" W	42" W	48" W
42" H	•	•	•	•	•	•	•
48" H	•	•	•	•	•	•	•
54" H	•	•	•	•	•	•	•
66" H	•	•	•	•	•	•	•
84" H	•	•	•	•	•	•	•



# Fabric Panel -Tackable Acoustic (3/8" Thick Tiles)

Face Styles

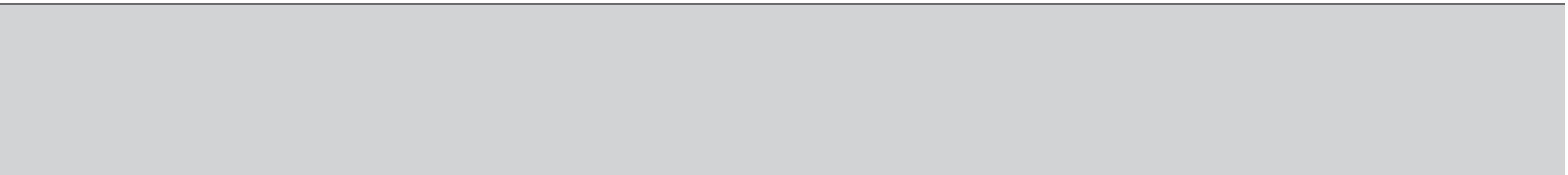

# Fabric Panel - Tackable Acoustic (3/8" Thick Tiles)

Half Segmented/Half Segmented Panel

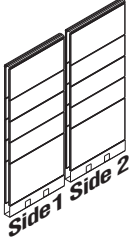
		MODEL NUMBER							
MODEL	W x H	Basic Model	Electrical Code	Horizontal Rail	Number of Raceway Tiles Side 1	Number of Raceway Tiles Side 2	Trim Color	Fabric Side 1	Fabric Side 2
 <p>PHH8</p>	<b>Half Segmented/Half Segmented Panel - 30"H with 18"H Tiles</b> • Two steel horizontal rails • One to three sets of plastic light blocks • Two 24" high fabric tiles with grey mounting hooks • Two, four or six 18" high fabric tiles with grey mounting hooks • One base/raceway consisting of a raceway pan and two doors • One rounded satin-textured polypropylene top cap with splice plate • Order power separately • Order vertical posts separately • SX Starlight Silver finish is only offered on flat aluminum trim	12 x 30"	PHH81230	<input type="checkbox"/>	<input type="checkbox"/>	<input type="checkbox"/>	<input type="checkbox"/>	<input type="checkbox"/>	<input type="checkbox"/>
	18 x 30"	PHH81830	<input type="checkbox"/>	<input type="checkbox"/>	<input type="checkbox"/>	<input type="checkbox"/>	<input type="checkbox"/>	<input type="checkbox"/>	<input type="checkbox"/>
	24 x 30"	PHH82430	<input type="checkbox"/>	<input type="checkbox"/>	<input type="checkbox"/>	<input type="checkbox"/>	<input type="checkbox"/>	<input type="checkbox"/>	<input type="checkbox"/>
	30 x 30"	PHH83030	<input type="checkbox"/>	<input type="checkbox"/>	<input type="checkbox"/>	<input type="checkbox"/>	<input type="checkbox"/>	<input type="checkbox"/>	<input type="checkbox"/>
	36 x 30"	PHH83630	<input type="checkbox"/>	<input type="checkbox"/>	<input type="checkbox"/>	<input type="checkbox"/>	<input type="checkbox"/>	<input type="checkbox"/>	<input type="checkbox"/>
	42 x 30"	PHH84230	<input type="checkbox"/>	<input type="checkbox"/>	<input type="checkbox"/>	<input type="checkbox"/>	<input type="checkbox"/>	<input type="checkbox"/>	<input type="checkbox"/>
	48 x 30"	PHH84830	<input type="checkbox"/>	<input type="checkbox"/>	<input type="checkbox"/>	<input type="checkbox"/>	<input type="checkbox"/>	<input type="checkbox"/>	<input type="checkbox"/>
	54 x 30"	PHH85430	<input type="checkbox"/>	<input type="checkbox"/>	<input type="checkbox"/>	<input type="checkbox"/>	<input type="checkbox"/>	<input type="checkbox"/>	<input type="checkbox"/>
	60 x 30"	PHH86030	<input type="checkbox"/>	<input type="checkbox"/>	<input type="checkbox"/>	<input type="checkbox"/>	<input type="checkbox"/>	<input type="checkbox"/>	<input type="checkbox"/>
	PHH8								
PHH8	<b>Half Segmented/Half Segmented Panel - 48"H with 18"H Tiles</b>	12 x 48"	PHH81248	<input type="checkbox"/>	<input type="checkbox"/>	<input type="checkbox"/>	<input type="checkbox"/>	<input type="checkbox"/>	<input type="checkbox"/>
	18 x 48"	PHH81848	<input type="checkbox"/>	<input type="checkbox"/>	<input type="checkbox"/>	<input type="checkbox"/>	<input type="checkbox"/>	<input type="checkbox"/>	
	24 x 48"	PHH82448	<input type="checkbox"/>	<input type="checkbox"/>	<input type="checkbox"/>	<input type="checkbox"/>	<input type="checkbox"/>	<input type="checkbox"/>	
	30 x 48"	PHH83048	<input type="checkbox"/>	<input type="checkbox"/>	<input type="checkbox"/>	<input type="checkbox"/>	<input type="checkbox"/>	<input type="checkbox"/>	
	36 x 48"	PHH83648	<input type="checkbox"/>	<input type="checkbox"/>	<input type="checkbox"/>	<input type="checkbox"/>	<input type="checkbox"/>	<input type="checkbox"/>	
	42 x 48"	PHH84248	<input type="checkbox"/>	<input type="checkbox"/>	<input type="checkbox"/>	<input type="checkbox"/>	<input type="checkbox"/>	<input type="checkbox"/>	
	48 x 48"	PHH84848	<input type="checkbox"/>	<input type="checkbox"/>	<input type="checkbox"/>	<input type="checkbox"/>	<input type="checkbox"/>	<input type="checkbox"/>	
	54 x 48"	PHH85448	<input type="checkbox"/>	<input type="checkbox"/>	<input type="checkbox"/>	<input type="checkbox"/>	<input type="checkbox"/>	<input type="checkbox"/>	
60 x 48"	PHH86048	<input type="checkbox"/>	<input type="checkbox"/>	<input type="checkbox"/>	<input type="checkbox"/>	<input type="checkbox"/>	<input type="checkbox"/>		

A

B

C

D

E

F

G

H

## HOW TO ORDER

Indicate the following information on order form:

- Quantity of each item.
- Model number, including options. See "How To Build a Model Number".
- Any special service required.

Note: • The  indicates that a choice is required.

- The absence of the  indicates that no choice is required.
- Alpha-numeric characters in place of  indicate that no other alternatives are available.

## HOW TO BUILD A MODEL NUMBER

**A** Select basic model.

**B** Select electrical code for base raceway.

**CN** - Chicago, no cutouts

**C1** - Chicago, 1 side w/cutouts

**CP** - Chicago, 2 sides w/cutouts

**DN** - Domestic, no cutouts

**D1** - Domestic, 1 side w/cutouts

**D** - Domestic, 2 sides w/cutouts

**C** Select horizontal rail.

**S** - Standard

**E** - Enhanced

**D** Select numbers of raceway tiles side 1

**R0** - Side 1 w/no raceway tile

**R1** - Side 1 w/1-18" raceway tile; add \$32

**E** Select numbers of raceway tiles side 2

**R20** - Side 2 w/no raceway tile

**R21** - Side 2 w/1-18" raceway tile; add \$32

**F** Select trim color.  
Refer to color addendum at ki.com or KI Fabrics & Finishes binder.  
Metallic paint requires upcharge.  
SX Starlight Silver finish is only offered on flat aluminum trim.

**G** Select fabric side 1.  
Refer to color addendum at ki.com or in KI Fabrics & Finishes binder.

**H** Select fabric side 2.  
Refer to color addendum at ki.com or in KI Fabrics & Finishes binder.

## UPHOLSTERY INFORMATION

### Fabric Mixing

If fabric is ordered from one group on side 1 and another group on side 2, calculate list price using the following method:

Example:

Grade 2 Fabric  
-Grade1 Fabric

Upcharge

Upcharge/2 = Cost for one side

Grade 1 Fabric  
+Cost for one side

Combined list price

### Fabric Disclaimer

Fabric will be applied as swatched by the fabric manufacturer. Fabric that is required to be applied differently than is swatched will need a Special Cost Request written specify-





# Fabric Panel - Tackable Acoustic (3/8" Thick Tiles)

Half Segmented/Half Segmented Panel

		MODEL NUMBER							
MODEL	W x H	Basic Model	Electrical Code	Horizontal Rail	Number of Raceway Tiles Side 1	Number of Raceway Tiles Side 2	Trim Color	Fabric Side 1	Fabric Side 2
 <p>PHH8</p>	<b>Half Segmented/Half Segmented Panel - 66"H with 18"H Tiles</b>	12 x 66"	PHH81266	<input type="checkbox"/>	<input type="checkbox"/>	<input type="checkbox"/>	<input type="checkbox"/>	<input type="checkbox"/>	<input type="checkbox"/>
		18 x 66"	PHH81866	<input type="checkbox"/>	<input type="checkbox"/>	<input type="checkbox"/>	<input type="checkbox"/>	<input type="checkbox"/>	<input type="checkbox"/>
	• Two steel horizontal rails	24 x 66"	PHH82466	<input type="checkbox"/>	<input type="checkbox"/>	<input type="checkbox"/>	<input type="checkbox"/>	<input type="checkbox"/>	<input type="checkbox"/>
	• One to three sets of plastic light blocks	30 x 66"	PHH83066	<input type="checkbox"/>	<input type="checkbox"/>	<input type="checkbox"/>	<input type="checkbox"/>	<input type="checkbox"/>	<input type="checkbox"/>
	• Two 24" high fabric tiles with grey mounting hooks	36 x 66"	PHH83666	<input type="checkbox"/>	<input type="checkbox"/>	<input type="checkbox"/>	<input type="checkbox"/>	<input type="checkbox"/>	<input type="checkbox"/>
	• Two, four or six 18" high fabric tiles with grey mounting hooks	42 x 66"	PHH84266	<input type="checkbox"/>	<input type="checkbox"/>	<input type="checkbox"/>	<input type="checkbox"/>	<input type="checkbox"/>	<input type="checkbox"/>
	• One base/raceway consisting of a raceway pan and two doors	48 x 66"	PHH84866	<input type="checkbox"/>	<input type="checkbox"/>	<input type="checkbox"/>	<input type="checkbox"/>	<input type="checkbox"/>	<input type="checkbox"/>
	• One rounded satin-textured polypropylene top cap with splice plate	54 x 66"	PHH85466	<input type="checkbox"/>	<input type="checkbox"/>	<input type="checkbox"/>	<input type="checkbox"/>	<input type="checkbox"/>	<input type="checkbox"/>
	• Order power separately	60 x 66"	PHH86066	<input type="checkbox"/>	<input type="checkbox"/>	<input type="checkbox"/>	<input type="checkbox"/>	<input type="checkbox"/>	<input type="checkbox"/>
• Order vertical posts separately									
• SX Starlight Silver finish is only offered on flat aluminum trim									
PHH8	<b>Half Segmented/Half Segmented Panel - 84"H with 18"H Tiles</b>	12 x 84"	PHH81284	<input type="checkbox"/>	<input type="checkbox"/>	<input type="checkbox"/>	<input type="checkbox"/>	<input type="checkbox"/>	<input type="checkbox"/>
		18 x 84"	PHH81884	<input type="checkbox"/>	<input type="checkbox"/>	<input type="checkbox"/>	<input type="checkbox"/>	<input type="checkbox"/>	<input type="checkbox"/>
		24 x 84"	PHH82484	<input type="checkbox"/>	<input type="checkbox"/>	<input type="checkbox"/>	<input type="checkbox"/>	<input type="checkbox"/>	<input type="checkbox"/>
		30 x 84"	PHH83084	<input type="checkbox"/>	<input type="checkbox"/>	<input type="checkbox"/>	<input type="checkbox"/>	<input type="checkbox"/>	<input type="checkbox"/>
		36 x 84"	PHH83684	<input type="checkbox"/>	<input type="checkbox"/>	<input type="checkbox"/>	<input type="checkbox"/>	<input type="checkbox"/>	<input type="checkbox"/>
		42 x 84"	PHH84284	<input type="checkbox"/>	<input type="checkbox"/>	<input type="checkbox"/>	<input type="checkbox"/>	<input type="checkbox"/>	<input type="checkbox"/>
		48 x 84"	PHH84884	<input type="checkbox"/>	<input type="checkbox"/>	<input type="checkbox"/>	<input type="checkbox"/>	<input type="checkbox"/>	<input type="checkbox"/>
		54 x 84"	PHH85484	<input type="checkbox"/>	<input type="checkbox"/>	<input type="checkbox"/>	<input type="checkbox"/>	<input type="checkbox"/>	<input type="checkbox"/>
	60 x 84"	PHH86084	<input type="checkbox"/>	<input type="checkbox"/>	<input type="checkbox"/>	<input type="checkbox"/>	<input type="checkbox"/>	<input type="checkbox"/>	
		<b>A</b>	<b>B</b>	<b>C</b>	<b>D</b>	<b>E</b>	<b>F</b>	<b>G</b>	<b>H</b>

## HOW TO ORDER

Indicate the following information on order form:

- Quantity of each item.
- Model number, including options. See "How To Build a Model Number".
- Any special service required.

Note: • The  indicates that a choice is required.

- The absence of the  indicates that no choice is required.
- Alpha-numeric characters in place of  indicate that no other alternatives are available.

## HOW TO BUILD A MODEL NUMBER

**A** Select basic model.

**B** Select electrical code for base raceway.

- CN** - Chicago, no cutouts
- C1** - Chicago, 1 side w/cutouts
- CP** - Chicago, 2 sides w/cutouts
- DN** - Domestic, no cutouts
- D1** - Domestic, 1 side w/cutouts
- D** - Domestic, 2 sides w/cutouts

**C** Select horizontal rail.

- S** - Standard
- E** - Enhanced

**D** Select numbers of raceway tiles side 1

- R0** - Side 1 w/no raceway tile
- R1** - Side 1 w/1-18" raceway tile; add \$32
- R2** - Side 1 w/2-18" raceway tiles; add \$64

**E** Select numbers of raceway tiles side 2

- R20** - Side 2 w/no raceway tile

**R21** - Side 2 w/1-18" raceway tile; add \$32

**R22** - Side 2 w/2-18" raceway tiles; add \$64

**F** Select trim color.

Refer to color addendum at [ki.com](http://ki.com) or KI Fabrics & Finishes binder. Metallic paint requires upcharge. SX Starlight Silver finish is only offered on flat aluminum trim.

**G** Select fabric side 1.

Refer to color addendum at [ki.com](http://ki.com) or in KI Fabrics & Finishes binder.

**H** Select fabric side 2.

Refer to color addendum at [ki.com](http://ki.com) or in KI Fabrics & Finishes binder.

## UPHOLSTERY INFORMATION

### Fabric Mixing

If fabric is ordered from one group on side 1 and another group on side 2, calculate list price using the following method:

Example:  
Grade 2 Fabric  
-Grade1 Fabric

Upcharge

Upcharge/2 = Cost for one side

Grade 1 Fabric  
+Cost for one side

Combined list price

### Fabric Disclaimer

Fabric will be applied as swatched by the fabric manufacturer. Fabric that is required to be applied differently than is swatched will need a Special Cost Request written specify-



# Fabric Panel - Tackable Acoustic (3/8" Thick Tiles)

Half Segmented/Half Segmented Panel

Approx. Packaged Weight	Delivered Pricing Fabric Grade 1 & C.O.M.	Delivered Pricing Fabric Grade 2	Delivered Pricing Fabric Grade 3 & Pallas Vertical Fabric Grade PV	Delivered Pricing Pallas Vertical Fabric Grade PV1	Delivered Pricing Pallas Vertical Fabric Grade PV2	Enhanced Horizontal Rail	Metallic Paint add to list price
34.0#	\$ 416	\$ 433	\$ 461	\$ 481	\$ 512	\$ 47	\$ 31
47.0#	510	530	570	587	630	49	32
60.0#	565	588	627	642	693	52	36
73.0#	722	754	805	830	891	64	46
86.0#	777	809	862	890	961	70	48
99.0#	847	883	938	967	1037	79	59
112.0#	871	906	965	992	1067	88	62
125.0#	955	991	1059	1091	1174	97	65
141.0#	1076	1119	1188	1226	1314	104	84
47.0#	\$ 527	\$ 549	\$ 586	\$ 608	\$ 655	\$ 47	\$ 31
65.0#	646	673	721	746	808	49	32
83.0#	708	740	788	813	877	52	36
101.0#	913	953	1019	1052	1138	64	46
116.0#	981	1029	1096	1133	1226	70	48
137.0#	1062	1106	1179	1222	1311	79	59
155.0#	1091	1140	1209	1252	1353	88	62
173.0#	1200	1255	1337	1382	1492	97	65
195.0#	1354	1413	1502	1551	1673	104	84

ing the direction the fabric is to be applied. The posted standard lead time will apply to the Special Cost Request.

## INFORMATION

### Maximum Raceway Tile Possibilities

Panel Height Side 1 Side 2

30"H	0	0
48"H	1	1
66"H	2	2
84"H	2	2

## SPECIAL SERVICES

### Special Carton Marking

With specially marked information N/C

### Shipping

Shipped **k.d. freight prepaid f.o.b. Manitowoc, Wisconsin 54220** factory. Freight class #70.

Specifications and prices are subject to change without prior notice.

# Fabric Panel - Tackable Acoustic (3/8" Thick Tiles)

Half Segmented/Half Segmented Panel

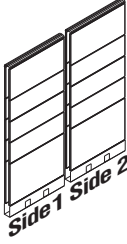
MODEL	W x H	MODEL NUMBER								
		Basic Model	Electrical Code	Horizontal Rail	Number of Raceway Tiles Side 1	Number of Raceway Tiles Side 2	Trim Color	Fabric Side 1	Fabric Side 2	
 <p>PHH2</p> <p><b>Half Segmented/Half Segmented Panel - 42"H with 12"H Tiles</b></p> <ul style="list-style-type: none"> <li>Two steel horizontal rails</li> <li>One to four sets of plastic light blocks</li> <li>Two 24" high fabric tiles with grey mounting hooks</li> <li>Two, four or six 12" high fabric tiles with grey mounting hooks</li> <li>Two 18" high fabric tiles included with 84" high panel with grey mounting hooks</li> <li>One base/raceway consisting of a raceway pan and two doors</li> <li>One rounded satin-textured polypropylene top cap with splice plate</li> <li>Order power separately</li> <li>Order vertical posts separately</li> <li>SX Starlight Silver finish is only offered on flat aluminum trim</li> </ul>	12 x 42"	PHH21242	<input type="checkbox"/>	<input type="checkbox"/>	<input type="checkbox"/>	<input type="checkbox"/>	<input type="checkbox"/>	<input type="checkbox"/>	<input type="checkbox"/>	
	18 x 42"	PHH21842	<input type="checkbox"/>	<input type="checkbox"/>	<input type="checkbox"/>	<input type="checkbox"/>	<input type="checkbox"/>	<input type="checkbox"/>	<input type="checkbox"/>	
	24 x 42"	PHH22442	<input type="checkbox"/>	<input type="checkbox"/>	<input type="checkbox"/>	<input type="checkbox"/>	<input type="checkbox"/>	<input type="checkbox"/>	<input type="checkbox"/>	
	30 x 42"	PHH23042	<input type="checkbox"/>	<input type="checkbox"/>	<input type="checkbox"/>	<input type="checkbox"/>	<input type="checkbox"/>	<input type="checkbox"/>	<input type="checkbox"/>	
	36 x 42"	PHH23642	<input type="checkbox"/>	<input type="checkbox"/>	<input type="checkbox"/>	<input type="checkbox"/>	<input type="checkbox"/>	<input type="checkbox"/>	<input type="checkbox"/>	
	42 x 42"	PHH24242	<input type="checkbox"/>	<input type="checkbox"/>	<input type="checkbox"/>	<input type="checkbox"/>	<input type="checkbox"/>	<input type="checkbox"/>	<input type="checkbox"/>	
	48 x 42"	PHH24842	<input type="checkbox"/>	<input type="checkbox"/>	<input type="checkbox"/>	<input type="checkbox"/>	<input type="checkbox"/>	<input type="checkbox"/>	<input type="checkbox"/>	
	54 x 42"	PHH25442	<input type="checkbox"/>	<input type="checkbox"/>	<input type="checkbox"/>	<input type="checkbox"/>	<input type="checkbox"/>	<input type="checkbox"/>	<input type="checkbox"/>	
	60 x 42"	PHH26042	<input type="checkbox"/>	<input type="checkbox"/>	<input type="checkbox"/>	<input type="checkbox"/>	<input type="checkbox"/>	<input type="checkbox"/>	<input type="checkbox"/>	
	PHH2	12 x 54"	PHH21254	<input type="checkbox"/>	<input type="checkbox"/>	<input type="checkbox"/>	<input type="checkbox"/>	<input type="checkbox"/>	<input type="checkbox"/>	<input type="checkbox"/>
18 x 54"		PHH21854	<input type="checkbox"/>	<input type="checkbox"/>	<input type="checkbox"/>	<input type="checkbox"/>	<input type="checkbox"/>	<input type="checkbox"/>	<input type="checkbox"/>	
24 x 54"		PHH22454	<input type="checkbox"/>	<input type="checkbox"/>	<input type="checkbox"/>	<input type="checkbox"/>	<input type="checkbox"/>	<input type="checkbox"/>	<input type="checkbox"/>	
30 x 54"		PHH23054	<input type="checkbox"/>	<input type="checkbox"/>	<input type="checkbox"/>	<input type="checkbox"/>	<input type="checkbox"/>	<input type="checkbox"/>	<input type="checkbox"/>	
36 x 54"		PHH23654	<input type="checkbox"/>	<input type="checkbox"/>	<input type="checkbox"/>	<input type="checkbox"/>	<input type="checkbox"/>	<input type="checkbox"/>	<input type="checkbox"/>	
42 x 54"		PHH24254	<input type="checkbox"/>	<input type="checkbox"/>	<input type="checkbox"/>	<input type="checkbox"/>	<input type="checkbox"/>	<input type="checkbox"/>	<input type="checkbox"/>	
48 x 54"		PHH24854	<input type="checkbox"/>	<input type="checkbox"/>	<input type="checkbox"/>	<input type="checkbox"/>	<input type="checkbox"/>	<input type="checkbox"/>	<input type="checkbox"/>	
54 x 54"		PHH25454	<input type="checkbox"/>	<input type="checkbox"/>	<input type="checkbox"/>	<input type="checkbox"/>	<input type="checkbox"/>	<input type="checkbox"/>	<input type="checkbox"/>	
60 x 54"	PHH26054	<input type="checkbox"/>	<input type="checkbox"/>	<input type="checkbox"/>	<input type="checkbox"/>	<input type="checkbox"/>	<input type="checkbox"/>	<input type="checkbox"/>		
			<b>A</b>	<b>B</b>	<b>C</b>	<b>D</b>	<b>E</b>	<b>F</b>	<b>G</b>	<b>H</b>

## HOW TO ORDER

Indicate the following information on order form:

- Quantity of each item.
- Model number, including options. See "How To Build a Model Number".
- Any special service required.

Note: • The  indicates that a choice is required.

- The absence of the  indicates that no choice is required.
- Alpha-numeric characters in place of  indicate that no other alternatives are available.

## HOW TO BUILD A MODEL NUMBER

**A** Select basic model.

**B** Select electrical code for base raceway.

- CN** - Chicago, no cutouts
- C1** - Chicago, 1 side w/cutouts
- CP** - Chicago, 2 sides w/cutouts
- DN** - Domestic, no cutouts
- D1** - Domestic, 1 side w/cutouts
- D** - Domestic, 2 sides w/cutouts

**C** Select horizontal rail.

- S** - Standard
- E** - Enhanced

**D** Select numbers of raceway tiles side 1

- R0** - Side 1 w/no raceway tile
- R1** - Side 1 w/1-12" raceway tile; add \$32
- R2** - Side 1 w/2-12" raceway tiles; add \$64

**E** Select numbers of raceway tiles side 2

- R20** - Side 2 w/no raceway tile

**R21** - Side 2 w/1-12" raceway tile; add \$32

**R22** - Side 2 w/2-12" raceway tiles; add \$64

**F** Select trim color.

Refer to color addendum at [ki.com](http://ki.com) or KI Fabrics & Finishes binder. Metallic paint requires upcharge. SX Starlight Silver finish is only offered on flat aluminum trim.

**G** Select fabric side 1.

Refer to color addendum at [ki.com](http://ki.com) or in KI Fabrics & Finishes binder.

**H** Select fabric side 2.

Refer to color addendum at [ki.com](http://ki.com) or in KI Fabrics & Finishes binder.

## UPHOLSTERY INFORMATION

### Fabric Mixing

If fabric is ordered from one group on side 1 and another group on side 2, calculate list price using the following method:

Example:

Grade 2 Fabric  
-Grade1 Fabric

Upcharge

Upcharge/2 = Cost for one side

Grade 1 Fabric  
+Cost for one side

Combined list price

### Fabric Disclaimer

Fabric will be applied as swatched by the fabric manufacturer. Fabric that is required to be applied differently than is swatched will need a Special Cost Request written specify-



# Fabric Panel - Tackable Acoustic (3/8" Thick Tiles)

Half Segmented/Half Segmented Panel

Approx. Packaged Weight	Delivered Pricing Fabric Grade 1 & C.O.M.	Delivered Pricing Fabric Grade 2	Delivered Pricing Fabric Grade 3 & Pallas Vertical Fabric Grade PV	Delivered Pricing Pallas Vertical Fabric Grade PV1	Delivered Pricing Pallas Vertical Fabric Grade PV2	Enhanced Horizontal Rail	Metallic Paint add to list price
22.0#	\$ 296	\$ 307	\$ 323	\$ 333	\$ 357	\$ 47	\$ 31
30.0#	353	365	385	398	428	49	32
38.0#	401	417	438	452	484	52	36
47.0#	495	515	544	559	600	64	46
55.0#	529	546	579	595	638	70	48
63.0#	597	617	657	671	715	79	59
71.0#	618	639	675	694	743	88	62
79.0#	656	679	716	739	787	97	65
88.0#	739	758	803	823	878	104	84

24.0#	\$ 397	\$ 412	\$ 438	\$ 454	\$ 488	\$ 47	\$ 31
33.0#	468	485	521	536	574	49	32
43.0#	528	547	580	599	641	52	36
52.0#	651	675	718	743	799	64	46
61.0#	693	719	766	788	849	70	48
70.0#	775	803	856	878	946	79	59
79.0#	834	840	888	914	982	88	62
88.0#	849	883	938	967	1037	97	65
100.0#	956	990	1046	1076	1153	104	84

ing the direction the fabric is to be applied. The posted standard lead time will apply to the Special Cost Request.

## INFORMATION

### Maximum Raceway Tile Possibilities

Panel Height	Side 1	Side 2
42"H	1	1
54"H	2	2
66"H	2	2

## SPECIAL SERVICES

### Special Carton Marking

With specially marked information N/C

### Shipping

Shipped k.d. freight prepaid f.o.b. Manitowoc, Wisconsin 54220 factory. Freight class #70.

Specifications and prices are subject to change without prior notice.

# Fabric Panel - Tackable Acoustic (3/8" Thick Tiles)

Half Segmented/Half Segmented Panel



PHH2

MODEL	W x H	MODEL NUMBER							
		Basic Model	Electrical Code	Horizontal Rail	Number of Raceway Tiles Side 1	Number of Raceway Tiles Side 2	Trim Color	Fabric Side 1	Fabric Side 2
<b>Half Segmented/Half Segmented Panel - 66"H with 12"H Tiles</b> • Two steel horizontal rails • One to four sets of plastic light blocks • Two 24" high fabric tiles with grey mounting hooks • Two, four or six 12" high fabric tiles with grey mounting hooks • Two 18" high fabric tiles included with 84" high panel with grey mounting hooks • One base/raceway consisting of a raceway pan and two doors • One rounded satin-textured polypropylene top cap with splice plate • Order power separately • Order vertical posts separately • SX Starlight Silver finish is only offered on flat aluminum trim	12 x 66"	PHH21266	<input type="checkbox"/> <input type="checkbox"/>	<input type="checkbox"/>	<input type="checkbox"/> <input type="checkbox"/>	<input type="checkbox"/> <input type="checkbox"/> <input type="checkbox"/>	<input type="checkbox"/>	<input type="checkbox"/> <input type="checkbox"/> <input type="checkbox"/> <input type="checkbox"/>	<input type="checkbox"/> <input type="checkbox"/> <input type="checkbox"/> <input type="checkbox"/>
	18 x 66"	PHH21866	<input type="checkbox"/> <input type="checkbox"/>	<input type="checkbox"/>	<input type="checkbox"/> <input type="checkbox"/>	<input type="checkbox"/> <input type="checkbox"/> <input type="checkbox"/>	<input type="checkbox"/>	<input type="checkbox"/> <input type="checkbox"/> <input type="checkbox"/> <input type="checkbox"/>	<input type="checkbox"/> <input type="checkbox"/> <input type="checkbox"/> <input type="checkbox"/>
	24 x 66"	PHH22466	<input type="checkbox"/> <input type="checkbox"/>	<input type="checkbox"/>	<input type="checkbox"/> <input type="checkbox"/>	<input type="checkbox"/> <input type="checkbox"/> <input type="checkbox"/>	<input type="checkbox"/>	<input type="checkbox"/> <input type="checkbox"/> <input type="checkbox"/> <input type="checkbox"/>	<input type="checkbox"/> <input type="checkbox"/> <input type="checkbox"/> <input type="checkbox"/>
	30 x 66"	PHH23066	<input type="checkbox"/> <input type="checkbox"/>	<input type="checkbox"/>	<input type="checkbox"/> <input type="checkbox"/>	<input type="checkbox"/> <input type="checkbox"/> <input type="checkbox"/>	<input type="checkbox"/>	<input type="checkbox"/> <input type="checkbox"/> <input type="checkbox"/> <input type="checkbox"/>	<input type="checkbox"/> <input type="checkbox"/> <input type="checkbox"/> <input type="checkbox"/>
	36 x 66"	PHH23666	<input type="checkbox"/> <input type="checkbox"/>	<input type="checkbox"/>	<input type="checkbox"/> <input type="checkbox"/>	<input type="checkbox"/> <input type="checkbox"/> <input type="checkbox"/>	<input type="checkbox"/>	<input type="checkbox"/> <input type="checkbox"/> <input type="checkbox"/> <input type="checkbox"/>	<input type="checkbox"/> <input type="checkbox"/> <input type="checkbox"/> <input type="checkbox"/>
	42 x 66"	PHH24266	<input type="checkbox"/> <input type="checkbox"/>	<input type="checkbox"/>	<input type="checkbox"/> <input type="checkbox"/>	<input type="checkbox"/> <input type="checkbox"/> <input type="checkbox"/>	<input type="checkbox"/>	<input type="checkbox"/> <input type="checkbox"/> <input type="checkbox"/> <input type="checkbox"/>	<input type="checkbox"/> <input type="checkbox"/> <input type="checkbox"/> <input type="checkbox"/>
	48 x 66"	PHH24866	<input type="checkbox"/> <input type="checkbox"/>	<input type="checkbox"/>	<input type="checkbox"/> <input type="checkbox"/>	<input type="checkbox"/> <input type="checkbox"/> <input type="checkbox"/>	<input type="checkbox"/>	<input type="checkbox"/> <input type="checkbox"/> <input type="checkbox"/> <input type="checkbox"/>	<input type="checkbox"/> <input type="checkbox"/> <input type="checkbox"/> <input type="checkbox"/>
	54 x 66"	PHH25466	<input type="checkbox"/> <input type="checkbox"/>	<input type="checkbox"/>	<input type="checkbox"/> <input type="checkbox"/>	<input type="checkbox"/> <input type="checkbox"/> <input type="checkbox"/>	<input type="checkbox"/>	<input type="checkbox"/> <input type="checkbox"/> <input type="checkbox"/> <input type="checkbox"/>	<input type="checkbox"/> <input type="checkbox"/> <input type="checkbox"/> <input type="checkbox"/>
	60 x 66"	PHH26066	<input type="checkbox"/> <input type="checkbox"/>	<input type="checkbox"/>	<input type="checkbox"/> <input type="checkbox"/>	<input type="checkbox"/> <input type="checkbox"/> <input type="checkbox"/>	<input type="checkbox"/>	<input type="checkbox"/> <input type="checkbox"/> <input type="checkbox"/> <input type="checkbox"/>	<input type="checkbox"/> <input type="checkbox"/> <input type="checkbox"/> <input type="checkbox"/>

**A**      **B**      **C**      **D**      **E**      **F**      **G**      **H**

## HOW TO ORDER

Indicate the following information on order form:

- Quantity of each item.
- Model number, including options. See "How To Build a Model Number".
- Any special service required.

Note: • The  indicates that a choice is required.

- The absence of the  indicates that no choice is required.
- Alpha-numeric characters in place of  indicate that no other alternatives are available.

## HOW TO BUILD A MODEL NUMBER

**A** Select basic model.

**B** Select electrical code for base raceway.

- CN** - Chicago, no cutouts
- C1** - Chicago, 1 side w/cutouts
- CP** - Chicago, 2 sides w/cutouts
- DN** - Domestic, no cutouts
- D1** - Domestic, 1 side w/cutouts
- D** - Domestic, 2 sides w/cutouts

**C** Select horizontal rail.

- S** - Standard
- E** - Enhanced

**D** Select numbers of raceway tiles side 1

- R0** - Side 1 w/no raceway tile
- R1** - Side 1 w/1-12" raceway tile; add \$32
- R2** - Side 1 w/2-12" raceway tiles; add \$64

**E** Select numbers of raceway tiles side 2

- R20** - Side 2 w/no raceway tile

**R21** - Side 2 w/1-12" raceway tile; add \$32

**R22** - Side 2 w/2-12" raceway tiles; add \$64

**F** Select trim color.

Refer to color addendum at ki.com or KI Fabrics & Finishes binder. Metallic paint requires upcharge. SX Starlight Silver finish is only offered on flat aluminum trim.

**G** Select fabric side 1.

Refer to color addendum at ki.com or in KI Fabrics & Finishes binder.

**H** Select fabric side 2.

Refer to color addendum at ki.com or in KI Fabrics & Finishes binder.

## UPHOLSTERY INFORMATION

### Fabric Mixing

If fabric is ordered from one group on side 1 and another group on side 2, calculate list price using the following method:

Example:

Grade 2 Fabric  
-Grade1 Fabric

Upcharge

Upcharge/2 = Cost for one side

Grade 1 Fabric  
+Cost for one side

Combined list price

### Fabric Disclaimer

Fabric will be applied as swatched by the fabric manufacturer. Fabric that is required to be applied differently than is swatched will need a Special Cost Request written specify-



# Fabric Panel - Tackable Acoustic (3/8" Thick Tiles)

Half Segmented/Half Segmented Panel

Approx. Packaged Weight	Delivered Pricing Fabric Grade 1 & C.O.M.	Delivered Pricing Fabric Grade 2	Delivered Pricing Fabric Grade 3 & Pallas Vertical Fabric Grade PV	Delivered Pricing Pallas Vertical Fabric Grade PV1	Delivered Pricing Pallas Vertical Fabric Grade PV2	Enhanced Horizontal Rail	Metallic Paint add to list price
37.0#	\$ 496	\$ 518	\$ 552	\$ 574	\$ 616	\$ 47	\$ 31
51.0#	580	607	648	670	720	49	32
65.0#	655	682	721	748	806	52	36
79.0#	803	839	891	920	992	64	46
92.0#	854	890	950	980	1057	70	48
106.0#	953	990	1056	1093	1169	79	59
119.0#	991	1032	1099	1135	1217	88	62
133.0#	1045	1091	1158	1199	1290	97	65
150.0#	1172	1223	1293	1336	1429	104	84

ing the direction the fabric is to be applied. The posted standard lead time will apply to the Special Cost Request.

## INFORMATION

### Maximum Raceway Tile Possibilities

Panel Height	Side 1	Side 2
42"H	1	1
54"H	2	2
66"H	2	2

## SPECIAL SERVICES

### Special Carton Marking

With specially marked information N/C

### Shipping

Shipped **k.d. freight prepaid f.o.b. Manitowoc, Wisconsin 54220** factory. Freight class #70.

Specifications and prices are subject to change without prior notice.

# Fabric Panel - Tackable Acoustic (3/8" Thick Tiles)

Monolithic/Half Segmented Panel

		MODEL NUMBER							
MODEL	W x H	Basic Model	Electrical Code	Horizontal Rail	Number of Raceway Tiles Side 1	Number of Raceway Tiles Side 2	Trim Color	Fabric Side 1	Fabric Side 2
 <p>PMH8</p> <p><b>Monolithic/Half Segmented Panel - 48"H with 18"H Tiles</b></p> <ul style="list-style-type: none"> <li>• Two steel horizontal rails</li> <li>• One to three individual plastic light blocks</li> <li>• One full height tile (6" shorter than height of panel) with blue mounting hooks</li> <li>• One or two 24" high fabric tiles with grey mounting hooks</li> <li>• One, two or three 18" high fabric tiles with grey mounting hooks</li> <li>• One base/raceway consisting of a raceway pan and two doors</li> <li>• One rounded satin-textured polypropylene top cap with splice plate</li> <li>• Order power separately</li> <li>• Order vertical posts separately</li> <li>• SX Starlight Silver finish is only offered on flat aluminum trim</li> </ul>	12 x 48"	PMH81248	<input type="checkbox"/>	<input type="checkbox"/>	R0	<input type="checkbox"/>	<input type="checkbox"/>	<input type="checkbox"/>	<input type="checkbox"/>
	18 x 48"	PMH81848	<input type="checkbox"/>	<input type="checkbox"/>	R0	<input type="checkbox"/>	<input type="checkbox"/>	<input type="checkbox"/>	<input type="checkbox"/>
	24 x 48"	PMH82448	<input type="checkbox"/>	<input type="checkbox"/>	R0	<input type="checkbox"/>	<input type="checkbox"/>	<input type="checkbox"/>	<input type="checkbox"/>
	30 x 48"	PMH83048	<input type="checkbox"/>	<input type="checkbox"/>	R0	<input type="checkbox"/>	<input type="checkbox"/>	<input type="checkbox"/>	<input type="checkbox"/>
	36 x 48"	PMH83648	<input type="checkbox"/>	<input type="checkbox"/>	R0	<input type="checkbox"/>	<input type="checkbox"/>	<input type="checkbox"/>	<input type="checkbox"/>
	42 x 48"	PMH84248	<input type="checkbox"/>	<input type="checkbox"/>	R0	<input type="checkbox"/>	<input type="checkbox"/>	<input type="checkbox"/>	<input type="checkbox"/>
	48 x 48"	PMH84848	<input type="checkbox"/>	<input type="checkbox"/>	R0	<input type="checkbox"/>	<input type="checkbox"/>	<input type="checkbox"/>	<input type="checkbox"/>
	54 x 48"	PMH85448	<input type="checkbox"/>	<input type="checkbox"/>	R0	<input type="checkbox"/>	<input type="checkbox"/>	<input type="checkbox"/>	<input type="checkbox"/>
	60 x 48"	PMH86048	<input type="checkbox"/>	<input type="checkbox"/>	R0	<input type="checkbox"/>	<input type="checkbox"/>	<input type="checkbox"/>	<input type="checkbox"/>
	<p>PMH8</p> <p><b>Monolithic/Half Segmented Panel - 66"H with 18"H Tiles</b></p>	12 x 66"	PMH81266	<input type="checkbox"/>	<input type="checkbox"/>	R0	<input type="checkbox"/>	<input type="checkbox"/>	<input type="checkbox"/>
18 x 66"		PMH81866	<input type="checkbox"/>	<input type="checkbox"/>	R0	<input type="checkbox"/>	<input type="checkbox"/>	<input type="checkbox"/>	<input type="checkbox"/>
24 x 66"		PMH82466	<input type="checkbox"/>	<input type="checkbox"/>	R0	<input type="checkbox"/>	<input type="checkbox"/>	<input type="checkbox"/>	<input type="checkbox"/>
30 x 66"		PMH83066	<input type="checkbox"/>	<input type="checkbox"/>	R0	<input type="checkbox"/>	<input type="checkbox"/>	<input type="checkbox"/>	<input type="checkbox"/>
36 x 66"		PMH83666	<input type="checkbox"/>	<input type="checkbox"/>	R0	<input type="checkbox"/>	<input type="checkbox"/>	<input type="checkbox"/>	<input type="checkbox"/>
42 x 66"		PMH84266	<input type="checkbox"/>	<input type="checkbox"/>	R0	<input type="checkbox"/>	<input type="checkbox"/>	<input type="checkbox"/>	<input type="checkbox"/>
48 x 66"		PMH84866	<input type="checkbox"/>	<input type="checkbox"/>	R0	<input type="checkbox"/>	<input type="checkbox"/>	<input type="checkbox"/>	<input type="checkbox"/>
60 x 66"		PMH86066	<input type="checkbox"/>	<input type="checkbox"/>	R0	<input type="checkbox"/>	<input type="checkbox"/>	<input type="checkbox"/>	<input type="checkbox"/>

**A**   **B**   **C**   **D**   **E**   **F**   **G**   **H**

## HOW TO ORDER

Indicate the following information on order form:

- Quantity of each item.
- Model number, including options. See "How To Build a Model Number".
- Any special service required.

Note: • The  indicates that a choice is required.

- The absence of the  indicates that no choice is required.
- Alpha-numeric characters in place of  indicate that no other alternatives are available.

## HOW TO BUILD A MODEL NUMBER

- A** Select basic model.
  - CN** - Chicago, no cutouts
  - C1** - Chicago, 1 side w/cutouts
  - CP** - Chicago, 2 sides w/cutouts
  - DN** - Domestic, no cutouts
  - D1** - Domestic, 1 side w/cutouts
  - D** - Domestic, 2 sides w/cutouts
- C** Select horizontal rail.
  - S** - Standard
  - E** - Enhanced
- D** Select numbers of raceway tiles side 1
  - R0** - Side 1 w/no raceway tile
- E** Select numbers of raceway tiles side 2
  - R20** - Side 2 w/no raceway tile
  - R21** - Side 2 w/1-18" raceway tile; add \$32
  - R22** - Side 2 w/2-18" raceway tiles; add \$64

- F** Select trim color. Refer to color addendum at ki.com or KI Fabrics & Finishes binder. Metallic paint requires upcharge. SX Starlight Silver finish is only offered on flat aluminum trim.
- G** Select fabric side 1. Refer to color addendum at ki.com or in KI Fabrics & Finishes binder.
- H** Select fabric side 2. Refer to color addendum at ki.com or in KI Fabrics & Finishes binder.

## UPHOLSTERY INFORMATION

### Fabric Mixing

If fabric is ordered from one group on side 1 and another group on side 2, calculate list price using the following method:

Example:  
Grade 2 Fabric  
-Grade1 Fabric

Upcharge

Upcharge/2 = Cost for one side

Grade 1 Fabric  
+Cost for one side

Combined list price

### Fabric Disclaimer

Fabric will be applied as swatched by the fabric manufacturer. Fabric that is required to be applied differently than is swatched will need a Special Cost Request written specify-





# Fabric Panel - Tackable Acoustic (3/8" Thick Tiles)

Monolithic/Half Segmented Panel

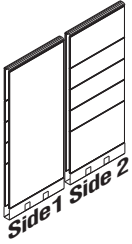
MODEL	W x H	MODEL NUMBER							
		Basic Model	Electrical Code	Horizontal Rail	Number of Raceway Tiles Side 1	Number of Raceway Tiles Side 2	Trim Color	Fabric Side 1	Fabric Side 2
 <p>PMH8</p> <p><b>Monolithic/Half Segmented Panel - 84"H with 18"H Tiles</b></p> <ul style="list-style-type: none"> <li>• Two steel horizontal rails</li> <li>• One to three individual plastic light blocks</li> <li>• One full height tile (6" shorter than height of panel) with blue mounting hooks</li> <li>• One or two 24" high fabric tiles with grey mounting hooks</li> <li>• One, two or three 18" high fabric tiles with grey mounting hooks</li> <li>• One base/raceway consisting of a raceway pan and two doors</li> <li>• One rounded satin-textured polypropylene top cap with splice plate</li> <li>• Order power separately</li> <li>• Order vertical posts separately</li> <li>• SX Starlight Silver finish is only offered on flat aluminum trim</li> </ul>	12 x 84"	PMH81284	<input type="checkbox"/>	<input type="checkbox"/>	R0	<input type="checkbox"/>	<input type="checkbox"/>	<input type="checkbox"/>	<input type="checkbox"/>
	18 x 84"	PMH81884	<input type="checkbox"/>	<input type="checkbox"/>	R0	<input type="checkbox"/>	<input type="checkbox"/>	<input type="checkbox"/>	<input type="checkbox"/>
	24 x 84"	PMH82484	<input type="checkbox"/>	<input type="checkbox"/>	R0	<input type="checkbox"/>	<input type="checkbox"/>	<input type="checkbox"/>	<input type="checkbox"/>
	30 x 84"	PMH83084	<input type="checkbox"/>	<input type="checkbox"/>	R0	<input type="checkbox"/>	<input type="checkbox"/>	<input type="checkbox"/>	<input type="checkbox"/>
	36 x 84"	PMH83684	<input type="checkbox"/>	<input type="checkbox"/>	R0	<input type="checkbox"/>	<input type="checkbox"/>	<input type="checkbox"/>	<input type="checkbox"/>
	42 x 84"	PMH84284	<input type="checkbox"/>	<input type="checkbox"/>	R0	<input type="checkbox"/>	<input type="checkbox"/>	<input type="checkbox"/>	<input type="checkbox"/>
	48 x 84"	PMH84884	<input type="checkbox"/>	<input type="checkbox"/>	R0	<input type="checkbox"/>	<input type="checkbox"/>	<input type="checkbox"/>	<input type="checkbox"/>
	54 x 84"	PMH85484	<input type="checkbox"/>	<input type="checkbox"/>	R0	<input type="checkbox"/>	<input type="checkbox"/>	<input type="checkbox"/>	<input type="checkbox"/>
	60 x 84"	PMH86084	<input type="checkbox"/>	<input type="checkbox"/>	R0	<input type="checkbox"/>	<input type="checkbox"/>	<input type="checkbox"/>	<input type="checkbox"/>

**A** **B** **C** **D** **E** **F** **G** **H**

## HOW TO ORDER

Indicate the following information on order form:

- Quantity of each item.
- Model number, including options. See "How To Build a Model Number".
- Any special service required.

Note: • The  indicates that a choice is required.

- The absence of the  indicates that no choice is required.
- Alpha-numeric characters in place of  indicate that no other alternatives are available.

## HOW TO BUILD A MODEL NUMBER

- A** Select basic model.
  - CN** - Chicago, no cutouts
  - C1** - Chicago, 1 side w/cutouts
  - CP** - Chicago, 2 sides w/cutouts
  - DN** - Domestic, no cutouts
  - D1** - Domestic, 1 side w/cutouts
  - D** - Domestic, 2 sides w/cutouts
- C** Select horizontal rail.
  - S** - Standard
  - E** - Enhanced
- D** Select numbers of raceway tiles side 1
  - R0** - Side 1 w/no raceway tile
- E** Select numbers of raceway tiles side 2
  - R20** - Side 2 w/no raceway tile
  - R21** - Side 2 w/1-18" raceway tile; add \$32
  - R22** - Side 2 w/2-18" raceway tiles; add \$64

- F** Select trim color. Refer to color addendum at ki.com or KI Fabrics & Finishes binder. Metallic paint requires upcharge. SX Starlight Silver finish is only offered on flat aluminum trim.
- G** Select fabric side 1. Refer to color addendum at ki.com or in KI Fabrics & Finishes binder.
- H** Select fabric side 2. Refer to color addendum at ki.com or in KI Fabrics & Finishes binder.

## UPHOLSTERY INFORMATION

**Fabric Mixing**  
If fabric is ordered from one group on side 1 and another group on side 2, calculate list price using the following method:

Example:  
Grade 2 Fabric  
-Grade1 Fabric

Upcharge  
Upcharge/2 = Cost for one side

Grade 1 Fabric  
+Cost for one side  
Combined list price

**Fabric Disclaimer**  
Fabric will be applied as swatched by the fabric manufacturer. Fabric that is required to be applied differently than is swatched will need a Special Cost Request written specify-



# Fabric Panel - Tackable Acoustic (3/8" Thick Tiles)

Monolithic/Half Segmented Panel

Approx. Packaged Weight	Delivered Pricing Fabric Grade 1 & C.O.M.	Delivered Pricing Fabric Grade 2	Delivered Pricing Fabric Grade 3 & Pallas Vertical Fabric Grade PV	Delivered Pricing Pallas Vertical Fabric Grade PV1	Delivered Pricing Pallas Vertical Fabric Grade PV2	Enhanced Horizontal Rail	Metallic Paint add to list price
45.0#	\$ 482	\$ 501	\$ 535	\$ 549	\$ 593	\$ 47	\$ 31
62.0#	573	595	636	659	710	49	32
79.0#	640	668	713	737	790	52	36
95.0#	768	802	852	881	948	64	46
117.0#	824	860	917	943	1018	70	48
127.0#	912	948	1009	1035	1115	79	59
143.0#	935	976	1036	1069	1147	88	62
160.0#	1023	1064	1133	1171	1260	97	65
180.0#	1151	1196	1268	1306	1402	104	84

ing the direction the fabric is to be applied. The posted standard lead time will apply to the Special Cost Request.

## INFORMATION

### Maximum Raceway Tile Possibilities

Panel Height	Side 1	Side 2
48"H	0	1
66"H	0	2
84"H	0	2

## SPECIAL SERVICES

### Special Carton Marking

With specially marked information N/C

### Shipping

Shipped **k.d. freight prepaid f.o.b. Manitowoc, Wisconsin 54220** factory. Freight class #70.

Specifications and prices are subject to change without prior notice.





# Fabric Panel - Tackable Acoustic (3/8" Thick Tiles)

Monolithic/Half Segmented Panel

Approx. Packaged Weight	Delivered Pricing Fabric Grade 1 & C.O.M.	Delivered Pricing Fabric Grade 2	Delivered Pricing Fabric Grade 3 & Pallas Vertical Fabric Grade PV	Delivered Pricing Pallas Vertical Fabric Grade PV1	Delivered Pricing Pallas Vertical Fabric Grade PV2	Enhanced Horizontal Rail	Metallic Paint add to list price
21.0#	\$ 302	\$ 312	\$ 329	\$ 340	\$ 365	\$ 47	\$ 31
29.0#	348	362	382	394	420	49	32
36.0#	396	409	431	444	479	52	36
44.0#	482	495	527	542	577	64	46
51.0#	523	543	574	589	632	70	48
56.0#	587	607	639	660	700	79	59
66.0#	603	624	661	677	719	88	62
74.0#	636	659	695	717	759	97	65
83.0#	709	731	769	791	842	104	84

ing the direction the fabric is to be applied. The posted standard lead time will apply to the Special Cost Request.

**INFORMATION**

**Maximum Raceway Tile Possibilities**

Panel Height	Side 1	Side 2
48"H	0	1
54"H	0	2
66"H	0	2

**SPECIAL SERVICES**

**Special Carton Marking**

With specially marked information N/C

**Shipping**

Shipped **k.d. freight prepaid f.o.b. Manitowoc, Wisconsin 54220** factory. Freight class #70.

Specifications and prices are subject to change without prior notice.

# Fabric Panel - Tackable Acoustic (3/8" Thick Tiles)

Monolithic/Half Segmented Panel

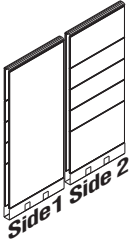
MODEL	W x H	MODEL NUMBER										
		Basic Model	Electrical Code	Horizontal Rail	Number of Raceway Tiles Side 1	Number of Raceway Tiles Side 2	Trim Color	Fabric Side 1	Fabric Side 2			
	<b>Monolithic/Half Segmented Panel - 54"H with 12"H Tiles</b>		12 x 54"	PMH21254	<input type="checkbox"/>	<input type="checkbox"/>	R0	<input type="checkbox"/>	<input type="checkbox"/>	<input type="checkbox"/>	<input type="checkbox"/>	<input type="checkbox"/>
	18 x 54"	PMH21854	<input type="checkbox"/>	<input type="checkbox"/>	R0	<input type="checkbox"/>	<input type="checkbox"/>	<input type="checkbox"/>	<input type="checkbox"/>	<input type="checkbox"/>	<input type="checkbox"/>	<input type="checkbox"/>
	24 x 54"	PMH22454	<input type="checkbox"/>	<input type="checkbox"/>	R0	<input type="checkbox"/>	<input type="checkbox"/>	<input type="checkbox"/>	<input type="checkbox"/>	<input type="checkbox"/>	<input type="checkbox"/>	<input type="checkbox"/>
	30 x 54"	PMH23054	<input type="checkbox"/>	<input type="checkbox"/>	R0	<input type="checkbox"/>	<input type="checkbox"/>	<input type="checkbox"/>	<input type="checkbox"/>	<input type="checkbox"/>	<input type="checkbox"/>	<input type="checkbox"/>
	36 x 54"	PMH23654	<input type="checkbox"/>	<input type="checkbox"/>	R0	<input type="checkbox"/>	<input type="checkbox"/>	<input type="checkbox"/>	<input type="checkbox"/>	<input type="checkbox"/>	<input type="checkbox"/>	<input type="checkbox"/>
	42 x 54"	PMH24254	<input type="checkbox"/>	<input type="checkbox"/>	R0	<input type="checkbox"/>	<input type="checkbox"/>	<input type="checkbox"/>	<input type="checkbox"/>	<input type="checkbox"/>	<input type="checkbox"/>	<input type="checkbox"/>
	48 x 54"	PMH24854	<input type="checkbox"/>	<input type="checkbox"/>	R0	<input type="checkbox"/>	<input type="checkbox"/>	<input type="checkbox"/>	<input type="checkbox"/>	<input type="checkbox"/>	<input type="checkbox"/>	<input type="checkbox"/>
	54 x 54"	PMH25454	<input type="checkbox"/>	<input type="checkbox"/>	R0	<input type="checkbox"/>	<input type="checkbox"/>	<input type="checkbox"/>	<input type="checkbox"/>	<input type="checkbox"/>	<input type="checkbox"/>	<input type="checkbox"/>
60 x 54"	PMH26054	<input type="checkbox"/>	<input type="checkbox"/>	R0	<input type="checkbox"/>	<input type="checkbox"/>	<input type="checkbox"/>	<input type="checkbox"/>	<input type="checkbox"/>	<input type="checkbox"/>	<input type="checkbox"/>	
PMH2												
PMH2	<b>Monolithic/Half Segmented Panel - 66"H with 12"H Tiles</b>		12 x 66"	PMH21266	<input type="checkbox"/>	<input type="checkbox"/>	R0	<input type="checkbox"/>	<input type="checkbox"/>	<input type="checkbox"/>	<input type="checkbox"/>	<input type="checkbox"/>
	18 x 66"	PMH21866	<input type="checkbox"/>	<input type="checkbox"/>	R0	<input type="checkbox"/>	<input type="checkbox"/>	<input type="checkbox"/>	<input type="checkbox"/>	<input type="checkbox"/>	<input type="checkbox"/>	<input type="checkbox"/>
	24 x 66"	PMH22466	<input type="checkbox"/>	<input type="checkbox"/>	R0	<input type="checkbox"/>	<input type="checkbox"/>	<input type="checkbox"/>	<input type="checkbox"/>	<input type="checkbox"/>	<input type="checkbox"/>	<input type="checkbox"/>
	30 x 66"	PMH23066	<input type="checkbox"/>	<input type="checkbox"/>	R0	<input type="checkbox"/>	<input type="checkbox"/>	<input type="checkbox"/>	<input type="checkbox"/>	<input type="checkbox"/>	<input type="checkbox"/>	<input type="checkbox"/>
	36 x 66"	PMH23666	<input type="checkbox"/>	<input type="checkbox"/>	R0	<input type="checkbox"/>	<input type="checkbox"/>	<input type="checkbox"/>	<input type="checkbox"/>	<input type="checkbox"/>	<input type="checkbox"/>	<input type="checkbox"/>
	42 x 66"	PMH24266	<input type="checkbox"/>	<input type="checkbox"/>	R0	<input type="checkbox"/>	<input type="checkbox"/>	<input type="checkbox"/>	<input type="checkbox"/>	<input type="checkbox"/>	<input type="checkbox"/>	<input type="checkbox"/>
	48 x 66"	PMH24866	<input type="checkbox"/>	<input type="checkbox"/>	R0	<input type="checkbox"/>	<input type="checkbox"/>	<input type="checkbox"/>	<input type="checkbox"/>	<input type="checkbox"/>	<input type="checkbox"/>	<input type="checkbox"/>
	54 x 66"	PMH25466	<input type="checkbox"/>	<input type="checkbox"/>	R0	<input type="checkbox"/>	<input type="checkbox"/>	<input type="checkbox"/>	<input type="checkbox"/>	<input type="checkbox"/>	<input type="checkbox"/>	<input type="checkbox"/>
60 x 66"	PMH26066	<input type="checkbox"/>	<input type="checkbox"/>	R0	<input type="checkbox"/>	<input type="checkbox"/>	<input type="checkbox"/>	<input type="checkbox"/>	<input type="checkbox"/>	<input type="checkbox"/>	<input type="checkbox"/>	
					<b>A</b>	<b>B</b>	<b>C</b>	<b>D</b>	<b>E</b>	<b>F</b>	<b>G</b>	<b>H</b>

## HOW TO ORDER

Indicate the following information on order form:

- Quantity of each item.
- Model number, including options. See "How To Build a Model Number".
- Any special service required.

Note: • The  indicates that a choice is required.

- The absence of the  indicates that no choice is required.
- Alpha-numeric characters in place of  indicate that no other alternatives are available.

## HOW TO BUILD A MODEL NUMBER

- A** Select basic model.
- B** Select electrical code for base raceway.
- CN** - Chicago, no cutouts  
**C1** - Chicago, 1 side w/cutouts  
**CP** - Chicago, 2 sides w/cutouts  
**DN** - Domestic, no cutouts  
**D1** - Domestic, 1 side w/cutouts  
**D** - Domestic, 2 sides w/cutouts
- C** Select horizontal rail.
- S** - Standard  
**E** - Enhanced
- D** Select numbers of raceway tiles side 1
- R0** - Side 1 w/no raceway tile
- E** Select numbers of raceway tiles side 2
- R20** - Side 2 w/no raceway tile  
**R21** - Side 2 w/1-12" raceway tile; add \$32  
**R22** - Side 2 w/2-12" raceway tiles; add \$64
- F** Select trim color.  
 Refer to color addendum at ki.com or KI Fabrics & Finishes binder. Metallic paint requires upcharge. SX Starlight Silver finish is only offered on flat aluminum trim.
- G** Select fabric side 1.  
 Refer to color addendum at ki.com or in KI Fabrics & Finishes binder.
- H** Select fabric side 2.  
 Refer to color addendum at ki.com or in KI Fabrics & Finishes binder.

## UPHOLSTERY INFORMATION

### Fabric Mixing

If fabric is ordered from one group on side 1 and another group on side 2, calculate list price using the following method:

Example:  
 Grade 2 Fabric  
 -Grade1 Fabric

Upcharge

Upcharge/2 = Cost for one side

Grade 1 Fabric  
 +Cost for one side

Combined list price

### Fabric Disclaimer

Fabric will be applied as swatched by the fabric manufacturer. Fabric that is required to be applied differently than is swatched will need a Special Cost Request written specify-



# Fabric Panel - Tackable Acoustic (3/8" Thick Tiles)

Monolithic/Half Segmented Panel

Approx. Packaged Weight	Delivered Pricing Fabric Grade 1 & C.O.M.	Delivered Pricing Fabric Grade 2	Delivered Pricing Fabric Grade 3 & Pallas Vertical Fabric Grade PV	Delivered Pricing Pallas Vertical Fabric Grade PV1	Delivered Pricing Pallas Vertical Fabric Grade PV2	Enhanced Horizontal Rail	Metallic Paint add to list price
27.0#	\$ 373	\$ 387	\$ 411	\$ 426	\$ 456	\$ 47	\$ 31
31.0#	438	454	484	499	535	49	32
48.0#	499	519	549	569	608	52	36
57.0#	597	621	661	680	723	64	46
67.0#	639	664	709	727	780	70	48
77.0#	722	751	797	817	873	79	59
86.0#	750	779	824	849	907	88	62
97.0#	810	842	891	920	986	97	65
108.0#	902	933	986	1015	1083	104	84
34.0#	\$ 448	\$ 467	\$ 495	\$ 511	\$ 551	\$ 47	\$ 31
46.0#	522	542	579	595	640	49	32
56.0#	579	603	640	661	708	52	36
71.0#	686	715	759	783	843	64	46
83.0#	737	762	811	836	899	70	48
95.0#	845	877	930	959	1027	79	59
106.0#	874	907	963	991	1066	88	62
119.0#	931	968	1029	1060	1136	97	65
133.0#	1046	1085	1145	1181	1260	104	84

ing the direction the fabric is to be applied. The posted standard lead time will apply to the Special Cost Request.

## INFORMATION

### Maximum Raceway Tile Possibilities

Panel Height	Side 1	Side 2
48"H	0	1
54"H	0	2
66"H	0	2

## SPECIAL SERVICES

### Special Carton Marking

With specially marked information N/C

### Shipping

Shipped **k.d. freight prepaid f.o.b. Manitowoc, Wisconsin 54220** factory. Freight class #70.

Specifications and prices are subject to change without prior notice.

# Glass/Fabric Panel - Acoustic (3/8" Thick Tiles)

Monolithic/Glass/Monolithic/Glass Panel



MODEL	W x H	MODEL NUMBER							Approx. Packaged Weight
		Basic Model	Electrical Code	Horizontal Rail	Glass Color	Trim Color	Fabric Side 1	Fabric Side 2	
<b>Monolithic/Glass/Monolithic/Glass Panel - 42"H</b> • Two steel horizontal rails • One set of plastic light blocks • Two 24" fabric tiles with grey mounting hooks • One panel, 1/4" thick glass with aluminum window frame with blue mounting hooks • One base/raceway consisting of a raceway pan and two doors • One rounded satin-textured polypropylene top cap with splice plate • Order power separately • Order vertical posts separately • Fabric tile is tackable • SX Starlight Silver finish is only offered on flat aluminum trim	12 x 42"	PMMGB1242	<input type="checkbox"/>	<input type="checkbox"/>	<input type="checkbox"/>	<input type="checkbox"/>	<input type="checkbox"/>	<input type="checkbox"/>	22.0#
	18 x 42"	PMMGB1842	<input type="checkbox"/>	<input type="checkbox"/>	<input type="checkbox"/>	<input type="checkbox"/>	<input type="checkbox"/>	<input type="checkbox"/>	31.0#
	24 x 42"	PMMGB2442	<input type="checkbox"/>	<input type="checkbox"/>	<input type="checkbox"/>	<input type="checkbox"/>	<input type="checkbox"/>	<input type="checkbox"/>	41.0#
	30 x 42"	PMMGB3042	<input type="checkbox"/>	<input type="checkbox"/>	<input type="checkbox"/>	<input type="checkbox"/>	<input type="checkbox"/>	<input type="checkbox"/>	51.0#
	36 x 42"	PMMGB3642	<input type="checkbox"/>	<input type="checkbox"/>	<input type="checkbox"/>	<input type="checkbox"/>	<input type="checkbox"/>	<input type="checkbox"/>	61.0#
	42 x 42"	PMMGB4242	<input type="checkbox"/>	<input type="checkbox"/>	<input type="checkbox"/>	<input type="checkbox"/>	<input type="checkbox"/>	<input type="checkbox"/>	71.0#
	48 x 42"	PMMGB4842	<input type="checkbox"/>	<input type="checkbox"/>	<input type="checkbox"/>	<input type="checkbox"/>	<input type="checkbox"/>	<input type="checkbox"/>	80.0#
<b>Monolithic/Glass/Monolithic/Glass Panel - 48"H</b>	12 x 48"	PMMGB1248	<input type="checkbox"/>	<input type="checkbox"/>	<input type="checkbox"/>	<input type="checkbox"/>	<input type="checkbox"/>	<input type="checkbox"/>	22.0#
	18 x 48"	PMMGB1848	<input type="checkbox"/>	<input type="checkbox"/>	<input type="checkbox"/>	<input type="checkbox"/>	<input type="checkbox"/>	<input type="checkbox"/>	31.0#
	24 x 48"	PMMGB2448	<input type="checkbox"/>	<input type="checkbox"/>	<input type="checkbox"/>	<input type="checkbox"/>	<input type="checkbox"/>	<input type="checkbox"/>	41.0#
	30 x 48"	PMMGB3048	<input type="checkbox"/>	<input type="checkbox"/>	<input type="checkbox"/>	<input type="checkbox"/>	<input type="checkbox"/>	<input type="checkbox"/>	51.0#
	36 x 48"	PMMGB3648	<input type="checkbox"/>	<input type="checkbox"/>	<input type="checkbox"/>	<input type="checkbox"/>	<input type="checkbox"/>	<input type="checkbox"/>	61.0#
	42 x 48"	PMMGB4248	<input type="checkbox"/>	<input type="checkbox"/>	<input type="checkbox"/>	<input type="checkbox"/>	<input type="checkbox"/>	<input type="checkbox"/>	71.0#
<b>Monolithic/Glass/Monolithic/Glass Panel - 54"H</b>	12 x 54"	PMMGB1254	<input type="checkbox"/>	<input type="checkbox"/>	<input type="checkbox"/>	<input type="checkbox"/>	<input type="checkbox"/>	<input type="checkbox"/>	30.0#
	18 x 54"	PMMGB1854	<input type="checkbox"/>	<input type="checkbox"/>	<input type="checkbox"/>	<input type="checkbox"/>	<input type="checkbox"/>	<input type="checkbox"/>	41.0#
	24 x 54"	PMMGB2454	<input type="checkbox"/>	<input type="checkbox"/>	<input type="checkbox"/>	<input type="checkbox"/>	<input type="checkbox"/>	<input type="checkbox"/>	53.0#
	30 x 54"	PMMGB3054	<input type="checkbox"/>	<input type="checkbox"/>	<input type="checkbox"/>	<input type="checkbox"/>	<input type="checkbox"/>	<input type="checkbox"/>	64.0#
	36 x 54"	PMMGB3654	<input type="checkbox"/>	<input type="checkbox"/>	<input type="checkbox"/>	<input type="checkbox"/>	<input type="checkbox"/>	<input type="checkbox"/>	75.0#
	42 x 54"	PMMGB4254	<input type="checkbox"/>	<input type="checkbox"/>	<input type="checkbox"/>	<input type="checkbox"/>	<input type="checkbox"/>	<input type="checkbox"/>	86.0#
	48 x 54"	PMMGB4854	<input type="checkbox"/>	<input type="checkbox"/>	<input type="checkbox"/>	<input type="checkbox"/>	<input type="checkbox"/>	<input type="checkbox"/>	98.0#

**A**      **B**      **C**      **D**      **E**      **F**      **G**

## HOW TO ORDER

Indicate the following information on order form:

- Quantity of each item.
- Model number, including options. See "How To Build a Model Number".
- Any special service required.

Note: • The  indicates that a choice is required.

- The absence of the  indicates that no choice is required.
- Alpha-numeric characters in place of  indicate that no other alternatives are available.

## HOW TO BUILD A MODEL NUMBER

**A** Select basic model.

**B** Select electrical code for base raceway.

- CN** - Chicago, no cutouts
- C1** - Chicago, 1 side w/cutouts
- CP** - Chicago, 2 sides w/cutouts
- DN** - Domestic, no cutouts
- D1** - Domestic, 1 side w/cutouts
- D** - Domestic, 2 sides w/cutouts

**C** Select horizontal rail.

- E** - Enhanced
- S** - Standard

**D** Select glass color.

- GLA** - Clear
- BRZ** - Tinted/Bronze
- GLC** - White laminate

See pricing columns for glass upcharge.

**E** Select trim color.

Refer to color addendum at ki.com or KI Fabrics & Finishes binder.

Metallic paint requires upcharge. SX Starlight Silver finish is only offered on flat aluminum trim.

**F** Select fabric side 1.

Refer to color addendum at ki.com or in KI Fabrics & Finishes binder.

**G** Select fabric side 2.

Refer to color addendum at ki.com or in KI Fabrics & Finishes binder.

## UPHOLSTERY INFORMATION

### Fabric Mixing

If fabric is ordered from one group on side 1 and another group on side 2, calculate list price using the following method:

Example:  
Grade 2 Fabric  
-Grade1 Fabric

Upcharge

Upcharge/2 = Cost for one side

Grade 1 Fabric  
+Cost for one side

Combined list price

### Fabric Disclaimer

Fabric will be applied as swatched by the fabric manufacturer. Fabric that is required to be applied differently than is swatched will need a Special Cost Request written specify-





# Glass/Fabric Panel - Acoustic (3/8" Thick Tiles)

Monolithic/Glass/Monolithic/Glass Panel

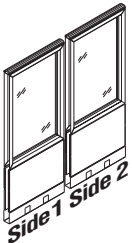
	MODEL	W x H	MODEL NUMBER							Approx. Packaged Weight
			Basic Model	Electrical Code	Horizontal Rail	Glass Color	Trim Color	Fabric Side 1	Fabric Side 2	
 <p>PMGB</p>	<b>Monolithic/Glass/Monolithic/Glass Panel - 66"H</b> <ul style="list-style-type: none"> <li>Two steel horizontal rails</li> <li>One set of plastic light blocks</li> <li>Two 24" fabric tiles with grey mounting hooks</li> <li>One panel, 1/4" thick glass with aluminum window frame with blue mounting hooks</li> <li>One base/raceway consisting of a raceway pan and two doors</li> <li>One rounded satin-textured polypropylene top cap with splice plate</li> <li>Order power separately</li> <li>Order vertical posts separately</li> <li>Fabric tile is tackable</li> <li>SX Starlight Silver finish is only offered on flat aluminum trim</li> </ul>	12 x 66"	PMMGB1266	<input type="checkbox"/>	<input type="checkbox"/>	<input type="checkbox"/>	<input type="checkbox"/>	<input type="checkbox"/>	<input type="checkbox"/>	30.0#
		18 x 66"	PMMGB1866	<input type="checkbox"/>	<input type="checkbox"/>	<input type="checkbox"/>	<input type="checkbox"/>	<input type="checkbox"/>	<input type="checkbox"/>	41.0#
		24 x 66"	PMMGB2466	<input type="checkbox"/>	<input type="checkbox"/>	<input type="checkbox"/>	<input type="checkbox"/>	<input type="checkbox"/>	<input type="checkbox"/>	53.0#
		30 x 66"	PMMGB3066	<input type="checkbox"/>	<input type="checkbox"/>	<input type="checkbox"/>	<input type="checkbox"/>	<input type="checkbox"/>	<input type="checkbox"/>	64.0#
		36 x 66"	PMMGB3666	<input type="checkbox"/>	<input type="checkbox"/>	<input type="checkbox"/>	<input type="checkbox"/>	<input type="checkbox"/>	<input type="checkbox"/>	75.0#
		42 x 66"	PMMGB4266	<input type="checkbox"/>	<input type="checkbox"/>	<input type="checkbox"/>	<input type="checkbox"/>	<input type="checkbox"/>	<input type="checkbox"/>	86.0#
		48 x 66"	PMMGB4866	<input type="checkbox"/>	<input type="checkbox"/>	<input type="checkbox"/>	<input type="checkbox"/>	<input type="checkbox"/>	<input type="checkbox"/>	98.0#
PMGB	<b>Monolithic/Glass/Monolithic/Glass Panel - 84"H</b>	12 x 84"	PMMGB1284	<input type="checkbox"/>	<input type="checkbox"/>	<input type="checkbox"/>	<input type="checkbox"/>	<input type="checkbox"/>	<input type="checkbox"/>	36.0#
		18 x 84"	PMMGB1884	<input type="checkbox"/>	<input type="checkbox"/>	<input type="checkbox"/>	<input type="checkbox"/>	<input type="checkbox"/>	<input type="checkbox"/>	50.0#
		24 x 84"	PMMGB2484	<input type="checkbox"/>	<input type="checkbox"/>	<input type="checkbox"/>	<input type="checkbox"/>	<input type="checkbox"/>	<input type="checkbox"/>	63.0#
		30 x 84"	PMMGB3084	<input type="checkbox"/>	<input type="checkbox"/>	<input type="checkbox"/>	<input type="checkbox"/>	<input type="checkbox"/>	<input type="checkbox"/>	77.0#
		36 x 84"	PMMGB3684	<input type="checkbox"/>	<input type="checkbox"/>	<input type="checkbox"/>	<input type="checkbox"/>	<input type="checkbox"/>	<input type="checkbox"/>	90.0#
		42 x 84"	PMMGB4284	<input type="checkbox"/>	<input type="checkbox"/>	<input type="checkbox"/>	<input type="checkbox"/>	<input type="checkbox"/>	<input type="checkbox"/>	104.0#
		48 x 84"	PMMGB4884	<input type="checkbox"/>	<input type="checkbox"/>	<input type="checkbox"/>	<input type="checkbox"/>	<input type="checkbox"/>	<input type="checkbox"/>	120.0#
				<b>A</b>	<b>B</b>	<b>C</b>	<b>D</b>	<b>E</b>	<b>F</b>	<b>G</b>

## HOW TO ORDER

Indicate the following information on order form:

- Quantity of each item.
- Model number, including options. See "How To Build a Model Number".
- Any special service required.

Note: • The  indicates that a choice is required.

- The absence of the  indicates that no choice is required.
- Alpha-numeric characters in place of  indicate that no other alternatives are available.

## HOW TO BUILD A MODEL NUMBER

**A** Select basic model.

- B** Select electrical code for base raceway.
- CN** - Chicago, no cutouts
  - C1** - Chicago, 1 side w/cutouts
  - CP** - Chicago, 2 sides w/cutouts
  - DN** - Domestic, no cutouts
  - D1** - Domestic, 1 side w/cutouts
  - D** - Domestic, 2 sides w/cutouts

**C** Select horizontal rail.

- E** - Enhanced
- S** - Standard

**D** Select glass color.

- GLA** - Clear
- BRZ** - Tinted/Bronze
- GLC** - White laminate

See pricing columns for glass upcharge.

**E** Select trim color.

Refer to color addendum at ki.com or KI Fabrics & Finishes binder.

Metallic paint requires upcharge. SX Starlight Silver finish is only offered on flat aluminum trim.

**F** Select fabric side 1.  
Refer to color addendum at ki.com or in KI Fabrics & Finishes binder.

**G** Select fabric side 2.  
Refer to color addendum at ki.com or in KI Fabrics & Finishes binder.

## UPHOLSTERY INFORMATION

### Fabric Mixing

If fabric is ordered from one group on side 1 and another group on side 2, calculate list price using the following method:

Example:  
Grade 2 Fabric  
-Grade 1 Fabric

Upcharge

Upcharge/2 = Cost for one side

Grade 1 Fabric  
+Cost for one side

Combined list price

### Fabric Disclaimer

Fabric will be applied as swatched by the fabric manufacturer. Fabric that is required to be applied differently than is swatched will







# Fabric Panel - Tackable Acoustic (3/4" Thick Tiles)

Face Styles

## Face Style: Fully Segmented

Basic Model: PFFA

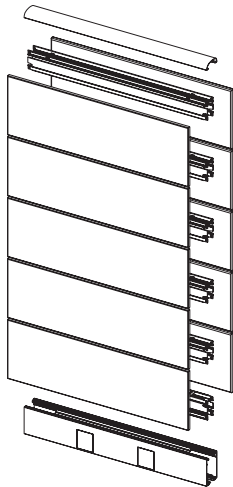

Fully Segmented panels consist of the following: Fabric tiles in 12" increments on both sides.  
Quantity of 12" tiles is dependent upon panel height. Base is 6". Panel thickness: 3/2".  
\*84" high panels include one 18" tile on top.

The 3/4" Tackable/Acoustic tile consists of a 1/2" thick mineral board core with a 1/4" thick fiberglass overlay.  
Each tile is framed on all four sides with steel. Fabric is glued to the steel frame on the back of the tile.

### STANDARD PANEL SIZES (Fabric-Acoustic)

	12" W	18" W	24" W	30" W	36" W	42" W	48" W	54" W	60" W	Side 1 Number of	Side 2 Number of
										12" Fabric Tiles	12" Fabric Tiles
30" H	•	•	•	•	•	•	•	•	•	2	2
42" H	•	•	•	•	•	•	•	•	•	3	3
54" H	•	•	•	•	•	•	•	•	•	4	4
66" H	•	•	•	•	•	•	•	•	•	5	5
84" H	•	•	•	•	•	•	•	•	•	5	5*

## Face Style: Monolithic/ Half Segmented

Basic Model: PMHA

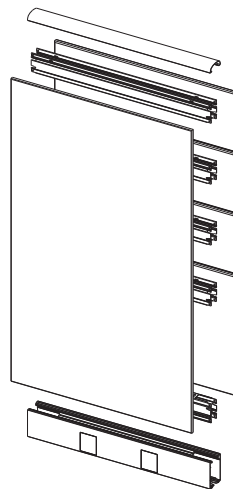

Monolithic/Half Segmented panels consist of the following: Single tile on side one;  
a 24" fabric tile on the bottom and 12" segmented tiles on top of side two.  
Quantity of 12" segmented tiles is dependent upon panel height. Base is 6". Panel thickness: 3/2".  
\*84" high panels include one 18" tile on top.

The 3/4" Tackable/Acoustic tile consists of a 1/2" thick mineral board core with a 1/4" thick fiberglass overlay.  
Each tile is framed on all four sides with steel. Fabric is glued to the steel frame on the back of the tile.

### STANDARD PANEL SIZES (Fabric-Acoustic)

	12" W	18" W	24" W	30" W	36" W	42" W	48" W	54" W	60" W	Side 1 Number of	Side 2 Number of
										12" Fabric Tiles	12" Fabric Tiles
30" H	N/A	N/A	N/A	N/A	N/A	N/A	N/A	N/A	N/A	N/A	N/A
42" H	•	•	•	•	•	•	•	•	•	N/A	1
54" H	•	•	•	•	•	•	•	•	•	N/A	2
66" H	•	•	•	•	•	•	•	•	•	N/A	3
84" H	•	•	•	•	•	•	•	•	•	N/A	3*





# Fabric Panel - Tackable Acoustic (3/4" Thick Tiles)

Face Styles



# Fabric Panel - Tackable Acoustic (3/4" Thick Tiles)

Monolithic Panel

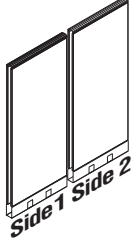
MODEL	W x H	MODEL NUMBER						Approx. Packaged Weight	
		Basic Model	Electrical Code	Horizontal Rail	Trim Color	Fabric Side 1	Fabric Side 2		
 <p><b>Monolithic Panel - 30"H</b></p> <ul style="list-style-type: none"> <li>Two horizontal rails</li> <li>Two fabric tiles with mounting hooks</li> <li>One base/raceway consisting of a raceway pan and two doors</li> <li>One rounded satin-textured polypropylene top cap with splice plate</li> <li>Order power separately</li> <li>Order vertical posts separately</li> <li>SX Starlight Silver finish is only offered on flat aluminum trim</li> </ul>	12 x 30"	PMMA1230	<input type="checkbox"/>	<input type="checkbox"/>	<input type="checkbox"/>	<input type="checkbox"/>	<input type="checkbox"/>	14.0#	
	18 x 30"	PMMA1830	<input type="checkbox"/>	<input type="checkbox"/>	<input type="checkbox"/>	<input type="checkbox"/>	<input type="checkbox"/>	20.0#	
	24 x 30"	PMMA2430	<input type="checkbox"/>	<input type="checkbox"/>	<input type="checkbox"/>	<input type="checkbox"/>	<input type="checkbox"/>	25.0#	
	30 x 30"	PMMA3030	<input type="checkbox"/>	<input type="checkbox"/>	<input type="checkbox"/>	<input type="checkbox"/>	<input type="checkbox"/>	30.0#	
	36 x 30"	PMMA3630	<input type="checkbox"/>	<input type="checkbox"/>	<input type="checkbox"/>	<input type="checkbox"/>	<input type="checkbox"/>	36.0#	
	42 x 30"	PMMA4230	<input type="checkbox"/>	<input type="checkbox"/>	<input type="checkbox"/>	<input type="checkbox"/>	<input type="checkbox"/>	41.0#	
	48 x 30"	PMMA4830	<input type="checkbox"/>	<input type="checkbox"/>	<input type="checkbox"/>	<input type="checkbox"/>	<input type="checkbox"/>	46.0#	
	54 x 30"	PMMA5430	<input type="checkbox"/>	<input type="checkbox"/>	<input type="checkbox"/>	<input type="checkbox"/>	<input type="checkbox"/>	52.0#	
60 x 30"	PMMA6030	<input type="checkbox"/>	<input type="checkbox"/>	<input type="checkbox"/>	<input type="checkbox"/>	<input type="checkbox"/>	58.0#		
PMMA									
PMMA	<b>Monolithic Panel - 42"H</b>	12 x 42"	PMMA1242	<input type="checkbox"/>	<input type="checkbox"/>	<input type="checkbox"/>	<input type="checkbox"/>	<input type="checkbox"/>	18.0#
		18 x 42"	PMMA1842	<input type="checkbox"/>	<input type="checkbox"/>	<input type="checkbox"/>	<input type="checkbox"/>	<input type="checkbox"/>	24.0#
		24 x 42"	PMMA2442	<input type="checkbox"/>	<input type="checkbox"/>	<input type="checkbox"/>	<input type="checkbox"/>	<input type="checkbox"/>	30.0#
		30 x 42"	PMMA3042	<input type="checkbox"/>	<input type="checkbox"/>	<input type="checkbox"/>	<input type="checkbox"/>	<input type="checkbox"/>	36.0#
		36 x 42"	PMMA3642	<input type="checkbox"/>	<input type="checkbox"/>	<input type="checkbox"/>	<input type="checkbox"/>	<input type="checkbox"/>	42.0#
		42 x 42"	PMMA4242	<input type="checkbox"/>	<input type="checkbox"/>	<input type="checkbox"/>	<input type="checkbox"/>	<input type="checkbox"/>	51.0#
		48 x 42"	PMMA4842	<input type="checkbox"/>	<input type="checkbox"/>	<input type="checkbox"/>	<input type="checkbox"/>	<input type="checkbox"/>	53.0#
		54 x 42"	PMMA5442	<input type="checkbox"/>	<input type="checkbox"/>	<input type="checkbox"/>	<input type="checkbox"/>	<input type="checkbox"/>	60.0#
60 x 42"	PMMA6042	<input type="checkbox"/>	<input type="checkbox"/>	<input type="checkbox"/>	<input type="checkbox"/>	<input type="checkbox"/>	67.0#		
PMMA	<b>Monolithic Panel - 54"H</b>	12 x 54"	PMMA1254	<input type="checkbox"/>	<input type="checkbox"/>	<input type="checkbox"/>	<input type="checkbox"/>	<input type="checkbox"/>	21.0#
		18 x 54"	PMMA1854	<input type="checkbox"/>	<input type="checkbox"/>	<input type="checkbox"/>	<input type="checkbox"/>	<input type="checkbox"/>	30.0#
		24 x 54"	PMMA2454	<input type="checkbox"/>	<input type="checkbox"/>	<input type="checkbox"/>	<input type="checkbox"/>	<input type="checkbox"/>	35.0#
		30 x 54"	PMMA3054	<input type="checkbox"/>	<input type="checkbox"/>	<input type="checkbox"/>	<input type="checkbox"/>	<input type="checkbox"/>	41.0#
		36 x 54"	PMMA3654	<input type="checkbox"/>	<input type="checkbox"/>	<input type="checkbox"/>	<input type="checkbox"/>	<input type="checkbox"/>	48.0#
		42 x 54"	PMMA4254	<input type="checkbox"/>	<input type="checkbox"/>	<input type="checkbox"/>	<input type="checkbox"/>	<input type="checkbox"/>	54.0#
		48 x 54"	PMMA4854	<input type="checkbox"/>	<input type="checkbox"/>	<input type="checkbox"/>	<input type="checkbox"/>	<input type="checkbox"/>	61.0#
		54 x 54"	PMMA5454	<input type="checkbox"/>	<input type="checkbox"/>	<input type="checkbox"/>	<input type="checkbox"/>	<input type="checkbox"/>	68.0#
60 x 54"	PMMA6054	<input type="checkbox"/>	<input type="checkbox"/>	<input type="checkbox"/>	<input type="checkbox"/>	<input type="checkbox"/>	75.0#		

A

B

C

D

E

F

## HOW TO ORDER

Indicate the following information on order form:

- Quantity of each item.
- Model number, including options. See "How To Build a Model Number".
- Any special service required.

Note: • The  indicates that a choice is required.

- The absence of the  indicates that no choice is required.
- Alpha-numeric characters in place of  indicate that no other alternatives are available.

## HOW TO BUILD A MODEL NUMBER

**A** Select basic model.

**B** Select electrical code for base raceway.

- CN** - Chicago, no cutouts
- C1** - Chicago, 1 side w/cutouts
- CP** - Chicago, 2 sides w/cutouts
- DN** - Domestic, no cutouts
- D1** - Domestic, 1 side w/cutouts
- D** - Domestic, 2 sides w/cutouts

**C** Select horizontal rail.

- E** - Enhanced
- S** - Standard

**D** Select trim color.

- Refer to color addendum at ki.com or KI Fabrics & Finishes binder.
- Metallic paint requires upcharge.
- SX Starlight Silver finish is only offered on flat aluminum trim.

**E** Select fabric side 1.

- Refer to color addendum at ki.com or in KI

Fabrics & Finishes binder.

**F** Select fabric side 2.

- Refer to color addendum at ki.com or in KI Fabrics & Finishes binder.

## UPHOLSTERY INFORMATION

### Fabric Mixing

If fabric is ordered from one group on side 1 and another group on side 2, calculate list price using the following method:

Example:  
Grade 2 Fabric  
-Grade1 Fabric

Upcharge

Upcharge/2 = Cost for one side

Grade 1 Fabric  
+Cost for one side

Combined list price

### Fabric Disclaimer

Fabric will be applied as swatched by the fabric manufacturer. Fabric that is required to be applied differently than is swatched will need a Special Cost Request written specify-





# Fabric Panel - Tackable Acoustic (3/4" Thick Tiles)

Monolithic Panel

Delivered Pricing Fabric Grade 1 & C.O.M.	Delivered Pricing Fabric Grade 2	Delivered Pricing Fabric Grade 3 & Pallas Vertical Fabric Grade PV	Delivered Pricing Pallas Vertical Fabric Grade PV1	Delivered Pricing Pallas Vertical Fabric Grade PV2	Enhanced Horizontal Rail	Metallic Paint add to list price
\$ 248	\$ 258	\$ 270	\$ 277	\$ 303	\$ 47	\$ 31
278	291	307	314	340	49	32
329	342	363	369	402	52	36
367	383	402	416	451	64	46
396	414	433	446	485	70	48
454	473	501	511	553	79	59
489	512	538	550	594	88	62
522	549	573	586	633	97	65
571	597	627	640	695	104	84
\$ 295	\$ 309	\$ 324	\$ 330	\$ 356	\$ 47	\$ 31
337	352	368	382	410	49	32
368	384	403	417	452	52	36
441	458	487	496	538	64	46
496	521	547	558	605	70	48
553	581	610	629	673	79	59
569	595	624	638	691	88	62
597	629	659	673	728	97	65
642	673	708	728	786	104	84
\$ 327	\$ 341	\$ 362	\$ 368	\$ 401	\$ 47	\$ 31
382	397	417	432	469	49	32
440	457	486	495	537	52	36
508	531	559	575	617	64	46
551	579	606	624	671	70	48
628	658	688	712	767	79	59
656	688	718	741	799	88	62
724	761	801	819	887	97	65
773	811	849	872	943	104	84

ing the direction the fabric is to be applied.  
The posted standard lead time will apply to  
the Special Cost Request.

## SPECIAL SERVICES

### Special Carton Marking

With specially marked information N/C

### Shipping

Shipped **k.d. freight prepaid f.o.b.**  
**Manitowoc, Wisconsin 54220** factory.  
Freight class #70.

Specifications and prices are subject to  
change without prior notice.

# Fabric Panel - Tackable Acoustic (3/4" Thick Tiles)

Monolithic Panel

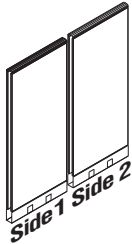
MODEL	W x H	MODEL NUMBER						Approx. Packaged Weight
		Basic Model	Electrical Code	Horizontal Rail	Trim Color	Fabric Side 1	Fabric Side 2	
 <p><b>Monolithic Panel - 66"H</b></p> <ul style="list-style-type: none"> <li>• Two horizontal rails</li> <li>• Two fabric tiles with mounting hooks</li> <li>• One base/raceway consisting of a raceway pan and two doors</li> <li>• One rounded satin-textured polypropylene top cap with splice plate</li> <li>• Order power separately</li> <li>• Order vertical posts separately</li> <li>• SX Starlight Silver finish is only offered on flat aluminum trim</li> </ul>	12 x 66"	PMMA1266	<input type="checkbox"/>	<input type="checkbox"/>	<input type="checkbox"/>	<input type="checkbox"/>	<input type="checkbox"/>	25.0#
	18 x 66"	PMMA1866	<input type="checkbox"/>	<input type="checkbox"/>	<input type="checkbox"/>	<input type="checkbox"/>	<input type="checkbox"/>	32.0#
	24 x 66"	PMMA2466	<input type="checkbox"/>	<input type="checkbox"/>	<input type="checkbox"/>	<input type="checkbox"/>	<input type="checkbox"/>	39.0#
	30 x 66"	PMMA3066	<input type="checkbox"/>	<input type="checkbox"/>	<input type="checkbox"/>	<input type="checkbox"/>	<input type="checkbox"/>	47.0#
	36 x 66"	PMMA3666	<input type="checkbox"/>	<input type="checkbox"/>	<input type="checkbox"/>	<input type="checkbox"/>	<input type="checkbox"/>	54.0#
	42 x 66"	PMMA4266	<input type="checkbox"/>	<input type="checkbox"/>	<input type="checkbox"/>	<input type="checkbox"/>	<input type="checkbox"/>	61.0#
	48 x 66"	PMMA4866	<input type="checkbox"/>	<input type="checkbox"/>	<input type="checkbox"/>	<input type="checkbox"/>	<input type="checkbox"/>	68.0#
	54 x 66"	PMMA5466	<input type="checkbox"/>	<input type="checkbox"/>	<input type="checkbox"/>	<input type="checkbox"/>	<input type="checkbox"/>	75.0#
	60 x 66"	PMMA6066	<input type="checkbox"/>	<input type="checkbox"/>	<input type="checkbox"/>	<input type="checkbox"/>	<input type="checkbox"/>	84.0#
PMMA								
<p><b>Monolithic Panel - 84"H</b></p>	12 x 84"	PMMA1284	<input type="checkbox"/>	<input type="checkbox"/>	<input type="checkbox"/>	<input type="checkbox"/>	<input type="checkbox"/>	30.0#
	18 x 84"	PMMA1884	<input type="checkbox"/>	<input type="checkbox"/>	<input type="checkbox"/>	<input type="checkbox"/>	<input type="checkbox"/>	38.0#
	24 x 84"	PMMA2484	<input type="checkbox"/>	<input type="checkbox"/>	<input type="checkbox"/>	<input type="checkbox"/>	<input type="checkbox"/>	47.0#
	30 x 84"	PMMA3084	<input type="checkbox"/>	<input type="checkbox"/>	<input type="checkbox"/>	<input type="checkbox"/>	<input type="checkbox"/>	55.0#
	36 x 84"	PMMA3684	<input type="checkbox"/>	<input type="checkbox"/>	<input type="checkbox"/>	<input type="checkbox"/>	<input type="checkbox"/>	63.0#
	42 x 84"	PMMA4284	<input type="checkbox"/>	<input type="checkbox"/>	<input type="checkbox"/>	<input type="checkbox"/>	<input type="checkbox"/>	71.0#
	48 x 84"	PMMA4884	<input type="checkbox"/>	<input type="checkbox"/>	<input type="checkbox"/>	<input type="checkbox"/>	<input type="checkbox"/>	79.0#
	54 x 84"	PMMA5484	<input type="checkbox"/>	<input type="checkbox"/>	<input type="checkbox"/>	<input type="checkbox"/>	<input type="checkbox"/>	87.0#
	60 x 84"	PMMA6084	<input type="checkbox"/>	<input type="checkbox"/>	<input type="checkbox"/>	<input type="checkbox"/>	<input type="checkbox"/>	97.0#
PMMA								

A

B

C

D

E

F

## HOW TO ORDER

Indicate the following information on order form:

1. Quantity of each item.
2. Model number, including options. See "How To Build a Model Number".
3. Any special service required.

Note: • The  indicates that a choice is required.

- The absence of the  indicates that no choice is required.
- Alpha-numeric characters in place of  indicate that no other alternatives are available.

## HOW TO BUILD A MODEL NUMBER

**A** Select basic model.

**B** Select electrical code for base raceway.

- CN** - Chicago, no cutouts
- C1** - Chicago, 1 side w/cutouts
- CP** - Chicago, 2 sides w/cutouts
- DN** - Domestic, no cutouts
- D1** - Domestic, 1 side w/cutouts
- D** - Domestic, 2 sides w/cutouts

**C** Select horizontal rail.

- E** - Enhanced
- S** - Standard

**D** Select trim color.

- Refer to color addendum at ki.com or KI Fabrics & Finishes binder.
- Metallic paint requires upcharge.
- SX Starlight Silver finish is only offered on flat aluminum trim.

**E** Select fabric side 1.

- Refer to color addendum at ki.com or in KI

Fabrics & Finishes binder.

**F** Select fabric side 2.

- Refer to color addendum at ki.com or in KI Fabrics & Finishes binder.

## UPHOLSTERY INFORMATION

### Fabric Mixing

If fabric is ordered from one group on side 1 and another group on side 2, calculate list price using the following method:

Example:  
Grade 2 Fabric  
-Grade1 Fabric

Upcharge

Upcharge/2 = Cost for one side

Grade 1 Fabric  
+Cost for one side

Combined list price

### Fabric Disclaimer

Fabric will be applied as swatched by the fabric manufacturer. Fabric that is required to be applied differently than is swatched will need a Special Cost Request written specify-



# Fabric Panel - Tackable Acoustic (3/4" Thick Tiles)

Monolithic Panel

Delivered Pricing Fabric Grade 1 & C.O.M.	Delivered Pricing Fabric Grade 2	Delivered Pricing Fabric Grade 3 & Pallas Vertical Fabric Grade PV	Delivered Pricing Pallas Vertical Fabric Grade PV1	Delivered Pricing Pallas Vertical Fabric Grade PV2	Enhanced Horizontal Rail	Metallic Paint add to list price
\$ 366	\$ 382	\$ 401	\$ 415	\$ 450	\$ 47	\$ 31
424	441	464	481	518	49	32
464	487	510	526	567	52	36
521	547	572	584	632	64	46
565	593	621	636	686	70	48
668	701	733	757	813	79	59
696	727	767	787	848	88	62
753	788	827	849	919	97	65
813	854	897	919	991	104	84
\$ 398	\$ 416	\$ 437	\$ 449	\$ 487	\$ 47	\$ 31
462	486	508	524	563	49	32
529	557	581	597	640	52	36
569	595	624	638	691	64	46
613	644	672	694	749	70	48
694	724	763	785	846	79	59
718	751	789	812	873	88	62
779	813	854	877	950	97	65
839	878	925	946	1023	104	84

ing the direction the fabric is to be applied.  
The posted standard lead time will apply to  
the Special Cost Request.

## SPECIAL SERVICES

### Special Carton Marking

With specially marked information N/C

### Shipping

Shipped **k.d. freight prepaid f.o.b.**  
**Manitowoc, Wisconsin 54220** factory.  
Freight class #70.

Specifications and prices are subject to  
change without prior notice.

# Fabric Panel - Tackable Acoustic (3/4" Thick Tiles)

Monolithic/Half Segmented Panel

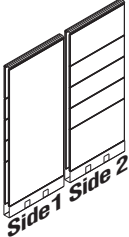
MODEL		W x H	MODEL NUMBER							
			Basic Model	Electrical Code	Horizontal Rail	Number of Raceway Tiles Side 1	Number of Raceway Tiles Side 2	Trim Color	Fabric Side 1	Fabric Side 2
 <p>PMHA</p>	<b>Monolithic/Half Segmented Panel - 42"H with 12"H tiles</b> <ul style="list-style-type: none"> <li>• Three to six horizontal rails</li> <li>• One, two or three 12" fabric tiles with mounting hooks</li> <li>• One 18" fabric tile included with 84" high panels with mounting hooks</li> <li>• One base/raceway consisting of a raceway pan and two doors</li> <li>• One rounded satin-textured polypropylene top cap with splice plate</li> <li>• Order power separately</li> <li>• Order vertical posts separately</li> <li>• SX Starlight Silver finish is only offered on flat aluminum trim</li> </ul>	12 x 42"	PMHA1242	<input type="checkbox"/>	<input type="checkbox"/>	R0	<input type="checkbox"/>	<input type="checkbox"/>	<input type="checkbox"/>	<input type="checkbox"/>
		18 x 42"	PMHA1842	<input type="checkbox"/>	<input type="checkbox"/>	R0	<input type="checkbox"/>	<input type="checkbox"/>	<input type="checkbox"/>	<input type="checkbox"/>
		24 x 42"	PMHA2442	<input type="checkbox"/>	<input type="checkbox"/>	R0	<input type="checkbox"/>	<input type="checkbox"/>	<input type="checkbox"/>	<input type="checkbox"/>
		30 x 42"	PMHA3042	<input type="checkbox"/>	<input type="checkbox"/>	R0	<input type="checkbox"/>	<input type="checkbox"/>	<input type="checkbox"/>	<input type="checkbox"/>
		36 x 42"	PMHA3642	<input type="checkbox"/>	<input type="checkbox"/>	R0	<input type="checkbox"/>	<input type="checkbox"/>	<input type="checkbox"/>	<input type="checkbox"/>
		42 x 42"	PMHA4242	<input type="checkbox"/>	<input type="checkbox"/>	R0	<input type="checkbox"/>	<input type="checkbox"/>	<input type="checkbox"/>	<input type="checkbox"/>
		48 x 42"	PMHA4842	<input type="checkbox"/>	<input type="checkbox"/>	R0	<input type="checkbox"/>	<input type="checkbox"/>	<input type="checkbox"/>	<input type="checkbox"/>
		54 x 42"	PMHA5442	<input type="checkbox"/>	<input type="checkbox"/>	R0	<input type="checkbox"/>	<input type="checkbox"/>	<input type="checkbox"/>	<input type="checkbox"/>
		60 x 42"	PMHA6042	<input type="checkbox"/>	<input type="checkbox"/>	R0	<input type="checkbox"/>	<input type="checkbox"/>	<input type="checkbox"/>	<input type="checkbox"/>
PMHA	<b>Monolithic/Half Segmented Panel - 54"H with 12"H tiles</b>	12 x 54"	PMHA1254	<input type="checkbox"/>	<input type="checkbox"/>	R0	<input type="checkbox"/>	<input type="checkbox"/>	<input type="checkbox"/>	<input type="checkbox"/>
		18 x 54"	PMHA1854	<input type="checkbox"/>	<input type="checkbox"/>	R0	<input type="checkbox"/>	<input type="checkbox"/>	<input type="checkbox"/>	<input type="checkbox"/>
		24 x 54"	PMHA2454	<input type="checkbox"/>	<input type="checkbox"/>	R0	<input type="checkbox"/>	<input type="checkbox"/>	<input type="checkbox"/>	<input type="checkbox"/>
		30 x 54"	PMHA3054	<input type="checkbox"/>	<input type="checkbox"/>	R0	<input type="checkbox"/>	<input type="checkbox"/>	<input type="checkbox"/>	<input type="checkbox"/>
		36 x 54"	PMHA3654	<input type="checkbox"/>	<input type="checkbox"/>	R0	<input type="checkbox"/>	<input type="checkbox"/>	<input type="checkbox"/>	<input type="checkbox"/>
		42 x 54"	PMHA4254	<input type="checkbox"/>	<input type="checkbox"/>	R0	<input type="checkbox"/>	<input type="checkbox"/>	<input type="checkbox"/>	<input type="checkbox"/>
		48 x 54"	PMHA4854	<input type="checkbox"/>	<input type="checkbox"/>	R0	<input type="checkbox"/>	<input type="checkbox"/>	<input type="checkbox"/>	<input type="checkbox"/>
		54 x 54"	PMHA5454	<input type="checkbox"/>	<input type="checkbox"/>	R0	<input type="checkbox"/>	<input type="checkbox"/>	<input type="checkbox"/>	<input type="checkbox"/>
60 x 54"	PMHA6054	<input type="checkbox"/>	<input type="checkbox"/>	R0	<input type="checkbox"/>	<input type="checkbox"/>	<input type="checkbox"/>	<input type="checkbox"/>		

A

B

C

D

E

F

G

H

## HOW TO ORDER

Indicate the following information on order form:

- Quantity of each item.
- Model number, including options. See "How To Build a Model Number".
- Any special service required.

Note: • The  indicates that a choice is required.

- The absence of the  indicates that no choice is required.
- Alpha-numeric characters in place of  indicate that no other alternatives are available.

## HOW TO BUILD A MODEL NUMBER

**A** Select basic model.

**B** Select electrical code for base raceway.

**CN** - Chicago, no cutouts

**C1** - Chicago, 1 side w/cutouts

**CP** - Chicago, 2 sides w/cutouts

**DN** - Domestic, no cutouts

**D1** - Domestic, 1 side w/cutouts

**D** - Domestic, 2 sides w/cutouts

**C** Select horizontal rail.

**E** - Enhanced

**S** - Standard

**D** Select numbers of raceway tiles side 1

**R0** - Side 1 w/no raceway tile

**E** Select numbers of raceway tiles side 2

**R20** - Side 2 w/no raceway tile

**R21** - Side 2 w/1-12" raceway tile; add \$32

**R22** - Side 2 w/2-12" raceway tiles; add \$64

**F** Select trim color.  
Refer to color addendum at [ki.com](http://ki.com) or KI Fabrics & Finishes binder.  
Metallic paint requires upcharge.  
SX Starlight Silver finish is only offered on flat aluminum trim.

**G** Select fabric side 1.  
Refer to color addendum at [ki.com](http://ki.com) or in KI Fabrics & Finishes binder.

**H** Select fabric side 2.  
Refer to color addendum at [ki.com](http://ki.com) or in KI Fabrics & Finishes binder.

## UPHOLSTERY INFORMATION

### Fabric Mixing

If fabric is ordered from one group on side 1 and another group on side 2, calculate list price using the following method:

Example:  
Grade 2 Fabric  
-Grade1 Fabric

Upcharge

Upcharge/2 = Cost for one side

Grade 1 Fabric  
+Cost for one side

Combined list price

### Fabric Disclaimer

Fabric will be applied as swatched by the fabric manufacturer. Fabric that is required to be applied differently than is swatched will need a Special Cost Request written specify-



# Fabric Panel - Tackable Acoustic (3/4" Thick Tiles)

Monolithic/Half Segmented Panel

Approx. Packaged Weight	Delivered Pricing Fabric Grade 1 & C.O.M.	Delivered Pricing Fabric Grade 2	Delivered Pricing Fabric Grade 3 & Pallas Vertical Fabric Grade PV	Delivered Pricing Pallas Vertical Fabric Grade PV1	Delivered Pricing Pallas Vertical Fabric Grade PV2	Enhanced Horizontal Rail	Metallic Paint add to list price
21.0#	\$ 356	\$ 372	\$ 388	\$ 401	\$ 432	\$ 47	\$ 31
29.0#	401	420	443	452	490	49	32
36.0#	449	468	493	505	545	52	36
44.0#	517	539	571	581	627	64	46
51.0#	575	606	631	650	699	70	48
56.0#	641	675	706	727	785	79	59
66.0#	673	708	742	762	824	88	62
74.0#	717	750	788	811	872	97	65
83.0#	785	823	861	884	958	104	84
27.0#	\$ 460	\$ 480	\$ 506	\$ 522	\$ 559	\$ 47	\$ 31
37.0#	519	542	571	581	629	49	32
48.0#	587	613	641	662	712	52	36
57.0#	661	695	723	748	806	64	46
67.0#	726	762	802	821	888	70	48
77.0#	818	860	903	924	996	79	59
86.0#	863	911	953	973	1056	88	62
97.0#	935	986	1031	1060	1141	97	65
108.0#	1029	1079	1130	1164	1255	104	84

ing the direction the fabric is to be applied. The posted standard lead time will apply to the Special Cost Request.

## INFORMATION

### Maximum Raceway Tile Possibilities

Panel Height	Side 1	Side 2
42"H	0	1
54"H	0	2
66"H	0	2
84"H	0	2

## SPECIAL SERVICES

### Special Carton Marking

With specially marked information N/C

### Shipping

Shipped **k.d. freight prepaid f.o.b. Manitowoc, Wisconsin 54220** factory. Freight class #70.

Specifications and prices are subject to change without prior notice.

# Fabric Panel - Tackable Acoustic (3/4" Thick Tiles)

Monolithic/Half Segmented Panel

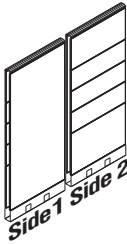
		MODEL NUMBER								
		Basic Model	Electrical Code	Horizontal Rail	Number of Raceway Tiles Side 1	Number of Raceway Tiles Side 2	Trim Color	Fabric Side 1	Fabric Side 2	
 <p>PMHA</p>	<b>Monolithic/Half Segmented Panel - 66"H with 12"H tiles</b> <ul style="list-style-type: none"> <li>• Three to six horizontal rails</li> <li>• One, two or three 12" fabric tiles with mounting hooks</li> <li>• One 18" fabric tile included with 84" high panels with mounting hooks</li> <li>• One base/raceway consisting of a raceway pan and two doors</li> <li>• One rounded satin-textured polypropylene top cap with splice plate</li> <li>• Order power separately</li> <li>• Order vertical posts separately</li> <li>• SX Starlight Silver finish is only offered on flat aluminum trim</li> </ul>	12 x 66"	PMHA1266	<input type="checkbox"/>	<input type="checkbox"/>	R0	<input type="checkbox"/>	<input type="checkbox"/>	<input type="checkbox"/>	<input type="checkbox"/>
		18 x 66"	PMHA1866	<input type="checkbox"/>	<input type="checkbox"/>	R0	<input type="checkbox"/>	<input type="checkbox"/>	<input type="checkbox"/>	<input type="checkbox"/>
		24 x 66"	PMHA2466	<input type="checkbox"/>	<input type="checkbox"/>	R0	<input type="checkbox"/>	<input type="checkbox"/>	<input type="checkbox"/>	<input type="checkbox"/>
		30 x 66"	PMHA3066	<input type="checkbox"/>	<input type="checkbox"/>	R0	<input type="checkbox"/>	<input type="checkbox"/>	<input type="checkbox"/>	<input type="checkbox"/>
		36 x 66"	PMHA3666	<input type="checkbox"/>	<input type="checkbox"/>	R0	<input type="checkbox"/>	<input type="checkbox"/>	<input type="checkbox"/>	<input type="checkbox"/>
		42 x 66"	PMHA4266	<input type="checkbox"/>	<input type="checkbox"/>	R0	<input type="checkbox"/>	<input type="checkbox"/>	<input type="checkbox"/>	<input type="checkbox"/>
		48 x 66"	PMHA4866	<input type="checkbox"/>	<input type="checkbox"/>	R0	<input type="checkbox"/>	<input type="checkbox"/>	<input type="checkbox"/>	<input type="checkbox"/>
		54 x 66"	PMHA5466	<input type="checkbox"/>	<input type="checkbox"/>	R0	<input type="checkbox"/>	<input type="checkbox"/>	<input type="checkbox"/>	<input type="checkbox"/>
		60 x 66"	PMHA6066	<input type="checkbox"/>	<input type="checkbox"/>	R0	<input type="checkbox"/>	<input type="checkbox"/>	<input type="checkbox"/>	<input type="checkbox"/>
PMHA	<b>Monolithic/Half Segmented Panel - 84"H with 12"H tiles</b>	12 x 84"	PMHA1284	<input type="checkbox"/>	<input type="checkbox"/>	R0	<input type="checkbox"/>	<input type="checkbox"/>	<input type="checkbox"/>	<input type="checkbox"/>
		18 x 84"	PMHA1884	<input type="checkbox"/>	<input type="checkbox"/>	R0	<input type="checkbox"/>	<input type="checkbox"/>	<input type="checkbox"/>	<input type="checkbox"/>
		24 x 84"	PMHA2484	<input type="checkbox"/>	<input type="checkbox"/>	R0	<input type="checkbox"/>	<input type="checkbox"/>	<input type="checkbox"/>	<input type="checkbox"/>
		30 x 84"	PMHA3084	<input type="checkbox"/>	<input type="checkbox"/>	R0	<input type="checkbox"/>	<input type="checkbox"/>	<input type="checkbox"/>	<input type="checkbox"/>
		36 x 84"	PMHA3684	<input type="checkbox"/>	<input type="checkbox"/>	R0	<input type="checkbox"/>	<input type="checkbox"/>	<input type="checkbox"/>	<input type="checkbox"/>
		42 x 84"	PMHA4284	<input type="checkbox"/>	<input type="checkbox"/>	R0	<input type="checkbox"/>	<input type="checkbox"/>	<input type="checkbox"/>	<input type="checkbox"/>
		48 x 84"	PMHA4884	<input type="checkbox"/>	<input type="checkbox"/>	R0	<input type="checkbox"/>	<input type="checkbox"/>	<input type="checkbox"/>	<input type="checkbox"/>
		60 x 84"	PMHA6084	<input type="checkbox"/>	<input type="checkbox"/>	R0	<input type="checkbox"/>	<input type="checkbox"/>	<input type="checkbox"/>	<input type="checkbox"/>

A

B

C

D

E

F

G

H

## HOW TO ORDER

Indicate the following information on order form:

1. Quantity of each item.
2. Model number, including options. See "How To Build a Model Number".
3. Any special service required.

Note: • The  indicates that a choice is required.

- The absence of the  indicates that no choice is required.
- Alpha-numeric characters in place of  indicate that no other alternatives are available.

## HOW TO BUILD A MODEL NUMBER

**A** Select basic model.

**B** Select electrical code for base raceway.

**CN** - Chicago, no cutouts

**C1** - Chicago, 1 side w/cutouts

**CP** - Chicago, 2 sides w/cutouts

**DN** - Domestic, no cutouts

**D1** - Domestic, 1 side w/cutouts

**D** - Domestic, 2 sides w/cutouts

**C** Select horizontal rail.

**E** - Enhanced

**S** - Standard

**D** Select numbers of raceway tiles side 1

**R0** - Side 1 w/no raceway tile

**E** Select numbers of raceway tiles side 2

**R20** - Side 2 w/no raceway tile

**R21** - Side 2 w/1-12" raceway tile; add \$32

**R22** - Side 2 w/2-12" raceway tiles; add \$64

**F** Select trim color.

Refer to color addendum at [ki.com](http://ki.com) or KI Fabrics & Finishes binder.

Metallic paint requires upcharge. SX Starlight Silver finish is only offered on flat aluminum trim.

**G** Select fabric side 1.

Refer to color addendum at [ki.com](http://ki.com) or in KI Fabrics & Finishes binder.

**H** Select fabric side 2.

Refer to color addendum at [ki.com](http://ki.com) or in KI Fabrics & Finishes binder.

## UPHOLSTERY INFORMATION

### Fabric Mixing

If fabric is ordered from one group on side 1 and another group on side 2, calculate list price using the following method:

Example:

Grade 2 Fabric

-Grade1 Fabric

Upcharge

Upcharge/2 = Cost for one side

Grade 1 Fabric  
+Cost for one side

Combined list price

### Fabric Disclaimer

Fabric will be applied as swatched by the fabric manufacturer. Fabric that is required to be applied differently than is swatched will need a Special Cost Request written specify-



# Fabric Panel - Tackable Acoustic (3/4" Thick Tiles)

Monolithic/Fully Segmented Panel

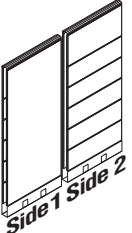
		MODEL NUMBER							
MODEL	W x H	Basic Model	Electrical Code	Horizontal Rail	Number of Raceway Tiles Side 1	Number of Raceway Tiles Side 2	Trim Color	Fabric Side 1	Fabric Side 2
 <p>PMFA</p>	<b>Monolithic/Fully Segmented Panel - 30"H with 12"H tiles</b>	12 x 30"	PMFA1230	<input type="checkbox"/>	<input type="checkbox"/>	R0	<input type="checkbox"/>	<input type="checkbox"/>	<input type="checkbox"/>
		18 x 30"	PMFA1830	<input type="checkbox"/>	<input type="checkbox"/>	R0	<input type="checkbox"/>	<input type="checkbox"/>	<input type="checkbox"/>
	• Three to six horizontal rails	24 x 30"	PMFA2430	<input type="checkbox"/>	<input type="checkbox"/>	R0	<input type="checkbox"/>	<input type="checkbox"/>	<input type="checkbox"/>
	• Two, three, four or five 12" fabric tiles with mounting hooks	30 x 30"	PMFA3030	<input type="checkbox"/>	<input type="checkbox"/>	R0	<input type="checkbox"/>	<input type="checkbox"/>	<input type="checkbox"/>
	• One 18" fabric tile included with 84" high panels with mounting hooks	36 x 30"	PMFA3630	<input type="checkbox"/>	<input type="checkbox"/>	R0	<input type="checkbox"/>	<input type="checkbox"/>	<input type="checkbox"/>
	• One base/raceway consisting of a raceway pan and two doors	42 x 30"	PMFA4230	<input type="checkbox"/>	<input type="checkbox"/>	R0	<input type="checkbox"/>	<input type="checkbox"/>	<input type="checkbox"/>
	• One rounded satin-textured polypropylene top cap with splice plate	48 x 30"	PMFA4830	<input type="checkbox"/>	<input type="checkbox"/>	R0	<input type="checkbox"/>	<input type="checkbox"/>	<input type="checkbox"/>
	• One rounded satin-textured polypropylene top cap with splice plate	54 x 30"	PMFA5430	<input type="checkbox"/>	<input type="checkbox"/>	R0	<input type="checkbox"/>	<input type="checkbox"/>	<input type="checkbox"/>
• Order power separately	60 x 30"	PMFA6030	<input type="checkbox"/>	<input type="checkbox"/>	R0	<input type="checkbox"/>	<input type="checkbox"/>	<input type="checkbox"/>	
• Order vertical posts separately									
• SX Starlight Silver finish is only offered on flat aluminum trim									
PMFA	<b>Monolithic/Fully Segmented Panel - 42"H with 12"H tiles</b>	12 x 42"	PMFA1242	<input type="checkbox"/>	<input type="checkbox"/>	R0	<input type="checkbox"/>	<input type="checkbox"/>	<input type="checkbox"/>
		18 x 42"	PMFA1842	<input type="checkbox"/>	<input type="checkbox"/>	R0	<input type="checkbox"/>	<input type="checkbox"/>	<input type="checkbox"/>
		24 x 42"	PMFA2442	<input type="checkbox"/>	<input type="checkbox"/>	R0	<input type="checkbox"/>	<input type="checkbox"/>	<input type="checkbox"/>
		30 x 42"	PMFA3042	<input type="checkbox"/>	<input type="checkbox"/>	R0	<input type="checkbox"/>	<input type="checkbox"/>	<input type="checkbox"/>
		36 x 42"	PMFA3642	<input type="checkbox"/>	<input type="checkbox"/>	R0	<input type="checkbox"/>	<input type="checkbox"/>	<input type="checkbox"/>
		42 x 42"	PMFA4242	<input type="checkbox"/>	<input type="checkbox"/>	R0	<input type="checkbox"/>	<input type="checkbox"/>	<input type="checkbox"/>
		48 x 42"	PMFA4842	<input type="checkbox"/>	<input type="checkbox"/>	R0	<input type="checkbox"/>	<input type="checkbox"/>	<input type="checkbox"/>
		54 x 42"	PMFA5442	<input type="checkbox"/>	<input type="checkbox"/>	R0	<input type="checkbox"/>	<input type="checkbox"/>	<input type="checkbox"/>
	60 x 42"	PMFA6042	<input type="checkbox"/>	<input type="checkbox"/>	R0	<input type="checkbox"/>	<input type="checkbox"/>	<input type="checkbox"/>	

A

B

C

D

E

F

G

H

## HOW TO ORDER

Indicate the following information on order form:

- Quantity of each item.
- Model number, including options. See "How To Build a Model Number".
- Any special service required.

Note: • The  indicates that a choice is required.

- The absence of the  indicates that no choice is required.
- Alpha-numeric characters in place of  indicate that no other alternatives are available.

## HOW TO BUILD A MODEL NUMBER

**A** Select basic model.

**B** Select electrical code for base raceway.

- CN** - Chicago, no cutouts
- C1** - Chicago, 1 side w/cutouts
- CP** - Chicago, 2 sides w/cutouts
- DN** - Domestic, no cutouts
- D1** - Domestic, 1 side w/cutouts
- D** - Domestic, 2 sides w/cutouts

**C** Select horizontal rail.

- E** - Enhanced
- S** - Standard

**D** Select numbers of raceway tiles side 1

- R0** - Side 1 w/no raceway tile

**E** Select numbers of raceway tiles side 2

- R20** - Side 2 w/no raceway tile
- R21** - Side 2 w/1-12" raceway tile; add \$32
- R22** - Side 2 w/2-12" raceway tiles; add \$64

**R23** - Side 2 w/3-12" raceway tiles; add \$94

**F** Select trim color.

Refer to color addendum at ki.com or KI Fabrics & Finishes binder. Metallic paint requires upcharge. SX Starlight Silver finish is only offered on flat aluminum trim.

**G** Select fabric side 1.

Refer to color addendum at ki.com or in KI Fabrics & Finishes binder.

**H** Select fabric side 2.

Refer to color addendum at ki.com or in KI Fabrics & Finishes binder.

## UPHOLSTERY INFORMATION

### Fabric Mixing

If fabric is ordered from one group on side 1 and another group on side 2, calculate list price using the following method:

Example:  
Grade 2 Fabric  
-Grade1 Fabric

Upcharge

Upcharge/2 = Cost for one side

Grade 1 Fabric  
+Cost for one side

Combined list price

### Fabric Disclaimer

Fabric will be applied as swatched by the fabric manufacturer. Fabric that is required to be applied differently than is swatched will need a Special Cost Request written specify-





# Fabric Panel - Tackable Acoustic (3/4" Thick Tiles)

Monolithic/Fully Segmented Panel

Approx. Packaged Weight	Delivered Pricing Fabric Grade 1 & C.O.M.	Delivered Pricing Fabric Grade 2	Delivered Pricing Fabric Grade 3 & Pallas Vertical Fabric Grade PV	Delivered Pricing Pallas Vertical Fabric Grade PV1	Delivered Pricing Pallas Vertical Fabric Grade PV2	Enhanced Horizontal Rail	Metallic Paint add to list price
17.0#	\$ 320	\$ 334	\$ 352	\$ 362	\$ 388	\$ 47	\$ 31
24.0#	358	374	394	403	440	49	32
32.0#	406	424	446	458	496	52	36
38.0#	456	474	502	512	556	64	46
45.0#	506	529	557	573	615	70	48
52.0#	570	596	625	639	694	79	59
59.0#	603	633	663	684	740	88	62
66.0#	641	675	706	727	785	97	65
74.0#	721	757	798	816	883	104	84

24.0#	\$ 431	\$ 449	\$ 472	\$ 485	\$ 526	\$ 47	\$ 31
33.0#	484	506	531	542	588	49	32
43.0#	529	557	581	597	640	52	36
52.0#	602	632	662	683	739	64	46
61.0#	683	716	749	771	830	70	48
70.0#	758	797	835	859	927	79	59
79.0#	790	829	870	893	961	88	62
88.0#	839	878	925	946	1023	97	65
100.0#	933	983	1029	1056	1138	104	84

ing the direction the fabric is to be applied. The posted standard lead time will apply to the Special Cost Request.

## INFORMATION

### Maximum Raceway Tile Possibilities

Panel Height	Side 1	Side 2
30"H	0	0
48"H	1	1
66"H	2	2
84"H	2	2

## SPECIAL SERVICES

### Special Carton Marking

With specially marked information N/C

### Shipping

Shipped **k.d. freight prepaid f.o.b. Manitowoc, Wisconsin 54220** factory. Freight class #70.

Specifications and prices are subject to change without prior notice.

# Fabric Panel - Tackable Acoustic (3/4" Thick Tiles)

Monolithic/Fully Segmented Panel

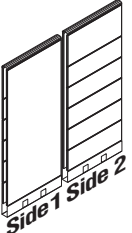
MODEL		W x H	MODEL NUMBER							
			Basic Model	Electrical Code	Horizontal Rail	Number of Raceway Tiles Side 1	Number of Raceway Tiles Side 2	Trim Color	Fabric Side 1	Fabric Side 2
 <p>PMFA</p>	<b>Monolithic/Fully Segmented Panel - 54"H with 12"H tiles</b> • Three to six horizontal rails • Two, three, four or five 12" fabric tiles with mounting hooks • One 18" fabric tile included with 84" high panels with mounting hooks • One base/raceway consisting of a raceway pan and two doors • One rounded satin-textured polypropylene top cap with splice plate • Order power separately • Order vertical posts separately • SX Starlight Silver finish is only offered on flat aluminum trim	12 x 54"	PMFA1254	<input type="checkbox"/>	<input type="checkbox"/>	R0	<input type="checkbox"/>	<input type="checkbox"/>	<input type="checkbox"/>	<input type="checkbox"/>
		18 x 54"	PMFA1854	<input type="checkbox"/>	<input type="checkbox"/>	R0	<input type="checkbox"/>	<input type="checkbox"/>	<input type="checkbox"/>	<input type="checkbox"/>
		24 x 54"	PMFA2454	<input type="checkbox"/>	<input type="checkbox"/>	R0	<input type="checkbox"/>	<input type="checkbox"/>	<input type="checkbox"/>	<input type="checkbox"/>
		30 x 54"	PMFA3054	<input type="checkbox"/>	<input type="checkbox"/>	R0	<input type="checkbox"/>	<input type="checkbox"/>	<input type="checkbox"/>	<input type="checkbox"/>
		36 x 54"	PMFA3654	<input type="checkbox"/>	<input type="checkbox"/>	R0	<input type="checkbox"/>	<input type="checkbox"/>	<input type="checkbox"/>	<input type="checkbox"/>
		42 x 54"	PMFA4254	<input type="checkbox"/>	<input type="checkbox"/>	R0	<input type="checkbox"/>	<input type="checkbox"/>	<input type="checkbox"/>	<input type="checkbox"/>
		48 x 54"	PMFA4854	<input type="checkbox"/>	<input type="checkbox"/>	R0	<input type="checkbox"/>	<input type="checkbox"/>	<input type="checkbox"/>	<input type="checkbox"/>
		54 x 54"	PMFA5454	<input type="checkbox"/>	<input type="checkbox"/>	R0	<input type="checkbox"/>	<input type="checkbox"/>	<input type="checkbox"/>	<input type="checkbox"/>
		60 x 54"	PMFA6054	<input type="checkbox"/>	<input type="checkbox"/>	R0	<input type="checkbox"/>	<input type="checkbox"/>	<input type="checkbox"/>	<input type="checkbox"/>
		<p>PMFA</p>	<b>Monolithic/Fully Segmented Panel - 66"H with 12"H tiles</b>	12 x 66"	PMFA1266	<input type="checkbox"/>	<input type="checkbox"/>	R0	<input type="checkbox"/>	<input type="checkbox"/>
		18 x 66"	PMFA1866	<input type="checkbox"/>	<input type="checkbox"/>	R0	<input type="checkbox"/>	<input type="checkbox"/>	<input type="checkbox"/>	
		24 x 66"	PMFA2466	<input type="checkbox"/>	<input type="checkbox"/>	R0	<input type="checkbox"/>	<input type="checkbox"/>	<input type="checkbox"/>	
		30 x 66"	PMFA3066	<input type="checkbox"/>	<input type="checkbox"/>	R0	<input type="checkbox"/>	<input type="checkbox"/>	<input type="checkbox"/>	
		36 x 66"	PMFA3666	<input type="checkbox"/>	<input type="checkbox"/>	R0	<input type="checkbox"/>	<input type="checkbox"/>	<input type="checkbox"/>	
		42 x 66"	PMFA4266	<input type="checkbox"/>	<input type="checkbox"/>	R0	<input type="checkbox"/>	<input type="checkbox"/>	<input type="checkbox"/>	
		48 x 66"	PMFA4866	<input type="checkbox"/>	<input type="checkbox"/>	R0	<input type="checkbox"/>	<input type="checkbox"/>	<input type="checkbox"/>	
		54 x 66"	PMFA5466	<input type="checkbox"/>	<input type="checkbox"/>	R0	<input type="checkbox"/>	<input type="checkbox"/>	<input type="checkbox"/>	
		60 x 66"	PMFA6066	<input type="checkbox"/>	<input type="checkbox"/>	R0	<input type="checkbox"/>	<input type="checkbox"/>	<input type="checkbox"/>	
<p>PMFA</p>	<b>Monolithic/Fully Segmented Panel - 84"H with 12"H tiles</b>	12 x 84"	PMFA1284	<input type="checkbox"/>	<input type="checkbox"/>	R0	<input type="checkbox"/>	<input type="checkbox"/>	<input type="checkbox"/>	
		18 x 84"	PMFA1884	<input type="checkbox"/>	<input type="checkbox"/>	R0	<input type="checkbox"/>	<input type="checkbox"/>	<input type="checkbox"/>	
		24 x 84"	PMFA2484	<input type="checkbox"/>	<input type="checkbox"/>	R0	<input type="checkbox"/>	<input type="checkbox"/>	<input type="checkbox"/>	
		30 x 84"	PMFA3084	<input type="checkbox"/>	<input type="checkbox"/>	R0	<input type="checkbox"/>	<input type="checkbox"/>	<input type="checkbox"/>	
		36 x 84"	PMFA3684	<input type="checkbox"/>	<input type="checkbox"/>	R0	<input type="checkbox"/>	<input type="checkbox"/>	<input type="checkbox"/>	
		42 x 84"	PMFA4284	<input type="checkbox"/>	<input type="checkbox"/>	R0	<input type="checkbox"/>	<input type="checkbox"/>	<input type="checkbox"/>	
		48 x 84"	PMFA4884	<input type="checkbox"/>	<input type="checkbox"/>	R0	<input type="checkbox"/>	<input type="checkbox"/>	<input type="checkbox"/>	
		54 x 84"	PMFA5484	<input type="checkbox"/>	<input type="checkbox"/>	R0	<input type="checkbox"/>	<input type="checkbox"/>	<input type="checkbox"/>	
		60 x 84"	PMFA6084	<input type="checkbox"/>	<input type="checkbox"/>	R0	<input type="checkbox"/>	<input type="checkbox"/>	<input type="checkbox"/>	

**A** **B** **C** **D** **E** **F** **G** **H**

## HOW TO ORDER

Indicate the following information on order form:

- Quantity of each item.
- Model number, including options. See "How To Build a Model Number".
- Any special service required.

Note: • The  indicates that a choice is required.

- The absence of the  indicates that no choice is required.
- Alpha-numeric characters in place of  indicate that no other alternatives are available.

## HOW TO BUILD A MODEL NUMBER

**A** Select basic model.

**B** Select electrical code for base raceway.

- CN** - Chicago, no cutouts
- C1** - Chicago, 1 side w/cutouts
- CP** - Chicago, 2 sides w/cutouts
- DN** - Domestic, no cutouts
- D1** - Domestic, 1 side w/cutouts
- D** - Domestic, 2 sides w/cutouts

**C** Select horizontal rail.

- E** - Enhanced
- S** - Standard

**D** Select numbers of raceway tiles side 1

- R0** - Side 1 w/no raceway tile

**E** Select numbers of raceway tiles side 2

- R20** - Side 2 w/no raceway tile
- R21** - Side 2 w/1-12" raceway tile; add \$32
- R22** - Side 2 w/2-12" raceway tiles; add \$64

**R23** - Side 2 w/3-12" raceway tiles; add \$94

**F** Select trim color.

Refer to color addendum at ki.com or KI Fabrics & Finishes binder. Metallic paint requires upcharge. SX Starlight Silver finish is only offered on flat aluminum trim.

**G** Select fabric side 1.

Refer to color addendum at ki.com or in KI Fabrics & Finishes binder.

**H** Select fabric side 2.

Refer to color addendum at ki.com or in KI Fabrics & Finishes binder.

## UPHOLSTERY INFORMATION

### Fabric Mixing

If fabric is ordered from one group on side 1 and another group on side 2, calculate list price using the following method:

Example:  
Grade 2 Fabric  
-Grade1 Fabric

Upcharge

Upcharge/2 = Cost for one side

Grade 1 Fabric  
+Cost for one side

Combined list price

### Fabric Disclaimer

Fabric will be applied as swatched by the fabric manufacturer. Fabric that is required to be applied differently than is swatched will need a Special Cost Request written specify-



# Fabric Panel - Tackable Acoustic (3/4" Thick Tiles)

Monolithic/Fully Segmented Panel

Approx. Packaged Weight	Delivered Pricing Fabric Grade 1 & C.O.M.	Delivered Pricing Fabric Grade 2	Delivered Pricing Fabric Grade 3 & Pallas Vertical Fabric Grade PV	Delivered Pricing Pallas Vertical Fabric Grade PV1	Delivered Pricing Pallas Vertical Fabric Grade PV2	Enhanced Horizontal Rail	Metallic Paint add to list price
54.0#	\$ 535	\$ 563	\$ 588	\$ 603	\$ 646	\$ 47	\$ 31
70.0#	597	629	659	673	728	49	32
87.0#	665	699	728	755	811	52	36
103.0#	748	783	818	845	912	64	46
119.0#	836	877	924	943	1022	70	48
135.0#	932	982	1027	1054	1137	79	59
150.0#	980	1030	1075	1103	1193	88	62
166.0#	1062	1119	1166	1204	1298	97	65
176.0#	1179	1237	1292	1332	1439	104	84
37.0#	\$ 638	\$ 671	\$ 701	\$ 723	\$ 779	\$ 47	\$ 31
51.0#	715	748	783	806	868	49	32
65.0#	779	813	854	877	950	52	36
79.0#	862	903	952	971	1051	64	46
92.0#	973	1021	1069	1098	1188	70	48
106.0#	1094	1148	1201	1238	1338	79	59
120.0#	1144	1203	1252	1295	1396	88	62
133.0#	1232	1293	1353	1391	1501	97	65
150.0#	1376	1440	1512	1554	1674	104	84
45.0#	\$ 747	\$ 782	\$ 817	\$ 844	\$ 911	\$ 47	\$ 31
62.0#	834	874	919	940	1020	49	32
79.0#	918	962	1010	1036	1119	52	36
95.0#	1018	1071	1118	1152	1241	64	46
112.0#	1137	1195	1246	1288	1388	70	48
127.0#	1259	1319	1383	1422	1535	79	59
143.0#	1318	1384	1453	1492	1610	88	62
160.0#	1429	1501	1570	1615	1743	97	65
180.0#	1584	1667	1740	1787	1932	104	84

ing the direction the fabric is to be applied.  
The posted standard lead time will apply to  
the Special Cost Request.

## INFORMATION

### Maximum Raceway Tile Possibilities

Panel Height	Side 1	Side 2
30"H	0	0
48"H	1	1
66"H	2	2
84"H	2	2

## SPECIAL SERVICES

### Special Carton Marking

With specially marked information N/C

### Shipping

Shipped **k.d. freight prepaid f.o.b.**  
**Manitowoc, Wisconsin 54220** factory.  
Freight class #70.

Specifications and prices are subject to  
change without prior notice.

# Fabric Panel - Tackable Acoustic (3/4" Thick Tiles)

Half Segmented/Half Segmented Panel

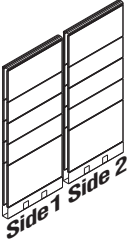
		MODEL NUMBER								
MODEL	W x H	Basic Model	Electrical Code	Horizontal Rail	Number of Raceway Tiles Side 1	Number of Raceway Tiles Side 2	Trim Color	Fabric Side 1	Fabric Side 2	
 <p>PHHA</p>	<b>Half Segmented/Half Segmented Panel - 42"H with 12"H tiles</b> <ul style="list-style-type: none"> <li>• Three to six horizontal rails</li> <li>• Two, four or six 12" fabric tiles with mounting hooks</li> <li>• Two 18" fabric tile included with 84" high panels with mounting hooks</li> <li>• One base/raceway consisting of a raceway pan and two doors</li> <li>• One rounded satin-textured polypropylene top cap with splice plate</li> <li>• Order power separately</li> <li>• Order vertical posts separately</li> <li>• SX Starlight Silver finish is only offered on flat aluminum trim</li> </ul>	12 x 42"	PHHA1242	<input type="checkbox"/>	<input type="checkbox"/>	<input type="checkbox"/>	<input type="checkbox"/>	<input type="checkbox"/>	<input type="checkbox"/>	<input type="checkbox"/>
	18 x 42"	PHHA1842	<input type="checkbox"/>	<input type="checkbox"/>	<input type="checkbox"/>	<input type="checkbox"/>	<input type="checkbox"/>	<input type="checkbox"/>	<input type="checkbox"/>	<input type="checkbox"/>
	24 x 42"	PHHA2442	<input type="checkbox"/>	<input type="checkbox"/>	<input type="checkbox"/>	<input type="checkbox"/>	<input type="checkbox"/>	<input type="checkbox"/>	<input type="checkbox"/>	<input type="checkbox"/>
	30 x 42"	PHHA3042	<input type="checkbox"/>	<input type="checkbox"/>	<input type="checkbox"/>	<input type="checkbox"/>	<input type="checkbox"/>	<input type="checkbox"/>	<input type="checkbox"/>	<input type="checkbox"/>
	36 x 42"	PHHA3642	<input type="checkbox"/>	<input type="checkbox"/>	<input type="checkbox"/>	<input type="checkbox"/>	<input type="checkbox"/>	<input type="checkbox"/>	<input type="checkbox"/>	<input type="checkbox"/>
	42 x 42"	PHHA4242	<input type="checkbox"/>	<input type="checkbox"/>	<input type="checkbox"/>	<input type="checkbox"/>	<input type="checkbox"/>	<input type="checkbox"/>	<input type="checkbox"/>	<input type="checkbox"/>
	48 x 42"	PHHA4842	<input type="checkbox"/>	<input type="checkbox"/>	<input type="checkbox"/>	<input type="checkbox"/>	<input type="checkbox"/>	<input type="checkbox"/>	<input type="checkbox"/>	<input type="checkbox"/>
	54 x 42"	PHHA5442	<input type="checkbox"/>	<input type="checkbox"/>	<input type="checkbox"/>	<input type="checkbox"/>	<input type="checkbox"/>	<input type="checkbox"/>	<input type="checkbox"/>	<input type="checkbox"/>
	60 x 42"	PHHA6042	<input type="checkbox"/>	<input type="checkbox"/>	<input type="checkbox"/>	<input type="checkbox"/>	<input type="checkbox"/>	<input type="checkbox"/>	<input type="checkbox"/>	<input type="checkbox"/>
PHHA	<b>Half Segmented/Half Segmented Panel - 54"H with 12"H tiles</b>	12 x 54"	PHHA1254	<input type="checkbox"/>	<input type="checkbox"/>	<input type="checkbox"/>	<input type="checkbox"/>	<input type="checkbox"/>	<input type="checkbox"/>	<input type="checkbox"/>
	18 x 54"	PHHA1854	<input type="checkbox"/>	<input type="checkbox"/>	<input type="checkbox"/>	<input type="checkbox"/>	<input type="checkbox"/>	<input type="checkbox"/>	<input type="checkbox"/>	<input type="checkbox"/>
	24 x 54"	PHHA2454	<input type="checkbox"/>	<input type="checkbox"/>	<input type="checkbox"/>	<input type="checkbox"/>	<input type="checkbox"/>	<input type="checkbox"/>	<input type="checkbox"/>	<input type="checkbox"/>
	30 x 54"	PHHA3054	<input type="checkbox"/>	<input type="checkbox"/>	<input type="checkbox"/>	<input type="checkbox"/>	<input type="checkbox"/>	<input type="checkbox"/>	<input type="checkbox"/>	<input type="checkbox"/>
	36 x 54"	PHHA3654	<input type="checkbox"/>	<input type="checkbox"/>	<input type="checkbox"/>	<input type="checkbox"/>	<input type="checkbox"/>	<input type="checkbox"/>	<input type="checkbox"/>	<input type="checkbox"/>
	42 x 54"	PHHA4254	<input type="checkbox"/>	<input type="checkbox"/>	<input type="checkbox"/>	<input type="checkbox"/>	<input type="checkbox"/>	<input type="checkbox"/>	<input type="checkbox"/>	<input type="checkbox"/>
	48 x 54"	PHHA4854	<input type="checkbox"/>	<input type="checkbox"/>	<input type="checkbox"/>	<input type="checkbox"/>	<input type="checkbox"/>	<input type="checkbox"/>	<input type="checkbox"/>	<input type="checkbox"/>
	54 x 54"	PHHA5454	<input type="checkbox"/>	<input type="checkbox"/>	<input type="checkbox"/>	<input type="checkbox"/>	<input type="checkbox"/>	<input type="checkbox"/>	<input type="checkbox"/>	<input type="checkbox"/>
	60 x 54"	PHHA6054	<input type="checkbox"/>	<input type="checkbox"/>	<input type="checkbox"/>	<input type="checkbox"/>	<input type="checkbox"/>	<input type="checkbox"/>	<input type="checkbox"/>	<input type="checkbox"/>
		<b>A</b>	<b>B</b>	<b>C</b>	<b>D</b>	<b>E</b>	<b>F</b>	<b>G</b>	<b>H</b>	

## HOW TO ORDER

Indicate the following information on order form:

1. Quantity of each item.
2. Model number, including options. See "How To Build a Model Number".
3. Any special service required.

Note: • The  indicates that a choice is required.

- The absence of the  indicates that no choice is required.
- Alpha-numeric characters in place of  indicate that no other alternatives are available.

## HOW TO BUILD A MODEL NUMBER

**A** Select basic model.

**B** Select electrical code for base raceway.

- CN** - Chicago, no cutouts
- C1** - Chicago, 1 side w/cutouts
- CP** - Chicago, 2 sides w/cutouts
- DN** - Domestic, no cutouts
- D1** - Domestic, 1 side w/cutouts
- D** - Domestic, 2 sides w/cutouts

**C** Select horizontal rail.

- S** - Standard
- E** - Enhanced

**D** Select numbers of raceway tiles side 1

- R0** - Side 1 w/no raceway tile
- R1** - Side 1 w/1-12" raceway tile; add \$32
- R2** - Side 1 w/2-12" raceway tiles; add \$64

**E** Select numbers of raceway tiles side 2

- R20** - Side 2 w/no raceway tile

**R21** - Side 2 w/1-12" raceway tile; add \$32

**R22** - Side 2 w/2-12" raceway tiles; add \$64

**F** Select trim color.

Refer to color addendum at [ki.com](http://ki.com) or KI Fabrics & Finishes binder. Metallic paint requires upcharge. SX Starlight Silver finish is only offered on flat aluminum trim.

**G** Select fabric side 1.

Refer to color addendum at [ki.com](http://ki.com) or in KI Fabrics & Finishes binder.

**H** Select fabric side 2.

Refer to color addendum at [ki.com](http://ki.com) or in KI Fabrics & Finishes binder.

## UPHOLSTERY INFORMATION

### Fabric Mixing

If fabric is ordered from one group on side 1 and another group on side 2, calculate list price using the following method:

Example:

Grade 2 Fabric  
-Grade1 Fabric

Upcharge

Upcharge/2 = Cost for one side

Grade 1 Fabric  
+Cost for one side

Combined list price

### Fabric Disclaimer

Fabric will be applied as swatched by the fabric manufacturer. Fabric that is required to be applied differently than is swatched will need a Special Cost Request written specify-



# Fabric Panel - Tackable Acoustic - 3/4" Thick Tiles

Half Segmented/Half Segmented Panel

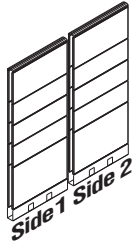

		MODEL NUMBER							
MODEL	W x H	Basic Model	Electrical Code	Horizontal Rail	Number of Raceway Tiles Side 1	Number of Raceway Tiles Side 2	Trim Color	Fabric Side 1	Fabric Side 2
<b>Half Segmented/Half Segmented Panel - 66"H with 12"H tiles</b> • Three to six horizontal rails • Two, four or six 12" fabric tiles with mounting hooks • Two 18" fabric tile included with 84" high panels with mounting hooks • One base/raceway consisting of a raceway pan and two doors • One rounded satin-textured polypropylene top cap with splice plate • Order power separately • Order vertical posts separately • SX Starlight Silver finish is only offered on flat aluminum trim	12 x 66"	PHHA1266	<input type="checkbox"/>	<input type="checkbox"/>	<input type="checkbox"/>	<input type="checkbox"/>	<input type="checkbox"/>	<input type="checkbox"/>	<input type="checkbox"/>
	18 x 66"	PHHA1866	<input type="checkbox"/>	<input type="checkbox"/>	<input type="checkbox"/>	<input type="checkbox"/>	<input type="checkbox"/>	<input type="checkbox"/>	<input type="checkbox"/>
	24 x 66"	PHHA2466	<input type="checkbox"/>	<input type="checkbox"/>	<input type="checkbox"/>	<input type="checkbox"/>	<input type="checkbox"/>	<input type="checkbox"/>	<input type="checkbox"/>
	30 x 66"	PHHA3066	<input type="checkbox"/>	<input type="checkbox"/>	<input type="checkbox"/>	<input type="checkbox"/>	<input type="checkbox"/>	<input type="checkbox"/>	<input type="checkbox"/>
	36 x 66"	PHHA3666	<input type="checkbox"/>	<input type="checkbox"/>	<input type="checkbox"/>	<input type="checkbox"/>	<input type="checkbox"/>	<input type="checkbox"/>	<input type="checkbox"/>
	42 x 66"	PHHA4266	<input type="checkbox"/>	<input type="checkbox"/>	<input type="checkbox"/>	<input type="checkbox"/>	<input type="checkbox"/>	<input type="checkbox"/>	<input type="checkbox"/>
	48 x 66"	PHHA4866	<input type="checkbox"/>	<input type="checkbox"/>	<input type="checkbox"/>	<input type="checkbox"/>	<input type="checkbox"/>	<input type="checkbox"/>	<input type="checkbox"/>
<b>Half Segmented/Half Segmented Panel - 84"H with 12"H tiles</b>	12 x 84"	PHHA1284	<input type="checkbox"/>	<input type="checkbox"/>	<input type="checkbox"/>	<input type="checkbox"/>	<input type="checkbox"/>	<input type="checkbox"/>	<input type="checkbox"/>
	18 x 84"	PHHA1884	<input type="checkbox"/>	<input type="checkbox"/>	<input type="checkbox"/>	<input type="checkbox"/>	<input type="checkbox"/>	<input type="checkbox"/>	<input type="checkbox"/>
	24 x 84"	PHHA2484	<input type="checkbox"/>	<input type="checkbox"/>	<input type="checkbox"/>	<input type="checkbox"/>	<input type="checkbox"/>	<input type="checkbox"/>	<input type="checkbox"/>
	30 x 84"	PHHA3084	<input type="checkbox"/>	<input type="checkbox"/>	<input type="checkbox"/>	<input type="checkbox"/>	<input type="checkbox"/>	<input type="checkbox"/>	<input type="checkbox"/>
	36 x 84"	PHHA3684	<input type="checkbox"/>	<input type="checkbox"/>	<input type="checkbox"/>	<input type="checkbox"/>	<input type="checkbox"/>	<input type="checkbox"/>	<input type="checkbox"/>
	42 x 84"	PHHA4284	<input type="checkbox"/>	<input type="checkbox"/>	<input type="checkbox"/>	<input type="checkbox"/>	<input type="checkbox"/>	<input type="checkbox"/>	<input type="checkbox"/>
	48 x 84"	PHHA4884	<input type="checkbox"/>	<input type="checkbox"/>	<input type="checkbox"/>	<input type="checkbox"/>	<input type="checkbox"/>	<input type="checkbox"/>	<input type="checkbox"/>
54 x 84"	PHHA5484	<input type="checkbox"/>	<input type="checkbox"/>	<input type="checkbox"/>	<input type="checkbox"/>	<input type="checkbox"/>	<input type="checkbox"/>	<input type="checkbox"/>	
60 x 84"	PHHA6084	<input type="checkbox"/>	<input type="checkbox"/>	<input type="checkbox"/>	<input type="checkbox"/>	<input type="checkbox"/>	<input type="checkbox"/>	<input type="checkbox"/>	

**A**   **B**   **C**   **D**   **E**   **F**   **G**   **H**

## HOW TO ORDER

Indicate the following information on order form:

- Quantity of each item.
- Model number, including options. See "How To Build a Model Number".
- Any special service required.

Note: • The  indicates that a choice is required.

- The absence of the  indicates that no choice is required.
- Alpha-numeric characters in place of  indicate that no other alternatives are available.

## HOW TO BUILD A MODEL NUMBER

**A** Select basic model.

**B** Select electrical code for base raceway.

- CN** - Chicago, no cutouts
- C1** - Chicago, 1 side w/cutouts
- CP** - Chicago, 2 sides w/cutouts
- DN** - Domestic, no cutouts
- D1** - Domestic, 1 side w/cutouts
- D** - Domestic, 2 sides w/cutouts

**C** Select horizontal rail.

- E** - Enhanced
- S** - Standard

**D** Select numbers of raceway tiles side 1

- R0** - Side 1 w/no raceway tile
- R1** - Side 1 w/1-12" raceway tile; add \$32
- R2** - Side 1 w/2-12" raceway tiles; add \$64

**E** Select numbers of raceway tiles side 2

- R20** - Side 2 w/no raceway tile

**R21** - Side 2 w/1-12" raceway tile; add \$32

**R22** - Side 2 w/2-12" raceway tiles; add \$64

**F** Select trim color.

Refer to color addendum at ki.com or KI Fabrics & Finishes binder. Metallic paint requires upcharge. SX Starlight Silver finish is only offered on flat aluminum trim.

**G** Select fabric side 1.

Refer to color addendum at ki.com or in KI Fabrics & Finishes binder.

**H** Select fabric side 2.

Refer to color addendum at ki.com or in KI Fabrics & Finishes binder.

## UPHOLSTERY INFORMATION

### Fabric Mixing

If fabric is ordered from one group on side 1 and another group on side 2, calculate list price using the following method:

Example:

Grade 2 Fabric  
-Grade1 Fabric

Upcharge

Upcharge/2 = Cost for one side

Grade 1 Fabric  
+Cost for one side

Combined list price

### Fabric Disclaimer

Fabric will be applied as swatched by the fabric manufacturer. Fabric that is required to be applied differently than is swatched will need a Special Cost Request written specify-



# Fabric Panel - Tackable Acoustic (3/4" Thick Tiles)

Half Segmented/Half Segmented Panel

Approx. Packaged Weight	Delivered Pricing Fabric Grade 1 & C.O.M.	Delivered Pricing Fabric Grade 2	Delivered Pricing Fabric Grade 3 & Pallas Vertical Fabric Grade PV	Delivered Pricing Pallas Vertical Fabric Grade PV1	Delivered Pricing Pallas Vertical Fabric Grade PV2	Enhanced Horizontal Rail	Metallic Paint add to list price
37.0#	\$ 708	\$ 744	\$ 777	\$ 802	\$ 860	\$ 47	\$ 31
51.0#	783	821	860	883	957	49	32
65.0#	863	911	953	973	1056	52	36
79.0#	953	1001	1046	1074	1159	64	46
92.0#	1067	1121	1171	1206	1300	70	48
106.0#	1181	1240	1298	1334	1441	79	59
119.0#	1252	1315	1376	1418	1527	88	62
133.0#	1337	1402	1471	1511	1628	97	65
150.0#	1490	1563	1637	1682	1816	104	84
43.0#	\$ 872	\$ 919	\$ 961	\$ 982	\$ 1063	\$ 47	\$ 31
59.0#	969	1018	1066	1094	1180	49	32
75.0#	1059	1107	1162	1195	1293	52	36
91.0#	1183	1242	1300	1337	1446	64	46
106.0#	1316	1382	1448	1488	1607	70	48
122.0#	1452	1525	1599	1640	1773	79	59
137.0#	1540	1616	1692	1738	1877	88	62
153.0#	1662	1749	1830	1880	2030	97	65
172.0#	1832	1924	2017	2072	2237	104	84

ing the direction the fabric is to be applied. The posted standard lead time will apply to the Special Cost Request.

## INFORMATION

### Maximum Raceway Tile Possibilities

Panel Height	Side 1	Side 2
42"H	1	1
54"H	2	2
66"H	2	2
84"H	2	2

## SPECIAL SERVICES

### Special Carton Marking

With specially marked information N/C

### Shipping

Shipped **k.d. freight prepaid f.o.b. Manitowoc, Wisconsin 54220** factory. Freight class #70.

Specifications and prices are subject to change without prior notice.

# Fabric Panel - Tackable Acoustic (3/4" Thick Tiles)

Half Segmented/Fully Segmented Panel

	MODEL	W x H	MODEL NUMBER									
			Basic Model	Electrical Code	Horizontal Rail	Number of Raceway Tiles Side 1	Number of Raceway Tiles Side 2	Trim Color	Fabric Side 1	Fabric Side 2		
 <p>PHFA</p>	<b>Half Segmented/Fully Segmented Panel - 42"H with 12"H tiles</b> • Three to seven horizontal rails • Four, six or eight 12" fabric tiles with mounting hooks • Two 18" fabric tiles included with 84" high panels with mounting hooks • One base/raceway consisting of a raceway pan and two doors • One rounded satin-textured polypropylene top cap with splice plate • Order power separately • Order vertical posts separately • SX Starlight Silver finish is only offered on flat aluminum trim	12 x 42"	PHFA1242	<input type="checkbox"/>	<input type="checkbox"/>	<input type="checkbox"/>	<input type="checkbox"/>	<input type="checkbox"/>	<input type="checkbox"/>	<input type="checkbox"/>	<input type="checkbox"/>	
		18 x 42"	PHFA1842	<input type="checkbox"/>	<input type="checkbox"/>	<input type="checkbox"/>	<input type="checkbox"/>	<input type="checkbox"/>	<input type="checkbox"/>	<input type="checkbox"/>	<input type="checkbox"/>	<input type="checkbox"/>
		24 x 42"	PHFA2442	<input type="checkbox"/>	<input type="checkbox"/>	<input type="checkbox"/>	<input type="checkbox"/>	<input type="checkbox"/>	<input type="checkbox"/>	<input type="checkbox"/>	<input type="checkbox"/>	<input type="checkbox"/>
		30 x 42"	PHFA3042	<input type="checkbox"/>	<input type="checkbox"/>	<input type="checkbox"/>	<input type="checkbox"/>	<input type="checkbox"/>	<input type="checkbox"/>	<input type="checkbox"/>	<input type="checkbox"/>	<input type="checkbox"/>
		36 x 42"	PHFA3642	<input type="checkbox"/>	<input type="checkbox"/>	<input type="checkbox"/>	<input type="checkbox"/>	<input type="checkbox"/>	<input type="checkbox"/>	<input type="checkbox"/>	<input type="checkbox"/>	<input type="checkbox"/>
		42 x 42"	PHFA4242	<input type="checkbox"/>	<input type="checkbox"/>	<input type="checkbox"/>	<input type="checkbox"/>	<input type="checkbox"/>	<input type="checkbox"/>	<input type="checkbox"/>	<input type="checkbox"/>	<input type="checkbox"/>
		48 x 42"	PHFA4842	<input type="checkbox"/>	<input type="checkbox"/>	<input type="checkbox"/>	<input type="checkbox"/>	<input type="checkbox"/>	<input type="checkbox"/>	<input type="checkbox"/>	<input type="checkbox"/>	<input type="checkbox"/>
		54 x 42"	PHFA5442	<input type="checkbox"/>	<input type="checkbox"/>	<input type="checkbox"/>	<input type="checkbox"/>	<input type="checkbox"/>	<input type="checkbox"/>	<input type="checkbox"/>	<input type="checkbox"/>	<input type="checkbox"/>
60 x 42"	PHFA6042	<input type="checkbox"/>	<input type="checkbox"/>	<input type="checkbox"/>	<input type="checkbox"/>	<input type="checkbox"/>	<input type="checkbox"/>	<input type="checkbox"/>	<input type="checkbox"/>	<input type="checkbox"/>		
PHFA	<b>Half Segmented/Fully Segmented Panel - 54"H with 12"H tiles</b>	12 x 54"	PHFA1254	<input type="checkbox"/>	<input type="checkbox"/>	<input type="checkbox"/>	<input type="checkbox"/>	<input type="checkbox"/>	<input type="checkbox"/>	<input type="checkbox"/>	<input type="checkbox"/>	
		18 x 54"	PHFA1854	<input type="checkbox"/>	<input type="checkbox"/>	<input type="checkbox"/>	<input type="checkbox"/>	<input type="checkbox"/>	<input type="checkbox"/>	<input type="checkbox"/>	<input type="checkbox"/>	
		24 x 54"	PHFA2454	<input type="checkbox"/>	<input type="checkbox"/>	<input type="checkbox"/>	<input type="checkbox"/>	<input type="checkbox"/>	<input type="checkbox"/>	<input type="checkbox"/>	<input type="checkbox"/>	
		30 x 54"	PHFA3054	<input type="checkbox"/>	<input type="checkbox"/>	<input type="checkbox"/>	<input type="checkbox"/>	<input type="checkbox"/>	<input type="checkbox"/>	<input type="checkbox"/>	<input type="checkbox"/>	
		36 x 54"	PHFA3654	<input type="checkbox"/>	<input type="checkbox"/>	<input type="checkbox"/>	<input type="checkbox"/>	<input type="checkbox"/>	<input type="checkbox"/>	<input type="checkbox"/>	<input type="checkbox"/>	
		42 x 54"	PHFA4254	<input type="checkbox"/>	<input type="checkbox"/>	<input type="checkbox"/>	<input type="checkbox"/>	<input type="checkbox"/>	<input type="checkbox"/>	<input type="checkbox"/>	<input type="checkbox"/>	
		48 x 54"	PHFA4854	<input type="checkbox"/>	<input type="checkbox"/>	<input type="checkbox"/>	<input type="checkbox"/>	<input type="checkbox"/>	<input type="checkbox"/>	<input type="checkbox"/>	<input type="checkbox"/>	
		54 x 54"	PHFA5454	<input type="checkbox"/>	<input type="checkbox"/>	<input type="checkbox"/>	<input type="checkbox"/>	<input type="checkbox"/>	<input type="checkbox"/>	<input type="checkbox"/>	<input type="checkbox"/>	
60 x 54"	PHFA6054	<input type="checkbox"/>	<input type="checkbox"/>	<input type="checkbox"/>	<input type="checkbox"/>	<input type="checkbox"/>	<input type="checkbox"/>	<input type="checkbox"/>	<input type="checkbox"/>			
				<b>A</b>	<b>B</b>	<b>C</b>	<b>D</b>	<b>E</b>	<b>F</b>	<b>G</b>	<b>H</b>	

## HOW TO ORDER

Indicate the following information on order form:

- Quantity of each item.
- Model number, including options. See "How To Build a Model Number".
- Any special service required.

Note: • The  indicates that a choice is required.

- The absence of the  indicates that no choice is required.
- Alpha-numeric characters in place of  indicate that no other alternatives are available.

## HOW TO BUILD A MODEL NUMBER

**A** Select basic model.

**B** Select electrical code for base raceway.

- CN** - Chicago, no cutouts
- C1** - Chicago, 1 side w/cutouts
- CP** - Chicago, 2 sides w/cutouts
- DN** - Domestic, no cutouts
- D1** - Domestic, 1 side w/cutouts
- D** - Domestic, 2 sides w/cutouts

**C** Select horizontal rail.

- E** - Enhanced
- S** - Standard

**D** Select numbers of raceway tiles side 1

- R0** - Side 1 w/no raceway tile
- R1** - Side 1 w/1-12" raceway tile; add \$32
- R2** - Side 1 w/2-12" raceway tiles; add \$64

**E** Select numbers of raceway tiles side 2

- R20** - Side 2 w/no raceway tile

**R21** - Side 2 w/1-12" raceway tile; add \$32

**R22** - Side 2 w/2-12" raceway tiles; add \$64

**R23** - Side 2 w/3-12" raceway tiles; add \$94

**F** Select trim color.

Refer to color addendum at ki.com or KI Fabrics & Finishes binder. Metallic paint requires upcharge. SX Starlight Silver finish is only offered on flat aluminum trim.

**G** Select fabric side 1.

Refer to color addendum at ki.com or in KI Fabrics & Finishes binder.

**H** Select fabric side 2.

Refer to color addendum at ki.com or in KI Fabrics & Finishes binder.

## UPHOLSTERY INFORMATION

### Fabric Mixing

If fabric is ordered from one group on side 1 and another group on side 2, calculate list price using the following method:

Example:

Grade 2 Fabric  
-Grade1 Fabric

Upcharge

Upcharge/2 = Cost for one side

Grade 1 Fabric  
+Cost for one side

Combined list price

### Fabric Disclaimer

Fabric will be applied as swatched by the fabric manufacturer. Fabric that is required to be applied differently than is swatched will need a Special Cost Request written specify-





# Fabric Panel - Tackable Acoustic (3/4" Thick Tiles)

Half Segmented/Fully Segmented Panel

		MODEL NUMBER							
MODEL	W x H	Basic Model	Electrical Code	Horizontal Rail	Number of Raceway Tiles Side 1	Number of Raceway Tiles Side 2	Trim Color	Fabric Side 1	Fabric Side 2
 <p>PHFA</p>	Half Segmented/Fully Segmented Panel - 66"H with 12"H tiles	12 x 66"	PHFA1266	<input type="checkbox"/>	<input type="checkbox"/>	<input type="checkbox"/>	<input type="checkbox"/>	<input type="checkbox"/>	<input type="checkbox"/>
		18 x 66"	PHFA1866	<input type="checkbox"/>	<input type="checkbox"/>	<input type="checkbox"/>	<input type="checkbox"/>	<input type="checkbox"/>	<input type="checkbox"/>
	• Three to seven horizontal rails	24 x 66"	PHFA2466	<input type="checkbox"/>	<input type="checkbox"/>	<input type="checkbox"/>	<input type="checkbox"/>	<input type="checkbox"/>	<input type="checkbox"/>
	• Four, six or eight 12" fabric tiles with mounting hooks	30 x 66"	PHFA3066	<input type="checkbox"/>	<input type="checkbox"/>	<input type="checkbox"/>	<input type="checkbox"/>	<input type="checkbox"/>	<input type="checkbox"/>
	• Two 18" fabric tiles included with 84" high panels with mounting hooks	36 x 66"	PHFA3666	<input type="checkbox"/>	<input type="checkbox"/>	<input type="checkbox"/>	<input type="checkbox"/>	<input type="checkbox"/>	<input type="checkbox"/>
	• One base/raceway consisting of a raceway pan and two doors	42 x 66"	PHFA4266	<input type="checkbox"/>	<input type="checkbox"/>	<input type="checkbox"/>	<input type="checkbox"/>	<input type="checkbox"/>	<input type="checkbox"/>
	• One rounded satin-textured polypropylene top cap with splice plate	48 x 66"	PHFA4866	<input type="checkbox"/>	<input type="checkbox"/>	<input type="checkbox"/>	<input type="checkbox"/>	<input type="checkbox"/>	<input type="checkbox"/>
	• One rounded satin-textured polypropylene top cap with splice plate	54 x 66"	PHFA5466	<input type="checkbox"/>	<input type="checkbox"/>	<input type="checkbox"/>	<input type="checkbox"/>	<input type="checkbox"/>	<input type="checkbox"/>
• Order power separately	60 x 66"	PHFA6066	<input type="checkbox"/>	<input type="checkbox"/>	<input type="checkbox"/>	<input type="checkbox"/>	<input type="checkbox"/>	<input type="checkbox"/>	
• Order vertical posts separately									
• SX Starlight Silver finish is only offered on flat aluminum trim									
PHFA	Half Segmented/Fully Segmented Panel - 84"H with 12"H tiles	12 x 84"	PHFA1284	<input type="checkbox"/>	<input type="checkbox"/>	<input type="checkbox"/>	<input type="checkbox"/>	<input type="checkbox"/>	<input type="checkbox"/>
		18 x 84"	PHFA1884	<input type="checkbox"/>	<input type="checkbox"/>	<input type="checkbox"/>	<input type="checkbox"/>	<input type="checkbox"/>	<input type="checkbox"/>
		24 x 84"	PHFA2484	<input type="checkbox"/>	<input type="checkbox"/>	<input type="checkbox"/>	<input type="checkbox"/>	<input type="checkbox"/>	<input type="checkbox"/>
		30 x 84"	PHFA3084	<input type="checkbox"/>	<input type="checkbox"/>	<input type="checkbox"/>	<input type="checkbox"/>	<input type="checkbox"/>	<input type="checkbox"/>
		36 x 84"	PHFA3684	<input type="checkbox"/>	<input type="checkbox"/>	<input type="checkbox"/>	<input type="checkbox"/>	<input type="checkbox"/>	<input type="checkbox"/>
		42 x 84"	PHFA4284	<input type="checkbox"/>	<input type="checkbox"/>	<input type="checkbox"/>	<input type="checkbox"/>	<input type="checkbox"/>	<input type="checkbox"/>
		48 x 84"	PHFA4884	<input type="checkbox"/>	<input type="checkbox"/>	<input type="checkbox"/>	<input type="checkbox"/>	<input type="checkbox"/>	<input type="checkbox"/>
		54 x 84"	PHFA5484	<input type="checkbox"/>	<input type="checkbox"/>	<input type="checkbox"/>	<input type="checkbox"/>	<input type="checkbox"/>	<input type="checkbox"/>
	60 x 84"	PHFA6084	<input type="checkbox"/>	<input type="checkbox"/>	<input type="checkbox"/>	<input type="checkbox"/>	<input type="checkbox"/>	<input type="checkbox"/>	

**A**   **B**   **C**   **D**   **E**   **F**   **G**   **H**

## HOW TO ORDER

Indicate the following information on order form:

- Quantity of each item.
- Model number, including options. See "How To Build a Model Number".
- Any special service required.

Note: • The  indicates that a choice is required.

- The absence of the  indicates that no choice is required.
- Alpha-numeric characters in place of  indicate that no other alternatives are available.

## HOW TO BUILD A MODEL NUMBER

**A** Select basic model.

**B** Select electrical code for base raceway.

- CN** - Chicago, no cutouts
- C1** - Chicago, 1 side w/cutouts
- CP** - Chicago, 2 sides w/cutouts
- DN** - Domestic, no cutouts
- D1** - Domestic, 1 side w/cutouts
- D** - Domestic, 2 sides w/cutouts

**C** Select horizontal rail.

- E** - Enhanced
- S** - Standard

**D** Select numbers of raceway tiles side 1

- R0** - Side 1 w/no raceway tile
- R1** - Side 1 w/1-12" raceway tile; add \$32
- R2** - Side 1 w/2-12" raceway tiles; add \$64

**E** Select numbers of raceway tiles side 2

- R20** - Side 2 w/no raceway tile

**R21** - Side 2 w/1-12" raceway tile; add \$32

**R22** - Side 2 w/2-12" raceway tiles; add \$64

**R23** - Side 2 w/3-12" raceway tiles; add \$94

**F** Select trim color.

Refer to color addendum at ki.com or KI Fabrics & Finishes binder. Metallic paint requires upcharge. SX Starlight Silver finish is only offered on flat aluminum trim.

**G** Select fabric side 1.

Refer to color addendum at ki.com or in KI Fabrics & Finishes binder.

**H** Select fabric side 2.

Refer to color addendum at ki.com or in KI Fabrics & Finishes binder.

## UPHOLSTERY INFORMATION

### Fabric Mixing

If fabric is ordered from one group on side 1 and another group on side 2, calculate list price using the following method:

Example:

Grade 2 Fabric  
-Grade1 Fabric

Upcharge

Upcharge/2 = Cost for one side

Grade 1 Fabric  
+Cost for one side

Combined list price

### Fabric Disclaimer

Fabric will be applied as swatched by the fabric manufacturer. Fabric that is required to be applied differently than is swatched will need a Special Cost Request written specify-



# Fabric Panel - Tackable Acoustic (3/4" Thick Tiles)

Half Segmented/Fully Segmented Panel

Approx. Packaged Weight	Delivered Pricing Fabric Grade 1 & C.O.M.	Delivered Pricing Fabric Grade 2	Delivered Pricing Fabric Grade 3 & Pallas Vertical Fabric Grade PV	Delivered Pricing Pallas Vertical Fabric Grade PV1	Delivered Pricing Pallas Vertical Fabric Grade PV2	Enhanced Horizontal Rail	Metallic Paint add to list price
40.0#	\$ 785	\$ 823	\$ 861	\$ 884	\$ 958	\$ 47	\$ 31
56.0#	862	903	952	971	1051	49	32
72.0#	940	989	1035	1063	1146	52	36
87.0#	1036	1088	1138	1173	1263	64	46
102.0#	1179	1235	1292	1332	1439	70	48
117.0#	1298	1359	1431	1469	1584	79	59
132.0#	1366	1438	1504	1545	1662	88	62
148.0#	1458	1531	1606	1646	1780	97	65
166.0#	1639	1723	1805	1850	2000	104	84
46.0#	\$ 951	\$ 998	\$ 1044	\$ 1072	\$ 1157	\$ 47	\$ 31
63.0#	1046	1098	1147	1183	1276	49	32
81.0#	1136	1194	1245	1286	1386	52	36
99.0#	1268	1332	1392	1437	1549	64	46
116.0#	1426	1497	1568	1613	1739	70	48
133.0#	1568	1651	1724	1773	1914	79	59
151.0#	1653	1737	1819	1867	2016	88	62
168.0#	1787	1879	1965	2015	2176	97	65
189.0#	1984	2081	2182	2242	2418	104	84

ing the direction the fabric is to be applied. The posted standard lead time will apply to the Special Cost Request.

## INFORMATION

### Maximum Raceway Tile Possibilities

Panel Height	Side 1	Side 2
42"H	1	2
54"H	2	3
66"H	2	3
84"H	2	3

## SPECIAL SERVICES

### Special Carton Marking

With specially marked information N/C

### Shipping

Shipped **k.d. freight prepaid f.o.b. Manitowoc, Wisconsin 54220** factory. Freight class #70.

Specifications and prices are subject to change without prior notice.

# Fabric Panel - Tackable Acoustic (3/4" Thick Tiles)

Fully Segmented/Fully Segmented Panel



		MODEL NUMBER								
MODEL	W x H	Basic Model	Electrical Code	Horizontal Rail	Number of Raceway Tiles Side 1	Number of Raceway Tiles Side 2	Trim Color	Fabric Side 1	Fabric Side 2	
<b>Fully Segmented/Fully Segmented Panel - 30"H with 12"H tiles</b> • Three to seven horizontal rails • Four, six or eight 12" fabric tiles with mounting hooks • Two 18" fabric tile included with 84" high panels with mounting hooks • One base/raceway consisting of a raceway pan and two doors • One rounded satin-textured polypropylene top cap with splice plate • Order power separately • Order vertical posts separately • SX Starlight Silver finish is only offered on flat aluminum trim	12 x 30"	PFFA1230	<input type="checkbox"/>	<input type="checkbox"/>	<input type="checkbox"/>	<input type="checkbox"/>	<input type="checkbox"/>	<input type="checkbox"/>	<input type="checkbox"/>	
	18 x 30"	PFFA1830	<input type="checkbox"/>	<input type="checkbox"/>	<input type="checkbox"/>	<input type="checkbox"/>	<input type="checkbox"/>	<input type="checkbox"/>	<input type="checkbox"/>	
	24 x 30"	PFFA2430	<input type="checkbox"/>	<input type="checkbox"/>	<input type="checkbox"/>	<input type="checkbox"/>	<input type="checkbox"/>	<input type="checkbox"/>	<input type="checkbox"/>	
	30 x 30"	PFFA3030	<input type="checkbox"/>	<input type="checkbox"/>	<input type="checkbox"/>	<input type="checkbox"/>	<input type="checkbox"/>	<input type="checkbox"/>	<input type="checkbox"/>	
	36 x 30"	PFFA3630	<input type="checkbox"/>	<input type="checkbox"/>	<input type="checkbox"/>	<input type="checkbox"/>	<input type="checkbox"/>	<input type="checkbox"/>	<input type="checkbox"/>	
	42 x 30"	PFFA4230	<input type="checkbox"/>	<input type="checkbox"/>	<input type="checkbox"/>	<input type="checkbox"/>	<input type="checkbox"/>	<input type="checkbox"/>	<input type="checkbox"/>	
	48 x 30"	PFFA4830	<input type="checkbox"/>	<input type="checkbox"/>	<input type="checkbox"/>	<input type="checkbox"/>	<input type="checkbox"/>	<input type="checkbox"/>	<input type="checkbox"/>	
	54 x 30"	PFFA5430	<input type="checkbox"/>	<input type="checkbox"/>	<input type="checkbox"/>	<input type="checkbox"/>	<input type="checkbox"/>	<input type="checkbox"/>	<input type="checkbox"/>	
60 x 30"	PFFA6030	<input type="checkbox"/>	<input type="checkbox"/>	<input type="checkbox"/>	<input type="checkbox"/>	<input type="checkbox"/>	<input type="checkbox"/>	<input type="checkbox"/>		
PFFA										
<b>Fully Segmented/Fully Segmented Panel - 42"H with 12"H tiles</b>	12 x 42"	PFFA1242	<input type="checkbox"/>	<input type="checkbox"/>	<input type="checkbox"/>	<input type="checkbox"/>	<input type="checkbox"/>	<input type="checkbox"/>	<input type="checkbox"/>	
	18 x 42"	PFFA1842	<input type="checkbox"/>	<input type="checkbox"/>	<input type="checkbox"/>	<input type="checkbox"/>	<input type="checkbox"/>	<input type="checkbox"/>	<input type="checkbox"/>	
	24 x 42"	PFFA2442	<input type="checkbox"/>	<input type="checkbox"/>	<input type="checkbox"/>	<input type="checkbox"/>	<input type="checkbox"/>	<input type="checkbox"/>	<input type="checkbox"/>	
	30 x 42"	PFFA3042	<input type="checkbox"/>	<input type="checkbox"/>	<input type="checkbox"/>	<input type="checkbox"/>	<input type="checkbox"/>	<input type="checkbox"/>	<input type="checkbox"/>	
	36 x 42"	PFFA3642	<input type="checkbox"/>	<input type="checkbox"/>	<input type="checkbox"/>	<input type="checkbox"/>	<input type="checkbox"/>	<input type="checkbox"/>	<input type="checkbox"/>	
	42 x 42"	PFFA4242	<input type="checkbox"/>	<input type="checkbox"/>	<input type="checkbox"/>	<input type="checkbox"/>	<input type="checkbox"/>	<input type="checkbox"/>	<input type="checkbox"/>	
	48 x 42"	PFFA4842	<input type="checkbox"/>	<input type="checkbox"/>	<input type="checkbox"/>	<input type="checkbox"/>	<input type="checkbox"/>	<input type="checkbox"/>	<input type="checkbox"/>	
	54 x 42"	PFFA5442	<input type="checkbox"/>	<input type="checkbox"/>	<input type="checkbox"/>	<input type="checkbox"/>	<input type="checkbox"/>	<input type="checkbox"/>	<input type="checkbox"/>	
60 x 42"	PFFA6042	<input type="checkbox"/>	<input type="checkbox"/>	<input type="checkbox"/>	<input type="checkbox"/>	<input type="checkbox"/>	<input type="checkbox"/>	<input type="checkbox"/>		
PFFA										
			<b>A</b>	<b>B</b>	<b>C</b>	<b>D</b>	<b>E</b>	<b>F</b>	<b>G</b>	<b>H</b>

## HOW TO ORDER

Indicate the following information on order form:

- Quantity of each item.
- Model number, including options. See "How To Build a Model Number".
- Any special service required.

Note: • The  indicates that a choice is required.

- The absence of the  indicates that no choice is required.
- Alpha-numeric characters in place of  indicate that no other alternatives are available.

## HOW TO BUILD A MODEL NUMBER

- A** Select basic model.
- B** Select electrical code for base raceway.
  - CN** - Chicago, no cutouts
  - C1** - Chicago, 1 side w/cutouts
  - CP** - Chicago, 2 sides w/cutouts
  - DN** - Domestic, no cutouts
  - D1** - Domestic, 1 side w/cutouts
  - D** - Domestic, 2 sides w/cutouts
- C** Select horizontal rail.
  - E** - Enhanced
  - S** - Standard
- D** Select numbers of raceway tiles side 1
  - R0** - Side 1 w/no raceway tile
  - R1** - Side 1 w/1-12" raceway tile; add \$32
  - R2** - Side 1 w/2-12" raceway tiles; add \$64
  - R3** - Side 1 w/3 12" raceway tiles; add \$94

- E** Select numbers of raceway tiles side 2
  - R20** - Side 2 w/no raceway tile
  - R21** - Side 2 w/1-12" raceway tile; add \$32
  - R22** - Side 2 w/2-12" raceway tiles; add \$64
  - R23** - Side 2 w/3-12" raceway tiles; add \$94
- F** Select trim color. Refer to color addendum at ki.com or KI Fabrics & Finishes binder. Metallic paint requires upcharge. SX Starlight Silver finish is only offered on flat aluminum trim.
- G** Select fabric side 1. Refer to color addendum at ki.com or in KI Fabrics & Finishes binder.
- H** Select fabric side 2. Refer to color addendum at ki.com or in KI Fabrics & Finishes binder.

## UPHOLSTERY INFORMATION

### Fabric Mixing

If fabric is ordered from one group on side 1 and another group on side 2, calculate list price using the following method:

Example:  
Grade 2 Fabric  
-Grade1 Fabric

Upcharge

Upcharge/2 = Cost for one side

Grade 1 Fabric  
+Cost for one side

Combined list price

### Fabric Disclaimer

Fabric will be applied as swatched by the fabric manufacturer. Fabric that is required to be applied differently than is swatched will need a Special Cost Request written specify-



# Fabric Panel - Tackable Acoustic (3/4" Thick Tiles)

Fully Segmented/Fully Segmented Panel

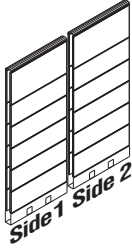
MODEL	W x H	MODEL NUMBER							
		Basic Model	Electrical Code	Horizontal Rail	Number of Raceway Tiles Side 1	Number of Raceway Tiles Side 2	Trim Color	Fabric Side 1	Fabric Side 2
 <p>PFFA</p> <p><b>Fully Segmented/Fully Segmented Panel - 54"H with 12"H tiles</b></p> <ul style="list-style-type: none"> <li>• Three to seven horizontal rails</li> <li>• Four, six or eight 12" fabric tiles with mounting hooks</li> <li>• Two 18" fabric tile included with 84" high panels with mounting hooks</li> <li>• One base/raceway consisting of a raceway pan and two doors</li> <li>• One rounded satin-textured polypropylene top cap with splice plate</li> <li>• Order power separately</li> <li>• Order vertical posts separately</li> <li>• SX Starlight Silver finish is only offered on flat aluminum trim</li> </ul>	12 x 54"	PFFA1254	<input type="checkbox"/>	<input type="checkbox"/>	<input type="checkbox"/>	<input type="checkbox"/>	<input type="checkbox"/>	<input type="checkbox"/>	<input type="checkbox"/>
	18 x 54"	PFFA1854	<input type="checkbox"/>	<input type="checkbox"/>	<input type="checkbox"/>	<input type="checkbox"/>	<input type="checkbox"/>	<input type="checkbox"/>	<input type="checkbox"/>
	24 x 54"	PFFA2454	<input type="checkbox"/>	<input type="checkbox"/>	<input type="checkbox"/>	<input type="checkbox"/>	<input type="checkbox"/>	<input type="checkbox"/>	<input type="checkbox"/>
	30 x 54"	PFFA3054	<input type="checkbox"/>	<input type="checkbox"/>	<input type="checkbox"/>	<input type="checkbox"/>	<input type="checkbox"/>	<input type="checkbox"/>	<input type="checkbox"/>
	36 x 54"	PFFA3654	<input type="checkbox"/>	<input type="checkbox"/>	<input type="checkbox"/>	<input type="checkbox"/>	<input type="checkbox"/>	<input type="checkbox"/>	<input type="checkbox"/>
	42 x 54"	PFFA4254	<input type="checkbox"/>	<input type="checkbox"/>	<input type="checkbox"/>	<input type="checkbox"/>	<input type="checkbox"/>	<input type="checkbox"/>	<input type="checkbox"/>
	48 x 54"	PFFA4854	<input type="checkbox"/>	<input type="checkbox"/>	<input type="checkbox"/>	<input type="checkbox"/>	<input type="checkbox"/>	<input type="checkbox"/>	<input type="checkbox"/>
	54 x 54"	PFFA5454	<input type="checkbox"/>	<input type="checkbox"/>	<input type="checkbox"/>	<input type="checkbox"/>	<input type="checkbox"/>	<input type="checkbox"/>	<input type="checkbox"/>
	60 x 54"	PFFA6054	<input type="checkbox"/>	<input type="checkbox"/>	<input type="checkbox"/>	<input type="checkbox"/>	<input type="checkbox"/>	<input type="checkbox"/>	<input type="checkbox"/>
PFFA	<b>Fully Segmented/Fully Segmented Panel - 66"H with 12"H tiles</b>	12 x 66"	PFFA1266	<input type="checkbox"/>	<input type="checkbox"/>	<input type="checkbox"/>	<input type="checkbox"/>	<input type="checkbox"/>	<input type="checkbox"/>
	18 x 66"	PFFA1866	<input type="checkbox"/>	<input type="checkbox"/>	<input type="checkbox"/>	<input type="checkbox"/>	<input type="checkbox"/>	<input type="checkbox"/>	
	24 x 66"	PFFA2466	<input type="checkbox"/>	<input type="checkbox"/>	<input type="checkbox"/>	<input type="checkbox"/>	<input type="checkbox"/>	<input type="checkbox"/>	
	30 x 66"	PFFA3066	<input type="checkbox"/>	<input type="checkbox"/>	<input type="checkbox"/>	<input type="checkbox"/>	<input type="checkbox"/>	<input type="checkbox"/>	
	36 x 66"	PFFA3666	<input type="checkbox"/>	<input type="checkbox"/>	<input type="checkbox"/>	<input type="checkbox"/>	<input type="checkbox"/>	<input type="checkbox"/>	
	42 x 66"	PFFA4266	<input type="checkbox"/>	<input type="checkbox"/>	<input type="checkbox"/>	<input type="checkbox"/>	<input type="checkbox"/>	<input type="checkbox"/>	
	48 x 66"	PFFA4866	<input type="checkbox"/>	<input type="checkbox"/>	<input type="checkbox"/>	<input type="checkbox"/>	<input type="checkbox"/>	<input type="checkbox"/>	
	60 x 66"	PFFA6066	<input type="checkbox"/>	<input type="checkbox"/>	<input type="checkbox"/>	<input type="checkbox"/>	<input type="checkbox"/>	<input type="checkbox"/>	
PFFA	<b>Fully Segmented/Fully Segmented Panel - 84"H with 12"H tiles</b>	12 x 84"	PFFA1284	<input type="checkbox"/>	<input type="checkbox"/>	<input type="checkbox"/>	<input type="checkbox"/>	<input type="checkbox"/>	<input type="checkbox"/>
	18 x 84"	PFFA1884	<input type="checkbox"/>	<input type="checkbox"/>	<input type="checkbox"/>	<input type="checkbox"/>	<input type="checkbox"/>	<input type="checkbox"/>	
	24 x 84"	PFFA2484	<input type="checkbox"/>	<input type="checkbox"/>	<input type="checkbox"/>	<input type="checkbox"/>	<input type="checkbox"/>	<input type="checkbox"/>	
	30 x 84"	PFFA3084	<input type="checkbox"/>	<input type="checkbox"/>	<input type="checkbox"/>	<input type="checkbox"/>	<input type="checkbox"/>	<input type="checkbox"/>	
	36 x 84"	PFFA3684	<input type="checkbox"/>	<input type="checkbox"/>	<input type="checkbox"/>	<input type="checkbox"/>	<input type="checkbox"/>	<input type="checkbox"/>	
	42 x 84"	PFFA4284	<input type="checkbox"/>	<input type="checkbox"/>	<input type="checkbox"/>	<input type="checkbox"/>	<input type="checkbox"/>	<input type="checkbox"/>	
	48 x 84"	PFFA4884	<input type="checkbox"/>	<input type="checkbox"/>	<input type="checkbox"/>	<input type="checkbox"/>	<input type="checkbox"/>	<input type="checkbox"/>	
	60 x 84"	PFFA6084	<input type="checkbox"/>	<input type="checkbox"/>	<input type="checkbox"/>	<input type="checkbox"/>	<input type="checkbox"/>	<input type="checkbox"/>	

A

B

C

D

E

F

G

H

## HOW TO ORDER

Indicate the following information on order form:

1. Quantity of each item.
2. Model number, including options. See "How To Build a Model Number".
3. Any special service required.

Note: • The  indicates that a choice is required.

- The absence of the  indicates that no choice is required.
- Alpha-numeric characters in place of  indicate that no other alternatives are available.

## HOW TO BUILD A MODEL NUMBER

**A** Select basic model.

**B** Select electrical code for base raceway.

- CN** - Chicago, no cutouts
- C1** - Chicago, 1 side w/cutouts
- CP** - Chicago, 2 sides w/cutouts
- DN** - Domestic, no cutouts
- D1** - Domestic, 1 side w/cutouts
- D** - Domestic, 2 sides w/cutouts

**C** Select horizontal rail.

- E** - Enhanced
- S** - Standard

**D** Select numbers of raceway tiles side 1

- R0** - Side 1 w/no raceway tile
- R1** - Side 1 w/1-12" raceway tile; add \$32
- R2** - Side 1 w/2-12" raceway tiles; add \$64
- R3** - Side 1 w/3 12" raceway tiles; add \$94

**E** Select numbers of raceway tiles side 2

- R20** - Side 2 w/no raceway tile
- R21** - Side 2 w/1-12" raceway tile; add \$32
- R22** - Side 2 w/2-12" raceway tiles; add \$64
- R23** - Side 2 w/3-12" raceway tiles; add \$94

**F** Select trim color.

Refer to color addendum at [ki.com](http://ki.com) or KI Fabrics & Finishes binder. Metallic paint requires upcharge. SX Starlight Silver finish is only offered on flat aluminum trim.

**G** Select fabric side 1.

Refer to color addendum at [ki.com](http://ki.com) or in KI Fabrics & Finishes binder.

**H** Select fabric side 2.

Refer to color addendum at [ki.com](http://ki.com) or in KI Fabrics & Finishes binder.

## UPHOLSTERY INFORMATION

### Fabric Mixing

If fabric is ordered from one group on side 1 and another group on side 2, calculate list price using the following method:

Example:

Grade 2 Fabric  
-Grade1 Fabric

Upcharge

Upcharge/2 = Cost for one side

Grade 1 Fabric  
+Cost for one side

Combined list price

### Fabric Disclaimer

Fabric will be applied as swatched by the fabric manufacturer. Fabric that is required to be applied differently than is swatched will need a Special Cost Request written specify-



# Fabric Panel - Tackable Acoustic (3/4" Thick Tiles)

Fully Segmented/Fully Segmented Panel

Approx. Packaged Weight	Delivered Pricing Fabric Grade 1 & C.O.M.	Delivered Pricing Fabric Grade 2	Delivered Pricing Fabric Grade 3 & Pallas Vertical Fabric Grade PV	Delivered Pricing Pallas Vertical Fabric Grade PV1	Delivered Pricing Pallas Vertical Fabric Grade PV2	Enhanced Horizontal Rail	Metallic Paint add to list price
34.0#	\$ 691	\$ 721	\$ 755	\$ 781	\$ 843	\$ 47	\$ 31
47.0#	753	788	827	849	919	49	32
60.0#	819	861	904	925	998	52	36
73.0#	903	950	993	1020	1101	64	46
86.0#	1031	1083	1133	1166	1258	70	48
99.0#	1137	1195	1246	1288	1388	79	59
112.0#	1188	1245	1303	1342	1448	88	62
125.0#	1265	1327	1388	1429	1541	97	65
141.0#	1433	1504	1573	1620	1746	104	84
41.0#	\$ 843	\$ 883	\$ 928	\$ 950	\$ 1027	\$ 47	\$ 31
57.0#	924	969	1016	1042	1124	49	32
74.0#	998	1050	1098	1130	1212	52	36
89.0#	1097	1152	1203	1241	1340	64	46
105.0#	1257	1317	1378	1420	1531	70	48
120.0#	1380	1444	1518	1558	1682	79	59
134.0#	1444	1513	1586	1628	1762	88	62
152.0#	1534	1612	1690	1733	1877	97	65
172.0#	1739	1828	1912	1963	2119	104	84
47.0#	\$ 1006	\$ 1060	\$ 1104	\$ 1138	\$ 1229	\$ 47	\$ 31
65.0#	1104	1159	1212	1249	1349	49	32
83.0#	1190	1249	1306	1344	1450	52	36
101.0#	1330	1392	1464	1500	1622	64	46
119.0#	1502	1579	1654	1697	1832	70	48
137.0#	1653	1737	1819	1867	2016	79	59
155.0#	1729	1818	1901	1952	2103	88	62
173.0#	1863	1956	2051	2106	2274	97	65
195.0#	2084	2186	2290	2355	2542	104	84

ing the direction the fabric is to be applied.  
The posted standard lead time will apply to  
the Special Cost Request.

## INFORMATION

### Maximum Raceway Tile Possibilities

Panel Height	Side 1	Side 2
30"H	1	1
42"H	2	2
48"H	3	3
66"H	3	3
84"H	3	3

## SPECIAL SERVICES

### Special Carton Marking

With specially marked information N/C

### Shipping

Shipped **k.d. freight prepaid f.o.b.**  
**Manitowoc, Wisconsin 54220** factory.  
Freight class #70.

Specifications and prices are subject to  
change without prior notice.

# Glass Panel

## Face Styles

### Face Style: Full Glass

#### Basic Model: PG

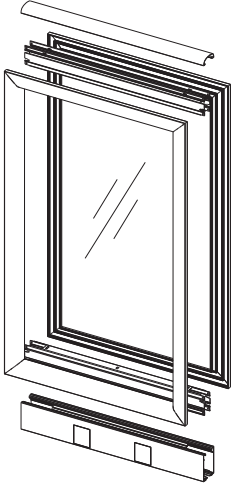

Full Glass panel consist of a full-sized glass tile.  
Consists of one glass tile utilizing a single panel  
of 1/4" thick tempered glass. Base is 6". Panel thickness: 3/2".

#### STANDARD PANEL SIZES (Glass Panels)

	12" W	18" W	24" W	30" W	36" W	42" W	48" W	54" W	60" W	Side 1 Number of	Side 2 Number of
30" H	N/A	N/A	N/A	N/A	N/A	N/A	N/A	N/A	N/A	12" Fabric Tiles	12" Fabric Tiles
42" H	N/A	N/A	N/A	N/A	N/A	N/A	N/A	N/A	N/A	N/A	N/A
54" H	•	•	•	•	•	•	•	N/A	N/A	N/A	N/A
66" H	•	•	•	•	•	•	•	N/A	N/A	N/A	N/A
84" H	•	•	•	•	•	•	•	N/A	N/A	N/A	N/A

### Face Style: Glass/Monolithic

#### Basic Model: PMMGA

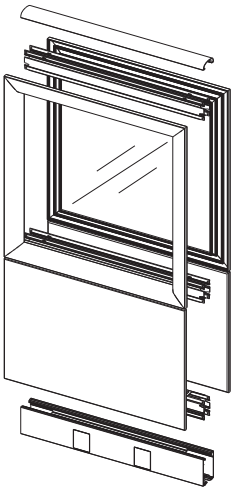

Glass/Monolithic panels consist of the following: 24" fabric tile on bottom.  
Remainder of panel consists of one glass tile utilizing a single panel of 1/4" thick tempered glass.  
Base is 6". Panel thickness: 3/2".

#### STANDARD PANEL SIZES (Fabric/Glass–Acoustic and Highly Acoustic)

	12" W	18" W	24" W	30" W	36" W	42" W	48" W	54" W	60" W	Side 1 Number of	Side 2 Number of
30" H	N/A	N/A	N/A	N/A	N/A	N/A	N/A	N/A	N/A	12" Fabric Tiles	12" Fabric Tiles
42" H	N/A	N/A	N/A	N/A	N/A	N/A	N/A	N/A	N/A	N/A	N/A
54" H	•	•	•	•	•	•	•	N/A	N/A	N/A	N/A
66" H	•	•	•	•	•	•	•	N/A	N/A	N/A	N/A
84" H	•	•	•	•	•	•	•	N/A	N/A	N/A	N/A





**Face Style: Monolithic/Fully Segmented/Glass**

**Basic Model: PMFGA**

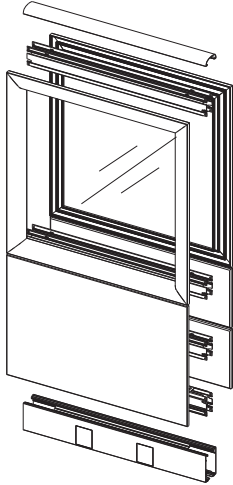

Monolithic/Fully Segmented/Glass panels consist of the following:  
 24" fabric tile on bottom of side one, two 12" segmented fabric tiles on bottom of side two.  
 Remainder of panel consists of one glass tile utilizing a single panel of 1/4" thick tempered glass.  
 Base is 6". Panel thickness: 3 1/2".

**STANDARD PANEL SIZES (Fabric/Glass–Acoustic)**

	12" W	18" W	24" W	30" W	36" W	42" W	48" W	54" W	60" W	Side 1 Number of 12" Fabric Tiles	Side 2 Number of 12" Fabric Tiles
30" H	N/A	N/A	N/A	N/A	N/A	N/A	N/A	N/A	N/A	N/A	N/A
42" H	N/A	N/A	N/A	N/A	N/A	N/A	N/A	N/A	N/A	N/A	N/A
54" H	•	•	•	•	•	•	•	N/A	N/A	N/A	2
66" H	•	•	•	•	•	•	•	N/A	N/A	N/A	2
84" H	•	•	•	•	•	•	•	N/A	N/A	N/A	2

**Face Style: Glass/Fully Segmented**

**Basic Model: PFFGA**

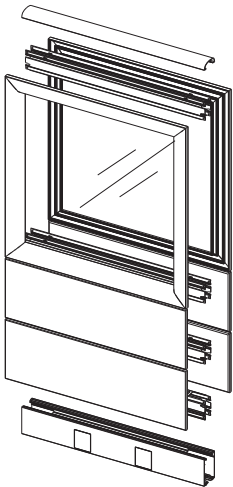

Glass/Fully Segmented panels consist of the following:  
 Two 12" fabric tile on bottom. Remainder of panel consists of  
 one glass tile utilizing a single panel of 1/4" thick tempered glass.  
 Base is 6". Panel thickness: 3 1/2".

**STANDARD PANEL SIZES (Fabric/Glass–Acoustic)**

	12" W	18" W	24" W	30" W	36" W	42" W	48" W	54" W	60" W	Side 1 Number of 12" Fabric Tiles	Side 2 Number of 12" Fabric Tiles
30" H	N/A	N/A	N/A	N/A	N/A	N/A	N/A	N/A	N/A	N/A	N/A
42" H	N/A	N/A	N/A	N/A	N/A	N/A	N/A	N/A	N/A	N/A	N/A
54" H	•	•	•	•	•	•	•	N/A	N/A	2	2
66" H	•	•	•	•	•	•	•	N/A	N/A	2	2
84" H	•	•	•	•	•	•	•	N/A	N/A	2	2

# Glass Panel

Full Glass Panel

	MODEL	W x H	MODEL NUMBER					Approx. Packaged Weight
			Basic Model	Electrical Code	Horizontal Rail	Glass Color	Trim Color	
	<b>Full Glass Panel - 54"H</b> • Two horizontal rails • Two aluminum window frames • One pane, 1/4" thick glass • One base/raceway consisting of a raceway pan and two doors • One rounded satin-textured polypropylene top cap with splice plate • Order power separately • Order vertical posts separately • SX Starlight Silver finish is only offered on flat aluminum trim	12 x 54"	PG1254	<input type="checkbox"/>	<input type="checkbox"/>	<input type="checkbox"/>	<input type="checkbox"/>	23.0#
		18 x 54"	PG1854	<input type="checkbox"/>	<input type="checkbox"/>	<input type="checkbox"/>	<input type="checkbox"/>	32.0#
		24 x 54"	PG2454	<input type="checkbox"/>	<input type="checkbox"/>	<input type="checkbox"/>	<input type="checkbox"/>	42.0#
		30 x 54"	PG3054	<input type="checkbox"/>	<input type="checkbox"/>	<input type="checkbox"/>	<input type="checkbox"/>	51.0#
		36 x 54"	PG3654	<input type="checkbox"/>	<input type="checkbox"/>	<input type="checkbox"/>	<input type="checkbox"/>	60.0#
		42 x 54"	PG4254	<input type="checkbox"/>	<input type="checkbox"/>	<input type="checkbox"/>	<input type="checkbox"/>	69.0#
		48 x 54"	PG4854	<input type="checkbox"/>	<input type="checkbox"/>	<input type="checkbox"/>	<input type="checkbox"/>	79.0#
PG								
PG	<b>Full Glass Panel - 66"H</b>	12 x 66"	PG1266	<input type="checkbox"/>	<input type="checkbox"/>	<input type="checkbox"/>	<input type="checkbox"/>	27.0#
		18 x 66"	PG1866	<input type="checkbox"/>	<input type="checkbox"/>	<input type="checkbox"/>	<input type="checkbox"/>	38.0#
		24 x 66"	PG2466	<input type="checkbox"/>	<input type="checkbox"/>	<input type="checkbox"/>	<input type="checkbox"/>	49.0#
		30 x 66"	PG3066	<input type="checkbox"/>	<input type="checkbox"/>	<input type="checkbox"/>	<input type="checkbox"/>	59.0#
		36 x 66"	PG3666	<input type="checkbox"/>	<input type="checkbox"/>	<input type="checkbox"/>	<input type="checkbox"/>	70.0#
		42 x 66"	PG4266	<input type="checkbox"/>	<input type="checkbox"/>	<input type="checkbox"/>	<input type="checkbox"/>	81.0#
		48 x 66"	PG4866	<input type="checkbox"/>	<input type="checkbox"/>	<input type="checkbox"/>	<input type="checkbox"/>	92.0#
PG	<b>Full Glass Panel - 84"H</b>	12 x 84"	PG1284	<input type="checkbox"/>	<input type="checkbox"/>	<input type="checkbox"/>	<input type="checkbox"/>	33.0#
		18 x 84"	PG1884	<input type="checkbox"/>	<input type="checkbox"/>	<input type="checkbox"/>	<input type="checkbox"/>	46.0#
		24 x 84"	PG2484	<input type="checkbox"/>	<input type="checkbox"/>	<input type="checkbox"/>	<input type="checkbox"/>	59.0#
		30 x 84"	PG3084	<input type="checkbox"/>	<input type="checkbox"/>	<input type="checkbox"/>	<input type="checkbox"/>	72.0#
		36 x 84"	PG3684	<input type="checkbox"/>	<input type="checkbox"/>	<input type="checkbox"/>	<input type="checkbox"/>	85.0#
		42 x 84"	PG4284	<input type="checkbox"/>	<input type="checkbox"/>	<input type="checkbox"/>	<input type="checkbox"/>	98.0#
		48 x 84"	PG4884	<input type="checkbox"/>	<input type="checkbox"/>	<input type="checkbox"/>	<input type="checkbox"/>	111.0#

A

B

C

D

E

## HOW TO ORDER

Indicate the following information on order form:

- Quantity of each item.
- Model number, including options. See "How To Build a Model Number".
- Any special service required.

Note: • The  indicates that a choice is required.

- The absence of the  indicates that no choice is required.
- Alpha-numeric characters in place of  indicate that no other alternatives are available.

## HOW TO BUILD A MODEL NUMBER

**A** Select basic model.

**B** Select electrical code for base raceway.

- CN** - Chicago, no cutouts  
 **C1** - Chicago, 1 side w/cutouts  
 **CP** - Chicago, 2 sides w/cutouts  
 **DN** - Domestic, no cutouts  
 **D1** - Domestic, 1 side w/cutouts  
 **D** - Domestic, 2 sides w/cutouts

**C** Select horizontal rail.

- E** - Enhanced  
 **S** - Standard

**D** Select glass color.

- BRZ** - Tinted/Bronze  
 **GLA** - Clear  
 **GLC** - White Laminate

**E** Select trim color.

Refer to color addendum at [ki.com](http://ki.com) or KI Fabrics & Finishes binder.  
Metallic paint requires upcharge.

SX Starlight Silver finish is only offered on flat aluminum trim.



# Glass Panel

Full Glass Panel

Clear (C)	Tinted/Bronze (T)	White Laminate (W)	Enhanced Horizontal Rail	Metallic Paint add to list price
\$ 535	\$ 560	\$ 695	\$ 47	\$ 31
584	612	756	49	32
639	671	830	52	36
703	742	915	64	46
768	809	998	70	48
865	911	1126	79	59
951	996	1233	88	62
<hr/>				
\$ 543	\$ 573	\$ 708	\$ 47	\$ 31
600	630	781	49	32
663	696	863	52	36
733	769	955	64	46
854	897	1107	70	48
957	1003	1242	79	59
992	1042	1294	88	62
<hr/>				
\$ 673	\$ 710	\$ 878	\$ 47	\$ 31
790	830	1027	49	32
862	905	1122	52	36
935	986	1222	64	46
1018	1067	1320	70	48
1129	1183	1470	79	59
1174	1232	1526	88	62

## SPECIAL SERVICES

### Special Carton Marking

With specially marked information N/C

### Shipping

Delivered. Shipped **k.d. freight prepaid f.o.b. Manitowoc, Wisconsin 54220** factory. Freight class #70.

Specifications and prices are subject to change without prior notice.

# Glass/Fabric Panel - Acoustic (3/4" Thick Tiles)

Monolithic/Monolithic/Glass Panel

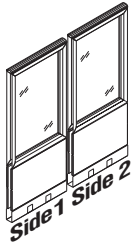
MODEL	W x H	MODEL NUMBER							Approx. Packaged Weight	
		Basic Model	Electrical Code	Horizontal Rail	Glass Color	Trim Color	Fabric Side 1	Fabric Side 2		
 <p>PMGA</p>	<b>Monolithic/Monolithic/Glass Panel - 54"H</b>	12 x 54"	PMMGA1254	<input type="checkbox"/>	<input type="checkbox"/>	<input type="checkbox"/>	<input type="checkbox"/>	<input type="checkbox"/>	<input type="checkbox"/>	26.0#
	18 x 54"	PMMGA1854	<input type="checkbox"/>	<input type="checkbox"/>	<input type="checkbox"/>	<input type="checkbox"/>	<input type="checkbox"/>	<input type="checkbox"/>	<input type="checkbox"/>	36.0#
	24 x 54"	PMMGA2454	<input type="checkbox"/>	<input type="checkbox"/>	<input type="checkbox"/>	<input type="checkbox"/>	<input type="checkbox"/>	<input type="checkbox"/>	<input type="checkbox"/>	46.0#
	30 x 54"	PMMGA3054	<input type="checkbox"/>	<input type="checkbox"/>	<input type="checkbox"/>	<input type="checkbox"/>	<input type="checkbox"/>	<input type="checkbox"/>	<input type="checkbox"/>	56.0#
	36 x 54"	PMMGA3654	<input type="checkbox"/>	<input type="checkbox"/>	<input type="checkbox"/>	<input type="checkbox"/>	<input type="checkbox"/>	<input type="checkbox"/>	<input type="checkbox"/>	66.0#
	42 x 54"	PMMGA4254	<input type="checkbox"/>	<input type="checkbox"/>	<input type="checkbox"/>	<input type="checkbox"/>	<input type="checkbox"/>	<input type="checkbox"/>	<input type="checkbox"/>	76.0#
	48 x 54"	PMMGA4854	<input type="checkbox"/>	<input type="checkbox"/>	<input type="checkbox"/>	<input type="checkbox"/>	<input type="checkbox"/>	<input type="checkbox"/>	<input type="checkbox"/>	85.0#
PMGA	<b>Monolithic/Monolithic/Glass Panel - 66"H</b>	12 x 66"	PMMGA1266	<input type="checkbox"/>	<input type="checkbox"/>	<input type="checkbox"/>	<input type="checkbox"/>	<input type="checkbox"/>	<input type="checkbox"/>	30.0#
	18 x 66"	PMMGA1866	<input type="checkbox"/>	<input type="checkbox"/>	<input type="checkbox"/>	<input type="checkbox"/>	<input type="checkbox"/>	<input type="checkbox"/>	<input type="checkbox"/>	41.0#
	24 x 66"	PMMGA2466	<input type="checkbox"/>	<input type="checkbox"/>	<input type="checkbox"/>	<input type="checkbox"/>	<input type="checkbox"/>	<input type="checkbox"/>	<input type="checkbox"/>	53.0#
	30 x 66"	PMMGA3066	<input type="checkbox"/>	<input type="checkbox"/>	<input type="checkbox"/>	<input type="checkbox"/>	<input type="checkbox"/>	<input type="checkbox"/>	<input type="checkbox"/>	64.0#
	36 x 66"	PMMGA3666	<input type="checkbox"/>	<input type="checkbox"/>	<input type="checkbox"/>	<input type="checkbox"/>	<input type="checkbox"/>	<input type="checkbox"/>	<input type="checkbox"/>	75.0#
	42 x 66"	PMMGA4266	<input type="checkbox"/>	<input type="checkbox"/>	<input type="checkbox"/>	<input type="checkbox"/>	<input type="checkbox"/>	<input type="checkbox"/>	<input type="checkbox"/>	86.0#
	48 x 66"	PMMGA4866	<input type="checkbox"/>	<input type="checkbox"/>	<input type="checkbox"/>	<input type="checkbox"/>	<input type="checkbox"/>	<input type="checkbox"/>	<input type="checkbox"/>	98.0#
PMGA	<b>Monolithic/Monolithic/Glass Panel - 84"H</b>	12 x 84"	PMMGA1284	<input type="checkbox"/>	<input type="checkbox"/>	<input type="checkbox"/>	<input type="checkbox"/>	<input type="checkbox"/>	<input type="checkbox"/>	36.0#
	18 x 84"	PMMGA1884	<input type="checkbox"/>	<input type="checkbox"/>	<input type="checkbox"/>	<input type="checkbox"/>	<input type="checkbox"/>	<input type="checkbox"/>	<input type="checkbox"/>	50.0#
	24 x 84"	PMMGA2484	<input type="checkbox"/>	<input type="checkbox"/>	<input type="checkbox"/>	<input type="checkbox"/>	<input type="checkbox"/>	<input type="checkbox"/>	<input type="checkbox"/>	63.0#
	30 x 84"	PMMGA3084	<input type="checkbox"/>	<input type="checkbox"/>	<input type="checkbox"/>	<input type="checkbox"/>	<input type="checkbox"/>	<input type="checkbox"/>	<input type="checkbox"/>	77.0#
	36 x 84"	PMMGA3684	<input type="checkbox"/>	<input type="checkbox"/>	<input type="checkbox"/>	<input type="checkbox"/>	<input type="checkbox"/>	<input type="checkbox"/>	<input type="checkbox"/>	90.0#
	42 x 84"	PMMGA4284	<input type="checkbox"/>	<input type="checkbox"/>	<input type="checkbox"/>	<input type="checkbox"/>	<input type="checkbox"/>	<input type="checkbox"/>	<input type="checkbox"/>	104.0#
	48 x 84"	PMMGA4884	<input type="checkbox"/>	<input type="checkbox"/>	<input type="checkbox"/>	<input type="checkbox"/>	<input type="checkbox"/>	<input type="checkbox"/>	<input type="checkbox"/>	120.0#

A

B

C

D

E

F

G

## HOW TO ORDER

Indicate the following information on order form:

- Quantity of each item.
- Model number, including options. See "How To Build a Model Number".
- Any special service required.

Note: • The  indicates that a choice is required.

- The absence of the  indicates that no choice is required.
- Alpha-numeric characters in place of  indicate that no other alternatives are available.

## HOW TO BUILD A MODEL NUMBER

**A** Select basic model.

**B** Select electrical code for base raceway.

- CN** - Chicago, no cutouts
- C1** - Chicago, 1 side w/cutouts
- CP** - Chicago, 2 sides w/cutouts
- DN** - Domestic, no cutouts
- D1** - Domestic, 1 side w/cutouts
- D** - Domestic, 2 sides w/cutouts

**C** Select horizontal rail.

- E** - Enhanced
- S** - Standard

**D** Select glass color.

- GLA** - Clear
- BRZ** - Tinted/Bronze
- GLC** - White laminate

See pricing columns for glass upcharge.

**E** Select trim color.

Refer to color addendum at ki.com or KI Fabrics & Finishes binder.

Metallic paint requires upcharge. SX Starlight Silver finish is only offered on flat aluminum trim.

**F** Select fabric side 1.

Refer to color addendum at ki.com or in KI Fabrics & Finishes binder.

**G** Select fabric side 2.

Refer to color addendum at ki.com or in KI Fabrics & Finishes binder.

## UPHOLSTERY INFORMATION

### Fabric Mixing

If fabric is ordered from one group on side 1 and another group on side 2, calculate list price using the following method:

Example:  
Grade 2 Fabric  
-Grade1 Fabric

Upcharge

Upcharge/2 = Cost for one side

Grade 1 Fabric  
+Cost for one side

Combined list price

### Fabric Disclaimer

Fabric will be applied as swatched by the fabric manufacturer. Fabric that is required to be applied differently than is swatched will need a Special Cost Request written specify-



# Glass/Fabric Panel - Acoustic (3/4" Thick Tiles)

Monolithic/Fully Segmented/Glass Panel

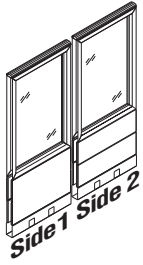
	W x H	MODEL NUMBER									Approx. Packaged Weight
		Basic Model	Electrical Code	Horizontal Rail	Number of Raceway Tiles Side 1	Number of Raceway Tiles Side 2	Glass Color	Trim Color	Fabric Side 1	Fabric Side 2	
 <p>PFGA Monolithic/Fully Segmented/Glass Panel - 54"H</p> <ul style="list-style-type: none"> <li>• Four horizontal rails</li> <li>• Two powder-coated aluminum window frames</li> <li>• One pane, 1/4" thick glass</li> <li>• One 24" fabric tile</li> <li>• Two 12" fabric tiles</li> <li>• One base/raceway consisting of a raceway pan and two doors</li> <li>• One rounded satin-textured polypropylene top cap with splice plate</li> <li>• Order power separately</li> <li>• Order vertical posts separately</li> <li>• Fabric tile is tackable</li> <li>• SX Starlight Silver finish is only offered on flat aluminum trim</li> </ul>	12 x 54"	PMFGA1254	<input type="checkbox"/>	<input type="checkbox"/>	R0	<input type="checkbox"/>	<input type="checkbox"/>	<input type="checkbox"/>	<input type="checkbox"/>	<input type="checkbox"/>	29.0#
	18 x 54"	PMFGA1854	<input type="checkbox"/>	<input type="checkbox"/>	R0	<input type="checkbox"/>	<input type="checkbox"/>	<input type="checkbox"/>	<input type="checkbox"/>	<input type="checkbox"/>	40.0#
	24 x 54"	PMFGA2454	<input type="checkbox"/>	<input type="checkbox"/>	R0	<input type="checkbox"/>	<input type="checkbox"/>	<input type="checkbox"/>	<input type="checkbox"/>	<input type="checkbox"/>	52.0#
	30 x 54"	PMFGA3054	<input type="checkbox"/>	<input type="checkbox"/>	R0	<input type="checkbox"/>	<input type="checkbox"/>	<input type="checkbox"/>	<input type="checkbox"/>	<input type="checkbox"/>	63.0#
	36 x 54"	PMFGA3654	<input type="checkbox"/>	<input type="checkbox"/>	R0	<input type="checkbox"/>	<input type="checkbox"/>	<input type="checkbox"/>	<input type="checkbox"/>	<input type="checkbox"/>	75.0#
	42 x 54"	PMFGA4254	<input type="checkbox"/>	<input type="checkbox"/>	R0	<input type="checkbox"/>	<input type="checkbox"/>	<input type="checkbox"/>	<input type="checkbox"/>	<input type="checkbox"/>	87.0#
	48 x 54"	PMFGA4854	<input type="checkbox"/>	<input type="checkbox"/>	R0	<input type="checkbox"/>	<input type="checkbox"/>	<input type="checkbox"/>	<input type="checkbox"/>	<input type="checkbox"/>	98.0#
PFGA	12 x 66"	PMFGA1266	<input type="checkbox"/>	<input type="checkbox"/>	R0	<input type="checkbox"/>	<input type="checkbox"/>	<input type="checkbox"/>	<input type="checkbox"/>	<input type="checkbox"/>	33.0#
<p>PFGA Monolithic/Fully Segmented/Glass Panel - 66"H</p>	18 x 66"	PMFGA1866	<input type="checkbox"/>	<input type="checkbox"/>	R0	<input type="checkbox"/>	<input type="checkbox"/>	<input type="checkbox"/>	<input type="checkbox"/>	<input type="checkbox"/>	46.0#
	24 x 66"	PMFGA2466	<input type="checkbox"/>	<input type="checkbox"/>	R0	<input type="checkbox"/>	<input type="checkbox"/>	<input type="checkbox"/>	<input type="checkbox"/>	<input type="checkbox"/>	60.0#
	30 x 66"	PMFGA3066	<input type="checkbox"/>	<input type="checkbox"/>	R0	<input type="checkbox"/>	<input type="checkbox"/>	<input type="checkbox"/>	<input type="checkbox"/>	<input type="checkbox"/>	72.0#
	36 x 66"	PMFGA3666	<input type="checkbox"/>	<input type="checkbox"/>	R0	<input type="checkbox"/>	<input type="checkbox"/>	<input type="checkbox"/>	<input type="checkbox"/>	<input type="checkbox"/>	85.0#
	42 x 66"	PMFGA4266	<input type="checkbox"/>	<input type="checkbox"/>	R0	<input type="checkbox"/>	<input type="checkbox"/>	<input type="checkbox"/>	<input type="checkbox"/>	<input type="checkbox"/>	98.0#
	48 x 66"	PMFGA4866	<input type="checkbox"/>	<input type="checkbox"/>	R0	<input type="checkbox"/>	<input type="checkbox"/>	<input type="checkbox"/>	<input type="checkbox"/>	<input type="checkbox"/>	111.0#
			<b>A</b>	<b>B</b>	<b>C</b>	<b>D</b>	<b>E</b>	<b>F</b>	<b>G</b>	<b>H</b>	<b>I</b>

## HOW TO ORDER

Indicate the following information on order form:

- Quantity of each item.
- Model number, including options. See "How To Build a Model Number".
- Any special service required.

Note: • The  indicates that a choice is required.

- The absence of the  indicates that no choice is required.
- Alpha-numeric characters in place of  indicate that no other alternatives are available.

## HOW TO BUILD A MODEL NUMBER

- A** Select basic model.
- B** Select electrical code for base raceway.
  - CN** - Chicago, no cutouts
  - C1** - Chicago, 1 side w/cutouts
  - CP** - Chicago, 2 sides w/cutouts
  - DN** - Domestic, no cutouts
  - D1** - Domestic, 1 side w/cutouts
  - D** - Domestic, 2 sides w/cutouts
- C** Select horizontal rail.
  - E** - Enhanced
  - S** - Standard
- D** Select numbers of raceway tiles side 1
  - R0** - Side 1 w/no raceway tile
- E** Select numbers of raceway tiles side 2
  - R20** - Side 2 w/no raceway tile
  - R21** - Side 2 w/1-12" raceway tile; add \$32
- F** Select glass color.

- GLA** - Clear
  - BRZ** - Tinted/Bronze
  - GLC** - White laminate
- See pricing columns for glass upcharge.

- G** Select trim color. Refer to color addendum at ki.com or KI Fabrics & Finishes binder. Metallic paint requires upcharge. SX Starlight Silver finish is only offered on flat aluminum trim.

- H** Select fabric side 1. Refer to color addendum at ki.com or in KI Fabrics & Finishes binder.

- I** Select fabric side 2. Refer to color addendum at ki.com or in KI Fabrics & Finishes binder.

## UPHOLSTERY INFORMATION

### Fabric Mixing

If fabric is ordered from one group on side 1 and another group on side 2, calculate list price using the following method:

Example:  
Grade 2 Fabric  
-Grade1 Fabric

Upcharge

Upcharge/2 = Cost for one side

Grade 1 Fabric  
+Cost for one side

Combined list price

### Fabric Disclaimer

Fabric will be applied as swatched by the fabric manufacturer. Fabric that is required to be applied differently than is swatched will need a Special Cost Request written specify-









# Glass/Fabric Panel - Acoustic (3/4" Thick Tiles)

Monolithic/Fully Segmented/Glass Panel

Delivered Pricing Fabric Grade 1 & C.O.M.	Delivered Pricing Fabric Grade 2	Delivered Pricing Fabric Grade 3 & Pallas Vertical Fabric Grade PV	Delivered Pricing Pallas Vertical Fabric Grade PV1	Delivered Pricing Pallas Vertical Fabric Grade PV2	Enhanced Horizontal Rail	Tinted/Bronze Upcharge	White Laminate Upcharge	Metallic Paint add to list price
\$ 790	\$ 804	\$ 813	\$ 829	\$ 852	\$ 47	\$ 14	\$ 118	\$ 31
869	884	896	915	939	49	16	130	32
956	970	983	1003	1031	52	19	143	36
1050	1067	1079	1100	1136	64	21	158	46
1159	1181	1192	1212	1251	70	24	174	48
1343	1372	1381	1407	1447	79	28	203	59
1405	1433	1445	1475	1512	88	29	211	62

ing the direction the fabric is to be applied.  
The posted standard lead time will apply to  
the Special Cost Request.

## INFORMATION

### Maximum Raceway Tile Possibilities

Panel Height	Side 1	Side 2
54"H	0	1
66"H	0	1
84"H	0	1

## SPECIAL SERVICES

### Special Carton Marking

With specially marked information N/C

### Shipping

Delivered. Shipped **k.d. freight prepaid**  
**f.o.b. Manitowoc, Wisconsin 54220**  
factory. Freight class #70.

Specifications and prices are subject to  
change without prior notice.

# Glass/Fabric Panel - Acoustic (3/4" Thick Tiles)

Fully Segmented/Fully Segmented/Glass Panel

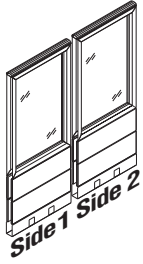
	W x H	MODEL NUMBER									Approx. Packaged Weight
		Basic Model	Electrical Code	Horizontal Rail	Number of Raceway Tiles Side 1	Number of Raceway Tiles Side 2	Glass Color	Trim Color	Fabric Side 1	Fabric Side 2	
	12 x 54"	PFFGA1254	<input type="checkbox"/>	<input type="checkbox"/>	<input type="checkbox"/>	<input type="checkbox"/>	<input type="checkbox"/>	<input type="checkbox"/>	<input type="checkbox"/>	<input type="checkbox"/>	30.0#
	18 x 54"	PFFGA1854	<input type="checkbox"/>	<input type="checkbox"/>	<input type="checkbox"/>	<input type="checkbox"/>	<input type="checkbox"/>	<input type="checkbox"/>	<input type="checkbox"/>	<input type="checkbox"/>	42.0#
	24 x 54"	PFFGA2454	<input type="checkbox"/>	<input type="checkbox"/>	<input type="checkbox"/>	<input type="checkbox"/>	<input type="checkbox"/>	<input type="checkbox"/>	<input type="checkbox"/>	<input type="checkbox"/>	54.0#
	30 x 54"	PFFGA3054	<input type="checkbox"/>	<input type="checkbox"/>	<input type="checkbox"/>	<input type="checkbox"/>	<input type="checkbox"/>	<input type="checkbox"/>	<input type="checkbox"/>	<input type="checkbox"/>	66.0#
	36 x 54"	PFFGA3654	<input type="checkbox"/>	<input type="checkbox"/>	<input type="checkbox"/>	<input type="checkbox"/>	<input type="checkbox"/>	<input type="checkbox"/>	<input type="checkbox"/>	<input type="checkbox"/>	78.0#
	42 x 54"	PFFGA4254	<input type="checkbox"/>	<input type="checkbox"/>	<input type="checkbox"/>	<input type="checkbox"/>	<input type="checkbox"/>	<input type="checkbox"/>	<input type="checkbox"/>	<input type="checkbox"/>	90.0#
	48 x 54"	PFFGA4854	<input type="checkbox"/>	<input type="checkbox"/>	<input type="checkbox"/>	<input type="checkbox"/>	<input type="checkbox"/>	<input type="checkbox"/>	<input type="checkbox"/>	<input type="checkbox"/>	102.0#
PGA											
<b>Fully Segmented/Fully Segmented/Glass Panel - 54"H</b> <ul style="list-style-type: none"> <li>• Four horizontal rails</li> <li>• Two powder-coated aluminum window frames</li> <li>• One pane, 1/4" thick glass</li> <li>• One base/raceway consisting of a raceway pan and two doors</li> <li>• One rounded satin-textured polypropylene top cap with splice plate</li> <li>• Order power separately</li> <li>• Order vertical posts separately</li> <li>• Fabric tile is tackable</li> <li>• SX Starlight Silver finish is only offered on flat aluminum trim</li> </ul>											
PGA											
	12 x 66"	PFFGA1266	<input type="checkbox"/>	<input type="checkbox"/>	<input type="checkbox"/>	<input type="checkbox"/>	<input type="checkbox"/>	<input type="checkbox"/>	<input type="checkbox"/>	<input type="checkbox"/>	34.0#
	18 x 66"	PFFGA1866	<input type="checkbox"/>	<input type="checkbox"/>	<input type="checkbox"/>	<input type="checkbox"/>	<input type="checkbox"/>	<input type="checkbox"/>	<input type="checkbox"/>	<input type="checkbox"/>	47.0#
	24 x 66"	PFFGA2466	<input type="checkbox"/>	<input type="checkbox"/>	<input type="checkbox"/>	<input type="checkbox"/>	<input type="checkbox"/>	<input type="checkbox"/>	<input type="checkbox"/>	<input type="checkbox"/>	61.0#
	30 x 66"	PFFGA3066	<input type="checkbox"/>	<input type="checkbox"/>	<input type="checkbox"/>	<input type="checkbox"/>	<input type="checkbox"/>	<input type="checkbox"/>	<input type="checkbox"/>	<input type="checkbox"/>	75.0#
	36 x 66"	PFFGA3666	<input type="checkbox"/>	<input type="checkbox"/>	<input type="checkbox"/>	<input type="checkbox"/>	<input type="checkbox"/>	<input type="checkbox"/>	<input type="checkbox"/>	<input type="checkbox"/>	88.0#
	42 x 66"	PFFGA4266	<input type="checkbox"/>	<input type="checkbox"/>	<input type="checkbox"/>	<input type="checkbox"/>	<input type="checkbox"/>	<input type="checkbox"/>	<input type="checkbox"/>	<input type="checkbox"/>	101.0#
	48 x 66"	PFFGA4866	<input type="checkbox"/>	<input type="checkbox"/>	<input type="checkbox"/>	<input type="checkbox"/>	<input type="checkbox"/>	<input type="checkbox"/>	<input type="checkbox"/>	<input type="checkbox"/>	115.0#
			<b>A</b>	<b>B</b>	<b>C</b>	<b>D</b>	<b>E</b>	<b>F</b>	<b>G</b>	<b>H</b>	<b>I</b>

## HOW TO ORDER

Indicate the following information on order form:

1. Quantity of each item.
2. Model number, including options. See "How To Build a Model Number".
3. Any special service required.

Note: • The  indicates that a choice is required.

- The absence of the  indicates that no choice is required.
- Alpha-numeric characters in place of  indicate that no other alternatives are available.

## HOW TO BUILD A MODEL NUMBER

**A** Select basic model.

**B** Select electrical code for base raceway.

- CN** - Chicago, no cutouts
- C1** - Chicago, 1 side w/cutouts
- CP** - Chicago, 2 sides w/cutouts
- DN** - Domestic, no cutouts
- D1** - Domestic, 1 side w/cutouts
- D** - Domestic, 2 sides w/cutouts

**C** Select horizontal rail.

- E** - Enhanced
- S** - Standard

**D** Select numbers of raceway tiles side 1

- R0** - Side 1 w/no raceway tile
- R1** - Side 1 w/1-12" raceway tile; add \$32

**E** Select numbers of raceway tiles side 2

- R20** - Side 2 w/no raceway tile
- R21** - Side 2 w/1-12" raceway tile; add \$32

**F** Select glass color.

- GLA** - Clear
- BRZ** - Tinted/Bronze
- GLC** - White laminate

See pricing columns for glass upcharge.

**G** Select trim color.

Refer to color addendum at [ki.com](http://ki.com) or KI Fabrics & Finishes binder. Metallic paint requires upcharge. SX Starlight Silver finish is only offered on flat aluminum trim.

**H** Select fabric side 1.

Refer to color addendum at [ki.com](http://ki.com) or in KI Fabrics & Finishes binder.

**I** Select fabric side 2.

Refer to color addendum at [ki.com](http://ki.com) or in KI Fabrics & Finishes binder.

## UPHOLSTERY INFORMATION

### Fabric Mixing

If fabric is ordered from one group on side 1 and another group on side 2, calculate list price using the following method:

Example:

Grade 2 Fabric  
-Grade1 Fabric

Upcharge

Upcharge/2 = Cost for one side

Grade 1 Fabric  
+Cost for one side

Combined list price

### Fabric Disclaimer

Fabric will be applied as swatched by the fabric manufacturer. Fabric that is required to be applied differently than is swatched will need a Special Cost Request written specify-



# Glass/Fabric Panel - Acoustic (3/4" Thick Tiles)

Fully Segmented/Fully Segmented/Glass Panel



PGA

Fully Segmented/Fully Segmented/  
Glass Panel - 84"H

W x H	MODEL NUMBER									Approx. Packaged Weight
	Basic Model	Electrical Code	Horizontal Rail	Number of Raceway Tiles Side 1	Number of Raceway Tiles Side 2	Glass Color	Trim Color	Fabric Side 1	Fabric Side 2	
12 x 84"	PFFGA1284	<input type="checkbox"/>	<input type="checkbox"/>	<input type="checkbox"/>	<input type="checkbox"/>	<input type="checkbox"/>	<input type="checkbox"/>	<input type="checkbox"/>	<input type="checkbox"/>	40.0#
18 x 84"	PFFGA1884	<input type="checkbox"/>	<input type="checkbox"/>	<input type="checkbox"/>	<input type="checkbox"/>	<input type="checkbox"/>	<input type="checkbox"/>	<input type="checkbox"/>	<input type="checkbox"/>	56.0#
24 x 84"	PFFGA2484	<input type="checkbox"/>	<input type="checkbox"/>	<input type="checkbox"/>	<input type="checkbox"/>	<input type="checkbox"/>	<input type="checkbox"/>	<input type="checkbox"/>	<input type="checkbox"/>	72.0#
30 x 84"	PFFGA3084	<input type="checkbox"/>	<input type="checkbox"/>	<input type="checkbox"/>	<input type="checkbox"/>	<input type="checkbox"/>	<input type="checkbox"/>	<input type="checkbox"/>	<input type="checkbox"/>	88.0#
36 x 84"	PFFGA3684	<input type="checkbox"/>	<input type="checkbox"/>	<input type="checkbox"/>	<input type="checkbox"/>	<input type="checkbox"/>	<input type="checkbox"/>	<input type="checkbox"/>	<input type="checkbox"/>	103.0#
42 x 84"	PFFGA4284	<input type="checkbox"/>	<input type="checkbox"/>	<input type="checkbox"/>	<input type="checkbox"/>	<input type="checkbox"/>	<input type="checkbox"/>	<input type="checkbox"/>	<input type="checkbox"/>	119.0#
48 x 84"	PFFGA4884	<input type="checkbox"/>	<input type="checkbox"/>	<input type="checkbox"/>	<input type="checkbox"/>	<input type="checkbox"/>	<input type="checkbox"/>	<input type="checkbox"/>	<input type="checkbox"/>	134.0#

**A**      **B**      **C**      **D**      **E**      **F**      **G**      **H**      **I**

## HOW TO ORDER

Indicate the following information on order form:

- Quantity of each item.
- Model number, including options. See "How To Build a Model Number".
- Any special service required.

Note: • The  indicates that a choice is required.

- The absence of the  indicates that no choice is required.
- Alpha-numeric characters in place of  indicate that no other alternatives are available.

## HOW TO BUILD A MODEL NUMBER

- A** Select basic model.
- B** Select electrical code for base raceway.
  - CN** - Chicago, no cutouts
  - C1** - Chicago, 1 side w/cutouts
  - CP** - Chicago, 2 sides w/cutouts
  - DN** - Domestic, no cutouts
  - D1** - Domestic, 1 side w/cutouts
  - D** - Domestic, 2 sides w/cutouts
- C** Select horizontal rail.
  - E** - Enhanced
  - S** - Standard
- D** Select numbers of raceway tiles side 1
  - R0** - Side 1 w/no raceway tile
  - R1** - Side 1 w/1-12" raceway tile; add \$32
- E** Select numbers of raceway tiles side 2
  - R20** - Side 2 w/no raceway tile
  - R21** - Side 2 w/1-12" raceway tile; add \$32

- F** Select glass color.
 

<b>GLA</b>	- Clear
<b>BRZ</b>	- Tinted/Bronze
<b>GLC</b>	- White laminate

See pricing columns for glass upcharge.
- G** Select trim color. Refer to color addendum at [ki.com](http://ki.com) or in KI Fabrics & Finishes binder. Metallic paint requires upcharge. SX Starlight Silver finish is only offered on flat aluminum trim.
- H** Select fabric side 1. Refer to color addendum at [ki.com](http://ki.com) or in KI Fabrics & Finishes binder.
- I** Select fabric side 2. Refer to color addendum at [ki.com](http://ki.com) or in KI Fabrics & Finishes binder.

## UPHOLSTERY INFORMATION

### Fabric Mixing

If fabric is ordered from one group on side 1 and another group on side 2, calculate list price using the following method:

Example:  
Grade 2 Fabric  
-Grade1 Fabric

Upcharge

Upcharge/2 = Cost for one side

Grade 1 Fabric  
+Cost for one side

Combined list price

### Fabric Disclaimer

Fabric will be applied as swatched by the fabric manufacturer. Fabric that is required to be applied differently than is swatched will need a Special Cost Request written specify-



# Glass/Fabric Panel - Acoustic (3/4" Thick Tiles)

Fully Segmented/Fully Segmented/Glass Panel

Delivered Pricing Fabric Grade 1 & C.O.M.	Delivered Pricing Fabric Grade 2	Delivered Pricing Fabric Grade 3 & Pallas Vertical Fabric Grade PV	Delivered Pricing Pallas Vertical Fabric Grade PV1	Delivered Pricing Pallas Vertical Fabric Grade PV2	Enhanced Horizontal Rail	Tinted/Bronze Upcharge	White Laminate Upcharge	Metallic Paint add to list price
\$ 848	\$ 861	\$ 871	\$ 889	\$ 913	\$ 47	\$ 15	\$ 128	\$ 31
929	946	958	979	1001	49	19	142	32
1011	1025	1039	1063	1094	52	20	151	36
1105	1124	1140	1160	1199	64	23	167	46
1234	1257	1269	1295	1333	70	25	184	48
1421	1450	1464	1492	1532	79	30	213	59
1480	1509	1529	1555	1598	88	31	221	62

ing the direction the fabric is to be applied. The posted standard lead time will apply to the Special Cost Request.

## INFORMATION

### Maximum Raceway Tile Possibilities

Panel Height	Side 1	Side 2
54"H	1	1
66"H	1	1
84"H	1	1

## SPECIAL SERVICES

### Special Carton Marking

With specially marked information N/C

### Shipping

Delivered. Shipped **k.d. freight prepaid f.o.b. Manitowoc, Wisconsin 54220** factory. Freight class #70.

Specifications and prices are subject to change without prior notice.

# Open Panel

## Face Styles

### Face Style: Fully Open

#### Basic Model: PO

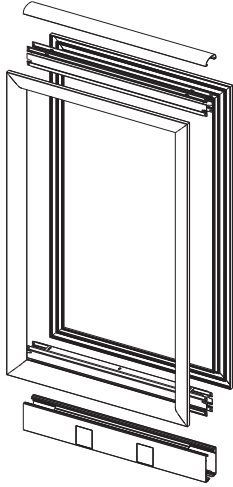

Fully Open panels consist of a full-sized open tile. Base is 6".

#### STANDARD PANEL SIZES (Open Panels)

	12" W	18" W	24" W	30" W	36" W	42" W	48" W	54" W	60" W	Side 1 Number of	Side 2 Number of
30" H	•	•	•	•	•	•	•	•	•	N/A	N/A
42" H	•	•	•	•	•	•	•	•	•	N/A	N/A
54" H	•	•	•	•	•	•	•	•	•	N/A	N/A
66" H	•	•	•	•	•	•	•	•	•	N/A	N/A
84" H	•	•	•	•	•	•	•	•	•	N/A	N/A

### Face Style: Open/Monolithic

#### Basic Model: POMMA

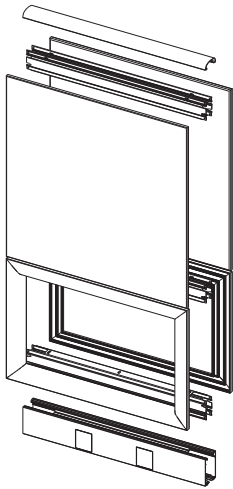

Open/Monolithic panels consist of the following:  
24" open tile on bottom. Remainder of panel is a  
single fabric tile. Base is 6". Panel thickness: 3 1/2".

#### STANDARD PANEL SIZES (Open/Fabric-Acoustic)

	12" W	18" W	24" W	30" W	36" W	42" W	48" W	54" W	60" W	Side 1 Number of	Side 2 Number of
30" H	N/A	N/A	N/A	N/A	N/A	N/A	N/A	N/A	N/A	N/A	N/A
42" H	•	•	•	•	•	•	•	•	•	1	1
54" H	•	•	•	•	•	•	•	•	•	N/A	N/A
66" H	•	•	•	•	•	•	•	•	•	N/A	N/A
84" H	•	•	•	•	•	•	•	•	•	N/A	N/A



**Face Style: Monolithic/Open Panels**

**Basic Model: PMMOA**

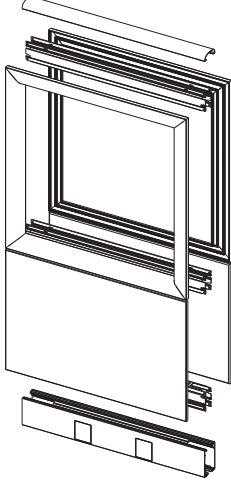

Monolithic/Open panels consist of the following:  
24" fabric tile on bottom and an open frame on top.  
Base is 6". Panel thickness: 3 1/2".

**STANDARD PANEL SIZES (Fabric/Open—Acoustic and Highly Acoustic)**

	12" W	18" W	24" W	30" W	36" W	42" W	48" W	54" W	60" W	Side 1 Number of	Side 2 Number of
										12" Fabric Tiles	12" Fabric Tiles
30" H	N/A	N/A	N/A	N/A	N/A	N/A	N/A	N/A	N/A	N/A	N/A
42" H	•	•	•	•	•	•	•	•	•	N/A	N/A
54" H	•	•	•	•	•	•	•	•	•	N/A	N/A
66" H	•	•	•	•	•	•	•	•	•	N/A	N/A
84" H	•	•	•	•	•	•	•	•	•	N/A	N/A

# Open Panel

## Full Open Panel

	MODEL	W x H	MODEL NUMBER				Approx. Packaged Weight
			Basic Model	Electrical Code	Horizontal Rail	Trim Color	
	<b>Full Open Panel - 30"H</b> • Two horizontal rails • Two powder-coated aluminum window frames • One base/raceway consisting of a raceway pan and two doors • One rounded satin-textured polypropylene top cap with splice plate • Order power separately • Order vertical posts separately • SX Starlight Silver finish is only offered on flat aluminum trim	12 x 30"	PO1230	<input type="checkbox"/>	<input type="checkbox"/>	<input type="checkbox"/>	9.0#
		18 x 30"	PO1830	<input type="checkbox"/>	<input type="checkbox"/>	<input type="checkbox"/>	13.0#
		24 x 30"	PO2430	<input type="checkbox"/>	<input type="checkbox"/>	<input type="checkbox"/>	16.0#
		30 x 30"	PO3030	<input type="checkbox"/>	<input type="checkbox"/>	<input type="checkbox"/>	20.0#
		36 x 30"	PO3630	<input type="checkbox"/>	<input type="checkbox"/>	<input type="checkbox"/>	24.0#
		42 x 30"	PO4230	<input type="checkbox"/>	<input type="checkbox"/>	<input type="checkbox"/>	27.0#
		48 x 30"	PO4830	<input type="checkbox"/>	<input type="checkbox"/>	<input type="checkbox"/>	31.0#
PO							
PO	<b>Full Open Panel - 42"H</b>	12 x 42"	PO1242	<input type="checkbox"/>	<input type="checkbox"/>	<input type="checkbox"/>	10.0#
		18 x 42"	PO1842	<input type="checkbox"/>	<input type="checkbox"/>	<input type="checkbox"/>	14.0#
		24 x 42"	PO2442	<input type="checkbox"/>	<input type="checkbox"/>	<input type="checkbox"/>	18.0#
		30 x 42"	PO3042	<input type="checkbox"/>	<input type="checkbox"/>	<input type="checkbox"/>	21.0#
		36 x 42"	PO3642	<input type="checkbox"/>	<input type="checkbox"/>	<input type="checkbox"/>	25.0#
		42 x 42"	PO4242	<input type="checkbox"/>	<input type="checkbox"/>	<input type="checkbox"/>	28.0#
		48 x 42"	PO4842	<input type="checkbox"/>	<input type="checkbox"/>	<input type="checkbox"/>	32.0#
PO	<b>Full Open Panel - 54"H</b>	12 x 54"	PO1254	<input type="checkbox"/>	<input type="checkbox"/>	<input type="checkbox"/>	12.0#
		18 x 54"	PO1854	<input type="checkbox"/>	<input type="checkbox"/>	<input type="checkbox"/>	15.0#
		24 x 54"	PO2454	<input type="checkbox"/>	<input type="checkbox"/>	<input type="checkbox"/>	19.0#
		30 x 54"	PO3054	<input type="checkbox"/>	<input type="checkbox"/>	<input type="checkbox"/>	22.0#
		36 x 54"	PO3654	<input type="checkbox"/>	<input type="checkbox"/>	<input type="checkbox"/>	26.0#
		42 x 54"	PO4254	<input type="checkbox"/>	<input type="checkbox"/>	<input type="checkbox"/>	30.0#
		48 x 54"	PO4854	<input type="checkbox"/>	<input type="checkbox"/>	<input type="checkbox"/>	33.0#

A

B

C

D

### HOW TO ORDER

Indicate the following information on order form:

- Quantity of each item.
- Model number, including options. See "How To Build a Model Number".
- Any special service required.

Note: • The  indicates that a choice is required.

- The absence of the  indicates that no choice is required.
- Alpha-numeric characters in place of  indicate that no other alternatives are available.

### HOW TO BUILD A MODEL NUMBER

**A** Select basic model.

**B** Select electrical code for base raceway.

<b>CN</b>	- Chicago, no cutouts
<b>C1</b>	- Chicago, 1 side w/cutouts
<b>CP</b>	- Chicago, 2 sides w/cutouts
<b>DN</b>	- Domestic, no cutouts
<b>D1</b>	- Domestic, 1 side w/cutouts
<b>D</b>	- Domestic, 2 sides w/cutouts

**C** Select horizontal rail.

<b>E</b>	- Enhanced
<b>S</b>	- Standard

**D** Select trim color.

Refer to color addendum at [ki.com](http://ki.com) or KI Fabrics & Finishes binder.  
Metallic paint requires upcharge.  
SX Starlight Silver finish is only offered on flat aluminum trim.





# Open Panel

Full Open Panel

Delivered Pricing	Enhanced Horizontal Rail	Metallic Paint add to list price
\$ 357	\$ 47	\$ 31
388	49	32
425	52	36
464	64	46
507	70	48
584	79	59
594	88	62
<hr/>		
\$ 422	\$ 47	\$ 31
449	49	32
489	52	36
529	64	46
574	70	48
655	79	59
663	88	62
<hr/>		
\$ 467	\$ 47	\$ 31
495	49	32
536	52	36
575	64	46
621	70	48
699	79	59
728	88	62

## SPECIAL SERVICES

### Special Carton Marking

With specially marked information N/C

### Shipping

Delivered. Shipped **k.d. freight prepaid f.o.b. Manitowoc, Wisconsin 54220** factory. Freight class #70.

Specifications and prices are subject to change without prior notice.

# Open Panel

Full Open Panel

	MODEL	W x H	MODEL NUMBER				Approx. Packaged Weight
			Basic Model	Electrical Code	Horizontal Rail	Trim Color	
	<b>Full Open Panel - 66"H</b> • Two horizontal rails • Two powder-coated aluminum window frames • One base/raceway consisting of a raceway pan and two doors • One rounded satin-textured polypropylene top cap with splice plate • Order power separately • Order vertical posts separately • SX Starlight Silver finish is only offered on flat aluminum trim	12 x 66"	PO1266	<input type="checkbox"/>	<input type="checkbox"/>	<input type="checkbox"/>	13.0#
		18 x 66"	PO1866	<input type="checkbox"/>	<input type="checkbox"/>	<input type="checkbox"/>	17.0#
		24 x 66"	PO2466	<input type="checkbox"/>	<input type="checkbox"/>	<input type="checkbox"/>	20.0#
		30 x 66"	PO3066	<input type="checkbox"/>	<input type="checkbox"/>	<input type="checkbox"/>	24.0#
		36 x 66"	PO3666	<input type="checkbox"/>	<input type="checkbox"/>	<input type="checkbox"/>	27.0#
		42 x 66"	PO4266	<input type="checkbox"/>	<input type="checkbox"/>	<input type="checkbox"/>	31.0#
		48 x 66"	PO4866	<input type="checkbox"/>	<input type="checkbox"/>	<input type="checkbox"/>	34.0#
PO							
PO	<b>Full Open Panel - 84"H</b>	12 x 84"	PO1284	<input type="checkbox"/>	<input type="checkbox"/>	<input type="checkbox"/>	15.0#
		18 x 84"	PO1884	<input type="checkbox"/>	<input type="checkbox"/>	<input type="checkbox"/>	18.0#
		24 x 84"	PO2484	<input type="checkbox"/>	<input type="checkbox"/>	<input type="checkbox"/>	22.0#
		30 x 84"	PO3084	<input type="checkbox"/>	<input type="checkbox"/>	<input type="checkbox"/>	25.0#
		36 x 84"	PO3684	<input type="checkbox"/>	<input type="checkbox"/>	<input type="checkbox"/>	29.0#
		42 x 84"	PO4284	<input type="checkbox"/>	<input type="checkbox"/>	<input type="checkbox"/>	33.0#
		48 x 84"	PO4884	<input type="checkbox"/>	<input type="checkbox"/>	<input type="checkbox"/>	36.0#
			<b>A</b>	<b>B</b>	<b>C</b>	<b>D</b>	

## HOW TO ORDER

Indicate the following information on order form:

- Quantity of each item.
- Model number, including options. See "How To Build a Model Number".
- Any special service required.

Note: • The  indicates that a choice is required.

- The absence of the  indicates that no choice is required.
- Alpha-numeric characters in place of  indicate that no other alternatives are available.

## HOW TO BUILD A MODEL NUMBER

**A** Select basic model.

**B** Select electrical code for base raceway.

<b>CN</b>	- Chicago, no cutouts
<b>C1</b>	- Chicago, 1 side w/cutouts
<b>CP</b>	- Chicago, 2 sides w/cutouts
<b>DN</b>	- Domestic, no cutouts
<b>D1</b>	- Domestic, 1 side w/cutouts
<b>D</b>	- Domestic, 2 sides w/cutouts

**C** Select horizontal rail.

<b>E</b>	- Enhanced
<b>S</b>	- Standard

**D** Select trim color.

Refer to color addendum at [ki.com](http://ki.com) or KI Fabrics & Finishes binder.  
Metallic paint requires upcharge.



# Open Panel

Full Open Panel

Delivered Pricing	Enhanced Horizontal Rail	Metallic Paint add to list price
\$ 471	\$ 47	\$ 31
503	49	32
541	52	36
580	64	46
646	70	48
722	79	59
739	88	62
\$ 593	\$ 47	\$ 31
642	49	32
683	52	36
722	64	46
767	70	48
846	79	59
859	88	62

## SPECIAL SERVICES

### Special Carton Marking

With specially marked information N/C

### Shipping

Delivered. Shipped **k.d. freight prepaid f.o.b. Manitowoc, Wisconsin 54220** factory. Freight class #70.

Specifications and prices are subject to change without prior notice.

# Open/Fabric Panel - Acoustic (3/4" Thick Tiles)

Open/Monolithic/Monolithic Panel

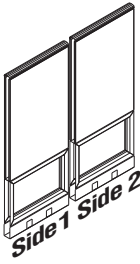
	W x H	MODEL NUMBER								Approx. Packaged Weight
		Basic Model	Electrical Code	Horizontal Rail	Number of Raceway Tiles Side 1	Number of Raceway Tiles Side 2	Trim Color	Fabric Side 1	Fabric Side 2	
	12 x 42"	POMMA1242	<input type="checkbox"/>	<input type="checkbox"/>	<input type="checkbox"/>	<input type="checkbox"/>	<input type="checkbox"/>	<input type="checkbox"/>	<input type="checkbox"/>	17.0#
	18 x 42"	POMMA1842	<input type="checkbox"/>	<input type="checkbox"/>	<input type="checkbox"/>	<input type="checkbox"/>	<input type="checkbox"/>	<input type="checkbox"/>	<input type="checkbox"/>	23.0#
	24 x 42"	POMMA2442	<input type="checkbox"/>	<input type="checkbox"/>	<input type="checkbox"/>	<input type="checkbox"/>	<input type="checkbox"/>	<input type="checkbox"/>	<input type="checkbox"/>	30.0#
	30 x 42"	POMMA3042	<input type="checkbox"/>	<input type="checkbox"/>	<input type="checkbox"/>	<input type="checkbox"/>	<input type="checkbox"/>	<input type="checkbox"/>	<input type="checkbox"/>	36.0#
	36 x 42"	POMMA3642	<input type="checkbox"/>	<input type="checkbox"/>	<input type="checkbox"/>	<input type="checkbox"/>	<input type="checkbox"/>	<input type="checkbox"/>	<input type="checkbox"/>	42.0#
	42 x 42"	POMMA4242	<input type="checkbox"/>	<input type="checkbox"/>	<input type="checkbox"/>	<input type="checkbox"/>	<input type="checkbox"/>	<input type="checkbox"/>	<input type="checkbox"/>	49.0#
	48 x 42"	POMMA4842	<input type="checkbox"/>	<input type="checkbox"/>	<input type="checkbox"/>	<input type="checkbox"/>	<input type="checkbox"/>	<input type="checkbox"/>	<input type="checkbox"/>	55.0#
POA										
Open/Monolithic/Monolithic Panel - 42"H										
<ul style="list-style-type: none"> <li>• Three horizontal rails</li> <li>• Two aluminum frames</li> <li>• Two full fabric tiles</li> <li>• One base/raceway consisting of a raceway pan and two doors</li> <li>• One rounded satin-textured polypropylene top cap with splice plate</li> <li>• Order power separately</li> <li>• Order vertical posts separately</li> <li>• Fabric tile is tackable</li> <li>• SX Starlight Silver finish is only offered on flat aluminum trim</li> </ul>										
POA	12 x 54"	POMMA1254	<input type="checkbox"/>	<input type="checkbox"/>			<input type="checkbox"/>	<input type="checkbox"/>	<input type="checkbox"/>	20.0#
	18 x 54"	POMMA1854	<input type="checkbox"/>	<input type="checkbox"/>			<input type="checkbox"/>	<input type="checkbox"/>	<input type="checkbox"/>	27.0#
Open/Monolithic/Monolithic Panel - 54"H	24 x 54"	POMMA2454	<input type="checkbox"/>	<input type="checkbox"/>			<input type="checkbox"/>	<input type="checkbox"/>	<input type="checkbox"/>	34.0#
	30 x 54"	POMMA3054	<input type="checkbox"/>	<input type="checkbox"/>			<input type="checkbox"/>	<input type="checkbox"/>	<input type="checkbox"/>	41.0#
	36 x 54"	POMMA3654	<input type="checkbox"/>	<input type="checkbox"/>			<input type="checkbox"/>	<input type="checkbox"/>	<input type="checkbox"/>	48.0#
	42 x 54"	POMMA4254	<input type="checkbox"/>	<input type="checkbox"/>			<input type="checkbox"/>	<input type="checkbox"/>	<input type="checkbox"/>	55.0#
	48 x 54"	POMMA4854	<input type="checkbox"/>	<input type="checkbox"/>			<input type="checkbox"/>	<input type="checkbox"/>	<input type="checkbox"/>	62.0#
			<b>A</b>	<b>B</b>	<b>C</b>	<b>D</b>	<b>E</b>	<b>F</b>	<b>G</b>	<b>H</b>

## HOW TO ORDER

Indicate the following information on order form:

- Quantity of each item.
- Model number, including options. See "How To Build a Model Number".
- Any special service required.

Note: • The  indicates that a choice is required.

- The absence of the  indicates that no choice is required.
- Alpha-numeric characters in place of  indicate that no other alternatives are available.

## HOW TO BUILD A MODEL NUMBER

**A** Select basic model.

**B** Select electrical code for base raceway.

- CN** - Chicago, no cutouts
- C1** - Chicago, 1 side w/cutouts
- CP** - Chicago, 2 sides w/cutouts
- DN** - Domestic, no cutouts
- D1** - Domestic, 1 side w/cutouts
- D** - Domestic, 2 sides w/cutouts

**C** Select horizontal rail.

- E** - Enhanced
- S** - Standard

**D** Select numbers of raceway tiles side 1

- R0** - Side 1 w/no raceway tile
- R1** - Side 1 w/1-12" raceway tile; add \$32

**E** Select numbers of raceway tiles side 2

- R20** - Side 2 w/no raceway tile
- R21** - Side 2 w/1-12" raceway tile; add \$32

**F** Select trim color.  
Refer to color addendum at ki.com or KI Fabrics & Finishes binder.  
Metallic paint requires upcharge.  
SX Starlight Silver finish is only offered on flat aluminum trim.

**G** Select fabric side 1.  
Refer to color addendum at ki.com or in KI Fabrics & Finishes binder.

**H** Select fabric side 2.  
Refer to color addendum at ki.com or in KI Fabrics & Finishes binder.

## UPHOLSTERY INFORMATION

### Fabric Mixing

If fabric is ordered from one group on side 1 and another group on side 2, calculate list price using the following method:

Example:  
Grade 2 Fabric  
-Grade1 Fabric

Upcharge

Upcharge/2 = Cost for one side

Grade 1 Fabric  
+Cost for one side

Combined list price

### Fabric Disclaimer

Fabric will be applied as swatched by the fabric manufacturer. Fabric that is required to be applied differently than is swatched will need a Special Cost Request written specify-



# Open/Fabric Panel - Acoustic (3/4" Thick Tiles)

Open/Monolithic/Monolithic Panel

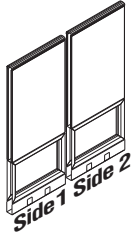
MODEL	W x H	MODEL NUMBER						Approx. Packaged Weight
		Basic Model	Electrical Code	Horizontal Rail	Trim Color	Fabric Side 1	Fabric Side 2	
	12 x 66"	POMMA1266	<input type="checkbox"/>	<input type="checkbox"/>	<input type="checkbox"/>	<input type="checkbox"/>	<input type="checkbox"/>	23.0#
	18 x 66"	POMMA1866	<input type="checkbox"/>	<input type="checkbox"/>	<input type="checkbox"/>	<input type="checkbox"/>	<input type="checkbox"/>	31.0#
	24 x 66"	POMMA2466	<input type="checkbox"/>	<input type="checkbox"/>	<input type="checkbox"/>	<input type="checkbox"/>	<input type="checkbox"/>	39.0#
	30 x 66"	POMMA3066	<input type="checkbox"/>	<input type="checkbox"/>	<input type="checkbox"/>	<input type="checkbox"/>	<input type="checkbox"/>	47.0#
	36 x 66"	POMMA3666	<input type="checkbox"/>	<input type="checkbox"/>	<input type="checkbox"/>	<input type="checkbox"/>	<input type="checkbox"/>	54.0#
	42 x 66"	POMMA4266	<input type="checkbox"/>	<input type="checkbox"/>	<input type="checkbox"/>	<input type="checkbox"/>	<input type="checkbox"/>	62.0#
	48 x 66"	POMMA4866	<input type="checkbox"/>	<input type="checkbox"/>	<input type="checkbox"/>	<input type="checkbox"/>	<input type="checkbox"/>	69.0#
POA								
POA	12 x 84"	POMMA1284	<input type="checkbox"/>	<input type="checkbox"/>	<input type="checkbox"/>	<input type="checkbox"/>	<input type="checkbox"/>	28.0#
	18 x 84"	POMMA1884	<input type="checkbox"/>	<input type="checkbox"/>	<input type="checkbox"/>	<input type="checkbox"/>	<input type="checkbox"/>	37.0#
	24 x 84"	POMMA2484	<input type="checkbox"/>	<input type="checkbox"/>	<input type="checkbox"/>	<input type="checkbox"/>	<input type="checkbox"/>	46.0#
	30 x 84"	POMMA3084	<input type="checkbox"/>	<input type="checkbox"/>	<input type="checkbox"/>	<input type="checkbox"/>	<input type="checkbox"/>	55.0#
	36 x 84"	POMMA3684	<input type="checkbox"/>	<input type="checkbox"/>	<input type="checkbox"/>	<input type="checkbox"/>	<input type="checkbox"/>	63.0#
	42 x 84"	POMMA4284	<input type="checkbox"/>	<input type="checkbox"/>	<input type="checkbox"/>	<input type="checkbox"/>	<input type="checkbox"/>	72.0#
	48 x 84"	POMMA4884	<input type="checkbox"/>	<input type="checkbox"/>	<input type="checkbox"/>	<input type="checkbox"/>	<input type="checkbox"/>	81.0#

A

B

C

D

E

F

## HOW TO ORDER

Indicate the following information on order form:

- Quantity of each item.
- Model number, including options. See "How To Build a Model Number".
- Any special service required.

Note: • The  indicates that a choice is required.

- The absence of the  indicates that no choice is required.
- Alpha-numeric characters in place of  indicate that no other alternatives are available.

## HOW TO BUILD A MODEL NUMBER

**A** Select basic model.

**B** Select electrical code for base raceway.

- CN** - Chicago, no cutouts
- C1** - Chicago, 1 side w/cutouts
- CP** - Chicago, 2 sides w/cutouts
- DN** - Domestic, no cutouts
- D1** - Domestic, 1 side w/cutouts
- D** - Domestic, 2 sides w/cutouts

**C** Select horizontal rail.

- E** - Enhanced
- S** - Standard

**D** Select trim color.

Refer to color addendum at ki.com or KI Fabrics & Finishes binder.  
Metallic paint requires upcharge.  
SX Starlight Silver finish is only offered on flat aluminum trim.

**E** Select fabric side 1.

Refer to color addendum at ki.com or in KI

Fabrics & Finishes binder.

**F** Select fabric side 2.

Refer to color addendum at ki.com or in KI Fabrics & Finishes binder.

## UPHOLSTERY INFORMATION

### Fabric Mixing

If fabric is ordered from one group on side 1 and another group on side 2, calculate list price using the following method:

Example:  
Grade 2 Fabric  
-Grade1 Fabric

Upcharge

Upcharge/2 = Cost for one side

Grade 1 Fabric  
+Cost for one side

Combined list price

### Fabric Disclaimer

Fabric will be applied as swatched by the fabric manufacturer. Fabric that is required to be applied differently than is swatched will need a Special Cost Request written specify-



# Open/Fabric Panel - Acoustic (3/4" Thick Tiles)

Open/Monolithic/Monolithic Panel

Delivered Pricing Fabric Grade 1 & C.O.M.	Delivered Pricing Fabric Grade 2	Delivered Pricing Fabric Grade 3 & Pallas Vertical Fabric Grade PV	Delivered Pricing Pallas Vertical Fabric Grade PV1	Delivered Pricing Pallas Vertical Fabric Grade PV2	Enhanced Horizontal Rail	Metallic Paint add to list price
\$ 579	\$ 590	\$ 597	\$ 612	\$ 631	\$ 47	\$ 31
638	650	665	677	695	49	32
691	701	717	728	750	52	36
779	790	809	824	849	64	46
870	886	903	921	952	70	48
971	989	1011	1027	1061	79	59
991	1011	1030	1051	1084	88	62
\$ 624	\$ 633	\$ 646	\$ 659	\$ 677	\$ 47	\$ 31
717	728	746	757	779	49	32
771	785	803	819	844	52	36
853	869	887	904	929	64	46
930	948	967	987	1018	70	48
1051	1068	1091	1115	1144	79	59
1111	1129	1158	1174	1209	88	62

ing the direction the fabric is to be applied.  
The posted standard lead time will apply to  
the Special Cost Request.

## SPECIAL SERVICES

### Special Carton Marking

With specially marked information N/C

### Shipping

Delivered. Shipped **k.d. freight prepaid**  
**f.o.b. Manitowoc, Wisconsin 54220**  
factory. Freight class #70.

Specifications and prices are subject to  
change without prior notice.

# Open/Fabric Panel - Acoustic (3/4" Thick Tiles)

Monolithic/Monolithic/Open Panel

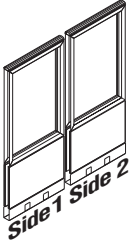
MODEL	W x H	MODEL NUMBER						Approx. Packaged Weight
		Basic Model	Electrical Code	Horizontal Rail	Trim Color	Fabric Side 1	Fabric Side 2	
 <p>PMOA</p> <p><b>Monolithic/Monolithic/Open Panel - 42"H</b></p> <ul style="list-style-type: none"> <li>• Three horizontal rails</li> <li>• Two aluminum frames</li> <li>• Two 24" fabric tiles</li> <li>• One base/raceway consisting of a raceway pan and two doors</li> <li>• One rounded satin-textured polypropylene top cap with splice plate</li> <li>• Order power separately</li> <li>• Order vertical posts separately</li> <li>• Fabric tile is tackable</li> <li>• SX Starlight Silver finish is only offered on flat aluminum trim</li> </ul>	12 x 42"	PMMOA1242	<input type="checkbox"/>	<input type="checkbox"/>	<input type="checkbox"/>	<input type="checkbox"/>	<input type="checkbox"/>	19.0#
	18 x 42"	PMMOA1842	<input type="checkbox"/>	<input type="checkbox"/>	<input type="checkbox"/>	<input type="checkbox"/>	<input type="checkbox"/>	26.0#
	24 x 42"	PMMOA2442	<input type="checkbox"/>	<input type="checkbox"/>	<input type="checkbox"/>	<input type="checkbox"/>	<input type="checkbox"/>	33.0#
	30 x 42"	PMMOA3042	<input type="checkbox"/>	<input type="checkbox"/>	<input type="checkbox"/>	<input type="checkbox"/>	<input type="checkbox"/>	37.0#
	36 x 42"	PMMOA3642	<input type="checkbox"/>	<input type="checkbox"/>	<input type="checkbox"/>	<input type="checkbox"/>	<input type="checkbox"/>	47.0#
	42 x 42"	PMMOA4242	<input type="checkbox"/>	<input type="checkbox"/>	<input type="checkbox"/>	<input type="checkbox"/>	<input type="checkbox"/>	54.0#
	48 x 42"	PMMOA4842	<input type="checkbox"/>	<input type="checkbox"/>	<input type="checkbox"/>	<input type="checkbox"/>	<input type="checkbox"/>	61.0#
<p>PMOA</p> <p><b>Monolithic/Monolithic/Open Panel - 54"H</b></p>	12 x 54"	PMMOA1254	<input type="checkbox"/>	<input type="checkbox"/>	<input type="checkbox"/>	<input type="checkbox"/>	<input type="checkbox"/>	20.0#
	18 x 54"	PMMOA1854	<input type="checkbox"/>	<input type="checkbox"/>	<input type="checkbox"/>	<input type="checkbox"/>	<input type="checkbox"/>	27.0#
	24 x 54"	PMMOA2454	<input type="checkbox"/>	<input type="checkbox"/>	<input type="checkbox"/>	<input type="checkbox"/>	<input type="checkbox"/>	34.0#
	30 x 54"	PMMOA3054	<input type="checkbox"/>	<input type="checkbox"/>	<input type="checkbox"/>	<input type="checkbox"/>	<input type="checkbox"/>	41.0#
	36 x 54"	PMMOA3654	<input type="checkbox"/>	<input type="checkbox"/>	<input type="checkbox"/>	<input type="checkbox"/>	<input type="checkbox"/>	48.0#
	42 x 54"	PMMOA4254	<input type="checkbox"/>	<input type="checkbox"/>	<input type="checkbox"/>	<input type="checkbox"/>	<input type="checkbox"/>	55.0#
	48 x 54"	PMMOA4854	<input type="checkbox"/>	<input type="checkbox"/>	<input type="checkbox"/>	<input type="checkbox"/>	<input type="checkbox"/>	62.0#

A

B

C

D

E

F

## HOW TO ORDER

Indicate the following information on order form:

1. Quantity of each item.
2. Model number, including options. See "How To Build a Model Number".
3. Any special service required.

Note: • The  indicates that a choice is required.

- The absence of the  indicates that no choice is required.
- Alpha-numeric characters in place of  indicate that no other alternatives are available.

## HOW TO BUILD A MODEL NUMBER

**A** Select basic model.

**B** Select electrical code for base raceway.

- CN** - Chicago, no cutouts
- C1** - Chicago, 1 side w/cutouts
- CP** - Chicago, 2 sides w/cutouts
- DN** - Domestic, no cutouts
- D1** - Domestic, 1 side w/cutouts
- D** - Domestic, 2 sides w/cutouts

**C** Select horizontal rail.

- E** - Enhanced
- S** - Standard

**D** Select trim color.

- Refer to color addendum at ki.com or KI Fabrics & Finishes binder.
- Metallic paint requires upcharge.
- SX Starlight Silver finish is only offered on flat aluminum trim.

**E** Select fabric side 1.

- Refer to color addendum at ki.com or in KI

Fabrics & Finishes binder.

**F** Select fabric side 2.

- Refer to color addendum at ki.com or in KI Fabrics & Finishes binder.

## UPHOLSTERY INFORMATION

### Fabric Mixing

If fabric is ordered from one group on side 1 and another group on side 2, calculate list price using the following method:

Example:  
Grade 2 Fabric  
-Grade1 Fabric

Upcharge

Upcharge/2 = Cost for one side

Grade 1 Fabric  
+Cost for one side

Combined list price

### Fabric Disclaimer

Fabric will be applied as swatched by the fabric manufacturer. Fabric that is required to be applied differently than is swatched will need a Special Cost Request written specify-





# Open/Fabric Panel - Acoustic (3/4" Thick Tiles)

Monolithic/Monolithic/Open Panel

Delivered Pricing Fabric Grade 1 & C.O.M.	Delivered Pricing Fabric Grade 2	Delivered Pricing Fabric Grade 3 & Pallas Vertical Fabric Grade PV	Delivered Pricing Pallas Vertical Fabric Grade PV1	Delivered Pricing Pallas Vertical Fabric Grade PV2	Enhanced Horizontal Rail	Metallic Paint add to list price
\$ 506	\$ 517	\$ 524	\$ 537	\$ 551	\$ 47	\$ 31
558	570	576	592	611	49	32
623	632	644	658	675	52	36
680	691	708	717	740	64	46
744	755	773	788	806	70	48
843	857	874	893	917	79	59
888	903	921	940	969	88	62
\$ 531	\$ 542	\$ 549	\$ 563	\$ 579	\$ 47	\$ 31
586	595	603	617	636	49	32
648	658	670	683	706	52	36
706	718	734	747	767	64	46
768	781	800	813	840	70	48
869	884	902	920	951	79	59
914	928	950	969	996	88	62

ing the direction the fabric is to be applied.  
The posted standard lead time will apply to  
the Special Cost Request.

## SPECIAL SERVICES

### Special Carton Marking

With specially marked information N/C

### Shipping

Delivered. Shipped **k.d. freight prepaid**  
**f.o.b. Manitowoc, Wisconsin 54220**  
factory. Freight class #70.

Specifications and prices are subject to  
change without prior notice.

# Open/Fabric Panel - Acoustic (3/4" Thick Tiles)

Monolithic/Monolithic/Open Panel

MODEL	W x H	MODEL NUMBER						Approx. Packaged Weight
		Basic Model	Electrical Code	Horizontal Rail	Trim Color	Fabric Side 1	Fabric Side 2	
	<b>Monolithic/Monolithic/Open Panel - 66"H</b>							
	12 x 66"	PMMOA1266	<input type="checkbox"/>	<input type="checkbox"/>	<input type="checkbox"/>	<input type="checkbox"/>	<input type="checkbox"/>	21.0#
	18 x 66"	PMMOA1866	<input type="checkbox"/>	<input type="checkbox"/>	<input type="checkbox"/>	<input type="checkbox"/>	<input type="checkbox"/>	28.0#
	24 x 66"	PMMOA2466	<input type="checkbox"/>	<input type="checkbox"/>	<input type="checkbox"/>	<input type="checkbox"/>	<input type="checkbox"/>	36.0#
	30 x 66"	PMMOA3066	<input type="checkbox"/>	<input type="checkbox"/>	<input type="checkbox"/>	<input type="checkbox"/>	<input type="checkbox"/>	43.0#
	36 x 66"	PMMOA3666	<input type="checkbox"/>	<input type="checkbox"/>	<input type="checkbox"/>	<input type="checkbox"/>	<input type="checkbox"/>	50.0#
	42 x 66"	PMMOA4266	<input type="checkbox"/>	<input type="checkbox"/>	<input type="checkbox"/>	<input type="checkbox"/>	<input type="checkbox"/>	57.0#
	48 x 66"	PMMOA4866	<input type="checkbox"/>	<input type="checkbox"/>	<input type="checkbox"/>	<input type="checkbox"/>	<input type="checkbox"/>	64.0#
PMOA								
PMOA	<b>Monolithic/Monolithic/Open Panel - 84"H</b>							
	12 x 84"	PMMOA1284	<input type="checkbox"/>	<input type="checkbox"/>	<input type="checkbox"/>	<input type="checkbox"/>	<input type="checkbox"/>	23.0#
	18 x 84"	PMMOA1884	<input type="checkbox"/>	<input type="checkbox"/>	<input type="checkbox"/>	<input type="checkbox"/>	<input type="checkbox"/>	30.0#
	24 x 84"	PMMOA2484	<input type="checkbox"/>	<input type="checkbox"/>	<input type="checkbox"/>	<input type="checkbox"/>	<input type="checkbox"/>	38.0#
	30 x 84"	PMMOA3084	<input type="checkbox"/>	<input type="checkbox"/>	<input type="checkbox"/>	<input type="checkbox"/>	<input type="checkbox"/>	44.0#
	36 x 84"	PMMOA3684	<input type="checkbox"/>	<input type="checkbox"/>	<input type="checkbox"/>	<input type="checkbox"/>	<input type="checkbox"/>	51.0#
	42 x 84"	PMMOA4284	<input type="checkbox"/>	<input type="checkbox"/>	<input type="checkbox"/>	<input type="checkbox"/>	<input type="checkbox"/>	58.0#
	48 x 84"	PMMOA4884	<input type="checkbox"/>	<input type="checkbox"/>	<input type="checkbox"/>	<input type="checkbox"/>	<input type="checkbox"/>	65.0#

A

B

C

D

E

F

## HOW TO ORDER

Indicate the following information on order form:

- Quantity of each item.
- Model number, including options. See "How To Build a Model Number".
- Any special service required.

Note: • The  indicates that a choice is required.

- The absence of the  indicates that no choice is required.
- Alpha-numeric characters in place of  indicate that no other alternatives are available.

## HOW TO BUILD A MODEL NUMBER

- A** Select basic model.
- B** Select electrical code for base raceway.
- |           |                               |
|-----------|-------------------------------|
| <b>CN</b> | - Chicago, no cutouts         |
| <b>C1</b> | - Chicago, 1 side w/cutouts   |
| <b>CP</b> | - Chicago, 2 sides w/cutouts  |
| <b>DN</b> | - Domestic, no cutouts        |
| <b>D1</b> | - Domestic, 1 side w/cutouts  |
| <b>D</b>  | - Domestic, 2 sides w/cutouts |
- C** Select horizontal rail.
- |          |            |
|----------|------------|
| <b>E</b> | - Enhanced |
| <b>S</b> | - Standard |
- D** Select trim color.  
Refer to color addendum at ki.com or KI Fabrics & Finishes binder.  
Metallic paint requires upcharge.  
SX Starlight Silver finish is only offered on flat aluminum trim.
- E** Select fabric side 1.  
Refer to color addendum at ki.com or in KI

Fabrics & Finishes binder.

- F** Select fabric side 2.  
Refer to color addendum at ki.com or in KI Fabrics & Finishes binder.

## UPHOLSTERY INFORMATION

### Fabric Mixing

If fabric is ordered from one group on side 1 and another group on side 2, calculate list price using the following method:

Example:  
Grade 2 Fabric  
-Grade 1 Fabric

Upcharge

Upcharge/2 = Cost for one side

Grade 1 Fabric  
+Cost for one side

Combined list price

### Fabric Disclaimer

Fabric will be applied as swatched by the fabric manufacturer. Fabric that is required to be applied differently than is swatched will



# Open/Fabric Panel - Acoustic (3/4" Thick Tiles)

Monolithic/Monolithic/Open Panel

Delivered Pricing Fabric Grade 1 & C.O.M.	Delivered Pricing Fabric Grade 2	Delivered Pricing Fabric Grade 3 & Pallas Vertical Fabric Grade PV	Delivered Pricing Pallas Vertical Fabric Grade PV1	Delivered Pricing Pallas Vertical Fabric Grade PV2	Enhanced Horizontal Rail	Metallic Paint add to list price
\$ 596	\$ 607	\$ 618	\$ 632	\$ 651	\$ 47	\$ 31
650	659	671	684	708	49	32
714	724	743	754	775	52	36
771	785	803	819	844	64	46
834	849	868	886	907	70	48
935	953	973	992	1023	79	59
984	999	1022	1039	1073	88	62
\$ 642	\$ 657	\$ 671	\$ 682	\$ 701	\$ 47	\$ 31
699	713	726	742	759	49	32
759	773	790	806	824	52	36
821	834	854	870	895	64	46
884	898	918	933	962	70	48
1009	1025	1048	1068	1099	79	59
1054	1071	1094	1118	1146	88	62

need a Special Cost Request written specifying the direction the fabric is to be applied. The posted standard lead time will apply to the Special Cost Request.

## SPECIAL SERVICES

### Special Carton Marking

With specially marked information N/C

### Shipping

Delivered. Shipped **k.d. freight prepaid f.o.b. Manitowoc, Wisconsin 54220** factory. Freight class #70.

Specifications and prices are subject to change without prior notice.

# Fabric Stackable Section - Acoustic (3/4" Tiles)

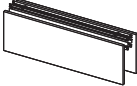
	MODEL	W x H	MODEL NUMBER						Approx. Packaged Weight	
			Basic Model	Electrical Code	Number of Raceway Tiles Side 1	Number of Raceway Tiles Side 2	Fabric Side 1	Fabric Side 2		
 PSA	<b>Stackable Fabric Section - 12"H</b> • One horizontal rail • Two full fabric tiles with mounting hooks • Use top cap from existing lower panel • Order power separately • Order stackable vertical posts separately • Fabric tile is stackable	12 x 12"	PSA1212	<input type="checkbox"/>	<input type="checkbox"/>	<input type="checkbox"/>	<input type="checkbox"/>	<input type="checkbox"/>	<input type="checkbox"/>	8.0#
		18 x 12"	PSA1812	<input type="checkbox"/>	<input type="checkbox"/>	<input type="checkbox"/>	<input type="checkbox"/>	<input type="checkbox"/>	<input type="checkbox"/>	10.0#
		24 x 12"	PSA2412	<input type="checkbox"/>	<input type="checkbox"/>	<input type="checkbox"/>	<input type="checkbox"/>	<input type="checkbox"/>	<input type="checkbox"/>	13.0#
		30 x 12"	PSA3012	<input type="checkbox"/>	<input type="checkbox"/>	<input type="checkbox"/>	<input type="checkbox"/>	<input type="checkbox"/>	<input type="checkbox"/>	16.0#
		36 x 12"	PSA3612	<input type="checkbox"/>	<input type="checkbox"/>	<input type="checkbox"/>	<input type="checkbox"/>	<input type="checkbox"/>	<input type="checkbox"/>	19.0#
		42 x 12"	PSA4212	<input type="checkbox"/>	<input type="checkbox"/>	<input type="checkbox"/>	<input type="checkbox"/>	<input type="checkbox"/>	<input type="checkbox"/>	22.0#
		48 x 12"	PSA4812	<input type="checkbox"/>	<input type="checkbox"/>	<input type="checkbox"/>	<input type="checkbox"/>	<input type="checkbox"/>	<input type="checkbox"/>	25.0#
		54 x 12"	PSA5412	<input type="checkbox"/>	<input type="checkbox"/>	<input type="checkbox"/>	<input type="checkbox"/>	<input type="checkbox"/>	<input type="checkbox"/>	28.0#
	60 x 12"	PSA6012	<input type="checkbox"/>	<input type="checkbox"/>	<input type="checkbox"/>	<input type="checkbox"/>	<input type="checkbox"/>	<input type="checkbox"/>	31.0#	
PSA	<b>Stackable Fabric Section - 18"H</b>	12 x 18"	PSA1218		R0	R20	<input type="checkbox"/>	<input type="checkbox"/>	9.0#	
		18 x 18"	PSA1818		R0	R20	<input type="checkbox"/>	<input type="checkbox"/>	12.0#	
		24 x 18"	PSA2418		R0	R20	<input type="checkbox"/>	<input type="checkbox"/>	16.0#	
		30 x 18"	PSA3018		R0	R20	<input type="checkbox"/>	<input type="checkbox"/>	19.0#	
		36 x 18"	PSA3618		R0	R20	<input type="checkbox"/>	<input type="checkbox"/>	22.0#	
		42 x 18"	PSA4218		R0	R20	<input type="checkbox"/>	<input type="checkbox"/>	25.0#	
		48 x 18"	PSA4818		R0	R20	<input type="checkbox"/>	<input type="checkbox"/>	28.0#	
		54 x 18"	PSA5418		R0	R20	<input type="checkbox"/>	<input type="checkbox"/>	31.0#	
	60 x 18"	PSA6018		R0	R20	<input type="checkbox"/>	<input type="checkbox"/>	35.0#		
PSA	<b>Stackable Fabric Section - 24"H</b>	12 x 24"	PSA1224		R0	R20	<input type="checkbox"/>	<input type="checkbox"/>	11.0#	
		18 x 24"	PSA1824		R0	R20	<input type="checkbox"/>	<input type="checkbox"/>	14.0#	
		24 x 24"	PSA2424		R0	R20	<input type="checkbox"/>	<input type="checkbox"/>	18.0#	
		30 x 24"	PSA3024		R0	R20	<input type="checkbox"/>	<input type="checkbox"/>	21.0#	
		36 x 24"	PSA3624		R0	R20	<input type="checkbox"/>	<input type="checkbox"/>	25.0#	
		42 x 24"	PSA4224		R0	R20	<input type="checkbox"/>	<input type="checkbox"/>	28.0#	
		48 x 24"	PSA4824		R0	R20	<input type="checkbox"/>	<input type="checkbox"/>	32.0#	
		54 x 24"	PSA5424		R0	R20	<input type="checkbox"/>	<input type="checkbox"/>	35.0#	
	60 x 24"	PSA6024		R0	R20	<input type="checkbox"/>	<input type="checkbox"/>	39.0#		

A

B

C

D

E

F

## HOW TO ORDER

Indicate the following information on order form:

- Quantity of each item.
- Model number, including options. See "How To Build a Model Number".
- Any special service required.

Note: • The  indicates that a choice is required.

- The absence of the  indicates that no choice is required.
- Alpha-numeric characters in place of  indicate that no other alternatives are available.

## HOW TO BUILD A MODEL NUMBER

- A** Select basic model.
- B** Select electrical code for base raceway.  
**CP** - Chicago, 2 sides w/cutouts  
**D** - Domestic, 2 sides w/cutouts
- C** Select numbers of raceway tiles side 1  
**R0** - Side 1 w/no raceway tile  
**R1** - Side 1 w/1-12" raceway tile; add \$32
- D** Select numbers of raceway tiles side 2  
**R20** - Side 2 w/no raceway tile  
**R21** - Side 2 w/1-12" raceway tile; add \$32
- E** Select fabric side 1.  
 Refer to color addendum at ki.com or in KI Fabrics & Finishes binder.
- F** Select fabric side 2.  
 Refer to color addendum at ki.com or in KI Fabrics & Finishes binder.

## UPHOLSTERY INFORMATION

### Fabric Mixing

If fabric is ordered from one group on side 1 and another group on side 2, calculate list price using the following method:

Example:  
 Grade 2 Fabric  
 -Grade1 Fabric

Upcharge

Upcharge/2 = Cost for one side

Grade 1 Fabric  
 +Cost for one side

Combined list price

### Fabric Disclaimer

Fabric will be applied as swatched by the fabric manufacturer. Fabric that is required to be applied differently than is swatched will need a Special Cost Request written specify-



## Fabric Stackable Section - Acoustic (3/4" Tiles)

Delivered Pricing Fabric Grade 1 & C.O.M.	Delivered Pricing Fabric Grade 2	Delivered Pricing Fabric Grade 3 & Pallas Vertical Fabric Grade PV	Delivered Pricing Pallas Vertical Fabric Grade PV1	Delivered Pricing Pallas Vertical Fabric Grade PV2
\$ 153	\$ 164	\$ 173	\$ 184	\$ 207
168	174	190	201	219
178	190	208	214	235
192	204	219	228	253
227	236	260	272	298
238	252	275	288	316
254	268	290	306	339
272	288	313	324	362
307	321	353	365	402
\$ 167	\$ 173	\$ 187	\$ 199	\$ 218
183	194	212	219	239
192	204	219	228	253
232	245	264	277	306
252	264	288	300	330
272	288	313	324	362
286	302	325	344	379
327	343	378	391	430
344	363	396	414	451
\$ 174	\$ 183	\$ 204	\$ 210	\$ 231
198	208	228	235	261
226	235	259	271	296
238	252	275	288	316
262	275	300	313	348
286	302	325	344	379
319	335	367	381	419
344	363	396	414	451
359	379	414	433	472

ing the direction the fabric is to be applied.  
The posted standard lead time will apply to  
the Special Cost Request.

### SPECIAL SERVICES

#### Special Carton Marking

With specially marked information N/C

#### Shipping

Delivered. Shipped **k.d. freight prepaid**  
**f.o.b. Manitowoc, Wisconsin 54220**  
factory. Freight class #70.

Specifications and prices are subject to  
change without prior notice.

# Glass Stackable Section

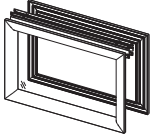
	MODEL	W x H	MODEL NUMBER			Approx. Packaged Weight
			Basic Model	Glass Color	Trim Color	
	<b>Stackable Glass Section - 12"H</b>	12 x 12"	PSG1212	<input type="checkbox"/> <input type="checkbox"/> <input type="checkbox"/>	<input type="checkbox"/>	7.0#
	• One horizontal rail	18 x 12"	PSG1812	<input type="checkbox"/> <input type="checkbox"/> <input type="checkbox"/>	<input type="checkbox"/>	11.0#
	• Two powder-coated aluminum window frames	24 x 12"	PSG2412	<input type="checkbox"/> <input type="checkbox"/> <input type="checkbox"/>	<input type="checkbox"/>	14.0#
	• One pane, 1/4" thick glass	30 x 12"	PSG3012	<input type="checkbox"/> <input type="checkbox"/> <input type="checkbox"/>	<input type="checkbox"/>	17.0#
	• Use top cap from existing lower panel	36 x 12"	PSG3612	<input type="checkbox"/> <input type="checkbox"/> <input type="checkbox"/>	<input type="checkbox"/>	20.0#
	• Order stackable vertical posts separately	42 x 12"	PSG4212	<input type="checkbox"/> <input type="checkbox"/> <input type="checkbox"/>	<input type="checkbox"/>	23.0#
		48 x 12"	PSG4812	<input type="checkbox"/> <input type="checkbox"/> <input type="checkbox"/>	<input type="checkbox"/>	26.0#
	PSG					
PSG	<b>Stackable Glass Section - 18"H</b>	12 x 18"	PSG1218	<input type="checkbox"/> <input type="checkbox"/> <input type="checkbox"/>	<input type="checkbox"/>	9.0#
		18 x 18"	PSG1818	<input type="checkbox"/> <input type="checkbox"/> <input type="checkbox"/>	<input type="checkbox"/>	13.0#
		24 x 18"	PSG2418	<input type="checkbox"/> <input type="checkbox"/> <input type="checkbox"/>	<input type="checkbox"/>	17.0#
		30 x 18"	PSG3018	<input type="checkbox"/> <input type="checkbox"/> <input type="checkbox"/>	<input type="checkbox"/>	21.0#
		36 x 18"	PSG3618	<input type="checkbox"/> <input type="checkbox"/> <input type="checkbox"/>	<input type="checkbox"/>	25.0#
		42 x 18"	PSG4218	<input type="checkbox"/> <input type="checkbox"/> <input type="checkbox"/>	<input type="checkbox"/>	29.0#
		48 x 18"	PSG4818	<input type="checkbox"/> <input type="checkbox"/> <input type="checkbox"/>	<input type="checkbox"/>	33.0#
	PSG					
PSG	<b>Stackable Glass Section - 24"H</b>	12 x 24"	PSG1224	<input type="checkbox"/> <input type="checkbox"/> <input type="checkbox"/>	<input type="checkbox"/>	14.0#
		18 x 24"	PSG1824	<input type="checkbox"/> <input type="checkbox"/> <input type="checkbox"/>	<input type="checkbox"/>	16.0#
		24 x 24"	PSG2424	<input type="checkbox"/> <input type="checkbox"/> <input type="checkbox"/>	<input type="checkbox"/>	22.0#
		30 x 24"	PSG3024	<input type="checkbox"/> <input type="checkbox"/> <input type="checkbox"/>	<input type="checkbox"/>	25.0#
		36 x 24"	PSG3624	<input type="checkbox"/> <input type="checkbox"/> <input type="checkbox"/>	<input type="checkbox"/>	30.0#
		42 x 24"	PSG4224	<input type="checkbox"/> <input type="checkbox"/> <input type="checkbox"/>	<input type="checkbox"/>	34.0#
		48 x 24"	PSG4824	<input type="checkbox"/> <input type="checkbox"/> <input type="checkbox"/>	<input type="checkbox"/>	39.0#
	PSG					

A

B

C

## HOW TO ORDER

Indicate the following information on order form:

- Quantity of each item.
- Model number, including options. See "How To Build a Model Number".
- Any special service required.

Note:

- The  indicates that a choice is required.
- The absence of the  indicates that no choice is required.
- Alpha-numeric characters in place of  indicate that no other alternatives are available.

## HOW TO BUILD A MODEL NUMBER

**A** Select basic model.

**B** Select glass color.

<b>GLA</b>	- Clear
<b>BRZ</b>	- Tinted/Bronze
<b>GLC</b>	- White Laminate

**C** Select trim color.

Refer to color addendum at [ki.com](http://ki.com) or KI Fabrics & Finishes binder.  
Metallic paint requires upcharge.



# Glass Stackable Section

Clear (C)	Tinted/Bronze (T)	White Laminate (W)	Metallic Paint add to list price
\$ 307	\$ 321	\$ 399	\$ 31
327	344	425	32
346	363	449	36
365	385	479	46
387	406	501	48
449	473	581	59
461	485	597	62
<hr/>			
\$ 323	\$ 342	\$ 423	\$ 31
352	367	453	32
367	387	481	36
393	411	511	46
436	456	567	48
484	507	628	59
493	522	642	62
<hr/>			
\$ 340	\$ 356	\$ 440	\$ 31
365	385	479	32
388	408	503	36
416	438	538	46
460	484	596	48
508	535	662	59
524	549	682	62

## SPECIAL SERVICES

### Special Carton Marking

With specially marked information N/C

### Shipping

Delivered. Shipped **k.d. freight prepaid f.o.b. Manitowoc, Wisconsin 54220** factory. Freight class #70.

Specifications and prices are subject to change without prior notice.

# Open Stackable Section

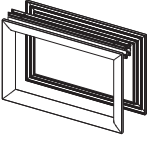
	MODEL	W x H	MODEL NUMBER		Approx. Packaged Weight
			Basic Model	Trim Color	
	<b>Stackable Open Section - 12"H</b>	12 x 12"	PS01212	<input type="checkbox"/>	4.0#
	• One horizontal rail	18 x 12"	PS01812	<input type="checkbox"/>	6.0#
	• Two aluminum frames	24 x 12"	PS02412	<input type="checkbox"/>	8.0#
	• Use top cap from existing lower panel	30 x 12"	PS03012	<input type="checkbox"/>	10.0#
	• Order stackable vertical posts separately	36 x 12"	PS03612	<input type="checkbox"/>	11.0#
		42 x 12"	PS04212	<input type="checkbox"/>	13.0#
		48 x 12"	PS04812	<input type="checkbox"/>	15.0#
PSO					
	<b>Stackable Open Section - 18"H</b>	12 x 18"	PS01218	<input type="checkbox"/>	5.0#
PSO		18 x 18"	PS01818	<input type="checkbox"/>	7.0#
		24 x 18"	PS02418	<input type="checkbox"/>	9.0#
		30 x 18"	PS03018	<input type="checkbox"/>	10.0#
		36 x 18"	PS03618	<input type="checkbox"/>	12.0#
		42 x 18"	PS04218	<input type="checkbox"/>	14.0#
		48 x 18"	PS04818	<input type="checkbox"/>	15.0#
	<b>Stackable Open Section - 24"H</b>	12 x 24"	PS01224	<input type="checkbox"/>	6.0#
PSO		18 x 24"	PS01824	<input type="checkbox"/>	7.0#
		24 x 24"	PS02424	<input type="checkbox"/>	9.0#
		30 x 24"	PS03024	<input type="checkbox"/>	11.0#
		36 x 24"	PS03624	<input type="checkbox"/>	13.0#
		42 x 24"	PS04224	<input type="checkbox"/>	14.0#
		48 x 24"	PS04824	<input type="checkbox"/>	16.0#

A

B

## HOW TO ORDER

Indicate the following information on order form:

- Quantity of each item.
- Model number, including options. See "How To Build a Model Number".
- Any special service required.

Note:

- The  indicates that a choice is required.
- The absence of the  indicates that no choice is required.
- Alpha-numeric characters in place of  indicate that no other alternatives are available.

## HOW TO BUILD A MODEL NUMBER

- A** Select basic model.
- B** Select trim color.  
Refer to color addendum at [ki.com](http://ki.com) or KI Fabrics & Finishes binder.  
Metallic paint requires upcharge





# Open Stackable Section

Delivered Pricing	Metallic Paint add to list price
\$ 260	\$ 31
277	32
290	36
310	46
346	48
390	59
396	62
<hr/>	
\$ 273	\$ 31
294	32
309	36
323	46
359	48
402	59
411	62
<hr/>	
\$ 283	\$ 31
306	32
318	36
337	46
369	48
417	59
424	62

## SPECIAL SERVICES

### Special Carton Marking

With specially marked information N/C

### Shipping

Delivered. Shipped **k.d. freight prepaid f.o.b. Manitowoc, Wisconsin 54220** factory. Freight class #70.

Specifications and prices are subject to change without prior notice.

# Doors

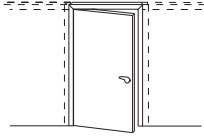
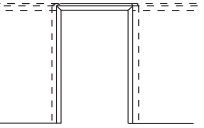
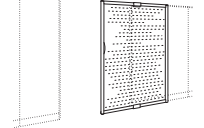
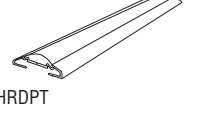
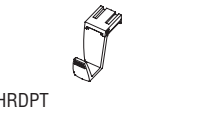
	MODEL	Panel Width	W x H	MODEL NUMBER			
				Basic Model	Trim Color	Surface Finish	Frame Color
 <p>Right shown</p> <p>PDR</p>	<b>Door</b> <ul style="list-style-type: none"> <li>Provides visual and acoustical privacy</li> <li>For use in conjunction with 84" panels</li> <li>Laminate surface on hollow core door</li> <li>Locking and non-locking options</li> <li>Lever handle to meet ADA guidelines</li> <li>Door hand swing is determined by standing on the side of door that swings toward the user when opening (handle to right is a right hand door)</li> <li>SX Starlight Silver finish is only offered on flat aluminum trim</li> </ul>	36" Right handed Locking	30 x 80"	PDRR36/L	<input type="checkbox"/>	<input type="checkbox"/>	
		36" Right handed Non-Locking	30 x 80"	PDRR36/N	<input type="checkbox"/>	<input type="checkbox"/>	
		36" Left handed Locking	30 x 80"	PDRL36/L	<input type="checkbox"/>	<input type="checkbox"/>	
		36" Left handed Non-Locking	30 x 80"	PDRL36/N	<input type="checkbox"/>	<input type="checkbox"/>	
		42" Right handed Locking	36 x 80"	PDRR42/L	<input type="checkbox"/>	<input type="checkbox"/>	
		42" Right handed Non-Locking	36 x 80"	PDRR42/N	<input type="checkbox"/>	<input type="checkbox"/>	
		42" Left handed Locking	36 x 80"	PDRL42/L	<input type="checkbox"/>	<input type="checkbox"/>	
		42" Left handed Non-Locking	36 x 80"	PDRL42/N	<input type="checkbox"/>	<input type="checkbox"/>	
 <p>PCOT</p>	<b>Door Pass-Through</b> <ul style="list-style-type: none"> <li>Trim</li> <li>SX Starlight Silver finish is only offered on flat aluminum trim</li> </ul>	36" x 84" H	30 x 80"	PCOT36	<input type="checkbox"/>		
		42" x 84" H	36 x 80"	PCOT42	<input type="checkbox"/>		
 <p>RSD</p>	<b>Door Sliding</b> <ul style="list-style-type: none"> <li>Will cover a 42" opening</li> <li>Designed to fit any panel 66" high &amp; over</li> <li>Aluminum frame w/clear poly insert</li> </ul>		48 x 66"	RSD4266FHC/CP/WW			<input type="checkbox"/>
 <p>HRDPT</p>	<b>Door Threshold</b> <ul style="list-style-type: none"> <li>Provides extra stability for attaching panels in a continuous run</li> <li>Available in door widths only</li> <li>Extruded aluminum door threshold with rubber seal strip</li> <li>Attaches to bottom of door frame</li> <li>SX Starlight Silver finish is only offered on flat aluminum trim</li> </ul>		36"	PDRT36	<input type="checkbox"/>		
			42"	PDRT42	<input type="checkbox"/>		
 <p>HRDPT</p>	<b>Coat Hooks/Picture Hanger</b> <ul style="list-style-type: none"> <li>Attaches under the top cap of the panel to support coat hangers</li> <li>Translucent plastic only</li> <li>Lock device holds hook securely to panel</li> <li>Can also be used to hang a picture (30# weight limit)</li> </ul>			PCH.CL			

A

B

C

D

## HOW TO ORDER

Indicate the following information on order form:

- Quantity of each item.
- Model number, including options. See "How To Build a Model Number".
- Any special service required.

Note: • The  indicates that a choice is required.

- The absence of the  indicates that no choice is required.
- Alpha-numeric characters in place of  indicate that no other alternatives are available.

## HOW TO BUILD A MODEL NUMBER

- A** Select basic model.
- B** Select trim color.  
Refer to color addendum at [ki.com](http://ki.com) or KI Fabrics & Finishes binder.  
Metallic paint requires upcharge.  
SX Starlight Silver finish is only offered on flat aluminum trim.
- C** Select surface finish.  
Refer to color addendum at [ki.com](http://ki.com) or KI Fabrics & Finishes binder.
- D** Select frame color.  
Refer to color addendum at [ki.com](http://ki.com) or KI Fabrics & Finishes binder.

## FINISH INFORMATION

### Additional Laminate Offering

Additional laminates beyond KI standard offering, are available with two weeks extended leadtime. To specify additional laminates, use these designators followed by the supplier's color/pattern code:

Formica - LF/supplier's color pattern code  
Nevamar - LN/supplier's color pattern code  
Wilsonart - LW/supplier's color pattern code

KI's standard finish is the supplier's recommended finish for that color/pattern.

Note: Nonstandard laminates from these suppliers (example: textured laminates), require an upcharge and additional leadtime. Contact KI.



## Doors

Approx. Packaged Weight	Delivered Pricing	Metallic Paint add to list price
40.0#	\$ 1683	\$ 46
40.0#	1486	46
40.0#	1683	46
40.0#	1486	46
40.0#	1820	62
40.0#	1623	62
40.0#	1820	62
40.0#	1623	62
1.0#	\$ 537	\$ 46
2.0#	541	62
24.0#	\$ 1003	N/A
1.0#	\$ 60	\$ 46
2.0#	61	62
1.0#	\$ 3	N/A

**SPECIAL SERVICES****Special Carton Marking**

With specially marked information N/C

**Shipping**

Delivered. Shipped k.d. freight prepaid  
f.o.b. Pembroke, Ontario K8A 0E1 factory.  
Freight class #70.

Specifications and prices are subject to  
change without prior notice.

# Preconfigured Intersection Conditions

90° 2-Way and End-of-Run

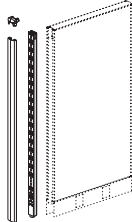
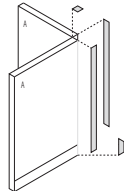
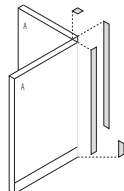
	MODEL	H	MODEL NUMBER				Approx. Packaged Weight	Delivered Pricing Unupholstered
			Basic Model	Trim Color	Fabric Color	Assembly		
 <p>PTN</p>	<b>End-of-Run Condition</b>	30"	PEP30	<input type="checkbox"/>			5.0#	\$ 79
	<ul style="list-style-type: none"> <li>• Unupholstered: trim colored</li> <li>• End-of-run trim</li> <li>• Top cap</li> <li>• Full-height post</li> <li>• SX Starlight Silver finish is only offered on flat aluminum trim</li> </ul>	36"	PEP36	<input type="checkbox"/>			5.0#	85
		42"	PEP42	<input type="checkbox"/>			7.0#	92
		48"	PEP48	<input type="checkbox"/>			7.0#	106
		54"	PEP54	<input type="checkbox"/>			9.0#	108
		60"	PEP60	<input type="checkbox"/>			9.0#	93
		66"	PEP66	<input type="checkbox"/>			11.0#	118
		72"	PEP72	<input type="checkbox"/>			11.0#	144
		78"	PEP78	<input type="checkbox"/>			11.0#	119
		84"	PEP84	<input type="checkbox"/>			13.0#	164
 <p>PTN</p>	<b>90° 2-Way "L" Corner, Both Panels Same Height</b>	30"	PCP9030	<input type="checkbox"/>		<input type="checkbox"/>	7.0#	\$ 168
	<ul style="list-style-type: none"> <li>• Unupholstered: trim colored</li> <li>• 90° top cap</li> <li>• 90° corner base trim</li> <li>• Two pieces of universal trim</li> <li>• Two half-posts</li> <li>• Connecting hardware</li> <li>• SX Starlight Silver finish is only offered on flat aluminum trim</li> </ul>	36"	PCP9036	<input type="checkbox"/>		<input type="checkbox"/>	7.0#	177
		42"	PCP9042	<input type="checkbox"/>		<input type="checkbox"/>	10.0#	206
		48"	PCP9048	<input type="checkbox"/>		<input type="checkbox"/>	10.0#	220
		54"	PCP9054	<input type="checkbox"/>		<input type="checkbox"/>	13.0#	245
		60"	PCP9060	<input type="checkbox"/>		<input type="checkbox"/>	13.0#	227
		66"	PCP9066	<input type="checkbox"/>		<input type="checkbox"/>	16.0#	252
		72"	PCP9072	<input type="checkbox"/>		<input type="checkbox"/>	16.0#	264
		78"	PCP9078	<input type="checkbox"/>		<input type="checkbox"/>	16.0#	277
		84"	PCP9084	<input type="checkbox"/>		<input type="checkbox"/>	20.0#	317
 <p>PTNF</p>	<b>90° 2-Way "L" Corner, Both Panels Same Height</b>	30"	PCPF9030	<input type="checkbox"/>	<input type="checkbox"/>	<input type="checkbox"/>	7.0#	N/A
	<ul style="list-style-type: none"> <li>• Upholstered</li> <li>• 90° top cap</li> <li>• 90° corner base trim</li> <li>• Two pieces of universal trim</li> <li>• Two half-posts</li> <li>• Connecting hardware</li> <li>• SX Starlight Silver finish is only offered on flat aluminum trim</li> </ul>	36"	PCPF9036	<input type="checkbox"/>	<input type="checkbox"/>	<input type="checkbox"/>	7.0#	N/A
		42"	PCPF9042	<input type="checkbox"/>	<input type="checkbox"/>	<input type="checkbox"/>	10.0#	N/A
		48"	PCPF9048	<input type="checkbox"/>	<input type="checkbox"/>	<input type="checkbox"/>	10.0#	N/A
		54"	PCPF9054	<input type="checkbox"/>	<input type="checkbox"/>	<input type="checkbox"/>	13.0#	N/A
		60"	PCPF9060	<input type="checkbox"/>	<input type="checkbox"/>	<input type="checkbox"/>	13.0#	N/A
		66"	PCPF9066	<input type="checkbox"/>	<input type="checkbox"/>	<input type="checkbox"/>	16.0#	N/A
		72"	PCPF9072	<input type="checkbox"/>	<input type="checkbox"/>	<input type="checkbox"/>	16.0#	N/A
		78"	PCPF9078	<input type="checkbox"/>	<input type="checkbox"/>	<input type="checkbox"/>	16.0#	N/A
		84"	PCPF9084	<input type="checkbox"/>	<input type="checkbox"/>	<input type="checkbox"/>	20.0#	N/A

A

B

C

D

## HOW TO ORDER

Indicate the following information on order form:

1. Quantity of each item.
2. Model number, including options. See "How To Build a Model Number".
3. Any special service required.

Note: • The  indicates that a choice is required.

- The absence of the  indicates that no choice is required.
- Alpha-numeric characters in place of  indicate that no other alternatives are available.

## HOW TO BUILD A MODEL NUMBER

**A** Select basic model.

**B** Select trim color.

Refer to color addendum at ki.com or KI Fabrics & Finishes binder.  
Metallic paint requires upcharge.  
SX Starlight Silver finish is only offered on flat aluminum trim.

**C** Select fabric color.

Refer to color addendum at ki.com or in KI Fabrics & Finishes binder.

**D** Select assembly.

**F** - Fully Assembled; add \$58  
**U** - Unassembled



# Preconfigured Intersection Conditions

90° 2-Way and End-of-Run

Delivered Pricing Fabric Grade 1 & C.O.M.	Delivered Pricing Fabric Grade 2	Delivered Pricing Fabric Grade 3 & Pallas Vertical Fabric Grade PV	Delivered Pricing Pallas Vertical Fabric Grade PV1	Delivered Pricing Pallas Vertical Fabric Grade PV2	Metallic Paint add to list price
					\$ 29
					30
					36
					36
					38
					39
					44
					46
					47
					48
					\$ 57
					59
					59
					79
					82
					83
					84
					88
					90
					91
\$ 228	\$ 233	\$ 234	\$ 237	\$ 248	\$ 32
235	238	241	248	256	32
294	299	302	309	316	32
307	312	314	318	330	32
333	339	342	348	357	32
303	309	311	317	323	32
341	347	350	357	366	32
357	364	367	378	386	32
359	366	368	379	388	32
416	423	426	437	448	32

**SPECIAL SERVICES**

**Special Carton Marking**

With specially marked information N/C

**Shipping**

Delivered. Shipped **k.d. freight prepaid f.o.b. Manitowoc, Wisconsin 54220** factory. Freight class #70.

Specifications and prices are subject to change without prior notice.

# Preconfigured Intersection Conditions

90° 2-Way

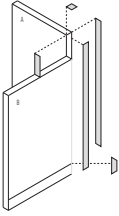
MODEL	A B A-B	MODEL NUMBER		Approx. Packaged Weight
		Basic Model	Trim Color	
 <p>PTN</p> <p><b>90° 2-Way "L" Corner, Two Different Heights</b></p> <ul style="list-style-type: none"> <li>• Unupholstered: trim colored</li> <li>• 1-way cap</li> <li>• 90° corner base trim</li> <li>• Two pieces of universal trim</li> <li>• One piece of universal height change trim</li> <li>• One half-post (height A)</li> <li>• One half-post (height B)</li> <li>• Connecting hardware</li> <li>• SX Starlight Silver finish is only offered on flat aluminum trim</li> </ul>	36" 30" 6"	PCPV903036	<input type="checkbox"/>	9.0#
	42" 30" 12"	PCPV903042	<input type="checkbox"/>	9.0#
	48" 30" 18"	PCPV903048	<input type="checkbox"/>	9.0#
	54" 30" 24"	PCPV903054	<input type="checkbox"/>	11.0#
	60" 30" 30"	PCPV903060	<input type="checkbox"/>	13.0#
	66" 30" 36"	PCPV903066	<input type="checkbox"/>	13.0#
	72" 30" 42"	PCPV903072	<input type="checkbox"/>	13.0#
	78" 30" 48"	PCPV903078	<input type="checkbox"/>	13.0#
	84" 30" 54"	PCPV903084	<input type="checkbox"/>	16.0#
	42" 36" 6"	PCPV903642	<input type="checkbox"/>	16.0#
	48" 36" 12"	PCPV903648	<input type="checkbox"/>	16.0#
	54" 36" 18"	PCPV903654	<input type="checkbox"/>	16.0#
	60" 36" 24"	PCPV903660	<input type="checkbox"/>	16.0#
	66" 36" 30"	PCPV903666	<input type="checkbox"/>	16.0#
	72" 36" 36"	PCPV903672	<input type="checkbox"/>	16.0#
	78" 36" 42"	PCPV903678	<input type="checkbox"/>	16.0#
	84" 36" 48"	PCPV903684	<input type="checkbox"/>	16.0#
	48" 42" 6"	PCPV904248	<input type="checkbox"/>	12.0#
	54" 42" 12"	PCPV904254	<input type="checkbox"/>	12.0#
	60" 42" 18"	PCPV904260	<input type="checkbox"/>	14.0#
	66" 42" 24"	PCPV904266	<input type="checkbox"/>	14.0#
	72" 42" 30"	PCPV904272	<input type="checkbox"/>	14.0#
	78" 42" 36"	PCPV904278	<input type="checkbox"/>	14.0#
	84" 42" 42"	PCPV904284	<input type="checkbox"/>	17.0#
	54" 48" 6"	PCPV904854	<input type="checkbox"/>	17.0#
	60" 48" 12"	PCPV904860	<input type="checkbox"/>	17.0#
	66" 48" 18"	PCPV904866	<input type="checkbox"/>	17.0#
	72" 48" 24"	PCPV904872	<input type="checkbox"/>	17.0#
	78" 48" 30"	PCPV904878	<input type="checkbox"/>	17.0#
	84" 48" 36"	PCPV904884	<input type="checkbox"/>	17.0#

A

B

## HOW TO ORDER

Indicate the following information on order form:

1. Quantity of each item.
2. Model number, including options. See "How To Build a Model Number".
3. Any special service required.

Note: • The  indicates that a choice is required.

- The absence of the  indicates that no choice is required.
- Alpha-numeric characters in place of  indicate that no other alternatives are available.

## HOW TO BUILD A MODEL NUMBER

**A** Select basic model.

**B** Select trim color.

Refer to color addendum at [ki.com](http://ki.com) or KI Fabrics & Finishes binder. Metallic paint requires upcharge. SX Starlight Silver finish is only offered on flat aluminum trim.



# Preconfigured Intersection Conditions

90° 2-Way

Delivered Pricing	Metallic Paint add to list price
\$ 211	\$ 73
226	74
262	93
286	95
290	98
296	98
329	113
352	114
374	116
226	73
235	93
286	95
290	98
295	98
309	100
342	109
378	116
250	92
272	95
294	96
313	97
337	100
358	109
381	115
276	94
294	96
310	97
319	99
342	100
363	104

## SPECIAL SERVICES

### Special Carton Marking

With specially marked information N/C

### Shipping

Delivered. Shipped **k.d. freight prepaid f.o.b. Manitowoc, Wisconsin 54220** factory. Freight class #70.

Specifications and prices are subject to change without prior notice.

# Preconfigured Intersection Conditions

90° 2-Way

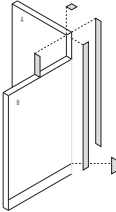
	MODEL	A	B	A-B	MODEL NUMBER		Approx. Packaged Weight
					Basic Model	Trim Color	
 <p>PTN</p> <p><b>90° 2-Way "L" Corner, Two Different Heights</b></p> <ul style="list-style-type: none"> <li>• Upholstered: trim colored</li> <li>• 1-way cap</li> <li>• 90° corner base trim</li> <li>• Two pieces of universal trim</li> <li>• One piece of universal height change trim</li> <li>• One half-post (height A)</li> <li>• One half-post (height B)</li> <li>• Connecting hardware</li> <li>• SX Starlight Silver finish is only offered on flat aluminum trim</li> </ul>	60" 54" 6"	PCPV905460	<input type="checkbox"/>	<input type="checkbox"/>	15.0#		
	66" 54" 12"	PCPV905466	<input type="checkbox"/>	<input type="checkbox"/>	15.0#		
	72" 54" 18"	PCPV905472	<input type="checkbox"/>	<input type="checkbox"/>	15.0#		
	78" 54" 24"	PCPV905478	<input type="checkbox"/>	<input type="checkbox"/>	15.0#		
	84" 54" 30"	PCPV905484	<input type="checkbox"/>	<input type="checkbox"/>	18.0#		
	66" 60" 6"	PCPV906066	<input type="checkbox"/>	<input type="checkbox"/>	18.0#		
	72" 60" 12"	PCPV906072	<input type="checkbox"/>	<input type="checkbox"/>	18.0#		
	78" 60" 18"	PCPV906078	<input type="checkbox"/>	<input type="checkbox"/>	18.0#		
	84" 60" 24"	PCPV906084	<input type="checkbox"/>	<input type="checkbox"/>	18.0#		
	72" 66" 6"	PCPV906672	<input type="checkbox"/>	<input type="checkbox"/>	18.0#		
	78" 66" 12"	PCPV906678	<input type="checkbox"/>	<input type="checkbox"/>	18.0#		
	84" 66" 18"	PCPV906684	<input type="checkbox"/>	<input type="checkbox"/>	19.0#		
	78" 72" 12"	PCPV907278	<input type="checkbox"/>	<input type="checkbox"/>	19.0#		
	84" 72" 12"	PCPV907284	<input type="checkbox"/>	<input type="checkbox"/>	19.0#		
	84" 78" 6"	PCPV907884	<input type="checkbox"/>	<input type="checkbox"/>	19.0#		

A

B

## HOW TO ORDER

Indicate the following information on order form:

1. Quantity of each item.
2. Model number, including options. See "How To Build a Model Number".
3. Any special service required.

Note: • The  indicates that a choice is required.

- The absence of the  indicates that no choice is required.
- Alpha-numeric characters in place of  indicate that no other alternatives are available.

## HOW TO BUILD A MODEL NUMBER

**A** Select basic model.

**B** Select trim color.

Refer to color addendum at [ki.com](http://ki.com) or KI Fabrics & Finishes binder. Metallic paint requires upcharge. SX Starlight Silver finish is only offered on flat aluminum trim.





# Preconfigured Intersection Conditions

90° 2-Way

Delivered Pricing	Metallic Paint add to list price
\$ 276	\$ 97
283	97
319	99
341	100
362	104
256	98
272	100
307	104
327	108
329	104
283	108
346	111
306	112
355	113
323	115

## SPECIAL SERVICES

### Special Carton Marking

With specially marked information N/C

### Shipping

Delivered. Shipped **k.d. freight prepaid f.o.b. Manitowoc, Wisconsin 54220** factory. Freight class #70.

Specifications and prices are subject to change without prior notice.

# Preconfigured Intersection Conditions

90° 2-Way

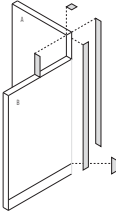
MODEL	A B A-B	MODEL NUMBER			Approx. Packaged Weight
		Basic Model	Trim Color	Fabric Color	
 <p>PTNF</p> <p><b>90° 2-Way "L" Corner, Two Different Heights</b></p> <ul style="list-style-type: none"> <li>• Upholstered</li> <li>• 1-way cap</li> <li>• 90° corner base trim</li> <li>• Two fabric-wrapped pieces of universal trim</li> <li>• One fabric-wrapped piece of universal height change trim</li> <li>• One half-post (height A)</li> <li>• One half-post (height B)</li> <li>• Connecting hardware</li> <li>• SX Starlight Silver finish is only offered on flat aluminum trim</li> </ul>	36" 30" 6"	PCPVF903036	<input type="checkbox"/>	<input type="checkbox"/>	9.0#
	42" 30" 12"	PCPVF903042	<input type="checkbox"/>	<input type="checkbox"/>	9.0#
	48" 30" 18"	PCPVF903048	<input type="checkbox"/>	<input type="checkbox"/>	9.0#
	54" 30" 24"	PCPVF903054	<input type="checkbox"/>	<input type="checkbox"/>	11.0#
	60" 30" 30"	PCPVF903060	<input type="checkbox"/>	<input type="checkbox"/>	11.0#
	66" 30" 36"	PCPVF903066	<input type="checkbox"/>	<input type="checkbox"/>	13.0#
	72" 30" 42"	PCPVF903072	<input type="checkbox"/>	<input type="checkbox"/>	13.0#
	78" 30" 48"	PCPVF903078	<input type="checkbox"/>	<input type="checkbox"/>	13.0#
	84" 30" 54"	PCPVF903084	<input type="checkbox"/>	<input type="checkbox"/>	16.0#
	42" 36" 6"	PCPVF903642	<input type="checkbox"/>	<input type="checkbox"/>	16.0#
	48" 36" 12"	PCPVF903648	<input type="checkbox"/>	<input type="checkbox"/>	16.0#
	54" 36" 18"	PCPVF903654	<input type="checkbox"/>	<input type="checkbox"/>	16.0#
	60" 36" 24"	PCPVF903660	<input type="checkbox"/>	<input type="checkbox"/>	16.0#
	66" 36" 30"	PCPVF903666	<input type="checkbox"/>	<input type="checkbox"/>	16.0#
	72" 36" 36"	PCPVF903672	<input type="checkbox"/>	<input type="checkbox"/>	16.0#
	78" 36" 42"	PCPVF903678	<input type="checkbox"/>	<input type="checkbox"/>	16.0#
	84" 36" 48"	PCPVF903684	<input type="checkbox"/>	<input type="checkbox"/>	16.0#
	48" 42" 6"	PCPVF904248	<input type="checkbox"/>	<input type="checkbox"/>	16.0#
	54" 42" 12"	PCPVF904254	<input type="checkbox"/>	<input type="checkbox"/>	12.0#
	60" 42" 18"	PCPVF904260	<input type="checkbox"/>	<input type="checkbox"/>	12.0#
	66" 42" 24"	PCPVF904266	<input type="checkbox"/>	<input type="checkbox"/>	14.0#
	72" 42" 30"	PCPVF904272	<input type="checkbox"/>	<input type="checkbox"/>	14.0#
	78" 42" 36"	PCPVF904278	<input type="checkbox"/>	<input type="checkbox"/>	14.0#
	84" 42" 42"	PCPVF904284	<input type="checkbox"/>	<input type="checkbox"/>	17.0#
	54" 48" 6"	PCPVF904854	<input type="checkbox"/>	<input type="checkbox"/>	17.0#
	60" 48" 12"	PCPVF904860	<input type="checkbox"/>	<input type="checkbox"/>	17.0#
	66" 48" 18"	PCPVF904866	<input type="checkbox"/>	<input type="checkbox"/>	17.0#
	72" 48" 24"	PCPVF904872	<input type="checkbox"/>	<input type="checkbox"/>	17.0#
	78" 48" 30"	PCPVF904878	<input type="checkbox"/>	<input type="checkbox"/>	17.0#
	84" 48" 36"	PCPVF904884	<input type="checkbox"/>	<input type="checkbox"/>	17.0#

A

B

C

## HOW TO ORDER

Indicate the following information on order form:

1. Quantity of each item.
2. Model number, including options. See "How To Build a Model Number".
3. Any special service required.

Note: • The  indicates that a choice is required.

- The absence of the  indicates that no choice is required.
- Alpha-numeric characters in place of  indicate that no other alternatives are available.

## HOW TO BUILD A MODEL NUMBER

- A** Select basic model.
- B** Select trim color.  
Refer to color addendum at [ki.com](http://ki.com) or KI Fabrics & Finishes binder.  
Metallic paint requires upcharge.  
SX Starlight Silver finish is only offered on flat aluminum trim.
- C** Select fabric color.  
Refer to color addendum at [ki.com](http://ki.com) or in KI Fabrics & Finishes binder.



# Preconfigured Intersection Conditions

90° 2-Way

Delivered Pricing Fabric Grade 1 & C.O.M.	Delivered Pricing Fabric Grade 2	Delivered Pricing Fabric Grade 3 & Pallas Vertical Fabric Grade PV	Delivered Pricing Pallas Vertical Fabric Grade PV1	Delivered Pricing Pallas Vertical Fabric Grade PV2	Metallic Paint add to list price
\$ 312	\$ 317	\$ 319	\$ 324	\$ 337	\$ 32
355	362	364	373	384	32
388	396	399	408	420	32
416	424	428	437	448	32
358	365	367	378	387	32
432	440	444	452	467	32
467	475	482	488	501	32
431	438	443	451	467	32
519	528	533	543	559	32
357	364	366	376	386	32
362	368	373	381	391	32
414	423	426	437	446	32
358	365	367	378	387	32
430	438	441	450	462	32
443	451	456	467	480	32
424	432	438	445	460	32
521	529	536	544	560	32
378	384	387	396	406	32
398	403	409	419	430	32
378	384	386	394	406	32
449	456	461	471	485	32
474	484	488	495	510	32
424	432	438	445	460	32
524	533	539	549	567	32
406	414	417	426	439	32
356	363	365	373	385	32
441	450	454	464	479	32
454	464	471	481	491	32
423	431	437	444	454	32
506	516	523	531	546	32

## SPECIAL SERVICES

### Special Carton Marking

With specially marked information N/C

### Shipping

Delivered. Shipped **k.d. freight prepaid**  
**f.o.b. Manitowoc, Wisconsin 54220**  
factory. Freight class #70.

Specifications and prices are subject to  
change without prior notice.

# Preconfigured Intersection Conditions

90° 2-Way

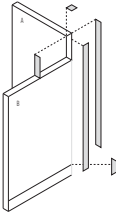
MODEL	A B A-B	MODEL NUMBER			Approx. Packaged Weight
		Basic Model	Trim Color	Fabric Color	
 <p>PTNF</p> <p><b>90° 2-Way "L" Corner, Two Different Heights</b></p> <ul style="list-style-type: none"> <li>• Upholstered</li> <li>• 1-way cap</li> <li>• 90° corner base trim</li> <li>• Two fabric-wrapped pieces of universal trim</li> <li>• One fabric-wrapped piece of universal height change trim</li> <li>• One half-post (height A)</li> <li>• One half-post (height B)</li> <li>• Connecting hardware</li> <li>• SX Starlight Silver finish is only offered on flat aluminum trim</li> </ul>	60" 54" 6"	PCPVF905460	<input type="checkbox"/>	<input type="checkbox"/>	15.0#
	66" 54" 12"	PCPVF905466	<input type="checkbox"/>	<input type="checkbox"/>	15.0#
	72" 54" 18"	PCPVF905472	<input type="checkbox"/>	<input type="checkbox"/>	15.0#
	78" 54" 24"	PCPVF905478	<input type="checkbox"/>	<input type="checkbox"/>	15.0#
	84" 54" 30"	PCPVF905484	<input type="checkbox"/>	<input type="checkbox"/>	18.0#
	66" 60" 36"	PCPVF906066	<input type="checkbox"/>	<input type="checkbox"/>	18.0#
	72" 60" 12"	PCPVF906072	<input type="checkbox"/>	<input type="checkbox"/>	18.0#
	78" 60" 18"	PCPVF906078	<input type="checkbox"/>	<input type="checkbox"/>	18.0#
	84" 60" 24"	PCPVF906084	<input type="checkbox"/>	<input type="checkbox"/>	18.0#
	72" 66" 6"	PCPVF906672	<input type="checkbox"/>	<input type="checkbox"/>	19.0#
	78" 66" 12"	PCPVF906678	<input type="checkbox"/>	<input type="checkbox"/>	19.0#
	84" 66" 18"	PCPVF906684	<input type="checkbox"/>	<input type="checkbox"/>	19.0#
	78" 72" 6"	PCPVF907278	<input type="checkbox"/>	<input type="checkbox"/>	19.0#
	84" 72" 12"	PCPVF907284	<input type="checkbox"/>	<input type="checkbox"/>	19.0#
	84" 78" 6"	PCPVF907884	<input type="checkbox"/>	<input type="checkbox"/>	19.0#

A

B

C

## HOW TO ORDER

Indicate the following information on order form:

1. Quantity of each item.
2. Model number, including options. See "How To Build a Model Number".
3. Any special service required.

Note:

- The  indicates that a choice is required.
- The absence of the  indicates that no choice is required.
- Alpha-numeric characters in place of  indicate that no other alternatives are available.

## HOW TO BUILD A MODEL NUMBER

- A** Select basic model.
- B** Select trim color.  
Refer to color addendum at [ki.com](http://ki.com) or KI Fabrics & Finishes binder.  
Metallic paint requires upcharge.  
SX Starlight Silver finish is only offered on flat aluminum trim.
- C** Select fabric color.  
Refer to color addendum at [ki.com](http://ki.com) or in KI Fabrics & Finishes binder.



# Preconfigured Intersection Conditions

90° 2-Way

Delivered Pricing Fabric Grade 1 & C.O.M.	Delivered Pricing Fabric Grade 2	Delivered Pricing Fabric Grade 3 & Pallas Vertical Fabric Grade PV	Delivered Pricing Pallas Vertical Fabric Grade PV1	Delivered Pricing Pallas Vertical Fabric Grade PV2	Metallic Paint add to list price
\$ 356	\$ 363	\$ 365	\$ 373	\$ 385	\$ 32
416	423	426	437	448	32
453	464	470	480	490	32
422	430	436	443	453	32
501	511	519	528	543	32
359	366	368	379	388	32
382	388	391	399	411	32
420	428	433	441	451	32
441	449	453	464	479	32
428	437	440	449	461	32
397	403	410	419	430	32
451	461	469	480	491	32
419	425	432	440	450	32
479	485	490	499	512	32
438	445	449	460	473	32

## SPECIAL SERVICES

### Special Carton Marking

With specially marked information N/C

### Shipping

Delivered. Shipped **k.d. freight prepaid f.o.b. Manitowoc, Wisconsin 54220** factory. Freight class #70.

Specifications and prices are subject to change without prior notice.

# Preconfigured Intersection Conditions

## Off-Module Post

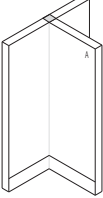
	MODEL	H	MODEL NUMBER		Approx. Packaged Weight
			Basic Model	Trim Color	
	<b>Off-Module Post</b>	30"	POMP30	<input type="checkbox"/>	3.0#
	<ul style="list-style-type: none"> <li>• Unupholstered: trim colored</li> <li>• Off-module top trim end cap</li> <li>• Off-module half-post</li> <li>• See specifications for applications</li> <li>• SX Starlight Silver finish is only offered on flat aluminum trim</li> </ul>	36"	POMP36	<input type="checkbox"/>	3.0#
		42"	POMP42	<input type="checkbox"/>	4.0#
		48"	POMP48	<input type="checkbox"/>	4.0#
		54"	POMP54	<input type="checkbox"/>	5.0#
		60"	POMP60	<input type="checkbox"/>	5.0#
		66"	POMP66	<input type="checkbox"/>	6.0#
		72"	POMP72	<input type="checkbox"/>	6.0#
		78"	POMP78	<input type="checkbox"/>	6.0#
		84"	POMP84	<input type="checkbox"/>	7.0#
PTN					
HRDPT	<b>Off-Module Post</b>	30"	POMPS.30	<input type="checkbox"/>	4.0#
	<ul style="list-style-type: none"> <li>• Off module post allows removal of tiles from spine way</li> <li>• Post is offset from spine 3/4"</li> <li>• Unupholstered: trim colored</li> <li>• Includes top cap and halfpost</li> <li>• See specifications for applications</li> <li>• SX Starlight Silver finish is only offered on flat aluminum trim</li> </ul>	36"	POMPS.36	<input type="checkbox"/>	5.0#
		42"	POMPS.42	<input type="checkbox"/>	6.0#
		48"	POMPS.48	<input type="checkbox"/>	7.0#
		54"	POMPS.54	<input type="checkbox"/>	8.0#
		60"	POMPS.60	<input type="checkbox"/>	9.0#
		66"	POMPS.66	<input type="checkbox"/>	10.0#
		72"	POMPS.72	<input type="checkbox"/>	11.0#
		78"	POMPS.78	<input type="checkbox"/>	12.0#
		84"	POMPS.84	<input type="checkbox"/>	13.0#

A

B

### HOW TO ORDER

Indicate the following information on order form:

1. Quantity of each item.
2. Model number, including options. See "How To Build a Model Number".
3. Any special service required.

Note: • The  indicates that a choice is required.

- The absence of the  indicates that no choice is required.
- Alpha-numeric characters in place of  indicate that no other alternatives are available.

### HOW TO BUILD A MODEL NUMBER

**A** Select basic model.

**B** Select trim color.

Refer to color addendum at [ki.com](http://ki.com) or KI Fabrics & Finishes binder. Metallic paint requires upcharge. SX Starlight Silver finish is only offered on flat aluminum trim.



# Preconfigured Intersection Conditions

Off-Module Post

Delivered Pricing	Metallic Paint add to list price
\$ 215	\$ 9
218	9
224	9
231	9
233	9
254	9
237	9
240	9
261	9
250	9
\$ 333	N/A
343	N/A
352	N/A
367	N/A
378	N/A
384	N/A
406	N/A
420	N/A
430	N/A
441	N/A

## SPECIAL SERVICES

### Special Carton Marking

With specially marked information N/C

### Shipping

Delivered. Shipped **k.d. freight prepaid f.o.b. Manitowoc, Wisconsin 54220** factory. Freight class #70.

Specifications and prices are subject to change without prior notice.

# Preconfigured Intersection Conditions

Adjustable Wall Mount

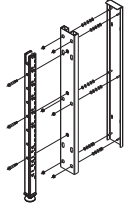
	MODEL	W x H x D	MODEL NUMBER		Approx. Packaged Weight
			Basic Model	Trim Color	
 <p>HRDPT</p>	<b>Wall Track</b>	2 1/2 x 31 x 1"	PWT30	<input type="checkbox"/>	2.0#
	<ul style="list-style-type: none"> <li>• Double slotted track accommodates wall mounting of overhead components and worksurfaces</li> <li>• Steel construction with painted finish</li> <li>• No hardware for wall attachment is included</li> <li>• See installation guidelines</li> <li>• SX Starlight Silver finish is only offered on flat aluminum trim</li> </ul>	2 1/2 x 37 x 1"	PWT36	<input type="checkbox"/>	2.0#
		2 1/2 x 43 x 1"	PWT42	<input type="checkbox"/>	3.0#
		2 1/2 x 49 x 1"	PWT48	<input type="checkbox"/>	3.0#
		2 1/2 x 55 x 1"	PWT54	<input type="checkbox"/>	3.0#
		2 1/2 x 61 x 1"	PWT60	<input type="checkbox"/>	4.0#
		2 1/2 x 67 x 1"	PWT66	<input type="checkbox"/>	4.0#
		2 1/2 x 73 x 1"	PWT72	<input type="checkbox"/>	4.0#
		2 1/2 x 79 x 1"	PWT78	<input type="checkbox"/>	5.0#
		2 1/2 x 85 x 1"	PWT84	<input type="checkbox"/>	5.0#
 <p>HRDPT</p>	<b>Adjustable Wall Mount</b>	2 1/2 x 30 x 1"	PWM30	<input type="checkbox"/>	11.0#
	<ul style="list-style-type: none"> <li>• Attaches a panel to a wall at the start of a run</li> <li>• Includes mounting plate and half-post</li> <li>• Steel construction with painted finish</li> <li>• Hardware for wall attachment is not included</li> <li>• Adjustable up to 3/4" to correct wall deflection</li> <li>• SX Starlight Silver finish is only offered on flat aluminum trim</li> </ul>	2 1/2 x 36 x 1"	PWM36	<input type="checkbox"/>	13.0#
		2 1/2 x 42 x 1"	PWM42	<input type="checkbox"/>	15.0#
		2 1/2 x 48 x 1"	PWM48	<input type="checkbox"/>	17.0#
		2 1/2 x 54 x 1"	PWM54	<input type="checkbox"/>	19.0#
		2 1/2 x 60 x 1"	PWM60	<input type="checkbox"/>	23.0#
		2 1/2 x 66 x 1"	PWM66	<input type="checkbox"/>	23.0#
		2 1/2 x 72 x 1"	PWM72	<input type="checkbox"/>	25.0#
		2 1/2 x 78 x 1"	PWM78	<input type="checkbox"/>	23.0#
2 1/2 x 84 x 1"	PWM84	<input type="checkbox"/>	30.0#		

**A**

**B**

## HOW TO ORDER

Indicate the following information on order form:

1. Quantity of each item.
2. Model number, including options. See "How To Build a Model Number".
3. Any special service required.

Note: • The  indicates that a choice is required.

- The absence of the  indicates that no choice is required.
- Alpha-numeric characters in place of  indicate that no other alternatives are available.

## HOW TO BUILD A MODEL NUMBER

**A** Select basic model.

**B** Select trim color.

Refer to color addendum at [ki.com](http://ki.com) or KI Fabrics & Finishes binder. Metallic paint requires upcharge. SX Starlight Silver finish is only offered on flat aluminum trim.





# Preconfigured Intersection Conditions

Adjustable Wall Mount

Delivered Pricing	Metallic Paint add to list price
\$ 33	\$ 12
35	12
36	16
37	20
39	25
41	28
46	30
47	31
48	32
49	32
\$ 144	\$ 31
148	31
164	48
168	50
171	50
220	54
220	56
252	58
258	60
269	62

## SPECIAL SERVICES

### Special Carton Marking

With specially marked information N/C

### Shipping

Delivered. Shipped **k.d. freight prepaid f.o.b. Manitowoc, Wisconsin 54220** factory. Freight class #70.

Specifications and prices are subject to change without prior notice.

# Preconfigured Intersection Conditions

180° 2-Way

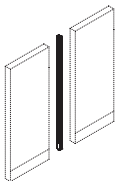
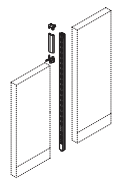
	MODEL	A	B	A-B	MODEL NUMBER		Approx. Packaged Weight
					Basic Model	Trim Color	
	<b>180° 2-Way In-Line Connection, Both Panels Same Height</b> • Unupholstered • Full-height post	30"			PFP30		4.0#
		36"			PFP36		5.0#
		42"			PFP42		5.0#
		48"			PFP48		6.0#
		54"			PFP54		6.0#
		66"			PFP66		7.0#
		72"			PFP72		8.0#
		84"			PFP84		9.0#
	<b>180° 2-Way In-Line Connection, Two Different Heights</b> • Unupholstered: trim colored • Full height post • In-line height change trim • In-line height change bottom cap • End-of-run top cap • SX Starlight Silver finish is only offered on flat aluminum trim	36" 30" 6"			PFPV3036	<input type="checkbox"/>	4.0#
		42" 30" 12"			PFPV3042	<input type="checkbox"/>	6.0#
		48" 30" 18"			PFPV3048	<input type="checkbox"/>	6.0#
		54" 30" 24"			PFPV3054	<input type="checkbox"/>	7.0#
		66" 30" 36"			PFPV3066	<input type="checkbox"/>	8.0#
		72" 30" 42"			PFPV3072	<input type="checkbox"/>	10.0#
		84" 30" 54"			PFPV3084	<input type="checkbox"/>	11.0#
		42" 36" 6"			PFPV3642	<input type="checkbox"/>	5.0#
		48" 36" 12"			PFPV3648	<input type="checkbox"/>	6.0#
		54" 36" 18"			PFPV3654	<input type="checkbox"/>	7.0#
		66" 36" 30"			PFPV3666	<input type="checkbox"/>	8.0#
		72" 36" 36"			PFPV3672	<input type="checkbox"/>	9.0#
		84" 36" 48"			PFPV3684	<input type="checkbox"/>	11.0#
		48" 42" 6"			PFPV4248	<input type="checkbox"/>	6.0#
		54" 42" 12"			PFPV4254	<input type="checkbox"/>	7.0#
		66" 42" 24"			PFPV4266	<input type="checkbox"/>	8.0#
		72" 42" 30"			PFPV4272	<input type="checkbox"/>	9.0#
		84" 42" 42"			PFPV4284	<input type="checkbox"/>	11.0#
		54" 48" 6"			PFPV4854	<input type="checkbox"/>	6.0#
		66" 48" 18"			PFPV4866	<input type="checkbox"/>	8.0#
		72" 48" 24"			PFPV4872	<input type="checkbox"/>	9.0#
		84" 48" 36"			PFPV4884	<input type="checkbox"/>	11.0#
		66" 54" 12"			PFPV5466	<input type="checkbox"/>	8.0#
		72" 54" 18"			PFPV5472	<input type="checkbox"/>	9.0#
		84" 54" 30"			PFPV5484	<input type="checkbox"/>	11.0#
		72" 66" 6"			PFPV6672	<input type="checkbox"/>	8.0#
		84" 66" 18"			PFPV6684	<input type="checkbox"/>	10.0#
		84" 72" 12"			PFPV7284	<input type="checkbox"/>	10.0#

A

B

## HOW TO ORDER

Indicate the following information on order form:

- Quantity of each item.
- Model number, including options. See "How To Build a Model Number".
- Any special service required.

Note: • The  indicates that a choice is required.

- The absence of the  indicates that no choice is required.
- Alpha-numeric characters in place of  indicate that no other alternatives are available.

## HOW TO BUILD A MODEL NUMBER

**A** Select basic model.

**B** Select trim color.

Refer to color addendum at [ki.com](http://ki.com) or KI Fabrics & Finishes binder. Metallic paint requires upcharge. SX Starlight Silver finish is only offered on flat aluminum trim.



# Preconfigured Intersection Conditions

180° 2-Way

Delivered Pricing	Metallic Paint add to list price
\$ 49	N/A
55	N/A
58	N/A
61	N/A
68	N/A
77	N/A
81	N/A
88	N/A
\$ 62	\$ 36
73	38
82	38
90	38
106	40
115	48
132	49
69	36
78	38
85	38
102	39
111	40
128	48
73	36
82	38
98	38
106	39
125	48
78	36
94	38
102	38
121	39
90	38
98	38
115	39
90	36
106	38
102	38

## SPECIAL SERVICES

### Special Carton Marking

With specially marked information N/C

### Shipping

Delivered. Shipped **k.d. freight prepaid f.o.b. Manitowoc, Wisconsin 54220** factory. Freight class #70.

Specifications and prices are subject to change without prior notice.

# Preconfigured Intersection Conditions

180° 2-Way

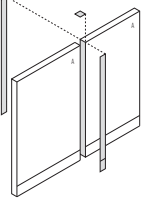
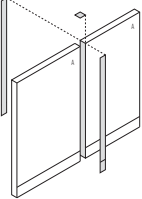
MODEL	A	MODEL NUMBER				Approx. Packaged Weight	Delivered Pricing Unupholstered
		Basic Model	Assembly	Trim Color	Fabric Color		
 <p><b>180° 2-Way In-Line Spacer, Both Panels Same Height</b></p> <ul style="list-style-type: none"> <li>• Unupholstered: trim colored</li> <li>• 180° top cap</li> <li>• Two pieces of universal trim</li> <li>• Two pieces of 3-way base trim</li> <li>• Two half-posts</li> <li>• Connecting hardware</li> <li>• SX Starlight Silver finish is only offered on flat aluminum trim</li> </ul>	30"	PSP18030	<input type="checkbox"/>	<input type="checkbox"/>		7.0#	\$ 171
	36"	PSP18036	<input type="checkbox"/>	<input type="checkbox"/>		9.0#	181
	42"	PSP18042	<input type="checkbox"/>	<input type="checkbox"/>		10.0#	208
	48"	PSP18048	<input type="checkbox"/>	<input type="checkbox"/>		13.0#	224
	54"	PSP18054	<input type="checkbox"/>	<input type="checkbox"/>		15.0#	250
	66"	PSP18066	<input type="checkbox"/>	<input type="checkbox"/>		16.0#	254
	72"	PSP18072	<input type="checkbox"/>	<input type="checkbox"/>		18.0#	269
	84"	PSP18084	<input type="checkbox"/>	<input type="checkbox"/>		20.0#	319
	PTN						
 <p><b>180° 2-Way In-Line Spacer, Both Panels Same Height</b></p> <ul style="list-style-type: none"> <li>• Upholstered</li> <li>• 180° top cap</li> <li>• Two fabric-wrapped pieces of universal trim</li> <li>• Two pieces of 3-way base trim</li> <li>• Two half-posts</li> <li>• Connecting hardware</li> <li>• SX Starlight Silver finish is only offered on flat aluminum trim</li> </ul>	30"	PSPF18030	<input type="checkbox"/>	<input type="checkbox"/>	<input type="checkbox"/>	7.0#	N/A
	36"	PSPF18036	<input type="checkbox"/>	<input type="checkbox"/>	<input type="checkbox"/>	9.0#	N/A
	42"	PSPF18042	<input type="checkbox"/>	<input type="checkbox"/>	<input type="checkbox"/>	10.0#	N/A
	48"	PSPF18048	<input type="checkbox"/>	<input type="checkbox"/>	<input type="checkbox"/>	13.0#	N/A
	54"	PSPF18054	<input type="checkbox"/>	<input type="checkbox"/>	<input type="checkbox"/>	15.0#	N/A
	66"	PSPF18066	<input type="checkbox"/>	<input type="checkbox"/>	<input type="checkbox"/>	16.0#	N/A
	72"	PSPF18072	<input type="checkbox"/>	<input type="checkbox"/>	<input type="checkbox"/>	18.0#	N/A
	84"	PSPF18084	<input type="checkbox"/>	<input type="checkbox"/>	<input type="checkbox"/>	20.0#	N/A
	PTNF						

A

B

C

D

## HOW TO ORDER

Indicate the following information on order form:

1. Quantity of each item.
2. Model number, including options. See "How To Build a Model Number".
3. Any special service required.

Note: • The  indicates that a choice is required.  
 • The absence of the  indicates that no choice is required.  
 • Alpha-numeric characters in place of  indicate that no other alternatives are available.

## HOW TO BUILD A MODEL NUMBER

**A** Select basic model.

**B** Select assembly.

**F** - Fully Assembled; add \$58  
**U** - Unassembled

**C** Select trim color.

Refer to color addendum at [ki.com](http://ki.com) or KI Fabrics & Finishes binder.  
 Metallic paint requires upcharge.  
 SX Starlight Silver finish is only offered on flat aluminum trim.

**D** Select fabric color.

Refer to color addendum at [ki.com](http://ki.com) or in KI Fabrics & Finishes binder.



# Preconfigured Intersection Conditions

180° 2-Way

Delivered Pricing Fabric Grade 1 & C.O.M.	Delivered Pricing Fabric Grade 2	Delivered Pricing Fabric Grade 3 & Pallas Vertical Fabric Grade PV	Delivered Pricing Pallas Vertical Fabric Grade PV1	Delivered Pricing Pallas Vertical Fabric Grade PV2	Metallic Paint add to list price
					\$ 64
					67
					67
					84
					88
					91
					93
					95
\$ 232	\$ 235	\$ 237	\$ 241	\$ 252	\$ 36
238	245	248	252	260	36
296	302	305	312	319	36
310	314	318	323	335	36
335	342	344	353	362	36
344	352	354	362	369	36
362	367	369	380	390	36
419	426	431	440	450	36

### SPECIAL SERVICES

#### Special Carton Marking

With specially marked information N/C

#### Shipping

Delivered. Shipped **k.d. freight prepaid f.o.b. Manitowoc, Wisconsin 54220** factory. Freight class #70.

Specifications and prices are subject to change without prior notice.

# Preconfigured Intersection Conditions

180° 2-Way

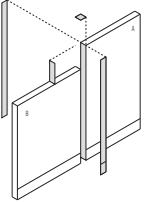
MODEL	A	B	A-B	MODEL NUMBER		Approx. Packaged Weight
				Basic Model	Trim Color	
 <p>PTN</p> <p><b>180° 2-Way In-Line Spacer, Two Different Heights</b></p> <ul style="list-style-type: none"> <li>• Upholstered: trim colored</li> <li>• Two pieces of 3-way base trim</li> <li>• 1-way top cap</li> <li>• Two pieces of universal trim</li> <li>• One piece of universal height change trim</li> <li>• One half-post (height A)</li> <li>• One half-post (height B)</li> <li>• Connecting hardware</li> <li>• SX Starlight Silver finish is only offered on flat aluminum trim</li> </ul>	36"	30"	6"	PSPV1803036	<input type="checkbox"/>	10.0#
	42"	30"	12"	PSPV1803042	<input type="checkbox"/>	9.0#
	48"	30"	18"	PSPV1803048	<input type="checkbox"/>	12.0#
	54"	30"	24"	PSPV1803054	<input type="checkbox"/>	11.0#
	66"	30"	36"	PSPV1803066	<input type="checkbox"/>	13.0#
	72"	30"	42"	PSPV1803072	<input type="checkbox"/>	17.0#
	84"	30"	54"	PSPV1803084	<input type="checkbox"/>	16.0#
	42"	36"	6"	PSPV1803642	<input type="checkbox"/>	11.0#
	48"	36"	12"	PSPV1803648	<input type="checkbox"/>	12.0#
	54"	36"	18"	PSPV1803654	<input type="checkbox"/>	14.0#
	66"	36"	30"	PSPV1803666	<input type="checkbox"/>	16.0#
	72"	36"	36"	PSPV1803672	<input type="checkbox"/>	17.0#
	84"	36"	48"	PSPV1803684	<input type="checkbox"/>	19.0#
	48"	42"	6"	PSPV1804248	<input type="checkbox"/>	13.0#
	54"	42"	12"	PSPV1804254	<input type="checkbox"/>	12.0#
	66"	42"	24"	PSPV1804266	<input type="checkbox"/>	14.0#
	72"	42"	30"	PSPV1804272	<input type="checkbox"/>	18.0#
	84"	42"	42"	PSPV1804284	<input type="checkbox"/>	17.0#
	54"	48"	6"	PSPV1804854	<input type="checkbox"/>	14.0#
	66"	48"	18"	PSPV1804866	<input type="checkbox"/>	17.0#
	72"	48"	24"	PSPV1804872	<input type="checkbox"/>	18.0#
	84"	48"	36"	PSPV1804884	<input type="checkbox"/>	20.0#
	66"	54"	12"	PSPV1805466	<input type="checkbox"/>	15.0#
	72"	54"	18"	PSPV1805472	<input type="checkbox"/>	18.0#
	84"	54"	30"	PSPV1805484	<input type="checkbox"/>	18.0#
	72"	66"	6"	PSPV1806672	<input type="checkbox"/>	18.0#
	84"	66"	18"	PSPV1806684	<input type="checkbox"/>	19.0#
	84"	72"	12"	PSPV1807284	<input type="checkbox"/>	21.0#

A

B

## HOW TO ORDER

Indicate the following information on order form:

1. Quantity of each item.
2. Model number, including options. See "How To Build a Model Number".
3. Any special service required.

Note: • The  indicates that a choice is required.

- The absence of the  indicates that no choice is required.
- Alpha-numeric characters in place of  indicate that no other alternatives are available.

## HOW TO BUILD A MODEL NUMBER

**A** Select basic model.

**B** Select trim color.

Refer to color addendum at [ki.com](http://ki.com) or KI Fabrics & Finishes binder. Metallic paint requires upcharge. SX Starlight Silver finish is only offered on flat aluminum trim.



# Preconfigured Intersection Conditions

180° 2-Way

Delivered Pricing	Metallic Paint add to list price
\$ 190	\$ 78
228	79
234	97
288	99
298	104
289	117
374	121
228	78
234	97
286	99
295	104
291	108
379	121
234	96
260	99
307	102
333	108
382	119
277	98
311	102
279	106
364	112
283	102
279	106
362	112
277	104
335	109
353	109

## SPECIAL SERVICES

### Special Carton Marking

With specially marked information N/C

### Shipping

Delivered. Shipped **k.d. freight prepaid f.o.b. Manitowoc, Wisconsin 54220** factory. Freight class #70.

Specifications and prices are subject to change without prior notice.

# Preconfigured Intersection Conditions

180° 2-Way

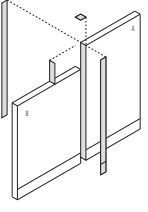
MODEL	A B A-B	MODEL NUMBER			Approx. Packaged Weight
		Basic Model	Trim Color	Fabric Color	
 <p>PTNF</p> <p><b>180° 2-Way In-Line Spacer, Two Different Heights</b></p> <ul style="list-style-type: none"> <li>• Upholstered</li> <li>• Two pieces of 3-way base trim</li> <li>• 1-way top cap</li> <li>• Two fabric-wrapped pieces of universal trim</li> <li>• One fabric-wrapped piece of universal height change trim</li> <li>• One half-post (height A)</li> <li>• One half-post (height B)</li> <li>• Connecting hardware</li> <li>• SX Starlight Silver finish is only offered on flat aluminum trim</li> </ul>	36" 30" 6"	PSPVF1803036	<input type="checkbox"/>	<input type="checkbox"/>	10.0#
	42" 30" 12"	PSPVF1803042	<input type="checkbox"/>	<input type="checkbox"/>	9.0#
	48" 30" 18"	PSPVF1803048	<input type="checkbox"/>	<input type="checkbox"/>	12.0#
	54" 30" 24"	PSPVF1803054	<input type="checkbox"/>	<input type="checkbox"/>	11.0#
	66" 30" 36"	PSPVF1803066	<input type="checkbox"/>	<input type="checkbox"/>	13.0#
	72" 30" 42"	PSPVF1803072	<input type="checkbox"/>	<input type="checkbox"/>	17.0#
	84" 30" 54"	PSPVF1803084	<input type="checkbox"/>	<input type="checkbox"/>	16.0#
	42" 36" 6"	PSPVF1803642	<input type="checkbox"/>	<input type="checkbox"/>	11.0#
	48" 36" 12"	PSPVF1803648	<input type="checkbox"/>	<input type="checkbox"/>	12.0#
	54" 36" 18"	PSPVF1803654	<input type="checkbox"/>	<input type="checkbox"/>	14.0#
	66" 36" 30"	PSPVF1803666	<input type="checkbox"/>	<input type="checkbox"/>	16.0#
	72" 36" 36"	PSPVF1803672	<input type="checkbox"/>	<input type="checkbox"/>	17.0#
	84" 36" 48"	PSPVF1803684	<input type="checkbox"/>	<input type="checkbox"/>	19.0#
	48" 42" 6"	PSPVF1804248	<input type="checkbox"/>	<input type="checkbox"/>	13.0#
	54" 42" 12"	PSPVF1804254	<input type="checkbox"/>	<input type="checkbox"/>	12.0#
	66" 42" 24"	PSPVF1804266	<input type="checkbox"/>	<input type="checkbox"/>	14.0#
	72" 42" 30"	PSPVF1804272	<input type="checkbox"/>	<input type="checkbox"/>	18.0#
	84" 42" 42"	PSPVF1804284	<input type="checkbox"/>	<input type="checkbox"/>	17.0#
	54" 48" 6"	PSPVF1804854	<input type="checkbox"/>	<input type="checkbox"/>	14.0#
	66" 48" 18"	PSPVF1804866	<input type="checkbox"/>	<input type="checkbox"/>	17.0#
	72" 48" 24"	PSPVF1804872	<input type="checkbox"/>	<input type="checkbox"/>	18.0#
	84" 48" 36"	PSPVF1804884	<input type="checkbox"/>	<input type="checkbox"/>	20.0#
	66" 54" 12"	PSPVF1805466	<input type="checkbox"/>	<input type="checkbox"/>	15.0#
	72" 54" 18"	PSPVF1805472	<input type="checkbox"/>	<input type="checkbox"/>	18.0#
	84" 54" 30"	PSPVF1805484	<input type="checkbox"/>	<input type="checkbox"/>	18.0#
	72" 66" 6"	PSPVF1806672	<input type="checkbox"/>	<input type="checkbox"/>	18.0#
	84" 66" 18"	PSPVF1806684	<input type="checkbox"/>	<input type="checkbox"/>	19.0#
	84" 72" 12"	PSPVF1807284	<input type="checkbox"/>	<input type="checkbox"/>	21.0#

A

B

C

## HOW TO ORDER

Indicate the following information on order form:

1. Quantity of each item.
2. Model number, including options. See "How To Build a Model Number".
3. Any special service required.

Note: • The  indicates that a choice is required.

- The absence of the  indicates that no choice is required.
- Alpha-numeric characters in place of  indicate that no other alternatives are available.

## HOW TO BUILD A MODEL NUMBER

**A** Select basic model.

**B** Select trim color.  
Refer to color addendum at ki.com or KI Fabrics & Finishes binder.  
Metallic paint requires upcharge.  
SX Starlight Silver finish is only offered on flat aluminum trim.

**C** Select fabric color.  
Refer to color addendum at ki.com or in KI Fabrics & Finishes binder.





# Preconfigured Intersection Conditions

180° 2-Way

Delivered Pricing Fabric Grade 1 & C.O.M.	Delivered Pricing Fabric Grade 2	Delivered Pricing Fabric Grade 3 & Pallas Vertical Fabric Grade PV	Delivered Pricing Pallas Vertical Fabric Grade PV1	Delivered Pricing Pallas Vertical Fabric Grade PV2	Metallic Paint add to list price
\$ 261	\$ 267	\$ 268	\$ 272	\$ 280	\$ 36
355	362	365	373	383	36
296	302	305	311	318	36
416	424	428	438	449	36
432	440	444	452	467	36
330	339	341	348	357	36
519	528	535	543	559	36
286	291	295	302	310	36
294	299	302	309	316	36
312	317	319	324	337	36
321	327	333	340	348	36
334	340	343	350	359	36
369	379	382	390	400	36
296	302	305	311	318	36
334	342	346	354	365	36
409	419	424	432	444	36
446	451	454	462	473	36
524	533	539	549	567	36
316	320	322	333	341	36
324	333	335	343	353	36
335	341	344	352	359	36
369	379	382	390	400	36
416	424	428	438	448	36
334	341	343	352	359	36
503	512	519	529	543	36
330	339	341	348	357	36
343	353	357	366	384	36
356	363	365	374	385	36

## SPECIAL SERVICES

### Special Carton Marking

With specially marked information N/C

### Shipping

Delivered. Shipped **k.d. freight prepaid**  
**f.o.b. Manitowoc, Wisconsin 54220**  
factory. Freight class #70.

Specifications and prices are subject to  
change without prior notice.

# Preconfigured Intersection Conditions

3-Way

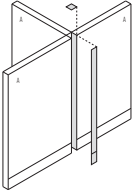
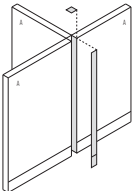
	MODEL	A	MODEL NUMBER				Approx. Packaged Weight	Delivered Pricing Unupholstered
			Basic Model	Assembly	Trim Color	Fabric Color		
 <p>PTN</p>	<b>3-Way "T" Intersection w/3-Way Cap, All Panels Same Height - AAA</b> <ul style="list-style-type: none"> <li>• Unupholstered</li> <li>• 3-way top cap</li> <li>• 3-way base trim</li> <li>• One piece of universal trim</li> <li>• Light block</li> <li>• Three half-posts</li> <li>• Connecting hardware</li> <li>• SX Starlight Silver finish is only offered on flat aluminum trim</li> </ul>	30"	PTP3W30	<input type="checkbox"/>	<input type="checkbox"/>		9.0#	\$ 185
		36"	PTP3W36	<input type="checkbox"/>	<input type="checkbox"/>		9.0#	201
		42"	PTP3W42	<input type="checkbox"/>	<input type="checkbox"/>		12.0#	224
		48"	PTP3W48	<input type="checkbox"/>	<input type="checkbox"/>		12.0#	250
		54"	PTP3W54	<input type="checkbox"/>	<input type="checkbox"/>		15.0#	264
		60"	PTP3W60	<input type="checkbox"/>	<input type="checkbox"/>		15.0#	235
		66"	PTP3W66	<input type="checkbox"/>	<input type="checkbox"/>		18.0#	273
		72"	PTP3W72	<input type="checkbox"/>	<input type="checkbox"/>		18.0#	280
		78"	PTP3W78	<input type="checkbox"/>	<input type="checkbox"/>		18.0#	286
		84"	PTP3W84	<input type="checkbox"/>	<input type="checkbox"/>		22.0#	340
 <p>PTF</p>	<b>3-Way "T" Intersection w/3-Way Cap, All Panels Same Height - AAA</b> <ul style="list-style-type: none"> <li>• Upholstered</li> <li>• 3-way top cap</li> <li>• 3-way base trim</li> <li>• One piece of fabric-wrapped universal trim</li> <li>• Light block</li> <li>• Three half-posts</li> <li>• Connecting hardware</li> <li>• SX Starlight Silver finish is only offered on flat aluminum trim</li> </ul>	30"	PTPF3W30	<input type="checkbox"/>	<input type="checkbox"/>	<input type="checkbox"/>	9.0#	N/A
		36"	PTPF3W36	<input type="checkbox"/>	<input type="checkbox"/>	<input type="checkbox"/>	9.0#	N/A
		42"	PTPF3W42	<input type="checkbox"/>	<input type="checkbox"/>	<input type="checkbox"/>	12.0#	N/A
		48"	PTPF3W48	<input type="checkbox"/>	<input type="checkbox"/>	<input type="checkbox"/>	12.0#	N/A
		54"	PTPF3W54	<input type="checkbox"/>	<input type="checkbox"/>	<input type="checkbox"/>	15.0#	N/A
		60"	PTPF3W60	<input type="checkbox"/>	<input type="checkbox"/>	<input type="checkbox"/>	15.0#	N/A
		66"	PTPF3W66	<input type="checkbox"/>	<input type="checkbox"/>	<input type="checkbox"/>	18.0#	N/A
		72"	PTPF3W72	<input type="checkbox"/>	<input type="checkbox"/>	<input type="checkbox"/>	18.0#	N/A
		78"	PTPF3W78	<input type="checkbox"/>	<input type="checkbox"/>	<input type="checkbox"/>	18.0#	N/A
		84"	PTPF3W84	<input type="checkbox"/>	<input type="checkbox"/>	<input type="checkbox"/>	22.0#	N/A

A

B

C

D

## HOW TO ORDER

Indicate the following information on order form:

1. Quantity of each item.
2. Model number, including options. See "How To Build a Model Number".
3. Any special service required.

Note:

- The  indicates that a choice is required.
- The absence of the  indicates that no choice is required.
- Alpha-numeric characters in place of  indicate that no other alternatives are available.

## HOW TO BUILD A MODEL NUMBER

**A** Select basic model.

**B** Select assembly.

F - Fully Assembled; add \$74

U - Unassembled

**C** Select trim color.

Refer to color addendum at [ki.com](http://ki.com) or KI Fabrics & Finishes binder. Metallic paint requires upcharge. SX Starlight Silver finish is only offered on flat aluminum trim.

**D** Select fabric color.

Refer to color addendum at [ki.com](http://ki.com) or in KI Fabrics & Finishes binder.



# Preconfigured Intersection Conditions

3-Way

Delivered Pricing Fabric Grade 1 & C.O.M.	Delivered Pricing Fabric Grade 2	Delivered Pricing Fabric Grade 3 & Pallas Vertical Fabric Grade PV	Delivered Pricing Pallas Vertical Fabric Grade PV1	Delivered Pricing Pallas Vertical Fabric Grade PV2	Metallic Paint add to list price
					\$ 38
					39
					39
					48
					49
					49
					50
					52
					52
					54
\$ 217	\$ 220	\$ 224	\$ 229	\$ 235	\$ 26
228	233	234	237	248	26
268	272	275	279	289	26
290	296	299	306	313	26
309	314	317	321	334	26
275	278	280	289	298	26
317	322	324	335	343	26
327	335	339	346	354	26
327	334	337	343	355	26
387	396	399	408	419	26

**SPECIAL SERVICES**

**Special Carton Marking**

With specially marked information N/C

**Shipping**

Delivered. Shipped **k.d. freight prepaid f.o.b. Manitowoc, Wisconsin 54220** factory. Freight class #70.

Specifications and prices are subject to change without prior notice.

# Preconfigured Intersection Conditions

3-Way

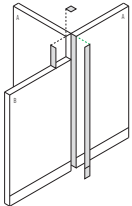
	MODEL	A	B	A-B	MODEL NUMBER		Approx. Packaged Weight
					Basic Model	Trim Color	
 <p>PTN</p> <p><b>3-Way "T" Intersection w/90° Top Cap, Two Different Heights - BAA</b></p> <ul style="list-style-type: none"> <li>• Upholstered: trim colored</li> <li>• 90° top cap</li> <li>• 3-way base trim</li> <li>• One piece of universal height change trim</li> <li>• Light block</li> <li>• Two half-posts (height A)</li> <li>• One half-post (height B)</li> <li>• Connecting hardware</li> <li>• SX Starlight Silver finish is only offered on flat aluminum trim</li> </ul>	36" 30" 6"	PTPV903036	<input type="checkbox"/>	10.0#			
	42" 30" 12"	PTPV903042	<input type="checkbox"/>	10.0#			
	48" 30" 18"	PTPV903048	<input type="checkbox"/>	11.0#			
	54" 30" 24"	PTPV903054	<input type="checkbox"/>	12.0#			
	66" 30" 36"	PTPV903066	<input type="checkbox"/>	14.0#			
	72" 30" 42"	PTPV903072	<input type="checkbox"/>	12.0#			
	84" 30" 54"	PTPV903084	<input type="checkbox"/>	16.0#			
	42" 36" 6"	PTPV903642	<input type="checkbox"/>	14.0#			
	48" 36" 12"	PTPV903648	<input type="checkbox"/>	16.0#			
	54" 36" 18"	PTPV903654	<input type="checkbox"/>	14.0#			
	66" 36" 30"	PTPV903666	<input type="checkbox"/>	16.0#			
	72" 36" 36"	PTPV903672	<input type="checkbox"/>	18.0#			
	84" 36" 48"	PTPV903684	<input type="checkbox"/>	17.0#			
	48" 42" 6"	PTPV904248	<input type="checkbox"/>	19.0#			
	54" 42" 12"	PTPV904254	<input type="checkbox"/>	14.0#			
	66" 42" 24"	PTPV904266	<input type="checkbox"/>	16.0#			
	72" 42" 30"	PTPV904272	<input type="checkbox"/>	22.0#			
	84" 42" 42"	PTPV904284	<input type="checkbox"/>	18.0#			
	54" 48" 6"	PTPV904854	<input type="checkbox"/>	10.0#			
	66" 48" 18"	PTPV904866	<input type="checkbox"/>	12.0#			
	72" 48" 24"	PTPV904872	<input type="checkbox"/>	14.0#			
	84" 48" 36"	PTPV904884	<input type="checkbox"/>	16.0#			
	66" 54" 12"	PTPV905466	<input type="checkbox"/>	17.0#			
	72" 54" 18"	PTPV905472	<input type="checkbox"/>	14.0#			
	84" 54" 30"	PTPV905484	<input type="checkbox"/>	19.0#			
	72" 66" 6"	PTPV906672	<input type="checkbox"/>	16.0#			
	84" 66" 18"	PTPV906684	<input type="checkbox"/>	22.0#			
	84" 72" 12"	PTPV907284	<input type="checkbox"/>	18.0#			

A

B

## HOW TO ORDER

Indicate the following information on order form:

1. Quantity of each item.
2. Model number, including options. See "How To Build a Model Number".
3. Any special service required.

Note: • The  indicates that a choice is required.

- The absence of the  indicates that no choice is required.
- Alpha-numeric characters in place of  indicate that no other alternatives are available.

## HOW TO BUILD A MODEL NUMBER

**A** Select basic model.

**B** Select trim color.

Refer to color addendum at [ki.com](http://ki.com) or KI Fabrics & Finishes binder. Metallic paint requires upcharge. SX Starlight Silver finish is only offered on flat aluminum trim.



# Preconfigured Intersection Conditions

3-Way

Delivered Pricing	Metallic Paint add to list price
\$ 231	\$ 50
240	52
258	62
305	64
316	67
342	77
390	79
269	50
286	62
306	64
316	67
334	68
366	79
286	59
300	64
313	65
327	68
398	78
311	62
320	65
342	67
368	69
309	65
320	67
381	69
317	65
342	68
362	68

## SPECIAL SERVICES

### Special Carton Marking

With specially marked information N/C

### Shipping

Delivered. Shipped **k.d. freight prepaid f.o.b. Manitowoc, Wisconsin 54220** factory. Freight class #70.

Specifications and prices are subject to change without prior notice.

# Preconfigured Intersection Conditions

3-Way

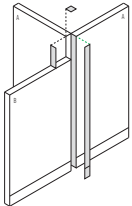
MODEL	A B A-B	MODEL NUMBER			Approx. Packaged Weight
		Basic Model	Trim Color	Fabric Color	
 <p><b>3-Way "T" Intersection w/90° Top Cap, Two Different Heights - BAA</b></p> <ul style="list-style-type: none"> <li>• Upholstered</li> <li>• 90° top cap</li> <li>• 3-way base trim</li> <li>• One piece of fabric-wrapped universal trim</li> <li>• One piece of universal height change trim</li> <li>• Light block</li> <li>• Two half-posts (height A)</li> <li>• One half-post (height B)</li> <li>• Connecting hardware</li> <li>• SX Starlight Silver finish is only offered on flat aluminum trim</li> </ul>	36" 30" 6"	PTPVF903036	<input type="checkbox"/>	<input type="checkbox"/>	12.0#
	42" 30" 12"	PTPVF903042	<input type="checkbox"/>	<input type="checkbox"/>	11.0#
	48" 30" 18"	PTPVF903048	<input type="checkbox"/>	<input type="checkbox"/>	16.0#
	54" 30" 24"	PTPVF903054	<input type="checkbox"/>	<input type="checkbox"/>	14.0#
	66" 30" 36"	PTPVF903066	<input type="checkbox"/>	<input type="checkbox"/>	17.0#
	72" 30" 42"	PTPVF903072	<input type="checkbox"/>	<input type="checkbox"/>	22.0#
	84" 30" 54"	PTPVF903084	<input type="checkbox"/>	<input type="checkbox"/>	21.0#
	42" 36" 6"	PTPVF903642	<input type="checkbox"/>	<input type="checkbox"/>	14.0#
	48" 36" 12"	PTPVF903648	<input type="checkbox"/>	<input type="checkbox"/>	16.0#
	54" 36" 18"	PTPVF903654	<input type="checkbox"/>	<input type="checkbox"/>	17.0#
	66" 36" 30"	PTPVF903666	<input type="checkbox"/>	<input type="checkbox"/>	20.0#
	72" 36" 36"	PTPVF903672	<input type="checkbox"/>	<input type="checkbox"/>	22.0#
	84" 36" 48"	PTPVF903684	<input type="checkbox"/>	<input type="checkbox"/>	25.0#
	48" 42" 6"	PTPVF904248	<input type="checkbox"/>	<input type="checkbox"/>	16.0#
	54" 42" 12"	PTPVF904254	<input type="checkbox"/>	<input type="checkbox"/>	15.0#
	66" 42" 24"	PTPVF904266	<input type="checkbox"/>	<input type="checkbox"/>	18.0#
	72" 42" 30"	PTPVF904272	<input type="checkbox"/>	<input type="checkbox"/>	23.0#
	84" 42" 42"	PTPVF904284	<input type="checkbox"/>	<input type="checkbox"/>	22.0#
	54" 48" 6"	PTPVF904854	<input type="checkbox"/>	<input type="checkbox"/>	18.0#
	66" 48" 18"	PTPVF904866	<input type="checkbox"/>	<input type="checkbox"/>	21.0#
	72" 48" 24"	PTPVF904872	<input type="checkbox"/>	<input type="checkbox"/>	23.0#
	84" 48" 36"	PTPVF904884	<input type="checkbox"/>	<input type="checkbox"/>	26.0#
	66" 54" 12"	PTPVF905466	<input type="checkbox"/>	<input type="checkbox"/>	18.0#
	72" 54" 18"	PTPVF905472	<input type="checkbox"/>	<input type="checkbox"/>	23.0#
	84" 54" 30"	PTPVF905484	<input type="checkbox"/>	<input type="checkbox"/>	22.0#
	72" 66" 6"	PTPVF906672	<input type="checkbox"/>	<input type="checkbox"/>	23.0#
	84" 66" 18"	PTPVF906684	<input type="checkbox"/>	<input type="checkbox"/>	23.0#
	84" 72" 12"	PTPVF907284	<input type="checkbox"/>	<input type="checkbox"/>	26.0#

A

B

C

## HOW TO ORDER

Indicate the following information on order form:

1. Quantity of each item.
2. Model number, including options. See "How To Build a Model Number".
3. Any special service required.

Note: • The  indicates that a choice is required.

- The absence of the  indicates that no choice is required.
- Alpha-numeric characters in place of  indicate that no other alternatives are available.

## HOW TO BUILD A MODEL NUMBER

**A** Select basic model.

**B** Select trim color.

Refer to color addendum at [ki.com](http://ki.com) or KI Fabrics & Finishes binder. Metallic paint requires upcharge. SX Starlight Silver finish is only offered on flat aluminum trim.

**C** Select fabric color.

Refer to color addendum at [ki.com](http://ki.com) or in KI Fabrics & Finishes binder.



# Preconfigured Intersection Conditions

3-Way

Delivered Pricing Fabric Grade 1 & C.O.M.	Delivered Pricing Fabric Grade 2	Delivered Pricing Fabric Grade 3 & Pallas Vertical Fabric Grade PV	Delivered Pricing Pallas Vertical Fabric Grade PV1	Delivered Pricing Pallas Vertical Fabric Grade PV2	Metallic Paint add to list price
\$ 302	\$ 307	\$ 310	\$ 316	\$ 322	\$ 26
323	333	335	342	352	26
366	376	379	386	397	26
387	394	398	406	419	26
402	411	416	424	437	26
378	384	387	396	406	26
483	490	495	506	521	26
329	335	340	346	355	26
342	347	352	358	367	26
362	367	373	381	390	26
378	385	387	396	406	26
380	387	390	399	410	26
436	443	446	454	469	26
343	350	353	359	369	26
369	379	381	390	399	26
412	422	425	433	445	26
440	445	448	454	467	26
489	496	505	515	528	26
367	376	380	387	398	26
382	388	393	400	411	26
384	390	394	401	412	26
437	444	448	456	470	26
390	398	401	410	422	26
382	388	393	400	411	26
470	481	485	492	507	26
380	387	390	399	410	26
401	411	417	426	440	26
423	431	436	444	454	26

## SPECIAL SERVICES

### Special Carton Marking

With specially marked information N/C

### Shipping

Delivered. Shipped **k.d. freight prepaid f.o.b. Manitowoc, Wisconsin 54220** factory. Freight class #70.

Specifications and prices are subject to change without prior notice.

# Preconfigured Intersection Conditions

3-Way

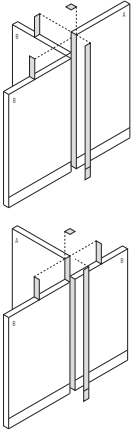
MODEL	A	B	A-B	MODEL NUMBER		Approx. Packaged Weight
				Basic Model	Trim Color	
 <p><b>3-Way "T" Intersection w/1-Way Cap, Two Different Heights - BBA or BAB</b></p> <ul style="list-style-type: none"> <li>• Unupholstered: trim colored</li> <li>• 1-way top cap</li> <li>• One piece of universal trim</li> <li>• Two pieces of universal height change trim</li> <li>• Light block</li> <li>• 3-way base trim</li> <li>• One half-post (height A)</li> <li>• Two half-posts (height B)</li> <li>• Connecting hardware</li> <li>• SX Starlight Silver finish is only offered on flat aluminum trim</li> </ul>	36" 30" 6"	PTPV1W3036	<input type="checkbox"/>	12.0#		
	42" 30" 12"	PTPV1W3042	<input type="checkbox"/>	10.0#		
	48" 30" 18"	PTPV1W3048	<input type="checkbox"/>	15.0#		
	54" 30" 24"	PTPV1W3054	<input type="checkbox"/>	14.0#		
	66" 30" 36"	PTPV1W3066	<input type="checkbox"/>	16.0#		
	72" 30" 42"	PTPV1W3072	<input type="checkbox"/>	20.0#		
	84" 30" 54"	PTPV1W3084	<input type="checkbox"/>	20.0#		
	42" 36" 6"	PTPV1W3642	<input type="checkbox"/>	14.0#		
	48" 36" 12"	PTPV1W3648	<input type="checkbox"/>	15.0#		
	54" 36" 18"	PTPV1W3654	<input type="checkbox"/>	16.0#		
	66" 36" 30"	PTPV1W3666	<input type="checkbox"/>	18.0#		
	72" 36" 36"	PTPV1W3672	<input type="checkbox"/>	20.0#		
	84" 36" 48"	PTPV1W3684	<input type="checkbox"/>	23.0#		
	48" 42" 6"	PTPV1W4248	<input type="checkbox"/>	16.0#		
	54" 42" 12"	PTPV1W4254	<input type="checkbox"/>	13.0#		
	66" 42" 24"	PTPV1W4266	<input type="checkbox"/>	15.0#		
	72" 42" 30"	PTPV1W4272	<input type="checkbox"/>	21.0#		
	84" 42" 42"	PTPV1W4284	<input type="checkbox"/>	17.0#		
	54" 48" 6"	PTPV1W4854	<input type="checkbox"/>	17.0#		
	66" 48" 18"	PTPV1W4866	<input type="checkbox"/>	20.0#		
	72" 48" 24"	PTPV1W4872	<input type="checkbox"/>	21.0#		
	84" 48" 36"	PTPV1W4884	<input type="checkbox"/>	23.0#		
	66" 54" 12"	PTPV1W5466	<input type="checkbox"/>	18.0#		
	72" 54" 18"	PTPV1W5472	<input type="checkbox"/>	22.0#		
	84" 54" 30"	PTPV1W5484	<input type="checkbox"/>	20.0#		
	72" 66" 6"	PTPV1W6672	<input type="checkbox"/>	23.0#		
	84" 66" 18"	PTPV1W6684	<input type="checkbox"/>	21.0#		
	84" 72" 12"	PTPV1W7284	<input type="checkbox"/>	26.0#		

A

B

## HOW TO ORDER

Indicate the following information on order form:

1. Quantity of each item.
2. Model number, including options. See "How To Build a Model Number".
3. Any special service required.

Note: • The  indicates that a choice is required.

- The absence of the  indicates that no choice is required.
- Alpha-numeric characters in place of  indicate that no other alternatives are available.

## HOW TO BUILD A MODEL NUMBER

**A** Select basic model.

**B** Select trim color.

Refer to color addendum at [ki.com](http://ki.com) or KI Fabrics & Finishes binder. Metallic paint requires upcharge. SX Starlight Silver finish is only offered on flat aluminum trim.





# Preconfigured Intersection Conditions

3-Way

Delivered Pricing	Metallic Paint add to list price
\$ 233	\$ 64
248	67
283	76
305	77
319	81
344	99
390	104
260	64
272	76
290	77
329	81
363	82
409	104
272	73
289	77
329	78
354	82
394	100
323	74
340	78
346	79
386	83
314	78
344	79
384	83
340	77
354	81
365	83

## SPECIAL SERVICES

### Special Carton Marking

With specially marked information N/C

### Shipping

Delivered. Shipped **k.d. freight prepaid f.o.b. Manitowoc, Wisconsin 54220** factory. Freight class #70.

Specifications and prices are subject to change without prior notice.

# Preconfigured Intersection Conditions

3-Way

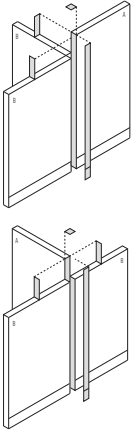
MODEL	A	B	A-B	MODEL NUMBER			Approx. Packaged Weight
				Basic Model	Trim Color	Fabric Color	
 <p><b>3-Way "T" Intersection w/1-Way Cap, Two Different Heights - BBA or BAB</b></p> <ul style="list-style-type: none"> <li>• Upholstered</li> <li>• 1-way top cap</li> <li>• One fabric-wrapped piece of universal trim</li> <li>• Two fabric-wrapped pieces of universal height change trim</li> <li>• Light block</li> <li>• 3-way base trim</li> <li>• One half-post (height A)</li> <li>• Two half-posts (height B)</li> <li>• Connecting hardware</li> <li>• SX Starlight Silver finish is only offered on flat aluminum trim</li> </ul>	36"	30"	6"	PTPVF1W3036	<input type="checkbox"/>	<input type="checkbox"/>	12.0#
	42"	30"	12"	PTPVF1W3042	<input type="checkbox"/>	<input type="checkbox"/>	10.0#
	48"	30"	18"	PTPVF1W3048	<input type="checkbox"/>	<input type="checkbox"/>	15.0#
	54"	30"	24"	PTPVF1W3054	<input type="checkbox"/>	<input type="checkbox"/>	14.0#
	66"	30"	36"	PTPVF1W3066	<input type="checkbox"/>	<input type="checkbox"/>	16.0#
	72"	30"	42"	PTPVF1W3072	<input type="checkbox"/>	<input type="checkbox"/>	20.0#
	84"	30"	54"	PTPVF1W3084	<input type="checkbox"/>	<input type="checkbox"/>	20.0#
	42"	36"	6"	PTPVF1W3642	<input type="checkbox"/>	<input type="checkbox"/>	14.0#
	48"	36"	12"	PTPVF1W3648	<input type="checkbox"/>	<input type="checkbox"/>	15.0#
	54"	36"	18"	PTPVF1W3654	<input type="checkbox"/>	<input type="checkbox"/>	16.0#
	66"	36"	30"	PTPVF1W3666	<input type="checkbox"/>	<input type="checkbox"/>	18.0#
	72"	36"	36"	PTPVF1W3672	<input type="checkbox"/>	<input type="checkbox"/>	20.0#
	84"	36"	48"	PTPVF1W3684	<input type="checkbox"/>	<input type="checkbox"/>	23.0#
	48"	42"	6"	PTPVF1W4248	<input type="checkbox"/>	<input type="checkbox"/>	16.0#
	54"	42"	12"	PTPVF1W4254	<input type="checkbox"/>	<input type="checkbox"/>	13.0#
	66"	42"	24"	PTPVF1W4266	<input type="checkbox"/>	<input type="checkbox"/>	15.0#
	72"	42"	30"	PTPVF1W4272	<input type="checkbox"/>	<input type="checkbox"/>	21.0#
	84"	42"	42"	PTPVF1W4284	<input type="checkbox"/>	<input type="checkbox"/>	17.0#
	54"	48"	6"	PTPVF1W4854	<input type="checkbox"/>	<input type="checkbox"/>	17.0#
	66"	48"	18"	PTPVF1W4866	<input type="checkbox"/>	<input type="checkbox"/>	19.0#
	72"	48"	24"	PTPVF1W4872	<input type="checkbox"/>	<input type="checkbox"/>	21.0#
	84"	48"	36"	PTPVF1W4884	<input type="checkbox"/>	<input type="checkbox"/>	23.0#
	66"	54"	12"	PTPVF1W5466	<input type="checkbox"/>	<input type="checkbox"/>	18.0#
	72"	54"	18"	PTPVF1W5472	<input type="checkbox"/>	<input type="checkbox"/>	22.0#
	84"	54"	30"	PTPVF1W5484	<input type="checkbox"/>	<input type="checkbox"/>	20.0#
	72"	66"	6"	PTPVF1W6672	<input type="checkbox"/>	<input type="checkbox"/>	23.0#
	84"	66"	18"	PTPVF1W6684	<input type="checkbox"/>	<input type="checkbox"/>	21.0#
	84"	72"	12"	PTPVF1W7284	<input type="checkbox"/>	<input type="checkbox"/>	26.0#

A

B

C

## HOW TO ORDER

Indicate the following information on order form:

1. Quantity of each item.
2. Model number, including options. See "How To Build a Model Number".
3. Any special service required.

Note: • The  indicates that a choice is required.

- The absence of the  indicates that no choice is required.
- Alpha-numeric characters in place of  indicate that no other alternatives are available.

## HOW TO BUILD A MODEL NUMBER

**A** Select basic model.

**B** Select trim color.

Refer to color addendum at [ki.com](http://ki.com) or KI Fabrics & Finishes binder. Metallic paint requires upcharge. SX Starlight Silver finish is only offered on flat aluminum trim.

**C** Select fabric color.

Refer to color addendum at [ki.com](http://ki.com) or in KI Fabrics & Finishes binder.



# Preconfigured Intersection Conditions

3-Way

Delivered Pricing Fabric Grade 1 & C.O.M.	Delivered Pricing Fabric Grade 2	Delivered Pricing Fabric Grade 3 & Pallas Vertical Fabric Grade PV	Delivered Pricing Pallas Vertical Fabric Grade PV1	Delivered Pricing Pallas Vertical Fabric Grade PV2	Metallic Paint add to list price
\$ 298	\$ 303	\$ 306	\$ 312	\$ 319	\$ 26
369	379	382	390	400	26
411	420	424	432	444	26
432	440	444	452	467	26
453	462	468	479	489	26
362	367	373	381	390	26
529	536	539	549	560	26
324	334	337	344	354	26
333	340	342	350	358	26
348	355	358	366	378	26
362	367	369	380	390	26
366	374	379	386	397	26
408	417	424	433	449	26
337	343	346	354	363	26
367	378	380	388	400	26
436	443	446	456	471	26
468	474	480	486	495	26
533	542	549	558	576	26
365	373	378	385	396	26
378	384	387	396	406	26
381	388	393	400	411	26
419	425	430	439	450	26
440	448	451	461	475	26
384	390	394	401	412	26
519	529	535	544	560	26
384	390	394	401	412	26
396	403	411	422	438	26
408	416	420	430	440	26

## SPECIAL SERVICES

### Special Carton Marking

With specially marked information N/C

### Shipping

Delivered. Shipped **k.d. freight prepaid f.o.b. Manitowoc, Wisconsin 54220** factory. Freight class #70.

Specifications and prices are subject to change without prior notice.

# Preconfigured Intersection Conditions

3-Way

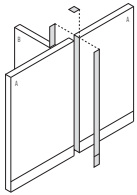
	MODEL	A	B	A-B	MODEL NUMBER		Approx. Packaged Weight
					Basic Model	Trim Color	
 <p>PTN</p> <p><b>3-Way "T" Intersection w/180° Top Cap, Two Different Heights - ABA</b></p> <ul style="list-style-type: none"> <li>• Unupholstered: trim colored</li> <li>• 180° top cap</li> <li>• One piece of universal trim</li> <li>• One piece of universal height change trim</li> <li>• Light block</li> <li>• 3-way base trim</li> <li>• Two half-posts (height A)</li> <li>• One half-post (height B)</li> <li>• Connecting hardware</li> <li>• SX Starlight Silver finish is only offered on flat aluminum trim</li> </ul>	36" 30" 6"	PTPV1803036	<input type="checkbox"/>	10.0#			
	42" 30" 12"	PTPV1803042	<input type="checkbox"/>	10.0#			
	48" 30" 18"	PTPV1803048	<input type="checkbox"/>	11.0#			
	54" 30" 24"	PTPV1803054	<input type="checkbox"/>	12.0#			
	66" 30" 36"	PTPV1803066	<input type="checkbox"/>	14.0#			
	72" 30" 42"	PTPV1803072	<input type="checkbox"/>	12.0#			
	84" 30" 54"	PTPV1803084	<input type="checkbox"/>	16.0#			
	42" 36" 6"	PTPV1803642	<input type="checkbox"/>	14.0#			
	48" 36" 12"	PTPV1803648	<input type="checkbox"/>	16.0#			
	54" 36" 18"	PTPV1803654	<input type="checkbox"/>	14.0#			
	66" 36" 30"	PTPV1803666	<input type="checkbox"/>	16.0#			
	72" 36" 36"	PTPV1803672	<input type="checkbox"/>	18.0#			
	84" 36" 48"	PTPV1803684	<input type="checkbox"/>	17.0#			
	48" 42" 6"	PTPV1804248	<input type="checkbox"/>	19.0#			
	54" 42" 12"	PTPV1804254	<input type="checkbox"/>	14.0#			
	66" 42" 24"	PTPV1804266	<input type="checkbox"/>	16.0#			
	72" 42" 30"	PTPV1804272	<input type="checkbox"/>	22.0#			
	84" 42" 42"	PTPV1804284	<input type="checkbox"/>	18.0#			
	54" 48" 6"	PTPV1804854	<input type="checkbox"/>	10.0#			
	66" 48" 18"	PTPV1804866	<input type="checkbox"/>	12.0#			
	72" 48" 24"	PTPV1804872	<input type="checkbox"/>	14.0#			
	84" 48" 36"	PTPV1804884	<input type="checkbox"/>	16.0#			
	66" 54" 12"	PTPV1805466	<input type="checkbox"/>	17.0#			
	72" 54" 18"	PTPV1805472	<input type="checkbox"/>	14.0#			
	84" 54" 30"	PTPV1805484	<input type="checkbox"/>	19.0#			
	72" 66" 6"	PTPV1806672	<input type="checkbox"/>	16.0#			
	84" 66" 18"	PTPV1806684	<input type="checkbox"/>	22.0#			
	84" 72" 12"	PTPV1807284	<input type="checkbox"/>	18.0#			

A

B

## HOW TO ORDER

Indicate the following information on order form:

1. Quantity of each item.
2. Model number, including options. See "How To Build a Model Number".
3. Any special service required.

Note: • The  indicates that a choice is required.

- The absence of the  indicates that no choice is required.
- Alpha-numeric characters in place of  indicate that no other alternatives are available.

## HOW TO BUILD A MODEL NUMBER

**A** Select basic model.

**B** Select trim color.

Refer to color addendum at [ki.com](http://ki.com) or KI Fabrics & Finishes binder. Metallic paint requires upcharge. SX Starlight Silver finish is only offered on flat aluminum trim.



# Preconfigured Intersection Conditions

3-Way

Delivered Pricing	Metallic Paint add to list price
\$ 231	\$ 50
240	39
258	62
305	49
316	50
313	67
390	54
269	79
286	50
306	62
316	64
317	67
366	68
286	79
306	49
342	50
359	65
398	54
311	78
320	62
320	65
368	67
309	69
320	65
381	67
317	69
341	65
362	68

## SPECIAL SERVICES

### Special Carton Marking

With specially marked information N/C

### Shipping

Delivered. Shipped **k.d. freight prepaid f.o.b. Manitowoc, Wisconsin 54220** factory. Freight class #70.

Specifications and prices are subject to change without prior notice.

# Preconfigured Intersection Conditions

3-Way

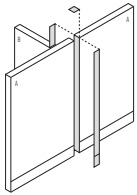
MODEL	A B A-B	MODEL NUMBER			Approx. Packaged Weight
		Basic Model	Trim Color	Fabric Color	
 <p><b>3-Way "T" Intersection w/180° Top Cap, Two Different Heights - ABA</b></p> <ul style="list-style-type: none"> <li>• Upholstered</li> <li>• 180° top cap</li> <li>• One fabric-wrapped piece of universal trim</li> <li>• One fabric-wrapped piece of universal height change trim</li> <li>• Light block</li> <li>• 3-way base trim</li> <li>• Two half-posts (height A)</li> <li>• One half-post (height B)</li> <li>• Connecting hardware</li> <li>• SX Starlight Silver finish is only offered on flat aluminum trim</li> </ul>	36" 30" 6"	PTPVF1803036	<input type="checkbox"/>	<input type="checkbox"/>	13.0#
	42" 30" 12"	PTPVF1803042	<input type="checkbox"/>	<input type="checkbox"/>	10.0#
	48" 30" 18"	PTPVF1803048	<input type="checkbox"/>	<input type="checkbox"/>	16.0#
	54" 30" 24"	PTPVF1803054	<input type="checkbox"/>	<input type="checkbox"/>	12.0#
	66" 30" 36"	PTPVF1803066	<input type="checkbox"/>	<input type="checkbox"/>	14.0#
	72" 30" 42"	PTPVF1803072	<input type="checkbox"/>	<input type="checkbox"/>	23.0#
	84" 30" 54"	PTPVF1803084	<input type="checkbox"/>	<input type="checkbox"/>	16.0#
	42" 36" 6"	PTPVF1803642	<input type="checkbox"/>	<input type="checkbox"/>	15.0#
	48" 36" 12"	PTPVF1803648	<input type="checkbox"/>	<input type="checkbox"/>	17.0#
	54" 36" 18"	PTPVF1803654	<input type="checkbox"/>	<input type="checkbox"/>	19.0#
	66" 36" 30"	PTPVF1803666	<input type="checkbox"/>	<input type="checkbox"/>	22.0#
	72" 36" 36"	PTPVF1803672	<input type="checkbox"/>	<input type="checkbox"/>	24.0#
	84" 36" 48"	PTPVF1803684	<input type="checkbox"/>	<input type="checkbox"/>	28.0#
	48" 42" 6"	PTPVF1804248	<input type="checkbox"/>	<input type="checkbox"/>	18.0#
	54" 42" 12"	PTPVF1804254	<input type="checkbox"/>	<input type="checkbox"/>	14.0#
	66" 42" 24"	PTPVF1804266	<input type="checkbox"/>	<input type="checkbox"/>	16.0#
	72" 42" 30"	PTPVF1804272	<input type="checkbox"/>	<input type="checkbox"/>	25.0#
	84" 42" 42"	PTPVF1804284	<input type="checkbox"/>	<input type="checkbox"/>	18.0#
	54" 48" 6"	PTPVF1804854	<input type="checkbox"/>	<input type="checkbox"/>	20.0#
	66" 48" 18"	PTPVF1804866	<input type="checkbox"/>	<input type="checkbox"/>	23.0#
	72" 48" 24"	PTPVF1804872	<input type="checkbox"/>	<input type="checkbox"/>	26.0#
	84" 48" 36"	PTPVF1804884	<input type="checkbox"/>	<input type="checkbox"/>	29.0#
	66" 54" 12"	PTPVF1805466	<input type="checkbox"/>	<input type="checkbox"/>	17.0#
	72" 54" 18"	PTPVF1805472	<input type="checkbox"/>	<input type="checkbox"/>	10.0#
	84" 54" 30"	PTPVF1805484	<input type="checkbox"/>	<input type="checkbox"/>	19.0#
	72" 66" 6"	PTPVF1806672	<input type="checkbox"/>	<input type="checkbox"/>	27.0#
	84" 66" 18"	PTPVF1806684	<input type="checkbox"/>	<input type="checkbox"/>	22.0#
	84" 72" 12"	PTPVF1807284	<input type="checkbox"/>	<input type="checkbox"/>	30.0#

A

B

C

## HOW TO ORDER

Indicate the following information on order form:

1. Quantity of each item.
2. Model number, including options. See "How To Build a Model Number".
3. Any special service required.

Note: • The  indicates that a choice is required.

- The absence of the  indicates that no choice is required.
- Alpha-numeric characters in place of  indicate that no other alternatives are available.

## HOW TO BUILD A MODEL NUMBER

**A** Select basic model.

**B** Select trim color.  
Refer to color addendum at [ki.com](http://ki.com) or KI Fabrics & Finishes binder.  
Metallic paint requires upcharge.  
SX Starlight Silver finish is only offered on flat aluminum trim.

**C** Select fabric color.  
Refer to color addendum at [ki.com](http://ki.com) or in KI Fabrics & Finishes binder.



# Preconfigured Intersection Conditions

3-Way

Delivered Pricing Fabric Grade 1 & C.O.M.	Delivered Pricing Fabric Grade 2	Delivered Pricing Fabric Grade 3 & Pallas Vertical Fabric Grade PV	Delivered Pricing Pallas Vertical Fabric Grade PV1	Delivered Pricing Pallas Vertical Fabric Grade PV2	Metallic Paint add to list price
\$ 302	\$ 309	\$ 311	\$ 317	\$ 323	\$ 26
327	335	339	346	354	26
368	379	381	388	399	26
390	397	400	410	422	26
406	414	419	426	439	26
380	386	390	398	409	26
485	492	499	508	523	26
333	339	342	348	357	26
344	350	354	362	369	26
364	369	376	384	394	26
380	387	390	399	410	26
382	390	393	401	412	26
438	445	449	458	471	26
346	353	355	363	374	26
373	381	384	393	401	26
416	424	428	437	448	26
443	449	452	461	473	26
491	500	507	517	530	26
369	379	382	390	400	26
385	391	396	402	414	26
386	393	397	403	416	26
439	446	450	460	473	26
393	400	403	412	425	26
385	391	396	402	416	26
473	483	487	495	510	26
382	390	393	401	412	26
403	414	420	430	443	26
425	433	439	445	458	26

## SPECIAL SERVICES

### Special Carton Marking

With specially marked information N/C

### Shipping

Delivered. Shipped **k.d. freight prepaid**  
**f.o.b. Manitowoc, Wisconsin 54220**  
factory. Freight class #70.

Specifications and prices are subject to  
change without prior notice.

# Preconfigured Intersection Conditions

4-Way

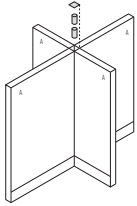
MODEL	A	MODEL NUMBER			Approx. Packaged Weight
		Basic Model	Assembly	Trim Color	
 <p><b>4-Way "X" Intersection with 4-Way Top Cap, All Panels Same Height</b></p> <ul style="list-style-type: none"> <li>• Upholstered: trim colored</li> <li>• 4-way top cap</li> <li>• 4-way light block</li> <li>• Four half-posts</li> <li>• Connecting hardware</li> <li>• SX Starlight Silver finish is only offered on flat aluminum trim</li> </ul>	30"	PXP4W30	<input type="checkbox"/>	<input type="checkbox"/>	10.0#
	36"	PXP4W36	<input type="checkbox"/>	<input type="checkbox"/>	10.0#
	42"	PXP4W42	<input type="checkbox"/>	<input type="checkbox"/>	14.0#
	48"	PXP4W48	<input type="checkbox"/>	<input type="checkbox"/>	14.0#
	54"	PXP4W54	<input type="checkbox"/>	<input type="checkbox"/>	19.0#
	60"	PXP4W60	<input type="checkbox"/>	<input type="checkbox"/>	19.0#
	66"	PXP4W66	<input type="checkbox"/>	<input type="checkbox"/>	23.0#
	72"	PXP4W72	<input type="checkbox"/>	<input type="checkbox"/>	23.0#
	78"	PXP4W78	<input type="checkbox"/>	<input type="checkbox"/>	23.0#
	84"	PXP4W84	<input type="checkbox"/>	<input type="checkbox"/>	30.0#

A

B

C

## HOW TO ORDER

Indicate the following information on order form:

1. Quantity of each item.
2. Model number, including options. See "How To Build a Model Number".
3. Any special service required.

Note:

- The  indicates that a choice is required.
- The absence of the  indicates that no choice is required.
- Alpha-numeric characters in place of  indicate that no other alternatives are available.

## HOW TO BUILD A MODEL NUMBER

**A** Select basic model.

**B** Select assembly.

F	- Fully Assembled; add \$91
U	- Unassembled

**C** Select trim color.

Refer to color addendum at [ki.com](http://ki.com) or KI Fabrics & Finishes binder.  
Metallic paint requires upcharge.  
SX Starlight Silver finish is only offered on flat aluminum trim.





# Preconfigured Intersection Conditions

4-Way

Delivered Pricing	Metallic Paint add to list price
\$ 206	\$ 9
214	9
236	9
269	9
279	9
254	9
290	9
291	9
305	9
356	9

## SPECIAL SERVICES

### Special Carton Marking

With specially marked information N/C

### Shipping

Delivered. Shipped **k.d. freight prepaid f.o.b. Manitowoc, Wisconsin 54220** factory. Freight class #70.

Specifications and prices are subject to change without prior notice.

# Preconfigured Intersection Conditions

4-Way

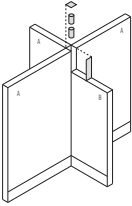
MODEL	A B A-B	MODEL NUMBER		Approx. Packaged Weight
		Basic Model	Trim Color	
 <p>PTN</p> <p><b>4-Way "X" Intersection with 3-Way Top Cap, Two Different Heights - AAAB</b></p> <ul style="list-style-type: none"> <li>• Upholstered: trim colored</li> <li>• 3-way top cap</li> <li>• 4-way light block</li> <li>• One piece of universal height change trim</li> <li>• One half-post (height B)</li> <li>• Three half-posts (height A)</li> <li>• Connecting hardware</li> <li>• SX Starlight Silver finish is only offered on flat aluminum trim</li> </ul>	36" 30" 6"	PXPV3W3036	<input type="checkbox"/>	13.0#
	42" 30" 12"	PXPV3W3042	<input type="checkbox"/>	14.0#
	48" 30" 18"	PXPV3W3048	<input type="checkbox"/>	17.0#
	54" 30" 24"	PXPV3W3054	<input type="checkbox"/>	17.0#
	66" 30" 36"	PXPV3W3066	<input type="checkbox"/>	20.0#
	72" 30" 42"	PXPV3W3072	<input type="checkbox"/>	23.0#
	84" 30" 54"	PXPV3W3084	<input type="checkbox"/>	26.0#
	42" 36" 6"	PXPV3W3642	<input type="checkbox"/>	16.0#
	48" 36" 12"	PXPV3W3648	<input type="checkbox"/>	17.0#
	54" 36" 18"	PXPV3W3654	<input type="checkbox"/>	19.0#
	66" 36" 30"	PXPV3W3666	<input type="checkbox"/>	21.0#
	72" 36" 36"	PXPV3W3672	<input type="checkbox"/>	23.0#
	84" 36" 48"	PXPV3W3684	<input type="checkbox"/>	26.0#
	48" 42" 6"	PXPV3W4248	<input type="checkbox"/>	18.0#
	54" 42" 12"	PXPV3W4254	<input type="checkbox"/>	18.0#
	66" 42" 24"	PXPV3W4266	<input type="checkbox"/>	21.0#
	72" 42" 30"	PXPV3W4272	<input type="checkbox"/>	24.0#
	84" 42" 42"	PXPV3W4284	<input type="checkbox"/>	27.0#
	54" 48" 6"	PXPV3W4854	<input type="checkbox"/>	20.0#
	66" 48" 18"	PXPV3W4866	<input type="checkbox"/>	23.0#
	72" 48" 24"	PXPV3W4872	<input type="checkbox"/>	25.0#
	84" 48" 36"	PXPV3W4884	<input type="checkbox"/>	27.0#
	66" 54" 12"	PXPV3W5466	<input type="checkbox"/>	22.0#
	72" 54" 18"	PXPV3W5472	<input type="checkbox"/>	26.0#
	84" 54" 30"	PXPV3W5484	<input type="checkbox"/>	28.0#
	72" 66" 6"	PXPV3W6672	<input type="checkbox"/>	27.0#
	84" 66" 18"	PXPV3W6684	<input type="checkbox"/>	29.0#
	84" 72" 12"	PXPV3W7284	<input type="checkbox"/>	30.0#

A

B

## HOW TO ORDER

Indicate the following information on order form:

1. Quantity of each item.
2. Model number, including options. See "How To Build a Model Number".
3. Any special service required.

Note: • The  indicates that a choice is required.

- The absence of the  indicates that no choice is required.
- Alpha-numeric characters in place of  indicate that no other alternatives are available.

## HOW TO BUILD A MODEL NUMBER

**A** Select basic model.

**B** Select trim color.

Refer to color addendum at [ki.com](http://ki.com) or KI Fabrics & Finishes binder. Metallic paint requires upcharge. SX Starlight Silver finish is only offered on flat aluminum trim.



# Preconfigured Intersection Conditions

4-Way

Delivered Pricing	Metallic Paint add to list price
\$ 251	\$ 26
260	26
311	28
320	28
339	30
300	36
409	38
260	26
283	28
296	28
311	29
305	30
359	36
281	26
311	28
348	28
369	29
419	36
303	26
316	28
309	28
363	30
329	28
309	28
399	29
306	26
330	28
355	28

## SPECIAL SERVICES

### Special Carton Marking

With specially marked information N/C

### Shipping

Delivered. Shipped **k.d. freight prepaid f.o.b. Manitowoc, Wisconsin 54220** factory. Freight class #70.

Specifications and prices are subject to change without prior notice.

# Preconfigured Intersection Conditions

4-Way

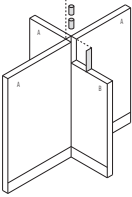
MODEL	A B A-B	MODEL NUMBER			Approx. Packaged Weight
		Basic Model	Trim Color	Fabric Color	
 <p>PTF</p> <p><b>4-Way "X" Intersection with 3-Way Top Cap, Two Different Heights - AAAB</b></p> <ul style="list-style-type: none"> <li>• Upholstered</li> <li>• 3-way top cap</li> <li>• 4-way light block</li> <li>• One fabric-wrapped piece of universal height change trim</li> <li>• One half-post (height B)</li> <li>• Three half-posts (height A)</li> <li>• Connecting hardware</li> <li>• SX Starlight Silver finish is only offered on flat aluminum trim</li> </ul>	36" 30" 6"	PXPVF3W3036	<input type="checkbox"/>	<input type="checkbox"/>	13.0#
	42" 30" 12"	PXPVF3W3042	<input type="checkbox"/>	<input type="checkbox"/>	14.0#
	48" 30" 18"	PXPVF3W3048	<input type="checkbox"/>	<input type="checkbox"/>	17.0#
	54" 30" 24"	PXPVF3W3054	<input type="checkbox"/>	<input type="checkbox"/>	17.0#
	66" 30" 36"	PXPVF3W3066	<input type="checkbox"/>	<input type="checkbox"/>	20.0#
	72" 30" 42"	PXPVF3W3072	<input type="checkbox"/>	<input type="checkbox"/>	23.0#
	84" 30" 54"	PXPVF3W3084	<input type="checkbox"/>	<input type="checkbox"/>	26.0#
	42" 36" 6"	PXPVF3W3642	<input type="checkbox"/>	<input type="checkbox"/>	16.0#
	48" 36" 12"	PXPVF3W3648	<input type="checkbox"/>	<input type="checkbox"/>	17.0#
	54" 36" 18"	PXPVF3W3654	<input type="checkbox"/>	<input type="checkbox"/>	19.0#
	66" 36" 30"	PXPVF3W3666	<input type="checkbox"/>	<input type="checkbox"/>	21.0#
	72" 36" 36"	PXPVF3W3672	<input type="checkbox"/>	<input type="checkbox"/>	23.0#
	84" 36" 48"	PXPVF3W3684	<input type="checkbox"/>	<input type="checkbox"/>	26.0#
	48" 42" 6"	PXPVF3W4248	<input type="checkbox"/>	<input type="checkbox"/>	18.0#
	54" 42" 12"	PXPVF3W4254	<input type="checkbox"/>	<input type="checkbox"/>	18.0#
	66" 42" 24"	PXPVF3W4266	<input type="checkbox"/>	<input type="checkbox"/>	21.0#
	72" 42" 30"	PXPVF3W4272	<input type="checkbox"/>	<input type="checkbox"/>	24.0#
	84" 42" 42"	PXPVF3W4284	<input type="checkbox"/>	<input type="checkbox"/>	27.0#
	54" 48" 6"	PXPVF3W4854	<input type="checkbox"/>	<input type="checkbox"/>	20.0#
	66" 48" 18"	PXPVF3W4866	<input type="checkbox"/>	<input type="checkbox"/>	23.0#
	72" 48" 24"	PXPVF3W4872	<input type="checkbox"/>	<input type="checkbox"/>	25.0#
	84" 48" 36"	PXPVF3W4884	<input type="checkbox"/>	<input type="checkbox"/>	27.0#
	66" 54" 12"	PXPVF3W5466	<input type="checkbox"/>	<input type="checkbox"/>	22.0#
	72" 54" 18"	PXPVF3W5472	<input type="checkbox"/>	<input type="checkbox"/>	26.0#
	84" 54" 30"	PXPVF3W5484	<input type="checkbox"/>	<input type="checkbox"/>	28.0#
	72" 66" 6"	PXPVF3W6672	<input type="checkbox"/>	<input type="checkbox"/>	27.0#
	84" 66" 18"	PXPVF3W6684	<input type="checkbox"/>	<input type="checkbox"/>	29.0#
	84" 72" 12"	PXPVF3W7284	<input type="checkbox"/>	<input type="checkbox"/>	30.0#

A

B

C

## HOW TO ORDER

Indicate the following information on order form:

1. Quantity of each item.
2. Model number, including options. See "How To Build a Model Number".
3. Any special service required.

Note: • The  indicates that a choice is required.

- The absence of the  indicates that no choice is required.
- Alpha-numeric characters in place of  indicate that no other alternatives are available.

## HOW TO BUILD A MODEL NUMBER

**A** Select basic model.

**B** Select trim color.

Refer to color addendum at [ki.com](http://ki.com) or KI Fabrics & Finishes binder. Metallic paint requires upcharge. SX Starlight Silver finish is only offered on flat aluminum trim.

**C** Select fabric color.

Refer to color addendum at [ki.com](http://ki.com) or in KI Fabrics & Finishes binder.



# Preconfigured Intersection Conditions

4-Way

Delivered Pricing Fabric Grade 1 & C.O.M.	Delivered Pricing Fabric Grade 2	Delivered Pricing Fabric Grade 3 & Pallas Vertical Fabric Grade PV	Delivered Pricing Pallas Vertical Fabric Grade PV1	Delivered Pricing Pallas Vertical Fabric Grade PV2	Metallic Paint add to list price
\$ 291	\$ 298	\$ 300	\$ 307	\$ 314	\$ 9
300	306	309	314	322	9
353	358	363	369	381	9
364	369	376	384	393	9
381	388	393	400	411	9
344	350	354	362	369	9
453	464	470	480	490	9
305	310	312	318	327	9
317	322	324	334	343	9
333	339	342	348	358	9
359	366	368	379	388	9
374	381	384	391	400	9
402	412	419	426	439	9
327	334	337	344	354	9
348	354	357	365	376	9
391	398	401	411	423	9
416	423	425	433	443	9
462	473	480	486	499	9
344	352	355	362	373	9
357	364	367	378	387	9
352	357	362	368	380	9
408	414	419	428	439	9
367	376	380	387	398	9
352	357	359	367	379	9
443	451	456	467	480	9
347	354	356	364	374	9
369	381	385	394	406	9
394	402	403	414	425	9

## SPECIAL SERVICES

### Special Carton Marking

With specially marked information N/C

### Shipping

Delivered. Shipped **k.d. freight prepaid**  
**f.o.b. Manitowoc, Wisconsin 54220**  
factory. Freight class #70.

Specifications and prices are subject to  
change without prior notice.

# Preconfigured Intersection Conditions

4-Way

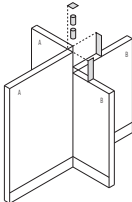
MODEL	A	B	A-B	MODEL NUMBER		Approx. Packaged Weight
				Basic Model	Trim Color	
 <p>PTN</p> <p><b>4-Way "X" Intersection w/90° Top Cap, Two Different Heights - AABB</b></p> <ul style="list-style-type: none"> <li>• Upholstered: trim colored</li> <li>• 90° top cap</li> <li>• 4-way light block</li> <li>• Two pieces of universal height change trim</li> <li>• Two half-posts (height A)</li> <li>• Two half-posts (height B)</li> <li>• Connecting hardware</li> <li>• SX Starlight Silver finish is only offered on flat aluminum trim</li> </ul>	36"	30"	6"	PXPV903036	<input type="checkbox"/>	13.0#
	42"	30"	12"	PXPV903042	<input type="checkbox"/>	13.0#
	48"	30"	18"	PXPV903048	<input type="checkbox"/>	17.0#
	54"	30"	24"	PXPV903054	<input type="checkbox"/>	16.0#
	66"	30"	36"	PXPV903066	<input type="checkbox"/>	19.0#
	72"	30"	42"	PXPV903072	<input type="checkbox"/>	24.0#
	84"	30"	54"	PXPV903084	<input type="checkbox"/>	23.0#
	42"	36"	6"	PXPV903642	<input type="checkbox"/>	16.0#
	48"	36"	12"	PXPV903648	<input type="checkbox"/>	17.0#
	54"	36"	18"	PXPV903654	<input type="checkbox"/>	19.0#
	66"	36"	30"	PXPV903666	<input type="checkbox"/>	22.0#
	72"	36"	36"	PXPV903672	<input type="checkbox"/>	24.0#
	84"	36"	48"	PXPV903684	<input type="checkbox"/>	27.0#
	48"	42"	6"	PXPV904248	<input type="checkbox"/>	18.0#
	54"	42"	12"	PXPV904254	<input type="checkbox"/>	17.0#
	66"	42"	24"	PXPV904266	<input type="checkbox"/>	20.0#
	72"	42"	30"	PXPV904272	<input type="checkbox"/>	25.0#
	84"	42"	42"	PXPV904284	<input type="checkbox"/>	24.0#
	54"	48"	6"	PXPV904854	<input type="checkbox"/>	20.0#
	66"	48"	18"	PXPV904866	<input type="checkbox"/>	23.0#
	72"	48"	24"	PXPV904872	<input type="checkbox"/>	25.0#
	84"	48"	36"	PXPV904884	<input type="checkbox"/>	28.0#
	66"	54"	12"	PXPV905466	<input type="checkbox"/>	21.0#
	72"	54"	18"	PXPV905472	<input type="checkbox"/>	26.0#
	84"	54"	30"	PXPV905484	<input type="checkbox"/>	25.0#
	72"	66"	6"	PXPV906672	<input type="checkbox"/>	27.0#
	84"	66"	18"	PXPV906684	<input type="checkbox"/>	27.0#
	84"	72"	12"	PXPV907284	<input type="checkbox"/>	30.0#

A

B

## HOW TO ORDER

Indicate the following information on order form:

1. Quantity of each item.
2. Model number, including options. See "How To Build a Model Number".
3. Any special service required.

Note: • The  indicates that a choice is required.

- The absence of the  indicates that no choice is required.
- Alpha-numeric characters in place of  indicate that no other alternatives are available.

## HOW TO BUILD A MODEL NUMBER

**A** Select basic model.

**B** Select trim color.

Refer to color addendum at [ki.com](http://ki.com) or KI Fabrics & Finishes binder. Metallic paint requires upcharge. SX Starlight Silver finish is only offered on flat aluminum trim.



# Preconfigured Intersection Conditions

4-Way

Delivered Pricing	Metallic Paint add to list price
\$ 253	\$ 36
262	39
309	39
319	39
364	44
309	59
409	64
263	36
281	39
295	39
312	41
314	44
364	59
280	36
307	39
352	39
368	41
414	59
306	36
320	39
319	39
366	44
335	39
319	39
401	41
314	36
333	39
347	39

## SPECIAL SERVICES

### Special Carton Marking

With specially marked information N/C

### Shipping

Delivered. Shipped **k.d. freight prepaid f.o.b. Manitowoc, Wisconsin 54220** factory. Freight class #70.

Specifications and prices are subject to change without prior notice.

# Preconfigured Intersection Conditions

4-Way

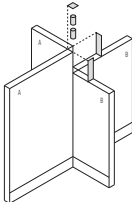
MODEL	A B A-B	MODEL NUMBER			Approx. Packaged Weight
		Basic Model	Trim Color	Fabric Color	
 <p>PTNF</p> <p><b>4-Way "X" Intersection w/90° Top Cap, Two Different Heights - AABB</b></p> <ul style="list-style-type: none"> <li>• Upholstered</li> <li>• 90° top cap</li> <li>• 4-way light block</li> <li>• Two fabric-wrapped pieces of universal height change trim</li> <li>• Two half-posts (height A)</li> <li>• Two half-posts (height B)</li> <li>• Connecting hardware</li> <li>• SX Starlight Silver finish is only offered on flat aluminum trim</li> </ul>	36" 30" 6"	PXPVF903036	<input type="checkbox"/>	<input type="checkbox"/>	13.0#
	42" 30" 12"	PXPVF903042	<input type="checkbox"/>	<input type="checkbox"/>	13.0#
	48" 30" 18"	PXPVF903048	<input type="checkbox"/>	<input type="checkbox"/>	17.0#
	54" 30" 24"	PXPVF903054	<input type="checkbox"/>	<input type="checkbox"/>	16.0#
	66" 30" 36"	PXPVF903066	<input type="checkbox"/>	<input type="checkbox"/>	19.0#
	72" 30" 42"	PXPVF903072	<input type="checkbox"/>	<input type="checkbox"/>	24.0#
	84" 30" 54"	PXPVF903084	<input type="checkbox"/>	<input type="checkbox"/>	23.0#
	42" 36" 6"	PXPVF903642	<input type="checkbox"/>	<input type="checkbox"/>	16.0#
	48" 36" 12"	PXPVF903648	<input type="checkbox"/>	<input type="checkbox"/>	17.0#
	54" 36" 18"	PXPVF903654	<input type="checkbox"/>	<input type="checkbox"/>	19.0#
	66" 36" 30"	PXPVF903666	<input type="checkbox"/>	<input type="checkbox"/>	22.0#
	72" 36" 36"	PXPVF903672	<input type="checkbox"/>	<input type="checkbox"/>	24.0#
	84" 36" 48"	PXPVF903684	<input type="checkbox"/>	<input type="checkbox"/>	27.0#
	48" 42" 6"	PXPVF904248	<input type="checkbox"/>	<input type="checkbox"/>	18.0#
	54" 42" 12"	PXPVF904254	<input type="checkbox"/>	<input type="checkbox"/>	17.0#
	66" 42" 24"	PXPVF904266	<input type="checkbox"/>	<input type="checkbox"/>	20.0#
	72" 42" 30"	PXPVF904272	<input type="checkbox"/>	<input type="checkbox"/>	25.0#
	84" 42" 42"	PXPVF904284	<input type="checkbox"/>	<input type="checkbox"/>	24.0#
	54" 48" 6"	PXPVF904854	<input type="checkbox"/>	<input type="checkbox"/>	20.0#
	66" 48" 18"	PXPVF904866	<input type="checkbox"/>	<input type="checkbox"/>	23.0#
	72" 48" 24"	PXPVF904872	<input type="checkbox"/>	<input type="checkbox"/>	25.0#
	84" 48" 36"	PXPVF904884	<input type="checkbox"/>	<input type="checkbox"/>	28.0#
	66" 54" 12"	PXPVF905466	<input type="checkbox"/>	<input type="checkbox"/>	21.0#
	72" 54" 18"	PXPVF905472	<input type="checkbox"/>	<input type="checkbox"/>	26.0#
	84" 54" 30"	PXPVF905484	<input type="checkbox"/>	<input type="checkbox"/>	25.0#
	72" 66" 6"	PXPVF906672	<input type="checkbox"/>	<input type="checkbox"/>	27.0#
	84" 66" 18"	PXPVF906684	<input type="checkbox"/>	<input type="checkbox"/>	27.0#
	84" 72" 12"	PXPVF907284	<input type="checkbox"/>	<input type="checkbox"/>	30.0#

A

B

C

## HOW TO ORDER

Indicate the following information on order form:

1. Quantity of each item.
2. Model number, including options. See "How To Build a Model Number".
3. Any special service required.

Note: • The  indicates that a choice is required.

- The absence of the  indicates that no choice is required.
- Alpha-numeric characters in place of  indicate that no other alternatives are available.

## HOW TO BUILD A MODEL NUMBER

**A** Select basic model.

**B** Select trim color.

Refer to color addendum at [ki.com](http://ki.com) or KI Fabrics & Finishes binder. Metallic paint requires upcharge. SX Starlight Silver finish is only offered on flat aluminum trim.

**C** Select fabric color.

Refer to color addendum at [ki.com](http://ki.com) or in KI Fabrics & Finishes binder.





# Preconfigured Intersection Conditions

4-Way

Delivered Pricing Fabric Grade 1 & C.O.M.	Delivered Pricing Fabric Grade 2	Delivered Pricing Fabric Grade 3 & Pallas Vertical Fabric Grade PV	Delivered Pricing Pallas Vertical Fabric Grade PV1	Delivered Pricing Pallas Vertical Fabric Grade PV2	Metallic Paint add to list price
\$ 339	\$ 344	\$ 348	\$ 355	\$ 364	\$ 9
343	348	353	359	368	9
393	401	402	412	424	9
406	414	419	426	439	9
451	460	464	474	487	9
397	402	408	416	428	9
499	508	516	526	539	9
348	355	358	366	378	9
363	368	373	381	391	9
379	385	388	397	408	9
406	414	419	426	439	9
420	428	432	441	451	9
448	464	473	488	511	9
367	376	380	387	398	9
387	394	398	406	419	9
437	444	448	456	470	9
456	467	470	480	489	9
501	511	519	528	543	9
391	398	401	410	423	9
408	414	419	428	439	9
408	414	419	428	439	9
454	464	469	481	490	9
414	423	426	437	448	9
403	412	417	426	438	9
488	496	505	515	529	9
399	406	410	420	431	9
414	424	430	439	451	9
428	437	440	449	461	9

## SPECIAL SERVICES

### Special Carton Marking

With specially marked information N/C

### Shipping

Delivered. Shipped **k.d. freight prepaid**  
**f.o.b. Manitowoc, Wisconsin 54220**  
factory. Freight class #70.

Specifications and prices are subject to  
change without prior notice.

# Preconfigured Intersection Conditions

4-Way

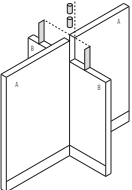
MODEL	A	B	A-B	MODEL NUMBER		Approx. Packaged Weight
				Basic Model	Trim Color	
 <p>PTN</p> <p><b>4-Way "X" Intersection w/180° Top Cap, Two Different Heights - ABAB</b></p> <ul style="list-style-type: none"> <li>• Unupholstered: trim colored</li> <li>• 180° top cap</li> <li>• 4-way light block</li> <li>• Two pieces of universal height change trim</li> <li>• Two half-posts (height B)</li> <li>• Two half-posts (height A)</li> <li>• Connecting hardware</li> <li>• SX Starlight Silver finish is only offered on flat aluminum trim</li> </ul>	36"	30"	6"	PXPV1803036	<input type="checkbox"/>	13.0#
	42"	30"	12"	PXPV1803042	<input type="checkbox"/>	13.0#
	48"	30"	18"	PXPV1803048	<input type="checkbox"/>	17.0#
	54"	30"	24"	PXPV1803054	<input type="checkbox"/>	16.0#
	66"	30"	36"	PXPV1803066	<input type="checkbox"/>	19.0#
	72"	30"	42"	PXPV1803072	<input type="checkbox"/>	22.0#
	84"	30"	54"	PXPV1803084	<input type="checkbox"/>	23.0#
	42"	36"	6"	PXPV1803642	<input type="checkbox"/>	16.0#
	48"	36"	12"	PXPV1803648	<input type="checkbox"/>	17.0#
	54"	36"	18"	PXPV1803654	<input type="checkbox"/>	19.0#
	66"	36"	30"	PXPV1803666	<input type="checkbox"/>	21.0#
	72"	36"	36"	PXPV1803672	<input type="checkbox"/>	23.0#
	84"	36"	48"	PXPV1803684	<input type="checkbox"/>	26.0#
	48"	42"	6"	PXPV1804248	<input type="checkbox"/>	18.0#
	54"	42"	12"	PXPV1804254	<input type="checkbox"/>	17.0#
	66"	42"	24"	PXPV1804266	<input type="checkbox"/>	20.0#
	72"	42"	30"	PXPV1804272	<input type="checkbox"/>	24.0#
	84"	42"	42"	PXPV1804284	<input type="checkbox"/>	25.0#
	54"	48"	6"	PXPV1804854	<input type="checkbox"/>	20.0#
	66"	48"	18"	PXPV1804866	<input type="checkbox"/>	23.0#
	72"	48"	24"	PXPV1804872	<input type="checkbox"/>	25.0#
	84"	48"	36"	PXPV1804884	<input type="checkbox"/>	27.0#
	66"	54"	12"	PXPV1805466	<input type="checkbox"/>	21.0#
	72"	54"	18"	PXPV1805472	<input type="checkbox"/>	25.0#
	84"	54"	30"	PXPV1805484	<input type="checkbox"/>	26.0#
	72"	66"	6"	PXPV1806672	<input type="checkbox"/>	26.0#
	84"	66"	18"	PXPV1806684	<input type="checkbox"/>	27.0#
	84"	72"	12"	PXPV1807284	<input type="checkbox"/>	30.0#

A

B

## HOW TO ORDER

Indicate the following information on order form:

1. Quantity of each item.
2. Model number, including options. See "How To Build a Model Number".
3. Any special service required.

Note: • The  indicates that a choice is required.

- The absence of the  indicates that no choice is required.
- Alpha-numeric characters in place of  indicate that no other alternatives are available.

## HOW TO BUILD A MODEL NUMBER

**A** Select basic model.

**B** Select trim color.

Refer to color addendum at [ki.com](http://ki.com) or KI Fabrics & Finishes binder. Metallic paint requires upcharge. SX Starlight Silver finish is only offered on flat aluminum trim.



# Preconfigured Intersection Conditions

4-Way

Delivered Pricing	Metallic Paint add to list price
\$ 256	\$ 36
264	39
311	39
321	39
343	44
311	59
411	64
267	36
286	39
298	39
314	41
317	44
366	59
283	36
310	39
353	39
373	41
417	59
309	36
323	39
321	39
368	44
339	39
321	39
403	41
316	36
334	39
352	39

## SPECIAL SERVICES

### Special Carton Marking

With specially marked information N/C

### Shipping

Delivered. Shipped **k.d. freight prepaid f.o.b. Manitowoc, Wisconsin 54220** factory. Freight class #70.

Specifications and prices are subject to change without prior notice.

# Preconfigured Intersection Conditions

4-Way

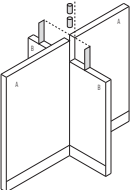
MODEL	A B A-B	MODEL NUMBER			Approx. Packaged Weight
		Basic Model	Trim Color	Fabric Color	
 <p><b>4-Way "X" Intersection w/180° Top Cap, Two Different Heights - AABB</b></p> <ul style="list-style-type: none"> <li>• Upholstered</li> <li>• 180° top cap</li> <li>• 4-way light block</li> <li>• Two fabric-wrapped pieces of universal height change trim</li> <li>• Two half-posts (height A)</li> <li>• Two half-posts (height B)</li> <li>• Connecting hardware</li> <li>• SX Starlight Silver finish is only offered on flat aluminum trim</li> </ul>	36" 30" 6"	PXPVF1803036	<input type="checkbox"/>	<input type="checkbox"/>	13.0#
	42" 30" 12"	PXPVF1803042	<input type="checkbox"/>	<input type="checkbox"/>	13.0#
	48" 30" 18"	PXPVF1803048	<input type="checkbox"/>	<input type="checkbox"/>	17.0#
	54" 30" 24"	PXPVF1803054	<input type="checkbox"/>	<input type="checkbox"/>	16.0#
	66" 30" 36"	PXPVF1803066	<input type="checkbox"/>	<input type="checkbox"/>	19.0#
	72" 30" 42"	PXPVF1803072	<input type="checkbox"/>	<input type="checkbox"/>	22.0#
	84" 30" 54"	PXPVF1803084	<input type="checkbox"/>	<input type="checkbox"/>	23.0#
	42" 36" 6"	PXPVF1803642	<input type="checkbox"/>	<input type="checkbox"/>	16.0#
	48" 36" 12"	PXPVF1803648	<input type="checkbox"/>	<input type="checkbox"/>	17.0#
	54" 36" 18"	PXPVF1803654	<input type="checkbox"/>	<input type="checkbox"/>	19.0#
	66" 36" 30"	PXPVF1803666	<input type="checkbox"/>	<input type="checkbox"/>	21.0#
	72" 36" 36"	PXPVF1803672	<input type="checkbox"/>	<input type="checkbox"/>	23.0#
	84" 36" 48"	PXPVF1803684	<input type="checkbox"/>	<input type="checkbox"/>	26.0#
	48" 42" 6"	PXPVF1804248	<input type="checkbox"/>	<input type="checkbox"/>	18.0#
	54" 42" 12"	PXPVF1804254	<input type="checkbox"/>	<input type="checkbox"/>	17.0#
	66" 42" 24"	PXPVF1804266	<input type="checkbox"/>	<input type="checkbox"/>	20.0#
	72" 42" 30"	PXPVF1804272	<input type="checkbox"/>	<input type="checkbox"/>	24.0#
	84" 42" 42"	PXPVF1804284	<input type="checkbox"/>	<input type="checkbox"/>	25.0#
	54" 48" 6"	PXPVF1804854	<input type="checkbox"/>	<input type="checkbox"/>	20.0#
	66" 48" 18"	PXPVF1804866	<input type="checkbox"/>	<input type="checkbox"/>	23.0#
	72" 48" 24"	PXPVF1804872	<input type="checkbox"/>	<input type="checkbox"/>	25.0#
	84" 48" 36"	PXPVF1804884	<input type="checkbox"/>	<input type="checkbox"/>	27.0#
	66" 54" 12"	PXPVF1805466	<input type="checkbox"/>	<input type="checkbox"/>	21.0#
	72" 54" 18"	PXPVF1805472	<input type="checkbox"/>	<input type="checkbox"/>	25.0#
	84" 54" 30"	PXPVF1805484	<input type="checkbox"/>	<input type="checkbox"/>	26.0#
	72" 66" 6"	PXPVF1806672	<input type="checkbox"/>	<input type="checkbox"/>	26.0#
	84" 66" 18"	PXPVF1806684	<input type="checkbox"/>	<input type="checkbox"/>	27.0#
	84" 72" 12"	PXPVF1807284	<input type="checkbox"/>	<input type="checkbox"/>	30.0#

A

B

C

## HOW TO ORDER

Indicate the following information on order form:

1. Quantity of each item.
2. Model number, including options. See "How To Build a Model Number".
3. Any special service required.

Note: • The  indicates that a choice is required.

- The absence of the  indicates that no choice is required.
- Alpha-numeric characters in place of  indicate that no other alternatives are available.

## HOW TO BUILD A MODEL NUMBER

**A** Select basic model.

**B** Select trim color.  
Refer to color addendum at ki.com or KI Fabrics & Finishes binder.  
Metallic paint requires upcharge.  
SX Starlight Silver finish is only offered on flat aluminum trim.

**C** Select fabric color.  
Refer to color addendum at ki.com or in KI Fabrics & Finishes binder.



# Preconfigured Intersection Conditions

4-Way

Delivered Pricing Fabric Grade 1 & C.O.M.	Delivered Pricing Fabric Grade 2	Delivered Pricing Fabric Grade 3 & Pallas Vertical Fabric Grade PV	Delivered Pricing Pallas Vertical Fabric Grade PV1	Delivered Pricing Pallas Vertical Fabric Grade PV2	Metallic Paint add to list price
\$ 289	\$ 295	\$ 298	\$ 305	\$ 312	\$ 9
346	352	355	363	373	9
396	401	406	416	426	9
409	417	422	431	441	9
432	440	444	452	467	9
330	337	341	347	356	9
501	511	519	528	542	9
302	307	310	316	323	9
314	320	322	330	341	9
324	333	337	343	353	9
339	344	348	355	364	9
337	343	346	354	363	9
379	386	388	398	409	9
318	323	327	337	344	9
348	355	358	366	380	9
439	446	450	460	473	9
440	446	450	456	468	9
506	516	523	531	547	9
342	348	353	358	368	9
354	359	363	369	381	9
348	355	357	365	378	9
388	397	399	409	420	9
417	425	430	439	450	9
352	357	362	368	380	9
490	500	507	517	531	9
352	357	362	368	380	9
364	374	380	388	401	9
380	386	390	398	409	9

## SPECIAL SERVICES

### Special Carton Marking

With specially marked information N/C

### Shipping

Delivered. Shipped **k.d. freight prepaid f.o.b. Manitowoc, Wisconsin 54220** factory. Freight class #70.

Specifications and prices are subject to change without prior notice.

# Preconfigured Stackable Intersection Conditions

180° 2-Way and End-of-Run

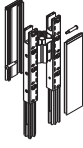
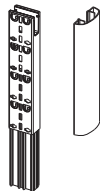
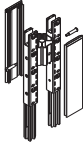
	MODEL	H	MODEL NUMBER			Approx. Packaged Weight	Delivered Pricing
			Basic Model	Trim Color	Fabric Color		
	<b>Stackable Panel-180° 2-Way In-Line Connection, Both Same Height</b> • Upholstered • One stackable full-post • Black only	12"	PSFP12			3.0#	\$ 73
		18"	PSFP18			4.0#	78
		24"	PSFP24			5.0#	82
	<b>Stackable Panel-180° 2-Way In-Line Spacer, Both Same Height</b> • Upholstered: trim colored • Two pieces of stackable universal trim • Stackable in-line trim • Two stackable half-posts • Corner connector block • Use top caps from existing lower panels • SX Starlight Silver finish is only offered on flat aluminum trim	12"	PSSP18012	<input type="checkbox"/>	<input type="checkbox"/>	3.0#	\$ 248
		18"	PSSP18018	<input type="checkbox"/>	<input type="checkbox"/>	4.0#	270
		24"	PSSP18024	<input type="checkbox"/>	<input type="checkbox"/>	5.0#	279
	<b>Stackable Panel - End-Of-Run Condition</b> • Upholstered • Stackable end-of-run trim • Stackable full-post • SX Starlight Silver finish is only offered on flat aluminum trim	12"	PSEP12	<input type="checkbox"/>	<input type="checkbox"/>	2.0#	\$ 82
		18"	PSEP18	<input type="checkbox"/>	<input type="checkbox"/>	2.0#	88
		24"	PSEP24	<input type="checkbox"/>	<input type="checkbox"/>	3.0#	96
	<b>Stackable Panel-180° 2-Way In-Line Spacer, Both Panels Same Height</b> • Upholstered • Two pieces of fabric-wrapped universal trim • Two stackable half-posts • Corner connector block • Use top caps from existing lower panels	12"	PSSPF18012		<input type="checkbox"/> <input type="checkbox"/> <input type="checkbox"/> <input type="checkbox"/>	3.0#	N/A
		18"	PSSPF18018		<input type="checkbox"/> <input type="checkbox"/> <input type="checkbox"/> <input type="checkbox"/>	4.0#	N/A
		24"	PSSPF18024		<input type="checkbox"/> <input type="checkbox"/> <input type="checkbox"/> <input type="checkbox"/>	5.0#	N/A

A

B

C

## HOW TO ORDER

Indicate the following information on order form:

- Quantity of each item.
- Model number, including options. See "How To Build a Model Number".
- Any special service required.

Note: • The  indicates that a choice is required.

- The absence of the  indicates that no choice is required.
- Alpha-numeric characters in place of  indicate that no other alternatives are available.

## HOW TO BUILD A MODEL NUMBER

**A** Select basic model.



**B** Select trim color.  
Refer to color addendum at ki.com or KI Fabrics & Finishes binder.  
Metallic paint requires upcharge.  
SX Starlight Silver finish is only offered on flat aluminum trim.

**C** Select fabric color.  
Refer to color addendum at ki.com or in KI Fabrics & Finishes binder.

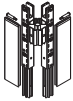
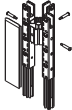

# Preconfigured Stackable Intersection Conditions

2-Way and 3-Way

	MODEL	H	MODEL NUMBER		Approx. Packaged Weight
			Basic Model	Trim Color	
 PST	<b>Stackable Panel-90° 2-Way "L" Corner, Both Panels Same Height</b> <ul style="list-style-type: none"> <li>• Unupholstered</li> <li>• Two pieces of stackable universal trim</li> <li>• Two stackable full-posts</li> <li>• Corner connector block</li> <li>• Use top caps from existing lower panels</li> <li>• SX Starlight Silver finish is only offered on flat aluminum trim</li> </ul>	12"	PSCP9012	<input type="checkbox"/>	3.0#
		18"	PSCP9018	<input type="checkbox"/>	4.0#
		24"	PSCP9024	<input type="checkbox"/>	5.0#
 PST	<b>Stackable Panel - 3-Way "T" Intersection/3-Way, All Panels Same Height</b> <ul style="list-style-type: none"> <li>• Unupholstered</li> <li>• Stackable universal trim</li> <li>• Three stackable half-posts</li> <li>• Corner connector block</li> <li>• Use top caps from existing lower panels</li> <li>• SX Starlight Silver finish is only offered on flat aluminum trim</li> </ul>	12"	PSTP3W12	<input type="checkbox"/>	4.0#
		18"	PSTP3W18	<input type="checkbox"/>	5.0#
		24"	PSTP3W24	<input type="checkbox"/>	7.0#
 HRDPT	<b>Stackable/Adjustable Wall Mount</b> <ul style="list-style-type: none"> <li>• Unupholstered</li> <li>• Attaches a stackable panel to a wall at the start of a run</li> <li>• Includes mounting plate and half-post</li> <li>• Steel construction with painted finish</li> <li>• Hardware for wall attachment is not included</li> <li>• Adjustable up to 1" to correct wall deflection</li> </ul>	12"	PSWM12		5.0#
		18"	PSWM18		7.0#
		24"	PSWM24		9.0#

**A**

**B**

## HOW TO ORDER

Indicate the following information on order form:

1. Quantity of each item.
2. Model number, including options. See "How To Build a Model Number".
3. Any special service required.

Note: • The  indicates that a choice is required.

- The absence of the  indicates that no choice is required.
- Alpha-numeric characters in place of  indicate that no other alternatives are available.

## HOW TO BUILD A MODEL NUMBER

**A** Select basic model.

**B** Select trim color.

Refer to color addendum at [ki.com](http://ki.com) or KI Fabrics & Finishes binder. Metallic paint requires upcharge. SX Starlight Silver finish is only offered on flat aluminum trim.





# Preconfigured Stackable Intersection Conditions

2-Way and 3-Way

Delivered Pricing	Metallic Paint add to list price
\$ 248	\$ 29
270	29
279	29
\$ 323	\$ 11
355	11
368	11
\$ 259	\$ 11
267	11
275	11

**SPECIAL SERVICES**

**Special Carton Marking**

With specially marked information N/C



**Shipping**

Delivered. Shipped **k.d. freight prepaid f.o.b. Manitowoc, Wisconsin 54220** factory. Freight class #70.

Specifications and prices are subject to change without prior notice.

# Preconfigured Stackable Intersection Conditions

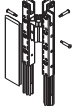
2-Way, 3-Way and 4-Way

	MODEL	H	MODEL NUMBER		Approx. Packaged Weight	Delivered Pricing
			Basic Model	Fabric Color		
 PSTF	<b>Stackable Panel-90° 2-way "L" Corner, Both Panels Same Height</b> <ul style="list-style-type: none"> <li>Upholstered</li> <li>Two pieces of stackable universal trim</li> <li>Two stackable half-posts</li> <li>Corner connector block</li> <li>Use top caps from existing lower panels</li> </ul>	12"	PSCPF9012	<input type="checkbox"/> <input type="checkbox"/> <input type="checkbox"/> <input type="checkbox"/>	3.0#	N/A
		18"	PSCPF9018	<input type="checkbox"/> <input type="checkbox"/> <input type="checkbox"/> <input type="checkbox"/>	4.0#	N/A
		24"	PSCPF9024	<input type="checkbox"/> <input type="checkbox"/> <input type="checkbox"/> <input type="checkbox"/>	5.0#	N/A
 PSTF	<b>Stackable Panel - 3-Way "T" Intersection/3-Way, All Panels Same Height</b> <ul style="list-style-type: none"> <li>Upholstered</li> <li>Fabric-wrapped stackable universal trim</li> <li>Three stackable half-posts</li> <li>Corner connector block</li> <li>Use top caps from existing lower panels</li> </ul>	12"	PSTPF3W12	<input type="checkbox"/> <input type="checkbox"/> <input type="checkbox"/> <input type="checkbox"/>	4.0#	N/A
		18"	PSTPF3W18	<input type="checkbox"/> <input type="checkbox"/> <input type="checkbox"/> <input type="checkbox"/>	5.0#	N/A
		24"	PSTPF3W24	<input type="checkbox"/> <input type="checkbox"/> <input type="checkbox"/> <input type="checkbox"/>	7.0#	N/A
 PST	<b>Stackable Panel-4Way "X" Intersection/4-Way Top Cap, All Same Height</b> <ul style="list-style-type: none"> <li>Unupholstered</li> <li>Four stackable half-posts</li> <li>Corner connector block</li> <li>4-way light block</li> <li>Use top caps from existing lower panels</li> </ul>	12"	PSXP4W12		5.0#	\$ 401
		18"	PSXP4W18		7.0#	425
		24"	PSXP4W24		9.0#	446

**A**

**B**

## HOW TO ORDER

Indicate the following information on order form:

- Quantity of each item.
- Model number, including options. See "How To Build a Model Number".
- Any special service required.

Note: • The  indicates that a choice is required.

- The absence of the  indicates that no choice is required.
- Alpha-numeric characters in place of  indicate that no other alternatives are available.

## HOW TO BUILD A MODEL NUMBER

**A** Select basic model.

**B** Select fabric color.

Refer to color addendum at [ki.com](http://ki.com) or in KI Fabrics & Finishes binder.



# Preconfigured Stackable Intersection Conditions

2-Way, 3-Way and 4-Way

Delivered Pricing Fabric Grade 1 & C.O.M.	Delivered Pricing Fabric Grade 2	Delivered Pricing Fabric Grade 3 & Pallas Vertical Fabric Grade PV	Delivered Pricing Pallas Vertical Fabric Grade PV1	Delivered Pricing Pallas Vertical Fabric Grade PV2
\$ 303	\$ 309	\$ 311	\$ 317	\$ 323
327	334	339	344	354
340	346	348	356	365
\$ 353	\$ 358	\$ 362	\$ 368	\$ 381
384	390	394	401	412
398	406	410	420	431

## SPECIAL SERVICES

### Special Carton Marking

With specially marked information N/C

### Shipping

Delivered. Shipped **k.d. freight prepaid f.o.b. Manitowoc, Wisconsin 54220** factory. Freight class #70.

Specifications and prices are subject to change without prior notice.

# Electrical

## 10-Wire System 6 Circuit "810

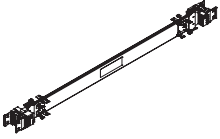
	MODEL	PANEL WIDTH	MODEL NUMBER	Approx. Packaged Weight
			Basic Model	
 <p>HRDPT</p> <p><b>Rigid Wireway - 6 Circuit</b></p> <ul style="list-style-type: none"> <li>• Distributes 10-wire power and allows receptacle mounting</li> <li>• Non-directional</li> <li>• Includes mounting clips</li> <li>• Wireway can be mounted inside the base raceway or behind any raceway tile 30 thru 60</li> <li>• Accommodates two duplex receptacles per side. Maximum of four per wireway as standard</li> <li>• Receptacles purchase separately</li> <li>• 24" wireway accommodates one duplex receptacle per side</li> </ul>		24"	PWET6WW.24	2.0#
		30"	PWET6WW.30	2.0#
		36"	PWET6WW.36	3.0#
		42"	PWET6WW.42	3.0#
		48"	PWET6WW.48	3.0#
		54"	PWET6WW.54	4.0#
		60"	PWET6WW.60	4.0#

**A**

### HOW TO ORDER

Indicate the following information on order form:

1. Quantity of each item.
2. Model number, including options. See "How To Build a Model Number".
3. Any special service required.

Note: • The  indicates that a choice is required.

- The absence of the  indicates that no choice is required.
- Alpha-numeric characters in place of  indicate that no other alternatives are available.

### HOW TO BUILD A MODEL NUMBER

- A** Select basic model.



Delivered  
Pricing

\$ 108  
112  
115  
121  
126  
129  
133

## SPECIAL SERVICES

### Special Carton Marking

With specially marked information N/C

### Shipping

Delivered. Shipped **k.d. freight prepaid**  
**f.o.b. Manitowoc, Wisconsin 54220**  
factory. Freight class #70.

Specifications and prices are subject to  
change without prior notice.

# Electrical

## 10-Wire System 6 Circuit "810

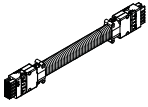
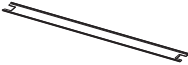
			MODEL NUMBER	
MODEL			Basic Model	Approx. Packaged Weight
			PANEL WIDTH	
 HRDPT	<b>Power Pass Through - 6 Circuit</b> <ul style="list-style-type: none"> <li>Distributes 10-wire power</li> <li>Non-directional</li> <li>Connects to adjacent Rigid Wireway or Power Pass Through via a horizontal jumper</li> <li>Receptacle access is not provided</li> <li>Pass through is the same length as the corresponding Rigid Wireway</li> <li>Pass through requires panel to panel jumpers (ordered separately)</li> </ul>	12"	PWET6PP.12	1.0#
		18"	PWET6PP.18	1.0#
		24"	PWET6PP.24	1.0#
		30"	PWET6PP.30	2.0#
		36"	PWET6PP.36	2.0#
		42"	PWET6PP.42	2.0#
		48"	PWET6PP.48	2.0#
		54"	PWET6PP.54	3.0#
		60"	PWET6PP.60	3.0#
		 HRDPT	<b>Power/Data Separation Septum</b> <ul style="list-style-type: none"> <li>Steel septum provides separation between power and data in base raceway</li> <li>Hint: A steel trough is supplied with raceway tiles to provide separation at other electrical heights</li> </ul>	12"
18"	PDS8.18.BL			1.0#
24"	PDS8.24.BL			1.0#
30"	PDS8.30.BL			1.0#
36"	PDS8.36.BL			2.0#
42"	PDS8.42.BL			2.0#
48"	PDS8.48.BL			2.0#
54"	PDS8.54.BL			2.0#
60"	PDS8.60.BL			2.0#

**A**

### HOW TO ORDER

Indicate the following information on order form:

- Quantity of each item.
- Model number, including options. See "How To Build a Model Number".
- Any special service required.

Note:

- The  indicates that a choice is required.
- The absence of the  indicates that no choice is required.
- Alpha-numeric characters in place of  indicate that no other alternatives are available.

### HOW TO BUILD A MODEL NUMBER

**A** Select basic model.



Delivered Pricing	
\$	112
	118
	125
	126
	127
	128
	129
	131
	132
\$	6
	6
	6
	7
	10
	10
	12
	12
	19

**SPECIAL SERVICES**

**Special Carton Marking**

With specially marked information N/C

**Shipping**

Delivered. Shipped **k.d. freight prepaid f.o.b. Manitowoc, Wisconsin 54220** factory. Freight class #70.

Specifications and prices are subject to change without prior notice.

# Electrical

## 10-Wire System 6 Circuit "810

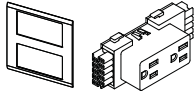
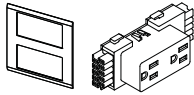
	MODEL	Features	MODEL NUMBER		Approx. Packaged Weight
			Basic Model	Trim Color	
 HRDPT	<b>15 Amp Duplex Receptacle with Bezel - 6 Circuit</b> <ul style="list-style-type: none"> <li>• Snaps to wireways of powered panels</li> <li>• 4I, 5I and 6I circuits are stamped with orange triangle</li> <li>• Includes Bezel with filler plate which can be removed to accept standard modular furniture data plates</li> <li>• Receptacles can be used at any height power</li> <li>• Receptacle color matches trim color</li> </ul>	Circuit 1	PWET6RC.1	<input type="checkbox"/>	1.0#
		Circuit 2	PWET6RC.2	<input type="checkbox"/>	1.0#
		Circuit 3	PWET6RC.3	<input type="checkbox"/>	1.0#
		Circuit 4	PWET6RC.4I	<input type="checkbox"/>	1.0#
		Circuit 5	PWET6RC.5I	<input type="checkbox"/>	1.0#
		Circuit 6	PWET6RC.6I	<input type="checkbox"/>	1.0#
 HRDPT	<b>20 Amp Simplex Receptacle with Bezel - 6 Circuit</b> <ul style="list-style-type: none"> <li>• Snaps to wireways of powered panels</li> <li>• Receptacle includes one 20 amp simplex and one 15 amp simplex</li> <li>• Occupies space of one duplex receptacle</li> <li>• 4I, 5I and 6I circuits are stamped with orange triangle</li> <li>• Includes Bezel with filler plate which can be removed to accept standard modular furniture data plates</li> <li>• Receptacles can be used at any height power</li> <li>• Receptacle color matches trim color</li> </ul>	Circuit 1	PWET620R.1	<input type="checkbox"/>	1.0#
		Circuit 2	PWET620R.2	<input type="checkbox"/>	1.0#
		Circuit 3	PWET620R.3	<input type="checkbox"/>	1.0#
		Circuit 4	PWET620R.4I	<input type="checkbox"/>	1.0#
		Circuit 5	PWET620R.5I	<input type="checkbox"/>	1.0#
		Circuit 6	PWET620R.6I	<input type="checkbox"/>	1.0#

A

B

### HOW TO ORDER

Indicate the following information on order form:

1. Quantity of each item.
2. Model number, including options. See "How To Build a Model Number".
3. Any special service required.

Note: • The  indicates that a choice is required.

- The absence of the  indicates that no choice is required.
- Alpha-numeric characters in place of  indicate that no other alternatives are available.

### HOW TO BUILD A MODEL NUMBER

- A** Select basic model.
- B** Select trim color.  
Refer to color addendum at [ki.com](http://ki.com) or KI Fabrics & Finishes binder.  
Metallic finish not available.





Delivered  
Pricing

\$ 30  
30  
30  
30  
30  
30

\$ 47  
47  
47  
47  
47  
47

**SPECIAL SERVICES**

**Special Carton Marking**

With specially marked information N/C





**Shipping**

Delivered. Shipped **k.d. freight prepaid**  
**f.o.b. Manitowoc, Wisconsin 54220**  
factory. Freight class #70.

Specifications and prices are subject to  
change without prior notice.

# Electrical

## 10-Wire System 6 Circuit "810

	MODEL	L	MODEL NUMBER		Approx. Packaged Weight
				Basic Model	
	<b>17" Panel to Panel Jumper - 6 Circuit</b> • Used on in-line intersections • Non-directional	17"	PWET6PJ.17		1.0#
HRDPT					
	<b>20" Panel to Panel Jumper - 6 Circuit</b> • Used on 90° corners and "T" intersections • Non-directional	20"	PWET6PJ.20		1.0#
HRDPT					
	<b>20" Vertical Jumper - 6 Circuit</b> • Jumps power from ADA-height to worksurface-height or worksurface-height to stand-up-height • Non-directional	20"	PWET6VJ.20		1.0#
HRDPT					
	<b>56" Vertical Jumper - 6 Circuit</b> • Jumps power from base to ADA-height, base to worksurface-height, base-height to stand-up height • Non-directional	56"	PWET6VJ.56		2.0#
HRDPT					
	<b>Internal Duplex Assembly - 6 Circuit</b> • UL listed for use with IT (communications) gear only • Circuit 6 only	16"	PWET6ID		2.0#
HRDPT					

**A**

### HOW TO ORDER

Indicate the following information on order form:

1. Quantity of each item.
2. Model number, including options. See "How To Build a Model Number".
3. Any special service required.

Note: • The  indicates that a choice is required.

- The absence of the  indicates that no choice is required.
- Alpha-numeric characters in place of  indicate that no other alternatives are available.

### HOW TO BUILD A MODEL NUMBER

- A** Select basic model.



Delivered  
Pricing

\$ 81

\$ 82

\$ 82

\$ 165

\$ 212

**SPECIAL SERVICES**

**Special Carton Marking**

With specially marked information N/C



**Shipping**

Delivered. Shipped **k.d. freight prepaid**  
**f.o.b. Manitowoc, Wisconsin 54220**  
factory. Freight class #70.

Specifications and prices are subject to  
change without prior notice.

# Electrical

## 10-Wire System 6 Circuit "810

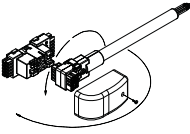
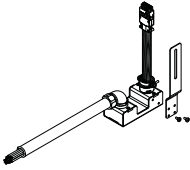
	MODEL	L	MODEL NUMBER		Approx. Packaged Weight
			Basic Model	Trim Color	
 HRDPT	<b>Top Feed with 7' or 10' Pole - 6 Circuit</b> <ul style="list-style-type: none"> <li>• Can be used at top of panel only</li> <li>• Connects to either end of Rigid Wireway at any level. Doesn't occupy space for duplex receptacle</li> <li>• Includes aluminum power pole, panel trim and ceiling trim</li> <li>• Specify trim color</li> </ul>	7"	PWET6TF7	<input type="checkbox"/>	10.0#
		10"	PWET6TF10	<input type="checkbox"/>	15.0#
 HRDPT	<b>Data Feed</b> <ul style="list-style-type: none"> <li>• Can be used at top of panel only</li> <li>• Includes aluminum power pole, panel trim and ceiling trim</li> <li>• Pole is available in two heights, 7' and 10'</li> <li>• Specify trim color</li> </ul>	84"	PDF8.7	<input type="checkbox"/>	7.0#
		120"	PDF8.10	<input type="checkbox"/>	10.0#
 HRDPT	<b>Universal Base Infeed with Bezel - 6 Circuit</b> <ul style="list-style-type: none"> <li>• Field notable for left, right and straight applications</li> <li>• Can be used at base level only</li> <li>• Includes Bezel with filler plate which can be removed to accept standard modular furniture data plates</li> <li>• 72" Whip is color matched to trim</li> <li>• Non-directional</li> </ul>	72"	PWET6BFU		4.0#
 HRDPT	<b>Tech Panel Base Infeed - 6 Circuit</b> <ul style="list-style-type: none"> <li>• Field notable for left, right and straight applications</li> <li>• Can be used at base level only</li> <li>• Designed to lay on floor and fit under lowest tile</li> <li>• 72" Whip is color matched to trim</li> <li>• Non-directional</li> </ul>	72"	PWET6TBF		6.0#

A

B

### HOW TO ORDER

Indicate the following information on order form:

1. Quantity of each item.
2. Model number, including options. See "How To Build a Model Number".
3. Any special service required.

Note:

- The  indicates that a choice is required.
- The absence of the  indicates that no choice is required.
- Alpha-numeric characters in place of  indicate that no other alternatives are available.

### HOW TO BUILD A MODEL NUMBER

- A** Select basic model.
- B** Select trim color.  
Refer to color addendum at [ki.com](http://ki.com) or KI Fabrics & Finishes binder.  
Metallic paint requires upcharge



# Electrical

10-Wire System 6 Circuit "810

Delivered Pricing	Metallic Paint add to list price
\$ 396	\$ 102
493	102
\$ 119	\$ 102
174	102
\$ 212	N/A
\$ 460	N/A

**SPECIAL SERVICES**

**Special Carton Marking**

With specially marked information N/C

**Shipping**

Delivered. Shipped **k.d. freight prepaid f.o.b. Manitowoc, Wisconsin 54220** factory. Freight class #70.

Specifications and prices are subject to change without prior notice.

# Electrical

## 10-Wire System 6 Circuit "810

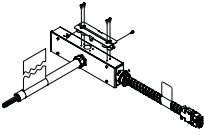
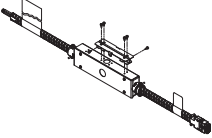
	MODEL	L	MODEL NUMBER		Approx. Packaged Weight
			Basic Model	Trim Color	
 <p>HRDPT</p>	<b>New York Power Infeed with Bezel - 6 Circuit</b> <ul style="list-style-type: none"> <li>• City of New York approved power entry box with panel to panel connectors</li> <li>• Can be used at base level only</li> <li>• 72" Whip is color matched to trim</li> <li>• Entry box is mounted to bottom horizontal on left or right side of panel</li> <li>• 14" panel jumper is hard wired to infeed box and plugs into wireway of adjacent panel</li> </ul>	72"	PWET6NYBF.72	<input type="checkbox"/> <input type="checkbox"/>	6.0#
 <p>HRDPT</p>	<b>New York Power Infeed Kit/Ceiling - 6 Circuit</b> <ul style="list-style-type: none"> <li>• Order power/data pole (PDF8. size(colors)) separately</li> </ul>	216"	PWET6NYTF.216		6.0#

A

B

### HOW TO ORDER

Indicate the following information on order form:

1. Quantity of each item.
2. Model number, including options. See "How To Build a Model Number".
3. Any special service required.

Note:

- The  indicates that a choice is required.
- The absence of the  indicates that no choice is required.
- Alpha-numeric characters in place of  indicate that no other alternatives are available.

### HOW TO BUILD A MODEL NUMBER

- A** Select basic model.
- B** Select trim color.  
Refer to color addendum at [ki.com](http://ki.com) or KI Fabrics & Finishes binder.  
Metallic finish not available.



Delivered  
Pricing

\$ 483

\$ 597

**SPECIAL SERVICES**

**Special Carton Marking**

With specially marked information N/C

**Shipping**

Delivered. Shipped **k.d. freight prepaid f.o.b. Manitowoc, Wisconsin 54220** factory. Freight class #70.

Specifications and prices are subject to change without prior notice.

# Electrical

## 10-Wire System 4 Circuit "810

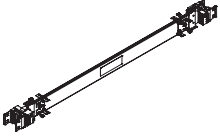
	MODEL	PANEL WIDTH	MODEL NUMBER	
			Basic Model	Approx. Packaged Weight
 <p>HRDPT</p> <p><b>Rigid Wireway - 4 Circuit</b></p> <ul style="list-style-type: none"> <li>• Distributes 10-wire power and allows receptacle mounting</li> <li>• Non-directional</li> <li>• Includes mounting clips</li> <li>• Wireway can be mounted inside the base raceway or behind any raceway tile 30 thru 60</li> <li>• Accommodates two duplex receptacles per side. Maximum of two per wireway as standard</li> <li>• 24" wireway accommodates one duplex receptacle per side</li> <li>• Receptacles purchased separately</li> </ul>		24"	PWET4WW.24	2.0#
		30"	PWET4WW.30	2.0#
		36"	PWET4WW.36	3.0#
		42"	PWET4WW.42	3.0#
		48"	PWET4WW.48	3.0#
		54"	PWET4WW.54	4.0#
		60"	PWET4WW.60	4.0#

**A**

### HOW TO ORDER

Indicate the following information on order form:

1. Quantity of each item.
2. Model number, including options. See "How To Build a Model Number".
3. Any special service required.

Note: • The  indicates that a choice is required.

- The absence of the  indicates that no choice is required.
- Alpha-numeric characters in place of  indicate that no other alternatives are available.

### HOW TO BUILD A MODEL NUMBER

- A** Select basic model.





Delivered  
Pricing

\$ 108  
112  
115  
121  
126  
129  
133

### SPECIAL SERVICES

#### Special Carton Marking

With specially marked information N/C

#### Shipping

Delivered. Shipped **k.d. freight prepaid f.o.b. Manitowoc, Wisconsin 54220** factory. Freight class #70.

Specifications and prices are subject to change without prior notice.

# Electrical

## 10-Wire System 4 Circuit "810

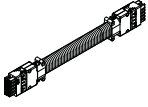
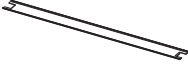
		MODEL NUMBER		Approx. Packaged Weight
MODEL	PANEL WIDTH	Basic Model		
 <p>HRDPT</p>	<b>Power Pass Through - 4 Circuit</b>	12"	PWET4PP.12	1.0#
	<ul style="list-style-type: none"> <li>Distributes 10-wire power</li> <li>Non-directional</li> <li>Connects to adjacent Rigid Wireway or Power Pass Through via a horizontal jumper</li> </ul>	18"	PWET4PP.18	1.0#
		24"	PWET4PP.24	1.0#
		30"	PWET4PP.30	2.0#
		36"	PWET4PP.36	2.0#
		42"	PWET4PP.42	2.0#
		48"	PWET4PP.48	2.0#
		54"	PWET4PP.54	3.0#
		60"	PWET4PP.60	3.0#
 <p>HRDPT</p>	<b>Power/Data Separation Septum</b>	12"	PDS8.12.BL	1.0#
	<ul style="list-style-type: none"> <li>Steel septum provides separation between power and data in base raceway</li> <li>Hint: A steel trough is supplied with raceway tiles to provide separation at other electrical heights</li> </ul>	18"	PDS8.18.BL	1.0#
		24"	PDS8.24.BL	1.0#
		30"	PDS8.30.BL	1.0#
		36"	PDS8.36.BL	2.0#
		42"	PDS8.42.BL	2.0#
		48"	PDS8.48.BL	2.0#
		54"	PDS8.54.BL	2.0#
		60"	PDS8.60.BL	2.0#

**A**

### HOW TO ORDER

Indicate the following information on order form:

- Quantity of each item.
- Model number, including options. See "How To Build a Model Number".
- Any special service required.

Note:

- The  indicates that a choice is required.
- The absence of the  indicates that no choice is required.
- Alpha-numeric characters in place of  indicate that no other alternatives are available.

### HOW TO BUILD A MODEL NUMBER

**A** Select basic model.



Delivered  
Pricing

\$ 112
118
125
132
107
107
111
114
115
\$ 6
6
6
7
10
10
12
12
19

### SPECIAL SERVICES

#### Special Carton Marking

With specially marked information N/C

#### Shipping

Delivered. Shipped **k.d. freight prepaid**  
**f.o.b. Manitowoc, Wisconsin 54220**  
factory. Freight class #70.

Specifications and prices are subject to  
change without prior notice.

# Electrical

## 10-Wire System 4 Circuit "810

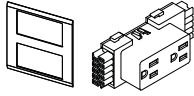
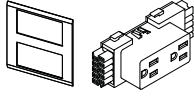
		MODEL	Features	MODEL NUMBER		Approx. Packaged Weight
				Basic Model	Trim Color	
 HRDPT	<b>15 Amp Duplex Receptacle with Bezel - 4 Circuit</b> <ul style="list-style-type: none"> <li>• Snaps to wireways of powered panels</li> <li>• 3l and 4l circuits are stamped with orange triangle</li> <li>• Includes Bezel with filler plate which can be removed to accept standard modular furniture data plates</li> <li>• Receptacles can be used at any height power</li> <li>• Receptacle color matches trim color</li> </ul>	Circuit 1	PWET4RC.1	<input type="checkbox"/>	1.0#	
		Circuit 2	PWET4RC.2	<input type="checkbox"/>	1.0#	
		Circuit 3	PWET4RC.3l	<input type="checkbox"/>	1.0#	
		Circuit 4	PWET4RC.4l	<input type="checkbox"/>	1.0#	
 HRDPT	<b>20 Amp Simplex Receptacle with Bezel - 4 Circuit</b> <ul style="list-style-type: none"> <li>• Snaps to wireways of powered panels</li> <li>• Receptacle includes one 20 amp simplex and one 15 amp simplex</li> <li>• Occupies space of one duplex receptacle</li> <li>• 4l, circuits are stamped with orange triangle</li> <li>• Includes Bezel with filler plate which can be removed to accept standard modular furniture data plates</li> <li>• Receptacles can be used at any height power</li> <li>• Receptacle color matches trim color</li> </ul>	Circuit 1	PWET420R.1	<input type="checkbox"/>	1.0#	
		Circuit 2	PWET420R.2	<input type="checkbox"/>	1.0#	
		Circuit 4	PWET420R.4l	<input type="checkbox"/>	1.0#	

A

B

### HOW TO ORDER

Indicate the following information on order form:

1. Quantity of each item.
2. Model number, including options. See "How To Build a Model Number".
3. Any special service required.

Note: • The  indicates that a choice is required.

- The absence of the  indicates that no choice is required.
- Alpha-numeric characters in place of  indicate that no other alternatives are available.

### HOW TO BUILD A MODEL NUMBER

- A** Select basic model.
- B** Select trim color.  
Refer to color addendum at [ki.com](http://ki.com) or KI Fabrics & Finishes binder.  
Metallic finish not available.



Delivered  
Pricing

\$ 31  
31  
31  
31

\$ 47  
47  
47

**SPECIAL SERVICES**

**Special Carton Marking**

With specially marked information N/C





**Shipping**

Delivered. Shipped **k.d. freight prepaid f.o.b. Manitowoc, Wisconsin 54220** factory. Freight class #70.

Specifications and prices are subject to change without prior notice.

# Electrical

## 10-Wire System 4 Circuit "810

	MODEL	L	MODEL NUMBER		Approx. Packaged Weight
				Basic Model	
	<b>17" Panel to Panel Jumper - 4 Circuit</b> • Used on in-line and inside 90° corner intersections • Non-directional	17"	PWET4PJ.17		1.0#
HRDPT					
	<b>20" Panel to Panel Jumper - 4 Circuit</b> • Used on outside 90° corners and straight through "T" intersections • Non-directional	20"	PWET4PJ.20		1.0#
HRDPT					
	<b>20" Vertical Jumper - 4 Circuit</b> • Jumps power from ADA-height to worksurface-height or worksurface-height to stand-up-height • Non-directional	20"	PWET4VJ.20		1.0#
HRDPT					
	<b>56" Vertical Jumper - 4 Circuit</b> • Jumps power from base to ADA-height, base to worksurface-height, base-height to stand-up height • Non-directional	56"	PWET4VJ.56		2.0#
HRDPT					
	<b>Internal Duplex Assembly - 4 Circuit</b> • UL listed for use with IT communications gear only • Circuit 4 only	16"	PWET4ID		2.0#
HRDPT					

**A**

### HOW TO ORDER

Indicate the following information on order form:

1. Quantity of each item.
2. Model number, including options. See "How To Build a Model Number".
3. Any special service required.

Note: • The  indicates that a choice is required.  
• The absence of the  indicates that no choice is required.  
• Alpha-numeric characters in place of  indicate that no other alternatives are available.

### HOW TO BUILD A MODEL NUMBER

**A** Select basic model.



Delivered  
Pricing

\$ 81

\$ 82

\$ 82

\$ 165

\$ 212

**SPECIAL SERVICES**

**Special Carton Marking**

With specially marked information N/C



**Shipping**

Delivered. Shipped **k.d. freight prepaid f.o.b. Manitowoc, Wisconsin 54220** factory. Freight class #70.

Specifications and prices are subject to change without prior notice.

# Electrical

## 10-Wire System 4 Circuit "810

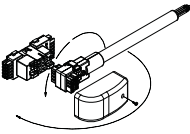
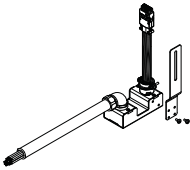
	MODEL	L	MODEL NUMBER		Approx. Packaged Weight
			Basic Model	Trim Color	
 HRDPT	<b>Top Infeed with 7' or 10' Pole - 4 Circuit</b> <ul style="list-style-type: none"> <li>• Can be used at top of panel only</li> <li>• Connects to either end of Rigid Wireway at any level. Doesn't occupy space for duplex receptacle</li> <li>• Includes aluminum power pole, panel trim and ceiling trim</li> <li>• Specify trim color</li> </ul>	7"	PWET4TF7	<input type="checkbox"/>	10.0#
		10"	PWET4TF10	<input type="checkbox"/>	15.0#
 HRDPT	<b>Data Feed</b> <ul style="list-style-type: none"> <li>• Can be used at top of panel only</li> <li>• Includes aluminum power pole, panel trim and ceiling trim</li> <li>• Pole is available in two heights, 7' and 10'</li> <li>• Specify trim color</li> </ul>	84"	PDF8.7	<input type="checkbox"/>	7.0#
		120"	PDF8.10	<input type="checkbox"/>	10.0#
 HRDPT	<b>Universal Base Infeed with Bezel - 4 Circuit</b> <ul style="list-style-type: none"> <li>• Field notable for left, right and straight applications</li> <li>• Can be used at base level only</li> <li>• Includes Bezel with filler plate which can be removed to accept standard modular furniture data plates</li> <li>• 72' Whip is color matched to trim</li> <li>• Non-directional</li> </ul>	72"	PWET4BFU		4.0#
 HRDPT	<b>Tech Panel Base Infeed - 4 Circuit</b> <ul style="list-style-type: none"> <li>• Field notable for left, right and straight applications</li> <li>• Can be used at base level only</li> <li>• Designed to lay on floor and fit under lowest tile</li> <li>• 72' Whip is color matched to trim</li> <li>• Non-directional</li> </ul>	72"	PWET4TBF		6.0#

A

B

### HOW TO ORDER

Indicate the following information on order form:

1. Quantity of each item.
2. Model number, including options. See "How To Build a Model Number".
3. Any special service required.

Note:

- The  indicates that a choice is required.
- The absence of the  indicates that no choice is required.
- Alpha-numeric characters in place of  indicate that no other alternatives are available.

### HOW TO BUILD A MODEL NUMBER

- A** Select basic model.
- B** Select trim color.  
Refer to color addendum at [ki.com](http://ki.com) or KI Fabrics & Finishes binder.  
Metallic paint requires upcharge.





# Electrical

10-Wire System 4 Circuit "810

Delivered Pricing	Metallic Paint add to list price
\$ 396	\$ 102
493	102
\$ 119	\$ 102
174	102
\$ 212	N/A
\$ 460	N/A

**SPECIAL SERVICES**

**Special Carton Marking**

With specially marked information N/C

**Shipping**

Delivered. Shipped **k.d. freight prepaid f.o.b. Manitowoc, Wisconsin 54220** factory. Freight class #70.

Specifications and prices are subject to change without prior notice.

# Electrical

10-Wire System 4 Circuit "810

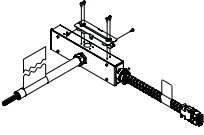
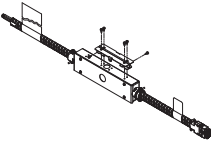
	MODEL	L	MODEL NUMBER		Approx. Packaged Weight
			Basic Model	Trim Color	
 <p>HRDPT</p>	<b>New York Power Infeed with Bezel - 4 Circuit</b> <ul style="list-style-type: none"> <li>• City of New York approved power entry box with panel to panel connector</li> <li>• Can be used at base level only</li> <li>• 72" Whip is color matched to trim</li> <li>• Entry box is mounted to bottom horizontal on left or right side of panel</li> <li>• 14" panel jumper is hard wired to infeed box and plugs into wireway of adjacent panel</li> </ul>	72"	PWET4NYBF.72	<input type="checkbox"/> <input type="checkbox"/>	6.0#
 <p>HRDPT</p>	<b>New York Power Infeed Kit/Ceiling - 4 Circuit</b> <ul style="list-style-type: none"> <li>• Order power/data pole (PDF8.size(color)) separately</li> </ul>	216"	PWET4NYTF.216		6.0#

**A**

**B**

## HOW TO ORDER

Indicate the following information on order form:

1. Quantity of each item.
2. Model number, including options. See "How To Build a Model Number".
3. Any special service required.

Note:

- The  indicates that a choice is required.
- The absence of the  indicates that no choice is required.
- Alpha-numeric characters in place of  indicate that no other alternatives are available.

## HOW TO BUILD A MODEL NUMBER

- A** Select basic model.
- B** Select trim color.  
Refer to color addendum at [ki.com](http://ki.com) or KI Fabrics & Finishes binder.  
Metallic finish not available.



Delivered  
Pricing

\$ 499

\$ 597

**SPECIAL SERVICES**

**Special Carton Marking**

With specially marked information N/C



**Shipping**

Delivered. Shipped **k.d. freight prepaid f.o.b. Manitowoc, Wisconsin 54220** factory. Freight class #70.

Specifications and prices are subject to change without prior notice.

# Electrical

## 8-Wire System

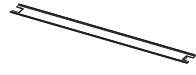
			MODEL NUMBER		Approx. Packaged Weight
MODEL	PANEL WIDTH		Basic Model		
 HRDPT	<b>Rigid Wireway Add-On Kit</b> <ul style="list-style-type: none"> <li>Distributes 8-wire power and allows receptacle mounting</li> <li>Includes two nylon mounting clips</li> <li>Wireway can be mounted inside the base raceway or behind any raceway tile</li> <li>Directional</li> </ul>	24"	PRW8.24	2.0#	
		30"	PRW8.30	2.0#	
		36"	PRW8.36	3.0#	
		42"	PRW8.42	3.0#	
		48"	PRW8.48	3.0#	
		54"	PRW8.54	4.0#	
		60"	PRW8.60	4.0#	
 HRDPT	<b>Power Pass Through</b> <ul style="list-style-type: none"> <li>Provides continuation of power in a non-powered panel when powered panels are on either side</li> <li>Consists of flexible conduit with eight conductors and a connector on each end</li> <li>Receptacle access is not provided</li> <li>Directional</li> </ul>	12"	PPT8.12	1.0#	
		18"	PPT8.18	1.0#	
		24"	PPT8.24	1.0#	
		30"	PPT8.30	2.0#	
		36"	PPT8.36	2.0#	
		42"	PPT8.42	2.0#	
		48"	PPT8.48	2.0#	
		54"	PPT8.54	3.0#	
60"	PPT8.60	3.0#			
 HRDPT	<b>Power/Data Separation Septum</b> <ul style="list-style-type: none"> <li>Steel septum provides separation between power and data in base raceway</li> <li>Hint: A steel trough is supplied with raceway tiles to provide separation at other electrical heights</li> </ul>	12"	PDS8.12.BL	1.0#	
		18"	PDS8.18.BL	1.0#	
		24"	PDS8.24.BL	1.0#	
		30"	PDS8.30.BL	1.0#	
		36"	PDS8.36.BL	2.0#	
		42"	PDS8.42.BL	2.0#	
		48"	PDS8.48.BL	2.0#	
		54"	PDS8.54.BL	2.0#	
60"	PDS8.60.BL	2.0#			

**A**

### HOW TO ORDER

Indicate the following information on order form:

- Quantity of each item.
- Model number, including options. See "How To Build a Model Number".
- Any special service required.

Note: • The  indicates that a choice is required.

- The absence of the  indicates that no choice is required.
- Alpha-numeric characters in place of  indicate that no other alternatives are available.

### HOW TO BUILD A MODEL NUMBER

- A** Select basic model.



Delivered  
Pricing

\$ 90
99
108
122
132
145
163
\$ 73
77
79
84
87
90
93
96
99
\$ 6
6
6
7
10
10
12
12
19

## SPECIAL SERVICES

### Special Carton Marking

With specially marked information N/C

### Shipping

Delivered. Shipped **k.d. freight prepaid**  
**f.o.b. Manitowoc, Wisconsin 54220**  
factory. Freight class #70.

Specifications and prices are subject to  
change without prior notice.

# Electrical

## 8-Wire System

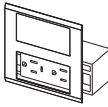
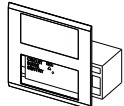
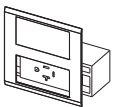
	MODEL	Features	MODEL NUMBER			Approx. Packaged Weight
			Basic Model	Receptacle Color	Trim Color	
 HRDPT	<b>15 Amp Duplex Receptacle w/Bezel</b> <ul style="list-style-type: none"> <li>• Snaps to wireways of powered panels</li> <li>• Rated at 15 amps @ 120 volts</li> <li>• #4 and #5 circuits are stamped with orange lettering</li> <li>• Includes filler plate which can be removed to accept standard modular furniture data plates</li> <li>• Receptacles can be used at any height power</li> <li>• Receptacles color matches trim color</li> </ul>	Circuit 1	PRCP815.1		<input type="checkbox"/>	0.2#
		Circuit 2	PRCP815.2		<input type="checkbox"/>	0.2#
		Circuit 3	PRCP815.3		<input type="checkbox"/>	0.2#
		Circuit 4	PRCP815.4		<input type="checkbox"/>	0.2#
		Circuit 5	PRCP815.5		<input type="checkbox"/>	0.2#
 HRDPT	<b>15 Amp Surge Suppression Module</b> <ul style="list-style-type: none"> <li>• Snaps to wireways of powered panels</li> <li>• Rated at 15 amps @ 120 volts</li> <li>• #4 and #5 circuits are stamped with orange lettering</li> <li>• Includes filler plate which can be removed to accept standard modular furniture data plates</li> <li>• Receptacles can be used at any height power</li> </ul>	Circuit 4	PRCPS815.4		<input type="checkbox"/>	0.2#
		Circuit 5	PRCPS815.5		<input type="checkbox"/>	0.2#
 PRCP	<b>20 Amp Simplex Receptacle and Bezel</b> <ul style="list-style-type: none"> <li>• Snaps to wireways of powered panels</li> <li>• Rated at 20 amps @ 120 volts</li> <li>• #5 circuit is stamped with orange lettering</li> <li>• Includes filler plate which can be removed to accept standard modular furniture data plates</li> <li>• Receptacles can be used at any height power</li> </ul>	Circuit 1	PRCP820.1	<input type="checkbox"/>	<input type="checkbox"/>	0.2#
		Circuit 2	PRCP820.2	<input type="checkbox"/>	<input type="checkbox"/>	0.2#
		Circuit 3	PRCP820.3	<input type="checkbox"/>	<input type="checkbox"/>	0.2#
		Circuit 4	PRCP820.4	<input type="checkbox"/>	<input type="checkbox"/>	0.2#
		Circuit 5	PRCP820.5	<input type="checkbox"/>	<input type="checkbox"/>	0.2#

A

B

C

### HOW TO ORDER

Indicate the following information on order form:

1. Quantity of each item.
2. Model number, including options. See "How To Build a Model Number".
3. Any special service required.

Note: • The  indicates that a choice is required.

- The absence of the  indicates that no choice is required.
- Alpha-numeric characters in place of  indicate that no other alternatives are available.

### HOW TO BUILD A MODEL NUMBER

- A** Select basic model.
- B** Select receptacle color.  
Refer to color addendum at [ki.com](http://ki.com) or KI Fabrics & Finishes binder.
- C** Select trim color.  
Refer to color addendum at [ki.com](http://ki.com) or KI Fabrics & Finishes binder.  
Metallic finish not available.



Delivered  
Pricing

\$ 30  
30  
30  
30  
30

\$ 127  
127

\$ 114  
114  
114  
114  
114

**SPECIAL SERVICES**

**Special Carton Marking**

With specially marked information N/C



**Shipping**

Delivered. Shipped **k.d. freight prepaid**  
**f.o.b. Manitowoc, Wisconsin 54220**  
factory. Freight class #70.

Specifications and prices are subject to  
change without prior notice.

# Electrical

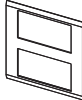
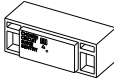
## 8-Wire System

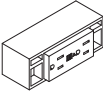
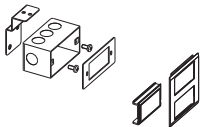
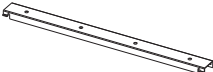
	MODEL	Panel Width	MODEL NUMBER			Approx. Packaged Weight
			Basic Model	Receptacle Color	Trim Color	
	<b>Bezel</b>		46.0073		<input type="checkbox"/> <input type="checkbox"/>	0.1#
HRDPT						
	<b>15 Amp Surge Suppression Module</b>	Circuit 4	46.0206.4	<input type="checkbox"/> <input type="checkbox"/>		0.2#
		Circuit 5	46.0206.5	<input type="checkbox"/> <input type="checkbox"/>		0.2#
HRDPT						
	<b>20 Amp Receptacle</b>	Circuit 1	46.0205.1		<input type="checkbox"/> <input type="checkbox"/>	0.2#
		Circuit 2	46.0205.2		<input type="checkbox"/> <input type="checkbox"/>	0.2#
		Circuit 3	46.0205.3		<input type="checkbox"/> <input type="checkbox"/>	0.2#
		Circuit 4	46.0205.4		<input type="checkbox"/> <input type="checkbox"/>	0.2#
		Circuit 5	46.0205.5		<input type="checkbox"/> <input type="checkbox"/>	0.2#
HRDPT						
	<b>15 Amp Receptacle</b>	Circuit 1	46.0082.1		<input type="checkbox"/> <input type="checkbox"/>	0.2#
		Circuit 2	46.0082.2		<input type="checkbox"/> <input type="checkbox"/>	0.2#
		Circuit 3	46.0082.3		<input type="checkbox"/> <input type="checkbox"/>	0.2#
		Circuit 4	46.0082.4		<input type="checkbox"/> <input type="checkbox"/>	0.2#
		Circuit 5	46.0082.5		<input type="checkbox"/> <input type="checkbox"/>	0.2#
HRDPT						
	<b>Chicago Code Receptacle Kit</b> • Receptacle box • Mounting bracket • Filler plate • Bezel • Levitan 5325 or equivalent receptacle supplied by customer		PRK.HW		<input type="checkbox"/> <input type="checkbox"/>	0.8#
HRDPT						
	<b>Chicago Electrical Mounting Bar</b> • Steel bar construction • Accepts Chicago code receptacle kit • Includes mounting hardware	24"	PCEM.24			1.0#
		30"	PCEM.30			2.0#
		36"	PCEM.36			2.0#
		42"	PCEM.42			2.0#
		48"	PCEM.48			3.0#
		54"	PCEM.54			3.0#
		60"	PCEM.60			3.0#

A

B

C

### HOW TO ORDER

Indicate the following information on order form:

- Quantity of each item.
- Model number, including options. See "How To Build a Model Number".
- Any special service required.

Note: • The  indicates that a choice is required.

- The absence of the  indicates that no choice is required.
- Alpha-numeric characters in place of  indicate that no other alternatives are available.

### HOW TO BUILD A MODEL NUMBER

- A** Select basic model.
- B** Select receptacle color.  
Refer to color addendum at [ki.com](http://ki.com) or KI Fabrics & Finishes binder.
- C** Select trim color.  
Refer to color addendum at [ki.com](http://ki.com) or KI Fabrics & Finishes binder.  
Metallic finish not available.





Delivered  
Pricing

\$ 2

\$ 125

125

\$ 111

111

111

111

111

\$ 26

26

26

26

26

\$ 34

\$ 21

25

28

33

36

36

36

**SPECIAL SERVICES**

**Special Carton Marking**

With specially marked information N/C



**Shipping**

Delivered. Shipped **k.d. freight prepaid**  
**f.o.b. Manitowoc, Wisconsin 54220**  
factory. Freight class #70.

Specifications and prices are subject to  
change without prior notice.

# Electrical

## 8-Wire System

	MODEL	Panel Width	L	MODEL NUMBER		Approx. Packaged Weight
				Basic Model	Trim Color	
 HRDPT	<b>Top Feed</b> • Includes the following: electrical infeed, extruded aluminium power pole (color specific), panel and ceiling trim • Directional	84"	PTF8.7	<input type="checkbox"/>	10.0#	
		120"	PTF8.10	<input type="checkbox"/>	15.0#	
 HRDPT	<b>Data Feed</b> • Includes the following: extruded aluminium power pole (color specific), panel and ceiling trim	84"	PDF8.7	<input type="checkbox"/>	7.0#	
		120"	PDF8.10	<input type="checkbox"/>	10.0#	
 HRDPT	<b>New York Power Infeed Kit</b> • City of New York approved power entry box	24"	PIF.NY.24	<input type="checkbox"/>	3.0#	
		30"	PIF.NY.30	<input type="checkbox"/>	3.0#	
		36"	PIF.NY.36	<input type="checkbox"/>	4.0#	
		42"	PIF.NY.42	<input type="checkbox"/>	5.0#	
		48"	PIF.NY.48	<input type="checkbox"/>	5.0#	
		54"	PIF.NY.54	<input type="checkbox"/>	6.0#	
		60"	PIF.NY.60	<input type="checkbox"/>	6.0#	

A

B

### HOW TO ORDER

Indicate the following information on order form:

- Quantity of each item.
- Model number, including options. See "How To Build a Model Number".
- Any special service required.

Note: • The  indicates that a choice is required.  
 • The absence of the  indicates that no choice is required.  
 • Alpha-numeric characters in place of  indicate that no other alternatives are available.

### HOW TO BUILD A MODEL NUMBER

- A** Select basic model.
- B** Select trim color.  
 Refer to color addendum at [ki.com](http://ki.com) or KI Fabrics & Finishes binder.  
 Metallic paint requires upcharge



# Electrical

8-Wire System

Delivered  
Pricing

Metallic  
Paint  
add to list  
price

\$ 397  
724

\$ 102  
102

\$ 119  
174

\$ 102  
102

\$ 309  
324  
343  
359  
379  
394  
411

\$ 102  
102  
102  
102  
102  
102  
102

## SPECIAL SERVICES

### Special Carton Marking

With specially marked information N/C





### Shipping

Delivered. Shipped **k.d. freight prepaid**  
**f.o.b. Manitowoc, Wisconsin 54220**  
factory. Freight class #70.

Specifications and prices are subject to  
change without prior notice.

# Electrical

## 8-Wire System

	MODEL	L	MODEL NUMBER		Approx. Packaged Weight
			Basic Model	Trim Color	
 HRDPT	<b>Universal Base Infeed</b> <ul style="list-style-type: none"> <li>Color specific base infeed</li> <li>Removable filler plate</li> <li>Bezel</li> <li>Field notable for left, right and straight applications</li> <li>Directional</li> </ul>	72"	PBF8	<input type="checkbox"/> <input type="checkbox"/>	4.0#
 HRDPT	<b>17" Panel to Panel Jumper</b> <ul style="list-style-type: none"> <li>Used on in-line and inside 90° corner intersections</li> <li>Directional</li> </ul>	17"	PHJMP8.17		1.0#
 HRDPT	<b>21" Panel to Panel Jumper</b> <ul style="list-style-type: none"> <li>Used on outside 90° corners and straight through "T" intersections</li> <li>Directional</li> </ul>	21"	PHJMP8.21		1.0#
 HRDPT	<b>23" Vertical Jumper</b> <ul style="list-style-type: none"> <li>Jumps power from ADA-height to worksurface-height or worksurface-height to stand-up-height</li> <li>Directional</li> </ul>	23"	PVJMP8.23		1.0#
 HRDPT	<b>53" Vertical Jumper</b> <ul style="list-style-type: none"> <li>Jumps power from base to ADA-height, base to worksurface-height, base-height to stand-up height, or ADA-height to stand-up height</li> <li>Directional</li> </ul>	53"	PVJMP8.53		2.0#

**A**

**B**

### HOW TO ORDER

Indicate the following information on order form:

- Quantity of each item.
- Model number, including options. See "How To Build a Model Number".
- Any special service required.

Note: • The  indicates that a choice is required.

- The absence of the  indicates that no choice is required.
- Alpha-numeric characters in place of  indicate that no other alternatives are available.

### HOW TO BUILD A MODEL NUMBER

**A** Select basic model.

**B** Select trim color.  
Refer to color addendum at [ki.com](http://ki.com) or KI Fabrics & Finishes binder.  
Metallic finish not available.



Delivered  
Pricing

\$ 161

\$ 65

\$ 69

\$ 79

\$ 96

**SPECIAL SERVICES**

**Special Carton Marking**

With specially marked information N/C

**Shipping**

Delivered. Shipped **k.d. freight prepaid f.o.b. Manitowoc, Wisconsin 54220** factory. Freight class #70.

Specifications and prices are subject to change without prior notice.

# Cable Management

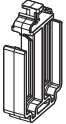
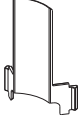
	MODEL	MODEL NUMBER		
		Basic Model	Approx. Packaged Weight	
 HRDPT	<b>Acoustical Tile Vertical Cable Guide</b> <ul style="list-style-type: none"> <li>• Clips into slots in vertical post</li> <li>• Allows cables to be laid in-between vertical posts and acoustic tile</li> <li>• Cannot be used with raceway tile</li> <li>• Maximum of two guides behind a 12" high acoustic tile</li> <li>• Ordered in packs of 25</li> </ul>	46.0097.PCK	0.2#	
 HRDPT	<b>Acoustical Tile Horizontal Cable Support</b> <ul style="list-style-type: none"> <li>• Clips into bottom midpoint of horizontal rail</li> <li>• Aligns with vertical cable guides to keep cables supported at midpoint of panel</li> <li>• Cable supports gang vertically</li> <li>• Can also support loops of cable</li> <li>• Cannot be used with raceway tile</li> <li>• Ordered in packs of 25</li> </ul>	46.0099.PCK	0.2#	
 HRDPT	<b>Tile 90 Cable Guard</b> <ul style="list-style-type: none"> <li>• Clips into slots in vertical post</li> <li>• Allows cables to be laid in-between vertical posts and acoustic tile at the inside of a 90° corner</li> <li>• Cannot be used with raceway tile</li> <li>• Need two guides per 12" high tile</li> <li>• Ordered in packs of 25</li> </ul>	46.0096.PCK	0.2#	

**A**

## HOW TO ORDER

Indicate the following information on order form:

1. Quantity of each item.
2. Model number, including options. See "How To Build a Model Number".
3. Any special service required.

Note: • The  indicates that a choice is required.

- The absence of the  indicates that no choice is required.
- Alpha-numeric characters in place of  indicate that no other alternatives are available.

## HOW TO BUILD A MODEL NUMBER

- A** Select basic model.



Delivered  
Pricing

\$ 29

\$ 34

\$ 28

### SPECIAL SERVICES

#### Special Carton Marking



With specially marked information N/C

#### Shipping

Delivered. Shipped **k.d. freight prepaid**  
**f.o.b. Manitowoc, Wisconsin 54220**  
factory. Freight class #70.

Specifications and prices are subject to change  
without prior notice.

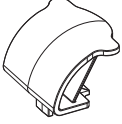
# Cable Management

	MODEL	MODEL NUMBER	
		Basic Model	Approx. Packaged Weight
 <p>HRDPT</p>	<b>Horizontal Rail Cable Guard</b> <ul style="list-style-type: none"> <li>Clips into end notch of horizontal rail</li> <li>Protects and manages cables</li> <li>Ordered in packs of 25</li> </ul>	46.0098.PCK	0.2#
 <p>HRDPT</p>	<b>Top Cap 90° Cable Guard</b> <ul style="list-style-type: none"> <li>Manages cables between half posts and under top cap</li> <li>Protects and manages cables</li> <li>Ordered in packs of 25</li> </ul>	46.0200.PCK	1.0#
<p>HRDPT</p>	<b>Cable Management Demo Pack</b> <ul style="list-style-type: none"> <li>Includes a sampling of cable guards and supports to demonstrate WireWorks® superior cable handling capabilities</li> </ul>	PCMDP	1.0#
 <p>HRDPT</p>	<b>Cable Tile Anchor Pad</b> <ul style="list-style-type: none"> <li>4-Way cable tie mounting device (1" x 1" base)</li> <li>Mounts to side of vertical post to anchor cable</li> <li>Ties and secures vertical runs of cables within the panel</li> <li>Accepts 18-40 lb. cable ties</li> <li>Mounts with adhesive foam tape</li> <li>Recommend one anchor pad for every 12" to 18" of vertical cables within a panel</li> <li>Ordered in packs of 100</li> </ul>	46.0753.PCK	2.0#

**A**

## HOW TO ORDER

Indicate the following information on order form:

- Quantity of each item.
- Model number, including options. See "How To Build a Model Number".
- Any special service required.

Note: • The  indicates that a choice is required.

- The absence of the  indicates that no choice is required.
- Alpha-numeric characters in place of  indicate that no other alternatives are available.

## HOW TO BUILD A MODEL NUMBER

- A** Select basic model.





Delivered  
Pricing  
\$ 31

\$ 19

\$ 12

\$ 61

### SPECIAL SERVICES

#### Special Carton Marking

With specially marked information N/C

#### Shipping

Delivered. Shipped **k.d. freight prepaid f.o.b. Manitowoc, Wisconsin 54220** factory. Freight class #70.

Specifications and prices are subject to change without prior notice.

# Worksurfaces

## Rectangular

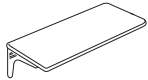
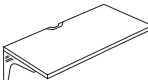
MODEL	D x W	MODEL NUMBER							Approx. Packaged Weight		
		Basic Model	Edge Style	Surface Finish	Trim Color	Grommet Location	Edge Color	Grommet Color			
 <p>Flat Vinyl T-Edge (BN)</p> <p>PWR</p>	<b>Rectangular Worksurfaces - 24" D</b>		24 x 24"	PWR2424	<input type="checkbox"/>	<input type="checkbox"/>	<input type="checkbox"/>	<input type="checkbox"/>	<input type="checkbox"/>	<input type="checkbox"/>	23.0#
	<ul style="list-style-type: none"> <li>60" worksurfaces contain two steel reinforcing bars</li> <li>Includes worksurface supports</li> <li>All surfaces 66" and longer are provided with an additional left-hand cantilever bracket</li> <li>Worksurfaces with 74P, postformed, knife edge and veneer edges have one 2-1/2" x 6" grommet up to 54" wide, 60" - 96" have two grommets</li> <li>3" diameter grommet optional on vinyl T-edge worksurfaces only</li> </ul>		24 x 30"	PWR2430	<input type="checkbox"/>	<input type="checkbox"/>	<input type="checkbox"/>	<input type="checkbox"/>	<input type="checkbox"/>	<input type="checkbox"/>	28.0#
	24 x 36"	PWR2436	<input type="checkbox"/>	<input type="checkbox"/>	<input type="checkbox"/>	<input type="checkbox"/>	<input type="checkbox"/>	<input type="checkbox"/>	<input type="checkbox"/>	33.0#	
	24 x 42"	PWR2442	<input type="checkbox"/>	<input type="checkbox"/>	<input type="checkbox"/>	<input type="checkbox"/>	<input type="checkbox"/>	<input type="checkbox"/>	<input type="checkbox"/>	37.0#	
	24 x 48"	PWR2448	<input type="checkbox"/>	<input type="checkbox"/>	<input type="checkbox"/>	<input type="checkbox"/>	<input type="checkbox"/>	<input type="checkbox"/>	<input type="checkbox"/>	42.0#	
	24 x 54"	PWR2454	<input type="checkbox"/>	<input type="checkbox"/>	<input type="checkbox"/>	<input type="checkbox"/>	<input type="checkbox"/>	<input type="checkbox"/>	<input type="checkbox"/>	46.0#	
	24 x 60"	PWR2460	<input type="checkbox"/>	<input type="checkbox"/>	<input type="checkbox"/>	<input type="checkbox"/>	<input type="checkbox"/>	<input type="checkbox"/>	<input type="checkbox"/>	51.0#	
	24 x 66"	PWR2466	<input type="checkbox"/>	<input type="checkbox"/>	<input type="checkbox"/>	<input type="checkbox"/>	<input type="checkbox"/>	<input type="checkbox"/>	<input type="checkbox"/>	56.0#	
	24 x 72"	PWR2472	<input type="checkbox"/>	<input type="checkbox"/>	<input type="checkbox"/>	<input type="checkbox"/>	<input type="checkbox"/>	<input type="checkbox"/>	<input type="checkbox"/>	61.0#	
	24 x 78"	PWR2478	<input type="checkbox"/>	<input type="checkbox"/>	<input type="checkbox"/>	<input type="checkbox"/>	<input type="checkbox"/>	<input type="checkbox"/>	<input type="checkbox"/>	66.0#	
	24 x 84"	PWR2484	<input type="checkbox"/>	<input type="checkbox"/>	<input type="checkbox"/>	<input type="checkbox"/>	<input type="checkbox"/>	<input type="checkbox"/>	<input type="checkbox"/>	71.0#	
	24 x 90"	PWR2490	<input type="checkbox"/>	<input type="checkbox"/>	<input type="checkbox"/>	<input type="checkbox"/>	<input type="checkbox"/>	<input type="checkbox"/>	<input type="checkbox"/>	74.0#	
	24 x 96"	PWR2496	<input type="checkbox"/>	<input type="checkbox"/>	<input type="checkbox"/>	<input type="checkbox"/>	<input type="checkbox"/>	<input type="checkbox"/>	<input type="checkbox"/>	76.0#	
	 <p>74P Edge (74P) Postformed Edge (PL) Wood Edge (WV)</p> <p>PWR</p>	<b>Rectangular Worksurfaces - 30" D</b>		30 x 24"	PWR3024	<input type="checkbox"/>	<input type="checkbox"/>	<input type="checkbox"/>	<input type="checkbox"/>	<input type="checkbox"/>	28.0#
30 x 30"		PWR3030	<input type="checkbox"/>	<input type="checkbox"/>	<input type="checkbox"/>	<input type="checkbox"/>	<input type="checkbox"/>	<input type="checkbox"/>	<input type="checkbox"/>	34.0#	
30 x 36"		PWR3036	<input type="checkbox"/>	<input type="checkbox"/>	<input type="checkbox"/>	<input type="checkbox"/>	<input type="checkbox"/>	<input type="checkbox"/>	<input type="checkbox"/>	40.0#	
30 x 42"		PWR3042	<input type="checkbox"/>	<input type="checkbox"/>	<input type="checkbox"/>	<input type="checkbox"/>	<input type="checkbox"/>	<input type="checkbox"/>	<input type="checkbox"/>	46.0#	
30 x 48"		PWR3048	<input type="checkbox"/>	<input type="checkbox"/>	<input type="checkbox"/>	<input type="checkbox"/>	<input type="checkbox"/>	<input type="checkbox"/>	<input type="checkbox"/>	57.0#	
30 x 54"		PWR3054	<input type="checkbox"/>	<input type="checkbox"/>	<input type="checkbox"/>	<input type="checkbox"/>	<input type="checkbox"/>	<input type="checkbox"/>	<input type="checkbox"/>	62.0#	
30 x 60"		PWR3060	<input type="checkbox"/>	<input type="checkbox"/>	<input type="checkbox"/>	<input type="checkbox"/>	<input type="checkbox"/>	<input type="checkbox"/>	<input type="checkbox"/>	68.0#	
30 x 66"		PWR3066	<input type="checkbox"/>	<input type="checkbox"/>	<input type="checkbox"/>	<input type="checkbox"/>	<input type="checkbox"/>	<input type="checkbox"/>	<input type="checkbox"/>	72.0#	
30 x 72"		PWR3072	<input type="checkbox"/>	<input type="checkbox"/>	<input type="checkbox"/>	<input type="checkbox"/>	<input type="checkbox"/>	<input type="checkbox"/>	<input type="checkbox"/>	79.0#	
30 x 78"		PWR3078	<input type="checkbox"/>	<input type="checkbox"/>	<input type="checkbox"/>	<input type="checkbox"/>	<input type="checkbox"/>	<input type="checkbox"/>	<input type="checkbox"/>	85.0#	
30 x 84"		PWR3084	<input type="checkbox"/>	<input type="checkbox"/>	<input type="checkbox"/>	<input type="checkbox"/>	<input type="checkbox"/>	<input type="checkbox"/>	<input type="checkbox"/>	89.0#	
30 x 90"		PWR3090	<input type="checkbox"/>	<input type="checkbox"/>	<input type="checkbox"/>	<input type="checkbox"/>	<input type="checkbox"/>	<input type="checkbox"/>	<input type="checkbox"/>	92.0#	
30 x 96"		PWR3096	<input type="checkbox"/>	<input type="checkbox"/>	<input type="checkbox"/>	<input type="checkbox"/>	<input type="checkbox"/>	<input type="checkbox"/>	<input type="checkbox"/>	94.0#	

A

B

C

D

E

F

G

### HOW TO ORDER

Indicate the following information on order form:

- Quantity of each item.
- Model number, including options. See "How To Build a Model Number".
- Any special service required.

Note: • The  indicates that a choice is required.

- The absence of the  indicates that no choice is required.
- Alpha-numeric characters in place of  indicate that no other alternatives are available.

### HOW TO BUILD A MODEL NUMBER

**A** Select basic model.

**B** Select edge style.

<b>BN</b>	- Flat vinyl T-edge
<b>74P</b>	- 74P edge
<b>KN</b>	- Knife edge
<b>PL</b>	- Postformed edge
<b>WE</b>	- Wood edge, laminate surface
<b>WV</b>	- Wood edge, veneer surface

**C** Select surface finish.

Refer to color addendum at [ki.com](http://ki.com) or KI Fabrics & Finishes binder.  
Surface finish offerings are based on edge style selections.

**D** Select trim color.

Refer to color addendum at [ki.com](http://ki.com) or KI Fabrics & Finishes binder.

**E** Select grommet location.

<b>N</b>	- No grommet
<b>L</b>	- Grommet : left; add \$42

**C** - Grommet : center; add \$42

**R** - Grommet : /right; add \$42

**LR** - Grommet : left/right; add \$87

**LC** - Grommet : left/center; add \$87

**CR** - Grommet : center/right; add \$87

**LCR** - Grommet : left/center/right; add \$128

**F** Select edge color.  
Refer to color addendum at [ki.com](http://ki.com) or KI Fabrics & Finishes binder.

**G** Select grommet color.  
Refer to color addendum at [ki.com](http://ki.com) or KI Fabrics & Finishes binder.

### FINISH INFORMATION

#### Additional Laminate Offering

Additional laminates beyond KI standard offering, are available with two weeks extended leadtime. To specify additional laminates, use these designators followed by the supplier's color/pattern code:

Formica - LF/supplier's color pattern code  
Nevamar - LN/supplier's color pattern code  
Wilsonart - LW/supplier's color pattern code

KI's standard finish is the supplier's recommended finish for that color/pattern.

Note: Nonstandard laminates from these suppliers (example: textured laminates), require an upcharge and additional leadtime. Contact KI.



# Worksurfaces

Rectangular

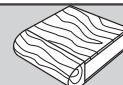
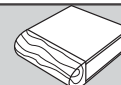
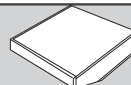
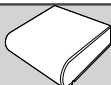
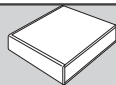
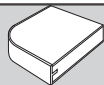

Flat Vinyl T-Edge  
(BN)

74P Edge  
(74P)

Postformed Edge  
(PL)

Knife Edge  
(KN)

Wood Edge Laminate  
(WE)

Wood Edge Veneer  
(WV)

\$ 254

\$ 267

\$ 317

\$ 278

\$ 364

\$ 724

275

288

344

303

406

799

294

309

365

320

450

896

334

353

420

366

492

981

357

378

446

393

539

1117

373

393

469

464

639

1246

388

406

486

482

744

1414

396

417

493

493

768

1497

402

424

506

511

806

1632

416

431

519

527

871

1787

428

448

536

542

915

1938

433

454

539

574

973

1986

439

461

549

590

1006

2038

\$ 275

\$ 288

\$ 344

\$ 303

\$ 394

\$ 799

294

309

365

294

441

872

316

330

394

346

488

987

355

369

443

364

541

1091

382

399

475

382

584

1237

393

411

489

538

686

1385

403

425

507

578

790

1593

420

440

523

596

817

1729

425

446

531

610

826

1861

436

456

542

630

930

2055

441

464

552

648

961

2254

449

473

564

667

1025

2319

461

485

576

683

1060

2388

## SPECIAL SERVICES

### Special Carton Marking

With specially marked information N/C

### Shipping

Shipped **k.d. freight prepaid f.o.b.**  
**Manitowoc, Wisconsin 54220** factory.  
Freight class #70.

Specifications and prices are subject to  
change without prior notice.

# Worksurfaces

"P" Shaped Peninsula/Piano Peninsula

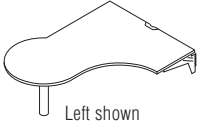
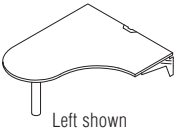
	MODEL	D x W x L	MODEL NUMBER							Approx. Packaged Weight	
			Basic Model	Dir.	Edge Style	Surface Finish	Trim Color	Edge Color	Grommet Color		
 <p>Left shown</p> <p>PWPR</p>	<b>"P" Shaped Peninsula Worksurfaces</b> <ul style="list-style-type: none"> <li>Includes worksurface supports</li> <li>Peninsula worksurfaces have one 2-1/2" x 6" grommet centered on rear edge</li> <li>72" worksurfaces contain two steel reinforcing bars</li> </ul>	24 x 48 x 60"	PWPT244860	<input type="checkbox"/>	<input type="checkbox"/>	<input type="checkbox"/>	<input type="checkbox"/>	<input type="checkbox"/>	<input type="checkbox"/>	65.0#	
		24 x 48 x 72"	PWPT244872	<input type="checkbox"/>	<input type="checkbox"/>	<input type="checkbox"/>	<input type="checkbox"/>	<input type="checkbox"/>	<input type="checkbox"/>	<input type="checkbox"/>	79.0#
		30 x 48 x 72"	PWPT304872	<input type="checkbox"/>	<input type="checkbox"/>	<input type="checkbox"/>	<input type="checkbox"/>	<input type="checkbox"/>	<input type="checkbox"/>	<input type="checkbox"/>	88.0#
 <p>Left shown</p> <p>PWPR</p>	<b>Piano Peninsula Worksurfaces</b> <ul style="list-style-type: none"> <li>Includes worksurface supports</li> <li>Peninsula worksurfaces have one 2-1/2" x 6" grommet centered on rear edge</li> <li>72" worksurfaces contain two steel reinforcing bars</li> </ul>	24 x 48 x 60"	PWPP244860	<input type="checkbox"/>	<input type="checkbox"/>	<input type="checkbox"/>	<input type="checkbox"/>	<input type="checkbox"/>	<input type="checkbox"/>	57.0#	
		24 x 48 x 72"	PWPP244872	<input type="checkbox"/>	<input type="checkbox"/>	<input type="checkbox"/>	<input type="checkbox"/>	<input type="checkbox"/>	<input type="checkbox"/>	<input type="checkbox"/>	72.0#
		30 x 48 x 72"	PWPP304872	<input type="checkbox"/>	<input type="checkbox"/>	<input type="checkbox"/>	<input type="checkbox"/>	<input type="checkbox"/>	<input type="checkbox"/>	<input type="checkbox"/>	82.0#
			<b>A</b>	<b>B</b>	<b>C</b>	<b>D</b>	<b>E</b>	<b>F</b>	<b>G</b>		

## HOW TO ORDER

Indicate the following information on order form:

- Quantity of each item.
- Model number, including options. See "How To Build a Model Number".
- Any special service required.

Note: • The  indicates that a choice is required.

- The absence of the  indicates that no choice is required.
- Alpha-numeric characters in place of  indicate that no other alternatives are available.

## HOW TO BUILD A MODEL NUMBER

- A** Select basic model.
- B** Select surface direction.  
 DL - Direction left  
 DR - Direction right  
 Direction is determined by the side of the worksurface that adjoins an adjacent worksurface.
- C** Select edge style.  
 74P - 74P edge  
 KN - Knife edge  
 WE - Wood edge, laminate surface  
 WV - Wood edge, veneer surface
- D** Select surface finish.  
 Refer to color addendum at [ki.com](http://ki.com) or KI Fabrics & Finishes binder.  
 Surface finish offerings are based on edge style selections.
- E** Select trim color.  
 Refer to color addendum at [ki.com](http://ki.com) or KI

Fabrics & Finishes binder.

- F** Select edge color.  
 Refer to color addendum at [ki.com](http://ki.com) or KI Fabrics & Finishes binder.
- G** Select grommet color.  
 Refer to color addendum at [ki.com](http://ki.com) or KI Fabrics & Finishes binder.

## FINISH INFORMATION

### Additional Laminate Offering

Additional laminates beyond KI standard offering, are available with two weeks extended leadtime. To specify additional laminates, use these designators followed by the supplier's color/pattern code:

Formica - LF/supplier's color pattern code  
 Nevamar - LN/supplier's color pattern code  
 Wilsonart - LW/supplier's color pattern code

KI's standard finish is the supplier's recommended finish for that color/pattern.

Note: Nonstandard laminates from these suppliers (example: textured laminates), require an upcharge and additional leadtime. Contact KI.



# Worksurfaces

"P" Shaped Peninsula/Piano Peninsula

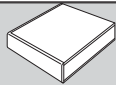

74P Edge  
(74P)

\$ 744  
788  
812

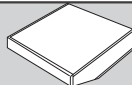

Knife Edge  
(KN)

\$ 802  
905  
906

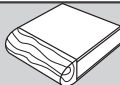

Wood Edge Laminate  
(WE)

\$ 1292  
1535  
1499

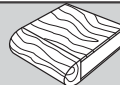

Wood Edge Veneer  
(WV)

\$ 4854  
5718  
5765

\$ 744  
788  
812

\$ 802  
905  
906

\$ 1182  
1399  
1399

\$ 3685  
4318  
4396

## SPECIAL SERVICES

### Special Carton Marking

With specially marked information N/C

### Shipping

Delivered. Shipped **k.d. freight prepaid**  
**f.o.b. Manitowoc, Wisconsin 54220**  
factory. Freight class #70.

Specifications and prices are subject to  
change without prior notice.

# Worksurfaces

Square Shoe/Conference End

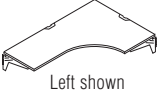
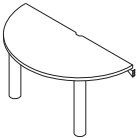
		MODEL NUMBER							Approx. Packaged Weight	
		Basic Model	Dir.	Edge Style	Surface Finish	Trim Color	Edge Color	Grommet Color		
 <p>Left shown</p> <p>PWPR</p>	<b>Square Shoe Worksurfaces</b>	24 x 48 x 60"	PWSS244860	<input type="checkbox"/>	<input type="checkbox"/>	<input type="checkbox"/>	<input type="checkbox"/>	<input type="checkbox"/>	<input type="checkbox"/>	71.0#
	• Includes worksurface supports	24 x 48 x 66"	PWSS244866	<input type="checkbox"/>	<input type="checkbox"/>	<input type="checkbox"/>	<input type="checkbox"/>	<input type="checkbox"/>	<input type="checkbox"/>	75.0#
	• 60" worksurfaces contain two steel reinforcing bars	24 x 48 x 72"	PWSS244872	<input type="checkbox"/>	<input type="checkbox"/>	<input type="checkbox"/>	<input type="checkbox"/>	<input type="checkbox"/>	<input type="checkbox"/>	79.0#
	• All surfaces 66" and longer are provided with an additional left-hand cantilever bracket	24 x 48 x 84"	PWSS244884	<input type="checkbox"/>	<input type="checkbox"/>	<input type="checkbox"/>	<input type="checkbox"/>	<input type="checkbox"/>	<input type="checkbox"/>	87.0#
	• All surfaces have one 2-1/2 x 6" grommet centered on side and rear edges	30 x 48 x 66"	PWSS304866	<input type="checkbox"/>	<input type="checkbox"/>	<input type="checkbox"/>	<input type="checkbox"/>	<input type="checkbox"/>	<input type="checkbox"/>	89.0#
		30 x 48 x 72"	PWSS304872	<input type="checkbox"/>	<input type="checkbox"/>	<input type="checkbox"/>	<input type="checkbox"/>	<input type="checkbox"/>	<input type="checkbox"/>	93.0#
		30 x 48 x 84"	PWSS304884	<input type="checkbox"/>	<input type="checkbox"/>	<input type="checkbox"/>	<input type="checkbox"/>	<input type="checkbox"/>	<input type="checkbox"/>	101.0#
 <p>PWCD</p>	<b>Conference End Worksurface</b>	26 x 52"	PWCE2652		<input type="checkbox"/>	<input type="checkbox"/>	<input type="checkbox"/>	<input type="checkbox"/>	<input type="checkbox"/>	21.0#
	• Includes two 3" diameter metal columns with adjustable glides	31 x 52"	PWCE3152		<input type="checkbox"/>	<input type="checkbox"/>	<input type="checkbox"/>	<input type="checkbox"/>	<input type="checkbox"/>	41.0#
		32 x 64"	PWCE3264		<input type="checkbox"/>	<input type="checkbox"/>	<input type="checkbox"/>	<input type="checkbox"/>	<input type="checkbox"/>	60.0#
		37 x 64"	PWCE3764		<input type="checkbox"/>	<input type="checkbox"/>	<input type="checkbox"/>	<input type="checkbox"/>	<input type="checkbox"/>	32.0#
				<b>A</b>	<b>B</b>	<b>C</b>	<b>D</b>	<b>E</b>	<b>F</b>	<b>G</b>

## HOW TO ORDER

Indicate the following information on order form:

- Quantity of each item.
- Model number, including options. See "How To Build a Model Number".
- Any special service required.

Note: • The  indicates that a choice is required.

- The absence of the  indicates that no choice is required.
- Alpha-numeric characters in place of  indicate that no other alternatives are available.

## HOW TO BUILD A MODEL NUMBER

- A** Select basic model.
- B** Select surface direction.  
**DL** - Direction left  
**DR** - Direction right  
 Direction is determined by the side of the worksurface that adjoins an adjacent worksurface.
- C** Select edge style.  
**BN** - Flat vinyl T-edge  
**74P** - 74P edge  
**KN** - Knife edge  
**WE** - Wood edge, laminate surface  
**WV** - Wood edge, veneer surface
- D** Select surface finish.  
 Refer to color addendum at ki.com or KI Fabrics & Finishes binder.  
 Surface finish offerings are based on edge style selections.
- E** Select trim color.

Refer to color addendum at ki.com or KI Fabrics & Finishes binder.

- F** Select edge color.  
 Refer to color addendum at ki.com or KI Fabrics & Finishes binder.
- G** Select grommet color.  
 Refer to color addendum at ki.com or KI Fabrics & Finishes binder.  
 \*\*Grommet color for 'Conference End Worksurfaces' is for 'BN' edge styles only.

## FINISH INFORMATION

### Additional Laminate Offering

Additional laminates beyond KI standard offering, are available with two weeks extended leadtime. To specify additional laminates, use these designators followed by the supplier's color/pattern code:

Formica - LF/supplier's color pattern code  
 Nevamar - LN/supplier's color pattern code  
 Wilsonart - LW/supplier's color pattern code

KI's standard finish is the supplier's recommended finish for that color/pattern.

Note: Nonstandard laminates from these suppliers (example: textured laminates), require an upcharge and additional leadtime. Contact KI.



# Worksurfaces

Square Shoe/Conference End

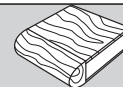
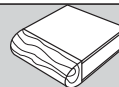
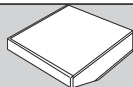
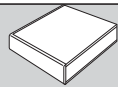
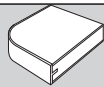

Flat Vinyl T-Edge  
(BN)

74P Edge  
(74P)

Knife Edge  
(KN)

Wood Edge Laminate  
(WE)

Wood Edge Veneer  
(WV)

N/A	\$ 680	\$ 709	\$ 1129	\$ 2986
N/A	716	724	1137	3282
N/A	731	745	1157	3581
N/A	749	781	1267	4165
N/A	747	766	1157	3282
N/A	759	777	1182	3581
N/A	779	792	1296	4165

\$ 419	\$ 438	\$ 656	\$ 867	\$ 1086
436	456	663	979	1215
449	473	699	1014	2911
616	648	713	1035	3469

## SPECIAL SERVICES

### Special Carton Marking

With specially marked information N/C

### Shipping

Delivered. Shipped **k.d. freight prepaid f.o.b. Manitowoc, Wisconsin 54220** factory. Freight class #70.

Specifications and prices are subject to change without prior notice.

# Worksurfaces

## "D" Shaped Peninsula

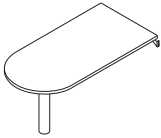
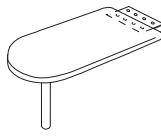
		MODEL NUMBER							Approx. Packaged Weight
MODEL	D x W	Basic Model	Edge Style	Surface Finish	Trim Color	Grommet Location	Edge Color	Grommet Color	
 <p>PWCD</p> <p><b>"D" Shaped Peninsula Worksurfaces</b></p> <ul style="list-style-type: none"> <li>• Not available with laminate postformed edge</li> <li>• Includes mounting hardware</li> <li>• 72" worksurfaces contain two steel reinforcing bars</li> <li>• Round grommets optional</li> <li>• Flat vinyl T-edge is available with 3" diameter grommets (30" or 36" edge only)</li> <li>• Veneer option must be ordered via KI Specials Dept (a. Specify left, right or center b. Specify depth of adjacent worksurface)</li> </ul>	30 x 48"	PWP3048	<input type="checkbox"/>	<input type="checkbox"/>	<input type="checkbox"/>	<input type="checkbox"/>	<input type="checkbox"/>	<input type="checkbox"/>	53.0#
	30 x 60"	PWP3060	<input type="checkbox"/>	<input type="checkbox"/>	<input type="checkbox"/>	<input type="checkbox"/>	<input type="checkbox"/>	<input type="checkbox"/>	63.0#
	30 x 72"	PWP3072	<input type="checkbox"/>	<input type="checkbox"/>	<input type="checkbox"/>	<input type="checkbox"/>	<input type="checkbox"/>	<input type="checkbox"/>	76.0#
	36 x 60"	PWP3660	<input type="checkbox"/>	<input type="checkbox"/>	<input type="checkbox"/>	<input type="checkbox"/>	<input type="checkbox"/>	<input type="checkbox"/>	75.0#
	36 x 72"	PWP3672	<input type="checkbox"/>	<input type="checkbox"/>	<input type="checkbox"/>	<input type="checkbox"/>	<input type="checkbox"/>	<input type="checkbox"/>	89.0#
 <p>PWCD</p> <p><b>"D" Shaped Peninsula Worksurface Mounts to Another Worksurface</b></p> <ul style="list-style-type: none"> <li>• Not available with laminate postformed edge</li> <li>• Does not include wire management grommet</li> <li>• Includes mounting hardware</li> <li>• 72" worksurfaces contain two steel reinforcing bars</li> </ul>	30 x 48"	PWSMP3048	<input type="checkbox"/>	<input type="checkbox"/>	<input type="checkbox"/>	<input type="checkbox"/>	<input type="checkbox"/>	<input type="checkbox"/>	54.0#
	30 x 60"	PWSMP3060	<input type="checkbox"/>	<input type="checkbox"/>	<input type="checkbox"/>	<input type="checkbox"/>	<input type="checkbox"/>	<input type="checkbox"/>	64.0#
	30 x 72"	PWSMP3072	<input type="checkbox"/>	<input type="checkbox"/>	<input type="checkbox"/>	<input type="checkbox"/>	<input type="checkbox"/>	<input type="checkbox"/>	77.0#

A

B

C

D

E

F

G

### HOW TO ORDER

Indicate the following information on order form:

1. Quantity of each item.
2. Model number, including options. See "How To Build a Model Number".
3. Any special service required.

Note:

- The  indicates that a choice is required.
- The absence of the  indicates that no choice is required.
- Alpha-numeric characters in place of  indicate that no other alternatives are available.

### HOW TO BUILD A MODEL NUMBER

**A** Select basic model.

**B** Select edge style.

<b>BN</b>	- Flat vinyl T-edge
<b>74P</b>	- 74P edge
<b>KN</b>	- Knife edge

**C** Select surface finish.

Refer to color addendum at ki.com or KI Fabrics & Finishes binder.  
Surface finish offerings are based on edge style selections.

**D** Select trim color.

Refer to color addendum at ki.com or KI Fabrics & Finishes binder.

**E** Select grommet location on T-edge (BN) only.

<b>N</b>	- No grommet
<b>L</b>	- Grommet : left; add \$42
<b>C</b>	- Grommet : center; add \$42
<b>R</b>	- Grommet : /right; add \$42

**LR** - Grommet : left/right; add \$87

**LC** - Grommet : left/center; add \$87

**CR** - Grommet : center/right; add \$87

**LCR** - Grommet : left/center/right; add \$128

**F** Select edge color.

Refer to color addendum at ki.com or KI Fabrics & Finishes binder.

**G** Select grommet color.

Refer to color addendum at ki.com or KI Fabrics & Finishes binder.  
For T-Edge (BN) only.

### FINISH INFORMATION

#### Additional Laminate Offering

Additional laminates beyond KI standard offering, are available with two weeks extended leadtime. To specify additional laminates, use these designators followed by the supplier's color/pattern code:

Formica - LF/supplier's color pattern code  
Nevamar - LN/supplier's color pattern code  
Wilsonart - LW/supplier's color pattern code

KI's standard finish is the supplier's recommended finish for that color/pattern.

Note: Nonstandard laminates from these suppliers (example: textured laminates), require an upcharge and additional leadtime. Contact KI.





# Worksurfaces

"D" Shaped Peninsula

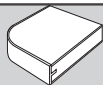

Flat Vinyl T-Edge  
(BN)

\$ 519  
574  
631  
700  
761

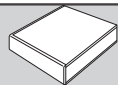

74P Edge  
(74P)

\$ 543  
600  
663  
741  
801

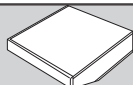

Knife Edge  
(KN)

\$ 552  
681  
826  
849  
1032

\$ 519  
574  
631

\$ 543  
600  
663

\$ 552  
681  
826

## SPECIAL SERVICES

### Special Carton Marking

With specially marked information N/C



### Shipping

Delivered. Shipped **k.d. freight prepaid**  
**f.o.b. Manitowoc, Wisconsin 54220**  
factory. Freight class #70.

Specifications and prices are subject to  
change without prior notice.

# Worksurfaces

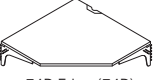
Dual Curvilinear/Diag/Curvilinear 90° Corner

	MODEL	D x W-LEFT x W-RIGHT x D	MODEL NUMBER				
			Basic Model	Edge Style	Surface Finish	Edge Color	Grommet Color
 PWWC	<b>Dual Curvilinear/Diag/Curvilinear 90° Corner</b> • Includes mounting hardware • Worksurfaces have one 2-1/2" x 6" grommet located 12" from rear corner along right rear edge	24 x 42 x 42 x 24"	PWDCE244224	<input type="checkbox"/>	<input type="checkbox"/>	<input type="checkbox"/>	<input type="checkbox"/>
		24 x 48 x 48 x 24"	PWDCE244824	<input type="checkbox"/>	<input type="checkbox"/>	<input type="checkbox"/>	<input type="checkbox"/>
		30 x 48 x 48 x 30"	PWDCE304830	<input type="checkbox"/>	<input type="checkbox"/>	<input type="checkbox"/>	<input type="checkbox"/>
 74P Edge (74P)   Flat Vinyl T-Edge (BN)  PWWC	<b>Diagonal 90° Corner Worksurface</b> • Includes mounting hardware • Left-hand cantilever is provided for rear corner • Includes one grommet	24 x 36 x 36 x 24"	PWD243624	<input type="checkbox"/>	<input type="checkbox"/>	<input type="checkbox"/>	<input type="checkbox"/>
		24 x 42 x 42 x 24"	PWD244224	<input type="checkbox"/>	<input type="checkbox"/>	<input type="checkbox"/>	<input type="checkbox"/>
		24 x 42 x 42 x 30"	PWD244230	<input type="checkbox"/>	<input type="checkbox"/>	<input type="checkbox"/>	<input type="checkbox"/>
		24 x 48 x 48 x 24"	PWD244824	<input type="checkbox"/>	<input type="checkbox"/>	<input type="checkbox"/>	<input type="checkbox"/>
		24 x 48 x 48 x 30"	PWD244830	<input type="checkbox"/>	<input type="checkbox"/>	<input type="checkbox"/>	<input type="checkbox"/>
		30 x 42 x 42 x 24"	PWD304224	<input type="checkbox"/>	<input type="checkbox"/>	<input type="checkbox"/>	<input type="checkbox"/>
		30 x 42 x 42 x 30"	PWD304230	<input type="checkbox"/>	<input type="checkbox"/>	<input type="checkbox"/>	<input type="checkbox"/>
		30 x 48 x 48 x 24"	PWD304824	<input type="checkbox"/>	<input type="checkbox"/>	<input type="checkbox"/>	<input type="checkbox"/>
30 x 48 x 48 x 30"	PWD304830	<input type="checkbox"/>	<input type="checkbox"/>	<input type="checkbox"/>	<input type="checkbox"/>		
 74P Edge (74P)  PWWC	<b>Curvilinear 90° Corner Worksurfaces</b> • Includes mounting hardware • Left-hand cantilever is provided for rear corner	24 x 36 x 36 x 24"	PWC243624	<input type="checkbox"/>	<input type="checkbox"/>	<input type="checkbox"/>	<input type="checkbox"/>
		24 x 42 x 42 x 24"	PWC244224	<input type="checkbox"/>	<input type="checkbox"/>	<input type="checkbox"/>	<input type="checkbox"/>
		24 x 42 x 42 x 30"	PWC244230	<input type="checkbox"/>	<input type="checkbox"/>	<input type="checkbox"/>	<input type="checkbox"/>
		24 x 48 x 48 x 24"	PWC244824	<input type="checkbox"/>	<input type="checkbox"/>	<input type="checkbox"/>	<input type="checkbox"/>
		24 x 48 x 48 x 30"	PWC244830	<input type="checkbox"/>	<input type="checkbox"/>	<input type="checkbox"/>	<input type="checkbox"/>
		30 x 36 x 36 x 30"	PWC303630	<input type="checkbox"/>	<input type="checkbox"/>	<input type="checkbox"/>	<input type="checkbox"/>
		30 x 42 x 42 x 24"	PWC304224	<input type="checkbox"/>	<input type="checkbox"/>	<input type="checkbox"/>	<input type="checkbox"/>
		30 x 42 x 42 x 30"	PWC304230	<input type="checkbox"/>	<input type="checkbox"/>	<input type="checkbox"/>	<input type="checkbox"/>
		30 x 48 x 48 x 24"	PWC304824	<input type="checkbox"/>	<input type="checkbox"/>	<input type="checkbox"/>	<input type="checkbox"/>
		30 x 48 x 48 x 30"	PWC304830	<input type="checkbox"/>	<input type="checkbox"/>	<input type="checkbox"/>	<input type="checkbox"/>

**A**   **B**   **C**   **D**   **E**

## HOW TO ORDER

Indicate the following information on order form:

- Quantity of each item.
- Model number, including options. See "How To Build a Model Number".
- Any special service required.

Note: • The  indicates that a choice is required.

- The absence of the  indicates that no choice is required.
- Alpha-numeric characters in place of  indicate that no other alternatives are available.

## HOW TO BUILD A MODEL NUMBER

**A** Select basic model.

**B** Select edge style.

<b>BN</b>	- Flat vinyl T-edge
<b>74P</b>	- 74P edge
<b>KN</b>	- Knife edge
<b>PL</b>	- Postformed edge
<b>WE</b>	- Wood edge, laminate surface
<b>WV</b>	- Wood edge, veneer surface

**C** Select surface finish.

Refer to color addendum at ki.com or KI Fabrics & Finishes binder.  
Surface finish offerings are based on edge style selections.

**D** Select trim color.

Refer to color addendum at ki.com or KI Fabrics & Finishes binder.

**E** Select edge color.

Refer to color addendum at ki.com or KI

Fabrics & Finishes binder.

**F** Select grommet color.

Refer to color addendum at ki.com or KI Fabrics & Finishes binder.

## FINISH INFORMATION

### Additional Laminate Offering

Additional laminates beyond KI standard offering, are available with two weeks extended leadtime. To specify additional laminates, use these designators followed by the supplier's color/pattern code:

Formica - LF/supplier's color pattern code  
Nevamar - LN/supplier's color pattern code  
Wilsonart - LW/supplier's color pattern code

KI's standard finish is the supplier's recommended finish for that color/pattern.

Note: Nonstandard laminates from these suppliers (example: textured laminates), require an upcharge and additional leadtime. Contact KI.



# Worksurfaces

Dual Curvilinear/Diag/Curvilinear 90° Corner

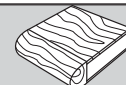
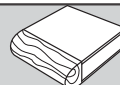
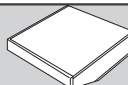
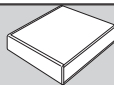
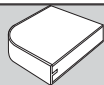

Approx. Packaged Weight	Flat Vinyl T-Edge (BN)	74P Edge (74P)	Postformed Edge (PL)	Knife Edge (KN)	Wood Edge Laminate (WE)	Wood Edge Veneer (WV)
75.0#	N/A	\$ 1893	N/A	\$ 1888	\$ 2183	\$ 4199
84.0#	N/A	1937	N/A	1933	2235	4741
98.0#	N/A	2044	N/A	2039	2281	4909

46.0#	\$ 399	\$ 422	\$ 501	\$ 449	N/A	\$ 1960
55.0#	462	486	577	503	N/A	2657
51.0#	430	449	N/A	503	N/A	N/A
64.0#	535	559	667	541	N/A	3336
62.0#	495	522	N/A	541	N/A	N/A
51.0#	430	449	N/A	503	N/A	N/A
69.0#	462	486	577	503	N/A	2743
62.0#	495	522	N/A	541	N/A	N/A
78.0#	535	559	667	541	N/A	3420

44.0#	N/A	\$ 461	N/A	\$ 449	\$ 716	\$ 2044
53.0#	N/A	489	N/A	503	785	2778
49.0#	N/A	489	N/A	503	N/A	2084
62.0#	N/A	610	N/A	541	809	3407
60.0#	N/A	610	N/A	541	N/A	2778
49.0#	N/A	461	N/A	449	673	2125
49.0#	N/A	489	N/A	503	N/A	2084
67.0#	N/A	523	N/A	503	766	2890
60.0#	N/A	610	N/A	541	N/A	2778
76.0#	N/A	642	N/A	541	824	3505

## SPECIAL SERVICES

### Special Carton Marking

With specially marked information N/C

### Shipping

Delivered. Shipped **k.d. freight prepaid f.o.b. Manitowoc, Wisconsin 54220** factory. Freight class #70.

Specifications and prices are subject to change without prior notice.

# Worksurfaces

## Countertops

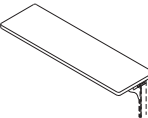
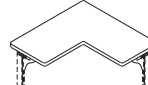
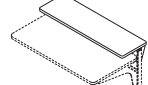
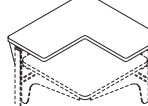
	MODEL	Features	D x W	MODEL NUMBER							
				Basic Model	Notch Location	Edge Style	Surface Finish	Trim Color	Edge Color	Grommet Color	
 <p>PWCT</p>	<b>Straight Countertops</b> • For notch location of "LS, RS, BS", the notch has a grommet and will require a grommet color selection • Brackets include steel locking clips to prevent dislodgement • Countertops accept task light	16 x 24"	PWCT24	<input type="checkbox"/>	<input type="checkbox"/>	<input type="checkbox"/>	<input type="checkbox"/>	<input type="checkbox"/>	<input type="checkbox"/>	<input type="checkbox"/>	
		16 x 30"	PWCT30	<input type="checkbox"/>	<input type="checkbox"/>	<input type="checkbox"/>	<input type="checkbox"/>	<input type="checkbox"/>	<input type="checkbox"/>	<input type="checkbox"/>	<input type="checkbox"/>
		16 x 36"	PWCT36	<input type="checkbox"/>	<input type="checkbox"/>	<input type="checkbox"/>	<input type="checkbox"/>	<input type="checkbox"/>	<input type="checkbox"/>	<input type="checkbox"/>	<input type="checkbox"/>
		16 x 42"	PWCT42	<input type="checkbox"/>	<input type="checkbox"/>	<input type="checkbox"/>	<input type="checkbox"/>	<input type="checkbox"/>	<input type="checkbox"/>	<input type="checkbox"/>	<input type="checkbox"/>
		16 x 48"	PWCT48	<input type="checkbox"/>	<input type="checkbox"/>	<input type="checkbox"/>	<input type="checkbox"/>	<input type="checkbox"/>	<input type="checkbox"/>	<input type="checkbox"/>	<input type="checkbox"/>
		16 x 54"	PWCT54	<input type="checkbox"/>	<input type="checkbox"/>	<input type="checkbox"/>	<input type="checkbox"/>	<input type="checkbox"/>	<input type="checkbox"/>	<input type="checkbox"/>	<input type="checkbox"/>
		16 x 60"	PWCT60	<input type="checkbox"/>	<input type="checkbox"/>	<input type="checkbox"/>	<input type="checkbox"/>	<input type="checkbox"/>	<input type="checkbox"/>	<input type="checkbox"/>	<input type="checkbox"/>
		16 x 66"	PWCT66	<input type="checkbox"/>	<input type="checkbox"/>	<input type="checkbox"/>	<input type="checkbox"/>	<input type="checkbox"/>	<input type="checkbox"/>	<input type="checkbox"/>	<input type="checkbox"/>
		16 x 72"	PWCT72	<input type="checkbox"/>	<input type="checkbox"/>	<input type="checkbox"/>	<input type="checkbox"/>	<input type="checkbox"/>	<input type="checkbox"/>	<input type="checkbox"/>	<input type="checkbox"/>
		16 x 78"	PWCT78	<input type="checkbox"/>	<input type="checkbox"/>	<input type="checkbox"/>	<input type="checkbox"/>	<input type="checkbox"/>	<input type="checkbox"/>	<input type="checkbox"/>	<input type="checkbox"/>
			16 x 84"	PWCT84	<input type="checkbox"/>	<input type="checkbox"/>	<input type="checkbox"/>	<input type="checkbox"/>	<input type="checkbox"/>	<input type="checkbox"/>	
 <p>PWCT</p>	<b>90° Corner Countertops</b> • For notch location of "LS, RS, BS", the notch has a grommet and will require a grommet color selection • Brackets include steel locking clips to prevent dislodgement • PL edge comes with two individual tops and are placed next to each other in field	2-piece standard	16 x 24"	PW9024	<input type="checkbox"/>	<input type="checkbox"/>	<input type="checkbox"/>	<input type="checkbox"/>	<input type="checkbox"/>	<input type="checkbox"/>	
		2-piece standard	16 x 30"	PW9030	<input type="checkbox"/>	<input type="checkbox"/>	<input type="checkbox"/>	<input type="checkbox"/>	<input type="checkbox"/>	<input type="checkbox"/>	<input type="checkbox"/>
		2-piece standard	16 x 36"	PW9036	<input type="checkbox"/>	<input type="checkbox"/>	<input type="checkbox"/>	<input type="checkbox"/>	<input type="checkbox"/>	<input type="checkbox"/>	<input type="checkbox"/>
 <p>PWCW</p>	<b>Straight Countertops - Wheelchair Height</b> • For notch location of "LS, RS, BS", the notch has a grommet and will require a grommet color selection • Brackets include steel locking clips to prevent dislodgement	16 x 24"	PWCTWC24	<input type="checkbox"/>	<input type="checkbox"/>	<input type="checkbox"/>	<input type="checkbox"/>	<input type="checkbox"/>	<input type="checkbox"/>	<input type="checkbox"/>	
		16 x 30"	PWCTWC30	<input type="checkbox"/>	<input type="checkbox"/>	<input type="checkbox"/>	<input type="checkbox"/>	<input type="checkbox"/>	<input type="checkbox"/>	<input type="checkbox"/>	<input type="checkbox"/>
		16 x 36"	PWCTWC36	<input type="checkbox"/>	<input type="checkbox"/>	<input type="checkbox"/>	<input type="checkbox"/>	<input type="checkbox"/>	<input type="checkbox"/>	<input type="checkbox"/>	<input type="checkbox"/>
		16 x 42"	PWCTWC42	<input type="checkbox"/>	<input type="checkbox"/>	<input type="checkbox"/>	<input type="checkbox"/>	<input type="checkbox"/>	<input type="checkbox"/>	<input type="checkbox"/>	<input type="checkbox"/>
		16 x 48"	PWCTWC48	<input type="checkbox"/>	<input type="checkbox"/>	<input type="checkbox"/>	<input type="checkbox"/>	<input type="checkbox"/>	<input type="checkbox"/>	<input type="checkbox"/>	<input type="checkbox"/>
		16 x 54"	PWCTWC54	<input type="checkbox"/>	<input type="checkbox"/>	<input type="checkbox"/>	<input type="checkbox"/>	<input type="checkbox"/>	<input type="checkbox"/>	<input type="checkbox"/>	<input type="checkbox"/>
		16 x 60"	PWCTWC60	<input type="checkbox"/>	<input type="checkbox"/>	<input type="checkbox"/>	<input type="checkbox"/>	<input type="checkbox"/>	<input type="checkbox"/>	<input type="checkbox"/>	<input type="checkbox"/>
		16 x 66"	PWCTWC66	<input type="checkbox"/>	<input type="checkbox"/>	<input type="checkbox"/>	<input type="checkbox"/>	<input type="checkbox"/>	<input type="checkbox"/>	<input type="checkbox"/>	<input type="checkbox"/>
		16 x 72"	PWCTWC72	<input type="checkbox"/>	<input type="checkbox"/>	<input type="checkbox"/>	<input type="checkbox"/>	<input type="checkbox"/>	<input type="checkbox"/>	<input type="checkbox"/>	<input type="checkbox"/>
		16 x 78"	PWCTWC78	<input type="checkbox"/>	<input type="checkbox"/>	<input type="checkbox"/>	<input type="checkbox"/>	<input type="checkbox"/>	<input type="checkbox"/>	<input type="checkbox"/>	<input type="checkbox"/>
			16 x 84"	PWCTWC84	<input type="checkbox"/>	<input type="checkbox"/>	<input type="checkbox"/>	<input type="checkbox"/>	<input type="checkbox"/>	<input type="checkbox"/>	
 <p>PWCW</p>	<b>90° Countertops - Wheelchair Height</b> • For notch location of "LS, RS, BS", the notch has a grommet and will require a grommet color selection • Brackets include steel locking clips to prevent dislodgement • PL edge comes with two individual tops and are placed next to each other in field	2-piece standard	16 x 24"	PWCTWC9024	<input type="checkbox"/>	<input type="checkbox"/>	<input type="checkbox"/>	<input type="checkbox"/>	<input type="checkbox"/>	<input type="checkbox"/>	
		2-piece standard	16 x 30"	PWCTWC9030	<input type="checkbox"/>	<input type="checkbox"/>	<input type="checkbox"/>	<input type="checkbox"/>	<input type="checkbox"/>	<input type="checkbox"/>	<input type="checkbox"/>
		2-piece standard	16 x 36"	PWCTWC9036	<input type="checkbox"/>	<input type="checkbox"/>	<input type="checkbox"/>	<input type="checkbox"/>	<input type="checkbox"/>	<input type="checkbox"/>	<input type="checkbox"/>

A      B      C      D      E      F      G

### HOW TO ORDER

Indicate the following information on order form:

- Quantity of each item.
- Model number, including options. See "How To Build a Model Number".
- Any special service required.

Note: • The  indicates that a choice is required.

- The absence of the  indicates that no choice is required.
- Alpha-numeric characters in place of  indicate that no other alternatives are available.

### HOW TO BUILD A MODEL NUMBER

**A** Select basic model.

**B** Select notch location.

- S** - Standard
- LS** - Left notch for std trim
- RS** - Right notch for std trim
- BS** - Both notches for std trim
- LF** - Left notch for flat trim
- RF** - Right notch for flat trim
- BF** - Both notches for flat trim

For notch location of "LS, RS, BS", the notch has a grommet and will require a separate grommet color selection

**C** Select edge style.

- BN** - Flat vinyl T-edge
- 74P** - 74P edge
- PL** - Postformed edge
- KN** - Knife edge
- WE** - Wood edge, laminate surface
- WV** - Wood edge, veneer surface

**D** Select surface finish.

Refer to color addendum at [ki.com](http://ki.com) or KI Fabrics & Finishes binder. Surface finish offerings are based on edge style selections.

**E** Select trim color.

Refer to color addendum at [ki.com](http://ki.com) or KI Fabrics & Finishes binder. Metallic finish not available.

**F** Select edge color.

Refer to color addendum at [ki.com](http://ki.com) or KI Fabrics & Finishes binder.

**G** Select grommet color.

For notch location of "LS, RS, BS", the notch has a grommet and will require a separate grommet color selection, otherwise there is no grommet color selection

Refer to color addendum at [ki.com](http://ki.com) or KI Fabrics & Finishes binder.

### FINISH INFORMATION

#### Additional Laminate Offering

Additional laminates beyond KI standard offering, are available with two weeks extended leadtime. To specify additional laminates, use these designators followed by the supplier's color/pattern code:

Formica - LF/supplier's color pattern code  
 Nevamar - LN/supplier's color pattern code  
 Wilsonart - LW/supplier's color pattern code

KI's standard finish is the supplier's recommended finish for that color/pattern.

Note: Nonstandard laminates from these suppliers (example: textured laminates), require an upcharge and additional leadtime. Contact KI.



# Worksurfaces

Countertops

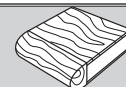
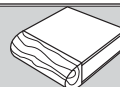
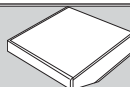
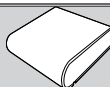
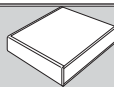
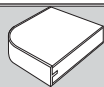

Approx. Packaged Weight	Flat Vinyl T-Edge (BN)	74P Edge (74P)	Postformed Edge (PL)	Knife Edge (KN)	Wood Edge Laminate (WE)	Wood Edge Veneer (WV)
16.0#	\$ 228	\$ 236	\$ 281	\$ 240	\$ 369	\$ 835
19.0#	251	262	311	267	402	981
22.0#	264	277	330	280	437	1089
25.0#	306	319	382	324	483	1194
28.0#	324	343	406	348	515	1339
31.0#	342	357	428	394	602	1521
34.0#	355	369	443	409	632	1700
37.0#	363	382	454	449	680	1808
40.0#	368	390	464	460	706	1881
43.0#	380	397	473	485	733	1921
43.0#	388	406	486	499	758	2276
23.0#	\$ 369	\$ 391	\$ 467	\$ 398	N/A	\$ 3088
30.0#	474	496	594	507	N/A	3308
37.0#	558	587	698	596	N/A	3463

16.0#	\$ 263	\$ 275	\$ 319	\$ 252	\$ 391	\$ 871
19.0#	283	300	348	279	355	1018
22.0#	303	316	366	314	388	1124
25.0#	342	356	419	333	436	1232
28.0#	363	380	443	347	467	1377
31.0#	379	394	464	420	552	1556
34.0#	391	408	483	437	586	1736
37.0#	398	419	489	488	631	1844
40.0#	406	425	499	503	659	1915
43.0#	417	436	510	527	684	1957
46.0#	424	443	522	543	714	2311
23.0#	\$ 408	\$ 428	\$ 501	\$ 431	N/A	\$ 3123
30.0#	511	536	630	485	N/A	3342
37.0#	594	624	733	519	N/A	3500

## SPECIAL SERVICES

### Special Carton Marking

With specially marked information N/C

### Shipping

Delivered. Shipped **k.d. freight prepaid f.o.b. Manitowoc, Wisconsin 54220** factory. Freight class #70.

Specifications and prices are subject to change without prior notice.

# Worksurfaces

Mobile Teardrop/Mobile Semi-Circle

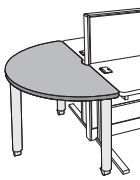
				MODEL NUMBER						
MODEL	Features	D x DIA	Basic Model	Edge Style	Height	Trim Color	Base	Surface Finish	Edge Color	
 <p>WMT</p>	<b>Mobile Teardrop Worksurface</b> • 1-1/4" solid particleboard with high-pressure laminate • Base consists of three 3" diameter metal support legs with adjustable chrome-plated glides as standard or optional casters • Connects to end of 24" or 30" worksurface • 29" height only with or without casters • Pointed end is removed to accommodate corner of two WireWorks panels	24 X 45"	WMTPW2446	<input type="checkbox"/>		<input type="checkbox"/>	<input type="checkbox"/>	<input type="checkbox"/>	<input type="checkbox"/>	
		30 X 55"	WMTPW3056	<input type="checkbox"/>		<input type="checkbox"/>	<input type="checkbox"/>	<input type="checkbox"/>	<input type="checkbox"/>	
 <p>WMT</p>	<b>Mobile Semi-Circle Worksurface</b> • 1-1/4" solid particleboard with high-pressure laminate • Base consists of three 3" diameter metal support legs with adjustable chrome-plated glide as standard or optional casters • Connects to end of 24" or 30" worksurface • Notched in center for wire management • 29" height only with or without casters • Notch enables surface to wrap around end cap of WireWorks® panel • 51-1/2" diameter accommodates two 24" deep worksurfaces separated by a WireWorks panel • 63-1/2" diameter accommodates two 30" deep worksurfaces separated by a WireWorks panel	Std. 24 X 51-1/2"	WMSCPW52	<input type="checkbox"/>	9	<input type="checkbox"/>	<input type="checkbox"/>	<input type="checkbox"/>	<input type="checkbox"/>	
		Std. 30 X 63-1/2"	WMSCPW64	<input type="checkbox"/>	9	<input type="checkbox"/>	<input type="checkbox"/>	<input type="checkbox"/>	<input type="checkbox"/>	
		Flat 24 X 51-1/2"	WMSCFW52	<input type="checkbox"/>	9	<input type="checkbox"/>	<input type="checkbox"/>	<input type="checkbox"/>	<input type="checkbox"/>	
		Flat 30 X 63-1/2"	WMSCFW64	<input type="checkbox"/>	9	<input type="checkbox"/>	<input type="checkbox"/>	<input type="checkbox"/>	<input type="checkbox"/>	
				<b>A</b>	<b>B</b>	<b>C</b>	<b>D</b>	<b>E</b>	<b>F</b>	<b>G</b>

## HOW TO ORDER

Indicate the following information on order form:

- Quantity of each item.
- Model number, including options. See "How To Build a Model Number".
- Any special service required.

Note: • The  indicates that a choice is required.

- The absence of the  indicates that no choice is required.
- Alpha-numeric characters in place of  indicate that no other alternatives are available.

## HOW TO BUILD A MODEL NUMBER

**A** Select basic model.

**B** Select edge style.

**BN** - Flat vinyl T-edge  
**74P** - 74P edge

**C** Select height.

**9** - 29" high

**D** Select trim color (edge/grommet/support bracket).

Refer to color addendum at ki.com or KI Fabrics & Finishes binder.

**E** Select base option.

**G** - Glides  
**C** - Casters; add \$40

**F** Select surface finish.

Refer to color addendum at ki.com or KI Fabrics & Finishes binder.  
Surface finish offerings are based on edge style selections.

**G** Select edge color.

Refer to color addendum at ki.com or KI Fabrics & Finishes binder.  
Edge color offerings are based on edge style selections.

## FINISH INFORMATION

### Additional Laminate Offering

Additional laminates beyond KI standard offering, are available with two weeks extended leadtime. To specify additional laminates, use these designators followed by the supplier's color/pattern code:

Formica - LF/supplier's color pattern code  
Nevamar - LN/supplier's color pattern code  
Wilsonart - LW/supplier's color pattern code

KI's standard finish is the supplier's recommended finish for that color/pattern.

Note: Nonstandard laminates from these suppliers (example: textured laminates), require an upcharge and additional leadtime. Contact KI.



# Worksurfaces

Mobile Teardrop/Mobile Semi-Circle

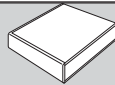
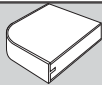

Approx.  
Packaged  
Weight

Flat Vinyl T-Edge  
(BN)

74P Edge  
(74P)

98.0#

\$ 849

\$ 890

132.0#

852

895

69.0#

\$ 1011

\$ 1061

88.0#

1030

1083

69.0#

1011

1061

88.0#

1030

1083

## SPECIAL SERVICES

### Special Carton Marking

With specially marked information N/C

### Shipping

Delivered. Shipped **k.d. freight prepaid**  
**f.o.b. Manitowoc, Wisconsin 54220**  
factory. Freight class #70.

Specifications and prices are subject to  
change without prior notice.







# Worksurfaces

Mobile Teardrop/Mobile Semi-Circle

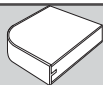

Flat Vinyl T-Edge  
(BN)

\$ 430

446

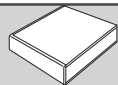

74P Edge  
(74P)

\$ 454

470

## SPECIAL SERVICES

### Special Carton Marking

With specially marked information N/C

### Shipping

Delivered. Shipped **k.d. freight prepaid f.o.b. Manitowoc, Wisconsin 54220** factory. Freight class #70.

Specifications and prices are subject to change without prior notice.

# Worksurfaces

## Worksurface Support Panel

MODEL	D x DIA	MODEL NUMBER						Approx. Packaged Weight
		Basic Model	Dir.	Surface Finish	Trim Color	Fabric Color	Edge Color	
<b>Worksurface Support Panel (Fabric/Laminate)</b> • Must specify left or right side version by adding /L (left) or /R (right) to product number • Support panel provides additional worksurface support in extensive worksurface loading applications • Mounts to panel and worksurface • Adjustable glides provide leveling capability • 26" worksurface height equals 24-7/8" panel height • 29" worksurface height equals 27-7/8" panel height	24 x 26"	PWSSP2426/BN	<input type="checkbox"/>	<input type="checkbox"/>		<input type="checkbox"/>	<input type="checkbox"/>	15.0#
	24 x 29"	PWSSP2429/BN	<input type="checkbox"/>	<input type="checkbox"/>		<input type="checkbox"/>	<input type="checkbox"/>	16.0#
	30 x 26"	PWSSP3026/BN	<input type="checkbox"/>	<input type="checkbox"/>		<input type="checkbox"/>	<input type="checkbox"/>	17.0#
	30 x 29"	PWSSP3029/BN	<input type="checkbox"/>	<input type="checkbox"/>		<input type="checkbox"/>	<input type="checkbox"/>	18.0#

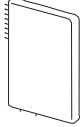

PWSP

**A**   **B**   **C**   **D**   **E**   **F**

### HOW TO ORDER

Indicate the following information on order form:

- Quantity of each item.
- Model number, including options. See "How To Build a Model Number".
- Any special service required.

Note:

- The  indicates that a choice is required.
- The absence of the  indicates that no choice is required.
- Alpha-numeric characters in place of  indicate that no other alternatives are available.

### HOW TO BUILD A MODEL NUMBER

- A** Select basic model.
- B** Select surface direction.  
 DL - Direction left  
 DR - Direction right
- C** Select surface finish.  
 Refer to color addendum at ki.com or KI Fabrics & Finishes binder.  
 Surface finish offerings are based on edge style selections.
- D** Select trim color.  
 Refer to color addendum at ki.com or KI Fabrics & Finishes binder.
- E** Select fabric color.  
 Refer to Vertical Fabric Pricing Addendum.
- F** Select edge color.  
 Refer to color addendum at ki.com or KI Fabrics & Finishes binder.

### FINISH INFORMATION

**Additional Laminate Offering**  
 Additional laminates beyond KI standard offering, are available with two weeks extended leadtime. To specify additional laminates, use these designators followed by the supplier's color/pattern code:

Formica - LF/supplier's color pattern code  
 Nevamar - LN/supplier's color pattern code  
 Wilsonart - LW/supplier's color pattern code

KI's standard finish is the supplier's recommended finish for that color/pattern.  
 Note: Nonstandard laminates from these suppliers (example: textured laminates), require an upcharge and additional leadtime. Contact KI.



Delivered Pricing Fabric Grade 1 & C.O.M.	Delivered Pricing Fabric Grade 2	Delivered Pricing Fabric Grade 3 & Pallas Vertical Fabric Grade PV	Delivered Pricing Pallas Vertical Fabric Grade PV1	Delivered Pricing Pallas Vertical Fabric Grade PV2
\$ 487	\$ 495	\$ 501	\$ 511	\$ 531
493	503	510	522	541
493	503	510	522	541
508	517	523	535	553

## SPECIAL SERVICES

### Special Carton Marking

With specially marked information N/C

### Shipping

Delivered. Shipped **k.d. freight prepaid f.o.b. Manitowoc, Wisconsin 54220** factory. Freight class #70.

Specifications and prices are subject to change without prior notice.

# Worksurfaces

## Worksurface Support Panel

MODEL	D x DIA	MODEL NUMBER						Approx. Packaged Weight
		Basic Model	Dir.	Edge Style	Surface Finish	Trim Color	Edge Color	
<b>Worksurface Support Panel (Laminate Both Sides)</b> <ul style="list-style-type: none"> <li>• Must specify left or right side version by adding /L (left) or /R (right) to product number</li> <li>• Support panel provides additional worksurface support in extensive worksurface loading applications</li> <li>• Mounts to panel and worksurface</li> <li>• Adjustable glides provide leveling capability</li> <li>• 26" worksurface height equals 24-7/8" panel height</li> <li>• 29" worksurface height equals 27-7/8" panel height</li> </ul>	24 x 26"	PWSSL2426	<input type="checkbox"/>	<input type="checkbox"/>	<input type="checkbox"/>	<input type="checkbox"/>	<input type="checkbox"/>	15.0#
	24 x 29"	PWSSL2429	<input type="checkbox"/>	<input type="checkbox"/>	<input type="checkbox"/>	<input type="checkbox"/>	<input type="checkbox"/>	16.0#
	30 x 26"	PWSSL3026	<input type="checkbox"/>	<input type="checkbox"/>	<input type="checkbox"/>	<input type="checkbox"/>	<input type="checkbox"/>	17.0#
	30 x 29"	PWSSL3029	<input type="checkbox"/>	<input type="checkbox"/>	<input type="checkbox"/>	<input type="checkbox"/>	<input type="checkbox"/>	18.0#
			<b>A</b>	<b>B</b>	<b>C</b>	<b>D</b>	<b>E</b>	<b>F</b>



PWSL

### HOW TO ORDER

Indicate the following information on order form:

1. Quantity of each item.
2. Model number, including options. See "How To Build a Model Number".
3. Any special service required.

Note: • The  indicates that a choice is required.

- The absence of the  indicates that no choice is required.
- Alpha-numeric characters in place of  indicate that no other alternatives are available.

### HOW TO BUILD A MODEL NUMBER

**A** Select basic model.

**B** Select surface direction.

**DR** - Direction right

**DL** - Direction left

**C** Select edge style.

**BN** - Flat vinyl T-edge

**74P** - 74P edge

**PL** - Postformed edge

**D** Select surface finish.

Refer to color addendum at ki.com or KI Fabrics & Finishes binder.  
Surface finish offerings are based on edge style selections.

**E** Select trim color.

Refer to color addendum at ki.com or KI Fabrics & Finishes binder.

**F** Select edge color.

Refer to color addendum at ki.com or KI Fabrics & Finishes binder.

### FINISH INFORMATION

#### Additional Laminate Offering

Additional laminates beyond KI standard offering, are available with two weeks extended leadtime. To specify additional laminates, use these designators followed by the supplier's color/pattern code:

Formica - LF/supplier's color pattern code  
Nevamar - LN/supplier's color pattern code  
Wilsonart - LW/supplier's color pattern code

KI's standard finish is the supplier's recommended finish for that color/pattern.

Note: Nonstandard laminates from these suppliers (example: textured laminates), require an upcharge and additional leadtime. Contact KI.



# Worksurfaces

Worksurface Support Panel

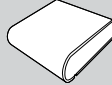
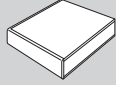
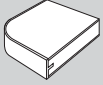

Flat Vinyl T-Edge  
(BN)

74P Edge  
(74P)

Postformed Edge  
(PL)

\$ 337	\$ 354	\$ 422
342	357	428
342	357	428
353	367	439

**SPECIAL SERVICES**

**Special Carton Marking**

With specially marked information N/C

**Shipping**

Delivered. Shipped **k.d. freight prepaid f.o.b. Manitowoc, Wisconsin 54220** factory. Freight class #70.

Specifications and prices are subject to change without prior notice.

# Worksurface Accessories

## Worksurface Accessories

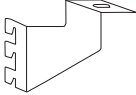
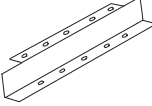
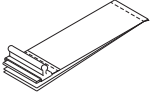
	MODEL	Features	W x D x H	MODEL NUMBER		Approx. Packaged Weight
				Basic Model	Trim Color	
 HRDPT	<b>Grommets - Field-Installed</b>	Inside - 2-3/4", Outside - 3"		WSG		1.0#
 HRDPT	<b>Worksurface Support Bracket</b>		3 x 4"	PWSB.L		1.0#
			3 x 4"	PWSB.R		1.0#
 HRDPT	<b>Worksurface Vertical Filler</b>		3 x 24"	WSVF.24		3.0#
			3 x 30"	WSVF.30		3.0#
 HRDPT	<b>Worksurface Wire Manager</b>	W - 2", D - 2-1/2"		WWM		1.0#

A

B

### HOW TO ORDER

Indicate the following information on order form:

- Quantity of each item.
- Model number, including options. See "How To Build a Model Number".
- Any special service required.

Note: • The  indicates that a choice is required.

- The absence of the  indicates that no choice is required.
- Alpha-numeric characters in place of  indicate that no other alternatives are available.

### HOW TO BUILD A MODEL NUMBER

- A** Select basic model.
- B** Select trim color.  
Refer to color addendum at [ki.com](http://ki.com) or KI Fabrics & Finishes binder.  
Metallic finish not available.



Delivered  
Pricing

\$ 4

\$ 21

21

\$ 42

46

\$ 48

### SPECIAL SERVICES

#### Special Carton Marking

With specially marked information N/C

#### Shipping

Shipped **k.d. freight prepaid f.o.b. Manitowoc, Wisconsin 54220** factory.  
Freight class #70.

Specifications and prices are subject to change without prior notice.

# Universal Storage and Accessories

## Overhead Storage

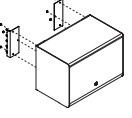
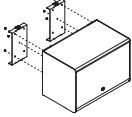
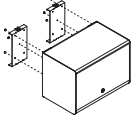
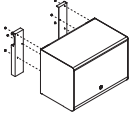
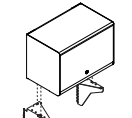
	MODEL	W x H x D	MODEL NUMBER				Approx. Packaged Weight
			Basic Model	Assembly	Paint Color	Key Option	
 PRDS	<b>Steel Door Overhead Cabinet-On-Module</b> • On-Module overheads (PM) mount into slots in vertical posts. Overheads must be same width as panel mounted to. Does not require a 12" tile for mounting. Allows for vertical adjustment in 1" increments	24 x 16-1/2 x 14-1/2"	PRDS24/WW/PM	<input type="checkbox"/>	<input type="checkbox"/>	<input type="checkbox"/>	32.0#
		30 x 16-1/2 x 14-1/2"	PRDS30/WW/PM	<input type="checkbox"/>	<input type="checkbox"/>	<input type="checkbox"/>	36.0#
		36 x 16-1/2 x 14-1/2"	PRDS36/WW/PM	<input type="checkbox"/>	<input type="checkbox"/>	<input type="checkbox"/>	40.0#
		42 x 16-1/2 x 14-1/2"	PRDS42/WW/PM	<input type="checkbox"/>	<input type="checkbox"/>	<input type="checkbox"/>	44.0#
		48 x 16-1/2 x 14-1/2"	PRDS48/WW/PM	<input type="checkbox"/>	<input type="checkbox"/>	<input type="checkbox"/>	49.0#
		54 x 16-1/2 x 14-1/2"	PRDS54/WW/PM	<input type="checkbox"/>	<input type="checkbox"/>	<input type="checkbox"/>	53.0#
		60 x 16-1/2 x 14-1/2"	PRDS60/WW/PM	<input type="checkbox"/>	<input type="checkbox"/>	<input type="checkbox"/>	57.0#
 PRDS	<b>Steel Door Overhead Cabinet-Off-Module</b> • Off-Module overheads (OM12) for WireWorks® mount into an integral track in the horizontal rail. Allows shelf to slide along track. Requires a 12" tile for mounting (i.e. must be a half or fully segmented panel)	24 x 16-1/2 x 14-1/2"	PRDS24/WW/OM12	<input type="checkbox"/>	<input type="checkbox"/>	<input type="checkbox"/>	32.0#
		30 x 16-1/2 x 14-1/2"	PRDS30/WW/OM12	<input type="checkbox"/>	<input type="checkbox"/>	<input type="checkbox"/>	36.0#
		36 x 16-1/2 x 14-1/2"	PRDS36/WW/OM12	<input type="checkbox"/>	<input type="checkbox"/>	<input type="checkbox"/>	40.0#
		42 x 16-1/2 x 14-1/2"	PRDS42/WW/OM12	<input type="checkbox"/>	<input type="checkbox"/>	<input type="checkbox"/>	44.0#
		48 x 16-1/2 x 14-1/2"	PRDS48/WW/OM12	<input type="checkbox"/>	<input type="checkbox"/>	<input type="checkbox"/>	49.0#
		54 x 16-1/2 x 14-1/2"	PRDS54/WW/OM12	<input type="checkbox"/>	<input type="checkbox"/>	<input type="checkbox"/>	53.0#
		60 x 16-1/2 x 14-1/2"	PRDS60/WW/OM12	<input type="checkbox"/>	<input type="checkbox"/>	<input type="checkbox"/>	57.0#
 PRDS	<b>Steel Door Cabinet-Off-Module</b> • Off-Module overheads (OM18) for WireWorks® mount into an integral track in the horizontal rail. Allows shelf to slide along track. Requires a 18" tile (OM18) for mounting (i.e. must be a half or fully segmented panel)	24 x 16-1/2 x 14-1/2"	PRDS24/WW/OM18	<input type="checkbox"/>	<input type="checkbox"/>	<input type="checkbox"/>	32.0#
		30 x 16-1/2 x 14-1/2"	PRDS30/WW/OM18	<input type="checkbox"/>	<input type="checkbox"/>	<input type="checkbox"/>	36.0#
		36 x 16-1/2 x 14-1/2"	PRDS36/WW/OM18	<input type="checkbox"/>	<input type="checkbox"/>	<input type="checkbox"/>	40.0#
		42 x 16-1/2 x 14-1/2"	PRDS42/WW/OM18	<input type="checkbox"/>	<input type="checkbox"/>	<input type="checkbox"/>	44.0#
		48 x 16-1/2 x 14-1/2"	PRDS48/WW/OM18	<input type="checkbox"/>	<input type="checkbox"/>	<input type="checkbox"/>	49.0#
		54 x 16-1/2 x 14-1/2"	PRDS54/WW/OM18	<input type="checkbox"/>	<input type="checkbox"/>	<input type="checkbox"/>	53.0#
		60 x 16-1/2 x 14-1/2"	PRDS60/WW/OM18	<input type="checkbox"/>	<input type="checkbox"/>	<input type="checkbox"/>	57.0#
 PRDS	<b>Steel Door Overhead Cabinet-Load Bar Mount</b> • Load Bar mount overheads (LB) for WireWorks® hang from an externally mounted load bar • Load Bar purchased separately	24 x 16-1/2 x 14-1/2"	PRDS24/WW/LB	<input type="checkbox"/>	<input type="checkbox"/>	<input type="checkbox"/>	32.0#
		30 x 16-1/2 x 14-1/2"	PRDS30/WW/LB	<input type="checkbox"/>	<input type="checkbox"/>	<input type="checkbox"/>	36.0#
		36 x 16-1/2 x 14-1/2"	PRDS36/WW/LB	<input type="checkbox"/>	<input type="checkbox"/>	<input type="checkbox"/>	40.0#
		42 x 16-1/2 x 14-1/2"	PRDS42/WW/LB	<input type="checkbox"/>	<input type="checkbox"/>	<input type="checkbox"/>	44.0#
		48 x 16-1/2 x 14-1/2"	PRDS48/WW/LB	<input type="checkbox"/>	<input type="checkbox"/>	<input type="checkbox"/>	49.0#
		54 x 16-1/2 x 14-1/2"	PRDS54/WW/LB	<input type="checkbox"/>	<input type="checkbox"/>	<input type="checkbox"/>	53.0#
		60 x 16-1/2 x 14-1/2"	PRDS60/WW/LB	<input type="checkbox"/>	<input type="checkbox"/>	<input type="checkbox"/>	57.0#
 PRDS	<b>Steel Door Overhead Cabinet-Upmount</b> • Upmount brackets position the storage component on a 54" high panel to the same height as on 66" high panels • On a 54" high panel, clearance between the cabinet and worksurface is 20" • On a 48" high panel, clearance between the cabinet and worksurface is 14"	24 x 16-1/2 x 14-1/2"	PRDS24/WW/UM	<input type="checkbox"/>	<input type="checkbox"/>	<input type="checkbox"/>	32.0#
		30 x 16-1/2 x 14-1/2"	PRDS30/WW/UM	<input type="checkbox"/>	<input type="checkbox"/>	<input type="checkbox"/>	36.0#
		36 x 16-1/2 x 14-1/2"	PRDS36/WW/UM	<input type="checkbox"/>	<input type="checkbox"/>	<input type="checkbox"/>	40.0#
		42 x 16-1/2 x 14-1/2"	PRDS42/WW/UM	<input type="checkbox"/>	<input type="checkbox"/>	<input type="checkbox"/>	44.0#
		48 x 16-1/2 x 14-1/2"	PRDS48/WW/UM	<input type="checkbox"/>	<input type="checkbox"/>	<input type="checkbox"/>	49.0#
		54 x 16-1/2 x 14-1/2"	PRDS54/WW/UM	<input type="checkbox"/>	<input type="checkbox"/>	<input type="checkbox"/>	53.0#
		60 x 16-1/2 x 14-1/2"	PRDS60/WW/UM	<input type="checkbox"/>	<input type="checkbox"/>	<input type="checkbox"/>	57.0#

A

B

C

D

### HOW TO ORDER

Indicate the following information on order form:

- Quantity of each item.
- Model number, including options. See "How To Build a Model Number".
- Any special service required.

Note: • The  indicates that a choice is required.

- The absence of the  indicates that no choice is required.
- Alpha-numeric characters in place of

indicate that no other alternatives are available.

### HOW TO BUILD A MODEL NUMBER

**A** Select basic model.

**B** Select assembly.

F - Fully Assembled; add \$131  
U - Unassembled

**C** Select paint color.

Refer to color addendum at ki.com or KI Fabrics & Finishes binder. Metallic paint requires upcharge.

**D** Select key alike.

KA - Key alike  
KS - Key standard  
NLC - No lock core

### INFORMATION

Steel bottom, top shelf and end panels with powder-coated finish  
Accepts shelf divider  
Door stores recessed with handle exposed  
Double bit lock is included  
Shelf depth is 13-1/4"





# Universal Storage and Accessories

Overhead Storage

Delivered  
Pricing

\$ 437

481

488

521

551

632

673

\$ 518

557

565

599

631

710

753

\$ 518

557

565

599

631

710

753

\$ 518

557

565

599

631

710

753

\$ 557

600

607

640

671

752

796

## SPECIAL SERVICES

### Special Carton Marking

With specially marked information N/C

### Shipping

Delivered. Shipped **k.d. freight prepaid f.o.b. Manitowoc, Wisconsin 54220** factory. Freight class #70.

Specifications and prices are subject to change without prior notice.

# Universal Storage and Accessories

## Overhead Storage

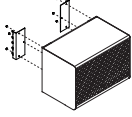
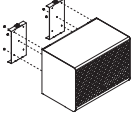
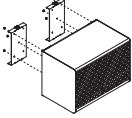
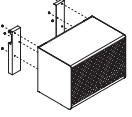
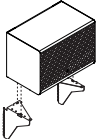
	MODEL	W x H x D	MODEL NUMBER					Approx. Packaged Weight
			Basic Model	Assembly	Paint Color	Fabric Color	Key Option	
 PRDF	<b>Fabric Door Overhead Cabinet-On-Module</b> <ul style="list-style-type: none"> <li>On-Module overheads (PM) mount into slots in vertical posts. Overheads must be same width as panel mounted to. Does not require a 12" tile for mounting. Allows for vertical adjustment in 1" increments</li> </ul>	24 x 16-1/2 x 14-1/2"	PRDF24/WW/PM	<input type="checkbox"/>	<input type="checkbox"/>	<input type="checkbox"/>	<input type="checkbox"/>	32.0#
		30 x 16-1/2 x 14-1/2"	PRDF30/WW/PM	<input type="checkbox"/>	<input type="checkbox"/>	<input type="checkbox"/>	<input type="checkbox"/>	36.0#
		36 x 16-1/2 x 14-1/2"	PRDF36/WW/PM	<input type="checkbox"/>	<input type="checkbox"/>	<input type="checkbox"/>	<input type="checkbox"/>	40.0#
		42 x 16-1/2 x 14-1/2"	PRDF42/WW/PM	<input type="checkbox"/>	<input type="checkbox"/>	<input type="checkbox"/>	<input type="checkbox"/>	44.0#
		48 x 16-1/2 x 14-1/2"	PRDF48/WW/PM	<input type="checkbox"/>	<input type="checkbox"/>	<input type="checkbox"/>	<input type="checkbox"/>	49.0#
		54 x 16-1/2 x 14-1/2"	PRDF54/WW/PM	<input type="checkbox"/>	<input type="checkbox"/>	<input type="checkbox"/>	<input type="checkbox"/>	53.0#
		60 x 16-1/2 x 14-1/2"	PRDF60/WW/PM	<input type="checkbox"/>	<input type="checkbox"/>	<input type="checkbox"/>	<input type="checkbox"/>	57.0#
 PRDF	<b>Fabric Door Overhead Cabinet-Off-Module</b> <ul style="list-style-type: none"> <li>Off-Module overheads (OM12) for WireWorks® mount into an integral track in the horizontal rail. Allows shelf to slide along track. Requires a 12" tile for mounting (i.e. must be a half or fully segmented panel)</li> </ul>	24 x 16-1/2 x 14-1/2"	PRDF24/WW/OM12	<input type="checkbox"/>	<input type="checkbox"/>	<input type="checkbox"/>	<input type="checkbox"/>	32.0#
		30 x 16-1/2 x 14-1/2"	PRDF30/WW/OM12	<input type="checkbox"/>	<input type="checkbox"/>	<input type="checkbox"/>	<input type="checkbox"/>	36.0#
		36 x 16-1/2 x 14-1/2"	PRDF36/WW/OM12	<input type="checkbox"/>	<input type="checkbox"/>	<input type="checkbox"/>	<input type="checkbox"/>	40.0#
		42 x 16-1/2 x 14-1/2"	PRDF42/WW/OM12	<input type="checkbox"/>	<input type="checkbox"/>	<input type="checkbox"/>	<input type="checkbox"/>	44.0#
		48 x 16-1/2 x 14-1/2"	PRDF48/WW/OM12	<input type="checkbox"/>	<input type="checkbox"/>	<input type="checkbox"/>	<input type="checkbox"/>	49.0#
		54 x 16-1/2 x 14-1/2"	PRDF54/WW/OM12	<input type="checkbox"/>	<input type="checkbox"/>	<input type="checkbox"/>	<input type="checkbox"/>	53.0#
		60 x 16-1/2 x 14-1/2"	PRDF60/WW/OM12	<input type="checkbox"/>	<input type="checkbox"/>	<input type="checkbox"/>	<input type="checkbox"/>	57.0#
 PRDF	<b>Fabric Door Overhead Cabinet-Off-Module</b> <ul style="list-style-type: none"> <li>Off-Module overheads (OM18) for WireWorks® mount into an integral track in the horizontal rail. Allows shelf to slide along track. Requires a 18" tile (OM18) for mounting (i.e. must be a half or fully segmented panel)</li> </ul>	24 x 16-1/2 x 14-1/2"	PRDF24/WW/OM18	<input type="checkbox"/>	<input type="checkbox"/>	<input type="checkbox"/>	<input type="checkbox"/>	32.0#
		30 x 16-1/2 x 14-1/2"	PRDF30/WW/OM18	<input type="checkbox"/>	<input type="checkbox"/>	<input type="checkbox"/>	<input type="checkbox"/>	36.0#
		36 x 16-1/2 x 14-1/2"	PRDF36/WW/OM18	<input type="checkbox"/>	<input type="checkbox"/>	<input type="checkbox"/>	<input type="checkbox"/>	40.0#
		42 x 16-1/2 x 14-1/2"	PRDF42/WW/OM18	<input type="checkbox"/>	<input type="checkbox"/>	<input type="checkbox"/>	<input type="checkbox"/>	44.0#
		48 x 16-1/2 x 14-1/2"	PRDF48/WW/OM18	<input type="checkbox"/>	<input type="checkbox"/>	<input type="checkbox"/>	<input type="checkbox"/>	49.0#
		54 x 16-1/2 x 14-1/2"	PRDF54/WW/OM18	<input type="checkbox"/>	<input type="checkbox"/>	<input type="checkbox"/>	<input type="checkbox"/>	53.0#
		60 x 16-1/2 x 14-1/2"	PRDF60/WW/OM18	<input type="checkbox"/>	<input type="checkbox"/>	<input type="checkbox"/>	<input type="checkbox"/>	57.0#
 PRDF	<b>Fabric Door Overhead Cabinet-Load Bar Mount</b> <ul style="list-style-type: none"> <li>Load Bar mount overheads (LB) for WireWorks® hang from an externally mounted load bar</li> <li>Load Bar purchased separately</li> </ul>	24 x 16-1/2 x 14-1/2"	PRDF24/WW/LB	<input type="checkbox"/>	<input type="checkbox"/>	<input type="checkbox"/>	<input type="checkbox"/>	32.0#
		30 x 16-1/2 x 14-1/2"	PRDF30/WW/LB	<input type="checkbox"/>	<input type="checkbox"/>	<input type="checkbox"/>	<input type="checkbox"/>	36.0#
		36 x 16-1/2 x 14-1/2"	PRDF36/WW/LB	<input type="checkbox"/>	<input type="checkbox"/>	<input type="checkbox"/>	<input type="checkbox"/>	40.0#
		42 x 16-1/2 x 14-1/2"	PRDF42/WW/LB	<input type="checkbox"/>	<input type="checkbox"/>	<input type="checkbox"/>	<input type="checkbox"/>	44.0#
		48 x 16-1/2 x 14-1/2"	PRDF48/WW/LB	<input type="checkbox"/>	<input type="checkbox"/>	<input type="checkbox"/>	<input type="checkbox"/>	49.0#
		54 x 16-1/2 x 14-1/2"	PRDF54/WW/LB	<input type="checkbox"/>	<input type="checkbox"/>	<input type="checkbox"/>	<input type="checkbox"/>	53.0#
		60 x 16-1/2 x 14-1/2"	PRDF60/WW/LB	<input type="checkbox"/>	<input type="checkbox"/>	<input type="checkbox"/>	<input type="checkbox"/>	57.0#
 PRDF	<b>Fabric Door Overhead Cabinet-Upmount</b> <ul style="list-style-type: none"> <li>Upmount brackets position the storage component on a 54" high panel to the same height as on 66" high panels</li> <li>On a 54" high panel, clearance between the cabinet and worksurface is 20"</li> <li>On a 48" high panel, clearance between the cabinet and worksurface is 14"</li> </ul>	24 x 16-1/2 x 14-1/2"	PRDF24/WW/UM	<input type="checkbox"/>	<input type="checkbox"/>	<input type="checkbox"/>	<input type="checkbox"/>	32.0#
		30 x 16-1/2 x 14-1/2"	PRDF30/WW/UM	<input type="checkbox"/>	<input type="checkbox"/>	<input type="checkbox"/>	<input type="checkbox"/>	36.0#
		36 x 16-1/2 x 14-1/2"	PRDF36/WW/UM	<input type="checkbox"/>	<input type="checkbox"/>	<input type="checkbox"/>	<input type="checkbox"/>	40.0#
		42 x 16-1/2 x 14-1/2"	PRDF42/WW/UM	<input type="checkbox"/>	<input type="checkbox"/>	<input type="checkbox"/>	<input type="checkbox"/>	44.0#
		48 x 16-1/2 x 14-1/2"	PRDF48/WW/UM	<input type="checkbox"/>	<input type="checkbox"/>	<input type="checkbox"/>	<input type="checkbox"/>	49.0#
		54 x 16-1/2 x 14-1/2"	PRDF54/WW/UM	<input type="checkbox"/>	<input type="checkbox"/>	<input type="checkbox"/>	<input type="checkbox"/>	53.0#
		60 x 16-1/2 x 14-1/2"	PRDF60/WW/UM	<input type="checkbox"/>	<input type="checkbox"/>	<input type="checkbox"/>	<input type="checkbox"/>	57.0#

### HOW TO ORDER

Indicate the following information on order form:

- Quantity of each item.
- Model number, including options. See "How To Build a Model Number".
- Any special service required.

Note: • The  indicates that a choice is required.

- The absence of the  indicates that no choice is required.
- Alpha-numeric characters in place of  indicate that no other alternatives are available.

### HOW TO BUILD A MODEL NUMBER

- A** Select basic model.
- B** Select assembly.
- |   |                              |
|---|------------------------------|
| F | - Fully Assembled; add \$131 |
| U | - Unassembled                |
- C** Select paint color.  
Refer to color addendum at ki.com or KI Fabrics & Finishes binder.  
Metallic paint requires upcharge.
- D** Select fabric color.  
Refer to Vertical Fabric Pricing Addendum.
- E** Select key alike.
- |     |                |
|-----|----------------|
| KA  | - Key alike    |
| KS  | - Key standard |
| NLC | - No lock core |

### INFORMATION

Steel bottom, top shelf and end panels with powder-coated finish  
Accepts shelf divider  
Door stores recessed with handle exposed  
Double bit lock is included  
Shelf depth is 13-1/4"

### INFORMATION

#### Fabric Disclaimer

Fabric will be applied as swatched by the fabric manufacturer. Fabric that is required to be applied differently than is swatched will need a Special Cost Request written specifying the direction the fabric is to be applied. The posted standard lead time will apply to the Special Cost Request.



# Universal Storage and Accessories

## Overhead Storage

Delivered Pricing Fabric Grade 1 & C.O.M.	Delivered Pricing Fabric Grade 2	Delivered Pricing Fabric Grade 3 & Pallas Vertical Fabric Grade PV	Delivered Pricing Pallas Vertical Fabric Grade PV1	Delivered Pricing Pallas Vertical Fabric Grade PV2
\$ 461	\$ 469	\$ 475	\$ 475	\$ 480
502	512	519	519	524
516	523	529	529	537
546	555	563	563	571
581	592	599	599	605
662	674	683	683	688
709	722	728	728	739
\$ 540	\$ 546	\$ 552	\$ 552	\$ 557
581	589	595	595	603
592	600	608	608	613
626	633	641	641	647
660	670	679	679	684
742	753	761	761	766
787	802	809	809	815
\$ 540	\$ 546	\$ 552	\$ 552	\$ 557
581	589	595	595	603
592	600	608	608	613
626	633	641	641	647
660	670	679	679	684
742	753	761	761	766
787	802	809	809	815
\$ 540	\$ 546	\$ 552	\$ 552	\$ 557
581	589	595	595	603
592	600	608	608	613
626	633	641	641	647
660	670	679	679	684
742	753	761	761	766
787	802	809	809	815
\$ 581	\$ 588	\$ 594	\$ 594	\$ 599
624	631	637	637	644
634	642	651	651	657
666	674	684	684	691
701	712	718	718	723
782	797	804	804	809
828	843	849	849	857

### SPECIAL SERVICES

#### Special Carton Marking

With specially marked information N/C

#### Shipping

Delivered. Shipped **k.d. freight prepaid**  
**f.o.b. Manitowoc, Wisconsin 54220**  
factory. Freight class #70.

Specifications and prices are subject to  
change without prior notice.

# Universal Storage and Accessories

## Overhead Storage

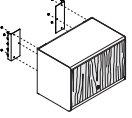
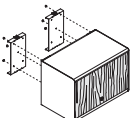
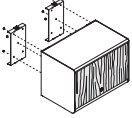
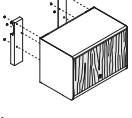
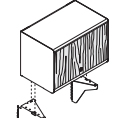
	MODEL	W x H x D	MODEL NUMBER					Approx. Packaged Weight
			Basic Model	Assembly	Paint Color	Laminate Color	Key Option	
 PRDL	<b>Laminate Door Overhead Cabinet-On-Module (PM)</b> • On-Module overheads mount into slots in vertical posts. Overheads must be same width as panel mounted to. Does not require 12" tile for mounting. Allows for vertical adjustment in 1" increments	24 x 16-1/2 x 14-1/2"	PRDL24/WW/PM	<input type="checkbox"/>	<input type="checkbox"/>	<input type="checkbox"/>	<input type="checkbox"/>	32.0#
		30 x 16-1/2 x 14-1/2"	PRDL30/WW/PM	<input type="checkbox"/>	<input type="checkbox"/>	<input type="checkbox"/>	<input type="checkbox"/>	36.0#
		36 x 16-1/2 x 14-1/2"	PRDL36/WW/PM	<input type="checkbox"/>	<input type="checkbox"/>	<input type="checkbox"/>	<input type="checkbox"/>	40.0#
		42 x 16-1/2 x 14-1/2"	PRDL42/WW/PM	<input type="checkbox"/>	<input type="checkbox"/>	<input type="checkbox"/>	<input type="checkbox"/>	44.0#
		48 x 16-1/2 x 14-1/2"	PRDL48/WW/PM	<input type="checkbox"/>	<input type="checkbox"/>	<input type="checkbox"/>	<input type="checkbox"/>	48.0#
		54 x 16-1/2 x 14-1/2"	PRDL54/WW/PM	<input type="checkbox"/>	<input type="checkbox"/>	<input type="checkbox"/>	<input type="checkbox"/>	53.0#
 PRDL	<b>Laminate Door Overhead Cabinet-Off-Module (OM12)</b> • Off-Module overheads for WireWorks® mount into an integral track in the horizontal rail. Allows shelf to slide along track. Requires 12" tile for mounting (i.e. must be a half or fully segmented panel)	24 x 16-1/2 x 14-1/2"	PRDL24/WW/OM12	<input type="checkbox"/>	<input type="checkbox"/>	<input type="checkbox"/>	<input type="checkbox"/>	32.0#
		30 x 16-1/2 x 14-1/2"	PRDL30/WW/OM12	<input type="checkbox"/>	<input type="checkbox"/>	<input type="checkbox"/>	<input type="checkbox"/>	36.0#
		36 x 16-1/2 x 14-1/2"	PRDL36/WW/OM12	<input type="checkbox"/>	<input type="checkbox"/>	<input type="checkbox"/>	<input type="checkbox"/>	40.0#
		42 x 16-1/2 x 14-1/2"	PRDL42/WW/OM12	<input type="checkbox"/>	<input type="checkbox"/>	<input type="checkbox"/>	<input type="checkbox"/>	44.0#
		48 x 16-1/2 x 14-1/2"	PRDL48/WW/OM12	<input type="checkbox"/>	<input type="checkbox"/>	<input type="checkbox"/>	<input type="checkbox"/>	48.0#
		54 x 16-1/2 x 14-1/2"	PRDL54/WW/OM12	<input type="checkbox"/>	<input type="checkbox"/>	<input type="checkbox"/>	<input type="checkbox"/>	53.0#
 PRDL	<b>Laminate Door Overhead Cabinet-Off-Module (OM18)</b> • Off-Module overheads for WireWorks® mount into an integral track in the horizontal rail. Allows shelf to slide along track. Requires 18" tile for mounting (i.e. must be a half or fully segmented panel)	24 x 16-1/2 x 14-1/2"	PRDL24/WW/OM18	<input type="checkbox"/>	<input type="checkbox"/>	<input type="checkbox"/>	<input type="checkbox"/>	32.0#
		30 x 16-1/2 x 14-1/2"	PRDL30/WW/OM18	<input type="checkbox"/>	<input type="checkbox"/>	<input type="checkbox"/>	<input type="checkbox"/>	36.0#
		36 x 16-1/2 x 14-1/2"	PRDL36/WW/OM18	<input type="checkbox"/>	<input type="checkbox"/>	<input type="checkbox"/>	<input type="checkbox"/>	40.0#
		42 x 16-1/2 x 14-1/2"	PRDL42/WW/OM18	<input type="checkbox"/>	<input type="checkbox"/>	<input type="checkbox"/>	<input type="checkbox"/>	44.0#
		48 x 16-1/2 x 14-1/2"	PRDL48/WW/OM18	<input type="checkbox"/>	<input type="checkbox"/>	<input type="checkbox"/>	<input type="checkbox"/>	48.0#
		54 x 16-1/2 x 14-1/2"	PRDL54/WW/OM18	<input type="checkbox"/>	<input type="checkbox"/>	<input type="checkbox"/>	<input type="checkbox"/>	53.0#
 PRDL	<b>Laminate Door Overhead Cabinet-Load Bar Mount (LB)</b> • Load Bar mount overheads (LB) for WireWorks® hang from an externally mounted load bar • Load Bar purchased separately	24 x 16-1/2 x 14-1/2"	PRDL24/WW/LB	<input type="checkbox"/>	<input type="checkbox"/>	<input type="checkbox"/>	<input type="checkbox"/>	32.0#
		30 x 16-1/2 x 14-1/2"	PRDL30/WW/LB	<input type="checkbox"/>	<input type="checkbox"/>	<input type="checkbox"/>	<input type="checkbox"/>	36.0#
		36 x 16-1/2 x 14-1/2"	PRDL36/WW/LB	<input type="checkbox"/>	<input type="checkbox"/>	<input type="checkbox"/>	<input type="checkbox"/>	40.0#
		42 x 16-1/2 x 14-1/2"	PRDL42/WW/LB	<input type="checkbox"/>	<input type="checkbox"/>	<input type="checkbox"/>	<input type="checkbox"/>	44.0#
		48 x 16-1/2 x 14-1/2"	PRDL48/WW/LB	<input type="checkbox"/>	<input type="checkbox"/>	<input type="checkbox"/>	<input type="checkbox"/>	48.0#
		54 x 16-1/2 x 14-1/2"	PRDL54/WW/LB	<input type="checkbox"/>	<input type="checkbox"/>	<input type="checkbox"/>	<input type="checkbox"/>	53.0#
 PRDL	<b>Laminate Door Overhead Cabinet-Upmount</b> • Upmount brackets position the storage component on a 54" high panel to the same height as on 66" high panels • On a 54" high panel, clearance between the cabinet and worksurface is 20" • On a 48" high panel, clearance between the cabinet and worksurface is 14"	24 x 16-1/2 x 14-1/2"	PRDL24/WW/UM	<input type="checkbox"/>	<input type="checkbox"/>	<input type="checkbox"/>	<input type="checkbox"/>	32.0#
		30 x 16-1/2 x 14-1/2"	PRDL30/WW/UM	<input type="checkbox"/>	<input type="checkbox"/>	<input type="checkbox"/>	<input type="checkbox"/>	36.0#
		36 x 16-1/2 x 14-1/2"	PRDL36/WW/UM	<input type="checkbox"/>	<input type="checkbox"/>	<input type="checkbox"/>	<input type="checkbox"/>	40.0#
		42 x 16-1/2 x 14-1/2"	PRDL42/WW/UM	<input type="checkbox"/>	<input type="checkbox"/>	<input type="checkbox"/>	<input type="checkbox"/>	44.0#
		48 x 16-1/2 x 14-1/2"	PRDL48/WW/UM	<input type="checkbox"/>	<input type="checkbox"/>	<input type="checkbox"/>	<input type="checkbox"/>	48.0#
		54 x 16-1/2 x 14-1/2"	PRDL54/WW/UM	<input type="checkbox"/>	<input type="checkbox"/>	<input type="checkbox"/>	<input type="checkbox"/>	53.0#
	60 x 16-1/2 x 14-1/2"	PRDL60/WW/UM	<input type="checkbox"/>	<input type="checkbox"/>	<input type="checkbox"/>	<input type="checkbox"/>	57.0#	

A

B

C

D

E

### HOW TO ORDER

Indicate the following information on order form:

- Quantity of each item.
- Model number, including options. See "How To Build a Model Number".
- Any special service required.

Note: • The  indicates that a choice is required.

- The absence of the  indicates that no choice is required.
- Alpha-numeric characters in place of  indicate that no other alternatives are available.

### HOW TO BUILD A MODEL NUMBER

**A** Select basic model.

**B** Select assembly.

F - Fully Assembled; add \$131  
U - Unassembled

**C** Select paint color.

Refer to color addendum at ki.com or KI Fabrics & Finishes binder.  
Metallic paint requires upcharge.

**D** Select laminate color.

Refer to color addendum at ki.com or KI Fabrics & Finishes binder.

**E** Select key alike.

KA - Key alike  
KS - Key standard  
NLC - No lock core

### INFORMATION

Steel bottom, top shelf and end panels with powder-coated finish  
Accepts shelf divider  
Door stores recessed with handle exposed  
Double bit lock is included  
Shelf depth is 13-1/4"



# Universal Storage and Accessories

Overhead Storage

## Delivered Pricing

\$ 590
647
660
702
746
854
914
\$ 668
724
740
781
824
930
989
\$ 668
724
740
781
824
930
989
\$ 668
724
740
781
824
930
989
\$ 711
767
779
823
865
974
1032

### SPECIAL SERVICES

#### Special Carton Marking

With specially marked information N/C

#### Shipping

Delivered. Shipped **k.d. freight prepaid f.o.b. Manitowoc, Wisconsin 54220** factory. Freight class #70.

Specifications and prices are subject to change without prior notice.

# Universal Storage and Accessories

## Overhead Storage

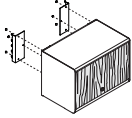
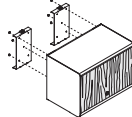
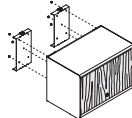
	MODEL	W x H x D	MODEL NUMBER					Approx. Packaged Weight
			Basic Model	Assembly	Paint Color	Veneer Color	Key Option	
 PRDV	<b>Veneer Door Overhead Cabinet-On-Module (PM)</b> • On-Module overheads mount into slots in vertical posts. Overheads must be same width as panel mounted to. Does not require 12" tile for mounting. Allows for vertical adjustment in 1" increments	24 x 16-1/2 x 14-1/2"	PRDV24/WW/PM	<input type="checkbox"/>	<input type="checkbox"/>	<input type="checkbox"/>	<input type="checkbox"/>	34.0#
		30 x 16-1/2 x 14-1/2"	PRDV30/WW/PM	<input type="checkbox"/>	<input type="checkbox"/>	<input type="checkbox"/>	<input type="checkbox"/>	36.0#
		36 x 16-1/2 x 14-1/2"	PRDV36/WW/PM	<input type="checkbox"/>	<input type="checkbox"/>	<input type="checkbox"/>	<input type="checkbox"/>	44.0#
		42 x 16-1/2 x 14-1/2"	PRDV42/WW/PM	<input type="checkbox"/>	<input type="checkbox"/>	<input type="checkbox"/>	<input type="checkbox"/>	49.0#
		48 x 16-1/2 x 14-1/2"	PRDV48/WW/PM	<input type="checkbox"/>	<input type="checkbox"/>	<input type="checkbox"/>	<input type="checkbox"/>	54.0#
		54 x 16-1/2 x 14-1/2"	PRDV54/WW/PM	<input type="checkbox"/>	<input type="checkbox"/>	<input type="checkbox"/>	<input type="checkbox"/>	60.0#
		60 x 16-1/2 x 14-1/2"	PRDV60/WW/PM	<input type="checkbox"/>	<input type="checkbox"/>	<input type="checkbox"/>	<input type="checkbox"/>	64.0#
 PRDV	<b>Veneer Door Overhead Cabinet-Off-Module (OM12)</b> • Off-Module overheads for WireWorks® mount into an integral track in the horizontal rail. Allows shelf to slide along track. Requires 12" tile for mounting (i.e. must be a half or fully segmented panel)	24 x 16-1/2 x 14-1/2"	PRDV24/WW/OM12	<input type="checkbox"/>	<input type="checkbox"/>	<input type="checkbox"/>	<input type="checkbox"/>	34.0#
		30 x 16-1/2 x 14-1/2"	PRDV30/WW/OM12	<input type="checkbox"/>	<input type="checkbox"/>	<input type="checkbox"/>	<input type="checkbox"/>	36.0#
		36 x 16-1/2 x 14-1/2"	PRDV36/WW/OM12	<input type="checkbox"/>	<input type="checkbox"/>	<input type="checkbox"/>	<input type="checkbox"/>	44.0#
		42 x 16-1/2 x 14-1/2"	PRDV42/WW/OM12	<input type="checkbox"/>	<input type="checkbox"/>	<input type="checkbox"/>	<input type="checkbox"/>	49.0#
		48 x 16-1/2 x 14-1/2"	PRDV48/WW/OM12	<input type="checkbox"/>	<input type="checkbox"/>	<input type="checkbox"/>	<input type="checkbox"/>	54.0#
		54 x 16-1/2 x 14-1/2"	PRDV54/WW/OM12	<input type="checkbox"/>	<input type="checkbox"/>	<input type="checkbox"/>	<input type="checkbox"/>	60.0#
		60 x 16-1/2 x 14-1/2"	PRDV60/WW/OM12	<input type="checkbox"/>	<input type="checkbox"/>	<input type="checkbox"/>	<input type="checkbox"/>	64.0#
 PRDV	<b>Veneer Door Overhead Cabinet-Off-Module (OM18)</b> • Off-Module overheads for WireWorks® mount into an integral track in the horizontal rail. Allows shelf to slide along track. Requires 18" tile for mounting (i.e. must be a half or fully segmented panel)	24 x 16-1/2 x 14-1/2"	PRDV24/WW/OM18	<input type="checkbox"/>	<input type="checkbox"/>	<input type="checkbox"/>	<input type="checkbox"/>	34.0#
		30 x 16-1/2 x 14-1/2"	PRDV30/WW/OM18	<input type="checkbox"/>	<input type="checkbox"/>	<input type="checkbox"/>	<input type="checkbox"/>	36.0#
		36 x 16-1/2 x 14-1/2"	PRDV36/WW/OM18	<input type="checkbox"/>	<input type="checkbox"/>	<input type="checkbox"/>	<input type="checkbox"/>	44.0#
		42 x 16-1/2 x 14-1/2"	PRDV42/WW/OM18	<input type="checkbox"/>	<input type="checkbox"/>	<input type="checkbox"/>	<input type="checkbox"/>	49.0#
		48 x 16-1/2 x 14-1/2"	PRDV48/WW/OM18	<input type="checkbox"/>	<input type="checkbox"/>	<input type="checkbox"/>	<input type="checkbox"/>	54.0#
		54 x 16-1/2 x 14-1/2"	PRDV54/WW/OM18	<input type="checkbox"/>	<input type="checkbox"/>	<input type="checkbox"/>	<input type="checkbox"/>	60.0#
		60 x 16-1/2 x 14-1/2"	PRDV60/WW/OM18	<input type="checkbox"/>	<input type="checkbox"/>	<input type="checkbox"/>	<input type="checkbox"/>	64.0#

A

B

C

D

E

### HOW TO ORDER

Indicate the following information on order form:

- Quantity of each item.
- Model number, including options. See "How To Build a Model Number".
- Any special service required.

Note:

- The  indicates that a choice is required.
- The absence of the  indicates that no choice is required.
- Alpha-numeric characters in place of  indicate that no other alternatives are available.

### HOW TO BUILD A MODEL NUMBER

- A** Select basic model.
- B** Select assembly.
- |   |                              |
|---|------------------------------|
| F | - Fully Assembled; add \$131 |
| U | - Unassembled                |
- C** Select paint color.  
Refer to color addendum at ki.com or KI Fabrics & Finishes binder.  
Metallic paint requires upcharge.
- D** Select veneer color.  
Refer to color addendum at ki.com or KI Fabrics & Finishes binder.
- E** Select key alike.
- |     |                |
|-----|----------------|
| KA  | - Key alike    |
| KS  | - Key standard |
| NLC | - No lock core |

### INFORMATION

Steel bottom, top shelf and end panels with powder-coated finish  
 Accepts shelf divider  
 Door stores recessed with handle exposed  
 Double bit lock is included  
 Shelf depth is 13-1/4"



# Universal Storage and Accessories

Overhead Storage

Delivered  
Pricing

\$ 1280

1348

1405

1583

1799

1965

2160

\$ 1358

1426

1480

1660

1877

2046

2236

\$ 1358

1426

1480

1660

1877

2046

2236

## SPECIAL SERVICES

### Special Carton Marking

With specially marked information N/C

### Shipping

Delivered. Shipped **k.d. freight prepaid f.o.b. Manitowoc, Wisconsin 54220** factory. Freight class #70.

Specifications and prices are subject to change without prior notice.

# Universal Storage and Accessories

## Overhead Storage

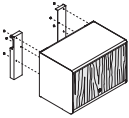
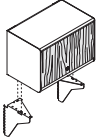
	MODEL	W x H x D	MODEL NUMBER					Approx. Packaged Weight
			Basic Model	Assembly	Paint Color	Veneer Color	Key Option	
 <p>PRDV</p>	<b>Veneer Door Overhead Cabinet-Load Bar Mount (LB)</b> <ul style="list-style-type: none"> <li>Load Bar mount overheads (LB) for WireWorks® hang from an externally mounted load bar</li> <li>Load Bar purchased separately</li> </ul>	24 x 16-1/2 x 14-1/2"	PRDV24/WW/LB	<input type="checkbox"/>	<input type="checkbox"/>	<input type="checkbox"/>	<input type="checkbox"/>	34.0#
		30 x 16-1/2 x 14-1/2"	PRDV30/WW/LB	<input type="checkbox"/>	<input type="checkbox"/>	<input type="checkbox"/>	<input type="checkbox"/>	36.0#
		36 x 16-1/2 x 14-1/2"	PRDV36/WW/LB	<input type="checkbox"/>	<input type="checkbox"/>	<input type="checkbox"/>	<input type="checkbox"/>	44.0#
		42 x 16-1/2 x 14-1/2"	PRDV42/WW/LB	<input type="checkbox"/>	<input type="checkbox"/>	<input type="checkbox"/>	<input type="checkbox"/>	49.0#
		48 x 16-1/2 x 14-1/2"	PRDV48/WW/LB	<input type="checkbox"/>	<input type="checkbox"/>	<input type="checkbox"/>	<input type="checkbox"/>	54.0#
		54 x 16-1/2 x 14-1/2"	PRDV54/WW/LB	<input type="checkbox"/>	<input type="checkbox"/>	<input type="checkbox"/>	<input type="checkbox"/>	60.0#
		60 x 16-1/2 x 14-1/2"	PRDV60/WW/LB	<input type="checkbox"/>	<input type="checkbox"/>	<input type="checkbox"/>	<input type="checkbox"/>	64.0#
 <p>PRDV</p>	<b>Veneer Door Overhead Cabinet-Upmount</b> <ul style="list-style-type: none"> <li>Upmount brackets position the storage component on a 54" high panel to the same height as on 66" high panels</li> <li>On a 54" high panel, clearance between the cabinet and worksurface is 20"</li> <li>On a 48" high panel, clearance between the cabinet and worksurface is 14"</li> </ul>	24 x 16-1/2 x 14-1/2"	PRDV24/WW/UM	<input type="checkbox"/>	<input type="checkbox"/>	<input type="checkbox"/>	<input type="checkbox"/>	34.0#
		30 x 16-1/2 x 14-1/2"	PRDV30/WW/UM	<input type="checkbox"/>	<input type="checkbox"/>	<input type="checkbox"/>	<input type="checkbox"/>	36.0#
		36 x 16 1/2 x 14 1/2"	PRDV36/WW/UM	<input type="checkbox"/>	<input type="checkbox"/>	<input type="checkbox"/>	<input type="checkbox"/>	44.0#
		42 x 16 1/2 x 14 1/2"	PRDV42/WW/UM	<input type="checkbox"/>	<input type="checkbox"/>	<input type="checkbox"/>	<input type="checkbox"/>	49.0#
		48 x 16 1/2 x 14 1/2"	PRDV48/WW/UM	<input type="checkbox"/>	<input type="checkbox"/>	<input type="checkbox"/>	<input type="checkbox"/>	54.0#
		54 x 16 1/2 x 14 1/2"	PRDV54/WW/UM	<input type="checkbox"/>	<input type="checkbox"/>	<input type="checkbox"/>	<input type="checkbox"/>	60.0#
		60 x 16 1/2 x 14 1/2"	PRDV60/WW/UM	<input type="checkbox"/>	<input type="checkbox"/>	<input type="checkbox"/>	<input type="checkbox"/>	64.0#
			<b>A</b>	<b>B</b>	<b>C</b>	<b>D</b>	<b>E</b>	

### HOW TO ORDER

Indicate the following information on order form:

- Quantity of each item.
- Model number, including options. See "How To Build a Model Number".
- Any special service required.

Note: • The  indicates that a choice is required.

- The absence of the  indicates that no choice is required.
- Alpha-numeric characters in place of  indicate that no other alternatives are available.

### HOW TO BUILD A MODEL NUMBER

- A** Select basic model.
- B** Select assembly.
- |          |                              |
|----------|------------------------------|
| <b>F</b> | - Fully Assembled; add \$131 |
| <b>U</b> | - Unassembled                |
- C** Select paint color.  
Refer to color addendum at ki.com or KI Fabrics & Finishes binder.  
Metallic paint requires upcharge.
- D** Select veneer color.  
Refer to color addendum at ki.com or KI Fabrics & Finishes binder.
- E** Select key alike.
- |            |                |
|------------|----------------|
| <b>KA</b>  | - Key alike    |
| <b>KS</b>  | - Key standard |
| <b>NLC</b> | - No lock core |

### INFORMATION

Steel bottom, top shelf and end panels with powder-coated finish  
Accepts shelf divider  
Door stores recessed with handle exposed  
Double bit lock is included  
Shelf depth is 13-1/4"





# Universal Storage and Accessories

Overhead Storage

## Delivered Pricing

\$ 1358
1426
1480
1660
1877
2046
2236
\$ 1402
1469
1523
1702
1919
2086
2277

### SPECIAL SERVICES

#### Special Carton Marking

With specially marked information N/C

#### Shipping

Delivered. Shipped **k.d. freight prepaid f.o.b. Manitowoc, Wisconsin 54220** factory. Freight class #70.

Specifications and prices are subject to change without prior notice.

# Universal Storage and Accessories

## Overhead Storage

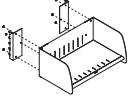
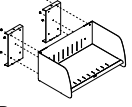
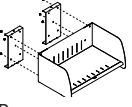
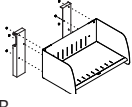
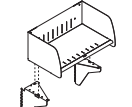
	MODEL	W x H x D	MODEL NUMBER		Approx. Packaged Weight
			Basic Model	Paint Color	
 ULSR	<b>Low Shelf-On-Module</b> • On-Module shelves (PM) mount into slots in vertical posts. Shelves must be same width as panel mounted to. Does not require a 12" tile for mounting. Allows for vertical adjustment in 1" increments	24 x 10-1/2 x 13-1/4"	ULSR24/WW/PM	<input type="checkbox"/>	14.0#
		30 x 10-1/2 x 13-1/4"	ULSR30/WW/PM	<input type="checkbox"/>	16.0#
		36 x 10-1/2 x 13-1/4"	ULSR36/WW/PM	<input type="checkbox"/>	17.0#
		42 x 10-1/2 x 13-1/4"	ULSR42/WW/PM	<input type="checkbox"/>	19.0#
		48 x 10-1/2 x 13-1/4"	ULSR48/WW/PM	<input type="checkbox"/>	20.0#
		54 x 10-1/2 x 13-1/4"	ULSR54/WW/PM	<input type="checkbox"/>	22.0#
		60 x 10-1/2 x 13-1/4"	ULSR60/WW/PM	<input type="checkbox"/>	24.0#
 ULSR	<b>Low Shelf-Off-Module</b> • Off-Module shelves (OM12) mount into the integral track in the horizontal rail. Allows shelf to slide along track. Requires a 12" tile for mounting (i.e. must be a half or fully segmented panel)	24 x 10-1/2 x 13-1/4"	ULSR24/WW/OM12	<input type="checkbox"/>	14.0#
		30 x 10-1/2 x 13-1/4"	ULSR30/WW/OM12	<input type="checkbox"/>	16.0#
		36 x 10-1/2 x 13-1/4"	ULSR36/WW/OM12	<input type="checkbox"/>	17.0#
		42 x 10-1/2 x 13-1/4"	ULSR42/WW/OM12	<input type="checkbox"/>	19.0#
		48 x 10-1/2 x 13-1/4"	ULSR48/WW/OM12	<input type="checkbox"/>	20.0#
		54 x 10-1/2 x 13-1/4"	ULSR54/WW/OM12	<input type="checkbox"/>	22.0#
		60 x 10-1/2 x 13-1/4"	ULSR60/WW/OM12	<input type="checkbox"/>	24.0#
 ULSR	<b>Low Shelf-Off-Module</b> • Off-Module shelves (OM18) mount into the integral track in the horizontal rail. Allows shelf to slide along track. Requires a 18" tile for mounting (i.e. must be a half or fully segmented panel)	24 x 10-1/2 x 13-1/4"	ULSR24/WW/OM18	<input type="checkbox"/>	14.0#
		30 x 10-1/2 x 13-1/4"	ULSR30/WW/OM18	<input type="checkbox"/>	16.0#
		36 x 10-1/2 x 13-1/4"	ULSR36/WW/OM18	<input type="checkbox"/>	17.0#
		42 x 10-1/2 x 13-1/4"	ULSR42/WW/OM18	<input type="checkbox"/>	19.0#
		48 x 10-1/2 x 13-1/4"	ULSR48/WW/OM18	<input type="checkbox"/>	20.0#
		54 x 10-1/2 x 13-1/4"	ULSR54/WW/OM18	<input type="checkbox"/>	22.0#
		60 x 10-1/2 x 13-1/4"	ULSR60/WW/OM18	<input type="checkbox"/>	24.0#
 ULSR	<b>Low Shelf-Load Bar Mount</b> • Load Bar mount overheads (LB) for WireWorks® hang from an externally mounted load bar • Load Bar purchased separately	24 x 10-1/2 x 13-1/4"	ULSR24/WW/LB	<input type="checkbox"/>	14.0#
		30 x 10-1/2 x 13-1/4"	ULSR30/WW/LB	<input type="checkbox"/>	16.0#
		36 x 10-1/2 x 13-1/4"	ULSR36/WW/LB	<input type="checkbox"/>	17.0#
		42 x 10-1/2 x 13-1/4"	ULSR42/WW/LB	<input type="checkbox"/>	19.0#
		48 x 10-1/2 x 13-1/4"	ULSR48/WW/LB	<input type="checkbox"/>	20.0#
		54 x 10-1/2 x 13-1/4"	ULSR54/WW/LB	<input type="checkbox"/>	22.0#
		60 x 10-1/2 x 13-1/4"	ULSR60/WW/LB	<input type="checkbox"/>	24.0#
 ULSR	<b>Low Shelf-Upmount</b> • Upmount brackets position the storage component on a 54" high panel to the same height as on 66" high panels • On a 54" high panel, clearance between the cabinet and worksurface is 20" • On a 48" high panel, clearance between the cabinet and worksurface is 14"	24 x 10-1/2 x 13-1/4"	ULSR24/WW/UM	<input type="checkbox"/>	14.0#
		30 x 10-1/2 x 13-1/4"	ULSR30/WW/UM	<input type="checkbox"/>	16.0#
		36 x 10-1/2 x 13-1/4"	ULSR36/WW/UM	<input type="checkbox"/>	17.0#
		42 x 10-1/2 x 13-1/4"	ULSR42/WW/UM	<input type="checkbox"/>	19.0#
		48 x 10-1/2 x 13-1/4"	ULSR48/WW/UM	<input type="checkbox"/>	20.0#
		54 x 10-1/2 x 13-1/4"	ULSR54/WW/UM	<input type="checkbox"/>	22.0#
		60 x 10-1/2 x 13-1/4"	ULSR60/WW/UM	<input type="checkbox"/>	24.0#

A

B

### HOW TO ORDER

Indicate the following information on order form:

- Quantity of each item.
- Model number, including options. See "How To Build a Model Number".
- Any special service required.

Note: • The  indicates that a choice is required.

- The absence of the  indicates that no choice is required.
- Alpha-numeric characters in place of  indicate that no other alternatives are available.

### HOW TO BUILD A MODEL NUMBER

- A** Select basic model.  
**B** Select paint color.  
 Refer to color addendum at [ki.com](http://ki.com) or KI Fabrics & Finishes binder.  
 Metallic paint requires upcharge

### INFORMATION

Includes 10-1/2" high back  
 Accepts shelf dividers  
 Shelves shipped assembled



# Universal Storage and Accessories

Overhead Storage

Delivered Pricing	Metallic Paint add to list price
\$ 190	\$ 74
197	82
208	83
215	90
219	95
231	111
241	115
\$ 268	\$ 74
276	82
284	83
294	90
298	95
309	111
319	115
\$ 268	\$ 74
276	82
284	83
294	90
298	95
309	111
319	115
\$ 268	\$ 74
276	82
284	83
294	90
298	95
309	111
319	115
\$ 309	\$ 74
316	82
327	83
337	90
340	95
349	111
363	115

## SPECIAL SERVICES

### Special Carton Marking

With specially marked information N/C

### Shipping

Delivered. Shipped **k.d. freight prepaid f.o.b. Manitowoc, Wisconsin 54220** factory. Freight class #70.

Specifications and prices are subject to change without prior notice.

# Universal Storage and Accessories

## Overhead Storage

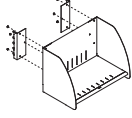
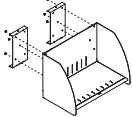
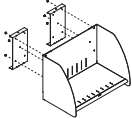
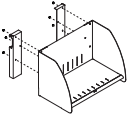
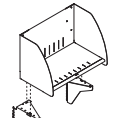
	MODEL	W x H x D	MODEL NUMBER		Approx. Packaged Weight
			Basic Model	Paint Color	
 URSR	<b>Regular Shelf-On-Module</b> • On-Module shelves mount into slots in vertical posts. Shelves must be same width as panel mounted to. Does not require a 12" tile for mounting. Allows for vertical adjustment in 1" increments	24 x 16-1/2 x 13-1/4"	URSR24/WW/PM	<input type="checkbox"/>	19.0#
		30 x 16-1/2 x 13-1/4"	URSR30/WW/PM	<input type="checkbox"/>	20.0#
		36 x 16-1/2 x 13-1/4"	URSR36/WW/PM	<input type="checkbox"/>	22.0#
		42 x 16-1/2 x 13-1/4"	URSR42/WW/PM	<input type="checkbox"/>	23.0#
		48 x 16-1/2 x 13-1/4"	URSR48/WW/PM	<input type="checkbox"/>	25.0#
		54 x 16-1/2 x 13-1/4"	URSR54/WW/PM	<input type="checkbox"/>	27.0#
		60 x 16-1/2 x 13-1/4"	URSR60/WW/PM	<input type="checkbox"/>	28.0#
 URSR	<b>Regular Shelf-Off-Module</b> • Off-Module shelves (OM12) mount into the integral track in the horizontal rail. Allows shelf to slide along track. Requires a 12" tile for mounting (i.e. must be a half or fully segmented panel)	24 x 16-1/2 x 13-1/4"	URSR24/WW/OM12	<input type="checkbox"/>	19.0#
		30 x 16-1/2 x 13-1/4"	URSR30/WW/OM12	<input type="checkbox"/>	20.0#
		36 x 16-1/2 x 13-1/4"	URSR36/WW/OM12	<input type="checkbox"/>	22.0#
		42 x 16-1/2 x 13-1/4"	URSR42/WW/OM12	<input type="checkbox"/>	23.0#
		48 x 16-1/2 x 13-1/4"	URSR48/WW/OM12	<input type="checkbox"/>	25.0#
		54 x 16-1/2 x 13-1/4"	URSR54/WW/OM12	<input type="checkbox"/>	27.0#
		60 x 16-1/2 x 13-1/4"	URSR60/WW/OM12	<input type="checkbox"/>	28.0#
 URSR	<b>Regular Shelf-Off-Module</b> • Off-Module shelves (OM18) mount into the integral track in the horizontal rail. Allows shelf to slide along track. Requires a 18" tile for mounting (i.e. must be a half or fully segmented panel)	24 x 16-1/2 x 13-1/4"	URSR24/WW/OM18	<input type="checkbox"/>	19.0#
		30 x 16-1/2 x 13-1/4"	URSR30/WW/OM18	<input type="checkbox"/>	20.0#
		36 x 16-1/2 x 13-1/4"	URSR36/WW/OM18	<input type="checkbox"/>	22.0#
		42 x 16-1/2 x 13-1/4"	URSR42/WW/OM18	<input type="checkbox"/>	23.0#
		48 x 16-1/2 x 13-1/4"	URSR48/WW/OM18	<input type="checkbox"/>	25.0#
		54 x 16-1/2 x 13-1/4"	URSR54/WW/OM18	<input type="checkbox"/>	27.0#
		60 x 16-1/2 x 13-1/4"	URSR60/WW/OM18	<input type="checkbox"/>	28.0#
 URSR	<b>Regular Shelf-Load Bar Mount</b> • Load Bar mount overheads (LB) for WireWorks® hang from an externally mounted load bar • Load Bar purchased separately	24 x 16-1/2 x 13-1/4"	URSR24/WW/LB	<input type="checkbox"/>	19.0#
		30 x 16-1/2 x 13-1/4"	URSR30/WW/LB	<input type="checkbox"/>	20.0#
		36 x 16-1/2 x 13-1/4"	URSR36/WW/LB	<input type="checkbox"/>	22.0#
		42 x 16-1/2 x 13-1/4"	URSR42/WW/LB	<input type="checkbox"/>	23.0#
		48 x 16-1/2 x 13-1/4"	URSR48/WW/LB	<input type="checkbox"/>	25.0#
		54 x 16-1/2 x 13-1/4"	URSR54/WW/LB	<input type="checkbox"/>	27.0#
		60 x 16-1/2 x 13-1/4"	URSR60/WW/LB	<input type="checkbox"/>	28.0#
 URSR	<b>Regular Shelf-Upmount</b> • Upmount brackets position the storage component on a 54" high panel to the same height as on 66" high panels • On a 54" high panel, clearance between the cabinet and worksurface is 20" • On a 48" high panel, clearance between the cabinet and worksurface is 14"	24 x 16-1/2 x 13-1/4"	URSR24/WW/UM	<input type="checkbox"/>	19.0#
		30 x 16-1/2 x 13-1/4"	URSR30/WW/UM	<input type="checkbox"/>	20.0#
		36 x 16-1/2 x 13-1/4"	URSR36/WW/UM	<input type="checkbox"/>	22.0#
		42 x 16-1/2 x 13-1/4"	URSR42/WW/UM	<input type="checkbox"/>	23.0#
		48 x 16-1/2 x 13-1/4"	URSR48/WW/UM	<input type="checkbox"/>	25.0#
		54 x 16-1/2 x 13-1/4"	URSR54/WW/UM	<input type="checkbox"/>	27.0#
		60 x 16-1/2 x 13-1/4"	URSR60/WW/UM	<input type="checkbox"/>	28.0#

A

B

### HOW TO ORDER

Indicate the following information on order form:

- Quantity of each item.
- Model number, including options. See "How To Build a Model Number".
- Any special service required.

Note: • The  indicates that a choice is required.

- The absence of the  indicates that no choice is required.
- Alpha-numeric characters in place of  indicate that no other alternatives are available.

### HOW TO BUILD A MODEL NUMBER

- A** Select basic model.  
**B** Select paint color.  
 Refer to color addendum at [ki.com](http://ki.com) or KI Fabrics & Finishes binder.  
 Metallic paint requires upcharge

### INFORMATION

Includes full back  
 Accepts shelf dividers  
 Shelves shipped assembled



# Universal Storage and Accessories

Overhead Storage

Delivered Pricing	Metallic Paint add to list price
\$ 205	\$ 74
213	82
219	83
226	90
236	95
245	111
255	115
\$ 282	\$ 74
291	82
298	83
306	90
313	95
323	111
335	115
\$ 282	\$ 74
291	82
298	83
306	90
313	95
323	111
335	115
\$ 282	\$ 74
291	82
298	83
306	90
313	95
323	111
335	115
\$ 324	\$ 74
334	82
340	83
346	90
355	95
365	111
375	115

## SPECIAL SERVICES

### Special Carton Marking

With specially marked information N/C

### Shipping

Delivered. Shipped **k.d. freight prepaid f.o.b. Manitowoc, Wisconsin 54220** factory. Freight class #70.

Specifications and prices are subject to change without prior notice.

# Universal Storage and Accessories

## Overhead Accessories

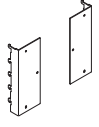
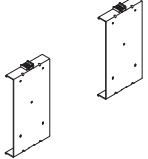
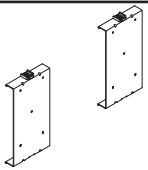
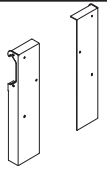
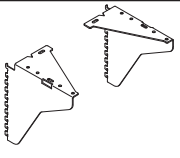
	MODEL	MODEL NUMBER		Approx. Packaged Weight
		Basic Model	Trim Color	
 HRDPT	<b>Universal Overhead On-Module Mounting Bracket</b> <ul style="list-style-type: none"> <li>Sold in pairs / Black only</li> <li>Mounts into slots in vertical posts</li> <li>Allows for vertical adjustments in 1" increments</li> <li>Only necessary to order if changing mounting style</li> </ul>	46.0233.SET		1.0#
 HRDPT	<b>Universal Overhead Off-Module Mounting Bracket-12" Tiles</b> <ul style="list-style-type: none"> <li>Sold in pairs / Black only</li> <li>Mounts into integral track in horizontal rail, attaches to 12" high tiles</li> <li>Allows cabinet or shelf to slide along track</li> <li>Only necessary to order if changing mounting style</li> </ul>	46.0234.SET		1.0#
 HRDPT	<b>Universal Overhead Off-Module Mounting Bracket-18" Tiles</b> <ul style="list-style-type: none"> <li>Sold in pairs / Black only</li> <li>Mounts into integral track in horizontal rail, attaches to 18" high tiles</li> <li>Allows cabinet or shelf to slide along track</li> <li>Only necessary to order if changing mounting style</li> </ul>	46.1229.SET		1.0#
 HRDPT	<b>Load Bar Brackets</b> <ul style="list-style-type: none"> <li>Load Bar mount overheads hang from an externally mounted load bar</li> <li>Load Bar purchased separately, Sold in pairs</li> </ul>	46.2103	<input type="checkbox"/>	1.0#
 HRDPT	<b>Upmount Brackets</b> <ul style="list-style-type: none"> <li>Upmount brackets position the storage component on a 54" high panel to the same height as on 66" high panels</li> <li>Sold in pairs</li> </ul>	46.1234	<input type="checkbox"/>	1.0#

A

B

### HOW TO ORDER

Indicate the following information on order form:

- Quantity of each item.
- Model number, including options. See "How To Build a Model Number".
- Any special service required.

Note: • The  indicates that a choice is required.  
 • The absence of the  indicates that no choice is required.  
 • Alpha-numeric characters in place of  indicate that no other alternatives are available.

### HOW TO BUILD A MODEL NUMBER

- A** Select basic model.
- B** Select trim color.  
 Refer to color addendum at [ki.com](http://ki.com) or KI Fabrics & Finishes binder.



# Universal Storage and Accessories

Overhead Accessories

Delivered  
Pricing  
\$ 40

\$ 117

\$ 117

\$ 117

\$ 145

### SPECIAL SERVICES

#### Special Carton Marking

With specially marked information N/C



#### Shipping

Delivered. Shipped **k.d. freight prepaid f.o.b. Manitowoc, Wisconsin 54220** factory. Freight class #70.

Specifications and prices are subject to change without prior notice.

# Universal Storage and Accessories

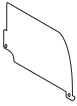
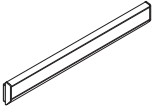
## Overhead Accessories

	MODEL	W x H	MODEL NUMBER				Approx. Packaged Weight
			Basic Model	Trim Color	Mounting	Fabric Color	
	<b>Universal Shelf Dividers</b> • Steel shelf dividers with powder-coated finish • Fits on all shelves and cabinets	7-1/4 x 11-1/2"	NSD	<input type="checkbox"/>			1.0#
HRDPT							
	<b>Wall Mounted Load Bar</b> • Supports overhead storage on drywall or other non-panel applications	24"	SWLB.24	<input type="checkbox"/>			5.0#
		30"	SWLB.30	<input type="checkbox"/>			6.0#
		36"	SWLB.36	<input type="checkbox"/>			7.0#
		42"	SWLB.42	<input type="checkbox"/>			8.0#
		48"	SWLB.48	<input type="checkbox"/>			10.0#
		54"	SWLB.54	<input type="checkbox"/>			13.0#
		60"	SWLB.60	<input type="checkbox"/>			12.0#
		66"	SWLB.66	<input type="checkbox"/>			13.0#
		72"	SWLB.72	<input type="checkbox"/>			14.0#
		84"	SWLB.84	<input type="checkbox"/>			17.0#
		96"	SWLB.96	<input type="checkbox"/>			19.0#
HRDPT							
	<b>Overhead Tackboard</b> • Hangs from bottom of flipper door cabinet or shelf • When hanging from Balance® overhead, specify attachment bar BMB (purchase separately) • Includes mounting brackets in black only • Specify 20" high tackboard to cover vertical space between bottom of overhead and top of worksurface, when worksurface is positioned at 29" above finished floor	24 x 12"	PTB02412	<input type="checkbox"/>	<input type="checkbox"/>	<input type="checkbox"/>	3.0#
		30 x 12"	PTB03012	<input type="checkbox"/>	<input type="checkbox"/>	<input type="checkbox"/>	3.0#
		36 x 12"	PTB03612	<input type="checkbox"/>	<input type="checkbox"/>	<input type="checkbox"/>	3.0#
		42 x 12"	PTB04212	<input type="checkbox"/>	<input type="checkbox"/>	<input type="checkbox"/>	4.0#
		48 x 12"	PTB04812	<input type="checkbox"/>	<input type="checkbox"/>	<input type="checkbox"/>	4.0#
		54 x 12"	PTB05412	<input type="checkbox"/>	<input type="checkbox"/>	<input type="checkbox"/>	4.0#
		60 x 12"	PTB06012	<input type="checkbox"/>	<input type="checkbox"/>	<input type="checkbox"/>	4.0#
		24 x 20"	PTB02420	<input type="checkbox"/>	<input type="checkbox"/>	<input type="checkbox"/>	4.0#
		30 x 20"	PTB03020	<input type="checkbox"/>	<input type="checkbox"/>	<input type="checkbox"/>	5.0#
		36 x 20"	PTB03620	<input type="checkbox"/>	<input type="checkbox"/>	<input type="checkbox"/>	6.0#
		42 x 20"	PTB04220	<input type="checkbox"/>	<input type="checkbox"/>	<input type="checkbox"/>	7.0#
		48 x 20"	PTB04820	<input type="checkbox"/>	<input type="checkbox"/>	<input type="checkbox"/>	8.0#
		54 x 20"	PTB05420	<input type="checkbox"/>	<input type="checkbox"/>	<input type="checkbox"/>	9.0#
		60 x 20"	PTB06020	<input type="checkbox"/>	<input type="checkbox"/>	<input type="checkbox"/>	10.0#
PTBO							

**A**   **B**   **C**   **D**

### HOW TO ORDER

Indicate the following information on order form:

- Quantity of each item.
- Model number, including options. See "How To Build a Model Number".
- Any special service required.

Note: • The  indicates that a choice is required.

- The absence of the  indicates that no choice is required.
- Alpha-numeric characters in place of  indicate that no other alternatives are available.

### HOW TO BUILD A MODEL NUMBER

- A** Select basic model.
- B** Select trim color.  
Refer to color addendum at ki.com or KI Fabrics & Finishes binder.
- C** Select load bar mounting.  
**YLBM** - Load Bar Mounted  
**NLBM** - Not load bar mounted
- D** Select fabric color.  
Refer to Vertical Fabric Pricing Addendum.

### INFORMATION

#### Fabric Disclaimer

Fabric will be applied as swatched by the fabric manufacturer. Fabric that is required to be applied differently than is swatched will need a Special Cost Request written specifying the direction the fabric is to be applied. The posted standard lead time will apply to the Special Cost Request.





# Universal Storage and Accessories

## Overhead Accessories

Delivered Pricing	Delivered Pricing Fabric Grade 1 & C.O.M.	Delivered Pricing Fabric Grade 2	Delivered Pricing Fabric Grade 3 & Pallas Vertical Fabric Grade PV	Delivered Pricing Pallas Vertical Fabric Grade PV1	Delivered Pricing Pallas Vertical Fabric Grade PV2
\$ 26					
\$ 111					
119					
121					
133					
138					
163					
164					
166					
173					
268					
280					
N/A	\$ 134	\$ 138	\$ 140	\$ 147	\$ 156
N/A	148	151	153	161	169
N/A	162	166	168	173	182
N/A	167	171	173	178	191
N/A	170	173	175	182	194
N/A	194	199	203	210	220
N/A	202	207	209	217	228
N/A	221	228	233	240	253
N/A	238	245	249	256	272
N/A	252	259	267	273	286
N/A	259	268	275	281	296
N/A	307	315	321	330	348
N/A	310	318	325	335	353
N/A	314	321	329	339	357

### SPECIAL SERVICES

#### Special Carton Marking

With specially marked information N/C

#### Shipping

Delivered. Shipped **k.d. freight prepaid f.o.b. Manitowoc, Wisconsin 54220** factory. Freight class #70.

Specifications and prices are subject to change without prior notice.

# Universal Storage and Accessories

## Shelf/Cabinet Task Light

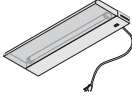
	MODEL	W	MODEL NUMBER		Approx. Packaged Weight
				Basic Model	
 HRDPT	<b>Shelf/Cabinet Task Light</b> • Electronic ballast	18"		TLT5.18	3.4#
		24"		TLT5.24	3.9#
		36"		TLT5.36	5.3#
		48"		TLT5.48	6.7#

**A**

### HOW TO ORDER

Indicate the following information on order form:

1. Quantity of each item.
2. Model number, including options. See "How To Build a Model Number".
3. Any special service required.

Note: • The  indicates that a choice is required.

- The absence of the  indicates that no choice is required.
- Alpha-numeric characters in place of  indicate that no other alternatives are available.

### HOW TO BUILD A MODEL NUMBER

**A** Select basic model.

### INFORMATION

#### TASK LIGHT CABINET WIDTH

Cabinet Width	Light Width
24"	18"
30"	24"
36"	24"
42"	36"
48"	36"
54"	48"
60"	48"



# Universal Storage and Accessories

Shelf/Cabinet Task Light

Delivered  
Pricing

\$	74
	76
	83
	91

## SPECIAL SERVICES

### Special Carton Marking

With specially marked information    N/C

### Shipping

Delivered. Shipped **k.d. freight prepaid**  
**f.o.b. Manitowoc, Wisconsin 54220**  
factory. Freight class #70.

Specifications and prices are subject to  
change without prior notice.

# Balance® Storage and Accessories

General Information

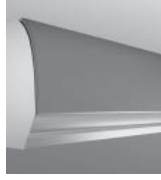

Solid Overhead (BLCS)

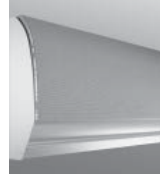

Fabric Overhead (BLCF)



Laminate Overhead (BLCL)

Features			
Cabinet available in 24 colors	•	•	•
Painted lower door available in 24 colors	•	•	•
Translucent upper door	•		
Fabric upper door		•	
Laminate upper door			•
Fully assembled	•	•	•
Task light	•	•	•
Hanging tackboard	•	•	•
Hanging tool rail	•	•	•
Also available on:			
System 3000® panel system	•	•	•
Genius®	•	•	•
WorkZone®	•	•	•
True® Desking	•	•	•

## SPECIFICATIONS

### Cabinet Construction

The overhead cabinet shall be assembled complete and powder-coated in widths of 30", 36", 42", 48", 54" and 60". The overall dimensions of the end panels shall be 17" high and 16-1/2" deep. The shelf depth shall be 13-1/2". Inside height shall allow for oversize binders, such as Folscap and A4, to be stored vertically. The cabinet top, bottom, and shelf shall be fabricated from 18-gauge steel. Side panels shall be fabricated from 14-gauge steel and attached via resistance welding. Cabinet top, bottom, and shelf shall contain reinforcements fabricated from 18-gauge steel and attached via resistance welding. Pins for door and shroud attachment shall be fabricated from 3/8" diameter steel and attached via resistance welding. Shroud will be black only. All accessible or visible edges shall be smooth and rounded.

### Door Construction

The upper door shall be available in colored

or translucent extruded rigid polypropylene with spattercoat finish, fabric or laminate applied. The overall door thickness shall be 3/8" with a .075 wall thickness. The door shall be capped with polycarbonate endcaps and attached to the case with polycarbonate arms. A center lock mechanism will be utilized between the upper and lower doors for security. The lower door shall be an aluminum extrusion with a powder-coat finish. The lower door shall have a .075 thickness and be ergonomic in design. The door shall be capped and attached to the case with polycarbonate arms.

### Door Operation

The overhead cabinet doors shall be effortlessly operated from either a seated or standing position through use of the upper door or lower door. The upper door and lower door shall be synchronized in motion through the use of two 10-gauge linkages. The doors shall be assisted with two extension springs and require less than 5 pounds of force to operate. Either door shall be

opened or closed with a closed fist. The upper door shall open over the outside of case.

### Cabinet Installation

The overhead cabinet shall include separate mounting brackets that allow for assembly to panels or desk systems. The brackets shall be attached to the back of the overhead via a hook and groove system and two screw fasteners. The hook and groove system shall allow the installer to assemble brackets to a panel before attaching to overhead. The desk supports shall attach to the bottom of overhead via four screw fasteners.

### Task Lights

Task lights shall be available which suspend from the underside of the cabinet. The task light shall mount flush with the underside of the overhead cabinet via two cantilever brackets. Task light shall be offered fully assembled in black only. The task light shall have an 8' long cord with three-prong grounded plug, and be available in three versions: standard high-power factor ballast, variable (high/low) high-power factor ballast,

and electronic ballast. All three options shall include a cool white lamp. Chords shall be routed into and through wire trough located at rear underside of cabinet shelf. Installation and removal shall be accomplished without the use of tools or fasteners.

### Shelf Dividers

Shelf dividers shall be powder-coated, 18-gauge steel and offered in the same color as the overhead case. Installation and removal shall be accomplished without the use of tools or fasteners.

### Tackboard/Tool Rail Mounting Bar

A powder-coated, 14-gauge bracket shall be available for the attachment of a hanging tool rail or tackboard to the underside of the overhead. The bracket shall be specified in the same widths as the overhead and is offered in the same colors as the overhead case.

### Overhead Hanging Tackboard

Tackboards shall be available in 12" height



and in 24", 30", 36", 42", 48", 54", and 60" widths. The tackboard shall be constructed of 3/4" industrial insulation board covered with fabric. The mounting brackets shall be steel powder-coated and attached to the coreboard with T-nuts and machine screws. Fabric shall be attached to the coreboard with staples. A mounting bracket bar is required to attach the tackboard to the overhead cabinet.

## INFORMATION

### C.O.M. Testing and Production Requirements

Not all materials are suitable for upholstering this product. A 1 yd. x 54" sample must be submitted and approved prior to acceptance of an order. If the fabric is directional in pattern or weave, the direction must be indicated on the submitted sample, and additional yardage may be requested.

Test samples must be sent to:  
KI  
Attn: C.O.M. Specialist  
1330 Bellevue Street  
Green Bay, WI 54302

## INFORMATION

### Warranty

Refer to KI Terms & Conditions document or visit [ki.com](http://ki.com).

# Balance® Storage and Accessories

## Overhead Storage

	MODEL	W x H x D	MODEL NUMBER				Approx. Packaged Weight
			Basic Model	Cabinet Paint Color	Upper Door Solid Color	Key Option	
<p>BOH</p>	<b>Balance® Overhead Cabinet-Solid Color Upper Door-On Module (PM)</b> • Colored or translucent extruded polypropylene door • On-Module overheads mount into slots in vertical posts. Overheads must be same width as panel mounted to. Allows for vertical adjustment in 1" increments	30 x 17 x 19-1/4"	BLCS30/WW/PM	<input type="checkbox"/> <input type="checkbox"/> <input type="checkbox"/>	<input type="checkbox"/> <input type="checkbox"/> <input type="checkbox"/>	<input type="checkbox"/> <input type="checkbox"/> <input type="checkbox"/>	46.0#
		36 x 17 x 19-1/4"	BLCS36/WW/PM	<input type="checkbox"/> <input type="checkbox"/> <input type="checkbox"/>	<input type="checkbox"/> <input type="checkbox"/> <input type="checkbox"/>	<input type="checkbox"/> <input type="checkbox"/> <input type="checkbox"/>	52.0#
		42 x 17 x 19-1/4"	BLCS42/WW/PM	<input type="checkbox"/> <input type="checkbox"/> <input type="checkbox"/>	<input type="checkbox"/> <input type="checkbox"/> <input type="checkbox"/>	<input type="checkbox"/> <input type="checkbox"/> <input type="checkbox"/>	58.0#
		48 x 17 x 19-1/4"	BLCS48/WW/PM	<input type="checkbox"/> <input type="checkbox"/> <input type="checkbox"/>	<input type="checkbox"/> <input type="checkbox"/> <input type="checkbox"/>	<input type="checkbox"/> <input type="checkbox"/> <input type="checkbox"/>	64.0#
		54 x 17 x 19-1/4"	BLCS54/WW/PM	<input type="checkbox"/> <input type="checkbox"/> <input type="checkbox"/>	<input type="checkbox"/> <input type="checkbox"/> <input type="checkbox"/>	<input type="checkbox"/> <input type="checkbox"/> <input type="checkbox"/>	70.0#
		60 x 17 x 19-1/4"	BLCS60/WW/PM	<input type="checkbox"/> <input type="checkbox"/> <input type="checkbox"/>	<input type="checkbox"/> <input type="checkbox"/> <input type="checkbox"/>	<input type="checkbox"/> <input type="checkbox"/> <input type="checkbox"/>	78.0#
<p>BOH</p>	<b>Balance® Overhead Cabinet-Solid Color Upper Door-Off-Module (OM12)</b> • Colored or translucent extruded polypropylene door • Off-Module overheads mount into an integral track in the horizontal rail. Allows unit to slide along track. Requires 12" tile for mounting (i.e. must be a half or fully segmented panel)	30 x 17 x 19-1/4"	BLCS30/WW/OM12	<input type="checkbox"/> <input type="checkbox"/> <input type="checkbox"/>	<input type="checkbox"/> <input type="checkbox"/> <input type="checkbox"/>	<input type="checkbox"/> <input type="checkbox"/> <input type="checkbox"/>	46.0#
		36 x 17 x 19-1/4"	BLCS36/WW/OM12	<input type="checkbox"/> <input type="checkbox"/> <input type="checkbox"/>	<input type="checkbox"/> <input type="checkbox"/> <input type="checkbox"/>	<input type="checkbox"/> <input type="checkbox"/> <input type="checkbox"/>	52.0#
		42 x 17 x 19-1/4"	BLCS42/WW/OM12	<input type="checkbox"/> <input type="checkbox"/> <input type="checkbox"/>	<input type="checkbox"/> <input type="checkbox"/> <input type="checkbox"/>	<input type="checkbox"/> <input type="checkbox"/> <input type="checkbox"/>	58.0#
		48 x 17 x 19-1/4"	BLCS48/WW/OM12	<input type="checkbox"/> <input type="checkbox"/> <input type="checkbox"/>	<input type="checkbox"/> <input type="checkbox"/> <input type="checkbox"/>	<input type="checkbox"/> <input type="checkbox"/> <input type="checkbox"/>	64.0#
		54 x 17 x 19-1/4"	BLCS54/WW/OM12	<input type="checkbox"/> <input type="checkbox"/> <input type="checkbox"/>	<input type="checkbox"/> <input type="checkbox"/> <input type="checkbox"/>	<input type="checkbox"/> <input type="checkbox"/> <input type="checkbox"/>	70.0#
		60 x 17 x 19-1/4"	BLCS60/WW/OM12	<input type="checkbox"/> <input type="checkbox"/> <input type="checkbox"/>	<input type="checkbox"/> <input type="checkbox"/> <input type="checkbox"/>	<input type="checkbox"/> <input type="checkbox"/> <input type="checkbox"/>	78.0#
<p>BOH</p>	<b>Balance® Overhead Cabinet-Solid Color Upper Door-Off-Module (OM18)</b> • Colored or translucent extruded polypropylene door • Off-Module overheads mount into an integral track in the horizontal rail. Allows unit to slide along track. Requires 18" tile for mounting (i.e. must be a half or fully segmented panel)	30 x 17 x 19-1/4"	BLCS30/WW/OM18	<input type="checkbox"/> <input type="checkbox"/> <input type="checkbox"/>	<input type="checkbox"/> <input type="checkbox"/> <input type="checkbox"/>	<input type="checkbox"/> <input type="checkbox"/> <input type="checkbox"/>	46.0#
		36 x 17 x 19-1/4"	BLCS36/WW/OM18	<input type="checkbox"/> <input type="checkbox"/> <input type="checkbox"/>	<input type="checkbox"/> <input type="checkbox"/> <input type="checkbox"/>	<input type="checkbox"/> <input type="checkbox"/> <input type="checkbox"/>	52.0#
		42 x 17 x 19-1/4"	BLCS42/WW/OM18	<input type="checkbox"/> <input type="checkbox"/> <input type="checkbox"/>	<input type="checkbox"/> <input type="checkbox"/> <input type="checkbox"/>	<input type="checkbox"/> <input type="checkbox"/> <input type="checkbox"/>	58.0#
		48 x 17 x 19-1/4"	BLCS48/WW/OM18	<input type="checkbox"/> <input type="checkbox"/> <input type="checkbox"/>	<input type="checkbox"/> <input type="checkbox"/> <input type="checkbox"/>	<input type="checkbox"/> <input type="checkbox"/> <input type="checkbox"/>	64.0#
		54 x 17 x 19-1/4"	BLCS54/WW/OM18	<input type="checkbox"/> <input type="checkbox"/> <input type="checkbox"/>	<input type="checkbox"/> <input type="checkbox"/> <input type="checkbox"/>	<input type="checkbox"/> <input type="checkbox"/> <input type="checkbox"/>	70.0#
		60 x 17 x 19-1/4"	BLCS60/WW/OM18	<input type="checkbox"/> <input type="checkbox"/> <input type="checkbox"/>	<input type="checkbox"/> <input type="checkbox"/> <input type="checkbox"/>	<input type="checkbox"/> <input type="checkbox"/> <input type="checkbox"/>	78.0#

**A                      B                      C                      D**

### HOW TO ORDER

Indicate the following information on order form:

- Quantity of each item.
- Model number, including options. See "How To Build a Model Number".
- Any special service required.

Note: • The  indicates that a choice is required.

- The absence of the  indicates that no choice is required.
- Alpha-numeric characters in place of  indicate that no other alternatives are available.

### HOW TO BUILD A MODEL NUMBER

- A** Select basic model.
- B** Select cabinet paint color.  
Refer to color addendum at [ki.com](http://ki.com) or KI Fabrics & Finishes binder.
- C** Select upper door color.  
Refer to color addendum at [ki.com](http://ki.com) or KI Fabrics & Finishes binder.
- D** Select key option.
 

<b>KA</b>	- Key alike
<b>KS</b>	- Key standard
<b>NLC</b>	- No lock core

### INFORMATION

Painted cabinet and lower door  
 Shelf dividers available separately  
 Cabinet is fully assembled  
 Door stores above top of cabinet  
 Will accept hanging tool rail and tackboards  
 (Attachment bar ordered separately)



# Balance® Storage and Accessories

Overhead Storage

Delivered Pricing

\$ 893  
951  
1001  
1035  
1112  
1154

\$ 938  
996  
1044  
1077  
1157  
1199

\$ 938  
996  
1044  
1077  
1157  
1199

**SPECIAL SERVICES**

**Special Carton Marking**

With specially marked information    N/C

**Shipping**

Shipped **assembled freight prepaid**  
**f.o.b. Manitowoc, Wisconsin 54220** factory.  
Freight class #77.5

Specifications and prices are subject to  
change without prior notice.

# Balance® Storage and Accessories

## Overhead Storage

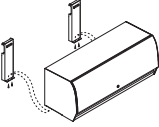
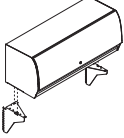
MODEL	W x H x D	MODEL NUMBER				Approx. Packaged Weight
		Basic Model	Cabinet Paint Color	Upper Door Solid Color	Key Option	
 <p>BOH</p> <p><b>Balance® Overhead Cabinet-Solid Color Upper Door-Load Bar Mount</b></p> <ul style="list-style-type: none"> <li>Colored or translucent extruded polypropylene door</li> <li>Load Bar Mount overhangs hang from an externally mounted load bar</li> <li>Load Bar purchased separately</li> </ul>	30 x 17 x 19-1/4"	BLCS30/WW/LB	<input type="checkbox"/> <input type="checkbox"/> <input type="checkbox"/>	<input type="checkbox"/> <input type="checkbox"/> <input type="checkbox"/>	<input type="checkbox"/> <input type="checkbox"/> <input type="checkbox"/>	46.0#
	36 x 17 x 19-1/4"	BLCS36/WW/LB	<input type="checkbox"/> <input type="checkbox"/> <input type="checkbox"/>	<input type="checkbox"/> <input type="checkbox"/> <input type="checkbox"/>	<input type="checkbox"/> <input type="checkbox"/> <input type="checkbox"/>	52.0#
	42 x 17 x 19-1/4"	BLCS42/WW/LB	<input type="checkbox"/> <input type="checkbox"/> <input type="checkbox"/>	<input type="checkbox"/> <input type="checkbox"/> <input type="checkbox"/>	<input type="checkbox"/> <input type="checkbox"/> <input type="checkbox"/>	58.0#
	48 x 17 x 19-1/4"	BLCS48/WW/LB	<input type="checkbox"/> <input type="checkbox"/> <input type="checkbox"/>	<input type="checkbox"/> <input type="checkbox"/> <input type="checkbox"/>	<input type="checkbox"/> <input type="checkbox"/> <input type="checkbox"/>	64.0#
	54 x 17 x 19-1/4"	BLCS54/WW/LB	<input type="checkbox"/> <input type="checkbox"/> <input type="checkbox"/>	<input type="checkbox"/> <input type="checkbox"/> <input type="checkbox"/>	<input type="checkbox"/> <input type="checkbox"/> <input type="checkbox"/>	70.0#
	60 x 17 x 19-1/4"	BLCS60/WW/LB	<input type="checkbox"/> <input type="checkbox"/> <input type="checkbox"/>	<input type="checkbox"/> <input type="checkbox"/> <input type="checkbox"/>	<input type="checkbox"/> <input type="checkbox"/> <input type="checkbox"/>	78.0#
 <p>BOH</p> <p><b>Balance® Overhead Cabinet-Solid Color Upper Door-Load Bar-Upmount</b></p> <ul style="list-style-type: none"> <li>Colored or translucent extruded polypropylene door</li> <li>Upmount brackets position the storage component on a 54" high panel to the same height as on 66" high panels</li> <li>On a 54" high panel, clearance between the cabinet and worksurface is 20"</li> <li>On a 48" high panel, clearance between the cabinet and worksurface is 14"</li> </ul>	30 x 17 x 19-1/4"	BLCS30/WW/UM	<input type="checkbox"/> <input type="checkbox"/> <input type="checkbox"/>	<input type="checkbox"/> <input type="checkbox"/> <input type="checkbox"/>	<input type="checkbox"/> <input type="checkbox"/> <input type="checkbox"/>	46.0#
	36 x 17 x 19-1/4"	BLCS36/WW/UM	<input type="checkbox"/> <input type="checkbox"/> <input type="checkbox"/>	<input type="checkbox"/> <input type="checkbox"/> <input type="checkbox"/>	<input type="checkbox"/> <input type="checkbox"/> <input type="checkbox"/>	52.0#
	42 x 17 x 19-1/4"	BLCS42/WW/UM	<input type="checkbox"/> <input type="checkbox"/> <input type="checkbox"/>	<input type="checkbox"/> <input type="checkbox"/> <input type="checkbox"/>	<input type="checkbox"/> <input type="checkbox"/> <input type="checkbox"/>	58.0#
	48 x 17 x 19-1/4"	BLCS48/WW/UM	<input type="checkbox"/> <input type="checkbox"/> <input type="checkbox"/>	<input type="checkbox"/> <input type="checkbox"/> <input type="checkbox"/>	<input type="checkbox"/> <input type="checkbox"/> <input type="checkbox"/>	64.0#
	54 x 17 x 19-1/4"	BLCS54/WW/UM	<input type="checkbox"/> <input type="checkbox"/> <input type="checkbox"/>	<input type="checkbox"/> <input type="checkbox"/> <input type="checkbox"/>	<input type="checkbox"/> <input type="checkbox"/> <input type="checkbox"/>	70.0#
	60 x 17 x 19-1/4"	BLCS60/WW/UM	<input type="checkbox"/> <input type="checkbox"/> <input type="checkbox"/>	<input type="checkbox"/> <input type="checkbox"/> <input type="checkbox"/>	<input type="checkbox"/> <input type="checkbox"/> <input type="checkbox"/>	78.0#

**A**      **B**      **C**      **D**

### HOW TO ORDER

Indicate the following information on order form:

- Quantity of each item.
- Model number, including options. See "How To Build a Model Number".
- Any special service required.

Note: • The  indicates that a choice is required.

- The absence of the  indicates that no choice is required.
- Alpha-numeric characters in place of  indicate that no other alternatives are available.

### HOW TO BUILD A MODEL NUMBER

- A** Select basic model.
- B** Select cabinet paint color. Refer to color addendum at [ki.com](http://ki.com) or KI Fabrics & Finishes binder.
- C** Select upper door color. Refer to color addendum at [ki.com](http://ki.com) or KI Fabrics & Finishes binder.
- D** Select key option.
 

<b>KA</b>	- Key alike
<b>KS</b>	- Key standard
<b>NLC</b>	- No lock core

### INFORMATION

Painted cabinet and lower door  
 Shelf dividers available separately  
 Cabinet is fully assembled  
 Door stores above top of cabinet  
 Will accept hanging tool rail and tackboards  
 (Attachment bar ordered separately)





# Balance® Storage and Accessories

Overhead Storage

Delivered Pricing

\$ 1032
1091
1137
1172
1249
1292
\$ 965
1023
1072
1106
1183
1228

### SPECIAL SERVICES

#### Special Carton Marking

With specially marked information N/C

#### Shipping

Shipped **assembled freight prepaid f.o.b. Manitowoc, Wisconsin 54220** factory. Freight class #77.5

Specifications and prices are subject to change without prior notice.

# Balance® Storage and Accessories

## Overhead Storage

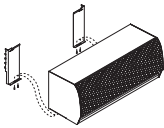
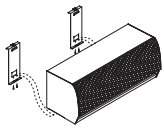
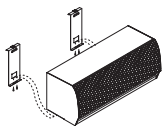
	MODEL	W x H x D	MODEL NUMBER				Approx. Packaged Weight
			Basic Model	Cabinet Paint Color	Fabric Color	Key Option	
 <p>BOH</p>	<b>Balance® Overhead Cabinet-Fabric Upper Door-On-Module</b> • On-Module overheads (PM) mount into slots in vertical posts. Overheads must be same width as panel mounted to. Allows for vertical adjustment in 1" increments.	30 x 17 x 19-1/4"	BLCF30/WW/PM	<input type="checkbox"/> <input type="checkbox"/> <input type="checkbox"/>	<input type="checkbox"/> <input type="checkbox"/> <input type="checkbox"/> <input type="checkbox"/>	<input type="checkbox"/> <input type="checkbox"/> <input type="checkbox"/>	46.0#
		36 x 17 x 19-1/4"	BLCF36/WW/PM	<input type="checkbox"/> <input type="checkbox"/> <input type="checkbox"/>	<input type="checkbox"/> <input type="checkbox"/> <input type="checkbox"/> <input type="checkbox"/>	<input type="checkbox"/> <input type="checkbox"/> <input type="checkbox"/>	52.0#
		42 x 17 x 19-1/4"	BLCF42/WW/PM	<input type="checkbox"/> <input type="checkbox"/> <input type="checkbox"/>	<input type="checkbox"/> <input type="checkbox"/> <input type="checkbox"/> <input type="checkbox"/>	<input type="checkbox"/> <input type="checkbox"/> <input type="checkbox"/>	58.0#
		48 x 17 x 19-1/4"	BLCF48/WW/PM	<input type="checkbox"/> <input type="checkbox"/> <input type="checkbox"/>	<input type="checkbox"/> <input type="checkbox"/> <input type="checkbox"/> <input type="checkbox"/>	<input type="checkbox"/> <input type="checkbox"/> <input type="checkbox"/>	64.0#
		54 x 17 x 19-1/4"	BLCF54/WW/PM	<input type="checkbox"/> <input type="checkbox"/> <input type="checkbox"/>	<input type="checkbox"/> <input type="checkbox"/> <input type="checkbox"/> <input type="checkbox"/>	<input type="checkbox"/> <input type="checkbox"/> <input type="checkbox"/>	70.0#
		60 x 17 x 19-1/4"	BLCF60/WW/PM	<input type="checkbox"/> <input type="checkbox"/> <input type="checkbox"/>	<input type="checkbox"/> <input type="checkbox"/> <input type="checkbox"/> <input type="checkbox"/>	<input type="checkbox"/> <input type="checkbox"/> <input type="checkbox"/>	78.0#
 <p>BOH</p>	<b>Balance® Overhead Cabinet-Fabric Upper Door-Off-Module</b> • Off-Module overheads (OM12) for WireWorks® mount into an integral track in the horizontal rail. Allows unit to slide along track. Requires a 12" tile for mounting (i.e. must be a half or fully segmented panel)	30 x 17 x 19-1/4"	BLCF30/WW/OM12	<input type="checkbox"/> <input type="checkbox"/> <input type="checkbox"/>	<input type="checkbox"/> <input type="checkbox"/> <input type="checkbox"/> <input type="checkbox"/>	<input type="checkbox"/> <input type="checkbox"/> <input type="checkbox"/>	46.0#
		36 x 17 x 19-1/4"	BLCF36/WW/OM12	<input type="checkbox"/> <input type="checkbox"/> <input type="checkbox"/>	<input type="checkbox"/> <input type="checkbox"/> <input type="checkbox"/> <input type="checkbox"/>	<input type="checkbox"/> <input type="checkbox"/> <input type="checkbox"/>	52.0#
		42 x 17 x 19-1/4"	BLCF42/WW/OM12	<input type="checkbox"/> <input type="checkbox"/> <input type="checkbox"/>	<input type="checkbox"/> <input type="checkbox"/> <input type="checkbox"/> <input type="checkbox"/>	<input type="checkbox"/> <input type="checkbox"/> <input type="checkbox"/>	58.0#
		48 x 17 x 19-1/4"	BLCF48/WW/OM12	<input type="checkbox"/> <input type="checkbox"/> <input type="checkbox"/>	<input type="checkbox"/> <input type="checkbox"/> <input type="checkbox"/> <input type="checkbox"/>	<input type="checkbox"/> <input type="checkbox"/> <input type="checkbox"/>	64.0#
		54 x 17 x 19-1/4"	BLCF54/WW/OM12	<input type="checkbox"/> <input type="checkbox"/> <input type="checkbox"/>	<input type="checkbox"/> <input type="checkbox"/> <input type="checkbox"/> <input type="checkbox"/>	<input type="checkbox"/> <input type="checkbox"/> <input type="checkbox"/>	70.0#
		60 x 17 x 19-1/4"	BLCF60/WW/OM12	<input type="checkbox"/> <input type="checkbox"/> <input type="checkbox"/>	<input type="checkbox"/> <input type="checkbox"/> <input type="checkbox"/> <input type="checkbox"/>	<input type="checkbox"/> <input type="checkbox"/> <input type="checkbox"/>	78.0#
 <p>BOH</p>	<b>Balance® Overhead Cabinet-Fabric Upper Door-Off-Module</b> • Off-Module overheads (OM18) for WireWorks® mount into an integral track in the horizontal rail. Allows unit to slide along track. Requires a 18" tile for mounting (i.e. must be a half or fully segmented panel)	30 x 17 x 19-1/4"	BLCF30/WW/OM18	<input type="checkbox"/> <input type="checkbox"/> <input type="checkbox"/>	<input type="checkbox"/> <input type="checkbox"/> <input type="checkbox"/> <input type="checkbox"/>	<input type="checkbox"/> <input type="checkbox"/> <input type="checkbox"/>	46.0#
		36 x 17 x 19-1/4"	BLCF36/WW/OM18	<input type="checkbox"/> <input type="checkbox"/> <input type="checkbox"/>	<input type="checkbox"/> <input type="checkbox"/> <input type="checkbox"/> <input type="checkbox"/>	<input type="checkbox"/> <input type="checkbox"/> <input type="checkbox"/>	52.0#
		42 x 17 x 19-1/4"	BLCF42/WW/OM18	<input type="checkbox"/> <input type="checkbox"/> <input type="checkbox"/>	<input type="checkbox"/> <input type="checkbox"/> <input type="checkbox"/> <input type="checkbox"/>	<input type="checkbox"/> <input type="checkbox"/> <input type="checkbox"/>	58.0#
		48 x 17 x 19-1/4"	BLCF48/WW/OM18	<input type="checkbox"/> <input type="checkbox"/> <input type="checkbox"/>	<input type="checkbox"/> <input type="checkbox"/> <input type="checkbox"/> <input type="checkbox"/>	<input type="checkbox"/> <input type="checkbox"/> <input type="checkbox"/>	64.0#
		54 x 17 x 19-1/4"	BLCF54/WW/OM18	<input type="checkbox"/> <input type="checkbox"/> <input type="checkbox"/>	<input type="checkbox"/> <input type="checkbox"/> <input type="checkbox"/> <input type="checkbox"/>	<input type="checkbox"/> <input type="checkbox"/> <input type="checkbox"/>	70.0#
		60 x 17 x 19-1/4"	BLCF60/WW/OM18	<input type="checkbox"/> <input type="checkbox"/> <input type="checkbox"/>	<input type="checkbox"/> <input type="checkbox"/> <input type="checkbox"/> <input type="checkbox"/>	<input type="checkbox"/> <input type="checkbox"/> <input type="checkbox"/>	78.0#

A
B
C
D

### HOW TO ORDER

Indicate the following information on order form:

- Quantity of each item.
- Model number, including options. See "How To Build a Model Number".
- Any special service required.

Note: • The  indicates that a choice is required.

- The absence of the  indicates that no choice is required.
- Alpha-numeric characters in place of  indicate that no other alternatives are available.

### HOW TO BUILD A MODEL NUMBER

- A** Select basic model.
- B** Select cabinet paint color.  
Refer to color addendum at [ki.com](http://ki.com) or KI Fabrics & Finishes binder.
- C** Select upper door color.  
Refer to color addendum at [ki.com](http://ki.com) or KI Fabrics & Finishes binder.
- D** Select key option.
 

<b>KA</b>	- Key alike
<b>KS</b>	- Key standard
<b>NLC</b>	- No lock core

### INFORMATION

Painted cabinet and lower door  
 Shelf dividers available separately  
 Cabinet is fully assembled  
 Door stores above top of cabinet  
 Will accept hanging tool rail and tackboards (Attachment bar ordered separately)

### INFORMATION

**Fabric Disclaimer**  
 Fabric will be applied as swatched by the fabric manufacturer. Fabric that is required to be applied differently than is swatched will need a Special Cost Request written specifying the direction the fabric is to be applied. The posted standard lead time will apply to the Special Cost Request.



# Balance® Storage and Accessories

Overhead Storage

Delivered Pricing Fabric Grade 1 & C.O.M.	Delivered Pricing Fabric Grade 2	Delivered Pricing Fabric Grade 3 & Pallas Vertical Fabric Grade PV	Delivered Pricing Pallas Vertical Fabric Grade PV1	Delivered Pricing Pallas Vertical Fabric Grade PV2
\$ 964	\$ 973	\$ 984	\$ 984	\$ 988
1027	1036	1049	1049	1052
1077	1090	1101	1101	1105
1119	1127	1138	1138	1143
1200	1211	1225	1225	1232
1246	1257	1272	1272	1278
\$ 1010	\$ 1018	\$ 1031	\$ 1031	\$ 1034
1071	1079	1094	1094	1097
1124	1132	1144	1144	1152
1161	1171	1183	1183	1189
1245	1257	1269	1269	1278
1290	1299	1313	1313	1319
\$ 1010	\$ 1018	\$ 1031	\$ 1031	\$ 1034
1071	1079	1094	1094	1097
1124	1132	1144	1144	1152
1161	1171	1183	1183	1189
1245	1257	1269	1269	1278
1290	1299	1313	1313	1319

**SPECIAL SERVICES**

**Special Carton Marking**

With specially marked information N/C

**Shipping**

Shipped **assembled freight prepaid** f.o.b. **Manitowoc, Wisconsin 54220** factory. Freight class #77.5

Specifications and prices are subject to change without prior notice.

# Balance® Storage and Accessories

## Overhead Storage

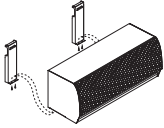
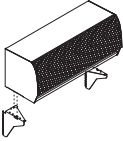
MODEL	W x H x D	MODEL NUMBER				Approx. Packaged Weight
		Basic Model	Cabinet Paint Color	Fabric Color	Key Option	
 <p><b>Balance® Overhead Cabinet-Fabric Upper Door-Load Bar Mount</b></p> <ul style="list-style-type: none"> <li>• Load Bar Mount overheads (LB) for WireWorks® hang from an externally mounted load bar</li> <li>• Load Bar purchased separately</li> </ul>	30 x 17 x 19-1/4"	BLCF30/WW/LB	<input type="checkbox"/> <input type="checkbox"/> <input type="checkbox"/>	<input type="checkbox"/> <input type="checkbox"/> <input type="checkbox"/> <input type="checkbox"/>	<input type="checkbox"/> <input type="checkbox"/> <input type="checkbox"/>	46.0#
	36 x 17 x 19-1/4"	BLCF36/WW/LB	<input type="checkbox"/> <input type="checkbox"/> <input type="checkbox"/>	<input type="checkbox"/> <input type="checkbox"/> <input type="checkbox"/> <input type="checkbox"/>	<input type="checkbox"/> <input type="checkbox"/> <input type="checkbox"/>	52.0#
	42 x 17 x 19-1/4"	BLCF42/WW/LB	<input type="checkbox"/> <input type="checkbox"/> <input type="checkbox"/>	<input type="checkbox"/> <input type="checkbox"/> <input type="checkbox"/> <input type="checkbox"/>	<input type="checkbox"/> <input type="checkbox"/> <input type="checkbox"/>	58.0#
	48 x 17 x 19-1/4"	BLCF48/WW/LB	<input type="checkbox"/> <input type="checkbox"/> <input type="checkbox"/>	<input type="checkbox"/> <input type="checkbox"/> <input type="checkbox"/> <input type="checkbox"/>	<input type="checkbox"/> <input type="checkbox"/> <input type="checkbox"/>	64.0#
	54 x 17 x 19-1/4"	BLCF54/WW/LB	<input type="checkbox"/> <input type="checkbox"/> <input type="checkbox"/>	<input type="checkbox"/> <input type="checkbox"/> <input type="checkbox"/> <input type="checkbox"/>	<input type="checkbox"/> <input type="checkbox"/> <input type="checkbox"/>	70.0#
	60 x 17 x 19-1/4"	BLCF60/WW/LB	<input type="checkbox"/> <input type="checkbox"/> <input type="checkbox"/>	<input type="checkbox"/> <input type="checkbox"/> <input type="checkbox"/> <input type="checkbox"/>	<input type="checkbox"/> <input type="checkbox"/> <input type="checkbox"/>	78.0#
 <p><b>Balance® Overhead Cabinet-Fabric Upper Door-Upmount</b></p> <ul style="list-style-type: none"> <li>• Upmount brackets position the storage component on a 54" high panel to the same height as on 66" high panels</li> <li>• On a 54" high panel, clearance between the cabinet and worksurface is 20"</li> <li>• On a 48" high panel, clearance between the cabinet and worksurface is 14"</li> </ul>	30 x 17 x 19-1/4"	BLCF30/WW/UM	<input type="checkbox"/> <input type="checkbox"/> <input type="checkbox"/>	<input type="checkbox"/> <input type="checkbox"/> <input type="checkbox"/> <input type="checkbox"/>	<input type="checkbox"/> <input type="checkbox"/> <input type="checkbox"/>	46.0#
	36 x 17 x 19-1/4"	BLCF36/WW/UM	<input type="checkbox"/> <input type="checkbox"/> <input type="checkbox"/>	<input type="checkbox"/> <input type="checkbox"/> <input type="checkbox"/> <input type="checkbox"/>	<input type="checkbox"/> <input type="checkbox"/> <input type="checkbox"/>	52.0#
	42 x 17 x 19-1/4"	BLCF42/WW/UM	<input type="checkbox"/> <input type="checkbox"/> <input type="checkbox"/>	<input type="checkbox"/> <input type="checkbox"/> <input type="checkbox"/> <input type="checkbox"/>	<input type="checkbox"/> <input type="checkbox"/> <input type="checkbox"/>	58.0#
	48 x 17 x 19-1/4"	BLCF48/WW/UM	<input type="checkbox"/> <input type="checkbox"/> <input type="checkbox"/>	<input type="checkbox"/> <input type="checkbox"/> <input type="checkbox"/> <input type="checkbox"/>	<input type="checkbox"/> <input type="checkbox"/> <input type="checkbox"/>	64.0#
	54 x 17 x 19-1/4"	BLCF54/WW/UM	<input type="checkbox"/> <input type="checkbox"/> <input type="checkbox"/>	<input type="checkbox"/> <input type="checkbox"/> <input type="checkbox"/> <input type="checkbox"/>	<input type="checkbox"/> <input type="checkbox"/> <input type="checkbox"/>	70.0#
	60 x 17 x 19-1/4"	BLCF60/WW/UM	<input type="checkbox"/> <input type="checkbox"/> <input type="checkbox"/>	<input type="checkbox"/> <input type="checkbox"/> <input type="checkbox"/> <input type="checkbox"/>	<input type="checkbox"/> <input type="checkbox"/> <input type="checkbox"/>	78.0#

**A**      **B**      **C**      **D**

### HOW TO ORDER

Indicate the following information on order form:

1. Quantity of each item.
2. Model number, including options. See "How To Build a Model Number".
3. Any special service required.

Note: • The  indicates that a choice is required.

- The absence of the  indicates that no choice is required.
- Alpha-numeric characters in place of  indicate that no other alternatives are available.

### HOW TO BUILD A MODEL NUMBER

- A** Select basic model.
- B** Select cabinet paint color.  
Refer to color addendum at ki.com or KI Fabrics & Finishes binder.
- C** Select upper door color.  
Refer to Vertical Fabric Pricing Addendum.
- D** Select key option.
 

<b>KA</b>	- Key alike
<b>KS</b>	- Key standard
<b>NLC</b>	- No lock core

### INFORMATION

Painted cabinet and lower door  
 Shelf dividers available separately  
 Cabinet is fully assembled  
 Door stores above top of cabinet  
 Will accept hanging tool rail and tackboards  
 (Attachment bar ordered separately)



# Balance® Storage and Accessories

Overhead Storage

Delivered Pricing Fabric Grade 1 & C.O.M.	Delivered Pricing Fabric Grade 2	Delivered Pricing Fabric Grade 3 & Pallas Vertical Fabric Grade PV	Delivered Pricing Pallas Vertical Fabric Grade PV1	Delivered Pricing Pallas Vertical Fabric Grade PV2
\$ 1101	\$ 1109	\$ 1123	\$ 1123	\$ 1126
1166	1174	1188	1188	1192
1217	1228	1242	1242	1245
1252	1263	1278	1278	1284
1338	1348	1360	1360	1371
1384	1394	1410	1410	1415
\$ 1038	\$ 1046	\$ 1059	\$ 1059	\$ 1063
1099	1107	1123	1123	1126
1153	1161	1174	1174	1179
1189	1200	1212	1212	1217
1274	1286	1298	1298	1305
1316	1330	1343	1343	1348

## SPECIAL SERVICES

### Special Carton Marking

With specially marked information N/C

### Shipping

Shipped **assembled freight prepaid**  
f.o.b. **Manitowoc, Wisconsin 54220** factory.  
Freight class #77.5

Specifications and prices are subject to  
change without prior notice.

# Balance® Storage and Accessories

## Overhead Storage

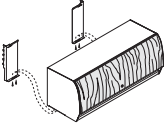
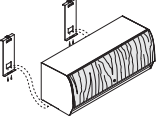
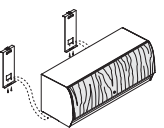
	MODEL	W x H x D	MODEL NUMBER					Approx. Packaged Weight
			Basic Model	Cabinet Paint Color	Laminate Color	Laminate Door Edge Color	Key Option	
 BOH	<b>Balance® Overhead Cabinet-Laminate Upper Door-On-Module</b> • On-Module overheads (PM) mount into slots in vertical posts. Overheads must be same width as panel mounted to. Allows for vertical adjustment in one-inch increments	30 x 17 x 19-1/4"	BLCL30/WW/PM	<input type="checkbox"/> <input type="checkbox"/> <input type="checkbox"/>	<input type="checkbox"/> <input type="checkbox"/> <input type="checkbox"/>	<input type="checkbox"/> <input type="checkbox"/> <input type="checkbox"/>	<input type="checkbox"/> <input type="checkbox"/> <input type="checkbox"/>	46.0#
		36 x 17 x 19-1/4"	BLCL36/WW/PM	<input type="checkbox"/> <input type="checkbox"/> <input type="checkbox"/>	<input type="checkbox"/> <input type="checkbox"/> <input type="checkbox"/>	<input type="checkbox"/> <input type="checkbox"/> <input type="checkbox"/>	<input type="checkbox"/> <input type="checkbox"/> <input type="checkbox"/>	52.0#
		42 x 17 x 19-1/4"	BLCL42/WW/PM	<input type="checkbox"/> <input type="checkbox"/> <input type="checkbox"/>	<input type="checkbox"/> <input type="checkbox"/> <input type="checkbox"/>	<input type="checkbox"/> <input type="checkbox"/> <input type="checkbox"/>	<input type="checkbox"/> <input type="checkbox"/> <input type="checkbox"/>	58.0#
		48 x 17 x 19-1/4"	BLCL48/WW/PM	<input type="checkbox"/> <input type="checkbox"/> <input type="checkbox"/>	<input type="checkbox"/> <input type="checkbox"/> <input type="checkbox"/>	<input type="checkbox"/> <input type="checkbox"/> <input type="checkbox"/>	<input type="checkbox"/> <input type="checkbox"/> <input type="checkbox"/>	64.0#
		54 x 17 x 19-1/4"	BLCL54/WW/PM	<input type="checkbox"/> <input type="checkbox"/> <input type="checkbox"/>	<input type="checkbox"/> <input type="checkbox"/> <input type="checkbox"/>	<input type="checkbox"/> <input type="checkbox"/> <input type="checkbox"/>	<input type="checkbox"/> <input type="checkbox"/> <input type="checkbox"/>	70.0#
		60 x 17 x 19-1/4"	BLCL60/WW/PM	<input type="checkbox"/> <input type="checkbox"/> <input type="checkbox"/>	<input type="checkbox"/> <input type="checkbox"/> <input type="checkbox"/>	<input type="checkbox"/> <input type="checkbox"/> <input type="checkbox"/>	<input type="checkbox"/> <input type="checkbox"/> <input type="checkbox"/>	78.0#
 BOH	<b>Balance® Overhead Cabinet-Laminate Upper Door-Off-Module</b> • Off-Module overheads (OM12) for WireWorks® mount into an integral track in the horizontal rail. Allows unit to slide along track. Requires a 12" tile for mounting (i.e. must be a half or fully segmented panel)	30 x 17 x 19-1/4"	BLCL30/WW/OM12	<input type="checkbox"/> <input type="checkbox"/> <input type="checkbox"/>	<input type="checkbox"/> <input type="checkbox"/> <input type="checkbox"/>	<input type="checkbox"/> <input type="checkbox"/> <input type="checkbox"/>	<input type="checkbox"/> <input type="checkbox"/> <input type="checkbox"/>	46.0#
		36 x 17 x 19-1/4"	BLCL36/WW/OM12	<input type="checkbox"/> <input type="checkbox"/> <input type="checkbox"/>	<input type="checkbox"/> <input type="checkbox"/> <input type="checkbox"/>	<input type="checkbox"/> <input type="checkbox"/> <input type="checkbox"/>	<input type="checkbox"/> <input type="checkbox"/> <input type="checkbox"/>	52.0#
		42 x 17 x 19-1/4"	BLCL42/WW/OM12	<input type="checkbox"/> <input type="checkbox"/> <input type="checkbox"/>	<input type="checkbox"/> <input type="checkbox"/> <input type="checkbox"/>	<input type="checkbox"/> <input type="checkbox"/> <input type="checkbox"/>	<input type="checkbox"/> <input type="checkbox"/> <input type="checkbox"/>	58.0#
		48 x 17 x 19-1/4"	BLCL48/WW/OM12	<input type="checkbox"/> <input type="checkbox"/> <input type="checkbox"/>	<input type="checkbox"/> <input type="checkbox"/> <input type="checkbox"/>	<input type="checkbox"/> <input type="checkbox"/> <input type="checkbox"/>	<input type="checkbox"/> <input type="checkbox"/> <input type="checkbox"/>	64.0#
		54 x 17 x 19-1/4"	BLCL54/WW/OM12	<input type="checkbox"/> <input type="checkbox"/> <input type="checkbox"/>	<input type="checkbox"/> <input type="checkbox"/> <input type="checkbox"/>	<input type="checkbox"/> <input type="checkbox"/> <input type="checkbox"/>	<input type="checkbox"/> <input type="checkbox"/> <input type="checkbox"/>	70.0#
		60 x 17 x 19-1/4"	BLCL60/WW/OM12	<input type="checkbox"/> <input type="checkbox"/> <input type="checkbox"/>	<input type="checkbox"/> <input type="checkbox"/> <input type="checkbox"/>	<input type="checkbox"/> <input type="checkbox"/> <input type="checkbox"/>	<input type="checkbox"/> <input type="checkbox"/> <input type="checkbox"/>	78.0#
 BOH	<b>Balance® Overhead Cabinet-Laminate Upper Door-Off-Module</b> • Off-Module overheads (OM18) for WireWorks® mount into an integral track in the horizontal rail. Allows unit to slide along track. Requires a 18" tile for mounting (i.e. must be a half or fully segmented panel)	30 x 17 x 19-1/4"	BLCL30/WW/OM18	<input type="checkbox"/> <input type="checkbox"/> <input type="checkbox"/>	<input type="checkbox"/> <input type="checkbox"/> <input type="checkbox"/>	<input type="checkbox"/> <input type="checkbox"/> <input type="checkbox"/>	<input type="checkbox"/> <input type="checkbox"/> <input type="checkbox"/>	46.0#
		36 x 17 x 19-1/4"	BLCL36/WW/OM18	<input type="checkbox"/> <input type="checkbox"/> <input type="checkbox"/>	<input type="checkbox"/> <input type="checkbox"/> <input type="checkbox"/>	<input type="checkbox"/> <input type="checkbox"/> <input type="checkbox"/>	<input type="checkbox"/> <input type="checkbox"/> <input type="checkbox"/>	52.0#
		42 x 17 x 19-1/4"	BLCL42/WW/OM18	<input type="checkbox"/> <input type="checkbox"/> <input type="checkbox"/>	<input type="checkbox"/> <input type="checkbox"/> <input type="checkbox"/>	<input type="checkbox"/> <input type="checkbox"/> <input type="checkbox"/>	<input type="checkbox"/> <input type="checkbox"/> <input type="checkbox"/>	58.0#
		48 x 17 x 19-1/4"	BLCL48/WW/OM18	<input type="checkbox"/> <input type="checkbox"/> <input type="checkbox"/>	<input type="checkbox"/> <input type="checkbox"/> <input type="checkbox"/>	<input type="checkbox"/> <input type="checkbox"/> <input type="checkbox"/>	<input type="checkbox"/> <input type="checkbox"/> <input type="checkbox"/>	64.0#
		54 x 17 x 19-1/4"	BLCL54/WW/OM18	<input type="checkbox"/> <input type="checkbox"/> <input type="checkbox"/>	<input type="checkbox"/> <input type="checkbox"/> <input type="checkbox"/>	<input type="checkbox"/> <input type="checkbox"/> <input type="checkbox"/>	<input type="checkbox"/> <input type="checkbox"/> <input type="checkbox"/>	70.0#
		60 x 17 x 19-1/4"	BLCL60/WW/OM18	<input type="checkbox"/> <input type="checkbox"/> <input type="checkbox"/>	<input type="checkbox"/> <input type="checkbox"/> <input type="checkbox"/>	<input type="checkbox"/> <input type="checkbox"/> <input type="checkbox"/>	<input type="checkbox"/> <input type="checkbox"/> <input type="checkbox"/>	78.0#

**A**      **B**      **C**      **D**      **E**

### HOW TO ORDER

Indicate the following information on order form:

- Quantity of each item.
- Model number, including options. See "How To Build a Model Number".
- Any special service required.

Note: • The  indicates that a choice is required.

- The absence of the  indicates that no choice is required.
- Alpha-numeric characters in place of  indicate that no other alternatives are available.

### HOW TO BUILD A MODEL NUMBER

- A** Select basic model.
- B** Select cabinet paint color.  
Refer to color addendum at ki.com or KI Fabrics & Finishes binder.
- C** Select upper door laminate color.  
Refer to color addendum at ki.com or KI Fabrics & Finishes binder.
- D** Select laminate door edge color.  
Refer to color addendum at ki.com or KI Fabrics & Finishes binder.
- E** Select key option.
 

<b>KA</b>	- Key alike
<b>KS</b>	- Key standard
<b>NLC</b>	- No lock core

### INFORMATION

Painted cabinet and lower door  
 Shelf dividers available separately  
 Cabinet is fully assembled  
 Door stores above top of cabinet  
 Will accept hanging tool rail and tackboards (Attachment bar ordered separately)

### FINISH INFORMATION

#### Additional Laminate Offering

Additional laminates beyond KI standard offering, are available with two weeks extended leadtime. To specify additional laminates, use these designators followed by the supplier's color/pattern code:

Formica - LF/supplier's color pattern code  
 Nevamar - LN/supplier's color pattern code  
 Wilsonart - LW/supplier's color pattern code

KI's standard finish is the supplier's recommended finish for that color/pattern.

Note: Nonstandard laminates from these suppliers (example: textured laminates), require an upcharge and additional leadtime. Contact KI.



# Balance® Storage and Accessories

Overhead Storage

Delivered Pricing

\$ 1096
1127
1202
1286
1414
1447

\$ 1140
1172
1247
1333
1461
1495

\$ 1140
1172
1247
1333
1461
1495

**SPECIAL SERVICES**

**Special Carton Marking**

With specially marked information N/C

**Shipping**

Shipped **assembled freight prepaid**  
**f.o.b. Manitowoc, Wisconsin 54220** factory.  
Freight class #77.5

Specifications and prices are subject to  
change without prior notice.

# Balance® Storage and Accessories

## Overhead Storage

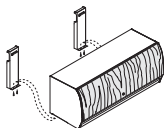
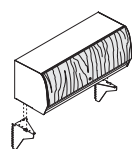
	MODEL	W x H x D	MODEL NUMBER					Approx. Packaged Weight
			Basic Model	Cabinet Paint Color	Laminate Color	Laminate Door Edge Color	Key Option	
 BOH	<b>Balance® Overhead Cabinet-Laminate Upper Door-Load Bar Mount</b> <ul style="list-style-type: none"> <li>Load Bar Mount overheads (LB) for WireWorks® hang from an externally mounted load bar</li> <li>Load Bar purchased separately</li> </ul>	30 x 17 x 19-1/4"	BLCL30/WW/LB	<input type="checkbox"/>	<input type="checkbox"/>	<input type="checkbox"/>	<input type="checkbox"/>	46.0#
		36 x 17 x 19-1/4"	BLCL36/WW/LB	<input type="checkbox"/>	<input type="checkbox"/>	<input type="checkbox"/>	<input type="checkbox"/>	52.0#
		42 x 17 x 19-1/4"	BLCL42/WW/LB	<input type="checkbox"/>	<input type="checkbox"/>	<input type="checkbox"/>	<input type="checkbox"/>	58.0#
		48 x 17 x 19-1/4"	BLCL48/WW/LB	<input type="checkbox"/>	<input type="checkbox"/>	<input type="checkbox"/>	<input type="checkbox"/>	64.0#
		54 x 17 x 19-1/4"	BLCL54/WW/LB	<input type="checkbox"/>	<input type="checkbox"/>	<input type="checkbox"/>	<input type="checkbox"/>	70.0#
		60 x 17 x 19-1/4"	BLCL60/WW/LB	<input type="checkbox"/>	<input type="checkbox"/>	<input type="checkbox"/>	<input type="checkbox"/>	78.0#
 BOH	<b>Balance® Overhead Cabinet-Laminate Upper Door-Upmount</b> <ul style="list-style-type: none"> <li>Upmount brackets position the storage component on a 54" high panel to the same height as on 66" high panels</li> <li>On a 54" high panel, clearance between the cabinet and worksurface is 20"</li> <li>On a 48" high panel, clearance between the cabinet and worksurface is 14"</li> </ul>	30 x 17 x 19-1/4"	BLCL30/WW/UM	<input type="checkbox"/>	<input type="checkbox"/>	<input type="checkbox"/>	<input type="checkbox"/>	46.0#
		36 x 17 x 19-1/4"	BLCL36/WW/UM	<input type="checkbox"/>	<input type="checkbox"/>	<input type="checkbox"/>	<input type="checkbox"/>	52.0#
		42 x 17 x 19-1/4"	BLCL42/WW/UM	<input type="checkbox"/>	<input type="checkbox"/>	<input type="checkbox"/>	<input type="checkbox"/>	58.0#
		48 x 17 x 19-1/4"	BLCL48/WW/UM	<input type="checkbox"/>	<input type="checkbox"/>	<input type="checkbox"/>	<input type="checkbox"/>	64.0#
		54 x 17 x 19-1/4"	BLCL54/WW/UM	<input type="checkbox"/>	<input type="checkbox"/>	<input type="checkbox"/>	<input type="checkbox"/>	70.0#
		60 x 17 x 19-1/4"	BLCL60/WW/UM	<input type="checkbox"/>	<input type="checkbox"/>	<input type="checkbox"/>	<input type="checkbox"/>	78.0#
			<b>A</b>	<b>B</b>	<b>C</b>	<b>D</b>	<b>E</b>	

### HOW TO ORDER

Indicate the following information on order form:

- Quantity of each item.
- Model number, including options. See "How To Build a Model Number".
- Any special service required.

Note: • The  indicates that a choice is required.

- The absence of the  indicates that no choice is required.
- Alpha-numeric characters in place of  indicate that no other alternatives are available.

### HOW TO BUILD A MODEL NUMBER

- A** Select basic model.  
**B** Select cabinet paint color.  
 Refer to color addendum at [ki.com](http://ki.com) or KI Fabrics & Finishes binder.  
**C** Select upper door laminate color.  
 Refer to color addendum at [ki.com](http://ki.com) or KI Fabrics & Finishes binder.  
**D** Select laminate door edge color.  
 Refer to color addendum at [ki.com](http://ki.com) or KI Fabrics & Finishes binder.  
**E** Select key option.

### INFORMATION

Painted cabinet and lower door  
 Shelf dividers available separately  
 Cabinet is fully assembled  
 Door stores above top of cabinet  
 Will accept hanging tool rail and tackboards  
 (Attachment bar ordered separately)

### FINISH INFORMATION

#### Additional Laminate Offering

Additional laminates beyond KI standard offering, are available with two weeks extended leadtime. To specify additional laminates, use these designators followed by the supplier's color/pattern code:

Formica - LF/supplier's color pattern code  
 Nevamar - LN/supplier's color pattern code  
 Wilsonart - LW/supplier's color pattern code

KI's standard finish is the supplier's recommended finish for that color/pattern.

Note: Nonstandard laminates from these suppliers (example: textured laminates), require an upcharge and additional leadtime. Contact KI.





# Balance® Storage and Accessories

Overhead Storage

Delivered  
Pricing

- \$ 1234
- 1263
- 1340
- 1422
- 1552
- 1587
- \$ 1170
- 1201
- 1276
- 1358
- 1488
- 1521

### SPECIAL SERVICES

#### Special Carton Marking

With specially marked information N/C

#### Shipping

Shipped **assembled freight prepaid**  
**f.o.b. Manitowoc, Wisconsin 54220** factory.  
Freight class #77.5

Specifications and prices are subject to  
change without prior notice.

# Balance® Storage and Accessories

## Overhead Accessories

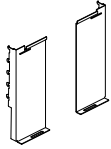
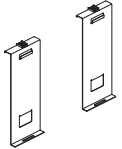
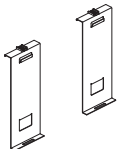
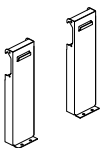
	MODEL	MODEL NUMBER		Approx. Packaged Weight
		Basic Model	Trim Color	
 <p><b>Balance® Overhead On-Module Mounting Bracket</b></p> <ul style="list-style-type: none"> <li>• Sold in pairs</li> <li>• Mounts into slots in vertical posts</li> <li>• Black only</li> </ul>	BOA/WW/PM		5.0#	
BOA				
 <p><b>Balance® Overhead Off-Module Mounting Bracket-12" Tiles</b></p> <ul style="list-style-type: none"> <li>• Sold in pairs</li> <li>• Mounts into slots in vertical posts</li> <li>• Black only</li> </ul>	BOA/WW/OM12		5.0#	
BOA				
 <p><b>Balance® Overhead Off-Module Mounting Bracket-18" Tiles</b></p> <ul style="list-style-type: none"> <li>• Sold in pairs</li> <li>• Mounts into slots in vertical posts</li> <li>• Black only</li> </ul>	BOA/WW/OM18		5.0#	
BOA				
 <p><b>Load Bar Brackets</b></p> <ul style="list-style-type: none"> <li>• Load Bar mount overheads (LB) for WireWorks® hang from an externally mounted load bar</li> <li>• Load Bar purchased separately</li> <li>• Sold in pairs</li> </ul>	BOA/WW/LB	<input type="checkbox"/>	5.0#	
BOA				

**A**

**B**

### HOW TO ORDER

Indicate the following information on order form:

1. Quantity of each item.
2. Model number, including options. See "How To Build a Model Number".
3. Any special service required.

- Note:
- The  indicates that a choice is required.
  - The absence of the  indicates that no choice is required.
  - Alpha-numeric characters in place of  indicate that no other alternatives are available.

### HOW TO BUILD A MODEL NUMBER

- A** Select basic model.
- B** Select trim color. Refer to color addendum at [ki.com](http://ki.com) or KI Fabrics & Finishes binder.



# Balance® Storage and Accessories

Overhead Accessories

Delivered  
Pricing

\$ 152

\$ 152

\$ 163

\$ 190

### SPECIAL SERVICES

#### Special Carton Marking

With specially marked information N/C

#### Shipping

Shipped **assembled freight prepaid**  
**f.o.b. Manitowoc, Wisconsin 54220** factory.  
Freight class #70.

Specifications and prices are subject to  
change without prior notice.

# Balance® Storage and Accessories

## Overhead Accessories

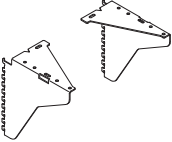
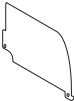
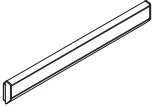
	MODEL	W	MODEL NUMBER		Approx. Packaged Weight
			Basic Model	Paint Color	
 <p><b>Upmount Brackets</b></p> <ul style="list-style-type: none"> <li>Upmount brackets position the storage component on a 54" high panel to the same height as on 66" high panels</li> <li>Sold in pairs</li> </ul>			BOA/WW/UM	<input type="checkbox"/> <input type="checkbox"/>	5.0#
	BOA				
 <p><b>Shelf Dividers</b></p> <ul style="list-style-type: none"> <li>Steel shelf dividers with powder coat finish</li> <li>Fits on all shelves and cabinets</li> </ul>	7-1/4 x 11-1/2"	NSD		<input type="checkbox"/> <input type="checkbox"/>	1.0#
	HRDPT				
 <p><b>Wall Mounted Load Bar</b></p>	24"	SWLB.24		<input type="checkbox"/> <input type="checkbox"/>	5.0#
	30"	SWLB.30		<input type="checkbox"/> <input type="checkbox"/>	6.0#
	36"	SWLB.36		<input type="checkbox"/> <input type="checkbox"/>	7.0#
	42"	SWLB.42		<input type="checkbox"/> <input type="checkbox"/>	8.0#
	48"	SWLB.48		<input type="checkbox"/> <input type="checkbox"/>	10.0#
	54"	SWLB.54		<input type="checkbox"/> <input type="checkbox"/>	13.0#
	60"	SWLB.60		<input type="checkbox"/> <input type="checkbox"/>	12.0#
	66"	SWLB.66		<input type="checkbox"/> <input type="checkbox"/>	13.0#
	72"	SWLB.72		<input type="checkbox"/> <input type="checkbox"/>	14.0#
	84"	SWLB.84		<input type="checkbox"/> <input type="checkbox"/>	17.0#
96"	SWLB.96		<input type="checkbox"/> <input type="checkbox"/>	19.0#	
HRDPT					

**A**

**B**

### HOW TO ORDER

Indicate the following information on order form:

- Quantity of each item.
- Model number, including options. See "How To Build a Model Number".
- Any special service required.

Note: • The  indicates that a choice is required.

- The absence of the  indicates that no choice is required.
- Alpha-numeric characters in place of  indicate that no other alternatives are available.

### HOW TO BUILD A MODEL NUMBER

- A** Select basic model.
- B** Select paint color. Refer to color addendum at [ki.com](http://ki.com) or KI Fabrics & Finishes binder.



# Balance® Storage and Accessories

Overhead Accessories

Delivered  
Pricing  
\$ 233

\$ 26

\$ 111  
119  
121  
133  
138  
163  
164  
166  
173  
268  
280

### SPECIAL SERVICES

#### Special Carton Marking

With specially marked information N/C



#### Shipping

Shipped **assembled freight prepaid**  
**f.o.b. Manitowoc, Wisconsin 54220** factory.  
Freight class #70.

Specifications and prices are subject to  
change without prior notice.

# Balance® Storage and Accessories

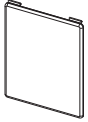
## Overhead Accessories

	MODEL	W x H	MODEL NUMBER			Approx. Packaged Weight	Delivered Pricing
			Basic Model	Trim Color	Fabric Color		
 <p>PTBO</p>	<b>Overhead Tackboard</b>	24 x 12"	PTB02412	<input type="checkbox"/>	<input type="checkbox"/> <input type="checkbox"/> <input type="checkbox"/> <input type="checkbox"/>	3.0#	N/A
	<ul style="list-style-type: none"> <li>Hangs from bottom of flipper door cabinet or shelf</li> </ul>	30 x 12"	PTB03012	<input type="checkbox"/>	<input type="checkbox"/> <input type="checkbox"/> <input type="checkbox"/> <input type="checkbox"/>	3.0#	N/A
	<ul style="list-style-type: none"> <li>When hanging from Balance® overhead, specify attachment bar BMB (purchase separately)</li> </ul>	36 x 12"	PTB03612	<input type="checkbox"/>	<input type="checkbox"/> <input type="checkbox"/> <input type="checkbox"/> <input type="checkbox"/>	3.0#	N/A
		42 x 12"	PTB04212	<input type="checkbox"/>	<input type="checkbox"/> <input type="checkbox"/> <input type="checkbox"/> <input type="checkbox"/>	4.0#	N/A
	<ul style="list-style-type: none"> <li>Includes mounting brackets in black only</li> </ul>	48 x 12"	PTB04812	<input type="checkbox"/>	<input type="checkbox"/> <input type="checkbox"/> <input type="checkbox"/> <input type="checkbox"/>	4.0#	N/A
		54 x 12"	PTB05412	<input type="checkbox"/>	<input type="checkbox"/> <input type="checkbox"/> <input type="checkbox"/> <input type="checkbox"/>	4.0#	N/A
	<ul style="list-style-type: none"> <li>Specify 20" high tackboard to cover vertical space between bottom of overhead and top of worksurface, when worksurface is positioned at 29" about finished floor</li> </ul>	60 x 12"	PTB06012	<input type="checkbox"/>	<input type="checkbox"/> <input type="checkbox"/> <input type="checkbox"/> <input type="checkbox"/>	4.0#	N/A
		24 x 16"	PTB02416	<input type="checkbox"/>	<input type="checkbox"/> <input type="checkbox"/> <input type="checkbox"/> <input type="checkbox"/>	3.0#	N/A
	30 x 16"	PTB03016	<input type="checkbox"/>	<input type="checkbox"/> <input type="checkbox"/> <input type="checkbox"/> <input type="checkbox"/>	4.0#	N/A	
	36 x 16"	PTB03616	<input type="checkbox"/>	<input type="checkbox"/> <input type="checkbox"/> <input type="checkbox"/> <input type="checkbox"/>	4.0#	N/A	
	42 x 16"	PTB04216	<input type="checkbox"/>	<input type="checkbox"/> <input type="checkbox"/> <input type="checkbox"/> <input type="checkbox"/>	5.0#	N/A	
	48 x 16"	PTB04816	<input type="checkbox"/>	<input type="checkbox"/> <input type="checkbox"/> <input type="checkbox"/> <input type="checkbox"/>	5.0#	N/A	
	54 x 16"	PTB05416	<input type="checkbox"/>	<input type="checkbox"/> <input type="checkbox"/> <input type="checkbox"/> <input type="checkbox"/>	6.0#	N/A	
	60 x 16"	PTB06016	<input type="checkbox"/>	<input type="checkbox"/> <input type="checkbox"/> <input type="checkbox"/> <input type="checkbox"/>	6.0#	N/A	
	24 x 20"	PTB02420	<input type="checkbox"/>	<input type="checkbox"/> <input type="checkbox"/> <input type="checkbox"/> <input type="checkbox"/>	4.0#	N/A	
	30 x 20"	PTB03020	<input type="checkbox"/>	<input type="checkbox"/> <input type="checkbox"/> <input type="checkbox"/> <input type="checkbox"/>	5.0#	N/A	
	36 x 20"	PTB03620	<input type="checkbox"/>	<input type="checkbox"/> <input type="checkbox"/> <input type="checkbox"/> <input type="checkbox"/>	6.0#	N/A	
	42 x 20"	PTB04220	<input type="checkbox"/>	<input type="checkbox"/> <input type="checkbox"/> <input type="checkbox"/> <input type="checkbox"/>	7.0#	N/A	
	48 x 20"	PTB04820	<input type="checkbox"/>	<input type="checkbox"/> <input type="checkbox"/> <input type="checkbox"/> <input type="checkbox"/>	8.0#	N/A	
	54 x 20"	PTB05420	<input type="checkbox"/>	<input type="checkbox"/> <input type="checkbox"/> <input type="checkbox"/> <input type="checkbox"/>	9.0#	N/A	
60 x 20"	PTB06020	<input type="checkbox"/>	<input type="checkbox"/> <input type="checkbox"/> <input type="checkbox"/> <input type="checkbox"/>	10.0#	N/A		
 <p>BOA</p>	<b>Tackboard/Tool Rail Attachment Bar</b>	30"	BMB30	BL		3.0#	\$ 37
	<ul style="list-style-type: none"> <li>Attachment bracket that attaches to bottom of overhead to accept overhead tackboard</li> <li>Order same size as overhead cabinet</li> <li>18-gauge steel</li> <li>Black only</li> </ul>	36"	BMB36	BL		3.0#	37
		42"	BMB42	BL		3.0#	38
		48"	BMB48	BL		4.0#	44
		54"	BMB54	BL		4.0#	45
		60"	BMB60	BL		4.0#	47

**A**   **B**   **C**

### HOW TO ORDER

Indicate the following information on order form:

- Quantity of each item.
- Model number, including options. See "How To Build a Model Number".
- Any special service required.

Note: • The  indicates that a choice is required.

- The absence of the  indicates that no choice is required.
- Alpha-numeric characters in place of  indicate that no other alternatives are available.

### HOW TO BUILD A MODEL NUMBER

- A** Select basic model.
- B** Select trim color.  
Refer to color addendum at [ki.com](http://ki.com) or KI Fabrics & Finishes binder.
- C** Select fabric color.  
Refer to Vertical Fabric Pricing Addendum.

### INFORMATION

#### Fabric Disclaimer

Fabric will be applied as swatched by the fabric manufacturer. Fabric that is required to be applied differently than is swatched will need a Special Cost Request written specifying the direction the fabric is to be applied. The posted standard lead time will apply to the Special Cost Request.



# Balance® Storage and Accessories

Overhead Accessories

Delivered Pricing Fabric Grade 1 & C.O.M.	Delivered Pricing Fabric Grade 2	Delivered Pricing Fabric Grade 3 & Pallas Vertical Fabric Grade PV	Delivered Pricing Pallas Vertical Fabric Grade PV1	Delivered Pricing Pallas Vertical Fabric Grade PV2
\$ 134	\$ 138	\$ 140	\$ 147	\$ 156
148	151	153	161	169
162	166	168	173	182
167	171	173	178	191
170	173	175	182	194
194	199	203	210	220
202	207	209	217	228
193	198	202	208	220
199	205	209	214	231
204	209	213	219	235
208	213	217	224	238
217	224	228	235	251
226	234	238	245	261
237	242	249	255	275
221	228	233	240	253
238	245	249	256	272
252	259	267	273	286
259	268	275	281	296
307	315	321	330	348
310	318	325	335	353
314	321	329	339	357

## SPECIAL SERVICES

### Special Carton Marking

With specially marked information N/C

### Shipping

Shipped **assembled freight prepaid**  
f.o.b. **Manitowoc, Wisconsin 54220** factory.  
Freight class #70.

Specifications and prices are subject to  
change without prior notice.

# Balance® Storage and Accessories

## Overhead Task Lights

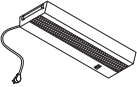
MODEL	W	MODEL NUMBER	Approx. Packaged Weight
		Basic Model	
 <p><b>Overhead Task Lights</b> • Electronic ballast</p>	24"	BTLT5.24	3.9#
	36"	BTLT5.36	5.3#
	48"	BTLT5.48	6.7#

HRDPT

**A**

### HOW TO ORDER

Indicate the following information on order form:

1. Quantity of each item.
2. Model number, including options. See "How To Build a Model Number".
3. Any special service required.

Note: • The  indicates that a choice is required.

- The absence of the  indicates that no choice is required.
- Alpha-numeric characters in place of  indicate that no other alternatives are available.

### HOW TO BUILD A MODEL NUMBER

**A** Select basic model.

### INFORMATION

#### TASK LIGHT CABINET WIDTH

Cabinet Width	Light Width
24"	18"
30"	24"
36"	24"
42"	36"
48"	36"
54"	48"
60"	48"





# Balance® Storage and Accessories

Overhead Task Lights

Delivered  
Pricing

\$ 102  
112  
117

### SPECIAL SERVICES

#### Special Carton Marking

With specially marked information N/C

#### Shipping

Shipped **assembled freight prepaid f.o.b. Manitowoc, Wisconsin 54220** factory. Freight class #100.

Specifications and prices are subject to change without prior notice.

# Accessories

## Sail

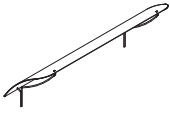
	MODEL	W	MODEL NUMBER		Approx. Packaged Weight
			Basic Model	Trim Color	
 <p>HRDPT</p> <p><b>Sail</b></p> <ul style="list-style-type: none"> <li>Sail attaches to top rail of panel (off module)</li> <li>Sail composed of .075" thick white crush grain polyethylene</li> <li>Sail brackets are Starlight Silver only</li> </ul>			SAIL.48.SX		3.0#
	<input type="checkbox"/>				
	<input type="checkbox"/>				
	<input type="checkbox"/>				

**A**

**B**

### HOW TO ORDER

Indicate the following information on order form:

- Quantity of each item.
- Model number, including options. See "How To Build a Model Number".
- Any special service required.

Note:

- The  indicates that a choice is required.
- The absence of the  indicates that no choice is required.
- Alpha-numeric characters in place of  indicate that no other alternatives are available.

### HOW TO BUILD A MODEL NUMBER

- A** Select basic model.
- B** Select trim color. Refer to color addendum at [ki.com](http://ki.com) or KI Fabrics & Finishes binder.



Delivered  
Pricing

\$ 254

**SPECIAL SERVICES**

**Special Carton Marking**

With specially marked information N/C



**Shipping**

Delivered. Shipped **k.d. freight prepaid f.o.b. Manitowoc, Wisconsin 54220** factory. Freight class #70.

Specifications and prices are subject to change without prior notice.

# Accessories

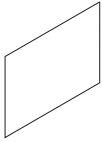
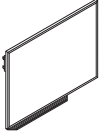
## Markerboards

	MODEL	Features	W x H	MODEL NUMBER	Approx. Packaged Weight
				Basic Model	
 HRDPT	<b>Markerboards</b> <ul style="list-style-type: none"> <li>• White "dry erase" painted steel</li> <li>• "No frame" construction of 22 gauge steel with honeycomb core adhered to back of tile to dampen sound</li> <li>• Includes magnetic removable 16" x 2-1/2" tray with markers and eraser</li> <li>• Specify for "on" or "off" module mounting brackets</li> <li>• Includes black mounting brackets</li> </ul>	Off-Module	30 x 30"	PDEMB.OM.3030	16.0#
		Off-Module	36 x 30"	PDEMB.OM.3630	24.0#
		Off-Module	42 x 30"	PDEMB.OM.4230	20.0#
		Off-Module	48 x 30"	PDEMB.OM.4830	22.0#
		Off-Module	54 x 30"	PDEMB.OM.5430	25.0#
		Off-Module	60 x 30"	PDEMB.OM.6030	29.0#
		On-Module	30 x 30"	PDEMB.PM.3030	17.0#
		On-Module	36 x 30"	PDEMB.PM.3630	25.0#
		On-Module	42 x 30"	PDEMB.PM.4230	21.0#
		On-Module	48 x 30"	PDEMB.PM.4830	23.0#
		On-Module	54 x 30"	PDEMB.PM.5430	26.0#
		On-Module	60 x 30"	PDEMB.PM.6030	30.0#
		 HRDPT	<b>Markerboards</b> <ul style="list-style-type: none"> <li>• White porcelain painted steel surface with matching white trim</li> <li>• Includes magnetic removable 16" x 2-1/2" tray with markers and eraser</li> <li>• Specify for "on" or "off" module mounting brackets</li> <li>• Includes black mounting brackets</li> </ul>	Off-Module	30 x 32"
Off-Module	36 x 32"			PMB.OM.3632	13.0#
Off-Module	42 x 32"			PMB.OM.4232	15.0#
Off-Module	48 x 32"			PMB.OM.4832	17.0#
Off-Module	54 x 32"			PMB.OM.5432	20.0#
Off-Module	60 x 32"			PMB.OM.6032	22.0#
On-Module	30 x 32"			PMB.PM.3032	11.0#
On-Module	36 x 32"			PMB.PM.3632	13.0#
On-Module	42 x 32"			PMB.PM.4232	15.0#
On-Module	48 x 32"			PMB.PM.4832	17.0#
 HRDPT	<b>Magnetic Tray</b>		16 x 2-1/2"	MB.TRAY	1.0#
HRDPT	<b>Tray/Eraser/4 Markers</b>			MB.MARKERKIT	1.0#

**A**

### HOW TO ORDER

Indicate the following information on order form:

1. Quantity of each item.
2. Model number, including options. See "How To Build a Model Number".
3. Any special service required.

Note: • The  indicates that a choice is required.

- The absence of the  indicates that no choice is required.
- Alpha-numeric characters in place of  indicate that no other alternatives are available.

### HOW TO BUILD A MODEL NUMBER

- A** Select basic model.



# Accessories

Markerboards

Delivered  
Pricing

\$ 267

309

318

330

438

449

267

309

318

330

438

449

\$ 551

576

641

657

715

750

551

576

641

657

715

750

\$ 38

\$ 92

## SPECIAL SERVICES

### Special Carton Marking

With specially marked information N/C

### Shipping

Delivered. Shipped **k.d. freight prepaid**  
**f.o.b. Manitowoc, Wisconsin 54220**  
factory. Freight class #70.

Specifications and prices are subject to  
change without prior notice.

# Accessories

## Tackboard

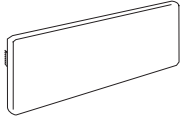

PTB

### MODEL

#### Tackboard

- Tackboards are constructed of 3/4" tackable core and covered with fabric
- Includes black mounting brackets
- Not available with countertops

### Features

### W x H

### MODEL NUMBER

Basic Model

Fabric Color

Approx. Packaged Weight

Off-Module	24 x 12"	PTB2412/OM	<input type="checkbox"/> <input type="checkbox"/> <input type="checkbox"/> <input type="checkbox"/>	3.0#
Off-Module	30 x 12"	PTB3012/OM	<input type="checkbox"/> <input type="checkbox"/> <input type="checkbox"/> <input type="checkbox"/>	3.0#
Off-Module	36 x 12"	PTB3612/OM	<input type="checkbox"/> <input type="checkbox"/> <input type="checkbox"/> <input type="checkbox"/>	4.0#
Off-Module	42 x 12"	PTB4212/OM	<input type="checkbox"/> <input type="checkbox"/> <input type="checkbox"/> <input type="checkbox"/>	4.0#
Off-Module	48 x 12"	PTB4812/OM	<input type="checkbox"/> <input type="checkbox"/> <input type="checkbox"/> <input type="checkbox"/>	5.0#
Off-Module	54 x 12"	PTB5412/OM	<input type="checkbox"/> <input type="checkbox"/> <input type="checkbox"/> <input type="checkbox"/>	5.0#
Off-Module	60 x 12"	PTB6012/OM	<input type="checkbox"/> <input type="checkbox"/> <input type="checkbox"/> <input type="checkbox"/>	6.0#
Off-Module	24 x 16"	PTB2416/OM	<input type="checkbox"/> <input type="checkbox"/> <input type="checkbox"/> <input type="checkbox"/>	4.0#
Off-Module	30 x 16"	PTB3016/OM	<input type="checkbox"/> <input type="checkbox"/> <input type="checkbox"/> <input type="checkbox"/>	4.0#
Off-Module	36 x 16"	PTB3616/OM	<input type="checkbox"/> <input type="checkbox"/> <input type="checkbox"/> <input type="checkbox"/>	5.0#
Off-Module	42 x 16"	PTB4216/OM	<input type="checkbox"/> <input type="checkbox"/> <input type="checkbox"/> <input type="checkbox"/>	5.0#
Off-Module	48 x 16"	PTB4816/OM	<input type="checkbox"/> <input type="checkbox"/> <input type="checkbox"/> <input type="checkbox"/>	6.0#
Off-Module	54 x 16"	PTB5416/OM	<input type="checkbox"/> <input type="checkbox"/> <input type="checkbox"/> <input type="checkbox"/>	6.0#
Off-Module	60 x 16"	PTB6016/OM	<input type="checkbox"/> <input type="checkbox"/> <input type="checkbox"/> <input type="checkbox"/>	7.0#
On-Module	24 x 12"	PTB2412/PM	<input type="checkbox"/> <input type="checkbox"/> <input type="checkbox"/> <input type="checkbox"/>	3.0#
On-Module	30 x 12"	PTB3012/PM	<input type="checkbox"/> <input type="checkbox"/> <input type="checkbox"/> <input type="checkbox"/>	3.0#
On-Module	36 x 12"	PTB3612/PM	<input type="checkbox"/> <input type="checkbox"/> <input type="checkbox"/> <input type="checkbox"/>	4.0#
On-Module	42 x 12"	PTB4212/PM	<input type="checkbox"/> <input type="checkbox"/> <input type="checkbox"/> <input type="checkbox"/>	4.0#
On-Module	48 x 12"	PTB4812/PM	<input type="checkbox"/> <input type="checkbox"/> <input type="checkbox"/> <input type="checkbox"/>	5.0#
On-Module	54 x 12"	PTB5412/PM	<input type="checkbox"/> <input type="checkbox"/> <input type="checkbox"/> <input type="checkbox"/>	5.0#
On-Module	60 x 12"	PTB6012/PM	<input type="checkbox"/> <input type="checkbox"/> <input type="checkbox"/> <input type="checkbox"/>	6.0#
On-Module	24 x 16"	PTB2416/PM	<input type="checkbox"/> <input type="checkbox"/> <input type="checkbox"/> <input type="checkbox"/>	4.0#
On-Module	30 x 16"	PTB3016/PM	<input type="checkbox"/> <input type="checkbox"/> <input type="checkbox"/> <input type="checkbox"/>	4.0#
On-Module	36 x 16"	PTB3616/PM	<input type="checkbox"/> <input type="checkbox"/> <input type="checkbox"/> <input type="checkbox"/>	5.0#
On-Module	42 x 16"	PTB4216/PM	<input type="checkbox"/> <input type="checkbox"/> <input type="checkbox"/> <input type="checkbox"/>	5.0#
On-Module	48 x 16"	PTB4816/PM	<input type="checkbox"/> <input type="checkbox"/> <input type="checkbox"/> <input type="checkbox"/>	6.0#
On-Module	54 x 16"	PTB5416/PM	<input type="checkbox"/> <input type="checkbox"/> <input type="checkbox"/> <input type="checkbox"/>	6.0#
On-Module	60 x 16"	PTB6016/PM	<input type="checkbox"/> <input type="checkbox"/> <input type="checkbox"/> <input type="checkbox"/>	7.0#

A

B

### HOW TO ORDER

Indicate the following information on order form:

1. Quantity of each item.
2. Model number, including options. See "How To Build a Model Number".
3. Any special service required.

Note: • The  indicates that a choice is required.

- The absence of the  indicates that no choice is required.
- Alpha-numeric characters in place of  indicate that no other alternatives are available.

### HOW TO BUILD A MODEL NUMBER

- A** Select basic model.
- B** Select fabric color.  
Refer to Vertical Fabric Pricing Addendum.



# Accessories

Tackboard

Delivered Pricing Fabric Grade 1 & C.O.M.	Delivered Pricing Fabric Grade 2	Delivered Pricing Fabric Grade 3 & Pallas Vertical Fabric Grade PV	Delivered Pricing Pallas Vertical Fabric Grade PV1	Delivered Pricing Pallas Vertical Fabric Grade PV2
\$ 145	\$ 148	\$ 150	\$ 146	\$ 169
162	165	168	163	181
173	177	180	176	199
178	183	185	181	207
182	185	190	184	210
210	214	218	213	237
217	222	226	220	248
148	150	153	150	172
162	165	168	163	181
164	168	170	165	183
180	184	187	184	208
187	192	198	193	214
224	229	233	228	254
231	235	238	236	262
145	148	150	146	169
162	165	168	163	181
173	177	180	176	199
178	183	185	181	207
182	185	190	184	210
210	214	218	213	237
217	222	226	220	248
148	150	153	150	172
162	165	168	163	181
164	168	170	165	183
180	184	187	184	208
187	192	198	193	214
224	229	233	228	254
231	235	238	236	262

## SPECIAL SERVICES

### Special Carton Marking

With specially marked information N/C

### Shipping

Delivered. Shipped **k.d. freight prepaid f.o.b. Manitowoc, Wisconsin 54220** factory. Freight class #70.

Specifications and prices are subject to change without prior notice.

# Accessories

## Tackboard

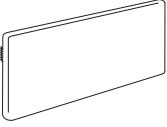
MODEL	Features	W x H	MODEL NUMBER		Approx. Packaged Weight
			Basic Model	Fabric Color	
 <p>PTB</p> <p><b>Tackboard</b></p> <ul style="list-style-type: none"> <li>Tackboards are constructed of 3/4" tackable core and covered with fabric</li> <li>Includes black mounting brackets</li> <li>Not available with countertops</li> </ul>	Off-Module	24 x 20"	PTB2420/OM	<input type="checkbox"/> <input type="checkbox"/> <input type="checkbox"/> <input type="checkbox"/>	4.0#
	Off-Module	30 x 20"	PTB3020/OM	<input type="checkbox"/> <input type="checkbox"/> <input type="checkbox"/> <input type="checkbox"/>	5.0#
	Off-Module	36 x 20"	PTB3620/OM	<input type="checkbox"/> <input type="checkbox"/> <input type="checkbox"/> <input type="checkbox"/>	6.0#
	Off-Module	42 x 20"	PTB4220/OM	<input type="checkbox"/> <input type="checkbox"/> <input type="checkbox"/> <input type="checkbox"/>	7.0#
	Off-Module	48 x 20"	PTB4820/OM	<input type="checkbox"/> <input type="checkbox"/> <input type="checkbox"/> <input type="checkbox"/>	8.0#
	Off-Module	54 x 20"	PTB5420/OM	<input type="checkbox"/> <input type="checkbox"/> <input type="checkbox"/> <input type="checkbox"/>	9.0#
	Off-Module	60 x 20"	PTB6020/OM	<input type="checkbox"/> <input type="checkbox"/> <input type="checkbox"/> <input type="checkbox"/>	10.0#
	Off-Module	24 x 30"	PTB2430/OM	<input type="checkbox"/> <input type="checkbox"/> <input type="checkbox"/> <input type="checkbox"/>	6.0#
	Off-Module	30 x 30"	PTB3030/OM	<input type="checkbox"/> <input type="checkbox"/> <input type="checkbox"/> <input type="checkbox"/>	7.0#
	Off-Module	36 x 30"	PTB3630/OM	<input type="checkbox"/> <input type="checkbox"/> <input type="checkbox"/> <input type="checkbox"/>	8.0#
	Off-Module	42 x 30"	PTB4230/OM	<input type="checkbox"/> <input type="checkbox"/> <input type="checkbox"/> <input type="checkbox"/>	10.0#
	Off-Module	48 x 30"	PTB4830/OM	<input type="checkbox"/> <input type="checkbox"/> <input type="checkbox"/> <input type="checkbox"/>	11.0#
	Off-Module	54 x 30"	PTB5430/OM	<input type="checkbox"/> <input type="checkbox"/> <input type="checkbox"/> <input type="checkbox"/>	12.0#
	Off-Module	60 x 30"	PTB6030/OM	<input type="checkbox"/> <input type="checkbox"/> <input type="checkbox"/> <input type="checkbox"/>	14.0#
	On-Module	24 x 20"	PTB2420/PM	<input type="checkbox"/> <input type="checkbox"/> <input type="checkbox"/> <input type="checkbox"/>	4.0#
	On-Module	30 x 20"	PTB3020/PM	<input type="checkbox"/> <input type="checkbox"/> <input type="checkbox"/> <input type="checkbox"/>	5.0#
	On-Module	36 x 20"	PTB3620/PM	<input type="checkbox"/> <input type="checkbox"/> <input type="checkbox"/> <input type="checkbox"/>	6.0#
	On-Module	42 x 20"	PTB4220/PM	<input type="checkbox"/> <input type="checkbox"/> <input type="checkbox"/> <input type="checkbox"/>	7.0#
	On-Module	48 x 20"	PTB4820/PM	<input type="checkbox"/> <input type="checkbox"/> <input type="checkbox"/> <input type="checkbox"/>	8.0#
	On-Module	54 x 20"	PTB5420/PM	<input type="checkbox"/> <input type="checkbox"/> <input type="checkbox"/> <input type="checkbox"/>	9.0#
	On-Module	60 x 20"	PTB6020/PM	<input type="checkbox"/> <input type="checkbox"/> <input type="checkbox"/> <input type="checkbox"/>	10.0#
	On-Module	24 x 30"	PTB2430/PM	<input type="checkbox"/> <input type="checkbox"/> <input type="checkbox"/> <input type="checkbox"/>	6.0#
	On-Module	30 x 30"	PTB3030/PM	<input type="checkbox"/> <input type="checkbox"/> <input type="checkbox"/> <input type="checkbox"/>	7.0#
	On-Module	36 x 30"	PTB3630/PM	<input type="checkbox"/> <input type="checkbox"/> <input type="checkbox"/> <input type="checkbox"/>	8.0#
	On-Module	42 x 30"	PTB4230/PM	<input type="checkbox"/> <input type="checkbox"/> <input type="checkbox"/> <input type="checkbox"/>	10.0#
	On-Module	48 x 30"	PTB4830/PM	<input type="checkbox"/> <input type="checkbox"/> <input type="checkbox"/> <input type="checkbox"/>	11.0#
	On-Module	54 x 30"	PTB5430/PM	<input type="checkbox"/> <input type="checkbox"/> <input type="checkbox"/> <input type="checkbox"/>	12.0#
	On-Module	60 x 30"	PTB6030/PM	<input type="checkbox"/> <input type="checkbox"/> <input type="checkbox"/> <input type="checkbox"/>	14.0#

A

B

### HOW TO ORDER

Indicate the following information on order form:

- Quantity of each item.
- Model number, including options. See "How To Build a Model Number".
- Any special service required.

Note: • The  indicates that a choice is required.

- The absence of the  indicates that no choice is required.
- Alpha-numeric characters in place of  indicate that no other alternatives are available.

### HOW TO BUILD A MODEL NUMBER

- A** Select basic model.
- B** Select fabric color.  
Refer to Vertical Fabric Pricing Addendum.





# Accessories

Tackboard

Delivered Pricing Fabric Grade 1 & C.O.M.	Delivered Pricing Fabric Grade 2	Delivered Pricing Fabric Grade 3 & Pallas Vertical Fabric Grade PV	Delivered Pricing Pallas Vertical Fabric Grade PV1	Delivered Pricing Pallas Vertical Fabric Grade PV2
\$ 218	\$ 227	\$ 229	\$ 235	\$ 251
235	241	248	256	269
252	259	263	271	286
260	267	271	279	295
310	318	323	334	353
313	321	329	340	357
317	327	334	343	362
237	247	252	242	273
295	303	310	300	337
312	319	327	319	356
330	340	348	338	378
348	356	365	354	396
356	365	374	364	403
379	390	397	385	431
218	227	229	235	251
235	241	248	256	269
252	259	263	271	286
260	267	271	279	295
310	318	323	334	353
313	321	329	340	357
317	327	334	343	362
237	247	252	242	273
295	303	310	300	337
312	319	327	319	356
330	340	348	338	378
348	356	365	354	396
356	365	374	364	403
379	390	397	385	431

## SPECIAL SERVICES

### Special Carton Marking

With specially marked information N/C

### Shipping

Delivered. Shipped **k.d. freight prepaid f.o.b. Manitowoc, Wisconsin 54220** factory. Freight class #70.

Specifications and prices are subject to change without prior notice.

# Accessories

## Tackboard

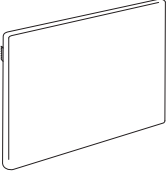
MODEL	Features	W x H	MODEL NUMBER		Approx. Packaged Weight
			Basic Model	Fabric Color	
 <p><b>Tackboard</b></p> <ul style="list-style-type: none"> <li>Tackboards are constructed of 3/4" tackable core and covered with fabric</li> <li>Includes mounting brackets</li> <li>Not available with countertops</li> </ul>	Off-Module	24 x 48"	PTB2448/OM	<input type="checkbox"/> <input type="checkbox"/> <input type="checkbox"/> <input type="checkbox"/>	9.0#
	Off-Module	30 x 48"	PTB3048/OM	<input type="checkbox"/> <input type="checkbox"/> <input type="checkbox"/> <input type="checkbox"/>	11.0#
	Off-Module	36 x 48"	PTB3648/OM	<input type="checkbox"/> <input type="checkbox"/> <input type="checkbox"/> <input type="checkbox"/>	13.0#
	Off-Module	42 x 48"	PTB4248/OM	<input type="checkbox"/> <input type="checkbox"/> <input type="checkbox"/> <input type="checkbox"/>	15.0#
	Off-Module	48 x 48"	PTB4848/OM	<input type="checkbox"/> <input type="checkbox"/> <input type="checkbox"/> <input type="checkbox"/>	17.0#
	Off-Module	54 x 48"	PTB5448/OM	<input type="checkbox"/> <input type="checkbox"/> <input type="checkbox"/> <input type="checkbox"/>	19.0#
	On-Module	24 x 48"	PTB2448/PM	<input type="checkbox"/> <input type="checkbox"/> <input type="checkbox"/> <input type="checkbox"/>	9.0#
	On-Module	30 x 48"	PTB3048/PM	<input type="checkbox"/> <input type="checkbox"/> <input type="checkbox"/> <input type="checkbox"/>	11.0#
	On-Module	36 x 48"	PTB3648/PM	<input type="checkbox"/> <input type="checkbox"/> <input type="checkbox"/> <input type="checkbox"/>	13.0#
	On-Module	42 x 48"	PTB4248/PM	<input type="checkbox"/> <input type="checkbox"/> <input type="checkbox"/> <input type="checkbox"/>	15.0#
	On-Module	48 x 48"	PTB4848/PM	<input type="checkbox"/> <input type="checkbox"/> <input type="checkbox"/> <input type="checkbox"/>	17.0#
	On-Module	54 x 48"	PTB5448/PM	<input type="checkbox"/> <input type="checkbox"/> <input type="checkbox"/> <input type="checkbox"/>	19.0#

PTB

A

B

### HOW TO ORDER

Indicate the following information on order form:

- Quantity of each item.
- Model number, including options. See "How To Build a Model Number".
- Any special service required.

Note: • The  indicates that a choice is required.

- The absence of the  indicates that no choice is required.
- Alpha-numeric characters in place of  indicate that no other alternatives are available.

### HOW TO BUILD A MODEL NUMBER

- A** Select basic model.
- B** Select fabric color.  
Refer to Vertical Fabric Pricing Addendum.



# Accessories

Tackboard

Delivered Pricing Fabric Grade 1 & C.O.M.	Delivered Pricing Fabric Grade 2	Delivered Pricing Fabric Grade 3 & Pallas Vertical Fabric Grade PV	Delivered Pricing Pallas Vertical Fabric Grade PV1	Delivered Pricing Pallas Vertical Fabric Grade PV2
\$ 305	\$ 312	\$ 319	\$ 311	\$ 347
352	358	367	356	399
399	411	422	408	453
411	424	436	419	469
438	451	460	446	499
446	458	470	454	508
305	312	319	311	347
352	358	367	356	399
399	411	422	408	453
411	424	436	419	469
438	451	460	446	499
446	458	470	454	508

## SPECIAL SERVICES

### Special Carton Marking

With specially marked information N/C

### Shipping

Delivered. Shipped **k.d. freight prepaid f.o.b. Manitowoc, Wisconsin 54220** factory. Freight class #70.

Specifications and prices are subject to change without prior notice.

# Accessories

## Brackets

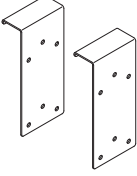
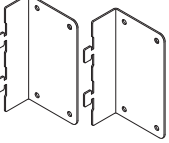
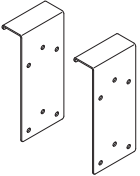
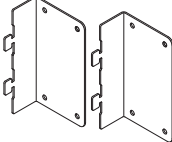
MODEL	MODEL NUMBER		Approx. Packaged Weight
	Basic Model		
 <p>HRDPT</p>	<b>Tackboard Off-Module Bracket</b> <ul style="list-style-type: none"> <li>• Pair of brackets</li> <li>• Order one kit for all heights</li> <li>• Includes mounting hardware</li> <li>• Not used on Overhead Tackboards</li> <li>• Only necessary to order if changing mounting style</li> <li>• Black only</li> </ul>	46.0371.TB.KIT	1.0#
 <p>HRDPT</p>	<b>Tackboard On-Module Bracket</b> <ul style="list-style-type: none"> <li>• Order one kit for 12" and 16" high tackboards</li> <li>• Order two kits for 20" and 30" high tackboards</li> <li>• Order three kits for 48" high tackboards</li> <li>• Not used on Overhead Tackboards</li> <li>• Only necessary to order if changing mounting style</li> <li>• Black only</li> </ul>	46.0078.TB.KIT	1.0#
 <p>HRDPT</p>	<b>Markerboard Off-Module Bracket</b> <ul style="list-style-type: none"> <li>• Pair of brackets</li> <li>• Order one kit for all heights</li> <li>• Includes mounting hardware</li> <li>• Only necessary to order if changing mounting style</li> <li>• Black only</li> </ul>	46.0371.MB.KIT	1.0#
 <p>HRDPT</p>	<b>Markerboard On-Module Bracket</b> <ul style="list-style-type: none"> <li>• Pair of brackets</li> <li>• Order one kit for all heights</li> <li>• Includes mounting hardware</li> <li>• Only necessary to order if changing mounting style</li> <li>• Black only</li> </ul>	46.0078.MB.KIT	1.0#

**A**

### HOW TO ORDER

Indicate the following information on order form:

1. Quantity of each item.
2. Model number, including options. See "How To Build a Model Number".
3. Any special service required.

Note: • The  indicates that a choice is required.

- The absence of the  indicates that no choice is required.
- Alpha-numeric characters in place of  indicate that no other alternatives are available.

### HOW TO BUILD A MODEL NUMBER

- A** Select basic model.



# Accessories

Brackets

Delivered  
Pricing

\$ 33

\$ 30

\$ 30

\$ 50

### SPECIAL SERVICES

#### Special Carton Marking

With specially marked information N/C



#### Shipping

Delivered. Shipped **k.d. freight prepaid f.o.b. Manitowoc, Wisconsin 54220** factory. Freight class #70.

Specifications and prices are subject to change without prior notice.

# Accessories

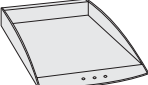
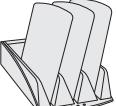
## Paper Management

	MODEL	H x W x D	MODEL NUMBER		Approx. Packaged Weight
			Basic Model	Trim Color	
 PTR	<b>On-Module Tool Rail</b> <ul style="list-style-type: none"> <li>Accommodates paper management components</li> <li>Attaches to panels "on" module</li> <li>Field installable</li> <li>Painted aluminum construction</li> <li>Consists of four slots to accept components</li> </ul>	18 x 4 1/2"	PPMTR18	<input type="checkbox"/>	3.0#
		24 x 4 1/2"	PPMTR24	<input type="checkbox"/>	3.0#
		30 x 4 1/2"	PPMTR30	<input type="checkbox"/>	4.0#
		36 x 4 1/2"	PPMTR36	<input type="checkbox"/>	5.0#
		42 x 4 1/2"	PPMTR42	<input type="checkbox"/>	6.0#
		48 x 4 1/2"	PPMTR48	<input type="checkbox"/>	6.0#
		54 x 4 1/2"	PPMTR54	<input type="checkbox"/>	7.0#
		60 x 4 1/2"	PPMTR60	<input type="checkbox"/>	7.0#
		72 x 4 1/2"	PPMTR72	<input type="checkbox"/>	8.0#
 HRDPT	<b>Plastic Paper Tray Unit</b> <ul style="list-style-type: none"> <li>Plastic construction</li> <li>Accepts letter and legal-size paper</li> <li>Suspends from Tool Rail</li> </ul>	2 x 9-1/2 x 14"	PPLL	<input type="checkbox"/>	1.0#
 HRDPT	<b>Plastic Diagonal Storage Unit</b> <ul style="list-style-type: none"> <li>Plastic construction</li> <li>Three slanted partitions per unit with dividers</li> <li>Suspends from Tool Rail</li> </ul>	2-1/2 x 7 x 12-1/2"	PPDS	<input type="checkbox"/>	4.0#
 HRDPT	<b>Plastic Vertical Storage Unit</b> <ul style="list-style-type: none"> <li>Injection-molded plastic construction</li> <li>Stores binders and books</li> <li>Suspends from Tool Rail</li> </ul>	9 x 5 x 10-1/2"	PPVS	<input type="checkbox"/>	1.0#

A

B

### HOW TO ORDER

Indicate the following information on order form:

- Quantity of each item.
- Model number, including options. See "How To Build a Model Number".
- Any special service required.

Note: • The  indicates that a choice is required.

- The absence of the  indicates that no choice is required.
- Alpha-numeric characters in place of  indicate that no other alternatives are available.

### HOW TO BUILD A MODEL NUMBER

**A** Select basic model.

**B** Select trim color.  
Refer to color addendum at [ki.com](http://ki.com) or KI Fabrics & Finishes binder.



Delivered  
Pricing

\$ 102

113

118

125

131

139

157

175

194

\$ 38

\$ 38

\$ 36

## SPECIAL SERVICES

### Special Carton Marking

With specially marked information N/C



### Shipping

Delivered. Shipped **k.d. freight prepaid f.o.b. Manitowoc, Wisconsin 54220** factory. Freight class #70.

Specifications and prices are subject to change without prior notice.

# Accessories

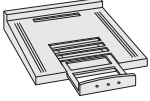
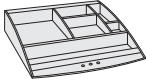
## Desktop Accessories

	MODEL	H x W x D	MODEL NUMBER		Approx. Packaged Weight
			Basic Model	Trim Color	
 HRDPT	<b>Telephone Caddy</b> • Plastic construction • Suspends from Tool Rail	2 x 8 1/2 x 9 1/2"	PPTC	<input type="checkbox"/>	0.8#
 HRDPT	<b>Accessory Tray</b> • Injection-molded plastic • Stores stamps, tape dispenser, post-it pads and paper clips • Suspends from Tool Rail	2 x 9 1/2 x 10"	PPAT	<input type="checkbox"/>	6.0#
 HRDPT	<b>Pencil Cup</b> • Injection-molded plastic • Suspends from Tool Rail	4 x 4 x 3 1/2"	PPPC	<input type="checkbox"/>	0.3#

A

B

### HOW TO ORDER

Indicate the following information on order form:

- Quantity of each item.
- Model number, including options. See "How To Build a Model Number".
- Any special service required.

Note: • The  indicates that a choice is required.

- The absence of the  indicates that no choice is required.
- Alpha-numeric characters in place of  indicate that no other alternatives are available.

### HOW TO BUILD A MODEL NUMBER

- A** Select basic model.
- B** Select trim color.  
Refer to color addendum at [ki.com](http://ki.com) or KI Fabrics & Finishes binder.





Delivered  
Pricing

\$ 46

\$ 32

\$ 32

### SPECIAL SERVICES

#### Special Carton Marking

With specially marked information N/C

#### Shipping

Delivered. Shipped **k.d. freight prepaid f.o.b. Manitowoc, Wisconsin 54220** factory. Freight class #70.

Specifications and prices are subject to change without prior notice.

# 120° Intersections

2-Way

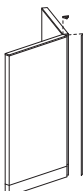
	MODEL	H	MODEL NUMBER				Approx. Packaged Weight	Delivered Pricing
			Basic Model	Trim Color	Upholstery Color	Assembly		
 PTN	<b>120° 2-Way, Both Panels Same Height</b>	30"	P1202W30			<input type="checkbox"/>	7.0#	\$ 286
	• Unupholstered: trim colored	36"	P1202W36	<input type="checkbox"/>		<input type="checkbox"/>	9.0#	303
	• 120° 2-way top cap	42"	P1202W42	<input type="checkbox"/>		<input type="checkbox"/>	10.0#	381
	• Light block	48"	P1202W48	<input type="checkbox"/>		<input type="checkbox"/>	12.0#	414
	• One piece of vertical trim extending to floor	54"	P1202W54	<input type="checkbox"/>		<input type="checkbox"/>	13.0#	419
	• Two half posts	66"	P1202W66	<input type="checkbox"/>		<input type="checkbox"/>	16.0#	428
	• Connecting hardware	72"	P1202W72	<input type="checkbox"/>		<input type="checkbox"/>	17.0#	543
	• SX Starlight Silver finish is only offered on flat aluminum trim	84"	P1202W84	<input type="checkbox"/>		<input type="checkbox"/>	20.0#	550
 PTNF	<b>120° 2-Way, Both Panels Same Height</b>	30"	P120F2W30	<input type="checkbox"/>	<input type="checkbox"/>	<input type="checkbox"/>	7.0#	N/A
	• Upholstered: trim colored	36"	P120F2W36	<input type="checkbox"/>	<input type="checkbox"/>	<input type="checkbox"/>	9.0#	N/A
	• 120° 2-way top cap	42"	P120F2W42	<input type="checkbox"/>	<input type="checkbox"/>	<input type="checkbox"/>	10.0#	N/A
	• Light block	48"	P120F2W48	<input type="checkbox"/>	<input type="checkbox"/>	<input type="checkbox"/>	12.0#	N/A
	• One piece of vertical trim extending to floor	54"	P120F2W54	<input type="checkbox"/>	<input type="checkbox"/>	<input type="checkbox"/>	13.0#	N/A
	• Two half posts	66"	P120F2W66	<input type="checkbox"/>	<input type="checkbox"/>	<input type="checkbox"/>	16.0#	N/A
	• Connecting hardware	72"	P120F2W72	<input type="checkbox"/>	<input type="checkbox"/>	<input type="checkbox"/>	17.0#	N/A
	• SX Starlight Silver finish is only offered on flat aluminum trim	84"	P120F2W84	<input type="checkbox"/>	<input type="checkbox"/>	<input type="checkbox"/>	20.0#	N/A

A

B

C

D

## HOW TO ORDER

Indicate the following information on order form:

- Quantity of each item.
- Model number, including options. See "How To Build a Model Number".
- Any special service required.

Note: • The  indicates that a choice is required.

- The absence of the  indicates that no choice is required.
- Alpha-numeric characters in place of  indicate that no other alternatives are available.

## HOW TO BUILD A MODEL NUMBER

- A** Select basic model.
- B** Select trim color.  
Refer to color addendum at ki.com or KI Fabrics & Finishes binder.  
Metallic paint requires upcharge.  
SX Starlight Silver finish is only offered on flat aluminum trim.
- C** Select upholstery color.  
Refer to color addendum at ki.com or in KI Fabrics & Finishes binder.
- D** Select assembly.
- |          |                             |
|----------|-----------------------------|
| <b>F</b> | - Fully Assembled; add \$58 |
| <b>U</b> | - Unassembled               |

## INFORMATION

### Fabric Disclaimer

Fabric will be applied as swatched by the fabric manufacturer. Fabric that is required to be applied differently than is swatched will need a Special Cost Request written specifying the direction the fabric is to be applied. The posted standard lead time will apply to the Special Cost Request.



# 120° Intersections

2-Way

Delivered Pricing Fabric Grade 1 & C.O.M.	Delivered Pricing Fabric Grade 2	Delivered Pricing Fabric Grade 3 & Pallas Vertical Fabric Grade PV	Delivered Pricing Pallas Vertical Fabric Grade PV1	Delivered Pricing Pallas Vertical Fabric Grade PV2	Metallic Paint add to list price
					\$ 29
					29
					36
					38
					38
					40
					40
					42
\$ 398	\$ 403	\$ 409	\$ 419	\$ 430	\$ 9
423	431	436	444	454	9
438	445	451	460	473	9
471	482	486	493	508	9
480	486	491	500	515	9
489	499	506	515	530	9
606	617	625	637	656	9
615	627	632	644	663	9

**SPECIAL SERVICES**

**Special Carton Marking**

With specially marked information N/C

**Shipping**

Delivered. Shipped **k.d. freight prepaid f.o.b. Manitowoc, Wisconsin 54220** factory. Freight class #70.

Specifications and prices are subject to change without prior notice.

# 120° Intersections

2-Way

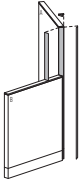
	MODEL	A x B	MODEL NUMBER		Approx. Packaged Weight
			Basic Model	Trim Color	
 <p>PTN</p>	<b>120° 2-Way, Two Different Heights</b>	36" 30"	P120V2W3036	<input type="checkbox"/>	9.0#
	• Unupholstered: trim colored	42" 30"	P120V2W3042	<input type="checkbox"/>	11.0#
	• 120° 1-way top cap	48" 30"	P120V2W3048	<input type="checkbox"/>	12.0#
	• Light block	54" 30"	P120V2W3054	<input type="checkbox"/>	13.0#
	• One piece of vertical trim extends to floor	66" 30"	P120V2W3066	<input type="checkbox"/>	15.0#
	• One piece of height change trim	72" 30"	P120V2W3072	<input type="checkbox"/>	16.0#
	• One half post A	84" 30"	P120V2W3084	<input type="checkbox"/>	20.0#
	• One half post B	42" 36"	P120V2W3642	<input type="checkbox"/>	9.0#
	• Connecting hardware	48" 36"	P120V2W3648	<input type="checkbox"/>	11.0#
	• SX Starlight Silver finish is only offered on flat aluminum trim	54" 36"	P120V2W3654	<input type="checkbox"/>	12.0#
		66" 36"	P120V2W3666	<input type="checkbox"/>	14.0#
		72" 36"	P120V2W3672	<input type="checkbox"/>	15.0#
		84" 36"	P120V2W3684	<input type="checkbox"/>	20.0#
		48" 42"	P120V2W4248	<input type="checkbox"/>	9.0#
		54" 42"	P120V2W4254	<input type="checkbox"/>	11.0#
		66" 42"	P120V2W4266	<input type="checkbox"/>	13.0#
		72" 42"	P120V2W4272	<input type="checkbox"/>	14.0#
		84" 42"	P120V2W4284	<input type="checkbox"/>	18.0#
		54" 48"	P120V2W4854	<input type="checkbox"/>	9.0#
		66" 48"	P120V2W4866	<input type="checkbox"/>	14.0#
		72" 48"	P120V2W4872	<input type="checkbox"/>	15.0#
		84" 48"	P120V2W4884	<input type="checkbox"/>	18.0#
		66" 54"	P120V2W5466	<input type="checkbox"/>	12.0#
		72" 54"	P120V2W5472	<input type="checkbox"/>	14.0#
		84" 54"	P120V2W5484	<input type="checkbox"/>	18.0#
		72" 66"	P120V2W6672	<input type="checkbox"/>	9.0#
	84" 66"	P120V2W6684	<input type="checkbox"/>	12.0#	
	84" 72"	P120V2W7284	<input type="checkbox"/>	11.0#	

A

B

## HOW TO ORDER

Indicate the following information on order form:

- Quantity of each item.
- Model number, including options. See "How To Build a Model Number".
- Any special service required.

Note: • The  indicates that a choice is required.

- The absence of the  indicates that no choice is required.
- Alpha-numeric characters in place of  indicate that no other alternatives are available.

## HOW TO BUILD A MODEL NUMBER

**A** Select basic model.

**B** Select trim color.

Refer to color addendum at [ki.com](http://ki.com) or KI Fabrics & Finishes binder. Metallic paint requires upcharge. SX Starlight Silver finish is only offered on flat aluminum trim.



# 120° Intersections

2-Way

Delivered Pricing	Metallic Paint add to list price
\$ 240	\$ 39
393	40
423	49
431	50
445	54
553	65
575	68
417	39
422	49
430	50
441	54
559	55
577	68
423	48
425	50
439	52
552	55
565	67
433	49
441	52
553	54
572	56
440	52
552	54
569	54
552	52
564	55
565	55

## SPECIAL SERVICES

### Special Carton Marking

With specially marked information N/C

### Shipping

Delivered. Shipped **k.d. freight prepaid f.o.b. Manitowoc, Wisconsin 54220** factory. Freight class #70.

Specifications and prices are subject to change without prior notice.

# 120° Intersections

2-Way

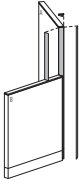
MODEL	A x B	MODEL NUMBER			Approx. Packaged Weight
		Basic Model	Trim Color	Upholstery Color	
 <p>PTNF</p> <p><b>120° 2-Way, Two Different Heights</b></p> <ul style="list-style-type: none"> <li>• Unupholstered: trim colored</li> <li>• 120° 1-way top cap</li> <li>• Light block</li> <li>• One piece of vertical trim extends to floor</li> <li>• One piece of height change trim</li> <li>• One half post A</li> <li>• One half post B</li> <li>• Connecting hardware</li> <li>• SX Starlight Silver finish is only offered on flat aluminum trim</li> </ul>	36" 30"	P120VF2W3036	<input type="checkbox"/>	<input type="checkbox"/>	9.0#
	42" 30"	P120VF2W3042	<input type="checkbox"/>	<input type="checkbox"/>	11.0#
	48" 30"	P120VF2W3048	<input type="checkbox"/>	<input type="checkbox"/>	12.0#
	54" 30"	P120VF2W3054	<input type="checkbox"/>	<input type="checkbox"/>	13.0#
	66" 30"	P120VF2W3066	<input type="checkbox"/>	<input type="checkbox"/>	15.0#
	72" 30"	P120VF2W3072	<input type="checkbox"/>	<input type="checkbox"/>	16.0#
	84" 30"	P120VF2W3084	<input type="checkbox"/>	<input type="checkbox"/>	20.0#
	42" 36"	P120VF2W3642	<input type="checkbox"/>	<input type="checkbox"/>	9.0#
	48" 36"	P120VF2W3648	<input type="checkbox"/>	<input type="checkbox"/>	11.0#
	54" 36"	P120VF2W3654	<input type="checkbox"/>	<input type="checkbox"/>	13.0#
	66" 36"	P120VF2W3666	<input type="checkbox"/>	<input type="checkbox"/>	15.0#
	72" 36"	P120VF2W3672	<input type="checkbox"/>	<input type="checkbox"/>	16.0#
	84" 36"	P120VF2W3684	<input type="checkbox"/>	<input type="checkbox"/>	20.0#
	48" 42"	P120VF2W4248	<input type="checkbox"/>	<input type="checkbox"/>	9.0#
	54" 42"	P120VF2W4254	<input type="checkbox"/>	<input type="checkbox"/>	11.0#
	66" 42"	P120VF2W4266	<input type="checkbox"/>	<input type="checkbox"/>	14.0#
	72" 42"	P120VF2W4272	<input type="checkbox"/>	<input type="checkbox"/>	15.0#
	84" 42"	P120VF2W4284	<input type="checkbox"/>	<input type="checkbox"/>	18.0#
	54" 48"	P120VF2W4854	<input type="checkbox"/>	<input type="checkbox"/>	9.0#
	66" 48"	P120VF2W4866	<input type="checkbox"/>	<input type="checkbox"/>	12.0#
	72" 48"	P120VF2W4872	<input type="checkbox"/>	<input type="checkbox"/>	14.0#
	84" 48"	P120VF2W4884	<input type="checkbox"/>	<input type="checkbox"/>	20.0#
	66" 54"	P120VF2W5466	<input type="checkbox"/>	<input type="checkbox"/>	11.0#
	72" 54"	P120VF2W5472	<input type="checkbox"/>	<input type="checkbox"/>	12.0#
	84" 54"	P120VF2W5484	<input type="checkbox"/>	<input type="checkbox"/>	18.0#
	72" 66"	P120VF2W6672	<input type="checkbox"/>	<input type="checkbox"/>	9.0#
	84" 66"	P120VF2W6684	<input type="checkbox"/>	<input type="checkbox"/>	16.0#
	84" 72"	P120VF2W7284	<input type="checkbox"/>	<input type="checkbox"/>	11.0#

A

B

C

## HOW TO ORDER

Indicate the following information on order form:

1. Quantity of each item.
2. Model number, including options. See "How To Build a Model Number".
3. Any special service required.

Note: • The  indicates that a choice is required.

- The absence of the  indicates that no choice is required.
- Alpha-numeric characters in place of  indicate that no other alternatives are available.

## HOW TO BUILD A MODEL NUMBER

- A** Select basic model.
- B** Select trim color.  
Refer to color addendum at [ki.com](http://ki.com) or KI Fabrics & Finishes binder.  
Metallic paint requires upcharge.  
SX Starlight Silver finish is only offered on flat aluminum trim.
- C** Select upholstery color.  
Refer to color addendum at [ki.com](http://ki.com) or in KI Fabrics & Finishes binder.

## INFORMATION

### Fabric Disclaimer

Fabric will be applied as swatched by the fabric manufacturer. Fabric that is required to be applied differently than is swatched will need a Special Cost Request written specifying the direction the fabric is to be applied. The posted standard lead time will apply to the Special Cost Request.



# 120° Intersections

2-Way

Delivered Pricing Fabric Grade 1 & C.O.M.	Delivered Pricing Fabric Grade 2	Delivered Pricing Fabric Grade 3 & Pallas Vertical Fabric Grade PV	Delivered Pricing Pallas Vertical Fabric Grade PV1	Delivered Pricing Pallas Vertical Fabric Grade PV2	Metallic Paint add to list price
\$ 424	\$ 432	\$ 437	\$ 445	\$ 456	\$ 9
512	523	528	538	552	9
539	550	556	569	581	9
543	553	560	572	588	9
569	577	584	595	612	9
682	694	701	715	737	9
702	717	723	740	758	9
516	526	531	541	557	9
542	551	558	571	586	9
546	557	565	574	592	9
560	573	578	590	608	9
681	693	700	714	734	9
706	720	726	741	759	9
543	552	559	572	587	9
546	557	565	574	592	9
557	570	575	586	603	9
672	685	694	706	724	9
692	702	712	723	747	9
552	565	572	580	597	9
564	574	579	592	609	9
673	686	695	708	726	9
723	741	747	758	782	9
567	576	581	593	610	9
675	688	696	709	728	9
686	701	708	720	742	9
680	692	699	713	733	9
683	698	703	716	740	9
691	701	710	722	745	9

## SPECIAL SERVICES

### Special Carton Marking

With specially marked information N/C

### Shipping

Delivered. Shipped **k.d. freight prepaid f.o.b. Manitowoc, Wisconsin 54220** factory. Freight class #70.

Specifications and prices are subject to change without prior notice.

# 120° Intersections

## 3-Way

MODEL	H	MODEL NUMBER			Approx. Packaged Weight
		Basic Model	Trim Color	Assembly	
 <p><b>120° 3-Way, All Panels Same Height</b></p> <ul style="list-style-type: none"> <li>• Unupholstered: trim colored</li> <li>• 120° 3-way top cap</li> <li>• Light block</li> <li>• Three half posts</li> <li>• Connecting hardware</li> <li>• SX Starlight Silver finish is only offered on flat aluminum trim</li> </ul>	30"	P1203W30	<input type="checkbox"/>	<input type="checkbox"/>	9.0#
	36"	P1203W36	<input type="checkbox"/>	<input type="checkbox"/>	11.0#
	42"	P1203W42	<input type="checkbox"/>	<input type="checkbox"/>	12.0#
	48"	P1203W48	<input type="checkbox"/>	<input type="checkbox"/>	13.0#
	54"	P1203W54	<input type="checkbox"/>	<input type="checkbox"/>	15.0#
	66"	P1203W66	<input type="checkbox"/>	<input type="checkbox"/>	18.0#
	72"	P1203W72	<input type="checkbox"/>	<input type="checkbox"/>	19.0#
	84"	P1203W84	<input type="checkbox"/>	<input type="checkbox"/>	22.0#

A

B

C

PTN

### HOW TO ORDER

Indicate the following information on order form:

1. Quantity of each item.
2. Model number, including options. See "How To Build a Model Number".
3. Any special service required.

Note: • The  indicates that a choice is required.

- The absence of the  indicates that no choice is required.
- Alpha-numeric characters in place of  indicate that no other alternatives are available.

### HOW TO BUILD A MODEL NUMBER

**A** Select basic model.

**B** Select trim color.  
Refer to color addendum at [ki.com](http://ki.com) or KI Fabrics & Finishes binder.  
Metallic paint requires upcharge.  
SX Starlight Silver finish is only offered on flat aluminum trim.

**C** Select assembly.

**F** - Fully Assembled; add \$74  
**U** - Unassembled





# 120° Intersections

3-Way

Delivered Pricing	Metallic Paint add to list price
\$ 296	\$ 9
310	9
390	9
414	9
423	9
436	9
537	9
547	9

## SPECIAL SERVICES

### Special Carton Marking

With specially marked information N/C

### Shipping

Delivered. Shipped **k.d. freight prepaid f.o.b. Manitowoc, Wisconsin 54220** factory. Freight class #70.

Specifications and prices are subject to change without prior notice.

# 120° Intersections

3-Way

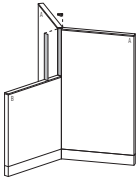
	MODEL	A x B	MODEL NUMBER		Approx. Packaged Weight
			Basic Model	Trim Color	
 <p>PTN</p>	<b>120° 3-Way, Two Different Heights</b>	36" 30"	P120V1203036	<input type="checkbox"/>	9.0#
	• Unupholstered: trim colored	42" 30"	P120V1203042	<input type="checkbox"/>	11.0#
	• 120° 3-way top cap	48" 30"	P120V1203048	<input type="checkbox"/>	12.0#
	• Light block	54" 30"	P120V1203054	<input type="checkbox"/>	13.0#
	• One piece of height change trim	66" 30"	P120V1203066	<input type="checkbox"/>	16.0#
	• Two half posts A	72" 30"	P120V1203072	<input type="checkbox"/>	17.0#
	• One half post B	84" 30"	P120V1203084	<input type="checkbox"/>	20.0#
	• Connecting hardware	42" 36"	P120V1203642	<input type="checkbox"/>	9.0#
	• SX Starlight Silver finish is only offered on flat aluminum trim	48" 36"	P120V1203648	<input type="checkbox"/>	11.0#
		54" 36"	P120V1203654	<input type="checkbox"/>	12.0#
		66" 36"	P120V1203666	<input type="checkbox"/>	15.0#
		72" 36"	P120V1203672	<input type="checkbox"/>	16.0#
		84" 36"	P120V1203684	<input type="checkbox"/>	20.0#
		48" 42"	P120V1204248	<input type="checkbox"/>	9.0#
		54" 42"	P120V1204254	<input type="checkbox"/>	11.0#
		66" 42"	P120V1204266	<input type="checkbox"/>	13.0#
		72" 42"	P120V1204272	<input type="checkbox"/>	15.0#
		84" 42"	P120V1204284	<input type="checkbox"/>	20.0#
		54" 48"	P120V1204854	<input type="checkbox"/>	9.0#
		66" 48"	P120V1204866	<input type="checkbox"/>	12.0#
		72" 48"	P120V1204872	<input type="checkbox"/>	15.0#
		84" 48"	P120V1204884	<input type="checkbox"/>	20.0#
		66" 54"	P120V1205466	<input type="checkbox"/>	11.0#
		72" 54"	P120V1205472	<input type="checkbox"/>	15.0#
		84" 54"	P120V1205484	<input type="checkbox"/>	20.0#
		72" 66"	P120V1206672	<input type="checkbox"/>	9.0#
		84" 66"	P120V1206684	<input type="checkbox"/>	12.0#
		84" 72"	P120V1207284	<input type="checkbox"/>	11.0#

A

B

## HOW TO ORDER

Indicate the following information on order form:

- Quantity of each item.
- Model number, including options. See "How To Build a Model Number".
- Any special service required.

Note: • The  indicates that a choice is required.

- The absence of the  indicates that no choice is required.
- Alpha-numeric characters in place of  indicate that no other alternatives are available.

## HOW TO BUILD A MODEL NUMBER

**A** Select basic model.

**B** Select trim color.

Refer to color addendum at [ki.com](http://ki.com) or KI Fabrics & Finishes binder. Metallic paint requires upcharge. SX Starlight Silver finish is only offered on flat aluminum trim.



# 120° Intersections

3-Way

Delivered Pricing	Metallic Paint add to list price
\$ 397	\$ 26
399	28
496	28
508	28
528	29
623	36
644	38
403	26
412	28
507	28
526	29
549	29
648	38
499	26
506	28
597	28
621	29
638	36
512	26
600	28
624	28
641	29
523	28
621	28
638	29
544	26
632	28
636	28

## SPECIAL SERVICES

### Special Carton Marking

With specially marked information N/C

### Shipping

Delivered. Shipped **k.d. freight prepaid f.o.b. Manitowoc, Wisconsin 54220** factory. Freight class #70.

Specifications and prices are subject to change without prior notice.

# 120° Intersections

3-Way

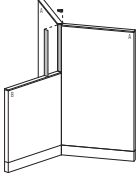
MODEL	A x B	MODEL NUMBER			Approx. Packaged Weight
		Basic Model	Trim Color	Upholstery Color	
 <p>PTNF</p> <p><b>120° 3-Way, Two Different Heights</b></p> <ul style="list-style-type: none"> <li>• Upholstered</li> <li>• 120° 2-way top cap</li> <li>• Light block</li> <li>• One piece of height change trim</li> <li>• Two half posts A</li> <li>• One half post B</li> <li>• Connecting hardware</li> <li>• SX Starlight Silver finish is only offered on flat aluminum trim</li> </ul>	36" 30"	P120VF1203036	<input type="checkbox"/>	<input type="checkbox"/>	9.0#
	42" 30"	P120VF1203042	<input type="checkbox"/>	<input type="checkbox"/>	11.0#
	48" 30"	P120VF1203048	<input type="checkbox"/>	<input type="checkbox"/>	12.0#
	54" 30"	P120VF1203054	<input type="checkbox"/>	<input type="checkbox"/>	13.0#
	66" 30"	P120VF1203066	<input type="checkbox"/>	<input type="checkbox"/>	15.0#
	72" 30"	P120VF1203072	<input type="checkbox"/>	<input type="checkbox"/>	16.0#
	84" 30"	P120VF1203084	<input type="checkbox"/>	<input type="checkbox"/>	20.0#
	42" 36"	P120VF1203642	<input type="checkbox"/>	<input type="checkbox"/>	9.0#
	48" 36"	P120VF1203648	<input type="checkbox"/>	<input type="checkbox"/>	10.0#
	54" 36"	P120VF1203654	<input type="checkbox"/>	<input type="checkbox"/>	11.0#
	66" 36"	P120VF1203666	<input type="checkbox"/>	<input type="checkbox"/>	13.0#
	72" 36"	P120VF1203672	<input type="checkbox"/>	<input type="checkbox"/>	14.0#
	84" 36"	P120VF1203684	<input type="checkbox"/>	<input type="checkbox"/>	18.0#
	48" 42"	P120VF1204248	<input type="checkbox"/>	<input type="checkbox"/>	9.0#
	54" 42"	P120VF1204254	<input type="checkbox"/>	<input type="checkbox"/>	11.0#
	66" 42"	P120VF1204266	<input type="checkbox"/>	<input type="checkbox"/>	13.0#
	72" 42"	P120VF1204272	<input type="checkbox"/>	<input type="checkbox"/>	14.0#
	84" 42"	P120VF1204284	<input type="checkbox"/>	<input type="checkbox"/>	18.0#
	54" 48"	P120VF1204854	<input type="checkbox"/>	<input type="checkbox"/>	9.0#
	66" 48"	P120VF1204866	<input type="checkbox"/>	<input type="checkbox"/>	12.0#
	72" 48"	P120VF1204872	<input type="checkbox"/>	<input type="checkbox"/>	14.0#
	84" 48"	P120VF1204884	<input type="checkbox"/>	<input type="checkbox"/>	18.0#
	66" 54"	P120VF1205466	<input type="checkbox"/>	<input type="checkbox"/>	11.0#
	72" 54"	P120VF1205472	<input type="checkbox"/>	<input type="checkbox"/>	12.0#
	84" 54"	P120VF1205484	<input type="checkbox"/>	<input type="checkbox"/>	16.0#
	72" 66"	P120VF1206672	<input type="checkbox"/>	<input type="checkbox"/>	9.0#
	84" 66"	P120VF1206684	<input type="checkbox"/>	<input type="checkbox"/>	11.0#
	84" 72"	P120VF1207284	<input type="checkbox"/>	<input type="checkbox"/>	11.0#

A

B

C

## HOW TO ORDER

Indicate the following information on order form:

1. Quantity of each item.
2. Model number, including options. See "How To Build a Model Number".
3. Any special service required.

Note: • The  indicates that a choice is required.

- The absence of the  indicates that no choice is required.
- Alpha-numeric characters in place of  indicate that no other alternatives are available.

## HOW TO BUILD A MODEL NUMBER

**A** Select basic model.

**B** Select trim color.  
Refer to color addendum at [ki.com](http://ki.com) or KI Fabrics & Finishes binder.  
Metallic paint requires upcharge.  
SX Starlight Silver finish is only offered on flat aluminum trim.

**C** Select upholstery color.  
Refer to color addendum at [ki.com](http://ki.com) or in KI Fabrics & Finishes binder.

## INFORMATION

### Fabric Disclaimer

Fabric will be applied as swatched by the fabric manufacturer. Fabric that is required to be applied differently than is swatched will need a Special Cost Request written specifying the direction the fabric is to be applied. The posted standard lead time will apply to the Special Cost Request.



# 120° Intersections

3-Way

Delivered Pricing Fabric Grade 1 & C.O.M.	Delivered Pricing Fabric Grade 2	Delivered Pricing Fabric Grade 3 & Pallas Vertical Fabric Grade PV	Delivered Pricing Pallas Vertical Fabric Grade PV1	Delivered Pricing Pallas Vertical Fabric Grade PV2	Metallic Paint add to list price
\$ 461	\$ 470	\$ 479	\$ 485	\$ 496	\$ 9
417	426	433	443	458	9
558	571	576	587	603	9
565	575	580	593	610	9
587	597	606	616	634	9
684	699	706	718	741	9
713	726	734	748	769	9
468	475	483	489	503	9
485	492	500	508	526	9
569	577	584	595	612	9
580	593	599	610	628	9
608	618	627	637	657	9
714	727	737	749	770	9
564	574	579	592	609	9
570	578	586	596	613	9
623	637	641	656	673	9
675	692	696	710	728	9
773	789	799	811	835	9
575	586	593	603	621	9
661	672	682	694	714	9
680	692	699	713	733	9
777	791	801	816	839	9
586	597	605	615	632	9
681	695	700	714	734	9
695	710	716	727	750	9
608	617	627	637	657	9
693	708	714	724	748	9
698	713	718	733	754	9

## SPECIAL SERVICES

### Special Carton Marking

With specially marked information N/C

### Shipping

Delivered. Shipped **k.d. freight prepaid f.o.b. Manitowoc, Wisconsin 54220** factory. Freight class #70.

Specifications and prices are subject to change without prior notice.

# 120° Intersections

3-Way

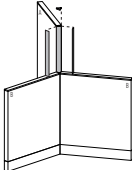
MODEL	A x B	MODEL NUMBER		Approx. Packaged Weight
		Basic Model	Trim Color	
 <p>PTN</p> <p><b>120° 3-Way, Two Different Heights</b></p> <ul style="list-style-type: none"> <li>• Upholstered: trim colored</li> <li>• 120° 1-way top cap</li> <li>• Light block</li> <li>• Two pieces of height change trim</li> <li>• One half post A</li> <li>• Two half posts B</li> <li>• Connecting hardware</li> <li>• SX Starlight Silver finish is only offered on flat aluminum trim</li> </ul>	36" 30"	P120V1W3036	<input type="checkbox"/>	9.0#
	42" 30"	P120V1W3042	<input type="checkbox"/>	10.0#
	48" 30"	P120V1W3048	<input type="checkbox"/>	11.0#
	54" 30"	P120V1W3054	<input type="checkbox"/>	12.0#
	66" 30"	P120V1W3066	<input type="checkbox"/>	15.0#
	72" 30"	P120V1W3072	<input type="checkbox"/>	16.0#
	84" 30"	P120V1W3084	<input type="checkbox"/>	20.0#
	42" 36"	P120V1W3642	<input type="checkbox"/>	9.0#
	48" 36"	P120V1W3648	<input type="checkbox"/>	11.0#
	54" 36"	P120V1W3654	<input type="checkbox"/>	12.0#
	66" 36"	P120V1W3666	<input type="checkbox"/>	15.0#
	72" 36"	P120V1W3672	<input type="checkbox"/>	16.0#
	84" 36"	P120V1W3684	<input type="checkbox"/>	20.0#
	48" 42"	P120V1W4248	<input type="checkbox"/>	9.0#
	54" 42"	P120V1W4254	<input type="checkbox"/>	11.0#
	66" 42"	P120V1W4266	<input type="checkbox"/>	14.0#
	72" 42"	P120V1W4272	<input type="checkbox"/>	16.0#
	84" 42"	P120V1W4284	<input type="checkbox"/>	20.0#
	54" 48"	P120V1W4854	<input type="checkbox"/>	9.0#
	66" 48"	P120V1W4866	<input type="checkbox"/>	12.0#
	72" 48"	P120V1W4872	<input type="checkbox"/>	14.0#
	84" 48"	P120V1W4884	<input type="checkbox"/>	18.0#
	66" 54"	P120V1W5466	<input type="checkbox"/>	11.0#
	72" 54"	P120V1W5472	<input type="checkbox"/>	12.0#
	84" 54"	P120V1W5484	<input type="checkbox"/>	16.0#
	72" 66"	P120V1W6672	<input type="checkbox"/>	9.0#
	84" 66"	P120V1W6684	<input type="checkbox"/>	12.0#
	84" 72"	P120V1W7284	<input type="checkbox"/>	11.0#

A

B

## HOW TO ORDER

Indicate the following information on order form:

1. Quantity of each item.
2. Model number, including options. See "How To Build a Model Number".
3. Any special service required.

Note: • The  indicates that a choice is required.

- The absence of the  indicates that no choice is required.
- Alpha-numeric characters in place of  indicate that no other alternatives are available.

## HOW TO BUILD A MODEL NUMBER

**A** Select basic model.

**B** Select trim color.

Refer to color addendum at [ki.com](http://ki.com) or KI Fabrics & Finishes binder. Metallic paint requires upcharge. SX Starlight Silver finish is only offered on flat aluminum trim.



# 120° Intersections

3-Way

Delivered Pricing	Metallic Paint add to list price
\$ 412	\$ 36
412	39
508	39
521	39
546	41
632	59
667	64
420	36
432	39
519	39
539	41
569	41
673	64
511	36
512	39
611	39
630	41
650	59
527	36
615	39
637	39
663	41
537	39
631	39
655	41
557	36
642	39
650	39

## SPECIAL SERVICES

### Special Carton Marking

With specially marked information N/C

### Shipping

Delivered. Shipped **k.d. freight prepaid f.o.b. Manitowoc, Wisconsin 54220** factory. Freight class #70.

Specifications and prices are subject to change without prior notice.

# 120° Intersections

3-Way

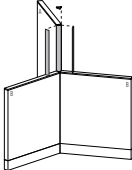
MODEL	A x B	MODEL NUMBER			Approx. Packaged Weight
		Basic Model	Trim Color	Upholstery Color	
 <p>PTNF</p> <p><b>120° 3-Way, Two Different Heights</b></p> <ul style="list-style-type: none"> <li>• Upholstered</li> <li>• 120° 1-way top cap</li> <li>• Light block</li> <li>• Two pieces of height change trim</li> <li>• One half post A</li> <li>• Two half posts B</li> <li>• Connecting hardware</li> <li>• SX Starlight Silver finish is only offered on flat aluminum trim</li> </ul>	36" 30"	P120VF1W3036	<input type="checkbox"/>	<input type="checkbox"/>	9.0#
	42" 30"	P120VF1W3042	<input type="checkbox"/>	<input type="checkbox"/>	12.0#
	48" 30"	P120VF1W3048	<input type="checkbox"/>	<input type="checkbox"/>	14.0#
	54" 30"	P120VF1W3054	<input type="checkbox"/>	<input type="checkbox"/>	16.0#
	66" 30"	P120VF1W3066	<input type="checkbox"/>	<input type="checkbox"/>	20.0#
	72" 30"	P120VF1W3072	<input type="checkbox"/>	<input type="checkbox"/>	22.0#
	84" 30"	P120VF1W3084	<input type="checkbox"/>	<input type="checkbox"/>	26.0#
	42" 36"	P120VF1W3642	<input type="checkbox"/>	<input type="checkbox"/>	9.0#
	48" 36"	P120VF1W3648	<input type="checkbox"/>	<input type="checkbox"/>	12.0#
	54" 36"	P120VF1W3654	<input type="checkbox"/>	<input type="checkbox"/>	14.0#
	66" 36"	P120VF1W3666	<input type="checkbox"/>	<input type="checkbox"/>	18.0#
	72" 36"	P120VF1W3672	<input type="checkbox"/>	<input type="checkbox"/>	20.0#
	84" 36"	P120VF1W3684	<input type="checkbox"/>	<input type="checkbox"/>	24.0#
	48" 42"	P120VF1W4248	<input type="checkbox"/>	<input type="checkbox"/>	9.0#
	54" 42"	P120VF1W4254	<input type="checkbox"/>	<input type="checkbox"/>	12.0#
	66" 42"	P120VF1W4266	<input type="checkbox"/>	<input type="checkbox"/>	16.0#
	72" 42"	P120VF1W4272	<input type="checkbox"/>	<input type="checkbox"/>	18.0#
	84" 42"	P120VF1W4284	<input type="checkbox"/>	<input type="checkbox"/>	22.0#
	54" 48"	P120VF1W4854	<input type="checkbox"/>	<input type="checkbox"/>	9.0#
	66" 48"	P120VF1W4866	<input type="checkbox"/>	<input type="checkbox"/>	14.0#
	72" 48"	P120VF1W4872	<input type="checkbox"/>	<input type="checkbox"/>	16.0#
	84" 48"	P120VF1W4884	<input type="checkbox"/>	<input type="checkbox"/>	20.0#
	66" 54"	P120VF1W5466	<input type="checkbox"/>	<input type="checkbox"/>	12.0#
	72" 54"	P120VF1W5472	<input type="checkbox"/>	<input type="checkbox"/>	14.0#
	84" 54"	P120VF1W5484	<input type="checkbox"/>	<input type="checkbox"/>	18.0#
	72" 66"	P120VF1W6672	<input type="checkbox"/>	<input type="checkbox"/>	9.0#
	84" 66"	P120VF1W6684	<input type="checkbox"/>	<input type="checkbox"/>	14.0#
	84" 72"	P120VF1W7284	<input type="checkbox"/>	<input type="checkbox"/>	12.0#

A

B

C

## HOW TO ORDER

Indicate the following information on order form:

1. Quantity of each item.
2. Model number, including options. See "How To Build a Model Number".
3. Any special service required.

Note: • The  indicates that a choice is required.

- The absence of the  indicates that no choice is required.
- Alpha-numeric characters in place of  indicate that no other alternatives are available.

## HOW TO BUILD A MODEL NUMBER

- A** Select basic model.
- B** Select trim color.  
Refer to color addendum at [ki.com](http://ki.com) or KI Fabrics & Finishes binder.  
Metallic paint requires upcharge.  
SX Starlight Silver finish is only offered on flat aluminum trim.
- C** Select upholstery color.  
Refer to color addendum at [ki.com](http://ki.com) or in KI Fabrics & Finishes binder.

## INFORMATION

### Fabric Disclaimer

Fabric will be applied as swatched by the fabric manufacturer. Fabric that is required to be applied differently than is swatched will need a Special Cost Request written specifying the direction the fabric is to be applied. The posted standard lead time will apply to the Special Cost Request.





# 120° Intersections

3-Way

Delivered Pricing Fabric Grade 1 & C.O.M.	Delivered Pricing Fabric Grade 2	Delivered Pricing Fabric Grade 3 & Pallas Vertical Fabric Grade PV	Delivered Pricing Pallas Vertical Fabric Grade PV1	Delivered Pricing Pallas Vertical Fabric Grade PV2	Metallic Paint add to list price
\$ 456	\$ 467	\$ 470	\$ 482	\$ 491	\$ 9
456	468	473	483	492	9
543	553	560	573	588	9
547	558	567	575	593	9
569	577	584	595	612	9
658	671	677	691	710	9
715	726	737	747	769	9
464	474	481	488	500	9
475	485	489	499	512	9
552	565	572	580	597	9
565	574	579	592	609	9
661	672	682	694	714	9
686	699	708	720	742	9
553	565	572	580	599	9
557	570	575	586	603	9
638	651	659	670	691	9
657	667	673	688	708	9
672	685	694	706	726	9
572	580	588	599	616	9
652	663	670	683	702	9
679	685	685	698	717	9
682	696	702	715	737	9
579	592	597	609	628	9
667	683	691	701	721	9
680	692	699	713	733	9
600	611	618	630	650	9
681	693	700	714	734	9
694	709	715	726	749	9

## SPECIAL SERVICES

### Special Carton Marking

With specially marked information N/C



### Shipping

Delivered. Shipped **k.d. freight prepaid f.o.b. Manitowoc, Wisconsin 54220** factory. Freight class #70.

Specifications and prices are subject to change without prior notice.

# 120° Intersections

2-Way and 3-Way Stackable

	MODEL	H	MODEL NUMBER			Approx. Packaged Weight	Delivered Pricing
			Basic Model	Trim Color	Upholstery Color		
	<b>2-Way Stackable</b> • Upholstered: trim color • One piece of stackable vertical trim • Two stackable half-posts • One 120° corner connector block • Use top cap from existing lower panel • SX Starlight Silver finish is only offered on flat aluminum trim	12"	PS1202W12	<input type="checkbox"/>		5.0#	\$ 278
		18"	PS1202W18	<input type="checkbox"/>		6.0#	368
		24"	PS1202W24	<input type="checkbox"/>		7.0#	384
PST							
	<b>2-Way Stackable</b> • Upholstered • One piece of stackable vertical trim • Two stackable half-posts • One 120° corner connector block • Use top cap from existing lower panel • SX Starlight Silver finish is only offered on flat aluminum trim	12"	PS120F2W12	<input type="checkbox"/>	<input type="checkbox"/> <input type="checkbox"/> <input type="checkbox"/> <input type="checkbox"/>	5.0#	N/A
		18"	PS120F2W18	<input type="checkbox"/>	<input type="checkbox"/> <input type="checkbox"/> <input type="checkbox"/> <input type="checkbox"/>	6.0#	N/A
		24"	PS120F2W24	<input type="checkbox"/>	<input type="checkbox"/> <input type="checkbox"/> <input type="checkbox"/> <input type="checkbox"/>	7.0#	N/A
PSTF							
	<b>3-Way Stackable</b> • Upholstered • Three stackable half-posts • One 120° corner connector block • Use top cap from existing lower panel • SX Starlight Silver finish is only offered on flat aluminum trim	12"	PS1203W12	<input type="checkbox"/>		7.0#	\$ 348
		18"	PS1203W18	<input type="checkbox"/>		8.0#	443
		24"	PS1203W24	<input type="checkbox"/>		9.0#	453
PST							

A

B

C

## HOW TO ORDER

Indicate the following information on order form:

- Quantity of each item.
- Model number, including options. See "How To Build a Model Number".
- Any special service required.

Note:

- The  indicates that a choice is required.
- The absence of the  indicates that no choice is required.
- Alpha-numeric characters in place of  indicate that no other alternatives are available.

## HOW TO BUILD A MODEL NUMBER

- A** Select basic model.
- B** Select trim color.  
Refer to color addendum at [ki.com](http://ki.com) or KI Fabrics & Finishes binder.  
Metallic paint requires upcharge.  
SX Starlight Silver finish is only offered on flat aluminum trim.
- C** Select upholstery color.  
Refer to color addendum at [ki.com](http://ki.com) or in KI Fabrics & Finishes binder.

## INFORMATION

### Fabric Disclaimer

Fabric will be applied as swatched by the fabric manufacturer. Fabric that is required to be applied differently than is swatched will need a Special Cost Request written specifying the direction the fabric is to be applied. The posted standard lead time will apply to the Special Cost Request.



# 120° Worksurfaces

## Corner Worksurfaces

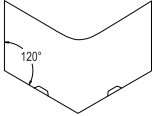
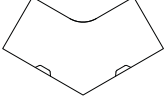
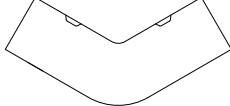
MODEL	MODEL NUMBER								Approx. Packaged Weight
	Basic Model	Edge Style	Surface Finish	Trim Color	Wood Edge Color	Veneer Color	Edge Color	Grommet Color	
 <p><b>Inside Corner Worksurface with 120° Ends</b></p> <ul style="list-style-type: none"> <li>Includes mounting hardware</li> <li>Left hand cantilever is provided for rear corner</li> <li>Includes two 2-1/2" x 6" grommets</li> </ul>	PW120243624	<input type="checkbox"/>	<input type="checkbox"/>	<input type="checkbox"/>	<input type="checkbox"/>	<input type="checkbox"/>	<input type="checkbox"/>	<input type="checkbox"/>	44.0#
	PW120244224	<input type="checkbox"/>	<input type="checkbox"/>	<input type="checkbox"/>	<input type="checkbox"/>	<input type="checkbox"/>	<input type="checkbox"/>	<input type="checkbox"/>	53.0#
	PW120244824	<input type="checkbox"/>	<input type="checkbox"/>	<input type="checkbox"/>	<input type="checkbox"/>	<input type="checkbox"/>	<input type="checkbox"/>	<input type="checkbox"/>	62.0#
	PW120303630	<input type="checkbox"/>	<input type="checkbox"/>	<input type="checkbox"/>	<input type="checkbox"/>	<input type="checkbox"/>	<input type="checkbox"/>	<input type="checkbox"/>	65.0#
	PW120304230	<input type="checkbox"/>	<input type="checkbox"/>	<input type="checkbox"/>	<input type="checkbox"/>	<input type="checkbox"/>	<input type="checkbox"/>	<input type="checkbox"/>	67.0#
	PW120304830	<input type="checkbox"/>	<input type="checkbox"/>	<input type="checkbox"/>	<input type="checkbox"/>	<input type="checkbox"/>	<input type="checkbox"/>	<input type="checkbox"/>	76.0#
 <p><b>Inside Corner Worksurface with 90° Ends</b></p>	PWIC120243624	<input type="checkbox"/>	<input type="checkbox"/>	<input type="checkbox"/>	<input type="checkbox"/>	<input type="checkbox"/>	<input type="checkbox"/>	<input type="checkbox"/>	44.0#
	PWIC120244224	<input type="checkbox"/>	<input type="checkbox"/>	<input type="checkbox"/>	<input type="checkbox"/>	<input type="checkbox"/>	<input type="checkbox"/>	<input type="checkbox"/>	53.0#
	PWIC120244824	<input type="checkbox"/>	<input type="checkbox"/>	<input type="checkbox"/>	<input type="checkbox"/>	<input type="checkbox"/>	<input type="checkbox"/>	<input type="checkbox"/>	62.0#
	PWIC120303630	<input type="checkbox"/>	<input type="checkbox"/>	<input type="checkbox"/>	<input type="checkbox"/>	<input type="checkbox"/>	<input type="checkbox"/>	<input type="checkbox"/>	65.0#
	PWIC120304230	<input type="checkbox"/>	<input type="checkbox"/>	<input type="checkbox"/>	<input type="checkbox"/>	<input type="checkbox"/>	<input type="checkbox"/>	<input type="checkbox"/>	67.0#
	PWIC120304830	<input type="checkbox"/>	<input type="checkbox"/>	<input type="checkbox"/>	<input type="checkbox"/>	<input type="checkbox"/>	<input type="checkbox"/>	<input type="checkbox"/>	70.0#
 <p><b>Outside Corner Worksurface with 90° Ends</b></p>	PWOC120243624	<input type="checkbox"/>	<input type="checkbox"/>	<input type="checkbox"/>	<input type="checkbox"/>	<input type="checkbox"/>	<input type="checkbox"/>	<input type="checkbox"/>	44.0#
	PWOC120244224	<input type="checkbox"/>	<input type="checkbox"/>	<input type="checkbox"/>	<input type="checkbox"/>	<input type="checkbox"/>	<input type="checkbox"/>	<input type="checkbox"/>	53.0#
	PWOC120244824	<input type="checkbox"/>	<input type="checkbox"/>	<input type="checkbox"/>	<input type="checkbox"/>	<input type="checkbox"/>	<input type="checkbox"/>	<input type="checkbox"/>	62.0#
	PWOC120303630	<input type="checkbox"/>	<input type="checkbox"/>	<input type="checkbox"/>	<input type="checkbox"/>	<input type="checkbox"/>	<input type="checkbox"/>	<input type="checkbox"/>	65.0#
	PWOC120304230	<input type="checkbox"/>	<input type="checkbox"/>	<input type="checkbox"/>	<input type="checkbox"/>	<input type="checkbox"/>	<input type="checkbox"/>	<input type="checkbox"/>	67.0#
	PWOC120304830	<input type="checkbox"/>	<input type="checkbox"/>	<input type="checkbox"/>	<input type="checkbox"/>	<input type="checkbox"/>	<input type="checkbox"/>	<input type="checkbox"/>	76.0#

A

B

C

D

E

F

G

H

### HOW TO ORDER

Indicate the following information on order form:

- Quantity of each item.
- Model number, including options. See "How To Build a Model Number".
- Any special service required.

Note: • The  indicates that a choice is required.

- The absence of the  indicates that no choice is required.
- Alpha-numeric characters in place of  indicate that no other alternatives are available.

### HOW TO BUILD A MODEL NUMBER

**A** Select basic model.

**B** Select edge style.

**74P** - 74P edge  
**KN** - Knife edge  
**WE** - Wood edge, laminate surface  
**WV** - Wood edge, veneer surface

**C** Select surface finish.

Refer to color addendum at ki.com or KI Fabrics & Finishes binder.  
 Surface finish offerings are based on edge style selections.

**D** Select trim color.

Refer to color addendum at ki.com or KI Fabrics & Finishes binder.

**E** Select wood edge color.

Refer to color addendum at ki.com or KI Fabrics & Finishes binder.

**F** Select wood veneer color.

Refer to color addendum at ki.com or KI Fabrics & Finishes binder.

**G** Select edge color.

Refer to color addendum at ki.com or KI Fabrics & Finishes binder.

**H** Select grommet color.

Refer to color addendum at ki.com or KI Fabrics & Finishes binder.

### FINISH INFORMATION

#### Additional Laminate Offering

Additional laminates beyond KI standard offering, are available with two weeks extended leadtime. To specify additional laminates, use these designators followed by the supplier's color/pattern code:

Formica - LF/supplier's color pattern code  
 Nevamar - LN/supplier's color pattern code  
 Wilsonart - LW/supplier's color pattern code

KI's standard finish is the supplier's recommended finish for that color/pattern.

Note: Nonstandard laminates from these suppliers (example: textured laminates), require an upcharge and additional leadtime. Contact KI.



# 120° Worksurfaces

Corner Worksurfaces

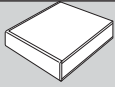

74P Edge  
(74P)

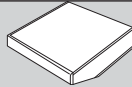

Knife Edge  
(KN)

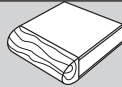

Wood Edge Laminate  
(WE)

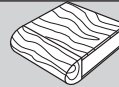

Wood Edge Veneer  
(WV)

\$ 809	\$ 899	\$ 1246	\$ 2634
856	932	1317	3131
973	1023	1481	3722
835	917	1284	2736
925	974	1383	3326
1107	1183	1614	3921
\$ 809	\$ 899	\$ 1246	\$ 1829
856	932	1317	1891
973	1023	1481	1919
835	917	1284	1945
925	974	1383	1978
1107	1183	1614	1988
\$ 809	\$ 899	\$ 1299	\$ 2261
856	932	1371	2309
973	1023	1534	2331
835	917	1337	2366
925	974	1558	2392
1107	1183	1682	2432

## SPECIAL SERVICES

### Special Carton Marking

With specially marked information N/C

### Shipping

Delivered. Shipped **k.d. freight prepaid**  
**f.o.b. Manitowoc, Wisconsin 54220**  
factory. Freight class #70.

Specifications and prices are subject to  
change without prior notice.

# 120° Build Your Own

## Components

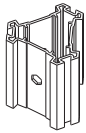
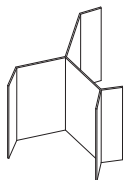
	MODEL	H	MODEL NUMBER		Approx. Packaged Weight
				Basic Model	
	<b>120° Connector Block</b> • Black only • Extruded aluminum block with three threaded inserts		46.0955		1.0#
HRDPT					
	<b>120° Light Block</b>	12"	46.1037.12		1.0#
		18"	46.1037.18		1.0#
		24"	46.1037.24		1.0#
		30"	46.1037.30		1.0#
		36"	46.1037.36		1.0#
		42"	46.1037.42		1.0#
		48"	46.1037.48		1.0#
		54"	46.1037.54		1.0#
		60"	46.1037.60		1.0#
		66"	46.1037.66		1.0#
		72"	46.1037.72		1.0#
		78"	46.1037.78		1.0#
84"	46.1037.84		1.0#		

**A**

### HOW TO ORDER

Indicate the following information on order form:

1. Quantity of each item.
2. Model number, including options. See "How To Build a Model Number".
3. Any special service required.

Note: • The  indicates that a choice is required.

- The absence of the  indicates that no choice is required.
- Alpha-numeric characters in place of  indicate that no other alternatives are available.

### HOW TO BUILD A MODEL NUMBER

**A** Select basic model.



# 120° Build Your Own

Components

Delivered  
Pricing

\$ 20

\$ 6  
6  
6  
7  
10  
10  
15  
15  
15  
15  
21  
21  
21

## SPECIAL SERVICES

### Special Carton Marking

With specially marked information N/C





### Shipping

Delivered. Shipped **k.d. freight prepaid**  
**f.o.b. Manitowoc, Wisconsin 54220**  
factory. Freight class #70.

Specifications and prices are subject to  
change without prior notice.

# 120° Build Your Own

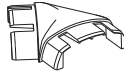
## Components

	MODEL	H	MODEL NUMBER		Approx. Packaged Weight
			Basic Model	Trim Color	
 HRDPT	120° Vertical Trim	30"	46.1032.30	<input type="checkbox"/>	1.0#
		36"	46.1032.36	<input type="checkbox"/>	1.0#
		42"	46.1032.42	<input type="checkbox"/>	1.0#
		48"	46.1032.48	<input type="checkbox"/>	1.0#
		54"	46.1032.54	<input type="checkbox"/>	2.0#
		60"	46.1032.60	<input type="checkbox"/>	2.0#
		66"	46.1032.66	<input type="checkbox"/>	2.0#
		72"	46.1032.72	<input type="checkbox"/>	2.0#
		84"	46.1032.84	<input type="checkbox"/>	2.0#
 HRDPT	120° 1-Way Top Cap		46.1027	<input type="checkbox"/>	1.0#
 HRDPT	120° 2-Way Top Cap		46.1028	<input type="checkbox"/>	1.0#
 HRDPT	120° 3-Way Top Cap		46.1029	<input type="checkbox"/>	1.0#

**A**

**B**

### HOW TO ORDER

Indicate the following information on order form:

- Quantity of each item.
- Model number, including options. See "How To Build a Model Number".
- Any special service required.

Note: • The  indicates that a choice is required.

- The absence of the  indicates that no choice is required.
- Alpha-numeric characters in place of  indicate that no other alternatives are available.

### HOW TO BUILD A MODEL NUMBER

**A** Select basic model.

**B** Select trim color.

Refer to color addendum at [ki.com](http://ki.com) or KI Fabrics & Finishes binder. Metallic paint requires upcharge.





# 120° Build Your Own

Components

Delivered Pricing	Metallic Paint add to list price
\$ 31	\$ 12
37	12
37	26
55	28
55	28
55	28
55	30
79	30
85	32
\$ 10	\$ 9
\$ 10	N/A
\$ 10	N/A

**SPECIAL SERVICES**

**Special Carton Marking**

With specially marked information N/C

**Shipping**

Delivered. Shipped **k.d. freight prepaid f.o.b. Manitowoc, Wisconsin 54220** factory. Freight class #70.

Specifications and prices are subject to change without prior notice.

# Tech Preconfigured Intersection Conditions

90° 2-Way and End-of-Run

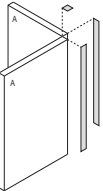
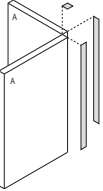
	MODEL	H	MODEL NUMBER			Approx. Packaged Weight	Delivered Pricing Unupholstered
			Basic Model	Trim Color	Fabric Color		
 <p>TECN</p>	<b>End-of-Run Condition</b>	30"	TEP/30	<input type="checkbox"/>		5.0#	\$ 62
	<ul style="list-style-type: none"> <li>• Unupholstered: trim colored</li> <li>• End-of-run trim (Tech)</li> <li>• Top cap</li> <li>• One full post</li> <li>• End-of-run base tile hooks</li> <li>• SX Starlight Silver finish is only offered on flat aluminum trim</li> </ul>	36"	TEP/36	<input type="checkbox"/>		5.0#	77
		42"	TEP/42	<input type="checkbox"/>		7.0#	78
		48"	TEP/48	<input type="checkbox"/>		8.0#	93
		54"	TEP/54	<input type="checkbox"/>		9.0#	94
		60"	TEP/60	<input type="checkbox"/>		10.0#	100
		66"	TEP/66	<input type="checkbox"/>		11.0#	119
		72"	TEP/72	<input type="checkbox"/>		11.0#	123
		78"	TEP/78	<input type="checkbox"/>		12.0#	126
		84"	TEP/84	<input type="checkbox"/>		13.0#	132
 <p>TECN</p>	<b>90° 2-Way "L" Corner, Both Panels Same Height</b>	30"	TCP90/30	<input type="checkbox"/>		9.0#	\$ 162
	<ul style="list-style-type: none"> <li>• Unupholstered: trim colored</li> <li>• 90° top cap</li> <li>• Two pieces of universal trim (Tech)</li> <li>• Two half-posts</li> <li>• Two sets of half post base tile hooks</li> <li>• Connecting hardware</li> <li>• SX Starlight Silver finish is only offered on flat aluminum trim</li> </ul>	36"	TCP90/36	<input type="checkbox"/>		9.0#	178
		42"	TCP90/42	<input type="checkbox"/>		11.0#	205
		48"	TCP90/48	<input type="checkbox"/>		12.0#	228
		54"	TCP90/54	<input type="checkbox"/>		13.0#	233
		60"	TCP90/60	<input type="checkbox"/>		15.0#	237
		66"	TCP90/66	<input type="checkbox"/>		16.0#	253
		72"	TCP90/72	<input type="checkbox"/>		16.0#	272
		78"	TCP90/78	<input type="checkbox"/>		16.0#	289
		84"	TCP90/84	<input type="checkbox"/>		16.0#	312
 <p>TEF2</p>	<b>90° 2-Way "L" Corner, Both Panels Same Height</b>	30"	TCPF90/30	<input type="checkbox"/>	<input type="checkbox"/> <input type="checkbox"/> <input type="checkbox"/> <input type="checkbox"/>	7.0#	N/A
	<ul style="list-style-type: none"> <li>• Upholstered</li> <li>• 90° top cap</li> <li>• Two pieces of universal trim</li> <li>• Two half-posts</li> <li>• Two sets of half post base tile hooks</li> <li>• Connecting hardware</li> <li>• SX Starlight Silver finish is only offered on flat aluminum trim</li> </ul>	36"	TCPF90/36	<input type="checkbox"/>	<input type="checkbox"/> <input type="checkbox"/> <input type="checkbox"/> <input type="checkbox"/>	7.0#	N/A
		42"	TCPF90/42	<input type="checkbox"/>	<input type="checkbox"/> <input type="checkbox"/> <input type="checkbox"/> <input type="checkbox"/>	10.0#	N/A
		48"	TCPF90/48	<input type="checkbox"/>	<input type="checkbox"/> <input type="checkbox"/> <input type="checkbox"/> <input type="checkbox"/>	11.0#	N/A
		54"	TCPF90/54	<input type="checkbox"/>	<input type="checkbox"/> <input type="checkbox"/> <input type="checkbox"/> <input type="checkbox"/>	13.0#	N/A
		60"	TCPF90/60	<input type="checkbox"/>	<input type="checkbox"/> <input type="checkbox"/> <input type="checkbox"/> <input type="checkbox"/>	14.0#	N/A
		66"	TCPF90/66	<input type="checkbox"/>	<input type="checkbox"/> <input type="checkbox"/> <input type="checkbox"/> <input type="checkbox"/>	16.0#	N/A
		72"	TCPF90/72	<input type="checkbox"/>	<input type="checkbox"/> <input type="checkbox"/> <input type="checkbox"/> <input type="checkbox"/>	16.0#	N/A
		78"	TCPF90/78	<input type="checkbox"/>	<input type="checkbox"/> <input type="checkbox"/> <input type="checkbox"/> <input type="checkbox"/>	16.0#	N/A
		84"	TCPF90/84	<input type="checkbox"/>	<input type="checkbox"/> <input type="checkbox"/> <input type="checkbox"/> <input type="checkbox"/>	16.0#	N/A

A

B

C

## HOW TO ORDER

Indicate the following information on order form:

1. Quantity of each item.
2. Model number, including options. See "How To Build a Model Number".
3. Any special service required.

Note: • The  indicates that a choice is required.

- The absence of the  indicates that no choice is required.
- Alpha-numeric characters in place of  indicate that no other alternatives are available.

## HOW TO BUILD A MODEL NUMBER

- A** Select basic model.
- B** Select trim color.  
Refer to color addendum at [ki.com](http://ki.com) or KI Fabrics & Finishes binder.  
Metallic paint requires upcharge.  
SX Starlight Silver finish is only offered on flat aluminum trim.
- C** Select fabric color.  
Refer to color addendum at [ki.com](http://ki.com) or in KI Fabrics & Finishes binder.

## INFORMATION

### Fabric Disclaimer

Fabric will be applied as swatched by the fabric manufacturer. Fabric that is required to be applied differently than is swatched will need a Special Cost Request written specifying the direction the fabric is to be applied. The posted standard lead time will apply to the Special Cost Request.



# Tech Preconfigured Intersection Conditions

90° 2-Way and End-of-Run

Delivered Pricing Fabric Grade 1 & C.O.M.	Delivered Pricing Fabric Grade 2	Delivered Pricing Fabric Grade 3 & Pallas Vertical Fabric Grade PV	Delivered Pricing Pallas Vertical Fabric Grade PV1	Delivered Pricing Pallas Vertical Fabric Grade PV2	Metallic Paint add to list price
					\$ 28
					29
					33
					34
					36
					39
					44
					44
					44
					46
					\$ 41
					42
					42
					65
					67
					69
					71
					73
					73
					74
\$ 227	\$ 231	\$ 232	\$ 235	\$ 245	\$ 32
241	248	251	256	262	35
272	276	278	288	296	39
302	307	310	317	323	42
310	314	317	323	327	42
316	320	322	333	342	44
330	337	340	348	357	47
356	363	365	374	385	49
369	379	381	390	400	56
430	437	441	451	464	62

**SPECIAL SERVICES**

**Special Carton Marking**

With specially marked information N/C

**Shipping**

Shipped **k.d. freight prepaid f.o.b. Manitowoc, Wisconsin 54220** factory. Freight class #70.

Specifications and prices are subject to change without prior notice.

# Tech Preconfigured Intersection Conditions

90° 2-Way

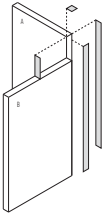
	MODEL	A	B	A-B	MODEL NUMBER		Approx. Packaged Weight
					Basic Model	Trim Color	
 <p>TECN</p> <p><b>90° 2-Way "L" Corner, Two Different Heights</b></p> <ul style="list-style-type: none"> <li>• Unupholstered</li> <li>• 1-way top cap</li> <li>• Two pieces of universal trim (Tech)</li> <li>• One piece of universal height change trim</li> <li>• One half-post (height A)</li> <li>• One half-post (height B)</li> <li>• Two sets of half post base tile hooks</li> <li>• Connecting hardware</li> <li>• SX Starlight Silver finish is only offered on flat aluminum trim</li> </ul>	30° 30° 6"	TCPV90/3036	<input type="checkbox"/>	9.0#			
	42° 30° 12"	TCPV90/3042	<input type="checkbox"/>	9.0#			
	48° 30° 18"	TCPV90/3048	<input type="checkbox"/>	9.0#			
	54° 30° 24"	TCPV90/3054	<input type="checkbox"/>	11.0#			
	60° 30° 30"	TCPV90/3060	<input type="checkbox"/>	11.0#			
	66° 30° 36"	TCPV90/3066	<input type="checkbox"/>	9.0#			
	72° 30° 42"	TCPV90/3072	<input type="checkbox"/>	9.0#			
	78° 30° 48"	TCPV90/3078	<input type="checkbox"/>	9.0#			
	84° 30° 54"	TCPV90/3084	<input type="checkbox"/>	9.0#			
	42° 36° 6"	TCPV90/3642	<input type="checkbox"/>	9.0#			
	48° 36° 12"	TCPV90/3648	<input type="checkbox"/>	9.0#			
	54° 36° 18"	TCPV90/3654	<input type="checkbox"/>	11.0#			
	60° 36° 24"	TCPV90/3660	<input type="checkbox"/>	11.0#			
	66° 36° 30"	TCPV90/3666	<input type="checkbox"/>	9.0#			
	72° 36° 36"	TCPV90/3672	<input type="checkbox"/>	9.0#			
	78° 36° 42"	TCPV90/3678	<input type="checkbox"/>	9.0#			
	84° 36° 48"	TCPV90/3684	<input type="checkbox"/>	9.0#			
	48° 42° 6"	TCPV90/4248	<input type="checkbox"/>	12.0#			
	54° 42° 12"	TCPV90/4254	<input type="checkbox"/>	12.0#			
	60° 42° 18"	TCPV90/4260	<input type="checkbox"/>	11.0#			
66° 42° 24"	TCPV90/4266	<input type="checkbox"/>	14.0#				
72° 42° 30"	TCPV90/4272	<input type="checkbox"/>	9.0#				
78° 42° 36"	TCPV90/4278	<input type="checkbox"/>	9.0#				
84° 42° 42"	TCPV90/4284	<input type="checkbox"/>	9.0#				

A

B

## HOW TO ORDER

Indicate the following information on order form:

1. Quantity of each item.
2. Model number, including options. See "How To Build a Model Number".
3. Any special service required.

Note: • The  indicates that a choice is required.

- The absence of the  indicates that no choice is required.
- Alpha-numeric characters in place of  indicate that no other alternatives are available.

## HOW TO BUILD A MODEL NUMBER

**A** Select basic model.

**B** Select trim color.

Refer to color addendum at [ki.com](http://ki.com) or KI Fabrics & Finishes binder. Metallic paint requires upcharge. SX Starlight Silver finish is only offered on flat aluminum trim.



# Tech Preconfigured Intersection Conditions

90° 2-Way

Delivered  
Pricing

\$ 236	\$ 70
238	70
263	81
269	83
272	83
270	84
278	87
306	88
317	91
253	70
275	83
277	84
280	83
278	87
294	90
310	91
330	91
357	87
359	90
364	94
363	95
378	95
396	98
408	100

## SPECIAL SERVICES

### Special Carton Marking

With specially marked information N/C

### Shipping

Shipped **k.d. freight prepaid f.o.b.**  
**Manitowoc, Wisconsin 54220** factory.  
Freight class #70.

Specifications and prices are subject to  
change without prior notice.

# Tech Preconfigured Intersection Conditions

90° 2-Way

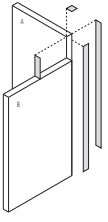
	MODEL	A B A-B	MODEL NUMBER		Approx. Packaged Weight
			Basic Model	Trim Color	
 <p>TECN</p> <p><b>90° 2-Way "L" Corner, Two Different Heights</b></p> <ul style="list-style-type: none"> <li>• Unupholstered</li> <li>• 1-way top cap</li> <li>• Two pieces of universal trim (Tech)</li> <li>• One piece of universal height change trim</li> <li>• One half-post (height A)</li> <li>• One half-post (height B)</li> <li>• Two sets of half post base tile hooks</li> <li>• Connecting hardware</li> <li>• SX Starlight Silver finish is only offered on flat aluminum trim</li> </ul>	54" 48" 6"	TCPV90/4854	<input type="checkbox"/>	12.0#	
	60" 48" 12"	TCPV90/4860	<input type="checkbox"/>	11.0#	
	66" 48" 18"	TCPV90/4866	<input type="checkbox"/>	14.0#	
	72" 48" 24"	TCPV90/4872	<input type="checkbox"/>	9.0#	
	78" 48" 30"	TCPV90/4878	<input type="checkbox"/>	9.0#	
	84" 48" 36"	TCPV90/4884	<input type="checkbox"/>	9.0#	
	60" 54" 6"	TCPV90/5460	<input type="checkbox"/>	11.0#	
	66" 54" 12"	TCPV90/5466	<input type="checkbox"/>	15.0#	
	72" 54" 18"	TCPV90/5472	<input type="checkbox"/>	9.0#	
	78" 54" 24"	TCPV90/5478	<input type="checkbox"/>	9.0#	
	84" 54" 30"	TCPV90/5484	<input type="checkbox"/>	9.0#	
	66" 60" 6"	TCPV90/6066	<input type="checkbox"/>	15.0#	
	72" 60" 12"	TCPV90/6072	<input type="checkbox"/>	9.0#	
	78" 60" 18"	TCPV90/6078	<input type="checkbox"/>	9.0#	
	84" 60" 24"	TCPV90/6084	<input type="checkbox"/>	9.0#	
	72" 66" 6"	TCPV90/6672	<input type="checkbox"/>	9.0#	
	78" 66" 12"	TCPV90/6678	<input type="checkbox"/>	9.0#	
	84" 66" 18"	TCPV90/6684	<input type="checkbox"/>	9.0#	
	78" 72" 6"	TCPV90/7278	<input type="checkbox"/>	9.0#	
	84" 72" 12"	TCPV90/7284	<input type="checkbox"/>	9.0#	
84" 78" 6"	TCPV90/7884	<input type="checkbox"/>	9.0#		

A

B

## HOW TO ORDER

Indicate the following information on order form:

1. Quantity of each item.
2. Model number, including options. See "How To Build a Model Number".
3. Any special service required.

Note: • The  indicates that a choice is required.

- The absence of the  indicates that no choice is required.
- Alpha-numeric characters in place of  indicate that no other alternatives are available.

## HOW TO BUILD A MODEL NUMBER

**A** Select basic model.

**B** Select trim color.

Refer to color addendum at [ki.com](http://ki.com) or KI Fabrics & Finishes binder. Metallic paint requires upcharge. SX Starlight Silver finish is only offered on flat aluminum trim.



# Tech Preconfigured Intersection Conditions

90° 2-Way

Delivered  
Pricing

\$ 366	\$ 92
368	92
366	93
382	94
399	92
419	94
399	95
373	95
387	96
406	93
423	94
381	94
393	95
411	95
430	96
394	96
412	97
436	97
424	99
440	99
441	99

## SPECIAL SERVICES

### Special Carton Marking

With specially marked information N/C

### Shipping

Shipped **k.d. freight prepaid f.o.b.**  
**Manitowoc, Wisconsin 54220** factory.  
Freight class #70.

Specifications and prices are subject to  
change without prior notice.

# Tech Preconfigured Intersection Conditions

90° 2-Way

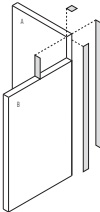
MODEL	A B A-B	MODEL NUMBER			Approx. Packaged Weight
		Basic Model	Trim Color	Fabric Color	
 <p>TEF2</p> <p><b>90° 2-Way "L" Corner, Two Different Heights</b></p> <ul style="list-style-type: none"> <li>• Upholstered</li> <li>• 1-way top cap</li> <li>• Two pieces of universal trim (Tech)</li> <li>• One piece of universal height change trim</li> <li>• One half-post (height A)</li> <li>• One half-post (height B)</li> <li>• Two sets of half post base tile hooks</li> <li>• Connecting hardware</li> <li>• SX Starlight Silver finish is only offered on flat aluminum trim</li> </ul>	36" 30" 6"	TCPVF90/3036	<input type="checkbox"/>	<input type="checkbox"/> <input type="checkbox"/> <input type="checkbox"/> <input type="checkbox"/>	9.0#
	42" 30" 12"	TCPVF90/3042	<input type="checkbox"/>	<input type="checkbox"/> <input type="checkbox"/> <input type="checkbox"/> <input type="checkbox"/>	9.0#
	48" 30" 18"	TCPVF90/3048	<input type="checkbox"/>	<input type="checkbox"/> <input type="checkbox"/> <input type="checkbox"/> <input type="checkbox"/>	9.0#
	54" 30" 24"	TCPVF90/3054	<input type="checkbox"/>	<input type="checkbox"/> <input type="checkbox"/> <input type="checkbox"/> <input type="checkbox"/>	11.0#
	60" 30" 30"	TCPVF90/3060	<input type="checkbox"/>	<input type="checkbox"/> <input type="checkbox"/> <input type="checkbox"/> <input type="checkbox"/>	11.0#
	66" 30" 36"	TCPVF90/3066	<input type="checkbox"/>	<input type="checkbox"/> <input type="checkbox"/> <input type="checkbox"/> <input type="checkbox"/>	16.0#
	72" 30" 42"	TCPVF90/3072	<input type="checkbox"/>	<input type="checkbox"/> <input type="checkbox"/> <input type="checkbox"/> <input type="checkbox"/>	16.0#
	78" 30" 48"	TCPVF90/3078	<input type="checkbox"/>	<input type="checkbox"/> <input type="checkbox"/> <input type="checkbox"/> <input type="checkbox"/>	16.0#
	84" 30" 54"	TCPVF90/3084	<input type="checkbox"/>	<input type="checkbox"/> <input type="checkbox"/> <input type="checkbox"/> <input type="checkbox"/>	16.0#
	42" 36" 6"	TCPVF90/3642	<input type="checkbox"/>	<input type="checkbox"/> <input type="checkbox"/> <input type="checkbox"/> <input type="checkbox"/>	9.0#
	48" 36" 12"	TCPVF90/3648	<input type="checkbox"/>	<input type="checkbox"/> <input type="checkbox"/> <input type="checkbox"/> <input type="checkbox"/>	9.0#
	54" 36" 18"	TCPVF90/3654	<input type="checkbox"/>	<input type="checkbox"/> <input type="checkbox"/> <input type="checkbox"/> <input type="checkbox"/>	11.0#
	60" 36" 24"	TCPVF90/3660	<input type="checkbox"/>	<input type="checkbox"/> <input type="checkbox"/> <input type="checkbox"/> <input type="checkbox"/>	11.0#
	66" 36" 30"	TCPVF90/3666	<input type="checkbox"/>	<input type="checkbox"/> <input type="checkbox"/> <input type="checkbox"/> <input type="checkbox"/>	16.0#
	72" 36" 36"	TCPVF90/3672	<input type="checkbox"/>	<input type="checkbox"/> <input type="checkbox"/> <input type="checkbox"/> <input type="checkbox"/>	16.0#
	78" 36" 42"	TCPVF90/3678	<input type="checkbox"/>	<input type="checkbox"/> <input type="checkbox"/> <input type="checkbox"/> <input type="checkbox"/>	16.0#
	84" 36" 48"	TCPVF90/3684	<input type="checkbox"/>	<input type="checkbox"/> <input type="checkbox"/> <input type="checkbox"/> <input type="checkbox"/>	16.0#
	48" 42" 6"	TCPVF90/4248	<input type="checkbox"/>	<input type="checkbox"/> <input type="checkbox"/> <input type="checkbox"/> <input type="checkbox"/>	12.0#
	54" 42" 12"	TCPVF90/4254	<input type="checkbox"/>	<input type="checkbox"/> <input type="checkbox"/> <input type="checkbox"/> <input type="checkbox"/>	12.0#
	60" 42" 18"	TCPVF90/4260	<input type="checkbox"/>	<input type="checkbox"/> <input type="checkbox"/> <input type="checkbox"/> <input type="checkbox"/>	11.0#
66" 42" 24"	TCPVF90/4266	<input type="checkbox"/>	<input type="checkbox"/> <input type="checkbox"/> <input type="checkbox"/> <input type="checkbox"/>	14.0#	
72" 42" 30"	TCPVF90/4272	<input type="checkbox"/>	<input type="checkbox"/> <input type="checkbox"/> <input type="checkbox"/> <input type="checkbox"/>	16.0#	
78" 42" 36"	TCPVF90/4278	<input type="checkbox"/>	<input type="checkbox"/> <input type="checkbox"/> <input type="checkbox"/> <input type="checkbox"/>	16.0#	
84" 42" 42"	TCPVF90/4284	<input type="checkbox"/>	<input type="checkbox"/> <input type="checkbox"/> <input type="checkbox"/> <input type="checkbox"/>	16.0#	

A

B

C

## HOW TO ORDER

Indicate the following information on order form:

1. Quantity of each item.
2. Model number, including options. See "How To Build a Model Number".
3. Any special service required.

Note: • The  indicates that a choice is required.

- The absence of the  indicates that no choice is required.
- Alpha-numeric characters in place of  indicate that no other alternatives are available.

## HOW TO BUILD A MODEL NUMBER

- A** Select basic model.
- B** Select trim color.  
Refer to color addendum at [ki.com](http://ki.com) or KI Fabrics & Finishes binder.  
Metallic paint requires upcharge.  
SX Starlight Silver finish is only offered on flat aluminum trim.
- C** Select fabric color.  
Refer to color addendum at [ki.com](http://ki.com) or in KI Fabrics & Finishes binder.

## INFORMATION

### Fabric Disclaimer

Fabric will be applied as swatched by the fabric manufacturer. Fabric that is required to be applied differently than is swatched will need a Special Cost Request written specifying the direction the fabric is to be applied. The posted standard lead time will apply to the Special Cost Request.





# Tech Preconfigured Intersection Conditions

90° 2-Way

Delivered Pricing Fabric Grade 1 & C.O.M.	Delivered Pricing Fabric Grade 2	Delivered Pricing Fabric Grade 3 & Pallas Vertical Fabric Grade PV	Delivered Pricing Pallas Vertical Fabric Grade PV1	Delivered Pricing Pallas Vertical Fabric Grade PV2	
\$ 334	\$ 340	\$ 342	\$ 352	\$ 359	\$ 15
330	337	340	348	357	15
365	373	376	385	396	15
373	380	382	391	401	15
381	387	390	399	410	15
382	388	391	400	411	15
398	403	410	420	430	15
423	430	436	444	453	15
471	481	486	493	508	15
369	379	381	390	400	15
379	385	387	397	408	15
384	390	393	401	412	15
388	396	398	408	420	15
391	398	400	410	423	15
411	419	424	433	444	15
425	432	438	448	460	15
485	491	499	508	526	15
461	470	479	486	496	15
468	475	483	490	505	15
470	480	485	492	507	15
471	481	486	493	508	15
492	501	508	521	535	15
511	521	528	537	552	15
559	571	577	588	605	15

## SPECIAL SERVICES

### Special Carton Marking

With specially marked information N/C

### Shipping

Shipped **k.d. freight prepaid f.o.b.**  
**Manitowoc, Wisconsin 54220** factory.  
 Freight class #70.

Specifications and prices are subject to  
 change without prior notice.

# Tech Preconfigured Intersection Conditions

90° 2-Way

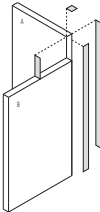
MODEL	A B A-B	MODEL NUMBER			Approx. Packaged Weight
		Basic Model	Trim Color	Fabric Color	
 <p>TEF2</p> <p><b>90° 2-Way "L" Corner, Two Different Heights</b></p> <ul style="list-style-type: none"> <li>• Upholstered</li> <li>• 1-way top cap</li> <li>• Two pieces of universal trim (Tech)</li> <li>• One piece of universal height change trim</li> <li>• One half-post (height A)</li> <li>• One half-post (height B)</li> <li>• Two sets of half post base tile hooks</li> <li>• Connecting hardware</li> <li>• SX Starlight Silver finish is only offered on flat aluminum trim</li> </ul>	54" 48" 6"	TCPVF90/4854	<input type="checkbox"/>	<input type="checkbox"/> <input type="checkbox"/> <input type="checkbox"/> <input type="checkbox"/>	12.0#
	60" 48" 12"	TCPVF90/4860	<input type="checkbox"/>	<input type="checkbox"/> <input type="checkbox"/> <input type="checkbox"/> <input type="checkbox"/>	11.0#
	66" 48" 18"	TCPVF90/4866	<input type="checkbox"/>	<input type="checkbox"/> <input type="checkbox"/> <input type="checkbox"/> <input type="checkbox"/>	14.0#
	72" 48" 24"	TCPVF90/4872	<input type="checkbox"/>	<input type="checkbox"/> <input type="checkbox"/> <input type="checkbox"/> <input type="checkbox"/>	16.0#
	78" 48" 30"	TCPVF90/4878	<input type="checkbox"/>	<input type="checkbox"/> <input type="checkbox"/> <input type="checkbox"/> <input type="checkbox"/>	16.0#
	84" 48" 36"	TCPVF90/4884	<input type="checkbox"/>	<input type="checkbox"/> <input type="checkbox"/> <input type="checkbox"/> <input type="checkbox"/>	16.0#
	60" 54" 6"	TCPVF90/5460	<input type="checkbox"/>	<input type="checkbox"/> <input type="checkbox"/> <input type="checkbox"/> <input type="checkbox"/>	11.0#
	66" 54" 12"	TCPVF90/5466	<input type="checkbox"/>	<input type="checkbox"/> <input type="checkbox"/> <input type="checkbox"/> <input type="checkbox"/>	15.0#
	72" 54" 18"	TCPVF90/5472	<input type="checkbox"/>	<input type="checkbox"/> <input type="checkbox"/> <input type="checkbox"/> <input type="checkbox"/>	16.0#
	78" 54" 24"	TCPVF90/5478	<input type="checkbox"/>	<input type="checkbox"/> <input type="checkbox"/> <input type="checkbox"/> <input type="checkbox"/>	16.0#
	84" 54" 30"	TCPVF90/5484	<input type="checkbox"/>	<input type="checkbox"/> <input type="checkbox"/> <input type="checkbox"/> <input type="checkbox"/>	16.0#
	66" 60" 6"	TCPVF90/6066	<input type="checkbox"/>	<input type="checkbox"/> <input type="checkbox"/> <input type="checkbox"/> <input type="checkbox"/>	15.0#
	72" 60" 12"	TCPVF90/6072	<input type="checkbox"/>	<input type="checkbox"/> <input type="checkbox"/> <input type="checkbox"/> <input type="checkbox"/>	16.0#
	78" 60" 18"	TCPVF90/6078	<input type="checkbox"/>	<input type="checkbox"/> <input type="checkbox"/> <input type="checkbox"/> <input type="checkbox"/>	16.0#
	84" 60" 24"	TCPVF90/6084	<input type="checkbox"/>	<input type="checkbox"/> <input type="checkbox"/> <input type="checkbox"/> <input type="checkbox"/>	16.0#
	72" 66" 6"	TCPVF90/6672	<input type="checkbox"/>	<input type="checkbox"/> <input type="checkbox"/> <input type="checkbox"/> <input type="checkbox"/>	16.0#
	78" 66" 12"	TCPVF90/6678	<input type="checkbox"/>	<input type="checkbox"/> <input type="checkbox"/> <input type="checkbox"/> <input type="checkbox"/>	16.0#
	84" 66" 18"	TCPVF90/6684	<input type="checkbox"/>	<input type="checkbox"/> <input type="checkbox"/> <input type="checkbox"/> <input type="checkbox"/>	16.0#
	78" 72" 6"	TCPVF90/7278	<input type="checkbox"/>	<input type="checkbox"/> <input type="checkbox"/> <input type="checkbox"/> <input type="checkbox"/>	16.0#
	84" 72" 12"	TCPVF90/7284	<input type="checkbox"/>	<input type="checkbox"/> <input type="checkbox"/> <input type="checkbox"/> <input type="checkbox"/>	16.0#
84" 78" 6"	TCPVF90/7884	<input type="checkbox"/>	<input type="checkbox"/> <input type="checkbox"/> <input type="checkbox"/> <input type="checkbox"/>	16.0#	

A

B

C

## HOW TO ORDER

Indicate the following information on order form:

1. Quantity of each item.
2. Model number, including options. See "How To Build a Model Number".
3. Any special service required.

Note: • The  indicates that a choice is required.

- The absence of the  indicates that no choice is required.
- Alpha-numeric characters in place of  indicate that no other alternatives are available.

## HOW TO BUILD A MODEL NUMBER

- A** Select basic model.
- B** Select trim color.  
Refer to color addendum at [ki.com](http://ki.com) or KI Fabrics & Finishes binder.  
Metallic paint requires upcharge.  
SX Starlight Silver finish is only offered on flat aluminum trim.
- C** Select fabric color.  
Refer to color addendum at [ki.com](http://ki.com) or in KI Fabrics & Finishes binder.

## INFORMATION

### Fabric Disclaimer

Fabric will be applied as swatched by the fabric manufacturer. Fabric that is required to be applied differently than is swatched will need a Special Cost Request written specifying the direction the fabric is to be applied. The posted standard lead time will apply to the Special Cost Request.



# Tech Preconfigured Intersection Conditions

90° 2-Way

Delivered Pricing Fabric Grade 1 & C.O.M.	Delivered Pricing Fabric Grade 2	Delivered Pricing Fabric Grade 3 & Pallas Vertical Fabric Grade PV	Delivered Pricing Pallas Vertical Fabric Grade PV1	Delivered Pricing Pallas Vertical Fabric Grade PV2	Metallic Paint add to list price
\$ 473	\$ 482	\$ 487	\$ 495	\$ 510	\$ 15
475	484	489	499	512	15
475	484	489	499	512	15
495	505	511	523	537	15
516	526	531	541	557	15
569	576	584	595	612	15
484	490	496	507	522	15
484	490	496	507	522	15
501	510	519	528	542	15
519	528	535	543	559	15
574	581	592	602	618	15
488	495	503	515	529	15
508	517	526	535	550	15
523	531	538	549	567	15
576	586	594	605	623	15
510	519	527	536	551	15
524	533	539	550	569	15
579	590	597	609	627	15
537	546	552	565	579	15
587	596	605	616	634	15
588	597	606	617	636	15

## SPECIAL SERVICES

### Special Carton Marking

With specially marked information N/C

### Shipping

Shipped **k.d. freight prepaid f.o.b.**  
**Manitowoc, Wisconsin 54220** factory.  
 Freight class #70.

Specifications and prices are subject to  
 change without prior notice.

# Tech Preconfigured Intersection Conditions

180° 2-Way

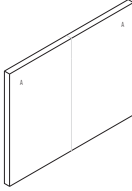
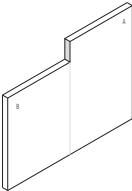
		MODEL			MODEL NUMBER		Approx. Packaged Weight
					Basic Model	Trim Color	
 <p>TECN</p>	<b>180° 2-Way In-Line Connection, Both Panels Same Height</b> <ul style="list-style-type: none"> <li>• Unupholstered</li> <li>• One full post</li> <li>• Two sets of half post base tile hooks</li> </ul>	A	B	A-B			
		30"			TFP/30		5.0#
		36"			TFP/36		5.0#
		42"			TFP/42		6.0#
		48"			TFP/48		6.0#
		54"			TFP/54		7.0#
		60"			TFP/60		7.0#
		66"			TFP/66		8.0#
		72"			TFP/72		9.0#
		78"			TFP/78		10.0#
84"			TFP/84		11.0#		
 <p>TECN</p>	<b>180° 2-Way In-Line Connection, Two Different Heights</b> <ul style="list-style-type: none"> <li>• Unupholstered: trim colored</li> <li>• One full post</li> <li>• In-line height change trim</li> <li>• In-line height change bottom cap</li> <li>• End-of-run top cap</li> <li>• Two sets of half post base tile hooks</li> <li>• SX Starlight Silver finish is only offered on flat aluminum trim</li> </ul>	A	B	A-B			
		36" 30" 6"			TFPV/3036	<input type="checkbox"/>	5.0#
		42" 30" 12"			TFPV/3042	<input type="checkbox"/>	6.0#
		54" 30" 24"			TFPV/3054	<input type="checkbox"/>	7.0#
		66" 30" 36"			TFPV/3066	<input type="checkbox"/>	8.0#
		84" 30" 54"			TFPV/3084	<input type="checkbox"/>	11.0#
		66" 42" 24"			TFPV/4266	<input type="checkbox"/>	8.0#
		84" 42" 42"			TFPV/4284	<input type="checkbox"/>	11.0#
		66" 54" 12"			TFPV/5466	<input type="checkbox"/>	8.0#
		84" 54" 30"			TFPV/5484	<input type="checkbox"/>	11.0#
84" 66" 18"			TFPV/6684	<input type="checkbox"/>	10.0#		

A

B

## HOW TO ORDER

Indicate the following information on order form:

1. Quantity of each item.
2. Model number, including options. See "How To Build a Model Number".
3. Any special service required.

Note: • The  indicates that a choice is required.

- The absence of the  indicates that no choice is required.
- Alpha-numeric characters in place of  indicate that no other alternatives are available.

## HOW TO BUILD A MODEL NUMBER

**A** Select basic model.

**B** Select trim color.

Refer to color addendum at [ki.com](http://ki.com) or KI Fabrics & Finishes binder. Metallic paint requires upcharge. SX Starlight Silver finish is only offered on flat aluminum trim.



# Tech Preconfigured Intersection Conditions

180° 2-Way

Delivered Pricing		Metallic Paint add to list price
\$ 41		N/A
47		N/A
48		N/A
52		N/A
55		N/A
61		N/A
62		N/A
69		N/A
71		N/A
78		N/A
\$ 69		\$ 33
76		36
88		36
104		39
132		47
96		36
123		47
90		36
118		38
108		36

## SPECIAL SERVICES

### Special Carton Marking

With specially marked information N/C

### Shipping

Shipped **k. d. freight prepaid f. o. b. Manitowoc, Wisconsin 54220** factory.  
Freight class #70.

Specifications and prices are subject to change without prior notice.

# Tech Preconfigured Intersection Conditions

180° 2-Way

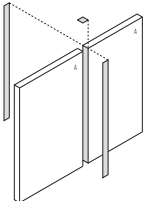
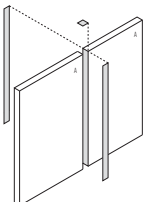
	MODEL	H	MODEL NUMBER			Approx. Packaged Weight	Delivered Pricing Unupholstered
			Basic Model	Trim Color	Fabric Color		
 <p>TECN</p>	<b>180° 2-Way In-Line Spacer, Both Panels Same Height</b>	30"	TSP180/30	<input type="checkbox"/>		4.0#	\$ 209
		36"	TSP180/36	<input type="checkbox"/>		4.0#	232
		42"	TSP180/42	<input type="checkbox"/>		5.0#	259
		48"	TSP180/48	<input type="checkbox"/>		5.0#	283
		54"	TSP180/54	<input type="checkbox"/>		6.0#	295
		60"	TSP180/60	<input type="checkbox"/>		6.0#	306
		66"	TSP180/66	<input type="checkbox"/>		7.0#	318
		72"	TSP180/72	<input type="checkbox"/>		7.0#	343
		78"	TSP180/78	<input type="checkbox"/>		7.0#	363
		84"	TSP180/84	<input type="checkbox"/>		7.0#	390
 <p>TEF2</p>	<b>180° 2-Way In-Line Spacer, Both Panels Same Height</b>	30"	TSPF180/30	<input type="checkbox"/>	<input type="checkbox"/> <input type="checkbox"/> <input type="checkbox"/> <input type="checkbox"/>	4.0#	N/A
		36"	TSPF180/36	<input type="checkbox"/>	<input type="checkbox"/> <input type="checkbox"/> <input type="checkbox"/> <input type="checkbox"/>	4.0#	N/A
		42"	TSPF180/42	<input type="checkbox"/>	<input type="checkbox"/> <input type="checkbox"/> <input type="checkbox"/> <input type="checkbox"/>	5.0#	N/A
		48"	TSPF180/48	<input type="checkbox"/>	<input type="checkbox"/> <input type="checkbox"/> <input type="checkbox"/> <input type="checkbox"/>	5.0#	N/A
		54"	TSPF180/54	<input type="checkbox"/>	<input type="checkbox"/> <input type="checkbox"/> <input type="checkbox"/> <input type="checkbox"/>	6.0#	N/A
		60"	TSPF180/60	<input type="checkbox"/>	<input type="checkbox"/> <input type="checkbox"/> <input type="checkbox"/> <input type="checkbox"/>	6.0#	N/A
		66"	TSPF180/66	<input type="checkbox"/>	<input type="checkbox"/> <input type="checkbox"/> <input type="checkbox"/> <input type="checkbox"/>	7.0#	N/A
		72"	TSPF180/72	<input type="checkbox"/>	<input type="checkbox"/> <input type="checkbox"/> <input type="checkbox"/> <input type="checkbox"/>	7.0#	N/A
		78"	TSPF180/78	<input type="checkbox"/>	<input type="checkbox"/> <input type="checkbox"/> <input type="checkbox"/> <input type="checkbox"/>	7.0#	N/A
		84"	TSPF180/84	<input type="checkbox"/>	<input type="checkbox"/> <input type="checkbox"/> <input type="checkbox"/> <input type="checkbox"/>	7.0#	N/A

A

B

C

## HOW TO ORDER

Indicate the following information on order form:

- Quantity of each item.
- Model number, including options. See "How To Build a Model Number".
- Any special service required.

Note:

- The  indicates that a choice is required.
- The absence of the  indicates that no choice is required.
- Alpha-numeric characters in place of  indicate that no other alternatives are available.

## HOW TO BUILD A MODEL NUMBER

- A** Select basic model.
- B** Select trim color.  
Refer to color addendum at ki.com or KI Fabrics & Finishes binder.  
Metallic paint requires upcharge.  
SX Starlight Silver finish is only offered on flat aluminum trim.
- C** Select fabric color.  
Refer to color addendum at ki.com or in KI Fabrics & Finishes binder.

## INFORMATION

### Fabric Disclaimer

Fabric will be applied as swatched by the fabric manufacturer. Fabric that is required to be applied differently than is swatched will need a Special Cost Request written specifying the direction the fabric is to be applied. The posted standard lead time will apply to the Special Cost Request.



# Tech Preconfigured Intersection Conditions

180° 2-Way

Delivered Pricing Fabric Grade 1 & C.O.M.	Delivered Pricing Fabric Grade 2	Delivered Pricing Fabric Grade 3 & Pallas Vertical Fabric Grade PV	Delivered Pricing Pallas Vertical Fabric Grade PV1	Delivered Pricing Pallas Vertical Fabric Grade PV2	Metallic Paint add to list price
					\$ 41
					41
					42
					44
					54
					56
					71
					71
					74
					74
\$ 278	\$ 283	\$ 288	\$ 294	\$ 302	\$ 15
337	343	346	353	363	15
353	358	362	367	381	15
388	396	399	409	420	15
394	401	401	412	424	15
399	408	411	420	431	15
414	423	426	436	445	15
483	490	493	506	521	15
485	492	499	508	524	15
486	493	500	510	524	15

**SPECIAL SERVICES**

**Special Carton Marking**

With specially marked information N/C

**Shipping**

Shipped **k.d. freight prepaid f.o.b. Manitowoc, Wisconsin 54220** factory. Freight class #70.

Specifications and prices are subject to change without prior notice.

# Tech Preconfigured Intersection Conditions

180° 2-Way

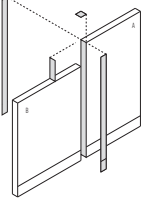
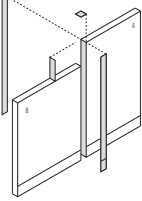
	MODEL	A	B	A-B	MODEL NUMBER			Approx. Packaged Weight	Delivered Pricing Unupholstered
					Basic Model	Trim Color	Fabric Color		
 <p>TECN</p>	<b>180° 2-Way In-Line Spacer, Two Different Heights</b>	36"	30"	6"	TPV180/3036	<input type="checkbox"/>	<input type="checkbox"/>	9.0#	\$ 201
		42"	30"	12"	TPV180/3042	<input type="checkbox"/>	<input type="checkbox"/>	9.0#	206
		54"	30"	24"	TPV180/3054	<input type="checkbox"/>	<input type="checkbox"/>	11.0#	263
		66"	30"	36"	TPV180/3066	<input type="checkbox"/>	<input type="checkbox"/>	13.0#	318
		84"	30"	54"	TPV180/3084	<input type="checkbox"/>	<input type="checkbox"/>	16.0#	341
		66"	42"	24"	TPV180/4266	<input type="checkbox"/>	<input type="checkbox"/>	14.0#	272
		84"	42"	42"	TPV180/4284	<input type="checkbox"/>	<input type="checkbox"/>	17.0#	335
		66"	54"	12"	TPV180/5466	<input type="checkbox"/>	<input type="checkbox"/>	15.0#	252
		84"	54"	30"	TPV180/5484	<input type="checkbox"/>	<input type="checkbox"/>	18.0#	314
		84"	66"	18"	TPV180/6684	<input type="checkbox"/>	<input type="checkbox"/>	19.0#	312
 <p>TEF2</p>	<b>180° 2-Way In-Line Spacer, Two Different Heights</b>	36"	30"	6"	TSPVF180/3036	<input type="checkbox"/>	<input type="checkbox"/>	9.0#	N/A
		42"	30"	12"	TSPVF180/3042	<input type="checkbox"/>	<input type="checkbox"/>	9.0#	N/A
		54"	30"	24"	TSPVF180/3054	<input type="checkbox"/>	<input type="checkbox"/>	11.0#	N/A
		66"	30"	36"	TSPVF180/3066	<input type="checkbox"/>	<input type="checkbox"/>	13.0#	N/A
		84"	30"	54"	TSPVF180/3084	<input type="checkbox"/>	<input type="checkbox"/>	16.0#	N/A
		66"	42"	24"	TSPVF180/4266	<input type="checkbox"/>	<input type="checkbox"/>	14.0#	N/A
		84"	42"	42"	TSPVF180/4284	<input type="checkbox"/>	<input type="checkbox"/>	17.0#	N/A
		66"	54"	12"	TSPVF180/5466	<input type="checkbox"/>	<input type="checkbox"/>	15.0#	N/A
		84"	54"	30"	TSPVF180/5484	<input type="checkbox"/>	<input type="checkbox"/>	18.0#	N/A
		84"	66"	18"	TSPVF180/6684	<input type="checkbox"/>	<input type="checkbox"/>	19.0#	N/A

A

B

C

## HOW TO ORDER

Indicate the following information on order form:

- Quantity of each item.
- Model number, including options. See "How To Build a Model Number".
- Any special service required.

Note:

- The  indicates that a choice is required.
- The absence of the  indicates that no choice is required.
- Alpha-numeric characters in place of  indicate that no other alternatives are available.

## HOW TO BUILD A MODEL NUMBER

- A** Select basic model.
- B** Select trim color.  
Refer to color addendum at ki.com or KI Fabrics & Finishes binder.  
Metallic paint requires upcharge.  
SX Starlight Silver finish is only offered on flat aluminum trim.
- C** Select fabric color.  
Refer to color addendum at ki.com or in KI Fabrics & Finishes binder.

## INFORMATION

### Fabric Disclaimer

Fabric will be applied as swatched by the fabric manufacturer. Fabric that is required to be applied differently than is swatched will need a Special Cost Request written specifying the direction the fabric is to be applied. The posted standard lead time will apply to the Special Cost Request.





# Tech Preconfigured Intersection Conditions

180° 2-Way

Delivered Pricing Fabric Grade 1 & C.O.M.	Delivered Pricing Fabric Grade 2	Delivered Pricing Fabric Grade 3 & Pallas Vertical Fabric Grade PV	Delivered Pricing Pallas Vertical Fabric Grade PV1	Delivered Pricing Pallas Vertical Fabric Grade PV2	Metallic Paint add to list price
					\$ 36
					47
					35
					47
					36
					35
					47
					47
					35
					47
\$ 441	\$ 446	\$ 448	\$ 452	\$ 462	\$ 15
437	443	446	453	464	15
522	529	533	542	553	15
546	553	558	570	579	15
642	655	660	668	685	15
564	573	577	586	597	15
657	664	671	682	698	15
533	541	544	553	567	15
616	627	631	641	658	15
612	623	628	637	655	15

**SPECIAL SERVICES**

**Special Carton Marking**

With specially marked information N/C

**Shipping**

Shipped **k.d. freight prepaid f.o.b. Manitowoc, Wisconsin 54220** factory. Freight class #70.

Specifications and prices are subject to change without prior notice.

# Tech Preconfigured Intersection Conditions

3-Way

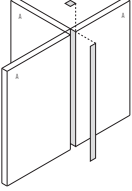
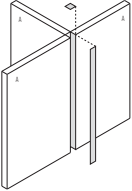
	MODEL	H	MODEL NUMBER			Approx. Packaged Weight	Delivered Pricing
			Basic Model	Trim Color	Fabric Color		
 <p>TECN</p>	<b>3-Way "T" Intersection w/3-Way Cap, All Panels Same Height</b> <ul style="list-style-type: none"> <li>• Upholstered: trim colored</li> <li>• 3-way top cap</li> <li>• One piece of universal trim (Tech)</li> <li>• Three half-posts</li> <li>• Three sets of half post base tile hooks</li> <li>• Connecting hardware</li> <li>• SX Starlight Silver finish is only offered on flat aluminum trim</li> </ul>	30"	TTP3W/30	<input type="checkbox"/>		10.0#	\$ 213
		36"	TTP3W/36	<input type="checkbox"/>		11.0#	236
		42"	TTP3W/42	<input type="checkbox"/>		12.0#	263
		48"	TTP3W/48	<input type="checkbox"/>		14.0#	290
		54"	TTP3W/54	<input type="checkbox"/>		15.0#	302
		60"	TTP3W/60	<input type="checkbox"/>		17.0#	311
		66"	TTP3W/66	<input type="checkbox"/>		18.0#	323
		72"	TTP3W/72	<input type="checkbox"/>		18.0#	347
		78"	TTP3W/78	<input type="checkbox"/>		18.0#	367
		84"	TTP3W/84	<input type="checkbox"/>		18.0#	394
 <p>TEF1</p>	<b>3-Way "T" Intersection w/3-Way Cap, All Panels Same Height</b> <ul style="list-style-type: none"> <li>• Upholstered</li> <li>• 3-way top cap</li> <li>• One piece of universal trim (Tech)</li> <li>• Three half-posts</li> <li>• Three sets of half post base tile hooks</li> <li>• Connecting hardware</li> <li>• SX Starlight Silver finish is only offered on flat aluminum trim</li> </ul>	30"	TTPF3W/30	<input type="checkbox"/>	<input type="checkbox"/> <input type="checkbox"/> <input type="checkbox"/> <input type="checkbox"/>	9.0#	N/A
		36"	TTPF3W/36	<input type="checkbox"/>	<input type="checkbox"/> <input type="checkbox"/> <input type="checkbox"/> <input type="checkbox"/>	9.0#	N/A
		42"	TTPF3W/42	<input type="checkbox"/>	<input type="checkbox"/> <input type="checkbox"/> <input type="checkbox"/> <input type="checkbox"/>	12.0#	N/A
		48"	TTPF3W/48	<input type="checkbox"/>	<input type="checkbox"/> <input type="checkbox"/> <input type="checkbox"/> <input type="checkbox"/>	12.0#	N/A
		54"	TTPF3W/54	<input type="checkbox"/>	<input type="checkbox"/> <input type="checkbox"/> <input type="checkbox"/> <input type="checkbox"/>	15.0#	N/A
		60"	TTPF3W/60	<input type="checkbox"/>	<input type="checkbox"/> <input type="checkbox"/> <input type="checkbox"/> <input type="checkbox"/>	15.0#	N/A
		66"	TTPF3W/66	<input type="checkbox"/>	<input type="checkbox"/> <input type="checkbox"/> <input type="checkbox"/> <input type="checkbox"/>	18.0#	N/A
		72"	TTPF3W/72	<input type="checkbox"/>	<input type="checkbox"/> <input type="checkbox"/> <input type="checkbox"/> <input type="checkbox"/>	18.0#	N/A
		78"	TTPF3W/78	<input type="checkbox"/>	<input type="checkbox"/> <input type="checkbox"/> <input type="checkbox"/> <input type="checkbox"/>	18.0#	N/A
		84"	TTPF3W/84	<input type="checkbox"/>	<input type="checkbox"/> <input type="checkbox"/> <input type="checkbox"/> <input type="checkbox"/>	18.0#	N/A

A

B

C

## HOW TO ORDER

Indicate the following information on order form:

1. Quantity of each item.
2. Model number, including options. See "How To Build a Model Number".
3. Any special service required.

Note: • The  indicates that a choice is required.

- The absence of the  indicates that no choice is required.
- Alpha-numeric characters in place of  indicate that no other alternatives are available.

## HOW TO BUILD A MODEL NUMBER

- A** Select basic model.
- B** Select trim color.  
Refer to color addendum at ki.com or KI Fabrics & Finishes binder.  
Metallic paint requires upcharge.  
SX Starlight Silver finish is only offered on flat aluminum trim.
- C** Select fabric color.  
Refer to color addendum at ki.com or in KI Fabrics & Finishes binder.

## INFORMATION

### Fabric Disclaimer

Fabric will be applied as swatched by the fabric manufacturer. Fabric that is required to be applied differently than is swatched will need a Special Cost Request written specifying the direction the fabric is to be applied. The posted standard lead time will apply to the Special Cost Request.



# Tech Preconfigured Intersection Conditions

3-Way

Delivered Pricing Fabric Grade 1 & C.O.M.	Delivered Pricing Fabric Grade 2	Delivered Pricing Fabric Grade 3 & Pallas Vertical Fabric Grade PV	Delivered Pricing Pallas Vertical Fabric Grade PV1	Delivered Pricing Pallas Vertical Fabric Grade PV2	Metallic Paint add to list price
					\$ 31
					35
					38
					41
					42
					44
					46
					48
					50
					57
\$ 279	\$ 286	\$ 288	\$ 296	\$ 303	\$ 15
305	310	312	318	324	15
333	340	342	350	358	15
363	368	373	382	391	15
378	384	386	396	406	15
386	393	396	403	416	15
402	411	414	424	437	15
436	443	445	453	468	15
449	456	464	473	485	15
511	522	527	537	552	15

## SPECIAL SERVICES

### Special Carton Marking

With specially marked information N/C

### Shipping

Shipped **k.d. freight prepaid f.o.b.**  
**Manitowoc, Wisconsin 54220** factory.  
Freight class #70.

Specifications and prices are subject to  
change without prior notice.

# Tech Preconfigured Intersection Conditions

3-Way

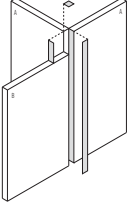
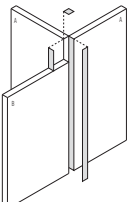
	MODEL	A	B	A-B	MODEL NUMBER			Approx. Packaged Weight	Delivered Pricing Unupholstered
					Basic Model	Trim Color	Fabric Color		
 <p>TECN</p>	<b>3-Way "T" Intersection w/90° Top Cap, Two Different Heights</b> <ul style="list-style-type: none"> <li>• Unupholstered: trim colored</li> <li>• 90° top cap</li> <li>• One piece of universal trim (Tech)</li> <li>• One piece of universal height change trim</li> <li>• Light block</li> <li>• Two half-posts (height A)</li> <li>• One half-post (height B)</li> <li>• Three sets of half post base tile hooks</li> <li>• Connecting hardware</li> <li>• SX Starlight Silver finish is only offered on flat aluminum trim</li> </ul>	36" 30" 6"	TTPV90/3036	<input type="checkbox"/>	<input type="checkbox"/>		15.0#	\$ 277	
		42" 30" 12"	TTPV90/3042	<input type="checkbox"/>	<input type="checkbox"/>		11.0#	288	
		54" 30" 24"	TTPV90/3054	<input type="checkbox"/>	<input type="checkbox"/>		14.0#	365	
		66" 30" 36"	TTPV90/3066	<input type="checkbox"/>	<input type="checkbox"/>		17.0#	382	
		84" 30" 54"	TTPV90/3084	<input type="checkbox"/>	<input type="checkbox"/>		21.0#	470	
		66" 42" 24"	TTPV90/4266	<input type="checkbox"/>	<input type="checkbox"/>		18.0#	398	
		84" 42" 42"	TTPV90/4284	<input type="checkbox"/>	<input type="checkbox"/>		22.0#	486	
		66" 54" 12"	TTPV90/5466	<input type="checkbox"/>	<input type="checkbox"/>		18.0#	359	
		84" 54" 30"	TTPV90/5484	<input type="checkbox"/>	<input type="checkbox"/>		22.0#	446	
		84" 66" 18"	TTPV90/6684	<input type="checkbox"/>	<input type="checkbox"/>		23.0#	444	
 <p>TEF2</p>	<b>3-Way "T" Intersection w/90° Top Cap, Two Different Heights</b> <ul style="list-style-type: none"> <li>• Upholstered</li> <li>• 90° top cap</li> <li>• One piece of universal trim (Tech)</li> <li>• One piece of universal height change trim</li> <li>• Light block</li> <li>• Two half-posts (height A)</li> <li>• One half-post (height B)</li> <li>• Three sets of half post base tile hooks</li> <li>• Connecting hardware</li> <li>• SX Starlight Silver finish is only offered on flat aluminum trim</li> </ul>	36" 30" 6"	TTPVF90/3036	<input type="checkbox"/>	<input type="checkbox"/>	<input type="checkbox"/>	<input type="checkbox"/>	15.0#	N/A
		42" 30" 12"	TTPVF90/3042	<input type="checkbox"/>	<input type="checkbox"/>	<input type="checkbox"/>	<input type="checkbox"/>	11.0#	N/A
		54" 30" 24"	TTPVF90/3054	<input type="checkbox"/>	<input type="checkbox"/>	<input type="checkbox"/>	<input type="checkbox"/>	14.0#	N/A
		66" 30" 36"	TTPVF90/3066	<input type="checkbox"/>	<input type="checkbox"/>	<input type="checkbox"/>	<input type="checkbox"/>	17.0#	N/A
		84" 30" 54"	TTPVF90/3084	<input type="checkbox"/>	<input type="checkbox"/>	<input type="checkbox"/>	<input type="checkbox"/>	21.0#	N/A
		66" 42" 24"	TTPVF90/4266	<input type="checkbox"/>	<input type="checkbox"/>	<input type="checkbox"/>	<input type="checkbox"/>	18.0#	N/A
		84" 42" 43"	TTPVF90/4284	<input type="checkbox"/>	<input type="checkbox"/>	<input type="checkbox"/>	<input type="checkbox"/>	22.0#	N/A
		66" 54" 12"	TTPVF90/5466	<input type="checkbox"/>	<input type="checkbox"/>	<input type="checkbox"/>	<input type="checkbox"/>	18.0#	N/A
		84" 54" 30"	TTPVF90/5484	<input type="checkbox"/>	<input type="checkbox"/>	<input type="checkbox"/>	<input type="checkbox"/>	22.0#	N/A
		84" 66" 18"	TTPVF90/6684	<input type="checkbox"/>	<input type="checkbox"/>	<input type="checkbox"/>	<input type="checkbox"/>	23.0#	N/A

A

B

C

## HOW TO ORDER

Indicate the following information on order form:

1. Quantity of each item.
2. Model number, including options. See "How To Build a Model Number".
3. Any special service required.

Note: • The  indicates that a choice is required.

- The absence of the  indicates that no choice is required.
- Alpha-numeric characters in place of  indicate that no other alternatives are available.

## HOW TO BUILD A MODEL NUMBER

**A** Select basic model.

**B** Select trim color.  
Refer to color addendum at ki.com or KI Fabrics & Finishes binder.  
Metallic paint requires upcharge.  
SX Starlight Silver finish is only offered on flat aluminum trim.

**C** Select fabric color.  
Refer to color addendum at ki.com or in KI Fabrics & Finishes binder.

## INFORMATION

### Fabric Disclaimer

Fabric will be applied as swatched by the fabric manufacturer. Fabric that is required to be applied differently than is swatched will need a Special Cost Request written specifying the direction the fabric is to be applied. The posted standard lead time will apply to the Special Cost Request.



# Tech Preconfigured Intersection Conditions

3-Way

Delivered Pricing Fabric Grade 1 & C.O.M.	Delivered Pricing Fabric Grade 2	Delivered Pricing Fabric Grade 3 & Pallas Vertical Fabric Grade PV	Delivered Pricing Pallas Vertical Fabric Grade PV1	Delivered Pricing Pallas Vertical Fabric Grade PV2	Metallic Paint add to list price
					\$ 47
					48
					62
					65
					68
					64
					68
					64
					67
					65
\$ 397	\$ 401	\$ 403	\$ 411	\$ 420	\$ 15
394	401	403	411	422	15
479	484	487	493	507	15
500	508	512	522	533	15
590	599	605	613	628	15
517	526	529	537	549	15
595	603	610	618	632	15
474	483	486	492	505	15
567	575	579	590	603	15
957	965	971	981	993	15

**SPECIAL SERVICES**

**Special Carton Marking**

With specially marked information N/C

**Shipping**

Shipped **k.d. freight prepaid f.o.b. Manitowoc, Wisconsin 54220** factory. Freight class #70.

Specifications and prices are subject to change without prior notice.

# Tech Preconfigured Intersection Conditions

3-Way

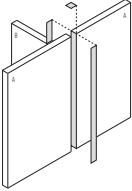
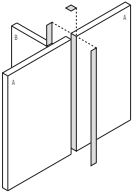
	MODEL	A B A-B	MODEL NUMBER			Approx. Packaged Weight	Delivered Pricing Unupholstered
			Basic Model	Trim Color	Fabric Color		
 <p>TECN</p>	<b>3-Way "T" Intersection w/180° Top Cap, Two Different Heights</b> <ul style="list-style-type: none"> <li>• Unupholstered: trim colored</li> <li>• 180° top cap</li> <li>• One piece of universal trim (Tech)</li> <li>• One piece of universal height change trim</li> <li>• Light block</li> <li>• Two half-posts (height A)</li> <li>• One half-post (height B)</li> <li>• Three sets of half post base tile hooks</li> <li>• Connecting hardware</li> <li>• SX Starlight Silver finish is only offered on flat aluminum trim</li> </ul>	36" 30" 6"	TTPV180/3036	<input type="checkbox"/>		10.0#	\$ 277
		42" 30" 12"	TTPV180/3042	<input type="checkbox"/>		10.0#	290
		54" 30" 24"	TTPV180/3054	<input type="checkbox"/>		12.0#	367
		66" 30" 36"	TTPV180/3066	<input type="checkbox"/>		14.0#	388
		84" 30" 54"	TTPV180/3084	<input type="checkbox"/>		16.0#	473
		66" 42" 24"	TTPV180/4266	<input type="checkbox"/>		16.0#	408
		84" 42" 42"	TTPV180/4284	<input type="checkbox"/>		18.0#	488
		66" 54" 12"	TTPV180/5466	<input type="checkbox"/>		17.0#	366
		84" 54" 30"	TTPV180/5484	<input type="checkbox"/>		19.0#	449
		84" 66" 18"	TTPV180/6684	<input type="checkbox"/>		22.0#	446
 <p>TEF2</p>	<b>3-Way "T" Intersection w/180° Top Cap, Two Different Heights</b> <ul style="list-style-type: none"> <li>• Upholstered</li> <li>• 180° top cap</li> <li>• One piece of fabric-wrapped universal trim (Tech)</li> <li>• One piece of fabric-wrapped universal height change trim</li> <li>• Light block</li> <li>• Two half-posts (height A)</li> <li>• One half-post (height B)</li> <li>• Three sets of half post base tile hooks</li> <li>• Connecting hardware</li> <li>• SX Starlight Silver finish is only offered on flat aluminum trim</li> </ul>	36" 30" 6"	TTPVF180/3036	<input type="checkbox"/>	<input type="checkbox"/>	10.0#	N/A
		42" 30" 12"	TTPVF180/3042	<input type="checkbox"/>	<input type="checkbox"/>	10.0#	N/A
		54" 30" 24"	TTPVF180/3054	<input type="checkbox"/>	<input type="checkbox"/>	12.0#	N/A
		66" 30" 36"	TTPVF180/3066	<input type="checkbox"/>	<input type="checkbox"/>	14.0#	N/A
		84" 30" 54"	TTPVF180/3084	<input type="checkbox"/>	<input type="checkbox"/>	16.0#	N/A
		66" 42" 24"	TTPVF180/4266	<input type="checkbox"/>	<input type="checkbox"/>	16.0#	N/A
		84" 42" 42"	TTPVF180/4284	<input type="checkbox"/>	<input type="checkbox"/>	18.0#	N/A
		66" 54" 12"	TTPVF180/5466	<input type="checkbox"/>	<input type="checkbox"/>	17.0#	N/A
		84" 54" 30"	TTPVF180/5484	<input type="checkbox"/>	<input type="checkbox"/>	19.0#	N/A
		84" 66" 18"	TTPVF180/6684	<input type="checkbox"/>	<input type="checkbox"/>	22.0#	N/A

A

B

C

## HOW TO ORDER

Indicate the following information on order form:

1. Quantity of each item.
2. Model number, including options. See "How To Build a Model Number".
3. Any special service required.

Note: • The  indicates that a choice is required.

- The absence of the  indicates that no choice is required.
- Alpha-numeric characters in place of  indicate that no other alternatives are available.

## HOW TO BUILD A MODEL NUMBER

- A** Select basic model.
- B** Select trim color.  
Refer to color addendum at ki.com or KI Fabrics & Finishes binder.  
Metallic paint requires upcharge.  
SX Starlight Silver finish is only offered on flat aluminum trim.
- C** Select fabric color.  
Refer to color addendum at ki.com or in KI Fabrics & Finishes binder.

## INFORMATION

### Fabric Disclaimer

Fabric will be applied as swatched by the fabric manufacturer. Fabric that is required to be applied differently than is swatched will need a Special Cost Request written specifying the direction the fabric is to be applied. The posted standard lead time will apply to the Special Cost Request.



# Tech Preconfigured Intersection Conditions

3-Way

Delivered Pricing Fabric Grade 1 & C.O.M.	Delivered Pricing Fabric Grade 2	Delivered Pricing Fabric Grade 3 & Pallas Vertical Fabric Grade PV	Delivered Pricing Pallas Vertical Fabric Grade PV1	Delivered Pricing Pallas Vertical Fabric Grade PV2	Metallic Paint add to list price
					\$ 59
					74
					65
					78
					70
					68
					79
					78
					69
					79
\$ 399	\$ 408	\$ 410	\$ 420	\$ 431	\$ 15
397	403	409	417	430	15
482	489	493	505	519	15
503	512	521	529	543	15
593	605	611	623	640	15
521	530	536	546	564	15
606	617	625	637	656	15
480	486	491	500	516	15
570	578	586	596	613	15
960	980	989	1009	1037	15

## SPECIAL SERVICES

### Special Carton Marking

With specially marked information N/C

### Shipping

Shipped **k.d. freight prepaid f.o.b.**  
**Manitowoc, Wisconsin 54220** factory.  
Freight class #70.

Specifications and prices are subject to  
change without prior notice.

# Tech Preconfigured Intersection Conditions

4-Way

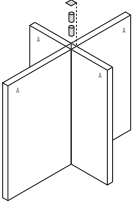
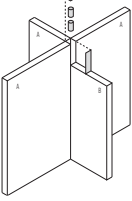
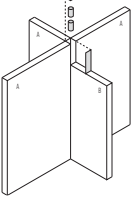
MODEL	A	B	A-B	MODEL NUMBER				Approx. Packaged Weight
				Basic Model	Assembly	Trim Color	Fabric Color	
 <p><b>4-Way "X" Intersection with 4-Way Top Cap, All Panels Same Height</b></p> <ul style="list-style-type: none"> <li>• Upholstered: trim colored</li> <li>• 4-way top cap</li> <li>• Light block</li> <li>• Four half-posts (height A)</li> <li>• Four sets of half post base tile hooks</li> <li>• Connecting hardware</li> <li>• SX Starlight Silver finish is only offered on flat aluminum trim</li> </ul>	30"			TXP4W/30	<input type="checkbox"/>	<input type="checkbox"/>		10.0#
	36"			TXP4W/36	<input type="checkbox"/>	<input type="checkbox"/>		10.0#
	42"			TXP4W/42	<input type="checkbox"/>	<input type="checkbox"/>		14.0#
	48"			TXP4W/48	<input type="checkbox"/>	<input type="checkbox"/>		14.0#
	54"			TXP4W/54	<input type="checkbox"/>	<input type="checkbox"/>		19.0#
	60"			TXP4W/60	<input type="checkbox"/>	<input type="checkbox"/>		19.0#
	66"			TXP4W/66	<input type="checkbox"/>	<input type="checkbox"/>		23.0#
	72"			TXP4W/72	<input type="checkbox"/>	<input type="checkbox"/>		23.0#
	78"			TXP4W/78	<input type="checkbox"/>	<input type="checkbox"/>		23.0#
	84"			TXP4W/84	<input type="checkbox"/>	<input type="checkbox"/>		30.0#
 <p><b>4-Way "X" Intersection with 3-Way Top Cap, Two Different Heights</b></p> <ul style="list-style-type: none"> <li>• Upholstered</li> <li>• 3-way top cap</li> <li>• One piece of universal height change trim</li> <li>• Light block</li> <li>• Three half-posts (height A)</li> <li>• One half-post (height B)</li> <li>• Four sets of half post base tile hooks</li> <li>• Connecting hardware</li> <li>• SX Starlight Silver finish is only offered on flat aluminum trim</li> </ul>	36" 30" 6"			TXPV3W/3036		<input type="checkbox"/>	<input type="checkbox"/>	18.0#
	42" 30" 12"			TXPV3W/3042		<input type="checkbox"/>	<input type="checkbox"/>	14.0#
	54" 30" 24"			TXPV3W/3054		<input type="checkbox"/>	<input type="checkbox"/>	17.0#
	66" 30" 36"			TXPV3W/3066		<input type="checkbox"/>	<input type="checkbox"/>	20.0#
	84" 30" 54"			TXPV3W/3084		<input type="checkbox"/>	<input type="checkbox"/>	26.0#
	66" 42" 36"			TXPV3W/4266		<input type="checkbox"/>	<input type="checkbox"/>	21.0#
	84" 42" 42"			TXPV3W/4284		<input type="checkbox"/>	<input type="checkbox"/>	27.0#
	66" 54" 12"			TXPV3W/5466		<input type="checkbox"/>	<input type="checkbox"/>	22.0#
	84" 54" 30"			TXPV3W/5484		<input type="checkbox"/>	<input type="checkbox"/>	28.0#
	84" 66" 18"			TXPV3W/6684		<input type="checkbox"/>	<input type="checkbox"/>	29.0#
 <p><b>4-Way "X" Intersection with 3-Way Top Cap, Two Different Heights</b></p> <ul style="list-style-type: none"> <li>• Upholstered</li> <li>• 3-way top cap</li> <li>• One piece of universal height change trim</li> <li>• Light block</li> <li>• Three half-posts (height A)</li> <li>• One half-post (height B)</li> <li>• Four sets of half post base tile hooks</li> <li>• Connecting hardware</li> <li>• SX Starlight Silver finish is only offered on flat aluminum trim</li> </ul>	36" 30" 6"			TXPVF3W/3036		<input type="checkbox"/>	<input type="checkbox"/>	18.0#
	42" 30" 12"			TXPVF3W/3042		<input type="checkbox"/>	<input type="checkbox"/>	14.0#
	54" 30" 24"			TXPVF3W/3054		<input type="checkbox"/>	<input type="checkbox"/>	17.0#
	66" 30" 36"			TXPVF3W/3066		<input type="checkbox"/>	<input type="checkbox"/>	20.0#
	84" 30" 54"			TXPVF3W/3084		<input type="checkbox"/>	<input type="checkbox"/>	26.0#
	66" 42" 24"			TXPVF3W/4266		<input type="checkbox"/>	<input type="checkbox"/>	21.0#
	84" 42" 42"			TXPVF3W/4284		<input type="checkbox"/>	<input type="checkbox"/>	27.0#
	66" 54" 12"			TXPVF3W/5466		<input type="checkbox"/>	<input type="checkbox"/>	22.0#
	84" 54" 30"			TXPVF3W/5484		<input type="checkbox"/>	<input type="checkbox"/>	28.0#
	84" 66" 18"			TXPVF3W/6684		<input type="checkbox"/>	<input type="checkbox"/>	29.0#

**A**      **B**      **C**      **D**

## HOW TO ORDER

Indicate the following information on order form:

1. Quantity of each item.
2. Model number, including options. See "How To Build a Model Number".
3. Any special service required.

Note: • The  indicates that a choice is required.  
 • The absence of the  indicates that no choice is required.  
 • Alpha-numeric characters in place of  indicate that no other alternatives are available.

## HOW TO BUILD A MODEL NUMBER

- A** Select basic model.
- B** Select assembly.
 

F	- Fully Assembled; add \$91
U	- Unassembled
- C** Select trim color. Refer to color addendum at [ki.com](http://ki.com) or KI Fabrics & Finishes binder. Metallic paint requires upcharge. SX Starlight Silver finish is only offered on flat aluminum trim.
- D** Select fabric color. Refer to color addendum at [ki.com](http://ki.com) or in KI Fabrics & Finishes binder.

## INFORMATION

**Fabric Disclaimer**  
 Fabric will be applied as swatched by the fabric manufacturer. Fabric that is required to be applied differently than is swatched will need a Special Cost Request written specifying the direction the fabric is to be applied. The posted standard lead time will apply to the Special Cost Request.





# Tech Preconfigured Intersection Conditions

4-Way

Delivered Pricing Unupholstered	Delivered Pricing Fabric Grade 1 & C.O.M.	Delivered Pricing Fabric Grade 2	Delivered Pricing Fabric Grade 3 & Pallas Vertical Fabric Grade PV	Delivered Pricing Pallas Vertical Fabric Grade PV1	Delivered Pricing Pallas Vertical Fabric Grade PV2	Metallic Paint add to list price
\$ 231						N/A
241						N/A
270						N/A
298						N/A
309						N/A
321						N/A
320						N/A
367						N/A
381						N/A
384						N/A
\$ 283						\$ 25
305						26
381						26
401						29
484						30
420						26
496						35
380						28
460						29
456						28
N/A	\$ 357	\$ 364	\$ 367	\$ 378	\$ 386	\$ 15
N/A	358	365	367	378	387	15
N/A	439	446	450	460	474	15
N/A	460	469	475	484	495	15
N/A	542	552	559	571	587	15
N/A	479	486	490	500	515	15
N/A	558	571	576	587	603	15
N/A	436	443	446	454	469	15
N/A	519	528	535	543	559	15
N/A	515	524	530	539	556	15

## SPECIAL SERVICES

### Special Carton Marking

With specially marked information N/C

### Shipping

Shipped **k.d. freight prepaid f.o.b.**  
**Manitowoc, Wisconsin 54220** factory.  
 Freight class #70.

Specifications and prices are subject to  
 change without prior notice.

# Tech Preconfigured Intersection Conditions

4-Way

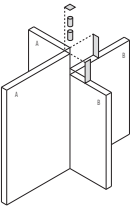
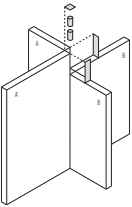
	MODEL	A	B	A-B	MODEL NUMBER			Approx. Packaged Weight	Delivered Pricing Unupholstered
					Basic Model	Trim Color	Fabric Color		
 <p>TECN</p>	<b>4-Way "X" Intersection with 90° Top Cap, Two Different Heights</b> <ul style="list-style-type: none"> <li>Unupholstered: trim colored</li> <li>90° top cap</li> <li>Two pieces of universal height change trim</li> <li>Light block</li> <li>Two half-posts (height B)</li> <li>Two half-posts (height A)</li> <li>Three sets of half post base tile hooks</li> <li>Connecting hardware</li> <li>SX Starlight Silver finish is only offered on flat aluminum trim</li> </ul>	36" 30" 6"			TXPV90/3036	<input type="checkbox"/>		17.0#	\$ 283
		42" 30" 12"			TXPV90/3042	<input type="checkbox"/>		13.0#	310
		54" 30" 24"			TXPV90/3054	<input type="checkbox"/>		16.0#	385
		66" 30" 36"			TXPV90/3066	<input type="checkbox"/>		19.0#	449
		84" 30" 54"			TXPV90/3084	<input type="checkbox"/>		23.0#	490
		66" 42" 24"			TXPV90/4266	<input type="checkbox"/>		20.0#	423
		84" 42" 24"			TXPV90/4284	<input type="checkbox"/>		24.0#	500
		66" 54" 12"			TXPV90/5466	<input type="checkbox"/>		21.0#	386
		84" 54" 30"			TXPV90/5484	<input type="checkbox"/>		25.0#	468
		84" 66" 18"			TXPV90/6684	<input type="checkbox"/>		27.0#	460
 <p>TEF2</p>	<b>4-Way "X" Intersection with 90° Top Cap, Two Different Heights</b> <ul style="list-style-type: none"> <li>Upholstered: trim colored</li> <li>90° top cap</li> <li>Two pieces of universal height change trim</li> <li>Light block</li> <li>Two half-posts (height A)</li> <li>Two half-posts (height B)</li> <li>Four sets of half post base tile hooks</li> <li>Connecting hardware</li> <li>SX Starlight Silver finish is only offered on flat aluminum trim</li> </ul>	36" 30" 6"			TXPVF90/3036	<input type="checkbox"/>	<input type="checkbox"/>	17.0#	N/A
		42" 30" 12"			TXPVF90/3042	<input type="checkbox"/>	<input type="checkbox"/>	13.0#	N/A
		54" 30" 24"			TXPVF90/3054	<input type="checkbox"/>	<input type="checkbox"/>	16.0#	N/A
		66" 30" 36"			TXPVF90/3066	<input type="checkbox"/>	<input type="checkbox"/>	19.0#	N/A
		84" 30" 54"			TXPVF90/3084	<input type="checkbox"/>	<input type="checkbox"/>	23.0#	N/A
		66" 42" 24"			TXPVF90/4266	<input type="checkbox"/>	<input type="checkbox"/>	20.0#	N/A
		84" 42" 24"			TXPVF90/4284	<input type="checkbox"/>	<input type="checkbox"/>	24.0#	N/A
		66" 54" 12"			TXPVF90/5466	<input type="checkbox"/>	<input type="checkbox"/>	21.0#	N/A
		84" 54" 30"			TXPVF90/5484	<input type="checkbox"/>	<input type="checkbox"/>	25.0#	N/A
		84" 66" 18"			TXPVF90/6684	<input type="checkbox"/>	<input type="checkbox"/>	27.0#	N/A

**A****B****C**

## HOW TO ORDER

Indicate the following information on order form:

- Quantity of each item.
- Model number, including options. See "How To Build a Model Number".
- Any special service required.

Note: • The  indicates that a choice is required.  
 • The absence of the  indicates that no choice is required.  
 • Alpha-numeric characters in place of  indicate that no other alternatives are available.

## HOW TO BUILD A MODEL NUMBER

- A** Select basic model.
- B** Select trim color.  
 Refer to color addendum at ki.com or KI Fabrics & Finishes binder.  
 Metallic paint requires upcharge.  
 SX Starlight Silver finish is only offered on flat aluminum trim.
- C** Select fabric color.  
 Refer to color addendum at ki.com or in KI Fabrics & Finishes binder.

## INFORMATION

### Fabric Disclaimer

Fabric will be applied as swatched by the fabric manufacturer. Fabric that is required to be applied differently than is swatched will need a Special Cost Request written specifying the direction the fabric is to be applied. The posted standard lead time will apply to the Special Cost Request.



# Tech Preconfigured Intersection Conditions

4-Way

Delivered Pricing Fabric Grade 1 & C.O.M.	Delivered Pricing Fabric Grade 2	Delivered Pricing Fabric Grade 3 & Pallas Vertical Fabric Grade PV	Delivered Pricing Pallas Vertical Fabric Grade PV1	Delivered Pricing Pallas Vertical Fabric Grade PV2	Metallic Paint add to list price
					\$ 35
					38
					38
					42
					59
					39
					58
					38
					40
					38
\$ 420	\$ 428	\$ 431	\$ 440	\$ 451	\$ 15
420	428	431	440	451	15
499	508	516	526	539	15
570	578	586	596	613	15
612	625	631	642	662	15
538	549	556	567	581	15
621	631	639	651	668	15
493	505	510	521	536	15
584	595	602	612	631	15
575	586	593	603	621	15

**SPECIAL SERVICES**

**Special Carton Marking**

With specially marked information N/C

**Shipping**

Shipped **k.d. freight prepaid f.o.b. Manitowoc, Wisconsin 54220** factory. Freight class #70.

Specifications and prices are subject to change without prior notice.

# Tech Preconfigured Intersection Conditions

## 4-Way

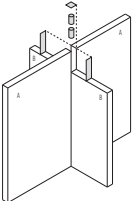
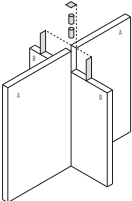
	MODEL	A	B	A-B	MODEL NUMBER			Approx. Packaged Weight	Delivered Pricing
					Basic Model	Trim Color	Fabric Color		
 <p>TECN</p>	<b>4-Way "X" Intersection with 180° Top Cap, Two Different Heights</b> <ul style="list-style-type: none"> <li>Unupholstered: trim colored</li> <li>180° top cap</li> <li>Two pieces of universal height change trim</li> <li>Light block</li> <li>Two half-posts (height A)</li> <li>Two half-posts (height B)</li> <li>Four sets of half post base tile hooks</li> <li>Connecting hardware</li> <li>SX Starlight Silver finish is only offered on flat aluminum trim</li> </ul>	36" 30" 6"			TXPV180/3036	<input type="checkbox"/>		17.0#	\$ 283
		42" 30" 12"			TXPV180/3042	<input type="checkbox"/>		13.0#	313
		54" 30" 24"			TXPV180/3054	<input type="checkbox"/>		16.0#	387
		66" 30" 36"			TXPV180/3066	<input type="checkbox"/>		19.0#	412
		84" 30" 54"			TXPV180/3084	<input type="checkbox"/>		23.0#	493
		66" 42" 24"			TXPV180/4266	<input type="checkbox"/>		20.0#	428
		84" 42" 42"			TXPV180/4284	<input type="checkbox"/>		25.0#	503
		66" 54" 12"			TXPV180/5466	<input type="checkbox"/>		21.0#	388
		84" 54" 30"			TXPV180/5484	<input type="checkbox"/>		26.0#	470
		84" 66" 18"			TXPV180/6684	<input type="checkbox"/>		27.0#	464
 <p>TEF2</p>	<b>4-Way "X" Intersection with 180° Top Cap, Two Different Heights</b> <ul style="list-style-type: none"> <li>Upholstered</li> <li>180° top cap</li> <li>Two pieces of fabric wrapped universal height change trim</li> <li>Light block</li> <li>Two half-posts (height A)</li> <li>Two half-posts (height B)</li> <li>Four sets of half post base tile hooks</li> <li>Connecting hardware</li> <li>SX Starlight Silver finish is only offered on flat aluminum trim</li> </ul>	36" 30" 6"			TXPVF180/3036	<input type="checkbox"/>	<input type="checkbox"/>	17.0#	N/A
		42" 30" 12"			TXPVF180/3042	<input type="checkbox"/>	<input type="checkbox"/>	13.0#	N/A
		54" 30" 24"			TXPVF180/3054	<input type="checkbox"/>	<input type="checkbox"/>	16.0#	N/A
		66" 30" 36"			TXPVF180/3066	<input type="checkbox"/>	<input type="checkbox"/>	19.0#	N/A
		84" 30" 54"			TXPVF180/3084	<input type="checkbox"/>	<input type="checkbox"/>	23.0#	N/A
		66" 42" 24"			TXPVF180/4266	<input type="checkbox"/>	<input type="checkbox"/>	20.0#	N/A
		84" 42" 42"			TXPVF180/4284	<input type="checkbox"/>	<input type="checkbox"/>	25.0#	N/A
		66" 54" 12"			TXPVF180/5466	<input type="checkbox"/>	<input type="checkbox"/>	21.0#	N/A
		84" 54" 30"			TXPVF180/5484	<input type="checkbox"/>	<input type="checkbox"/>	26.0#	N/A
		84" 66" 18"			TXPVF180/6684	<input type="checkbox"/>	<input type="checkbox"/>	27.0#	N/A

**A**      **B**      **C**

### HOW TO ORDER

Indicate the following information on order form:

- Quantity of each item.
- Model number, including options. See "How To Build a Model Number".
- Any special service required.

Note: • The  indicates that a choice is required.  
 • The absence of the  indicates that no choice is required.  
 • Alpha-numeric characters in place of  indicate that no other alternatives are available.

### HOW TO BUILD A MODEL NUMBER

- A** Select basic model.
- B** Select trim color.  
Refer to color addendum at [ki.com](http://ki.com) or KI Fabrics & Finishes binder. Metallic paint requires upcharge. SX Starlight Silver finish is only offered on flat aluminum trim.
- C** Select fabric color.  
Refer to color addendum at [ki.com](http://ki.com) or in KI Fabrics & Finishes binder.

### INFORMATION

**Fabric Disclaimer**  
 Fabric will be applied as swatched by the fabric manufacturer. Fabric that is required to be applied differently than is swatched will need a Special Cost Request written specifying the direction the fabric is to be applied. The posted standard lead time will apply to the Special Cost Request.



# Tech Preconfigured Intersection Conditions

4-Way

Delivered Pricing Fabric Grade 1 & C.O.M.	Delivered Pricing Fabric Grade 2	Delivered Pricing Fabric Grade 3 & Pallas Vertical Fabric Grade PV	Delivered Pricing Pallas Vertical Fabric Grade PV1	Delivered Pricing Pallas Vertical Fabric Grade PV2	Metallic Paint add to list price
					\$ 35
					38
					38
					40
					59
					38
					58
					38
					40
					38
\$ 341	\$ 347	\$ 352	\$ 357	\$ 367	\$ 15
423	431	436	444	454	15
501	511	519	528	542	15
529	539	544	556	573	15
615	628	634	646	664	15
542	551	558	571	586	15
624	636	641	656	672	15
496	507	515	524	538	15
587	597	605	616	634	15
577	588	595	606	625	15

**SPECIAL SERVICES**

**Special Carton Marking**

With specially marked information N/C

**Shipping**

Shipped **k.d. freight prepaid f.o.b. Manitowoc, Wisconsin 54220** factory. Freight class #70.

Specifications and prices are subject to change without prior notice.

# Tech Preconfigured Intersection Conditions

## Tech Panel Components

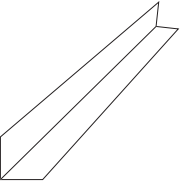
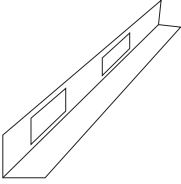
	MODEL	W	MODEL NUMBER		Approx. Packaged Weight
			Basic Model	Trim Color	
 <p>HRDPT</p>	<b>Single Side Base Raceway-No Grommet Holes</b>	12"	46.1220.12	<input type="checkbox"/>	1.0#
	<ul style="list-style-type: none"> <li>Allows Tech Panel on one side of panel and access to power/data cables on opposite side</li> <li>Solid bottom and hinged door</li> <li>SX Starlight Silver finish is only offered on flat aluminum trim</li> </ul>	18"	46.1220.18	<input type="checkbox"/>	1.0#
		24"	46.1220.24	<input type="checkbox"/>	1.0#
		30"	46.1220.30	<input type="checkbox"/>	2.0#
		36"	46.1220.36	<input type="checkbox"/>	3.0#
		42"	46.1220.42	<input type="checkbox"/>	3.0#
		48"	46.1220.48	<input type="checkbox"/>	3.0#
		54"	46.1220.54	<input type="checkbox"/>	3.0#
		60"	46.1220.60	<input type="checkbox"/>	4.0#
 <p>HRDPT</p>	<b>Single Side Raceway w/Grommet Holes</b>	24"	46.1215.24	<input type="checkbox"/>	1.0#
	<ul style="list-style-type: none"> <li>Allows Tech Panel on one side of panel and access power/data receptacles on opposite side</li> <li>Solid bottom and hinged door</li> <li>12" and 18" not available with grommet holes</li> <li>24" available with one grommet hole</li> <li>Each hole includes a standard filler plate</li> <li>Grommets ordered separately (included with duplex receptacles)</li> <li>SX Starlight Silver finish is only offered on flat aluminum trim</li> </ul>	30"	46.1215.30	<input type="checkbox"/>	2.0#
		36"	46.1215.36	<input type="checkbox"/>	2.0#
		42"	46.1215.42	<input type="checkbox"/>	3.0#
		48"	46.1215.48	<input type="checkbox"/>	3.0#
		54"	46.1215.54	<input type="checkbox"/>	3.0#
		60"	46.1215.60	<input type="checkbox"/>	4.0#

A

B

### HOW TO ORDER

Indicate the following information on order form:

- Quantity of each item.
- Model number, including options. See "How To Build a Model Number".
- Any special service required.

Note: • The  indicates that a choice is required.

- The absence of the  indicates that no choice is required.
- Alpha-numeric characters in place of  indicate that no other alternatives are available.

### HOW TO BUILD A MODEL NUMBER

**A** Select basic model.

**B** Select trim color.

Refer to color addendum at [ki.com](http://ki.com) or KI Fabrics & Finishes binder. Metallic paint requires upcharge. SX Starlight Silver finish is only offered on flat aluminum trim.



# Tech Preconfigured Intersection Conditions

Tech Panel Components

Delivered Pricing	Metallic Paint add to list price
\$ 33	\$ 6
36	7
44	9
50	11
52	11
68	15
68	11
68	19
84	26
\$ 44	\$ 11
50	11
52	11
68	15
68	19
68	11
84	26

## SPECIAL SERVICES

### Special Carton Marking

With specially marked information N/C



### Shipping

Shipped **k. d. freight prepaid f. o. b. Manitowoc, Wisconsin 54220** factory.  
Freight class #70.

Specifications and prices are subject to change without prior notice.

# Pedestals - Worksurface Supporting

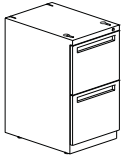
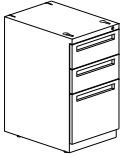
700 Series® Pedestals with Filler Bracket

MODEL	Features	MODEL NUMBER				Approx. Packaged Weight	
		Basic Model	Pull Option	Unit Color	Key Option		
 <p>S7PDU</p>	<b>Pedestal - FF</b> • Two 12" file drawers with hanging folder partitions • Includes four leveling glides • Includes painted steel filler bracket, factory attached to the rear of pedestal (also engages slots of WireWorks panels) • Includes filler bar painted to match pedestal	Supporting	SYS/1524WFF	<input type="checkbox"/> <input type="checkbox"/> <input type="checkbox"/> <input type="checkbox"/>	<input type="checkbox"/> <input type="checkbox"/>	<input type="checkbox"/> <input type="checkbox"/> <input type="checkbox"/>	59.0#
		Supporting	SYS/1530WFF	<input type="checkbox"/> <input type="checkbox"/> <input type="checkbox"/> <input type="checkbox"/>	<input type="checkbox"/> <input type="checkbox"/>	<input type="checkbox"/> <input type="checkbox"/> <input type="checkbox"/>	95.0#
 <p>S7PDU</p>	<b>Pedestal - BBF</b> • Two 6" box drawers • One 12" file drawer with hanging folder partition • Includes four leveling glides • Includes filler bar painted to match pedestal • Includes painted steel filler bracket, factory attached to the rear of pedestal (also engages slots of WireWorks panels)	Supporting	SYS/1524WBBF	<input type="checkbox"/> <input type="checkbox"/> <input type="checkbox"/> <input type="checkbox"/>	<input type="checkbox"/> <input type="checkbox"/>	<input type="checkbox"/> <input type="checkbox"/> <input type="checkbox"/>	80.0#
		Supporting	SYS/1530WBBF	<input type="checkbox"/> <input type="checkbox"/> <input type="checkbox"/> <input type="checkbox"/>	<input type="checkbox"/> <input type="checkbox"/>	<input type="checkbox"/> <input type="checkbox"/> <input type="checkbox"/>	93.0#
 <p>S7PDU</p>	<b>Pedestals - BBBB</b> • Four 6" box drawers • Includes four leveling glides • Includes painted steel filler bracket, factory attached to the rear of pedestal (also engages slots of WireWorks panels) • Includes filler bar painted to match pedestal	Supporting	SYS/1524WBBBB	<input type="checkbox"/> <input type="checkbox"/> <input type="checkbox"/> <input type="checkbox"/>	<input type="checkbox"/> <input type="checkbox"/>	<input type="checkbox"/> <input type="checkbox"/> <input type="checkbox"/>	70.0#
		Supporting	SYS/1530WBBBB	<input type="checkbox"/> <input type="checkbox"/> <input type="checkbox"/> <input type="checkbox"/>	<input type="checkbox"/> <input type="checkbox"/>	<input type="checkbox"/> <input type="checkbox"/> <input type="checkbox"/>	81.0#

**A**      **B**      **C**      **D**

## HOW TO ORDER

Indicate the following information on order form:

- Quantity of each item.
- Model number, including options. See "How To Build a Model Number".
- Any special service required.

- Note:
- The  indicates that a choice is required.
  - The absence of the  indicates that no choice is required.
  - Alpha-numeric characters in place of  indicate that no other alternatives are available.

## HOW TO BUILD A MODEL NUMBER

- A** Select basic model.
- B** Select pull option.
- ALBT** - Aluminum bow tie
  - ALMT** - Aluminum metric
  - ARCN** - Arc nickel
  - CLSC** - Classic (inset pull)
  - NKBT** - Nickel bow tie
  - NOPL** - No pull (pre-drilled for customer provided pull)
  - RETN** - Retro nickel
- C** Select unit and drawer color.  
Refer to color addendum at ki.com or KI Fabrics & Finishes binder.
- D** Select key option.
- KS** - Key standard
  - NLC** - No lock core
  - KA** - Key alike

## INFORMATION

**Height**  
All dimensions shown include 1/4" allowance for glides in recessed position.

**Accessories**  
See accessory section for accessories that can be ordered separately.

**Weights**  
Figures provided are approximate and reflect packaged product without additional accessories.





# Pedestals - Worksurface Supporting

700 Series® Pedestals with Filler Bracket

Delivered  
Pricing

\$ 753

785

\$ 826

870

\$ 839

915

### SPECIAL SERVICES

#### Special Carton Marking

With specially marked information N/C

#### Shipping

Shipped **k.d. freight prepaid f.o.b. Manitowoc, Wisconsin 54220** factory.  
Freight class #70.

Specifications and prices are subject to change without prior notice.

# WireWorks® C.O.M. Yardage Requirements

Tile Size	Actual Cut-Size	54" Non-Directional	54" Directional	66" Non-Directional	66" Directional	Tile Size	Actual Cut-Size	54" Non-Directional	54" Directional	66" Non-Directional	66" Directional
12 x 12	16 x 16	0.148	0.148	0.111	0.111	42 x 12	46 x 16	0.444	0.444	0.444	0.444
12 x 18	16 x 22	0.204	0.204	0.153	0.153	42 x 18	46 x 22	0.611	0.611	0.611	0.611
12 x 24	16 x 28	0.259	0.259	0.194	0.194	42 x 24	46 x 28	0.778	0.778	0.778	0.778
12 x 30	16 x 34	0.315	0.315	0.236	0.236	42 x 30	46 x 34	0.944	0.944	0.944	0.944
12 x 36	16 x 40	0.370	0.370	0.278	0.278	42 x 36	46 x 40	1.111	1.111	1.111	1.111
12 x 42	16 x 46	0.426	0.426	0.319	0.319	42 x 42	46 x 46	1.278	1.278	1.278	1.278
12 x 48	16 x 52	0.481	0.481	0.361	0.361	42 x 48	46 x 52	1.444	1.444	1.444	1.444
12 x 54	16 x 58	0.537	0.537	0.403	0.403	42 x 54	46 x 58	1.611	1.611	1.611	1.611
12 x 60	16 x 64	0.593	0.593	0.444	0.444	42 x 60	46 x 64	1.778	1.778	1.778	1.778
12 x 66	16 x 70	0.648	0.648	0.486	0.486	42 x 66	46 x 70	1.944	1.944	1.944	1.944
12 x 72	16 x 76	0.704	0.704	0.528	0.528	42 x 72	46 x 76	2.111	2.111	2.111	2.111
12 x 78	16 x 82	0.759	0.759	0.569	0.569	42 x 78	46 x 82	2.278	2.278	2.278	2.278
18 x 12	22 x 16	0.222	0.222	0.148	0.148	48 x 12	52 x 16	0.444	0.444	0.444	0.444
18 x 18	22 x 22	0.306	0.306	0.204	0.204	48 x 18	52 x 22	0.611	0.611	0.611	0.611
18 x 24	22 x 28	0.389	0.389	0.259	0.259	48 x 24	52 x 28	0.778	0.778	0.778	0.778
18 x 30	22 x 34	0.472	0.472	0.315	0.315	48 x 30	52 x 34	0.944	0.944	0.944	0.944
18 x 36	22 x 40	0.556	0.556	0.370	0.370	48 x 36	52 x 40	1.111	1.111	1.111	1.111
18 x 42	22 x 46	0.639	0.639	0.426	0.426	48 x 42	52 x 46	1.278	1.278	1.278	1.278
18 x 48	22 x 52	0.722	0.722	0.481	0.481	48 x 48	52 x 52	1.444	1.444	1.444	1.444
18 x 54	22 x 58	0.806	0.806	0.537	0.537	48 x 54	52 x 58	1.611	1.611	1.611	1.611
18 x 60	22 x 64	0.889	0.889	0.593	0.593	48 x 60	52 x 64	1.778	1.778	1.778	1.778
18 x 66	22 x 70	0.972	0.972	0.648	0.648	48 x 66	52 x 70	1.944	1.944	1.944	1.944
18 x 72	22 x 76	1.056	1.056	0.704	0.704	48 x 72	52 x 76	2.111	2.111	2.111	2.111
18 x 78	22 x 82	1.139	1.139	0.759	0.759	48 x 78	52 x 82	2.278	2.278	2.278	2.278
24 x 12	28 x 16	0.444	0.444	0.222	0.222	54 x 12	58 x 16			0.444	0.444
24 x 18	28 x 22	0.611	0.611	0.306	0.306	54 x 18	58 x 22			0.611	0.611
24 x 24	28 x 28	0.778	0.778	0.389	0.389	54 x 24	58 x 28			0.778	0.778
24 x 30	28 x 34	0.944	0.944	0.472	0.472	54 x 30	58 x 34			0.944	0.944
24 x 36	28 x 40	1.111	1.111	0.556	0.556	54 x 36	58 x 40			1.111	1.111
24 x 42	28 x 46	1.278	1.278	0.639	0.639	54 x 42	58 x 46			1.278	1.278
24 x 48	28 x 52	1.444	1.444	0.722	0.722	54 x 48	58 x 52			1.444	1.444
24 x 54	28 x 58	1.611	1.611	0.806	0.806	54 x 54	58 x 58			1.611	1.611
24 x 60	28 x 64	1.778	1.778	0.889	0.889	54 x 60	58 x 64			1.778	1.778
24 x 66	28 x 70	1.944	1.944	0.972	0.972	54 x 66	58 x 70			1.944	1.944
24 x 72	28 x 76	2.111	2.111	1.056	1.056	54 x 72	58 x 76			2.111	2.111
24 x 78	28 x 82	2.278	2.278	1.139	1.139	54 x 78	58 x 82			2.278	2.278
30 x 12	34 x 16	0.444	0.444	0.444	0.444	60 x 12	64 x 16			0.444	0.444
30 x 18	34 x 22	0.611	0.611	0.611	0.611	60 x 18	64 x 22			0.611	0.611
30 x 24	34 x 28	0.778	0.778	0.778	0.778	60 x 24	64 x 28			0.778	0.778
30 x 30	34 x 34	0.944	0.944	0.944	0.944	60 x 30	64 x 34			0.944	0.944
30 x 36	34 x 40	1.111	1.111	1.111	1.111	60 x 36	64 x 40			1.111	1.111
30 x 42	34 x 46	1.278	1.278	1.278	1.278	60 x 42	64 x 46			1.278	1.278
30 x 48	34 x 52	1.444	1.444	1.444	1.444	60 x 48	64 x 52			1.444	1.444
30 x 54	34 x 58	1.611	1.611	1.611	1.611	60 x 54	64 x 58			1.611	1.611
30 x 60	34 x 64	1.778	1.778	1.778	1.778	60 x 60	64 x 64			1.778	1.778
30 x 66	34 x 70	1.944	1.944	1.944	1.944	60 x 66	64 x 70			1.944	1.944
30 x 72	34 x 76	2.111	2.111	2.111	2.111	60 x 72	64 x 76			2.111	2.111
30 x 78	34 x 82	2.278	2.278	2.278	2.278	60 x 78	64 x 82			2.278	2.278
36 x 12	40 x 16	0.444	0.444	0.444	0.444	<b>PRTU (Raceway Tiles)</b>					
36 x 18	40 x 22	0.611	0.611	0.611	0.611	12 x 12	18 x 18	0.167	0.167	0.167	0.167
36 x 24	40 x 28	0.778	0.778	0.778	0.778	18 x 12	24 x 18	0.250	0.250	0.250	0.250
36 x 30	40 x 34	0.944	0.944	0.944	0.944	24 x 12	30 x 18	0.500	0.500	0.250	0.250
36 x 36	40 x 40	1.111	1.111	1.111	1.111	30 x 12	36 x 18	0.500	0.500	0.500	0.500
36 x 42	40 x 46	1.278	1.278	1.278	1.278	36 x 12	42 x 18	0.500	0.500	0.500	0.500
36 x 48	40 x 52	1.444	1.444	1.444	1.444	42 x 12	48 x 18	0.500	0.500	0.500	0.500
36 x 54	40 x 58	1.611	1.611	1.611	1.611	48 x 12	54 x 18	0.500	0.500	0.500	0.500
36 x 60	40 x 64	1.778	1.778	1.778	1.778	54 x 12	60 x 18			0.500	0.500
36 x 66	40 x 70	1.944	1.944	1.944	1.944	60 x 12	66 x 18			0.500	0.500
36 x 72	40 x 76	2.111	2.111	2.111	2.111						
36 x 78	40 x 82	2.278	2.278	2.278	2.278						



# WireWorks® C.O.M. Yardage Requirements

Tile Size	Actual Cut-Size	54" Non-Directional	54" Directional	66" Non-Directional	66" Directional
<b>TB (Tackboards)</b>					
24 x 12	30 x 18	0.500	0.500	0.250	0.250
30 x 12	36 x 18	0.500	0.500	0.500	0.500
36 x 12	42 x 18	0.500	0.500	0.500	0.500
42 x 12	48 x 18	0.500	0.500	0.500	0.500
48 x 12	54 x 18	0.500	0.500	0.500	0.500
54 x 12	60 x 18			0.500	0.500
60 x 12	66 x 18			0.500	0.500
24 x 16	30 x 22	0.611	0.611	0.306	0.306
30 x 16	36 x 22	0.611	0.611	0.611	0.611
36 x 16	42 x 22	0.611	0.611	0.611	0.611
42 x 16	48 x 22	0.611	0.611	0.611	0.611
48 x 16	54 x 22	0.611	0.611	0.611	0.611
54 x 16	60 x 22			0.611	0.611
60 x 16	66 x 22			0.611	0.611
24 x 30	30 x 36	1.000	1.000	0.500	0.500
30 x 30	36 x 36	1.000	1.000	1.000	1.000
36 x 30	42 x 36	1.000	1.000	1.000	1.000
42 x 30	48 x 36	1.000	1.000	1.000	1.000
48 x 30	54 x 36	1.000	1.000	1.000	1.000
54 x 30	60 x 36			1.000	1.000
60 x 30	66 x 36			1.000	1.000
24 x 48	30 x 54	1.500	1.500	0.750	0.750
30 x 48	36 x 54	1.500	1.500	1.500	1.500
36 x 48	42 x 54	1.500	1.500	1.500	1.500
42 x 48	48 x 54	1.500	1.500	1.500	1.500
48 x 48	54 x 54	1.500	1.500	1.500	1.500
54 x 48	60 x 54			1.500	1.500
60 x 48	66 x 54			1.500	1.500
<b>PRDF (Overhead Cabinet)</b>					
24	30 x 22	0.611	0.611	0.306	0.306
30	36 x 22	0.611	0.611	0.611	0.611
36	42 x 22	0.611	0.611	0.611	0.611
42	48 x 22	0.611	0.611	0.611	0.611
48	54 x 22	0.611	0.611	0.611	0.611
54	60 x 22			0.611	0.611
60	66 x 22			0.611	0.611
<b>UTHF (Universal Trim Height Change)</b>					
6	6 x 8	0.025	0.025	0.020	0.020
12	6 x 14	0.043	0.043	0.035	0.035
18	6 x 20	0.062	0.062	0.051	0.051
24	6 x 26	0.080	0.080	0.066	0.066
30	6 x 32	0.099	0.099	0.081	0.081
36	6 x 38	0.117	0.117	0.096	0.096
42	6 x 44	0.136	0.136	0.111	0.111
48	6 x 50	0.154	0.154	0.126	0.126
54	6 x 56	0.173	0.173	0.141	0.141
<b>UTFF (Universal Trim Full Height)</b>					
12	6 x 14	0.043	0.043	0.035	0.035
18	6 x 20	0.062	0.062	0.051	0.051
24	6 x 26	0.080	0.080	0.066	0.066
30	6 x 32	0.099	0.099	0.081	0.081
36	6 x 38	0.117	0.117	0.096	0.096
42	6 x 44	0.136	0.136	0.111	0.111
48	6 x 50	0.154	0.154	0.126	0.126
54	6 x 56	0.173	0.173	0.141	0.141
60	6 x 62	0.191	0.191	0.157	0.157
72	6 x 74	0.228	0.228	0.187	0.187

## Index

Model No.	Description	Page	Model No.	Description	Page
46.0073	8-Wire System: Bezel	174		Color Upper Door-Off-Module (OM12)	228
46.0078.MB.KIT	Brackets: Markerboard On-Module Bracket	258	BLCS30/WW/OM18	Overhead Storage: Balance® Overhead Cabinet-Solid	
46.0078.TB.KIT	Brackets: Tackboard On-Module Bracket	258		Color Upper Door-Off-Module (OM18)	228
46.0082.1	8-Wire System: 15 Amp Receptacle	174	BLCS30/WW/PM	Overhead Storage: Balance® Overhead Cabinet-Solid	
46.0096.PCK	Tile 90 Cable Guard	180		Color Upper Door-On Module (PM)	228
46.0097.PCK	Acoustical Tile Vertical Cable Guide	180	BLCS30/WW/UM	Overhead Storage: Balance® Overhead Cabinet-Solid	
46.0098.PCK	Horizontal Rail Cable Guard	182		Color Upper Door-Load Bar-Upmount	230
46.0099.PCK	Acoustical Tile Horizontal Cable Support	180	BMB30	Overhead Accessories: Tackboard/Tool Rail Attachment Bar	244
46.0200.PCK	Top Cap 90° Cable Guard	182	BOA/WW/LB	Overhead Accessories: Load Bar Brackets	240
46.0205.1	8-Wire System: 20 Amp Receptacle	174	BOA/WW/OM12	Overhead Accessories: Balance® Overhead Off-Module	
46.0206.4	8-Wire System: 15 Amp Surge Suppression Module	174		Mounting Bracket-12" Tiles	240
46.0233.SET	Overhead Accessories: Universal Overhead On-Module		BOA/WW/OM18	Overhead Accessories: Balance® Overhead Off-Module	
	Mounting Bracket	220		Mounting Bracket-18" Tiles	240
46.0234.SET	Overhead Accessories: Universal Overhead Off-Module		BOA/WW/PM	Overhead Accessories: Balance® Overhead On-Module	
	Mounting Bracket-12" Tiles	220		Mounting Bracket	240
46.0371.MB.KIT	Brackets: Markerboard Off-Module Bracket	258	BOA/WW/UM	Overhead Accessories: Upmount Brackets	242
46.0371.TB.KIT	Brackets: Tackboard Off-Module Bracket	258	BTLT5.24	Overhead Task Lights: Overhead Task Lights	246
46.0753.PCK	Cable Tile Anchor Pad	182	MB.MARKERKIT	Markerboards: Tray/Eraser/4 Markers	250
46.0955	Components: 120° Connector Block	284	MB.TRAY	Markerboards: Magnetic Tray	250
46.1027	Components: 120° 1-Way Top Cap	286	NSD	Overhead Accessories: Universal Shelf Dividers	222
46.1028	Components: 120° 2-Way Top Cap	286	P1202W30	2-Way: 120° 2-Way, Both Panels Same Height	264
46.1029	Components: 120° 3-Way Top Cap	286	P1203W30	3-Way: 120° 3-Way, All Panels Same Height	270
46.1032.30	Components: 120° Vertical Trim	286	P120F2W30	2-Way: 120° 2-Way, Both Panels Same Height	264
46.1037.12	Components: 120° Light Block	284	P120V1203036	3-Way: 120° 3-Way, Two Different Heights	272
46.1215.24	Tech Panel Components: Single Side Raceway w/ Grommet Holes	316	P120V1W3036	3-Way: 120° 3-Way, Two Different Heights	276
46.1220.12	Tech Panel Components: Single Side Base Raceway- No Grommet Holes	316	P120V2W3036	2-Way: 120° 2-Way, Two Different Heights	266
46.1229.SET	Overhead Accessories: Universal Overhead Off-Module		P120VF1203036	3-Way: 120° 3-Way, Two Different Heights	274
	Mounting Bracket-18" Tiles	220	P120VF1W3036	3-Way: 120° 3-Way, Two Different Heights	278
46.1234	Overhead Accessories: Upmount Brackets	220	P120VF2W3036	2-Way: 120° 2-Way, Two Different Heights	268
46.2103	Overhead Accessories: Load Bar Brackets	220	PBF8	8-Wire System: Universal Base Infeed	178
BLCF30/WW/LB	Overhead Storage: Balance® Overhead Cabinet-Fabric		PCEM.24	8-Wire System: Chicago Electrical Mounting Bar	174
	Upper Door-Load Bar Mount	234	PCH.CL	Coat Hooks/Picture Hanger	88
BLCF30/WW/OM12	Overhead Storage: Balance® Overhead Cabinet-Fabric		PCMDP	Cable Management Demo Pack	182
	Upper Door-Off-Module	232	PCOT36	Door Pass-Through	88
BLCF30/WW/OM18	Overhead Storage: Balance® Overhead Cabinet-Fabric		PCP9030	90° 2-Way and End-of-Run: 90° 2-Way "L" Corner,	
	Upper Door-Off-Module	232		Both Panels Same Height	90
BLCF30/WW/PM	Overhead Storage: Balance® Overhead Cabinet-Fabric		PCPF9030	90° 2-Way and End-of-Run: 90° 2-Way "L" Corner,	
	Upper Door-On-Module	232		Both Panels Same Height	90
BLCF30/WW/UM	Overhead Storage: Balance® Overhead Cabinet-Fabric		PCPV903036	90° 2-Way: 90° 2-Way "L" Corner, Two Different Heights	92
	Upper Door-Upmount	234	PCPV905460	90° 2-Way: 90° 2-Way "L" Corner, Two Different Heights	94
BLCL30/WW/LB	Overhead Storage: Balance® Overhead Cabinet-Lami- nate Upper Door-Load Bar Mount	238	PCPVF903036	90° 2-Way: 90° 2-Way "L" Corner, Two Different Heights	96
BLCL30/WW/OM12	Overhead Storage: Balance® Overhead Cabinet-Lami- nate Upper Door-Off-Module	236	PCPVF905460	90° 2-Way: 90° 2-Way "L" Corner, Two Different Heights	98
BLCL30/WW/OM18	Overhead Storage: Balance® Overhead Cabinet-Lami- nate Upper Door-Off-Module	236	PDEMB.OM.3030	Markerboards: Markerboards	250
BLCL30/WW/PM	Overhead Storage: Balance® Overhead Cabinet-Lami- nate Upper Door-On-Module	236	PDF8.7	10-Wire System 6 Circuit "810": Data Feed	154
BLCL30/WW/UM	Overhead Storage: Balance® Overhead Cabinet-Lami- nate Upper Door-Upmount	238	PDRR36/L	Door	88
BLCS30/WW/LB	Overhead Storage: Balance® Overhead Cabinet-Solid		PDRTH36	Door Threshold	88
	Color Upper Door-Load Bar Mount	230	PDS8.12.BL	10-Wire System 6 Circuit "810": Power/Data Separation Septum	148
BLCS30/WW/OM12	Overhead Storage: Balance® Overhead Cabinet-Solid		PEP30	90° 2-Way and End-of-Run: End-of-Run Condition	90
			PFFA1230	Fully Segmented/Fully Segmented Panel: Fully Seg- mented/Fully Segmented Panel - 30"H with 12"H tiles	50
			PFFA1242	Fully Segmented/Fully Segmented Panel: Fully Seg- mented/Fully Segmented Panel - 42"H with 12"H tiles	50
			PFFA1254	Fully Segmented/Fully Segmented Panel: Fully Seg- mented/Fully Segmented Panel - 54"H with 12"H tiles	52
			PFFA1266	Fully Segmented/Fully Segmented Panel: Fully Seg- mented/Fully Segmented Panel - 66"H with 12"H tiles	52
			PFFA1284	Fully Segmented/Fully Segmented Panel: Fully Seg-	



Model No.	Description	Page	Model No.	Description	Page
PFFGA1254	mented/Fully Segmented Panel - 84"H with 12"H tiles Fully Segmented/Fully Segmented/Glass Panel: Fully Segmented/Fully Segmented/Glass Panel - 54"H	52 64	PMFGA1266	Monolithic/Fully Segmented/Glass Panel: Monolithic/ Fully Segmented/Glass Panel - 66"H	60
PFFGA1266	Fully Segmented/Fully Segmented/Glass Panel: Fully Segmented/Fully Segmented/Glass Panel - 66"H	64	PMFGA1284	Monolithic/Fully Segmented/Glass Panel: Monolithic/ Fully Segmented/Glass Panel - 84"H	62
PFFGA1284	Fully Segmented/Fully Segmented/Glass Panel: Fully Segmented/Fully Segmented/Glass Panel - 84"H	66	PMH21242	Monolithic/Half Segmented Panel: Monolithic/Half Segmented Panel - 42"H with 12"H Tiles	18
PFP30	180° 2-Way: 180° 2-Way In-Line Connection, Both Panels Same Height	104	PMH21254	Monolithic/Half Segmented Panel: Monolithic/Half Segmented Panel - 54"H with 12"H Tiles	20
PFPV3036	180° 2-Way: 180° 2-Way In-Line Connection, Two Different Heights	104	PMH21266	Monolithic/Half Segmented Panel: Monolithic/Half Segmented Panel - 66"H with 12"H Tiles	20
PG1254	Full Glass Panel: Full Glass Panel - 54"H	56	PMH81248	Monolithic/Half Segmented Panel: Monolithic/Half Segmented Panel - 48"H with 18"H Tiles	14
PG1266	Full Glass Panel: Full Glass Panel - 66"H	56	PMH81266	Monolithic/Half Segmented Panel: Monolithic/Half Segmented Panel - 66"H with 18"H Tiles	14
PG1284	Full Glass Panel: Full Glass Panel - 84"H	56	PMH81284	Monolithic/Half Segmented Panel: Monolithic/Half Segmented Panel - 84"H with 18"H Tiles	16
PHFA1242	Half Segmented/Fully Segmented Panel: Half Segmented/Fully Segmented Panel - 42"H with 12"H tiles	46	PMHA1242	Monolithic/Half Segmented Panel: Monolithic/Half Segmented Panel - 42"H with 12"H tiles	34
PHFA1254	Half Segmented/Fully Segmented Panel: Half Segmented/Fully Segmented Panel - 54"H with 12"H tiles	46	PMHA1254	Monolithic/Half Segmented Panel: Monolithic/Half Segmented Panel - 54"H with 12"H tiles	34
PHFA1266	Half Segmented/Fully Segmented Panel: Half Segmented/Fully Segmented Panel - 66"H with 12"H tiles	48	PMHA1266	Monolithic/Half Segmented Panel: Monolithic/Half Segmented Panel - 66"H with 12"H tiles	36
PHFA1284	Half Segmented/Fully Segmented Panel: Half Segmented/Fully Segmented Panel - 84"H with 12"H tiles	48	PMHA1284	Monolithic/Half Segmented Panel: Monolithic/Half Segmented Panel - 84"H with 12"H tiles	36
PHH21242	Half Segmented/Half Segmented Panel: Half Segmented/Half Segmented Panel - 42"H with 12"H Tiles	10	PMMA1230	Monolithic Panel: Monolithic Panel - 30"H	30
PHH21254	Half Segmented/Half Segmented Panel: Half Segmented/Half Segmented Panel - 54"H with 12"H Tiles	10	PMMA1242	Monolithic Panel: Monolithic Panel - 42"H	30
PHH21266	Half Segmented/Half Segmented Panel: Half Segmented/Half Segmented Panel - 66"H with 12"H Tiles	12	PMMA1254	Monolithic Panel: Monolithic Panel - 54"H	30
PHH81230	Half Segmented/Half Segmented Panel: Half Segmented/Half Segmented Panel - 30"H with 18"H Tiles	6	PMMA1266	Monolithic Panel: Monolithic Panel - 66"H	32
PHH81248	Half Segmented/Half Segmented Panel: Half Segmented/Half Segmented Panel - 48"H with 18"H Tiles	6	PMMA1284	Monolithic Panel: Monolithic Panel - 84"H	32
PHH81266	Half Segmented/Half Segmented Panel: Half Segmented/Half Segmented Panel - 66"H with 18"H Tiles	8	PMMGA1254	Monolithic/Monolithic/Glass Panel: Monolithic/Monolithic/Glass Panel - 54"H	58
PHH81284	Half Segmented/Half Segmented Panel: Half Segmented/Half Segmented Panel - 84"H with 18"H Tiles	8	PMMGA1266	Monolithic/Monolithic/Glass Panel: Monolithic/Monolithic/Glass Panel - 66"H	58
PHHA1242	Half Segmented/Half Segmented Panel: Half Segmented/Half Segmented Panel - 42"H with 12"H tiles	42	PMMGA1284	Monolithic/Monolithic/Glass Panel: Monolithic/Monolithic/Glass Panel - 84"H	58
PHHA1254	Half Segmented/Half Segmented Panel: Half Segmented/Half Segmented Panel - 54"H with 12"H tiles	42	PMMGB1242	Monolithic/Glass/Monolithic/Glass Panel: Monolithic/Glass/Monolithic/Glass Panel - 42"H	22
PHHA1266	Half Segmented/Half Segmented Panel: Half Segmented/Half Segmented Panel - 66"H with 12"H tiles	44	PMMGB1248	Monolithic/Glass/Monolithic/Glass Panel: Monolithic/Glass/Monolithic/Glass Panel - 48"H	22
PHHA1284	Half Segmented/Half Segmented Panel: Half Segmented/Half Segmented Panel - 84"H with 12"H tiles	44	PMMGB1254	Monolithic/Glass/Monolithic/Glass Panel: Monolithic/Glass/Monolithic/Glass Panel - 54"H	22
PHJMP8.17	8-Wire System: 17" Panel to Panel Jumper	178	PMMGB1266	Monolithic/Glass/Monolithic/Glass Panel: Monolithic/Glass/Monolithic/Glass Panel - 66"H	24
PHJMP8.21	8-Wire System: 21" Panel to Panel Jumper	178	PMMGB1284	Monolithic/Glass/Monolithic/Glass Panel: Monolithic/Glass/Monolithic/Glass Panel - 84"H	24
PIF.NY.24	8-Wire System: New York Power Infeed Kit	176	PMMOA1242	Monolithic/Monolithic/Open Panel: Monolithic/Monolithic/Open Panel - 42"H	78
PMB.OM.3032	Markerboards: Markerboards	250	PMMOA1254	Monolithic/Monolithic/Open Panel: Monolithic/Monolithic/Open Panel - 54"H	78
PMFA1230	Monolithic/Fully Segmented Panel: Monolithic/Fully Segmented Panel - 30"H with 12"H tiles	38	PMMOA1266	Monolithic/Monolithic/Open Panel: Monolithic/Monolithic/Open Panel - 66"H	80
PMFA1242	Monolithic/Fully Segmented Panel: Monolithic/Fully Segmented Panel - 42"H with 12"H tiles	38	PMMOA1284	Monolithic/Monolithic/Open Panel: Monolithic/Monolithic/Open Panel - 84"H	80
PMFA1254	Monolithic/Fully Segmented Panel: Monolithic/Fully Segmented Panel - 54"H with 12"H tiles	40	PO1230	Full Open Panel: Full Open Panel - 30"H	70
PMFA1266	Monolithic/Fully Segmented Panel: Monolithic/Fully Segmented Panel - 66"H with 12"H tiles	40	PO1242	Full Open Panel: Full Open Panel - 42"H	70
PMFA1284	Monolithic/Fully Segmented Panel: Monolithic/Fully Segmented Panel - 84"H with 12"H tiles	40	PO1254	Full Open Panel: Full Open Panel - 54"H	70
PMFGA1254	Monolithic/Fully Segmented/Glass Panel: Monolithic/ Fully Segmented/Glass Panel - 54"H	60	PO1266	Full Open Panel: Full Open Panel - 66"H	72
			PO1284	Full Open Panel: Full Open Panel - 84"H	72
			POMMA1242	Open/Monolithic/Monolithic Panel: Open/Monolithic/ Monolithic Panel - 42"H	74



## Index

Model No.	Description	Page	Model No.	Description	Page
POMMA1254	Open/Monolithic/Monolithic Panel: Open/Monolithic/Monolithic Panel - 54"H	74	PRDV24/WW/PM	Overhead Storage: Veneer Door Overhead Cabinet-On-Module (PM)	212
POMMA1266	Open/Monolithic/Monolithic Panel: Open/Monolithic/Monolithic Panel - 66"H	76	PRDV24/WW/UM	Overhead Storage: Veneer Door Overhead Cabinet-Upmount	214
POMMA1284	Open/Monolithic/Monolithic Panel: Open/Monolithic/Monolithic Panel - 84"H	76	PRK.HW	8-Wire System: Chicago Code Receptacle Kit	174
POMP30	Off-Module Post: Off-Module Post	100	PRW8.24	8-Wire System: Rigid Wireway Add-On Kit	170
POMPS.30	Off-Module Post: Off-Module Post	100	PS1202W12	2-Way and 3-Way Stackable: 2-Way Stackable	280
PPAT	Desktop Accessories: Accessory Tray	262	PS1203W12	2-Way and 3-Way Stackable: 3-Way Stackable	280
PPDS	Paper Management: Plastic Diagonal Storage Unit	260	PS120F2W12	2-Way and 3-Way Stackable: 2-Way Stackable	280
PPLL	Paper Management: Plastic Paper Tray Unit	260	PSA1212	Stackable Fabric Section - 12"H	82
PPMTR18	Paper Management: On-Module Tool Rail	260	PSA1218	Stackable Fabric Section - 18"H	82
PPPC	Desktop Accessories: Pencil Cup	262	PSA1224	Stackable Fabric Section - 24"H	82
PPT8.12	8-Wire System: Power Pass Through	170	PSCP9012	2-Way and 3-Way: Stackable Panel-90° 2-Way "L" Corner, Both Panels Same Height	142
PPTC	Desktop Accessories: Telephone Caddy	262	PSCPF9012	2-Way, 3-Way and 4-Way: Stackable Panel-90° 2-way "L" Corner, Both Panels Same Height	144
PPVS	Paper Management: Plastic Vertical Storage Unit	260	PSEP12	180° 2-Way and End-of-Run: Stackable Panel - End-Of-Run Condition	140
PRCP815.1	8-Wire System: 15 Amp Duplex Receptacle w/Bezel	172	PSFP12	180° 2-Way and End-of-Run: Stackable Panel-180° 2-Way In-Line Connection, Both Same Height	140
PRCP820.1	8-Wire System: 20 Amp Simplex Receptacle and Bezel	172	PSG1212	Stackable Glass Section - 12"H	84
PRCPS815.4	8-Wire System: 15 Amp Surge Suppression Module	172	PSG1218	Stackable Glass Section - 18"H	84
PRDF24/WW/LB	Overhead Storage: Fabric Door Overhead Cabinet-Load Bar Mount	208	PSG1224	Stackable Glass Section - 24"H	84
PRDF24/WW/OM12	Overhead Storage: Fabric Door Overhead Cabinet-Off-Module	208	PSO1212	Stackable Open Section - 12"H	86
PRDF24/WW/OM18	Overhead Storage: Fabric Door Overhead Cabinet-Off-Module	208	PSO1218	Stackable Open Section - 18"H	86
PRDF24/WW/PM	Overhead Storage: Fabric Door Overhead Cabinet-On-Module	208	PSO1224	Stackable Open Section - 24"H	86
PRDF24/WW/UM	Overhead Storage: Fabric Door Overhead Cabinet-Upmount	208	PSP18030	180° 2-Way: 180° 2-Way In-Line Spacer, Both Panels Same Height	106
PRDL24/WW/LB	Overhead Storage: Laminate Door Overhead Cabinet-Load Bar Mount (LB)	210	PSPF18030	180° 2-Way: 180° 2-Way In-Line Spacer, Both Panels Same Height	106
PRDL24/WW/OM12	Overhead Storage: Laminate Door Overhead Cabinet-Off-Module (OM12)	210	PSPV1803036	180° 2-Way: 180° 2-Way In-Line Spacer, Two Different Heights	108
PRDL24/WW/OM18	Overhead Storage: Laminate Door Overhead Cabinet-Off-Module (OM18)	210	PSPVF1803036	180° 2-Way: 180° 2-Way In-Line Spacer, Two Different Heights	110
PRDL24/WW/PM	Overhead Storage: Laminate Door Overhead Cabinet-On-Module (PM)	210	PSSP18012	180° 2-Way and End-of-Run: Stackable Panel-180° 2-Way In-Line Spacer, Both Same Height	140
PRDL24/WW/UM	Overhead Storage: Laminate Door Overhead Cabinet-Upmount	210	PSSPF18012	180° 2-Way and End-of-Run: Stackable Panel-180° 2-Way In-Line Spacer, Both Panels Same Height	140
PRDS24/WW/LB	Overhead Storage: Steel Door Overhead Cabinet-Load Bar Mount	206	PSTP3W12	2-Way and 3-Way: Stackable Panel - 3-Way "T" Intersection/3-Way, All Panels Same Height	142
PRDS24/WW/OM12	Overhead Storage: Steel Door Overhead Cabinet-Off-Module	206	PSTPF3W12	2-Way, 3-Way and 4-Way: Stackable Panel - 3-Way "T" Intersection/3-Way, All Panels Same Height	144
PRDS24/WW/OM18	Overhead Storage: Steel Door Cabinet-Off-Module	206	PSWM12	2-Way and 3-Way: Stackable/Adjustable Wall Mount	142
PRDS24/WW/PM	Overhead Storage: Steel Door Overhead Cabinet-On-Module	206	PSXP4W12	2-Way, 3-Way and 4-Way: Stackable Panel-4Way "X" Intersection/4-Way Top Cap, All Same Height	144
PRDS24/WW/UM	Overhead Storage: Steel Door Overhead Cabinet-Upmount	206	PTB2412/OM	Tackboard: Tackboard	252
PRDV24/WW/LB	Overhead Storage: Veneer Door Overhead Cabinet-Load Bar Mount (LB)	214	PTB2420/OM	Tackboard: Tackboard	254
PRDV24/WW/OM12	Overhead Storage: Veneer Door Overhead Cabinet-Off-Module (OM12)	212	PTB2448/OM	Tackboard: Tackboard	256
PRDV24/WW/OM18	Overhead Storage: Veneer Door Overhead Cabinet-Off-Module (OM18)	212	PTB02412	Overhead Accessories: Overhead Tackboard	222
			PTF8.7	8-Wire System: Top Feed	176
			PTP3W30	3-Way: 3-Way "T" Intersection w/3-Way Cap, All Panels Same Height - AAA	112
			PTPF3W30	3-Way: 3-Way "T" Intersection w/3-Way Cap, All Panels Same Height - AAA	112
			PTPV1803036	3-Way: 3-Way "T" Intersection w/180° Top Cap, Two Different Heights - ABA	122
			PTPV1W3036	3-Way: 3-Way "T" Intersection w/1-Way Cap, Two Different Heights - BBA or BAB	118
			PTPV903036	3-Way: 3-Way "T" Intersection w/90° Top Cap, Two Different Heights - BAA	114



Model No.	Description	Page	Model No.	Description	Page
PTPVF1803036	3-Way: 3-Way "T" Intersection w/180° Top Cap, Two Different Heights - ABA	124	PWET6PP.12	Jumper - 6 Circuit 10-Wire System 6 Circuit "810": Power Pass Through - 6 Circuit	152 148
PTPVF1W3036	3-Way: 3-Way "T" Intersection w/1-Way Cap, Two Different Heights - BBA or BAB	120	PWET6RC.1	10-Wire System 6 Circuit "810": 15 Amp Duplex Receptacle with Bezel - 6 Circuit	150
PTPVF903036	3-Way: 3-Way "T" Intersection w/90° Top Cap, Two Different Heights - BAA	116	PWET6TBF	10-Wire System 6 Circuit "810": Tech Panel Base Infeed - 6 Circuit	154
PVJMP8.23	8-Wire System: 23" Vertical Jumper	178	PWET6TF7	10-Wire System 6 Circuit "810": Top Feed with 7' or 10' Pole - 6 Circuit	154
PVJMP8.53	8-Wire System: 53" Vertical Jumper	178	PWET6VJ.20	10-Wire System 6 Circuit "810": 20" Vertical Jumper - 6 Circuit	152
PW120243624	Corner Worksurfaces: Inside Corner Worksurface with 120° Ends	282	PWET6VJ.56	10-Wire System 6 Circuit "810": 56" Vertical Jumper - 6 Circuit	152
PW9024	Countertops: 90° Corner Countertops	194	PWET6WW.24	10-Wire System 6 Circuit "810": Rigid Wireway - 6 Circuit	146
PWC243624	Dual Curvilinear/Diag/Curvilinear 90° Corner: Curvilinear 90° Corner Worksurfaces	192	PWIC120243624	Corner Worksurfaces: Inside Corner Worksurface with 90° Ends	282
PWCE2652	Square Shoe/Conference End: Conference End Worksurface	188	PWM30	Adjustable Wall Mount: Adjustable Wall Mount	102
PWCT24	Countertops: Straight Countertops	194	PWOC120243624	Corner Worksurfaces: Outside Corner Worksurface with 90° Ends	282
PWCTWC24	Countertops: Straight Countertops - Wheelchair Height	194	PWP3048	"D" Shaped Peninsula: "D" Shaped Peninsula Worksurfaces	190
PWCTWC9024	Countertops: 90° Countertops - Wheelchair Height	194	PWPP244860	"P" Shaped Peninsula/Piano Peninsula: Piano Peninsula Worksurfaces	186
PWD243624	Dual Curvilinear/Diag/Curvilinear 90° Corner: Diagonal 90° Corner Worksurface	192	PWPT244860	"P" Shaped Peninsula/Piano Peninsula: "P" Shaped Peninsula Worksurfaces	186
PWDCE244224	Dual Curvilinear/Diag/Curvilinear 90° Corner: Dual Curvilinear/Diag/Curvilinear 90° Corner	192	PWR2424	Rectangular: Rectangular Worksurfaces - 24" D	184
PWET420R.1	10-Wire System 4 Circuit "810": 20 Amp Simplex Receptacle with Bezel - 4 Circuit	162	PWR3024	Rectangular: Rectangular Worksurfaces - 30" D	184
PWET4BFU	10-Wire System 4 Circuit "810": Universal Base Infeed with Bezel - 4 Circuit	166	PWSB.L	Worksurface Accessories: Worksurface Support Bracket	204
PWET4ID	10-Wire System 4 Circuit "810": Internal Duplex Assembly - 4 Circuit	164	PWSMP3048	"D" Shaped Peninsula: "D" Shaped Peninsula Worksurface Mounts to Another Worksurface	190
PWET4NYBF.72	10-Wire System 4 Circuit "810": New York Power Infeed with Bezel - 4 Circuit	168	PWSS244860	Square Shoe/Conference End: Square Shoe Worksurfaces	188
PWET4NYTF.216	10-Wire System 4 Circuit "810": New York Power Infeed Kit/Ceiling - 4 Circuit	168	PWSSL2426	Worksurface Support Panel: Worksurface Support Panel (Laminate Both Sides)	202
PWET4PJ.17	10-Wire System 4 Circuit "810": 17" Panel to Panel Jumper - 4 Circuit	164	PWSSP2426/BN	Worksurface Support Panel: Worksurface Support Panel (Fabric/Laminate)	200
PWET4PJ.20	10-Wire System 4 Circuit "810": 20" Panel to Panel Jumper - 4 Circuit	164	PWT30	Adjustable Wall Mount: Wall Track	102
PWET4PP.12	10-Wire System 4 Circuit "810": Power Pass Through - 4 Circuit	160	PXP4W30	4-Way: 4-Way "X" Intersection with 4-Way Top Cap, All Panels Same Height	126
PWET4RC.1	10-Wire System 4 Circuit "810": 15 Amp Duplex Receptacle with Bezel - 4 Circuit	162	PXPV1803036	4-Way: 4-Way "X" Intersection w/180° Top Cap, Two Different Heights - ABAB	136
PWET4TBF	10-Wire System 4 Circuit "810": Tech Panel Base Infeed - 4 Circuit	166	PXPV3W3036	4-Way: 4-Way "X" Intersection with 3-Way Top Cap, Two Different Heights - AAAB	128
PWET4TF7	10-Wire System 4 Circuit "810": Top Infeed with 7' or 10' Pole - 4 Circuit	166	PXPV903036	4-Way: 4-Way "X" Intersection w/90° Top Cap, Two Different Heights - AABB	132
PWET4VJ.20	10-Wire System 4 Circuit "810": 20" Vertical Jumper - 4 Circuit	164	PXPVF1803036	4-Way: 4-Way "X" Intersection w/180° Top Cap, Two Different Heights - AABB	138
PWET4VJ.56	10-Wire System 4 Circuit "810": 56" Vertical Jumper - 4 Circuit	164	PXPVF3W3036	4-Way: 4-Way "X" Intersection with 3-Way Top Cap, Two Different Heights - AAAB	130
PWET4WW.24	10-Wire System 4 Circuit "810": Rigid Wireway - 4 Circuit	158	PXPVF903036	4-Way: 4-Way "X" Intersection w/90° Top Cap, Two Different Heights - AABB	134
PWET620R.1	10-Wire System 6 Circuit "810": 20 Amp Simplex Receptacle with Bezel - 6 Circuit	150	RSD4266FHC/CP/WW	Door Sliding	88
PWET6BFU	10-Wire System 6 Circuit "810": Universal Base Infeed with Bezel - 6 Circuit	154	SAIL.48.SX	Panel Mount Task Light: Sail	248
PWET6ID	10-Wire System 6 Circuit "810": Internal Duplex Assembly - 6 Circuit	152	SWLB.24	Overhead Accessories: Wall Mounted Load Bar	222
PWET6NYBF.72	10-Wire System 6 Circuit "810": New York Power Infeed with Bezel - 6 Circuit	156	SYS/1524WBBBB	700 Series® Pedestals with Filler Bracket: Pedestals - BBBB	318
PWET6NYTF.216	10-Wire System 6 Circuit "810": New York Power Infeed Kit/Ceiling - 6 Circuit	156	SYS/1524WBBF	700 Series® Pedestals with Filler Bracket: Pedestal - BBF	318
PWET6PJ.17	10-Wire System 6 Circuit "810": 17" Panel to Panel Jumper - 6 Circuit	152	SYS/1524WFF	700 Series® Pedestals with Filler Bracket: Pedestal - FF	318
PWET6PJ.20	10-Wire System 6 Circuit "810": 20" Panel to Panel Jumper - 6 Circuit	152	TCP90/30	90° 2-Way and End-of-Run: 90° 2-Way "L" Corner, Both Panels Same Height	288
			TCPF90/30	90° 2-Way and End-of-Run: 90° 2-Way "L" Corner,	

# Index

Model No.	Description	Page	Model No.	Description	Page
	Both Panels Same Height	288		Overhead Storage: Regular Shelf-On-Module	218
TCPV90/3036	90° 2-Way: 90° 2-Way "L" Corner, Two Different Heights	290	URSR24/WW/UM		
TCPV90/4854	90° 2-Way: 90° 2-Way "L" Corner, Two Different Heights	292		Overhead Storage: Regular Shelf-Upmount	218
TCPVF90/3036	90° 2-Way: 90° 2-Way "L" Corner, Two Different Heights	294	WMSCPW52	Mobile Teardrop/Mobile Semi-Circle: Mobile Semi-Circle Worksurface	196
TCPVF90/4854	90° 2-Way: 90° 2-Way "L" Corner, Two Different Heights	296	WMTPW2446	Mobile Teardrop/Mobile Semi-Circle: Mobile Teardrop Worksurface	196
TEP/30	90° 2-Way and End-of-Run: End-of-Run Condition	288	WQRPW24	Mobile Teardrop/Mobile Semi-Circle: Quarter Round Transitional Worksurface	198
TFP/30	180° 2-Way: 180° 2-Way In-Line Connection, Both Panels Same Height	298	WSG	Worksurface Accessories: Grommets - Field-Installed	204
TFPV/3036	180° 2-Way: 180° 2-Way In-Line Connection, Two Different Heights	298	WSVF.24	Worksurface Accessories: Worksurface Vertical Filler	204
TLPM24	Panel Mount Task Light: Panel Mount Task Light	248	WWM	Worksurface Accessories: Worksurface Wire Manager	204
TLT5.18	Shelf/Cabinet Task Light: Shelf/Cabinet Task Light	224			
TPV180/3036	180° 2-Way: 180° 2-Way In-Line Spacer, Two Different Heights	302			
TSP180/30	180° 2-Way: 180° 2-Way In-Line Spacer, Both Panels Same Height	300			
TSPF180/30	180° 2-Way: 180° 2-Way In-Line Spacer, Both Panels Same Height	300			
TSPVF180/3036	180° 2-Way: 180° 2-Way In-Line Spacer, Two Different Heights	302			
TTP3W/30	3-Way: 3-Way "T" Intersection w/3-Way Cap, All Panels Same Height	304			
TTPF3W/30	3-Way: 3-Way "T" Intersection w/3-Way Cap, All Panels Same Height	304			
TTPV180/3036	3-Way: 3-Way "T" Intersection w/180° Top Cap, Two Different Heights	308			
TTPV90/3036	3-Way: 3-Way "T" Intersection w/90° Top Cap, Two Different Heights	306			
TTPVF180/3036	3-Way: 3-Way "T" Intersection w/180° Top Cap, Two Different Heights	308			
TTPVF90/3036	3-Way: 3-Way "T" Intersection w/90° Top Cap, Two Different Heights	306			
TXP4W/30	4-Way: 4-Way "X" Intersection with 4-Way Top Cap, All Panels Same Height	310			
TXPV180/3036	4-Way: 4-Way "X" Intersection with 180° Top Cap, Two Different Heights	314			
TXPV3W/3036	4-Way: 4-Way "X" Intersection with 3-Way Top Cap, Two Different Heights	310			
TXPV90/3036	4-Way: 4-Way "X" Intersection with 90° Top Cap, Two Different Heights	312			
TXPVF180/3036	4-Way: 4-Way "X" Intersection with 180° Top Cap, Two Different Heights	314			
TXPVF3W/3036	4-Way: 4-Way "X" Intersection with 3-Way Top Cap, Two Different Heights	310			
TXPVF90/3036	4-Way: 4-Way "X" Intersection with 90° Top Cap, Two Different Heights	312			
ULSR24/WW/LB	Overhead Storage: Low Shelf-Load Bar Mount	216			
ULSR24/WW/OM12	Overhead Storage: Low Shelf-Off-Module	216			
ULSR24/WW/OM18	Overhead Storage: Low Shelf-Off-Module	216			
ULSR24/WW/PM	Overhead Storage: Low Shelf-On-Module	216			
ULSR24/WW/UM	Overhead Storage: Low Shelf-Upmount	216			
URSR24/WW/LB	Overhead Storage: Regular Shelf-Load Bar Mount	218			
URSR24/WW/OM12	Overhead Storage: Regular Shelf-Off-Module	218			
URSR24/WW/OM18	Overhead Storage: Regular Shelf-Off-Module	218			
URSR24/WW/PM					







KI  
1330 Bellevue Street  
P.O. Box 8100  
Green Bay, Wisconsin 54308-8100  
1-800-424-2432  
[www.ki.com](http://www.ki.com)

KI and Furnishing Knowledge  
are registered trademarks  
of Krueger International, Inc.

© 2011 KI  
All Rights Reserved.  
Litho in USA.  
Code KI-11392R1/KI/PDF/211

Printed using only water-based inks,  
including metallics. Please recycle.