

2015 PRICE LIST

COMMUNITY

EFFECTIVE 15 OCTOBER 2015

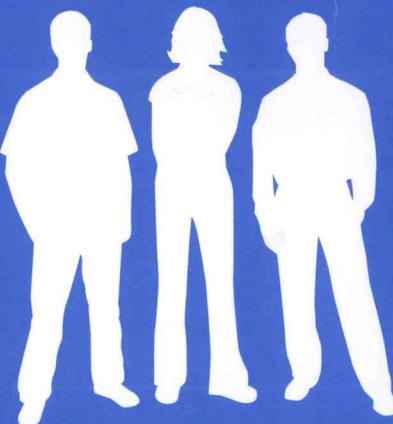

Effective **November 1, 2016**
5.0%
 Price Increase on the
Community 2015 Price List
 List Prices reflect price increase

Table of Contents

Environmental Mission	2	Sayde	186-187
Terms and Conditions	3-5	Sterling	188-191
Ordering Information	6	Sultan	192-193
Custom Options	7-8	Trinity	194-195
Finish Information	9	Walker	196-197
Fabric Information	10-20	Wink	198-201
Planning	21-24		
Product Information	25	Lounge	
GSA Terms and Conditions	26-28	Bairden	203-205
Seating		Cadet	206-209
Accolade	32-35	Callaway	210-214
Addison	36-37	Corbin	215-220
Alden	38-41	Encore	221-237
Alpine	42-45	Esque	238-239
Americana	46-51	Regal	240-243
Americana II	52-54	Richmond	244-246
Avalon	55-66		
Avini	67-70	Tables	
Bison	71-73	Table Options	249
Boston	74-77	Multi-Purpose Tables	250-287
Brockton	78-79	Jefferson	250-252
Calculus	80-85	Lincoln	253-255
Carriage	86-88	Menu	256-258
Chancellor	89-91	Menu Bases	259-262
Chandler	92-97	Fresco	263-265
Class Act	98-103	Prep	266-283
Classmate	104-107	Stockton Science Tables	284-287
Classmate II	108-111	Training Tables	288-314
Collegian & Collegian II	112-114	Cruz Training Tables	289-302
Cym	115-122	Prep Training Tables	303-314
Dexter	123-124	Lounge Tables	315-325
Dimension	125-127	Callaway Lounge Tables	316-317
Emerson	128-129	Encore Lounge Tables	318-321
Finley	130-132	Laurel Lounge Tables	322-323
Hampton	133-135	Lincoln Lounge Tables	324-325
Hanover	136-137	Children's	
Hoopz	138-139	Addison	328-329
Kendall	140-142	Calculus	330-331
Kinsey	143-144	Class Act	332-335
Laurel	148-154	Classmate	336-341
Logan	155-156	Classmate II	342-347
Madison	157-159	Collegian	348-351
Medallion	160-162	Jefferson	352-354
Melrose	163-170	Lincoln	355-357
Metro	171-173	Casegoods	
Milk	174-177	Congress Bookcases	360-361
Murphy	178-179		
Parker	180-182	Index	362-364
Profile	183-185		

Community Environmental Mission

Our vision and goal is a sustaining supplier, manufacturer and customer for the long term protection and preservation of our environment for future generations.

MISSION

To achieve this vision, we are dedicated to ensuring the health and well-being of all of our partners, reducing negative impact on the environment, and maintaining price structure by increasing efficiencies and reducing consumption.

The Jasper Group family of brands, including JSI, is an international manufacturer that has been an environmentally conscious organization for more than 80 years.

We are proud to use wood as our primary sustainable material resource and all corporate policies and procedures support the efforts to “recover, recycle, reuse, repurpose, reduce, refuse, and re-engineer”. In doing this, we are committed to the conservation of the environment and its natural resources as well as encouraging our suppliers and customers to do the same. A goal of a “Sustainable Partnership”, supplier, manufacturer and customer, is essential for the long term protection preservation and sustainability of our environment for future generations.

LOCATION

Our manufacturing facilities are located in Southern Indiana. With our diverse product offering and manufacturing capabilities, we provide a single source for all of your project needs allowing you to conserve our fossil fuels and reduce greenhouse gases.

PACKAGING

We place emphasis on the minimal use of disposable packaging while still providing adequate protection to the finished product. Our corrugated packaging is recyclable, reusable, and up to 100% recycled content. We reuse or recycle more than 125 tons of corrugated material annually.

REGULATORY

All of our manufacturing facilities are in compliance with applicable OSHA regulations and meet or exceed all applicable DEM and EPA regulations for air emissions, storm water, and hazardous waste disposal.

MANUFACTURING FACILITIES

Our manufacturing facilities are geared toward eco-efficiency and are encouraged to continually improve and conserve. Solid wood not used in the direct manufacturing process is recovered for the operation of our dry kilns, thus reducing greenhouse gases, the use of fossil fuels, and the burden of waste placed on landfills. Composite panels not used in the direct manufacturing process are ground and sold for use as animal bedding. In addition to other energy savings techniques, our manufacturing facilities use high efficient lighting, make use of power factor capacitors, and encourage all to conserve and reduce energy consumption and water usage. Condensation pumps are used to aid in water conservation as well as extending boiler life.

MANUFACTURING PROCESSES

Our finish processes utilize efficient spray guns and proper spray techniques to reduce wasted material. Excess finish material, solvents, and waste are recycled. Many of the assembly processes use water based glues that contain no hazardous ingredients.

TEXTILES

Many of our fabric options utilize up to 100% recycled content. Our leather alternative program includes selections that contain no toxic materials, plasticizers, heavy metals, or formaldehyde and have a 100% biodegradable back cloth. Some of the available panel fabric used, if discarded is a biological nutrient for the soil. Most of the components (foam, batting, and polycord) used in upholstered products are recyclable and contain various percentages of recycled content. Excess fabrics and leathers not utilized in the upholstery process go to recyclers and local charities for additional use.

WOOD

Wood is the most diverse, most process friendly, and most widely utilized natural resource in mankind’s history. No other natural resource can match the environmental advantages of wood, including being renewable, recyclable, natural, carbon negative, and biodegradable. Utilizing the sun’s energy, trees grow and remove carbon dioxide from the air while giving off oxygen to benefit the entire planet. Approximately 49% of wood’s dry weight is carbon and harvesting mature trees in a sustainable forest, which has slowed in the absorption of carbon dioxide, allows the photosynthetic cycle to continue at full optimization and allow for the carbon to remain sequestered. We are proud to use wood as our primary “sustainable” renewable resource.

WOOD OPTIONS

Many environmentally friendly solid wood and engineered wood options are available for quote, including: Lyptus®, Plyboo®, reclaimed woods, agricultural and post-consumer waste fiber products, soy-based resin bi-composites, etc.

INDOOR AIR QUALITY

Our goal is to reduce the impact our products will have on the indoor air quality. We practice the latest technologies and utilize a third party to assure we meet this goal. GreenGuard, one of the leaders in IAQ certification, continues to certify our product offering, awarding us the UL2818 - GreenGuard Indoor Air Quality standard.

PARTNERSHIPS

BIFMA
 Business and Institutional Furniture Manufacturer Association
 USGBC
 United States Green Building Council
 IIDA
 International Interior Design Association
 FSC
 Forest Stewardship Council
 GreenGuard

Terms and Conditions

Warranty

Community warrants to the original purchaser that each piece of furniture will be free from defects in workmanship given normal use for a period of fifteen (15) years of single shift service. Products used in multiple shift applications including but not limited to restaurants, casinos, nightclubs, etc. are warranted for five (5) years. Casters are warranted to be free from defects in materials and workmanship for a period of five (5) years. Fabric manufacturers warranty will apply. Electrical items not manufactured by Community are covered for a period of one year. Community, at its option, will repair or replace any defective furniture within the terms of the warranty. This warranty does not apply to damage resulting from accident, alteration, or misuse. Goods other than furniture are sold by Community to customer without warranty.

Pricing

All prices are list and FOB destination. This catalog supersedes all prices previously quoted and is subject to change. Possession of this price list does not constitute an offer to sell. Orders can only be received from authorized Community dealers.

Acceptance, Modification, Assignment

By placing this order for furniture, material or other products (sometimes collectively referred to as "goods"), customer (as identified on the reverse side hereof or the invoice) agrees to these terms and conditions which shall prevail over inconsistent provisions in any other form or document of customer. No change or modification shall be applicable unless set forth in writing and signed by company. Neither this order nor any interest therein shall be assigned by customer except with the prior written consent of company.

Payment

Customer agrees to pay deposit or down payment as required by company. Customer agrees to pay to company the amount indicated on the invoice, 1% 15 days, net 30 days from date of invoice (U.S. funds only), for goods ordered. **Interest will be charged after 30 days from the date of invoice at the rate of one and a half percent (1.5%) per month.** International sales will require additional payment arrangements. No goods shall be sold on consignment or conditional sales basis. Payment for the goods delivered hereunder shall constitute acceptance thereof.

Delivery

All shipments are FOB point of shipment, freight prepaid and allowed to the 48 contiguous states. All other shipments are freight prepaid and allowed to port of exit. Community reserves the right to select the appropriate carrier. Special requests including, but not limited to, inside delivery and installation, are not included in the price. Any charges arising from failure to meet shipment, rerouting while in transit, or carrier storage charges are the responsibility of the customer. **Orders of less than \$1,000 net will be assessed a handling charge of \$75 net per order (waived for items shipped via UPS).** Certain chairs from Community are UPS shippable and are noted as such by the following symbol: . There will be a \$12 list per chair charge for UPS packaging. Any additional costs incurred packaging the goods as a result of request by customer will be at customer's cost. If the goods are not accompanied by a bill of lading, company's invoice shall be conclusive. Community reserves the right to add a fuel surcharge when necessary.

Claims

All shipments are delivered to the carrier in good condition and company's liability ceases after acceptance by carrier. If shipment arrives short or damaged, the customer must file a claim immediately with the carrier. In the event of concealed damage, notify carrier and request an immediate inspection. Keep all cartons and packing material. Failure to file claim within 15 days after receipt of goods constitutes acceptance and a waiver of any such claims.

Attorneys' Fees

Customer shall be responsible for all expenses and costs in connection with the enforcement by company of these terms and conditions and the costs of collection (including the fees of any collection agencies to whom the customer's account may be referred), plus reasonable attorneys' fees (which attorneys' fees shall not be less than 25% of the amount due, unless a lower amount is specified by applicable law).

Disclaimer of Warranties

The express warranties above are the company's sole warranties of its goods, there are no understandings, agreements, representations, or warranties, express or implied (including any regarding the merchantability or fitness for a particular purpose), not specified herein, respecting the goods. Except for those obligations of the company identified in these terms and conditions, all risks related to the quality and performance of the goods and responsibility for repair or service costs rests solely on the customer. Company reserves the right to limit the applicable warranty to the goods depending upon the division or catalogue through which said goods were sold. Some states do not allow limitations on implied warranties, limitations on how long an implied warranty lasts, or the exclusion or limitation of incidental or consequential damages, so the above limitations may not apply to all customers. This warranty gives the customer specific legal rights, and each customer may also have other rights which vary from state to state.

Cancellation

All cancellations must be made in writing. Administrative and/or labor charges may be incurred by the customer depending upon the production stage of the order. Orders specifying special finish cannot be cancelled once finishing has begun. Cancellations cannot be accepted once final production has begun.

Order Changes

All changes to an order must be made in writing and are subject to company's ability to conform. Administrative and/or labor charges may be incurred by the customer depending upon the production stage of the order. Once final production has begun, no changes can be accepted.

Remedies

The remedies herein reserved shall be cumulative and additional to any other or further remedies provided in law or equity. No waiver of a breach of any provision of these terms and conditions shall constitute waiver of any other breach or of such provision.

Insolvency

Company may forthwith cancel this order in the event of the happening of any of the following or any other comparable event: insolvency of the customer, the filing of a voluntary petition in bankruptcy, the filing of any involuntary petition to have customer declared bankrupt provided it is not vacated within thirty (30) days from the date of filing, the appointment of a receiver or trustee for customer provided such appointment is not vacated within thirty (30) days from the date of such appointment, or the execution by customer of an assignment for the benefit of creditors.

Terms and Conditions

Limited Liability

The company shall not under any circumstances be liable to the customer, owner of the goods or any third party for special, indirect, incidental, or consequential damages, including, without limitation, loss of profits or revenues, loss or damage to other property or equipment, cost of capital or of purchased or replacement goods, or expense, delay or inconvenience caused by or arising from the purchase, sale, use, repair or inability to use the goods or by any performance or non-performance under, or breach of these terms and conditions. The company's sole liability for any defective goods shall be its repair or its replacement pursuant to the express warranties set forth above, or if amended, as applicable at the time of manufacture or repair of the goods. Some states do not allow the exclusion or limitation of incidental or consequential damages, so the above limitations or exclusion may not apply to all customers. Any action resulting from any breach on the part of company as to the goods or services delivered hereunder must be commenced within one year after the cause of action has occurred.

Security Agreement

The company may require and customer shall grant a security interest in goods sold pursuant to any credit the company may extend to the customer.

Allowances

Reasonable touch-up and deluxing is the dealer's responsibility. The company will not make allowances for trip or delivery charges, but will only make allowance for actual work performed to correct manufacturing defects. Allowances may be authorized only by a company officer.

Repairs

Community will not issue credit allowance for any type of repairs without prior written consent. Sales order, product model numbers, and reason for repair will be expected in order to process the repair request. A digital photo will help to expedite the request. JSI reserves the right to recommend solutions for repair.

Returns

No merchandise may be returned to Community without a signed Return Good Authorization (RGA) form issued by our Customer Service Department. Any authorized return not due to damage or defect will be assessed a 45% restocking fee and all return freight charges must be prepaid. Additional restocking fees may apply for any modification, special or custom built product.

Liability for defective merchandise shall be limited to replacement or repair.

Under no circumstance can we accept COD (Cash on Delivery) returns. Any such shipment will be refused.

Replacement Parts

Prices for replacement parts can be obtained by calling our customer service department. Please have the model number available when ordering replacement parts.

Governing Law

All disputes between the parties, whether or not arising out of these terms and conditions, will be governed by the laws of the state of Indiana. Customer agrees to submit to the jurisdiction of and agrees all lawsuits relating to any disputes between the customer and the company will be brought only in a state court located in Dubois County, Indiana or the United States District Court for the Southern District of Indiana. The customer hereby waives the right to a trial by jury in any action, proceeding, claim, or counterclaim whether in contract or tort, at law or in equity, arising out of or relating in any way to these terms and conditions and all other disputes between the parties.

Mitigation

If the company repossesses the goods prior to payment by the customer of all amounts due hereunder, the company may sell the goods, as is, where is, free and clear of all rights of the customer at either public or private sale, and apply the list proceeds (after deducting expenses of repossession and sale) to the obligation of customer hereunder. The customer shall remain liable for any deficiency. The company may dispose of the goods in any commercially reasonable place and manner and the customer waives any notice of time, place and manner of sale.

Integration

This order for goods, including these terms and conditions, along with any credit application, invoice, statement, dealer contract, acknowledgement, bill of lading (and any exhibits, addenda or amendments thereto) of which this order may be a part, constitutes the sole and complete agreement between the company and the customer with respect to the purchase of the goods.

Dimensions, Specifications and Finishes

All dimensions are approximate and may vary due to the upholstery technique of each craftsman. If exact dimensions are required, it is necessary for the customer to state such specifications with the order. Detailed specification sheets are available for each series of goods, and customer should consult the company's customer service department for these specification sheets. Company reserves the right to make changes in dimensions, style, or specifications if company believes these changes will improve the goods' quality or appearance. Company reserves the right to substitute hardwoods due to availability at production. Due to the natural characteristics of wood, environmental effects, and material upgrades, the company cannot guarantee exact finish matches on existing goods previously ordered from company. If an exact match to customer's existing goods are required, it must be specified so that the proper procedures can be followed to ensure an acceptable finish. Company will accept no liability for the finish if this procedure is not followed. Company reserves the right to make changes in a finish formula if company believes the change will improve the quality or appearance of company's goods.

Product Modifications

While we offer a wide range of products to accommodate many possible solutions, we also recognize the needs for our products to be modified from our standard offering. In the series introduction section of each product, we address modification options for that series.

To see if the desired modification is possible, please contact our Customer Service Department for a quote. Note that order quantities and material availability can affect the quote. Additional information may be requested to fully quote modifications.

Acknowledgement

All orders will be acknowledged promptly, showing how the order was entered, the approximate shipping time and other pertinent information. It is the customer's obligation to examine this acknowledgement carefully and notify company immediately of any discrepancies. Every reasonable effort is made to ship as acknowledged, however, the acknowledged ship date is approximate. Company will generally ship within five (5) working days of the acknowledged ship date. If a firm ship date is necessary, customer must inform company at time of order and company will make all reasonable efforts to meet each customer's request. Acknowledged shipping dates are contingent upon the force majeure conditions contained in these terms and conditions.

Terms and Conditions

Company's Performance of Its Obligations

The production and delivery of the goods to the extent delayed or hindered or prevented from the performance by reason of natural disasters, acts of God, strikes, lockouts, labor troubles, inability to procure materials, casualties, failure of power, restrictive governmental laws or regulations, riots, insurrection, acts of terrorism, war or other reason of a like nature not the fault of the company shall excuse, for the period of the delay, the company's performance and the period for the performance shall be extended for a period equivalent to the period of such delay.

Care and Maintenance

To maintain your Community product for years of use, please follow these care guidelines: Wood Finishes: To clean, do not use household abrasive solvents. To repair scratches, use a wax repair stick. Surface water spills should be wiped up immediately. Metal Finishes: Wipe smooth powder coat finishes and textured metals with a damp cloth. For stubborn stains and grease marks, use soap and water. Brush textured metals with a soft dry brush to remove dirt. Textiles: Cleanability will vary based on fabric type. For best results, a professional service is recommended. Dirt and crumbs may be gently brushed or vacuumed off. Spill should be wiped up immediately with a cloth. If upholstery has been protected with Scotchgard or Zepel, the coating should be reapplied yearly. Vinyl textiles can be cleaned with warm soapy water and then wiped down with a warm damp cloth. Laminate Finishes: Apply a self-cleaning wax. To remove stains, wipe surface with a damp cloth using soap water. Remove stubborn stains with a baking soda paste, leaving on for one minute and then blotting away. Do not use abrasive cleaners. Acid based spilled products should be immediately wiped up and then rinsed with warm water.

Ordering Information

Orders

To assist in submitting a complete order, an order check list can be referenced for each series.

Additional information may be obtained by consulting the Customer Service Department or our website.

Indicate shipping address if different from billing address.

Send Orders To:

US Mail - Community

225 Clay Street

Jasper, IN 47546

Fax - 812-482-1548

Email - orders@jaspergroup.us.com

Community reserves the right to make changes in dimensions, styles, or specifications if we believe these changes will improve the safety, quality, or appearance of the product.

Acceptance of orders will be subject to credit approval, barring any acts of governments, or any other causes beyond our control (e.g. strikes, fire, embargo of materials, etc).

Custom Options

Wood and Metal Laser Cut Backs

Many of our seating models are available with custom wood engraving or laser cut backs. University seals, logos, unique designs, or any type of graphic can be designed into the seating back for a custom creation. Copyright approval may be required. Consult Community Customer Service for pricing and artwork specifications. Artwork must be submitted as a JPG or PDF file.

Example



Wood Laser Engraving and Cut Outs General Pricing

* must order plain back when choosing these options

For Artwork 4" x 4" or Less	\$44 list per chair
For Artwork Less than 6" x 6"	\$79 list per chair
For Artwork Larger than 6" x 6"	Call For Pricing

For orders fewer than 50 pieces, add \$120 list per design, per order. This pricing reflects etching (leaving the wood dark). If additional painted colors are added to artwork please call customer service for pricing.

A \$105 list set-up fee applies. ▲

Metal Laser Cut Out General Pricing

* must order plain back when choosing this option.

Contact Customer Service for pricing.

Examples shown below



Leather engraving also available. Please call Customer Service for pricing and availability.

Options

Modifications

Community willingly accepts customer modifications to standard products. Please call the customer service department at 800-622-5661 for special quotes and product lead times.



Leg Protectors

Clear plastic leg protector sleeve available. Add \$15 list for set of 4 per chair. Recommended for the following series:

- Accolade
- Alden
- Americana
- Americana II
- Avalon
- Boston
- Brockton
- Hanover
- Melrose (chairs only, cannot be added to barstools)
- Murphy
- Sterling

Glides

Rubber cushion metal glides standard. Rubber cushion nylon glides for wood or tile floors are available upon request at time of order with no upcharge. Additional nylon and metal glides sold separately for post order field installation. Add \$7 list for set of four.

Casters

Casters may be specified as an option on **some** Community chair models. Please contact customer service for caster/chair compatibility. Add \$90 list per chair for 4 casters or \$46 list for front leg casters.

Self-Centering Plate

Self-centering swivel plate mechanism available on swivel stools upon request. No upcharge.



Linking Bracket

Optional linking bracket available. Specify as an option when ordering. Add \$26 list per chair.

Finish Information

DuraTex Low-Emission Finish

To reduce hazardous formaldehyde emissions, we use a proprietary, specially designed top coat that offers exceptional hardness, abrasion and impact resistance while removing hazardous or harmful gases.

Safety - DuraTex significantly reduces hazardous formaldehyde emissions which helps to improve the quality of the indoor air we breathe.

Quality - DuraTex was developed to be tough and durable with special attention to appearance. Our highest priority seeking a safe solution was to provide a finish that preserves the natural beauty of wood that our customers have come to expect

Durability - DuraTex was designed to meet a wide range of demanding performance and environmental standards to withstand even the heaviest wear and tear. It's no coincidence that we find 'durability' in DuraTex.

Natural Wood Finishes

Every tree has unique and defining characteristics, similar to fingerprints. These characteristics include differences in color, grain configurations, and texture. When specifying natural or light finishes, these natural markings are not masked and are easily detected. With this in mind, we hope you enjoy and appreciate the beauty of each tree's fingerprints.

Due to the natural characteristics of wood, environmental effects, and material upgrades, we cannot guarantee exact finish matches on existing furniture previously ordered from Community. If an exact match to existing furniture is required, it must be specified so that the proper procedures can be followed to ensure an acceptable finish. Community will accept no liability for the finish if this procedure is not followed.

We reserve the right to make changes in a finish formula if we believe the change will improve the quality or appearance of our furniture.

Wood finishes are represented in individual samples of cherry, maple, oak, walnut or color stain options. Contact Community customer service for ordering information.

Wood Finish/Color Options

Seating

Oak

BRW	Brownie (Dark Mahogany)
CAN	Canyon (Medium Mahogany)
CIT	Citron (Golden Oak)
DES	Desert (Light Cherry)
ECU	Ecru (Natural Oak)
HEN	Henna (Medium Cherry)
HNY	Honey (Medium Oak)
NUT	Nut Brown (Medium Walnut)

Maple/Beech

ALE	Ale (Natural Maple)	CIT	Citron (Golden Oak)
AUB	Auburn (Windsor Mahogany)	CLA	Classic (Classic Cherry)
AUT	Autumn (Autumn Cherry)	DES	Desert (Light Cherry)
BRL	Barley	EAR	Earthy
BBN	Bourbon (Natural Cherry)	ESP	Espresso
BRG	Brighton (Brighton Cherry)	FLX	Flax
BRW	Brownie (Dark Mahogany)	HEN	Henna (Medium Cherry)
BUT	Butterscotch	HNY	Honey (Medium Oak)
CAN	Canyon (Medium Mahogany)	LGC	Legacy (Legacy Cherry)
CIN	Cinnamon	MCH	Mocha

NTO	Night Owl (Vintage Walnut)
NUT	Nut Brown (Medium Walnut)
PRL	Praline (Vintage Cherry)
SAF	Saffron (Medium Cherry)
SIE	Sienna
TOF	Toffee
TRF	Truffle
VEN	Venetian (Dark Mahogany)

Tables

Cherry

AUT	Autumn (Autumn Cherry)
BRL	Barley
BBN	Bourbon (Natural Cherry)
BRG	Brighton (Brighton Cherry)
CLA	Classic (Classic Cherry)
EAR	Earthy
LGC	Legacy (Legacy Cherry)
PRL	Praline (Vintage Cherry)
SAF	Saffron (Medium Cherry)

Maple

ALE	Ale (Natural Maple)
BUT	Butterscotch
CIN	Cinnamon
FLX	Flax
VEN	Venetian (Dark Mahogany)

Oak

BRW	Brownie (Dark Mahogany)
CAN	Canyon (Medium Mahogany)
CIT	Citron (Golden Oak)
DES	Desert (Light Cherry)
ECU	Ecru (Natural Oak)
HEN	Henna (Medium Cherry)
HNY	Honey (Medium Oak)
NUT	Nut Brown (Medium Walnut)

Walnut

AUB	Auburn (Windsor Mahogany)
ESP	Espresso
MCH	Mocha
NTO	Night Owl (Vintage Walnut)
SIE	Sienna
TOF	Toffee
TRF	Truffle

Colors - Add \$31 list per item

BKD	Backdrop	DRG	Daring	GLF	Gulf Stream	RBZ	Relic Bronze
BFX	Black Fox	DYN	Dynamo	HTB	Heartthrob	SND	Sandbank
BWH	Bright White	ENG	Enigma	NET	Network Gray	STM	Storm
CGP	Cargo Pants	FRR	French Roast	NWH	Nonchalant White	TRC	Tricorn Black
CHT	Chatroom	GBY	Georgian Bay	PAR	Paradise		
DSY	Daisy	GRV	Greek Villa	QXP	Quixotic Plum		

Special Finishes

Add a charge of \$289 list per order for any non-standard wood finish. Community reserves the right to decline any request for a custom finish if we feel that we will be unable to match it due to limitations of the wood species or of the sample provided to us. Because of the natural variations of wood, minor differences in color may occur.

Colors

Add a charge of \$289 list per order and \$31 list per item for any non-standard paint color. Community reserves the right to decline any request for a custom finish if we feel that we will be unable to match it due to limitations of the wood species or of the sample provided to us. Because of the natural variations of wood, minor differences in color may occur. When specifying paint finishes please be aware the flush joint may be more visible.

Textile Carded Programs

Community is proud to partner with Maharam, Momentum, Ultraleather and Wollsdorf Leather. Please refer to the respective pages in this pricer for each of these partners. Scan the QR codes on the back of the swatch card for latest grades and other information.

Textile Grade-In Programs

For the convenience of our specifiers, we have graded in the following suppliers:

Arc Com	Pallas
Designtex	Stinson
Maharam	Ultrafabrics
Mayer	Wollsdorf Leather
Momentum	

Please contact Customer Service for pricing grades on textiles and leathers not listed.

Indicate on purchase order if Community is to order the fabric.

For samples, contact Fabric Manufacturer.

Grades and availability of fabric are subject to change without notice. Changes could include but are not limited to price increase, discontinued patterns, discontinued colors, etc. See communityfurniture.com▲ for up to date information.

Many textiles have repeats and the additional yardage required has been factored in for textiles ordered through the Community Carded and Grade-In Programs. We reserve the right not to match textiles with a horizontal or vertical repeat greater than 17". Additional charges may apply for textile being applied with special instructions.

COM Policy

Refer to the COM price column for list prices.

All yardage requirements listed in the price list are based upon 54" plain non-directional material. The textile on most products is cut "up the roll"; refer to the check list pages for each individual series for further information.

Additional yardage may be required. Contact Customer Service for any of the following conditions to assure proper yardage:

- + horizontal repeats or vertical repeats greater than 3"
- + textile less than 54" wide off the roll
- + patterned textile to be applied a special way

To assure quick turn around and accurate calculation of yardage, please supply the following information:

- + supplier's name
- + pattern name and color name
- + the Community model numbers and the order quantity
- + any special direction and/or special instructions

We cannot assume responsibility for defective COM delivery to us or for the tailoring quality issues some textiles may create. Bulky textiles, thin weight textiles or fiber content may not tailor well on some models.

COM Fabric Repeat Guide▲

Roll Width	Plain Fabric	1" - 5" Repeat	6" - 10" Repeat	11" - 15" Repeat	16" - 20" Repeat	21" - 30" Repeat	31" - 40" Repeat	41" - 50" Repeat
54"	0%	10%	15%	20%	25%	30%	40%	50%
53" to 51"	15%	20%	25%	30%	35%	40%	50%	60%
50" to 48"	30%	35%	40%	45%	50%	55%	70%	90%
47" to 36"	60%	65%	70%	75%	80%	85%	100%	120%

The percentage represents the additional fabric yardage that needs to be added to the COM yardage. Contact Customer Service for repeats greater than 50".

Large Repeats and Striped Fabrics

Community does not recommend large fabric repeats or striped fabrics on large curved lounge sections. The geometry prevents matching the patterns at the seams.

Contact Customer Service with questions or for suggestions on how to achieve the aesthetics you desire.

*Tips: use contrasting fabric
request fabric pattern not be matched
run fabric railroad*

COL Policy

Refer to the COL price column for list prices.

Customer's own leather requirements are based on an average hide of 50 square feet.

Contact Customer Service for requirements on any other sizes.

All square footage requirements are based upon usable footage. The shape of the hide and the usable footage may make it necessary for us to request additional leather.

Placing Orders with COM or COL

- COM & COL orders must include the following:
- + model number where the COM or COL will be applied
 - + textile/leather supplier's name
 - + sample of the textile/leather attached to order
 - + special application instructions

Ship COM/COL prepaid to the following:

Community
Attn: COM Dept
932 Mill Street
Jasper, IN 47546

Make sure the supplier tags the shipment with the customer purchase order number and sales order numbers if available.

All COM/COL orders will ship at standard lead time from the delivery of the COM/COL, except for orders requiring special custom matched finishes or special application of the COM/COL.

Fire Retardancy

At a minimum standard, all Community upholstered products are manufactured to comply with Bureau of Electronics, Appliance Repair, Home Furnishings and Thermal Insulation-Technical Bulletin 117-2013 issued by State of California Department of Consumer Affairs. With a January 1, 2015 effective date, this standard was passed and requires upholstered furniture to be safer from the hazards associated with smolder ignition in all four (4) categories of materials, as applicable.

Compliance with more stringent codes may require special manufacturing considerations and upcharges.

California Technical Bulletin 133 (CAL 133)

Community uses a barrier material between the foam cushioning and the upholstery cover in order to comply with CAL 133. The standard upcharge on products specified to comply with CAL 133 is **\$58 list per yard** of textile.

Community has performed a series of full scale fire tests on samples - representing a variety of product styles and worst case scenarios of upholstery covers - to comply with the requirements of the state of California Technical Bulletin 133 (CAL 133). Products in compliance will be labeled that they have been manufactured to meet the CAL 133 standard.

Some product designs and fabric cannot be combined to comply with CAL 133. Because of this, we reserve the right to reject any request for an upholstery cover, including COM, or product style that we feel may compromise the integrity or safety of a product specified to comply with CAL 133.

Contact Customer Service for a quote if you require laboratory certification that a specific product and upholstery combination WILL PASS CAL 133. The quotation will include testing, video, and transportation charges plus the list cost of the sample.

Our standard lead time will apply to products that do not require certification. Allow an additional six weeks over the standard lead time for products that need actual laboratory certification.

The end user, specifier and/or dealer have the responsibility to make sure all products specified will meet the flammability and safety codes of the jurisdiction where the products will be located and used.

Arc Com Fabric Grading

For memo samples call Arc-Com at 800-223-5466

Grades and availability of fabric are subject to change without notice. Changes could include but are not limited to price increases, discontinued patterns, discontinued colors, etc. See jsifurniture.com for updated information.

Pattern	Grade	Pattern	Grade	Pattern	Grade	Pattern	Grade
Allegra	E	Fiore	G	Metro	I	Spectrum	D
Alpha	E	Fireflies	E	Mirror, Mirror	E	Spin	G
Analog	H	Forsythia	G	Monte Carlo	F	Spirit	D
Antigua	E	Francesca Wool	F	Moon Beam	E	Spot-On	F
Apex	G	Francesca Wool II	H	Moon Beam 2	E	Spotlight	G
Arashi	F	Frontier	C	Morocco	F	Spring	G
Astral	F	Galaxy	E	Murano	G	Spyro	F
Atomic	H	Gamma	E	Mystique	E	Stonehenge	G
Aurora	F	Gardenia	F	Navigator	F	Strand-It	G
Axis	F	Gatsby	D	Network	G	Strata	D
Bauble	F	Gem	D	Niagara	F	Streamline	D
Beat Box	G	Geostitch	F	Nova	G	Symphony	G
Block Party	G	Glimmer	E	Oasis	F	Tally	E
Bloom	G	Grand Central	E	Odyssey	E	Tango	F
Blossom	G	Grid	F	Ombre Petal	F	Tectonic	F
Boardwalk	E	Harlequin	G	Omega	E	Tempo	F
Bounce	G	Highlands	F	Orion	D	Terrain	D
Bourbon Street	F	Hopscotch	G	Pala	F	The Plaid	I
Brayer Flower	F	Hush	E	Palatine	E	Theory	C
Bronco	E	Iguana	E	Palatine 2	E	Trio	F
Bubbly	G	Illusion	C	Panache	E	Tritik	F
Campus Stripe	F	Illusion 2	C	Pebble Beach	D	Uptown	H
Candy Land	G	Intaglio	E	Pinball	E	Urban	G
Carnival	E	Intaglio 2	E	Pinpoint	E	Velocity	F
Casablanca	G	Intersect	E	Plateau	D	Vineyard	F
Cascade	F	Isabella	D	Polo	F	Vista	D
Cassio	E	Itajime	F	Posh	F	Volley	F
Channel	E	Jardin	H	Prism	C	Volt	J
Chit-Chat	E	Jing	E	Quad	F	Wonderland	G
Chroma	E	Jive	F	Radiant	G	Yoyo	H
Cirque	G	Juliet	I	Radius	G	Zipline	F
Clarion	F	Katano	E	Ravenna	F		
Coastline	E	Key	F	Rhythm	F		
Column	E	Kinetic	F	Ringling	F		
Compass	I	Kirigami	F	Riviera	G		
Constantine	H	Kumo	F	Robotic	F		
Contour	D	Laurel	G	Rodeo	D		
Crossroads	E	Leaflet	F	Roundabout	E		
Dakota	D	Legacy	E	Royal Garden	H		
Dakota 2	D	Leonardo	G	Sagrada	J		
Dazzle	G	Loara	F	Sahara	E		
Delphi	D	Lotus	F	Samba	F		
Delta	D	Luxe	E	Santa Fe	E		
Durango	C	Lyre	E	Savannah	F		
Dynasty	E	Lyric	G	Saxon	G		
Echo	G	Marathon	E	Sequoia	E		
Eclipse	F	Mason	F	Sherlock	D		
Empress	D	Masquerade	G	Shibori	G		
Etc.	F	Meadow	G	Shimmer	D		
Etch	E	Meridian	C	Shimmer 2	D		
Facet	J	Mesa	D	Silverado	D		

Designtex Fabric Grading

For memo samples call Designtex at 800-221-1540

Grades and availability of fabric are subject to change without notice. Changes could include but are not limited to price increases, discontinued patterns, discontinued colors, etc. See jsifurniture.com for updated information.

Pattern	Grade	Pattern	Grade	Pattern	Grade	Pattern	Grade	Pattern	Grade	Pattern	Grade
Acacia	G	Circolo	F	Henrik Small W/Knit	J	Metamorphosis	H	Rotary	I	Tweed Multi	D
Adler	E	Circumference	I	Backing		Metta	D	Rothestay	G	Urban Grid	G
Aggregate	F	Claire	I	Hexstripe	F	Microgrid	E	Rothestay with	H	Valanka	I
Ainsley	I	Closed Loop	F	Holmes	G	Migration	H	Backing		Valet	E
Aksel	F	Cobble	J	Honor Plus	I	Mingle	F	Rough & Ready II	F	Variant	I
Alcazar	E	Colorblock	G	Horizon	H	Mod	H	Round Leaves	I	Versed	D
Alchemy	E	Colorful Plaid	E	Hyphen	F	Modern Tweed	I	Rove	H	Vivid	D
Aleman	H	Concept	H	Inertia	H	Moderne	H	Rumeli	E	Volley	H
Alistair	G	Converge	G	Inga Small	I	Mohair Plus	J	Samba	H	Vox	F
Alpine	D	Cross Court	H	Inga Small W/Knit	J	Motif	F	Samba Otra Vez	H	W	F
Amaranth	H	Crosshatch	G	Backing		New Selkrik	H	Saugatuck	F	Westside	I
Amuse	I	Crossweave	D	Inkling	F	Nexus	H	See Saw	H	Whim	F
Annex	F	Crosswind	F	Inlet	F	Noble	D	Seed	G	Windowpane	E
Appleseed	F	Culebra	I	Inside Edge	F	Nonchalant	E	Sett	I	Winsome	E
Argiano	E	Current	F	Interlock	G	Notion	G	Shibori Stripe	G	Wire	J
Array	I	Cusco	I	Introvert	E	Omar	E	Shimmering Tide	H	Woodcut	F
Arthur	I	Cut & Paste	I	Irregular Grid	E	Ophidian	F	Signal	I	Wren	D
Aster	I	Dahlia	H	Isometry	H	Opulent	D	Singing In The Rain	D	Yoruba	G
Astrid	E	Dart	G	Isotope	F	Oscillate	G	Skye	H	Yucca	F
Banda	G	Dashing	D	Jaunt	I	Oxford Stripe	H	Sorano	D	Zhuba	F
Baratto	G	Delaine	F	Journey	I	Palomino	E	Spandau	E	Zocalo	H
Barque	J	Dharma Stripe	E	Kabuki	F	Parga	E	Spiro	G		
Battista	I	Dichotomy	H	Kalahari	E	Pennington	I	Splendor	D		
Bee	D	Dot To Dot	G	Klange	F	Phase	F	Stacks	H		
Beetled Linen	H	Draft	F	Komposition	F	Pigment	G	Starburst	G		
Beguiled By The Wild	G	Eastside	I	Lambert	G	Piiki	H	Steppe	E		
		Ellipsis	C	Lattice	H	Pika	E	Striae	E		
Big Dot	F	Eon	F	Leaf Dot	F	Pinball	I	Sugar Shoots	H		
Billiard Cloth	F	Epiphany	F	Leafette	E	Pivot	E	Swayed	J		
Billiard Panel	E	Essence	C	Leap	F	Pleat	F	Swing	J		
Birch Bark Plaid	H	Faux Sure	F	Leaves	G	Pop Art	H	Swing Set	G		
Bit	E	Florin	F	Leland	F	Porte	F	Synthesis	I		
Block Print	H	Flux	G	Linari	D	Posey	H	Tack Cloth	F		
Bolt	F	Fortuna	H	Lindos	F	Prairie	E	Tarascon	D		
Bordo	H	Friendly Faux	F	Lioret	F	Precision	F	Terrain	G		
Botanique	E	Fuse	G	Little Dot	F	Prime	D	Tesellate	I		
Boucle	F	Gale	E	Little Plaid	E	Quintessence	G	Tetris	J		
Boucle Two-Tone	E	Gallone	F	Lofty	D	Radar	F	The Last Aphid	I		
Bounce	H	Gamut	C	Lolland	I	Rail	H	Tinos	G		
Breena	E	Glaze	F	Loop To Loop	H	Razor Stripe	H	Tiny Herringbone	F		
Bunta	F	Gleam	F	Lorien	G	Refine	D	Titanium	H		
Caiman	E	Gradate	G	Ludington	C	Restore	F	To The Point	E		
Cascadia	E	Gramercy	J	Luster	F	Reuse	G	Tombolo	E		
Catalyst	F	Grandeur	D	Lydia	I	Rice	F	Top Spin	I		
Cestino	G	Griglia	F	Maglia	H	Rio Grande	F	Trace	J		
Chapiteau	E	Hashtag	E	Mandala	F	Rivergrass	F	Tramway	G		
Checker Stripe	I	Heather	G	Margin	I	Rivet	E	Transport	H		
Chevron	J	Hem Stitch	E	Match Point	I	Rivet Pearl	E	Travertine	E		
Chromatic	E	Henrietta	I	Melange	E	Rocket	D	Tumble Stones	H		
Circa	F	Henrik Small	I	Melrose	I	Rosairo	I	Tumbleweed	F		

Maharam Fabric Grading

For memo samples call Maharam at 800-645-3943

Grades and availability of fabric are subject to change without notice. Changes could include but are not limited to price increases, discontinued patterns, discontinued colors, etc. See jsifurniture.com for updated information.

Pattern	Grade	Pattern	Grade	Pattern	Grade	Pattern	Grade	Pattern	Grade
Abacus	J	Coincide High	G	Hero by Kvadrat	F	Pick	C	Strum	F
Abacus Standard	G	Performance	G	Houndstooth	I	Pick Crypton	F	Sudden	F
Acre	F	Colline by Kvadrat	F	Hum	E	Pitch	E	Surge	F
Across*	G	Colorwheel	I	Inlay 466353	I	Plait	F	Tailor	F
Akimbo	F	Column	H	by Hella Jongerius	I	Plait High Performance	G	Tally	G
Align	F	Commentary	F	Insignia	H	Plural	J	Tandem	G
Alloy	E	Compound	F	Instill	E	Ply Mesh Black/Tan	J	Teatro	H
Alpaca Herringbone	J	Confetti	J	Jacobs Coat	J	Pocket	G	Technic	C
Alter	F	Cotton Velvet	J	Kindred	H	Point	J	Tend	F
Anagram	I	Couple	H	Knot	I	Quatrefoil	J	Terrace	F
Arabesque	I	Cover	F	Lariat	E	Quick	E	Ticker	G
Aria	I	Crew	H	Latch	J	Radiant	J	Tilt	G
Array	G	Crosspatch	J	Ledger	E	Recollection	F	Tokyo by Kvadrat	H
Article	D	Crush	F	Lens	G	Reel	H	Tonica by Kvadrat	F
Balustrade	I	Cursive	J	Lift	G	Regatta	J	Tonus by Kvadratt	G
Banister	H	Cycle	F	Lineage	F	Remix by Kvadrat	F	Tonus Meadow	G
Bar	C	Dapper	E	Link	G	Repeat Dot Ring	J	by Kvadrat	G
Bar Crypton	F	Dart	G	Manner	C	Ring	G	Toostripe	J
Basel by Kvadrat	F	Dash	F	Marquee	E	Rise	I	Trait	F
Before	F	Decode	G	Matrix by Kvadrat	H	Rove	F	Transport	I
Beside	F	Defer	E	Meander	G	Rubric	F	Tread	G
Bevel	E	Design 9297	J	Mechanism	H	Rule	G	Treat	G
Bitmap	J	Disc	C	Medium	C	Runner	G	Trellis	I
Blip	H	Disc Crypton	F	Melange Tweed	I	Runner Standard	E	Tremor	F
Blumen	J	Disperse	H	Meridian	F	Salon	H	Trio	J
Bound	E	Ditto	G	Messenger	C	Scape	G	Turn	H
Boundary	F	Divide	C	Metric	C	Schema	F	Twice	F
Bridge	E	Divide Crypton	F	Micro	E	Scout	F	Twine	F
Bright Angle	H	Divina by Kvadrat	G	Mikado	J	Scribe	F	Unisol	J
Bright Cube	H	Divina MD by Kvadrat	G	Milestone	C	Scuba	E	Urban	H
Bright Grid	H	Divina Melange by	G	Mimic	G	Seam	F	Vary	E
Brim	G	Kvadrat	G	Mineral	F	Semblance	C	Vases by Hella	I
Candid	E	Division	E	Minicheck	I	Sequence	F	Jongerius	I
Canvas by Kvadrat	F	Double Triangles	I	by Alexander Girad	I	Shadowbox	G	Velvet Stripe	J
Cartouche	F	Ellipsis	F	Minimal	F	Sheen	F	Venn	G
Centric	I	Emblem	G	Mister	H	Shuttle	G	Vestige	H
Certain	F	Emboss	F	Mode	D	Shuttle Standard	E	Vineyard	I
Chalet	F	Emmesh	F	Mohair Supreme	J	Signal	F	Voyage	I
Chance	G	Exchange	E	Molly by Kvadrat	F	Silk Canvas	I	Waterborn by Kvadrat	I
Checker by Alexander	I	Facets	I	Monk's Wool	J	Skein	E	Waxen	D
Girard	I	Fasten	H	Mortise	G	Slant	F	Wedge	J
Checker Split	J	Fathom	F	Oblique	C	Small Dot Pattern	J	Weimar	H
Chenille Cord	G	Feature	F	Octave	J	Snap	J	Whirl	F
Chenille Stripe	I	Fiddle	H	Offset	G	Soft Tweed	I	Wool Rib	I
Chime	E	Floret	G	Omen	F	Sort	I	Wrap	J
Chock	G	Fluent Crypton	F	Optik	J	Stack	E		
Cinch	D	Fluted Silk	I	Orakelblume	J	Star by Kvadrat	H		
Cipher	H	Focus	E	Ottoman Stripe	J	Stature	F		
Circles	J	Fraction	G	Outback by Kvadrat	G	Steady	E		
Circuit	G	Fruit by Hella Jongerius	J	Parched Silk	I	Steady Crypton	F		
Coach Cloth	I	Garden	I	Park	J	Steelcut by Kvadrat	G		
Cobblestone	J	Glint	E	Pavement	I	Steelcut Trio	G		
Coda by Kvadrat	I	Grade	H	Paver	F	by Kvadrat	G		
Coin	C	Hallingdal by Kvadrat	G	Pebble Wool	J	Strand	G		
Coin Crypton	F	Hedge	F	Pebble Wool Multi	J	Stride	G		
Coincide	E	Helix	H	Pennant	H	Stripes	J		

Mayer Fabric Grading

For memo samples call Mayer at 800-428-4415.

Grades and availability of fabric are subject to change without notice. Changes could include but are not limited to price increases, discontinued patterns, discontinued colors, etc. See jsifurniture.com for updated information.

Pattern	Grade	Pattern	Grade	Pattern	Grade	Pattern	Grade	Pattern	Grade
Acclaim	D	Daydream	D	Holiday	E	Obi	F	Silk Screen	C
Align	C	Dazzle	D	Hombre	E	Obsession	G	Silverweave	D
All Seasons FR	C	Debonair	G	Hoopla	D	On The Spot	G	Skate	D
All Use FR	C	Debut	F	Hopsack	E	Optic	C	Sketch	C
Amadeus	G	Destiny	D	Illusion	G	Orbit	D	Slick	D
Antique	D	Destiny plus	E	Images	D	Origami	F	Smart Suede	D
Apex	C	Durablock™	E	Impulse	D	Ottoman	F	Social Network	E
Arabesque	E	Detail	E	In The Groove	D	Outback	C	Solaris	F
Aristocrat	D	Disco	E	Infinity	G	Oxen SP Black	A	Soleil	F
Array	F	Dublin Tweed FR	D	Interlace	D	Palermo	D	Solid Ground	E
Artistry	C	Durango	C	Interlochen	D	Panache	G	Sophisticate	C
Ascension	G	Duraweave® 10	B	Intrigue	D	Paparazzi	F	Source	D
Athens FR	D	Echo	D	Jekyll & Hyde	C	Pastime	E	Source plus	E
Atomic	C	Ecosphere	F	Jenga	E	Patent	E	Durablock™	E
Aurora	G	Eleanor Rigby	F	Jitterbug	E	Patio	C	Spacer Mesh	B
Avenue	F	Element	C	Journey	E	Pavilion	F	Spirograph	D
Awakening	H	Empire	I	Jubilee	D	Peerless	C	Spotlight	F
Banner	C	Emu	C	Juncture	H	Phoenix	C	Stanza	E
Bar None	E	Encore	F	Karma	F	Pinehurst	D	Stop & Go	F
Batik	C	Enigma	G	Katagami	J	Pinnacle	D	Stratosphere	H
BeBop	F	Entourage	F	Key Largo	C	Plaza	D	Suede	D
Bella	F	Entwine	D	Kismet	F	Portal	E	Swank	F
Berkshire	D	Equation	D	Kobe	C	Positive Thoughts	G	Synapse	F
Big Top	F	Equinox	D	Komodo	D	Prado	D	Tangled Web	G
Blocks	C	Erode	G	Laredo	E	Primo	D	Theory	C
Bolero	D	Escapade	G	Linen	C	Prism	C	Time Line	E
Botanica	F	Esprit	D	Links	D	Pulse	F	Toss Up	D
Boteh	J	Essex	D	Locomotion	D	Punch	C	Tributary	D
Brio	E	Europa	E	Longhorn	D	Quark	F	Turnabout	G
Bungalow	I	Evolve	G	Lunar	E	Quattro	B	Tussah	D
Burst	E	Facets	F	Madras	E	Rain Dance	E	Twister	E
Camelot	E	Factor	D	Madrid SP Black	A	Ranchero	A	Uptown	C
Canvas	E	Fairy Tales	G	Makore	F	Rapport	C	Valet	C
Caressa FR	C	Fanfare	F	Malibu	D	Ratio	F	Variant	C
Caressa Suede	C	Fantasy	F	Mandala	H	Razzmatazz	F	Venetian	H
Cascade	D	Fathom	E	Marquise	C	Realm	F	Venue	D
Catalyst	D	Figure Eight	C	Marvel	F	Rebound	F	Verona	C
Cavalier	C	Finale	D	Matrix	G	Reiki	F	Vibrant	D
Cayman	F	Finesse	C	Maverick	C	Relic	F	Viewpoint	F
Celtic	E	Finish Line	E	Maze	F	Replay	F	Vintage Mohair	I
Chaps FR	C	Flock	G	Meander	D	Reveal	D	Vinyl Stat ESD	D
Charade	G	Florentino	C	Melody	E	Reverb	C	Vogue	E
Charette	E	Flower Power	D	Metro	D	Rhythm	G	Volante	H
Circuit	H	Focal Point	C	Microdot	C	Rift	D	Wallaby SP Black	A
Circumference	G	Forte	A	Milano	D	Rock & Roll	F	Webscape	D
Collage	G	Foundation 10	B	Monogram	D	Round 'N Round	F	Whimsy	G
Component	D	Gala	F	Moonscape	C	Sakura	G	Wildflower	G
Contempo	C	Geisha	G	Mosaic	D	Samurai	F	Willow	E
Continuum	C	Genesis	C	Mosaic plus	F	Sashiko	G	Wool Boucle	G
Cork	E	Genesis plus	D	Durablock™	F	Sequel	B	Xanadu	G
Counterpoint	D	Durablock™	D	Motif	G	Sequel plus	D		
Cross Check	B	Glee	D	Myriad	F	Durablock™	D		
Crystals	D	Glimmer	E	Mystic	C	Sequence	C		
Cuddle Up	F	Groundworks	F	New Dimensions	G	Shantung	D		
Curlicue	C	Guardian	C	Nirvana	G	Sherlock	C		
Dakota	C	Haberdash	C	Nostalgia	D	Shibori	F		
Dande	E	Habitat	E	Nuance	E	Shimmer	E		
Dapper	C	Hole In One	F	Nylon-Stat ESD	E	Sierra SP Black	A		

Momentum Fabric Grading

For memo samples call Momentum at 800-366-6839

Grades and availability of fabric are subject to change without notice. Changes could include but are not limited to price increases, discontinued patterns, discontinued colors, etc. See jsifurniture.com for updated information.

Pattern	Grade	Pattern	Grade	Pattern	Grade	Pattern	Grade	Pattern	Grade
Ace	C	Cycle	D	Impact	D	Ohs II	G	Silica Leather	F
Acoustic	F	Dash	F	Imperial Mohair	J	Ona	I	Silica Reach	G
Agora II	D	Dayspell	H	Index	G	Origin	A	Silica Roam	G
Aldo	G	Decode	C	Infinity	B	Ozone	H	Silica Stride	G
Align	I	Delano	G	Infusion	F	Pace Crypton	E	Silica Tech	F
Allegory	I	Delve	I	Inner Circle	H	Pace Incase	D	Silica Waltz	G
Amenity II	G	Dive	F	Insight	A	Panorama	J	Silk Struktur	H
Amuse	D	Dividend	G	Interim	I	Parable	F	Sketching Air	G
April	F	Dogwood Leaves	E	Intermezzo	I	Parkside Crypton	F	Skip	C
Ardour II	H	Domain	F	Intermix II	D	Parkside Incase	E	Small Talk	G
Arrange	H	Drift	G	Intersect	C	Parterre	E	Solace	C
Ascend	E	Duo	F	Interval	B	Passages	I	Solo 2	D
Audio	G	Ebb	F	Isla	E	Perk	B	Soma	G
Audubon	H	Edison	H	Jardin	G	Photon	H	Sort	F
Avanti	H	Effloresce	H	Jest	F	Pierre	G	Span Crypton	E
Avenue	D	Elevate	I	Jitney	E	Ping	D	Span Incase	D
Axis	C	Elle	F	Juncture	H	Pique	D	Spin	G
Bandwidth II	F	Emanate	H	Keynote	D	Plus	F	Splendeur	J
Bangle	A	Embark	F	Kindle	F	Propensity	C	Starboard	F
Banter	H	Eon	C	Kindred	F	Prospect	D	Streamers	D
Basis	B	Essay	F	Kinney	D	Proviso	G	Strut	E
Beeline	C	Estrella	H	Knack	C	Proximity	G	Sublime II	C
Beep	E	Evolve	H	Kudos	G	Quirk	D	Substance	J
Bento	F	Expo	B	Lana	I	Raffia	I	Sway II	G
Bias	G	Feliz	G	Ledge	E	Rally	H	Symbol	I
Bloc	G	Felt	G	Lella	G	Rattan	I	Synergy	D
Boom II	D	Felt Melange	G	Lina	I	Recollection II	G	Syntax	C
Boxcar	G	Flection	G	Lineage	I	Redux	D	System	G
Bravo II	D	Fleet	E	Lineup	C	Rein II	D	Tactic	G
Brisk	G	Flow	G	Linq	I	Respite	C	Tesla	G
Buoy	G	Flux	G	Livia	J	Revolve	H	Tetra	D
Cairns	H	Focal	D	Lloyd	G	Riga	G	Tone	E
Cairo II	G	Foray	D	Lore	F	Rivet	D	Torque	H
Camber	F	Free	C	Loupe	I	Row	D	Tradition	B
Canter	C	Fringe	E	Lucio	H	Sail	H	Trefoil	I
Carlo	H	Fuse	A	Ludwig	G	Scan	I	Trove	H
Cashmere II	C	Gentry	H	Malmo	G	Scape	G	Turin	G
Catalogue	H	Geo	J	Mapping Ideas	G	Scrabble	C	Twist	G
Central	E	Golden Leaf Tree	E	Marathon	B	Scribe	D	Upside	G
Centric	F	Gradient 18	H	Marcel	H	Sense	E	Vario	D
Channel	E	Gradient 36	J	Medley	F	Sidebar Crypton	F	Veer	H
Chant	F	Gradient Solid	F	Mensa	H	Sidebar Incase	F	Velocity	D
Chipper	I	H2O	J	Method	G	Sidestep	F	Venue	D
Cinch	B	Habit	C	Millennium	B	Signet	I	Via	C
Cite	G	Hearsay	H	Mix	I	Silica	F	Viva II	E
Clang	D	Helm	F	Molto	H	Silica Andy	G	Vox	B
Classique	J	Hickory Leaf	D	Nagoya	H	Silica Breeze	G	Wander	F
Context	B	Hive	E	Neon	H	Silica Deflect	G	Waver	E
Core	B	Hue	C	Nifty	D	Silica Etch	F	Waypoint	C
Course	G	Hula	H	Nile	H	Silica Fiona	G	Weaving Palettes	F
Cover Cloth	C	Icon	D	Nimble	H	Silica Fritz	G	Whim	F
Crete	H	Idyll	G	Oath	E	Silica Hiatus	G		
Current	C	Illumina	I	Odyssey	B	Silica Hoop	G		

FABRIC GRADING

Pallas Fabric Grading

For memo samples call email www.pallastextiles.com

Grades and availability of fabric are subject to change without notice. Changes could include but are not limited to price increases, discontinued patterns, discontinued colors, etc. See jsifurniture.com for updated information.

Pattern	Grade	Pattern	Grade	Pattern	Grade
Abstract Chevron	F	Kwaart	G	Turtle Neck	G
Algorithm	F	Laced Up	E	Twine	D
Amari	F	Larkspur	G	Unraveled	E
Asha	F	Latifolia	G	Unspun	G
Aurora	F	Le Fleur	F	Urbanized	E
Basaltes	F	Line	F	Vespa	E
Bevel	F	Majolica	G	Whim	E
Bonnaroo	F	Marbles	F	Wonder Wheel	H
Boulevard	F	Meadowrue	F	Work Horse	F
Bounce	E	Melody Maker	F		
Busy Bee	H	Milano	G		
Carnivale	G	Modern Blaze	F		
Cell Theory	I	Mosaic	E		
Chakra	F	Off Track	E		
Chitra	E	On The Fringe	H		
Chroma	G	Painted Stripe	G		
Composition	G	Patina	E		
Criss Crossing	F	Perfect Pitch	F		
Curve	H	Petals	G		
Dapple	E	Ping Pong	E		
Deeply Rooted	H	Point	F		
Deflect	E	Polka Dotty	F		
Delphinium	G	Promenade	F		
Dot Dot Dot	G	Racy	F		
Field Play	G	Raku	F		
Flame	F	Ravenna	G		
Flexing Muscles	F	Reel To Reel	G		
Formula	G	Reverb	G		
Fortune Teller	F	Rooftops	G		
Fracture	G	Round	I		
French Crepe	F	Running Stitch	H		
Friendship Bracelet	E	Sandstone	D		
Gather	E	Seeking Truth	G		
Gene Pool	G	Sheepish	F		
Graph	D	Skip	E		
Grasmere	F	Solid Footing	E		
Grid	F	Spin Art	G		
Grill Cloth	G	Spontaneous	I		
Ground Breaking	F	Spot On	F		
H2O	F	Spun	E		
Hand-Woven	F	Stamped Out	I		
Heritage	E	Stereo Stripe	G		
Highway Patrol	E	Surface	E		
Hitch	F	Swing	F		
Holy Cow	E	Tempo	E		
Holy Cow Too	E	Terra	D		
Infinite Helix	G	The Burbs	F		
Inlay	F	Top Color	F		
Interlace	G	Transom	G		
Jacks	H	Trellis	H		
Karoke	F	Tulips	G		

Stinson Fabric Grading

For memo samples call Stinson at 800-841-6279

Grades and availability of fabric are subject to change without notice. Changes could include but are not limited to price increases, discontinued patterns, discontinued colors, etc. See jsifurniture.com for updated information.

Pattern	Grade	Pattern	Grade	Pattern	Grade	Pattern	Grade	Pattern	Grade		
Abacus	G	Channel	D	Flex	E	Liquid	E	Respite	F	Tendrill	D
Acadia Epingle	I	Chauncey	D	Flight	G	Makeover	G	Retrograde	D	Tessellate	G
Acanthus	H	Chi w/Agion	G	Flip Flops	G	Mali	G	Revolution	G	Tessuto	C
Ace	C	Chloe	F	Florentine	G	Malta	I	Revolve	H	Thicket	D
Acrobat	G	Chroma	E	Folio	G	Manchester	E	Rialto	C	Torus	F
Adirondack	F	Cielo	H	Fractal	F	Marimba	F	Riddle	D	Tracing	E
Aero	F	Cinnamon Blossom	H	Freehand	E	Marquetry	F	Rivera	F	Tranquility	H
Affinity	F	Cirque	E	Furrows	D	Martini	F	Rogue II	B	Transcend	C
Alchemy	E	Cirro	F	Fuse	C	Matrix	E	Rolling Stones	H	Trax	D
Alfresco	G	Citadel	C	Geodesic	G	Mesa	H	Salinas	I	Tribeca	C
Algiers	G	Clean Slate	D	GeoMet	E	Metro	D	San Simeon	G	True Path w/Agion	H
Alignment	G	Coco	F	Glacier	C	Mica	D	Satellite	D	Tuscan Hills	H
All American	B	Colden	F	Glisten	H	Mingle	F	Scintillate	G	Tweed	F
Aloha	H	Colorguard All	C	Gradation	E	Moccasin	C	Scout	C	Umbrian Rain	H
Apex.Crypton Revl	E	Seasons	C	Grand Sierra	C	Modena	F	Scribe	D	Up Tempo w/Agion	H
Arc	F	Comeback	G	Gravity	E	Monhegan	G	Script	D	Urban Grid	C
Archetype	E	Concentric	G	Grille	D	Montage	E	Seagrass	G	Valise	D
Arioso	E	Connect	C	Grove	G	Montana	C	Sebago	F	Vanish	H
Ascend	F	Continuum	E	Hands On	F	Moxie	F	Second Act	G	Vapor	F
Aspen	F	Core	C	Happy Hour	E	Mumbai	G	Sedona	H	Varati	I
Atlas	C	Cottonwood	G	Happy Tappy	I	Natural World	J	Sentry - HC	C	Vegas	C
Atmosphere	C	Courtyard	H	Haven	E	Naugaleather	C	Sequence	D	Velocity	E
Auberge	H	Cozy	E	Helix	H	Naugasoft	C	Shantung	C	Verdure - Envi	F
Aura	I	Cranbrook Loop	J	Hi-Fi	D	Neochrome III	C	Shift	C	Vermont	H
Avant	C	Criss Cross	C	Highlight	C	Nest	H	Sideline	E	Vibe	F
Balance Beam	G	Cruisin	H	Hive	D	New Hempstead	C	Silverado w/Agion	F	View	H
Bali	F	Crypton Suede	D	Horizons	H	Next Scene	F	Simplicity	C	Vineyard	I
Balustrade	H	Crystalline	G	Hot Spot	F	Nimble	F	Skyline	G	Vintage	H
Bambu-Envi	F	Curves Ahead	G	Hourglass	G	Nishiki	C	Sleek	D	Vision	C
Banyan	F	Cyma	H	Hudson	G	Nova	E	Sleeping Bear Dunes	F	Voltage	H
Bari	F	Daddy-O w/Agion	G	Hush	F	Now & Zen w/Agion	I	Smile	G	Volterra-Hc	H
Bass Line	G	Dakota	D	I Spy	H	Olympus	F	Smoothie	C	Vortexia	I
Beatbox	F	Dart	C	Impression	H	On The Money	F	Snuggle	E	Walk the Line	J
Beep Beep	G	Dash	D	Inside Track	D	Orbit	D	Solitaire	D	Whirl	G
Bespoke	E	Deflection	G	Interplay	F	Oscillate	I	Spark	J	Whisper	C
Bistro	C	Delphi	F	Interval	E	Outlander	D	Sphere	E	Whitney	F
Blip	C	Detail	G	Isabella	H	Oxford	C	Spindles	H	Willow Talk	H
Block Party	F	Deza	I	Jala	I	Pacifica	G	Spirit Millennium	C	Wink w/Agion	F
Bon Voyage	J	Diffusion	I	Jam Session w/Agion	I	Panorama	J	Splash	F	Wish	I
Bongo	H	Diva	D	Jambi Stripe	G	Park Avenue	F	Sprint	C	Wyatt	D
Breton	G	Dodgeball	G	Jasmine Screen	F	Patriot Plus II	C	Squire	E	Ybor	F
Brilliant	D	Double Time w/Agion	I	Jump w/Agion	I	Peninsula Mohair	I	Stat-Con	E	Ziggy	C
Bryant Park	C	Duet	E	Juxy	F	Perimeter	D	Stellar	D	Zodiac	D
Bubblerake	G	Dynasty	C	Kambala	I	Persuasion	E	Sterling w/Agion	F	Zoom	E
Budget Black	A	E'lan-HC	H	Kennebunk	F	Petals	G	Stipple	D		
Burkshire	C	Effervescense	F	Ketana	H	Pivot	C	Stitch In Time	D		
Calibration	F	Elderberry	G	Kilkenny Tweed	C	Polka	E	Straight and Narrow	G		
Calla	G	Eli	F	Kinetic	F	Portico	F	Strand	C		
Camino	H	English Pub	C	Knock Knock	I	Posh	E	Stratford	I		
Cannon Beach	H	Entrada	G	Kusari	D	Prisma	F	Sumatran Palm	H		
Canterbury	G	Equinox	F	Labyrinth	G	Profile	E	Summit	E		
Capreni	F	Excursion	E	Laredo	C	Promenade	E	Sunburst	G		
Carlisle	D	Expressions	C	Latitude	D	Queue	F	Sundance	E		
Casablanca	I	Facet	D	Lava	H	Radiance	H	w/Stakleen			
Cassidy	C	Fast Lane	D	Leaps & Bounds	F	Raffia	E	Sunswept	I		
Catalina	F	Fenestra	H	Lift	G	Rainier	C	Supersillyness	I		
Catalyst	C	Figment	H	Lindley Park	D	Rally	B	Swivel	G		
Catwalk	F	Finite	E	Line Dance	F	Raquette	G	Symmetry	H		
Celeste	J	Firefly	G	Links	G	Realm	E	Symphony Classic	C		
Chakra	H	Fizz	E	Linus	F	Refraction	C	Tender	H		



Ultrafabrics Fabric Grading

For memo samples at Ultrafabrics email charlotteakirby@yahoo.com

Grades and availability of fabric are subject to change without notice. Changes could include but are not limited to price increases, discontinued patterns, discontinued colors, etc. See jsifurniture.com for updated information.

<u>Pattern</u>	<u>Grade</u>
Brisa	E
Brisa Distressed	E
Brisa Fresco	E
Buffalina	E
Eco Tech	E
Hammered	E
Metro Tech	E
Patine	E
Raffia	E
Ultraleather	E
Ultraleather Fusion	E
Ultraleather Fusion Shimmer	E
Ultraleather Linen	E
Ultraleather Pearlized	E
Ultraleather Pony	E
Ultraleather Pro	F
Ultraleather Promessa	E
Ultraleather Uccello	E
Ultratech	E
Viva	E

Effective January 1, 2016 ▲

Wollsdorf Leather Grading

For memo samples call Wollsdorf at 336-884-5005

Grades and availability of leather are subject to change without notice. Changes could include but are not limited to price increases, discontinued patterns, discontinued colors, etc. See jsifurniture.com for updated information.

<u>Pattern</u>	<u>Grade</u>
Alpine	L2
Atlantic	L2
Euroglazed	L2
Finesse	L2
FOC Earth Black	L2
FOC Earth Colors	L2
Genoa	L2
Mammut	L1
Oslo	L2
Paloma	L2
Prima	L2
Pull Up	L2
Sattel	L2
Sedona	L2

Planning Chair Dimensions

Overall Height
From highest point

Overall Width
From widest point

Overall Depth
From widest point

Seat Width
Between arms at widest point

Seat Depth
From back to front of seat

Seat Height
Highest point of seat to floor

Arm Height
If arm is sloped center point is used

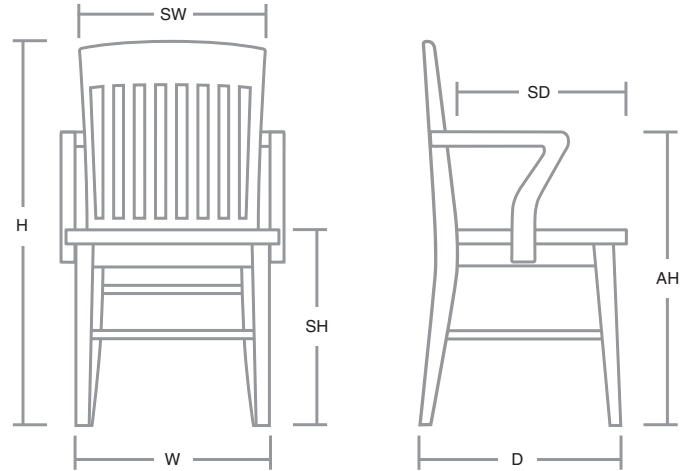

Planning For Kids

Suggested table and chair heights.

Kindergarten (ages 4-7)

Seat Height: 12"

Table Height: 20"-22" (not available as a standard)



K-3 (ages 7-9)

Seat Height: 14"

Table Height: 25"



Grade 4-8 (ages 9-12)

Seat Height: 16"

Table Height: 27"



Planning With Tables

Some General Tips

1. 14 sq. ft. per person for spacious dining - allows for table, chair and aisle.
2. 12 sq. ft. per person for cafeteria or restaurant.
3. 10 sq. ft. per person for banquet, institutional or close seating.
4. Allow 18" for person seated from edge of table to back of chair.

Round Tables

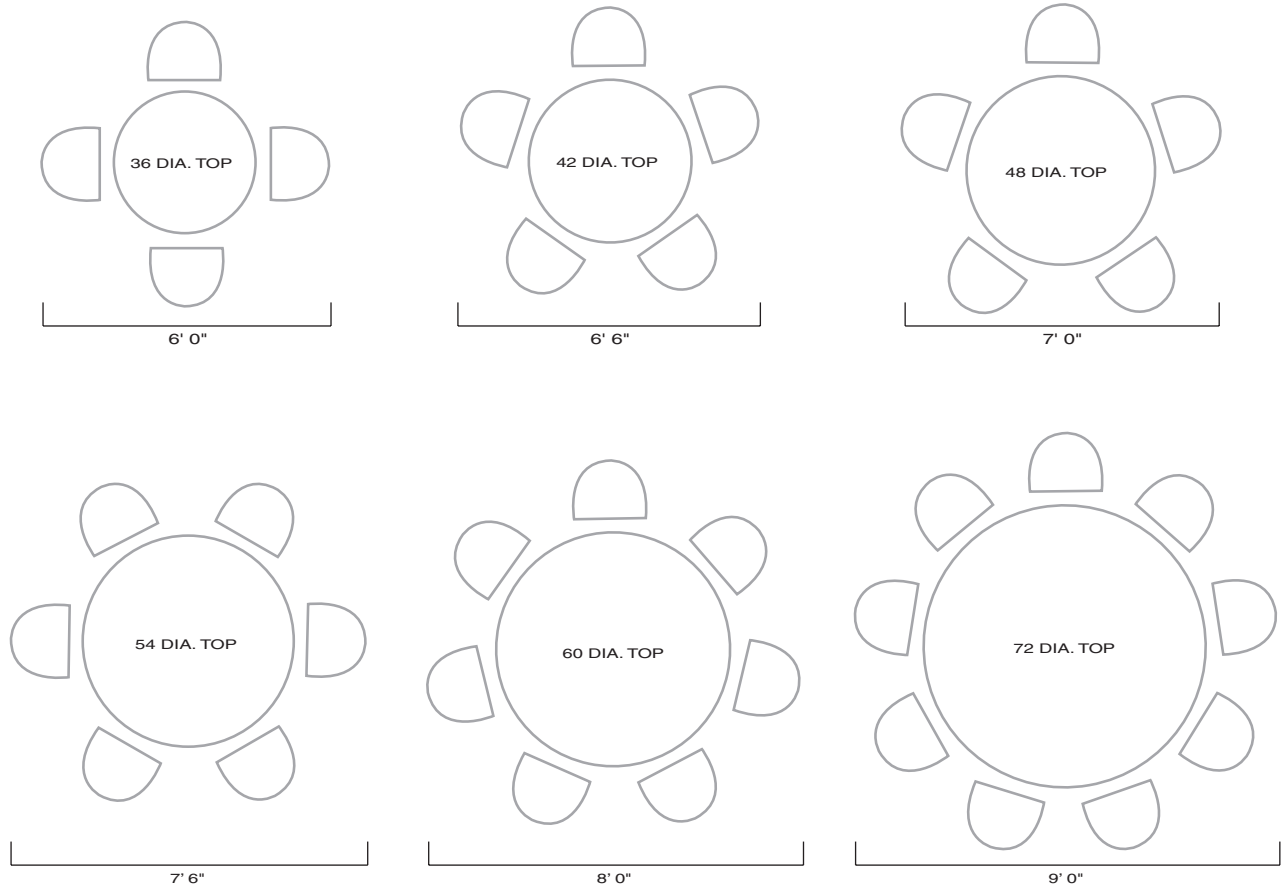

Planning With Tables

Diagonal and Square Table Planning Tips

1. Diagonal seating saves floor space - Deuce tables and wall spacing saves the most space.
2. Allow 42" between squared tables for chairs back to back leaves 6" to push out.
3. Allow 60" between squared tables for chairs back to back leaves 26" service aisle.
4. Allow 24" between corners of diagonal tables for customer access - no aisle.
5. Allow 30" between corners of diagonal tables for customer access - narrow aisle.

Square Tables

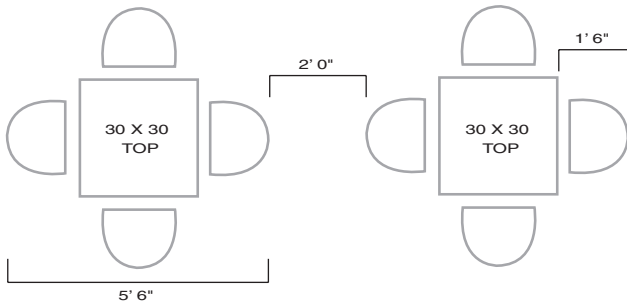
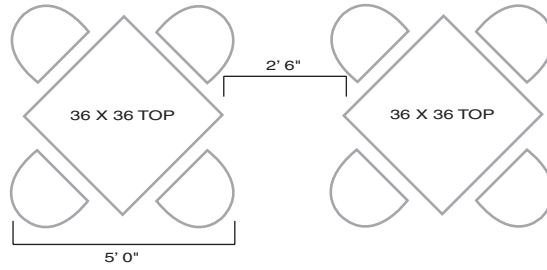
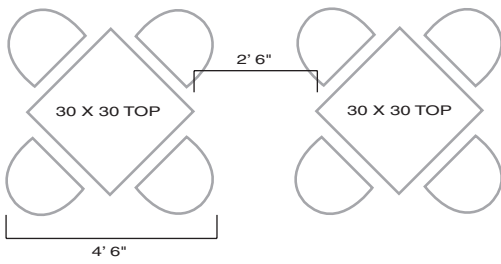

Order Check List

Community products are manufactured to order and provide a multitude of options to address your individual customer needs. As you process your order do not forget to include all the necessary information to allow the order entry process to be completed. Please see the order checklist at the beginning of every series.

Community customer service edits every order for complete information. If details are not included with the purchase order, customer service will contact you to answer these questions. If information is not completed in a timely manner it will delay the entry process and could effect your product delivery date. To avoid delay in order entry and potential delay in delivery of your order, please double check the line items to insure all selections have been completed.

To insure complete Community details on your purchase order, electronic catalogs and specification tools have been developed to aid in the process. These electronic tools include:

20-20 GIZA Studio and **20-20 CAP Studio** software offers state-of-the-art design, specification, photo-realistic rendering and three-dimensional visualization capabilities for configurable products in the commercial interior design markets. 20-20 GIZA Studio and 20-20 CAP Studio are available for all Community Casegood and Seating products, in 2D and 3D graphics and the Specifier Catalog. Updates are made monthly reflecting any changes that occurred. To be sure the most up to date information is provided on orders, users of this software program are responsible to update their catalogs.

ProjectMatrix, Inc offers a full software solution for the contract furniture industry. Their software can help you create space plans to specifications for ease of specifying our Community Casegood and Seating product lines. Updates are made monthly reflecting any changes that occurred. To be sure the most up to date information is provided on orders, users of this software program are responsible to update their catalogs.

GSAdvantage is a Federal Government electronic catalog site offered to assist GSA customers in specifying and pricing Community product. Listed at this site are all contract items and prices under GSA Contract # GS-28F-0030U.

Our Community web site www.communityfurniture.com provides many tools to assist in the design and order selection. Included in the site are downloadable images, brochures, contact information, price lists, sales representative locations, literature order form, warranty and environmental information.

Care and Maintenance

Care of Upholstery Surfaces

Cleanability will vary based on the fabric type. For best results, a professional service is recommended. Dirt and crumbs may be gently brushed or vacuumed off. Spills should be wiped up immediately with a cloth. Vinyl textiles can be cleaned with warm soapy water and then wiped down with a warm damp cloth. For more details on any Community carded fabrics and vinyls, please visit our website at www.communityfurniture.com or consult the back of the appropriate swatch card for cleaning codes and any specific instructions. For COM materials, consult with the individual textile manufacturer for cleaning codes and any specific instructions pertaining to your particular fabric.

Maintenance of Mechanical Parts

Clean any lint or debris from the moving parts of the base mechanisms. Mechanisms have been designed and tested to not require lubrication under normal conditions however lubricant can be used if needed.

Wood Edges and Veneer Surfaces

Clean all surfaces frequently with water dampened soft cloth, moving the cloth with the grain direction. Immediately remove any liquids that come in contact with wood surfaces with a blotting action to absorb liquid. Buff dry. Lift objects to move them, never pull them across the finished surface. For an additional safeguard, use a protective surface pad. This will ensure a lasting finish by protecting your furniture from possible damage caused by pens, cups and sharp objects.

Avoid exposure of furniture to extremes of heat and cold, or to wide humidity variances. Avoid exposure of furniture to strong sunlight. Avoid exposure of furniture to harsh solvents such as nail polish remover, acetates, etc., as it will cause finish deterioration. If using a protective glass top, place spacer pads under the glass top to allow the wood to breath.

Metal finishes

Wipe smooth powder coat finishes and textured metals with a damp cloth. For stubborn stains and grease marks, use soap and water. Lightly brush textiles metals with a soft, dry brush to remove dirt.

GSA Terms and Conditions



Contract Holder

Contract # GS-28F-0030U

In addition to the standard terms and conditions, the following terms and conditions apply to GSA contract.

Contract Number

GS-28F-0030U

Contract Period

September 23, 1999 - June 24, 2018

Statement of Intended Use

The furniture covered by special item numbers 711-11, 711-16, 711-17, 711-18 and 711-19 is intended for use by Government executives (or equivalent military rank) in the executive, judicial, and legislative branches or armed forces of the federal government. To help customers make a good purchasing decision based on their needs and budget, GSA has established four grades of furniture: Grade (1) includes furniture that tends to be the most expensive on this schedule, Grade (2) furniture tends to be more moderately priced and Grades (3) and (4) furniture tend to be affordable pricing when compared to grades (1) and (2). The ordering agency or service is responsible for determining furniture appropriate for use in its offices which will fit within budget and comply with applicable federal or internal agency procurement regulations.

Description of Special Item Numbers SIN#

711-11 Tables, occasional and conference
 711-16 Upholstered seating
 711-17 Multiple seating
 711-18 Multi purpose seating
 711-19 Stacking chairs and dollies

Maximum Order

711-11 \$500,000 (*five hundred thousand dollars*) net
 711-16 \$300,000 (*three hundred thousand dollars*) net
 711-17 \$200,000 (*two hundred thousand dollars*) net
 711-18 \$200,000 (*two hundred thousand dollars*) net
 711-19 \$200,000 (*two hundred thousand dollars*) net

Minimum Order

\$100 (One hundred dollars) net

Geographic Coverage

48 contiguous states and Washington D.C.

Business Size

Large Business

Point of Production

Ferdinand, Dubois County, Indiana
 French Lick, Orange County, Indiana
 Jasper, Dubois County, Indiana
 Paoli, Orange County, Indiana

Pricing

All prices shown are list prices (freight included)

Discount

Discount 59.4%* off list.

Quantity Discounts

Not applicable.

Prompt Payment Terms

1% 15 - net 30 days from date of invoice.

Government Commercial Credit Cards

Accepted. No additional discount offered.

Foreign Terms

Not applicable.

Delivery Time

30-75 days after receipt of order, 90 days maximum.

Overnight and 2-day Delivery

Not applicable.

Urgent Requirements

Contact Customer Service if faster delivery is required.

F.O.B. Points

F.O.B. destination, freight prepaid and allowed to 48 contiguous states and Washington D.C. excludes special delivery requirements.

Ordering Address

Community
 Attn: Participating Dealer
 225 Clay Street
 Jasper, IN 47546
 Fax: 812-482-1548
 Phone: 800-457-4511
 Email: orders@jaspergroup.us.com

Product Modifications

We willingly accept customers' modifications to standard products. See product modifications information by series at the start of each series under the "Product Modification" sections. If there is a modification you desire that is not listed in this section, please call Customer Service for a modification quote/price.

GSA Terms and Conditions

Payment Address

Community
225 Clay Street
Jasper, IN 47546

Warranty Provision

Community's commercial 15[▲] year warranty applies. See page 3.

Export Package Charges

Quoted on project-by-project basis.

Terms of Government Commercial Credit Card Acceptance

Accepted.

Rental, Maintenance, and Repair

Not applicable.

Installation

Contact dealer or installation representative.

Repair Parts

Not applicable.

Service and Distribution Points

National distribution.

Participating Dealers

Contact JSI customer service at 800-457-4511.

Preventive Maintenance

Not applicable.

Environmental Attributes

JSI is committed to protecting the environment. For JSI's complete environmental information, contact the GSA Customer Service at 800-457-4511. Go to jsifurniture.com for additional information.

Duns

00-636-7767

Notification Regarding Registration in SAMS Database

Name: Jasper Seating Company, Inc.
Cage code: 31881

Acceptance, Modification, Assignment

By placing this order for furniture, material or other products (sometimes collectively referred to as "goods"), customer agrees to these terms and conditions which shall prevail over inconsistent provisions in any other form or document of customer. No change or modification shall be applicable unless set forth in writing and signed by company. Neither this order nor any interest therein shall be assigned by customer except with the prior written consent of company.

Payment

Customer agrees to pay to company the amount indicated on the invoice, 1% 15 days, net 30 days from date of invoice (U.S.funds only), for goods ordered. Interest will be charged after 30 days from the date of invoice at the rate of one and a half percent (1.5%) per month. International sales will require additional payment arrangements. No goods shall be sold on consignment or conditional sales basis. Payment for the goods delivered hereunder shall constitute acceptance thereof.

Attorneys' Fees

Customer shall be responsible for all expenses and cost in connection with the enforcement by company of these terms and conditions and the cost of collection (including the fees of any collection agencies to whom the customer's account may be referred), plus reasonable attorneys' fees (which attorneys' fees shall not be less than 25% of the amount due, unless a lower amount is specified by applicable law).

Remedies

The remedies herein reserved shall be cumulative, and additional to any other or further remedies provided in law or equity. No waiver of a breach of any provision of these terms and conditions shall constitute waiver of any other breach or of such provision.

Insolvency

Company may forthwith cancel this order in the event of the happening of any of the following or any other comparable event: insolvency of the customer, the filing of a voluntary petition in bankruptcy, the filing of any involuntary petition to have customer declared bankrupt provided it is not vacated within thirty (30) days from the date of filing, the appointment of a receiver or trustee for customer provided such appointment is not vacated within thirty (30) days from the date of such appointment, or the execution by customer of an assignment for the benefit of creditors.

Limitation of Liability

The Company shall not under any circumstances be liable to the customer, owner of the goods or any third party for special, indirect, incidental, or consequential damages, including, without limitation, loss of profits or revenues, loss or damage to other property or equipment, cost of capital or of purchased or replacement goods, or expense, delay, or inconvenience cause by or arising from the purchase, sale, use, repair or inability to use the goods or by any performance or non-performance under, or breach of, these terms and conditions. The Company's sole liability for any defective goods shall be its repair or its replacement pursuant to the express warranties set forth above, or if amended, as applicable at the time of manufacture or repair of the goods. Some states do not allow the exclusion or limitation of incidental or consequential damages, so the above limitations or exclusion may not apply to all customers. Any action resulting from any breach on the part of company as to the goods or services delivered here under must be commenced within one year after the cause of action has occurred.

Returns and Allowances

Reasonable touch-up and deluxing is the dealer's responsibility. The Company will not make allowances for trip or delivery charges, but will only make allowance for actual work performed to correct manufacturing defects. Allowances maybe authorized only by a company officer. It is the responsibility of the field sales representative to inspect any defective merchandise and make suggestions and recommendations as to the proper disposition. Field personnel cannot obligate or bind the company by definite agreement, without final authorization by a company officer. Company will not accept automatic charge backs which do not have prior authorization. All defects must be called to the company's attention upon arrival at the customer's "ship to" destination. To initiate any type of claim or request for parts, it is imperative to have the model number or fabric number, which may be located on the tag attached to the frame of the unit. Authorization for return to the company via a return goods authorization. Company will not issue credit allowances for any repairs without company's prior consent. Under no circumstances shall the company accept COD (cash on delivery) returns, and any such shipment will be refused.

GSA Terms and Conditions

Security Agreement

The Company may require and customer shall grant a security interest in goods sold pursuant to any credit the company may extend to the customer.

Governing Law

All disputes between the parties, whether or not arising out of these terms and conditions, will be governed by the laws of the state of Indiana. Customer agrees to submit to the jurisdiction of and agrees all lawsuits relating to any disputes between the customer and the company will be brought only in a state court located in Dubois County, Indiana or the United States District Court for the Southern District of Indiana. The customer hereby waives the right to a trial by jury in any action, proceeding, claim, or counterclaim whether in contract or tort, at law or in equity, arising out of or relating in any way to these terms and conditions and all other disputes between the parties.

Mitigation

If the company repossesses the goods prior to payment by the customer of all amounts due hereunder, the company may sell the goods, as is, where is, free and clear of all rights of the customer at either public or private sales, and apply the net proceeds (after deducting expenses of repossession and sale) to the obligation of customer hereunder. The customer may dispose of the goods in any commercially reasonable place and manner and the customer waives any notice of time, place and manner of sale.

Integration

This order for goods, including these terms and conditions, along with any credit application, invoice, statement, dealer contract, acknowledgment, bill of lading (and any exhibits, addenda or amendments thereto) of which this order may be a part, constitutes the sole and complete agreement between the company and the customer with respect to the purchase of the goods.

Dimensions/Specifications/Finishes

All dimensions are approximate and may vary due to the upholstery technique of each craftsman. If exact dimensions are required, it is necessary for the customer to state such specifications with the order. Detailed specifications sheets are available for each series of goods, and customer should consult the company's customer service department for these specification sheets. Company reserves the right to make changes in dimensions, style, or specifications if company believes these changes will improve the goods' quality or appearance. Company reserves the right to substitute hardwoods due to availability at production. Due to the natural characteristics of wood, environmental effects, and material upgrades, the company cannot guarantee exact finish matches on existing goods previously ordered from company. If an exact match to customer's existing goods is required, it must be specified so that the proper procedures can be followed to ensure an acceptable finish. Company will accept no liability for the finish if this procedure isn't followed. Company reserves the right to make changes in a finish formula if company believes the change will improve the quality or appearance of company's goods.

Company's Performance of Its Obligation

The production and delivery of the goods to the extent delayed or hindered or prevented from the performance by reason of natural disasters, acts of god, strikes, lockouts, labor troubles, inability to procure materials, casualties, failure of power, restrictive governmental laws or regulations, riots, insurrections, acts of terrorism, war or other reason of a like nature not the fault of the company shall excuse for the period of the delay the company's performance and the period for the performance shall be extended for a period equivalent to the period of such delay.

Seating Overview



Accolade 32



Addison 36



Alden 38



Alpine 42



Americana 46



Americana II 52



Avalon 55



Avini 67



Bison 71



Boston 74



Brockton 78



Calculus 80



Carriage 86



Chancellor 89



Chandler 92



Class Act 96

SEATING

Seating Overview

SEATING



Classmate 104



Classmate II 108



Collegian 112



Collegian II 112



Cym 115



Dexter 123



Dimension 125



Emerson 128



Finley 130



Hampton 133



Hanover 136



Hoopz 138



Kendall 140



Kinsey 143



Laurel 148

Seating Overview



Logan 155



Madison 157



Medallion 160



Melrose 163



Metro 171



Milk 174



Murphy 178



Parker 180



Profile 183



Sayde 186



Sterling 188



Sultan 192



Trinity 194



Walker 196



Wink 198

SEATING

Accolade Order Check List:

SEATING



Specify:

- 1. Model Number
- 2. Wood Species - Beech (B)
- 3. Wood Finish/Color
- 4. Fabric Selection - vendor, pattern and color
- 5. Optional FRONT LEG casters - add \$46 list; specify seat height
NOT AVAILABLE on BARSTOOLS
- 6. Optional Rubber Cushion Nylon Glides - no upcharge

Example:

463C | B | AUB | MOMENTUM | VOX | MYSTIC
 (model #) | (wood species) | (finish) | (fabric vendor) | (pattern name) | (pattern color)

1. Model Number

2. Wood Species - Beech (B)

3. Wood Finish/Color Options: ▲

ALE Ale	FLX Flax
AUB Auburn	HEN Henna
AUT Autumn	HNY Honey
BRL Barley	LGC Legacy
BBN Bourbon	MCH Mocha
BRG Brighton	NTO Night Owl
BRW Brownie	NUT Nut Brown
BUT Butterscotch	PRL Praline
CAN Canyon	SAF Saffron
CIN Cinnamon	SIE Sienna
CIT Citron	TOF Toffee
CLA Classic	TRF Truffle
DES Desert	VEN Venetian
EAR Earthy	
ESP Espresso	

Color - Add \$31 list per item

BKD Backdrop	GRV Greek Villa
BFX Black Fox	GLF Gulf Stream
BWH Bright White	HTB Heartthrob
CGP Cargo Pants	NET Network Gray
CHT Chatroom	NWH Nonchalant White
DSY Daisy	PAR Paradise
DRG Daring	QXP Quixotic Plum
DYN Dynamo	RBZ Relic Bronze
ENG Enigma	SND Sandbank
FRR French Roast	STM Storm
GBY Georgian Bay	TRC Tricorn Black

4. Fabric Selection - Please supply the following:

- Fabric vendor
- Pattern name
- Pattern color

All COM orders must include the following:



- Vendor's name, pattern name and color
- Sample of the fabric attached to order
- Model numbers of items for fabric application
- Special application instructions (e.g., all stripes will be applied front to back unless specified otherwise)
- Customer and purchase order number

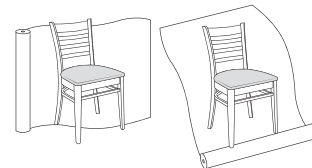

Ship prepaid COM material to:
 Community
 Attn: COM Dept
 932 Mill Street
 Jasper, IN 47546

Application of fabric:
 Railroaded Up the Roll



All COM orders will ship at standard lead time from receipt of COM except for orders requiring special custom matched finishes.

Description	Model	Specifications				List Price Per Grade	
		Dimensions	D	W	H	All Wood	COM
Armless 	463A All Wood					\$276	
	463C Uph. Seat					\$320	
 	<ul style="list-style-type: none"> horizontal slat back optional front leg casters available - add \$46 list for set of 2 casters 	Overall	19	16 1/2	34	A	\$331
		Seat	16 1/2	17	18 1/2	B	\$345
		Upholstery		Shipping		COL/C	\$367
		COM Ydg	3/4	Ctn Wt	20	D	\$396
		COL Sq Ft	9	Cu Ft	9	E	\$426
						F	\$457
						G	\$501
						H	\$548
						I	\$621
						J	\$709
						L1	\$510
						L2	\$557

Description	Model	Specifications				List Price Per Grade	
		Dimensions	D	W	H	All Wood	COM
Barstool	468A All Wood					\$319	
	468C Uph. Seat					\$362	
 	<ul style="list-style-type: none"> horizontal slat back casters not available standard with brass scuff plate, also available in polished aluminum or matte black 	Overall	19 1/4	17	42	A	\$374
		Seat	16 1/2	17	30	B	\$387
		Upholstery		Shipping		COL/C	\$410
		COM Ydg	3/4	Ctn Wt	30	D	\$439
		COL Sq Ft	9	Cu Ft	13	E	\$469
						F	\$499
						G	\$543
						H	\$591
						I	\$664
						J	\$751
						L1	\$553
						L2	\$599

To Order, Specify:

- 1 Model Number
- 2 Wood Species - Beech (B)
- 3 Wood Finish/Color
- 4 Fabric Selection - vendor, pattern and color
- 5 Optional FRONT LEG Casters - add \$46 list; specify seat height. **NOT AVAILABLE on BARSTOOLS**

3 Wood Finish/Color Options: ▲

ALE Ale	FLX Flax
AUB Auburn	HEN Henna
AUT Autumn	HNY Honey
BRL Barley	LGC Legacy
BBN Bourbon	MCH Mocha
BRG Brighton	NTO Night Owl
BRW Brownie	NUT Nut Brown
BUT Butterscotch	PRL Praline
CAN Canyon	SAF Saffron
CIN Cinnamon	SIE Sienna
CIT Citron	TOF Toffee
CLA Classic	TRF Truffle
DES Desert	VEN Venetian
EAR Earthy	
ESP Espresso	

Color - Add \$31 list per item

BKD Backdrop	GRV Greek Villa
BFX Black Fox	GLF Gulf Stream
BWH Bright White	HTB Heartthrob
CGP Cargo Pants	NET Network Gray
CHT Chatroom	NWH Nonchalant White
DSY Daisy	PAR Paradise
DRG Daring	QXP Quixotic Plum
DYN Dynamo	RBZ Relic Bronze
ENG Enigma	SND Sandbank
FRR French Roast	STM Storm
GBY Georgian Bay	TRC Tricorn Black

Specifications

- Wood species - Beech.
- Seat is upholstered with 1 1/2" polyurethane foam and synthetic sheet webbing for added comfort.
- Mortise and tenon construction with corner blocks, glue and screws.
- Standard with rubber cushion metal glides.

4 See a selection of graded in fabric manufacturers and patterns on pages 12-20. Contact Customer Service for additional fabric options.

Description

① Model

Specifications

List Price Per Grade

Armless



473A
all wood



473C
uph. seat

473A All Wood
473C Uph. Seat
 · vertical slat back
 · optional front leg casters available - add \$46 list for set of 2 casters

Dimensions	D	W	H
Overall	20 ½	17	35
Seat	16 ½	17	18 ½
Upholstery		Shipping	
COM Ydg	¾	Ctn Wt	20
COL Sq Ft	9	Cu Ft	9

All Wood	\$276
COM	\$320
A	\$331
B	\$345
COL/C	\$367
D	\$396
E	\$426
F	\$457
G	\$501
H	\$548
I	\$621
J	\$709
L1	\$510
L2	\$557

Barstool



478A
all wood



478C
uph. seat

478A All Wood
478C Uph. Seat
 · vertical slat back
 · casters not available
 · standard with brass scuff plate, also available in polished aluminum or matte black

Dimensions	D	W	H
Overall	19 ¾	17 ¼ ▲	43 ¾ ▲
Seat	16 ¾ ▲	17 ¼ ▲	30
Upholstery		Shipping	
COM Ydg	¾	Ctn Wt	30
COL Sq Ft	9	Cu Ft	13

All Wood	\$319
COM	\$362
A	\$374
B	\$387
COL/C	\$410
D	\$439
E	\$469
F	\$499
G	\$543
H	\$591
I	\$664
J	\$751
L1	\$553
L2	\$599

Armless



483A
all wood





483C
uph. seat

483A All wood
483C Uph. Seat
 · vertical slat back
 · optional front leg casters available - add \$46 list for set of 2 casters

Dimensions	D	W	H
Overall	20 ½	17	35
Seat	16 ½	17	18 ½
Upholstery		Shipping	
COM Ydg	¾	Ctn Wt	20
COL Sq Ft	9	Cu Ft	9

All Wood	\$276
COM	\$320
A	\$331
B	\$345
COL/C	\$367
D	\$396
E	\$426
F	\$457
G	\$501
H	\$548
I	\$621
J	\$709
L1	\$510
L2	\$557

Description	Model	Specifications			List Price Per Grade		
		Dimensions	D	W	H	All Wood	COM
Barstool   488A all wood 488C uph. seat	488A All Wood 488C Uph. Seat · vertical slat back · casters not available · standard with brass scuff plate, also available in polished aluminum or matte black	Overall	19 ¾▲	17 ¼▲	43 ¾▲	\$319	\$362
	Seat	16 ¾▲	17 ¼▲	30	A	\$374	
		Upholstery		Shipping		B	\$387
		COM Ydg	¾	Ctn Wt	30	COL/C	\$410
		COL Sq Ft	9	Cu Ft	13	D	\$439
						E	\$469
						F	\$499
						G	\$543
						H	\$591
						I	\$664
						J	\$751
						L1	\$553
						L2	\$599

SEATING

To Order, Specify:

- ① Model Number
- ② Wood Species - Beech (B)
- ③ Wood Finish/Color
- ④ Fabric Selection - vendor, pattern and color
- ⑤ Optional FRONT LEG Casters - add \$46 list; specify seat height. **NOT AVAILABLE on BARSTOOLS**

③ Wood Finish/Color Options: ▲

ALE Ale	FLX Flax
AUB Auburn	HEN Henna
AUT Autumn	HNY Honey
BRL Barley	LGC Legacy
BBN Bourbon	MCH Mocha
BRG Brighton	NTO Night Owl
BRW Brownie	NUT Nut Brown
BUT Butterscotch	PRL Praline
CAN Canyon	SAF Saffron
CIN Cinnamon	SIE Sienna
CIT Citron	TOF Toffee
CLA Classic	TRF Truffle
DES Desert	VEN Venetian
EAR Earthy	
ESP Espresso	

Color - Add \$31 list per item

BKD Backdrop	GRV Greek Villa
BFX Black Fox	GLF Gulf Stream
BWH Bright White	HTB Heartthrob
CGP Cargo Pants	NET Network Gray
CHT Chatroom	NWH Nonchalant White
DSY Daisy	PAR Paradise
DRG Daring	QXP Quixotic Plum
DYN Dynamo	RBZ Relic Bronze
ENG Enigma	SND Sandbank
FRR French Roast	STM Storm
GBY Georgian Bay	TRC Tricorn Black

- ④ See a selection of graded in fabric manufacturers and patterns on pages 12-20. Contact Customer Service for additional fabric options.

Specifications

- Wood species - Beech.
- Seat is upholstered with 1 ½" polyurethane foam and synthetic sheet webbing for added comfort.
- Mortise and tenon construction with corner blocks, glue and screws.
- Standard with rubber cushion metal glides.

Addison Order Check List:



SEATING

Coordinating Children's collection. See page 328.

Specify:

- 1. Model Number
- 2. Wood Species - Oak (O) or Maple (M)
- 3. Wood Finish/Color
- 4. Fabric Selection - vendor, pattern and color
- 5. Optional FRONT LEG casters - add \$46 list; specify seat height
NOT AVAILABLE on BARSTOOLS
- 6. Optional Rubber Cushion Nylon Glides - no upcharge

Example:

353C (model #)	O (wood species)	HEN (finish)	MOMENTUM (fabric vendor)	VOX (pattern name)	MYSTIC (pattern color)
--------------------------	----------------------------	------------------------	------------------------------------	------------------------------	----------------------------------

1. Model Number

2. Wood Species - Oak (O) or Maple (M)

3. Wood Base/Color Options:

Oak

BRW Brownie	ECU Ecru
CAN Canyon	HEN Henna
CIT Citron	HNY Honey
DES Desert	NUT Nut Brown

Maple

ALE Ale	FLX Flax
AUB Auburn	LGC Legacy
AUT Autumn	MCH Mocha
BRL Barley	NTO Night Owl
BBN Bourbon	PRL Praline
BRG Brighton	SAF Saffron
BUT Butterscotch	SIE Sienna
CIN Cinnamon	TOF Toffee
CLA Classic	TRF Truffle
EAR Earthy	VEN Venetian
ESP Espresso	

Color - Add \$31 list per item

BKD Backdrop	GRV Greek Villa
BFX Black Fox	GLF Gulf Stream
BWH Bright White	HTB Heartthrob
CGP Cargo Pants	NET Network Gray
CHT Chatroom	NWH Nonchalant White
DSY Daisy	PAR Paradise
DRG Daring	QXP Quixotic Plum
DYN Dynamo	RBZ Relic Bronze
ENG Enigma	SND Sandbank
FRR French Roast	STM Storm
GBY Georgian Bay	TRC Tricorn Black

4. Fabric Selection - Please supply the following:

- Fabric vendor
- Pattern name
- Pattern color

All COM orders must include the following:

- Vendor's name, pattern name and color
- Sample of the fabric attached to order
- Model numbers of items for fabric application
- Special application instructions (e.g., all stripes will be applied front to back unless specified otherwise)
- Customer and purchase order number

Ship prepaid COM material to:
Community
Attn: COM Dept
932 Mill Street
Jasper, IN 47546

Application of fabric:
Railroaded Up the Roll

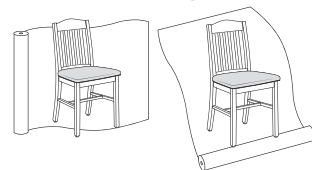

All COM orders will ship at standard lead time from receipt of COM except for orders requiring special custom matched finishes.

Description	Model	Specifications				List Price Per Grade	
		Dimensions	D	W	H	All Wood	COM
Armless 	353A All Wood 353C Uph. Seat • optional front leg casters available - add \$46 list for set of 2 casters • coordinating Children's collection - see page 328	Overall	20 1/2	18	34 1/2	\$286	\$327
		Seat	15 1/2	18	18 1/2		
		Upholstery		Shipping			
		COM Ydgs	3/4	Ctn Wt	20		
		COL Sq Ft	9	Cu Ft	9		

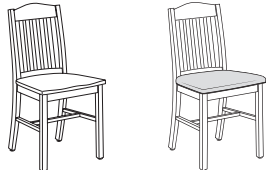

353A all wood
353C uph. seat

Description	Model	Specifications				List Price Per Grade	
		Dimensions	D	W	H	All Wood	COM
Barstool	358A All Wood 358C Uph. Seat • casters not available • standard with brass scuff plate, also available in polished aluminum or matte black	Overall	20 3/8	18	46 3/4	\$347	\$387
		Seat	15 1/2	18	30		
		Upholstery		Shipping			
		COM Ydgs	3/4	Ctn Wt	25		
		COL Sq Ft	9	Cu Ft	13		

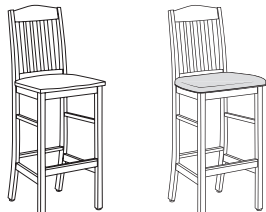

358A all wood
358C uph. seat

To Order, Specify:

- 1 Model Number
- 2 Wood Species - Oak (O) or Maple (M)
- 3 Wood Finish/Color
- 4 Fabric Selection - vendor, pattern and color
- 5 Optional FRONT LEG Casters - add \$46 list; specify seat height. **NOT AVAILABLE on BARSTOOLS**
- 6 Optional Rubber Cushion Nylon Glides - no upcharge

4 Wood Finish/Color Options:

- | | | |
|------------------|--------------|---------------|
| Oak | BRW Brownie | ECU Ecu |
| CAN Canyon | CIT Citron | HEN Henna |
| DES Desert | Maple | HNY Honey |
| ALE Ale | AUB Auburn | NUT Nut Brown |
| AUT Autumn | BRL Barley | FLX Flax |
| BBN Bourbon | BRG Brighton | LGC Legacy |
| BUT Butterscotch | CIN Cinnamon | MCH Mocha |
| CLA Classic | EAR Earthy | NTO Night Owl |
| ESP Espresso | | PRL Praline |
| | | SAF Saffron |
| | | SIE Sienna |
| | | TOF Toffee |
| | | TRF Truffle |
| | | VEN Venetian |

Specifications

- Wood species - Oak or Maple.
- Seat is upholstered with 1 1/2" polyurethane foam and synthetic sheet webbing for added comfort.
- Mortise and tenon construction with corner blocks, glue and screws.
- Coordinating Children's collection. See page 328.
- Standard with rubber cushion metal glides.

Color - Add \$31 list per item

- | | |
|------------------|----------------------|
| BKD Backdrop | GRV Greek Villa |
| BFX Black Fox | GLF Gulf Stream |
| BWH Bright White | HTB Heartthrob |
| CGP Cargo Pants | NET Network Gray |
| CHT Chatroom | NWH Nonchalant White |
| DSY Daisy | PAR Paradise |
| DRG Daring | QXP Quixotic Plum |
| DYN Dynamo | RBZ Relic Bronze |
| ENG Enigma | SND Sandbank |
| FRR French Roast | STM Storm |
| GBY Georgian Bay | TRC Tricorn Black |

4 See a selection of graded in fabric manufacturers and patterns on pages 12-20. Contact Customer Service for additional fabric options.

Alden Order Check List:

SEATING



Specify:

- 1. Model Number
- 2. Wood Species - Beech (B)
- 3. Wood Seat Finish/Color
- 4. Metal Frame Color
- 5. Fabric Selection - vendor, pattern and color
- 6. Optional Clear Leg Protectors - add \$15 list per chair for set of 4

Example:

253C | B | AUB | BRONZE | MOMENTUM | VOX | MYSTIC
 (model #) | (wood species) | (finish) | (metal frame) | (fabric vendor) | (pattern name) | (pattern color)

1. Model Number

2. Wood Species - Beech (B)[▲]

3. Wood Seat Finish /Color Options:[▲]

ALE Ale	FLX Flax
AUB Auburn	HEN Henna
AUT Autumn	HNY Honey
BRL Barley	LGC Legacy
BBN Bourbon	MCH Mocha
BRG Brighton	NTO Night Owl
BRW Brownie	NUT Nut Brown
BUT Butterscotch	PRL Praline
CAN Canyon	SAF Saffron
CIN Cinnamon	SIE Sienna
CIT Citron	TOF Toffee
CLA Classic	TRF Truffle
DES Desert	VEN Venetian
EAR Earthy	
ESP Espresso	

Color - Add \$31 list per item

BKD Backdrop	GRV Greek Villa
BFX Black Fox	GLF Gulf Stream
BWH Bright White	HTB Heartthrob
CGP Cargo Pants	NET Network Gray
CHT Chatroom	NWH Nonchalant White
DSY Daisy	PAR Paradise
DRG Daring	QXP Quixotic Plum
DYN Dynamo	RBZ Relic Bronze
ENG Enigma	SND Sandbank
FRR French Roast	STM Storm
GBY Georgian Bay	TRC Tricorn Black

4. Metal Frame Color Options

Anodized Nickel	Pewter
Black Sandtex	Silver Bullet
Bronze	Silver Vein
Copper Vein	Sparkle Silver

5. Fabric Selection - Please supply the following:

- Fabric vendor
- Pattern name
- Pattern color

All COM orders must include the following:



- Vendor's name, pattern name and color
- Sample of the fabric attached to order
- Model numbers of items for fabric application
- Special application instructions (e.g., all stripes will be applied front to back unless specified otherwise)
- Customer and purchase order number

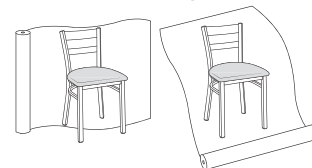

Ship prepaid COM material to:
 Community
 Attn: COM Dept
 932 Mill Street
 Jasper, IN 47546

Application of fabric:
 Railroaded Up the Roll



All COM orders will ship at standard lead time from receipt of COM except for orders requiring special custom matched finishes.

Description	Model	Specifications			List Price Per Grade	
Armless   253A wood seat	253A Wood Seat 253C Uph. Seat · two horizontal back slats	Dimensions	D	W	H	Wood Seat \$324
		Overall	18 ½	16 ½	31 ½	COM \$336
 253C uph. seat		Seat	15 ½	17	18 ½	A \$349
		Upholstery	Shipping			B \$364
		COM Ydg	¾	Ctn Wt	21	COL/C \$390
		COL Sq Ft	9	Cu Ft	9	D \$423
						E \$455
						F \$507
						G \$562
						H \$621
						I \$712
						J \$823
						L1 \$573
						L2 \$632

Description	Model	Specifications			List Price Per Grade	
Barstool  258A wood seat	258A Wood Seat 258C Uph. Seat · two horizontal back slats	Dimensions	D	W	H	Wood Seat \$394
		Overall	17 ½	17	41 ½	COM \$404
 258C uph. seat		Seat	15 ½	17	30	A \$417
		Upholstery	Shipping			B \$432
		COM Ydg	¾	Ctn Wt	28	COL/C \$458
		COL Sq Ft	9	Cu Ft	13	D \$491
						E \$523
						F \$575
						G \$630
						H \$689
						I \$781
						J \$890
						L1 \$641
						L2 \$700

To Order, Specify:

- 1 Model Number
- 2 Wood Species - Beech (B)
- 3 Wood Seat Finish/Color
- 4 Metal Frame Color
- 5 Fabric Selection - vendor, pattern and color
- 6 Optional Clear Leg Protectors - add \$15 list per chair for set of 4

3 Wood Finish/Color Options: ▲

ALE Ale	FLX Flax
AUB Auburn	HEN Henna
AUT Autumn	HNY Honey
BRL Barley	LGC Legacy
BBN Bourbon	MCH Mocha
BRG Brighton	NTO Night Owl
BRW Brownie	NUT Nut Brown
BUT Butterscotch	PRL Praline
CAN Canyon	SAF Saffron
CIN Cinnamon	SIE Sienna
CIT Citron	TOF Toffee
CLA Classic	TRF Truffle
DES Desert	VEN Venetian
EAR Earthy	
ESP Espresso	

Color - Add \$31 list per item

BKD Backdrop	GRV Greek Villa
BFX Black Fox	GLF Gulf Stream
BWH Bright White	HTB Heartthrob
CGP Cargo Pants	NET Network Gray
CHT Chatroom	NWH Nonchalant White
DSY Daisy	PAR Paradise
DRG Daring	QXP Quixotic Plum
DYN Dynamo	RBZ Relic Bronze
ENG Enigma	SND Sandbank
FRR French Roast	STM Storm
GBY Georgian Bay	TRC Tricorn Black



4 Metal Frame Color Options:



Anodized Nickel	Pewter
Black Sandtex	Silver Bullet
Bronze	Silver Vein
Copper Vein	Sparkle Silver



- 5 See a selection of graded in fabric manufacturers and patterns on pages 12-20. Contact Customer Service for additional fabric options.



Specifications



- Wood species - Beech.
- 18 gauge metal frame.
- Seat is upholstered with 1 ½" polyurethane foam and synthetic sheet webbing for added comfort.
- Standard with 1 ¼" clear K-resin rocker glides.
- Legs 1 ¼" square tube.
- Stretcher rim and seat rim ¾" square tube.

Description	① Model	Specifications	List Price Per Grade
Swivel Barstool  259A wood seat	259A Wood Seat 259C Uph. Seat · two horizontal back slats · 360° swivel · optional self-centering swivel plate - no upcharge, please specify when ordering	Dimensions	Wood Seat \$481
		Overall	COM \$488
 259C uph. seat		D 20	A \$502
	Seat	W 18	B \$517
		H 44	COL/C \$543
		Upholstery	D \$576
		COM Ydg ¾	E \$609
		Shipping	F \$661
		Ctn Wt 31	G \$716
		COL Sq Ft 9	H \$774
		Cu Ft 13	I \$866
			J \$976
			L1 \$726
			L2 \$785

Description	① Model	Specifications	List Price Per Grade
Armless   263A wood seat	263A Wood Seat 263C Uph. Seat · four horizontal back slats	Dimensions	Wood Seat \$305
		Overall	COM \$317
 263C uph. seat		D 18	A \$329
	Seat	W 16½	B \$344
		H 31½	COL/C \$369
		Upholstery	D \$403
		COM Ydg ¾	E \$435
		Shipping	F \$487
		Ctn Wt 21	G \$541
		COL Sq Ft 9	H \$600
		Cu Ft 9	I \$692
			J \$802
			L1 \$553
			L2 \$612

Description	① Model	Specifications	List Price Per Grade
Armless  264A wood seat	264A Wood Seat 264C Uph. Seat · five horizontal back slats	Dimensions	Wood Seat \$333
		Overall	COM \$344
 264C uph. seat		D 20½	A \$356
	Seat	W 17	B \$371
		H 36½	COL/C \$397
		Upholstery	D \$430
		COM Ydg ¾	E \$464
		Shipping	F \$514
		Ctn Wt 28	G \$570
		COL Sq Ft 9	H \$628
		Cu Ft 13	I \$720
			J \$830
			L1 \$580
			L2 \$639

Description	Model	Specifications			List Price Per Grade	
		Dimensions	D	W		H
Barstool  268A wood seat	268A Wood Seat 268C Uph. Seat · four horizontal back slats	Overall	18	17	41 ½	Wood Seat \$392 COM \$401 A \$414 B \$429 COL/C \$455 D \$488 E \$520 F \$572 G \$627 H \$685 I \$777 J \$887 L1 \$638 L2 \$697
		Seat	15 ½	17	30	
 268C uph. seat		Upholstery		Shipping		
		COM Ydg	¾	Ctn Wt	28	
		COL Sq Ft	9	Cu Ft	13	

Description	Model	Specifications			List Price Per Grade	
		Dimensions	D	W		H
Swivel Barstool  269A wood seat	269A Wood Seat 269C Uph. Seat · three horizontal back slats · 360° swivel · optional self-centering swivel plate - no upcharge, please specify when ordering	Overall	20	18	44	Wood Seat \$449 COM \$456 A \$471 B \$486 COL/C \$511 D \$544 E \$577 F \$628 G \$683 H \$742 I \$834 J \$943 L1 \$695 L2 \$753
		Seat	16	17	30	
 269C uph. seat		Upholstery		Shipping		
		COM Ydg	¾	Ctn Wt	31	
		COL Sq Ft	9	Cu Ft	13	

To Order, Specify:

- 1 Model Number
- 2 Wood Species - Beech (B)
- 3 Wood Seat Finish/Color
- 4 Metal Frame Color
- 5 Fabric Selection - vendor, pattern and color
- 6 Optional Clear Leg Protectors - add \$15 list per chair for set of 4

3 Wood Finish/Color Options: ▲

ALE Ale	FLX Flax
AUB Auburn	HEN Henna
AUT Autumn	HNY Honey
BRL Barley	LGC Legacy
BBN Bourbon	MCH Mocha
BRG Brighton	NTO Night Owl
BRW Brownie	NUT Nut Brown
BUT Butterscotch	PRL Praline
CAN Canyon	SAF Saffron
CIN Cinnamon	SIE Sienna
CIT Citron	TOF Toffee
CLA Classic	TRF Truffle
DES Desert	VEN Venetian
EAR Earthy	
ESP Espresso	

Color - Add \$31 list per item

BKD Backdrop	GRV Greek Villa
BFX Black Fox	GLF Gulf Stream
BWH Bright White	HTB Heartthrob
CGP Cargo Pants	NET Network Gray
CHT Chatroom	NWH Nonchalant White
DSY Daisy	PAR Paradise
DRG Daring	QXP Quixotic Plum
DYN Dynamo	RBZ Relic Bronze
ENG Enigma	SND Sandbank
FRR French Roast	STM Storm
GBY Georgian Bay	TRC Tricorn Black

4 Metal Frame Color Options:

Anodized Nickel	Pewter
Black Sandtex	Silver Bullet
Bronze	Silver Vein
Copper Vein	Sparkle Silver

- 5 See a selection of graded in fabric manufacturers and patterns on pages 12-20. Contact Customer Service for additional fabric options.

Specifications

- Wood species - Beech.
- 18 gauge metal frame.
- Steel ball bearing swivel plate, standard on swivel models.
- Seat is upholstered with 1 ½" polyurethane foam and synthetic sheet webbing for added comfort.
- Standard with 1 ¼" clear K-resin rocker glides.
- Legs 1 ¼" square tube.
- Stretcher rim and seat rim ¾" square tube.

Alpine Order Check List:

SEATING



Specify:

- 1. Model Number
- 2. Wood Species - Beech (B)
- 3. Wood Finish/Color
- 4. Fabric Selection - vendor, pattern and color
- 5. Optional Laser Engraving Back Imprint - specify location and size
- 6. Optional Rubber Cushion Nylon Glides - no upcharge

Example:

393C (model #)	B (wood species)	AUB (finish)	MOMENTUM (fabric vendor)	VOX (pattern name)	MYSTIC (pattern color)
--------------------------	----------------------------	------------------------	------------------------------------	------------------------------	----------------------------------

1. Model Number

2. Wood Species - Beech (B)

3. Wood Finish/Color Options:[▲]

ALE Ale	ESP Espresso
AUB Auburn	FLX Flax
AUT Autumn	HEN Henna
BRL Barley	HNY Honey
BBN Bourbon	LGC Legacy
BRG Brighton	MCH Mocha
BRW Brownie	NTO Night Owl
BUT Butterscotch	NUT Nut Brown
CAN Canyon	PRL Praline
CIN Cinnamon	SAF Saffron
CIT Citron	SIE Sienna
CLA Classic	TOF Toffee
DES Desert	TRF Truffle
EAR Earthy	VEN Venetian

Color - Add \$31 list per item

BKD Backdrop	GRV Greek Villa
BFX Black Fox	GLF Gulf Stream
BWH Bright White	HTB Heartthrob
CGP Cargo Pants	NET Network Gray
CHT Chatroom	NWH Nonchalant White
DSY Daisy	PAR Paradise
DRG Daring	QXP Quixotic Plum
DYN Dynamo	RBZ Relic Bronze
ENG Enigma	SND Sandbank
FRR French Roast	STM Storm
GBY Georgian Bay	TRC Tricorn Black

4. Fabric Selection - Please supply the following:

- Fabric vendor
- Pattern name
- Pattern color

When specifying contrasting upholstery, indicate clearly which upholstery is to be applied to the seat, back and arms. Use higher grade pricing.

- Indicate direction of fabric - Railroaded or Up the Roll
- Please provide illustration, if available

All COM orders must include the following:

- Vendor's name, pattern name and color
- Sample of the fabric attached to order
- Model numbers of items for fabric application
- Special application instructions (e.g., all stripes will be applied front to back unless specified otherwise)
- Customer and purchase order number

Ship prepaid COM material to:
 Community
 Attn: COM Dept
 932 Mill Street
 Jasper, IN 47546

Application of fabric:
 Railroaded Up the Roll

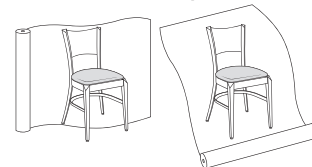

All COM orders will ship at standard lead time from receipt of COM except for orders requiring special custom matched finishes.

5. Optional Lazer Engraving Back Imprint - available on model 393A/C and 398A/C. see page 7 for details.



Specify:

- location - inside/outside of back
- size of design

Description	Model	Specifications	List Price Per Grade												
Armless  393A all wood	393A All Wood 393B Uph. Back · stacks five high · optional laser engraving back imprint, specify location and size - see page 7 for details. (A model only)	<table border="1"> <thead> <tr> <th>Dimensions</th> <th>D</th> <th>W</th> <th>H</th> </tr> </thead> <tbody> <tr> <td>Overall</td> <td>16 ¼</td> <td>17</td> <td>32 ¾</td> </tr> <tr> <td>Seat</td> <td>16 ¼</td> <td>17</td> <td>19</td> </tr> </tbody> </table>	Dimensions	D	W	H	Overall	16 ¼	17	32 ¾	Seat	16 ¼	17	19	All Wood \$362 COM \$444 A \$457 B \$469 COL/C \$491 D \$518 E \$545 F \$588 G \$634 H \$683 I \$760 J \$851 L1 \$643 L2 \$692
		Dimensions	D	W	H										
Overall	16 ¼	17	32 ¾												
Seat	16 ¼	17	19												
<table border="1"> <thead> <tr> <th>Upholstery</th> <th colspan="3">Shipping</th> </tr> </thead> <tbody> <tr> <td>COM Ydg</td> <td>⅝</td> <td>Ctn Wt</td> <td>21</td> </tr> <tr> <td>COL Sq Ft</td> <td>8</td> <td>Cu Ft</td> <td>9</td> </tr> </tbody> </table>	Upholstery	Shipping			COM Ydg	⅝	Ctn Wt	21	COL Sq Ft	8	Cu Ft	9			
Upholstery	Shipping														
COM Ydg	⅝	Ctn Wt	21												
COL Sq Ft	8	Cu Ft	9												

Description	Model	Specifications	List Price Per Grade												
Armless 	393C Uph. Seat · stacks five high · optional laser engraving back imprint, specify location and size - see page 7 for details.	<table border="1"> <thead> <tr> <th>Dimensions</th> <th>D</th> <th>W</th> <th>H</th> </tr> </thead> <tbody> <tr> <td>Overall</td> <td>16 ¼</td> <td>17</td> <td>32 ¾</td> </tr> <tr> <td>Seat</td> <td>16 ¼</td> <td>17</td> <td>19</td> </tr> </tbody> </table>	Dimensions	D	W	H	Overall	16 ¼	17	32 ¾	Seat	16 ¼	17	19	COM \$387 A \$401 B \$415 COL/C \$440 D \$474 E \$507 F \$558 G \$613 H \$671 I \$764 J \$873 L1 \$624 L2 \$683
		Dimensions	D	W	H										
Overall	16 ¼	17	32 ¾												
Seat	16 ¼	17	19												
<table border="1"> <thead> <tr> <th>Upholstery</th> <th colspan="3">Shipping</th> </tr> </thead> <tbody> <tr> <td>COM Ydg</td> <td>¾</td> <td>Ctn Wt</td> <td>21</td> </tr> <tr> <td>COL Sq Ft</td> <td>9</td> <td>Cu Ft</td> <td>9</td> </tr> </tbody> </table>	Upholstery	Shipping			COM Ydg	¾	Ctn Wt	21	COL Sq Ft	9	Cu Ft	9			
Upholstery	Shipping														
COM Ydg	¾	Ctn Wt	21												
COL Sq Ft	9	Cu Ft	9												

To Order, Specify:

- 1 Model Number
- 2 Wood Species - Beech (B)
- 3 Wood Finish/Color
- 4 Fabric Selection - vendor, pattern and color
- 5 Optional Laser Engraving Back Imprint - specify location and size; see page 7 for details.
(A and C MODELS ONLY)
- 6 Optional Rubber Cushion Nylon Glides - no upcharge

3 Wood Finish/Color Options: ▲

ALE Ale	FLX Flax
AUB Auburn	HEN Henna
AUT Autumn	HNY Honey
BRL Barley	LGC Legacy
BBN Bourbon	MCH Mocha
BRG Brighton	NTO Night Owl
BRW Brownie	NUT Nut Brown
BUT Butterscotch	PRL Praline
CAN Canyon	SAF Saffron
CIN Cinnamon	SIE Sienna
CIT Citron	TOF Toffee
CLA Classic	TRF Truffle
DES Desert	VEN Venetian
EAR Earthy	
ESP Espresso	





Color - Add \$31 list per item

BKD Backdrop	GRV Greek Villa
BFX Black Fox	GLF Gulf Stream
BWH Bright White	HTB Heartthrob
CGP Cargo Pants	NET Network Gray
CHT Chatroom	NWH Nonchalant White
DSY Daisy	PAR Paradise
DRG Daring	QXP Quixotic Plum
DYN Dynamo	RBZ Relic Bronze
ENG Enigma	SND Sandbank
FRR French Roast	STM Storm
GBY Georgian Bay	TRC Tricorn Black

- 4 See a selection of graded in fabric manufacturers and patterns on pages 12-20. Contact Customer Service for additional fabric options.

Specifications

- Wood species - Beech.
- Seat is upholstered with 2" high density polyurethane foam and synthetic sheet webbing for added comfort.
- Back is upholstered front and back with ½" polyurethane foam.
- Mortise and tenon construction with corner blocks, glue and screws.
- Standard with rubber cushion metal glides.

Description	① Model	Specifications	List Price Per Grade																										
Armless 	393D Uph. Seat/Back · stacks five high	<table border="1"> <thead> <tr> <th>Dimensions</th> <th>D</th> <th>W</th> <th>H</th> </tr> </thead> <tbody> <tr> <td>Overall</td> <td>16 ¼</td> <td>17</td> <td>32 ¾</td> </tr> <tr> <td>Seat</td> <td>16 ¼</td> <td>17</td> <td>19</td> </tr> <tr> <th colspan="2">Upholstery</th> <th colspan="2">Shipping</th> </tr> <tr> <td>COM Ydg</td> <td>1 ¼</td> <td>Ctn Wt</td> <td>21</td> </tr> <tr> <td>COL Sq Ft</td> <td>15</td> <td>Cu Ft</td> <td>9</td> </tr> </tbody> </table>	Dimensions	D	W	H	Overall	16 ¼	17	32 ¾	Seat	16 ¼	17	19	Upholstery		Shipping		COM Ydg	1 ¼	Ctn Wt	21	COL Sq Ft	15	Cu Ft	9	COM \$467 A \$483 B \$503 COL/C \$538 D \$582 E \$625 F \$695 G \$767 H \$846 I \$968 J \$1,115 L1 \$782 L2 \$860		
		Dimensions	D	W	H																								
		Overall	16 ¼	17	32 ¾																								
		Seat	16 ¼	17	19																								
		Upholstery		Shipping																									
		COM Ydg	1 ¼	Ctn Wt	21																								
		COL Sq Ft	15	Cu Ft	9																								
		Barstool  	398A All Wood 398B Uph. Back · does not stack · optional laser engraving back imprint, specify location and size - see page 7 for details. (A model only) · standard with brass scuff plate, also available in polished aluminum or matte black	<table border="1"> <thead> <tr> <th>Dimensions</th> <th>D</th> <th>W</th> <th>H</th> </tr> </thead> <tbody> <tr> <td>Overall</td> <td>18 ½</td> <td>16 ½</td> <td>43 ½</td> </tr> <tr> <td>Seat</td> <td>16</td> <td>16 ½</td> <td>30</td> </tr> <tr> <th colspan="2">Upholstery</th> <th colspan="2">Shipping</th> </tr> <tr> <td>COM Ydg</td> <td>⅝</td> <td>Ctn Wt</td> <td>28</td> </tr> <tr> <td>COL Sq Ft</td> <td>8</td> <td>Cu Ft</td> <td>13</td> </tr> </tbody> </table>	Dimensions	D	W	H	Overall	18 ½	16 ½	43 ½	Seat	16	16 ½	30	Upholstery		Shipping		COM Ydg	⅝	Ctn Wt	28	COL Sq Ft	8	Cu Ft	13	All Wood \$395 COM \$478 A \$492 B \$504 COL/C \$525 D \$553 E \$581 F \$623 G \$669 H \$718 I \$794 J \$886 L1 \$679 L2 \$727
				Dimensions	D	W	H																						
				Overall	18 ½	16 ½	43 ½																						
Seat	16			16 ½	30																								
Upholstery				Shipping																									
COM Ydg	⅝			Ctn Wt	28																								
COL Sq Ft	8			Cu Ft	13																								
Barstool 	398C Uph. Seat · does not stack · optional laser engraving back imprint, specify location and size - see page 7 for details. · standard with brass scuff plate, also available in polished aluminum or matte black			<table border="1"> <thead> <tr> <th>Dimensions</th> <th>D</th> <th>W</th> <th>H</th> </tr> </thead> <tbody> <tr> <td>Overall</td> <td>18 ½</td> <td>16 ½</td> <td>43 ½</td> </tr> <tr> <td>Seat</td> <td>16</td> <td>16 ½</td> <td>30</td> </tr> <tr> <th colspan="2">Upholstery</th> <th colspan="2">Shipping</th> </tr> <tr> <td>COM Ydg</td> <td>¾</td> <td>Ctn Wt</td> <td>28</td> </tr> <tr> <td>COL Sq Ft</td> <td>9</td> <td>Cu Ft</td> <td>13</td> </tr> </tbody> </table>	Dimensions	D	W	H	Overall	18 ½	16 ½	43 ½	Seat	16	16 ½	30	Upholstery		Shipping		COM Ydg	¾	Ctn Wt	28	COL Sq Ft	9	Cu Ft	13	COM \$419 A \$433 B \$448 COL/C \$474 D \$507 E \$540 F \$592 G \$646 H \$705 I \$796 J \$907 L1 \$657 L2 \$716
				Dimensions	D	W	H																						
				Overall	18 ½	16 ½	43 ½																						
		Seat	16	16 ½	30																								
		Upholstery		Shipping																									
		COM Ydg	¾	Ctn Wt	28																								
		COL Sq Ft	9	Cu Ft	13																								

Description	Model	Specifications			List Price Per Grade		
		Dimensions	D	W	H	COM	Grade
Barstool 	398D Uph. Seat/Back · does not stack · standard with brass scuff plate, also available in polished aluminum or matte black	Overall	18 ½	16 ½	43 ½	COM	\$499
		Seat	16	16 ½	30	A	\$517
		Upholstery		Shipping		B	\$537
		COM Ydg	1 ¼	Ctn Wt	28	COL/C	\$571
		COL Sq Ft	15	Cu Ft	13	D	\$615
						E	\$659
						F	\$727
						G	\$801
						H	\$878
						I	\$1,001
						J	\$1,147
						L1	\$815
						L2	\$893

To Order, Specify:

- 1 Model Number
- 2 Wood Species - Beech (B)
- 3 Wood Finish/Color
- 4 Fabric Selection - vendor, pattern and color
- 5 Optional Laser Engraving Back Imprint - specify location and size; see page 7 for details.
(A and C MODELS ONLY)
- 6 Optional Rubber Cushion Nylon Glides - no upcharge

3 Wood Finish/Color Options: ▲

ALE Ale	FLX Flax
AUB Auburn	HEN Henna
AUT Autumn	HNY Honey
BRL Barley	LGC Legacy
BBN Bourbon	MCH Mocha
BRG Brighton	NTO Night Owl
BRW Brownie	NUT Nut Brown
BUT Butterscotch	PRL Praline
CAN Canyon	SAF Saffron
CIN Cinnamon	SIE Sienna
CIT Citron	TOF Toffee
CLA Classic	TRF Truffle
DES Desert	VEN Venetian
EAR Earthy	
ESP Espresso	

Color - Add \$31 list per item

BKD Backdrop	GRV Creek Villa
BFX Black Fox	GLF Gulf Stream
BWH Bright White	HTB Heartthrob
CGP Cargo Pants	NET Network Gray
CHT Chatroom	NWH Nonchalant White
DSY Daisy	PAR Paradise
DRG Daring	QXP Quixotic Plum
DYN Dynamo	RBZ Relic Bronze
ENG Enigma	SND Sandbank
FRR French Roast	STM Storm
GBY Georgian Bay	TRC Tricorn Black

Specifications

- Wood species - Beech.
- Seat is upholstered with 2" high density polyurethane foam and synthetic sheet webbing for added comfort.
- Back is upholstered front and back with ½" polyurethane foam.
- Mortise and tenon construction with corner blocks, glue and screws.
- Standard with rubber cushion metal glides.

4 See a selection of graded in fabric manufacturers and patterns on pages 12-20. Contact Customer Service for additional fabric options.

Americana Order Check List:



Coordinating Children's Collegian collection. See page 348.

Specify:

- 1. Model Number
- 2. Wood Species - Oak (O) or Maple (M)
- 3. Wood Finish/Color
- 4. Upholstered seat style - horseshoe style available; add \$18 list per chair/barstool; add \$24 list per bench
- 5. Fabric Selection - vendor, pattern and color
- 6. Optional FRONT LEG casters - add \$46 list; specify seat height NOT AVAILABLE on BARSTOOLS
- 7. Optional Trim Nails; add \$90 list per chair/barstool; add \$115 list per bench. Standard trim nail color is Antique Brass. Optional Black trim nails available.
- 8. Optional Rubber Cushion Nylon Glides - no upcharge

Example:

301C | O | HEN | MOMENTUM | VOX | MYSTIC
 (model #) | (wood species) | (finish) | (fabric vendor) | (pattern name) | (pattern color)

1. Model Number

2. Wood Species - Oak (O) or Maple (M)

3. Wood Finish/Color Options:

Oak			
BRW	Brownie	ECU	Ecru
CAN	Canyon	HEN	Henna
CIT	Citron	HNY	Honey
DES	Desert	NUT	Nut Brown

Maple			
ALE	Ale	FLX	Flax
AUB	Auburn	LGC	Legacy
AUT	Autumn	MCH	Mocha
BRL	Barley	NTO	Night Owl
BBN	Bourbon	PRL	Praline
BRG	Brighton	SAF	Saffron
BUT	Butterscotch	SIE	Sienna
CIN	Cinnamon	TOF	Toffee
CLA	Classic	TRF	Truffle
EAR	Earthy	VEN	Venetian
ESP	Espresso		

Color - Add \$31 list per item

BKD	Backdrop	GRV	Greek Villa
BFX	Black Fox	GLF	Gulf Stream
BWH	Bright White	HTB	Heartthrob
CGP	Cargo Pants	NET	Network Gray
CHT	Chatroom	NWH	Nonchalant White
DSY	Daisy	PAR	Paradise
DRG	Daring	QXP	Quixotic Plum
DYN	Dynamo	RBZ	Relic Bronze
ENG	Enigma	SND	Sandbank
FRR	French Roast	STM	Storm
GBY	Georgian Bay	TRC	Tricorn Black

4. Upholstered Seat Style - standard with fully upholstered seat. Optional horseshoe style with welt cord available; add \$18 list per chair/barstool; add \$24 list per bench.

5. Fabric Selection - Please supply the following:

- Fabric vendor
- Pattern name
- Pattern color

All COM orders must include the following:

- Vendor's name, pattern name and color
- Sample of the fabric attached to order
- Model numbers of items for fabric application
- Special application instructions (e.g., all stripes will be applied front to back unless specified otherwise)
- Customer and purchase order number



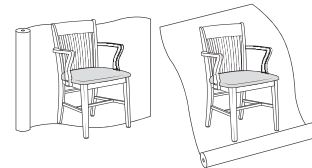

Ship prepaid COM material to:
 Community
 Attn: COM Dept
 932 Mill Street
 Jasper, IN 47546



Application of fabric:
 Railroaded Up the Roll



All COM orders will ship at standard lead time from receipt of COM except for orders requiring special custom matched finishes.

7. Optional Trim Nails - add \$90 per chair/barstool; add \$115 list per bench. Standard trim nail color is Antique Brass. Optional Black trim nails are available. Optional Black trim nails must be specified when ordering.

Description	Model	Specifications	List Price Per Grade																												
<p>Swivel</p>   <p>300A all wood</p>  <p>300C uph. seat</p>  <p>optional jury base</p>	<p>300A All Wood 300C Uph. Seat</p> <ul style="list-style-type: none"> optional five star base with pneumatic lift - add \$60 list dual black casters available, no upcharge - specify when ordering optional jury base available, revolves, tilts, self-centering plate - add \$150 list optional jury base does not include site installation hardware 	<table border="1"> <thead> <tr> <th>Dimensions</th> <th>D</th> <th>W</th> <th>H</th> </tr> </thead> <tbody> <tr> <td>Overall</td> <td>21 1/2</td> <td>23 1/2</td> <td>33-35 3/4</td> </tr> <tr> <td>Seat</td> <td>17 1/2</td> <td>19 1/2</td> <td>16 1/4-19</td> </tr> <tr> <td>Arm</td> <td colspan="3">25 1/2-28 3/4</td> </tr> <tr> <th colspan="2">Upholstery</th> <th colspan="2">Shipping</th> </tr> <tr> <td>COM Ydg</td> <td>3/4</td> <td>Ctn Wt</td> <td>40</td> </tr> <tr> <td>COL Sq Ft</td> <td>9</td> <td>Cu Ft</td> <td>12</td> </tr> </tbody> </table>	Dimensions	D	W	H	Overall	21 1/2	23 1/2	33-35 3/4	Seat	17 1/2	19 1/2	16 1/4-19	Arm	25 1/2-28 3/4			Upholstery		Shipping		COM Ydg	3/4	Ctn Wt	40	COL Sq Ft	9	Cu Ft	12	<p>All Wood \$527 COM \$575 A \$591 B \$603 COL/C \$626 D \$656 E \$685 F \$716 G \$760 H \$807 I \$880 J \$968 L1 \$769 L2 \$815</p>
Dimensions	D	W	H																												
Overall	21 1/2	23 1/2	33-35 3/4																												
Seat	17 1/2	19 1/2	16 1/4-19																												
Arm	25 1/2-28 3/4																														
Upholstery		Shipping																													
COM Ydg	3/4	Ctn Wt	40																												
COL Sq Ft	9	Cu Ft	12																												

Arm	Model	Specifications	List Price Per Grade																												
  <p>301A all wood</p>  <p>301C uph. seat</p>	<p>301A All Wood 301C Uph. Seat</p> <ul style="list-style-type: none"> optional front leg casters available - add \$46 list for set of 2 casters coordinating Children's Collegian collection - see page 348 	<table border="1"> <thead> <tr> <th>Dimensions</th> <th>D</th> <th>W</th> <th>H</th> </tr> </thead> <tbody> <tr> <td>Overall</td> <td>23 3/4</td> <td>23</td> <td>34 1/2</td> </tr> <tr> <td>Seat</td> <td>17 3/4</td> <td>19 1/4</td> <td>18 1/4</td> </tr> <tr> <td>Arm</td> <td colspan="3">27 1/2</td> </tr> <tr> <th colspan="2">Upholstery</th> <th colspan="2">Shipping</th> </tr> <tr> <td>COM Ydg</td> <td>3/4</td> <td>Ctn Wt</td> <td>28</td> </tr> <tr> <td>COL Sq Ft</td> <td>9</td> <td>Cu Ft</td> <td>12</td> </tr> </tbody> </table>	Dimensions	D	W	H	Overall	23 3/4	23	34 1/2	Seat	17 3/4	19 1/4	18 1/4	Arm	27 1/2			Upholstery		Shipping		COM Ydg	3/4	Ctn Wt	28	COL Sq Ft	9	Cu Ft	12	<p>All Wood \$415 COM \$453 A \$467 B \$480 COL/C \$502 D \$532 E \$561 F \$593 G \$636 H \$683 I \$756 J \$845 L1 \$645 L2 \$692</p>
Dimensions	D	W	H																												
Overall	23 3/4	23	34 1/2																												
Seat	17 3/4	19 1/4	18 1/4																												
Arm	27 1/2																														
Upholstery		Shipping																													
COM Ydg	3/4	Ctn Wt	28																												
COL Sq Ft	9	Cu Ft	12																												

To Order, Specify:

- Model Number
- Wood Species - Oak (O) or Maple (M)
- Wood Finish/Color
- Upholstered Seat Style - horseshoe style; add \$18 list per chair/barstool; add \$24 list per bench
- Fabric Selection - vendor, pattern and color
- Optional FRONT LEG Casters - add \$46 list; specify seat height. **NOT AVAILABLE on BARSTOOLS**
- Optional Trim Nails - add \$90 list per chair/barstool. Antique Brass standard; optional Black trim nails available, specify when ordering
- Optional Rubber Cushion Nylon Glides - no upcharge

Wood Finish/Color Options:

- | | | |
|-------|-----|-----------|
| Oak | ECU | Ecru |
| BRW | HEN | Henna |
| CAN | HNY | Honey |
| CIT | NUT | Nut Brown |
| DES | | |
| Maple | | |
| ALE | FLX | Flax |
| AUB | LGC | Legacy |
| AUT | MCH | Mocha |
| BRL | NTO | Night Owl |
| BBN | PRL | Praline |
| BRG | SAF | Saffron |
| BUT | SIE | Sienna |
| CIN | TOF | Toffee |
| CLA | TRF | Truffle |
| EAR | VEN | Venetian |
| ESP | | |

Specifications

- Wood species - Oak or Maple.
- Seat is upholstered with 1" high density polyurethane foam.
- Mortise and tenon construction with corner blocks, glue and screws.
- Coordinating Children's Collegian collection. See page 348.
- Standard with rubber cushion metal glides.

Color - Add \$31 list per item

- | | | |
|-----|-----|------------------|
| BKD | GRV | Greek Villa |
| BFX | GLF | Gulf Stream |
| BWH | HTB | Hearthrob |
| CGP | NET | Network Gray |
| CHT | NWH | Nonchalant White |
| DSY | PAR | Paradise |
| DRG | QXP | Quixotic Plum |
| DYN | RBZ | Relic Bronze |
| ENG | SND | Sandbank |
| FRR | STM | Storm |
| GBY | TRC | Tricorn Black |

- See a selection of graded in fabric manufacturers and patterns on pages 12-20. Contact Customer Service for additional fabric options.

Description

① Model

Specifications

List Price Per Grade

Armless



302A
all wood



302C
uph. seat



optional jury
base

302A All Wood
302C Uph. Seat

- optional five star base with pneumatic lift - add \$60 list
- dual black casters available, no upcharge - specify when ordering
- optional jury base available, revolves, tilts, self-centering plate - add \$150 list

Dimensions	D	W	H
Overall	29	28	33-36 ¾
Seat	16 ¾	18 ¼	16 ¼-20
Upholstery		Shipping	
COM Ydg	¾	Ctn Wt	38
COL Sq Ft	9	Cu Ft	10

All Wood	\$498
COM	\$546
A	\$561
B	\$575
COL/C	\$598
D	\$627
E	\$656
F	\$687
G	\$731
H	\$779
I	\$851
J	\$939
L1	\$740
L2	\$787

Armless



303A
all wood



303C
uph. seat

303A All Wood
303C Uph. Seat

- optional front leg casters available - add \$46 list for set of 2 casters
- coordinating Children's Collegian collection - see page 348

Dimensions	D	W	H
Overall	21 ½	18 ½	34 ½
Seat	16 ¼	18 ¼	18
Upholstery		Shipping	
COM Ydg	¾	Ctn Wt	20
COL Sq Ft	9	Cu Ft	9

All Wood	\$312
COM	\$350
A	\$363
B	\$375
COL/C	\$398
D	\$428
E	\$457
F	\$488
G	\$532
H	\$579
I	\$653
J	\$740
L1	\$540
L2	\$587

Barstool 43" H



307A
all wood





307C
uph. seat



307A All Wood
307C Uph. Seat

- 43 ½" back height
- casters not available
- standard with brass scuff plate, also available in polished aluminum or matte black

Dimensions	D	W	H
Overall	21	18 ¾	43 ½
Seat	17	18 ¾	30 ¾
Upholstery		Shipping	
COM Ydg	¾	Ctn Wt	30
COL Sq Ft	9	Cu Ft	13

All Wood	\$440
COM	\$476
A	\$490
B	\$503
COL/C	\$527
D	\$556
E	\$584
F	\$616
G	\$660
H	\$706
I	\$780
J	\$868
L1	\$668
L2	\$716

Description	Model	Specifications			List Price Per Grade		
		Dimensions	D	W	H	All Wood	COM
Barstool 46" H  308A all wood	308A All Wood 308C Uph. Seat <ul style="list-style-type: none"> · 46" back height · casters not available · standard with brass scuff plate, also available in polished aluminum or matte black 	Overall	21	18 3/4	46	\$417	\$454
		Seat	17	18 3/4	30 3/4		\$468
 308C uph. seat		Upholstery		Shipping		COL/C	\$503
		COM Ydg	3/4	Ctn Wt	30	D	\$533
		COL Sq Ft	9	Cu Ft	13	E	\$562
						F	\$594
						G	\$638
						H	\$684
						I	\$758
						J	\$846
						L1	\$646
						L2	\$693

Description	Model	Specifications			List Price Per Grade		
		Dimensions	D	W	H	All Wood	COM
Tablet  309A all wood	309A All Wood 309C Uph. Seat <ul style="list-style-type: none"> · 11 x 11 1/2 standard size tablet · optional 11 x 17 tablet arm available - add \$31 upcharge · tablet standard on right · available with left tablet - please specify when ordering · optional front leg casters available - add \$46 list for set of 2 casters 	Overall	28 1/4	24 1/2	34 1/2	\$420	\$471
		Seat	14	20	18 1/4		\$485
 309C uph. seat		Arm			29 1/2	COL/C	\$521
		Upholstery		Shipping		D	\$550
		COM Ydg	3/4	Ctn Wt	33	E	\$579
		COL Sq Ft	9	Cu Ft	14	F	\$611
						G	\$655
						H	\$701
						I	\$774
						J	\$863
						L1	\$663
						L2	\$710

To Order, Specify:

- Model Number
- Wood Species - Oak (O) or Maple (M)
- Wood Finish/Color
- Upholstered Seat Style - horseshoe style; add \$18 list per chair/barstool; add \$24 list per bench
- Fabric Selection - vendor, pattern and color
- Optional FRONT LEG casters - add \$46 list; specify seat height. **NOT AVAILABLE on BARSTOOLS**
- Optional Trim Nails - add \$90 list per chair/barstool. Antique Brass standard; optional Black trim nails available, specify when ordering
- Optional Rubber Cushion Nylon Glides - no upcharge

Wood Finish/Color Options:

Oak	BRW Brownie	ECU Ecu
CAN Canyon	CIT Citron	HEN Henna
DES Desert	Maple	HNY Honey
ALE Ale	AUB Auburn	NUT Nut Brown
AUT Autumn	BRL Barley	FLX Flax
BBN Bourbon	BRG Brighton	LGC Legacy
BUT Butterscotch	CIN Cinnamon	MCH Mocha
CLA Classic	EAR Earthy	NTO Night Owl
ESP Espresso		PRL Praline
		SAF Saffron
		SIE Sienna
		TOF Toffee
		TRF Truffle
		VEN Venetian

Color - Add \$31 list per item

BKD Backdrop	GRV Creek Villa
BFX Black Fox	GLF Gulf Stream
BWH Bright White	HTB Heartthrob
CGP Cargo Pants	NET Network Gray
CHT Chatroom	NWH Nonchalant White
DSY Daisy	PAR Paradise
DRG Daring	QXP Quixotic Plum
DYN Dynamo	RBZ Relic Bronze
ENG Enigma	SND Sandbank
FRR French Roast	STM Storm
GBY Georgian Bay	TRC Tricorn Black

Specifications

- Wood species - Oak or Maple.
- Seat is upholstered with 1" high density polyurethane foam.
- Mortise and tenon construction with corner blocks, glue and screws.
- Coordinating Children's Collegian collection. See page 348.
- Standard with rubber cushion metal glides.

See a selection of graded in fabric manufacturers and patterns on pages 12-20. Contact Customer Service for additional fabric options.

Description

① Model

Specifications

List Price Per Grade

Swivel Barstool



319A
all wood

319C
uph. seat

319A All Wood
319C Uph. Seat
 · 360° swivel
 · optional self-centering swivel plate - no upcharge, please specify when ordering
 · casters not available
 · standard with brass scuff plate, also available in polished aluminum or matte black

Dimensions	D	W	H
Overall	20 1/2	18 3/4	46 3/4
Seat	16	18 1/2	30
Upholstery		Shipping	
COM Ydg	3/4	Ctn Wt	42
COL Sq Ft	9	Cu Ft	13

All Wood	\$506
COM	\$541
A	\$556
B	\$570
COL/C	\$593
D	\$621
E	\$650
F	\$682
G	\$726
H	\$772
I	\$846
J	\$934
L1	\$734
L2	\$782

Bench 52" W

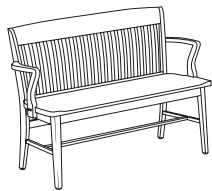

321A
all wood

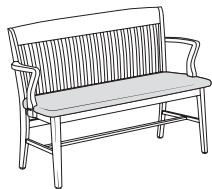

321C
uph. seat

321A All Wood
321C Uph. Seat
 · casters not available

Dimensions	D	W	H
Overall	20 3/4	52 1/4	34 3/4
Seat	17	48 1/4	18
Arm			27 1/4
Upholstery		Shipping	
COM Ydg	1 3/4	Ctn Wt	70
COL Sq Ft	23	Cu Ft	31

All Wood	\$1,736
COM	\$1,843
A	\$1,886
B	\$1,917
COL/C	\$1,970
D	\$2,039
E	\$2,107
F	\$2,179
G	\$2,282
H	\$2,391
I	\$2,562
J	\$2,767
L1	\$2,302
L2	\$2,412

Bench 63" W

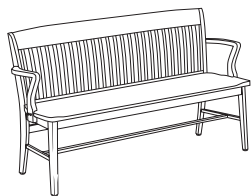

322A
all wood

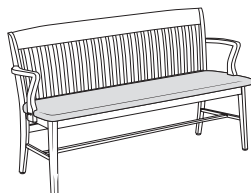

322C
uph. seat

322A All Wood
322C Uph. Seat
 · casters not available

Dimensions	D	W	H
Overall	21 1/2	63	34 3/4
Seat	17	59	18
Arm			27 1/4
Upholstery		Shipping	
COM Ydg	1 3/4	Ctn Wt	90
COL Sq Ft	23	Cu Ft	40

All Wood	\$1,963
COM	\$2,091
A	\$2,138
B	\$2,169
COL/C	\$2,222
D	\$2,291
E	\$2,359
F	\$2,431
G	\$2,533
H	\$2,643
I	\$2,813
J	\$3,019
L1	\$2,554
L2	\$2,663

Description	Model	Specifications			List Price Per Grade		
		Dimensions	D	W	H	All Wood	COM
Bench 72" W	323A All Wood	Overall	21 1/2	71 3/4	34 3/4	\$2,173	\$2,310
	323C Uph. Seat · casters not available	Seat	17	67 3/4	18	A \$2,365	B \$2,404
		Arm			27 1/4	COL/C \$2,473	D \$2,560
		Upholstery		Shipping		E \$2,649	F \$2,742
		COM Ydg	2 1/4	Ctn Wt	110	G \$2,873	H \$3,014
		COL Sq Ft	23	Cu Ft	41	I \$3,234	J \$3,498
						L1 \$2,900	L2 \$3,040

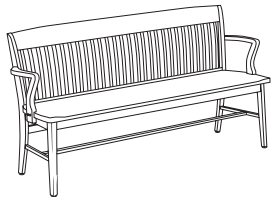

323A
all wood

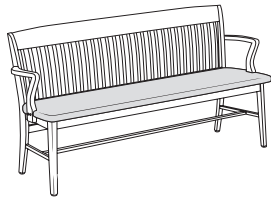

323C
uph. seat

SEATING

To Order, Specify:

- 1 Model Number
- 2 Wood Species - Oak (O) or Maple (M)
- 3 Wood Finish/Color
- 4 Upholstered Seat Style - horseshoe style; add \$18 list per chair/barstool; add \$24 list per bench
- 5 Fabric Selection - vendor, pattern and color
- 6 Optional Trim Nails - add \$90 list per chair/barstool; add \$115 list per bench. Antique Brass standard; optional Black trim nails available, specify when ordering
- 7 Optional Rubber Cushion Nylon Glides - no upcharge

3 Wood Finish/Color Options:

Oak	BRW Brownie	ECU Ecu
CAN Canyon	CIT Citron	HEN Henna
DES Desert		HNY Honey
		NUT Nut Brown
Maple		
ALE Ale	AUB Auburn	FLX Flax
AUT Autumn	BRL Barley	LGC Legacy
BBN Bourbon	BRG Brighton	MCH Mocha
BUT Butterscotch	CIN Cinnamon	NTO Night Owl
CLA Classic	EAR Earthy	PRL Praline
ESP Espresso		SAF Saffron
		SIE Sienna
		TOF Toffee
		TRF Truffle
		VEN Venetian

Color - Add \$31 list per item

BKD Backdrop	BFX Black Fox	BWH Bright White	CGP Cargo Pants	CHT Chatroom	DSY Daisy	DRG Daring	DYN Dynamo	ENG Enigma	FRR French Roast	GBY Georgian Bay	GRV Greek Villa	GLF Gulf Stream	HTB Hearthrob	NET Network Gray	NWH Nonchalant White	PAR Paradise	QXP Quixotic Plum	RBZ Relic Bronze	SND Sandbank	STM Storm	TRC Tricorn Black
--------------	---------------	------------------	-----------------	--------------	-----------	------------	------------	------------	------------------	------------------	-----------------	-----------------	---------------	------------------	----------------------	--------------	-------------------	------------------	--------------	-----------	-------------------

Specifications

- Wood species - Oak or Maple.
- Seat is upholstered with 1" high density polyurethane foam.
- Mortise and tenon construction with corner blocks, glue and screws.
- Standard with rubber cushion metal glides.

5 See a selection of graded in fabric manufacturers and patterns on pages 12-20. Contact Customer Service for additional fabric options.

Americana II Order Check List:



Coordinating Children's Collegian collection. See page 348.

Specify:

- 1. Model Number
- 2. Wood Species - Oak (O) or Maple (M)
- 3. Wood Finish/Color
- 4. Upholstered seat style - horseshoe style available; add \$18 list per chair/barstool
- 5. Fabric Selection - vendor, pattern and color
- 6. Optional FRONT LEG casters - add \$46 list; specify seat height NOT AVAILABLE on BARSTOOLS
- 7. Optional Trim Nails; add \$90 list per chair/barstool. Standard trim nail color is Antique Brass. Optional Black trim nails available.
- 8. Optional 1 3/4" Circle Back Cut Out - add \$14 list per chair
- 9. Optional Rubber Cushion Nylon Glides - no upcharge

Example:

313C | O | HEN | MOMENTUM | VOX | MYSTIC
 (model #) | (wood species) | (finish) | (fabric vendor) | (pattern name) | (pattern color)

1. Model Number

2. Wood Species - Oak (O) or Maple (M)

3. Wood Finish/Color Options:

Oak			
BRW	Brownie	ECU	Ecru
CAN	Canyon	HEN	Henna
CIT	Citron	HNY	Honey
DES	Desert	NUT	Nut Brown

Maple			
ALE	Ale	FLX	Flax
AUB	Auburn	LGC	Legacy
AUT	Autumn	MCH	Mocha
BRL	Barley	NTO	Night Owl
BBN	Bourbon	PRL	Praline
BRG	Brighton	SAF	Saffron
BUT	Butterscotch	SIE	Sienna
CIN	Cinnamon	TOF	Toffee
CLA	Classic	TRF	Truffle
EAR	Earthy	VEN	Venetian
ESP	Espresso		

Color - Add \$31 list per item

BKD	Backdrop	GRV	Greek Villa
BFX	Black Fox	GLF	Gulf Stream
BWH	Bright White	HTB	Heartthrob
CGP	Cargo Pants	NET	Network Gray
CHT	Chatroom	NWH	Nonchalant White
DSY	Daisy	PAR	Paradise
DRG	Daring	QXP	Quixotic Plum
DYN	Dynamo	RBZ	Relic Bronze
ENG	Enigma	SND	Sandbank
FRR	French Roast	STM	Storm
GBY	Georgian Bay	TRC	Tricorn Black

4. Upholstered Seat Style - standard with fully upholstered seat. Optional horseshoe style with welt cord available; add \$18 list per chair/barstool

5. Fabric Selection - Please supply the following:

- Fabric vendor
- Pattern name
- Pattern color

All COM orders must include the following:

- Vendor's name, pattern name and color
- Sample of the fabric attached to order
- Model numbers of items for fabric application
- Special application instructions (e.g., all stripes will be applied front to back unless specified otherwise)
- Customer and purchase order number

Ship prepaid COM material to:
 Community
 Attn: COM Dept
 932 Mill Street
 Jasper, IN 47546

Application of fabric:
 Railroaded Up the Roll

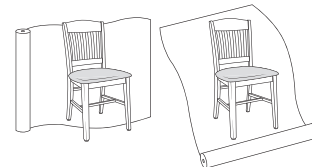

All COM orders will ship at standard lead time from receipt of COM except for orders requiring special custom matched finishes.

7. Optional Trim Nails - add \$90 list per chair/barstool. Standard trim nail color is Antique Brass. Optional Black trim nails are available. Optional Black trim nails must be specified when ordering.

8. Optional Back Cut Out - 1.3/4" circle; add \$14 list per chair



Description	Model	Specifications			List Price Per Grade		
		Dimensions	D	W	H	All Wood	COM
Armless 	313A All Wood 313C Uph. Seat • optional front leg casters available - add \$46 list for set of 2 casters • optional 1 3/4" circle back cut out - add \$14 list per chair • coordinating Children's Collegian collection - see page 348	Overall	22	18 1/2	35 1/4	\$312	\$352
		Seat	16 1/4	18 1/2	18 3/4	\$365	\$377
		Upholstery		Shipping		\$401	\$430
		COM Ydg	3/4	Ctn Wt	20	\$459	\$490
		COL Sq Ft	9	Cu Ft	9	\$534	\$581
						\$655	\$742
						\$542	\$590

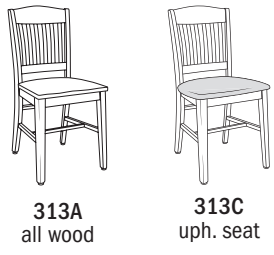

Description	Model	Specifications			List Price Per Grade		
		Dimensions	D	W	H	All Wood	COM
Barstool 44" H 	317A All Wood 317C Uph. Seat • 43 1/2" back height • optional 1 3/4" circle back cut out - add \$14 list per chair • casters not available • standard with brass scuff plate, also available in polished aluminum or matte black	Overall	21	18 3/4	43 1/2	\$440	\$476
		Seat	17	18 3/4	30 3/4	\$490	\$503
		Upholstery		Shipping		\$527	\$556
		COM Ydg	3/4	Ctn Wt	30	\$584	\$616
		COL Sq Ft	9	Cu Ft	13	\$660	\$706
						\$780	\$868
						\$668	\$716

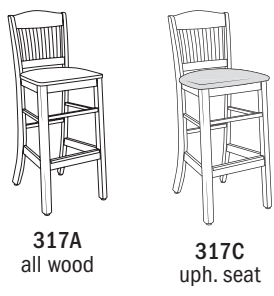

To Order, Specify:

- 1 Model Number
- 2 Wood Species - Oak (O) or Maple (M)
- 3 Wood Finish/Color
- 4 Upholstered Seat Style - horseshoe style; add \$18 list per chair/barstool
- 5 Fabric Selection - vendor, pattern and color
- 6 Optional FRONT LEG casters - add \$46 list; specify seat height. **NOT AVAILABLE on BARSTOOLS**
- 7 Optional Trim Nails - add \$90 list per chair/barstool. Antique Brass standard; optional Black trim nails available, specify when ordering
- 8 Optional 1 3/4" Circle Back Cut Out - add \$14 list per chair
- 9 Optional Rubber Cushion Nylon Glides - no upcharge

3 Wood Finish/Color Options:

- | | | |
|------------------|--------------|---------------|
| Oak | BRW Brownie | ECU Ecu |
| CAN Canyon | CIT Citron | HEN Henna |
| DES Desert | | HNY Honey |
| | | NUT Nut Brown |
| Maple | | |
| ALE Ale | AUB Auburn | FLX Flax |
| AUT Autumn | BRL Barley | LGC Legacy |
| BBN Bourbon | BRG Brighton | MCH Mocha |
| BUT Butterscotch | CIN Cinnamon | NTO Night Owl |
| CLA Classic | EAR Earthy | PRL Praline |
| ESP Espresso | | SAF Saffron |
| | | SIE Sienna |
| | | TOF Toffee |
| | | TRF Truffle |
| | | VEN Venetian |
- Color - Add \$31 list per item
- | | |
|------------------|----------------------|
| BKD Backdrop | GRV Greek Villa |
| BFX Black Fox | GLF Gulf Stream |
| BWH Bright White | HTB Hearthrob |
| CGP Cargo Pants | NET Network Gray |
| CHT Chatroom | NWH Nonchalant White |
| DSY Daisy | PAR Paradise |
| DRG Daring | QXP Quixotic Plum |
| DYN Dynamo | RBZ Relic Bronze |
| ENG Enigma | SND Sandbank |
| FRR French Roast | STM Storm |
| GBY Georgian Bay | TRC Tricorn Black |

Specifications

- Wood species - Oak or Maple.
- Seat is upholstered with 1" high density polyurethane foam.
- Mortise and tenon construction with corner blocks, glue and screws.
- Coordinating Children's Collegian collection. See page 348.
- Standard with rubber cushion metal glides.

5 See a selection of graded in fabric manufacturers and patterns on pages 12-20. Contact Customer Service for additional fabric options.

Description

1 Model

Specifications

List Price Per Grade

Barstool 46" H

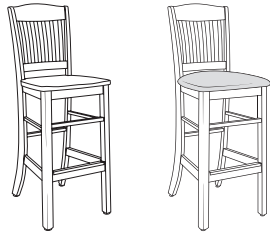

318A
all wood

318C
uph. seat

318A All Wood
318C Uph. Seat
 · 46" back height
 · optional 1 3/4" circle back cut out - add \$14 list per chair
 · casters not available
 · standard with brass scuff plate, also available in polished aluminum or matte black

Dimensions	D	W	H
Overall	21	18 3/4	46
Seat	17	18 3/4	30 3/4
Upholstery		Shipping	
COM Ydg	3/4	Ctn Wt	30
COL Sq Ft	9	Cu Ft	13

All Wood	\$417
COM	\$454
A	\$468
B	\$481
COL/C	\$503
D	\$533
E	\$562
F	\$594
G	\$638
H	\$684
I	\$758
J	\$846
L1	\$646
L2	\$693

To Order, Specify:

- 1 Model Number
- 2 Wood Species - Oak (O) or Maple (M)
- 3 Wood Finish/Color
- 4 Upholstered Seat Style - horseshoe style; add \$18 list per chair/barstool
- 5 Fabric Selection - vendor, pattern and color
- 6 Optional Trim Nails - add \$90 list per chair/barstool. Antique Brass standard; optional Black trim nails available, specify when ordering
- 7 Optional 1 3/4" Circle Back Cut Out - add \$14 list per chair
- 8 Optional Rubber Cushion Nylon Glides - no upcharge

3 Wood Finish/Color Options:

Oak		ECU	Ecru
BRW	Brownie	HEN	Henna
CAN	Canyon	HNY	Honey
CIT	Citron	NUT	Nut Brown
DES	Desert		
Maple			
ALE	Ale	FLX	Flax
AUB	Auburn	LGC	Legacy
AUT	Autumn	MCH	Mocha
BRL	Barley	NTO	Night Owl
BBN	Bourbon	PRL	Praline
BRG	Brighton	SAF	Saffron
BUT	Butterscotch	SIE	Sienna
CIN	Cinnamon	TOF	Toffee
CLA	Classic	TRF	Truffle
EAR	Earthy	VEN	Venetian
ESP	Espresso		

Color - Add \$31 list per item

BKD	Backdrop	GRV	Greek Villa
BFX	Black Fox	GLF	Gulf Stream
BWH	Bright White	HTB	Heartthrob
CGP	Cargo Pants	NET	Network Gray
CHT	Chatroom	NWH	Nonchalant White
DSY	Daisy	PAR	Paradise
DRG	Daring	QXP	Quixotic Plum
DYN	Dynamo	RBZ	Relic Bronze
ENG	Enigma	SND	Sandbank
FRR	French Roast	STM	Storm
GBY	Georgian Bay	TRC	Tricorn Black

Specifications

- Wood species - Oak or Maple.
- Seat is upholstered with 1" high density polyurethane foam.
- Mortise and tenon construction with corner blocks, glue and screws.
- Standard with rubber cushion metal glides.

- 5 See a selection of graded in fabric manufacturers and patterns on pages 12-20. Contact Customer Service for additional fabric options.

Avalon Order Check List:



Specify:

- 1. Model Number
- 2. Wood Species - Beech (B)
- 3. Wood Seat Finish/Color
- 4. Metal Frame Color
- 5. Fabric Selection - vendor, pattern and color
- 6. Optional Clear Leg Protectors - add \$15 list per chair for set of 4

Example:

163C (model #)	B (wood species)	AUB (finish)	BRONZE (metal frame)	MOMENTUM (fabric vendor)	VOX (pattern name)	MYSTIC (pattern color)
--------------------------	----------------------------	------------------------	--------------------------------	------------------------------------	------------------------------	----------------------------------

1. Model Number

2. Wood Species - Beech (B)

3. Wood Seat Finish/Color Options: ⁴

ALE Ale	FLX Flax
AUB Auburn	HEN Henna
AUT Autumn	HNY Honey
BRL Barley	LGC Legacy
BBN Bourbon	MCH Mocha
BRG Brighton	NTO Night Owl
BRW Brownie	NUT Nut Brown
BUT Butterscotch	PRL Praline
CAN Canyon	SAF Saffron
CIN Cinnamon	SIE Sienna
CIT Citron	TOF Toffee
CLA Classic	TRF Truffle
DES Desert	VEN Venetian
EAR Earthy	
ESP Espresso	

Color - Add \$31 list per item

BKD Backdrop	GRV Greek Villa
BFX Black Fox	GLF Gulf Stream
BWH Bright White	HTB Heartthrob
CGP Cargo Pants	NET Network Gray
CHT Chatroom	NWH Nonchalant White
DSY Daisy	PAR Paradise
DRG Daring	QXP Quixotic Plum
DYN Dynamo	RBZ Relic Bronze
ENG Enigma	SND Sandbank
FRR French Roast	STM Storm
GBY Georgian Bay	TRC Tricorn Black

4. Metal Frame Color Options:

Anodized Nickel	Pewter
Black Sandtex	Silver Bullet
Bronze	Silver Vein
Copper Vein	Sparkle Silver

5. Fabric Selection - Please supply the following:

- Fabric vendor
- Pattern name
- Pattern color

All COM orders must include the following:

- Vendor's name, pattern name and color
- Sample of the fabric attached to order
- Model numbers of items for fabric application
- Special application instructions (e.g., all stripes will be applied front to back unless specified otherwise)
- Customer and purchase order number

Ship prepaid COM material to:
Community
Attn: COM Dept
932 Mill Street
Jasper, IN 47546

Application of fabric:
Railroaded Up the Roll

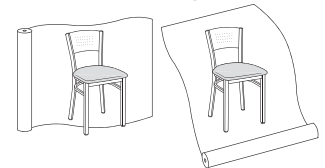

All COM orders will ship at standard lead time from receipt of COM except for orders requiring special custom matched finishes.

Description

① Model

Specifications

List Price Per Grade

Armless Stacker

162A Wood Seat

162C Uph. Seat

- upholstered seat models not recommended for stacking
- stacks five high



162A wood seat



162C uph. seat



stacking frame

Dimensions	D	W	H
Overall	17	17	31 ½
Seat	15 ½	17	19
Upholstery		Shipping	
COM Ydg	¾	Ctn Wt	21
COL Sq Ft	9	Cu Ft	9

Wood Seat	\$349
COM	\$360
A	\$373
B	\$388
COL/C	\$413
D	\$446
E	\$479
F	\$531
G	\$585
H	\$644
I	\$735
J	\$846
L1	\$597
L2	\$655

Armless

163A Wood Seat

163C Uph. Seat



163A wood seat



163C uph. seat

Dimensions	D	W	H
Overall	17	17	31 ½
Seat	15 ½	17	19
Upholstery		Shipping	
COM Ydg	¾	Ctn Wt	21
COL Sq Ft	9	Cu Ft	9

Wood Seat	\$349
COM	\$360
A	\$373
B	\$388
COL/C	\$413
D	\$446
E	\$479
F	\$531
G	\$585
H	\$644
I	\$735
J	\$846
L1	\$597
L2	\$655

Barstool

168A Wood Seat

168C Uph. Seat





168A wood seat





168C uph. seat

Dimensions	D	W	H
Overall	16 ½	17	41 ½
Seat	15 ½	17	31
Upholstery		Shipping	
COM Ydg	¾	Ctn Wt	28
COL Sq Ft	9	Cu Ft	13

Wood Seat	\$407
COM	\$415
A	\$429
B	\$444
COL/C	\$470
D	\$502
E	\$536
F	\$586
G	\$642
H	\$701
I	\$792
J	\$902
L1	\$653
L2	\$711

Description	Model	Specifications			List Price Per Grade		
		Dimensions	D	W		H	
Swivel Barstool	169A Wood Seat	Overall	20	18	44	Wood Seat \$521	
	169C Uph. Seat	Seat	15 1/2	17	31	COM \$527	
 169A wood seat  169C uph. seat	169C Uph. Seat • 360° swivel • optional self-centering swivel plate - no upcharge, please specify when ordering	Upholstery		Shipping		COL/C \$582	
		COM Ydg	3/4	Ctn Wt	31		D \$616
		COL Sq Ft	9	Cu Ft	13		E \$648
							F \$700
							G \$754
					H \$813		
					I \$906		
					J \$1,015		
					L1 \$766		
					L2 \$825		

Description	Model	Specifications			List Price Per Grade		
		Dimensions	D	W		H	
Armless Stacker	172A Wood Seat	Overall	17	17	31 1/2	Wood Seat \$349	
	172C Uph. Seat	Seat	15 1/2	17	19	COM \$360	
 172A wood seat  172C uph. seat	172C Uph. Seat • upholstered seat models not recommended for stacking • stacks five high	Upholstery		Shipping		COL/C \$413	
		COM Ydg	3/4	Ctn Wt	21		D \$446
		COL Sq Ft	9	Cu Ft	9		E \$479
							F \$531
							G \$585
					H \$644		
					I \$735		
					J \$846		
					L1 \$597		
					L2 \$655		

To Order, Specify:

- 1 Model Number
- 2 Wood Species - Beech (B)
- 3 Wood Seat Finish/Color
- 4 Metal Frame Color
- 5 Fabric Selection - vendor, pattern and color
- 6 Optional Clear Leg Protectors - add \$15 list per chair for set of 4

3 Wood Seat Finish/Color Options: ▲

ALE Ale	FLX Flax
AUB Auburn	HEN Henna
AUT Autumn	HNY Honey
BRL Barley	LGC Legacy
BBN Bourbon	MCH Mocha
BRG Brighton	NTO Night Owl
BRW Brownie	NUT Nut Brown
BUT Bitterscotch	PRL Praline
CAN Canyon	SAF Saffron
CIN Cinnamon	SIE Sienna
CIT Citron	TOF Toffee
CLA Classic	TRF Truffle
DES Desert	VEN Venetian
EAR Earthy	
ESP Espresso	

Specifications

- Wood species - Beech.
- 18 gauge metal frame.
- Steel ball bearing swivel plate standard on swivel models.
- Seat is upholstered with 1 1/2" polyurethane foam and synthetic sheet webbing for added comfort.
- Standard with 1 1/4" clear K-resin rocker glides.
- Legs 1 1/4" square tube.
- Stretcher rim and seat rim 3/4" square tube.



Color - Add \$31 list per item



BKD Backdrop	GRV Greek Villa
BFX Black Fox	GLF Gulf Stream
BWH Bright White	HTB Heartthrob
CGP Cargo Pants	NET Network Gray
CHT Chatroom	NWH Nonchalant White
DSY Daisy	PAR Paradise
DRG Daring	QXP Quixotic Plum
DYN Dynamo	RBZ Relic Bronze
ENG Enigma	SND Sandbank
FRR French Roast	STM Storm
GBY Georgian Bay	TRC Tricorn Black



4 Metal Frame Color Options:





Anodized Nickel	Pewter
Black Sandtex	Silver Bullet
Bronze	Silver Vein
Copper Vein	Sparkle Silver





- 5 See a selection of graded in fabric manufacturers and patterns on pages 12-20. Contact Customer Service for additional fabric options.

Description	① Model	Specifications				List Price Per Grade
Armless 	173A Wood Seat	Dimensions	D	W	H	Wood Seat \$349
	173C Uph. Seat	Overall	17	17	31 ½	COM \$360
		Seat	15 ½	17	19	A \$373
173A wood seat	173C uph. seat	Upholstery	Shipping			B \$388
		COM Ydg	¾	Ctn Wt	21	COL/C \$413
		COL Sq Ft	9	Cu Ft	9	D \$446
						E \$479
						F \$531
						G \$585
						H \$644
						I \$735
						J \$846
						L1 \$597
						L2 \$655

Description	① Model	Specifications				List Price Per Grade
Barstool	178A Wood Seat	Dimensions	D	W	H	Wood Seat \$407
	178C Uph. Seat	Overall	16 ½	17	41 ½	COM \$415
		Seat	15 ½	17	31	A \$429
178A wood seat	178C uph. seat	Upholstery	Shipping			B \$444
		COM Ydg	¾	Ctn Wt	28	COL/C \$470
		COL Sq Ft	9	Cu Ft	13	D \$502
						E \$536
						F \$586
						G \$642
						H \$701
						I \$792
						J \$902
						L1 \$653
						L2 \$711

Description	① Model	Specifications				List Price Per Grade
Swivel Barstool	179A Wood Seat	Dimensions	D	W	H	Wood Seat \$521
	179C Uph. Seat	Overall	20	18	44	COM \$527
		Seat	15 ½	17	31	A \$542
179A wood seat	179C uph. seat	Upholstery	Shipping			B \$557
		COM Ydg	¾	Ctn Wt	31	COL/C \$582
		COL Sq Ft	9	Cu Ft	13	D \$616
						E \$648
						F \$700
						G \$754
						H \$813
						I \$906
						J \$1015
						L1 \$766
						L2 \$825

Description	Model	Specifications	List Price Per Grade																																																	
Armless Stacker   182A wood seat	182A Wood Seat 182C Uph. Seat · upholstered seat models not recommended for stacking · stacks five high	<table border="1"> <thead> <tr> <th>Dimensions</th> <th>D</th> <th>W</th> <th>H</th> </tr> </thead> <tbody> <tr> <td>Overall</td> <td>17</td> <td>17</td> <td>31 ½</td> </tr> <tr> <td>Seat</td> <td>15 ½</td> <td>17</td> <td>19</td> </tr> </tbody> </table>	Dimensions	D	W	H	Overall	17	17	31 ½	Seat	15 ½	17	19	<table border="1"> <thead> <tr> <th>Upholstery</th> <th>Shipping</th> </tr> </thead> <tbody> <tr> <td>COM Ydg</td> <td>¾ Ctn Wt 21</td> </tr> <tr> <td>COL Sq Ft</td> <td>9 Cu Ft 9</td> </tr> </tbody> </table>	Upholstery	Shipping	COM Ydg	¾ Ctn Wt 21	COL Sq Ft	9 Cu Ft 9	<table border="1"> <thead> <tr> <th>Wood Seat</th> <th>Price</th> </tr> </thead> <tbody> <tr><td>COM</td><td>\$349</td></tr> <tr><td>A</td><td>\$360</td></tr> <tr><td>B</td><td>\$373</td></tr> <tr><td>B</td><td>\$388</td></tr> <tr><td>COL/C</td><td>\$413</td></tr> <tr><td>D</td><td>\$446</td></tr> <tr><td>E</td><td>\$479</td></tr> <tr><td>F</td><td>\$531</td></tr> <tr><td>G</td><td>\$585</td></tr> <tr><td>H</td><td>\$644</td></tr> <tr><td>I</td><td>\$735</td></tr> <tr><td>J</td><td>\$846</td></tr> <tr><td>L1</td><td>\$597</td></tr> <tr><td>L2</td><td>\$655</td></tr> </tbody> </table>	Wood Seat	Price	COM	\$349	A	\$360	B	\$373	B	\$388	COL/C	\$413	D	\$446	E	\$479	F	\$531	G	\$585	H	\$644	I	\$735	J	\$846	L1	\$597	L2	\$655
		Dimensions	D	W	H																																															
Overall	17	17	31 ½																																																	
Seat	15 ½	17	19																																																	
Upholstery	Shipping																																																			
COM Ydg	¾ Ctn Wt 21																																																			
COL Sq Ft	9 Cu Ft 9																																																			
Wood Seat	Price																																																			
COM	\$349																																																			
A	\$360																																																			
B	\$373																																																			
B	\$388																																																			
COL/C	\$413																																																			
D	\$446																																																			
E	\$479																																																			
F	\$531																																																			
G	\$585																																																			
H	\$644																																																			
I	\$735																																																			
J	\$846																																																			
L1	\$597																																																			
L2	\$655																																																			
 183A wood seat	 183C uph. seat	<table border="1"> <thead> <tr> <th>Dimensions</th> <th>D</th> <th>W</th> <th>H</th> </tr> </thead> <tbody> <tr> <td>Overall</td> <td>17</td> <td>17</td> <td>31 ½</td> </tr> <tr> <td>Seat</td> <td>15 ½</td> <td>17</td> <td>19</td> </tr> </tbody> </table>	Dimensions	D	W	H	Overall	17	17	31 ½	Seat	15 ½	17	19	<table border="1"> <thead> <tr> <th>Upholstery</th> <th>Shipping</th> </tr> </thead> <tbody> <tr> <td>COM Ydg</td> <td>¾ Ctn Wt 21</td> </tr> <tr> <td>COL Sq Ft</td> <td>9 Cu Ft 9</td> </tr> </tbody> </table>	Upholstery	Shipping	COM Ydg	¾ Ctn Wt 21	COL Sq Ft	9 Cu Ft 9	<table border="1"> <thead> <tr> <th>Wood Seat</th> <th>Price</th> </tr> </thead> <tbody> <tr><td>COM</td><td>\$349</td></tr> <tr><td>A</td><td>\$360</td></tr> <tr><td>B</td><td>\$373</td></tr> <tr><td>B</td><td>\$388</td></tr> <tr><td>COL/C</td><td>\$413</td></tr> <tr><td>D</td><td>\$446</td></tr> <tr><td>E</td><td>\$479</td></tr> <tr><td>F</td><td>\$531</td></tr> <tr><td>G</td><td>\$585</td></tr> <tr><td>H</td><td>\$644</td></tr> <tr><td>I</td><td>\$735</td></tr> <tr><td>J</td><td>\$846</td></tr> <tr><td>L1</td><td>\$597</td></tr> <tr><td>L2</td><td>\$655</td></tr> </tbody> </table>	Wood Seat	Price	COM	\$349	A	\$360	B	\$373	B	\$388	COL/C	\$413	D	\$446	E	\$479	F	\$531	G	\$585	H	\$644	I	\$735	J	\$846	L1	\$597	L2	\$655
Dimensions	D	W	H																																																	
Overall	17	17	31 ½																																																	
Seat	15 ½	17	19																																																	
Upholstery	Shipping																																																			
COM Ydg	¾ Ctn Wt 21																																																			
COL Sq Ft	9 Cu Ft 9																																																			
Wood Seat	Price																																																			
COM	\$349																																																			
A	\$360																																																			
B	\$373																																																			
B	\$388																																																			
COL/C	\$413																																																			
D	\$446																																																			
E	\$479																																																			
F	\$531																																																			
G	\$585																																																			
H	\$644																																																			
I	\$735																																																			
J	\$846																																																			
L1	\$597																																																			
L2	\$655																																																			

Description	Model	Specifications	List Price Per Grade																																																	
Armless   183A wood seat	183A Wood Seat 183C Uph. Seat	<table border="1"> <thead> <tr> <th>Dimensions</th> <th>D</th> <th>W</th> <th>H</th> </tr> </thead> <tbody> <tr> <td>Overall</td> <td>17</td> <td>17</td> <td>31 ½</td> </tr> <tr> <td>Seat</td> <td>15 ½</td> <td>17</td> <td>19</td> </tr> </tbody> </table>	Dimensions	D	W	H	Overall	17	17	31 ½	Seat	15 ½	17	19	<table border="1"> <thead> <tr> <th>Upholstery</th> <th>Shipping</th> </tr> </thead> <tbody> <tr> <td>COM Ydg</td> <td>¾ Ctn Wt 21</td> </tr> <tr> <td>COL Sq Ft</td> <td>9 Cu Ft 9</td> </tr> </tbody> </table>	Upholstery	Shipping	COM Ydg	¾ Ctn Wt 21	COL Sq Ft	9 Cu Ft 9	<table border="1"> <thead> <tr> <th>Wood Seat</th> <th>Price</th> </tr> </thead> <tbody> <tr><td>COM</td><td>\$349</td></tr> <tr><td>A</td><td>\$360</td></tr> <tr><td>B</td><td>\$373</td></tr> <tr><td>B</td><td>\$388</td></tr> <tr><td>COL/C</td><td>\$413</td></tr> <tr><td>D</td><td>\$446</td></tr> <tr><td>E</td><td>\$479</td></tr> <tr><td>F</td><td>\$531</td></tr> <tr><td>G</td><td>\$585</td></tr> <tr><td>H</td><td>\$644</td></tr> <tr><td>I</td><td>\$735</td></tr> <tr><td>J</td><td>\$846</td></tr> <tr><td>L1</td><td>\$597</td></tr> <tr><td>L2</td><td>\$655</td></tr> </tbody> </table>	Wood Seat	Price	COM	\$349	A	\$360	B	\$373	B	\$388	COL/C	\$413	D	\$446	E	\$479	F	\$531	G	\$585	H	\$644	I	\$735	J	\$846	L1	\$597	L2	\$655
		Dimensions	D	W	H																																															
Overall	17	17	31 ½																																																	
Seat	15 ½	17	19																																																	
Upholstery	Shipping																																																			
COM Ydg	¾ Ctn Wt 21																																																			
COL Sq Ft	9 Cu Ft 9																																																			
Wood Seat	Price																																																			
COM	\$349																																																			
A	\$360																																																			
B	\$373																																																			
B	\$388																																																			
COL/C	\$413																																																			
D	\$446																																																			
E	\$479																																																			
F	\$531																																																			
G	\$585																																																			
H	\$644																																																			
I	\$735																																																			
J	\$846																																																			
L1	\$597																																																			
L2	\$655																																																			
 183A wood seat	 183C uph. seat	<table border="1"> <thead> <tr> <th>Dimensions</th> <th>D</th> <th>W</th> <th>H</th> </tr> </thead> <tbody> <tr> <td>Overall</td> <td>17</td> <td>17</td> <td>31 ½</td> </tr> <tr> <td>Seat</td> <td>15 ½</td> <td>17</td> <td>19</td> </tr> </tbody> </table>	Dimensions	D	W	H	Overall	17	17	31 ½	Seat	15 ½	17	19	<table border="1"> <thead> <tr> <th>Upholstery</th> <th>Shipping</th> </tr> </thead> <tbody> <tr> <td>COM Ydg</td> <td>¾ Ctn Wt 21</td> </tr> <tr> <td>COL Sq Ft</td> <td>9 Cu Ft 9</td> </tr> </tbody> </table>	Upholstery	Shipping	COM Ydg	¾ Ctn Wt 21	COL Sq Ft	9 Cu Ft 9	<table border="1"> <thead> <tr> <th>Wood Seat</th> <th>Price</th> </tr> </thead> <tbody> <tr><td>COM</td><td>\$349</td></tr> <tr><td>A</td><td>\$360</td></tr> <tr><td>B</td><td>\$373</td></tr> <tr><td>B</td><td>\$388</td></tr> <tr><td>COL/C</td><td>\$413</td></tr> <tr><td>D</td><td>\$446</td></tr> <tr><td>E</td><td>\$479</td></tr> <tr><td>F</td><td>\$531</td></tr> <tr><td>G</td><td>\$585</td></tr> <tr><td>H</td><td>\$644</td></tr> <tr><td>I</td><td>\$735</td></tr> <tr><td>J</td><td>\$846</td></tr> <tr><td>L1</td><td>\$597</td></tr> <tr><td>L2</td><td>\$655</td></tr> </tbody> </table>	Wood Seat	Price	COM	\$349	A	\$360	B	\$373	B	\$388	COL/C	\$413	D	\$446	E	\$479	F	\$531	G	\$585	H	\$644	I	\$735	J	\$846	L1	\$597	L2	\$655
Dimensions	D	W	H																																																	
Overall	17	17	31 ½																																																	
Seat	15 ½	17	19																																																	
Upholstery	Shipping																																																			
COM Ydg	¾ Ctn Wt 21																																																			
COL Sq Ft	9 Cu Ft 9																																																			
Wood Seat	Price																																																			
COM	\$349																																																			
A	\$360																																																			
B	\$373																																																			
B	\$388																																																			
COL/C	\$413																																																			
D	\$446																																																			
E	\$479																																																			
F	\$531																																																			
G	\$585																																																			
H	\$644																																																			
I	\$735																																																			
J	\$846																																																			
L1	\$597																																																			
L2	\$655																																																			

To Order, Specify:

- 1 Model Number
- 2 Wood Species - Beech (B)
- 3 Wood Seat Finish/Color
- 4 Metal Frame Color
- 5 Fabric Selection - vendor, pattern and color
- 6 Optional Clear Leg Protectors - add \$15 list per chair for set of 4

3 Wood Seat Finish/Color Options: ▲

ALE	Ale	FLX	Flax
AUB	Auburn	HEN	Henna
AUT	Autumn	HNY	Honey
BRL	Barley	LGC	Legacy
BBN	Bourbon	MCH	Mocha
BRG	Brighton	NTO	Night Owl
BRW	Brownie	NUT	Nut Brown
BUT	Butterscotch	PRL	Praline
CAN	Canyon	SAF	Saffron
CIN	Cinnamon	SIE	Sienna
CIT	Citron	TOF	Toffee
CLA	Classic	TRF	Truffle
DES	Desert	VEN	Venetian
EAR	Earthy		
ESP	Espresso		

Color - Add \$31 list per item

BKD	Backdrop	GRV	Greek Villa
BFX	Black Fox	GLF	Gulf Stream
BWH	Bright White	HTB	Heartthrob
CGP	Cargo Pants	NET	Network Gray
CHT	Chatroom	NWH	Nonchalant White
DSY	Daisy	PAR	Paradise
DRG	Daring	QXP	Quixotic Plum
DYN	Dynamo	RBZ	Relic Bronze
ENG	Enigma	SND	Sandbank
FRR	French Roast	STM	Storm
GBY	Georgian Bay	TRC	Tricorn Black



4 Metal Frame Color Options:



Anodized Nickel	Pewter
Black Sandtex	Silver Bullet
Bronze	Silver Vein
Copper Vein	Sparkle Silver



- 5 See a selection of graded in fabric manufacturers and patterns on pages 12-20. Contact Customer Service for additional fabric options.

Specifications



- Wood species - Beech.
- 18 gauge metal frame.
- Steel ball bearing swivel plate standard on swivel models.
- Seat is upholstered with 1 ½" polyurethane foam and synthetic sheet webbing for added comfort.
- Standard with 1 ¼" clear K-resin rocker glides.
- Legs 1 ¼" square tube.
- Stretcher rim and seat rim ¾" square tube.



Description	① Model	Specifications	List Price Per Grade																																								
Barstool  188A wood seat	188A Wood Seat 188C Uph. Seat	<table border="1"> <thead> <tr> <th>Dimensions</th> <th>D</th> <th>W</th> <th>H</th> </tr> </thead> <tbody> <tr> <td>Overall</td> <td>16 ½</td> <td>17</td> <td>41 ½</td> </tr> <tr> <td>Seat</td> <td>15 ½</td> <td>17</td> <td>31</td> </tr> </tbody> </table>	Dimensions	D	W	H	Overall	16 ½	17	41 ½	Seat	15 ½	17	31	<table border="1"> <tbody> <tr> <td>Wood Seat</td> <td>\$407</td> </tr> <tr> <td>COM</td> <td>\$415</td> </tr> <tr> <td>A</td> <td>\$429</td> </tr> <tr> <td>B</td> <td>\$444</td> </tr> <tr> <td>COL/C</td> <td>\$470</td> </tr> <tr> <td>D</td> <td>\$502</td> </tr> <tr> <td>E</td> <td>\$536</td> </tr> <tr> <td>F</td> <td>\$586</td> </tr> <tr> <td>G</td> <td>\$642</td> </tr> <tr> <td>H</td> <td>\$701</td> </tr> <tr> <td>I</td> <td>\$792</td> </tr> <tr> <td>J</td> <td>\$902</td> </tr> <tr> <td>L1</td> <td>\$653</td> </tr> <tr> <td>L2</td> <td>\$711</td> </tr> </tbody> </table>	Wood Seat	\$407	COM	\$415	A	\$429	B	\$444	COL/C	\$470	D	\$502	E	\$536	F	\$586	G	\$642	H	\$701	I	\$792	J	\$902	L1	\$653	L2	\$711
		Dimensions	D	W	H																																						
Overall	16 ½	17	41 ½																																								
Seat	15 ½	17	31																																								
Wood Seat	\$407																																										
COM	\$415																																										
A	\$429																																										
B	\$444																																										
COL/C	\$470																																										
D	\$502																																										
E	\$536																																										
F	\$586																																										
G	\$642																																										
H	\$701																																										
I	\$792																																										
J	\$902																																										
L1	\$653																																										
L2	\$711																																										
 188C uph. seat	<table border="1"> <thead> <tr> <th>Upholstery</th> <th colspan="3">Shipping</th> </tr> </thead> <tbody> <tr> <td>COM Ydg</td> <td>¾</td> <td>Ctn Wt</td> <td>28</td> </tr> <tr> <td>COL Sq Ft</td> <td>9</td> <td>Cu Ft</td> <td>13</td> </tr> </tbody> </table>	Upholstery	Shipping			COM Ydg	¾	Ctn Wt	28	COL Sq Ft	9	Cu Ft	13																														
Upholstery	Shipping																																										
COM Ydg	¾	Ctn Wt	28																																								
COL Sq Ft	9	Cu Ft	13																																								

Description	① Model	Specifications	List Price Per Grade																																								
Swivel Barstool  189A wood seat	189A Wood Seat 189C Uph. Seat · 360° swivel · optional self-centering swivel plate - no upcharge, please specify when ordering	<table border="1"> <thead> <tr> <th>Dimensions</th> <th>D</th> <th>W</th> <th>H</th> </tr> </thead> <tbody> <tr> <td>Overall</td> <td>20</td> <td>18</td> <td>44</td> </tr> <tr> <td>Seat</td> <td>15 ½</td> <td>17</td> <td>31</td> </tr> </tbody> </table>	Dimensions	D	W	H	Overall	20	18	44	Seat	15 ½	17	31	<table border="1"> <tbody> <tr> <td>Wood Seat</td> <td>\$521</td> </tr> <tr> <td>COM</td> <td>\$527</td> </tr> <tr> <td>A</td> <td>\$542</td> </tr> <tr> <td>B</td> <td>\$557</td> </tr> <tr> <td>COL/C</td> <td>\$582</td> </tr> <tr> <td>D</td> <td>\$616</td> </tr> <tr> <td>E</td> <td>\$648</td> </tr> <tr> <td>F</td> <td>\$700</td> </tr> <tr> <td>G</td> <td>\$754</td> </tr> <tr> <td>H</td> <td>\$813</td> </tr> <tr> <td>I</td> <td>\$906</td> </tr> <tr> <td>J</td> <td>\$1,015</td> </tr> <tr> <td>L1</td> <td>\$766</td> </tr> <tr> <td>L2</td> <td>\$825</td> </tr> </tbody> </table>	Wood Seat	\$521	COM	\$527	A	\$542	B	\$557	COL/C	\$582	D	\$616	E	\$648	F	\$700	G	\$754	H	\$813	I	\$906	J	\$1,015	L1	\$766	L2	\$825
		Dimensions	D	W	H																																						
Overall	20	18	44																																								
Seat	15 ½	17	31																																								
Wood Seat	\$521																																										
COM	\$527																																										
A	\$542																																										
B	\$557																																										
COL/C	\$582																																										
D	\$616																																										
E	\$648																																										
F	\$700																																										
G	\$754																																										
H	\$813																																										
I	\$906																																										
J	\$1,015																																										
L1	\$766																																										
L2	\$825																																										
 189C uph. seat	<table border="1"> <thead> <tr> <th>Upholstery</th> <th colspan="3">Shipping</th> </tr> </thead> <tbody> <tr> <td>COM Ydg</td> <td>¾</td> <td>Ctn Wt</td> <td>31</td> </tr> <tr> <td>COL Sq Ft</td> <td>9</td> <td>Cu Ft</td> <td>13</td> </tr> </tbody> </table>	Upholstery	Shipping			COM Ydg	¾	Ctn Wt	31	COL Sq Ft	9	Cu Ft	13																														
Upholstery	Shipping																																										
COM Ydg	¾	Ctn Wt	31																																								
COL Sq Ft	9	Cu Ft	13																																								

Description	① Model	Specifications	List Price Per Grade																																								
Armless Stacker  192A wood seat	192A Wood Seat 192C Uph. Seat · upholstered seat models not recommended for stacking · stacks five high	<table border="1"> <thead> <tr> <th>Dimensions</th> <th>D</th> <th>W</th> <th>H</th> </tr> </thead> <tbody> <tr> <td>Overall</td> <td>17</td> <td>17</td> <td>31 ½</td> </tr> <tr> <td>Seat</td> <td>15 ½</td> <td>17</td> <td>19</td> </tr> </tbody> </table>	Dimensions	D	W	H	Overall	17	17	31 ½	Seat	15 ½	17	19	<table border="1"> <tbody> <tr> <td>Wood Seat</td> <td>\$349</td> </tr> <tr> <td>COM</td> <td>\$360</td> </tr> <tr> <td>A</td> <td>\$373</td> </tr> <tr> <td>B</td> <td>\$388</td> </tr> <tr> <td>COL/C</td> <td>\$413</td> </tr> <tr> <td>D</td> <td>\$446</td> </tr> <tr> <td>E</td> <td>\$479</td> </tr> <tr> <td>F</td> <td>\$531</td> </tr> <tr> <td>G</td> <td>\$585</td> </tr> <tr> <td>H</td> <td>\$644</td> </tr> <tr> <td>I</td> <td>\$735</td> </tr> <tr> <td>J</td> <td>\$846</td> </tr> <tr> <td>L1</td> <td>\$597</td> </tr> <tr> <td>L2</td> <td>\$655</td> </tr> </tbody> </table>	Wood Seat	\$349	COM	\$360	A	\$373	B	\$388	COL/C	\$413	D	\$446	E	\$479	F	\$531	G	\$585	H	\$644	I	\$735	J	\$846	L1	\$597	L2	\$655
		Dimensions	D	W	H																																						
Overall	17	17	31 ½																																								
Seat	15 ½	17	19																																								
Wood Seat	\$349																																										
COM	\$360																																										
A	\$373																																										
B	\$388																																										
COL/C	\$413																																										
D	\$446																																										
E	\$479																																										
F	\$531																																										
G	\$585																																										
H	\$644																																										
I	\$735																																										
J	\$846																																										
L1	\$597																																										
L2	\$655																																										
 192C uph. seat	<table border="1"> <thead> <tr> <th>Upholstery</th> <th colspan="3">Shipping</th> </tr> </thead> <tbody> <tr> <td>COM Ydg</td> <td>¾</td> <td>Ctn Wt</td> <td>21</td> </tr> <tr> <td>COL Sq Ft</td> <td>9</td> <td>Cu Ft</td> <td>9</td> </tr> </tbody> </table>	Upholstery	Shipping			COM Ydg	¾	Ctn Wt	21	COL Sq Ft	9	Cu Ft	9																														
Upholstery	Shipping																																										
COM Ydg	¾	Ctn Wt	21																																								
COL Sq Ft	9	Cu Ft	9																																								

stacking frame

Description	Model	Specifications			List Price Per Grade	
		Dimensions	D	W		H
Armless 	193A Wood Seat				Wood Seat \$349	
	193C Uph. Seat				COM \$360	
		Overall	17	17	31 1/2	A \$373
		Seat	15 1/2	17	19	B \$388
		Upholstery		Shipping		COL/C \$413
		COM Ydg	3/4	Ctn Wt	21	D \$446
		COL Sq Ft	9	Cu Ft	9	E \$479
						F \$531
						G \$585
						H \$644
						I \$735
						J \$846
						L1 \$597
						L2 \$655

Description	Model	Specifications			List Price Per Grade	
		Dimensions	D	W		H
Barstool	198A Wood Seat				Wood Seat \$407	
	198C Uph. Seat				COM \$415	
		Overall	16 1/2	17	41 1/2	A \$429
		Seat	15 1/2	17	31	B \$444
		Upholstery		Shipping		COL/C \$470
		COM Ydg	3/4	Ctn Wt	28	D \$502
		COL Sq Ft	9	Cu Ft	13	E \$536
						F \$586
						G \$642
						H \$701
						I \$792
						J \$902
						L1 \$653
						L2 \$711

To Order, Specify:

- 1 Model Number
- 2 Wood Species - Beech (B)
- 3 Wood Seat Finish/Color
- 4 Metal Frame Color
- 5 Fabric Selection - vendor, pattern and color
- 6 Optional Clear Leg Protectors - add \$15 list per chair for set of 4

3 Wood Seat Finish/Color Options: ▲

ALE Ale	FLX Flax
AUB Auburn	HEN Henna
AUT Autumn	HNY Honey
BRL Barley	LGC Legacy
BBN Bourbon	MCH Mocha
BRG Brighton	NTO Night Owl
BRW Brownie	NUT Nut Brown
BUT Butterscotch	PRL Praline
CAN Canyon	SAF Saffron
CIN Cinnamon	SIE Sienna
CIT Citron	TOF Toffee
CLA Classic	TRF Truffle
DES Desert	VEN Venetian
EAR Earthy	
ESP Espresso	

Color - Add \$31 list per item

BKD Backdrop	GRV Greek Villa
BFX Black Fox	GLF Gulf Stream
BWH Bright White	HTB Heartthrob
CGP Cargo Pants	NET Network Gray
CHT Chatroom	NWH Nonchalant White
DSY Daisy	PAR Paradise
DRG Daring	QXP Quixotic Plum
DYN Dynamo	RBZ Relic Bronze
ENG Enigma	SND Sandbank
FRR French Roast	STM Storm
GBY Georgian Bay	TRC Tricorn Black



4 Metal Frame Color Options:



Anodized Nickel	Pewter
Black Sandtex	Silver Bullet
Bronze	Silver Vein
Copper Vein	Sparkle Silver

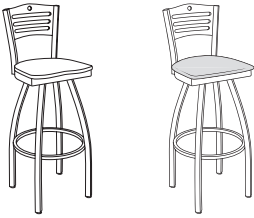
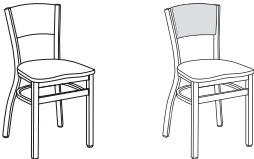

- 5 See a selection of graded in fabric manufacturers and patterns on pages 12-20. Contact Customer Service for additional fabric options.

Specifications

- Wood species - Beech.
- 18 gauge metal frame.
- Steel ball bearing swivel plate standard on swivel models.
- Seat is upholstered with 1 1/2" polyurethane foam and synthetic sheet webbing for added comfort.
- Standard with 1 1/4" clear K-resin rocker glides.
- Legs 1 1/4" square tube.
- Stretcher rim and seat rim 3/4" square tube.

Description	Model	Specifications	List Price Per Grade																																						
Swivel Barstool 	199A Wood Seat 199C Uph. Seat · 360° swivel · optional self-centering swivel plate - no upcharge, please specify when ordering	<table border="1"> <thead> <tr> <th>Dimensions</th> <th>D</th> <th>W</th> <th>H</th> </tr> </thead> <tbody> <tr> <td>Overall</td> <td>20</td> <td>18</td> <td>44</td> </tr> <tr> <td>Seat</td> <td>15 ½</td> <td>17</td> <td>31</td> </tr> </tbody> </table>	Dimensions	D	W	H	Overall	20	18	44	Seat	15 ½	17	31	<table border="1"> <thead> <tr> <th colspan="2">Upholstery</th> <th colspan="2">Shipping</th> </tr> </thead> <tbody> <tr> <td>COM Ydg</td> <td>¾</td> <td>Ctn Wt</td> <td>31</td> </tr> <tr> <td>COL Sq Ft</td> <td>9</td> <td>Cu Ft</td> <td>13</td> </tr> </tbody> </table>	Upholstery		Shipping		COM Ydg	¾	Ctn Wt	31	COL Sq Ft	9	Cu Ft	13														
		Dimensions	D	W	H																																				
Overall	20	18	44																																						
Seat	15 ½	17	31																																						
Upholstery		Shipping																																							
COM Ydg	¾	Ctn Wt	31																																						
COL Sq Ft	9	Cu Ft	13																																						
<table border="1"> <thead> <tr> <th colspan="2">Upholstery</th> <th colspan="2">Shipping</th> </tr> </thead> <tbody> <tr> <td>COM Ydg</td> <td>¾</td> <td>Ctn Wt</td> <td>31</td> </tr> <tr> <td>COL Sq Ft</td> <td>9</td> <td>Cu Ft</td> <td>13</td> </tr> </tbody> </table>	Upholstery		Shipping		COM Ydg	¾	Ctn Wt	31	COL Sq Ft	9	Cu Ft	13	<table border="1"> <tbody> <tr><td>Wood Seat</td><td>\$521</td></tr> <tr><td>COM</td><td>\$527</td></tr> <tr><td>A</td><td>\$542</td></tr> <tr><td>B</td><td>\$557</td></tr> <tr><td>COL/C</td><td>\$582</td></tr> <tr><td>D</td><td>\$616</td></tr> <tr><td>E</td><td>\$648</td></tr> <tr><td>F</td><td>\$700</td></tr> <tr><td>G</td><td>\$754</td></tr> <tr><td>H</td><td>\$813</td></tr> <tr><td>I</td><td>\$906</td></tr> <tr><td>J</td><td>\$1,015</td></tr> <tr><td>L1</td><td>\$766</td></tr> <tr><td>L2</td><td>\$825</td></tr> </tbody> </table>	Wood Seat	\$521	COM	\$527	A	\$542	B	\$557	COL/C	\$582	D	\$616	E	\$648	F	\$700	G	\$754	H	\$813	I	\$906	J	\$1,015	L1	\$766	L2	\$825
Upholstery		Shipping																																							
COM Ydg	¾	Ctn Wt	31																																						
COL Sq Ft	9	Cu Ft	13																																						
Wood Seat	\$521																																								
COM	\$527																																								
A	\$542																																								
B	\$557																																								
COL/C	\$582																																								
D	\$616																																								
E	\$648																																								
F	\$700																																								
G	\$754																																								
H	\$813																																								
I	\$906																																								
J	\$1,015																																								
L1	\$766																																								
L2	\$825																																								
Armless Stacker 	202A Wood Seat 202B Uph. Back · optional laser engraving back imprint, specify location and size - see page 7 for details. (A model only) · when using contrasting upholstery, indicate application and use higher grade pricing · upholstered seat models not recommended for stacking · stacks five high	<table border="1"> <thead> <tr> <th>Dimensions</th> <th>D</th> <th>W</th> <th>H</th> </tr> </thead> <tbody> <tr> <td>Overall</td> <td>17</td> <td>17</td> <td>31 ½</td> </tr> <tr> <td>Seat</td> <td>15 ½</td> <td>17</td> <td>19</td> </tr> </tbody> </table>	Dimensions	D	W	H	Overall	17	17	31 ½	Seat	15 ½	17	19	<table border="1"> <thead> <tr> <th colspan="2">Upholstery</th> <th colspan="2">Shipping</th> </tr> </thead> <tbody> <tr> <td>COM Ydg</td> <td>¾</td> <td>Ctn Wt</td> <td>21</td> </tr> <tr> <td>COL Sq Ft</td> <td>9</td> <td>Cu Ft</td> <td>9</td> </tr> </tbody> </table>	Upholstery		Shipping		COM Ydg	¾	Ctn Wt	21	COL Sq Ft	9	Cu Ft	9														
		Dimensions	D	W	H																																				
Overall	17	17	31 ½																																						
Seat	15 ½	17	19																																						
Upholstery		Shipping																																							
COM Ydg	¾	Ctn Wt	21																																						
COL Sq Ft	9	Cu Ft	9																																						
<table border="1"> <thead> <tr> <th colspan="2">Upholstery</th> <th colspan="2">Shipping</th> </tr> </thead> <tbody> <tr> <td>COM Ydg</td> <td>¾</td> <td>Ctn Wt</td> <td>21</td> </tr> <tr> <td>COL Sq Ft</td> <td>9</td> <td>Cu Ft</td> <td>9</td> </tr> </tbody> </table>	Upholstery		Shipping		COM Ydg	¾	Ctn Wt	21	COL Sq Ft	9	Cu Ft	9	<table border="1"> <tbody> <tr><td>Wood Seat</td><td>\$340</td></tr> <tr><td>COM</td><td>\$373</td></tr> <tr><td>A</td><td>\$384</td></tr> <tr><td>B</td><td>\$394</td></tr> <tr><td>COL/C</td><td>\$411</td></tr> <tr><td>D</td><td>\$433</td></tr> <tr><td>E</td><td>\$455</td></tr> <tr><td>F</td><td>\$490</td></tr> <tr><td>G</td><td>\$525</td></tr> <tr><td>H</td><td>\$565</td></tr> <tr><td>I</td><td>\$626</td></tr> <tr><td>J</td><td>\$700</td></tr> <tr><td>L1</td><td>\$533</td></tr> <tr><td>L2</td><td>\$573</td></tr> </tbody> </table>	Wood Seat	\$340	COM	\$373	A	\$384	B	\$394	COL/C	\$411	D	\$433	E	\$455	F	\$490	G	\$525	H	\$565	I	\$626	J	\$700	L1	\$533	L2	\$573
Upholstery		Shipping																																							
COM Ydg	¾	Ctn Wt	21																																						
COL Sq Ft	9	Cu Ft	9																																						
Wood Seat	\$340																																								
COM	\$373																																								
A	\$384																																								
B	\$394																																								
COL/C	\$411																																								
D	\$433																																								
E	\$455																																								
F	\$490																																								
G	\$525																																								
H	\$565																																								
I	\$626																																								
J	\$700																																								
L1	\$533																																								
L2	\$573																																								
Armless Stacker 	202C Uph. Seat · optional laser engraving back imprint, specify location and size - see page 7 for details. · when using contrasting upholstery, indicate application and use higher grade pricing · upholstered seat models not recommended for stacking · stacks five high	<table border="1"> <thead> <tr> <th>Dimensions</th> <th>D</th> <th>W</th> <th>H</th> </tr> </thead> <tbody> <tr> <td>Overall</td> <td>17</td> <td>17</td> <td>31 ½</td> </tr> <tr> <td>Seat</td> <td>15 ½</td> <td>17</td> <td>19</td> </tr> </tbody> </table>	Dimensions	D	W	H	Overall	17	17	31 ½	Seat	15 ½	17	19	<table border="1"> <thead> <tr> <th colspan="2">Upholstery</th> <th colspan="2">Shipping</th> </tr> </thead> <tbody> <tr> <td>COM Ydg</td> <td>¾</td> <td>Ctn Wt</td> <td>21</td> </tr> <tr> <td>COL Sq Ft</td> <td>9</td> <td>Cu Ft</td> <td>9</td> </tr> </tbody> </table>	Upholstery		Shipping		COM Ydg	¾	Ctn Wt	21	COL Sq Ft	9	Cu Ft	9														
		Dimensions	D	W	H																																				
Overall	17	17	31 ½																																						
Seat	15 ½	17	19																																						
Upholstery		Shipping																																							
COM Ydg	¾	Ctn Wt	21																																						
COL Sq Ft	9	Cu Ft	9																																						
<table border="1"> <thead> <tr> <th colspan="2">Upholstery</th> <th colspan="2">Shipping</th> </tr> </thead> <tbody> <tr> <td>COM Ydg</td> <td>¾</td> <td>Ctn Wt</td> <td>21</td> </tr> <tr> <td>COL Sq Ft</td> <td>9</td> <td>Cu Ft</td> <td>9</td> </tr> </tbody> </table>	Upholstery		Shipping		COM Ydg	¾	Ctn Wt	21	COL Sq Ft	9	Cu Ft	9	<table border="1"> <tbody> <tr><td>COM</td><td>\$350</td></tr> <tr><td>A</td><td>\$363</td></tr> <tr><td>B</td><td>\$377</td></tr> <tr><td>COL/C</td><td>\$404</td></tr> <tr><td>D</td><td>\$436</td></tr> <tr><td>E</td><td>\$470</td></tr> <tr><td>F</td><td>\$521</td></tr> <tr><td>G</td><td>\$576</td></tr> <tr><td>H</td><td>\$635</td></tr> <tr><td>I</td><td>\$726</td></tr> <tr><td>J</td><td>\$836</td></tr> <tr><td>L1</td><td>\$586</td></tr> <tr><td>L2</td><td>\$645</td></tr> </tbody> </table>	COM	\$350	A	\$363	B	\$377	COL/C	\$404	D	\$436	E	\$470	F	\$521	G	\$576	H	\$635	I	\$726	J	\$836	L1	\$586	L2	\$645		
Upholstery		Shipping																																							
COM Ydg	¾	Ctn Wt	21																																						
COL Sq Ft	9	Cu Ft	9																																						
COM	\$350																																								
A	\$363																																								
B	\$377																																								
COL/C	\$404																																								
D	\$436																																								
E	\$470																																								
F	\$521																																								
G	\$576																																								
H	\$635																																								
I	\$726																																								
J	\$836																																								
L1	\$586																																								
L2	\$645																																								
Armless Stacker 	202D Uph. Seat/Back · when using contrasting upholstery, indicate application and use higher grade pricing · upholstered seat models not recommended for stacking · stacks five high	<table border="1"> <thead> <tr> <th>Dimensions</th> <th>D</th> <th>W</th> <th>H</th> </tr> </thead> <tbody> <tr> <td>Overall</td> <td>17</td> <td>17</td> <td>31 ½</td> </tr> <tr> <td>Seat</td> <td>15 ½</td> <td>17</td> <td>19</td> </tr> </tbody> </table>	Dimensions	D	W	H	Overall	17	17	31 ½	Seat	15 ½	17	19	<table border="1"> <thead> <tr> <th colspan="2">Upholstery</th> <th colspan="2">Shipping</th> </tr> </thead> <tbody> <tr> <td>COM Ydg</td> <td>¾</td> <td>Ctn Wt</td> <td>21</td> </tr> <tr> <td>COL Sq Ft</td> <td>9</td> <td>Cu Ft</td> <td>9</td> </tr> </tbody> </table>	Upholstery		Shipping		COM Ydg	¾	Ctn Wt	21	COL Sq Ft	9	Cu Ft	9														
		Dimensions	D	W	H																																				
Overall	17	17	31 ½																																						
Seat	15 ½	17	19																																						
Upholstery		Shipping																																							
COM Ydg	¾	Ctn Wt	21																																						
COL Sq Ft	9	Cu Ft	9																																						
<table border="1"> <thead> <tr> <th colspan="2">Upholstery</th> <th colspan="2">Shipping</th> </tr> </thead> <tbody> <tr> <td>COM Ydg</td> <td>¾</td> <td>Ctn Wt</td> <td>21</td> </tr> <tr> <td>COL Sq Ft</td> <td>9</td> <td>Cu Ft</td> <td>9</td> </tr> </tbody> </table>	Upholstery		Shipping		COM Ydg	¾	Ctn Wt	21	COL Sq Ft	9	Cu Ft	9	<table border="1"> <tbody> <tr><td>COM</td><td>\$430</td></tr> <tr><td>A</td><td>\$447</td></tr> <tr><td>B</td><td>\$467</td></tr> <tr><td>COL/C</td><td>\$500</td></tr> <tr><td>D</td><td>\$544</td></tr> <tr><td>E</td><td>\$588</td></tr> <tr><td>F</td><td>\$657</td></tr> <tr><td>G</td><td>\$730</td></tr> <tr><td>H</td><td>\$808</td></tr> <tr><td>I</td><td>\$931</td></tr> <tr><td>J</td><td>\$1,077</td></tr> <tr><td>L1</td><td>\$745</td></tr> <tr><td>L2</td><td>\$823</td></tr> </tbody> </table>	COM	\$430	A	\$447	B	\$467	COL/C	\$500	D	\$544	E	\$588	F	\$657	G	\$730	H	\$808	I	\$931	J	\$1,077	L1	\$745	L2	\$823		
Upholstery		Shipping																																							
COM Ydg	¾	Ctn Wt	21																																						
COL Sq Ft	9	Cu Ft	9																																						
COM	\$430																																								
A	\$447																																								
B	\$467																																								
COL/C	\$500																																								
D	\$544																																								
E	\$588																																								
F	\$657																																								
G	\$730																																								
H	\$808																																								
I	\$931																																								
J	\$1,077																																								
L1	\$745																																								
L2	\$823																																								

Description	Model	Specifications			List Price Per Grade																						
		Dimensions	D	W		H																					
Armless    203A wood seat 203B uph. back	203A Wood Seat 203B Uph. Back • optional laser engraving back imprint, specify location and size - see page 7 for details. (A model only) • when using contrasting upholstery, indicate application and use higher grade pricing	<table border="1"> <tr> <th>Dimensions</th> <th>D</th> <th>W</th> <th>H</th> </tr> <tr> <td>Overall</td> <td>17</td> <td>17</td> <td>31 1/2</td> </tr> <tr> <td>Seat</td> <td>15 1/2</td> <td>17</td> <td>19</td> </tr> <tr> <th colspan="2">Upholstery</th> <th colspan="2">Shipping</th> </tr> <tr> <td>COM Ydg</td> <td>3/4</td> <td>Ctn Wt</td> <td>21</td> </tr> <tr> <td>COL Sq Ft</td> <td>9</td> <td>Cu Ft</td> <td>9</td> </tr> </table>	Dimensions	D	W	H	Overall	17	17	31 1/2	Seat	15 1/2	17	19	Upholstery		Shipping		COM Ydg	3/4	Ctn Wt	21	COL Sq Ft	9	Cu Ft	9	Wood Seat \$340 COM \$373 A \$384 B \$394 COL/C \$411 D \$433 E \$455 F \$490 G \$525 H \$565 I \$626 J \$700 L1 \$533 L2 \$573
	Dimensions	D	W	H																							
Overall	17	17	31 1/2																								
Seat	15 1/2	17	19																								
Upholstery		Shipping																									
COM Ydg	3/4	Ctn Wt	21																								
COL Sq Ft	9	Cu Ft	9																								

Description	Model	Specifications			List Price Per Grade																						
		Dimensions	D	W		H																					
Armless  	203C Uph. Seat • optional laser engraving back imprint, specify location and size - see page 7 for details. • when using contrasting upholstery, indicate application and use higher grade pricing	<table border="1"> <tr> <th>Dimensions</th> <th>D</th> <th>W</th> <th>H</th> </tr> <tr> <td>Overall</td> <td>17</td> <td>17</td> <td>31 1/2</td> </tr> <tr> <td>Seat</td> <td>15 1/2</td> <td>17</td> <td>19</td> </tr> <tr> <th colspan="2">Upholstery</th> <th colspan="2">Shipping</th> </tr> <tr> <td>COM Ydg</td> <td>3/4</td> <td>Ctn Wt</td> <td>21</td> </tr> <tr> <td>COL Sq Ft</td> <td>9</td> <td>Cu Ft</td> <td>9</td> </tr> </table>	Dimensions	D	W	H	Overall	17	17	31 1/2	Seat	15 1/2	17	19	Upholstery		Shipping		COM Ydg	3/4	Ctn Wt	21	COL Sq Ft	9	Cu Ft	9	COM \$350 A \$363 B \$377 COL/C \$404 D \$436 E \$470 F \$521 G \$576 H \$635 I \$726 J \$836 L1 \$586 L2 \$645
Dimensions	D	W	H																								
Overall	17	17	31 1/2																								
Seat	15 1/2	17	19																								
Upholstery		Shipping																									
COM Ydg	3/4	Ctn Wt	21																								
COL Sq Ft	9	Cu Ft	9																								

To Order, Specify:

- Model Number
- Wood Species - Beech (B)
- Wood Seat Finish/Color
- Metal Frame Color
- Fabric Selection - vendor, pattern and color
- Optional Laser Engraving Back Imprint - specify location and size; see page 7 for details. (A and C MODELS ONLY)
- Optional Clear Leg Protectors - add \$15 list per chair for set of 4

3 Wood Seat Finish/Color Options:

- | | |
|------------------|---------------|
| ALE Ale | FLX Flax |
| AUB Auburn | HEN Henna |
| AUT Autumn | HNY Honey |
| BRL Barley | LGC Legacy |
| BBN Bourbon | MCH Mocha |
| BRG Brighton | NTO Night Owl |
| BRW Brownie | NUT Nut Brown |
| BUT Butterscotch | PRL Praline |
| CAN Canyon | SAF Saffron |
| CIN Cinnamon | SIE Sienna |
| CIT Citron | TOF Toffee |
| CLA Classic | TRF Truffle |
| DES Desert | VEN Venetian |
| EAR Earthy | |
| ESP Espresso | |

Specifications

- Wood species - Beech.
- 18 gauge metal frame.
- Steel ball bearing swivel plate standard on swivel models.
- Seat is upholstered with 1 1/2" polyurethane foam and synthetic sheet webbing for added comfort.
- Upholstered back is upholstered front and back with 1/2" polyurethane foam.
- Standard with 1 1/4" clear K-resin rocker glides.
- Legs 1 1/4" square tube.
- Stretcher rim and seat rim 3/4" square tube.







Color - Add \$31 list per item; not available with laser engraving option

- | | |
|------------------|----------------------|
| BKD Backdrop | GRV Greek Villa |
| BFX Black Fox | GLF Gulf Stream |
| BWH Bright White | HTB Heartthrob |
| CGP Cargo Pants | NET Network Gray |
| CHT Chatroom | NWH Nonchalant White |
| DSY Daisy | PAR Paradise |
| DRG Daring | QXP Quixotic Plum |
| DYN Dynamo | RBZ Relic Bronze |
| ENG Enigma | SND Sandbank |
| FRR French Roast | STM Storm |
| GBY Georgian Bay | TRC Tricorn Black |

4 Metal Frame Color Options:

- | | |
|-----------------|----------------|
| Anodized Nickel | Pewter |
| Black Sandtex | Silver Bullet |
| Bronze | Silver Vein |
| Copper Vein | Sparkle Silver |

- See a selection of graded in fabric manufacturers and patterns on pages 12-20. Contact Customer Service for additional fabric options.

Description	① Model	Specifications	List Price Per Grade												
Armless  	203D Uph. Seat/Back · when using contrasting upholstery, indicate application and use higher grade pricing	<table border="1"> <thead> <tr> <th>Dimensions</th> <th>D</th> <th>W</th> <th>H</th> </tr> </thead> <tbody> <tr> <td>Overall</td> <td>17</td> <td>17</td> <td>31 ½</td> </tr> <tr> <td>Seat</td> <td>15 ½</td> <td>17</td> <td>19</td> </tr> </tbody> </table>	Dimensions	D	W	H	Overall	17	17	31 ½	Seat	15 ½	17	19	COM \$430 A \$447 B \$467 COL/C \$500 D \$544 E \$588 F \$657 G \$730 H \$808 I \$931 J \$1,077 L1 \$745 L2 \$823
		Dimensions	D	W	H										
Overall	17	17	31 ½												
Seat	15 ½	17	19												
<table border="1"> <thead> <tr> <th>Upholstery</th> <th colspan="3">Shipping</th> </tr> </thead> <tbody> <tr> <td>COM Ydg</td> <td>¾</td> <td>Ctn Wt</td> <td>21</td> </tr> <tr> <td>COL Sq Ft</td> <td>9</td> <td>Cu Ft</td> <td>9</td> </tr> </tbody> </table>	Upholstery	Shipping			COM Ydg	¾	Ctn Wt	21	COL Sq Ft	9	Cu Ft	9			
Upholstery	Shipping														
COM Ydg	¾	Ctn Wt	21												
COL Sq Ft	9	Cu Ft	9												
Barstool  208A wood seat	208A Wood Seat 208B Uph. Back · optional laser engraving back imprint, specify location and size - see page 7 for details. (A model only) · when using contrasting upholstery, indicate application and use higher grade pricing	<table border="1"> <thead> <tr> <th>Dimensions</th> <th>D</th> <th>W</th> <th>H</th> </tr> </thead> <tbody> <tr> <td>Overall</td> <td>16 ½</td> <td>17</td> <td>41 ½</td> </tr> <tr> <td>Seat</td> <td>15 ½</td> <td>17</td> <td>31</td> </tr> </tbody> </table>	Dimensions	D	W	H	Overall	16 ½	17	41 ½	Seat	15 ½	17	31	Wood Seat \$397 COM \$430 A \$441 B \$452 COL/C \$469 D \$491 E \$513 F \$546 G \$583 H \$622 I \$684 J \$756 L1 \$591 L2 \$629
		Dimensions	D	W	H										
Overall	16 ½	17	41 ½												
Seat	15 ½	17	31												
<table border="1"> <thead> <tr> <th>Upholstery</th> <th colspan="3">Shipping</th> </tr> </thead> <tbody> <tr> <td>COM Ydg</td> <td>¾</td> <td>Ctn Wt</td> <td>28</td> </tr> <tr> <td>COL Sq Ft</td> <td>9</td> <td>Cu Ft</td> <td>13</td> </tr> </tbody> </table>	Upholstery	Shipping			COM Ydg	¾	Ctn Wt	28	COL Sq Ft	9	Cu Ft	13			
Upholstery	Shipping														
COM Ydg	¾	Ctn Wt	28												
COL Sq Ft	9	Cu Ft	13												
 208B uph. back															
Barstool 	208C Uph. Seat · optional laser engraving back imprint, specify location and size - see page 7 for details. · when using contrasting upholstery, indicate application and use higher grade pricing	<table border="1"> <thead> <tr> <th>Dimensions</th> <th>D</th> <th>W</th> <th>H</th> </tr> </thead> <tbody> <tr> <td>Overall</td> <td>16 ½</td> <td>17</td> <td>41 ½</td> </tr> <tr> <td>Seat</td> <td>15 ½</td> <td>17</td> <td>31</td> </tr> </tbody> </table>	Dimensions	D	W	H	Overall	16 ½	17	41 ½	Seat	15 ½	17	31	COM \$407 A \$420 B \$435 COL/C \$461 D \$494 E \$527 F \$578 G \$634 H \$692 I \$784 J \$894 L1 \$644 L2 \$703
		Dimensions	D	W	H										
Overall	16 ½	17	41 ½												
Seat	15 ½	17	31												
<table border="1"> <thead> <tr> <th>Upholstery</th> <th colspan="3">Shipping</th> </tr> </thead> <tbody> <tr> <td>COM Ydg</td> <td>¾</td> <td>Ctn Wt</td> <td>28</td> </tr> <tr> <td>COL Sq Ft</td> <td>9</td> <td>Cu Ft</td> <td>13</td> </tr> </tbody> </table>	Upholstery	Shipping			COM Ydg	¾	Ctn Wt	28	COL Sq Ft	9	Cu Ft	13			
Upholstery	Shipping														
COM Ydg	¾	Ctn Wt	28												
COL Sq Ft	9	Cu Ft	13												
Barstool 	208D Uph. Seat/Back · when using contrasting upholstery, indicate application and use higher grade pricing	<table border="1"> <thead> <tr> <th>Dimensions</th> <th>D</th> <th>W</th> <th>H</th> </tr> </thead> <tbody> <tr> <td>Overall</td> <td>16 ½</td> <td>17</td> <td>41 ½</td> </tr> <tr> <td>Seat</td> <td>15 ½</td> <td>17</td> <td>31</td> </tr> </tbody> </table>	Dimensions	D	W	H	Overall	16 ½	17	41 ½	Seat	15 ½	17	31	COM \$486 A \$503 B \$522 COL/C \$557 D \$601 E \$645 F \$713 G \$787 H \$865 I \$986 J \$1,133 L1 \$802 L2 \$879
		Dimensions	D	W	H										
Overall	16 ½	17	41 ½												
Seat	15 ½	17	31												
<table border="1"> <thead> <tr> <th>Upholstery</th> <th colspan="3">Shipping</th> </tr> </thead> <tbody> <tr> <td>COM Ydg</td> <td>¾</td> <td>Ctn Wt</td> <td>28</td> </tr> <tr> <td>COL Sq Ft</td> <td>9</td> <td>Cu Ft</td> <td>13</td> </tr> </tbody> </table>	Upholstery	Shipping			COM Ydg	¾	Ctn Wt	28	COL Sq Ft	9	Cu Ft	13			
Upholstery	Shipping														
COM Ydg	¾	Ctn Wt	28												
COL Sq Ft	9	Cu Ft	13												

Description	Model	Specifications			List Price Per Grade		
		Dimensions	D	W	H	Wood Seat	COM
Swivel Barstool	209A Wood Seat	Overall	20	18	44	\$513	\$541
	209B Uph. Back	Seat	15 1/2	17	31	A \$555	B \$564
		Upholstery		Shipping		COL/C \$581	D \$603
		COM Ydg	3/4	Ctn Wt	31	E \$625	F \$660
		COL Sq Ft	9	Cu Ft	13	G \$697	H \$735
						I \$796	J \$870
						L1 \$704	L2 \$743



Description	Model	Specifications			List Price Per Grade		
		Dimensions	D	W	H	COM	COL/C
Swivel Barstool	209C Uph. Seat	Overall	20	18	44	\$518	A \$534
		Seat	15 1/2	17	31	B \$549	C \$574
		Upholstery		Shipping		D \$607	E \$640
		COM Ydg	3/4	Ctn Wt	31	F \$691	G \$746
		COL Sq Ft	9	Cu Ft	13	H \$805	I \$896
						J \$1,006	L1 \$758
						L2 \$816	



To Order, Specify:

- 1 Model Number
- 2 Wood Species - Beech (B)
- 3 Wood Seat Finish/Color
- 4 Metal Frame Color
- 5 Fabric Selection - vendor, pattern and color
- 6 Optional Laser Engraving Back Imprint - specify location and size; see page 7 for details.
(A and C MODELS ONLY)
- 7 Optional Clear Leg Protectors - add \$15 list per chair for set of 4

3 Wood Seat Finish/Color Options:

- | | |
|------------------|---------------|
| ALE Ale | FLX Flax |
| AUB Auburn | HEN Henna |
| AUT Autumn | HNY Honey |
| BRL Barley | LGC Legacy |
| BBN Bourbon | MCH Mocha |
| BRG Brighton | NTO Night Owl |
| BRW Brownie | NUT Nut Brown |
| BUT Butterscotch | PRL Praline |
| CAN Canyon | SAF Saffron |
| CIN Cinnamon | SIE Sienna |
| CIT Citron | TOF Toffee |
| CLA Classic | TRF Truffle |
| DES Desert | VEN Venetian |
| EAR Earthy | |
| ESP Espresso | |

Specifications

- Wood species - Beech.
- 18 gauge metal frame.
- Steel ball bearing swivel plate standard on swivel models.
- Seat is upholstered with 1 1/2" polyurethane foam and synthetic sheet webbing for added comfort.
- Upholstered back is upholstered front and back with 1/2" polyurethane foam.
- Standard with 1 1/4" clear K-resin rocker glides.
- Legs 1 1/4" square tube.
- Stretcher rim and seat rim 3/4" square tube.

Color - Add \$31 list per item; not available with laser engraving option

- | | |
|------------------|----------------------|
| BKD Backdrop | GRV Greek Villa |
| BFX Black Fox | GLF Gulf Stream |
| BWH Bright White | HTB Heartthrob |
| CGP Cargo Pants | NET Network Gray |
| CHT Chatroom | NWH Nonchalant White |
| DSY Daisy | PAR Paradise |
| DRG Daring | QXP Quixotic Plum |
| DYN Dynamo | RBZ Relic Bronze |
| ENG Enigma | SND Sandbank |
| FRR French Roast | STM Storm |
| GBY Georgian Bay | TRC Tricorn Black |

4 Metal Frame Color Options:

- | | |
|-----------------|----------------|
| Anodized Nickel | Pewter |
| Black Sandtex | Silver Bullet |
| Bronze | Silver Vein |
| Copper Vein | Sparkle Silver |

5 See a selection of graded in fabric manufacturers and patterns on pages 12-20. Contact Customer Service for additional fabric options.

Description	① Model	Specifications				List Price Per Grade	
		Dimensions	D	W	H	COM	COL/C
Swivel Barstool 	209D Uph. Seat/Back · when using contrasting upholstery, indicate application and use higher grade pricing · 360° swivel · optional self-centering swivel plate - no upcharge, please specify when ordering	Overall	20	18	44	\$597	\$616
		Seat	15 ½	17	31	\$636	\$670
		Upholstery		Shipping			
		COM Ydg	¾	Ctn Wt	31	\$713	\$758
		COL Sq Ft	9	Cu Ft	13	\$826	\$899
						\$978	\$1,100
						\$1247	\$914
						\$993	

SEATING

To Order, Specify:

- ① Model Number
- ② Wood Species - Beech (B)
- ③ Wood Seat Finish/Color
- ④ Metal Frame Color
- ⑤ Fabric Selection - vendor, pattern and color
- ⑥ Optional Clear Leg Protectors - add \$15 list per chair for set of 4

③ Wood Seat Finish/Color Options: ▲

ALE Ale	FLX Flax
AUB Auburn	HEN Henna
AUT Autumn	HNY Honey
BRL Barley	LGC Legacy
BBN Bourbon	MCH Mocha
BRG Brighton	NTO Night Owl
BRW Brownie	NUT Nut Brown
BUT Butterscotch	PRL Praline
CAN Canyon	SAF Saffron
CIN Cinnamon	SIE Sienna
CIT Citron	TOF Toffee
CLA Classic	TRF Truffle
DES Desert	VEN Venetian
EAR Earthy	
ESP Espresso	

Color - Add \$31 list per item; not available with laser engraving option

BKD Backdrop	GRV Greek Villa
BFX Black Fox	GLF Gulf Stream
BWH Bright White	HTB Heartthrob
CGP Cargo Pants	NET Network Gray
CHT Chatroom	NWH Nonchalant White
DSY Daisy	PAR Paradise
DRG Daring	QXP Quixotic Plum
DYN Dynamo	RBZ Relic Bronze
ENG Enigma	SND Sandbank
FRR French Roast	STM Storm
GBY Georgian Bay	TRC Tricorn Black

④ Metal Frame Color Options:

Anodized Nickel	Pewter
Black Sandtex	Silver Bullet
Bronze	Silver Vein
Copper Vein	Sparkle Silver

- ⑤ See a selection of graded in fabric manufacturers and patterns on pages 12-20. Contact Customer Service for additional fabric options.

Specifications

- Wood species - Beech.
- 18 gauge metal frame.
- Steel ball bearing swivel plate standard on swivel models.
- Seat is upholstered with 1 ½" polyurethane foam and synthetic sheet webbing for added comfort.
- Upholstered back is upholstered front and back with ½" polyurethane foam.
- Standard with 1 ¼" clear K-resin rocker glides.
- Legs 1 ¼" square tube.
- Stretcher rim and seat rim ¾" square tube.

Avini Lounge Order Check List:



SEATING

Specify:

- 1. Model Number
- 2. Wood Species - Maple (M)
- 3. Wood Finish/Color
- 4. Fabric Selection - vendor, pattern and color
- 5. Optional Rubber Cushion Nylon Glides - no upcharge

Example:

AV1021W | M | AUB | MOMENTUM | VOX | MYSTIC
 (model #) | (wood species) | (finish) | (fabric vendor) | (pattern name) | (pattern color)

1. Model Number

2. Wood Species - Maple (M)

3. Wood Seat Finish/Color Options: ▲

ALE Ale	FLX Flax
AUB Auburn	HEN Henna
AUT Autumn	HNY Honey
BRL Barley	LGC Legacy
BBN Bourbon	MCH Mocha
BRG Brighton	NTO Night Owl
BRW Brownie	NUT Nut Brown
BUT Butterscotch	PRL Praline
CAN Canyon	SAF Saffron
CIN Cinnamon	SIE Sienna
CIT Citron	TOF Toffee
CLA Classic	TRF Truffle
DES Desert	VEN Venetian
EAR Earthy	
ESP Espresso	

Color - Add \$31 list per item

BKD Backdrop	GRV Greek Villa
BFX Black Fox	GLF Gulf Stream
BWH Bright White	HTB Heartthrob
CGP Cargo Pants	NET Network Gray
CHT Chatroom	NWH Nonchalant White
DSY Daisy	PAR Paradise
DRG Daring	QXP Quixotic Plum
DYN Dynamo	RBZ Relic Bronze
ENG Enigma	SND Sandbank
FRR French Roast	STM Storm
GBY Georgian Bay	TRC Tricorn Black

4. Fabric Selection - Please supply the following:

- Fabric vendor
- Pattern name
- Pattern color

When specifying contrasting upholstery, indicate clearly which upholstery is to be applied to the seat, back and arms. Use higher grade pricing.

- Indicate direction of fabric - Railroaded or Up the Roll
- Please provide illustration, if available



All COM orders must include the following:

- Vendor's name, pattern name and color
- Sample of the fabric attached to order
- Model numbers of items for fabric application
- Special application instructions (e.g., all stripes will be applied front to back unless specified otherwise)
- Customer and purchase order number

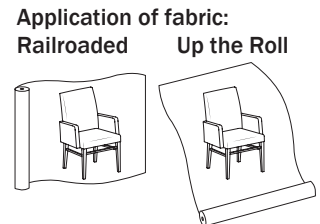
Ship prepaid COM material to:
 Community
 Attn: COM Dept
 932 Mill Street
 Jasper, IN 47546

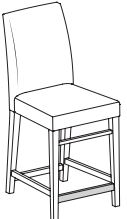

All COM orders will ship at standard lead time from receipt of COM except for orders requiring special custom matched finishes.

Description	Model	Specifications				List Price Per Grade	
Armless 	AV1023D · upholstered seat and back	Dimensions		D	W	H	COM \$781 A \$812 B \$852 COL/C \$920 D \$1,007 E \$1,096 F \$1,233 G \$1,379 H \$1,536 I \$1,780 J \$2,073 L1 \$1,409 L2 \$1,565
		Overall	23 ½	21 ½	36 ½		
		Seat	18	21 ½	18 ½		
		Upholstery		Shipping			
		COM Ydg	2	Ctn Wt	22		
		COL Sq Ft	40	Cu Ft	14		
Wood Arm 	AV1021W · upholstered seat and back	Dimensions		D	W	H	COM \$802 A \$834 B \$873 COL/C \$941 D \$1,029 E \$1,118 F \$1,254 G \$1,400 H \$1,557 I \$1,801 J \$2,094 L1 \$1,430 L2 \$1,586
		Overall	23 ½	23 ½	36 ½		
		Seat	18	21 ½	18 ½		
		Arm			26		
		Upholstery		Shipping			
		COM Ydg	2	Ctn Wt	23		
		COL Sq Ft	40	Cu Ft	14		
Upholstered Arm 	AV1021U · upholstered seat, back and arms	Dimensions		D	W	H	COM \$1,018 A \$1,063 B \$1,122 COL/C \$1,225 D \$1,356 E \$1,488 F \$1,693 G \$1,914 H \$2,148 I \$2,514 J \$2,954 L1 \$1,958 L2 \$2,192
		Overall	23 ½	24	36 ½		
		Seat	18	21 ½	18 ½		
		Arm			26		
		Upholstery		Shipping			
		COM Ydg	3	Ctn Wt	25		
		COL Sq Ft	60	Cu Ft	14		
Counter Height Stool 	AV1024D · upholstered seat and back · stainless steel foot rest	Dimensions		D	W	H	COM \$917 A \$951 B \$990 COL/C \$1,059 D \$1,146 E \$1,234 F \$1,371 G \$1,518 H \$1,674 I \$1,919 J \$2,212 L1 \$1,547 L2 \$1,704
		Overall	22	17 ½	40		
		Seat	16 ½	17 ½	24 ½		
		Upholstery		Shipping			
		COM Ydg	2	Ctn Wt	25		
		COL Sq Ft	40	Cu Ft	11		

Description	① Model	Specifications				List Price Per Grade	
Counter Height Stool 	AV1024E · upholstered seat and back · solid maple crown · stainless steel foot rest	Dimensions	D	W	H	COM	\$987
		Overall	22	17 ½	40	A	\$1,022
		Seat	16 ½	17 ½	24 ½	B	\$1,061
		Upholstery	Shipping			COL/C	\$1,130
		COM Ydg	2	Ctn Wt	25	D	\$1,217
		COL Sq Ft	40	Cu Ft	11	E	\$1,306
						F	\$1,442
				G	\$1,589		
				H	\$1,746		
				I	\$1,990		
				J	\$2,283		
				L1	\$1,619		
				L2	\$1,775		

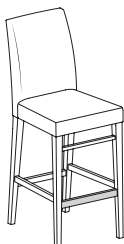
Description	① Model	Specifications				List Price Per Grade	
Barstool 	AV1028D · upholstered seat and back · stainless steel foot rest	Dimensions	D	W	H	COM	\$917
		Overall	22	17 ½	46	A	\$951
		Seat	16 ½	17 ½	30 ½	B	\$990
		Upholstery	Shipping			COL/C	\$1,059
		COM Ydg	2 ▲	Ctn Wt	25	D	\$1,146
		COL Sq Ft	40	Cu Ft	12	E	\$1,234
						F	\$1,371
				G	\$1,518		
				H	\$1,674		
				I	\$1,919		
				J	\$2,212		
				L1	\$1,547		
				L2	\$1,704		

To Order, Specify:

- ① Model Number
- ② Wood Species - Maple (M)
- ③ Wood Finish/Color
- ④ Fabric Selection - vendor, pattern and color
- ⑤ Optional Rubber Cushion Nylon Glides - no upcharge

③ Wood Finish/Color Options: ▲

ALE	Ale	FLX	Flax
AUB	Auburn	HEN	Henna
AUT	Autumn	HNY	Honey
BRL	Barley	LGC	Legacy
BBN	Bourbon	MCH	Mocha
BRG	Brighton	NTO	Night Owl
BRW	Brownie	NUT	Nut Brown
BUT	Butterscotch	PRL	Praline
CAN	Canyon	SAF	Saffron
CIN	Cinnamon	SIE	Sienna
CIT	Citron	TOF	Toffee
CLA	Classic	TRF	Truffle
DES	Desert	VEN	Venetian
EAR	Earthy		
ESP	Espresso		

Color - Add \$31 list per item

BKD	Backdrop	GRV	Greek Villa
BFX	Black Fox	GLF	Gulf Stream
BWH	Bright White	HTB	Heartthrob
CGP	Cargo Pants	NET	Network Gray
CHT	Chatroom	NWH	Nonchalant White
DSY	Daisy	PAR	Paradise
DRG	Daring	QXP	Quixotic Plum
DYN	Dynamo	RBZ	Relic Bronze
ENG	Enigma	SND	Sandbank
FRR	French Roast	STM	Storm
GBY	Georgian Bay	TRC	Tricorn Black

- ④ See a selection of graded in fabric manufacturers and patterns on pages 12-20. Contact Customer Service for additional fabric options.

Specifications

- Wood species - Maple.
- Seat is upholstered with 2 ½" high density polyurethane foam and synthetic sheet webbing for added comfort.
- Seat has single needle top stitch detail for added style and durability.
- Back is upholstered with 1" polyurethane foam.
- Arms are upholstered with polyurethane foam.
- Mortise and tenon construction with corner blocks, glue and screws.
- Standard with rubber cushion metal glides.

Description

1 Model

Specifications

List Price Per Grade

Barstool

AV1028E

- upholstered seat and back
- solid maple crown
- stainless steel foot rest

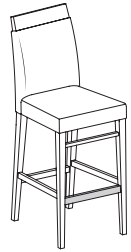

Dimensions	D	W	H
Overall	22	17 1/2	46
Seat	16 1/2	17 1/2	30 1/2
Upholstery		Shipping	
COM Ydg	2 ▲	Ctn Wt	25
COL Sq Ft	40	Cu Ft	12

COM	\$987
A	\$1,022
B	\$1,061
COL/C	\$1,130
D	\$1,217
E	\$1,306
F	\$1,442
G	\$1,589
H	\$1,746
I	\$1,990
J	\$2,283
L1	\$1,619
L2	\$1,775

SEATING

To Order, Specify:

- 1 Model Number
- 2 Wood Species - Maple (M)
- 3 Wood Finish/Color
- 4 Fabric Selection - vendor, pattern and color
- 5 Optional Rubber Cushion Nylon Glides - no upcharge

3 Wood Finish/Color Options: ▲

ALE Ale	FLX Flax
AUB Auburn	HEN Henna
AUT Autumn	HNY Honey
BRL Barley	LGC Legacy
BBN Bourbon	MCH Mocha
BRG Brighton	NTO Night Owl
BRW Brownie	NUT Nut Brown
BUT Butterscotch	PRL Praline
CAN Canyon	SAF Saffron
CIN Cinnamon	SIE Sienna
CIT Citron	TOF Toffee
CLA Classic	TRF Truffle
DES Desert	VEN Venetian
EAR Earthy	
ESP Espresso	

Color - Add \$31 list per item

BKD Backdrop	GRV Greek Villa
BFX Black Fox	GLF Gulf Stream
BWH Bright White	HTB Heartthrob
CGP Cargo Pants	NET Network Gray
CHT Chatroom	NWH Nonchalant White
DSY Daisy	PAR Paradise
DRG Daring	QXP Quixotic Plum
DYN Dynamo	RBZ Relic Bronze
ENG Enigma	SND Sandbank
FRR French Roast	STM Storm
GBY Georgian Bay	TRC Tricorn Black

Specifications

- Wood species - Maple.
- Seat is upholstered with 2 1/2" high density polyurethane foam and synthetic sheet webbing for added comfort.
- Seat has single needle top stitch detail for added style and durability.
- Back is upholstered with 1" polyurethane foam.
- Arms are upholstered with polyurethane foam.
- Mortise and tenon construction with corner blocks, glue and screws.
- Standard with rubber cushion metal glides.

- 4 See a selection of graded in fabric manufacturers and patterns on pages 12-20. Contact Customer Service for additional fabric options.

Bison Order Check List:



Specify:

- 1. Model Number
- 2. Wood Species - Oak (O) or Maple (M)
- 3. Wood Finish/Color
- 4. Fabric Selection - vendor, pattern and color
- 5. Optional Rubber Cushion Nylon Glides - no upcharge

Example:

4C | O | HEN | MOMENTUM | VOX | MYSTIC
 (model #) | (wood species) | (finish) | (fabric vendor) | (pattern name) | (pattern color)

1. Model Number

2. Wood Species - Oak (O) or Maple (M)

3. Wood Finish/Color Options:

Oak

BRW Brownie	ECU Ecru
CAN Canyon	HEN Henna
CIT Citron	HNY Honey
DES Desert	NUT Nut Brown

Maple

ALE Ale	FLX Flax
AUB Auburn	LGC Legacy
AUT Autumn	MCH Mocha
BRL Barley	NTO Night Owl
BBN Bourbon	PRL Praline
BRG Brighton	SAF Saffron
BUT Butterscotch	SIE Sienna
CIN Cinnamon	TOF Toffee
CLA Classic	TRF Truffle
EAR Earthy	VEN Venetian
ESP Espresso	

Color - Add \$31 list per item

BKD Backdrop	GRV Greek Villa
BFX Black Fox	GLF Gulf Stream
BWH Bright White	HTB Heartthrob
CGP Cargo Pants	NET Network Gray
CHT Chatroom	NWH Nonchalant White
DSY Daisy	PAR Paradise
DRG Daring	QXP Quixotic Plum
DYN Dynamo	RBZ Relic Bronze
ENG Enigma	SND Sandbank
FRR French Roast	STM Storm
GBY Georgian Bay	TRC Tricorn Black

4. Fabric Selection - Please supply the following:

- Fabric vendor
- Pattern name
- Pattern color

All COM orders must include the following:

- Vendor's name, pattern name and color
- Sample of the fabric attached to order
- Model numbers of items for fabric application
- Special application instructions (e.g., all stripes will be applied front to back unless specified otherwise)
- Customer and purchase order number

Ship prepaid COM material to:
 Community
 Attn: COM Dept
 932 Mill Street
 Jasper, IN 47546

Application of fabric:
 Railroaded Up the Roll

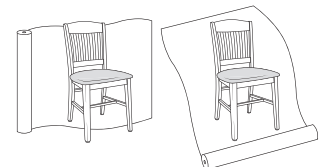

All COM orders will ship at standard lead time from receipt of COM except for orders requiring special custom matched finishes.

Description

① Model

Specifications

List Price Per Grade

Barstool 18" H

3A All Wood
3C Uph. Seat
 · 18" seat height

Dimensions	D	W	H
Overall	14 ¼	14 ¼	18
Seat	14	14	18
Upholstery		Shipping	
COM Ydg	1	Ctn Wt	13
COL Sq Ft	12	Cu Ft	4

All Wood	\$216
COM	\$266
A	\$280
B	\$297
COL/C	\$327
D	\$366
E	\$406
F	\$447
G	\$506
H	\$567
I	\$665
J	\$783
L1	\$517
L2	\$579



3A
all wood



3C
uph. seat

Barstool 24" H

4A All Wood
4C Uph. Seat
 · 24" seat height

Dimensions	D	W	H
Overall	16	16	24 ¼
Seat	14	14	24
Upholstery		Shipping	
COM Ydg	1	Ctn Wt	15
COL Sq Ft	12	Cu Ft	6



All Wood	\$227
COM	\$276
A	\$289
B	\$306
COL/C	\$336
D	\$375
E	\$415
F	\$456
G	\$515
H	\$577
I	\$675
J	\$792
L1	\$527
L2	\$590



4A
all wood



4C
uph. seat

Description	Model	Specifications				List Price Per Grade	
		Dimensions	D	W	H	All Wood	
Barstool 30" H 	5A All Wood 5C Uph. Seat · 30" seat height	Overall	18	18	30 ¼	COM	\$251
		Seat	14	14	30	A	\$304
 5A all wood	 5C uph. seat	Upholstery		Shipping		B	\$335
		COM Ydg	1	Ctn Wt	18	COL/C	\$366
		COL Sq Ft	12	Cu Ft	7	D	\$405
						E	\$444
						F	\$485
						G	\$543
						H	\$606
						I	\$704
						J	\$822
						L1	\$555
						L2	\$618

SEATING

To Order, Specify:

- 1 Model Number
- 2 Wood Species - Oak (O) or Maple (M)
- 3 Wood Finish/Color
- 4 Fabric Selection - vendor, pattern and color
- 5 Optional Rubber Cushion Nylon Glides - no upcharge

3 Wood Finish/Color Options:

Oak		ECU	Ecru
BRW	Brownie	HEN	Henna
CAN	Canyon	HNY	Honey
CIT	Citron	NUT	Nut Brown
DES	Desert		
Maple			
ALE	Ale	FLX	Flax
AUB	Auburn	LGC	Legacy
AUT	Autumn	MCH	Mocha
BRL	Barley	NTO	Night Owl
BBN	Bourbon	PRL	Praline
BRG	Brighton	SAF	Saffron
BUT	Butterscotch	SIE	Sienna
CIN	Cinnamon	TOF	Toffee
CLA	Classic	TRF	Truffle
EAR	Earthy	VEN	Venetian
ESP	Espresso		

Color - Add \$31 list per item

BKD	Backdrop	GRV	Creek Villa
BFX	Black Fox	GLF	Gulf Stream
BWH	Bright White	HTB	Heartthrob
CGP	Cargo Pants	NET	Network Gray
CHT	Chatroom	NWH	Nonchalant White
DSY	Daisy	PAR	Paradise
DRG	Daring	QXP	Quixotic Plum
DYN	Dynamo	RBZ	Relic Bronze
ENG	Enigma	SND	Sandbank
FRR	French Roast	STM	Storm
GBY	Georgian Bay	TRC	Tricorn Black

Specifications

- Wood species - Oak or Maple.
- Seat is upholstered with 4" high density polyurethane foam.
- Mortise and tenon construction with corner blocks, glue.
- Standard with rubber cushion metal glides.

4 See a selection of graded in fabric manufacturers and patterns on pages 12-20. Contact Customer Service for additional fabric options.

Boston Order Check List:



SEATING

Specify:

- 1. Model Number
- 2. Wood Species - Oak (O) or Maple (M)
- 3. Wood Finish/Color
- 4. Fabric Selection - vendor, pattern and color
- 5. Optional FRONT LEG Casters - add \$46 list; specify seat height
NOT AVAILABLE on BENCHES
- 6. Optional Trim Nails - add \$90 list per chair; add \$115 list per bench
- 7. Optional Rubber Cushion Nylon Glides - no upcharge

Example:

981C <small>(model #)</small>	O <small>(wood species)</small>	HEN <small>(finish)</small>	MOMENTUM <small>(fabric vendor)</small>	VOX <small>(pattern name)</small>	MYSTIC <small>(pattern color)</small>
----------------------------------	------------------------------------	--------------------------------	--	--------------------------------------	--

1. Model Number

2. Wood Species - Oak (O) or Maple (M)

3. Wood Finish/Color Options:

Oak

BRW Brownie	ECU Ecru
CAN Canyon	HEN Henna
CIT Citron	HNY Honey
DES Desert	NUT Nut Brown

Maple

ALE Ale	FLX Flax
AUB Auburn	LGC Legacy
AUT Autumn	MCH Mocha
BRL Barley	NTO Night Owl
BBN Bourbon	PRL Praline
BRG Brighton	SAF Saffron
BUT Butterscotch	SIE Sienna
CIN Cinnamon	TOF Toffee
CLA Classic	TRF Truffle
EAR Earthy	VEN Venetian
ESP Espresso	

Color - Add \$31 list per item

BKD Backdrop	GRV Greek Villa
BFX Black Fox	GLF Gulf Stream
BWH Bright White	HTB Heartthrob
CGP Cargo Pants	NET Network Gray
CHT Chatroom	NWH Nonchalant White
DSY Daisy	PAR Paradise
DRG Daring	QXP Quixotic Plum
DYN Dynamo	RBZ Relic Bronze
ENG Enigma	SND Sandbank
FRR French Roast	STM Storm
GBY Georgian Bay	TRC Tricorn Black

4. Fabric Selection - Please supply the following:

- Fabric vendor
- Pattern name
- Pattern color

All COM orders must include the following:

- Vendor's name, pattern name and color
- Sample of the fabric attached to order
- Model numbers of items for fabric application
- Special application instructions (e.g., all stripes will be applied front to back unless specified otherwise)
- Customer and purchase order number



Ship prepaid COM material to:
Community
Attn: COM Dept
932 Mill Street
Jasper, IN 47546

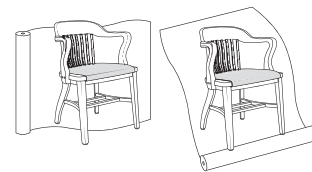

Application of fabric:
Railroaded Up the Roll



All COM orders will ship at standard lead time from receipt of COM except for orders requiring special custom matched finishes.

5. Optional trim nails - add \$90 list per chair; add \$115 list per bench

Description	Model	Specifications	List Price Per Grade														
Swivel  980A all wood	980C Uph. Seat  980C uph. seat	Dimensions	All Wood \$1,081 COM \$1,146 A \$1,172 B \$1,190 COL/C \$1,221 D \$1,259 E \$1,298 F \$1,339 G \$1,398 H \$1,461 I \$1,559 J \$1,676 L1 \$1,410 L2 \$1,473														
		<table border="1"> <thead> <tr> <th></th> <th>D</th> <th>W</th> <th>H</th> </tr> </thead> <tbody> <tr> <td>Overall</td> <td>22</td> <td>23 ¼</td> <td>32-36</td> </tr> <tr> <td>Seat</td> <td>17 ½</td> <td>19 ¾</td> <td>14 ⅝-18 ⅝</td> </tr> <tr> <td>Arm</td> <td colspan="3">26-30</td> </tr> </tbody> </table>		D	W	H	Overall	22	23 ¼	32-36	Seat	17 ½	19 ¾	14 ⅝-18 ⅝	Arm	26-30	
	D	W	H														
Overall	22	23 ¼	32-36														
Seat	17 ½	19 ¾	14 ⅝-18 ⅝														
Arm	26-30																
 optional jury base	<ul style="list-style-type: none"> optional five star base with pneumatic lift - add \$60 list dual black casters available, no upcharge - specify when ordering optional jury base available, revolves, tilts, self-centering plate - add \$150 list optional jury base does not include site installation hardware 	<table border="1"> <thead> <tr> <th>Upholstery</th> <th colspan="2">Shipping</th> </tr> </thead> <tbody> <tr> <td>COM Ydg</td> <td>1</td> <td>Ctn Wt 45</td> </tr> <tr> <td>COL Sq Ft</td> <td>12</td> <td>Cu Ft 12</td> </tr> </tbody> </table>	Upholstery	Shipping		COM Ydg	1	Ctn Wt 45	COL Sq Ft	12	Cu Ft 12						
Upholstery	Shipping																
COM Ydg	1	Ctn Wt 45															
COL Sq Ft	12	Cu Ft 12															

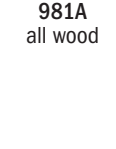
Description	Model	Specifications	List Price Per Grade														
Arm  981A all wood	981C Uph. Seat  981C uph. seat	Dimensions	All Wood \$837 COM \$910 A \$933 B \$950 COL/C \$980 D \$1,019 E \$1,059 F \$1,100 G \$1,159 H \$1,221 I \$1,319 J \$1,436 L1 \$1,170 L2 \$1,233														
		<table border="1"> <thead> <tr> <th></th> <th>D</th> <th>W</th> <th>H</th> </tr> </thead> <tbody> <tr> <td>Overall</td> <td>23 ½</td> <td>24</td> <td>32 ¼</td> </tr> <tr> <td>Seat</td> <td>17 ¾</td> <td>19 ¾</td> <td>18 ½</td> </tr> <tr> <td>Arm</td> <td colspan="3">28 ¾</td> </tr> </tbody> </table>		D	W	H	Overall	23 ½	24	32 ¼	Seat	17 ¾	19 ¾	18 ½	Arm	28 ¾	
	D	W	H														
Overall	23 ½	24	32 ¼														
Seat	17 ¾	19 ¾	18 ½														
Arm	28 ¾																
 optional front leg casters available - add \$46 list for set of 2 casters	<ul style="list-style-type: none"> optional front leg casters available - add \$46 list for set of 2 casters 	<table border="1"> <thead> <tr> <th>Upholstery</th> <th colspan="2">Shipping</th> </tr> </thead> <tbody> <tr> <td>COM Ydg</td> <td>1</td> <td>Ctn Wt 39</td> </tr> <tr> <td>COL Sq Ft</td> <td>12</td> <td>Cu Ft 13</td> </tr> </tbody> </table>	Upholstery	Shipping		COM Ydg	1	Ctn Wt 39	COL Sq Ft	12	Cu Ft 13						
Upholstery	Shipping																
COM Ydg	1	Ctn Wt 39															
COL Sq Ft	12	Cu Ft 13															

To Order, Specify:

- Model Number
- Wood Species - Oak (O) or Maple (M)
- Wood Finish/Color
- Fabric Selection - vendor, pattern and color
- Optional FRONT LEG Casters - add \$46 list; specify seat height. **NOT AVAILABLE on BENCHES**
- Optional Trim Nails - add \$90 list per chair; add \$115 list per bench
- Optional Rubber Cushion Nylon Glides - no upcharge

Wood Finish/Color Options:

- | | | |
|------------------|--------------|---------------|
| Oak | BRW Brownie | ECU Ecu |
| CAN Canyon | CIT Citron | HEN Henna |
| DES Desert | Maple | HNY Honey |
| ALE Ale | AUB Auburn | NUT Nut Brown |
| AUT Autumn | BRL Barley | FLX Flax |
| BBN Bourbon | BRG Brighton | LGC Legacy |
| BUT Butterscotch | CIN Cinnamon | MCH Mocha |
| CLA Classic | EAR Earthy | NTN Night Owl |
| ESP Espresso | | PRL Praline |
| | | SAF Saffron |
| | | SIE Sienna |
| | | TOF Toffee |
| | | TRF Truffle |
| | | VEN Venetian |



Color - Add \$31 list per item



- | | | | | | | | | | | | | | | | | | | | | | |
|--------------|---------------|------------------|-----------------|--------------|-----------|------------|------------|------------|------------------|------------------|-----------------|-----------------|---------------|------------------|----------------------|--------------|-------------------|------------------|--------------|-----------|-------------------|
| BKD Backdrop | BFX Black Fox | BWH Bright White | CGP Cargo Pants | CHT Chatroom | DSY Daisy | DRG Daring | DYN Dynamo | ENG Enigma | FRR French Roast | GBY Georgian Bay | GRV Creek Villa | GLF Gulf Stream | HTB Hearthrob | NET Network Gray | NWH Nonchalant White | PAR Paradise | QXP Quixotic Plum | RBZ Relic Bronze | SND Sandbank | STM Storm | TRC Tricorn Black |
|--------------|---------------|------------------|-----------------|--------------|-----------|------------|------------|------------|------------------|------------------|-----------------|-----------------|---------------|------------------|----------------------|--------------|-------------------|------------------|--------------|-----------|-------------------|

Specifications

- Wood species - Oak or Maple.
- Seat is upholstered with 1 ½" high density polyurethane foam and features horseshoe style upholstery.
- Spiral grooved hardwood dowels with corner blocks, glue and screws.
- Standard with rubber cushion metal glides.

4 See a selection of graded in fabric manufacturers and patterns on pages 12-20. Contact Customer Service for additional fabric options.

Description	Model	Specifications	List Price Per Grade																																								
Armless  983A all wood	983A All Wood 983C Uph. Seat · optional front leg casters available - add \$46 list for set of 2 casters	<table border="1"> <thead> <tr> <th>Dimensions</th> <th>D</th> <th>W</th> <th>H</th> </tr> </thead> <tbody> <tr> <td>Overall</td> <td>23 ¾</td> <td>20</td> <td>32 ¼</td> </tr> <tr> <td>Seat</td> <td>18 ¼</td> <td>20 ¾</td> <td>19 ¼</td> </tr> </tbody> </table>	Dimensions	D	W	H	Overall	23 ¾	20	32 ¼	Seat	18 ¼	20 ¾	19 ¼	<table border="1"> <tbody> <tr> <td>All Wood</td> <td>\$770</td> </tr> <tr> <td>COM</td> <td>\$845</td> </tr> <tr> <td>A</td> <td>\$867</td> </tr> <tr> <td>B</td> <td>\$884</td> </tr> <tr> <td>COL/C</td> <td>\$914</td> </tr> <tr> <td>D</td> <td>\$954</td> </tr> <tr> <td>E</td> <td>\$993</td> </tr> <tr> <td>F</td> <td>\$1,034</td> </tr> <tr> <td>G</td> <td>\$1,092</td> </tr> <tr> <td>H</td> <td>\$1,155</td> </tr> <tr> <td>I</td> <td>\$1,253</td> </tr> <tr> <td>J</td> <td>\$1,370</td> </tr> <tr> <td>L1</td> <td>\$1,104</td> </tr> <tr> <td>L2</td> <td>\$1,167</td> </tr> </tbody> </table>	All Wood	\$770	COM	\$845	A	\$867	B	\$884	COL/C	\$914	D	\$954	E	\$993	F	\$1,034	G	\$1,092	H	\$1,155	I	\$1,253	J	\$1,370	L1	\$1,104	L2	\$1,167
		Dimensions	D	W	H																																						
Overall	23 ¾	20	32 ¼																																								
Seat	18 ¼	20 ¾	19 ¼																																								
All Wood	\$770																																										
COM	\$845																																										
A	\$867																																										
B	\$884																																										
COL/C	\$914																																										
D	\$954																																										
E	\$993																																										
F	\$1,034																																										
G	\$1,092																																										
H	\$1,155																																										
I	\$1,253																																										
J	\$1,370																																										
L1	\$1,104																																										
L2	\$1,167																																										
 983C uph. seat	<table border="1"> <thead> <tr> <th>Upholstery</th> <th colspan="2">Shipping</th> </tr> </thead> <tbody> <tr> <td>COM Ydg</td> <td>1</td> <td>Ctn Wt 37</td> </tr> <tr> <td>COL Sq Ft</td> <td>12</td> <td>Cu Ft 13</td> </tr> </tbody> </table>	Upholstery	Shipping		COM Ydg	1	Ctn Wt 37	COL Sq Ft	12	Cu Ft 13																																	
Upholstery	Shipping																																										
COM Ydg	1	Ctn Wt 37																																									
COL Sq Ft	12	Cu Ft 13																																									

Description	Model	Specifications	List Price Per Grade																																												
Low Arm  984A all wood	984A All Wood 984C Uph. Seat · low arm - 26" arm height · optional front leg casters available - add \$46 list for set of 2 casters	<table border="1"> <thead> <tr> <th>Dimensions</th> <th>D</th> <th>W</th> <th>H</th> </tr> </thead> <tbody> <tr> <td>Overall</td> <td>22 ½</td> <td>22 ¼</td> <td>33</td> </tr> <tr> <td>Seat</td> <td>17 ¾</td> <td>19 ½</td> <td>18 ¼</td> </tr> <tr> <td>Arm</td> <td></td> <td></td> <td>26</td> </tr> </tbody> </table>	Dimensions	D	W	H	Overall	22 ½	22 ¼	33	Seat	17 ¾	19 ½	18 ¼	Arm			26	<table border="1"> <tbody> <tr> <td>All Wood</td> <td>\$922</td> </tr> <tr> <td>COM</td> <td>\$992</td> </tr> <tr> <td>A</td> <td>\$1,016</td> </tr> <tr> <td>B</td> <td>\$1,033</td> </tr> <tr> <td>COL/C</td> <td>\$1,063</td> </tr> <tr> <td>D</td> <td>\$1,103</td> </tr> <tr> <td>E</td> <td>\$1,142</td> </tr> <tr> <td>F</td> <td>\$1,183</td> </tr> <tr> <td>G</td> <td>\$1,242</td> </tr> <tr> <td>H</td> <td>\$1,305</td> </tr> <tr> <td>I</td> <td>\$1,402</td> </tr> <tr> <td>J</td> <td>\$1,519</td> </tr> <tr> <td>L1</td> <td>\$1,253</td> </tr> <tr> <td>L2</td> <td>\$1,316</td> </tr> </tbody> </table>	All Wood	\$922	COM	\$992	A	\$1,016	B	\$1,033	COL/C	\$1,063	D	\$1,103	E	\$1,142	F	\$1,183	G	\$1,242	H	\$1,305	I	\$1,402	J	\$1,519	L1	\$1,253	L2	\$1,316
		Dimensions	D	W	H																																										
Overall	22 ½	22 ¼	33																																												
Seat	17 ¾	19 ½	18 ¼																																												
Arm			26																																												
All Wood	\$922																																														
COM	\$992																																														
A	\$1,016																																														
B	\$1,033																																														
COL/C	\$1,063																																														
D	\$1,103																																														
E	\$1,142																																														
F	\$1,183																																														
G	\$1,242																																														
H	\$1,305																																														
I	\$1,402																																														
J	\$1,519																																														
L1	\$1,253																																														
L2	\$1,316																																														
 984C uph. seat	<table border="1"> <thead> <tr> <th>Upholstery</th> <th colspan="2">Shipping</th> </tr> </thead> <tbody> <tr> <td>COM Ydg</td> <td>1</td> <td>Ctn Wt 38</td> </tr> <tr> <td>COL Sq Ft</td> <td>12</td> <td>Cu Ft 13</td> </tr> </tbody> </table>	Upholstery	Shipping		COM Ydg	1	Ctn Wt 38	COL Sq Ft	12	Cu Ft 13																																					
Upholstery	Shipping																																														
COM Ydg	1	Ctn Wt 38																																													
COL Sq Ft	12	Cu Ft 13																																													

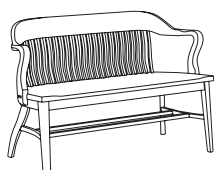
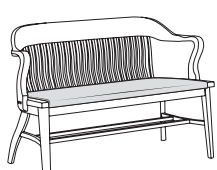
Description	Model	Specifications	List Price Per Grade																																												
Bench 49" W  991A all wood	991A All Wood 991C Uph. Seat · casters not available	<table border="1"> <thead> <tr> <th>Dimensions</th> <th>D</th> <th>W</th> <th>H</th> </tr> </thead> <tbody> <tr> <td>Overall</td> <td>23</td> <td>49 ¼</td> <td>33</td> </tr> <tr> <td>Seat</td> <td>17 ¾</td> <td>45 ¼</td> <td>18 ¼</td> </tr> <tr> <td>Arm</td> <td></td> <td></td> <td>28 ½</td> </tr> </tbody> </table>	Dimensions	D	W	H	Overall	23	49 ¼	33	Seat	17 ¾	45 ¼	18 ¼	Arm			28 ½	<table border="1"> <tbody> <tr> <td>All Wood</td> <td>\$2,992</td> </tr> <tr> <td>COM</td> <td>\$3,033</td> </tr> <tr> <td>A</td> <td>\$3,086</td> </tr> <tr> <td>B</td> <td>\$3,102</td> </tr> <tr> <td>COL/C</td> <td>\$3,128</td> </tr> <tr> <td>D</td> <td>\$3,162</td> </tr> <tr> <td>E</td> <td>\$3,197</td> </tr> <tr> <td>F</td> <td>\$3,232</td> </tr> <tr> <td>G</td> <td>\$3,284</td> </tr> <tr> <td>H</td> <td>\$3,338</td> </tr> <tr> <td>I</td> <td>\$3,425</td> </tr> <tr> <td>J</td> <td>\$3,527</td> </tr> <tr> <td>L1</td> <td>\$3,294</td> </tr> <tr> <td>L2</td> <td>\$3,349</td> </tr> </tbody> </table>	All Wood	\$2,992	COM	\$3,033	A	\$3,086	B	\$3,102	COL/C	\$3,128	D	\$3,162	E	\$3,197	F	\$3,232	G	\$3,284	H	\$3,338	I	\$3,425	J	\$3,527	L1	\$3,294	L2	\$3,349
		Dimensions	D	W	H																																										
Overall	23	49 ¼	33																																												
Seat	17 ¾	45 ¼	18 ¼																																												
Arm			28 ½																																												
All Wood	\$2,992																																														
COM	\$3,033																																														
A	\$3,086																																														
B	\$3,102																																														
COL/C	\$3,128																																														
D	\$3,162																																														
E	\$3,197																																														
F	\$3,232																																														
G	\$3,284																																														
H	\$3,338																																														
I	\$3,425																																														
J	\$3,527																																														
L1	\$3,294																																														
L2	\$3,349																																														
 991C uph. seat	<table border="1"> <thead> <tr> <th>Upholstery</th> <th colspan="2">Shipping</th> </tr> </thead> <tbody> <tr> <td>COM Ydg</td> <td>7/8</td> <td>Ctn Wt 76</td> </tr> <tr> <td>COL Sq Ft</td> <td>23</td> <td>Cu Ft 31</td> </tr> </tbody> </table>	Upholstery	Shipping		COM Ydg	7/8	Ctn Wt 76	COL Sq Ft	23	Cu Ft 31																																					
Upholstery	Shipping																																														
COM Ydg	7/8	Ctn Wt 76																																													
COL Sq Ft	23	Cu Ft 31																																													

Description

Bench 69" W

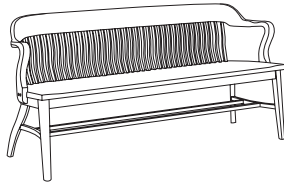

993A
all wood

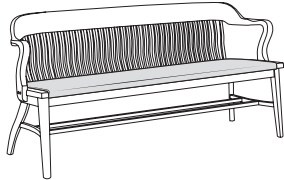

993C
uph. seat

1 Model

993A All Wood

993C Uph. Seat

· casters not available

Specifications

Dimensions	D	W	H
Overall	23	69 1/2	33 1/2
Seat	18	66 1/4	18
Arm			28 1/2
Upholstery		Shipping	
COM Ydg	2 1/4	Ctn Wt	109
COL Sq Ft	23	Cu Ft	47

List Price Per Grade

All Wood	\$3,356
COM	\$3,480
A	\$3,553
B	\$3,591
COL/C	\$3,660
D	\$3,748
E	\$3,836
F	\$3,929
G	\$4,061
H	\$4,202
I	\$4,421
J	\$4,686
L1	\$4,087
L2	\$4,228

SEATING

To Order, Specify:

- 1 Model Number
- 2 Wood Species - Oak (O) or Maple (M)
- 3 Wood Finish/Color
- 4 Fabric Selection - vendor, pattern and color
- 5 Optional FRONT LEG Casters - add \$46 list; specify seat height. **NOT AVAILABLE on BENCHES**
- 6 Optional Trim Nails - add \$90 list per chair; add \$115 list per bench
- 7 Optional Rubber Cushion Nylon Glides - no upcharge

3 Wood Finish/Color Options:

Oak		ECU	Ecru
BRW	Brownie	HEN	Henna
CAN	Canyon	HNY	Honey
CIT	Citron	NUT	Nut Brown
DES	Desert		
Maple		FLX	Flax
ALE	Ale	LGC	Legacy
AUB	Auburn	MCH	Mocha
AUT	Autumn	NTO	Night Owl
BRL	Barley	PRL	Praline
BBN	Bourbon	SAF	Saffron
BRG	Brighton	SIE	Sienna
BUT	Butterscotch	TOF	Toffee
CIN	Cinnamon	TRF	Truffle
CLA	Classic	VEN	Venetian
EAR	Earthy		
ESP	Espresso		

Color - Add \$31 list per item

BKD	Backdrop	GRV	Greek Villa
BFX	Black Fox	GLF	Gulf Stream
BWH	Bright White	HTB	Hearthrob
CGP	Cargo Pants	NET	Network Gray
CHT	Chatroom	NWH	Nonchalant White
DSY	Daisy	PAR	Paradise
DRG	Daring	QXP	Quixotic Plum
DYN	Dynamo	RBZ	Relic Bronze
ENG	Enigma	SND	Sandbank
FRR	French Roast	STM	Storm
GBY	Georgian Bay	TRC	Tricorn Black

Specifications

- Wood species - Oak or Maple.
- Seat is upholstered with 1 1/2" high density polyurethane foam and features horseshoe style upholstery.
- Spiral grooved hardwood dowels with corner blocks, glue and screws.
- Standard with rubber cushion metal glides.

- 4 See a selection of graded in fabric manufacturers and patterns on pages 12-20. Contact Customer Service for additional fabric options.

Brockton Order Check List:



SEATING

Specify:

- 1. Model Number
- 2. Wood Species - Oak (O) or Maple (M)
- 3. Wood Finish/Color
- 4. Upholstered Seat Style - horseshoe style available; add \$18 list per chair/barstool
- 5. Fabric Selection - vendor, pattern and color
- 6. Optional Antique Brass Trim Nails - add \$90 list per chair/barstool
- 7. Optional FRONT LEG Casters - add \$46 list; specify seat height
NOT AVAILABLE on BARSTOOLS
- 8. Optional Rubber Cushion Nylon Glides - no upcharge

Example:

953C <small>(model #)</small>	O <small>(wood species)</small>	HEN <small>(finish)</small>	MOMENTUM <small>(fabric vendor)</small>	VOX <small>(pattern name)</small>	MYSTIC <small>(pattern color)</small>
----------------------------------	------------------------------------	--------------------------------	--	--------------------------------------	--

1. Model Number

2. Wood Species - Oak (O) or Maple (M)

3. Wood Base/Arm Cap Finish Options:

Oak

BRW Brownie	ECU Ecru
CAN Canyon	HEN Henna
CIT Citron	HNY Honey
DES Desert	NUT Nut Brown

Maple

ALE Ale	FLX Flax
AUB Auburn	LGC Legacy
AUT Autumn	MCH Mocha
BRL Barley	NTO Night Owl
BBN Bourbon	PRL Praline
BRG Brighton	SAF Saffron
BUT Butterscotch	SIE Sienna
CIN Cinnamon	TOF Toffee
CLA Classic	TRF Truffle
EAR Earthy	VEN Venetian
ESP Espresso	

Color - Add \$31 list per item

BKD Backdrop	GRV Greek Villa
BFX Black Fox	GLF Gulf Stream
BWH Bright White	HTB Heartthrob
CGP Cargo Pants	NET Network Gray
CHT Chatroom	NWH Nonchalant White
DSY Daisy	PAR Paradise
DRG Daring	QXP Quixotic Plum
DYN Dynamo	RBZ Relic Bronze
ENG Enigma	SND Sandbank
FRR French Roast	STM Storm
GBY Georgian Bay	TRC Tricorn Black

4. Upholstered Seat Style - standard with fully upholstered seat. Optional horseshoe style with welt cord available; add \$18 list per chair/barstool

5. Fabric Selection - Please supply the following:

- Fabric vendor
- Pattern name
- Pattern color

All COM orders must include the following:

- Vendor's name, pattern name and color
- Sample of the fabric attached to order
- Model numbers of items for fabric application
- Special application instructions (e.g., all stripes will be applied front to back unless specified otherwise)
- Customer and purchase order number



Ship prepaid COM material to:
Community
Attn: COM Dept
932 Mill Street
Jasper, IN 47546

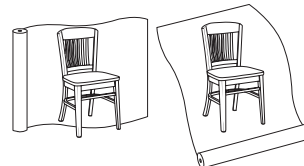

Application of fabric:
Railroaded Up the Roll



All COM orders will ship at standard lead time from receipt of COM except for orders requiring special custom matched finishes.

6. Optional Antique Brass Trim Nails - add \$90 list per chair/barstool

Description	Model	Specifications			List Price Per Grade																				
Armless   	953A All Wood 953C Uph. Seat • optional front leg casters available - add \$46 list for set of 2 casters	Dimensions	D	W	H	All Wood \$443 COM \$480 A \$495 B \$508 COL/C \$531 D \$560 E \$590 F \$620 G \$664 H \$711 I \$784 J \$872 L1 \$672 L2 \$720																			
	<table border="1"> <thead> <tr> <th>Overall</th> <th>D</th> <th>W</th> <th>H</th> </tr> </thead> <tbody> <tr> <td>21 3/8</td> <td>17 3/4</td> <td>17 3/4</td> <td>33 1/2</td> </tr> <tr> <th>Seat</th> <td>17</td> <td>17 3/4</td> <td>18</td> </tr> </tbody> </table> <table border="1"> <thead> <tr> <th>Upholstery</th> <th colspan="2">Shipping</th> </tr> </thead> <tbody> <tr> <td>COM Ydg 3/4</td> <td>Ctn Wt</td> <td>20</td> </tr> <tr> <td>COL Sq Ft 9</td> <td>Cu Ft</td> <td>9</td> </tr> </tbody> </table>	Overall	D	W	H	21 3/8	17 3/4	17 3/4	33 1/2	Seat	17	17 3/4	18	Upholstery	Shipping		COM Ydg 3/4	Ctn Wt	20	COL Sq Ft 9	Cu Ft	9			
Overall	D	W	H																						
21 3/8	17 3/4	17 3/4	33 1/2																						
Seat	17	17 3/4	18																						
Upholstery	Shipping																								
COM Ydg 3/4	Ctn Wt	20																							
COL Sq Ft 9	Cu Ft	9																							

Description	Model	Specifications			List Price Per Grade																				
Barstool  	958A All Wood 958C Uph. Seat • casters not available • standard with brass scuff plate, also available in polished aluminum or matte black	Dimensions	D	W	H	All Wood \$591 COM \$621 A \$638 B \$650 COL/C \$674 D \$703 E \$732 F \$763 G \$807 H \$854 I \$927 J \$1,015 L1 \$815 L2 \$863																			
	<table border="1"> <thead> <tr> <th>Overall</th> <th>D</th> <th>W</th> <th>H</th> </tr> </thead> <tbody> <tr> <td>21 3/8</td> <td>19</td> <td>19</td> <td>45 1/2</td> </tr> <tr> <th>Seat</th> <td>17</td> <td>19</td> <td>30 1/2</td> </tr> </tbody> </table> <table border="1"> <thead> <tr> <th>Upholstery</th> <th colspan="2">Shipping</th> </tr> </thead> <tbody> <tr> <td>COM Ydg 3/4</td> <td>Ctn Wt</td> <td>30</td> </tr> <tr> <td>COL Sq Ft 9</td> <td>Cu Ft</td> <td>13</td> </tr> </tbody> </table>	Overall	D	W	H	21 3/8	19	19	45 1/2	Seat	17	19	30 1/2	Upholstery	Shipping		COM Ydg 3/4	Ctn Wt	30	COL Sq Ft 9	Cu Ft	13			
Overall	D	W	H																						
21 3/8	19	19	45 1/2																						
Seat	17	19	30 1/2																						
Upholstery	Shipping																								
COM Ydg 3/4	Ctn Wt	30																							
COL Sq Ft 9	Cu Ft	13																							

To Order, Specify:

- 1 Model Number
- 2 Wood Species - Oak (O) or Maple (M)
- 3 Wood Finish/Color
- 4 Upholstered Seat Style - horseshoe style; add \$18 list per chair/barstool
- 5 Fabric Selection - vendor, pattern and color
- 6 Optional Antique Brass Trim Nails - add \$90 list per chair/barstool
- 7 Optional FRONT LEG Casters - add \$46 list; specify seat height. **NOT AVAILABLE on BARSTOOLS**
- 8 Optional Rubber Cushion Nylon Glides - no upcharge

Wood Finish/Color Options:

- | | | |
|------------------|--------------|---------------|
| Oak | BRW Brownie | ECU Ecu |
| CAN Canyon | CIT Citron | HEN Henna |
| DES Desert | Maple | HNY Honey |
| ALE Ale | AUB Auburn | NUT Nut Brown |
| AUT Autumn | BRL Barley | FLX Flax |
| BBN Bourbon | BRG Brighton | LGC Legacy |
| BUT Butterscotch | CIN Cinnamon | MCH Mocha |
| CLA Classic | EAR Earthy | NTO Night Owl |
| ESP Espresso | | PRL Praline |
| | | SAF Saffron |
| | | SIE Sienna |
| | | TOF Toffee |
| | | TRF Truffle |
| | | VEN Venetian |

Color - Add \$31 list per item

- | | |
|------------------|----------------------|
| BKD Backdrop | GRV Greek Villa |
| BFX Black Fox | GLF Gulf Stream |
| BWH Bright White | HTB Hearthrob |
| CGP Cargo Pants | NET Network Gray |
| CHT Chatroom | NWH Nonchalant White |
| DSY Daisy | PAR Paradise |
| DRG Daring | QXP Quixotic Plum |
| DYN Dynamo | RBZ Relic Bronze |
| ENG Enigma | SND Sandbank |
| FRR French Roast | STM Storm |
| GBY Georgian Bay | TRC Tricorn Black |

Specifications

- Wood species - Oak or Maple.
- Seat is upholstered with 1 1/2" high density polyurethane foam.
- Spiral grooved hardwood dowels with corner blocks, glue and screws.
- Standard with rubber cushion metal glides.

4 See a selection of graded in fabric manufacturers and patterns on pages 12-20. Contact Customer Service for additional fabric options.

Calculus Order Check List:



Coordinating Children's collection. See page 330.

Specify:

- 1. Model Number
- 2. Wood Species - Oak (0)
- 3. Wood Finish/Color
- 4. Fabric Selection - vendor, pattern and color
- 5. Optional Linking Brackets - add \$26 list per chair/stool
- 6. Optional Laser Engraving Back Imprint - specify location and size

Example:

41C (model #)	0 (wood species)	HEN (finish)	MOMENTUM (fabric vendor)	VOX (pattern name)	MYSTIC (pattern color)
-------------------------	----------------------------	------------------------	------------------------------------	------------------------------	----------------------------------

1. Model Number

2. Wood Species - Oak (0)

3. Wood Finish/Color Options:

BRW Brownie	ECU Ecu
CAN Canyon	HEN Henna
CIT Citron	HNY Honey
DES Desert	NUT Nut Brown

Color - Add \$31 list per item

BKD Backdrop	GRV Greek Villa
BFX Black Fox	GLF Gulf Stream
BWH Bright White	HTB Heartthrob
CGP Cargo Pants	NET Network Gray
CHT Chatroom	NWH Nonchalant White
DSY Daisy	PAR Paradise
DRG Daring	QXP Quixotic Plum
DYN Dynamo	RBZ Relic Bronze
ENG Enigma	SND Sandbank
FRR French Roast	STM Storm
GBY Georgian Bay	TRC Tricorn Black

4. Fabric Selection - Please supply the following:

- Fabric vendor
- Pattern name
- Pattern color

When specifying contrasting upholstery, indicate clearly which upholstery is to be applied to the seat and back. Use higher grade pricing.

- Indicate direction of fabric - Railroaded or Up the Roll
- Please provide illustration, if available

All COM orders must include the following:

- Vendor's name, pattern name and color
- Sample of the fabric attached to order
- Model numbers of items for fabric application
- Special application instructions (e.g., all stripes will be applied front to back unless specified otherwise)
- Customer and purchase order number

Ship prepaid COM material to:
Community
Attn: COM Dept
932 Mill Street
Jasper, IN 47546

Application of fabric:
Railroaded Up the Roll

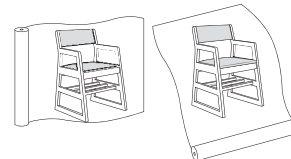

All COM orders will ship at standard lead time from receipt of COM except for orders requiring special custom matched finishes.

5. Optional Linking Brackets - add \$26 list per chair/stool/bench









6. Optional Laser Engraving Back Imprint - available on models 41A/C, 42A/C, 48A/C and 49A/C. See page 7 for details.



- Specify:**
- location - inside/outside of back
 - size of design

SEATING

Description	Model	Specifications	List Price Per Grade																												
Arm    41A all wood 41B uph. back	41A All Wood 41B Uph. Back <ul style="list-style-type: none"> optional linking brackets - add \$26 list per chair optional laser engraving back imprint, specify location and size - see page 7 for details. (A model only) coordinating Children's collection - see page 330 	<table border="1"> <thead> <tr> <th>Dimensions</th> <th>D</th> <th>W</th> <th>H</th> </tr> </thead> <tbody> <tr> <td>Overall</td> <td>23 1/2</td> <td>21</td> <td>32</td> </tr> <tr> <td>Seat</td> <td>17 1/4</td> <td>19</td> <td>18</td> </tr> <tr> <td>Arm</td> <td colspan="3">25</td> </tr> <tr> <th colspan="2">Upholstery</th> <th colspan="2">Shipping</th> </tr> <tr> <td>COM Ydg</td> <td>3/4</td> <td>Ctn Wt</td> <td>35</td> </tr> <tr> <td>COL Sq Ft</td> <td>9</td> <td>Cu Ft</td> <td>11</td> </tr> </tbody> </table>	Dimensions	D	W	H	Overall	23 1/2	21	32	Seat	17 1/4	19	18	Arm	25			Upholstery		Shipping		COM Ydg	3/4	Ctn Wt	35	COL Sq Ft	9	Cu Ft	11	All Wood \$399 COM \$451 A \$465 B \$478 COL/C \$500 D \$530 E \$559 F \$591 G \$634 H \$681 I \$754 J \$843 L1 \$643 L2 \$689
	Dimensions	D	W	H																											
Overall	23 1/2	21	32																												
Seat	17 1/4	19	18																												
Arm	25																														
Upholstery		Shipping																													
COM Ydg	3/4	Ctn Wt	35																												
COL Sq Ft	9	Cu Ft	11																												
Arm  	41C Uph. Seat <ul style="list-style-type: none"> optional linking brackets - add \$26 list per chair optional laser engraving back imprint, specify location and size - see page 7 for details. coordinating Children's collection - see page 330 	<table border="1"> <thead> <tr> <th>Dimensions</th> <th>D</th> <th>W</th> <th>H</th> </tr> </thead> <tbody> <tr> <td>Overall</td> <td>23 1/2</td> <td>21</td> <td>32</td> </tr> <tr> <td>Seat</td> <td>17 1/4</td> <td>19</td> <td>18</td> </tr> <tr> <td>Arm</td> <td colspan="3">25</td> </tr> <tr> <th colspan="2">Upholstery</th> <th colspan="2">Shipping</th> </tr> <tr> <td>COM Ydg</td> <td>3/4</td> <td>Ctn Wt</td> <td>35</td> </tr> <tr> <td>COL Sq Ft</td> <td>9</td> <td>Cu Ft</td> <td>11</td> </tr> </tbody> </table>	Dimensions	D	W	H	Overall	23 1/2	21	32	Seat	17 1/4	19	18	Arm	25			Upholstery		Shipping		COM Ydg	3/4	Ctn Wt	35	COL Sq Ft	9	Cu Ft	11	COM \$451 A \$465 B \$478 COL/C \$500 D \$530 E \$559 F \$591 G \$634 H \$681 I \$754 J \$843 L1 \$643 L2 \$689
	Dimensions	D	W	H																											
Overall	23 1/2	21	32																												
Seat	17 1/4	19	18																												
Arm	25																														
Upholstery		Shipping																													
COM Ydg	3/4	Ctn Wt	35																												
COL Sq Ft	9	Cu Ft	11																												
Arm  	41D Uph. Seat/Back <ul style="list-style-type: none"> optional linking brackets - add \$26 list per chair coordinating Children's collection - see page 330 	<table border="1"> <thead> <tr> <th>Dimensions</th> <th>D</th> <th>W</th> <th>H</th> </tr> </thead> <tbody> <tr> <td>Overall</td> <td>23 1/2</td> <td>21</td> <td>32</td> </tr> <tr> <td>Seat</td> <td>17 1/4</td> <td>19</td> <td>18</td> </tr> <tr> <td>Arm</td> <td colspan="3">25</td> </tr> <tr> <th colspan="2">Upholstery</th> <th colspan="2">Shipping</th> </tr> <tr> <td>COM Ydg</td> <td>3/4</td> <td>Ctn Wt</td> <td>35</td> </tr> <tr> <td>COL Sq Ft</td> <td>18</td> <td>Cu Ft</td> <td>11</td> </tr> </tbody> </table>	Dimensions	D	W	H	Overall	23 1/2	21	32	Seat	17 1/4	19	18	Arm	25			Upholstery		Shipping		COM Ydg	3/4	Ctn Wt	35	COL Sq Ft	18	Cu Ft	11	COM \$497 A \$512 B \$524 COL/C \$548 D \$577 E \$606 F \$637 G \$681 H \$728 I \$802 J \$889 L1 \$689 L2 \$737
	Dimensions	D	W	H																											
Overall	23 1/2	21	32																												
Seat	17 1/4	19	18																												
Arm	25																														
Upholstery		Shipping																													
COM Ydg	3/4	Ctn Wt	35																												
COL Sq Ft	18	Cu Ft	11																												

To Order, Specify:

- Model Number
- Wood Species - Oak (O)
- Wood Finish/Color
- Fabric Selection - vendor, pattern and color
- Optional Linking Brackets - add \$26 list per chair/stool
- Optional Laser Engraving Back Imprint - specify location and size; see page 7 for details
(A and C MODELS ONLY)









Wood Finish/Color Options:

BRW	Brownie	ECU	Ecru
CAN	Canyon	HEN	Henna
CIT	Citron	HNY	Honey
DES	Desert	NUT	Nut Brown
Color - Add \$31 list per item			
BKD	Backdrop	GRV	Greek Villa
BFX	Black Fox	GLF	Gulf Stream
BWH	Bright White	HTB	Hearthrob
CGP	Cargo Pants	NET	Network Gray
CHT	Chatroom	NWH	Nonchalant White
DSY	Daisy	PAR	Paradise
DRG	Daring	QXP	Quixotic Plum
DYN	Dynamo	RBZ	Relic Bronze
ENG	Enigma	SND	Sandbank
FRR	French Roast	STM	Storm
GBY	Georgian Bay	TRC	Tricorn Black

Specifications

- Wood species - Oak.
- Chairs - three stretcher shelf for storage and added stability.
- Seat is upholstered with 1 1/2" high density polyurethane foam and synthetic sheet webbing for added comfort.
- Back is upholstered front and back with 1" polyurethane foam.
- Mortise and tenon construction with corner blocks, glue and screws.
- Coordinating Children's collection. See page 330.

- See a selection of graded in fabric manufacturers and patterns on pages 12-20. Contact Customer Service for additional fabric options.

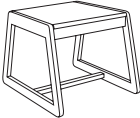
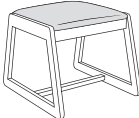
Description	① Model	Specifications	List Price Per Grade																								
Armless   	42A All Wood 42B Uph. Back · optional linking brackets - add \$26 list per chair · optional laser engraving back imprint, specify location and size - see page 7 for details. (A model only) · coordinating Children's collection - see page 330	<table border="1"> <thead> <tr> <th>Dimensions</th> <th>D</th> <th>W</th> <th>H</th> </tr> </thead> <tbody> <tr> <td>Overall</td> <td>24 1/2</td> <td>19</td> <td>32</td> </tr> <tr> <td>Seat</td> <td>17</td> <td>17</td> <td>17 1/2</td> </tr> <tr> <th colspan="2">Upholstery</th> <th colspan="2">Shipping</th> </tr> <tr> <td>COM Ydg</td> <td>3/4</td> <td>Ctn Wt</td> <td>32</td> </tr> <tr> <td>COL Sq Ft</td> <td>9</td> <td>Cu Ft</td> <td>11</td> </tr> </tbody> </table>	Dimensions	D	W	H	Overall	24 1/2	19	32	Seat	17	17	17 1/2	Upholstery		Shipping		COM Ydg	3/4	Ctn Wt	32	COL Sq Ft	9	Cu Ft	11	All Wood \$371 COM \$417 A \$431 B \$444 COL/C \$467 D \$496 E \$525 F \$556 G \$600 H \$647 I \$720 J \$808 L1 \$608 L2 \$656
	Dimensions	D	W	H																							
Overall	24 1/2	19	32																								
Seat	17	17	17 1/2																								
Upholstery		Shipping																									
COM Ydg	3/4	Ctn Wt	32																								
COL Sq Ft	9	Cu Ft	11																								
42A all wood	42B uph. back																										
Armless  	42C Uph. Seat · optional linking brackets - add \$26 list per chair · optional laser engraving back imprint, specify location and size - see page 7 for details. · coordinating Children's collection - see page 330	<table border="1"> <thead> <tr> <th>Dimensions</th> <th>D</th> <th>W</th> <th>H</th> </tr> </thead> <tbody> <tr> <td>Overall</td> <td>24 1/2</td> <td>19</td> <td>32</td> </tr> <tr> <td>Seat</td> <td>17</td> <td>17</td> <td>17 1/2</td> </tr> <tr> <th colspan="2">Upholstery</th> <th colspan="2">Shipping</th> </tr> <tr> <td>COM Ydg</td> <td>3/4</td> <td>Ctn Wt</td> <td>32</td> </tr> <tr> <td>COL Sq Ft</td> <td>9</td> <td>Cu Ft</td> <td>11</td> </tr> </tbody> </table>	Dimensions	D	W	H	Overall	24 1/2	19	32	Seat	17	17	17 1/2	Upholstery		Shipping		COM Ydg	3/4	Ctn Wt	32	COL Sq Ft	9	Cu Ft	11	COM \$417 A \$431 B \$444 COL/C \$467 D \$496 E \$525 F \$556 G \$600 H \$647 I \$720 J \$808 L1 \$608 L2 \$656
	Dimensions	D	W	H																							
Overall	24 1/2	19	32																								
Seat	17	17	17 1/2																								
Upholstery		Shipping																									
COM Ydg	3/4	Ctn Wt	32																								
COL Sq Ft	9	Cu Ft	11																								
Armless  	42D Uph. Seat/Back · optional linking brackets - add \$26 list per chair · coordinating Children's collection - see page 330	<table border="1"> <thead> <tr> <th>Dimensions</th> <th>D</th> <th>W</th> <th>H</th> </tr> </thead> <tbody> <tr> <td>Overall</td> <td>24 1/2</td> <td>19</td> <td>32</td> </tr> <tr> <td>Seat</td> <td>17</td> <td>17</td> <td>17 1/2</td> </tr> <tr> <th colspan="2">Upholstery</th> <th colspan="2">Shipping</th> </tr> <tr> <td>COM Ydg</td> <td>3/4</td> <td>Ctn Wt</td> <td>32</td> </tr> <tr> <td>COL Sq Ft</td> <td>18</td> <td>Cu Ft</td> <td>11</td> </tr> </tbody> </table>	Dimensions	D	W	H	Overall	24 1/2	19	32	Seat	17	17	17 1/2	Upholstery		Shipping		COM Ydg	3/4	Ctn Wt	32	COL Sq Ft	18	Cu Ft	11	COM \$467 A \$480 B \$494 COL/C \$516 D \$545 E \$575 F \$606 G \$650 H \$697 I \$770 J \$858 L1 \$659 L2 \$706
	Dimensions	D	W	H																							
Overall	24 1/2	19	32																								
Seat	17	17	17 1/2																								
Upholstery		Shipping																									
COM Ydg	3/4	Ctn Wt	32																								
COL Sq Ft	18	Cu Ft	11																								
Stool 18" H   	45A All Wood 45C Uph. Seat · 18" seat height · optional linking brackets - add \$26 list per stool	<table border="1"> <thead> <tr> <th>Dimensions</th> <th>D</th> <th>W</th> <th>H</th> </tr> </thead> <tbody> <tr> <td>Overall</td> <td>24 3/4</td> <td>21</td> <td>18</td> </tr> <tr> <td>Seat</td> <td>19</td> <td>19</td> <td>18</td> </tr> <tr> <th colspan="2">Upholstery</th> <th colspan="2">Shipping</th> </tr> <tr> <td>COM Ydg</td> <td>3/4</td> <td>Ctn Wt</td> <td>23</td> </tr> <tr> <td>COL Sq Ft</td> <td>9</td> <td>Cu Ft</td> <td>7</td> </tr> </tbody> </table>	Dimensions	D	W	H	Overall	24 3/4	21	18	Seat	19	19	18	Upholstery		Shipping		COM Ydg	3/4	Ctn Wt	23	COL Sq Ft	9	Cu Ft	7	All Wood \$387 COM \$390 A \$403 B \$416 COL/C \$438 D \$468 E \$497 F \$529 G \$573 H \$619 I \$692 J \$781 L1 \$581 L2 \$628
	Dimensions	D	W	H																							
Overall	24 3/4	21	18																								
Seat	19	19	18																								
Upholstery		Shipping																									
COM Ydg	3/4	Ctn Wt	23																								
COL Sq Ft	9	Cu Ft	7																								
45A all wood	45C uph. seat																										

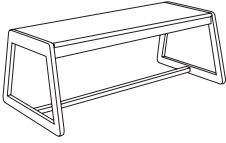
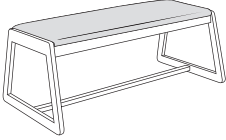
Description	Model	Specifications				List Price Per Grade	
		Dimensions	D	W	H	All Wood	COM
Bench 48" W  46A all wood  46C uph. seat	46A All Wood 46C Uph. Seat · optional linking brackets - add \$26 list per bench ▲	Overall	24 ¾	48	18	\$616	\$612
	Seat	19	46	18	A \$627	B \$641	
		Upholstery		Shipping		COL/C \$664	D \$692
		COM Ydg	¾	Ctn Wt	35	E \$722	F \$753
		COL Sq Ft	23	Cu Ft	14	G \$797	H \$844
						I \$917	J \$1,005
						L1 \$806	L2 \$853

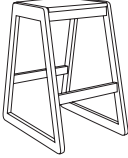
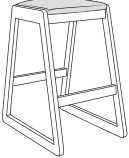
Description	Model	Specifications				List Price Per Grade	
		Dimensions	D	W	H	All Wood	COM
Barstool 29" H  47A all wood  47C uph. seat	47A All Wood 47C Uph. Seat · 29" seat height · linking not available · optional brass, matte black or polished aluminum scuff plates - add \$31 list for set of two	Overall	25 ½	17	29	\$450	\$448
	Seat	14 ½	15	29	A \$461	B \$474	
		Upholstery		Shipping		COL/C \$497	D \$527
		COM Ydg	¾	Ctn Wt	30	E \$556	F \$587
		COL Sq Ft	9	Cu Ft	11	G \$630	H \$678
						I \$751	J \$839
						L1 \$640	L2 \$686

To Order, Specify:

- 1 Model Number
- 2 Wood Species - Oak (0)
- 3 Wood Finish/Color
- 4 Fabric Selection - vendor, pattern and color
- 5 Optional Linking Brackets - add \$26 list per chair/stool
- 6 Optional Laser Engraving Back Imprint - specify location and size; see page 7 for details
(A and C MODELS ONLY)

3 Wood Finish/Color Options:

BRW	Brownie	ECU	Ecru
CAN	Canyon	HEN	Henna
CIT	Citron	HNY	Honey
DES	Desert	NUT	Nut Brown

Color - Add \$31 list per item



BKD	Backdrop	GRV	Greek Villa
BFX	Black Fox	GLF	Gulf Stream
BWH	Bright White	HTB	Heartthrob
CGP	Cargo Pants	NET	Network Gray
CHT	Chatroom	NWH	Nonchalant White
DSY	Daisy	PAR	Paradise
DRG	Daring	QXP	Quixotic Plum
DYN	Dynamo	RBZ	Relic Bronze
ENG	Enigma	SND	Sandbank
FRR	French Roast	STM	Storm
GBY	Georgian Bay	TRC	Tricorn Black

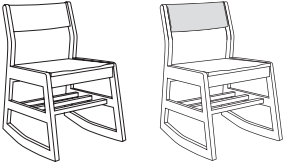

Specifications

- Wood species - Oak.
- Chairs - three stretcher shelf for storage and added stability.
- Seat is upholstered with 1 ½" high density polyurethane foam and synthetic sheet webbing for added comfort.
- Back is upholstered front and back with 1" polyurethane foam.
- Mortise and tenon construction with corner blocks, glue and screws.
- Coordinating Children's collection. See page 330.



- 4 See a selection of graded in fabric manufacturers and patterns on pages 12-20. Contact Customer Service for additional fabric options.

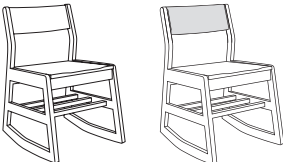

Description	① Model	Specifications	List Price Per Grade																																																				
Two-Position  	48A All Wood 48B Uph. Back · optional laser engraving back imprint, specify location and size - see page 7 for details. (A model only)	<table border="1"> <thead> <tr> <th>Dimensions</th> <th>D</th> <th>W</th> <th>H</th> </tr> </thead> <tbody> <tr> <td>Overall</td> <td>23 ¼</td> <td>19</td> <td>30 ½-32</td> </tr> <tr> <td>Seat</td> <td>17 ½</td> <td>17</td> <td>17 ½-19 ¾</td> </tr> <tr> <th colspan="2">Upholstery</th> <th colspan="2">Shipping</th> </tr> <tr> <td>COM Ydg</td> <td>¾</td> <td>Ctn Wt</td> <td>35</td> </tr> <tr> <td>COL Sq Ft</td> <td>9</td> <td>Cu Ft</td> <td>11</td> </tr> </tbody> </table>	Dimensions	D	W	H	Overall	23 ¼	19	30 ½-32	Seat	17 ½	17	17 ½-19 ¾	Upholstery		Shipping		COM Ydg	¾	Ctn Wt	35	COL Sq Ft	9	Cu Ft	11	<table border="1"> <tbody> <tr><td>All Wood</td><td>\$384</td></tr> <tr><td>COM</td><td>\$444</td></tr> <tr><td>A</td><td>\$457</td></tr> <tr><td>B</td><td>\$470</td></tr> <tr><td>COL/C</td><td>\$493</td></tr> <tr><td>D</td><td>\$522</td></tr> <tr><td>E</td><td>\$552</td></tr> <tr><td>F</td><td>\$582</td></tr> <tr><td>G</td><td>\$626</td></tr> <tr><td>H</td><td>\$674</td></tr> <tr><td>I</td><td>\$747</td></tr> <tr><td>J</td><td>\$835</td></tr> <tr><td>L1</td><td>\$636</td></tr> <tr><td>L2</td><td>\$682</td></tr> </tbody> </table>	All Wood	\$384	COM	\$444	A	\$457	B	\$470	COL/C	\$493	D	\$522	E	\$552	F	\$582	G	\$626	H	\$674	I	\$747	J	\$835	L1	\$636	L2	\$682
Dimensions	D	W	H																																																				
Overall	23 ¼	19	30 ½-32																																																				
Seat	17 ½	17	17 ½-19 ¾																																																				
Upholstery		Shipping																																																					
COM Ydg	¾	Ctn Wt	35																																																				
COL Sq Ft	9	Cu Ft	11																																																				
All Wood	\$384																																																						
COM	\$444																																																						
A	\$457																																																						
B	\$470																																																						
COL/C	\$493																																																						
D	\$522																																																						
E	\$552																																																						
F	\$582																																																						
G	\$626																																																						
H	\$674																																																						
I	\$747																																																						
J	\$835																																																						
L1	\$636																																																						
L2	\$682																																																						

Two-Position  	48C Uph. Seat · optional laser engraving back imprint, specify location and size - see page 7 for details.	<table border="1"> <thead> <tr> <th>Dimensions</th> <th>D</th> <th>W</th> <th>H</th> </tr> </thead> <tbody> <tr> <td>Overall</td> <td>23 ¼</td> <td>19</td> <td>30 ½-32</td> </tr> <tr> <td>Seat</td> <td>17 ½</td> <td>17</td> <td>17 ½-19 ¾</td> </tr> <tr> <th colspan="2">Upholstery</th> <th colspan="2">Shipping</th> </tr> <tr> <td>COM Ydg</td> <td>¾</td> <td>Ctn Wt</td> <td>35</td> </tr> <tr> <td>COL Sq Ft</td> <td>9</td> <td>Cu Ft</td> <td>11</td> </tr> </tbody> </table>	Dimensions	D	W	H	Overall	23 ¼	19	30 ½-32	Seat	17 ½	17	17 ½-19 ¾	Upholstery		Shipping		COM Ydg	¾	Ctn Wt	35	COL Sq Ft	9	Cu Ft	11	<table border="1"> <tbody> <tr><td>COM</td><td>\$444</td></tr> <tr><td>A</td><td>\$457</td></tr> <tr><td>B</td><td>\$470</td></tr> <tr><td>COL/C</td><td>\$493</td></tr> <tr><td>D</td><td>\$522</td></tr> <tr><td>E</td><td>\$552</td></tr> <tr><td>F</td><td>\$582</td></tr> <tr><td>G</td><td>\$626</td></tr> <tr><td>H</td><td>\$674</td></tr> <tr><td>I</td><td>\$747</td></tr> <tr><td>J</td><td>\$835</td></tr> <tr><td>L1</td><td>\$636</td></tr> <tr><td>L2</td><td>\$682</td></tr> </tbody> </table>	COM	\$444	A	\$457	B	\$470	COL/C	\$493	D	\$522	E	\$552	F	\$582	G	\$626	H	\$674	I	\$747	J	\$835	L1	\$636	L2	\$682
Dimensions	D	W	H																																																		
Overall	23 ¼	19	30 ½-32																																																		
Seat	17 ½	17	17 ½-19 ¾																																																		
Upholstery		Shipping																																																			
COM Ydg	¾	Ctn Wt	35																																																		
COL Sq Ft	9	Cu Ft	11																																																		
COM	\$444																																																				
A	\$457																																																				
B	\$470																																																				
COL/C	\$493																																																				
D	\$522																																																				
E	\$552																																																				
F	\$582																																																				
G	\$626																																																				
H	\$674																																																				
I	\$747																																																				
J	\$835																																																				
L1	\$636																																																				
L2	\$682																																																				

Two-Position  	48D Uph. Seat/Back	<table border="1"> <thead> <tr> <th>Dimensions</th> <th>D</th> <th>W</th> <th>H</th> </tr> </thead> <tbody> <tr> <td>Overall</td> <td>23 ¼</td> <td>19</td> <td>30 ½-32</td> </tr> <tr> <td>Seat</td> <td>17 ½</td> <td>17</td> <td>17 ½-19 ¾</td> </tr> <tr> <th colspan="2">Upholstery</th> <th colspan="2">Shipping</th> </tr> <tr> <td>COM Ydg</td> <td>¾</td> <td>Ctn Wt</td> <td>35</td> </tr> <tr> <td>COL Sq Ft</td> <td>18</td> <td>Cu Ft</td> <td>11</td> </tr> </tbody> </table>	Dimensions	D	W	H	Overall	23 ¼	19	30 ½-32	Seat	17 ½	17	17 ½-19 ¾	Upholstery		Shipping		COM Ydg	¾	Ctn Wt	35	COL Sq Ft	18	Cu Ft	11	<table border="1"> <tbody> <tr><td>COM</td><td>\$495</td></tr> <tr><td>A</td><td>\$510</td></tr> <tr><td>B</td><td>\$522</td></tr> <tr><td>COL/C</td><td>\$545</td></tr> <tr><td>D</td><td>\$575</td></tr> <tr><td>E</td><td>\$604</td></tr> <tr><td>F</td><td>\$635</td></tr> <tr><td>G</td><td>\$679</td></tr> <tr><td>H</td><td>\$726</td></tr> <tr><td>I</td><td>\$800</td></tr> <tr><td>J</td><td>\$887</td></tr> <tr><td>L1</td><td>\$687</td></tr> <tr><td>L2</td><td>\$734</td></tr> </tbody> </table>	COM	\$495	A	\$510	B	\$522	COL/C	\$545	D	\$575	E	\$604	F	\$635	G	\$679	H	\$726	I	\$800	J	\$887	L1	\$687	L2	\$734
Dimensions	D	W	H																																																		
Overall	23 ¼	19	30 ½-32																																																		
Seat	17 ½	17	17 ½-19 ¾																																																		
Upholstery		Shipping																																																			
COM Ydg	¾	Ctn Wt	35																																																		
COL Sq Ft	18	Cu Ft	11																																																		
COM	\$495																																																				
A	\$510																																																				
B	\$522																																																				
COL/C	\$545																																																				
D	\$575																																																				
E	\$604																																																				
F	\$635																																																				
G	\$679																																																				
H	\$726																																																				
I	\$800																																																				
J	\$887																																																				
L1	\$687																																																				
L2	\$734																																																				

Three-Position  	49A All Wood 49B Uph. Back · optional linking brackets - add \$26 list per chair · optional laser engraving back imprint, specify location and size - see page 7 for details. (A model only)	<table border="1"> <thead> <tr> <th>Dimensions</th> <th>D</th> <th>W</th> <th>H</th> </tr> </thead> <tbody> <tr> <td>Overall</td> <td>23 ¼</td> <td>19</td> <td>30 ½-32 ¾</td> </tr> <tr> <td>Seat</td> <td>17 ½</td> <td>17</td> <td>17 ¼-19 ¾</td> </tr> <tr> <th colspan="2">Upholstery</th> <th colspan="2">Shipping</th> </tr> <tr> <td>COM Ydg</td> <td>¾</td> <td>Ctn Wt</td> <td>32</td> </tr> <tr> <td>COL Sq Ft</td> <td>9</td> <td>Cu Ft</td> <td>11</td> </tr> </tbody> </table>	Dimensions	D	W	H	Overall	23 ¼	19	30 ½-32 ¾	Seat	17 ½	17	17 ¼-19 ¾	Upholstery		Shipping		COM Ydg	¾	Ctn Wt	32	COL Sq Ft	9	Cu Ft	11	<table border="1"> <tbody> <tr><td>All Wood</td><td>\$384</td></tr> <tr><td>COM</td><td>\$444</td></tr> <tr><td>A</td><td>\$457</td></tr> <tr><td>B</td><td>\$470</td></tr> <tr><td>COL/C</td><td>\$493</td></tr> <tr><td>D</td><td>\$522</td></tr> <tr><td>E</td><td>\$552</td></tr> <tr><td>F</td><td>\$582</td></tr> <tr><td>G</td><td>\$626</td></tr> <tr><td>H</td><td>\$674</td></tr> <tr><td>I</td><td>\$747</td></tr> <tr><td>J</td><td>\$835</td></tr> <tr><td>L1</td><td>\$636</td></tr> <tr><td>L2</td><td>\$682</td></tr> </tbody> </table>	All Wood	\$384	COM	\$444	A	\$457	B	\$470	COL/C	\$493	D	\$522	E	\$552	F	\$582	G	\$626	H	\$674	I	\$747	J	\$835	L1	\$636	L2	\$682
Dimensions	D	W	H																																																				
Overall	23 ¼	19	30 ½-32 ¾																																																				
Seat	17 ½	17	17 ¼-19 ¾																																																				
Upholstery		Shipping																																																					
COM Ydg	¾	Ctn Wt	32																																																				
COL Sq Ft	9	Cu Ft	11																																																				
All Wood	\$384																																																						
COM	\$444																																																						
A	\$457																																																						
B	\$470																																																						
COL/C	\$493																																																						
D	\$522																																																						
E	\$552																																																						
F	\$582																																																						
G	\$626																																																						
H	\$674																																																						
I	\$747																																																						
J	\$835																																																						
L1	\$636																																																						
L2	\$682																																																						

Description	Model	Specifications				List Price Per Grade	
		Dimensions	D	W	H	COM	
Three-Position  	49C Uph. Seat • optional linking brackets - add \$26 list per chair • optional laser engraving back imprint, specify location and size - see page 7 for details.	Overall	23 ¼	19	30 ½-32 ¾	COM	\$444
		Seat	17 ½	17	17 ¼-19 ¾	COL/C	\$493
		Upholstery		Shipping			
		COM Ydg	¾	Ctn Wt	32	D	\$522
		COL Sq Ft	9	Cu Ft	11	E	\$552
						F	\$582
						G	\$626
						H	\$674
						I	\$747
						J	\$835
						L1	\$636
						L2	\$682

Description	Model	Specifications				List Price Per Grade	
		Dimensions	D	W	H	COM	
Three-Position  	49D Uph. Seat/Back • optional linking brackets - add \$26 list per chair	Overall	23 ¼	19	30 ½-32 ¾	COM	\$495
		Seat	17 ½	17	17 ¼-19 ¾	COL/C	\$545
		Upholstery		Shipping			
		COM Ydg	¾	Ctn Wt	32	D	\$575
		COL Sq Ft	18	Cu Ft	11	E	\$604
						F	\$635
						G	\$679
						H	\$726
						I	\$800
						J	\$887
						L1	\$687
						L2	\$734

To Order, Specify:

- 1 Model Number
- 2 Wood Species - Oak (O)
- 3 Wood Finish/Color
- 4 Fabric Selection - vendor, pattern and color
- 5 Optional Linking Brackets - add \$26 list per chair/stool
- 6 Optional Laser Engraving Back Imprint - specify location and size; see page 7 for details
(A and C MODELS ONLY)

3 Wood Finish/Color Options:

BRW	Brownie	ECU	Ecru
CAN	Canyon	HEN	Henna
CIT	Citron	HNY	Honey
DES	Desert	NUT	Nut Brown

Color - Add \$31 list per item

BKD	Backdrop	GRV	Greek Villa
BFX	Black Fox	GLF	Gulf Stream
BWH	Bright White	HTB	Heartthrob
CGP	Cargo Pants	NET	Network Gray
CHT	Chatroom	NWH	Nonchalant White
DSY	Daisy	PAR	Paradise
DRG	Daring	QXP	Quixotic Plum
DYN	Dynamo	RBZ	Relic Bronze
ENG	Enigma	SND	Sandbank
FRR	French Roast	STM	Storm
GBY	Georgian Bay	TRC	Tricorn Black

Specifications

- Wood species - Oak.
- Two and three position reclining action allows movement.
- Chairs - three stretcher shelf for storage and added stability.
- Seat is upholstered with 1 ½" high density polyurethane foam and synthetic sheet webbing for added comfort.
- Back is upholstered front and back with 1" polyurethane foam.
- Mortise and tenon construction with corner blocks, glue and screws.

- 4 See a selection of graded in fabric manufacturers and patterns on pages 12-20. Contact Customer Service for additional fabric options.

Carriage Order Check List:



SEATING

Specify:

- 1. Model Number
- 2. Wood Species - Oak (O)
- 3. Wood Finish/Color
- 4. Fabric Selection - vendor, pattern and color
- 5. Optional Antique Brass Trim Nails - add \$90 list per chair/barstool
- 6. Optional Rubber Cushion Nylon Glides - no upcharge

Example:

401C | O | HEN | MOMENTUM | VOX | MYSTIC
 (model #) | (wood species) | (finish) | (fabric vendor) | (pattern name) | (pattern color)

1. Model Number

2. Wood Species - Oak (O)

3. Wood Finish/Color Options:

BRW Brownie	ECU Ecru
CAN Canyon	HEN Henna
CIT Citron	HNY Honey
DES Desert	NUT Nut Brown
Color - Add \$31 list per item	
BKD Backdrop	GRV Greek Villa
BFX Black Fox	GLF Gulf Stream
BWH Bright White	HTB Heartthrob
CGP Cargo Pants	NET Network Gray
CHT Chatroom	NWH Nonchalant White
DSY Daisy	PAR Paradise
DRG Daring	QXP Quixotic Plum
DYN Dynamo	RBZ Relic Bronze
ENG Enigma	SND Sandbank
FRR French Roast	STM Storm
GBY Georgian Bay	TRC Tricorn Black

4. Fabric Selection - Please supply the following:

- Fabric vendor
- Pattern name
- Pattern color

All COM orders must include the following:



- Vendor's name, pattern name and color
- Sample of the fabric attached to order
- Model numbers of items for fabric application
- Special application instructions (e.g., all stripes will be applied front to back unless specified otherwise)
- Customer and purchase order number

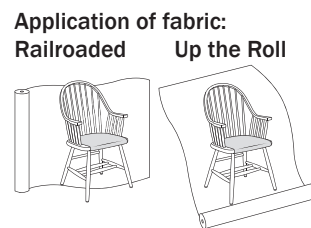

Ship prepaid COM material to:
 Community
 Attn: COM Dept
 932 Mill Street
 Jasper, IN 47546



All COM orders will ship at standard lead time from receipt of COM except for orders requiring special custom matched finishes.

5. Optional Antique Brass Trim Nails - add \$90 list per chair/barstool

Description	Model	Specifications				List Price Per Grade	
Arm  401A all wood	401A All Wood 401C Uph. Seat	Dimensions	D	W	H	All Wood	\$492
		Overall	22 ½	22 ½	37 ¼	COM	\$541
 401C uph. seat		Seat	16	18 ½	17 ¾	A	\$557
		Arm			25 ¾	B	\$573
		Upholstery	Shipping			COL/C	\$599
		COM Ydg	7/8	Ctn Wt	28	D	\$634
		COL Sq Ft	11	Cu Ft	14	E	\$667
						F	\$704
						G	\$755
						H	\$810
						I	\$895
						J	\$998
						L1	\$765
						L2	\$821

Description	Model	Specifications				List Price Per Grade	
Armless  403A all wood	403A All Wood 403C Uph. Seat	Dimensions	D	W	H	All Wood	\$398
		Overall	21 ½	19 ¾	38	COM	\$452
 403C uph. seat		Seat	15 ¾	18	17 ½	A	\$467
		Upholstery	Shipping			B	\$482
		COM Ydg	7/8	Ctn Wt	21	COL/C	\$509
		COL Sq Ft	11	Cu Ft	9	D	\$543
						E	\$577
						F	\$614
						G	\$664
						H	\$720
						I	\$805
						J	\$908
						L1	\$675
						L2	\$729

To Order, Specify:

- ① Model Number
- ② Wood Species - Oak (O)
- ③ Wood Finish/Color
- ④ Fabric Selection - vendor, pattern and color
- ⑤ Optional Antique Brass Trim Nails - add \$90 list per chair/barstool
- ⑥ Optional Rubber Cushion Nylon Glides - no upcharge

③ Wood Finish/Color Options:

- | | |
|-------------|---------------|
| BRW Brownie | ECU Ecu |
| CAN Canyon | HEN Henna |
| CIT Citron | HNY Honey |
| DES Desert | NUT Nut Brown |
- Color - Add \$31 list per item
- | | |
|------------------|----------------------|
| BKD Backdrop | GRV Greek Villa |
| BFX Black Fox | GLF Gulf Stream |
| BWH Bright White | HTB Heartthrob |
| CGP Cargo Pants | NET Network Gray |
| CHT Chatroom | NWH Nonchalant White |
| DSY Daisy | PAR Paradise |
| DRG Daring | QXP Quixotic Plum |
| DYN Dynamo | RBZ Relic Bronze |
| ENG Enigma | SND Sandbank |
| FRR French Roast | STM Storm |
| GBY Georgian Bay | TRC Tricorn Black |

Specifications

- Wood species - Oak.
- Steel ball bearing swivel plate standard on swivel models.
- Seat is upholstered with 1" high density polyurethane foam and features horseshoe style upholstery.
- Solid wood, round tenon construction with glue.
- Standard with rubber cushion metal glides.

- ④ See a selection of graded in fabric manufacturers and patterns on pages 12-20. Contact Customer Service for additional fabric options.

Description

1 Model

Specifications

List Price Per Grade

Swivel Barstool

408A All Wood
408C Uph. Seat
 · 360° swivel
 · optional self-centering swivel plate - no upcharge, please specify when ordering

Dimensions	D	W	H
Overall	20	20	52 ½
Seat	15 ¾	18 ¼	31
Upholstery		Shipping	
COM Ydg	7/8	Ctn Wt	42
COL Sq Ft	11	Cu Ft	16

All Wood	\$561
COM	\$608
A	\$625
B	\$641
COL/C	\$667
D	\$702
E	\$735
F	\$772
G	\$824
H	\$878
I	\$963
J	\$1,066
L1	\$833
L2	\$889



408A
all wood

408C
uph. seat

To Order, Specify:

- 1 Model Number
- 2 Wood Species - Oak (O)
- 3 Wood Finish/Color
- 4 Fabric Selection - vendor, pattern and color
- 5 Optional Antique Brass Trim Nails - add \$90 list per chair/barstool
- 6 Optional Rubber Cushion Nylon Glides - no upcharge

3 Wood Finish/Color Options:

BRW	Brownie	ECU	Ecu
CAN	Canyon	HEN	Henna
CIT	Citron	HNY	Honey
DES	Desert	NUT	Nut Brown
Color - Add \$31 list per item			
BKD	Backdrop	GRV	Greek Villa
BFX	Black Fox	GLF	Gulf Stream
BWH	Bright White	HTB	Heartthrob
CGP	Cargo Pants	NET	Network Gray
CHT	Chatroom	NWH	Nonchalant White
DSY	Daisy	PAR	Paradise
DRG	Daring	QXP	Quixotic Plum
DYN	Dynamo	RBZ	Relic Bronze
ENG	Enigma	SND	Sandbank
FRR	French Roast	STM	Storm
GBY	Georgian Bay	TRC	Tricorn Black

Specifications

- Wood species - Oak.
- Steel ball bearing swivel plate standard on swivel models.
- Seat is upholstered with 1" high density polyurethane foam and features horseshoe style upholstery.
- Solid wood, round tenon construction with glue.
- Standard with rubber cushion metal glides.

- 4 See a selection of graded in fabric manufacturers and patterns on pages 12-20. Contact Customer Service for additional fabric options.

Chancellor Order Check List:



SEATING

- Specify:**
- 1. Model Number
 - 2. Wood Species - Oak (0)
 - 3. Wood Finish/Color
 - 4. Fabric Selection - vendor, pattern and color
 - 5. Optional Linking Brackets - add \$26 list per chair
ARMLESS MODELS ONLY
 - 6. Optional Single Top Horizontal Back Slat - no upcharge
 - 7. Optional Rubber Cushion Nylon Glides - no upcharge

Example:

331C (model #)	0 (wood species)	HEN (finish)	MOMENTUM (fabric vendor)	VOX (pattern name)	MYSTIC (pattern color)
--------------------------	----------------------------	------------------------	------------------------------------	------------------------------	----------------------------------

1. Model Number

2. Wood Species - Oak (0)

3. Wood Finish/Color Options:

BRW Brownie	ECU Ecru
CAN Canyon	HEN Henna
CIT Citron	HNY Honey
DES Desert	NUT Nut Brown

Color - Add \$31 list per item

BKD Backdrop	GRV Greek Villa
BFX Black Fox	GLF Gulf Stream
BWH Bright White	HTB Heartthrob
CGP Cargo Pants	NET Network Gray
CHT Chatroom	NWH Nonchalant White
DSY Daisy	PAR Paradise
DRG Daring	QXP Quixotic Plum
DYN Dynamo	RBZ Relic Bronze
ENG Enigma	SND Sandbank
FRR French Roast	STM Storm
GBY Georgian Bay	TRC Tricorn Black

4. Fabric Selection - Please supply the following:

- Fabric vendor
- Pattern name
- Pattern color

All COM orders must include the following:

- Vendor's name, pattern name and color
- Sample of the fabric attached to order
- Model numbers of items for fabric application
- Special application instructions (e.g., all stripes will be applied front to back unless specified otherwise)
- Customer and purchase order number

Ship prepaid COM material to:
Community
Attn: COM Dept
932 Mill Street
Jasper, IN 47546

Application of fabric:
Railroaded Up the Roll

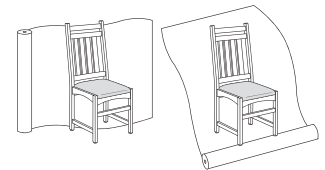

All COM orders will ship at standard lead time from receipt of COM except for orders requiring special custom matched finishes.

**5. Optional Linking Brackets - add \$26 list per chair
ARMLESS MODELS ONLY**



6. Optional Single Top Horizontal Back Slat Available.
Chair back height 40"; barstool back height 42 1/2". Specify as an option when ordering. No upcharge.

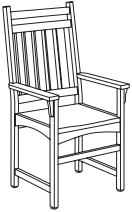
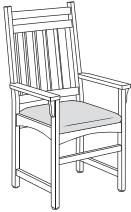

Description	Model	Specifications			List Price Per Grade		
Arm  331A all wood	331A All Wood 331C Uph. Seat · optional single top horizontal back slat available - back height 40". No upcharge. Specify when ordering.	Dimensions			All Wood \$659		
			D	W	H	COM \$651	
 331C uph. seat		Overall	23 ¾	24 ¼	44 ½	A \$668	
		Seat	18 ¾	18 ¼	18 ½	B \$681	
		Arm				26	COL/C \$704
		Upholstery		Shipping		D \$733	
		COM Ydg	¾	Ctn Wt	28	E \$763	
		COL Sq Ft	9	Cu Ft	19	F \$793	
						G \$837	
						H \$885	
						I \$958	
						J \$1,046	
						L1 \$847	
						L2 \$893	

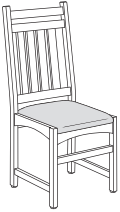
Description	Model	Specifications			List Price Per Grade	
Armless  333A all wood	333A All Wood 333C Uph. Seat · optional single top horizontal back slat available - back height 40". No upcharge. Specify when ordering. · optional linking brackets - add \$26 list per chair	Dimensions			All Wood \$620	
			D	W	H	COM \$614
 333C uph. seat		Overall	23 ¾	19	44 ½	A \$629
		Seat	18 ¾	16 ½	18 ½	B \$643
		Upholstery		Shipping		COL/C \$666
		COM Ydg	¾	Ctn Wt	27	D \$696
		COL Sq Ft	9	Cu Ft	15	E \$724
						F \$755
						G \$800
						H \$846
						I \$919
						J \$1,007
						L1 \$808
						L2 \$855

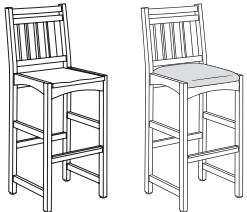
Description	Model	Specifications				List Price Per Grade	
		Dimensions	D	W	H	All Wood	COM
Barstool  338A all wood 338C uph. seat	338A All Wood 338C Uph. Seat • optional single top horizontal back slat available - back height 42 1/2". No upcharge. Specify when ordering. • standard with brass scuff plate, also available in polished aluminum or matte black	Overall	20 1/4	18	46	\$731	\$720
	Seat	17	15 1/2	30			
		Upholstery		Shipping			
		COM Ydg	3/4	Ctn Wt	34		
		COL Sq Ft	9	Cu Ft	13		
						COL/C \$773	
						D \$803	
						E \$832	
						F \$863	
						G \$907	
						H \$954	
						I \$1,027	
						J \$1,116	
						L1 \$916	
						L2 \$962	

SEATING

To Order, Specify:

- 1 Model Number
 - 2 Wood Species - Oak (0)
 - 3 Wood Finish/Color
 - 4 Fabric Selection - vendor, pattern and color
 - 5 Optional linking brackets —add \$26 list per chair.
- ARMLESS MODELS ONLY**
- 6 Optional Single Top Horizontal Back Slat - no upcharge
 - 7 Optional Rubber Cushion Nylon Glides - no upcharge

3 Wood Finish/Color Options:

BRW	Brownie	ECU	Ecru
CAN	Canyon	HEN	Henna
CIT	Citron	HNY	Honey
DES	Desert	NUT	Nut Brown

Color - Add \$31 list per item

BKD	Backdrop	GRV	Greek Villa
BFX	Black Fox	GLF	Gulf Stream
BWH	Bright White	HTB	Heartthrob
CGP	Cargo Pants	NET	Network Gray
CHT	Chatroom	NWH	Nonchalant White
DSY	Daisy	PAR	Paradise
DRG	Daring	QXP	Quixotic Plum
DYN	Dynamo	RBZ	Relic Bronze
ENG	Enigma	SND	Sandbank
FRR	French Roast	STM	Storm
GBY	Georgian Bay	TRC	Tricorn Black

Specifications

- Wood species - Oak.
- Seat is upholstered with 2" high density polyurethane foam and synthetic sheet webbing for added comfort.
- Mortise and tenon construction with corner blocks, glue and screws.
- Standard with rubber cushion metal glides.

- 4 See a selection of graded in fabric manufacturers and patterns on pages 12-20. Contact Customer Service for additional fabric options.

Chandler Order Check List:

SEATING



Specify:

- 1. Model Number
- 2. Wood Species - Beech (B)
- 3. Wood Finish/Color
- 4. Fabric Selection - vendor, pattern and color
- 5. Optional Rubber Cushion Nylon Glides - no upcharge

Example:

5001C | B | AUB | MOMENTUM | VOX | MYSTIC
 (model #) | (wood species) | (finish) | (fabric vendor) | (pattern name) | (pattern color)

1. Model Number

2. Wood Species - Beech (B)

3. Wood Finish/Color Options: ▲

ALE Ale	FLX Flax
AUB Auburn	HEN Henna
AUT Autumn	HNY Honey
BRL Barley	LGC Legacy
BBN Bourbon	MCH Mocha
BRG Brighton	NTO Night Owl
BRW Brownie	NUT Nut Brown
BUT Butterscotch	PRL Praline
CAN Canyon	SAF Saffron
CIN Cinnamon	SIE Sienna
CIT Citron	TOF Toffee
CLA Classic	TRF Truffle
CIT Citron	VEN Venetian
DES Desert	
EAR Earthy	
ESP Espresso	

Color - Add \$31 list per item

BKD Backdrop	GRV Greek Villa
BFX Black Fox	GLF Gulf Stream
BWH Bright White	HTB Heartthrob
CGP Cargo Pants	NET Network Gray
CHT Chatroom	NWH Nonchalant White
DSY Daisy	PAR Paradise
DRG Daring	QXP Quixotic Plum
DYN Dynamo	RBZ Relic Bronze
ENG Enigma	SND Sandbank
FRR French Roast	STM Storm
GBY Georgian Bay	TRC Tricorn Black

4. Fabric Selection - Please supply the following:

- Fabric vendor
- Pattern name
- Pattern color

When specifying contrasting upholstery, indicate clearly which upholstery is to be applied to the seat and back. Use higher grade pricing.

- Indicate direction of fabric - Railroaded or Up the Roll
- Please provide illustration, if available

All COM orders must include the following:

- Vendor's name, pattern name and color
- Sample of the fabric attached to order
- Model numbers of items for fabric application
- Special application instructions (e.g., all stripes will be applied front to back unless specified otherwise)
- Customer and purchase order number

Ship prepaid COM material to:
 Community
 Attn: COM Dept
 932 Mill Street
 Jasper, IN 47546

Application of fabric:
 Railroaded Up the Roll

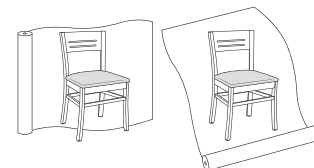

All COM orders will ship at standard lead time from receipt of COM except for orders requiring special custom matched finishes.

Description	Model	Specifications			List Price Per Grade	
Arm 	5001C Uph. Seat · optional casters - add \$90 list for a set of 4 casters	Dimensions	D	W	H	COM \$667
		Overall	20½	24½	33	A \$684
		Seat	17	20½	20	B \$698
		Arm			26½	COL/C \$720
		Upholstery	Shipping			D \$749
		COM Ydg	¾	Ctn Wt	28	E \$779
		COL Sq Ft	9	Cu Ft	12	F \$810
						G \$854
						H \$900
						I \$974
				J \$1,062		
				L1 \$863		
				L2 \$910		

Description	Model	Specifications			List Price Per Grade	
Arm 	5001D Uph. Seat/Lower Back · optional casters - add \$90 list for a set of 4 casters	Dimensions	D	W	H	COM \$771
		Overall	20½	24½	33	A \$792
		Seat	17	20½	20	B \$809
		Arm			26½	COL/C \$839
		Upholstery	Shipping			D \$879
		COM Ydg	1	Ctn Wt	28	E \$918
		COL Sq Ft	24	Cu Ft	12	F \$959
						G \$1,018
						H \$1,080
						I \$1,179
				J \$1,295		
				L1 \$1,029		
				L2 \$1,092		

To Order, Specify:

- ① Model Number
- ② Wood Species - Beech (B)
- ③ Wood Finish/Color
- ④ Fabric Selection - vendor, pattern and color
- ⑤ Optional Rubber Cushion Nylon Glides - no upcharge

③ Wood Finish/Color Options:[▲]

ALE Ale	FLX Flax
AUB Auburn	HEN Henna
AUT Autumn	HNY Honey
BRL Barley	LGC Legacy
BBN Bourbon	MCH Mocha
BRG Brighton	NTO Night Owl
BRW Brownie	NUT Nut Brown
BUT Butterscotch	PRL Praline
CAN Canyon	SAF Saffron
CIN Cinnamon	SIE Sienna
CIT Citron	TOF Toffee
CLA Classic	TRF Truffle
DES Desert	VEN Venetian
EAR Earthy	
ESP Espresso	





Color - Add \$31 list per item

BKD Backdrop	GRV Greek Villa
BFX Black Fox	GLF Gulf Stream
BWH Bright White	HTB Heartthrob
CGP Cargo Pants	NET Network Gray
CHT Chatroom	NWH Nonchalant White
DSY Daisy	PAR Paradise
DRG Daring	QXP Quixotic Plum
DYN Dynamo	RBZ Relic Bronze
ENG Enigma	SND Sandbank
FRR French Roast	STM Storm
GBY Georgian Bay	TRC Tricorn Black



Specifications

- Wood species - Beech.
- Seat and backs are upholstered with 1 ½" polyurethane foam and synthetic sheet webbing for added comfort.
- Mortise and tenon construction with corner blocks, glue and screws.
- Standard with rubber cushion metal glides.

④ See a selection of graded in fabric manufacturers and patterns on pages 12-20. Contact Customer Service for additional fabric options.

Description	Model	Specifications	List Price Per Grade																
Arm 	5001F Uph. Seat/Upper Back · optional casters - add \$90 list for a set of 4 casters	<table border="1"> <thead> <tr> <th>Dimensions</th> <th>D</th> <th>W</th> <th>H</th> </tr> </thead> <tbody> <tr> <td>Overall</td> <td>20 ½</td> <td>24 ½</td> <td>33</td> </tr> <tr> <td>Seat</td> <td>17</td> <td>20 ½</td> <td>20</td> </tr> <tr> <td>Arm</td> <td></td> <td></td> <td>26 ½</td> </tr> </tbody> </table>	Dimensions	D	W	H	Overall	20 ½	24 ½	33	Seat	17	20 ½	20	Arm			26 ½	COM \$771 A \$792 B \$809 COL/C \$839 D \$879 E \$918 F \$959 G \$1,018 H \$1,080 I \$1,179 J \$1,295 L1 \$1,029 L2 \$1,092
		Dimensions	D	W	H														
		Overall	20 ½	24 ½	33														
		Seat	17	20 ½	20														
		Arm			26 ½														
		<table border="1"> <thead> <tr> <th>Upholstery</th> <th>Shipping</th> </tr> </thead> <tbody> <tr> <td>COM Ydg 1</td> <td>Ctn Wt 28</td> </tr> <tr> <td>COL Sq Ft 24</td> <td>Cu Ft 12</td> </tr> </tbody> </table>	Upholstery	Shipping	COM Ydg 1	Ctn Wt 28	COL Sq Ft 24	Cu Ft 12											
		Upholstery	Shipping																
		COM Ydg 1	Ctn Wt 28																
		COL Sq Ft 24	Cu Ft 12																
		Armless 	5003A All Wood optional casters - add \$90 list for a set of 4 casters	<table border="1"> <thead> <tr> <th>Dimensions</th> <th>D</th> <th>W</th> <th>H</th> </tr> </thead> <tbody> <tr> <td>Overall</td> <td>20 ½</td> <td>19 ¾</td> <td>33</td> </tr> <tr> <td>Seat</td> <td>17 ¾</td> <td>19 ¾</td> <td>20</td> </tr> </tbody> </table>	Dimensions	D	W	H	Overall	20 ½	19 ¾	33	Seat	17 ¾	19 ¾	20	All Wood \$371 COM \$466 A \$481 B \$499 COL/C \$530 D \$569 E \$607 F \$649 G \$708 H \$770 I \$868 J \$985 L1 \$720 L2 \$782		
Dimensions	D			W	H														
Overall	20 ½			19 ¾	33														
Seat	17 ¾			19 ¾	20														
<table border="1"> <thead> <tr> <th>Upholstery</th> <th>Shipping</th> </tr> </thead> <tbody> <tr> <td>COM Ydg 1</td> <td>Ctn Wt 20</td> </tr> <tr> <td>COL Sq Ft 24</td> <td>Cu Ft 9</td> </tr> </tbody> </table>	Upholstery			Shipping	COM Ydg 1	Ctn Wt 20	COL Sq Ft 24	Cu Ft 9											
Upholstery	Shipping																		
COM Ydg 1	Ctn Wt 20																		
COL Sq Ft 24	Cu Ft 9																		
	5003B Uph. Upper Back optional casters - add \$90 list for a set of 4 casters			<table border="1"> <thead> <tr> <th>Dimensions</th> <th>D</th> <th>W</th> <th>H</th> </tr> </thead> <tbody> <tr> <td>Overall</td> <td>20 ½</td> <td>19 ¾</td> <td>33</td> </tr> <tr> <td>Seat</td> <td>17 ¾</td> <td>19 ¾</td> <td>20</td> </tr> </tbody> </table>	Dimensions	D	W	H	Overall	20 ½	19 ¾	33	Seat	17 ¾	19 ¾	20		All Wood \$371 COM \$466 A \$481 B \$499 COL/C \$530 D \$569 E \$607 F \$649 G \$708 H \$770 I \$868 J \$985 L1 \$720 L2 \$782	
				Dimensions	D	W	H												
		Overall	20 ½	19 ¾	33														
		Seat	17 ¾	19 ¾	20														
		<table border="1"> <thead> <tr> <th>Upholstery</th> <th>Shipping</th> </tr> </thead> <tbody> <tr> <td>COM Ydg 1</td> <td>Ctn Wt 20</td> </tr> <tr> <td>COL Sq Ft 24</td> <td>Cu Ft 9</td> </tr> </tbody> </table>	Upholstery	Shipping	COM Ydg 1	Ctn Wt 20	COL Sq Ft 24	Cu Ft 9											
		Upholstery	Shipping																
		COM Ydg 1	Ctn Wt 20																
		COL Sq Ft 24	Cu Ft 9																
		Armless 	5003C Uph. Seat · optional casters - add \$90 list for a set of 4 casters	<table border="1"> <thead> <tr> <th>Dimensions</th> <th>D</th> <th>W</th> <th>H</th> </tr> </thead> <tbody> <tr> <td>Overall</td> <td>20 ½</td> <td>19 ¾</td> <td>33</td> </tr> <tr> <td>Seat</td> <td>17 ¾</td> <td>19 ¾</td> <td>20</td> </tr> </tbody> </table>	Dimensions	D	W	H	Overall	20 ½	19 ¾	33	Seat	17 ¾	19 ¾	20	COM \$408 A \$422 B \$434 COL/C \$457 D \$487 E \$515 F \$546 G \$591 H \$638 I \$710 J \$798 L1 \$599 L2 \$646		
				Dimensions	D	W	H												
Overall	20 ½			19 ¾	33														
Seat	17 ¾			19 ¾	20														
<table border="1"> <thead> <tr> <th>Upholstery</th> <th>Shipping</th> </tr> </thead> <tbody> <tr> <td>COM Ydg ¾</td> <td>Ctn Wt 20</td> </tr> <tr> <td>COL Sq Ft 9</td> <td>Cu Ft 9</td> </tr> </tbody> </table>	Upholstery			Shipping	COM Ydg ¾	Ctn Wt 20	COL Sq Ft 9	Cu Ft 9											
Upholstery	Shipping																		
COM Ydg ¾	Ctn Wt 20																		
COL Sq Ft 9	Cu Ft 9																		
Armless 	5003D Uph. Seat/Lower Back · optional casters - add \$90 list for a set of 4 casters			<table border="1"> <thead> <tr> <th>Dimensions</th> <th>D</th> <th>W</th> <th>H</th> </tr> </thead> <tbody> <tr> <td>Overall</td> <td>20 ½</td> <td>19 ¾</td> <td>33</td> </tr> <tr> <td>Seat</td> <td>17 ¾</td> <td>19 ¾</td> <td>20</td> </tr> </tbody> </table>	Dimensions	D	W	H	Overall	20 ½	19 ¾	33	Seat	17 ¾	19 ¾	20		COM \$515 A \$532 B \$550 COL/C \$580 D \$619 E \$658 F \$699 G \$758 H \$821 I \$918 J \$1,036 L1 \$769 L2 \$832	
				Dimensions	D	W	H												
		Overall	20 ½	19 ¾	33														
		Seat	17 ¾	19 ¾	20														
		<table border="1"> <thead> <tr> <th>Upholstery</th> <th>Shipping</th> </tr> </thead> <tbody> <tr> <td>COM Ydg 1</td> <td>Ctn Wt 20</td> </tr> <tr> <td>COL Sq Ft 24</td> <td>Cu Ft 9</td> </tr> </tbody> </table>	Upholstery	Shipping	COM Ydg 1	Ctn Wt 20	COL Sq Ft 24	Cu Ft 9											
		Upholstery	Shipping																
		COM Ydg 1	Ctn Wt 20																
		COL Sq Ft 24	Cu Ft 9																

Description	Model	Specifications			List Price Per Grade			
Armless 	5003F Uph. Seat/Upper Back · optional casters - add \$90 list for a set of 4 casters	Dimensions			COM	\$515		
			D	W		H	A	\$532
		Overall	20 ½	19 ¾		33	B	\$550
						COL/C	\$580	
		Seat	17 ¾	19 ¾	20		D	\$619
							E	\$658
		Upholstery		Shipping		F	\$699	
		COM Ydg	1	Ctn Wt	20	G	\$758	
		COL Sq Ft	24	Cu Ft	9	H	\$821	
						I	\$918	
						J	\$1,036	
						L1	\$769	
						L2	\$832	

Description	Model	Specifications			List Price Per Grade			
Barstool  	5008A All Wood 5008B Uph. Upper Back · casters not available · standard with brass scuff plate, also available in polished aluminum or matte black	Dimensions			All Wood	\$428		
			D	W		H	COM	\$521
		Overall	19	18		42	A	\$538
						COL/C	\$586	
		Seat	16 ½	18	30		D	\$625
							E	\$664
		Upholstery		Shipping		F	\$705	
		COM Ydg	1	Ctn Wt	33	G	\$764	
		COL Sq Ft	24	Cu Ft	14	H	\$827	
						I	\$924	
						J	\$1,042	
						L1	\$775	
						L2	\$838	

To Order, Specify:

- 1 Model Number
- 2 Wood Species - Beech (B)
- 3 Wood Finish/Color
- 4 Fabric Selection - vendor, pattern and color
- 5 Optional Rubber Cushion Nylon Glides - no upcharge

3 Wood Finish/Color Options:[▲]

ALE	Ale	FLX	Flax
AUB	Auburn	HEN	Henna
AUT	Autumn	HNY	Honey
BRL	Barley	LGC	Legacy
BBN	Bourbon	MCH	Mocha
BRG	Brighton	NTO	Night Owl
BRW	Brownie	NUT	Nut Brown
BUT	Butterscotch	PRL	Praline
CAN	Canyon	SAF	Saffron
CIN	Cinnamon	SIE	Sienna
CIT	Citron	TOF	Toffee
CLA	Classic	TRF	Truffle
DES	Desert	VEN	Venetian
EAR	Earthy		
ESP	Espresso		

Color - Add \$31 list per item

BKD	Backdrop	GRV	Greek Villa
BFX	Black Fox	GLF	Gulf Stream
BWH	Bright White	HTB	Heartthrob
CGP	Cargo Pants	NET	Network Gray
CHT	Chatroom	NWH	Nonchalant White
DSY	Daisy	PAR	Paradise
DRG	Daring	QXP	Quixotic Plum
DYN	Dynamo	RBZ	Relic Bronze
ENG	Enigma	SND	Sandbank
FRR	French Roast	STM	Storm
GBY	Georgian Bay	TRC	Tricorn Black

- 4 See a selection of graded in fabric manufacturers and patterns on pages 12-20. Contact Customer Service for additional fabric options.

Specifications

- Wood species - Beech.
- Seat and backs are upholstered with 1 ½" polyurethane foam and synthetic sheet webbing for added comfort.
- Mortise and tenon construction with corner blocks, glue and screws.
- Standard with rubber cushion metal glides.

Description	① Model	Specifications				List Price Per Grade	
Barstool 	5008C Uph. Seat · casters not available · standard with brass scuff plate, also available in polished aluminum or matte black	Dimensions		D	W	H	COM \$465
		Overall		19	18	42	A \$478
		Seat		16 ½	18	30	B \$492
		Upholstery		Shipping			COL/C \$514
		COM Ydg		¾	Ctn Wt	33	D \$543
		COL Sq Ft		9	Cu Ft	14	E \$573
					F \$604		
					G \$648		
					H \$695		
					I \$768		
					J \$856		
					L1 \$657		
					L2 \$704		

Barstool 	5008D Uph. Seat/Lower Back · casters not available · standard with brass scuff plate, also available in polished aluminum or matte black	Dimensions		D	W	H	COM \$571
		Overall		19	18	42	A \$588
		Seat		16 ½	18	30	B \$605
		Upholstery		Shipping			COL/C \$636
		COM Ydg		1	Ctn Wt	33	D \$676
		COL Sq Ft		24	Cu Ft	14	E \$714
					F \$755		
					G \$814		
					H \$877		
					I \$975		
					J \$1,091		
					L1 \$826		
					L2 \$889		

Description	Model	Specifications				List Price Per Grade	
		Dimensions	D	W	H	COM	
Barstool 	5008F Uph. Seat/Upper Back · casters not available · standard with brass scuff plate, also available in polished aluminum or matte black	Overall	19	18	42	COM	\$571
		Seat	16½	18	30	A	\$588
		Upholstery		Shipping		B	\$605
		COM Ydg	1	Ctn Wt	33	COL/C	\$636
		COL Sq Ft	24	Cu Ft	14	D	\$676
						E	\$714
						F	\$755
						G	\$814
						H	\$877
						I	\$975
						J	\$1,091
						L1	\$826
						L2	\$889

SEATING

To Order, Specify:

- 1 Model Number
- 2 Wood Species - Beech (B)
- 3 Wood Finish/Color
- 4 Fabric Selection - vendor, pattern and color
- 5 Optional Rubber Cushion Nylon Glides - no upcharge

3 Wood Finish/Color Options:[▲]

ALE Ale	FLX Flax
AUB Auburn	HEN Henna
AUT Autumn	HNY Honey
BRL Barley	LGC Legacy
BBN Bourbon	MCH Mocha
BRG Brighton	NTO Night Owl
BRW Brownie	NUT Nut Brown
BUT Butterscotch	PRL Praline
CAN Canyon	SAF Saffron
CIN Cinnamon	SIE Sienna
CIT Citron	TOF Toffee
CLA Classic	TRF Truffle
DES Desert	VEN Venetian
EAR Earthy	
ESP Espresso	

Color - Add \$31 list per item

BKD Backdrop	GRV Greek Villa
BFX Black Fox	GLF Gulf Stream
BWH Bright White	HTB Heartthrob
CGP Cargo Pants	NET Network Gray
CHT Chatroom	NWH Nonchalant White
DSY Daisy	PAR Paradise
DRG Daring	QXP Quixotic Plum
DYN Dynamo	RBZ Relic Bronze
ENG Enigma	SND Sandbank
FRR French Roast	STM Storm
GBY Georgian Bay	TRC Tricorn Black

Specifications

- Wood species - Beech.
- Seat and backs are upholstered with 1 ½" polyurethane foam and synthetic sheet webbing for added comfort.
- Mortise and tenon construction with corner blocks, glue and screws.
- Standard with rubber cushion metal glides.

4 See a selection of graded in fabric manufacturers and patterns on pages 12-20. Contact Customer Service for additional fabric options.

Class Act Order Check List:



Coordinating Children's collection. See page 332.

Specify:

- 1. Model Number
- 2. Wood Species - Oak (O) or Maple (M)
- 3. Wood Finish/Color
- 4. Fabric Selection - vendor, pattern and color
- 5. Optional Linking Brackets - add \$26 list per chair/bench
- 6. Optional Laser Engraving Back Imprint - specify location and size
- 7. Optional Rubber Cushion Nylon Glides - no upcharge; LEG MODELS ONLY

Example:

11C (model #)	O (wood species)	HEN (finish)	MOMENTUM (fabric vendor)	VOX (pattern name)	MYSTIC (pattern color)
-------------------------	----------------------------	------------------------	------------------------------------	------------------------------	----------------------------------

1. Model Number

2. Wood Species - Oak (O) or Maple (M)

3. Wood Base/Arm Cap Finish Options:

Oak

BRW Brownie	ECU Ecru
CAN Canyon	HEN Henna
CIT Citron	HNY Honey
DES Desert	NUT Nut Brown

Maple

ALE Ale	FLX Flax
AUB Auburn	LGC Legacy
AUT Autumn	MCH Mocha
BRL Barley	NTO Night Owl
BBN Bourbon	PRL Praline
BRG Brighton	SAF Saffron
BUT Butterscotch	SIE Sienna
CIN Cinnamon	TOF Toffee
CLA Classic	TRF Truffle
EAR Earthy	VEN Venetian
ESP Espresso	

Color - Add \$31 list per item

BKD Backdrop	GRV Greek Villa
BFX Black Fox	GLF Gulf Stream
BWH Bright White	HTB Heartthrob
CGP Cargo Pants	NET Network Gray
CHT Chatroom	NWH Nonchalant White
DSY Daisy	PAR Paradise
DRG Daring	QXP Quixotic Plum
DYN Dynamo	RBZ Relic Bronze
ENG Enigma	SND Sandbank
FRR French Roast	STM Storm
GBY Georgian Bay	TRC Tricorn Black

4. Fabric Selection - Please supply the following:

- Fabric vendor
- Pattern name
- Pattern color

When specifying contrasting upholstery, indicate clearly which upholstery is to be applied to the seat and back. Use higher grade pricing.

- Indicate direction of fabric - Railroaded or Up the Roll
- Please provide illustration, if available

All COM orders must include the following:

- Vendor's name, pattern name and color
- Sample of the fabric attached to order
- Model numbers of items for fabric application
- Special application instructions (e.g., all stripes will be applied front to back unless specified otherwise)
- Customer and purchase order number

Ship prepaid COM material to:
Community
Attn: COM Dept
932 Mill Street
Jasper, IN 47546

Application of fabric:
Railroaded Up the Roll

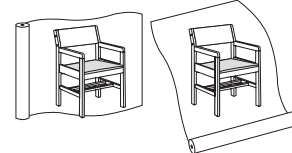

All COM orders will ship at standard lead time from receipt of COM except for orders requiring special custom matched finishes.

5. Optional Linking Brackets - add \$26 list per chair/bench







6. Optional Laser Engraving Back Imprint - available on models 11A/C, 12A/C, 18A/C and 19A/C. See page 7 for details.

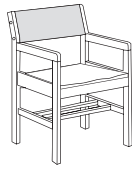

Specify:

- location - inside/outside of back
- size of design

Description	Model	Specifications			List Price Per Grade																						
		Dimensions	D	W	H	All Wood	COM																				
Arm    11A all wood 11B uph. back	11A All Wood 11B Uph. Back • optional linking brackets - add \$26 list per chair • optional laser engraving back imprint, specify location and size - see page 7 for details. (A model only) • coordinating Children's collection - see page 332 • optional casters - add \$90 list for a set of 4 casters	<table border="1"> <tr> <td>Overall</td> <td>22</td> <td>21</td> <td>32 1/4</td> </tr> <tr> <td>Seat</td> <td>18</td> <td>19</td> <td>18</td> </tr> <tr> <td>Arm</td> <td colspan="3">25 1/4</td> </tr> <tr> <th colspan="2">Upholstery</th> <th colspan="2">Shipping</th> </tr> <tr> <td>COM Ydg</td> <td>3/4</td> <td>Ctn Wt</td> <td>30</td> </tr> <tr> <td>COL Sq Ft</td> <td>9</td> <td>Cu Ft</td> <td>10</td> </tr> </table>	Overall	22	21	32 1/4	Seat	18	19	18	Arm	25 1/4			Upholstery		Shipping		COM Ydg	3/4	Ctn Wt	30	COL Sq Ft	9	Cu Ft	10	All Wood \$331 COM \$381 A \$393 B \$407 COL/C \$429 D \$458 E \$488 F \$519 G \$562 H \$609 I \$683 J \$771 L1 \$572 L2 \$618
	Overall	22	21	32 1/4																							
Seat	18	19	18																								
Arm	25 1/4																										
Upholstery		Shipping																									
COM Ydg	3/4	Ctn Wt	30																								
COL Sq Ft	9	Cu Ft	10																								

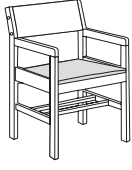
Description	Model	Specifications			List Price Per Grade																						
		Dimensions	D	W	H	COM	COL/C																				
Arm  	11C Uph. Seat • optional linking brackets - add \$26 list per chair • optional laser engraving back imprint, specify location and size - see page 7 for details. • coordinating Children's collection - see page 332 • optional casters - add \$90 list for a set of 4 casters	<table border="1"> <tr> <td>Overall</td> <td>22</td> <td>21</td> <td>32 1/4</td> </tr> <tr> <td>Seat</td> <td>18</td> <td>19</td> <td>18</td> </tr> <tr> <td>Arm</td> <td colspan="3">25 1/4</td> </tr> <tr> <th colspan="2">Upholstery</th> <th colspan="2">Shipping</th> </tr> <tr> <td>COM Ydg</td> <td>3/4</td> <td>Ctn Wt</td> <td>30</td> </tr> <tr> <td>COL Sq Ft</td> <td>9</td> <td>Cu Ft</td> <td>10</td> </tr> </table>	Overall	22	21	32 1/4	Seat	18	19	18	Arm	25 1/4			Upholstery		Shipping		COM Ydg	3/4	Ctn Wt	30	COL Sq Ft	9	Cu Ft	10	COM \$381 A \$393 B \$407 COL/C \$429 D \$458 E \$488 F \$519 G \$562 H \$609 I \$683 J \$771 L1 \$572 L2 \$618
Overall	22	21	32 1/4																								
Seat	18	19	18																								
Arm	25 1/4																										
Upholstery		Shipping																									
COM Ydg	3/4	Ctn Wt	30																								
COL Sq Ft	9	Cu Ft	10																								

To Order, Specify:

- 1 Model Number
- 2 Wood Species - Oak (O) or Maple (M)
- 3 Wood Finish/Color
- 4 Fabric Selection - vendor, pattern and color
- 5 Optional Linking Brackets - add \$26 list per chair
- 6 Optional Laser Engraving Back Imprint - specify location and size; see page 7 for details.
(A and C MODELS ONLY)
- 7 Optional Rubber Cushion Nylon Glides - no upcharge
LEG MODELS ONLY

3 Wood Finish/Color Options:

- | | | |
|------------------|--------------|---------------|
| Oak | BRW Brownie | ECU E cru |
| CAN Canyon | CIT Citron | HEN Henna |
| DES Desert | Maple | HNY Honey |
| ALE Ale | AUB Auburn | NUT Nut Brown |
| AUT Autumn | BRL Barley | FLX Flax |
| BBN Bourbon | BRG Brighton | LGC Legacy |
| BUT Butterscotch | CIN Cinnamon | MCH Mocha |
| CLA Classic | EAR Earthy | NTO Night Owl |
| ESP Espresso | | PRL Praline |
| | | SAF Saffron |
| | | SIE Sienna |
| | | TOF Toffee |
| | | TRF Truffle |
| | | VEN Venetian |

Specifications

- Wood species - Oak or Maple.
- Two stretcher shelf for added stability.
- Seat is upholstered with 1 1/2" polyurethane foam and synthetic sheet webbing for added comfort.
- Back is upholstered front and back with 1" polyurethane foam.
- Mortise and tenon construction with corner blocks, glue and screws.
- Coordinating Children's collection. See page 332.
- Standard with rubber cushion metal glides (leg models only).

Color - Add \$31 list per item

- | | |
|------------------|----------------------|
| BKD Backdrop | GRV Greek Villa |
| BFX Black Fox | GLF Gulf Stream |
| BWH Bright White | HTB Heartthrob |
| CGP Cargo Pants | NET Network Gray |
| CHT Chatroom | NWH Nonchalant White |
| DSY Daisy | PAR Paradise |
| DRG Daring | QXP Quixotic Plum |
| DYN Dynamo | RBZ Relic Bronze |
| ENG Enigma | SND Sandbank |
| FRR French Roast | STM Storm |
| GBY Georgian Bay | TRC Tricorn Black |

- 4 See a selection of graded in fabric manufacturers and patterns on pages 12-20. Contact Customer Service for additional fabric options.

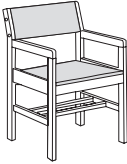
Description	① Model	Specifications	List Price Per Grade																												
Arm  	11D Uph. Seat/Back · optional linking brackets - add \$26 list per chair · coordinating Children's collection - see page 332 · optional casters - add \$90 list for a set of 4 casters	<table border="1"> <thead> <tr> <th>Dimensions</th> <th>D</th> <th>W</th> <th>H</th> </tr> </thead> <tbody> <tr> <td>Overall</td> <td>22</td> <td>21</td> <td>32 ¼</td> </tr> <tr> <td>Seat</td> <td>18</td> <td>19</td> <td>18</td> </tr> <tr> <td>Arm</td> <td></td> <td></td> <td>25 ¼</td> </tr> <tr> <th colspan="2">Upholstery</th> <th colspan="2">Shipping</th> </tr> <tr> <td>COM Ydg</td> <td>¾</td> <td>Ctn Wt</td> <td>30</td> </tr> <tr> <td>COL Sq Ft</td> <td>18</td> <td>Cu Ft</td> <td>10</td> </tr> </tbody> </table>	Dimensions	D	W	H	Overall	22	21	32 ¼	Seat	18	19	18	Arm			25 ¼	Upholstery		Shipping		COM Ydg	¾	Ctn Wt	30	COL Sq Ft	18	Cu Ft	10	COM \$422 A \$435 B \$448 COL/C \$471 D \$500 E \$530 F \$560 G \$604 H \$651 I \$725 J \$812 L1 \$613 L2 \$660
Dimensions	D	W	H																												
Overall	22	21	32 ¼																												
Seat	18	19	18																												
Arm			25 ¼																												
Upholstery		Shipping																													
COM Ydg	¾	Ctn Wt	30																												
COL Sq Ft	18	Cu Ft	10																												

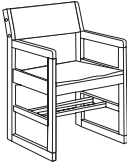
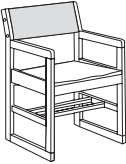
Arm   	12A All Wood 12B Uph. Back · optional linking brackets - add \$26 list per chair · optional laser engraving back imprint, specify location and size - see page 7 for details. (A model only) · coordinating Children's collection - see page 332	<table border="1"> <thead> <tr> <th>Dimensions</th> <th>D</th> <th>W</th> <th>H</th> </tr> </thead> <tbody> <tr> <td>Overall</td> <td>20 ¾</td> <td>21</td> <td>32 ¼</td> </tr> <tr> <td>Seat</td> <td>18</td> <td>19</td> <td>18</td> </tr> <tr> <td>Arm</td> <td></td> <td></td> <td>25</td> </tr> <tr> <th colspan="2">Upholstery</th> <th colspan="2">Shipping</th> </tr> <tr> <td>COM Ydg</td> <td>¾</td> <td>Ctn Wt</td> <td>32</td> </tr> <tr> <td>COL Sq Ft</td> <td>9</td> <td>Cu Ft</td> <td>10</td> </tr> </tbody> </table>	Dimensions	D	W	H	Overall	20 ¾	21	32 ¼	Seat	18	19	18	Arm			25	Upholstery		Shipping		COM Ydg	¾	Ctn Wt	32	COL Sq Ft	9	Cu Ft	10	All Wood \$339 COM \$388 A \$401 B \$414 COL/C \$436 D \$466 E \$495 F \$527 G \$571 H \$617 I \$690 J \$779 L1 \$579 L2 \$626
Dimensions	D	W	H																												
Overall	20 ¾	21	32 ¼																												
Seat	18	19	18																												
Arm			25																												
Upholstery		Shipping																													
COM Ydg	¾	Ctn Wt	32																												
COL Sq Ft	9	Cu Ft	10																												

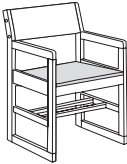
Arm  	12C Uph. Seat · optional linking brackets - add \$26 list per chair · optional laser engraving back imprint, specify location and size - see page 7 for details. · coordinating Children's collection - see page 332	<table border="1"> <thead> <tr> <th>Dimensions</th> <th>D</th> <th>W</th> <th>H</th> </tr> </thead> <tbody> <tr> <td>Overall</td> <td>20 ¾</td> <td>21</td> <td>32 ¼</td> </tr> <tr> <td>Seat</td> <td>18</td> <td>19</td> <td>18</td> </tr> <tr> <td>Arm</td> <td></td> <td></td> <td>25</td> </tr> <tr> <th colspan="2">Upholstery</th> <th colspan="2">Shipping</th> </tr> <tr> <td>COM Ydg</td> <td>¾</td> <td>Ctn Wt</td> <td>32</td> </tr> <tr> <td>COL Sq Ft</td> <td>9</td> <td>Cu Ft</td> <td>10</td> </tr> </tbody> </table>	Dimensions	D	W	H	Overall	20 ¾	21	32 ¼	Seat	18	19	18	Arm			25	Upholstery		Shipping		COM Ydg	¾	Ctn Wt	32	COL Sq Ft	9	Cu Ft	10	COM \$388 A \$401 B \$414 COL/C \$436 D \$466 E \$495 F \$527 G \$571 H \$617 I \$690 J \$779 L1 \$579 L2 \$626
Dimensions	D	W	H																												
Overall	20 ¾	21	32 ¼																												
Seat	18	19	18																												
Arm			25																												
Upholstery		Shipping																													
COM Ydg	¾	Ctn Wt	32																												
COL Sq Ft	9	Cu Ft	10																												

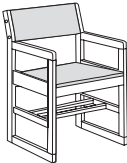
Arm  	12D Uph. Seat/Back · optional linking brackets - add \$26 list per chair · coordinating Children's collection - see page 332	<table border="1"> <thead> <tr> <th>Dimensions</th> <th>D</th> <th>W</th> <th>H</th> </tr> </thead> <tbody> <tr> <td>Overall</td> <td>20 ¾</td> <td>21</td> <td>32 ¼</td> </tr> <tr> <td>Seat</td> <td>18</td> <td>19</td> <td>18</td> </tr> <tr> <td>Arm</td> <td></td> <td></td> <td>25</td> </tr> <tr> <th colspan="2">Upholstery</th> <th colspan="2">Shipping</th> </tr> <tr> <td>COM Ydg</td> <td>¾</td> <td>Ctn Wt</td> <td>32</td> </tr> <tr> <td>COL Sq Ft</td> <td>18</td> <td>Cu Ft</td> <td>10</td> </tr> </tbody> </table>	Dimensions	D	W	H	Overall	20 ¾	21	32 ¼	Seat	18	19	18	Arm			25	Upholstery		Shipping		COM Ydg	¾	Ctn Wt	32	COL Sq Ft	18	Cu Ft	10	COM \$430 A \$444 B \$456 COL/C \$479 D \$509 E \$538 F \$569 G \$613 H \$660 I \$733 J \$821 L1 \$622 L2 \$668
Dimensions	D	W	H																												
Overall	20 ¾	21	32 ¼																												
Seat	18	19	18																												
Arm			25																												
Upholstery		Shipping																													
COM Ydg	¾	Ctn Wt	32																												
COL Sq Ft	18	Cu Ft	10																												

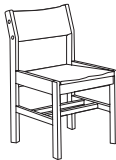
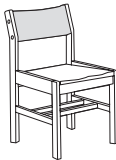
Description	Model	Specifications				List Price Per Grade	
		Dimensions	D	W	H	All Wood	COM
Armless    18A all wood 18B uph. back	18A All Wood 18B Uph. Back • optional linking brackets - add \$26 list per chair • optional laser engraving back imprint, specify location and size - see page 7 for details. (A model only) • coordinating Children's collection - see page 332 • optional casters - add \$90 list for a set of 4 casters	Overall	20½	19	32½	\$303	\$354
	Seat	18¼	17	18		\$367	\$380
		Upholstery		Shipping			\$403
		COM Ydg	¾	Ctn Wt	25		\$432
		COL Sq Ft	9	Cu Ft	10		\$461
							\$492
							\$536
							\$583
							\$657
							\$744
							\$544
							\$592

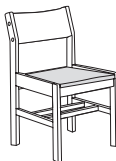
Description	Model	Specifications				List Price Per Grade	
		Dimensions	D	W	H	COM	COL/C
Armless  	18C Uph. Seat • optional linking brackets - add \$26 list per chair • optional laser engraving back imprint, specify location and size - see page 7 for details. • coordinating Children's collection - see page 332 • optional casters - add \$90 list for a set of 4 casters	Overall	20½	19	32½	\$354	\$354
	Seat	18¼	17	18		\$367	\$380
		Upholstery		Shipping			\$403
		COM Ydg	¾	Ctn Wt	25		\$432
		COL Sq Ft	9	Cu Ft	10		\$461
							\$492
							\$536
							\$583
							\$657
							\$744
							\$544
							\$592

To Order, Specify:

- 1 Model Number
- 2 Wood Species - Oak (O) or Maple (M)
- 3 Wood Finish/Color
- 4 Fabric Selection - vendor, pattern and color
- 5 Optional Linking Brackets - add \$26 list per chair
- 6 Optional Laser Engraving Back Imprint - specify location and size; see page 7 for details.
(A and C CHAIR MODELS ONLY)
- 7 Optional Rubber Cushion Nylon Glides - no upcharge
LEG MODELS ONLY

3 Wood Finish/Color Options:

- | | |
|------------------|---------------|
| Oak | ECU Ecru |
| BRW Brownie | HEN Henna |
| CAN Canyon | HNY Honey |
| CIT Citron | NUT Nut Brown |
| DES Desert | |
| Maple | FLX Flax |
| ALE Ale | LGC Legacy |
| AUB Auburn | MCH Mocha |
| AUT Autumn | NTO Night Owl |
| BRL Barley | PRL Praline |
| BBN Bourbon | SAF Saffron |
| BRG Brighton | SIE Sienna |
| BUT Butterscotch | TOF Toffee |
| CIN Cinnamon | TRF Truffle |
| CLA Classic | VEN Venetian |
| EAR Earthy | |
| ESP Espresso | |







Specifications

- Wood species - Oak or Maple.
- Two stretcher shelf for added stability.
- Seat is upholstered with 1½" polyurethane foam and synthetic sheet webbing for added comfort.
- Back is upholstered front and back with 1" polyurethane foam.
- Mortise and tenon construction with corner blocks, glue and screws.
- Coordinating Children's collection. See page 332.
- Standard with rubber cushion metal glides (leg models only).

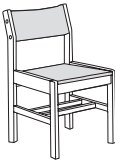
Color - Add \$31 list per item

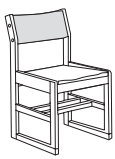
- | | |
|------------------|----------------------|
| BKD Backdrop | GRV Greek Villa |
| BFX Black Fox | GLF Gulf Stream |
| BWH Bright White | HTB Hearthrob |
| CGP Cargo Pants | NET Network Gray |
| CHT Chatroom | NWH Nonchalant White |
| DSY Daisy | PAR Paradise |
| DRG Daring | QXP Quixotic Plum |
| DYN Dynamo | RBZ Relic Bronze |
| ENG Enigma | SND Sandbank |
| FRR French Roast | STM Storm |
| GBY Georgian Bay | TRC Tricorn Black |

- 4 See a selection of graded in fabric manufacturers and patterns on pages 12-20. Contact Customer Service for additional fabric options.

Description	① Model	Specifications	List Price Per Grade												
Armless  	18D Uph. Seat/Back · optional linking brackets - add \$26 list per chair · coordinating Children's collection - see page 332 · optional casters - add \$90 list for a set of 4 casters	<table border="1"> <thead> <tr> <th>Dimensions</th> <th>D</th> <th>W</th> <th>H</th> </tr> </thead> <tbody> <tr> <td>Overall</td> <td>20 ½</td> <td>19</td> <td>32 ½</td> </tr> <tr> <td>Seat</td> <td>18 ¼</td> <td>17</td> <td>18</td> </tr> </tbody> </table>	Dimensions	D	W	H	Overall	20 ½	19	32 ½	Seat	18 ¼	17	18	COM \$395 A \$408 B \$422 COL/C \$444 D \$473 E \$502 F \$534 G \$578 H \$624 I \$698 J \$786 L1 \$586 L2 \$634
		Dimensions	D	W	H										
Overall	20 ½	19	32 ½												
Seat	18 ¼	17	18												
<table border="1"> <thead> <tr> <th>Upholstery</th> <th colspan="3">Shipping</th> </tr> </thead> <tbody> <tr> <td>COM Ydg</td> <td>¾</td> <td>Ctn Wt</td> <td>25</td> </tr> <tr> <td>COL Sq Ft</td> <td>18</td> <td>Cu Ft</td> <td>10</td> </tr> </tbody> </table>	Upholstery	Shipping			COM Ydg	¾	Ctn Wt	25	COL Sq Ft	18	Cu Ft	10			
Upholstery	Shipping														
COM Ydg	¾	Ctn Wt	25												
COL Sq Ft	18	Cu Ft	10												
Armless  	19A All Wood 19B Uph. Back · optional linking brackets - add \$26 list per chair · optional laser engraving back imprint, specify location and size - see page 7 for details. (A model only) · coordinating Children's collection - see page 332	<table border="1"> <thead> <tr> <th>Dimensions</th> <th>D</th> <th>W</th> <th>H</th> </tr> </thead> <tbody> <tr> <td>Overall</td> <td>20 ½</td> <td>19</td> <td>32 ¼</td> </tr> <tr> <td>Seat</td> <td>18</td> <td>17</td> <td>18</td> </tr> </tbody> </table>	Dimensions	D	W	H	Overall	20 ½	19	32 ¼	Seat	18	17	18	All Wood \$310 COM \$362 A \$374 B \$387 COL/C \$410 D \$439 E \$469 F \$499 G \$543 H \$591 I \$664 J \$751 L1 \$553 L2 \$599
			Dimensions	D	W	H									
Overall	20 ½	19	32 ¼												
Seat	18	17	18												
<table border="1"> <thead> <tr> <th>Upholstery</th> <th colspan="3">Shipping</th> </tr> </thead> <tbody> <tr> <td>COM Ydg</td> <td>¾</td> <td>Ctn Wt</td> <td>28</td> </tr> <tr> <td>COL Sq Ft</td> <td>9</td> <td>Cu Ft</td> <td>10</td> </tr> </tbody> </table>	Upholstery	Shipping			COM Ydg	¾	Ctn Wt	28	COL Sq Ft	9	Cu Ft	10			
Upholstery	Shipping														
COM Ydg	¾	Ctn Wt	28												
COL Sq Ft	9	Cu Ft	10												
	19B uph. back														
Armless  	19C Uph. Seat · optional linking brackets - add \$26 list per chair · optional laser engraving back imprint, specify location and size - see page 7 for details. · coordinating Children's collection - see page 332	<table border="1"> <thead> <tr> <th>Dimensions</th> <th>D</th> <th>W</th> <th>H</th> </tr> </thead> <tbody> <tr> <td>Overall</td> <td>20 ½</td> <td>19</td> <td>32 ¼</td> </tr> <tr> <td>Seat</td> <td>18</td> <td>17</td> <td>18</td> </tr> </tbody> </table>	Dimensions	D	W	H	Overall	20 ½	19	32 ¼	Seat	18	17	18	COM \$362 A \$374 B \$387 COL/C \$410 D \$439 E \$469 F \$499 G \$543 H \$591 I \$664 J \$751 L1 \$553 L2 \$599
			Dimensions	D	W	H									
Overall	20 ½	19	32 ¼												
Seat	18	17	18												
<table border="1"> <thead> <tr> <th>Upholstery</th> <th colspan="3">Shipping</th> </tr> </thead> <tbody> <tr> <td>COM Ydg</td> <td>¾</td> <td>Ctn Wt</td> <td>28</td> </tr> <tr> <td>COL Sq Ft</td> <td>9</td> <td>Cu Ft</td> <td>10</td> </tr> </tbody> </table>	Upholstery	Shipping			COM Ydg	¾	Ctn Wt	28	COL Sq Ft	9	Cu Ft	10			
Upholstery	Shipping														
COM Ydg	¾	Ctn Wt	28												
COL Sq Ft	9	Cu Ft	10												
Armless  	19D Uph. Seat/Back · optional linking brackets - add \$26 list per chair · coordinating Children's collection - see page 332	<table border="1"> <thead> <tr> <th>Dimensions</th> <th>D</th> <th>W</th> <th>H</th> </tr> </thead> <tbody> <tr> <td>Overall</td> <td>20 ½</td> <td>19</td> <td>32 ¼</td> </tr> <tr> <td>Seat</td> <td>18</td> <td>17</td> <td>18</td> </tr> </tbody> </table>	Dimensions	D	W	H	Overall	20 ½	19	32 ¼	Seat	18	17	18	COM \$403 A \$415 B \$429 COL/C \$452 D \$480 E \$510 F \$541 G \$585 H \$632 I \$705 J \$793 L1 \$594 L2 \$641
			Dimensions	D	W	H									
Overall	20 ½	19	32 ¼												
Seat	18	17	18												
<table border="1"> <thead> <tr> <th>Upholstery</th> <th colspan="3">Shipping</th> </tr> </thead> <tbody> <tr> <td>COM Ydg</td> <td>¾</td> <td>Ctn Wt</td> <td>28</td> </tr> <tr> <td>COL Sq Ft</td> <td>18</td> <td>Cu Ft</td> <td>10</td> </tr> </tbody> </table>	Upholstery	Shipping			COM Ydg	¾	Ctn Wt	28	COL Sq Ft	18	Cu Ft	10			
Upholstery	Shipping														
COM Ydg	¾	Ctn Wt	28												
COL Sq Ft	18	Cu Ft	10												

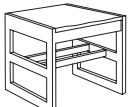
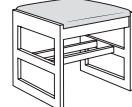
Description	Model	Specifications			List Price Per Grade		
		Dimensions	D	W	H	All Wood	COM
Bench 19" W   25A all wood 25C uph. seat	25A All Wood 25C Uph. Seat • optional linking brackets - add \$26 list per bench	Overall	19	19	18	\$363	\$363
	Seat	19	17	18	A \$375	B \$388	
		Upholstery		Shipping		COL/C \$411	D \$440
		COM Ydg	¾	Ctn Wt	22	E \$470	F \$500
		COL Sq Ft	9	Cu Ft	5	G \$544	H \$592
						I \$665	J \$752
						L1 \$554	L2 \$600

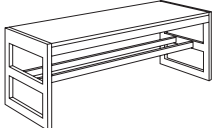
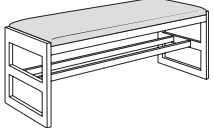
Description	Model	Specifications			List Price Per Grade		
		Dimensions	D	W	H	All Wood	COM
Bench 48" W   26A all wood 26C uph. seat	26A All Wood 26C Uph. Seat • optional linking brackets - add \$26 list per bench	Overall	19	48	18	\$563	\$559
	Seat	19	46	18	A \$575	B \$587	
		Upholstery		Shipping		COL/C \$611	D \$640
		COM Ydg	¾	Ctn Wt	34	E \$669	F \$700
		COL Sq Ft	23	Cu Ft	13	G \$744	H \$791
						I \$864	J \$952
						L1 \$752	L2 \$800

To Order, Specify:

- 1 Model Number
- 2 Wood Species - Oak (O) or Maple (M)
- 3 Wood Finish/Color
- 4 Fabric Selection - vendor, pattern and color
- 5 Optional Linking Brackets - add \$26 list per chair
- 6 Optional Laser Engraving Back Imprint - specify location and size; see page 7 for details.
(A and C CHAIR MODELS ONLY)
- 7 Optional Rubber Cushion Nylon Glides - no upcharge
LEG MODELS ONLY

3 Wood Finish/Color Options:

- | | | |
|------------------|--------------|---------------|
| Oak | BRW Brownie | ECU Ecu |
| CAN Canyon | CIT Citron | HEN Henna |
| DES Desert | Maple | HNY Honey |
| ALE Ale | AUB Auburn | NUT Nut Brown |
| AUT Autumn | BRL Barley | FLX Flax |
| BBN Bourbon | BRG Brighton | LGC Legacy |
| BUT Butterscotch | CIN Cinnamon | MCH Mocha |
| CLA Classic | EAR Earthy | NTO Night Owl |
| ESP Espresso | | PRL Praline |
| | | SAF Saffron |
| | | SIE Sienna |
| | | TOF Toffee |
| | | TRF Truffle |
| | | VEN Venetian |

Color - Add \$31 list per item

- | | |
|------------------|----------------------|
| BKD Backdrop | GRV Creek Villa |
| BFX Black Fox | GLF Gulf Stream |
| BWH Bright White | HTB Hearthrob |
| CGP Cargo Pants | NET Network Gray |
| CHT Chatroom | NWH Nonchalant White |
| DSY Daisy | PAR Paradise |
| DRG Daring | QXP Quixotic Plum |
| DYN Dynamo | RBZ Relic Bronze |
| ENG Enigma | SND Sandbank |
| FRR French Roast | STM Storm |
| GBY Georgian Bay | TRC Tricorn Black |

Specifications

- Wood species - Oak or Maple.
- Two stretcher shelf for added stability.
- Seat is upholstered with 1 ½" polyurethane foam and synthetic sheet webbing for added comfort.
- Back is upholstered front and back with 1" polyurethane foam.
- Mortise and tenon construction with corner blocks, glue and screws.
- Coordinating Children's collection. See page 332.
- Standard with rubber cushion metal glides (leg models only).

4 See a selection of graded in fabric manufacturers and patterns on pages 12-20. Contact Customer Service for additional fabric options.

Classmate Order Check List:



Coordinating Children's collection. See page 336.

Specify:

- 1. Model Number
 - 2. Wood Species - Oak (O) or Maple (M)
 - 3. Wood Finish/Color
 - 4. Fabric Selection - vendor, pattern and color
 - 5. Optional Linking Brackets - add \$26 list per chair
 - 6. Optional Rubber Cushion Nylon Glides - no upcharge
- LEG MODELS ONLY**

Example:

58C (model #)	O (wood species)	HEN (finish)	MOMENTUM (fabric vendor)	VOX (pattern name)	MYSTIC (pattern color)
-------------------------	----------------------------	------------------------	------------------------------------	------------------------------	----------------------------------

1. Model Number

2. Wood Species - Oak (O) or Maple (M)

3. Wood Finish/Color Options:

Oak			
BRW	Brownie	ECU	Ecru
CAN	Canyon	HEN	Henna
CIT	Citron	HNY	Honey
DES	Desert	NUT	Nut Brown

Maple			
ALE	Ale	FLX	Flax
AUB	Auburn	LGC	Legacy
AUT	Autumn	MCH	Mocha
BRL	Barley	NTO	Night Owl
BBN	Bourbon	PRL	Praline
BRG	Brighton	SAF	Saffron
BUT	Butterscotch	SIE	Sienna
CIN	Cinnamon	TOF	Toffee
CLA	Classic	TRF	Truffle
EAR	Earthy	VEN	Venetian
ESP	Espresso		

Color - Add \$31 list per item

BKD	Backdrop	GRV	Greek Villa
BFX	Black Fox	GLF	Gulf Stream
BWH	Bright White	HTB	Heartthrob
CGP	Cargo Pants	NET	Network Gray
CHT	Chatroom	NWH	Nonchalant White
DSY	Daisy	PAR	Paradise
DRG	Daring	QXP	Quixotic Plum
DYN	Dynamo	RBZ	Relic Bronze
ENG	Enigma	SND	Sandbank
FRR	French Roast	STM	Storm
GBY	Georgian Bay	TRC	Tricorn Black

4. Fabric Selection - Please supply the following:

- Fabric vendor
- Pattern name
- Pattern color

When specifying contrasting upholstery, indicate clearly which upholstery is to be applied to the seat and back. Use higher grade pricing.

- Indicate direction of fabric - Railroaded or Up the Roll
- Please provide illustration, if available

All COM orders must include the following:

- Vendor's name, pattern name and color
- Sample of the fabric attached to order
- Model numbers of items for fabric application
- Special application instructions (e.g., all stripes will be applied front to back unless specified otherwise)
- Customer and purchase order number

Ship prepaid COM material to:
 Community
 Attn: COM Dept
 932 Mill Street
 Jasper, IN 47546

Application of fabric:
 Railroaded Up the Roll

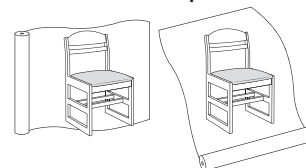



All COM orders will ship at standard lead time from receipt of COM except for orders requiring special custom matched finishes.

5. Optional Linking Brackets - add \$26 list per chair/bench

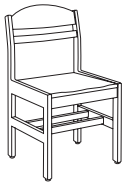
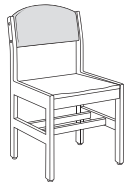

Description	Model	Specifications			List Price Per Grade		
		Dimensions	D	W	H	All Wood	COM
Armless   58A all wood	58A All Wood 58B Uph. Back • optional linking brackets - add \$26 list per chair • coordinating Children's collection - see page 336 • optional casters - add \$90 list for a set of 4 casters	Overall	22	19	34½	\$342	\$391
		Seat	18	17	18¼	\$402	\$410
 58B uph. back		Upholstery		Shipping		\$426	\$446
		COM Ydg	½	Ctn Wt	26	\$465	\$486
		COL Sq Ft	6	Cu Ft	10	\$515	\$546
						\$595	\$654
						\$520	\$552

Description	Model	Specifications			List Price Per Grade		
		Dimensions	D	W	H	COM	COL/C
Armless  	58C Uph. Seat • optional linking brackets - add \$26 list per chair • coordinating Children's collection - see page 336 • optional casters - add \$90 list for a set of 4 casters	Overall	22	19	34½	\$391	\$439
		Seat	18	17	18¼	\$404	\$417
		Upholstery		Shipping		\$469	\$498
		COM Ydg	¾	Ctn Wt	26	\$530	\$574
		COL Sq Ft	9	Cu Ft	10	\$620	\$693
						\$782	\$582
						\$629	

To Order, Specify:

- Model Number
- Wood Species - Oak (O) or Maple (M)
- Wood Finish/Color
- Fabric Selection - vendor, pattern and color
- Optional Linking Brackets - add \$26 list per chair
- Optional Rubber Cushion Nylon Glides - no upcharge

LEG MODELS ONLY

Wood Finish/Color Options:

- | | | |
|------------------|------------------|---------------|
| Oak | BRW Brownie | ECU Ecu |
| CAN Canyon | CIT Citron | HEN Henna |
| DES Desert | | HNY Honey |
| | | NUT Nut Brown |
| Maple | | |
| ALE Ale | AUB Auburn | FLX Flax |
| AUT Autumn | BRL Barley | LGC Legacy |
| BBN Bourbon | BRG Brighton | MCH Mocha |
| BUT Butterscotch | BBN Bourbon | NTO Night Owl |
| CIN Cinnamon | BUT Butterscotch | PRL Praline |
| CLA Classic | CIN Cinnamon | SAF Saffron |
| EAR Earthy | CLA Classic | SIE Sienna |
| ESP Espresso | EAR Earthy | TOF Toffee |
| | ESP Espresso | TRF Truffle |
| | | VEN Venetian |



Color - Add \$31 list per item



- | | |
|------------------|----------------------|
| BKD Backdrop | GRV Greek Villa |
| BFX Black Fox | GLF Gulf Stream |
| BWH Bright White | HTB Hearthrob |
| CGP Cargo Pants | NET Network Gray |
| CHT Chatroom | NWH Nonchalant White |
| DSY Daisy | PAR Paradise |
| DRG Daring | QXP Quixotic Plum |
| DYN Dynamo | RBZ Relic Bronze |
| ENG Enigma | SND Sandbank |
| FRR French Roast | STM Storm |
| GBY Georgian Bay | TRC Tricorn Black |



Specifications



- Wood species - Oak or Maple.
- Two stretcher shelf for added stability.
- Seat is upholstered with 1" high density polyurethane foam.
- Back is upholstered front and back with 1" polyurethane foam.
- Mortise and tenon construction with corner blocks, glue and screws.
- Coordinating Children's collection. See page 336.
- Standard with rubber cushion metal glides (leg models only).

- See a selection of graded in fabric manufacturers and patterns on pages 12-20. Contact Customer Service for additional fabric options.

Description	① Model	Specifications				List Price Per Grade	
Armless  	58D Uph. Seat/Back · optional linking brackets - add \$26 list per chair · coordinating Children's collection - see page 336 · optional casters - add \$90 list for a set of 4 casters	Dimensions		D	W	H	COM \$429
		Overall	22	19	34½	A \$444	
		Seat	18	17	18¼	B \$458	
		Upholstery		Shipping		COL/C \$486	
		COM Ydg	7/8	Ctn Wt	26	D \$519	
		COL Sq Ft	15	Cu Ft	10	E \$554	
						F \$590	
						G \$641	
						H \$696	
						I \$782	
				J \$884			
				L1 \$651			
				L2 \$706			

Armless Sled   	59A All Wood 59B Uph. Back · optional linking brackets - add \$26 list per chair · coordinating Children's collection - see page 336	Dimensions		D	W	H	All Wood \$351
		Overall	22	19	34½	COM \$401	
		Seat	18½	17	18	A \$411	
		Upholstery		Shipping		B \$420	
		COM Ydg	½	Ctn Wt	27	COL/C \$435	
		COL Sq Ft	6	Cu Ft	10	D \$455	
						E \$474	
						F \$495	
						G \$524	
						H \$556	
				I \$604			
				J \$663			
				L1 \$530			
				L2 \$561			

Armless Sled  	59C Uph. Seat · optional linking brackets - add \$26 list per chair · coordinating Children's collection - see page 336	Dimensions		D	W	H	COM \$401
		Overall	22	19	34½	A \$413	
		Seat	18½	17	18	B \$427	
		Upholstery		Shipping		COL/C \$450	
		COM Ydg	¾	Ctn Wt	27	D \$478	
		COL Sq Ft	9	Cu Ft	10	E \$508	
						F \$539	
						G \$583	
						H \$629	
						I \$703	
				J \$791			
				L1 \$592			
				L2 \$639			

Description	1 Model	Specifications			List Price Per Grade		
		Dimensions	D	W	H	COM	
Armless Sled  	59D Uph. Seat/Back • optional linking brackets - add \$26 list per chair • coordinating Children's collection - see page 336	Overall	22	19	34½	A	\$436
		Seat	18½	17	18	B	\$451
		Upholstery		Shipping		C	\$466
		COM Ydg	7/8	Ctn Wt	27	COL/C	\$493
		COL Sq Ft	15	Cu Ft	10	D	\$527
						E	\$561
						F	\$597
						G	\$648
						H	\$703
						I	\$789
						J	\$891
						L1	\$659
						L2	\$713

SEATING

To Order, Specify:

- 1 Model Number
- 2 Wood Species - Oak (O) or Maple (M)
- 3 Wood Finish/Color
- 4 Fabric Selection - vendor, pattern and color
- 5 Optional Linking Brackets - add \$26 list per chair
- 6 Optional Rubber Cushion Nylon Glides - no upcharge

LEG MODELS ONLY

3 Wood Finish/Color Options:

Oak		ECU	Ecru
BRW	Brownie	HEN	Henna
CAN	Canyon	HNY	Honey
CIT	Citron	NUT	Nut Brown
DES	Desert		
Maple			
ALE	Ale	FLX	Flax
AUB	Auburn	LGC	Legacy
AUT	Autumn	MCH	Mocha
BRL	Barley	NTO	Night Owl
BBN	Bourbon	PRL	Praline
BRG	Brighton	SAF	Saffron
BUT	Butterscotch	SIE	Sienna
CIN	Cinnamon	TOF	Toffee
CLA	Classic	TRF	Truffle
EAR	Earthy	VEN	Venetian
ESP	Espresso		

Color - Add \$31 list per item

BKD	Backdrop	GRV	Creek Villa
BFX	Black Fox	GLF	Gulf Stream
BWH	Bright White	HTB	Hearthrob
CGP	Cargo Pants	NET	Network Gray
CHT	Chatroom	NWH	Nonchalant White
DSY	Daisy	PAR	Paradise
DRG	Daring	QXP	Quixotic Plum
DYN	Dynamo	RBZ	Relic Bronze
ENG	Enigma	SND	Sandbank
FRR	French Roast	STM	Storm
GBY	Georgian Bay	TRC	Tricorn Black

Specifications

- Wood species - Oak or Maple.
- Two stretcher shelf for added stability.
- Seat is upholstered with 1" high density polyurethane foam.
- Back is upholstered front and back with 1" polyurethane foam.
- Mortise and tenon construction with corner blocks, glue and screws.
- Coordinating Children's collection. See page 336.
- Standard with rubber cushion metal glides (leg models only).

- 4 See a selection of graded in fabric manufacturers and patterns on pages 12-20. Contact Customer Service for additional fabric options.

Classmate II Order Check List:



Coordinating Children's collection. See page 342.

Specify:

- 1. Model Number
 - 2. Wood Species - Oak (O) or Maple (M)
 - 3. Wood Finish/Color
 - 4. Fabric Selection - vendor, pattern and color
 - 5. Optional Linking Brackets - add \$26 list per chair
 - 6. Optional Rubber Cushion Nylon Glides - no upcharge
- LEG MODELS ONLY**

Example:

68C (model #)	O (wood species)	HEN (finish)	MOMENTUM (fabric vendor)	VOX (pattern name)	MYSTIC (pattern color)
-------------------------	----------------------------	------------------------	------------------------------------	------------------------------	----------------------------------

1. Model Number

2. Wood Species - Oak (O) or Maple (M)

3. Wood Finish/Color Options:

Oak			
BRW	Brownie	ECU	Ecru
CAN	Canyon	HEN	Henna
CIT	Citron	HNY	Honey
DES	Desert	NUT	Nut Brown

Maple			
ALE	Ale	FLX	Flax
AUB	Auburn	LGC	Legacy
AUT	Autumn	MCH	Mocha
BRL	Barley	NTO	Night Owl
BBN	Bourbon	PRL	Praline
BRG	Brighton	SAF	Saffron
BUT	Butterscotch	SIE	Sienna
CIN	Cinnamon	TOF	Toffee
CLA	Classic	TRF	Truffle
EAR	Earthy	VEN	Venetian
ESP	Espresso		

Color - Add \$31 list per item

BKD	Backdrop	GRV	Greek Villa
BFX	Black Fox	GLF	Gulf Stream
BWH	Bright White	HTB	Heartthrob
CGP	Cargo Pants	NET	Network Gray
CHT	Chatroom	NWH	Nonchalant White
DSY	Daisy	PAR	Paradise
DRG	Daring	QXP	Quixotic Plum
DYN	Dynamo	RBZ	Relic Bronze
ENG	Enigma	SND	Sandbank
FRR	French Roast	STM	Storm
GBY	Georgian Bay	TRC	Tricorn Black

4. Fabric Selection - Please supply the following:

- Fabric vendor
- Pattern name
- Pattern color

When specifying contrasting upholstery, indicate clearly which upholstery is to be applied to the seat and back. Use higher grade pricing.

- Indicate direction of fabric - Railroaded or Up the Roll
- Please provide illustration, if available

All COM orders must include the following:

- Vendor's name, pattern name and color
- Sample of the fabric attached to order
- Model numbers of items for fabric application
- Special application instructions (e.g., all stripes will be applied front to back unless specified otherwise)
- Customer and purchase order number

Ship prepaid COM material to:
Community
Attn: COM Dept
932 Mill Street
Jasper, IN 47546

Application of fabric:
Railroaded Up the Roll

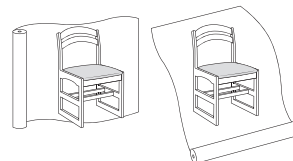

All COM orders will ship at standard lead time from receipt of COM except for orders requiring special custom matched finishes.

5. Optional Linking Brackets - add \$26 list per chair/bench

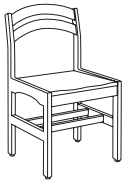
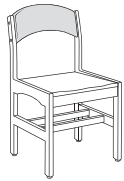

SEATING

Description	Model	Specifications				List Price Per Grade	
		Dimensions	D	W	H	All Wood	COM
Armless   68A all wood	68A All Wood 68B Uph. Back • optional linking brackets - add \$26 list per chair • coordinating Children's collection - see page 342 • optional casters - add \$90 list for a set of 4 casters	Overall	22	19	34½	\$342	\$391
		Seat	18	17	18¼	\$402	\$410
		Upholstery		Shipping		\$426	\$446
		COM Ydg	½	Ctn Wt	26	\$465	\$486
		COL Sq Ft	6	Cu Ft	10	\$515	\$546
						\$595	\$654
						\$520	\$552

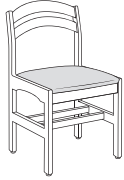
Description	Model	Specifications				List Price Per Grade	
		Dimensions	D	W	H	COM	A
Armless 	68C Uph. Seat • optional linking brackets - add \$26 list per chair • coordinating Children's collection - see page 342 • optional casters - add \$90 list for a set of 4 casters	Overall	22	19	34½	\$391	\$404
		Seat	18	17	18¼	\$417	\$439
		Upholstery		Shipping		\$469	\$498
		COM Ydg	¾	Ctn Wt	26	\$530	\$574
		COL Sq Ft	9	Cu Ft	10	\$620	\$693
						\$782	\$582
						\$629	

To Order, Specify:

- 1 Model Number
- 2 Wood Species - Oak (O) or Maple (M)
- 3 Wood Finish/Color
- 4 Fabric Selection - vendor, pattern and color
- 5 Optional Linking Brackets - add \$26 list per chair
- 6 Optional Rubber Cushion Nylon Glides - no upcharge

LEG MODELS ONLY

3 Wood Finish/Color Options:

- | | | |
|------------------|------------------|---------------|
| Oak | BRW Brownie | ECU Ecu |
| CAN Canyon | CIT Citron | HEN Henna |
| DES Desert | | HNY Honey |
| Maple | | NUT Nut Brown |
| ALE Ale | AUB Auburn | FLX Flax |
| AUT Autumn | BRL Barley | LGC Legacy |
| BBN Bourbon | BRG Brighton | MCH Mocha |
| BUT Butterscotch | BBN Bourbon | NTO Night Owl |
| CIN Cinnamon | BRG Brighton | PRL Praline |
| CLA Classic | BUT Butterscotch | SAF Saffron |
| EAR Earthy | CIN Cinnamon | SIE Sienna |
| ESP Espresso | CLA Classic | TOF Toffee |
| | EAR Earthy | TRF Truffle |
| | ESP Espresso | VEN Venetian |



Color - Add \$31 list per item

- | | |
|------------------|----------------------|
| BKD Backdrop | GRV Creek Villa |
| BFX Black Fox | GLF Gulf Stream |
| BWH Bright White | HTB Hearthrob |
| CGP Cargo Pants | NET Network Gray |
| CHT Chatroom | NWH Nonchalant White |
| DSY Daisy | PAR Paradise |
| DRG Daring | QXP Quixotic Plum |
| DYN Dynamo | RBZ Relic Bronze |
| ENG Enigma | SND Sandbank |
| FRR French Roast | STM Storm |
| GBY Georgian Bay | TRC Tricorn Black |

Specifications

- Wood species - Oak or Maple.
- Two stretcher shelf for added stability.
- Seat is upholstered with 1" high density polyurethane foam.
- Back is upholstered front and back with 1" polyurethane foam.
- Mortise and tenon construction with corner blocks, glue and screws.
- Coordinating Children's collection. See page 342.
- Standard with rubber cushion metal glides (leg models only).

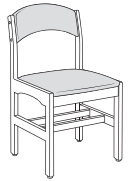
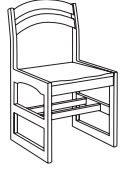
- 4 See a selection of graded in fabric manufacturers and patterns on pages 12-20. Contact Customer Service for additional fabric options.

Description	Model	Specifications				List Price Per Grade	
Armless 	68D Uph. Seat/Back · optional linking brackets - add \$26 list per chair · coordinating Children's collection - see page 342 · optional casters - add \$90 list for a set of 4 casters	Dimensions		D	W	H	COM \$429
		Overall		22	19	34½	A \$444
		Seat		18	17	18¼	B \$458
		Upholstery		Shipping			COL/C \$486
		COM Ydg		7/8	Ctn Wt	26	D \$519
		COL Sq Ft		15	Cu Ft	10	E \$554
							F \$590
							G \$641
							H \$696
							I \$782
					J \$884		
					L1 \$651		
					L2 \$706		
Armless Sled 	69A All Wood 69B Uph. Back · optional linking brackets - add \$26 list per chair · coordinating Children's collection - see page 342	Dimensions		D	W	H	All Wood \$351
		Overall		22	19	34½	COM \$401
		Seat		18½	17	18	A \$411
		Upholstery		Shipping			B \$420
		COM Ydg		½	Ctn Wt	27	COL/C \$435
		COL Sq Ft		6	Cu Ft	10	D \$455
							E \$474
							F \$495
							G \$524
							H \$556
					I \$604		
					J \$663		
					L1 \$530		
					L2 \$561		
Armless Sled 	69C Uph. Seat · optional linking brackets - add \$26 list per chair · coordinating Children's collection - see page 342	Dimensions		D	W	H	COM \$401
		Overall		22	19	34½	A \$413
		Seat		18½	17	18	B \$427
		Upholstery		Shipping			COL/C \$450
		COM Ydg		¾	Ctn Wt	27	D \$478
		COL Sq Ft		9	Cu Ft	10	E \$508
							F \$539
							G \$583
							H \$629
							I \$703
					J \$791		
					L1 \$592		
					L2 \$639		

Description	Model	Specifications				List Price Per Grade	
		Dimensions	D	W	H	COM	
Armless Sled 	69D Uph. Seat/Back · optional linking brackets - add \$26 list per chair · coordinating Children's collection - see page 342	Overall	22	19	34½	COM	\$436
		Seat	18½	17	18	COL/C	\$493
		Upholstery		Shipping		D	\$527
		COM Ydg	7/8	Ctn Wt	27	E	\$561
		COL Sq Ft	15	Cu Ft	10	F	\$597
						G	\$648
						H	\$703
						I	\$789
						J	\$891
						L1	\$659
						L2	\$713

SEATING

To Order, Specify:

- 1 Model Number
- 2 Wood Species - Oak (O) or Maple (M)
- 3 Wood Finish/Color
- 4 Fabric Selection - vendor, pattern and color
- 5 Optional Linking Brackets - add \$26 list per chair
- 6 Optional Rubber Cushion Nylon Glides - no upcharge

LEG MODELS ONLY

3 Wood Finish/Color Options:

Oak		ECU	Ecru
BRW	Brownie	HEN	Henna
CAN	Canyon	HNY	Honey
CIT	Citron	NUT	Nut Brown
DES	Desert		
Maple			
ALE	Ale	FLX	Flax
AUB	Auburn	LGC	Legacy
AUT	Autumn	MCH	Mocha
BRL	Barley	NTO	Night Owl
BBN	Bourbon	PRL	Praline
BRG	Brighton	SAF	Saffron
BUT	Butterscotch	SIE	Sienna
CIN	Cinnamon	TOF	Toffee
CLA	Classic	TRF	Truffle
EAR	Earthy	VEN	Venetian
ESP	Espresso		

Color - Add \$31 list per item

BKD	Backdrop	GRV	Greek Villa
BFX	Black Fox	GLF	Gulf Stream
BWH	Bright White	HTB	Hearthrob
CGP	Cargo Pants	NET	Network Gray
CHT	Chatroom	NWH	Nonchalant White
DSY	Daisy	PAR	Paradise
DRG	Daring	QXP	Quixotic Plum
DYN	Dynamo	RBZ	Relic Bronze
ENG	Enigma	SND	Sandbank
FRR	French Roast	STM	Storm
GBY	Georgian Bay	TRC	Tricorn Black

Specifications

- Wood species - Oak or Maple.
- Two stretcher shelf for added stability.
- Seat is upholstered with 1" high density polyurethane foam.
- Back is upholstered front and back with 1" polyurethane foam.
- Mortise and tenon construction with corner blocks, glue and screws.
- Coordinating Children's collection. See page 342.
- Standard with rubber cushion metal glides (leg models only).

- 4 See a selection of graded in fabric manufacturers and patterns on pages 12-20. Contact Customer Service for additional fabric options.

Collegian & Collegian II Order Check List:



SEATING

Coordinating Children's collection. See page 348.

Specify:

- 1. Model Number
- 2. Wood Species - Oak (0)
- 3. Wood Finish/Color
- 4. Fabric Selection - vendor, pattern and color
- 5. Optional Rubber Cushion Nylon Glides - no upcharge

Example:

1098C (model #)	0 (wood species)	HEN (finish)	MOMENTUM (fabric vendor)	VOX (pattern name)	MYSTIC (pattern color)
---------------------------	----------------------------	------------------------	------------------------------------	------------------------------	----------------------------------

1. Model Number

2. Wood Species - Oak (0)

3. Wood Finish/Color Options:

BRW Brownie	ECU Ecru
CAN Canyon	HEN Henna
CIT Citron	HNY Honey
DES Desert	NUT Nut Brown
Color - Add \$31 list per item	
BKD Backdrop	GRV Greek Villa
BFX Black Fox	GLF Gulf Stream
BWH Bright White	HTB Heartthrob
CGP Cargo Pants	NET Network Gray
CHT Chatroom	NWH Nonchalant White
DSY Daisy	PAR Paradise
DRG Daring	QXP Quixotic Plum
DYN Dynamo	RBZ Relic Bronze
ENG Enigma	SND Sandbank
FRR French Roast	STM Storm
GBY Georgian Bay	TRC Tricorn Black

4. Fabric Selection - Please supply the following:

- Fabric vendor
- Pattern name
- Pattern color

All COM orders must include the following:



- Vendor's name, pattern name and color
- Sample of the fabric attached to order
- Model numbers of items for fabric application
- Special application instructions (e.g., all stripes will be applied front to back unless specified otherwise)
- Customer and purchase order number

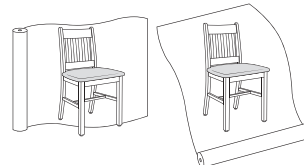

Ship prepaid COM material to:
 Community
 Attn: COM Dept
 932 Mill Street
 Jasper, IN 47546

Application of fabric:
 Railroaded Up the Roll



All COM orders will ship at standard lead time from receipt of COM except for orders requiring special custom matched finishes.

Description	Model	Specifications				List Price Per Grade	
		Dimensions	D	W	H	All Wood	COM
Armless Vertical Slat    1098A all wood 1098C uph. seat	1098A All Wood 1098C Uph. Seat · vertical slat back · casters not available · coordinating Children's collection - see page 348	Overall	19 ½	18 ¼	33 ½	\$298	\$360
		Seat	15	18 ¼	18		\$372
		Upholstery		Shipping			\$408
		COM Ydg	¾	Ctn Wt	20		\$437
		COL Sq Ft	9	Cu Ft	9		\$467
							\$497
							\$541
							\$588
							\$662
							\$749
							\$551
							\$597

Description	Model	Specifications				List Price Per Grade	
		Dimensions	D	W	H	All Wood	COM
Armless Horizontal Slat    1218A all wood 1218C uph. seat	1218A All Wood 1218C Uph. Seat · horizontal slat back · casters not available · coordinating Children's collection - see page 348	Overall	19 ½	18 ¼	33 ½	\$298	\$360
		Seat	15	18 ¼	18		\$372
		Upholstery		Shipping			\$408
		COM Ydg	¾	Ctn Wt	20		\$437
		COL Sq Ft	9	Cu Ft	9		\$467
							\$497
							\$541
							\$588
							\$662
							\$749
							\$551
							\$597

To Order, Specify:

- 1 Model Number
- 2 Wood Species - Oak (0)
- 3 Wood Finish/Color
- 4 Fabric Selection - vendor, pattern and color
- 5 Optional Rubber Cushion Nylon Glides - no upcharge

3 Wood Finish/Color Options:

BRW	Brownie	ECU	Ecru
CAN	Canyon	HEN	Henna
CIT	Citron	HNY	Honey
DES	Desert	NUT	Nut Brown







Color - Add \$31 list per item

BKD	Backdrop	GRV	Creek Villa
BFX	Black Fox	GLF	Gulf Stream
BWH	Bright White	HTB	Heartthrob
CGP	Cargo Pants	NET	Network Gray
CHT	Chatroom	NWH	Nonchalant White
DSY	Daisy	PAR	Paradise
DRG	Daring	QXP	Quixotic Plum
DYN	Dynamo	RBZ	Relic Bronze
ENG	Enigma	SND	Sandbank
FRR	French Roast	STM	Storm
GBY	Georgian Bay	TRC	Tricorn Black

Specifications

- Wood species - Oak.
- Seat is upholstered with 1" high density polyurethane foam.
- Mortise and tenon construction with corner blocks, glue and screws.
- Coordinating Children's collection. See page 348.
- Standard with rubber cushion metal glides.

- 4 See a selection of graded in fabric manufacturers and patterns on pages 12-20. Contact Customer Service for additional fabric options.

Description	1 Model	Specifications	List Price Per Grade												
Armless Solid Back   753A all wood	753A All Wood 753B Uph. Back · optional laser engraving back imprint, specify location and size - see page 7 for details. (A model only) · when using contrasting upholstery, indicate application and use higher grade pricing	<table border="1"> <thead> <tr> <th>Dimensions</th> <th>D</th> <th>W</th> <th>H</th> </tr> </thead> <tbody> <tr> <td>Overall</td> <td>20</td> <td>18 ¼</td> <td>32 ¼</td> </tr> <tr> <td>Seat</td> <td>16</td> <td>18 ¼</td> <td>17 ¾</td> </tr> </tbody> </table>	Dimensions	D	W	H	Overall	20	18 ¼	32 ¼	Seat	16	18 ¼	17 ¾	All Wood \$313 COM \$364 A \$375 B \$387 COL/C \$407 D \$433 E \$459 F \$487 G \$525 H \$567 I \$633 J \$710 L1 \$534 L2 \$576
		Dimensions	D	W	H										
Overall	20	18 ¼	32 ¼												
Seat	16	18 ¼	17 ¾												
<table border="1"> <thead> <tr> <th>Upholstery</th> <th>Shipping</th> </tr> </thead> <tbody> <tr> <td>COM Ydg</td> <td>¾</td> </tr> <tr> <td>COL Sq Ft</td> <td>8</td> </tr> </tbody> </table>	Upholstery	Shipping	COM Ydg	¾	COL Sq Ft	8									
Upholstery	Shipping														
COM Ydg	¾														
COL Sq Ft	8														
 753B uph. back															
Armless Solid Back   753C Uph. Seat	· optional laser engraving back imprint, specify location and size - see page 7 for details. · when using contrasting upholstery, indicate application and use higher grade pricing	<table border="1"> <thead> <tr> <th>Dimensions</th> <th>D</th> <th>W</th> <th>H</th> </tr> </thead> <tbody> <tr> <td>Overall</td> <td>20</td> <td>18 ¼</td> <td>32 ¼</td> </tr> <tr> <td>Seat</td> <td>16</td> <td>18 ¼</td> <td>17 ¾</td> </tr> </tbody> </table>	Dimensions	D	W	H	Overall	20	18 ¼	32 ¼	Seat	16	18 ¼	17 ¾	COM \$364 A \$376 B \$389 COL/C \$412 D \$441 E \$471 F \$501 G \$545 H \$593 I \$666 J \$753 L1 \$555 L2 \$601
		Dimensions	D	W	H										
Overall	20	18 ¼	32 ¼												
Seat	16	18 ¼	17 ¾												
<table border="1"> <thead> <tr> <th>Upholstery</th> <th>Shipping</th> </tr> </thead> <tbody> <tr> <td>COM Ydg</td> <td>¾</td> </tr> <tr> <td>COL Sq Ft</td> <td>9</td> </tr> </tbody> </table>	Upholstery	Shipping	COM Ydg	¾	COL Sq Ft	9									
Upholstery	Shipping														
COM Ydg	¾														
COL Sq Ft	9														
Armless Solid Back   753D Uph. Seat/Back	· when using contrasting upholstery, indicate application and use higher grade pricing	<table border="1"> <thead> <tr> <th>Dimensions</th> <th>D</th> <th>W</th> <th>H</th> </tr> </thead> <tbody> <tr> <td>Overall</td> <td>20</td> <td>18 ¼</td> <td>32 ¼</td> </tr> <tr> <td>Seat</td> <td>16</td> <td>18 ¼</td> <td>17 ¾</td> </tr> </tbody> </table>	Dimensions	D	W	H	Overall	20	18 ¼	32 ¼	Seat	16	18 ¼	17 ¾	COM \$399 A \$412 B \$426 COL/C \$449 D \$477 E \$507 F \$538 G \$582 H \$628 I \$702 J \$790 L1 \$591 L2 \$638
		Dimensions	D	W	H										
Overall	20	18 ¼	32 ¼												
Seat	16	18 ¼	17 ¾												
<table border="1"> <thead> <tr> <th>Upholstery</th> <th>Shipping</th> </tr> </thead> <tbody> <tr> <td>COM Ydg</td> <td>¾</td> </tr> <tr> <td>COL Sq Ft</td> <td>17</td> </tr> </tbody> </table>	Upholstery	Shipping	COM Ydg	¾	COL Sq Ft	17									
Upholstery	Shipping														
COM Ydg	¾														
COL Sq Ft	17														

To Order, Specify:

- 1 Model Number
- 2 Wood Species - Oak (0)
- 3 Wood Finish/Color
- 4 Fabric Selection - vendor, pattern and color
- 5 Optional laser engraving back imprint—specify location and size; see page 7 for details.
(A and C MODELS ONLY)
- 6 Optional Rubber Cushion Nylon Glides - no upcharge

3 Wood Finish/Color Options:

- | | |
|-------------|---------------|
| BRW Brownie | ECU Ecu |
| CAN Canyon | HEN Henna |
| CIT Citron | HNY Honey |
| DES Desert | NUT Nut Brown |
- Color - Add \$31 list per item
- | | |
|------------------|----------------------|
| BKD Backdrop | GRV Greek Villa |
| BFX Black Fox | GLF Gulf Stream |
| BWH Bright White | HTB Heartthrob |
| CGP Cargo Pants | NET Network Gray |
| CHT Chatroom | NWH Nonchalant White |
| DSY Daisy | PAR Paradise |
| DRG Daring | QXP Quixotic Plum |
| DYN Dynamo | RBZ Relic Bronze |
| ENG Enigma | SND Sandbank |
| FRR French Roast | STM Storm |
| GBY Georgian Bay | TRC Tricorn Black |

Specifications

- Wood species - Oak.
- Seat is upholstered with 1" high density polyurethane foam.
- Mortise and tenon construction with corner blocks, glue and screws.
- Standard with rubber cushion metal glides.

4 See a selection of graded in fabric manufacturers and patterns on pages 12-20. Contact Customer Service for additional fabric options.

Cym Order Check List:



Specify:

- 1. Model Number
- 2. Seat and Back Plastic Color
- 3. Frame Color - Arctic Silver or Black Sandtex
- 4. Fabric Selection - vendor, pattern and color
- 5. Optional Polished Aluminum Base - add \$77 list per chair

Example:

CM4403C | CY | ARCTIC SILVER | MOMENTUM | VOX | MYSTIC
 (model #) | (seat & back color) | (frame color) | (fabric vendor) | (pattern name) | (pattern color)

1. Model Number

2. Seat and Back Plastic Color Options
 (seat and back will be same color):

- CR Chatroom
- CY Cayenne
- FS Fusion
- GV Greek Villa
- RB Resonant Blue
- TB Tricorn Black

3. Frame Color Selection - Arctic Silver or Black Sandtex

4. Fabric Selection - Please supply the following:

- Fabric vendor
- Pattern name
- Pattern color

When specifying contrasting upholstery, indicate clearly which upholstery is to be applied to the seat and back. Use higher grade pricing.

- Indicate direction of fabric - Railroaded or Up the Roll
- Please provide illustration, if available

All COM orders must include the following:



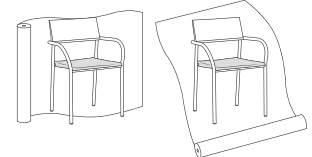

- Vendor's name, pattern name and color
- Sample of the fabric attached to order
- Model numbers of items for fabric application
- Special application instructions (e.g., all stripes will be applied front to back unless specified otherwise)
- Customer and purchase order number

Ship prepaid COM material to:
 Community
 Attn: COM Dept
 932 Mill Street
 Jasper, IN 47546

Application of fabric:
 Railroaded Up the Roll



All COM orders will ship at standard lead time from receipt of COM except for orders requiring special custom matched finishes.

Description	Model	Specifications	List Price Per Grade																
Armless  CM4403A all plastic	CM4403A All Plastic CM4403B Uph. Back · metal frame · single chair weight - 17 lbs	<table border="1"> <thead> <tr> <th>Dimensions</th> <th>D</th> <th>W</th> <th>H</th> </tr> </thead> <tbody> <tr> <td>Overall</td> <td>20 ¼</td> <td>19 ¼</td> <td>32</td> </tr> <tr> <td>Seat</td> <td>17 ½</td> <td>18</td> <td>18</td> </tr> </tbody> </table>	Dimensions	D	W	H	Overall	20 ¼	19 ¼	32	Seat	17 ½	18	18	All Plastic \$441 COM \$521 A \$535 B \$544 COL/C \$561 D \$583 E \$605 F \$640 G \$677 H \$716 I \$776 J \$850 L1 \$684 L2 \$723				
		Dimensions	D	W	H														
Overall	20 ¼	19 ¼	32																
Seat	17 ½	18	18																
<table border="1"> <thead> <tr> <th>Upholstery</th> <th colspan="3">Shipping</th> </tr> </thead> <tbody> <tr> <td>COM Ydg</td> <td>¾</td> <td>Ctn Wt</td> <td>21</td> </tr> <tr> <td>COL Sq Ft</td> <td>9</td> <td>Cu Ft</td> <td>9</td> </tr> </tbody> </table>	Upholstery	Shipping			COM Ydg	¾	Ctn Wt	21	COL Sq Ft	9	Cu Ft	9							
Upholstery	Shipping																		
COM Ydg	¾	Ctn Wt	21																
COL Sq Ft	9	Cu Ft	9																
Armless  CM4403C uph. back	CM4403C Uph. Seat · metal frame · single chair weight - 17 lbs	<table border="1"> <thead> <tr> <th>Dimensions</th> <th>D</th> <th>W</th> <th>H</th> </tr> </thead> <tbody> <tr> <td>Overall</td> <td>20 ¼</td> <td>19 ¼</td> <td>32</td> </tr> <tr> <td>Seat</td> <td>17 ½</td> <td>18</td> <td>18</td> </tr> </tbody> </table>	Dimensions	D	W	H	Overall	20 ¼	19 ¼	32	Seat	17 ½	18	18	COM \$503 A \$519 B \$534 COL/C \$559 D \$592 E \$625 F \$677 G \$731 H \$790 I \$881 J \$992 L1 \$743 L2 \$801				
Dimensions	D	W	H																
Overall	20 ¼	19 ¼	32																
Seat	17 ½	18	18																
		<table border="1"> <thead> <tr> <th>Upholstery</th> <th colspan="3">Shipping</th> </tr> </thead> <tbody> <tr> <td>COM Ydg</td> <td>¾</td> <td>Ctn Wt</td> <td>21</td> </tr> <tr> <td>COL Sq Ft</td> <td>9</td> <td>Cu Ft</td> <td>9</td> </tr> </tbody> </table>	Upholstery	Shipping			COM Ydg	¾	Ctn Wt	21	COL Sq Ft	9	Cu Ft	9					
Upholstery	Shipping																		
COM Ydg	¾	Ctn Wt	21																
COL Sq Ft	9	Cu Ft	9																
Armless  CM4403D uph. back	CM4403D Uph. Seat/Back · metal frame · single chair weight - 17 lbs	<table border="1"> <thead> <tr> <th>Dimensions</th> <th>D</th> <th>W</th> <th>H</th> </tr> </thead> <tbody> <tr> <td>Overall</td> <td>20 ¼</td> <td>19 ¼</td> <td>32</td> </tr> <tr> <td>Seat</td> <td>17 ½</td> <td>18</td> <td>18</td> </tr> </tbody> </table>	Dimensions	D	W	H	Overall	20 ¼	19 ¼	32	Seat	17 ½	18	18	COM \$585 A \$604 B \$624 COL/C \$658 D \$702 E \$746 F \$814 G \$888 H \$966 I \$1,088 J \$1,235 L1 \$902 L2 \$980				
Dimensions	D	W	H																
Overall	20 ¼	19 ¼	32																
Seat	17 ½	18	18																
		<table border="1"> <thead> <tr> <th>Upholstery</th> <th colspan="3">Shipping</th> </tr> </thead> <tbody> <tr> <td>COM Ydg</td> <td>1</td> <td>Ctn Wt</td> <td>21</td> </tr> <tr> <td>COL Sq Ft</td> <td>9</td> <td>Cu Ft</td> <td>9</td> </tr> </tbody> </table>	Upholstery	Shipping			COM Ydg	1	Ctn Wt	21	COL Sq Ft	9	Cu Ft	9					
Upholstery	Shipping																		
COM Ydg	1	Ctn Wt	21																
COL Sq Ft	9	Cu Ft	9																
Arm  CM4401A all plastic	CM4401A All Plastic CM4401B Uph. Back · metal frame · single chair weight - 20 lbs	<table border="1"> <thead> <tr> <th>Dimensions</th> <th>D</th> <th>W</th> <th>H</th> </tr> </thead> <tbody> <tr> <td>Overall</td> <td>20 ¼</td> <td>22 ¾</td> <td>32</td> </tr> <tr> <td>Seat</td> <td>17 ½</td> <td>18</td> <td>18</td> </tr> <tr> <td>Arm</td> <td></td> <td></td> <td>25 ½</td> </tr> </tbody> </table>	Dimensions	D	W	H	Overall	20 ¼	22 ¾	32	Seat	17 ½	18	18	Arm			25 ½	All Plastic \$451 COM \$531 A \$544 B \$554 COL/C \$571 D \$593 E \$615 F \$649 G \$686 H \$725 I \$786 J \$859 L1 \$693 L2 \$732
		Dimensions	D	W	H														
Overall	20 ¼	22 ¾	32																
Seat	17 ½	18	18																
Arm			25 ½																
<table border="1"> <thead> <tr> <th>Upholstery</th> <th colspan="3">Shipping</th> </tr> </thead> <tbody> <tr> <td>COM Ydg</td> <td>¾</td> <td>Ctn Wt</td> <td>24</td> </tr> <tr> <td>COL Sq Ft</td> <td>9</td> <td>Cu Ft</td> <td>10</td> </tr> </tbody> </table>	Upholstery	Shipping			COM Ydg	¾	Ctn Wt	24	COL Sq Ft	9	Cu Ft	10							
Upholstery	Shipping																		
COM Ydg	¾	Ctn Wt	24																
COL Sq Ft	9	Cu Ft	10																

Description	Model	Specifications			List Price Per Grade		
		Dimensions	D	W	H	COM	
Arm 	CM4401C Uph. Seat metal frame · single chair weight - 20 lbs	Overall	20 ¼	22 ¾	32	COM	\$514
		Seat	17 ½	18	18	A	\$530
		Arm			25 ½	B	\$544
		Upholstery		Shipping		COL/C	\$570
		COM Ydg	¾	Ctn Wt	24	D	\$603
		COL Sq Ft	9	Cu Ft	10	E	\$636
						F	\$687
						G	\$742
						H	\$801
						I	\$892
				J	\$1,002		
				L1	\$753		
				L2	\$812		

Description	Model	Specifications			List Price Per Grade		
		Dimensions	D	W	H	COM	
Arm 	CM4401D Uph. Seat/Back metal frame · single chair weight - 20 lbs	Overall	20 ¼	22 ¾	32	COM	\$595
		Seat	17 ½	18	18	A	\$614
		Arm			25 ½	B	\$634
		Upholstery		Shipping		COL/C	\$667
		COM Ydg	1	Ctn Wt	24	D	\$711
		COL Sq Ft	9	Cu Ft	10	E	\$755
						F	\$824
						G	\$897
						H	\$976
						I	\$1,098
				J	\$1,245		
				L1	\$912		
				L2	\$991		

Description	D	W	H	CTN WT	CU FT	Model	List Price
Transport Cart	27	20	14	42	6	TC02	\$576

- 
- welded steel frame
 - 4" industrial casters
 - only available in black

To Order, Specify:

- 1 Model Number
- 2 Seat and Back Plastic Color
- 3 Frame Color - Arctic Silver or Black Sandtex
- 4 Fabric Selection - vendor, pattern and color

3 Seat and Back Plastic Color Options:

- CR Chatroom
- CY Cayenne
- FS Fusion
- GV Greek Villa
- RB Resonant Blue
- TB Tricorn Black









Stack - 10 high on floor or cart (CM4403 and CM4401 models only)

Specifications



- Seat and back are polypropylene.
- Back is upholstered with ½" polyurethane foam.
- Frame is 1" 14 gauge round steel tube; powder coat metal.
- Glide is ABS plastic.
- Stacking bumper is HDPE.
- Upholstered seat has ½" high density polyurethane foam.

- 4 See a selection of graded in fabric manufacturers and patterns on pages 12-20. Contact Customer Service for additional fabric options.

Description	Model	Specifications	List Price Per Grade									
Armless  CM4402A all plastic	CM4402A All Plastic CM4402B Uph. Back · metal frame · single chair weight - 17 lbs · casters - 60 mm dual wheel non-hooded black nylon plastic · non-stacking	Dimensions	All Plastic \$467 COM \$542 A \$556 B \$565 COL/C \$582 D \$604 E \$626 F \$661 G \$698 H \$737 I \$797 J \$871 L1 \$705 L2 \$744									
		<table border="1"> <thead> <tr> <th>D</th> <th>W</th> <th>H</th> </tr> </thead> <tbody> <tr> <td>20 ¼</td> <td>19 ¼</td> <td>32</td> </tr> <tr> <td>17 ½</td> <td>18</td> <td>18</td> </tr> </tbody> </table>		D	W	H	20 ¼	19 ¼	32	17 ½	18	18
D	W	H										
20 ¼	19 ¼	32										
17 ½	18	18										
 CM4402B uph. back		Upholstery										
		<table border="1"> <thead> <tr> <th>Shipping</th> </tr> </thead> <tbody> <tr> <td>Ctn Wt 21</td> </tr> <tr> <td>Cu Ft 9</td> </tr> </tbody> </table>	Shipping	Ctn Wt 21	Cu Ft 9							
Shipping												
Ctn Wt 21												
Cu Ft 9												
Armless 	CM4402C Uph. Seat · metal frame · single chair weight - 17 lbs · casters - 60 mm dual wheel non-hooded black nylon plastic · non-stacking	Dimensions	COM \$524 A \$540 B \$555 COL/C \$580 D \$614 E \$646 F \$698 G \$752 H \$811 I \$903 J \$1,013 L1 \$764 L2 \$823									
		<table border="1"> <thead> <tr> <th>D</th> <th>W</th> <th>H</th> </tr> </thead> <tbody> <tr> <td>20 ¼</td> <td>19 ¼</td> <td>32</td> </tr> <tr> <td>17 ½</td> <td>18</td> <td>18</td> </tr> </tbody> </table>		D	W	H	20 ¼	19 ¼	32	17 ½	18	18
D	W	H										
20 ¼	19 ¼	32										
17 ½	18	18										
		Upholstery										
		<table border="1"> <thead> <tr> <th>Shipping</th> </tr> </thead> <tbody> <tr> <td>Ctn Wt 21</td> </tr> <tr> <td>Cu Ft 9</td> </tr> </tbody> </table>	Shipping	Ctn Wt 21	Cu Ft 9							
Shipping												
Ctn Wt 21												
Cu Ft 9												
Armless 	CM4402D Uph. Seat/Back · metal frame · single chair weight - 17 lbs · casters - 60 mm dual wheel non-hooded black nylon plastic · non-stacking	Dimensions	COM \$606 A \$625 B \$645 COL/C \$680 D \$724 E \$767 F \$836 G \$909 H \$987 I \$1,109 J \$1,256 L1 \$923 L2 \$1,002									
		<table border="1"> <thead> <tr> <th>D</th> <th>W</th> <th>H</th> </tr> </thead> <tbody> <tr> <td>20 ¼</td> <td>19 ¼</td> <td>32</td> </tr> <tr> <td>17 ½</td> <td>18</td> <td>18</td> </tr> </tbody> </table>		D	W	H	20 ¼	19 ¼	32	17 ½	18	18
D	W	H										
20 ¼	19 ¼	32										
17 ½	18	18										
		Upholstery										
		<table border="1"> <thead> <tr> <th>Shipping</th> </tr> </thead> <tbody> <tr> <td>Ctn Wt 21</td> </tr> <tr> <td>Cu Ft 9</td> </tr> </tbody> </table>	Shipping	Ctn Wt 21	Cu Ft 9							
Shipping												
Ctn Wt 21												
Cu Ft 9												
Arm  CM4404A all plastic	CM4404A All Plastic CM4404B Uph. Back · metal frame · single chair weight - 20 lbs · casters - 60 mm dual wheel non-hooded black nylon plastic · non-stacking	Dimensions	All Plastic \$471 COM \$542 A \$556 B \$565 COL/C \$582 D \$604 E \$626 F \$661 G \$698 H \$737 I \$797 J \$871 L1 \$705 L2 \$744									
		<table border="1"> <thead> <tr> <th>D</th> <th>W</th> <th>H</th> </tr> </thead> <tbody> <tr> <td>20 ¼</td> <td>22 ¾</td> <td>32</td> </tr> <tr> <td>17 ½</td> <td>18</td> <td>18</td> </tr> <tr> <td></td> <td></td> <td>25 ½</td> </tr> </tbody> </table>		D	W	H	20 ¼	22 ¾	32	17 ½	18	18
D	W	H										
20 ¼	22 ¾	32										
17 ½	18	18										
		25 ½										
 CM4404B uph. back		Upholstery										
		<table border="1"> <thead> <tr> <th>Shipping</th> </tr> </thead> <tbody> <tr> <td>Ctn Wt 24</td> </tr> <tr> <td>Cu Ft 10</td> </tr> </tbody> </table>	Shipping	Ctn Wt 24	Cu Ft 10							
Shipping												
Ctn Wt 24												
Cu Ft 10												

Description	1 Model	Specifications			List Price Per Grade	
Arm 	CM4404C Uph. Seat • metal frame • single chair weight - 20 lbs • casters - 60 mm dual wheel • non-hooded black nylon plastic • non-stacking	Dimensions	D	W	H	COM \$524
		Overall	20 ¼	22 ¾	32	A \$540
		Seat	17 ½	18	18	B \$555
		Arm			25 ½	COL/C \$580
		Upholstery	Shipping			D \$614
		COM Ydg	¾	Ctn Wt	24	E \$646
		COL Sq Ft	9	Cu Ft	10	F \$698
						G \$752
						H \$811
						I \$903
				J \$1,013		
				L1 \$764		
				L2 \$823		

Description	1 Model	Specifications			List Price Per Grade	
Arm 	CM4404D Uph. Seat/Back • metal frame • single chair weight - 20 lbs • casters - 60 mm dual wheel • non-hooded black nylon plastic • non-stacking	Dimensions	D	W	H	COM \$606
		Overall	20 ¼	22 ¾	32	A \$625
		Seat	17 ½	18	18	B \$645
		Arm			25 ½	COL/C \$680
		Upholstery	Shipping			D \$724
		COM Ydg	1	Ctn Wt	24	E \$767
		COL Sq Ft	9	Cu Ft	10	F \$836
						G \$909
						H \$987
						I \$1,109
				J \$1,256		
				L1 \$923		
				L2 \$1002		

Description	1 Model	Specifications			List Price Per Grade	
Armless  	CM4407A All Plastic CM4407B Uph. Back • counter height stool • metal frame • single chair weight - 20 lbs • non-stacking	Dimensions	D	W	H	All Plastic \$560
		Overall	22	19 ¼	36	COM \$637
		Seat	17 ½	19 ¼	24	A \$651
		Upholstery	Shipping			B \$662
		COM Ydg	¾	Ctn Wt	27	COL/C \$679
		COL Sq Ft	9	Cu Ft	11	D \$701
						E \$723
						F \$756
						G \$793
						H \$832
				I \$894		
				J \$966		
				L1 \$801		
				L2 \$839		

To Order, Specify:

- 1 Model Number
- 2 Seat and Back Plastic Color
- 3 Frame Color - Arctic Silver or Black Sandtex
- 4 Fabric Selection - vendor, pattern and color

3 Seat and Back Plastic Color Options:

- CR Chatroom
- CY Cayenne
- FS Fusion
- GV Greek Villa
- RB Resonant Blue
- TB Tricorn Black







Stack - 10 high on floor or cart (CM4403 and CM4401 models only)

Specifications

- Seat and back are polypropylene.
- Back is upholstered with ½" polyurethane foam.
- Frame is 1" 14 gauge round steel tube; powder coat metal.
- Glide is ABS plastic.
- Stacking bumper is HDPE.
- Upholstered seat has ½" high density polyurethane foam.

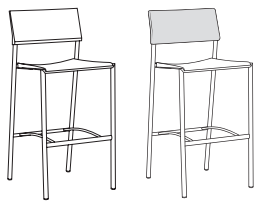
- 4 See a selection of graded in fabric manufacturers and patterns on pages 12-20. Contact Customer Service for additional fabric options.

Description	Model	Specifications	List Price Per Grade												
Armless 	CM4407C Uph. Seat · counter height stool · metal frame · single chair weight - 20 lbs · non-stacking	<table border="1"> <thead> <tr> <th>Dimensions</th> <th>D</th> <th>W</th> <th>H</th> </tr> </thead> <tbody> <tr> <td>Overall</td> <td>22</td> <td>19 ¼</td> <td>36</td> </tr> <tr> <td>Seat</td> <td>17 ½</td> <td>19 ¼</td> <td>24</td> </tr> </tbody> </table>	Dimensions	D	W	H	Overall	22	19 ¼	36	Seat	17 ½	19 ¼	24	COM \$619 A \$636 B \$650 COL/C \$677 D \$709 E \$743 F \$793 G \$849 H \$908 I \$999 J \$1,109 L1 \$859 L2 \$918
		Dimensions	D	W	H										
Overall	22	19 ¼	36												
Seat	17 ½	19 ¼	24												
<table border="1"> <thead> <tr> <th>Upholstery</th> <th colspan="3">Shipping</th> </tr> </thead> <tbody> <tr> <td>COM Ydg</td> <td>¾</td> <td>Ctn Wt</td> <td>27</td> </tr> <tr> <td>COL Sq Ft</td> <td>9</td> <td>Cu Ft</td> <td>11</td> </tr> </tbody> </table>	Upholstery	Shipping			COM Ydg	¾	Ctn Wt	27	COL Sq Ft	9	Cu Ft	11			
Upholstery	Shipping														
COM Ydg	¾	Ctn Wt	27												
COL Sq Ft	9	Cu Ft	11												
Armless 	CM4407D Uph. Seat/Back · counter height stool · metal frame · single chair weight - 20 lbs · non-stacking	<table border="1"> <thead> <tr> <th>Dimensions</th> <th>D</th> <th>W</th> <th>H</th> </tr> </thead> <tbody> <tr> <td>Overall</td> <td>22</td> <td>19 ¼</td> <td>36</td> </tr> <tr> <td>Seat</td> <td>17 ½</td> <td>19 ¼</td> <td>24</td> </tr> </tbody> </table>	Dimensions	D	W	H	Overall	22	19 ¼	36	Seat	17 ½	19 ¼	24	COM \$701 A \$722 B \$741 COL/C \$775 D \$819 E \$864 F \$932 G \$1,005 H \$1,083 I \$1,206 J \$1,352 L1 \$1,020 L2 \$1,098
		Dimensions	D	W	H										
Overall	22	19 ¼	36												
Seat	17 ½	19 ¼	24												
<table border="1"> <thead> <tr> <th>Upholstery</th> <th colspan="3">Shipping</th> </tr> </thead> <tbody> <tr> <td>COM Ydg</td> <td>1</td> <td>Ctn Wt</td> <td>27</td> </tr> <tr> <td>COL Sq Ft</td> <td>9</td> <td>Cu Ft</td> <td>11</td> </tr> </tbody> </table>	Upholstery	Shipping			COM Ydg	1	Ctn Wt	27	COL Sq Ft	9	Cu Ft	11			
Upholstery	Shipping														
COM Ydg	1	Ctn Wt	27												
COL Sq Ft	9	Cu Ft	11												
Armless 	CM4408A All Plastic CM4408B Uph. Back · bar height stool · metal frame · single chair weight - 21 lbs · non-stacking	<table border="1"> <thead> <tr> <th>Dimensions</th> <th>D</th> <th>W</th> <th>H</th> </tr> </thead> <tbody> <tr> <td>Overall</td> <td>22</td> <td>19 ¼</td> <td>42</td> </tr> <tr> <td>Seat</td> <td>17 ½</td> <td>19 ¼</td> <td>30</td> </tr> </tbody> </table>	Dimensions	D	W	H	Overall	22	19 ¼	42	Seat	17 ½	19 ¼	30	All Plastic \$565 COM \$642 A \$657 B \$667 COL/C \$684 D \$706 E \$728 F \$762 G \$798 H \$837 I \$899 J \$972 L1 \$806 L2 \$845
		Dimensions	D	W	H										
Overall	22	19 ¼	42												
Seat	17 ½	19 ¼	30												
<table border="1"> <thead> <tr> <th>Upholstery</th> <th colspan="3">Shipping</th> </tr> </thead> <tbody> <tr> <td>COM Ydg</td> <td>¾</td> <td>Ctn Wt</td> <td>28</td> </tr> <tr> <td>COL Sq Ft</td> <td>9</td> <td>Cu Ft</td> <td>12</td> </tr> </tbody> </table>	Upholstery	Shipping			COM Ydg	¾	Ctn Wt	28	COL Sq Ft	9	Cu Ft	12			
Upholstery	Shipping														
COM Ydg	¾	Ctn Wt	28												
COL Sq Ft	9	Cu Ft	12												
Armless 	CM4408C Uph. Seat · bar height stool · metal frame · single chair weight - 21 lbs · non-stacking	<table border="1"> <thead> <tr> <th>Dimensions</th> <th>D</th> <th>W</th> <th>H</th> </tr> </thead> <tbody> <tr> <td>Overall</td> <td>22</td> <td>19 ¼</td> <td>42</td> </tr> <tr> <td>Seat</td> <td>17 ½</td> <td>19 ¼</td> <td>30</td> </tr> </tbody> </table>	Dimensions	D	W	H	Overall	22	19 ¼	42	Seat	17 ½	19 ¼	30	COM \$625 A \$642 B \$657 COL/C \$683 D \$716 E \$749 F \$800 G \$855 H \$914 I \$1,005 J \$1,116 L1 \$866 L2 \$924
		Dimensions	D	W	H										
Overall	22	19 ¼	42												
Seat	17 ½	19 ¼	30												
<table border="1"> <thead> <tr> <th>Upholstery</th> <th colspan="3">Shipping</th> </tr> </thead> <tbody> <tr> <td>COM Ydg</td> <td>¾</td> <td>Ctn Wt</td> <td>28</td> </tr> <tr> <td>COL Sq Ft</td> <td>9</td> <td>Cu Ft</td> <td>12</td> </tr> </tbody> </table>	Upholstery	Shipping			COM Ydg	¾	Ctn Wt	28	COL Sq Ft	9	Cu Ft	12			
Upholstery	Shipping														
COM Ydg	¾	Ctn Wt	28												
COL Sq Ft	9	Cu Ft	12												

Description	Model	Specifications			List Price Per Grade	
Armless 	CM4408D Uph. Seat/Back • bar height stool • metal frame • single chair weight - 21 lbs • non-stacking	Dimensions	D	W	H	COM \$706 A \$727 B \$747 COL/C \$781 D \$825 E \$869 F \$937 G \$1,011 H \$1,088 I \$1,211 J \$1,357 L1 \$1,025 L2 \$1,103
		Overall	22	19 ¼	42	
		Seat	17 ½	19 ¼	30	
		Upholstery	Shipping			
		COM Ydg	1	Ctn Wt	28	
		COL Sq Ft	9	Cu Ft	12	

Arm	Model	Specifications			List Price Per Grade	
CM4400A All Plastic 	CM4400B Uph. Back • swivel tilt mechanism • black nylon base • optional polished aluminum base - add \$77 list • metal frame • single chair weight - 31 lbs • overall height range is 29 ¼ - 33 • seat height range is 17 ¾ - 21 ½ • arm height range is 24 ½ - 28 ¼	Dimensions	D	W	H	All Plastic \$630 COM \$706 A \$722 B \$732 COL/C \$749 D \$771 E \$793 F \$827 G \$864 H \$902 I \$964 J \$1,037 L1 \$871 L2 \$910
		Overall	20 ¼	22 ¾	33	
CM4400B uph. back		Seat	17 ½	18	21 ½	
		Arm	28 ¼			
		Upholstery	Shipping			
		COM Ydg	¾	Ctn Wt	38	
		COL Sq Ft	9	Cu Ft	13	

Arm	Model	Specifications			List Price Per Grade	
CM4400C Uph. Seat 	• swivel tilt mechanism • black nylon base • optional polished aluminum base - add \$77 list • metal frame • single chair weight - 31 lbs • overall height range is 29 ¼ - 33 • seat height range is 17 ¾ - 21 ½ • arm height range is 24 ½ - 28 ¼	Dimensions	D	W	H	COM \$689 A \$707 B \$722 COL/C \$748 D \$781 E \$814 F \$865 G \$920 H \$979 I \$1,070 J \$1,181 L1 \$931 L2 \$990
		Overall	20 ¼	22 ¾	33	
		Seat	17 ½	18	21 ½	
		Arm	28 ¼			
		Upholstery	Shipping			
		COM Ydg	¾	Ctn Wt	38	
		COL Sq Ft	9	Cu Ft	13	

To Order, Specify:

- 1 Model Number
- 2 Seat and Back Plastic Color
- 3 Frame Color - Arctic Silver or Black Sandtex
- 4 Fabric Selection - vendor, pattern and color
- 5 Optional Polished Aluminum Base - add \$77 list

3 Seat and Back Plastic Color Options:

- CR Chatroom
- CY Cayenne
- FS Fusion
- GV Greek Villa
- RB Resonant Blue
- TB Tricorn Black

- 4 See a selection of graded in fabric manufacturers and patterns on pages 12-20. Contact Customer Service for additional fabric options.

Specifications

- Seat and back are polypropylene.
- Back is upholstered with ½" polyurethane foam.
- Frame is 1" 14 gauge round steel tube; powder coat metal.
- Swivel tilt mechanism has locking, pneumatic height adjustment and tension adjustment.
- Base is glass reinforced black nylon.
- Casters are 60 mm dual wheel non-hooded black nylon plastic.
- Glide is ABS plastic.
- Upholstered seat has ½" high density polyurethane foam.

Description	① Model	Specifications			List Price Per Grade		
Arm 	CM4400D Uph. Seat/Back · swivel tilt mechanism · black nylon base · optional polished aluminum base - add \$77 list · metal frame · single chair weight - 31 lbs · overall height range is 29 ¼ - 33 · seat height range is 17 ¾ - 21 ½ · arm height range is 24 ½ - 28 ¼	Dimensions		D	W	H	COM \$769
		Overall	20 ¼	22 ¾	33	A \$791	
		Seat	17 ½	18	21 ½	B \$810	
		Arm			28 ¼	COL/C \$845	
		Upholstery		Shipping		D \$889	
		COM Ydg	1	Ctn Wt	38	E \$933	
		COL Sq Ft	9	Cu Ft	13	F \$1,001	
						G \$1,075	
						H \$1,152	
						I \$1,275	
						J \$1,421	
						L1 \$1,089	
						L2 \$1,167	

SEATING

To Order, Specify:

- ① Model Number
- ② Seat and Back Plastic Color
- ③ Frame Color - Arctic Silver or Black Sandtex
- ④ Fabric Selection - vendor, pattern and color
- ⑤ Optional Polished Aluminum Base - add \$73 list

③ Seat and Back Plastic Color Options:

- CR Chatroom
- CY Cayenne
- FS Fusion
- GV Greek Villa
- RB Resonant Blue
- TB Tricorn Black

- ④ See a selection of graded in fabric manufacturers and patterns on pages 12-20. Contact Customer Service for additional fabric options.

Specifications

- Seat and back are polypropylene.
- Back is upholstered with ½" polyurethane foam.
- Frame is 1" 14 gauge round steel tube; powder coat metal.
- Swivel tilt mechanism has locking, pneumatic height adjustment and tension adjustment.
- Base is glass reinforced black nylon.
- Casters are 60 mm dual wheel non-hooded black nylon plastic.
- Glide is ABS plastic.
- Upholstered seat has ½" high density polyurethane foam.

Dexter Order Check List:



SEATING

Specify:

- 1. Model Number
- 2. Wood Species - Beech (B)
- 3. Wood Finish/Color
- 4. Fabric Selection - vendor, pattern and color
- 5. Optional Rubber Cushion Nylon Glides - no upcharge

Example:

DR6611D | B | AUB | MOMENTUM | VOX | MYSTIC
 (model #) | (wood species) | (finish) | (fabric vendor) | (pattern name) | (pattern color)

1. Model Number

2. Wood Species - Beech (B)

3. Wood Finish/Color Options: ▲

ALE Ale	FLX Flax
AUB Auburn	HEN Henna
AUT Autumn	HNY Honey
BRL Barley	LGC Legacy
BBN Bourbon	MCH Mocha
BRG Brighton	NTO Night Owl
BRW Brownie	NUT Nut Brown
BUT Butterscotch	PRL Praline
CAN Canyon	SAF Saffron
CIN Cinnamon	SIE Sienna
CIT Citron	TOF Toffee
CLA Classic	TRF Truffle
DES Desert	VEN Venetian
EAR Earthy	
ESP Espresso	
Color - Add \$31 list per item	
BKD Backdrop	GRV Greek Villa
BFX Black Fox	GLF Gulf Stream
BWH Bright White	HTB Heartthrob
CGP Cargo Pants	NET Network Gray
CHT Chatroom	NWH Nonchalant White
DSY Daisy	PAR Paradise
DRG Daring	QXP Quixotic Plum
DYN Dynamo	RBZ Relic Bronze
ENG Enigma	SND Sandbank
FRR French Roast	STM Storm
GBY Georgian Bay	TRC Tricorn Black

4. Fabric Selection - Please supply the following:

- Fabric vendor
- Pattern name
- Pattern color

When specifying contrasting upholstery, indicate clearly which upholstery is to be applied to the seat and back. Use higher grade pricing.

- Indicate direction of fabric - Railroaded or Up the Roll
- Please provide illustration, if available

All COM orders must include the following:

- Vendor's name, pattern name and color
- Sample of the fabric attached to order
- Model numbers of items for fabric application
- Special application instructions (e.g., all stripes will be applied front to back unless specified otherwise)
- Customer and purchase order number

Ship prepaid COM material to:
 Community
 Attn: COM Dept
 932 Mill Street
 Jasper, IN 47546

Application of fabric:
 Railroaded Up the Roll

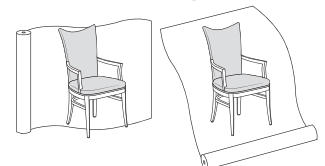

All COM orders will ship at standard lead time from receipt of COM except for orders requiring special custom matched finishes.

Description	1 Model	Specifications				List Price Per Grade
	DR6611D · open arm	Dimensions				COM \$839
			D	W	H	A \$868
		Overall	23	22 1/2	40 1/2	B \$898
		Seat	18 3/4	18 1/4	18 1/2	COL/C \$952
		Arm			25 3/4	D \$1,020
		Upholstery		Shipping		E \$1,088
		COM Ydg	1 3/4	Ctn Wt	38	F \$1,161
		COL Sq Ft	35	Cu Ft	15	G \$1,263
						H \$1,373
						I \$1,544
				J \$1,749		
				L1 \$1,284		
				L2 \$1,393		

	DR6613D · armless	Dimensions				COM \$770
			D	W	H	A \$797
		Overall	23	22 1/2	40 1/2	B \$828
		Seat	18 3/4	18 1/4	18 1/2	COL/C \$881
		Upholstery		Shipping		D \$950
		COM Ydg	1 3/4	Ctn Wt	27	E \$1,018
		COL Sq Ft	35	Cu Ft	14	F \$1,090
						G \$1,192
						H \$1,302
						I \$1,474
				J \$1,678		
				L1 \$1,213		
				L2 \$1,322		

To Order, Specify:

- 1 Model Number
- 2 Wood Species - Beech (B)
- 3 Wood Finish/Color
- 4 Fabric Selection - vendor, pattern and color
- 5 Optional Rubber Cushion Nylon Glides - no upcharge

3 Wood Finish/Color Options: ▲

ALE Ale	FLX Flax
AUB Auburn	HEN Henna
AUT Autumn	HNY Honey
BRL Barley	LGC Legacy
BBN Bourbon	MCH Mocha
BRG Brighton	NTO Night Owl
BRW Brownie	NUT Nut Brown
BUT Butterscotch	PRL Praline
CAN Canyon	SAF Saffron
CIN Cinnamon	SIE Sienna
CIT Citron	TOF Toffee
CLA Classic	TRF Truffle
DES Desert	VEN Venetian
EAR Earthy	
ESP Espresso	

Color - Add \$31 list per item

BKD Backdrop	GRV Greek Villa
BFX Black Fox	GLF Gulf Stream
BWH Bright White	HTB Heartthrob
CGP Cargo Pants	NET Network Gray
CHT Chatroom	NWH Nonchalant White
DSY Daisy	PAR Paradise
DRG Daring	QXP Quixotic Plum
DYN Dynamo	RBZ Relic Bronze
ENG Enigma	SND Sandbank
FRR French Roast	STM Storm
GBY Georgian Bay	TRC Tricorn Black

Specifications

- Wood species - Beech
- Seat as 2 1/2" high density polyurethane foam.
- Back has 2" high density polyurethane foam.
- Mortise and tenon construction with corner blocks, glue and screws.
- Standard with rubber cushion metal glides.

- 4 See a selection of graded in fabric manufacturers and patterns on pages 12-20. Contact Customer Service for additional fabric options.

Dimension Order Check List:



SEATING

Specify:

- 1. Model Number
- 2. Wood Species - Oak (O)
- 3. Wood Finish/Color
- 4. Fabric Selection - vendor, pattern and color
- 5. Optional Laser Engraving Back Imprint - specify location and size

Example:

21C <small>(model #)</small>	O <small>(wood species)</small>	HEN <small>(finish)</small>	MOMENTUM <small>(fabric vendor)</small>	VOX <small>(pattern name)</small>	MYSTIC <small>(pattern color)</small>
---------------------------------	------------------------------------	--------------------------------	--	--------------------------------------	--

1. Model Number

2. Wood Species - Oak (O)

3. Wood Finish/Color Options:

BRW Brownie	ECU Ecru	
CAN Canyon	HEN Henna	
CIT Citron	HNY Honey	
DES Desert	NUT Nut Brown	
Color - Add \$31 list per item		
BKD Backdrop	GRV Greek Villa	
BFX Black Fox	GLF Gulf Stream	
BWH Bright White	HTB Heartthrob	
CGP Cargo Pants	NET Network Gray	
CHT Chatroom	NWH Nonchalant White	
DSY Daisy	PAR Paradise	
DRG Daring	QXP Quixotic Plum	
DYN Dynamo	RBZ Relic Bronze	
ENG Enigma	SND Sandbank	
FRR French Roast	STM Storm	
GBY Georgian Bay	TRC Tricorn Black	

4. Fabric Selection - Please supply the following:

- Fabric vendor
- Pattern name
- Pattern color

When specifying contrasting upholstery, indicate clearly which upholstery is to be applied to the seat and back. Use higher grade pricing.

- Indicate direction of fabric - Railroaded or Up the Roll
- Please provide illustration, if available

All COM orders must include the following:

- Vendor's name, pattern name and color
- Sample of the fabric attached to order
- Model numbers of items for fabric application
- Special application instructions (e.g., all stripes will be applied front to back unless specified otherwise)
- Customer and purchase order number

Ship prepaid COM material to:
Community
Attn: COM Dept
932 Mill Street
Jasper, IN 47546

Application of fabric:
Railroaded Up the Roll

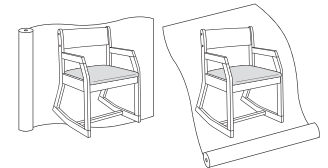









All COM orders will ship at standard lead time from receipt of COM except for orders requiring special custom matched finishes.

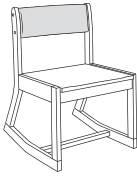

5. Optional Laser Engraving Back Imprint - available on models 20A/C and 21A/C. See page 7 for details.

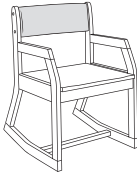

Specify:

- location - inside/outside of back
- size of design

Description	① Model	Specifications	List Price Per Grade																												
Armless   20A all wood	20A All Wood 20B Uph. Back · optional laser engraving back imprint, specify location and size - see page 7 for details. (A model only)	<table border="1"> <thead> <tr> <th>Dimensions</th> <th>D</th> <th>W</th> <th>H</th> </tr> </thead> <tbody> <tr> <td>Overall</td> <td>24 ½</td> <td>21</td> <td>30 ¾-32</td> </tr> <tr> <td>Seat</td> <td>18 ½</td> <td>19</td> <td>16 ½-18 ½</td> </tr> <tr> <th colspan="2">Upholstery</th> <th colspan="2">Shipping</th> </tr> <tr> <td>COM Ydg</td> <td>¾</td> <td>Ctn Wt</td> <td>30</td> </tr> <tr> <td>COL Sq Ft</td> <td>9</td> <td>Cu Ft</td> <td>14</td> </tr> </tbody> </table>	Dimensions	D	W	H	Overall	24 ½	21	30 ¾-32	Seat	18 ½	19	16 ½-18 ½	Upholstery		Shipping		COM Ydg	¾	Ctn Wt	30	COL Sq Ft	9	Cu Ft	14	All Wood \$345 COM \$375 A \$388 B \$401 COL/C \$424 D \$453 E \$482 F \$513 G \$557 H \$604 I \$678 J \$766 L1 \$566 L2 \$613				
		Dimensions	D	W	H																										
Overall	24 ½	21	30 ¾-32																												
Seat	18 ½	19	16 ½-18 ½																												
Upholstery		Shipping																													
COM Ydg	¾	Ctn Wt	30																												
COL Sq Ft	9	Cu Ft	14																												
 20B uph. back																															
Armless  	20C Uph. Seat · optional laser engraving back imprint, specify location and size - see page 7 for details.	<table border="1"> <thead> <tr> <th>Dimensions</th> <th>D</th> <th>W</th> <th>H</th> </tr> </thead> <tbody> <tr> <td>Overall</td> <td>24 ½</td> <td>21</td> <td>30 ¾-32</td> </tr> <tr> <td>Seat</td> <td>18 ½</td> <td>19</td> <td>16 ½-18 ½</td> </tr> <tr> <th colspan="2">Upholstery</th> <th colspan="2">Shipping</th> </tr> <tr> <td>COM Ydg</td> <td>¾</td> <td>Ctn Wt</td> <td>30</td> </tr> <tr> <td>COL Sq Ft</td> <td>9</td> <td>Cu Ft</td> <td>14</td> </tr> </tbody> </table>	Dimensions	D	W	H	Overall	24 ½	21	30 ¾-32	Seat	18 ½	19	16 ½-18 ½	Upholstery		Shipping		COM Ydg	¾	Ctn Wt	30	COL Sq Ft	9	Cu Ft	14	COM \$375 A \$388 B \$401 COL/C \$424 D \$453 E \$482 F \$513 G \$557 H \$604 I \$678 J \$766 L1 \$566 L2 \$613				
Dimensions	D	W	H																												
Overall	24 ½	21	30 ¾-32																												
Seat	18 ½	19	16 ½-18 ½																												
Upholstery		Shipping																													
COM Ydg	¾	Ctn Wt	30																												
COL Sq Ft	9	Cu Ft	14																												
Armless  	20D Uph. Seat/Back	<table border="1"> <thead> <tr> <th>Dimensions</th> <th>D</th> <th>W</th> <th>H</th> </tr> </thead> <tbody> <tr> <td>Overall</td> <td>24 ½</td> <td>21</td> <td>30 ¾-32</td> </tr> <tr> <td>Seat</td> <td>18 ½</td> <td>19</td> <td>16 ½-18 ½</td> </tr> <tr> <th colspan="2">Upholstery</th> <th colspan="2">Shipping</th> </tr> <tr> <td>COM Ydg</td> <td>¾</td> <td>Ctn Wt</td> <td>30</td> </tr> <tr> <td>COL Sq Ft</td> <td>18</td> <td>Cu Ft</td> <td>14</td> </tr> </tbody> </table>	Dimensions	D	W	H	Overall	24 ½	21	30 ¾-32	Seat	18 ½	19	16 ½-18 ½	Upholstery		Shipping		COM Ydg	¾	Ctn Wt	30	COL Sq Ft	18	Cu Ft	14	COM \$448 A \$461 B \$474 COL/C \$497 D \$527 E \$556 F \$587 G \$630 H \$678 I \$751 J \$839 L1 \$640 L2 \$686				
Dimensions	D	W	H																												
Overall	24 ½	21	30 ¾-32																												
Seat	18 ½	19	16 ½-18 ½																												
Upholstery		Shipping																													
COM Ydg	¾	Ctn Wt	30																												
COL Sq Ft	18	Cu Ft	14																												
Arm   21A all wood	21A All Wood 21B Uph. Back · arm height is 25 ¼" when reclined · optional laser engraving back imprint, specify location and size - see page 7 for details. (A model only)	<table border="1"> <thead> <tr> <th>Dimensions</th> <th>D</th> <th>W</th> <th>H</th> </tr> </thead> <tbody> <tr> <td>Overall</td> <td>24 ½</td> <td>21</td> <td>30 ¾-32</td> </tr> <tr> <td>Seat</td> <td>18 ½</td> <td>19</td> <td>16 ½-18 ½</td> </tr> <tr> <td>Arm</td> <td></td> <td></td> <td>23 ¾-25 ¼</td> </tr> <tr> <th colspan="2">Upholstery</th> <th colspan="2">Shipping</th> </tr> <tr> <td>COM Ydg</td> <td>¾</td> <td>Ctn Wt</td> <td>32</td> </tr> <tr> <td>COL Sq Ft</td> <td>9</td> <td>Cu Ft</td> <td>14</td> </tr> </tbody> </table>	Dimensions	D	W	H	Overall	24 ½	21	30 ¾-32	Seat	18 ½	19	16 ½-18 ½	Arm			23 ¾-25 ¼	Upholstery		Shipping		COM Ydg	¾	Ctn Wt	32	COL Sq Ft	9	Cu Ft	14	All Wood \$366 COM \$427 A \$440 B \$453 COL/C \$476 D \$506 E \$535 F \$565 G \$609 H \$657 I \$730 J \$817 L1 \$618 L2 \$665
		Dimensions	D	W	H																										
Overall	24 ½	21	30 ¾-32																												
Seat	18 ½	19	16 ½-18 ½																												
Arm			23 ¾-25 ¼																												
Upholstery		Shipping																													
COM Ydg	¾	Ctn Wt	32																												
COL Sq Ft	9	Cu Ft	14																												
 21B uph. back																															

Description	Model	Specifications			List Price Per Grade	
Arm  	21C Uph. Seat · arm height is 25 ¼" when reclined · optional laser engraving back imprint, specify location and size - see page 7 for details.	Dimensions			COM \$427 A \$440 B \$453 COL/C \$476 D \$506 E \$535 F \$565 G \$609 H \$657 I \$730 J \$817 L1 \$618 L2 \$665	
			D	W		H
		Overall	24 ½	21		30 ¾-32
		Seat	18 ½	19		16 ½-18 ½
		Arm				23 ¾-25 ¼
		Upholstery		Shipping		
		COM Ydg	¾	Ctn Wt		32
		COL Sq Ft	9	Cu Ft		14

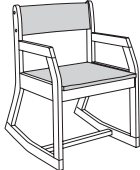
Arm  	21D Uph. Seat/Back · arm height is 25 ¼" when reclined	Dimensions			COM \$481 A \$496 B \$509 COL/C \$532 D \$561 E \$591 F \$621 G \$665 H \$712 I \$785 J \$873 L1 \$674 L2 \$721	
			D	W		H
		Overall	24 ½	21		30 ¾-32
		Seat	18 ½	19		16 ½-18 ½
		Arm				23 ¾-25 ¼
		Upholstery		Shipping		
		COM Ydg	¾	Ctn Wt		32
		COL Sq Ft	18	Cu Ft		14

To Order, Specify:

- ① Model Number
- ② Wood Species - Oak (O)
- ③ Wood Finish/Color
- ④ Fabric Selection - vendor, pattern and color
- ⑤ Optional Laser Engraving Back Imprint - specify location and size; see page 7 for details.
(A and C MODELS ONLY)

③ Wood Finish/Color Options:

BRW	Brownie	ECU	Ecru
CAN	Canyon	HEN	Henna
CIT	Citron	HNY	Honey
DES	Desert	NUT	Nut Brown
Color - Add \$31 list per item			
BKD	Backdrop	GRV	Greek Villa
BFX	Black Fox	GLF	Gulf Stream
BWH	Bright White	HTB	Heartthrob
CGP	Cargo Pants	NET	Network Gray
CHT	Chatroom	NWH	Nonchalant White
DSY	Daisy	PAR	Paradise
DRG	Daring	QXP	Quixotic Plum
DYN	Dynamo	RBZ	Relic Bronze
ENG	Enigma	SND	Sandbank
FRR	French Roast	STM	Storm
GBY	Georgian Bay	TRC	Tricorn Black

Specifications

- Wood species - Oak.
- Two position reclining action allows movement.
- Seat is upholstered with 1 ½" polyurethane foam and synthetic sheet webbing for added comfort.
- Back is upholstered with 1" polyurethane foam.
- Mortise and tenon construction with corner blocks, glue and screws.

- ④ See a selection of graded in fabric manufacturers and patterns on pages 12-20. Contact Customer Service for additional fabric options.

Emerson Order Check List:



SEATING

Specify:

- 1. Model Number
- 2. Wood Species - Oak (O) or Maple (M)
- 3. Wood Finish/Color
- 4. Fabric Selection - vendor, pattern and color
- 5. Optional FRONT LEG Casters - add \$46 list; specify seat height
- 6. Optional Rubber Cushion Nylon Glides - no upcharge

Example:

701C (model #)	O (wood species)	HEN (finish)	MOMENTUM (fabric vendor)	VOX (pattern name)	MYSTIC (pattern color)
-------------------	---------------------	-----------------	-----------------------------	-----------------------	---------------------------

1. Model Number

2. Wood Species - Oak (O) or Maple (M)

3. Wood Finish/Color Options:

Oak			
BRW	Brownie	ECU	Ecru
CAN	Canyon	HEN	Henna
CIT	Citron	HNY	Honey
DES	Desert	NUT	Nut Brown

Maple			
ALE	Ale	FLX	Flax
AUB	Auburn	LGC	Legacy
AUT	Autumn	MCH	Mocha
BRL	Barley	NTO	Night Owl
BBN	Bourbon	PRL	Praline
BRG	Brighton	SAF	Saffron
BUT	Butterscotch	SIE	Sienna
CIN	Cinnamon	TOF	Toffee
CLA	Classic	TRF	Truffle
EAR	Earthy	VEN	Venetian
ESP	Espresso		

Color - Add \$31 list per item

BKD	Backdrop	GRV	Greek Villa
BFX	Black Fox	GLF	Gulf Stream
BWH	Bright White	HTB	Heartthrob
CGP	Cargo Pants	NET	Network Gray
CHT	Chatroom	NWH	Nonchalant White
DSY	Daisy	PAR	Paradise
DRG	Daring	QXP	Quixotic Plum
DYN	Dynamo	RBZ	Relic Bronze
ENG	Enigma	SND	Sandbank
FRR	French Roast	STM	Storm
GBY	Georgian Bay	TRC	Tricorn Black

4. Fabric Selection - Please supply the following:

- Fabric vendor
- Pattern name
- Pattern color

All COM orders must include the following:



- Vendor's name, pattern name and color
- Sample of the fabric attached to order
- Model numbers of items for fabric application
- Special application instructions (e.g., all stripes will be applied front to back unless specified otherwise)
- Customer and purchase order number

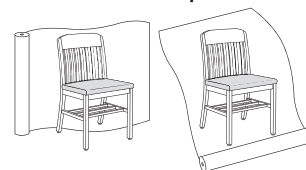

Ship prepaid COM material to:
 Community
 Attn: COM Dept
 932 Mill Street
 Jasper, IN 47546

Application of fabric:
 Railroaded Up the Roll



All COM orders will ship at standard lead time from receipt of COM except for orders requiring special custom matched finishes.

Description	Model	Specifications			List Price Per Grade		
		Dimensions	D	W	H	All Wood	COM
Arm  701A all wood	701A All Wood 701C Uph. Seat • optional front leg casters available - add \$46 list for set of 2 casters	Overall	22 1/2	21 1/2	33 1/4	\$747	\$811
		Seat	18	19 3/4	18	\$830	\$844
 701C uph. seat		Arm			26 1/2	\$866	\$895
			Upholstery		Shipping		\$924
		COM Ydg	3/4	Ctn Wt	33	\$1,000	\$1,046
		COL Sq Ft	9	Cu Ft	12	\$1,120	\$1,208
						L1 \$1,008	L2 \$1,056

Description	Model	Specifications			List Price Per Grade		
		Dimensions	D	W	H	All Wood	COM
Armless   703A all wood	703A All Wood 703C Uph. Seat • optional front leg casters available - add \$46 list for set of 2 casters	Overall	21 1/2	18 1/4	33 1/2	\$644	\$705
		Seat	17	18 1/4	18	\$723	\$735
 703C uph. seat		Upholstery		Shipping		\$759	\$788
		COM Ydg	3/4	Ctn Wt	28	\$817	\$848
		COL Sq Ft	9	Cu Ft	10	\$892	\$939
						I \$1,013	J \$1,100
						L1 \$900	L2 \$948

To Order, Specify:

- 1 Model Number
- 2 Wood Species - Oak (O) or Maple (M)
- 3 Wood Finish/Color
- 4 Fabric Selection - vendor, pattern and color
- 5 Optional FRONT LEG Casters - add \$46 list; specify seat height
- 6 Optional Rubber Cushion Nylon Glides - no upcharge

3 Wood Finish/Color Options:

- | | | |
|------------------|------------------|---------------|
| Oak | BRW Brownie | ECU Ecu |
| AUB Auburn | CAN Canyon | HEN Henna |
| AUT Autumn | CIT Citron | HNY Honey |
| BRL Barley | DES Desert | NUT Nut Brown |
| BBN Bourbon | | |
| BRG Brighton | Maple | FLX Flax |
| BUT Butterscotch | ALE Ale | LGC Legacy |
| CIN Cinnamon | AUB Auburn | MCH Mocha |
| CLA Classic | AUT Autumn | NTO Night Owl |
| EAR Earthy | BRL Barley | PRL Praline |
| ESP Espresso | BBN Bourbon | SAF Saffron |
| | BRG Brighton | SIE Sienna |
| | BUT Butterscotch | TOF Toffee |
| | CIN Cinnamon | TRF Truffle |
| | CLA Classic | VEN Venetian |

Specifications

- Wood species - Oak or Maple.
- Seat is upholstered with 1 1/2" high density polyurethane foam and synthetic sheet webbing for added comfort.
- Mortise and tenon construction with corner blocks, glue and screws.
- Standard with rubber cushion metal glides.

Color - Add \$31 list per item

- | | |
|------------------|----------------------|
| BKD Backdrop | GRV Greek Villa |
| BFX Black Fox | GLF Gulf Stream |
| BWH Bright White | HTB Hearthrob |
| CGP Cargo Pants | NET Network Gray |
| CHT Chatroom | NWH Nonchalant White |
| DSY Daisy | PAR Paradise |
| DRG Daring | QXP Quixotic Plum |
| DYN Dynamo | RBZ Relic Bronze |
| ENG Enigma | SND Sandbank |
| FRR French Roast | STM Storm |
| GBY Georgian Bay | TRC Tricorn Black |

4 See a selection of graded in fabric manufacturers and patterns on pages 12-20. Contact Customer Service for additional fabric options.

Finley Order Check List:

SEATING



Specify:

- 1. Model Number
- 2. Wood Species - Beech (B)
- 3. Wood Seat and Back Finish/Color
- 4. Metal Frame Color
- 5. Fabric Selection - vendor, pattern and color
- 6. Wood Back Style - A or C

Example:

223C | B | AUB | BRONZE | MOMENTUM | VOX | MYSTIC | A
 (model #) | (wood species) | (wood seat & back finish) | (metal frame) | (fabric vendor) | (pattern name) | (pattern color) | (back style)

1. Model Number

2. Wood Species - Beech (B)

3. Wood Seat and Back Finish/Color Options: ▲

ALE Ale	FLX Flax
AUB Auburn	HEN Henna
AUT Autumn	HNY Honey
BRL Barley	LGC Legacy
BBN Bourbon	MCH Mocha
BRG Brighton	NTO Night Owl
BRW Brownie	NUT Nut Brown
BUT Butterscotch	PRL Praline
CAN Canyon	SAF Saffron
CIN Cinnamon	SIE Sienna
CIT Citron	TOF Toffee
CLA Classic	TRF Truffle
DES Desert	VEN Venetian
EAR Earthy	
ESP Espresso	

Color - Add \$31 list per item

BKD Backdrop	GRV Greek Villa
BFX Black Fox	GLF Gulf Stream
BWH Bright White	HTB Heartthrob
CGP Cargo Pants	NET Network Gray
CHT Chatroom	NWH Nonchalant White
DSY Daisy	PAR Paradise
DRG Daring	QXP Quixotic Plum
DYN Dynamo	RBZ Relic Bronze
ENG Enigma	SND Sandbank
FRR French Roast	STM Storm
GBY Georgian Bay	TRC Tricorn Black

4. Metal Frame Color Options

Anodized Nickel	Pewter
Black Sandtex	Silver Bullet
Bronze	Silver Vein
Copper Vein	Sparkle Silver

5. Fabric Selection - Please supply the following:

- Fabric vendor
- Pattern name
- Pattern color

All COM orders must include the following:

- Vendor's name, pattern name and color
- Sample of the fabric attached to order
- Model numbers of items for fabric application
- Special application instructions (e.g., all stripes will be applied front to back unless specified otherwise)
- Customer and purchase order number

Ship prepaid COM material to:
 Community
 Attn: COM Dept
 932 Mill Street
 Jasper, IN 47546

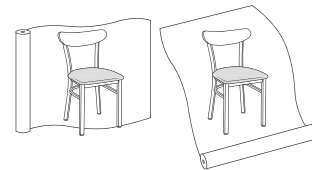

Application of fabric:
 Railroaded Up the Roll





All COM orders will ship at standard lead time from receipt of COM except for orders requiring special custom matched finishes.

6. Wood Back Style



Description	Model	Specifications			List Price Per Grade	
		Dimensions	D	W		H
Armless 	223A Wood Seat				Wood Seat \$345	
	223C Uph. Seat				COM \$355	
		Overall	19	18	32 1/2	A \$369
		Seat	17	17	18	B \$384
		Upholstery		Shipping		COL/C \$409
		COM Ydg	3/4	Ctn Wt	21	D \$441
		COL Sq Ft	9	Cu Ft	8	E \$475
						F \$527
						G \$581
						H \$640
						I \$731
						J \$842
						L1 \$592
						L2 \$650

Description	Model	Specifications			List Price Per Grade	
		Dimensions	D	W		H
Barstool	228A Wood Seat				Wood Seat \$409	
	228C Uph. Seat				COM \$417	
		Overall	20	19	43 1/4	A \$431
		Seat	17	17	30	B \$446
		Upholstery		Shipping		COL/C \$472
		COM Ydg	3/4	Ctn Wt	28	D \$504
		COL Sq Ft	9	Cu Ft	13	E \$538
						F \$590
						G \$644
						H \$703
						I \$794
						J \$905
						L1 \$655
						L2 \$713

To Order, Specify:

- 1 Model Number
- 2 Wood Species - Beech (B)
- 3 Wood Seat and Back Finish/Color
- 4 Metal Frame Color
- 5 Fabric Selection - vendor, pattern and color
- 6 Wood Back Style - A or C

3 Wood Finish/Color Options: ▲

ALE Ale	FLX Flax
AUB Auburn	HEN Henna
AUT Autumn	HNY Honey
BRL Barley	LGC Legacy
BBN Bourbon	MCH Mocha
BRG Brighton	NTO Night Owl
BRW Brownie	NUT Nut Brown
BUT Butterscotch	PRL Praline
CAN Canyon	SAF Saffron
CIN Cinnamon	SIE Sienna
CIT Citron	TOF Toffee
CLA Classic	TRF Truffle
DES Desert	VEN Venetian
EAR Earthy	
ESP Espresso	

Specifications

- Wood species - Beech.
- 18 gauge metal frame.
- Seat is upholstered with 2" high density polyurethane foam.
- Standard with 1 1/4" clear K-resin rocker glides.

Color - Add \$31 list per item

BKD Backdrop	GRV Greek Villa
BFX Black Fox	GLF Gulf Stream
BWH Bright White	HTB Heartthrob
CGP Cargo Pants	NET Network Gray
CHT Chatroom	NWH Nonchalant White
DSY Daisy	PAR Paradise
DRG Daring	QXP Quixotic Plum
DYN Dynamo	RBZ Relic Bronze
ENG Enigma	SND Sandbank
FRR French Roast	STM Storm
GBY Georgian Bay	TRC Tricorn Black

4 Metal Frame/Color Options:

Anodized Nickel	Pewter
Black Sandtex	Silver Bullet
Bronze	Silver Vein
Copper Vein	Sparkle Silver

- 5 See a selection of graded in fabric manufacturers and patterns on pages 12-20. Contact Customer Service for additional fabric options.

Description	① Model	Specifications	List Price Per Grade
Swivel Barstool	229A Wood Seat	Dimensions	Wood Seat \$503
	229C Uph. Seat	D	COM \$511
	· 360° swivel	W	A \$527
	· optional self-centering swivel plate - no upcharge, please specify when ordering	H	B \$541
		Upholstery	COL/C \$566
		Shipping	D \$600
		COM Ydg ¾	E \$633
		COL Sq Ft 9	F \$684
		Ctn Wt 31	G \$739
		Cu Ft 13	H \$797
			I \$889
			J \$999
			L1 \$750
			L2 \$808



229A
wood seat
shown with
A back style

229C
uph. seat
shown with
C back style

To Order, Specify:

- ① Model Number
- ② Wood Species - Beech (B)
- ③ Wood Seat and Back Finish/Color
- ④ Metal Frame Color
- ⑤ Fabric Selection - vendor, pattern and color
- ⑥ Wood Back Style - A or C

③ Wood Finish/Color Options:

- | | |
|------------------|---------------|
| ALE Ale | FLX Flax |
| AUB Auburn | HEN Henna |
| AUT Autumn | HNY Honey |
| BRL Barley | LGC Legacy |
| BBN Bourbon | MCH Mocha |
| BRG Brighton | NTO Night Owl |
| BRW Brownie | NUT Nut Brown |
| BUT Butterscotch | PRL Praline |
| CAN Canyon | SAF Saffron |
| CIN Cinnamon | SIE Sienna |
| CIT Citron | TOF Toffee |
| CLA Classic | TRF Truffle |
| DES Desert | VEN Venetian |
| EAR Earthy | |
| ESP Espresso | |

Color - Add \$31 list per item

- | | |
|------------------|----------------------|
| BKD Backdrop | GRV Greek Villa |
| BFX Black Fox | GLF Gulf Stream |
| BWH Bright White | HTB Heartthrob |
| CGP Cargo Pants | NET Network Gray |
| CHT Chatroom | NWH Nonchalant White |
| DSY Daisy | PAR Paradise |
| DRG Daring | QXP Quixotic Plum |
| DYN Dynamo | RBZ Relic Bronze |
| ENG Enigma | SND Sandbank |
| FRR French Roast | STM Storm |
| GBY Georgian Bay | TRC Tricorn Black |

④ Metal Frame/Color Options:

- | | |
|-----------------|----------------|
| Anodized Nickel | Pewter |
| Black Sandtex | Silver Bullet |
| Bronze | Silver Vein |
| Copper Vein | Sparkle Silver |

- ⑤ See a selection of graded in fabric manufacturers and patterns on pages 12-20. Contact Customer Service for additional fabric options.

Specifications

- Wood species - Beech.
- 18 gauge metal frame.
- Steel ball bearing swivel plate standard on swivel models.
- Seat is upholstered with 2" high density polyurethane foam.
- Standard with 1 ¼" clear K-resin rocker glides.

Hampton Order Check List:



SEATING

Specify:

- 1. Model Number
- 2. Wood Species - Beech (B)
- 3. Wood Finish
- 4. Fabric Selection - vendor, pattern and color
- 5. Optional Rubber Cushion Nylon Glides - no upcharge

Example:

4003C | B | AUB | MOMENTUM | VOX | MYSTIC
 (model #) | (wood species) | (finish) | (fabric vendor) | (pattern name) | (pattern color)

1. Model Number

2. Wood Species - Beech (B)

3. Wood Finish/Color Options: ▲

ALE Ale	ESP Espresso
AUB Auburn	FLX Flax
AUT Autumn	HEN Henna
BRL Barley	HNY Honey
BBN Bourbon	LGC Legacy
BRG Brighton	MCH Mocha
BRW Brownie	NTO Night Owl
BUT Butterscotch	NUT Nut Brown
CAN Canyon	PRL Praline
CIN Cinnamon	SAF Saffron
CIT Citron	SIE Sienna
CLA Classic	TOF Toffee
DES Desert	TRF Truffle
EAR Earthy	VEN Venetian

4. Fabric Selection - Please supply the following:

- Fabric vendor
- Pattern name
- Pattern color

When specifying contrasting upholstery, indicate clearly which upholstery is to be applied to the seat and back. Use higher grade pricing.

- Indicate direction of fabric - Railroaded or Up the Roll
- Please provide illustration, if available

All COM orders must include the following:



- Vendor's name, pattern name and color
- Sample of the fabric attached to order
- Model numbers of items for fabric application
- Special application instructions (e.g., all stripes will be applied front to back unless specified otherwise)
- Customer and purchase order number

Ship prepaid COM material to:
 Community
 Attn: COM Dept
 932 Mill Street
 Jasper, IN 47546

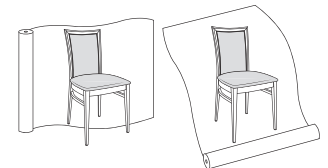
Application of fabric:
 Railroaded Up the Roll



All COM orders will ship at standard lead time from receipt of COM except for orders requiring special custom matched finishes.

Description	① Model	Specifications				List Price Per Grade	
Armless  	4003C Uph. Seat	Dimensions		D	W	H	COM \$471
		Overall	21 ¼	18 ¾	37	A \$485	
		Seat	17 ¾	18 ¾	19	B \$498	
		Upholstery		Shipping		COL/C \$521	
		COM Ydg	¾	Ctn Wt	20	D \$550	
		COL Sq Ft	9	Cu Ft	9	E \$579	
						F \$611	
				G \$655			
				H \$701			
				I \$774			
				J \$863			
				L1 \$663			
				L2 \$710			

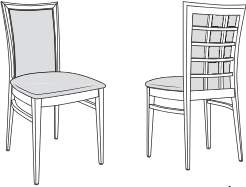
Description	① Model	Specifications				List Price Per Grade	
Armless   exposed back design	4003D Uph. Seat/Back · exposed back design	Dimensions		D	W	H	COM \$584
		Overall	21 ¼	18 ¾	37	A \$604	
		Seat	17 ¾	18 ¾	19	B \$626	
		Upholstery		Shipping		COL/C \$664	
		COM Ydg	1 ¼	Ctn Wt	20	D \$713	
		COL Sq Ft	15	Cu Ft	9	E \$762	
						F \$813	
				G \$887			
				H \$965			
				I \$1,087			
				J \$1,234			
				L1 \$901			
				L2 \$979			

Description	① Model	Specifications				List Price Per Grade	
Barstool 	4008C Uph. Seat · standard with brass scuff plate, also available in polished aluminum or black	Dimensions		D	W	H	COM \$508
		Overall	19 ¾	17 ½	44	A \$522	
		Seat	16 ¼	17 ½	30	B \$535	
		Upholstery		Shipping		COL/C \$558	
		COM Ydg	¾	Ctn Wt	30	D \$587	
		COL Sq Ft	9	Cu Ft	13	E \$617	
						F \$647	
				G \$691			
				H \$739			
				I \$812			
				J \$900			
				L1 \$701			
				L2 \$747			

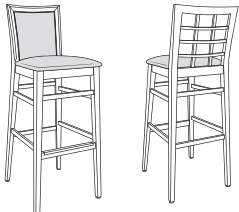
Description	Model	Specifications				List Price Per Grade	
		Dimensions	D	W	H	COM	Grade
Barstool  exposed back design	4008D Uph. Seat/Back · exposed back design standard with brass scuff plate, also available in polished aluminum or matte black	Overall	19 ¾	17 ½	44	COM	\$620
		Seat	16 ¼	17 ½	30	A	\$639
		Upholstery		Shipping		B	\$656
		COM Ydg	1	Ctn Wt	30	COL/C	\$686
		COL Sq Ft	12	Cu Ft	13	D	\$725
						E	\$765
						F	\$806
						G	\$865
						H	\$927
						I	\$1,024
						J	\$1,142
						L1	\$876
						L2	\$938

To Order, Specify:

- ❶ Model Number
- ❷ Wood Species - Beech (B)
- ❸ Wood Finish
- ❹ Fabric Selection - vendor, pattern and color
- ❺ Optional Rubber Cushion Nylon Glides - no upcharge

❸ Wood Finish/Color Options: ▲

ALE Ale	FLX Flax
AUB Auburn	HEN Henna
AUT Autumn	HNY Honey
BRL Barley	LGC Legacy
BBN Bourbon	MCH Mocha
BRG Brighton	NTO Night Owl
BRW Brownie	NUT Nut Brown
BUT Butterscotch	PRL Praline
CAN Canyon	SAF Saffron
CIN Cinnamon	SIE Sienna
CIT Citron	TOF Toffee
CLA Classic	TRF Truffle
DES Desert	VEN Venetian
EAR Earthy	
ESP Espresso	

Specifications

- Wood species - Beech.
- Mitered corner design for additional stability
- Seat is upholstered with 1 ½" high density polyurethane foam.
- Back is upholstered with ½" polyurethane foam.
- Mortise and tenon construction with corner blocks, glue and screws.
- Standard with rubber cushion metal glides.

❹ See a selection of graded in fabric manufacturers and patterns on pages 12-20. Contact Customer Service for additional fabric options.

Hanover Order Check List:



SEATING

Specify:

- 1. Model Number
- 2. Wood Species - Oak (O) or Maple (M)
- 3. Wood Seat Finish/Color
- 4. Metal Frame Color
- 5. Fabric Selection - vendor, pattern and color
- 6. Optional Clear Leg Protectors - add \$15 list per chair for set of 4

Example:

105C | O | HEN | BRONZE | MOMENTUM | VOX | MYSTIC
 (model #) | (wood species) | (wood seat finish) | (metal frame) | (fabric vendor) | (pattern name) | (pattern color)

1. Model Number

2. Wood Species - Oak (O) or Maple (M)

3. Wood Seat Finish/Color Options:

Oak			
BRW	Brownie	ECU	Ecru
CAN	Canyon	HEN	Henna
CIT	Citron	HNY	Honey
DES	Desert	NUT	Nut Brown

Maple			
ALE	Ale	FLX	Flax
AUB	Auburn	LGC	Legacy
AUT	Autumn	MCH	Mocha
BRL	Barley	NTO	Night Owl
BBN	Bourbon	PRL	Praline
BRG	Brighton	SAF	Saffron
BUT	Butterscotch	SIE	Sienna
CIN	Cinnamon	TOF	Toffee
CLA	Classic	TRF	Truffle
EAR	Earthy	VEN	Venetian
ESP	Espresso		

Color - Add \$31 list per item

BKD	Backdrop	GRV	Greek Villa
BFX	Black Fox	GLF	Gulf Stream
BWH	Bright White	HTB	Heartthrob
CGP	Cargo Pants	NET	Network Gray
CHT	Chatroom	NWH	Nonchalant White
DSY	Daisy	PAR	Paradise
DRG	Daring	QXP	Quixotic Plum
DYN	Dynamo	RBZ	Relic Bronze
ENG	Enigma	SND	Sandbank
FRR	French Roast	STM	Storm
GBY	Georgian Bay	TRC	Tricorn Black

4. Metal Frame Color Options

Anodized Nickel	Pewter
Black Sandtex	Silver Bullet
Bronze	Silver Vein
Copper Vein	Sparkle Silver

5. Fabric Selection - Please supply the following:



- Fabric vendor
- Pattern name
- Pattern color

All COM orders must include the following:

- Vendor's name, pattern name and color
- Sample of the fabric attached to order
- Model numbers of items for fabric application
- Special application instructions
- Customer and purchase order number

Ship prepaid COM material to:
 Community
 Attn: COM Dept
 932 Mill Street
 Jasper, IN 47546

All COM orders will ship at standard lead time from receipt of COM except for orders requiring special custom matched finishes.

Description	Model	Specifications				List Price Per Grade
Barstool  105A wood seat 105C uph. seat	105A Wood Seat 105C Uph. Seat	Dimensions	D	W	H	Wood Seat \$285
		Overall	18	18	30 1/2	COM \$341
		Seat		18	30 1/2	A \$353
		Upholstery	Shipping			B \$368
		COM Ydg	3/4	Ctn Wt	22	COL/C \$394
		COL Sq Ft	9	Cu Ft	7	D \$427
						E \$460
						F \$511
						G \$566
						H \$625
						I \$717
						J \$827
						L1 \$577
						L2 \$636
Swivel Barstool  106A wood seat 106C uph. seat	106A Wood Seat 106C Uph. Seat • 360° swivel	Dimensions	D	W	H	Wood Seat \$307
		Overall	18	18	31 1/4	COM \$361
		Seat		18	31 1/4	A \$374
		Upholstery	Shipping			B \$389
		COM Ydg	3/4	Ctn Wt	22	COL/C \$414
		COL Sq Ft	9	Cu Ft	7	D \$447
						E \$480
						F \$532
						G \$586
						H \$645
						I \$737
						J \$847
						L1 \$598
						L2 \$656

To Order, Specify:

- 1 Model Number
- 2 Wood Species - Oak (O) or Maple (M)
- 3 Wood Seat Finish/Color
- 4 Metal Frame Color
- 5 Fabric Selection - vendor, pattern and color
- 6 Optional Clear Leg Protectors - add \$15 list per chair for set of 4

3 Wood Seat Finish/Color Options:

Oak		ECU	Ecru
BRW	Brownie	HEN	Henna
CAN	Canyon	HNY	Honey
CIT	Citron	NUT	Nut Brown
DES	Desert		
Maple			
ALE	Ale	FLX	Flax
AUB	Auburn	LGC	Legacy
AUT	Autumn	MCH	Mocha
BRL	Barley	NTO	Night Owl
BBN	Bourbon	PRL	Praline
BRG	Brighton	SAF	Saffron
BUT	Butterscotch	SIE	Sienna
CIN	Cinnamon	TOF	Toffee
CLA	Classic	TRF	Truffle
EAR	Earthy	VEN	Venetian
ESP	Espresso		

Color - Add \$31 list per item

BKD	Backdrop	GRV	Greek Villa
BFX	Black Fox	GLF	Gulf Stream
BWH	Bright White	HTB	Heartthrob
CGP	Cargo Pants	NET	Network Gray
CHT	Chatroom	NWH	Nonchalant White
DSY	Daisy	PAR	Paradise
DRG	Daring	QXP	Quixotic Plum
DYN	Dynamo	RBZ	Relic Bronze
ENG	Enigma	SND	Sandbank
FRR	French Roast	STM	Storm
GBY	Georgian Bay	TRC	Tricorn Black

4 Metal Frame/Color Options:

Anodized Nickel	Pewter
Black Sandtex	Silver Bullet
Bronze	Silver Vein
Copper Vein	Sparkle Silver

- 5 See a selection of graded in fabric manufacturers and patterns on pages 12-20. Contact Customer Service for additional fabric options.

Specifications

- Wood species - Oak or Maple.
- 18 gauge metal frame.
- Steel ball bearing swivel plate on swivel models.
- Seat is upholstered with 1 1/2" high density polyurethane foam.
- Standard with 1 1/4" clear K-resin rocker glides.
- Legs 1 1/4" square tube.
- Stretcher rim and seat rim 3/4" steel tube.

Hoopz Order Check List:

SEATING



Specify:

- 1. Model Number
- 2. Seat and Back Plastic Color
- 3. Fabric Selections - vendor, pattern and color

Example:

HZ143A (model #)	DG (seat & back color)
----------------------------	----------------------------------

1. Model Number

2. Seat and Back Plastic Color Options:

(seat and back will be the same color)

- BB Balanced Beige
- BN Black Night
- DG Dancing Green
- EW Extra White
- HS Heartstone Gray
- ST Stop Red

3. Fabric Selection - Please supply the following:

- Fabric vendor
- Pattern name
- Pattern color

When specifying contrasting upholstery, indicate clearly which upholstery is to be applied to the seat and back. Use higher grade pricing.

- Indicate direction of fabric - Railroaded or Up the Roll
- Please provide illustration, if available

All COM orders must include the following:

- Vendor's name, pattern name and color
- Sample of the fabric attached to order
- Model numbers of items for fabric application
- Special application instructions (e.g., all stripes will be applied front to back unless specified otherwise)
- Customer and purchase order number

Ship prepaid COM material to:
 Community
 Attn: COM Dept
 932 Mill Street
 Jasper, IN 47546

Application of fabric:
 Railroaded Up the Roll

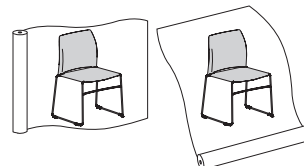

All COM orders will ship at standard lead time from receipt of COM except for orders requiring special custom matched finishes.

Description	① Model	Specifications			List Price	
Armless 	HZ143A · metal frame · single chair weight - 13 lbs · load capacity meets or exceeds BIFMA requirements · integrated passive linking glide · stacks 10 [▲] high on the floor or 45 on the cart	Dimensions	D	W	H	\$225
		Overall	22	21 ¾	33	
		Seat	16 ¾	17 ½	18	
		Upholstery	Shipping			
			Ctn Wt	17		
			Cu Ft	12		

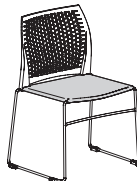
Description	① Model	Specifications			List Price Per Grade		
		Armless 	HZ143C · upholstered seat · metal frame · single chair weight 13 lbs · load capacity meets or exceeds BIFMA requirements · integrated passive linking glide · stacking not recommended	Dimensions	D	W	H
Overall	22	21 ¾		33	A	\$362	
		Seat	16 ¾	17 ½	18	B	\$376
		Upholstery	Shipping			COL/C	\$402
		COM Ydg	¾	Ctn Wt	17	D	\$433
		COL Sq Ft	15	Cu Ft	12	E	\$466
						F	\$516
						G	\$571
						H	\$627
						I	\$718
						J	\$826
						L1	\$581
						L2	\$645

Description	① Model	Specifications			List Price Per Grade		
		Armless 	HZ143D · upholstered seat and back · metal frame · single chair weight 15 lbs · load capacity meets or exceeds BIFMA requirements · integrated passive linking glide · stacking not recommended	Dimensions	D	W	H
Overall	22	21 ¾		33	A	\$438	
		Seat	16 ¾	17 ½	18	B	\$460
		Upholstery	Shipping			COL/C	\$499
		COM Ydg	1 ¼	Ctn Wt	18	D	\$549
		COL Sq Ft	23	Cu Ft	12	E	\$598
						F	\$675
						G	\$758
						H	\$846
						I	\$983
						J	\$1,148
						L1	\$774
						L2	\$873

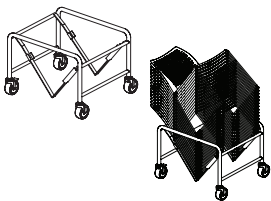
Description	D	W	H	CTN WT	CU FT	① Model	List Price
Transport Cart 	30	26	19	40	9	HZ140	\$957
· welded steel frame · four heavy duty casters · two locking casters · only available in black · cart accommodates 45 HZ143A chairs · total height with 45 chairs stacked on cart is 7'							

To Order, Specify:

- ① Model Number
- ② Seat and Back Plastic Color
- ③ Fabric Selection - vendor, pattern and color

② Seat and Back Plastic Color Options:

- BB Balanced Beige
- BN Black Knight
- DG Dancing Green
- EW Extra White
- HS Heartstone Gray
- ST Stop Red

③ See a selection of graded in fabric manufacturers and patterns on pages 12-20. Contact Customer Service for additional fabric options.

Specifications

- Metal frame.
- Load capacity meets or exceeds BIFMA requirements.
- Integrated passive linking glide.

Kendall Order Check List:



SEATING

Specify:

- 1. Model Number
- 2. Wood Species - Beech (B)
- 3. Wood Finish
- 4. Fabric Selection - vendor, pattern and color
- 5. Optional Rubber Cushion Nylon Glides - no upcharge

Example:

KE6551D | B | AUB | MOMENTUM | VOX | MYSTIC
 (model #) | (wood species) | (finish) | (fabric vendor) | (pattern name) | (pattern color)

1. Model Number

2. Wood Species - Beech (B)

3. Wood Finish Options: ▲

ALE Ale	ESP Espresso
AUB Auburn	FLX Flax
AUT Autumn	HEN Henna
BRL Barley	HNY Honey
BBN Bourbon	LGC Legacy
BRG Brighton	MCH Mocha
BRW Brownie	NTO Night Owl
BUT Butterscotch	NUT Nut Brown
CAN Canyon	PRL Praline
CIN Cinnamon	SAF Saffron
CIT Citron	SIE Sienna
CLA Classic	TOF Toffee
DES Desert	TRF Truffle
EAR Earthy	VEN Venetian

4. Fabric Selection - Please supply the following:

- Fabric vendor
- Pattern name
- Pattern color

When specifying contrasting upholstery, indicate clearly which upholstery is to be applied to the seat and back. Use higher grade pricing.

- Indicate direction of fabric - Railroaded or Up the Roll
- Please provide illustration, if available

All COM orders must include the following:

- Vendor's name, pattern name and color
- Sample of the fabric attached to order
- Model numbers of items for fabric application
- Special application instructions (e.g., all stripes will be applied front to back unless specified otherwise)
- Customer and purchase order number

Ship prepaid COM material to:
 Community
 Attn: COM Dept
 932 Mill Street
 Jasper, IN 47546

Application of fabric:
 Railroaded Up the Roll

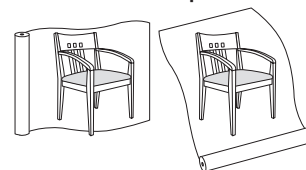

All COM orders will ship at standard lead time from receipt of COM except for orders requiring special custom matched finishes.

Description	Model	Specifications	List Price Per Grade																
Side Chair 	KE6571C · upholstered seat · vertical slat back/square detail	<table border="1"> <thead> <tr> <th>Dimensions</th> <th>D</th> <th>W</th> <th>H</th> </tr> </thead> <tbody> <tr> <td>Overall</td> <td>22 ½</td> <td>22 ¼</td> <td>33 ½</td> </tr> <tr> <td>Seat</td> <td>19</td> <td>19</td> <td>19</td> </tr> <tr> <td>Arm</td> <td></td> <td></td> <td>27</td> </tr> </tbody> </table>	Dimensions	D	W	H	Overall	22 ½	22 ¼	33 ½	Seat	19	19	19	Arm			27	COM \$773 A \$781 B \$793 COL/C \$816 D \$846 E \$875 F \$906 G \$950 H \$997 I \$1,070 J \$1,158 L1 \$958 L2 \$1,005
		Dimensions	D	W	H														
		Overall	22 ½	22 ¼	33 ½														
		Seat	19	19	19														
		Arm			27														
		<table border="1"> <thead> <tr> <th>Upholstery</th> <th>Shipping</th> </tr> </thead> <tbody> <tr> <td>COM Ydg</td> <td>¾ Ctn Wt 30</td> </tr> <tr> <td>COL Sq Ft</td> <td>9 Cu Ft 15</td> </tr> </tbody> </table>	Upholstery	Shipping	COM Ydg	¾ Ctn Wt 30	COL Sq Ft	9 Cu Ft 15											
		Upholstery	Shipping																
		COM Ydg	¾ Ctn Wt 30																
		COL Sq Ft	9 Cu Ft 15																

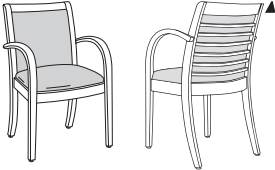
Description	Model	Specifications	List Price Per Grade																
Side Chair  <p>exposed back design</p>	KE6581D · upholstered seat and back · exposed horizontal slat back-side	<table border="1"> <thead> <tr> <th>Dimensions</th> <th>D</th> <th>W</th> <th>H</th> </tr> </thead> <tbody> <tr> <td>Overall</td> <td>21 ¼</td> <td>22 ¾</td> <td>32 ¾</td> </tr> <tr> <td>Seat</td> <td>16 ½</td> <td>18 ¾</td> <td>19 ¾</td> </tr> <tr> <td>Arm</td> <td></td> <td></td> <td>28 ¼</td> </tr> </tbody> </table>	Dimensions	D	W	H	Overall	21 ¼	22 ¾	32 ¾	Seat	16 ½	18 ¾	19 ¾	Arm			28 ¼	COM \$851 A \$860 B \$877 COL/C \$908 D \$948 E \$986 F \$1,027 G \$1,086 H \$1,148 I \$1,247 J \$1,363 L1 \$1,098 L2 \$1,161
		Dimensions	D	W	H														
		Overall	21 ¼	22 ¾	32 ¾														
		Seat	16 ½	18 ¾	19 ¾														
		Arm			28 ¼														
		<table border="1"> <thead> <tr> <th>Upholstery</th> <th>Shipping</th> </tr> </thead> <tbody> <tr> <td>COM Ydg</td> <td>1 Ctn Wt 30</td> </tr> <tr> <td>COL Sq Ft</td> <td>12 Cu Ft 12</td> </tr> </tbody> </table>	Upholstery	Shipping	COM Ydg	1 Ctn Wt 30	COL Sq Ft	12 Cu Ft 12											
		Upholstery	Shipping																
		COM Ydg	1 Ctn Wt 30																
		COL Sq Ft	12 Cu Ft 12																

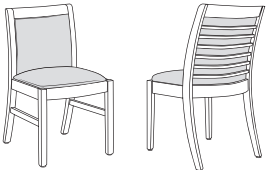
Description	Model	Specifications	List Price Per Grade																
Armless  <p>exposed back design</p>	KE6583D · upholstered seat and back · exposed horizontal slat back-side · metal glides	<table border="1"> <thead> <tr> <th>Dimensions</th> <th>D</th> <th>W</th> <th>H</th> </tr> </thead> <tbody> <tr> <td>Overall</td> <td>20 ¾</td> <td>19</td> <td>33</td> </tr> <tr> <td>Seat</td> <td>16</td> <td>17 ¾</td> <td>18</td> </tr> <tr> <td>Arm</td> <td></td> <td></td> <td></td> </tr> </tbody> </table>	Dimensions	D	W	H	Overall	20 ¾	19	33	Seat	16	17 ¾	18	Arm				COM \$790 A \$811 B \$829 COL/C \$859 D \$898 E \$937 F \$978 G \$1,037 H \$1,100 I \$1,197 J \$1,315 L1 \$1,048 L2 \$1,111
		Dimensions	D	W	H														
		Overall	20 ¾	19	33														
		Seat	16	17 ¾	18														
		Arm																	
		<table border="1"> <thead> <tr> <th>Upholstery</th> <th>Shipping</th> </tr> </thead> <tbody> <tr> <td>COM Ydg</td> <td>1 Ctn Wt 21</td> </tr> <tr> <td>COL Sq Ft</td> <td>12 Cu Ft 9</td> </tr> </tbody> </table>	Upholstery	Shipping	COM Ydg	1 Ctn Wt 21	COL Sq Ft	12 Cu Ft 9											
		Upholstery	Shipping																
		COM Ydg	1 Ctn Wt 21																
		COL Sq Ft	12 Cu Ft 9																

To Order, Specify:

- 1 Model Number
- 2 Wood Species - Beech (B)
- 3 Wood Finish
- 4 Fabric Selection - vendor, pattern and color
- 5 Optional Rubber Cushion Nylon Glides - no upcharge

3 Wood Finish Options:

ALE Ale	FLX Flax
AUB Auburn	HEN Henna
AUT Autumn	HNY Honey
BRL Barley	LGC Legacy
BBN Bourbon	MCH Mocha
BRG Brighton	NTO Night Owl
BRW Brownie	NUT Nut Brown
BUT Butterscotch	PRL Praline
CAN Canyon	SAF Saffron
CIN Cinnamon	SIE Sienna
CIT Citron	TOF Toffee
CLA Classic	TRF Truffle
DES Desert	VEN Venetian
EAR Earthy	
ESP Espresso	

Specifications

- Wood species - Beech.
- Seat has 1 ½" polyurethane foam.
- Back has 1" polyurethane foam.
- Mortise and tenon construction with corner blocks, glue and screws.
- Standard with rubber cushion metal glides.

4 See a selection of graded in fabric manufacturers and patterns on pages 12-20. Contact Customer Service for additional fabric options.

Kinsey Order Check List:



SEATING

- Specify:**
- 1. Model Number
 - 2. Wood Species - Beech (B)
 - 3. Wood Finish
 - 4. Fabric Selection - vendor, pattern and color
 - 5. Optional Rubber Cushion Nylon Glides - no upcharge

Example:

1381D <small>(model #)</small>	B <small>(wood species)</small>	AUB <small>(finish)</small>	MOMENTUM <small>(fabric vendor)</small>	VOX <small>(pattern name)</small>	MYSTIC <small>(pattern color)</small>
-----------------------------------	------------------------------------	--------------------------------	--	--------------------------------------	--

1. Model Number

2. Wood Species - Beech (B)

3. Wood Finish Options: ▲

ALE Ale	ESP Espresso
AUB Auburn	FLX Flax
AUT Autumn	HEN Henna
BRL Barley	HNY Honey
BBN Bourbon	LGC Legacy
BRG Brighton	MCH Mocha
BRW Brownie	NTO Night Owl
BUT Butterscotch	NUT Nut Brown
CAN Canyon	PRL Praline
CIN Cinnamon	SAF Saffron
CIT Citron	SIE Sienna
CLA Classic	TOF Toffee
DES Desert	TRF Truffle
EAR Earthy	VEN Venetian

4. Fabric Selection - Please supply the following:

- Fabric vendor
- Pattern name
- Pattern color

When specifying contrasting upholstery, indicate clearly which upholstery is to be applied to the seat and back. Use higher grade pricing.

- Indicate direction of fabric - Railroaded or Up the Roll
- Please provide illustration, if available

All COM orders must include the following:

- Vendor's name, pattern name and color
- Sample of the fabric attached to order
- Model numbers of items for fabric application
- Special application instructions (e.g., all stripes will be applied front to back unless specified otherwise)
- Customer and purchase order number

Ship prepaid COM material to:
Community
Attn: COM Dept
932 Mill Street
Jasper, IN 47546

Application of fabric:
Railroaded Up the Roll

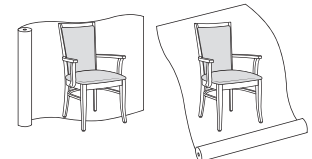

All COM orders will ship at standard lead time from receipt of COM except for orders requiring special custom matched finishes.

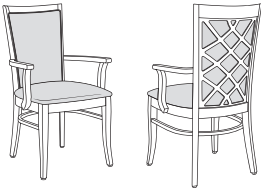
Description	1 Model	Specifications	List Price Per Grade																																										
Arm  exposed back design	1381D Uph. Seat/Back · exposed back design	<table border="1"> <thead> <tr> <th>Dimensions</th> <th>D</th> <th>W</th> <th>H</th> </tr> </thead> <tbody> <tr> <td>Overall</td> <td>22</td> <td>22 ½</td> <td>37 ½</td> </tr> <tr> <td>Seat</td> <td>18</td> <td>18 ½</td> <td>18</td> </tr> <tr> <td>Arm</td> <td></td> <td></td> <td>25 ¼</td> </tr> </tbody> </table>	Dimensions	D	W	H	Overall	22	22 ½	37 ½	Seat	18	18 ½	18	Arm			25 ¼	<table border="1"> <tbody> <tr> <td>COM</td> <td>\$705</td> </tr> <tr> <td>A</td> <td>\$731</td> </tr> <tr> <td>B</td> <td>\$762</td> </tr> <tr> <td>COL/C</td> <td>\$815</td> </tr> <tr> <td>D</td> <td>\$884</td> </tr> <tr> <td>E</td> <td>\$952</td> </tr> <tr> <td>F</td> <td>\$1,024</td> </tr> <tr> <td>G</td> <td>\$1,127</td> </tr> <tr> <td>H</td> <td>\$1,236</td> </tr> <tr> <td>I</td> <td>\$1,407</td> </tr> <tr> <td>J</td> <td>\$1,612</td> </tr> <tr> <td>L1</td> <td>\$1,147</td> </tr> <tr> <td>L2</td> <td>\$1,256</td> </tr> </tbody> </table>	COM	\$705	A	\$731	B	\$762	COL/C	\$815	D	\$884	E	\$952	F	\$1,024	G	\$1,127	H	\$1,236	I	\$1,407	J	\$1,612	L1	\$1,147	L2	\$1,256
		Dimensions	D	W	H																																								
Overall	22	22 ½	37 ½																																										
Seat	18	18 ½	18																																										
Arm			25 ¼																																										
COM	\$705																																												
A	\$731																																												
B	\$762																																												
COL/C	\$815																																												
D	\$884																																												
E	\$952																																												
F	\$1,024																																												
G	\$1,127																																												
H	\$1,236																																												
I	\$1,407																																												
J	\$1,612																																												
L1	\$1,147																																												
L2	\$1,256																																												
		<table border="1"> <thead> <tr> <th>Upholstery</th> <th colspan="2">Shipping</th> </tr> </thead> <tbody> <tr> <td>COM Ydg</td> <td>1 ¾</td> <td>Ctn Wt 26</td> </tr> <tr> <td>COL Sq Ft</td> <td>35</td> <td>Cu Ft 12</td> </tr> </tbody> </table>	Upholstery	Shipping		COM Ydg	1 ¾	Ctn Wt 26	COL Sq Ft	35	Cu Ft 12																																		
Upholstery	Shipping																																												
COM Ydg	1 ¾	Ctn Wt 26																																											
COL Sq Ft	35	Cu Ft 12																																											

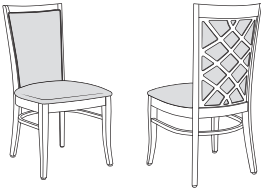
Description	1 Model	Specifications	List Price Per Grade																																						
Armless  exposed back design	1383D Uph. Seat/Back · exposed back design	<table border="1"> <thead> <tr> <th>Dimensions</th> <th>D</th> <th>W</th> <th>H</th> </tr> </thead> <tbody> <tr> <td>Overall</td> <td>22</td> <td>20</td> <td>37 ½</td> </tr> <tr> <td>Seat</td> <td>18</td> <td>18 ½</td> <td>18</td> </tr> </tbody> </table>	Dimensions	D	W	H	Overall	22	20	37 ½	Seat	18	18 ½	18	<table border="1"> <tbody> <tr> <td>COM</td> <td>\$628</td> </tr> <tr> <td>A</td> <td>\$654</td> </tr> <tr> <td>B</td> <td>\$684</td> </tr> <tr> <td>COL/C</td> <td>\$738</td> </tr> <tr> <td>D</td> <td>\$806</td> </tr> <tr> <td>E</td> <td>\$874</td> </tr> <tr> <td>F</td> <td>\$947</td> </tr> <tr> <td>G</td> <td>\$1,048</td> </tr> <tr> <td>H</td> <td>\$1,159</td> </tr> <tr> <td>I</td> <td>\$1,330</td> </tr> <tr> <td>J</td> <td>\$1,535</td> </tr> <tr> <td>L1</td> <td>\$1,069</td> </tr> <tr> <td>L2</td> <td>\$1,179</td> </tr> </tbody> </table>	COM	\$628	A	\$654	B	\$684	COL/C	\$738	D	\$806	E	\$874	F	\$947	G	\$1,048	H	\$1,159	I	\$1,330	J	\$1,535	L1	\$1,069	L2	\$1,179
		Dimensions	D	W	H																																				
Overall	22	20	37 ½																																						
Seat	18	18 ½	18																																						
COM	\$628																																								
A	\$654																																								
B	\$684																																								
COL/C	\$738																																								
D	\$806																																								
E	\$874																																								
F	\$947																																								
G	\$1,048																																								
H	\$1,159																																								
I	\$1,330																																								
J	\$1,535																																								
L1	\$1,069																																								
L2	\$1,179																																								
		<table border="1"> <thead> <tr> <th>Upholstery</th> <th colspan="2">Shipping</th> </tr> </thead> <tbody> <tr> <td>COM Ydg</td> <td>1 ¾</td> <td>Ctn Wt 22</td> </tr> <tr> <td>COL Sq Ft</td> <td>35</td> <td>Cu Ft 9</td> </tr> </tbody> </table>	Upholstery	Shipping		COM Ydg	1 ¾	Ctn Wt 22	COL Sq Ft	35	Cu Ft 9																														
Upholstery	Shipping																																								
COM Ydg	1 ¾	Ctn Wt 22																																							
COL Sq Ft	35	Cu Ft 9																																							

To Order, Specify:

- 1 Model Number
- 2 Wood Species - Beech (B)
- 3 Wood Finish
- 4 Fabric Selection - vendor, pattern and color
- 5 Optional Rubber Cushion Nylon Glides - no upcharge

3 Wood Finish Options:

- | | |
|------------------|---------------|
| ALE Ale | FLX Flax |
| AUB Auburn | HEN Henna |
| AUT Autumn | HNY Honey |
| BRL Barley | LGC Legacy |
| BBN Bourbon | MCH Mocha |
| BRG Brighton | NTO Night Owl |
| BRW Brownie | NUT Nut Brown |
| BUT Butterscotch | PRL Praline |
| CAN Canyon | SAF Saffron |
| CIN Cinnamon | SIE Sienna |
| CIT Citron | TOF Toffee |
| CLA Classic | TRF Truffle |
| DES Desert | VEN Venetian |
| EAR Earthy | |
| ESP Espresso | |

Specifications

- Wood species - Beech.
- Seat is upholstered with 2" high density polyurethane foam.
- Back is upholstered with 1" polyurethane foam.
- Mortise and tenon construction with corner blocks, glue and screws.
- Standard with rubber cushion metal glides.

4 See a selection of graded in fabric manufacturers and patterns on pages 12-20. Contact Customer Service for additional fabric options.

Laurel Lounge Order Check List:



SEATING

Specify:

- 1. Model Number
- 2. Wood Species - Beech (B) (chairs) or Maple (M) (tables)
- 3. Wood Finish/Color
- 4. Fabric Selection - vendor, pattern and color
- 5. Optional Anti-Microbial Arm Cap - add \$56 list per arm cap
- 6. Optional Rubber Cushion Nylon Glides - no upcharge
- 7. Optional Coordinating Wood Grain Laminate Table Tops - no upcharge; tables only

Example:

LA1281 (model #)	B (wood species)	AUB (finish)	MOMENTUM (fabric vendor)	VOX (pattern name)	MYSTIC (pattern color)
----------------------------	----------------------------	------------------------	------------------------------------	------------------------------	----------------------------------

1. Model Number

2. Wood Species - Beech (B) (chairs) or Maple (M) (tables)

3. Wood Finish/Color Options: ▲

Beech/Maple

ALE Ale*	FLX Flax
AUB Auburn*	HEN Henna*
AUT Autumn*	HNY Honey*
BRL Barley*	LGC Legacy*
BBN Bourbon*	MCH Mocha*
BRG Brighton*	NTO Night Owl*
BRW Brownie*	NUT Nut Brown*
BUT Butterscotch	PRL Praline*
CAN Canyon*	SAF Saffron*
CIN Cinnamon*	SIE Sienna*
CIT Citron*	TOF Toffee*
CLA Classic*	TRF Truffle*
DES Desert*	VEN Venetian*
EAR Earthy	
ESP Espresso	

Color - Add \$31 list per item

BKD Backdrop	GRV Greek Villa
BFX Black Fox	GLF Gulf Stream
BWH Bright White	HTB Heartthrob
CGP Cargo Pants	NET Network Gray
CHT Chatroom	NWH Nonchalant White
DSY Daisy	PAR Paradise
DRG Daring	QXP Quixotic Plum
DYN Dynamo	RBZ Relic Bronze
ENG Enigma	SND Sandbank
FRR French Roast	STM Storm
GBY Georgian Bay	TRC Tricorn Black

4. Fabric Selection - Please supply the following:

Fabric vendor
 Pattern name
 Pattern color

When specifying contrasting upholstery, indicate clearly which upholstery is to be applied to the seat and back. Use higher grade pricing.

- Indicate direction of fabric - Railroaded or Up the Roll
- Please provide illustration, if available

All COM orders must include the following:

- Vendor's name, pattern name and color
- Sample of the fabric attached to order
- Model numbers of items for fabric application
- Special application instructions (e.g., all stripes will be applied front to back unless specified otherwise)
- Customer and purchase order number

Ship prepaid COM material to:
 Community
 Attn: COM Dept
 932 Mill Street
 Jasper, IN 47546

Application of fabric:
 Railroaded Up the Roll

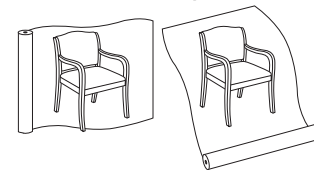

All COM orders will ship at standard lead time from receipt of COM except for orders requiring special custom matched finishes.

5. Optional Anti-Microbial Arm Cap - add \$56 list per arm cap. Available on any Laurel model.



6. Optional Rubber Cushion Nylon Glides - no upcharge; chairs only

7. Optional Coordinating Wood Grain Laminate Table Tops - no upcharge; tables only. Finishes with an asterisk (*) have a coordinating laminate available.

Description	Model	Specifications				List Price Per Grade
		Dimensions	D	W	H	
Side Chair 	LA1281 · optional anti-microbial arm cap - add \$112 list					COM \$741
						A \$754
						B \$781
						COL/C \$826
						D \$885
						E \$943
						F \$1,005
						G \$1,094
						H \$1,187
						I \$1,334
				J \$1,509		
				L1 \$1,110		
				L2 \$1,205		

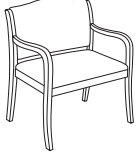
Description	Model	Specifications				List Price Per Grade
		Dimensions	D	W	H	
30" Bariatric 	LA1281B · meets BIFMA x5.11 large occupant standard (253-400 lb individual) · optional antimicrobial arm cap - add \$112 list					COM \$1,448
						A \$1,468
						B \$1,507
						COL/C \$1,577
						D \$1,664
						E \$1,752
						F \$1,845
						G \$1,977
						H \$2,117
						I \$2,338
				J \$2,601		
				L1 \$2,003		
				L2 \$2,144		

To Order, Specify:

- 1 Model Number
- 2 Wood Species - Beech (B)
- 3 Wood Finish/Color
- 4 Fabric Selection - vendor, pattern and color
- 5 Optional Anti-Microbial Arm Cap - add \$56 list per arm cap
- 6 Optional Rubber Cushion Nylon Glides - no upcharge

3 Wood Finish/Color Options:

ALE Ale*	FLX Flax
AUB Auburn*	HEN Henna*
AUT Autumn*	HNY Honey*
BRL Barley*	LGC Legacy*
BBN Bourbon*	MCH Mocha*
BRG Brighton*	NTO Night Owl*
BRW Brownie*	NUT Nut Brown*
BUT Butterscotch	PRL Praline*
CAN Canyon*	SAF Saffron*
CIN Cinnamon*	SIE Sienna*
CIT Citron*	TOF Toffee*
CLA Classic*	TRF Truffle*
DES Desert*	VEN Venetian*
EAR Earthy	
ESP Espresso	

Color - Add \$31 list per item

BKD Backdrop	GRV Creek Villa
BFX Black Fox	GLF Gulf Stream
BWH Bright White	HTB Heartthrob
CGP Cargo Pants	NET Network Gray
CHT Chatroom	NWH Nonchalant White
DSY Daisy	PAR Paradise
DRG Daring	QXP Quixotic Plum
DYN Dynamo	RBZ Relic Bronze
ENG Enigma	SND Sandbank
FRR French Roast	STM Storm
GBY Georgian Bay	TRC Tricorn Black

Specifications

- Wood species - Beech (chairs).
- Seat has synthetic sheet webbing and 2" high density polyurethane foam.
- Back has polypropylene webbing and 1 1/2" polyurethane foam.
- Mortise and tenon construction with blocks, glue and screws.
- Solid one piece steam bent arms with front leg assembly.
- Standard with rubber cushion metal glides.

4 See a selection of graded in fabric manufacturers and patterns on pages 12-20. Contact Customer Service for additional fabric options.

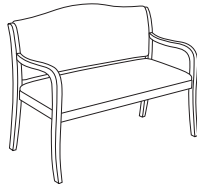
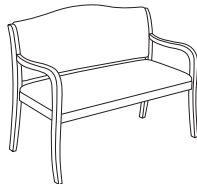
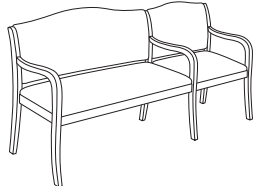
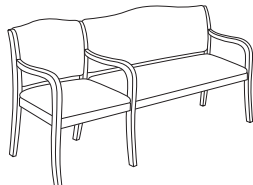
Description	① Model	Specifications			List Price Per Grade		
Loveseat 	LA1282 · optional anti-microbial arm cap - add \$112 list	Dimensions		D	W	H	COM \$1,284 A \$1,304 B \$1,342 COL/C \$1,412 D \$1,499 E \$1,587 F \$1,680 G \$1,812 H \$1,952 I \$2,173 J \$2,436 L1 \$1,908 L2 \$2,067
		Overall	26	43 ½	34 ½		
		Seat	18 ¼	41	18		
		Arm	27 ½				
		Upholstery		Shipping			
		COM Ydg	2 ¼	Ctn Wt	46		
		COL Sq Ft	45	Cu Ft	30		
42" Bariatric 	LA1282B · meets BIFMA x5.11 large occupant standard (253-400 lb individual) · optional antimicrobial arm cap - add \$112 list	Dimensions		D	W	H	COM \$1,581 A \$1,601 B \$1,640 COL/C \$1,709 D \$1,796 E \$1,884 F \$1,978 G \$2,109 H \$2,250 I \$2,470 J \$2,734 L1 \$2,205 L2 \$2,364
		Overall	26	43 ½	34 ½		
		Seat	18 ¼	41	18		
		Arm	27 ½				
		Upholstery		Shipping			
		COM Ydg	2 ¼	Ctn Wt	51		
		COL Sq Ft	45	Cu Ft	30		
Loveseat/Chair Unit 	LA1283 Loveseat/Chair · sequence facing unit · optional antimicrobial arm cap - add \$167 list	Dimensions		D	W	H	COM \$1,876 A \$1,909 B \$1,974 COL/C \$2,088 D \$2,235 E \$2,382 F \$2,536 G \$2,756 H \$2,991 I \$3,357 J \$3,797 L1 \$2,917 L2 \$3,181
		Overall	26	64 ½	34 ½		
		Seat	18 ¼	41/20	18		
		Arm	27 ½				
		Upholstery		Shipping			
		COM Ydg	3 ¾	Ctn Wt	64		
		COL Sq Ft	75	Cu Ft	44		
Chair/Loveseat Unit 	LA1284 Chair/Loveseat · sequence facing unit · optional antimicrobial arm cap - add \$167 list	Dimensions		D	W	H	COM \$1,876 A \$1,909 B \$1,974 COL/C \$2,088 D \$2,235 E \$2,382 F \$2,536 G \$2,756 H \$2,991 I \$3,357 J \$3,797 L1 \$2,917 L2 \$3,181
		Overall	26	64 ½	34 ½		
		Seat	18 ¼	20/41	18		
		Arm	27 ½				
		Upholstery		Shipping			
		COM Ydg	3 ¾	Ctn Wt	64		
		COL Sq Ft	75	Cu Ft	44		

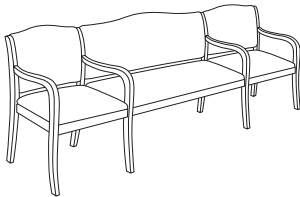
Description	Model	Specifications			List Price Per Grade		
		Dimensions	D	W	H	COM	
Chair/Loveseat/Chair Unit 	LA1285 Chair/Loveseat/Chair · sequence facing unit · optional antimicrobial arm cap - add \$223 list	Overall	26	85 ¾	34 ½	COM	\$2,465
		Seat	18 ¼	20/41/20	18	A	\$2,511
		Arm			27 ½	B	\$2,602
		Upholstery		Shipping		COL/C	\$2,762
		COM Ydg	5 ¼	Ctn Wt	82	D	\$2,968
		COL Sq Ft	105	Cu Ft	58	E	\$3,173
						F	\$3,389
						G	\$3,696
						H	\$4,025
						I	\$4,539
						J	\$5,154
						L1	\$3,922
						L2	\$4,292

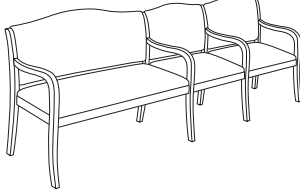
Description	Model	Specifications			List Price Per Grade		
		Dimensions	D	W	H	COM	
Loveseat/Chair/Chair Unit 	LA1286 Loveseat/Chair/Chair · sequence facing unit · optional antimicrobial arm cap - add \$223 list	Overall	26	85 ¾	34 ½	COM	\$2,465
		Seat	18 ¼	41/20/20	18	A	\$2,511
		Arm			27 ½	B	\$2,602
		Upholstery		Shipping		COL/C	\$2,762
		COM Ydg	5 ¼	Ctn Wt	82	D	\$2,968
		COL Sq Ft	105	Cu Ft	58	E	\$3,173
						F	\$3,389
						G	\$3,696
						H	\$4,025
						I	\$4,539
						J	\$5,154
						L1	\$3,922
						L2	\$4,292

To Order, Specify:

- 1 Model Number
- 2 Wood Species - Beech (B)
- 3 Wood Finish/Color
- 4 Fabric Selection - vendor, pattern and color
- 5 Optional Anti-Microbial Arm Cap - add \$56 list per arm cap
- 6 Optional Rubber Cushion Nylon Glides - no upcharge

3 Wood Finish/Color Options:

ALE Ale*	FLX Flax
AUB Auburn*	HEN Henna*
AUT Autumn*	HNY Honey*
BRL Barley*	LGC Legacy*
BBN Bourbon*	MCH Mocha*
BRG Brighton*	NTO Night Owl*
BRW Brownie*	NUT Nut Brown*
BUT Butterscotch	PRL Praline*
CAN Canyon*	SAF Saffron*
CIN Cinnamon*	SIE Sienna*
CIT Citron*	TOF Toffee*
CLA Classic*	TRF Truffle*
DES Desert*	VEN Venetian*
EAR Earthy	
ESP Espresso	

Color - Add \$31 list per item

BKD Backdrop	GRV Creek Villa
BFX Black Fox	GLF Gulf Stream
BWH Bright White	HTB Heartthrob
CGP Cargo Pants	NET Network Gray
CHT Chatroom	NWH Nonchalant White
DSY Daisy	PAR Paradise
DRG Daring	QXP Quixotic Plum
DYN Dynamo	RBZ Relic Bronze
ENG Enigma	SND Sandbank
FRR French Roast	STM Storm
GBY Georgian Bay	TRC Tricorn Black

Specifications

- Wood species - Beech (chairs).
- Seat has synthetic sheet webbing and 2" high density polyurethane foam.
- Back has polypropylene webbing and 1 ½" polyurethane foam.
- Mortise and tenon construction with blocks, glue and screws.
- Solid one piece steam bent arms with front leg assembly.
- Standard with rubber cushion metal glides.

4 See a selection of graded in fabric manufacturers and patterns on pages 12-20. Contact Customer Service for additional fabric options.

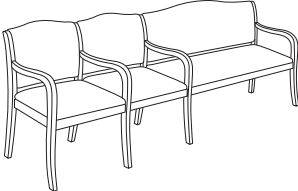
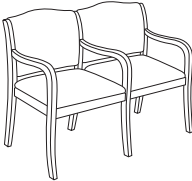
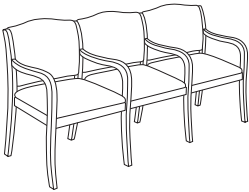
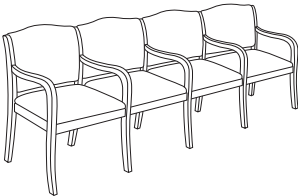
Description	Model	Specifications	List Price Per Grade																												
Chair/Chair/Loveseat Unit 	LA1287 Chair/Chair/Loveseat · sequence facing unit · optional antimicrobial arm cap - add \$223 list	<table border="1"> <thead> <tr> <th>Dimensions</th> <th>D</th> <th>W</th> <th>H</th> </tr> </thead> <tbody> <tr> <td>Overall</td> <td>26</td> <td>85 ¾</td> <td>34 ½</td> </tr> <tr> <td>Seat</td> <td>18 ¼</td> <td>20/20/41</td> <td>18</td> </tr> <tr> <td>Arm</td> <td></td> <td></td> <td>27 ½</td> </tr> <tr> <th colspan="2">Upholstery</th> <th colspan="2">Shipping</th> </tr> <tr> <td>COM Ydg</td> <td>5 ¼</td> <td>Ctn Wt</td> <td>82</td> </tr> <tr> <td>COL Sq Ft</td> <td>105</td> <td>Cu Ft</td> <td>58</td> </tr> </tbody> </table>	Dimensions	D	W	H	Overall	26	85 ¾	34 ½	Seat	18 ¼	20/20/41	18	Arm			27 ½	Upholstery		Shipping		COM Ydg	5 ¼	Ctn Wt	82	COL Sq Ft	105	Cu Ft	58	COM \$2,465 A \$2,511 B \$2,602 COL/C \$2,762 D \$2,968 E \$3,173 F \$3,389 G \$3,696 H \$4,025 I \$4,539 J \$5,154 L1 \$3,922 L2 \$4,292
		Dimensions	D	W	H																										
Overall	26	85 ¾	34 ½																												
Seat	18 ¼	20/20/41	18																												
Arm			27 ½																												
Upholstery		Shipping																													
COM Ydg	5 ¼	Ctn Wt	82																												
COL Sq Ft	105	Cu Ft	58																												
Two Seat Unit 	LA1292 · optional antimicrobial arm cap - add \$167 list	<table border="1"> <thead> <tr> <th>Dimensions</th> <th>D</th> <th>W</th> <th>H</th> </tr> </thead> <tbody> <tr> <td>Overall</td> <td>26</td> <td>43 ½</td> <td>34 ½</td> </tr> <tr> <td>Seat</td> <td>18 ¼</td> <td>20</td> <td>18</td> </tr> <tr> <td>Arm</td> <td></td> <td></td> <td>27 ½</td> </tr> <tr> <th colspan="2">Upholstery</th> <th colspan="2">Shipping</th> </tr> <tr> <td>COM Ydg</td> <td>3</td> <td>Ctn Wt</td> <td>42</td> </tr> <tr> <td>COL Sq Ft</td> <td>60</td> <td>Cu Ft</td> <td>30</td> </tr> </tbody> </table>	Dimensions	D	W	H	Overall	26	43 ½	34 ½	Seat	18 ¼	20	18	Arm			27 ½	Upholstery		Shipping		COM Ydg	3	Ctn Wt	42	COL Sq Ft	60	Cu Ft	30	COM \$1,333 A \$1,359 B \$1,412 COL/C \$1,503 D \$1,621 E \$1,737 F \$1,861 G \$2,037 H \$2,224 I \$2,518 J \$2,870 L1 \$2,072 L2 \$2,260
		Dimensions	D	W	H																										
Overall	26	43 ½	34 ½																												
Seat	18 ¼	20	18																												
Arm			27 ½																												
Upholstery		Shipping																													
COM Ydg	3	Ctn Wt	42																												
COL Sq Ft	60	Cu Ft	30																												
Three Seat Unit 	LA1293 · optional antimicrobial arm cap - add \$223 list	<table border="1"> <thead> <tr> <th>Dimensions</th> <th>D</th> <th>W</th> <th>H</th> </tr> </thead> <tbody> <tr> <td>Overall</td> <td>26</td> <td>64 ⅞</td> <td>34 ½</td> </tr> <tr> <td>Seat</td> <td>18 ¼</td> <td>20</td> <td>18</td> </tr> <tr> <td>Arm</td> <td></td> <td></td> <td>27 ½</td> </tr> <tr> <th colspan="2">Upholstery</th> <th colspan="2">Shipping</th> </tr> <tr> <td>COM Ydg</td> <td>4 ½</td> <td>Ctn Wt</td> <td>60</td> </tr> <tr> <td>COL Sq Ft</td> <td>90</td> <td>Cu Ft</td> <td>44</td> </tr> </tbody> </table>	Dimensions	D	W	H	Overall	26	64 ⅞	34 ½	Seat	18 ¼	20	18	Arm			27 ½	Upholstery		Shipping		COM Ydg	4 ½	Ctn Wt	60	COL Sq Ft	90	Cu Ft	44	COM \$1,923 A \$1,963 B \$2,041 COL/C \$2,178 D \$2,354 E \$2,530 F \$2,716 G \$2,979 H \$3,261 I \$3,701 J \$4,228 L1 \$3,032 L2 \$3,313
		Dimensions	D	W	H																										
Overall	26	64 ⅞	34 ½																												
Seat	18 ¼	20	18																												
Arm			27 ½																												
Upholstery		Shipping																													
COM Ydg	4 ½	Ctn Wt	60																												
COL Sq Ft	90	Cu Ft	44																												
Four Seat Unit 	LA1294 · optional antimicrobial arm cap - add \$279 list	<table border="1"> <thead> <tr> <th>Dimensions</th> <th>D</th> <th>W</th> <th>H</th> </tr> </thead> <tbody> <tr> <td>Overall</td> <td>26</td> <td>86 ⅞</td> <td>34 ½</td> </tr> <tr> <td>Seat</td> <td>18 ¼</td> <td>20</td> <td>18</td> </tr> <tr> <td>Arm</td> <td></td> <td></td> <td>27 ½</td> </tr> <tr> <th colspan="2">Upholstery</th> <th colspan="2">Shipping</th> </tr> <tr> <td>COM Ydg</td> <td>6</td> <td>Ctn Wt</td> <td>78</td> </tr> <tr> <td>COL Sq Ft</td> <td>120</td> <td>Cu Ft</td> <td>58</td> </tr> </tbody> </table>	Dimensions	D	W	H	Overall	26	86 ⅞	34 ½	Seat	18 ¼	20	18	Arm			27 ½	Upholstery		Shipping		COM Ydg	6	Ctn Wt	78	COL Sq Ft	120	Cu Ft	58	COM \$2,512 A \$2,565 B \$2,670 COL/C \$2,851 D \$3,086 E \$3,321 F \$3,568 G \$3,920 H \$4,295 I \$4,882 J \$5,585 L1 \$3,990 L2 \$4,365
		Dimensions	D	W	H																										
Overall	26	86 ⅞	34 ½																												
Seat	18 ¼	20	18																												
Arm			27 ½																												
Upholstery		Shipping																													
COM Ydg	6	Ctn Wt	78																												
COL Sq Ft	120	Cu Ft	58																												

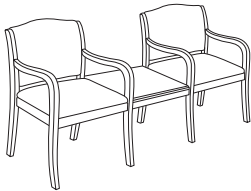
Description	Model	Specifications				List Price Per Grade	
		Dimensions	D	W	H	COM	
Chair/Table/Chair Unit 	LA1295 · table - optional coordinating wood grain laminate tops - no upcharge · optional anti-microbial arm cap - add \$223 list	Overall	26	64½	34½		\$1,795
		Seat	18¼	20	18	COL/C	\$1,965
		Arm			27½	D	\$2,083
		Upholstery		Shipping		E	\$2,199
		COM Ydg	3	Ctn Wt	58	F	\$2,323
		COL Sq Ft	60	Cu Ft	44	G	\$2,499
						H	\$2,686
						I	\$2,980
						J	\$3,332
						L1	\$2,534
				L2	\$2,722		

SEATING

To Order, Specify:

- 1 Model Number
- 2 Wood Species - Beech (B)
- 3 Wood Finish/Color
- 4 Fabric Selection - vendor, pattern and color
- 5 Optional Anti-Microbial Arm Cap - add \$56 list per arm cap
- 6 Optional Rubber Cushion Nylon Glides - no upcharge
- 7 Optional Coordinating Wood Grain Laminate Table
Tops - no upcharge; finishes with an asterisk (*) have a coordinating laminate available

3 Wood Finish/Color Options:▲

ALE Ale*	FLX Flax
AUB Auburn*	HEN Henna*
AUT Autumn*	HNY Honey*
BRL Barley*	LGC Legacy*
BBN Bourbon*	MCH Mocha*
BRG Brighton*	NTO Night Owl*
BRW Brownie*	NUT Nut Brown*
BUT Butterscotch	PRL Praline*
CAN Canyon*	SAF Saffron*
CIN Cinnamon*	SIE Sienna*
CIT Citron*	TOF Toffee*
CLA Classic*	TRF Truffle*
DES Desert*	VEN Venetian*
EAR Earthy	
ESP Espresso	

Color - Add \$31 list per item

BKD Backdrop	GRV Greek Villa
BFX Black Fox	GLF Gulf Stream
BWH Bright White	HTB Heartthrob
CGP Cargo Pants	NET Network Gray
CHT Chatroom	NWH Nonchalant White
DSY Daisy	PAR Paradise
DRG Daring	QXP Quixotic Plum
DYN Dynamo	RBZ Relic Bronze
ENG Enigma	SND Sandbank
FRR French Roast	STM Storm
GBY Georgian Bay	TRC Tricorn Black

Specifications

- Wood species - Beech (chairs).
- Seat has synthetic sheet webbing and 2" high density polyurethane foam.
- Back has polypropylene webbing and 1½" polyurethane foam.
- Mortise and tenon construction with blocks, glue and screws.
- Solid one piece steam bent arms with front leg assembly.
- Standard with rubber cushion metal glides.

4 See a selection of graded in fabric manufacturers and patterns on pages 12-20. Contact Customer Service for additional fabric options.

Description	D	W	H	CTN WT	CU FT	① Model	List Price
End Table	30	30	17	40	6	LA3030ET	\$689

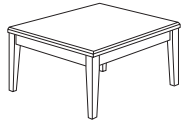

· ships KD

End Table	24	24	17	25	4	LA2424ET	\$588
-----------	----	----	----	----	---	----------	-------

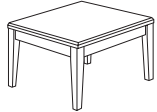

· ships KD

Magazine Table	20	42	17	45	6	LA2042MT	\$696
----------------	----	----	----	----	---	----------	-------



· ships KD

Corner Table	36	36	17	50	8	LA3636CT	\$809
--------------	----	----	----	----	---	----------	-------



· ships KD

To Order, Specify:

- ① Model Number
- ② Top Material - Veneer (W) or Laminate (L)
- ③ Wood Species - Maple (M)
- ④ Wood Finish/Color
- ⑤ Optional Coordinating Wood Grain Laminate Table
Tops - no upcharge; finishes with an asterisk (*) have a coordinating laminate available

③ Wood Finish/Color Options: ▲

ALE Ale*	FLX Flax
AUB Auburn*	HEN Henna*
AUT Autumn*	HNY Honey*
BRL Barley*	LGC Legacy*
BBN Bourbon*	MCH Mocha*
BRG Brighton*	NTO Night Owl*
BRW Brownie*	NUT Nut Brown*
BUT Butterscotch	PRL Praline*
CAN Canyon*	SAF Saffron*
CIN Cinnamon*	SIE Sienna*
CIT Citron*	TOF Toffee*
CLA Classic*	TRF Truffle*
DES Desert*	VEN Venetian*
EAR Earthy	
ESP Espresso	

Specifications

- Wood species - Maple (tables).
- Top core material is 1 1/8" thick with 45 lb. density industrial grade particle board.
- Face is wood veneer or horizontal grade HPL.
- Backer is bonded to bottom side to ensure balanced construction.
- All tops have internal solid lumbar bands with overlay laminate or veneer.

Color - Add \$31 list per item

BKD Backdrop	GRV Greek Villa
BFX Black Fox	GLF Gulf Stream
BWH Bright White	HTB Heartthrob
CGP Cargo Pants	NET Network Gray
CHT Chatroom	NWH Nonchalant White
DSY Daisy	PAR Paradise
DRG Daring	QXP Quixotic Plum
DYN Dynamo	RBZ Relic Bronze
ENG Enigma	SND Sandbank
FRR French Roast	STM Storm
GBY Georgian Bay	TRC Tricorn Black

Logan Order Check List:



Specify:

- 1. Model Number
- 2. Wood Species - Beech (B)
- 3. Wood Finish/Color
- 4. Fabric Selection - vendor, pattern and color
- 5. Optional Rubber Cushion Nylon Glides - no upcharge

Example:

LG6411D | B | AUB | MOMENTUM | VOX | MYSTIC
 (model #) | (wood species) | (finish) | (fabric vendor) | (pattern name) | (pattern color)

1. Model Number

2. Wood Species - Beech (B)

3. Wood Finish/Color Options: ▲

- | | |
|------------------|---------------|
| ALE Ale | FLX Flax |
| AUB Auburn | HEN Henna |
| AUT Autumn | HNY Honey |
| BRL Barley | LGC Legacy |
| BBN Bourbon | MCH Mocha |
| BRG Brighton | NTO Night Owl |
| BRW Brownie | NUT Nut Brown |
| BUT Butterscotch | PRL Praline |
| CAN Canyon | SAF Saffron |
| CIN Cinnamon | SIE Sienna |
| CIT Citron | TOF Toffee |
| CLA Classic | TRF Truffle |
| DES Desert | VEN Venetian |
| EAR Earthy | |
| ESP Espresso | |
- Color - Add \$31 list per item**
- | | |
|------------------|----------------------|
| BKD Backdrop | GRV Greek Villa |
| BFX Black Fox | GLF Gulf Stream |
| BWH Bright White | HTB Heartthrob |
| CGP Cargo Pants | NET Network Gray |
| CHT Chatroom | NWH Nonchalant White |
| DSY Daisy | PAR Paradise |
| DRG Daring | QXP Quixotic Plum |
| DYN Dynamo | RBZ Relic Bronze |
| ENG Enigma | SND Sandbank |
| FRR French Roast | STM Storm |
| GBY Georgian Bay | TRC Tricorn Black |

4. Fabric Selection - Please supply the following:

- Fabric vendor
- Pattern name
- Pattern color

When specifying contrasting upholstery, indicate clearly which upholstery is to be applied to the seat and back. Use higher grade pricing.

- Indicate direction of fabric - Railroaded or Up the Roll
- Please provide illustration, if available

All COM orders must include the following:

- Vendor's name, pattern name and color
- Sample of the fabric attached to order
- Model numbers of items for fabric application
- Special application instructions (e.g., all stripes will be applied front to back unless specified otherwise)
- Customer and purchase order number

Ship prepaid COM material to:
 Community
 Attn: COM Dept
 932 Mill Street
 Jasper, IN 47546

Application of fabric:
 Railroaded Up the Roll

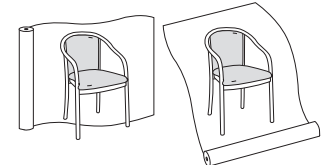

All COM orders will ship at standard lead time from receipt of COM except for orders requiring special custom matched finishes.

Description	① Model	Specifications			List Price Per Grade		
		Dimensions	D	W	H	COM	COL/C
Stacking Chair 	LG6411D · open arms · upholstered seat and back · metal glides · stacks 5 high	Overall	22 ½	22	32 ¼	\$701	
		Seat	17 ¾	19	19	\$713	
		Arm			27	\$740	
		Upholstery		Shipping		\$785	
		COM Ydg	1 ½	Ctn Wt	33	\$844	
		COL Sq Ft	30	Cu Ft	12	\$902	
						\$964	
						\$1,053	
						\$1,146	
						\$1,293	
				\$1,468			
				\$1,069			
				\$1,164			

SEATING

To Order, Specify:

- ① Model Number
- ② Wood Species - Beech (B)
- ③ Wood Finish/Color
- ④ Fabric Selection - vendor, pattern and color
- ⑤ Optional Rubber Cushion Nylon Glides - no upcharge

③ Wood Finish/Color Options: ▲

ALE Ale	FLX Flax
AUB Auburn	HEN Henna
AUT Autumn	HNY Honey
BRL Barley	LGC Legacy
BBN Bourbon	MCH Mocha
BRG Brighton	NTO Night Owl
BRW Brownie	NUT Nut Brown
BUT Butterscotch	PRL Praline
CAN Canyon	SAF Saffron
CIN Cinnamon	SIE Sienna
CIT Citron	TOF Toffee
CLA Classic	TRF Truffle
DES Desert	VEN Venetian
EAR Earthy	
ESP Espresso	

Color - Add \$31 list per item

BKD Backdrop	GRV Greek Villa
BFX Black Fox	GLF Gulf Stream
BWH Bright White	HTB Hearthrob
CGP Cargo Pants	NET Network Gray
CHT Chatroom	NWH Nonchalant White
DSY Daisy	PAR Paradise
DRG Daring	QXP Quixotic Plum
DYN Dynamo	RBZ Relic Bronze
ENG Enigma	SND Sandbank
FRR French Roast	STM Storm
GBY Georgian Bay	TRC Tricorn Black

Specifications

- Wood species - Beech (chairs).
- Seat has synthetic sheet webbing, one layer of 2" polyurethane foam.
- Back has 1" polyurethane foam.
- Mortise and tenon construction with corner blocks, glue and screws.
- Standard with rubber cushion metal glides.

④ See a selection of graded in fabric manufacturers and patterns on pages 12-20. Contact Customer Service for additional fabric options.

Madison Order Check List:



SEATING

Specify:

- 1. Model Number
- 2. Wood Species - Maple (M)
- 3. Wood Finish/Color
- 4. Fabric Selection - vendor, pattern and color
- 5. Optional Antique Black Trim Nails - no upcharge
(Replaces standard antique brass trim nails)
- 6. Optional Rubber Cushion Nylon Glides - no upcharge
MODELS MA1561F and MA1561J ONLY

Example:

MA1561F | **M** | **AUB** | **MOMENTUM** | **VOX** | **MYSTIC**
 (model #) | (wood species) | (finish) | (fabric vendor) | (pattern name) | (pattern color)

1. Model Number

2. Wood Species - Maple (M)

3. Wood Finish/Color Options: ▲

ALE Ale	FLX Flax
AUB Auburn	HEN Henna
AUT Autumn	HNY Honey
BRL Barley	LGC Legacy
BBN Bourbon	MCH Mocha
BRG Brighton	NTO Night Owl
BRW Brownie	NUT Nut Brown
BUT Butterscotch	PRL Praline
CAN Canyon	SAF Saffron
CIN Cinnamon	SIE Sienna
CIT Citron	TOF Toffee
CLA Classic	TRF Truffle
DES Desert	VEN Venetian
EAR Earthy	
ESP Espresso	

Color - Add \$31 list per item

BKD Backdrop	GRV Greek Villa
BFX Black Fox	GLF Gulf Stream
BWH Bright White	HTB Heartthrob
CGP Cargo Pants	NET Network Gray
CHT Chatroom	NWH Nonchalant White
DSY Daisy	PAR Paradise
DRG Daring	QXP Quixotic Plum
DYN Dynamo	RBZ Relic Bronze
ENG Enigma	SND Sandbank
FRR French Roast	STM Storm
GBY Georgian Bay	TRC Tricorn Black

4. Fabric Selection - Please supply the following:

- Fabric vendor
- Pattern name
- Pattern color

When specifying contrasting upholstery, indicate clearly which upholstery is to be applied to the seat, back and arms. Use higher grade pricing.

- Indicate direction of fabric - Railroaded or Up the Roll
- Please provide illustration, if available

All COM orders must include the following:

- Vendor's name, pattern name and color
- Sample of the fabric attached to order
- Model numbers of items for fabric application
- Special application instructions (e.g., all stripes will be applied front to back unless specified otherwise)
- Customer and purchase order number

Ship prepaid COM material to:
 Community
 Attn: COM Dept
 932 Mill Street
 Jasper, IN 47546

Application of fabric:
 Railroaded Up the Roll

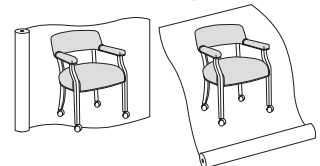



All COM orders will ship at standard lead time from receipt of COM except for orders requiring special custom matched finishes.

5. Optional Antique Black Trim Nails - no upcharge

Description	① Model	Specifications				List Price Per Grade	
	MA1561F · plain seat and back	Dimensions		D	W	H	COM \$612
		Overall	25 ¼	24 ½	30		A \$629
		Seat	19 ½	18 ¼	19 ½		B \$664
		Arm			25		COL/C \$725
		Upholstery		Shipping			D \$804
		COM Ydg	2	Ctn Wt	34		E \$881
		COL Sq Ft	40	Cu Ft	14		F \$964
							G \$1,081
							H \$1,206
							I \$1,402
					J \$1,636		
					L1 \$1,105		
					L2 \$1,230		

	MA1561J · plain seat and back · antique brass trim nails	Dimensions		D	W	H	COM \$665
		Overall	25 ¼	24 ½	30		A \$683
		Seat	19 ½	18 ¼	19 ½		B \$718
		Arm			25		COL/C \$779
		Upholstery		Shipping			D \$857
		COM Ydg	2	Ctn Wt	34		E \$935
		COL Sq Ft	40	Cu Ft	14		F \$1,018
							G \$1,134
							H \$1,259
							I \$1,456
					J \$1,690		
					L1 \$1,159		
					L2 \$1,284		

	MA1563F · plain seat and back · antique brass hooded casters	Dimensions		D	W	H	COM \$713
		Overall	25 ¼	24 ¼	30 ¼		A \$731
		Seat	20	18 ¼	18 ¼		B \$766
		Arm			25		COL/C \$827
		Upholstery		Shipping			D \$906
		COM Ydg	2	Ctn Wt	34		E \$983
		COL Sq Ft	40	Cu Ft	14		F \$1,066
							G \$1,183
							H \$1,308
							I \$1,504
					J \$1,738		
					L1 \$1,207		
					L2 \$1,332		

Description	Model	Specifications				List Price Per Grade	
		Dimensions	D	W	H	COM	
Side Chair 	MA1563J · plain seat and back · antique brass hooded casters · antique brass trim nails	Overall	25 ¼	24 ¼	30 ¼	A	\$785
		Seat	20	18 ¼	18 ¼	B	\$819
		Arm			25	COL/C	\$880
		Upholstery		Shipping		D	\$959
		COM Ydg	2	Ctn Wt	34	E	\$1,037
		COL Sq Ft	40	Cu Ft	14	F	\$1,120
						G	\$1,236
						H	\$1,361
						I	\$1,558
						J	\$1,792
				L1	\$1,260		
				L2	\$1,385		

SEATING

To Order, Specify:

- 1 Model Number
- 2 Wood Species - Maple (M)
- 3 Wood Finish/Color
- 4 Fabric Selection - vendor, pattern and color
- 5 Optional Black Antique Trim Nails - no upcharge
(Replaces standard antique brass trim nails)

3 Wood Finish/Color Options:

Maple		FLX	Flax
ALE	Ale	HEN	Henna
AUB	Auburn	HNY	Honey
AUT	Autumn	LGC	Legacy
BRL	Barley	MCH	Mocha
BBN	Bourbon	NTO	Night Owl
BRG	Brighton	NUT	Nut Brown
BRW	Brownie	PRL	Praline
BUT	Butterscotch	SAF	Saffron
CAN	Canyon	SIE	Sienna
CIN	Cinnamon	TOF	Toffee
CIT	Citron	TRF	Truffle
CLA	Classic	VEN	Venetian
DES	Desert		
EAR	Earthy		
ESP	Espresso		

Color - Add \$31 list per item

BKD	Backdrop	GRV	Greek Villa
BFX	Black Fox	GLF	Gulf Stream
BWH	Bright White	HTB	Hearthrob
CGP	Cargo Pants	NET	Network Gray
CHT	Chatroom	NWH	Nonchalant White
DSY	Daisy	PAR	Paradise
DRG	Daring	QXP	Quixotic Plum
DYN	Dynamo	RBZ	Relic Bronze
ENG	Enigma	SND	Sandbank
FRR	French Roast	STM	Storm
GBY	Georgian Bay	TRC	Tricorn Black

Specifications

- Wood species - Maple.
- Seat has synthetic sheet webbing and 3" polyurethane foam.
- Back has polypropylene webbing and 2" polyurethane foam.
- Arms have 1 ½" polyurethane foam.
- Spiral grooved hardwood dowels with corner blocks, glue and screws.
- Standard with rubber cushion metal glides (models MA1561F and MA1561J only).

4 See a selection of graded in fabric manufacturers and patterns on pages 12-20. Contact Customer Service for additional fabric options.

Medallion Order Check List:

SEATING



Specify:

- 1. Model Number
- 2. Wood Species - Beech (B)
- 3. Wood Finish
- 4. Fabric Selection - vendor, pattern and color
- 5. Optional Rubber Cushion Nylon Glides - no upcharge

Example:

6801C | **B** | **AUB** | **MOMENTUM** | **VOX** | **MYSTIC**
 (model #) | (wood species) | (finish) | (fabric vendor) | (pattern name) | (pattern color)

1. Model Number

2. Wood Species - Beech (B)

3. Wood Finish Options: ▲

ALE Ale	FLX Flax
AUB Auburn	HEN Henna
AUT Autumn	HNY Honey
BRL Barley	LGC Legacy
BBN Bourbon	MCH Mocha
BRG Brighton	NTO Night Owl
BRW Brownie	NUT Nut Brown
BUT Butterscotch	PRL Praline
CAN Canyon	SAF Saffron
CIN Cinnamon	SIE Sienna
CIT Citron	TOF Toffee
CLA Classic	TRF Truffle
DES Desert	VEN Venetian
EAR Earthy	
ESP Espresso	

4. Fabric Selection - Please supply the following:

- Fabric vendor
- Pattern name
- Pattern color

When specifying contrasting upholstery, indicate clearly which upholstery is to be applied to the seat and back. Use higher grade pricing.

- Indicate direction of fabric - Railroaded or Up the Roll
- Please provide illustration, if available

All COM orders must include the following:

- Vendor's name, pattern name and color
- Sample of the fabric attached to order
- Model numbers of items for fabric application
- Special application instructions (e.g., all stripes will be applied front to back unless specified otherwise)
- Customer and purchase order number

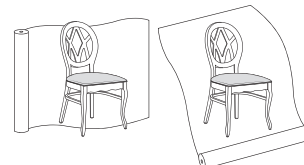

Ship prepaid COM material to:
 Community
 Attn: COM Dept
 932 Mill Street
 Jasper, IN 47546

Application of fabric:
 Railroaded Up the Roll



All COM orders will ship at standard lead time from receipt of COM except for orders requiring special custom matched finishes.

Description	Model	Specifications			List Price Per Grade	
Arm	6801C Uph. Seat	Dimensions	D	W	H	COM \$501
		Overall	24 3/4	23 3/4	39	A \$516
		Seat	17 3/4	19 1/4	19 1/2	B \$529
		Arm			27 1/2	COL/C \$552
		Upholstery	Shipping			D \$581
		COM Ydg	3/4	Ctn Wt	30	E \$611
		COL Sq Ft	9	Cu Ft	12	F \$641
						G \$685
						H \$732
						I \$806
						J \$893
					L1 \$695	
					L2 \$741	

Description	Model	Specifications			List Price Per Grade	
Arm	6801D Uph. Seat/Back · exposed back design	Dimensions	D	W	H	COM \$584
  <p>exposed back design</p>		Overall	24 3/4	23 3/4	39	A \$603
		Seat	17 3/4	19 1/4	19 1/2	B \$623
		Arm			27 1/2	COL/C \$657
		Upholstery	Shipping			D \$701
		COM Ydg	1 1/8	Ctn Wt	30	E \$745
		COL Sq Ft	14	Cu Ft	12	F \$791
						G \$857
						H \$928
						I \$1,038
						J \$1,170
					L1 \$871	
					L2 \$941	

Description	Model	Specifications			List Price Per Grade	
Armless	6803C Uph. Seat	Dimensions	D	W	H	COM \$441
		Overall	24 3/4	19 1/2	39	A \$455
		Seat	17 3/4	19 1/4	19 1/2	B \$468
		Upholstery	Shipping			COL/C \$491
		COM Ydg	3/4	Ctn Wt	25	D \$520
		COL Sq Ft	9	Cu Ft	9	E \$550
						F \$580
						G \$624
						H \$671
						I \$745
						J \$833
					L1 \$634	
					L2 \$680	

To Order, Specify:

- 1 Model Number
- 2 Wood Species - Beech (B)
- 3 Wood Finish
- 4 Fabric Selection - vendor, pattern and color
- 5 Optional Rubber Cushion Nylon Glides - no upcharge

3 Wood Finish Options:[▲]

ALE Ale	FLX Flax
AUB Auburn	HEN Henna
AUT Autumn	HNY Honey
BRL Barley	LGC Legacy
BBN Bourbon	MCH Mocha
BRG Brighton	NTO Night Owl
BRW Brownie	NUT Nut Brown
BUT Butterscotch	PRL Praline
CAN Canyon	SAF Saffron
CIN Cinnamon	SIE Sienna
CIT Citron	TOF Toffee
CLA Classic	TRF Truffle
DES Desert	VEN Venetian
EAR Earthy	
ESP Espresso	

Specifications

- Wood species - Beech.
- Seat is upholstered with 2" high density polyurethane foam.
- Back is upholstered with 1/2" polyurethane foam.
- Mortise and tenon construction with corner blocks, glue and screws.
- Standard with rubber cushion metal glides.

4 See a selection of graded in fabric manufacturers and patterns on pages 12-20. Contact Customer Service for additional fabric options.

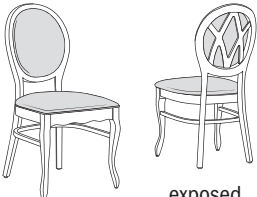
Description	1 Model	Specifications	List Price Per Grade												
Armless  exposed back design	6803D Uph. Seat/Back · exposed back design	<table border="1"> <thead> <tr> <th>Dimensions</th> <th>D</th> <th>W</th> <th>H</th> </tr> </thead> <tbody> <tr> <td>Overall</td> <td>24 ¾</td> <td>19 ½</td> <td>39</td> </tr> <tr> <td>Seat</td> <td>17 ¾</td> <td>19 ¼</td> <td>19 ½</td> </tr> </tbody> </table>	Dimensions	D	W	H	Overall	24 ¾	19 ½	39	Seat	17 ¾	19 ¼	19 ½	COM \$522 A \$540 B \$560 COL/C \$594 D \$638 E \$682 F \$728 G \$794 H \$865 I \$975 J \$1,107 L1 \$808 L2 \$878
		Dimensions	D	W	H										
Overall	24 ¾	19 ½	39												
Seat	17 ¾	19 ¼	19 ½												
<table border="1"> <thead> <tr> <th>Upholstery</th> <th>Shipping</th> </tr> </thead> <tbody> <tr> <td>COM Ydg</td> <td>1 ⅞</td> </tr> <tr> <td>COL Sq Ft</td> <td>14</td> </tr> <tr> <td>Ctn Wt</td> <td>25</td> </tr> <tr> <td>Cu Ft</td> <td>9</td> </tr> </tbody> </table>	Upholstery	Shipping	COM Ydg	1 ⅞	COL Sq Ft	14	Ctn Wt	25	Cu Ft	9					
Upholstery	Shipping														
COM Ydg	1 ⅞														
COL Sq Ft	14														
Ctn Wt	25														
Cu Ft	9														

Barstool 	6808C Uph. Seat · standard with brass scuff plate, also available in polished aluminum or matte black	<table border="1"> <thead> <tr> <th>Dimensions</th> <th>D</th> <th>W</th> <th>H</th> </tr> </thead> <tbody> <tr> <td>Overall</td> <td>22</td> <td>16 ¾</td> <td>45</td> </tr> <tr> <td>Seat</td> <td>17</td> <td>16 ½</td> <td>30</td> </tr> </tbody> </table>	Dimensions	D	W	H	Overall	22	16 ¾	45	Seat	17	16 ½	30	COM \$518 A \$533 B \$545 COL/C \$569 D \$598 E \$627 F \$659 G \$702 H \$749 I \$823 J \$911 L1 \$711 L2 \$758
		Dimensions	D	W	H										
Overall	22	16 ¾	45												
Seat	17	16 ½	30												
<table border="1"> <thead> <tr> <th>Upholstery</th> <th>Shipping</th> </tr> </thead> <tbody> <tr> <td>COM Ydg</td> <td>¾</td> </tr> <tr> <td>COL Sq Ft</td> <td>9</td> </tr> <tr> <td>Ctn Wt</td> <td>30</td> </tr> <tr> <td>Cu Ft</td> <td>13</td> </tr> </tbody> </table>	Upholstery	Shipping	COM Ydg	¾	COL Sq Ft	9	Ctn Wt	30	Cu Ft	13					
Upholstery	Shipping														
COM Ydg	¾														
COL Sq Ft	9														
Ctn Wt	30														
Cu Ft	13														

Barstool  exposed back design	6808D Uph. Seat/Back · exposed back design · standard with brass scuff plate, also available in polished aluminum or matte black	<table border="1"> <thead> <tr> <th>Dimensions</th> <th>D</th> <th>W</th> <th>H</th> </tr> </thead> <tbody> <tr> <td>Overall</td> <td>22</td> <td>16 ¾</td> <td>45</td> </tr> <tr> <td>Seat</td> <td>17</td> <td>16 ½</td> <td>30</td> </tr> </tbody> </table>	Dimensions	D	W	H	Overall	22	16 ¾	45	Seat	17	16 ½	30	COM \$597 A \$616 B \$636 COL/C \$670 D \$713 E \$758 F \$805 G \$870 H \$940 I \$1,050 J \$1,183 L1 \$884 L2 \$954
		Dimensions	D	W	H										
Overall	22	16 ¾	45												
Seat	17	16 ½	30												
<table border="1"> <thead> <tr> <th>Upholstery</th> <th>Shipping</th> </tr> </thead> <tbody> <tr> <td>COM Ydg</td> <td>1 ⅞</td> </tr> <tr> <td>COL Sq Ft</td> <td>14</td> </tr> <tr> <td>Ctn Wt</td> <td>30</td> </tr> <tr> <td>Cu Ft</td> <td>13</td> </tr> </tbody> </table>	Upholstery	Shipping	COM Ydg	1 ⅞	COL Sq Ft	14	Ctn Wt	30	Cu Ft	13					
Upholstery	Shipping														
COM Ydg	1 ⅞														
COL Sq Ft	14														
Ctn Wt	30														
Cu Ft	13														

To Order, Specify:

- 1 Model Number
- 2 Wood Species - Beech (B)
- 3 Wood Finish
- 4 Fabric Selection - vendor, pattern and color
- 5 Optional Rubber Cushion Nylon Glides - no upcharge

3 Wood Finish Options: ▲

ALE Ale	FLX Flax
AUB Auburn	HEN Henna
AUT Autumn	HNY Honey
BRL Barley	LGC Legacy
BBN Bourbon	MCH Mocha
BRG Brighton	NTO Night Owl
BRW Brownie	NUT Nut Brown
BUT Butterscotch	PRL Praline
CAN Canyon	SAF Saffron
CIN Cinnamon	SIE Sienna
CIT Citron	TOF Toffee
CLA Classic	TRF Truffle
DES Desert	VEN Venetian
EAR Earthy	
ESP Espresso	

Specifications

- Wood species - Beech.
- Seat is upholstered with 2" high density polyurethane foam.
- Back is upholstered with ½" polyurethane foam.
- Mortise and tenon construction with corner blocks, glue and screws.
- Standard with rubber cushion metal glides.

4 See a selection of graded in fabric manufacturers and patterns on pages 12-20. Contact Customer Service for additional fabric options.

Melrose Order Check List:



Specify:

- 1. Model Number
- 2. Wood Species - Oak (O) or Maple (M)
- 3. Wood Finish/Color
- 4. Fabric Selection - vendor, pattern and color
- 5. Optional FRONT LEG Casters - add \$46 list; specify seat height
NOT AVAILABLE on BARSTOOLS
- 6. Optional Rubber Cushion Nylon Glides - no upcharge

Example:

383FC | O | HEN | MOMENTUM | VOX | MYSTIC
 (model #) | (wood species) | (finish) | (fabric vendor) | (pattern name) | (pattern color)

1. Model Number

2. Wood Species - Oak (O) or Maple (M)

3. Wood Finish/Color Options:

Oak

BRW Brownie	ECU Ecru
CAN Canyon	HEN Henna
CIT Citron	HNY Honey
DES Desert	NUT Nut Brown

Maple

ALE Ale	FLX Flax
AUB Auburn	LGC Legacy
AUT Autumn	MCH Mocha
BRL Barley	NTO Night Owl
BBN Bourbon	PRL Praline
BRG Brighton	SAF Saffron
BUT Butterscotch	SIE Sienna
CIN Cinnamon	TOF Toffee
CLA Classic	TRF Truffle
EAR Earthy	VEN Venetian
ESP Espresso	

Color - Add \$31 list per item; not available with laser engraving option or on models 383M and 388M

BKD Backdrop	GRV Greek Villa
BFX Black Fox	GLF Gulf Stream
BWH Bright White	HTB Heartthrob
CGP Cargo Pants	NET Network Gray
CHT Chatroom	NWH Nonchalant White
DSY Daisy	PAR Paradise
DRG Daring	QXP Quixotic Plum
DYN Dynamo	RBZ Relic Bronze
ENG Enigma	SND Sandbank
FRR French Roast	STM Storm
GBY Georgian Bay	TRC Tricorn Black

4. Fabric Selection - Please supply the following:

- Fabric vendor
- Pattern name
- Pattern color

All COM orders must include the following:



- Vendor's name, pattern name and color
- Sample of the fabric attached to order
- Model numbers of items for fabric application
- Special application instructions (e.g., all stripes will be applied front to back unless specified otherwise)
- Customer and purchase order number

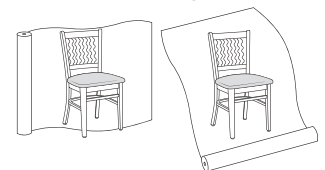

Ship prepaid COM material to:
 Community
 Attn: COM Dept
 932 Mill Street
 Jasper, IN 47546



Application of fabric:
 Railroaded Up the Roll





All COM orders will ship at standard lead time from receipt of COM except for orders requiring special custom matched finishes.

Description	① Model	Specifications	List Price Per Grade																								
Armless    383FA all wood 383FC uph. seat	383FA All Wood 383FC Uph. Seat <ul style="list-style-type: none"> standard cut out shown; plain back will be used for laser engraving or cut out optional laser engraving, specify location and size - see page 7 for details optional laser cut out, specify location and size - see page 7 for details shown with standard cut out optional front leg casters available - add \$46 list for set of 2 casters 	<table border="1"> <thead> <tr> <th>Dimensions</th> <th>D</th> <th>W</th> <th>H</th> </tr> </thead> <tbody> <tr> <td>Overall</td> <td>19 ½</td> <td>18 ¼</td> <td>35</td> </tr> <tr> <td>Seat</td> <td>16</td> <td>18 ¼</td> <td>18 ¼</td> </tr> <tr> <th colspan="2">Upholstery</th> <th colspan="2">Shipping</th> </tr> <tr> <td>COM Ydg</td> <td>¾</td> <td>Ctn Wt</td> <td>28</td> </tr> <tr> <td>COL Sq Ft</td> <td>9</td> <td>Cu Ft</td> <td>9</td> </tr> </tbody> </table>	Dimensions	D	W	H	Overall	19 ½	18 ¼	35	Seat	16	18 ¼	18 ¼	Upholstery		Shipping		COM Ydg	¾	Ctn Wt	28	COL Sq Ft	9	Cu Ft	9	All Wood \$398 COM \$435 A \$449 B \$461 COL/C \$485 D \$514 E \$543 F \$574 G \$618 H \$665 I \$739 J \$826 L1 \$627 L2 \$674
Dimensions	D	W	H																								
Overall	19 ½	18 ¼	35																								
Seat	16	18 ¼	18 ¼																								
Upholstery		Shipping																									
COM Ydg	¾	Ctn Wt	28																								
COL Sq Ft	9	Cu Ft	9																								

Description	① Model	Specifications	List Price Per Grade																								
Barstool   388FA all wood 388FC uph. seat	388FA All Wood 388FC Uph. Seat <ul style="list-style-type: none"> standard cut out shown; plain back will be used for laser engraving or cut out optional laser engraving, specify location and size - see page 7 for details optional laser cut out, specify location and size - see page 7 for details shown with standard cut out casters not available standard with brass scuff plate, also available in polished aluminum or matte black 	<table border="1"> <thead> <tr> <th>Dimensions</th> <th>D</th> <th>W</th> <th>H</th> </tr> </thead> <tbody> <tr> <td>Overall</td> <td>19 ½</td> <td>18 ¼</td> <td>47</td> </tr> <tr> <td>Seat</td> <td>16</td> <td>18 ¼</td> <td>30</td> </tr> <tr> <th colspan="2">Upholstery</th> <th colspan="2">Shipping</th> </tr> <tr> <td>COM Ydg</td> <td>¾</td> <td>Ctn Wt</td> <td>30</td> </tr> <tr> <td>COL Sq Ft</td> <td>9</td> <td>Cu Ft</td> <td>13</td> </tr> </tbody> </table>	Dimensions	D	W	H	Overall	19 ½	18 ¼	47	Seat	16	18 ¼	30	Upholstery		Shipping		COM Ydg	¾	Ctn Wt	30	COL Sq Ft	9	Cu Ft	13	All Wood \$462 COM \$496 A \$511 B \$523 COL/C \$546 D \$576 E \$605 F \$636 G \$680 H \$727 I \$801 J \$888 L1 \$688 L2 \$735
Dimensions	D	W	H																								
Overall	19 ½	18 ¼	47																								
Seat	16	18 ¼	30																								
Upholstery		Shipping																									
COM Ydg	¾	Ctn Wt	30																								
COL Sq Ft	9	Cu Ft	13																								

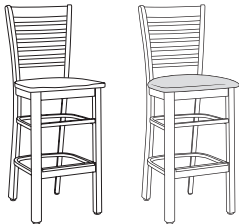
Description	① Model	Specifications	List Price Per Grade																								
Armless    383GA all wood 383GC uph. seat	383GA All Wood 383GC Uph. Seat <ul style="list-style-type: none"> horizontal slat back optional front leg casters available - add \$46 list for set of 2 casters 	<table border="1"> <thead> <tr> <th>Dimensions</th> <th>D</th> <th>W</th> <th>H</th> </tr> </thead> <tbody> <tr> <td>Overall</td> <td>19 ½</td> <td>18 ¼</td> <td>35</td> </tr> <tr> <td>Seat</td> <td>16</td> <td>18 ¼</td> <td>18 ¼</td> </tr> <tr> <th colspan="2">Upholstery</th> <th colspan="2">Shipping</th> </tr> <tr> <td>COM Ydg</td> <td>¾</td> <td>Ctn Wt</td> <td>28</td> </tr> <tr> <td>COL Sq Ft</td> <td>9</td> <td>Cu Ft</td> <td>9</td> </tr> </tbody> </table>	Dimensions	D	W	H	Overall	19 ½	18 ¼	35	Seat	16	18 ¼	18 ¼	Upholstery		Shipping		COM Ydg	¾	Ctn Wt	28	COL Sq Ft	9	Cu Ft	9	All Wood \$342 COM \$381 A \$393 B \$407 COL/C \$429 D \$458 E \$488 F \$519 G \$562 H \$609 I \$683 J \$771 L1 \$572 L2 \$618
Dimensions	D	W	H																								
Overall	19 ½	18 ¼	35																								
Seat	16	18 ¼	18 ¼																								
Upholstery		Shipping																									
COM Ydg	¾	Ctn Wt	28																								
COL Sq Ft	9	Cu Ft	9																								

Description	Model	Specifications			List Price Per Grade	
Barstool 	388GA All Wood 388GC Uph. Seat · horizontal slat back · casters not available · standard with brass scuff plate, also available in polished aluminum or matte black	Dimensions	D	W	H	All Wood \$403
		Overall	19 ½	18 ¼	47	COM \$439
		Seat	16	18 ¼	30	A \$453
		Upholstery	Shipping			B \$466
		COM Ydg	¾	Ctn Wt	30	COL/C \$489
		COL Sq Ft	9	Cu Ft	13	D \$518
						E \$548
						F \$578
						G \$622
						H \$669
						I \$743
						J \$831
						L1 \$632
						L2 \$678

Description	Model	Specifications			List Price Per Grade	
Armless 	383HB Uph. Back/Wood Seat · optional front leg casters available - add \$46 list for set of 2 casters · when using contrasting upholstery, indicate application and use higher grade pricing	Dimensions	D	W	H	COM \$398
		Overall	19 ½	18 ¼	35	A \$409
		Seat	16	18 ¼	18 ¼	B \$418
		Upholstery	Shipping			COL/C \$433
		COM Ydg	½	Ctn Wt	28	D \$453
		COL Sq Ft	6	Cu Ft	9	E \$472
						F \$493
						G \$522
						H \$554
						I \$602
						J \$661
						L1 \$528
						L2 \$559

To Order, Specify:

- Model Number
- Wood Species - Oak (O) or Maple (M)
- Wood Finish/Color
- Fabric Selection - vendor, pattern and color
- Optional FRONT LEG Casters - add \$46 list; specify seat height. **NOT AVAILABLE on BARSTOOLS**
- Optional Laser Engraving Back Imprint - specify location and size; see page 7 for details.
- Optional Laser Cut Out - specify location and size; see page 7 for details.
- Optional Rubber Cushion Nylon Glides - no upcharge

Wood Finish/Color Options:

Oak		ECU	Ecru
BRW	Brownie	HEN	Henna
CAN	Canyon	HNY	Honey
CIT	Citron	NUT	Nut Brown
DES	Desert		
Maple		FLX	Flax
ALE	Ale	LGC	Legacy
AUB	Auburn	MCH	Mocha
AUT	Autumn	NTO	Night Owl
BRL	Barley	PRL	Praline
BBN	Bourbon	SAF	Saffron
BRG	Brighton	SIE	Sienna
BUT	Butterscotch	TOF	Toffee
CIN	Cinnamon	TRF	Truffle
CLA	Classic	VEN	Venetian
EAR	Earthy		
ESP	Espresso		



Specifications

- Wood species - Oak or Maple.
- Seat is upholstered with 1 ½" high density polyurethane foam.
- Mortise and tenon construction with corner blocks, glue and screws.
- Standard with rubber cushion metal glides.

Color - Add \$31 list per item; not available with laser engraving option



BKD	Backdrop	GRV	Greek Villa
BFX	Black Fox	GLF	Gulf Stream
BWH	Bright White	HTB	Heartthrob
CGP	Cargo Pants	NET	Network Gray
CHT	Chatroom	NWH	Nonchalant White
DSY	Daisy	PAR	Paradise
DRG	Daring	QXP	Quixotic Plum
DYN	Dynamo	RBZ	Relic Bronze
ENG	Enigma	SND	Sandbank
FRR	French Roast	STM	Storm
GBY	Georgian Bay	TRC	Tricorn Black



- See a selection of graded in fabric manufacturers and patterns on pages 12-20. Contact Customer Service for additional fabric options.

Description	① Model	Specifications				List Price Per Grade	
Armless  	383HD Uph. Seat/Back · optional front leg casters available - add \$46 list for set of 2 casters · back is upholstered with ¾ of high density polyurethane · when using contrasting upholstery, indicate application and use higher grade pricing	Dimensions		D	W	H	COM \$441 A \$457 B \$475 COL/C \$506 D \$544 E \$583 F \$624 G \$683 H \$746 I \$844 J \$961 L1 \$695 L2 \$758
		Overall	19 ½	18 ¼	35		
		Seat	16	18 ¼	18 ¼		
		Upholstery		Shipping			
		COM Ydg	1	Ctn Wt	28		
		COL Sq Ft	12	Cu Ft	9		

Barstool 	388HB Uph. Back/Wood Seat · casters not available · when using contrasting upholstery, indicate application and use higher grade pricing	Dimensions		D	W	H	COM \$457 A \$469 B \$477 COL/C \$493 D \$513 E \$532 F \$553 G \$582 H \$613 I \$662 J \$721 L1 \$587 L2 \$619
		Overall	19 ½	18 ¼	47		
		Seat	16	18 ¼	30		
		Upholstery		Shipping			
		COM Ydg	½	Ctn Wt	30		
		COL Sq Ft	6	Cu Ft	13		

Barstool 	388HD Uph. Seat/Back · casters not available · back is upholstered with ¾ of high density polyurethane · when using contrasting upholstery, indicate application and use higher grade pricing · standard with brass scuff plate, also available in polished aluminum or matte black	Dimensions		D	W	H	COM \$500 A \$517 B \$534 COL/C \$564 D \$604 E \$643 F \$684 G \$743 H \$806 I \$903 J \$1,020 L1 \$754 L2 \$817
		Overall	19 ½	18 ¼	47		
		Seat	16	18 ¼	30		
		Upholstery		Shipping			
		COM Ydg	1	Ctn Wt	30		
		COL Sq Ft	12	Cu Ft	13		

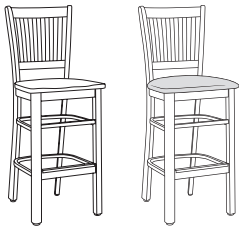
Armless   	383IA All Wood 383IC Uph. Seat · vertical slat back · optional front leg casters available - add \$46 list for set of 2 casters	Dimensions		D	W	H	All Wood \$342 COM \$381 A \$393 B \$407 COL/C \$429 D \$458 E \$488 F \$519 G \$562 H \$609 I \$683 J \$771 L1 \$572 L2 \$618
		Overall	19 ½	18 ¼	35		
		Seat	16	18 ¼	18 ¼		
		Upholstery		Shipping			
		COM Ydg	¾	Ctn Wt	28		
		COL Sq Ft	9	Cu Ft	9		

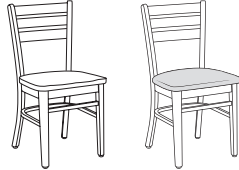
Description	Model	Specifications	List Price Per Grade																																																	
Barstool  388IA all wood 388IC uph. seat	388IA All Wood 388IC Uph. Seat · vertical slat back · casters not available · standard with brass scuff plate, also available in polished aluminum or matte black	<table border="1"> <thead> <tr> <th>Dimensions</th> <th>D</th> <th>W</th> <th>H</th> </tr> </thead> <tbody> <tr> <td>Overall</td> <td>19 1/2</td> <td>18 1/4</td> <td>47</td> </tr> <tr> <td>Seat</td> <td>16</td> <td>18 1/4</td> <td>30</td> </tr> </tbody> </table> <table border="1"> <thead> <tr> <th>Upholstery</th> <th colspan="2">Shipping</th> </tr> </thead> <tbody> <tr> <td>COM Ydg</td> <td>3/4</td> <td>Ctn Wt 30</td> </tr> <tr> <td>COL Sq Ft</td> <td>9</td> <td>Cu Ft 13</td> </tr> </tbody> </table>	Dimensions	D	W	H	Overall	19 1/2	18 1/4	47	Seat	16	18 1/4	30	Upholstery	Shipping		COM Ydg	3/4	Ctn Wt 30	COL Sq Ft	9	Cu Ft 13	<table border="1"> <tbody> <tr><td>All Wood</td><td>\$403</td></tr> <tr><td>COM</td><td>\$439</td></tr> <tr><td>A</td><td>\$453</td></tr> <tr><td>B</td><td>\$466</td></tr> <tr><td>COL/C</td><td>\$489</td></tr> <tr><td>D</td><td>\$518</td></tr> <tr><td>E</td><td>\$548</td></tr> <tr><td>F</td><td>\$578</td></tr> <tr><td>G</td><td>\$622</td></tr> <tr><td>H</td><td>\$669</td></tr> <tr><td>I</td><td>\$743</td></tr> <tr><td>J</td><td>\$831</td></tr> <tr><td>L1</td><td>\$632</td></tr> <tr><td>L2</td><td>\$678</td></tr> </tbody> </table>	All Wood	\$403	COM	\$439	A	\$453	B	\$466	COL/C	\$489	D	\$518	E	\$548	F	\$578	G	\$622	H	\$669	I	\$743	J	\$831	L1	\$632	L2	\$678
		Dimensions	D	W	H																																															
Overall	19 1/2	18 1/4	47																																																	
Seat	16	18 1/4	30																																																	
Upholstery	Shipping																																																			
COM Ydg	3/4	Ctn Wt 30																																																		
COL Sq Ft	9	Cu Ft 13																																																		
All Wood	\$403																																																			
COM	\$439																																																			
A	\$453																																																			
B	\$466																																																			
COL/C	\$489																																																			
D	\$518																																																			
E	\$548																																																			
F	\$578																																																			
G	\$622																																																			
H	\$669																																																			
I	\$743																																																			
J	\$831																																																			
L1	\$632																																																			
L2	\$678																																																			
Armless   383KA all wood 383KC uph. seat	383KA All Wood 383KC Uph. Seat · horizontal slat back · optional front leg casters available - add \$46 list for set of 2 casters	<table border="1"> <thead> <tr> <th>Dimensions</th> <th>D</th> <th>W</th> <th>H</th> </tr> </thead> <tbody> <tr> <td>Overall</td> <td>19 1/2</td> <td>18 1/4</td> <td>35</td> </tr> <tr> <td>Seat</td> <td>16</td> <td>18 1/4</td> <td>18 1/4</td> </tr> </tbody> </table> <table border="1"> <thead> <tr> <th>Upholstery</th> <th colspan="2">Shipping</th> </tr> </thead> <tbody> <tr> <td>COM Ydg</td> <td>3/4</td> <td>Ctn Wt 28</td> </tr> <tr> <td>COL Sq Ft</td> <td>9</td> <td>Cu Ft 9</td> </tr> </tbody> </table>	Dimensions	D	W	H	Overall	19 1/2	18 1/4	35	Seat	16	18 1/4	18 1/4	Upholstery	Shipping		COM Ydg	3/4	Ctn Wt 28	COL Sq Ft	9	Cu Ft 9	<table border="1"> <tbody> <tr><td>All Wood</td><td>\$342</td></tr> <tr><td>COM</td><td>\$381</td></tr> <tr><td>A</td><td>\$393</td></tr> <tr><td>B</td><td>\$407</td></tr> <tr><td>COL/C</td><td>\$429</td></tr> <tr><td>D</td><td>\$458</td></tr> <tr><td>E</td><td>\$488</td></tr> <tr><td>F</td><td>\$519</td></tr> <tr><td>G</td><td>\$562</td></tr> <tr><td>H</td><td>\$609</td></tr> <tr><td>I</td><td>\$683</td></tr> <tr><td>J</td><td>\$771</td></tr> <tr><td>L1</td><td>\$572</td></tr> <tr><td>L2</td><td>\$618</td></tr> </tbody> </table>	All Wood	\$342	COM	\$381	A	\$393	B	\$407	COL/C	\$429	D	\$458	E	\$488	F	\$519	G	\$562	H	\$609	I	\$683	J	\$771	L1	\$572	L2	\$618
		Dimensions	D	W	H																																															
Overall	19 1/2	18 1/4	35																																																	
Seat	16	18 1/4	18 1/4																																																	
Upholstery	Shipping																																																			
COM Ydg	3/4	Ctn Wt 28																																																		
COL Sq Ft	9	Cu Ft 9																																																		
All Wood	\$342																																																			
COM	\$381																																																			
A	\$393																																																			
B	\$407																																																			
COL/C	\$429																																																			
D	\$458																																																			
E	\$488																																																			
F	\$519																																																			
G	\$562																																																			
H	\$609																																																			
I	\$683																																																			
J	\$771																																																			
L1	\$572																																																			
L2	\$618																																																			

To Order, Specify:

- 1 Model Number
- 2 Wood Species - Oak (O) or Maple (M)
- 3 Wood Finish/Color
- 4 Fabric Selection - vendor, pattern and color
- 5 Optional FRONT LEG Casters - add \$46 list; specify seat height. **NOT AVAILABLE on BARSTOOLS**
- 6 Optional Rubber Cushion Nylon Glides - no upcharge

Wood Finish/Color Options:

Oak		ECU	Ecru
BRW	Brownie	HEN	Henna
CAN	Canyon	HNY	Honey
CIT	Citron	NUT	Nut Brown
DES	Desert		
Maple		FLX	Flax
ALE	Ale	LGC	Legacy
AUB	Auburn	MCH	Mocha
AUT	Autumn	NTO	Night Owl
BRL	Barley	PRL	Praline
BBN	Bourbon	SAF	Saffron
BRG	Brighton	SIE	Sienna
BUT	Butterscotch	TOF	Toffee
CIN	Cinnamon	TRF	Truffle
CLA	Classic	VEN	Venetian
EAR	Earthy		
ESP	Espresso		



Color - Add \$31 list per item



BKD	Backdrop	GRV	Creek Villa
BFX	Black Fox	GLF	Gulf Stream
BWH	Bright White	HTB	Hearthrob
CGP	Cargo Pants	NET	Network Gray
CHT	Chatroom	NWH	Nonchalant White
DSY	Daisy	PAR	Paradise
DRG	Daring	QXP	Quixotic Plum
DYN	Dynamo	RBZ	Relic Bronze
ENG	Enigma	SND	Sandbank
FRR	French Roast	STM	Storm
GBY	Georgian Bay	TRC	Tricorn Black



Specifications



- Wood species - Oak or Maple.
- 18 gauge metal frame.
- Seat is upholstered with 1 1/2" high density polyurethane foam.
- Mortise and tenon construction with corner blocks, glue and screws.
- Standard with rubber cushion metal glides.



- 4 See a selection of graded in fabric manufacturers and patterns on pages 12-20. Contact Customer Service for additional fabric options.

Description	① Model	Specifications	List Price Per Grade																																								
Barstool  388KA all wood	388KA All Wood 388KC Uph. Seat <ul style="list-style-type: none"> horizontal slat back casters not available standard with brass scuff plate, also available in polished aluminum or matte black 	<table border="1"> <thead> <tr> <th>Dimensions</th> <th>D</th> <th>W</th> <th>H</th> </tr> </thead> <tbody> <tr> <td>Overall</td> <td>19 ½</td> <td>18 ¼</td> <td>47</td> </tr> <tr> <td>Seat</td> <td>16</td> <td>18 ¼</td> <td>30</td> </tr> </tbody> </table>	Dimensions	D	W	H	Overall	19 ½	18 ¼	47	Seat	16	18 ¼	30	<table border="1"> <tbody> <tr><td>All Wood</td><td>\$403</td></tr> <tr><td>COM</td><td>\$439</td></tr> <tr><td>A</td><td>\$453</td></tr> <tr><td>B</td><td>\$466</td></tr> <tr><td>COL/C</td><td>\$489</td></tr> <tr><td>D</td><td>\$518</td></tr> <tr><td>E</td><td>\$548</td></tr> <tr><td>F</td><td>\$578</td></tr> <tr><td>G</td><td>\$622</td></tr> <tr><td>H</td><td>\$669</td></tr> <tr><td>I</td><td>\$743</td></tr> <tr><td>J</td><td>\$831</td></tr> <tr><td>L1</td><td>\$632</td></tr> <tr><td>L2</td><td>\$678</td></tr> </tbody> </table>	All Wood	\$403	COM	\$439	A	\$453	B	\$466	COL/C	\$489	D	\$518	E	\$548	F	\$578	G	\$622	H	\$669	I	\$743	J	\$831	L1	\$632	L2	\$678
		Dimensions	D	W	H																																						
Overall	19 ½	18 ¼	47																																								
Seat	16	18 ¼	30																																								
All Wood	\$403																																										
COM	\$439																																										
A	\$453																																										
B	\$466																																										
COL/C	\$489																																										
D	\$518																																										
E	\$548																																										
F	\$578																																										
G	\$622																																										
H	\$669																																										
I	\$743																																										
J	\$831																																										
L1	\$632																																										
L2	\$678																																										
 388KC uph. seat	<table border="1"> <thead> <tr> <th>Upholstery</th> <th colspan="3">Shipping</th> </tr> </thead> <tbody> <tr> <td>COM Ydg</td> <td>¾</td> <td>Ctn Wt</td> <td>30</td> </tr> <tr> <td>COL Sq Ft</td> <td>9</td> <td>Cu Ft</td> <td>13</td> </tr> </tbody> </table>	Upholstery	Shipping			COM Ydg	¾	Ctn Wt	30	COL Sq Ft	9	Cu Ft	13																														
Upholstery	Shipping																																										
COM Ydg	¾	Ctn Wt	30																																								
COL Sq Ft	9	Cu Ft	13																																								

Armless   383LA all wood	383LA All Wood 383LC Uph. Seat <ul style="list-style-type: none"> vertical slat back optional contrasting slats available - contact customer service for pricing optional front leg casters available - add \$46 list for set of 2 casters 	<table border="1"> <thead> <tr> <th>Dimensions</th> <th>D</th> <th>W</th> <th>H</th> </tr> </thead> <tbody> <tr> <td>Overall</td> <td>19 ½</td> <td>18 ¼</td> <td>35</td> </tr> <tr> <td>Seat</td> <td>16</td> <td>18 ¼</td> <td>18 ¼</td> </tr> </tbody> </table>	Dimensions	D	W	H	Overall	19 ½	18 ¼	35	Seat	16	18 ¼	18 ¼	<table border="1"> <tbody> <tr><td>All Wood</td><td>\$342</td></tr> <tr><td>COM</td><td>\$381</td></tr> <tr><td>A</td><td>\$393</td></tr> <tr><td>B</td><td>\$407</td></tr> <tr><td>COL/C</td><td>\$429</td></tr> <tr><td>D</td><td>\$458</td></tr> <tr><td>E</td><td>\$488</td></tr> <tr><td>F</td><td>\$519</td></tr> <tr><td>G</td><td>\$562</td></tr> <tr><td>H</td><td>\$609</td></tr> <tr><td>I</td><td>\$683</td></tr> <tr><td>J</td><td>\$771</td></tr> <tr><td>L1</td><td>\$572</td></tr> <tr><td>L2</td><td>\$618</td></tr> </tbody> </table>	All Wood	\$342	COM	\$381	A	\$393	B	\$407	COL/C	\$429	D	\$458	E	\$488	F	\$519	G	\$562	H	\$609	I	\$683	J	\$771	L1	\$572	L2	\$618
		Dimensions	D	W	H																																						
Overall	19 ½	18 ¼	35																																								
Seat	16	18 ¼	18 ¼																																								
All Wood	\$342																																										
COM	\$381																																										
A	\$393																																										
B	\$407																																										
COL/C	\$429																																										
D	\$458																																										
E	\$488																																										
F	\$519																																										
G	\$562																																										
H	\$609																																										
I	\$683																																										
J	\$771																																										
L1	\$572																																										
L2	\$618																																										
 383LC uph. seat	<table border="1"> <thead> <tr> <th>Upholstery</th> <th colspan="3">Shipping</th> </tr> </thead> <tbody> <tr> <td>COM Ydg</td> <td>¾</td> <td>Ctn Wt</td> <td>28</td> </tr> <tr> <td>COL Sq Ft</td> <td>9</td> <td>Cu Ft</td> <td>9</td> </tr> </tbody> </table>	Upholstery	Shipping			COM Ydg	¾	Ctn Wt	28	COL Sq Ft	9	Cu Ft	9																														
Upholstery	Shipping																																										
COM Ydg	¾	Ctn Wt	28																																								
COL Sq Ft	9	Cu Ft	9																																								

Barstool  388LA all wood	388LA All Wood 388LC Uph. Seat <ul style="list-style-type: none"> vertical slat back optional contrasting slats available - contact customer service for pricing casters not available standard with brass scuff plate, also available in polished aluminum or matte black 	<table border="1"> <thead> <tr> <th>Dimensions</th> <th>D</th> <th>W</th> <th>H</th> </tr> </thead> <tbody> <tr> <td>Overall</td> <td>19 ½</td> <td>18 ¼</td> <td>47</td> </tr> <tr> <td>Seat</td> <td>16</td> <td>18 ¼</td> <td>30</td> </tr> </tbody> </table>	Dimensions	D	W	H	Overall	19 ½	18 ¼	47	Seat	16	18 ¼	30	<table border="1"> <tbody> <tr><td>All Wood</td><td>\$403</td></tr> <tr><td>COM</td><td>\$439</td></tr> <tr><td>A</td><td>\$453</td></tr> <tr><td>B</td><td>\$466</td></tr> <tr><td>COL/C</td><td>\$489</td></tr> <tr><td>D</td><td>\$518</td></tr> <tr><td>E</td><td>\$548</td></tr> <tr><td>F</td><td>\$578</td></tr> <tr><td>G</td><td>\$622</td></tr> <tr><td>H</td><td>\$669</td></tr> <tr><td>I</td><td>\$743</td></tr> <tr><td>J</td><td>\$831</td></tr> <tr><td>L1</td><td>\$632</td></tr> <tr><td>L2</td><td>\$678</td></tr> </tbody> </table>	All Wood	\$403	COM	\$439	A	\$453	B	\$466	COL/C	\$489	D	\$518	E	\$548	F	\$578	G	\$622	H	\$669	I	\$743	J	\$831	L1	\$632	L2	\$678
		Dimensions	D	W	H																																						
Overall	19 ½	18 ¼	47																																								
Seat	16	18 ¼	30																																								
All Wood	\$403																																										
COM	\$439																																										
A	\$453																																										
B	\$466																																										
COL/C	\$489																																										
D	\$518																																										
E	\$548																																										
F	\$578																																										
G	\$622																																										
H	\$669																																										
I	\$743																																										
J	\$831																																										
L1	\$632																																										
L2	\$678																																										
 388LC uph. seat	<table border="1"> <thead> <tr> <th>Upholstery</th> <th colspan="3">Shipping</th> </tr> </thead> <tbody> <tr> <td>COM Ydg</td> <td>¾</td> <td>Ctn Wt</td> <td>30</td> </tr> <tr> <td>COL Sq Ft</td> <td>9</td> <td>Cu Ft</td> <td>13</td> </tr> </tbody> </table>	Upholstery	Shipping			COM Ydg	¾	Ctn Wt	30	COL Sq Ft	9	Cu Ft	13																														
Upholstery	Shipping																																										
COM Ydg	¾	Ctn Wt	30																																								
COL Sq Ft	9	Cu Ft	13																																								

Description	Model	Specifications				List Price Per Grade																					
Armless    383MA all wood 383MC uph. seat	383MA All Wood 383MC Uph. Seat • design cut out back • optional front leg casters available - add \$46 list for set of 2 casters • color finish not available	Dimensions	D	W	H	All Wood \$342 COM \$381 A \$393 B \$407 COL/C \$429 D \$458 E \$488 F \$519 G \$562 H \$609 I \$683 J \$771 L1 \$572 L2 \$618																					
	<table border="1"> <thead> <tr> <th>Overall</th> <th>D</th> <th>W</th> <th>H</th> </tr> </thead> <tbody> <tr> <td>19 ½</td> <td>18 ¼</td> <td>35</td> <td></td> </tr> <tr> <th>Seat</th> <td>16</td> <td>18 ¼</td> <td>18 ¼</td> </tr> </tbody> </table> <table border="1"> <thead> <tr> <th>Upholstery</th> <th colspan="3">Shipping</th> </tr> </thead> <tbody> <tr> <td>COM Ydg ¾</td> <td>Ctn Wt</td> <td colspan="2">28</td> </tr> <tr> <td>COL Sq Ft 9</td> <td>Cu Ft</td> <td colspan="2">9</td> </tr> </tbody> </table>	Overall	D	W	H	19 ½	18 ¼	35		Seat	16	18 ¼	18 ¼	Upholstery	Shipping			COM Ydg ¾	Ctn Wt	28		COL Sq Ft 9	Cu Ft	9			
Overall	D	W	H																								
19 ½	18 ¼	35																									
Seat	16	18 ¼	18 ¼																								
Upholstery	Shipping																										
COM Ydg ¾	Ctn Wt	28																									
COL Sq Ft 9	Cu Ft	9																									

Description	Model	Specifications				List Price Per Grade																					
Barstool   388MA all wood 388MC uph. seat	388MA All Wood 388MC Uph. Seat • design cut out back • casters not available • standard with brass scuff plate, also available in polished aluminum or matte black • color finish not available	Dimensions	D	W	H	All Wood \$403 COM \$439 A \$453 B \$466 COL/C \$489 D \$518 E \$548 F \$578 G \$622 H \$669 I \$743 J \$831 L1 \$632 L2 \$678																					
	<table border="1"> <thead> <tr> <th>Overall</th> <th>D</th> <th>W</th> <th>H</th> </tr> </thead> <tbody> <tr> <td>19 ½</td> <td>18 ¼</td> <td>47</td> <td></td> </tr> <tr> <th>Seat</th> <td>16</td> <td>18 ¼</td> <td>30</td> </tr> </tbody> </table> <table border="1"> <thead> <tr> <th>Upholstery</th> <th colspan="3">Shipping</th> </tr> </thead> <tbody> <tr> <td>COM Ydg ¾</td> <td>Ctn Wt</td> <td colspan="2">30</td> </tr> <tr> <td>COL Sq Ft 9</td> <td>Cu Ft</td> <td colspan="2">13</td> </tr> </tbody> </table>	Overall	D	W	H	19 ½	18 ¼	47		Seat	16	18 ¼	30	Upholstery	Shipping			COM Ydg ¾	Ctn Wt	30		COL Sq Ft 9	Cu Ft	13			
Overall	D	W	H																								
19 ½	18 ¼	47																									
Seat	16	18 ¼	30																								
Upholstery	Shipping																										
COM Ydg ¾	Ctn Wt	30																									
COL Sq Ft 9	Cu Ft	13																									

To Order, Specify:

- Model Number
- Wood Species - Oak (O) or Maple (M)
- Wood Finish/Color
- Fabric Selection - vendor, pattern and color
- Optional FRONT LEG Casters - add \$46 list; specify seat height. **NOT AVAILABLE on BARSTOOLS**
- Optional Rubber Cushion Nylon Glides - no upcharge

Wood Finish/Color Options:

Oak		ECU	Ecru
BRW	Brownie	HEN	Henna
CAN	Canyon	HNY	Honey
CIT	Citron	NUT	Nut Brown
DES	Desert		
Maple		FLX	Flax
ALE	Ale	LGC	Legacy
AUB	Auburn	MCH	Mocha
AUT	Autumn	NTO	Night Owl
BRL	Barley	PRL	Praline
BBN	Bourbon	SAF	Saffron
BRG	Brighton	SIE	Sienna
BUT	Butterscotch	TOF	Toffee
CIN	Cinnamon	TRF	Truffle
CLA	Classic	VEN	Venetian
EAR	Earthy		
ESP	Espresso		



Specifications



- Wood species - Oak or Maple
- Seat is upholstered with 1 ½" high density polyurethane foam.
- Mortise and tenon construction with corner blocks, glue and screws.
- Standard with rubber cushion metal glides.

Color - Add \$31 list per item; not available with laser engraving option or on models 383M and 388M

BKD	Backdrop	GRV	Greek Villa
BFX	Black Fox	GLF	Gulf Stream
BWH	Bright White	HTB	Heartthrob
CGP	Cargo Pants	NET	Network Gray
CHT	Chatroom	NWH	Nonchalant White
DSY	Daisy	PAR	Paradise
DRG	Daring	QXP	Quixotic Plum
DYN	Dynamo	RBZ	Relic Bronze
ENG	Enigma	SND	Sandbank
FRR	French Roast	STM	Storm
GBY	Georgian Bay	TRC	Tricorn Black

- See a selection of graded in fabric manufacturers and patterns on pages 12-20. Contact Customer Service for additional fabric options.

Description	① Model	Specifications				List Price Per Grade
Armless   	383NA All Wood 383NC Uph. Seat · vertical slat back · optional contrasting slats available - contact customer service for pricing · optional front leg casters available - add \$46 list for set of 2 casters	Dimensions	D	W	H	All Wood \$342
		Overall	19 ½	18 ¼	35	
		Seat	16	18 ¼	18 ¼	A \$393
		Upholstery	Shipping			B \$407
		COM Ydg	¾	Ctn Wt	28	COL/C \$429
		COL Sq Ft	9	Cu Ft	9	D \$458
						E \$488
						F \$519
						G \$562
						H \$609
						I \$683
						J \$771
						L1 \$572
						L2 \$618

Description	① Model	Specifications				List Price Per Grade
Barstool  	388NA All Wood 388NC Uph. Seat · vertical slat back · optional contrasting slats available - contact customer service for pricing · casters not available · standard with brass scuff plate, also available in polished aluminum or matte black	Dimensions	D	W	H	All Wood \$403
		Overall	19 ½	18 ¼	47	
		Seat	16	18 ¼	30	A \$453
		Upholstery	Shipping			B \$466
		COM Ydg	¾	Ctn Wt	30	COL/C \$489
		COL Sq Ft	9	Cu Ft	13	D \$518
						E \$548
						F \$578
						G \$622
						H \$669
						I \$743
						J \$831
						L1 \$632
						L2 \$678

To Order, Specify:

- ① Model Number
- ② Wood Species - Oak (O) or Maple (M)
- ③ Wood Finish/Color
- ④ Fabric Selection - vendor, pattern and color
- ⑤ Optional FRONT LEG casters—add \$46 list; specify seat height. **NOT AVAILABLE on BARSTOOLS**
- ⑥ Optional Rubber Cushion Nylon Glides - no upcharge

③ Wood Finish/Color Options:

Oak		ECU	Ecru
BRW	Brownie	HEN	Henna
CAN	Canyon	HNY	Honey
CIT	Citron	NUT	Nut Brown
DES	Desert		
Maple			
ALE	Ale	FLX	Flax
AUB	Auburn	LGC	Legacy
AUT	Autumn	MCH	Mocha
BRL	Barley	NTO	Night Owl
BBN	Bourbon	PRL	Praline
BRG	Brighton	SAF	Saffron
BUT	Butterscotch	SIE	Sienna
CIN	Cinnamon	TOF	Toffee
CLA	Classic	TRF	Truffle
EAR	Earthy	VEN	Venetian
ESP	Espresso		

Specifications

- Wood species - Oak or Maple.
- Seat is upholstered with 1 ½" high density polyurethane foam.
- Mortise and tenon construction with corner blocks, glue and screws.
- Standard with rubber cushion metal glides.

Color - Add \$31 list per item; not available on models

383M and 388M

BKD	Backdrop	GRV	Greek Villa
BFX	Black Fox	GLF	Gulf Stream
BWH	Bright White	HTB	Heartthrob
CGP	Cargo Pants	NET	Network Gray
CHT	Chatroom	NWH	Nonchalant White
DSY	Daisy	PAR	Paradise
DRG	Daring	QXP	Quixotic Plum
DYN	Dynamo	RBZ	Relic Bronze
ENG	Enigma	SND	Sandbank
FRR	French Roast	STM	Storm
GBY	Georgian Bay	TRC	Tricorn Black

- ④ See a selection of graded in fabric manufacturers and patterns on pages 12-20. Contact Customer Service for additional fabric options.

Metro Order Check List:



SEATING

Specify:

- 1. Model Number
- 2. Wood Species - Beech (B)
- 3. Wood Finish/Color
- 4. Fabric Selection - vendor, pattern and color
- 5. Optional Rubber Cushion Nylon Glides - no upcharge

Example:

2001C (model #)	B (wood species)	AUB (finish)	MOMENTUM (fabric vendor)	VOX (pattern name)	MYSTIC (pattern color)
---------------------------	----------------------------	------------------------	------------------------------------	------------------------------	----------------------------------

1. Model Number

2. Wood Species - Beech (B)

3. Wood Finish/Color Options: ▲

- | | |
|------------------|---------------|
| ALE Ale | FLX Flax |
| AUB Auburn | HEN Henna |
| AUT Autumn | HNY Honey |
| BRL Barley | LGC Legacy |
| BBN Bourbon | MCH Mocha |
| BRG Brighton | NTO Night Owl |
| BRW Brownie | NUT Nut Brown |
| BUT Butterscotch | PRL Praline |
| CAN Canyon | SAF Saffron |
| CIN Cinnamon | SIE Sienna |
| CIT Citron | TOF Toffee |
| CLA Classic | TRF Truffle |
| DES Desert | VEN Venetian |
| EAR Earthy | |
| ESP Espresso | |
- Color - Add \$31 list per item**
- | | |
|------------------|----------------------|
| BKD Backdrop | GRV Greek Villa |
| BFX Black Fox | GLF Gulf Stream |
| BWH Bright White | HTB Heartthrob |
| CGP Cargo Pants | NET Network Gray |
| CHT Chatroom | NWH Nonchalant White |
| DSY Daisy | PAR Paradise |
| DRG Daring | QXP Quixotic Plum |
| DYN Dynamo | RBZ Relic Bronze |
| ENG Enigma | SND Sandbank |
| FRR French Roast | STM Storm |
| GBY Georgian Bay | TRC Tricorn Black |

4. Fabric Selection - Please supply the following:

- Fabric vendor
- Pattern name
- Pattern color

When specifying contrasting upholstery, indicate clearly which upholstery is to be applied to the seat and back. Use higher grade pricing.

- Indicate direction of fabric - Railroaded or Up the Roll
- Please provide illustration, if available

All COM orders must include the following:







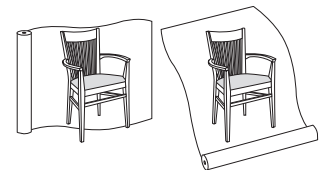

- Vendor's name, pattern name and color
- Sample of the fabric attached to order
- Model numbers of items for fabric application
- Special application instructions (e.g., all stripes will be applied front to back unless specified otherwise)
- Customer and purchase order number

Ship prepaid COM material to:
Community
Attn: COM Dept
932 Mill Street
Jasper, IN 47546

Application of fabric:
Railroaded Up the Roll



All COM orders will ship at standard lead time from receipt of COM except for orders requiring special custom matched finishes.

Description	Model	Specifications	List Price Per Grade																														
Arm 	2001C Uph. Seat · vertical slat back	<table border="1"> <thead> <tr> <th>Dimensions</th> <th>D</th> <th>W</th> <th>H</th> </tr> </thead> <tbody> <tr> <td>Overall</td> <td>20 ½</td> <td>24 ½</td> <td>35 ¾</td> </tr> <tr> <td>Seat</td> <td>16</td> <td>21 ¾</td> <td>19</td> </tr> <tr> <td>Arm</td> <td></td> <td></td> <td>25 ¾</td> </tr> <tr> <th colspan="2">Upholstery</th> <th colspan="2">Shipping</th> </tr> <tr> <td>COM Ydg</td> <td>¾</td> <td>Ctn Wt</td> <td>28</td> </tr> <tr> <td>COL Sq Ft</td> <td>9</td> <td>Cu Ft</td> <td>12</td> </tr> </tbody> </table>	Dimensions	D	W	H	Overall	20 ½	24 ½	35 ¾	Seat	16	21 ¾	19	Arm			25 ¾	Upholstery		Shipping		COM Ydg	¾	Ctn Wt	28	COL Sq Ft	9	Cu Ft	12	COM \$495 A \$510 B \$522 COL/C \$545 D \$575 E \$604 F \$635 G \$679 H \$726 I \$800 J \$887 L1 \$687 L2 \$734		
		Dimensions	D	W	H																												
		Overall	20 ½	24 ½	35 ¾																												
		Seat	16	21 ¾	19																												
		Arm			25 ¾																												
		Upholstery		Shipping																													
		COM Ydg	¾	Ctn Wt	28																												
		COL Sq Ft	9	Cu Ft	12																												
		Arm   <p>exposed back design</p>	2001D Uph. Seat/Back · vertical slat back · exposed back design	<table border="1"> <thead> <tr> <th>Dimensions</th> <th>D</th> <th>W</th> <th>H</th> </tr> </thead> <tbody> <tr> <td>Overall</td> <td>20 ½</td> <td>24 ½</td> <td>35 ¾</td> </tr> <tr> <td>Seat</td> <td>16</td> <td>21 ¾</td> <td>19</td> </tr> <tr> <td>Arm</td> <td></td> <td></td> <td>25 ¾</td> </tr> <tr> <th colspan="2">Upholstery</th> <th colspan="2">Shipping</th> </tr> <tr> <td>COM Ydg</td> <td>1 ¼</td> <td>Ctn Wt</td> <td>28</td> </tr> <tr> <td>COL Sq Ft</td> <td>15</td> <td>Cu Ft</td> <td>12</td> </tr> </tbody> </table>	Dimensions	D	W	H	Overall	20 ½	24 ½	35 ¾	Seat	16	21 ¾	19	Arm			25 ¾	Upholstery		Shipping		COM Ydg	1 ¼	Ctn Wt	28	COL Sq Ft	15	Cu Ft	12	COM \$612 A \$633 B \$654 COL/C \$691 D \$741 E \$790 F \$842 G \$914 H \$993 I \$1,115 J \$1,262 L1 \$929 L2 \$1,007
				Dimensions	D	W	H																										
Overall	20 ½			24 ½	35 ¾																												
Seat	16			21 ¾	19																												
Arm					25 ¾																												
Upholstery				Shipping																													
COM Ydg	1 ¼			Ctn Wt	28																												
COL Sq Ft	15			Cu Ft	12																												
Armless   <p>2003A all wood</p>	2003A All Wood 2003C Uph. Seat · vertical slat back			<table border="1"> <thead> <tr> <th>Dimensions</th> <th>D</th> <th>W</th> <th>H</th> </tr> </thead> <tbody> <tr> <td>Overall</td> <td>20 ½</td> <td>17 ¾</td> <td>35 ¾</td> </tr> <tr> <td>Seat</td> <td>16</td> <td>17 ¾</td> <td>19</td> </tr> <tr> <th colspan="2">Upholstery</th> <th colspan="2">Shipping</th> </tr> <tr> <td>COM Ydg</td> <td>¾</td> <td>Ctn Wt</td> <td>21</td> </tr> <tr> <td>COL Sq Ft</td> <td>9</td> <td>Cu Ft</td> <td>9</td> </tr> </tbody> </table>	Dimensions	D	W	H	Overall	20 ½	17 ¾	35 ¾	Seat	16	17 ¾	19	Upholstery		Shipping		COM Ydg	¾	Ctn Wt	21	COL Sq Ft	9	Cu Ft	9	All Wood \$434 COM \$471 A \$485 B \$498 COL/C \$521 D \$550 E \$579 F \$611 G \$655 H \$701 I \$774 J \$863 L1 \$663 L2 \$710				
				Dimensions	D	W	H																										
		Overall	20 ½	17 ¾	35 ¾																												
		Seat	16	17 ¾	19																												
		Upholstery		Shipping																													
		COM Ydg	¾	Ctn Wt	21																												
		COL Sq Ft	9	Cu Ft	9																												
		 <p>2003C uph. seat</p>			COM \$471 A \$485 B \$498 COL/C \$521 D \$550 E \$579 F \$611 G \$655 H \$701 I \$774 J \$863 L1 \$663 L2 \$710																												
					Armless    <p>exposed back design</p>	2003D Uph. Seat/Back · vertical slat back · exposed back design	<table border="1"> <thead> <tr> <th>Dimensions</th> <th>D</th> <th>W</th> <th>H</th> </tr> </thead> <tbody> <tr> <td>Overall</td> <td>20 ½</td> <td>17 ¾</td> <td>35 ¾</td> </tr> <tr> <td>Seat</td> <td>16</td> <td>17 ¾</td> <td>19</td> </tr> <tr> <th colspan="2">Upholstery</th> <th colspan="2">Shipping</th> </tr> <tr> <td>COM Ydg</td> <td>1 ¼</td> <td>Ctn Wt</td> <td>21</td> </tr> <tr> <td>COL Sq Ft</td> <td>15</td> <td>Cu Ft</td> <td>9</td> </tr> </tbody> </table>	Dimensions	D	W	H	Overall	20 ½	17 ¾	35 ¾	Seat	16	17 ¾	19	Upholstery		Shipping		COM Ydg	1 ¼	Ctn Wt	21	COL Sq Ft	15	Cu Ft	9	COM \$587 A \$607 B \$629 COL/C \$667 D \$717 E \$765 F \$816 G \$890 H \$969 I \$1,090 J \$1,237 L1 \$905 L2 \$982	
							Dimensions	D	W	H																							
Overall	20 ½						17 ¾	35 ¾																									
Seat	16						17 ¾	19																									
Upholstery							Shipping																										
COM Ydg	1 ¼						Ctn Wt	21																									
COL Sq Ft	15						Cu Ft	9																									

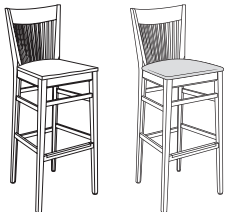
Description	Model	Specifications			List Price Per Grade		
		Dimensions	D	W	H	All Wood	COM
Barstool 	2008A All Wood 2008C Uph. Seat · vertical slat back · standard with brass scuff plate, also available in polished aluminum or matte black	Overall	20 ½	17 ½	43 ½	\$480	\$517
		Seat	16	17 ¼	30	\$532	\$544
		Upholstery		Shipping		\$567	
		COM Ydg	¾	Ctn Wt	28	\$597	\$626
		COL Sq Ft	9	Cu Ft	13	\$658	\$701
						\$748	\$822
						\$910	\$710
						\$756	

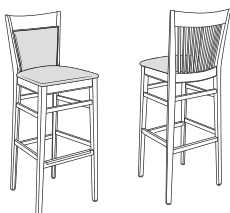
Description	Model	Specifications			List Price Per Grade		
		Dimensions	D	W	H	COM	COL/C
Barstool 	2008D Uph. Seat/Back · vertical slat back · standard with brass scuff plate, also available in polished aluminum or matte black · exposed back design	Overall	20 ½	17 ½	43 ½	\$634	\$653
		Seat	16	17 ¼	30	\$669	\$700
		Upholstery		Shipping		\$740	
		COM Ydg	1	Ctn Wt	28	\$779	\$819
		COL Sq Ft	12	Cu Ft	13	\$878	\$940
						\$1,039	\$1,155
						\$890	\$953

To Order, Specify:

- 1 Model Number
- 2 Wood Species - Beech (B)
- 3 Wood Finish/Color
- 4 Fabric Selection - vendor, pattern and color
- 5 Optional Rubber Cushion Nylon Glides - no upcharge

3 Wood Finish Options:

ALE Ale	FLX Flax
AUB Auburn	HEN Henna
AUT Autumn	HNY Honey
BRL Barley	LGC Legacy
BBN Bourbon	MCH Mocha
BRG Brighton	NTO Night Owl
BRW Brownie	NUT Nut Brown
BUT Butterscotch	PRL Praline
CAN Canyon	SAF Saffron
CIN Cinnamon	SIE Sienna
CIT Citron	TOF Toffee
CLA Classic	TRF Truffle
DES Desert	VEN Venetian
EAR Earthy	
ESP Espresso	

Color - Add \$31 list per item

BKD Backdrop	GRV Greek Villa
BFX Black Fox	GLF Gulf Stream
BWH Bright White	HTB Heartthrob
CGP Cargo Pants	NET Network Gray
CHT Chatroom	NWH Nonchalant White
DSY Daisy	PAR Paradise
DRG Daring	QXP Quixotic Plum
DYN Dynamo	RBZ Relic Bronze
ENG Enigma	SND Sandbank
FRR French Roast	STM Storm
GBY Georgian Bay	TRC Tricorn Black

Specifications

- Wood species - Beech.
- Seat is upholstered with 1 ½" high density polyurethane foam.
- Back is upholstered with ½" high density polyurethane foam.
- Mortise and tenon construction with corner blocks, glue and screws.
- Standard with rubber cushion metal glides.

4 See a selection of graded in fabric manufacturers and patterns on pages 12-20. Contact Customer Service for additional fabric options.

Milk Order Check List:



SEATING

Specify:

- 1. Model Number
- 2. Seat and Back Plastic Color
- 3. Frame Color - Network Gray (NG), Repose Gray (RG) or Tricorn Black (TB)
- 4. Fabric Selection - vendor, pattern and color

Example:

MK5203C (model #)	CB (seat & back color)	TB (frame color)	MOMENTUM (fabric vendor)	VOX (pattern name)	MYSTIC (pattern color)
-----------------------------	----------------------------------	----------------------------	------------------------------------	------------------------------	----------------------------------

1. Model Number

2. Seat and Back Plastic Color Options

(seat and back will be same color):

- CB Candid Blue
- DF Daffodil
- GV Greek Villa
- MD Mandarin
- TB Tricorn Black
- VA Valentine

3 Frame Color Selection - Network Gray (NG), Repose Gray (RG) or Tricorn Black (TB)

4. Fabric Selection - Please supply the following:

- Fabric vendor
- Pattern name
- Pattern color

When specifying contrasting upholstery, indicate clearly which upholstery is to be applied to the seat and back. Use higher grade pricing.

- Indicate direction of fabric - Railroaded or Up the Roll
- Please provide illustration, if available

All COM orders must include the following:



- Vendor's name, pattern name and color
- Sample of the fabric attached to order
- Model numbers of items for fabric application
- Special application instructions (e.g., all stripes will be applied front to back unless specified otherwise)
- Customer and purchase order number

Ship prepaid COM material to:
Community
Attn: COM Dept
932 Mill Street
Jasper, IN 47546

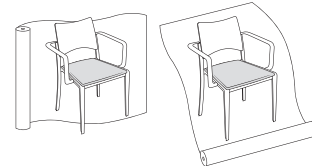
Application of fabric:
Railroaded Up the Roll



All COM orders will ship at standard lead time from receipt of COM except for orders requiring special custom matched finishes.

Description	Model	Specifications			List Price Per Grade		
		Dimensions	D	W	H	All Plastic	COM
Armless   MK5203A all plastic	MK5203A All Plastic MK5203B Uph. Back • nylon frame • stacking bumpers (A model only) • not recommended to stack plastic seat chairs with upholstered seat chairs • single chair weight - 9 lbs	Overall	19 1/2	20	31 3/4	\$283	\$349
		Seat	17 1/2	17 1/2	18	\$360	\$369
		Upholstery		Shipping		COL/C	\$387
		COM Ydg	3/4	Ctn Wt	45	D	\$409
		COL Sq Ft	9	Cu Ft		E	\$431
						F	\$465
						G	\$501
						H	\$540
						I	\$601
						J	\$675
						L1	\$509
						L2	\$548

Description	Model	Specifications			List Price Per Grade		
		Dimensions	D	W	H	COM	A
Armless  MK5203C uph. seat	MK5203C Uph. Seat • nylon frame • not recommended to stack plastic seat chairs with upholstered seat chairs • single chair weight - 9 lbs	Overall	19 1/2	20	31 3/4	\$342	\$354
		Seat	17 1/2	17 1/2	18	\$369	\$395
		Upholstery		Shipping		COL/C	\$428
		COM Ydg	3/4	Ctn Wt	45	D	\$461
		COL Sq Ft	9	Cu Ft		E	\$512
						F	\$567
						H	\$626
						I	\$718
						J	\$828
						L1	\$578
						L2	\$637

Description	Model	Specifications			List Price Per Grade		
		Dimensions	D	W	H	COM	A
Armless  MK5203D uph. seat/back	MK5203D Uph. Seat/Back • nylon frame • not recommended to stack plastic seat chairs with upholstered seat chairs • single chair weight - 9 lbs	Overall	19 1/2	20	31 3/4	\$401	\$417
		Seat	17 1/2	17 1/2	18	\$436	\$471
		Upholstery		Shipping		COL/C	\$515
		COM Ydg	3/4	Ctn Wt	45	D	\$558
		COL Sq Ft	9	Cu Ft		F	\$627
						G	\$700
						H	\$779
						I	\$900
						J	\$1,047
						L1	\$714
						L2	\$793

To Order, Specify:

- 1 Model Number
- 2 Seat and Back Plastic Color
- 3 Frame Color - Network Gray (NG), Repose Gray (RG) or Tricorn Black (TB)
- 4 Fabric Selection - vendor, pattern and color

2 Seat and Back Plastic Color Options:

- CB Candid Blue
- DF Daffodil
- GV Greek Villa
- MD Mandarin
- TB Tricorn Black
- VA Valentine

- 4 See a selection of graded in fabric manufacturers and patterns on pages 12-20. Contact Customer Service for additional fabric options.

Specifications

- Seat and back are glass reinforced polypropylene.
- Frame is glass reinforced nylon.
- Glide is integrated nylon.
- Plastic seat models have stacking bumper.
- Upholstered seat models have polypropylene stacking guard on underside of seat.
- Upholstered seat has 1/2" high density polyurethane foam.

Description	D	W	H	CTN WT	CU FT	Model	List Price
Transport Cart	34	23 3/4	40 3/4	29		TC01	\$615



- 16 ga. steel tube
- 4" heavy duty casters
- only available in black finish
- recommended for armless models only



Quantity	Stacks On	Chair	Seat
6	Floor	Arm	Upholstered
7	Floor	Arm	Plastic
8	Floor	Armless	Upholstered
10	Floor	Armless	Plastic
15	Cart	Armless	Upholstered
15	Cart	Armless	Plastic

SEATING

Description	Model	Specifications	List Price Per Grade																												
Arm	MK5201A All Plastic	<table border="1"> <thead> <tr> <th>Dimensions</th> <th>D</th> <th>W</th> <th>H</th> </tr> </thead> <tbody> <tr> <td>Overall</td> <td>19 1/2</td> <td>23 1/4</td> <td>31 3/4</td> </tr> <tr> <td>Seat</td> <td>17 1/2</td> <td>19 3/4</td> <td>18</td> </tr> <tr> <td>Arm</td> <td></td> <td></td> <td>26</td> </tr> <tr> <th colspan="2">Upholstery</th> <th colspan="2">Shipping</th> </tr> <tr> <td>COM Ydg</td> <td>3/4</td> <td>Ctn Wt</td> <td>53</td> </tr> <tr> <td>COL Sq Ft</td> <td>9</td> <td>Cu Ft</td> <td></td> </tr> </tbody> </table>	Dimensions	D	W	H	Overall	19 1/2	23 1/4	31 3/4	Seat	17 1/2	19 3/4	18	Arm			26	Upholstery		Shipping		COM Ydg	3/4	Ctn Wt	53	COL Sq Ft	9	Cu Ft		All Plastic \$340
	Dimensions		D	W	H																										
Overall	19 1/2	23 1/4	31 3/4																												
Seat	17 1/2	19 3/4	18																												
Arm			26																												
Upholstery		Shipping																													
COM Ydg	3/4	Ctn Wt	53																												
COL Sq Ft	9	Cu Ft																													
	MK5201B Uph. Back		COM \$405																												
	<ul style="list-style-type: none"> · nylon frame · stacking bumpers · not stackable on cart · not recommended to stack plastic seat chairs with upholstered seat chairs · single chair weight - 11 lbs · seat width range is 17 1/2 - 19 3/4 		A \$416																												
			B \$426																												
			COL/C \$444																												
			D \$465																												
			E \$487																												
			F \$521																												
			G \$558																												
			H \$597																												
			I \$658																												
			J \$731																												
			L1 \$565																												
			L2 \$604																												



MK5201A all plastic



MK5201B uph. back

Description	Model	Specifications	List Price Per Grade																												
Arm	MK5201C Uph. Seat	<table border="1"> <thead> <tr> <th>Dimensions</th> <th>D</th> <th>W</th> <th>H</th> </tr> </thead> <tbody> <tr> <td>Overall</td> <td>19 1/2</td> <td>23 1/4</td> <td>31 3/4</td> </tr> <tr> <td>Seat</td> <td>17 1/2</td> <td>19 3/4</td> <td>18</td> </tr> <tr> <td>Arm</td> <td></td> <td></td> <td>26</td> </tr> <tr> <th colspan="2">Upholstery</th> <th colspan="2">Shipping</th> </tr> <tr> <td>COM Ydg</td> <td>3/4</td> <td>Ctn Wt</td> <td>53</td> </tr> <tr> <td>COL Sq Ft</td> <td>9</td> <td>Cu Ft</td> <td></td> </tr> </tbody> </table>	Dimensions	D	W	H	Overall	19 1/2	23 1/4	31 3/4	Seat	17 1/2	19 3/4	18	Arm			26	Upholstery		Shipping		COM Ydg	3/4	Ctn Wt	53	COL Sq Ft	9	Cu Ft		COM \$396
Dimensions	D		W	H																											
Overall	19 1/2	23 1/4	31 3/4																												
Seat	17 1/2	19 3/4	18																												
Arm			26																												
Upholstery		Shipping																													
COM Ydg	3/4	Ctn Wt	53																												
COL Sq Ft	9	Cu Ft																													
	<ul style="list-style-type: none"> · nylon frame · not stackable on cart · not recommended to stack plastic seat chairs with upholstered seat chairs · single chair weight - 11 lbs · seat width range is 17 1/2 - 19 3/4 		A \$410																												
			B \$425																												
			COL/C \$451																												
			D \$483																												
			E \$516																												
			F \$567																												
			G \$623																												
			H \$681																												
			I \$773																												
			J \$882																												
			L1 \$634																												
			L2 \$692																												



Description	Model	Specifications			List Price Per Grade			
		Dimensions	D	W	H	COM	COL/C	
Arm 	MK5201D Uph. Seat/Back • nylon frame • not stackable on cart • not recommended to stack plastic seat chairs with upholstered seat chairs • single chair weight - 11 lbs • seat width range is 17 ½ - 19 ¾	Overall	19 ½	23 ¼	31 ¾	\$456	\$473	
		Seat	17 ½	19 ¾	18	\$493	\$528	
		Arm			26	\$571		
		Upholstery		Shipping		\$615		
		COM Ydg	¾	Ctn Wt	53	\$683		
		COL Sq Ft	9	Cu Ft		\$756		
						\$835		
						\$957		
						\$1,104		
						\$771		
				\$850				

SEATING

To Order, Specify:

- ① Model Number
- ② Seat and Back Plastic Color
- ③ Frame Color - Network Gray (NG), Repose Gray (RG) or Tricorn Black (TB)
- ④ Fabric Selection - vendor, pattern and color

② Seat and Back Plastic Color Options:

- CB Candid Blue
- DF Daffodil
- GV Greek Villa
- MD Mandarin
- TB Tricorn Black
- VA Valentine

- ④ See a selection of graded in fabric manufacturers and patterns on pages 12-20. Contact Customer Service for additional fabric options.

Specifications

- Seat and back are glass reinforced polypropylene.
- Frame is glass reinforced nylon.
- Glide is integrated nylon.
- Plastic seat models have stacking bumper.
- Upholstered seat models have polypropylene stacking guard on underside of seat.
- Upholstered seat has ½" high density polyurethane foam.

Murphy Order Check List:

SEATING



Specify:

- 1. Model Number
- 2. Wood Species - Maple (M)
- 3. Wood Finish/Color
- 4. Fabric Selection - vendor, pattern and color
- 5. Optional Rubber Cushion Nylon Glides - no upcharge

Example:

373C | M | AUB | MOMENTUM | VOX | MYSTIC
 (model #) | (wood species) | (finish) | (fabric vendor) | (pattern name) | (pattern color)

1. Model Number

2. Wood Species - Maple (M)

3. Wood Finish/Color Options: ▲

ALE Ale	FLX Flax
AUB Auburn	HEN Henna
AUT Autumn	HNY Honey
BRL Barley	LGC Legacy
BBN Bourbon	MCH Mocha
BRG Brighton	NTO Night Owl
BRW Brownie	NUT Nut Brown
BUT Butterscotch	PRL Praline
CAN Canyon	SAF Saffron
CIN Cinnamon	SIE Sienna
CIT Citron	TOF Toffee
CLA Classic	TRF Truffle
DES Desert	VEN Venetian
EAR Earthy	
ESP Espresso	

Color - Add \$31 list per item

BKD Backdrop	GRV Greek Villa
BFX Black Fox	GLF Gulf Stream
BWH Bright White	HTB Heartthrob
CGP Cargo Pants	NET Network Gray
CHT Chatroom	NWH Nonchalant White
DSY Daisy	PAR Paradise
DRG Daring	QXP Quixotic Plum
DYN Dynamo	RBZ Relic Bronze
ENG Enigma	SND Sandbank
FRR French Roast	STM Storm
GBY Georgian Bay	TRC Tricorn Black

4. Fabric Selection - Please supply the following:

- Fabric vendor
- Pattern name
- Pattern color

All COM orders must include the following:



- Vendor's name, pattern name and color
- Sample of the fabric attached to order
- Model numbers of items for fabric application
- Special application instructions (e.g., all stripes will be applied front to back unless specified otherwise)
- Customer and purchase order number

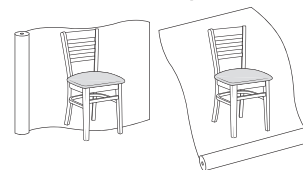

Ship prepaid COM material to:
 Community
 Attn: COM Dept
 932 Mill Street
 Jasper, IN 47546

Application of fabric:
 Railroaded Up the Roll



All COM orders will ship at standard lead time from receipt of COM except for orders requiring special custom matched finishes.

Description	Model	Specifications				List Price Per Grade	
		Dimensions	D	W	H	All Wood	COM
Armless 	373A All Wood					\$304	
	373C Uph. Seat · horizontal slat back					\$344	
 	373A all wood	Overall	19 ¼	16 ¼	32 ¾	A	\$356
	373C uph. seat	Seat	16	15 ½	18 ¼	B	\$369
		Upholstery		Shipping		COL/C	\$392
		COM Ydg	¾	Ctn Wt	25	D	\$422
		COL Sq Ft	9	Cu Ft	9	E	\$451
						F	\$481
						G	\$525
						H	\$573
						I	\$645
						J	\$733
						L1	\$534
						L2	\$581

Description	Model	Specifications				List Price Per Grade	
		Dimensions	D	W	H	All Wood	COM
Barstool	378A All Wood					\$366	
	378C Uph. Seat · horizontal slat back · standard with brass scuff plate, also available in polished aluminum or matte black					\$403	
 	378A all wood	Overall	22	19	43 ¾	A	\$415
	378C uph. seat	Seat	16 ¼	19	29 ½	B	\$429
		Upholstery		Shipping		COL/C	\$452
		COM Ydg	¾	Ctn Wt	30	D	\$480
		COL Sq Ft	9	Cu Ft	13	E	\$510
						F	\$541
						G	\$585
						H	\$632
						I	\$705
						J	\$793
						L1	\$594
						L2	\$641

To Order, Specify:

- 1 Model Number
- 2 Wood Species - Maple (M)
- 3 Wood Finish/Color
- 4 Fabric Selection - vendor, pattern and color
- 5 Optional Rubber Cushion Nylon Glides - no upcharge

3 Wood Finish/Color Options: ▲

ALE Ale	FLX Flax
AUB Auburn	HEN Henna
AUT Autumn	HNY Honey
BRL Barley	LGC Legacy
BBN Bourbon	MCH Mocha
BRG Brighton	NTO Night Owl
BRW Brownie	NUT Nut Brown
BUT Butterscotch	PRL Praline
CAN Canyon	SAF Saffron
CIN Cinnamon	SIE Sienna
CIT Citron	TOF Toffee
CLA Classic	TRF Truffle
DES Desert	VEN Venetian
EAR Earthy	
ESP Espresso	

Color - Add \$31 list per item

BKD Backdrop	GRV Greek Villa
BFX Black Fox	GLF Gulf Stream
BWH Bright White	HTB Heartthrob
CGP Cargo Pants	NET Network Gray
CHT Chatroom	NWH Nonchalant White
DSY Daisy	PAR Paradise
DRG Daring	QXP Quixotic Plum
DYN Dynamo	RBZ Relic Bronze
ENG Enigma	SND Sandbank
FRR French Roast	STM Storm
GBY Georgian Bay	TRC Tricorn Black

- 4 See a selection of graded in fabric manufacturers and patterns on pages 12-20. Contact Customer Service for additional fabric options.

Specifications

- Wood species - Maple.
- Seat is upholstered with 1 ½" polyurethane foam and synthetic sheet webbing for added comfort.
- Spiral grooved hardwood dowels with corner blocks, glue and screws.
- Standard with rubber cushion metal glides.

Parker Order Check List:



SEATING

Specify:

- 1. Model Number
- 2. Wood Species - Maple (M)
- 3. Wood Finish/Color
- 4. Fabric Selection - vendor, pattern and color
- 5. Optional Chrome Foot Ring - add \$31 list
ROUND BARSTOOLS ONLY
- 6. Optional Polished Aluminum or Black Scuff Plates - no upcharge
SQUARE BARSTOOL ONLY
- 7. Optional Rubber Cushion Nylon Glides - no upcharge

Example:

88C <small>(model #)</small>	M <small>(wood species)</small>	AUB <small>(finish)</small>	MOMENTUM <small>(fabric vendor)</small>	VOX <small>(pattern name)</small>	MYSTIC <small>(pattern color)</small>
---------------------------------	------------------------------------	--------------------------------	--	--------------------------------------	--

1. Model Number

2. Wood Species - Maple (M)

3. Wood Finish/Color Options: ▲

ALE Ale	FLX Flax
AUB Auburn	HEN Henna
AUT Autumn	HNY Honey
BRL Barley	LGC Legacy
BBN Bourbon	MCH Mocha
BRG Brighton	NTO Night Owl
BRW Brownie	NUT Nut Brown
BUT Butterscotch	PRL Praline
CAN Canyon	SAF Saffron
CIN Cinnamon	SIE Sienna
CIT Citron	TOF Toffee
CLA Classic	TRF Truffle
DES Desert	VEN Venetian
EAR Earthy	
ESP Espresso	

Color - Add \$31 list per item

BKD Backdrop	GRV Greek Villa
BFX Black Fox	GLF Gulf Stream
BWH Bright White	HTB Heartthrob
CGP Cargo Pants	NET Network Gray
CHT Chatroom	NWH Nonchalant White
DSY Daisy	PAR Paradise
DRG Daring	QXP Quixotic Plum
DYN Dynamo	RBZ Relic Bronze
ENG Enigma	SND Sandbank
FRR French Roast	STM Storm
GBY Georgian Bay	TRC Tricorn Black

4. Fabric Selection - Please supply the following:

- Fabric vendor
- Pattern name
- Pattern color

All COM orders must include the following:

- Vendor's name, pattern name and color
- Sample of the fabric attached to order
- Model numbers of items for fabric application
- Special application instructions (e.g., all stripes will be applied front to back unless specified otherwise)
- Customer and purchase order number

Ship prepaid COM material to:
 Community
 Attn: COM Dept
 932 Mill Street
 Jasper, IN 47546

All COM orders will ship at standard lead time from receipt of COM except for orders requiring special custom matched finishes.

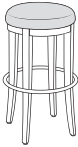
Description	Model	Specifications				List Price Per Grade	
		Dimensions	D	W	H	COM	
Barstool Round 	88C Uph. Seat · round seat · features brass foot rings · optional chrome foot ring - add \$31 list	Overall	18	18	30	COM	\$356
		Seat	17	17	30	A	\$369
		Upholstery		Shipping		B	\$382
		COM Ydg	¾	Ctn Wt	18	COL/C	\$405
		COL Sq Ft	9	Cu Ft	7	D	\$434
						E	\$464
						F	\$494
						G	\$538
						H	\$585
						I	\$659
						J	\$746
						L1	\$546
						L2	\$594

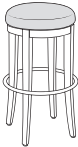
Description	Model	Specifications				List Price Per Grade	
		Dimensions	D	W	H	COM	
Barstool Round Swivel 	89C Uph. Seat · 360° swivel seat · features brass foot rings · optional chrome foot ring - add \$31 list	Overall	18	18	31	COM	\$374
		Seat	17	17	31	A	\$387
		Upholstery		Shipping		B	\$399
		COM Ydg	¾	Ctn Wt	18	COL/C	\$423
		COL Sq Ft	9	Cu Ft	7	D	\$452
						E	\$481
						F	\$512
						G	\$556
						H	\$603
						I	\$677
						J	\$765
						L1	\$565
						L2	\$612

To Order, Specify:

- 1 Model Number
 - 2 Wood Species - Maple (M)
 - 3 Wood Finish/Color
 - 4 Fabric Selection - vendor, pattern and color
 - 5 Optional Chrome Foot Ring - add \$31 list
- ROUND BARSTOOLS ONLY**
- 6 Optional Rubber Cushion Nylon Glides - no upcharge

3 Wood Finish/Color Options:

ALE Ale	FLX Flax
AUB Auburn	HEN Henna
AUT Autumn	HNY Honey
BRL Barley	LGC Legacy
BBN Bourbon	MCH Mocha
BRG Brighton	NTO Night Owl
BRW Brownie	NUT Nut Brown
BUT Butterscotch	PRL Praline
CAN Canyon	SAF Saffron
CIN Cinnamon	SIE Sienna
CIT Citron	TOF Toffee
CLA Classic	TRF Truffle
DES Desert	VEN Venetian
EAR Earthy	
ESP Espresso	

Color - Add \$31 list per item

BKD Backdrop	GRV Greek Villa
BFX Black Fox	GLF Gulf Stream
BWH Bright White	HTB Heartthrob
CGP Cargo Pants	NET Network Gray
CHT Chatroom	NWH Nonchalant White
DSY Daisy	PAR Paradise
DRG Daring	QXP Quixotic Plum
DYN Dynamo	RBZ Relic Bronze
ENG Enigma	SND Sandbank
FRR French Roast	STM Storm
GBY Georgian Bay	TRC Tricorn Black

Specifications

- Wood species - Maple.
- Round seats are upholstered with 4" high density polyurethane foam.
- Mortise and tenon construction with corner blocks, glue.
- Standard with rubber cushion metal glides.

4 See a selection of graded in fabric manufacturers and patterns on pages 12-20. Contact Customer Service for additional fabric options.

Description	① Model	Specifications				List Price Per Grade
		Dimensions	D	W	H	
Barstool Square 	98C Uph. Seat · square seat · standard with four brass scuff plates, also available in polished aluminum or matte black	Overall	17	17	30	COM \$329
		Seat	17	17	30	A \$341
		Upholstery		Shipping		B \$354
		COM Ydg	¾	Ctn Wt	18	COL/C \$377
		COL Sq Ft	9	Cu Ft	7	D \$406
						E \$435
						F \$467
				G \$511		
				H \$557		
				I \$630		
				J \$719		
				L1 \$519		
				L2 \$566		

SEATING

To Order, Specify:

- ① Model Number
- ② Wood Species - Maple (M)
- ③ Wood Finish/Color
- ④ Fabric Selection - vendor, pattern and color
- ⑤ Optional Polished Aluminum or Black Scuff Plates - no upcharge
- SQUARE BARSTOOL ONLY**
- ⑥ Optional Rubber Cushion Nylon Glides - no upcharge

③ Wood Finish/Color Options: ▲

ALE Ale	FLX Flax
AUB Auburn	HEN Henna
AUT Autumn	HNY Honey
BRL Barley	LGC Legacy
BBN Bourbon	MCH Mocha
BRG Brighton	NTO Night Owl
BRW Brownie	NUT Nut Brown
BUT Butterscotch	PRL Praline
CAN Canyon	SAF Saffron
CIN Cinnamon	SIE Sienna
CIT Citron	TOF Toffee
CLA Classic	TRF Truffle
DES Desert	VEN Venetian
EAR Earthy	
ESP Espresso	

Color - Add \$31 list per item

BKD Backdrop	GRV Greek Villa
BFX Black Fox	GLF Gulf Stream
BWH Bright White	HTB Hearthrob
CGP Cargo Pants	NET Network Gray
CHT Chatroom	NWH Nonchalant White
DSY Daisy	PAR Paradise
DRG Daring	QXP Quixotic Plum
DYN Dynamo	RBZ Relic Bronze
ENG Enigma	SND Sandbank
FRR French Roast	STM Storm
GBY Georgian Bay	TRC Tricorn Black

Specifications

- Wood species - Maple.
- Square seats are upholstered with 1 ½" high density polyurethane foam.
- Mortise and tenon construction with corner blocks, glue.
- Standard with rubber cushion metal glides.

④ See a selection of graded fabric manufacturers and patterns on pages 12-20. Contact Customer Service for additional fabric options.

Profile Order Check List:



SEATING

- Specify:**
- 1. Model Number
 - 2. Wood Species - Beech (B)
 - 3. Wood Finish/Color
 - 4. Fabric Selection - vendor, pattern and color
 - 5. Optional Rubber Cushion Nylon Glides - no upcharge

Example:

PR6631C (model #)	B (wood species)	AUB (finish)	MOMENTUM (fabric vendor)	VOX (pattern name)	MYSTIC (pattern color)
-----------------------------	----------------------------	------------------------	------------------------------------	------------------------------	----------------------------------

1. Model Number

2. Wood Species - Beech (B)

3. Wood Finish/Color Options: ▲

ALE Ale	FLX Flax
AUB Auburn	HEN Henna
AUT Autumn	HNY Honey
BRL Barley	LGC Legacy
BBN Bourbon	MCH Mocha
BRG Brighton	NTO Night Owl
BRW Brownie	NUT Nut Brown
BUT Butterscotch	PRL Praline
CAN Canyon	SAF Saffron
CIN Cinnamon	SIE Sienna
CIT Citron	TOF Toffee
CLA Classic	TRF Truffle
DES Desert	VEN Venetian
EAR Earthy	
ESP Espresso	
Color - Add \$31 list per item	
BKD Backdrop	GRV Greek Villa
BFX Black Fox	GLF Gulf Stream
BWH Bright White	HTB Heartthrob
CGP Cargo Pants	NET Network Gray
CHT Chatroom	NWH Nonchalant White
DSY Daisy	PAR Paradise
DRG Daring	QXP Quixotic Plum
DYN Dynamo	RBZ Relic Bronze
ENG Enigma	SND Sandbank
FRR French Roast	STM Storm
GBY Georgian Bay	TRC Tricorn Black

4. Fabric Selection - Please supply the following:

- Fabric vendor
- Pattern name
- Pattern color

When specifying contrasting upholstery, indicate clearly which upholstery is to be applied to the seat, back and arms. Use higher grade pricing.

- Indicate direction of fabric - Railroaded or Up the Roll
- Please provide illustration, if available

All COM orders must include the following:

- Vendor's name, pattern name and color
- Sample of the fabric attached to order
- Model numbers of items for fabric application
- Special application instructions (e.g., all stripes will be applied front to back unless specified otherwise)
- Customer and purchase order number

Ship prepaid COM material to:
Community
Attn: COM Dept
932 Mill Street
Jasper, IN 47546

Application of fabric:
Railroaded Up the Roll

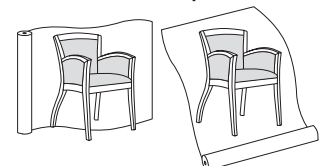

All COM orders will ship at standard lead time from receipt of COM except for orders requiring special custom matched finishes.

Description	Model	Specifications			List Price Per Grade	
Guest Chair 	PR66310 · open arm	Dimensions	D	W	H	COM \$758
		Overall	23 ¼	23 ½	33 ¼	A \$771
		Seat	19 ¾	18	20 ¼	B \$797
		Arm			27 ¾	COL/C \$843
		Upholstery	Shipping			D \$901
		COM Ydg	1 ½	Ctn Wt	31	E \$960
		COL Sq Ft	30	Cu Ft	14	F \$1,022
						G \$1,110
						H \$1,204
						I \$1,351
				J \$1,526		
				L1 \$1,127		
				L2 \$1,222		

Guest Chair 	PR6631C · closed arm	Dimensions	D	W	H	COM \$836
		Overall	23 ¼	23 ½	33 ¼	A \$854
		Seat	19 ¾	18	20 ¼	B \$889
		Arm			27 ¾	COL/C \$950
		Upholstery	Shipping			D \$1,028
		COM Ydg	2	Ctn Wt	31	E \$1,106
		COL Sq Ft	40	Cu Ft	14	F \$1,189
						G \$1,306
						H \$1,431
						I \$1,627
				J \$1,861		
				L1 \$1,330		
				L2 \$1,455		

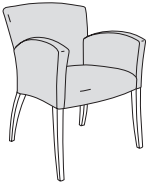
Description	Model	Specifications			List Price Per Grade		
		Dimensions	D	W	H	COM	Grade
Guest Chair 	PR6631F · fully upholstered	Overall	23 ¼	23 ½	33 ¼	COM	\$878
		Seat	19 ¾	18	20 ¼	A	\$902
		Arm			27 ¾	B	\$951
		Upholstery		Shipping		COL/C	\$1,035
		COM Ydg	2 ¾	Ctn Wt	31	D	\$1,142
		COL Sq Ft	55	Cu Ft	14	E	\$1,249
						F	\$1,362
						G	\$1,524
						H	\$1,696
						I	\$1,965
				J	\$2,287		
				L1	\$1,557		
				L2	\$1,728		

SEATING

To Order, Specify:

- ① Model Number
- ② Wood Species - Beech (B)
- ③ Wood Finish/Color
- ④ Fabric Selection - vendor, pattern and color
- ⑤ Optional Rubber Cushion Nylon Glides - no upcharge

③ Wood Finish/Color Options:▲

ALE Ale	FLX Flax
AUB Auburn	HEN Henna
AUT Autumn	HNY Honey
BRL Barley	LGC Legacy
BBN Bourbon	MCH Mocha
BRG Brighton	NTO Night Owl
BRW Brownie	NUT Nut Brown
BUT Butterscotch	PRL Praline
CAN Canyon	SAF Saffron
CIN Cinnamon	SIE Sienna
CIT Citron	TOF Toffee
CLA Classic	TRF Truffle
DES Desert	VEN Venetian
EAR Earthy	
ESP Espresso	

Color - Add \$31 list per item

BKD Backdrop	GRV Greek Villa
BFX Black Fox	GLF Gulf Stream
BWH Bright White	HTB Heartthrob
CGP Cargo Pants	NET Network Gray
CHT Chatroom	NWH Nonchalant White
DSY Daisy	PAR Paradise
DRG Daring	QXP Quixotic Plum
DYN Dynamo	RBZ Relic Bronze
ENG Enigma	SND Sandbank
FRR French Roast	STM Storm
GBY Georgian Bay	TRC Tricorn Black

- ④ See a selection of graded in fabric manufacturers and patterns on pages 12-20. Contact Customer Service for additional fabric options.

Specifications

- Wood species - Beech.
- Seat has synthetic sheet webbing, one layer of 2" polyurethane foam.
- Back has 1" polyurethane foam.
- Mortise and tenon construction with corner blocks, glue and screws.
- Standard with rubber cushion metal glides.

Sayde Order Check List:

SEATING



Specify:

- 1. Model Number
- 2. Wood Species - Beech (B)
- 3. Wood Finish/Color
- 4. Fabric Selection - vendor, pattern and color

Example:

211A | **B** | **AUB**
 (model #) | (wood species) | (finish)

1. Model Number

2. Wood Species - Beech (B)

3. Wood Finish/Color Options: ⁴

ALE Ale	FLX Flax
AUB Auburn	HEN Henna
AUT Autumn	HNY Honey
BRL Barley	LGC Legacy
BBN Bourbon	MCH Mocha
BRG Brighton	NTO Night Owl
BRW Brownie	NUT Nut Brown
BUT Butterscotch	PRL Praline
CAN Canyon	SAF Saffron
CIN Cinnamon	SIE Sienna
CIT Citron	TOF Toffee
CLA Classic	TRF Truffle
DES Desert	VEN Venetian
EAR Earthy	
ESP Espresso	
Color - Add \$31 list per item	
BKD Backdrop	GRV Greek Villa
BFX Black Fox	GLF Gulf Stream
BWH Bright White	HTB Heartthrob
CGP Cargo Pants	NET Network Gray
CHT Chatroom	NWH Nonchalant White
DSY Daisy	PAR Paradise
DRG Daring	QXP Quixotic Plum
DYN Dynamo	RBZ Relic Bronze
ENG Enigma	SND Sandbank
FRR French Roast	STM Storm
GBY Georgian Bay	TRC Tricorn Black

4. Fabric Selection - Please supply the following:

- Fabric vendor
- Pattern name
- Pattern color

When specifying contrasting upholstery, indicate clearly which upholstery is to be applied to the seat, back and arms. Use higher grade pricing.

- Indicate direction of fabric - Railroaded or Up the Roll
- Please provide illustration, if available

All COM orders must include the following:

- Vendor's name, pattern name and color
- Sample of the fabric attached to order
- Model numbers of items for fabric application
- Special application instructions (e.g., all stripes will be applied front to back unless specified otherwise)
- Customer and purchase order number

Ship prepaid COM material to:
 Community
 Attn: COM Dept
 932 Mill Street
 Jasper, IN 47546

Application of fabric:
 Railroaded Up the Roll

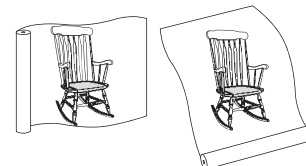

All COM orders will ship at standard lead time from receipt of COM except for orders requiring special custom matched finishes.

Description	Model	Specifications			List Price Per Grade		
		Dimensions	D	W	H	All Wood	COM
Wood Rocker	211A All Wood	Overall	31 1/2	25 1/4	43	\$576	\$642
	211C Uph. Seat	Seat	17 3/4	17 3/4	18 3/4	\$660	\$675
		Arm			29 1/2	\$700	\$732
		Upholstery		Shipping		\$766	\$817
		COM Ydg	3/4	Ctn Wt	35	\$872	\$931
		COL Sq Ft	9	Cu Ft	19	\$1,022	\$1,132
						\$1,132	\$1,132
						\$884	\$941
						\$884	\$941

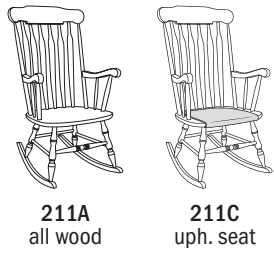

Description	Model	Specifications			List Price Per Grade		
		Dimensions	D	W	H	All Wood	COM
Wood Rocker	6021A All Wood	Overall	31 1/2	24 1/2	41	\$601	\$667
	6021C Uph. Seat	Seat	17 1/2	17 1/4	17 1/4	\$685	\$700
		Arm			27 1/2	\$725	\$759
		Upholstery		Shipping		\$791	\$843
		COM Ydg	3/4	Ctn Wt	35	\$897	\$956
		COL Sq Ft	9	Cu Ft	19	\$1,048	\$1,158
						\$909	\$968
						\$909	\$968

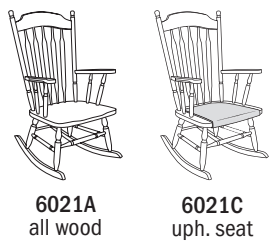

To Order, Specify:

- 1 Model Number
- 2 Wood Species - Beech (B)
- 3 Wood Finish/Color
- 4 Fabric Selection - vendor, pattern and color

3 Wood Finish/Color Options:

- | | |
|------------------|---------------|
| ALE Ale | FLX Flax |
| AUB Auburn | HEN Henna |
| AUT Autumn | HNY Honey |
| BRL Barley | LGC Legacy |
| BBN Bourbon | MCH Mocha |
| BRG Brighton | NTO Night Owl |
| BRW Brownie | NUT Nut Brown |
| BUT Butterscotch | PRL Praline |
| CAN Canyon | SAF Saffron |
| CIN Cinnamon | SIE Sienna |
| CIT Citron | TOF Toffee |
| CLA Classic | TRF Truffle |
| DES Desert | VEN Venetian |
| EAR Earthy | |
| ESP Espresso | |

Color - Add \$31 list per item

- | | |
|------------------|----------------------|
| BKD Backdrop | GRV Greek Villa |
| BFX Black Fox | GLF Gulf Stream |
| BWH Bright White | HTB Heartthrob |
| CGP Cargo Pants | NET Network Gray |
| CHT Chatroom | NWH Nonchalant White |
| DSY Daisy | PAR Paradise |
| DRG Daring | QXP Quixotic Plum |
| DYN Dynamo | RBZ Relic Bronze |
| ENG Enigma | SND Sandbank |
| FRR French Roast | STM Storm |
| GBY Georgian Bay | TRC Tricorn Black |

4 See a selection of graded in fabric manufacturers and patterns on pages 12-20. Contact Customer Service for additional fabric options.

Specifications

- Wood species - Beech.
- Seat is upholstered with 1" high density polyurethane foam.
- Mortise and tenon construction with glue and screws.

Sterling Order Check List:



SEATING

Specify:

- 1. Model Number
- 2. Wood Species - Beech (B)
- 3. Wood Finish/Color
- 4. Fabric Selection - vendor, pattern and color
- 5. Optional Linking Brackets - add \$26 list per chair
- 6. Optional Laser Engraving Back Imprint - specify location and size
- 7. Optional Rubber Cushion Nylon Glides - no upcharge

Example:

ST1171C (model #)	B (wood species)	AUB (finish)	MOMENTUM (fabric vendor)	VOX (pattern name)	MYSTIC (pattern color)
-----------------------------	----------------------------	------------------------	------------------------------------	------------------------------	----------------------------------

1. Model Number

2. Wood Species - Beech (B)

3. Wood Finish/Color Options: ▲

ALE Ale	FLX Flax
AUB Auburn	HEN Henna
AUT Autumn	HNY Honey
BRL Barley	LGC Legacy
BBN Bourbon	MCH Mocha
BRG Brighton	NTO Night Owl
BRW Brownie	NUT Nut Brown
BUT Butterscotch	PRL Praline
CAN Canyon	SAF Saffron
CIN Cinnamon	SIE Sienna
CIT Citron	TOF Toffee
CLA Classic	TRF Truffle
DES Desert	VEN Venetian
EAR Earthy	
ESP Espresso	

Color - Add \$31 list per item

BKD Backdrop	GRV Greek Villa
BFX Black Fox	GLF Gulf Stream
BWH Bright White	HTB Heartthrob
CGP Cargo Pants	NET Network Gray
CHT Chatroom	NWH Nonchalant White
DSY Daisy	PAR Paradise
DRG Daring	QXP Quixotic Plum
DYN Dynamo	RBZ Relic Bronze
ENG Enigma	SND Sandbank
FRR French Roast	STM Storm
GBY Georgian Bay	TRC Tricorn Black

4. Fabric Selection - Please supply the following:

- Fabric vendor
- Pattern name
- Pattern color

When specifying contrasting upholstery, indicate clearly which upholstery is to be applied to the seat, back and arms. Use higher grade pricing.

- Indicate direction of fabric - Railroaded or Up the Roll
- Please provide illustration, if available

All COM orders must include the following:

- Vendor's name, pattern name and color
- Sample of the fabric attached to order
- Model numbers of items for fabric application
- Special application instructions (e.g., all stripes will be applied front to back unless specified otherwise)
- Customer and purchase order number

Ship prepaid COM material to:
Community
Attn: COM Dept
932 Mill Street
Jasper, IN 47546

Application of fabric:
Railroaded Up the Roll

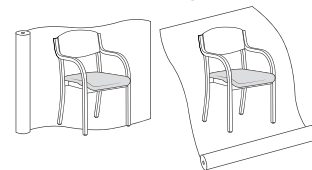

All COM orders will ship at standard lead time from receipt of COM except for orders requiring special custom matched finishes.

5. Optional Linking Brackets - add \$26 list per chair/stool







6. Optional Laser Engraving Back Imprint - available on models ST1171A/C and ST1173A/C. See page 7 for details.



Specify:

- location - inside/outside of back.
- size of design

Description	Model	Specifications			List Price Per Grade		
		Dimensions	D	W	H	All Wood	COM
Arm	ST1171A All Wood					\$359	
  ST1171A all wood	ST1171B Uph. Back · stacks ten high · optional laser engraving back imprint, specify location and size - see page 7 for details. (A models only)	Overall	20 ½	20 ¾	33		\$367
		Seat	17	18	18 ½		\$377
		Arm			26		\$386
		Upholstery		Shipping			\$402
		COM Ydg	½	Ctn Wt	25		\$420
		COL Sq Ft	9	Cu Ft	12		\$440
							\$460
							\$490
							\$521
							\$571
							\$629
							\$496
							\$528

Description	Model	Specifications			List Price Per Grade		
		Dimensions	D	W	H	COM	COL/C
Arm	ST1171C Uph. Seat					\$369	
 	· stacks ten high · optional laser engraving back imprint, specify location and size - see page 7 for details.	Overall	20 ½	20 ¾	33		\$382
		Seat	17	18	18 ½		\$394
		Arm			26		\$417
		Upholstery		Shipping			\$447
		COM Ydg	¾	Ctn Wt	25		\$476
		COL Sq Ft	9	Cu Ft	12		\$507
							\$551
							\$598
							\$671
							\$760
							\$560
							\$606

To Order, Specify:

- 1 Model Number
- 2 Wood Species - Beech (B)
- 3 Wood Finish/Color
- 4 Fabric Selection - vendor, pattern and color
- 5 Optional Linking Brackets - add \$26 list per chair
- 6 Optional Laser Engraving Back Imprint - specify location and size; see page 7 for details.
(A and C MODELS ONLY)
- 7 Optional Rubber Cushion Nylon Glides - no upcharge

3 Wood Finish/Color Options: ▲

ALE Ale	FLX Flax
AUB Auburn	HEN Henna
AUT Autumn	HNY Honey
BRL Barley	LGC Legacy
BBN Bourbon	MCH Mocha
BRG Brighton	NTO Night Owl
BRW Brownie	NUT Nut Brown
BUT Butterscotch	PRL Praline
CAN Canyon	SAF Saffron
CIN Cinnamon	SIE Sienna
CIT Citron	TOF Toffee
CLA Classic	TRF Truffle
DES Desert	VEN Venetian
EAR Earthy	
ESP Espresso	









Specifications

- Wood species - Beech.
- Seat is upholstered with 1 ½" high density polyurethane foam.
- Back is upholstered with 1" polyurethane foam.
- Barrel nut assembly with glue, screws and fasteners.
- Standard with rubber cushion metal glides.

Color - Add \$31 list per item; not available with laser engraving option

BKD Backdrop	GRV Greek Villa
BFX Black Fox	GLF Gulf Stream
BWH Bright White	HTB Heartthrob
CGP Cargo Pants	NET Network Gray
CHT Chatroom	NWH Nonchalant White
DSY Daisy	PAR Paradise
DRG Daring	QXP Quixotic Plum
DYN Dynamo	RBZ Relic Bronze
ENG Enigma	SND Sandbank
FRR French Roast	STM Storm
GBY Georgian Bay	TRC Tricorn Black

- 4 See a selection of graded in fabric manufacturers and patterns on pages 12-20. Contact Customer Service for additional fabric options.

Description	① Model	Specifications	List Price Per Grade																												
Arm  	ST1171D Uph. Seat/Back · stacks ten high	<table border="1"> <thead> <tr> <th>Dimensions</th> <th>D</th> <th>W</th> <th>H</th> </tr> </thead> <tbody> <tr> <td>Overall</td> <td>20 ½</td> <td>20 ¾</td> <td>33</td> </tr> <tr> <td>Seat</td> <td>17</td> <td>18</td> <td>18 ½</td> </tr> <tr> <td>Arm</td> <td></td> <td></td> <td>26</td> </tr> <tr> <th colspan="2">Upholstery</th> <th colspan="2">Shipping</th> </tr> <tr> <td>COM Ydg</td> <td>1</td> <td>Ctn Wt</td> <td>25</td> </tr> <tr> <td>COL Sq Ft</td> <td>12</td> <td>Cu Ft</td> <td>12</td> </tr> </tbody> </table>	Dimensions	D	W	H	Overall	20 ½	20 ¾	33	Seat	17	18	18 ½	Arm			26	Upholstery		Shipping		COM Ydg	1	Ctn Wt	25	COL Sq Ft	12	Cu Ft	12	COM \$376 A \$391 B \$409 COL/C \$439 D \$478 E \$517 F \$558 G \$617 H \$680 I \$777 J \$895 L1 \$628 L2 \$691
Dimensions	D	W	H																												
Overall	20 ½	20 ¾	33																												
Seat	17	18	18 ½																												
Arm			26																												
Upholstery		Shipping																													
COM Ydg	1	Ctn Wt	25																												
COL Sq Ft	12	Cu Ft	12																												
Armless   	ST1173A All Wood ST1173B Uph. Back · stacks ten high · optional laser engraving back imprint, specify location and size - see page 7 for details. (A model only)	<table border="1"> <thead> <tr> <th>Dimensions</th> <th>D</th> <th>W</th> <th>H</th> </tr> </thead> <tbody> <tr> <td>Overall</td> <td>20 ½</td> <td>20 ¾</td> <td>33</td> </tr> <tr> <td>Seat</td> <td>17</td> <td>18</td> <td>18 ½</td> </tr> <tr> <th colspan="2">Upholstery</th> <th colspan="2">Shipping</th> </tr> <tr> <td>COM Ydg</td> <td>½</td> <td>Ctn Wt</td> <td>25</td> </tr> <tr> <td>COL Sq Ft</td> <td>9</td> <td>Cu Ft</td> <td>12</td> </tr> </tbody> </table>	Dimensions	D	W	H	Overall	20 ½	20 ¾	33	Seat	17	18	18 ½	Upholstery		Shipping		COM Ydg	½	Ctn Wt	25	COL Sq Ft	9	Cu Ft	12	All Wood \$359 COM \$367 A \$377 B \$386 COL/C \$402 D \$420 E \$440 F \$460 G \$490 H \$521 I \$571 J \$629 L1 \$496 L2 \$528				
Dimensions	D	W	H																												
Overall	20 ½	20 ¾	33																												
Seat	17	18	18 ½																												
Upholstery		Shipping																													
COM Ydg	½	Ctn Wt	25																												
COL Sq Ft	9	Cu Ft	12																												
ST1171A all wood	ST1171B uph. back																														
Armless  	ST1173C Uph. Seat · stacks ten high · optional laser engraving back imprint, specify location and size - see page 7 for details.	<table border="1"> <thead> <tr> <th>Dimensions</th> <th>D</th> <th>W</th> <th>H</th> </tr> </thead> <tbody> <tr> <td>Overall</td> <td>20 ½</td> <td>20 ¾</td> <td>33</td> </tr> <tr> <td>Seat</td> <td>17</td> <td>18</td> <td>18 ½</td> </tr> <tr> <th colspan="2">Upholstery</th> <th colspan="2">Shipping</th> </tr> <tr> <td>COM Ydg</td> <td>¾</td> <td>Ctn Wt</td> <td>25</td> </tr> <tr> <td>COL Sq Ft</td> <td>9</td> <td>Cu Ft</td> <td>12</td> </tr> </tbody> </table>	Dimensions	D	W	H	Overall	20 ½	20 ¾	33	Seat	17	18	18 ½	Upholstery		Shipping		COM Ydg	¾	Ctn Wt	25	COL Sq Ft	9	Cu Ft	12	COM \$369 A \$382 B \$394 COL/C \$417 D \$447 E \$476 F \$507 G \$551 H \$598 I \$671 J \$760 L1 \$560 L2 \$606				
Dimensions	D	W	H																												
Overall	20 ½	20 ¾	33																												
Seat	17	18	18 ½																												
Upholstery		Shipping																													
COM Ydg	¾	Ctn Wt	25																												
COL Sq Ft	9	Cu Ft	12																												
Armless  	ST1173D Uph. Seat/Back · stacks ten high	<table border="1"> <thead> <tr> <th>Dimensions</th> <th>D</th> <th>W</th> <th>H</th> </tr> </thead> <tbody> <tr> <td>Overall</td> <td>20 ½</td> <td>20 ¾</td> <td>33</td> </tr> <tr> <td>Seat</td> <td>17</td> <td>18</td> <td>18 ½</td> </tr> <tr> <th colspan="2">Upholstery</th> <th colspan="2">Shipping</th> </tr> <tr> <td>COM Ydg</td> <td>1</td> <td>Ctn Wt</td> <td>25</td> </tr> <tr> <td>COL Sq Ft</td> <td>12</td> <td>Cu Ft</td> <td>12</td> </tr> </tbody> </table>	Dimensions	D	W	H	Overall	20 ½	20 ¾	33	Seat	17	18	18 ½	Upholstery		Shipping		COM Ydg	1	Ctn Wt	25	COL Sq Ft	12	Cu Ft	12	COM \$376 A \$391 B \$409 COL/C \$439 D \$478 E \$517 F \$558 G \$617 H \$680 I \$777 J \$895 L1 \$628 L2 \$691				
Dimensions	D	W	H																												
Overall	20 ½	20 ¾	33																												
Seat	17	18	18 ½																												
Upholstery		Shipping																													
COM Ydg	1	Ctn Wt	25																												
COL Sq Ft	12	Cu Ft	12																												

Description	D	W	H	CTN WT	CU FT	① Model	List Price
Dolly	24	16	24	12	7	ST1100	\$347

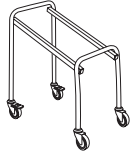

• locking casters



stacks up to ten high on dolly

To Order, Specify:

- ① Model Number
- ② Wood Species - Beech (B)
- ③ Wood Finish/Color
- ④ Fabric Selection - vendor, pattern and color
- ⑤ Optional Linking Brackets - add \$26 list per chair
- ⑥ Optional Laser Engraving Back Imprint - specify location and size; see page 7 for details.
(A and C MODELS ONLY)
- ⑦ Optional Rubber Cushion Nylon Glides - no upcharge

③ Wood Finish/Color Options: ▲

ALE	Ale	FLX	Flax
AUB	Auburn	HEN	Henna
AUT	Autumn	HNY	Honey
BRL	Barley	LGC	Legacy
BBN	Bourbon	MCH	Mocha
BRG	Brighton	NTO	Night Owl
BRW	Brownie	NUT	Nut Brown
BUT	Butterscotch	PRL	Praline
CAN	Canyon	SAF	Saffron
CIN	Cinnamon	SIE	Sienna
CIT	Citron	TOF	Toffee
CLA	Classic	TRF	Truffle
DES	Desert	VEN	Venetian
EAR	Earthy		
ESP	Espresso		

Specifications

- Wood species - Beech.
- Seat is upholstered with 1 ½" high density polyurethane foam.
- Back is upholstered with 1" polyurethane foam.
- Barrel nut assembly with glue, screws and fasteners.
- Standard with rubber cushion metal glides.

Color - Add \$31 list per item; not available with laser engraving option

BKD	Backdrop	GRV	Greek Villa
BFX	Black Fox	GLF	Gulf Stream
BWH	Bright White	HTB	Heartthrob
CGP	Cargo Pants	NET	Network Gray
CHT	Chatroom	NWH	Nonchalant White
DSY	Daisy	PAR	Paradise
DRG	Daring	QXP	Quixotic Plum
DYN	Dynamo	RBZ	Relic Bronze
ENG	Enigma	SND	Sandbank
FRR	French Roast	STM	Storm
GBY	Georgian Bay	TRC	Tricorn Black

- ④ See a selection of graded in fabric manufacturers and patterns on pages 12-20. Contact Customer Service for additional fabric options.

Sultan Order Check List:

SEATING



Specify:

- 1. Model Number
- 2. Wood Species - Beech (B)
- 3. Wood Finish/Color
- 4. Fabric Selection - vendor, pattern and color
- 5. Optional Rubber Cushion Nylon Glides - no upcharge

Example:

SL3101D | B | AUB | MOMENTUM | VOX | MYSTIC
 (model #) | (wood species) | (finish) | (fabric vendor) | (pattern name) | (pattern color)

1. Model Number

2. Wood Species - Beech (B)

3. Wood Finish/Color Options: ▲

ALE Ale	FLX Flax
AUB Auburn	HEN Henna
AUT Autumn	HNY Honey
BRL Barley	LGC Legacy
BBN Bourbon	MCH Mocha
BRG Brighton	NTO Night Owl
BRW Brownie	NUT Nut Brown
BUT Butterscotch	PRL Praline
CAN Canyon	SAF Saffron
CIN Cinnamon	SIE Sienna
CIT Citron	TOF Toffee
CLA Classic	TRF Truffle
DES Desert	VEN Venetian
EAR Earthy	
ESP Espresso	

Color - Add \$31 list per item

BKD Backdrop	GRV Greek Villa
BFX Black Fox	GLF Gulf Stream
BWH Bright White	HTB Heartthrob
CGP Cargo Pants	NET Network Gray
CHT Chatroom	NWH Nonchalant White
DSY Daisy	PAR Paradise
DRG Daring	QXP Quixotic Plum
DYN Dynamo	RBZ Relic Bronze
ENG Enigma	SND Sandbank
FRR French Roast	STM Storm
GBY Georgian Bay	TRC Tricorn Black

4. Fabric Selection - Please supply the following:

- Fabric vendor
- Pattern name
- Pattern color

When specifying contrasting upholstery, indicate clearly which upholstery is to be applied to the seat and back. Use higher grade pricing.

- Indicate direction of fabric - Railroaded or Up the Roll
- Please provide illustration, if available

All COM orders must include the following:

- Vendor's name, pattern name and color
- Sample of the fabric attached to order
- Model numbers of items for fabric application
- Special application instructions (e.g., all stripes will be applied front to back unless specified otherwise)
- Customer and purchase order number

Ship prepaid COM material to:
 Community
 Attn: COM Dept
 932 Mill Street
 Jasper, IN 47546

Application of fabric:
 Railroaded Up the Roll

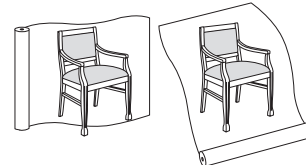

All COM orders will ship at standard lead time from receipt of COM except for orders requiring special custom matched finishes.

Description	Model	Specifications				List Price Per Grade	
		Dimensions	D	W	H	COM	
Side Chair 	SL3101D · open arms · upholstered seat and back	Overall	23	22 ¼	35 ½	COM	\$753
		Seat	19 ¼	18 ¼	19	A	\$763
		Arm			26 ¼	B	\$780
		Upholstery		Shipping		COL/C	\$810
		COM Ydg	1	Ctn Wt	30	D	\$850
		COL Sq Ft	12	Cu Ft	14	E	\$889
						F	\$930
						G	\$989
						H	\$1,050
						I	\$1,149

Description	Model	Specifications				List Price Per Grade	
		Dimensions	D	W	H	COM	
Side Chair 	SL3103D · upholstered seat and back	Overall	23	22 ¼	35 ½	COM	\$679
		Seat	19 ¼	18 ¼	19	A	\$688
		Arm				B	\$705
		Upholstery		Shipping		COL/C	\$735
		COM Ydg	1	Ctn Wt	28	D	\$775
		COL Sq Ft	12	Cu Ft	14	E	\$814
						F	\$855
						G	\$914
						H	\$976
						I	\$1,075

To Order, Specify:

- 1 Model Number
- 2 Wood Species - Beech (B)
- 3 Wood Finish/Color
- 4 Fabric Selection - vendor, pattern and color
- 5 Optional Rubber Cushion Nylon Glides - no upcharge

3 Wood Finish/Color Options:

- | | |
|------------------|---------------|
| ALE Ale | FLX Flax |
| AUB Auburn | HEN Henna |
| AUT Autumn | HNY Honey |
| BRL Barley | LGC Legacy |
| BBN Bourbon | MCH Mocha |
| BRG Brighton | NTO Night Owl |
| BRW Brownie | NUT Nut Brown |
| BUT Butterscotch | PRL Praline |
| CAN Canyon | SAF Saffron |
| CIN Cinnamon | SIE Sienna |
| CIT Citron | TOF Toffee |
| CLA Classic | TRF Truffle |
| DES Desert | VEN Venetian |
| EAR Earthy | |
| ESP Espresso | |

Color - Add \$31 list per item

- | | |
|------------------|----------------------|
| BKD Backdrop | GRV Greek Villa |
| BFX Black Fox | GLF Gulf Stream |
| BWH Bright White | HTB Heartthrob |
| CGP Cargo Pants | NET Network Gray |
| CHT Chatroom | NWH Nonchalant White |
| DSY Daisy | PAR Paradise |
| DRG Daring | QXP Quixotic Plum |
| DYN Dynamo | RBZ Relic Bronze |
| ENG Enigma | SND Sandbank |
| FRR French Roast | STM Storm |
| GBY Georgian Bay | TRC Tricorn Black |

Specifications

- Wood species - Beech.
- Seat has synthetic sheet webbing, one layer of 2" polyurethane foam.
- Back has 1" polyurethane foam.
- Mortise and tenon construction with corner blocks, glue and screws.
- Standard with rubber cushion metal glides.

4 See a selection of graded in fabric manufacturers and patterns on pages 12-20. Contact Customer Service for additional fabric options.

Trinity Order Check List:



SEATING

Specify:

- 1. Model Number
- 2. Wood Species - Beech (B)
- 3. Wood Finish/Color
- 4. Frame Color - Black Powder Coat (BP) or Chrome (CH)
- 5. Fabric Selection - vendor, pattern and color
- 6. Wood Back Style - R, S, T, U, V or W
- 7. Optional Linking Brackets - add \$26 list per chair
- 8. Optional Laser Engraving Back Imprint - specify location and size
- 9. Optional Laser Cut Out - specify location and size

Example:

Tr503A (model #)	B (wood species)	AUB (finish)	BP (frame color)	MOMENTUM (fabric vendor)	VOX (pattern name)	MYSTIC (pattern color)
---------------------	---------------------	-----------------	---------------------	-----------------------------	-----------------------	---------------------------

1. Model Number

2. Wood Species - Beech (B)

3. Wood Finish/Color Options: ▲

ALE Ale	FLX Flax
AUB Auburn	HEN Henna
AUT Autumn	HNY Honey
BRL Barley	LGC Legacy
BBN Bourbon	MCH Mocha
BRG Brighton	NTO Night Owl
BRW Brownie	NUT Nut Brown
BUT Butterscotch	PRL Praline
CAN Canyon	SAF Saffron
CIN Cinnamon	SIE Sienna
CIT Citron	TOF Toffee
CLA Classic	TRF Truffle
DES Desert	VEN Venetian
EAR Earthy	
ESP Espresso	

Color - Add \$31 list per item

BKD Backdrop	GRV Greek Villa
BFX Black Fox	GLF Gulf Stream
BWH Bright White	HTB Heartthrob
CGP Cargo Pants	NET Network Gray
CHT Chatroom	NWH Nonchalant White
DSY Daisy	PAR Paradise
DRG Daring	QXP Quixotic Plum
DYN Dynamo	RBZ Relic Bronze
ENG Enigma	SND Sandbank
FRR French Roast	STM Storm
GBY Georgian Bay	TRC Tricorn Black

4. Frame Color Selection - Matte Black (MBK) or Chrome (CHR)

5. Fabric Selection - Please supply the following:

- Fabric vendor
- Pattern name
- Pattern color

When specifying contrasting upholstery, indicate clearly which upholstery is to be applied to the seat and back. Use higher grade pricing.

- Indicate direction of fabric - Railroaded or Up the Roll
- Please provide illustration, if available

All COM orders must include the following:

- Vendor's name, pattern name and color
- Sample of the fabric attached to order
- Model numbers of items for fabric application
- Special application instructions (e.g., all stripes will be applied front to back unless specified otherwise)
- Customer and purchase order number

Ship prepaid COM material to:
Community
Attn: COM Dept
932 Mill Street
Jasper, IN 47546

Application of fabric:
Railroaded Up the Roll

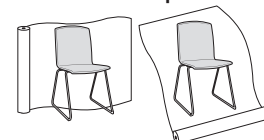

All COM orders will ship at standard lead time from receipt of COM except for orders requiring special custom matched finishes.

6. Wood Back Options:

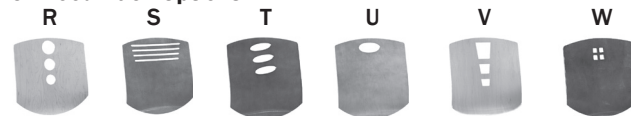

7. Optional Linking Brackets - add \$26 list per chair▲



8. Optional Laser Engraving Back Imprint - available on models TR503A/C. See page 7 for details.



- Specify:**
- location - inside/outside of back.
 - size of design

9. Optional Laser Cut Out Available - available on models TR503A/C. Specify location and size. See page 7 for details.

Description	1 Model	Specifications				List Price Per Grade	
Side Chair 	TR503D Fully Upholstered • protective stack bumpers • not recommended for stacking	Dimensions		D	W	H	COM \$524
		Overall	22	18 1/2	33 3/4	A	\$543
		Seat	16	17	19	B	\$565
		Upholstery		Shipping		COL/C	\$603
		COM Ydg	1 1/4	Ctn Wt	16	D	\$653
		COL Sq Ft	25	Cu Ft	9	E	\$701
				F	\$752		
				G	\$826		
				H	\$905		
				I	\$1,026		
				J	\$1,173		
				L1	\$840		
				L2	\$919		

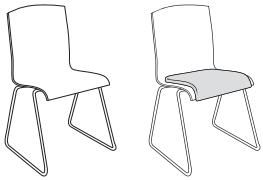
Description	1 Model	Specifications				List Price Per Grade	
Stack/Side Chair 	TR503A All Wood TR503C Upholstered Seat • protective stack bumpers • stacks ten high • upholstered models not recommended for stacking • optional laser engraving back imprint, specify location and size - see page 7 for details. • optional laser cut out, specify location and size - see page 7 for details	Dimensions		D	W	H	All Wood \$375
		Overall	22	18 1/2	33 3/4	COM	\$444
		Seat	16	17	19	A	\$457
		Upholstery		Shipping		B	\$470
		COM Ydg	3/4	Ctn Wt	16	COL/C	\$493
		COL Sq Ft	9	Cu Ft	9	D	\$522
				E	\$552		
				F	\$582		
				G	\$626		
				H	\$674		
				I	\$747		
				J	\$835		
				L1	\$636		
				L2	\$682		

Description	D	W	H	CTN WT	CU FT	1 Model	List Price
Dolly	21	20	8	15	4	TR500	\$275

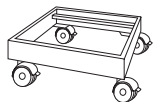

To Order, Specify:

- 1 Model Number
- 2 Wood Species - Beech (B)
- 3 Wood Finish/Color
- 4 Frame Color - Black Powder Coat (BP) or Chrome (CH)
- 5 Fabric Selection - vendor, pattern and color
- 6 Wood Back Style - R, S, T, U, V or W
- 7 Optional Linking Brackets - add \$26 list per chair
- 8 Optional Laser Engraving Back Imprint - specify location and size; see page 7 for details.
(A and C MODELS ONLY)
- 9 Optional Laser Cut Out - specify location and size; see page 7 for details.
(A and C MODELS ONLY)

3 Wood Finish/Color Options:

- | | |
|------------------|---------------|
| ALE Ale | FLX Flax |
| AUB Auburn | HEN Henna |
| AUT Autumn | HNY Honey |
| BRL Barley | LGC Legacy |
| BBN Bourbon | MCH Mocha |
| BRG Brighton | NTO Night Owl |
| BRW Brownie | NUT Nut Brown |
| BUT Butterscotch | PRL Praline |
| CAN Canyon | SAF Saffron |
| CIN Cinnamon | SIE Sienna |
| CIT Citron | TOF Toffee |
| CLA Classic | TRF Truffle |
| DES Desert | VEN Venetian |
| EAR Earthy | |
| ESP Espresso | |

Color - Add \$31 list per item

- | | |
|------------------|----------------------|
| BKD Backdrop | GRV Creek Villa |
| BFX Black Fox | GLF Gulf Stream |
| BWH Bright White | HTB Heartthrob |
| CGP Cargo Pants | NET Network Gray |
| CHT Chatroom | NWH Nonchalant White |
| DSY Daisy | PAR Paradise |
| DRG Daring | QXP Quixotic Plum |
| DYN Dynamo | RBZ Relic Bronze |
| ENG Enigma | SND Sandbank |
| FRR French Roast | STM Storm |
| GBY Georgian Bay | TRC Tricorn Black |

5 See a selection of graded in fabric manufacturers and patterns on pages 12-20. Contact Customer Service for additional fabric options.

Shell Specifications

- Wood species - Beech.
- Stacks ten high.
- Consists of seven-ply hardwood construction.
- Contoured molded seat panel.
- Upholstered shell or seat 1/2" polyurethane foam.

Frame Specifications

- Manufactured with 7/16" solid steel rod.
- Four clear plastic glides - chrome frame.
- Four black plastic glides - black frame.
- Four protective stack bumpers.

Walker Order Check List:



SEATING

Specify:

- 1. Model Number
- 2. Wood Species - Beech (B)
- 3. Wood Seat and Back Finish/Color
- 4. Metal Frame Color
- 5. Fabric Selection - vendor, pattern and color
- 6. Back Style - A, C, D, E, F or G
- 7. Optional Wood or Metal Laser Engraving Back Imprint - specify location

Example:

283C | B | AUB | BRONZE | MOMENTUM | VOX | MYSTIC
 (model #) | (wood species) | (finish) | (metal frame) | (fabric vendor) | (pattern name) | (pattern color)

1. Model Number

2. Wood Species - Beech (B)

3. Wood Finish/Color Options: ▲

ALE Ale	FLX Flax
AUB Auburn	HEN Henna
AUT Autumn	HNY Honey
BRL Barley	LGC Legacy
BBN Bourbon	MCH Mocha
BRG Brighton	NTO Night Owl
BRW Brownie	NUT Nut Brown
BUT Butterscotch	PRL Praline
CAN Canyon	SAF Saffron
CIN Cinnamon	SIE Sienna
CIT Citron	TOF Toffee
CLA Classic	TRF Truffle
DES Desert	VEN Venetian
EAR Earthy	
ESP Espresso	

Color - Add \$31 list per item

BKD Backdrop	GRV Greek Villa
BFX Black Fox	GLF Gulf Stream
BWH Bright White	HTB Heartthrob
CGP Cargo Pants	NET Network Gray
CHT Chatroom	NWH Nonchalant White
DSY Daisy	PAR Paradise
DRG Daring	QXP Quixotic Plum
DYN Dynamo	RBZ Relic Bronze
ENG Enigma	SND Sandbank
FRR French Roast	STM Storm
GBY Georgian Bay	TRC Tricorn Black

4. Metal Frame Color Options

Anodized Nickel	Pewter
Black Sandtex	Silver Bullet
Bronze	Silver Vein
Copper Vein	Sparkle Silver

5. Fabric Selection - Please supply the following:

- Fabric vendor
- Pattern name
- Pattern color

All COM orders must include the following:

- Vendor's name, pattern name and color
- Sample of the fabric attached to order
- Model numbers of items for fabric application
- Special application instructions (e.g., all stripes will be applied front to back unless specified otherwise)
- Customer and purchase order number

Ship prepaid COM material to:
 Community
 Attn: COM Dept
 932 Mill Street
 Jasper, IN 47546

Application of fabric:
 Railroaded Up the Roll

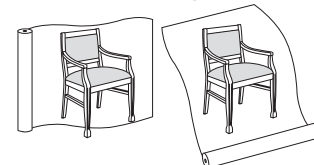

All COM orders will ship at standard lead time from receipt of COM except for orders requiring special custom matched finishes.

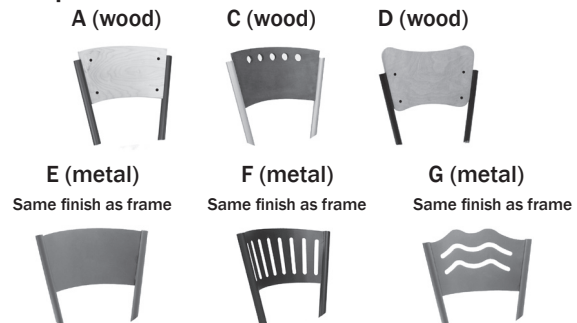

6. Back Options:





7. Optional Wood or Metal Laser Engraving Back Imprint - available on models 283A and 288A. See page 7 for details.



- Specify:**
- location - inside/outside of back
 - size of design

Description	Model	Specifications			List Price Per Grade	
		Dimensions	D	W		H
Armless 	283A Wood Seat				Wood Seat \$405	
	283B Uph. Back				COM \$440	
 283A wood seat	<ul style="list-style-type: none"> · upholstered back · must specify back option · optional wood or metal laser engraving back imprint, specify location - see page 7 for details (A models only) 	Overall	19	17	31	A \$452
		Seat	16	17	18	B \$462
 283B uph. back		Upholstery		Shipping		COL/C \$479
		COM Ydg	.5	Ctn Wt	18	D \$501
		COL Sq Ft	9	Cu Ft	9	E \$523
						F \$557
						G \$594
						H \$634
						I \$695
						J \$768
						L1 \$601
						L2 \$641

Description	Model	Specifications			List Price Per Grade	
		Dimensions	D	W		H
Barstool 	288A Wood Seat				Wood Seat \$475	
	288B Uph. Back				COM \$509	
 288A wood seat	<ul style="list-style-type: none"> · must specify back option · optional wood or metal laser engraving back imprint, specify location - see page 7 for details (A models only) 	Overall	19	17	41	A \$521
		Seat	16	17	30	B \$532
 288B uph. back		Upholstery		Shipping		COL/C \$549
		COM Ydg	.5	Ctn Wt	25	D \$571
		COL Sq Ft	9	Cu Ft	13	E \$593
						F \$626
						G \$663
						H \$703
						I \$764
						J \$837
						L1 \$670
						L2 \$710

To Order, Specify:

- 1 Model Number
- 2 Wood Species - Maple (M)
- 3 Wood Seat and Back Finish/Color
- 4 Metal Frame Color
- 5 Fabric Selection - vendor, pattern and color
- 6 Back Style - A, C, D, E, F or G
- 7 Optional wood or metal laser engraving back imprint (A models only) - specify location; see page 7 for details

3 Wood Finish/Color Options:

ALE Ale	FLX Flax
AUB Auburn	HEN Henna
AUT Autumn	HNY Honey
BRL Barley	LGC Legacy
BBN Bourbon	MCH Mocha
BRG Brighton	NTO Night Owl
BRW Brownie	NUT Nut Brown
BUT Butterscotch	PRL Praline
CAN Canyon	SAF Saffron
CIN Cinnamon	SIE Sienna
CIT Citron	TOF Toffee
CLA Classic	TRF Truffle
DES Desert	VEN Venetian
EAR Earthy	
ESP Espresso	

Color - Add \$31 list per item

BKD Backdrop	GRV Greek Villa
BFX Black Fox	GLF Gulf Stream
BWH Bright White	HTB Heartthrob
CGP Cargo Pants	NET Network Gray
CHT Chatroom	NWH Nonchalant White
DSY Daisy	PAR Paradise
DRG Daring	QXP Quixotic Plum
DYN Dynamo	RBZ Relic Bronze
ENG Enigma	SND Sandbank
FRR French Roast	STM Storm
GBY Georgian Bay	TRC Tricorn Black

4 Metal Frame Color Options:

Anodized Nickel	Pewter
Black Sandtex	Silver Bullet
Bronze	Silver Vein
Copper Vein	Sparkle Silver

- 5 See a selection of graded in fabric manufacturers and patterns on pages 12-20. Contact Customer Service for additional fabric options.

Specifications

- Wood species - Beech.
- 18 gauge metal frame.
- Seat is upholstered with 1 1/2" polyurethane foam and synthetic sheet webbing for added comfort.
- Back is upholstered with 1/2" polyurethane foam.
- Standard with nylon cushioned plated swivel glide.

Wink Order Check List:



SEATING

Specify:

- 1. Model Number
- 2. Plastic Color or Wood Finish
- 3. Fabric Selection - vendor, pattern and color
- 4. Optional Felt Glides - no upcharge (available on 4-leg chairs and 4-leg stools only, not available on sled base chairs and stools)

Example:

WK821CP | SMOKE | MOMENTUM | VOX | MYSTIC
 (model #) | (plastic color) | (fabric vendor) | (pattern name) | (pattern color)

1. Model Number

2. Plastic Color or Wood Finish Options: See individual model for shell availability

Gloss Plastic Color: ▲

BBG Balanced Beige Gloss EWG Extra White Gloss
 BNG Black Night Gloss NOG Navel Orange Gloss
 CTG Cherry Tomato Gloss

Matte Plastic Color: ▲

BNM Black Night Matte
 SRM Stop Red Matte
 EWM Extra White Matte

Translucent Color: ▲

CLR Clear
 SMK Smoke

Wood Finish: ▲

BLC Black Cherry
 NOO Natural Oak
 OAS Olive Ash
 SSY Sapeli Sycamore
 WAL Walnut

3. Fabric Selection - Please supply the following:

Fabric vendor
 Pattern name
 Pattern color

All COM orders must include the following:

- Vendor's name, pattern name and color
- Sample of the fabric attached to order
- Model numbers of items for fabric application
- Special application instructions (e.g., all stripes will be applied front to back unless specified otherwise)
- Customer and purchase order number

Ship prepaid COM material to:

Community
 Attn: COM Dept
 932 Mill Street
 Jasper, IN 47546

Application of fabric:
 Railroaded Up the Roll

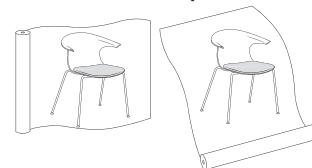



All COM orders will ship at standard lead time from receipt of COM except for orders requiring special custom matched finishes.



4. Frame Finish - Chrome standard, Bright White powder coat available, specify and add \$83 list.



Care and Maintenance Information:

- do not use a dry cloth or paper towel
- do not use any cleaner, liquid or soap containing ammonia, acetone, trichloroethylene or alcohol.
- use a soft cloth with warm water and buff dry with lint free soft cloth
- if heavier soiled cleaning is required, use small amount of liquid soap free of above listed chemicals diluted in warm water, rinse and buff dry with a soft lint free cloth
- spray cleaners can be used if they are designed for cleaning acrylic, plexiglas, polycarbonate or mylar window films and do not contain ammonia or alcohol. However, some cleaners could leave residue and might cause finger printing or smearing

▲Revised 7/26/16

Description	Model	Specifications	List Price Per Grade																																																				
Guest Chair Armless  WK823AP plastic seat  WK823CP uph. seat  translucent seat	WK823AP Plastic Seat WK823CP Uph. Seat <ul style="list-style-type: none"> low density stacker stacks 5 high available with Gloss, Matte and Translucent Plastic shell colors 4-leg Chrome base standard, optional Bright White 4-leg base, add \$83 list optional felt glides available, no upcharge 	<table border="1"> <thead> <tr> <th>Dimensions</th> <th>D</th> <th>W</th> <th>H</th> </tr> </thead> <tbody> <tr> <td>Overall</td> <td>21</td> <td>23</td> <td>32</td> </tr> <tr> <td>Seat</td> <td>16</td> <td>18½</td> <td>17¾</td> </tr> <tr> <th colspan="2">Upholstery</th> <th colspan="2">Shipping</th> </tr> <tr> <td>COM Ydg</td> <td>¾</td> <td>Ctn Wt</td> <td>18</td> </tr> <tr> <td>COL Sq Ft</td> <td></td> <td>Cu Ft</td> <td>12</td> </tr> </tbody> </table>	Dimensions	D	W	H	Overall	21	23	32	Seat	16	18½	17¾	Upholstery		Shipping		COM Ydg	¾	Ctn Wt	18	COL Sq Ft		Cu Ft	12	<table border="1"> <tbody> <tr> <td>Plastic Seat</td> <td>\$455</td> </tr> <tr> <td>COM</td> <td>\$587</td> </tr> <tr> <td>A</td> <td>\$604</td> </tr> <tr> <td>B</td> <td>\$619</td> </tr> <tr> <td>COL/C</td> <td>\$644</td> </tr> <tr> <td>D</td> <td>\$678</td> </tr> <tr> <td>E</td> <td>\$710</td> </tr> <tr> <td>F</td> <td>\$762</td> </tr> <tr> <td>G</td> <td>\$816</td> </tr> <tr> <td>H</td> <td>\$875</td> </tr> <tr> <td>I</td> <td>\$966</td> </tr> <tr> <td>J</td> <td>\$1,077</td> </tr> <tr> <td>L1</td> <td>\$828</td> </tr> <tr> <td>L2</td> <td>\$887</td> </tr> </tbody> </table>	Plastic Seat	\$455	COM	\$587	A	\$604	B	\$619	COL/C	\$644	D	\$678	E	\$710	F	\$762	G	\$816	H	\$875	I	\$966	J	\$1,077	L1	\$828	L2	\$887
		Dimensions	D	W	H																																																		
		Overall	21	23	32																																																		
Seat	16	18½	17¾																																																				
Upholstery		Shipping																																																					
COM Ydg	¾	Ctn Wt	18																																																				
COL Sq Ft		Cu Ft	12																																																				
Plastic Seat	\$455																																																						
COM	\$587																																																						
A	\$604																																																						
B	\$619																																																						
COL/C	\$644																																																						
D	\$678																																																						
E	\$710																																																						
F	\$762																																																						
G	\$816																																																						
H	\$875																																																						
I	\$966																																																						
J	\$1,077																																																						
L1	\$828																																																						
L2	\$887																																																						

Description	Model	Specifications	List Price Per Grade																																																								
Guest Chair  WK821AP plastic seat  WK821CP uph. seat  translucent seat	WK821AP Plastic Seat WK821CP Uph. Seat <ul style="list-style-type: none"> low density stacker stacks 5 high available with Gloss and Translucent Plastic shell colors 4-leg Chrome base standard, optional Bright White 4-leg base, add \$83 list optional felt glides available, no upcharge 	<table border="1"> <thead> <tr> <th>Dimensions</th> <th>D</th> <th>W</th> <th>H</th> </tr> </thead> <tbody> <tr> <td>Overall</td> <td>22¼</td> <td>24¾</td> <td>31¾</td> </tr> <tr> <td>Seat</td> <td>14½</td> <td>18½</td> <td>18</td> </tr> <tr> <td>Arm</td> <td></td> <td></td> <td>28¼</td> </tr> <tr> <th colspan="2">Upholstery</th> <th colspan="2">Shipping</th> </tr> <tr> <td>COM Ydg</td> <td>¾</td> <td>Ctn Wt</td> <td>20</td> </tr> <tr> <td>COL Sq Ft</td> <td></td> <td>Cu Ft</td> <td>12</td> </tr> </tbody> </table>	Dimensions	D	W	H	Overall	22¼	24¾	31¾	Seat	14½	18½	18	Arm			28¼	Upholstery		Shipping		COM Ydg	¾	Ctn Wt	20	COL Sq Ft		Cu Ft	12	<table border="1"> <tbody> <tr> <td>Plastic Seat</td> <td>\$489</td> </tr> <tr> <td>COM</td> <td>\$628</td> </tr> <tr> <td>A</td> <td>\$645</td> </tr> <tr> <td>B</td> <td>\$660</td> </tr> <tr> <td>COL/C</td> <td>\$686</td> </tr> <tr> <td>D</td> <td>\$719</td> </tr> <tr> <td>E</td> <td>\$752</td> </tr> <tr> <td>F</td> <td>\$804</td> </tr> <tr> <td>G</td> <td>\$858</td> </tr> <tr> <td>H</td> <td>\$917</td> </tr> <tr> <td>I</td> <td>\$1,008</td> </tr> <tr> <td>J</td> <td>\$1,119</td> </tr> <tr> <td>L1</td> <td>\$869</td> </tr> <tr> <td>L2</td> <td>\$928</td> </tr> </tbody> </table>	Plastic Seat	\$489	COM	\$628	A	\$645	B	\$660	COL/C	\$686	D	\$719	E	\$752	F	\$804	G	\$858	H	\$917	I	\$1,008	J	\$1,119	L1	\$869	L2	\$928
		Dimensions	D	W	H																																																						
		Overall	22¼	24¾	31¾																																																						
Seat	14½	18½	18																																																								
Arm			28¼																																																								
Upholstery		Shipping																																																									
COM Ydg	¾	Ctn Wt	20																																																								
COL Sq Ft		Cu Ft	12																																																								
Plastic Seat	\$489																																																										
COM	\$628																																																										
A	\$645																																																										
B	\$660																																																										
COL/C	\$686																																																										
D	\$719																																																										
E	\$752																																																										
F	\$804																																																										
G	\$858																																																										
H	\$917																																																										
I	\$1,008																																																										
J	\$1,119																																																										
L1	\$869																																																										
L2	\$928																																																										

Description	Model	Specifications	List Price Per Grade																																																								
Guest Chair  WK821AW all wood  WK821CW uph. seat	WK821AW All Wood WK821CW Uph. Seat <ul style="list-style-type: none"> 4-leg Chrome base standard, optional Bright White 4-leg base, add \$83 list optional felt glides available, no upcharge pricing reflects Natural Oak wood, add \$458 list if Black Cherry or Olive Ash are specified or \$685 list if Sapeli Sycamore or Walnut are specified 	<table border="1"> <thead> <tr> <th>Dimensions</th> <th>D</th> <th>W</th> <th>H</th> </tr> </thead> <tbody> <tr> <td>Overall</td> <td>22¾</td> <td>24</td> <td>31¼</td> </tr> <tr> <td>Seat</td> <td>15½</td> <td>18</td> <td>18</td> </tr> <tr> <td>Arm</td> <td></td> <td></td> <td>27¼</td> </tr> <tr> <th colspan="2">Upholstery</th> <th colspan="2">Shipping</th> </tr> <tr> <td>COM Ydg</td> <td>¾</td> <td>Ctn Wt</td> <td>18</td> </tr> <tr> <td>COL Sq Ft</td> <td></td> <td>Cu Ft</td> <td>12</td> </tr> </tbody> </table>	Dimensions	D	W	H	Overall	22¾	24	31¼	Seat	15½	18	18	Arm			27¼	Upholstery		Shipping		COM Ydg	¾	Ctn Wt	18	COL Sq Ft		Cu Ft	12	<table border="1"> <tbody> <tr> <td>All Wood</td> <td>\$1,422</td> </tr> <tr> <td>COM</td> <td>\$1,536</td> </tr> <tr> <td>A</td> <td>\$1,566</td> </tr> <tr> <td>B</td> <td>\$1,581</td> </tr> <tr> <td>COL/C</td> <td>\$1,607</td> </tr> <tr> <td>D</td> <td>\$1,640</td> </tr> <tr> <td>E</td> <td>\$1,673</td> </tr> <tr> <td>F</td> <td>\$1,724</td> </tr> <tr> <td>G</td> <td>\$1,779</td> </tr> <tr> <td>H</td> <td>\$1,838</td> </tr> <tr> <td>I</td> <td>\$1,929</td> </tr> <tr> <td>J</td> <td>\$2,040</td> </tr> <tr> <td>L1</td> <td>\$1,790</td> </tr> <tr> <td>L2</td> <td>\$1,848</td> </tr> </tbody> </table>	All Wood	\$1,422	COM	\$1,536	A	\$1,566	B	\$1,581	COL/C	\$1,607	D	\$1,640	E	\$1,673	F	\$1,724	G	\$1,779	H	\$1,838	I	\$1,929	J	\$2,040	L1	\$1,790	L2	\$1,848
		Dimensions	D	W	H																																																						
		Overall	22¾	24	31¼																																																						
Seat	15½	18	18																																																								
Arm			27¼																																																								
Upholstery		Shipping																																																									
COM Ydg	¾	Ctn Wt	18																																																								
COL Sq Ft		Cu Ft	12																																																								
All Wood	\$1,422																																																										
COM	\$1,536																																																										
A	\$1,566																																																										
B	\$1,581																																																										
COL/C	\$1,607																																																										
D	\$1,640																																																										
E	\$1,673																																																										
F	\$1,724																																																										
G	\$1,779																																																										
H	\$1,838																																																										
I	\$1,929																																																										
J	\$2,040																																																										
L1	\$1,790																																																										
L2	\$1,848																																																										

To Order, Specify:

- Model Number
- Plastic Color or Wood Finish
- Fabric Selection - vendor, pattern and color
- Frame Finish -
 - Chrome - Standard
 - Bright White - Optional; add \$83 list
- Optional Felt Glides - no upcharge

Plastic Color or Wood Finish Options:

- Gloss Plastic Color:** ▲
- BBG Balanced Beige Gloss
 - BNG Black Night Gloss
 - CTG Cherry Tomato Gloss
 - EWG Extra White Gloss
 - NOG Navel Orange Gloss
- Matte Plastic Color:** ▲
- BNM Black Night Matte
 - EWM Extra White Matte
 - SRM Stop Red Matte
- Translucent Color:** ▲
- CLR Clear
 - SMK Smoke
- Wood Finish:** ▲
- BLC Black Cherry
 - NOO Natural Oak
 - OAS Olive Ash
 - SSY Sapeli Sycamore
 - WAL Walnut



Specifications



- Plastic/Translucent - ¼" thick plastic seat and back.
- Wood - ¾" thick, 5 ply wood seat and back.
- Seat is upholstered with ¾" polyurethane foam.
- Chromium plated metal legs.
- 4-leg chairs standard with rubber cushion nylon glides.



*Due to limited quantities, contact Customer Service for availability.

- See a selection of graded in fabric manufacturers and patterns on pages 12-20. Contact Customer Service for additional fabric options.



SEATING

Description	① Model	Specifications	List Price Per Grade
Stool Armless	WK824AP Plastic Seat WK824CP Uph. Seat	Dimensions	Plastic Seat \$640
	<ul style="list-style-type: none"> · counter height stool · available with Gloss, Matte and Translucent Plastic shell colors · Chrome sled base standard, optional Bright White sled base, add \$83 list 	D	COM \$771
		W	A \$790
		H	B \$805
WK824AP plastic seat		Overall	COL/C \$831
WK824CP uph. seat		Seat	D \$864
		Upholstery	E \$897
		Shipping	F \$949
		COM Ydg	G \$1,003
		COL Sq Ft	H \$1,062
			I \$1,153
			J \$1,264
			L1 \$1,014
			L2 \$1,073

Stool	WK825AP Plastic Seat WK825CP Uph. Seat	Dimensions	Plastic Seat \$682
	<ul style="list-style-type: none"> · counter height stool · available with Gloss and Translucent Plastic shell colors · Chrome sled base standard, optional Bright White sled base, add \$83 list 	D	COM \$808
		W	A \$828
		H	B \$843
WK825AP plastic seat		Overall	COL/C \$868
WK825CP uph. seat		Seat	D \$901
		Arm	E \$934
		Upholstery	F \$985
		Shipping	G \$1,040
		COM Ydg	H \$1,099
		COL Sq Ft	I \$1,191
			J \$1,300
			L1 \$1,052
			L2 \$1,110

Barstool Armless	WK828AP Plastic Seat WK828CP Uph. Seat	Dimensions	Plastic Seat \$646
	<ul style="list-style-type: none"> · bar height stool · available with Gloss, Matte and Translucent Plastic shell colors · Chrome sled base standard, optional Bright White sled base, add \$83 list 	D	COM \$772
		W	A \$791
		H	B \$806
WK828AP plastic seat		Overall	COL/C \$832
WK828CP uph. seat		Seat	D \$865
		Upholstery	E \$898
		Shipping	F \$950
		COM Ydg	G \$1,004
		COL Sq Ft	H \$1,063
			I \$1,154
			J \$1,265
			L1 \$1,015
			L2 \$1,074

▲Revised 7/26/16

Description	Model	Specifications			List Price Per Grade		
		Dimensions	D	W	H	Plastic Seat	
Barstool  WK827AP plastic seat	WK827AP Plastic Seat WK827CP Uph. Seat • bar height stool • available with Gloss and Translucent Plastic shell colors • Chrome sled base standard, optional Bright White sled base, add \$83 list	Overall	19 ½	24 ¾	43 ½	COM	\$683
		Seat	16	18 ½	29 ½	A	\$829
 WK827CP uph. seat		Arm			39 ½	B	\$844
		Upholstery		Shipping		COL/C	\$869
 translucent seat		COM Ydg	¾	Ctn Wt	28	D	\$902
		COL Sq Ft		Cu Ft	15	E	\$935
						F	\$986
						G	\$1,041
						H	\$1,100
						I	\$1,192
						J	\$1,301
						L1	\$1,053
						L2	\$1,111

SEATING

To Order, Specify:

- 1 Model Number
- 2 Plastic Color
- 3 Fabric Selection - vendor, pattern and color
- 4 Frame Finish -
 - a. Chrome - Standard
 - b. Bright White - Optional; add \$83 list

2 Plastic Color or Wood Finish Options:

- Gloss Plastic Color:** ▲
- BBG Balanced Beige Gloss
 - BNG Black Night Gloss
 - CTG Cherry Tomato Gloss
 - EWG Extra White Gloss
 - NOG Navel Orange Gloss

- Translucent Color:** ▲
- CLR Clear
 - SMK Smoke

- Matte Plastic Color:** ▲
- BNM Black Night Matte
 - EWM Extra White Matte
 - SRM Stop Red Matte

Specifications

- Plastic/Translucent - ¼" thick plastic seat and back.
- Seat is upholstered with ¾" polyurethane foam.
- Chromium plated metal legs.
- Sled base standard with snap-on clear glides.

*Due to limited quantities, contact Customer Service for availability.

- 3 See a selection of graded in fabric manufacturers and patterns on pages 12-20. Contact Customer Service for additional fabric options.

Description	① Model	Specifications			List Price	
Mini Stool Armless 	WK826AP Plastic Seat · counter height stool · available with Matte Plastic shell colors · Chrome sled base standard, optional Bright White sled base, add \$83 list	Dimensions	D	W	H	\$492
		Overall	19	21 ½	32 ½	
		Seat	14 ½	17 ¼	25 ½	
				Shipping		
				Ctn Wt	23	
		Cu Ft	10			

Mini Barstool Armless 	WK829AP Plastic Seat · bar height stool · available with Matte Plastic shell colors · Chrome sled base standard, optional Bright White sled base, add \$83 list	Dimensions	D	W	H	\$497
		Overall	19	21 ½	38 ¼	
		Seat	14 ½	17 ¼	30 ¼	
				Shipping		
				Ctn Wt	24	
		Cu Ft	12			

▲Added 5/2/16

Description	① Model	Specifications			List Price	
	WK836AP Plastic Seat <ul style="list-style-type: none"> · counter height stool · available with Matte Plastic shell colors · 4-leg Chrome base standard, optional Bright White 4-leg base, add \$83 list · optional felt glides available, no upcharge 	Dimensions	D	W	H	\$492
		Overall	19	18	32 ½	
		Seat	14 ½	17 ¼	25 ½	
		Shipping				
		Ctn Wt	15			
		Cu Ft	9			

	WK839AP Plastic Seat <ul style="list-style-type: none"> · bar height stool · available with Matte Plastic shell colors · 4-leg Chrome base standard, optional Bright White 4-leg base, add \$83 list · optional felt glides available, no upcharge 	Dimensions	D	W	H	\$497
		Overall	19	18	38 ¼	
		Seat	14 ½	17 ¼	30 ¼	
		Shipping				
		Ctn Wt	16			
		Cu Ft	10			

To Order, Specify:

- ① Model Number
- ② Plastic Color
- ③ Frame Finish -
 - a. Chrome - Standard
 - b. Bright White - Optional; add \$83 list
- ④ Optional Felt Glides - no upcharge

② Plastic Color Options:

Matte Plastic Color:
 BNM Black Night Matte
 EWM Extra White Matte
 SRM Stop Red Matte

Specifications

- Plastic - ¼" thick plastic seat and back.
- Seat is upholstered with ¾" polyurethane foam.
- Chromium plated metal legs.
- Standard with snap-on clear glides with sled base.
- 4-leg stools standard with rubber cushion nylon glides.

Lounge Overview



Bairden 203



Cadet 206



Callaway 210



Corbin 215



Encore 221



Esque 238



Regal 240



Richmond 244

LOUNGE

Bairden Lounge Order Check List:



Specify:

- 1. Model Number
- 2. Wood Species - Maple (M)
- 3. Wood Finish/Color
- 4. Fabric Selection - vendor, pattern and color
- 5. Optional Rubber Cushion Nylon Glides - no upcharge

Example:

BD5801 (model #)	M (wood species)	AUB (finish)	MOMENTUM (fabric vendor)	VOX (pattern name)	MYSTIC (pattern color)
---------------------	---------------------	-----------------	-----------------------------	-----------------------	---------------------------

1. Model Number

2. Wood Species - Maple (M)

3. Wood Finish/Color Options: ▲

Maple

ALE Ale	FLX Flax
AUB Auburn	HEN Henna
AUT Autumn	HNY Honey
BRL Barley	LGC Legacy
BBN Bourbon	MCH Mocha
BRG Brighton	NTO Night Owl
BRW Brownie	NUT Nut Brown
BUT Butterscotch	PRL Praline
CAN Canyon	SAF Saffron
CIN Cinnamon	SIE Sienna
CIT Citron	TOF Toffee
CLA Classic	TRF Truffle
DES Desert	VEN Venetian
EAR Earthy	
ESP Espresso	

Color - Add \$31 list per item

BKD Backdrop	GRV Greek Villa
BFX Black Fox	GLF Gulf Stream
BWH Bright White	HTB Heartthrob
CGP Cargo Pants	NET Network Gray
CHT Chatroom	NWH Nonchalant White
DSY Daisy	PAR Paradise
DRG Daring	QXP Quixotic Plum
DYN Dynamo	RBZ Relic Bronze
ENG Enigma	SND Sandbank
FRR French Roast	STM Storm
GBY Georgian Bay	TRC Tricorn Black

4. Fabric Selection - Please supply the following:

- Fabric vendor
- Pattern name
- Pattern color

When specifying contrasting upholstery, indicate clearly which upholstery is to be applied to the seat, back and arms. Use higher grade pricing.

- Indicate direction of fabric - Railroaded or Up the Roll
- Please provide illustration, if available

All COM orders must include the following:

- Vendor's name, pattern name and color
- Sample of the fabric attached to order
- Model numbers of items for fabric application
- Special application instructions (e.g., all stripes will be applied front to back unless specified otherwise)
- Customer and purchase order number

Ship prepaid COM material to:
Community
Attn: COM Dept
932 Mill Street
Jasper, IN 47546

Application of fabric:
Railroaded Up the Roll

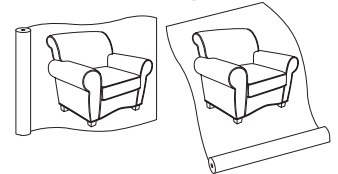

All COM orders will ship at standard lead time from receipt of COM except for orders requiring special custom matched finishes.

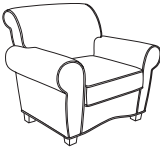
Description	① Model	Specifications			List Price Per Grade	
Single Seat 	BD5801	Dimensions	D	W	H	COM \$ 1,678
		Overall	34 ½	40	32 ½	A \$ 1,775
		Seat	20 ½	22	18	B \$ 1,916
		Arm			24 ½	COL/C \$ 2,163
		Upholstery	Shipping			D \$ 2,481
		COM Ydg	8 ¼	Ctn Wt	74	E \$ 2,799
		COL Sq Ft	179	Cu Ft	38	F \$ 3,134
						G \$ 3,610
						H \$ 4,119
						I \$ 4,912
				J \$ 5,866		
				L1 \$ 4,341		
				L2 \$ 5,007		

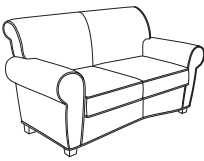
Description	① Model	Specifications			List Price Per Grade	
Two Seat 	BD5802	Dimensions	D	W	H	COM \$ 2,201
		Overall	34 ½	60	32 ½	A \$ 2,352
		Seat	20 ½	42 ½	18	B \$ 2,588
		Arm			24 ½	COL/C \$ 2,997
		Upholstery	Shipping			D \$ 3,525
		COM Ydg	13 ½	Ctn Wt	107	E \$ 4,053
		COL Sq Ft	297	Cu Ft	55	F \$ 4,610
						G \$ 5,402
						H \$ 6,246
						I \$ 7,566
				J \$ 9,149		
				L1 \$ 6,615		
				L2 \$ 7,723		

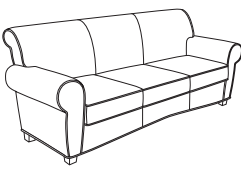
Description	① Model	Specifications			List Price Per Grade	
Three Seat 	BD5803	Dimensions	D	W	H	COM \$ 2,616
		Overall	34 ½	81	32 ½	A \$ 2,802
		Seat	20 ½	63	18	B \$ 3,093
		Arm			24 ½	COL/C \$ 3,602
		Upholstery	Shipping			D \$ 4,257
		COM Ydg	16 ¾	Ctn Wt	130	E \$ 4,912
		COL Sq Ft	369	Cu Ft	72	F \$ 5,603
						G \$ 6,585
						H \$ 7,633
						I \$ 9,270
				J \$ 11,234		
				L1 \$ 8,092		
				L2 \$ 9,466		

LOUNGE

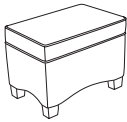
Description	Model	Specifications				List Price Per Grade	
		Dimensions	D	W	H	COM	
Ottoman 	BD5804	Overall	19	22	18	A	\$ 775
		Upholstery		Shipping		B	\$ 809
		COM Ydg	2 ½	Ctn Wt	30	C	\$ 853
		COL Sq Ft	55	Cu Ft	6	COL/C	\$ 929
						D	\$ 1,026
				E	\$ 1,124		
				F	\$ 1,227		
				G	\$ 1,374		
				H	\$ 1,530		
				I	\$ 1,775		
				J	\$ 2,068		
				L1	\$ 1,481		
				L2	\$ 1,657		

LOUNGE

To Order, Specify:

- ① Model Number
- ② Wood Species - Maple (M)
- ③ Wood Finish/Color
- ④ Fabric Selection - vendor, pattern and color
- ⑤ Optional rubber cushion nylon glides - no upcharge

③ Wood Finish/Color Options:

Maple		FLX	Flax
ALE	Ale	HEN	Henna
AUB	Auburn	HNY	Honey
AUT	Autumn	LGC	Legacy
BRL	Barley	MCH	Mocha
BBN	Bourbon	NTO	Night Owl
BRG	Brighton	NUT	Nut Brown
BRW	Brownie	PRL	Praline
BUT	Butterscotch	SAF	Saffron
CAN	Canyon	SIE	Sienna
CIN	Cinnamon	TOF	Toffee
CIT	Citron	TRF	Truffle
CLA	Classic	VEN	Venetian
DES	Desert		
EAR	Earthy		
ESP	Espresso		

Color - Add \$31 list per item

BKD	Backdrop	GRV	Greek Villa
BFX	Black Fox	GLF	Gulf Stream
BWH	Bright White	HTB	Hearthrob
CGP	Cargo Pants	NET	Network Gray
CHT	Chatroom	NWH	Nonchalant White
DSY	Daisy	PAR	Paradise
DRG	Daring	QXP	Quixotic Plum
DYN	Dynamo	RBZ	Relic Bronze
ENG	Enigma	SND	Sandbank
FRR	French Roast	STM	Storm
GBY	Georgian Bay	TRC	Tricorn Black

Specifications

- Wood species - Maple.
- Removable seat cushions have sheet webbing and 5 ½" loose cushions. (Except ottoman)
- Backs have synthetic sheet webbing and 3" high density polyurethane foam.
- Arms have 1" polyurethane foam.
- 7/8" thick furniture-grade plywood with locking tenons, glue and screws.
- Standard with rubber cushion metal glides.

④ See a selection of graded in fabric manufacturers and patterns on pages 12-20. Contact Customer Service for additional fabric options.

Cadet Order Check List:



Specify:

- 1. Model Number
- 2. Wood Species - Oak (O) or Maple (M)
- 3. Wood Finish/Color
- 4. Fabric Selection - vendor, pattern and color
- 5. Optional Arm Inserts - see options and pricing
- 6. Optional Rubber Cushion Nylon Glides - no upcharge
LEG MODELS ONLY

standard leg



standard sled



Example:

8911D | O | HEN | MOMENTUM | VOX | MYSTIC
 (model #) | (wood species) | (finish) | (fabric vendor) | (pattern name) | (pattern color)

1. Model Number

2. Wood Species - Oak (O) or Maple (M)

3. Wood Base/Arm Cap Finish Options:

Oak			
BRW	Brownie	ECU	Ecru
CAN	Canyon	HEN	Henna
CIT	Citron	HNY	Honey
DES	Desert	NUT	Nut Brown

Maple			
ALE	Ale	FLX	Flax
AUB	Auburn	LGC	Legacy
AUT	Autumn	MCH	Mocha
BRL	Barley	NTO	Night Owl
BBN	Bourbon	PRL	Praline
BRG	Brighton	SAF	Saffron
BUT	Butterscotch	SIE	Sienna
CIN	Cinnamon	TOF	Toffee
CLA	Classic	TRF	Truffle
EAR	Earthy	VEN	Venetian
ESP	Espresso		

Color - Add \$31 list per item

BKD	Backdrop	GRV	Greek Villa
BFX	Black Fox	GLF	Gulf Stream
BWH	Bright White	HTB	Heartthrob
CGP	Cargo Pants	NET	Network Gray
CHT	Chatroom	NWH	Nonchalant White
DSY	Daisy	PAR	Paradise
DRG	Daring	QXP	Quixotic Plum
DYN	Dynamo	RBZ	Relic Bronze
ENG	Enigma	SND	Sandbank
FRR	French Roast	STM	Storm
GBY	Georgian Bay	TRC	Tricorn Black

4. Fabric Selection - Please supply the following:

- Fabric vendor
- Pattern name
- Pattern color

When specifying contrasting upholstery, indicate clearly which upholstery is to be applied to the seat, back and arms. Use higher grade pricing.

- Indicate direction of fabric - Railroaded or Up the Roll
- Please provide illustration, if available

All COM orders must include the following:

- Vendor's name, pattern name and color
- Sample of the fabric attached to order
- Model numbers of items for fabric application
- Special application instructions (e.g., all stripes will be applied front to back unless specified otherwise)
- Customer and purchase order number

Ship prepaid COM material to:
 Community
 Attn: COM Dept
 932 Mill Street
 Jasper, IN 47546

Application of fabric:
 Railroaded Up the Roll

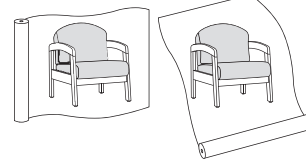



All COM orders will ship at standard lead time from receipt of COM except for orders requiring special custom matched finishes.

5. Arm Insert Options:

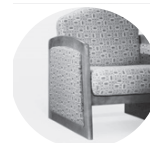
- Insert top leg - \$137 list per arm
- Insert top sled - \$137 list per arm
- Insert top and bottom sled - \$208 list per arm (requires two inserts)



Description	1 Model	Specifications			List Price Per Grade	
Lounge Chair 	8911D Four Leg • optional arm inserts - top leg insert (8911D), top sled insert (8921D) or top and bottom sled insert (8921D); see check list for pricing.	Dimensions	D	W	H	COM \$ 905
		Overall	31 ½	26 ¾	34	A \$ 937
		Seat	20	24 ¼	18	B \$ 974
		Arm			26	COL/C \$ 1,039
		Upholstery	Shipping			D \$ 1,122
		COM Ydg	2 ½	Ctn Wt	70	E \$ 1,205
		COL Sq Ft	43	Cu Ft	24	F \$ 1,292
						G \$ 1,417
						H \$ 1,550
						I \$ 1,758
				J \$ 2,007		
				L1 \$ 1,508		
				L2 \$ 1,658		

Description	1 Model	Specifications			List Price Per Grade	
Lounge Chair 	8921D Sled Leg • optional arm inserts - top leg insert (8911D), top sled insert (8921D) or top and bottom sled insert (8921D); see check list for pricing.	Dimensions	D	W	H	COM \$ 935
		Overall	31 ½	26 ¾	34	A \$ 968
		Seat	20	24 ¼	18	B \$ 1,005
		Arm			26	COL/C \$ 1,069
		Upholstery	Shipping			D \$ 1,152
		COM Ydg	2 ½	Ctn Wt	70	E \$ 1,235
		COL Sq Ft	43	Cu Ft	24	F \$ 1,323
						G \$ 1,448
						H \$ 1,581
						I \$ 1,789
				J \$ 2,037		
				L1 \$ 1,540		
				L2 \$ 1,689		

LOUNGE

To Order, Specify:

- 1 Model Number
- 2 Wood Species - Oak (O) or Maple (M)
- 3 Wood Finish/Color
- 4 Fabric Selection - vendor, pattern and color
- 5 Optional Arm Inserts - see check list for pricing
- 6 Optional Rubber Cushion Nylon Glides - no upcharge

LEG MODELS ONLY

3 Wood Finish/Color Options:

- | | | |
|------------------|------------------|---------------|
| Oak | BRW Brownie | ECU Ecu |
| AUB Auburn | CAN Canyon | HEN Henna |
| AUT Autumn | CIT Citron | HNY Honey |
| BRL Barley | DES Desert | NUT Nut Brown |
| BBN Bourbon | | |
| BRG Brighton | Maple | FLX Flax |
| BUT Butterscotch | ALE Ale | LGC Legacy |
| CIN Cinnamon | AUB Auburn | MCH Mocha |
| CLA Classic | AUT Autumn | NTO Night Owl |
| EAR Earthy | BRL Barley | PRL Praline |
| ESP Espresso | BBN Bourbon | SAF Saffron |
| | BRG Brighton | SIE Sienna |
| | BUT Butterscotch | TOF Toffee |
| | CIN Cinnamon | TRF Truffle |
| | CLA Classic | VEN Venetian |
| | EAR Earthy | |
| | ESP Espresso | |

Specifications

- Wood species - Oak or Maple.
- Features fixed cushions.
- Seat is upholstered with 3 ¼" high density polyurethane foam.
- Back is upholstered with 5 ½" high density polyurethane foam.
- Mortise and tenon with corner blocks, glue and screws.
- Standard with rubber cushion metal glides (legs models only)

Color - Add \$31 list per item

- | | |
|------------------|----------------------|
| BKD Backdrop | GRV Greek Villa |
| BFX Black Fox | GLF Gulf Stream |
| BWH Bright White | HTB Hearthrob |
| CGP Cargo Pants | NET Network Gray |
| CHT Chatroom | NWH Nonchalant White |
| DSY Daisy | PAR Paradise |
| DRG Daring | QXP Quixotic Plum |
| DYN Dynamo | RBZ Relic Bronze |
| ENG Enigma | SND Sandbank |
| FRR French Roast | STM Storm |
| GBY Georgian Bay | TRC Tricorn Black |

- 4 See a selection of graded in fabric manufacturers and patterns on pages 12-20. Contact Customer Service for additional fabric options.

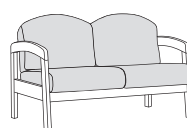
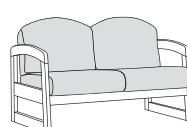
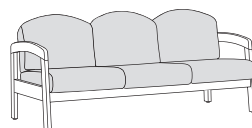
Description	① Model	Specifications				List Price Per Grade	
Two Seat	8912D Four Leg	Dimensions				COM \$ 1,529	
	· optional arm inserts - top leg insert (8912D), top sled insert (8922D) or top and bottom sled insert (8922D); see check list for pricing.					A \$ 1,590	
		Overall	31 ½	51	34	B \$ 1,664	
		Seat	20	48 ½	18	COL/C \$ 1,793	
		Arm				26	D \$ 1,959
		Upholstery		Shipping			E \$ 2,125
COM Ydg		4 ¼	Ctn Wt		112	F \$ 2,301	
COL Sq Ft		86	Cu Ft		41	G \$ 2,550	
						H \$ 2,816	
						I \$ 3,231	
						J \$ 3,729	
						L1 \$ 2,733	
						L2 \$ 3,032	
Two Seat	8922D Sled Leg	Dimensions				COM \$ 1,560	
	· optional arm inserts - top leg insert (8912D), top sled insert (8922D) or top and bottom sled insert (8922D); see check list for pricing.					A \$ 1,621	
		Overall	31 ½	51	34	B \$ 1,694	
		Seat	20	48 ½	18	COL/C \$ 1,823	
		Arm				26	D \$ 1,990
		Upholstery		Shipping			E \$ 2,156
COM Ydg		4 ¼	Ctn Wt		112	F \$ 2,331	
COL Sq Ft		86	Cu Ft		41	G \$ 2,580	
						H \$ 2,846	
						I \$ 3,262	
						J \$ 3,761	
						L1 \$ 2,763	
						L2 \$ 3,062	
Three Seat	8913D Four Leg	Dimensions				COM \$ 2,124	
	· optional arm inserts - top leg insert (8913D), top sled insert (8923D) or top and bottom sled insert (8923D); see check list for pricing.					A \$ 2,212	
		Overall	31 ½	75	34	B \$ 2,322	
		Seat	20	72 ¾	18	COL/C \$ 2,516	
		Arm				26	D \$ 2,765
		Upholstery		Shipping			E \$ 3,015
COM Ydg		6 ¾	Ctn Wt		145	F \$ 3,278	
COL Sq Ft		129	Cu Ft		66	G \$ 3,651	
						H \$ 4,050	
						I \$ 4,673	
						J \$ 5,421	
						L1 \$ 3,925	
						L2 \$ 4,374	

LOUNGE

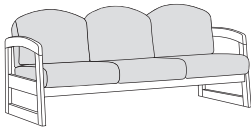
Description	Model	Specifications			List Price Per Grade		
		Dimensions	D	W	H	COM	
Three Seat 	8923D Sled Leg optional arm inserts - top leg insert (8913D), top sled insert (8923D) or top and bottom sled insert (8923D); see check list for pricing.	Overall	31 1/2	75	34	COM	\$ 2,158
		Seat	20	72 3/4	18	A	\$ 2,246
		Arm			26	B	\$ 2,358
		Upholstery		Shipping		COL/C	\$ 2,551
		COM Ydg	6 3/8	Ctn Wt	145	D	\$ 2,801
		COL Sq Ft	129	Cu Ft	66	E	\$ 3,050
						F	\$ 3,313
						G	\$ 3,687
						H	\$ 4,085
						I	\$ 4,709
				J	\$ 5,456		
				L1	\$ 3,961		
				L2	\$ 4,409		

LOUNGE

To Order, Specify:

- 1 Model Number
- 2 Wood Species - Oak (O) or Maple (M)
- 3 Wood Finish/Color
- 4 Fabric Selection - vendor, pattern and color
- 5 Optional Arm Inserts - see check list for pricing
- 6 Optional Rubber Cushion Nylon Glides - no upcharge

LEG MODELS ONLY

3 Wood Finish/Color Options:

Oak		ECU	Ecru
BRW	Brownie	HEN	Henna
CAN	Canyon	HNY	Honey
CIT	Citron	NUT	Nut Brown
DES	Desert		
Maple			
ALE	Ale	FLX	Flax
AUB	Auburn	LGC	Legacy
AUT	Autumn	MCH	Mocha
BRL	Barley	NTO	Night Owl
BBN	Bourbon	PRL	Praline
BRG	Brighton	SAF	Saffron
BUT	Butterscotch	SIE	Sienna
CIN	Cinnamon	TOF	Toffee
CLA	Classic	TRF	Truffle
EAR	Earthy	VEN	Venetian
ESP	Espresso		

Color - Add \$31 list per item

BKD	Backdrop	GRV	Greek Villa
BFX	Black Fox	GLF	Gulf Stream
BWH	Bright White	HTB	Hearthrob
CGP	Cargo Pants	NET	Network Gray
CHT	Chatroom	NWH	Nonchalant White
DSY	Daisy	PAR	Paradise
DRG	Daring	QXP	Quixotic Plum
DYN	Dynamo	RBZ	Relic Bronze
ENG	Enigma	SND	Sandbank
FRR	French Roast	STM	Storm
GBY	Georgian Bay	TRC	Tricom Black

Specifications

- Wood species - Oak or Maple.
- Features fixed cushions.
- Seat is upholstered with 3 1/4" high density polyurethane foam.
- Back is upholstered with 5 1/2" high density polyurethane foam.
- Mortise and tenon construction with corner blocks, glue and screws.
- Standard with rubber cushion metal glides (legs models only)

- 4 See a selection of graded in fabric manufacturers and patterns on pages 12-20. Contact Customer Service for additional fabric options.

Callaway Seating Order Check List:



Specify:

- 1. Model Number
- 2. Wood Species - Oak (O) or Maple (M)
- 3. Wood Finish/Color
- 4. Fabric Selection - vendor, pattern and color
- 5. Optional Arm Inserts - see options and pricing
- 6. Optional Rubber Cushion Nylon Glides - no upcharge LEG MODELS ONLY

standard leg standard sled



Example:

6311D | **O** | **HEN** | **MOMENTUM** | **VOX** | **MYSTIC**
 (model #) | (wood species) | (finish) | (fabric vendor) | (pattern name) | (pattern color)

1. Model Number

2. Wood Species - Oak (O) or Maple (M)

3. Wood Base/Arm Cap Finish Options:

Oak

BRW Brownie	ECU Ecu
CAN Canyon	HEN Henna
CIT Citron	HNY Honey
DES Desert	NUT Nut Brown

Maple

ALE Ale	FLX Flax
AUB Auburn	LGC Legacy
AUT Autumn	MCH Mocha
BRL Barley	NTO Night Owl
BBN Bourbon	PRL Praline
BRG Brighton	SAF Saffron
BUT Butterscotch	SIE Sienna
CIN Cinnamon	TOF Toffee
CLA Classic	TRF Truffle
EAR Earthy	VEN Venetian
ESP Espresso	

Color - Add \$31 list per item

BKD Backdrop	GRV Greek Villa
BFX Black Fox	GLF Gulf Stream
BWH Bright White	HTB Heartthrob
CGP Cargo Pants	NET Network Gray
CHT Chatroom	NWH Nonchalant White
DSY Daisy	PAR Paradise
DRG Daring	QXP Quixotic Plum
DYN Dynamo	RBZ Relic Bronze
ENG Enigma	SND Sandbank
FRR French Roast	STM Storm
GBY Georgian Bay	TRC Tricorn Black

- Indicate direction of fabric - Railroaded or Up the Roll
- Please provide illustration, if available

All COM orders must include the following:

- Vendor's name, pattern name and color
- Sample of the fabric attached to order
- Model numbers of items for fabric application
- Special application instructions (e.g., all stripes will be applied front to back unless specified otherwise)
- Customer and purchase order number

Ship prepaid COM material to:
 Community
 Attn: COM Dept
 932 Mill Street
 Jasper, IN 47546

Application of fabric:
 Railroaded Up the Roll

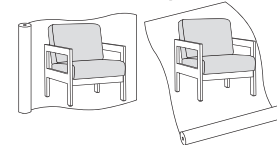

All COM orders will ship at standard lead time from receipt of COM except for orders requiring special custom matched finishes.

5. Arm Insert Options:

Insert top leg - \$137 list per arm



Insert top sled - \$137 list per arm



Insert top and bottom sled - \$208 list per arm (requires two inserts)



4. Fabric Selection - Please supply the following:

- Fabric vendor
- Pattern name
- Pattern color

When specifying contrasting upholstery, indicate clearly which upholstery is to be applied to the seat, back and arms. Use higher grade pricing.

Callaway Tables Order Check List:



Specify:

- 1. Model Number
- 2. Wood Species - Cherry (CH1), Maple (MA1), Oak (OK1) or Walnut (WA1) ▲
- 3. Wood Finish/Color
- 4. Edge Profile
- 5. Optional Premium or Specialty Laminate Tops Available - contact customer service for pricing

Example:

CA2030-16 | OK1 | HEN |
 (model #) | (wood species) | (finish) |

1. Model Number

2. Wood Species - Cherry (CH1), Maple (MA1), Oak (OK1) or Walnut (WA1)

4. Wood Finish/Color Options:

Cherry

- | | |
|---------------|--------------|
| AUT Autumn* | EAR Earthy |
| BRL Barley* | LGC Legacy* |
| BBN Bourbon* | PRL Praline* |
| BRG Brighton* | SAF Saffron* |
| CLA Classic* | |

Maple

- ALE Ale*
- BUT Butterscotch
- CIN Cinnamon*
- FLX Flax
- VEN Venetian*

Oak

- | | |
|--------------|----------------|
| BRW Brownie* | ECU Ecu* |
| CAN Canyon* | HEN Henna* |
| CIT Citron* | HNY Honey* |
| DES Desert* | NUT Nut Brown* |

Walnut

- | | |
|----------------|--------------|
| AUB Auburn* | SIE Sienna* |
| ESP Espresso | TOF Toffee* |
| MCH Mocha* | TRF Truffle* |
| NTO Night Owl* | |

Color - Add \$31 list per item

- | | |
|------------------|----------------------|
| BKD Backdrop | GRV Greek Villa |
| BFX Black Fox | GLF Gulf Stream |
| BWH Bright White | HTB Heartthrob |
| CGP Cargo Pants | NET Network Gray |
| CHT Chatroom | NWH Nonchalant White |
| DSY Daisy | PAR Paradise |
| DRG Daring | QXP Quixotic Plum |
| DYN Dynamo | RBZ Relic Bronze |
| ENG Enigma | SND Sandbank |
| FRR French Roast | STM Storm |
| GBY Georgian Bay | TRC Tricorn Black |

5. Edge Profile Options:

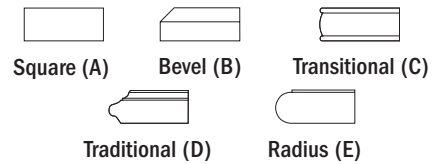

LOUNGE

Description	① Model	Specifications				List Price Per Grade	
Lounge Chair 	6311D Four Leg · optional arm inserts - top leg insert; see check list for pricing.	Dimensions		D	W	H	COM \$ 838
		Overall	32	26 ¾	34	A \$ 870	
		Seat	20	24 ¼	18	B \$ 907	
		Arm			24	COL/C \$ 972	
		Upholstery		Shipping		D \$ 1,055	
		COM Ydg	2 ⅛	Ctn Wt	70	E \$ 1,138	
		COL Sq Ft	43	Cu Ft	31	F \$ 1,226	
						G \$ 1,350	
						H \$ 1,483	
						I \$ 1,691	
				J \$ 1,940			
				L1 \$ 1,441			
				L2 \$ 1,591			

Lounge Chair 	6321D Sled Leg · optional arm inserts - top sled insert or top and bottom sled insert; see check list for pricing.	Dimensions		D	W	H	COM \$ 856
		Overall	32	26 ¾	34	A \$ 888	
		Seat	20	24 ¼	18	B \$ 926	
		Arm			24	COL/C \$ 990	
		Upholstery		Shipping		D \$ 1,073	
		COM Ydg	2 ⅛	Ctn Wt	70	E \$ 1,155	
		COL Sq Ft	43	Cu Ft	31	F \$ 1,244	
						G \$ 1,368	
						H \$ 1,501	
						I \$ 1,709	
				J \$ 1,958			
				L1 \$ 1,459			
				L2 \$ 1,609			

LOUNGE

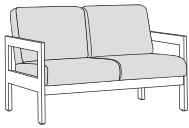
Description	Model	Specifications			List Price Per Grade	
Two Seat 	6312D Four Leg · optional arm inserts - top leg insert; see check list for pricing.	Dimensions	D	W	H	COM \$ 1,421
		Overall	32	51	34	A \$ 1,480
		Seat	20	48½	18	B \$ 1,553
		Arm			24	COL/C \$ 1,683
		Upholstery	Shipping			D \$ 1,850
		COM Ydg	4 ¼	Ctn Wt	112	E \$ 2,015
		COL Sq Ft	86	Cu Ft	51	F \$ 2,191
						G \$ 2,440
						H \$ 2,705
						I \$ 3,121
				J \$ 3,620		
				L1 \$ 2,622		
				L2 \$ 2,922		

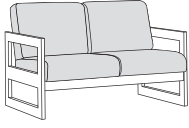
Two Seat 	6322D Sled Leg · optional arm inserts - top sled insert or top and bottom sled insert; see check list for pricing.	Dimensions	D	W	H	COM \$ 1,437
		Overall	32	51	34	A \$ 1,496
		Seat	20	48½	18	B \$ 1,570
		Arm			24	COL/C \$ 1,699
		Upholstery	Shipping			D \$ 1,865
		COM Ydg	4 ¼	Ctn Wt	112	E \$ 2,031
		COL Sq Ft	86	Cu Ft	51	F \$ 2,207
						G \$ 2,456
						H \$ 2,722
						I \$ 3,137
				J \$ 3,636		
				L1 \$ 2,639		
				L2 \$ 2,937		

LOUNGE

To Order, Specify:

- 1 Model Number
- 2 Wood Species - Oak (O) or Maple (M)
- 3 Wood Finish/Color
- 4 Fabric Selection - vendor, pattern and color
- 5 Optional Arm Inserts - see check list for pricing
- 6 Optional Rubber Cushion Nylon Glides - no upcharge

LEG MODELS ONLY

3 Wood Finish/Color Options:

- | | | |
|------------------|------------------|---------------|
| Oak | BRW Brownie | ECU Ecu |
| AUB Auburn | CAN Canyon | HEN Henna |
| AUT Autumn | CIT Citron | HNY Honey |
| BRL Barley | DES Desert | NUT Nut Brown |
| BBN Bourbon | | |
| BRG Brighton | Maple | FLX Flax |
| BUT Butterscotch | ALE Ale | LGC Legacy |
| CIN Cinnamon | AUB Auburn | MCH Mocha |
| CLA Classic | AUT Autumn | NTO Night Owl |
| EAR Earthy | BRL Barley | PRL Praline |
| ESP Espresso | BBN Bourbon | SAF Saffron |
| | BRG Brighton | SIE Sienna |
| | BUT Butterscotch | TOF Toffee |
| | CIN Cinnamon | TRF Truffle |
| | CLA Classic | VEN Venetian |
| | EAR Earthy | |
| | ESP Espresso | |

Color - Add \$31 list per item

- | | |
|------------------|----------------------|
| BKD Backdrop | GRV Greek Villa |
| BFX Black Fox | GLF Gulf Stream |
| BWH Bright White | HTB Hearthrob |
| CGP Cargo Pants | NET Network Gray |
| CHT Chatroom | NWH Nonchalant White |
| DSY Daisy | PAR Paradise |
| DRG Daring | QXP Quixotic Plum |
| DYN Dynamo | RBZ Relic Bronze |
| ENG Enigma | SND Sandbank |
| FRR French Roast | STM Storm |
| GBY Georgian Bay | TRC Tricorn Black |

Specifications

- Wood species - Oak or Maple.
- Features fixed cushions.
- Seat is upholstered with 3 ¼" high density polyurethane foam.
- Back is upholstered with 5 ½" high density polyurethane foam.
- Spiral grooved hardwood dowels with corner blocks, glue and screws.
- Standard with rubber cushion metal glides. (leg models only).

- 4 See a selection of graded in fabric manufacturers and patterns on pages 12-20. Contact Customer Service for additional fabric options.

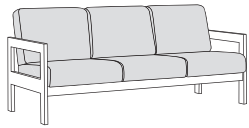
Description	1 Model	Specifications	List Price Per Grade																																										
	6313D Four Leg · optional arm inserts - top leg insert; see check list for pricing.	<table border="1"> <thead> <tr> <th>Dimensions</th> <th>D</th> <th>W</th> <th>H</th> </tr> </thead> <tbody> <tr> <td>Overall</td> <td>32</td> <td>75</td> <td>34</td> </tr> <tr> <td>Seat</td> <td>20</td> <td>72 1/2</td> <td>18</td> </tr> <tr> <td>Arm</td> <td></td> <td></td> <td>24</td> </tr> </tbody> </table>	Dimensions	D	W	H	Overall	32	75	34	Seat	20	72 1/2	18	Arm			24	<table border="1"> <tbody> <tr><td>COM</td><td>\$ 2,063</td></tr> <tr><td>A</td><td>\$ 2,150</td></tr> <tr><td>B</td><td>\$ 2,260</td></tr> <tr><td>COL/C</td><td>\$ 2,454</td></tr> <tr><td>D</td><td>\$ 2,703</td></tr> <tr><td>E</td><td>\$ 2,953</td></tr> <tr><td>F</td><td>\$ 3,216</td></tr> <tr><td>G</td><td>\$ 3,589</td></tr> <tr><td>H</td><td>\$ 3,988</td></tr> <tr><td>I</td><td>\$ 4,611</td></tr> <tr><td>J</td><td>\$ 5,359</td></tr> <tr><td>L1</td><td>\$ 3,863</td></tr> <tr><td>L2</td><td>\$ 4,312</td></tr> </tbody> </table>	COM	\$ 2,063	A	\$ 2,150	B	\$ 2,260	COL/C	\$ 2,454	D	\$ 2,703	E	\$ 2,953	F	\$ 3,216	G	\$ 3,589	H	\$ 3,988	I	\$ 4,611	J	\$ 5,359	L1	\$ 3,863	L2	\$ 4,312
		Dimensions	D	W	H																																								
		Overall	32	75	34																																								
		Seat	20	72 1/2	18																																								
		Arm			24																																								
		COM	\$ 2,063																																										
		A	\$ 2,150																																										
		B	\$ 2,260																																										
		COL/C	\$ 2,454																																										
		D	\$ 2,703																																										
E	\$ 2,953																																												
F	\$ 3,216																																												
G	\$ 3,589																																												
H	\$ 3,988																																												
I	\$ 4,611																																												
J	\$ 5,359																																												
L1	\$ 3,863																																												
L2	\$ 4,312																																												
<table border="1"> <thead> <tr> <th>Upholstery</th> <th colspan="2">Shipping</th> </tr> </thead> <tbody> <tr> <td>COM Ydg</td> <td>6 3/8</td> <td>Ctn Wt 145</td> </tr> <tr> <td>COL Sq Ft</td> <td>129</td> <td>Cu Ft 61</td> </tr> </tbody> </table>		Upholstery	Shipping		COM Ydg	6 3/8	Ctn Wt 145	COL Sq Ft	129	Cu Ft 61																																			
Upholstery	Shipping																																												
COM Ydg	6 3/8	Ctn Wt 145																																											
COL Sq Ft	129	Cu Ft 61																																											

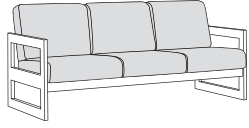
Description	1 Model	Specifications	List Price Per Grade																																										
	6323D Sled Leg · optional arm inserts - top sled insert or top and bottom sled insert; see check list for pricing.	<table border="1"> <thead> <tr> <th>Dimensions</th> <th>D</th> <th>W</th> <th>H</th> </tr> </thead> <tbody> <tr> <td>Overall</td> <td>32</td> <td>75</td> <td>34</td> </tr> <tr> <td>Seat</td> <td>20</td> <td>72 1/2</td> <td>18</td> </tr> <tr> <td>Arm</td> <td></td> <td></td> <td>24</td> </tr> </tbody> </table>	Dimensions	D	W	H	Overall	32	75	34	Seat	20	72 1/2	18	Arm			24	<table border="1"> <tbody> <tr><td>COM</td><td>\$ 2,084</td></tr> <tr><td>A</td><td>\$ 2,171</td></tr> <tr><td>B</td><td>\$ 2,282</td></tr> <tr><td>COL/C</td><td>\$ 2,475</td></tr> <tr><td>D</td><td>\$ 2,725</td></tr> <tr><td>E</td><td>\$ 2,974</td></tr> <tr><td>F</td><td>\$ 3,238</td></tr> <tr><td>G</td><td>\$ 3,611</td></tr> <tr><td>H</td><td>\$ 4,009</td></tr> <tr><td>I</td><td>\$ 4,633</td></tr> <tr><td>J</td><td>\$ 5,381</td></tr> <tr><td>L1</td><td>\$ 3,885</td></tr> <tr><td>L2</td><td>\$ 4,334</td></tr> </tbody> </table>	COM	\$ 2,084	A	\$ 2,171	B	\$ 2,282	COL/C	\$ 2,475	D	\$ 2,725	E	\$ 2,974	F	\$ 3,238	G	\$ 3,611	H	\$ 4,009	I	\$ 4,633	J	\$ 5,381	L1	\$ 3,885	L2	\$ 4,334
		Dimensions	D	W	H																																								
		Overall	32	75	34																																								
		Seat	20	72 1/2	18																																								
		Arm			24																																								
		COM	\$ 2,084																																										
		A	\$ 2,171																																										
		B	\$ 2,282																																										
		COL/C	\$ 2,475																																										
		D	\$ 2,725																																										
E	\$ 2,974																																												
F	\$ 3,238																																												
G	\$ 3,611																																												
H	\$ 4,009																																												
I	\$ 4,633																																												
J	\$ 5,381																																												
L1	\$ 3,885																																												
L2	\$ 4,334																																												
<table border="1"> <thead> <tr> <th>Upholstery</th> <th colspan="2">Shipping</th> </tr> </thead> <tbody> <tr> <td>COM Ydg</td> <td>6 3/8</td> <td>Ctn Wt 145</td> </tr> <tr> <td>COL Sq Ft</td> <td>129</td> <td>Cu Ft 61</td> </tr> </tbody> </table>		Upholstery	Shipping		COM Ydg	6 3/8	Ctn Wt 145	COL Sq Ft	129	Cu Ft 61																																			
Upholstery	Shipping																																												
COM Ydg	6 3/8	Ctn Wt 145																																											
COL Sq Ft	129	Cu Ft 61																																											

To Order, Specify:

- 1 Model Number
- 2 Wood Species - Oak (O) or Maple (M)
- 3 Wood Finish/Color
- 4 Fabric Selection - vendor, pattern and color
- 5 Optional Arm Inserts - see check list for pricing
- 6 Optional Rubber Cushion Nylon Glides - no upcharge

LEG MODELS ONLY

3 Wood Finish/Color Options:

Oak		ECU	Ecu
BRW	Brownie	HEN	Henna
CAN	Canyon	HNY	Honey
CIT	Citron	NUT	Nut Brown
DES	Desert		
Maple			
ALE	Ale	FLX	Flax
AUB	Auburn	LGC	Legacy
AUT	Autumn	MCH	Mocha
BRL	Barley	NTO	Night Owl
BBN	Bourbon	PRL	Praline
BRG	Brighton	SAF	Saffron
BUT	Butterscotch	SIE	Sienna
CIN	Cinnamon	TOF	Toffee
CLA	Classic	TRF	Truffle
EAR	Earthy	VEN	Venetian
ESP	Espresso		

Color - Add \$31 list per item

BKD	Backdrop	GRV	Greek Villa
BFX	Black Fox	GLF	Gulf Stream
BWH	Bright White	HTB	Heartthrob
CGP	Cargo Pants	NET	Network Gray
CHT	Chatroom	NWH	Nonchalant White
DSY	Daisy	PAR	Paradise
DRG	Daring	QXP	Quixotic Plum
DYN	Dynamo	RBZ	Relic Bronze
ENG	Enigma	SND	Sandbank
FRR	French Roast	STM	Storm
GBY	Georgian Bay	TRC	Tricorn Black

Specifications

- Wood species - Oak or Maple.
- Features fixed cushions.
- Seat is upholstered with 3 1/4" high density polyurethane foam.
- Back is upholstered with 5 1/2" high density polyurethane foam.
- Spiral grooved hardwood dowels with corner blocks, glue and screws.
- Standard with rubber cushion metal glides. (leg models only).

- 4 See a selection of graded in fabric manufacturers and patterns on pages 12-20. Contact Customer Service for additional fabric options.

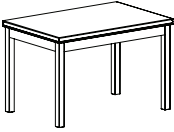
Description	D	W	H	CTN WT	CU FT	① Model	List Price
	20	30	16	34		CA2030-16	\$ 647
	20	48	16	46		CA2048-16	\$ 659
	20	30	20	34		CA2030-20	\$ 669
	20	48	20	46		CA2048-20	\$ 683

· ships KD

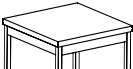
	28	28	16	38		CA2828-16	\$ 629
	28	28	20	38		CA2828-20	\$ 655

· ships KD

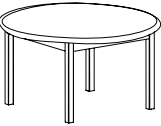
	36	N/A	16	42		CA36-16	\$ 779
	36	N/A	20	42		CA36-20	\$ 802

· ships KD

LOUNGE

To Order, Specify:

- ① Model Number
- ② Wood Species - Cherry (CH1), Maple (MA1), Oak (OK1) or Walnut (WA1)
- ③ Wood Finish/Color
- ④ Fabric Selection - vendor, pattern and color
- ⑤ Optional Arm Inserts - see check list for pricing
- ⑥ Optional Rubber Cushion Nylon Glides - no upcharge

LEG MODELS ONLY

④ Wood Finish/Color Options:

Cherry		Maple	
AUT	Autumn*	ALE	Ale*
BRL	Barley*	BUT	Butterscotch
BBN	Bourbon*	CIN	Cinnamon*
BRG	Brighton*	FLX	Flax
CLA	Classic*	VEN	Venetian*
EAR	Earthy		
LGC	Legacy*		
PRL	Praline*		
SAF	Saffron*		

Oak		Walnut	
BRW	Brownie*	AUB	Auburn*
CAN	Canyon*	ESP	Espresso
CIT	Citron*	MCH	Mocha*
DES	Desert*	NTO	Night Owl*
ECU	Ecru*	SIE	Sienna*
HEN	Henna*	TOF	Toffee*
HNY	Honey*	TRF	Truffle*
NUT	Nut Brown*		

Color - Add \$31 list per item

BKD	Backdrop	GRV	Creek Villa
BFX	Black Fox	GLF	Gulf Stream
BWH	Bright White	HTB	Heartthrob
CGP	Cargo Pants	NET	Network Gray
CHT	Chatroom	NWH	Nonchalant White
DSY	Daisy	PAR	Paradise
DRG	Daring	QXP	Quixotic Plum
DYN	Dynamo	RBZ	Relic Bronze
ENG	Enigma	SND	Sandbank
FRR	French Roast	STM	Storm
GBY	Georgian Bay	TRC	Tricorn Black

Specifications

- Wood species - Cherry, Maple, Oak or Walnut.
- Features fixed cushions.
- Seat is upholstered with 3 ¼" high density polyurethane foam.
- Back is upholstered with 5 ½" high density polyurethane foam.
- Spiral grooved hardwood dowels with corner blocks, glue and screws.
- Standard with rubber cushion metal glides. (leg models only).

④ See a selection of graded in fabric manufacturers and patterns on pages 12-20. Contact Customer Service for additional fabric options.

Corbin Lounge Order Check List:



Specify:

- 1. Model Number
- 2. Wood Species - Maple (M)
- 3. Wood Finish/Color
- 4. Fabric Selection - vendor, pattern and color
- 5. Optional Rubber Cushion Nylon Glides - no upcharge
WOOD LEG MODELS ONLY

Example:

CB7501S (model #)	M (wood species)	AUB (finish)	MOMENTUM (fabric vendor)	VOX (pattern name)	MYSTIC (pattern color)
-----------------------------	----------------------------	------------------------	------------------------------------	------------------------------	----------------------------------

1. Model Number

2. Wood Species - Maple (M)

3. Wood Finish/Color Options: ▲

Maple

ALE Ale	FLX Flax
AUB Auburn	HEN Henna
AUT Autumn	HNY Honey
BRL Barley	LGC Legacy
BBN Bourbon	MCH Mocha
BRG Brighton	NTO Night Owl
BRW Brownie	NUT Nut Brown
BUT Butterscotch	PRL Praline
CAN Canyon	SAF Saffron
CIN Cinnamon	SIE Sienna
CIT Citron	TOF Toffee
CLA Classic	TRF Truffle
DES Desert	VEN Venetian
EAR Earthy	
ESP Espresso	

Color - Add \$31 list per item

BKD Backdrop	GRV Greek Villa
BFX Black Fox	GLF Gulf Stream
BWH Bright White	HTB Heartthrob
CGP Cargo Pants	NET Network Gray
CHT Chatroom	NWH Nonchalant White
DSY Daisy	PAR Paradise
DRG Daring	QXP Quixotic Plum
DYN Dynamo	RBZ Relic Bronze
ENG Enigma	SND Sandbank
FRR French Roast	STM Storm
GBY Georgian Bay	TRC Tricorn Black

4. Fabric Selection - Please supply the following:

- Fabric vendor
- Pattern name
- Pattern color

When specifying contrasting upholstery, indicate clearly which upholstery is to be applied to the seat, back and arms. Use higher grade pricing.

- Indicate direction of fabric - Railroaded or Up the Roll
- Please provide illustration, if available

All COM orders must include the following:

- Vendor's name, pattern name and color
- Sample of the fabric attached to order
- Model numbers of items for fabric application
- Special application instructions (e.g., all stripes will be applied front to back unless specified otherwise)
- Customer and purchase order number

Ship prepaid COM material to:
Community
Attn: COM Dept
932 Mill Street
Jasper, IN 47546

Application of fabric:
Railroaded Up the Roll

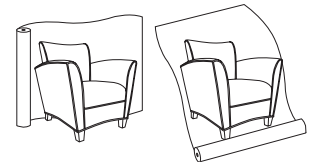

All COM orders will ship at standard lead time from receipt of COM except for orders requiring special custom matched finishes.

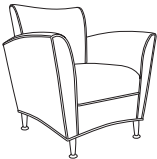
Description	① Model	Specifications				List Price Per Grade
Single Seat 	CB7501S · satin nickel metal leg	Dimensions				COM \$ 1,756
		D	W	H	A \$ 1,822	
		Overall	32	34	35	B \$ 1,952
		Seat	22	20	18	COL/C \$ 2,180
		Arm			28	D \$ 2,473
		Upholstery		Shipping		E \$ 2,767
		COM Ydg	7½	Ctn Wt	74	F \$ 3,076
		COL Sq Ft	165	Cu Ft	27	G \$ 3,516
						H \$ 3,985
						I \$ 4,718
				J \$ 5,598		
				L1 \$ 4,190		
				L2 \$ 4,806		

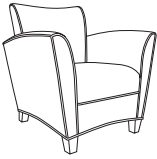
Description	① Model	Specifications				List Price Per Grade
Single Seat 	CB7501W · wood leg	Dimensions				COM \$ 1,756
		D	W	H	A \$ 1,822	
		Overall	32	34	35	B \$ 1,952
		Seat	22	20	18	COL/C \$ 2,180
		Arm			28	D \$ 2,473
		Upholstery		Shipping		E \$ 2,767
		COM Ydg	7½	Ctn Wt	74	F \$ 3,076
		COL Sq Ft	165	Cu Ft	27	G \$ 3,516
						H \$ 3,985
						I \$ 4,718
				J \$ 5,598		
				L1 \$ 4,190		
				L2 \$ 4,806		

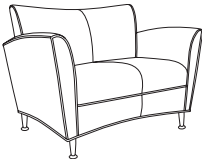
Description	① Model	Specifications				List Price Per Grade
Two Seat 	CB7502S · satin nickel metal leg	Dimensions				COM \$ 2,396
		D	W	H	A \$ 2,492	
		Overall	32	54	35	B \$ 2,683
		Seat	22	40	18	COL/C \$ 3,018
		Arm			28	D \$ 3,448
		Upholstery		Shipping		E \$ 3,878
		COM Ydg	11	Ctn Wt	93	F \$ 4,332
		COL Sq Ft	242	Cu Ft	45	G \$ 4,976
						H \$ 5,664
						I \$ 6,739
				J \$ 8,030		
				L1 \$ 5,966		
				L2 \$ 6,869		

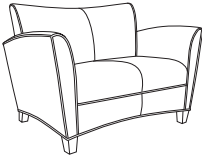
Description	① Model	Specifications				List Price Per Grade
Two Seat 	CB7502W · wood leg	Dimensions				COM \$ 2,396
		D	W	H	A \$ 2,492	
		Overall	32	54	35	B \$ 2,683
		Seat	22	40	18	COL/C \$ 3,018
		Arm			28	D \$ 3,448
		Upholstery		Shipping		E \$ 3,878
		COM Ydg	11	Ctn Wt	93	F \$ 4,332
		COL Sq Ft	242	Cu Ft	45	G \$ 4,976
						H \$ 5,664
						I \$ 6,739
				J \$ 8,030		
				L1 \$ 5,966		
				L2 \$ 6,869		

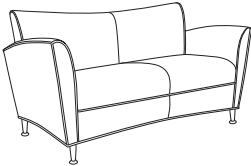
Description	Model	Specifications			List Price Per Grade		
		Dimensions	D	W	H	COM	
Three Seat 	CB7503S · satin nickel metal leg	Overall	32	74	35	A	\$ 2,781
		Seat	22	60	18	B	\$ 3,007
		Arm			28	COL/C	\$ 3,401
		Upholstery		Shipping		D	\$ 3,910
		COM Ydg	13	Ctn Wt	126	E	\$ 4,418
		COL Sq Ft	286	Cu Ft	63	F	\$ 4,954
						G	\$ 5,717
						H	\$ 6,529
						I	\$ 7,800
						J	\$ 9,324
				L1	\$ 6,885		
				L2	\$ 7,952		

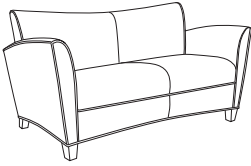
Description	Model	Specifications			List Price Per Grade		
		Dimensions	D	W	H	COM	
Three Seat 	CB7503W · wood leg	Overall	32	74	35	A	\$ 2,781
		Seat	22	60	18	B	\$ 3,007
		Arm			28	COL/C	\$ 3,401
		Upholstery		Shipping		D	\$ 3,910
		COM Ydg	13	Ctn Wt	126	E	\$ 4,418
		COL Sq Ft	286	Cu Ft	63	F	\$ 4,954
						G	\$ 5,717
						H	\$ 6,529
						I	\$ 7,800
						J	\$ 9,324
				L1	\$ 6,885		
				L2	\$ 7,952		

LOUNGE

To Order, Specify:

- 1 Model Number
 - 2 Wood Species - Maple (M)
 - 3 Wood Finish/Color
 - 4 Fabric Selection - vendor, pattern and color
 - 5 Optional Rubber Cushion Nylon Glides - no upcharge
- WOOD LEG MODELS ONLY**

3 Wood Finish/Color Options:

ALE Ale	FLX Flax
AUB Auburn	HEN Henna
AUT Autumn	HNY Honey
BRL Barley	LGC Legacy
BBN Bourbon	MCH Mocha
BRG Brighton	NTO Night Owl
BRW Brownie	NUT Nut Brown
BUT Butterscotch	PRL Praline
CAN Canyon	SAF Saffron
CIN Cinnamon	SIE Sienna
CIT Citron	TOF Toffee
CLA Classic	TRF Truffle
DES Desert	VEN Venetian
EAR Earthy	
ESP Espresso	





Color - Add \$31 list per item

BKD Backdrop	GRV Greek Villa
BFX Black Fox	GLF Gulf Stream
BWH Bright White	HTB Heartthrob
CGP Cargo Pants	NET Network Gray
CHT Chatroom	NWH Nonchalant White
DSY Daisy	PAR Paradise
DRG Daring	QXP Quixotic Plum
DYN Dynamo	RBZ Relic Bronze
ENG Enigma	SND Sandbank
FRR French Roast	STM Storm
GBY Georgian Bay	TRC Tricorn Black

Specifications

- Wood species - Maple.
- Metal leg - Satin Nickel.
- Features fixed cushions.
- 7/8" thick furniture-grade plywood.
- Seats and backs have synthetic sheet webbing suspension.
- Seat has 6" polyurethane foam with Dacron® wrap and synthetic sheet webbing with cross strap reinforcement.
- Back has 4 1/2" polyurethane foam.
- Standard with rubber cushion metal glides (wood leg models only).

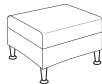
4 See a selection of graded in fabric manufacturers and patterns on pages 12-20. Contact Customer Service for additional fabric options.

Description	① Model	Specifications				List Price Per Grade	
Ottoman 	CB7504S · satin nickel metal leg · packaged 2/box	Dimensions		D	W	H	COM \$ 871
		Overall		19	22	17	A \$ 893
		Upholstery		Shipping			B \$ 937
		COM Ydg	2 ½	Ctn Wt	61	COL/C \$ 1,013	
		COL Sq Ft	50	Cu Ft	20	D \$ 1,110	
					E \$ 1,208		
					F \$ 1,311		
					G \$ 1,458		
					H \$ 1,614		
					I \$ 1,859		
					J \$ 2,152		
					L1 \$ 1,565		
					L2 \$ 1,741		
Ottoman 	CB7504W · wood leg · packaged 2/box	Dimensions		D	W	H	COM \$ 871
		Overall		19	22	17	A \$ 893
		Upholstery		Shipping			B \$ 937
		COM Ydg	2 ½	Ctn Wt	61	COL/C \$ 1,013	
		COL Sq Ft	50	Cu Ft	20	D \$ 1,110	
					E \$ 1,208		
					F \$ 1,311		
					G \$ 1,458		
					H \$ 1,614		
					I \$ 1,859		
					J \$ 2,152		
					L1 \$ 1,565		
					L2 \$ 1,741		
Single Seat Bench 	CB7591S · satin nickel metal leg	Dimensions		D	W	H	COM \$ 1,091
		Overall		25 ½	20 ½	17 ¾	A \$ 1,109
		Upholstery		Shipping			B \$ 1,144
		COM Ydg	2	Ctn Wt	41	COL/C \$ 1,205	
		COL Sq Ft	40	Cu Ft	30	D \$ 1,284	
					E \$ 1,361		
					F \$ 1,444		
					G \$ 1,561		
					H \$ 1,686		
					I \$ 1,882		
					J \$ 2,116		
					L1 \$ 1,647		
					L2 \$ 1,788		
Single Seat Bench 	CB7591W · wood leg	Dimensions		D	W	H	COM \$ 1,091
		Overall		25 ½	20 ½	17 ¾	A \$ 1,109
		Upholstery		Shipping			B \$ 1,144
		COM Ydg	2	Ctn Wt	41	COL/C \$ 1,205	
		COL Sq Ft	40	Cu Ft	30	D \$ 1,284	
					E \$ 1,361		
					F \$ 1,444		
					G \$ 1,561		
					H \$ 1,686		
					I \$ 1,882		
					J \$ 2,116		
					L1 \$ 1,647		
					L2 \$ 1,788		

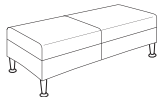
Description	① Model	Specifications			List Price Per Grade	
		Dimensions	D	W		H
Two Seat Bench 	CB7592S · satin nickel metal leg	Overall	25 ½	40 ½	16	COM \$ 1,483
		Upholstery		Shipping		A \$ 1,507
		COM Ydg	2 ¾	Ctn Wt	76	B \$ 1,556
		COL Sq Ft	55	Cu Ft	46	COL/C \$ 1,640
						D \$ 1,747
						E \$ 1,854
						F \$ 1,967
						G \$ 2,129
						H \$ 2,301
						I \$ 2,570
						J \$ 2,892
						L1 \$ 2,247
						L2 \$ 2,441

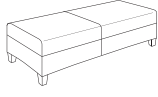
Description	① Model	Specifications			List Price Per Grade	
		Dimensions	D	W		H
Two Seat Bench 	CB7592W · wood leg	Overall	25 ½	40 ½	16	COM \$ 1,483
		Upholstery		Shipping		A \$ 1,507
		COM Ydg	2 ¾	Ctn Wt	76	B \$ 1,556
		COL Sq Ft	55	Cu Ft	46	COL/C \$ 1,640
						D \$ 1,747
						E \$ 1,854
						F \$ 1,967
						G \$ 2,129
						H \$ 2,301
						I \$ 2,570
						J \$ 2,892
						L1 \$ 2,247
						L2 \$ 2,441

LOUNGE

To Order, Specify:

- ① Model Number
 - ② Wood Species - Maple (M)
 - ③ Wood Finish/Color
 - ④ Fabric Selection - vendor, pattern and color
 - ⑤ Optional Rubber Cushion Nylon Glides - no upcharge
- WOOD LEG MODELS ONLY**

③ Wood Finish/Color Options:

ALE Ale	FLX Flax
AUB Auburn	HEN Henna
AUT Autumn	HNY Honey
BRL Barley	LGC Legacy
BBN Bourbon	MCH Mocha
BRG Brighton	NTO Night Owl
BRW Brownie	NUT Nut Brown
BUT Butterscotch	PRL Praline
CAN Canyon	SAF Saffron
CIN Cinnamon	SIE Sienna
CIT Citron	TOF Toffee
CLA Classic	TRF Truffle
DES Desert	VEN Venetian
EAR Earthy	
ESP Espresso	

Color - Add \$31 list per item

BKD Backdrop	GRV Creek Villa
BFX Black Fox	GLF Gulf Stream
BWH Bright White	HTB Heartthrob
CGP Cargo Pants	NET Network Gray
CHT Chatroom	NWH Nonchalant White
DSY Daisy	PAR Paradise
DRG Daring	QXP Quixotic Plum
DYN Dynamo	RBZ Relic Bronze
ENG Enigma	SND Sandbank
FRR French Roast	STM Storm
GBY Georgian Bay	TRC Tricorn Black

Specifications

- Wood species - Maple.
- Metal leg - Satin Nickel.
- Features fixed cushions.
- ¾" thick furniture-grade plywood.
- Seats have synthetic sheet webbing suspension.
- Seat has 6" polyurethane foam with Dacron® wrap.
- Standard with rubber cushion metal glides (wood leg models only).

- ④ See a selection of graded in fabric manufacturers and patterns on pages 12-20. Contact Customer Service for additional fabric options.

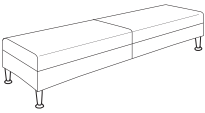
Description	① Model	Specifications			List Price Per Grade	
		Dimensions	D	W		H
Three Seat Bench 	CB7593S · satin nickel metal leg	Overall	25 ½	60 ½	17 ¾	COM \$ 1,805
		Upholstery		Shipping		A \$ 1,847
		COM Ydg	4 ¾	Ctn Wt	116	B \$ 1,930
		COL Sq Ft	95	Cu Ft	62	COL/C \$ 2,074
						D \$ 2,260
						E \$ 2,446
						F \$ 2,641
						G \$ 2,921
						H \$ 3,218
						I \$ 3,682
						J \$ 4,238
						L1 \$ 3,124
						L2 \$ 3,458

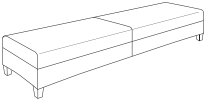
Description	① Model	Specifications			List Price Per Grade	
		Dimensions	D	W		H
Three Seat Bench 	CB7593W · wood leg	Overall	25 ½	60 ½	17 ¾	COM \$ 1,805
		Upholstery		Shipping		A \$ 1,847
		COM Ydg	4 ¾	Ctn Wt	116	B \$ 1,930
		COL Sq Ft	95	Cu Ft	62	COL/C \$ 2,074
						D \$ 2,260
						E \$ 2,446
						F \$ 2,641
						G \$ 2,921
						H \$ 3,218
						I \$ 3,682
						J \$ 4,238
						L1 \$ 3,124
						L2 \$ 3,458

LOUNGE

To Order, Specify:

- ① Model Number
- ② Wood Species - Maple (M)
- ③ Wood Finish/Color
- ④ Fabric Selection - vendor, pattern and color
- ⑤ Optional Rubber Cushion Nylon Glides - no upcharge

WOOD LEG MODELS ONLY

③ Wood Finish/Color Options:

ALE Ale	FLX Flax
AUB Auburn	HEN Henna
AUT Autumn	HNY Honey
BRL Barley	LGC Legacy
BBN Bourbon	MCH Mocha
BRG Brighton	NTO Night Owl
BRW Brownie	NUT Nut Brown
BUT Butterscotch	PRL Praline
CAN Canyon	SAF Saffron
CIN Cinnamon	SIE Sienna
CIT Citron	TOF Toffee
CLA Classic	TRF Truffle
DES Desert	VEN Venetian
EAR Earthy	
ESP Espresso	

Color - Add \$31 list per item

BKD Backdrop	GRV Greek Villa
BFX Black Fox	GLF Gulf Stream
BWH Bright White	HTB Heartthrob
CGP Cargo Pants	NET Network Gray
CHT Chatroom	NWH Nonchalant White
DSY Daisy	PAR Paradise
DRG Daring	QXP Quixotic Plum
DYN Dynamo	RBZ Relic Bronze
ENG Enigma	SND Sandbank
FRR French Roast	STM Storm
GBY Georgian Bay	TRC Tricorn Black

Specifications

- Wood leg species - Maple.
- Metal leg - Satin Nickel.
- Features fixed cushions.
- 7/8" thick furniture-grade plywood.
- Seats have synthetic sheet webbing suspension.
- Seat has 6" polyurethane foam with Dacron® wrap.
- Standard with rubber cushion metal glides (wood leg models only).

- ④ See a selection of graded in fabric manufacturers and patterns on pages 12-20. Contact Customer Service for additional fabric options.

Encore Lounge Order Check List:



Specify:

- 1. Model Number
- 2. Wood Species - Maple (M)
- 3. Wood Finish/Color
- 4. Fabric Selection - vendor, pattern and color
- 5. Leg Style - disk or column
- 6. Leg/Trim Color - Black Sandtex (BSX) or Stardust Silver (STS)
- 7. Optional Easy Mobility Package - add \$108 list per chair; available on any single seat, non-wedge lounge
- 8. Optional Coordinating Wood Grain Laminate Surfaces - no upcharge

Example:

EN9201UW | M | AUB | MOMENTUM | VOX | MYSTIC | COLUMN | BLACK SANDTEX
 (model #) | (wood species) | (finish) | (fabric vendor) | (pattern name) | (pattern color) | (leg style) | (leg color)

1. Model Number

2. Wood Species - Maple (M)

3. Wood Finish/Color Options: ▲

ALE Ale*	FLX Flax
AUB Auburn*	HEN Henna*
AUT Autumn*	HNY Honey*
BRL Barley*	LGC Legacy*
BBN Bourbon*	MCH Mocha*
BRG Brighton*	NTO Night Owl*
BRW Brownie*	NUT Nut Brown*
BUT Butterscotch	PRL Praline*
CAN Canyon*	SAF Saffron*
CIN Cinnamon*	SIE Sienna*
CIT Citron*	TOF Toffee*
CLA Classic*	TRF Truffle*
DES Desert*	VEN Venetian*
EAR Earthy	
ESP Espresso	

Color - Add \$31 list per item

BKD Backdrop	GRV Greek Villa
BFX Black Fox	GLF Gulf Stream
BWH Bright White	HTB Heartthrob
CGP Cargo Pants	NET Network Gray
CHT Chatroom	NWH Nonchalant White
DSY Daisy	PAR Paradise
DRG Daring	QXP Quixotic Plum
DYN Dynamo	RBZ Relic Bronze
ENG Enigma	SND Sandbank
FRR French Roast	STM Storm
GBY Georgian Bay	TRC Tricorn Black

4. Fabric Selection - Please supply the following:

- Fabric vendor
- Pattern name
- Pattern color

When specifying contrasting upholstery, indicate clearly which upholstery is to be applied to the seat, back and arms. Use higher grade pricing.

- Indicate direction of fabric - Railroaded or Up the Roll
- Please provide illustration, if available

All COM orders must include the following:

- Vendor's name, pattern name and color
- Sample of the fabric attached to order
- Model numbers of items for fabric application
- Special application instructions (e.g., all stripes will be applied front to back unless specified otherwise)
- Customer and purchase order number

Ship prepaid COM material to:
 Community
 Attn: COM Dept
 932 Mill Street
 Jasper, IN 47546

Application of fabric:
 Railroaded Up the Roll

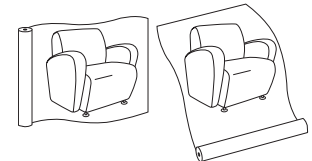

All COM orders will ship at standard lead time from receipt of COM except for orders requiring special custom matched finishes.

5. Leg Style Options:

Lounge Leg Style



Lounge Disk Leg
· adjustable height

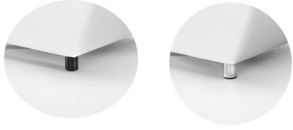

Lounge Column Leg
· fixed height

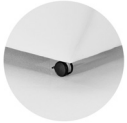

Lounge Caster

Table Leg Style



Table Disk Leg
· adjustable height

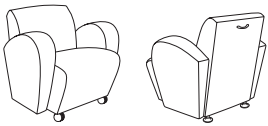

Table Column Leg
· fixed height

LOUNGE

6. Leg/Trim Color - Black Sandtex or Stardust Silver

7. Easy Mobility Package Option - add \$108 list per chair



- available on any single seat, non-wedge lounge
- front casters, back legs for easy mobility
- handle attached on back

8. Optional Coordinating Wood Grain Laminate Available on Wood Cap Arms, Tablet Arm and Table Tops - no upcharge. Finishes with an asterisk (*) have a coordinating laminate available. For additional laminate offering contact Customer Service.

Description	Model	Specifications			List Price Per Grade	
		Dimensions	D	W		H
Single Seat 	EN9201U · upholstered arm · optional easy mobility package - add \$108 list per chair · optional tablet available on right or left (as seated in unit); specify when ordering and add \$283 list	Overall	29	35 1/2	32	COM \$ 1,804
		Seat	20 1/2	23 1/2	18	A \$ 1,857
		Arm			26	B \$ 1,962
		Upholstery		Shipping		COL/C \$ 2,144
		COM Ydg	6	Ctn Wt	80	D \$ 2,379
		COL Sq Ft	120	Cu Ft	21	E \$ 2,613
						F \$ 2,861
						G \$ 3,212
						H \$ 3,587
						I \$ 4,174
						J \$ 4,878
						L1 \$ 3,471
						L2 \$ 3,893

Single Seat with Folding Tablet Arm



tablet on right arm



tablet arm stowed



easy mobility package

EN9251

- tablet arm: 19 1/4" x 10 3/4"
- tablet features beveled edge
- tablet height: 27"
- rotating tablet with tilt and stow mechanism
- additional width required, clearance for tablet operations is 10"
- includes easy mobility package
- tablet available on right or left arm (as seated in unit); specify when ordering

Dimensions	D	W	H	COM
Overall	29	36 1/2	32	\$ 2,117
Seat	20 1/2	23 1/2	18	A \$ 2,172
Arm			26	B \$ 2,281
Upholstery		Shipping		COL/C \$ 2,471
COM Ydg	6 1/4	Ctn Wt	85	D \$ 2,716
COL Sq Ft	125	Cu Ft	21	E \$ 2,959
				F \$ 3,218
				G \$ 3,584
				H \$ 3,975
				I \$ 4,586
				J \$ 5,319
				L1 \$ 3,853
				L2 \$ 4,292

To Order, Specify:

- Model Number
- Wood Species - Maple (M)
- Wood Finish/Color
- Fabric Selection - vendor, pattern and color
- Leg Style - disk or column
- Leg/Trim Color - Black Sandtex or Stardust Silver
- Optional Easy Mobility Package - add \$108 list
- Optional Coordinating Wood Grain Laminate
Surfaces - no upcharge; Finishes with an asterisk have a coordinating laminate available.

Wood Finish/Color Options:

ALE Ale*	FLX Flax
AUB Auburn*	HEN Henna*
AUT Autumn*	HNY Honey*
BRL Barley*	LGC Legacy*
BBN Bourbon*	MCH Mocha*
BRG Brighton*	NTO Night Owl*
BRW Brownie*	NUT Nut Brown*
BUT Butterscotch	PRL Praline*
CAN Canyon*	SAF Saffron*
CIN Cinnamon*	SIE Sienna*
CIT Citron*	TOF Toffee*
CLA Classic*	TRF Truffle*
DES Desert*	VEN Venetian*
EAR Earthy	
ESP Espresso	

Color - Add \$31 list per item

BKD Backdrop	GRV Greek Villa
BFX Black Fox	GLF Gulf Stream
BWH Bright White	HTB Heartthrob
CGP Cargo Pants	NET Network Gray
CHT Chatroom	NWH Nonchalant White
DSY Daisy	PAR Paradise
DRG Daring	QXP Quixotic Plum
DYN Dynamo	RBZ Relic Bronze
ENG Enigma	SND Sandbank
FRR French Roast	STM Storm
GBY Georgian Bay	TRC Tricorn Black

- See a selection of graded in fabric manufacturers and patterns on pages 12-20. Contact Customer Service for additional fabric options.

Specifications

- Wood species - Maple.
- Seat has 8 1/2" high density polyurethane foam.
- Back has 7 1/2" high density polyurethane foam.
- Upholstered arms have 4 1/2" high density polyurethane foam.
- Plywood construction with spiral grooved solid wood dowels, glue and screws.
- Some assembly required.

Description	① Model	Specifications				List Price Per Grade
		Dimensions	D	W	H	
Single Seat 	EN9201UW · upholstered/wood arm · metal spacers will match leg color · optional easy mobility package - add \$108 list per chair	Overall	30	36½	32	COM \$ 1,930
		Seat	20½	23½	18	A \$ 1,983
		Arm			24½	B \$ 2,088
		Upholstery		Shipping		COL/C \$ 2,270
		COM Ydg	6	Ctn Wt	80	D \$ 2,505
		COL Sq Ft	120	Cu Ft	21	E \$ 2,739
						F \$ 2,987
						G \$ 3,338
						H \$ 3,713
						I \$ 4,300
						J \$ 5,004
						L1 \$ 3,597
						L2 \$ 4,019

Description	① Model	Specifications				List Price Per Grade
		Dimensions	D	W	H	
Single Seat 	EN9201W · open wood arm · metal arm support will match leg color · optional easy mobility package - add \$108 list per chair	Overall	30	36½	32	COM \$ 1,437
		Seat	20½	23½	18	A \$ 1,463
		Arm			24½	B \$ 1,516
		Upholstery		Shipping		COL/C \$ 1,607
		COM Ydg	3	Ctn Wt	64	D \$ 1,725
		COL Sq Ft	60	Cu Ft	21	E \$ 1,841
						F \$ 1,965
						G \$ 2,141
						H \$ 2,328
						I \$ 2,622
						J \$ 2,974
						L1 \$ 2,271
						L2 \$ 2,482

Description	① Model	Specifications				List Price Per Grade
		Dimensions	D	W	H	
Single Seat 	EN9201T-R · 360° swivel tablet arm - right · optional tilt-out power available; specify right or left (as seated in unit); see page 237 for more details. · tablet features flat edge · metal tablet arm will match leg color · optional easy mobility package - add \$108 list per chair	Overall	29	30½	32	COM \$ 1,146
		Seat	20½	23½	18	A \$ 1,172
		Arm			24½	B \$ 1,225
		Upholstery		Shipping		COL/C \$ 1,316
		COM Ydg	3	Ctn Wt	55	D \$ 1,434
		COL Sq Ft	60	Cu Ft	18	E \$ 1,550
						F \$ 1,674
						G \$ 1,851
						H \$ 2,037
						I \$ 2,331
						J \$ 2,683
						L1 \$ 1,980
						L2 \$ 2,191

Description	① Model	Specifications				List Price Per Grade
		Dimensions	D	W	H	
Single Seat 	EN9201T-L · 360° swivel tablet arm - left · optional tilt-out power available; specify right or left (as seated in unit); see page 237 for more details. · tablet features flat edge · metal tablet arm will match leg color · optional easy mobility package - add \$108 list per chair	Overall	29	30½	32	COM \$ 1,146
		Seat	20½	23½	18	A \$ 1,172
		Arm			24½	B \$ 1,225
		Upholstery		Shipping		COL/C \$ 1,316
		COM Ydg	3	Ctn Wt	55	D \$ 1,434
		COL Sq Ft	60	Cu Ft	18	E \$ 1,550
						F \$ 1,674
						G \$ 1,851
						H \$ 2,037
						I \$ 2,331
						J \$ 2,683
						L1 \$ 1,980
						L2 \$ 2,191

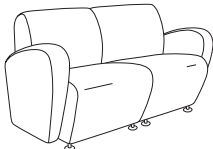
Description	Model	Specifications			List Price Per Grade		
		Dimensions	D	W	H	COM	
Two Seat 	EN9202U · upholstered arm · optional tablet available on right or left arm (as seated in unit); specify when ordering and add \$283 list	Overall	29	59 ¼	32	COM	\$ 2,805
		Seat	20 ½	47 ¼	18	A	\$ 2,884
		Arm			26	B	\$ 3,040
		Upholstery		Shipping		COL/C	\$ 3,314
		COM Ydg	9	Ctn Wt	130	D	\$ 3,666
		COL Sq Ft	180	Cu Ft	35	E	\$ 4,018
						F	\$ 4,389
						G	\$ 4,917
						H	\$ 5,479
						I	\$ 6,359
				J	\$ 7,415		
				L1	\$ 5,304		
				L2	\$ 5,937		

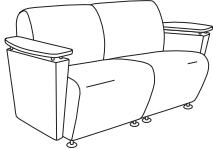
Description	Model	Specifications			List Price Per Grade		
		Dimensions	D	W	H	COM	
Two Seat 	EN9202UW · upholstered/wood arm · metal spacers will match leg color	Overall	30	60 ¼	32	COM	\$ 2,932
		Seat	20 ½	47 ¼	18	A	\$ 3,011
		Arm			24 ½	B	\$ 3,167
		Upholstery		Shipping		COL/C	\$ 3,441
		COM Ydg	9	Ctn Wt	130	D	\$ 3,793
		COL Sq Ft	180	Cu Ft	35	E	\$ 4,145
						F	\$ 4,517
						G	\$ 5,044
						H	\$ 5,606
						I	\$ 6,486
				J	\$ 7,542		
				L1	\$ 5,431		
				L2	\$ 6,064		

LOUNGE

To Order, Specify:

- 1 Model Number
- 2 Wood Species - Maple (M)
- 3 Wood Finish/Color
- 4 Fabric Selection - vendor, pattern and color
- 5 Leg Style - disk or column
- 6 Leg/Trim Color - Black Sandtex or Stardust Silver
- 7 Optional Easy Mobility Package - add \$108 list
- 8 Optional Coordinating Wood Grain Laminate
Surfaces - no upcharge; Finishes with an asterisk have a coordinating laminate available.

3 Wood Finish/Color Options:▲

- | | |
|------------------|----------------|
| ALE Ale* | FLX Flax |
| AUB Auburn* | HEN Henna* |
| AUT Autumn* | HNY Honey* |
| BRL Barley* | LGC Legacy* |
| BBN Bourbon* | MCH Mocha* |
| BRG Brighton* | NTO Night Owl* |
| BRW Brownie* | NUT Nut Brown* |
| BUT Butterscotch | PRL Praline* |
| CAN Canyon* | SAF Saffron* |
| CIN Cinnamon* | SIE Sienna* |
| CIT Citron* | TOF Toffee* |
| CLA Classic* | TRF Truffle* |
| DES Desert* | VEN Venetian* |
| EAR Earthy | |
| ESP Espresso | |

Color - Add \$31 list per item

- | | |
|------------------|----------------------|
| BKD Backdrop | GRV Greek Villa |
| BFX Black Fox | GLF Gulf Stream |
| BWH Bright White | HTB Heartthrob |
| CGP Cargo Pants | NET Network Gray |
| CHT Chatroom | NWH Nonchalant White |
| DSY Daisy | PAR Paradise |
| DRG Daring | QXP Quixotic Plum |
| DYN Dynamo | RBZ Relic Bronze |
| ENG Enigma | SND Sandbank |
| FRR French Roast | STM Storm |
| GBY Georgian Bay | TRC Tricorn Black |

Specifications

- Wood species - Maple.
- Seat has 8 ½" high density polyurethane foam.
- Back has 7 ½" high density polyurethane foam.
- Upholstered arms have 4 ½" high density polyurethane foam.
- Plywood construction with spiral grooved solid wood dowels, glue and screws.
- Some assembly required.

4 See a selection of graded in fabric manufacturers and patterns on pages 12-20. Contact Customer Service for additional fabric options.

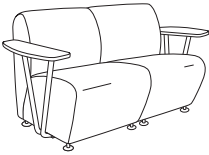
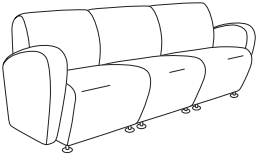
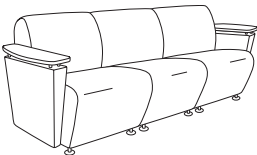
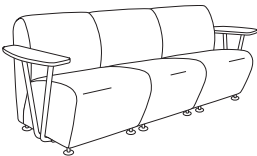
Description	① Model	Specifications			List Price Per Grade	
Two Seat 	EN9202W · open wood arm · metal arm support will match leg color	Dimensions	D	W	H	COM \$ 2,443
		Overall	30	60 ¼	32	A \$ 2,495
		Seat	20 ½	47 ¼	18	B \$ 2,600
		Arm			24 ½	COL/C \$ 2,782
		Upholstery	Shipping			D \$ 3,017
		COM Ydg	6	Ctn Wt	114	E \$ 3,251
		COL Sq Ft	120	Cu Ft	35	F \$ 3,499
						G \$ 3,851
						H \$ 4,226
						I \$ 4,813
				J \$ 5,516		
				L1 \$ 4,109		
				L2 \$ 4,531		
Three Seat 	EN9203U · upholstered arm · some assembly required · optional tablet available on right or left arm (as seated in unit); specify when ordering and add \$283 list	Dimensions	D	W	H	COM \$ 3,811
		Overall	29	83	32	A \$ 3,916
		Seat	20 ½	70 ¾	18	B \$ 4,125
		Arm			26	COL/C \$ 4,489
		Upholstery	Shipping			D \$ 4,959
		COM Ydg	12	Ctn Wt	180	E \$ 5,428
		COL Sq Ft	240	Cu Ft	49	F \$ 5,922
						G \$ 6,627
						H \$ 7,377
						I \$ 8,550
				J \$ 9,958		
				L1 \$ 7,143		
				L2 \$ 7,987		
Three Seat 	EN9203UW · upholstered/wood arm · some assembly required · metal spacers will match leg color	Dimensions	D	W	H	COM \$ 3,937
		Overall	30	84	32	A \$ 4,042
		Seat	20 ½	70 ¾	18	B \$ 4,251
		Arm			24 ½	COL/C \$ 4,615
		Upholstery	Shipping			D \$ 5,085
		COM Ydg	12	Ctn Wt	180	E \$ 5,554
		COL Sq Ft	240	Cu Ft	49	F \$ 6,048
						G \$ 6,753
						H \$ 7,503
						I \$ 8,676
				J \$ 10,084		
				L1 \$ 7,269		
				L2 \$ 8,113		
Three Seat 	EN9203W · open wood arm · some assembly required · metal arm support will match leg color	Dimensions	D	W	H	COM \$ 3,443
		Overall	30	84	32	A \$ 3,522
		Seat	20 ½	70 ¾	18	B \$ 3,679
		Arm			24 ½	COL/C \$ 3,953
		Upholstery	Shipping			D \$ 4,304
		COM Ydg	9	Ctn Wt	164	E \$ 4,656
		COL Sq Ft	180	Cu Ft	49	F \$ 5,028
						G \$ 5,555
						H \$ 6,118
						I \$ 6,998
				J \$ 8,053		
				L1 \$ 5,942		
				L2 \$ 6,576		

LOUNGE

Description	D	W	H	CTN WT	CU FT	① Model	List Price
Oval Magazine Table	21 ½	42 ½	17	25	3	EN2142	\$ 1,017

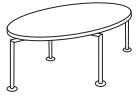

· ships KD

Round Magazine Table	36 ½	36 ½	17	28	4	EN36R	\$ 944
	30 ½	30 ½	17	25	3	EN30R	\$ 919



· ships KD

Rectangular Magazine Table	24 ½	48 ½	17	30	4	EN2448	\$ 889
----------------------------	------	------	----	----	---	--------	--------



· ships KD

Square End Table	30 ¾	30 ¾	22 ¼	25	3	EN3030-22	\$ 861
	24 ¾	24 ¾	22 ¼	20	3	EN2424-22	\$ 748

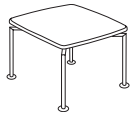

· ships KD

Square Magazine Table	30 ¾	30 ¾	17	25	3	EN3030-17	\$ 839
	24 ¾	24 ¾	17	20	3	EN2424-17	\$ 729

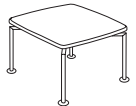

· ships KD

To Order, Specify:

- ① Model Number
- ② Wood Species - Maple (M)
- ③ Wood Finish/Color
- ④ Fabric Selection - vendor, pattern and color
- ⑤ Leg Style - disk or column
- ⑥ Leg/Trim Color - Black Sandtex or Stardust Silver
- ⑦ Optional Coordinating Wood Grain Laminate available on wood cap arms and table top - no upcharge. Finishes with an asterisk have a coordinating laminate available.

③ Wood Finish/Color Options:▲

ALE Ale*	FLX Flax
AUB Auburn*	HEN Henna*
AUT Autumn*	HNY Honey*
BRL Barley*	LGC Legacy*
BBN Bourbon*	MCH Mocha*
BRG Brighton*	NTO Night Owl*
BRW Brownie*	NUT Nut Brown*
BUT Butterscotch	PRL Praline*
CAN Canyon*	SAF Saffron*
CIN Cinnamon*	SIE Sienna*
CIT Citron*	TOF Toffee*
CLA Classic*	TRF Truffle*
DES Desert*	VEN Venetian*
EAR Earthy	
ESP Espresso	

Color - Add \$31 list per item

BKD Backdrop	GRV Greek Villa
BFX Black Fox	GLF Gulf Stream
BWH Bright White	HTB Heartthrob
CGP Cargo Pants	NET Network Gray
CHT Chatroom	NWH Nonchalant White
DSY Daisy	PAR Paradise
DRG Daring	QXP Quixotic Plum
DYN Dynamo	RBZ Relic Bronze
ENG Enigma	SND Sandbank
FRR French Roast	STM Storm
GBY Georgian Bay	TRC Tricorn Black

Specifications

- Wood species - Maple.
- Table tops and wood caps are ¾" thick.
- Seat has 8 ½" high density polyurethane foam.
- Back has 7 ½" high density polyurethane foam.
- Upholstered arms have 4 ½" high density polyurethane foam.
- Plywood construction with spiral grooved solid wood dowels, glue and screws.
- Tables ship KD; some assembly required.
- Standard with nylon glides.

- ④ See a selection of graded in fabric manufacturers and patterns on pages 12-20. Contact Customer Service for additional fabric options.

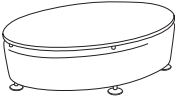
Description	① Model	Specifications				List Price Per Grade	
		Dimensions	D	W	H	COM	
Oval Magazine Table 	EN2142B · upholstered base · metal spacers will match leg color	Overall	21 ½	42 ½	17	COM	\$ 1,213
		Upholstery		Shipping		A	\$ 1,229
		COM Ydg	1 ¾	Ctn Wt	56	B	\$ 1,259
		COL Sq Ft	35	Cu Ft	10	COL/C	\$ 1,313
						D	\$ 1,381
				E	\$ 1,449		
				F	\$ 1,522		
				G	\$ 1,624		
				H	\$ 1,734		
				I	\$ 1,905		
				J	\$ 2,110		
				L1	\$ 1,699		
				L2	\$ 1,822		

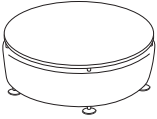
Description	① Model	Specifications				List Price Per Grade	
		Dimensions	D	W	H	COM	
Round Magazine Table 	EN36RB · upholstered base · metal spacers will match leg color	Overall	36 ½	36 ½	17	COM	\$ 1,149
		Upholstery		Shipping		A	\$ 1,175
		COM Ydg	3	Ctn Wt	75	B	\$ 1,228
		COL Sq Ft	60	Cu Ft	14	COL/C	\$ 1,319
						D	\$ 1,437
				E	\$ 1,553		
				F	\$ 1,677		
				G	\$ 1,854		
				H	\$ 2,041		
				I	\$ 2,335		
				J	\$ 2,686		
				L1	\$ 1,983		
				L2	\$ 2,194		

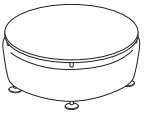
Description	① Model	Specifications				List Price Per Grade	
		Dimensions	D	W	H	COM	
Round Magazine Table 	EN30RB · upholstered base · metal spacers will match leg color	Overall	30 ½	30 ½	17	COM	\$ 1,124
		Upholstery		Shipping		A	\$ 1,142
		COM Ydg	2	Ctn Wt	58	B	\$ 1,176
		COL Sq Ft	40	Cu Ft	11	COL/C	\$ 1,237
						D	\$ 1,316
				E	\$ 1,394		
				F	\$ 1,477		
				G	\$ 1,593		
				H	\$ 1,718		
				I	\$ 1,915		
				J	\$ 2,149		
				L1	\$ 1,679		
				L2	\$ 1,820		

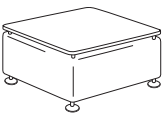
Description	① Model	Specifications				List Price Per Grade	
		Dimensions	D	W	H	COM	
Square Magazine Table 	EN3030-17B · upholstered base · metal spacers will match leg color	Overall	30 ¾	30 ¾	17	COM	\$ 1,047
		Upholstery		Shipping		A	\$ 1,074
		COM Ydg	3	Ctn Wt	78	B	\$ 1,126
		COL Sq Ft	60	Cu Ft	11	COL/C	\$ 1,217
						D	\$ 1,335
				E	\$ 1,452		
				F	\$ 1,575		
				G	\$ 1,752		
				H	\$ 1,939		
				I	\$ 2,233		
				J	\$ 2,585		
				L1	\$ 1,881		
				L2	\$ 2,092		

LOUNGE

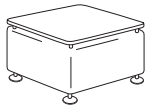
Description	① Model	Specifications				List Price Per Grade
Square Magazine Table 	EN2424-17B · upholstered base · metal spacers will match leg color	Dimensions	D	W	H	COM \$ 955
		Overall	24 ¾	24 ¾	17	A \$ 973
		Upholstery	Shipping		B \$ 1,007	
		COM Ydg	2	Ctn Wt	58	COL/C \$ 1,068
		COL Sq Ft	40	Cu Ft	8	D \$ 1,147
						E \$ 1,225
				F \$ 1,308		
				G \$ 1,424		
				H \$ 1,549		
				I \$ 1,746		
				J \$ 1,980		
				L1 \$ 1,510		
				L2 \$ 1,651		

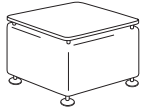
Description	① Model	Specifications				List Price Per Grade
Square End Table 	EN2424-22B · upholstered base · metal spacers will match leg color	Dimensions	D	W	H	COM \$ 960
		Overall	24 ¾	24 ¾	22	A \$ 979
		Upholstery	Shipping		B \$ 1,016	
		COM Ydg	2 ½	Ctn Wt	65	COL/C \$ 1,081
		COL Sq Ft	43	Cu Ft	10	D \$ 1,164
						E \$ 1,247
				F \$ 1,335		
				G \$ 1,459		
				H \$ 1,592		
				I \$ 1,800		
				J \$ 2,049		
				L1 \$ 1,550		
				L2 \$ 1,700		

LOUNGE

To Order, Specify:

- ① Model Number
- ② Wood Species - Maple (M)
- ③ Wood Finish/Color
- ④ Fabric Selection - vendor, pattern and color
- ⑤ Leg Style - disk or column
- ⑥ Leg/Trim Color - Black Sandtex or Stardust Silver
- ⑦ Optional Coordinating Wood Grain Laminate
Surfaces - no upcharge; Finishes with an asterisk have a coordinating laminate available.

③ Wood Finish/Color Options:▲

ALE Ale*	FLX Flax
AUB Auburn*	HEN Henna*
AUT Autumn*	HNY Honey*
BRL Barley*	LGC Legacy*
BBN Bourbon*	MCH Mocha*
BRG Brighton*	NTO Night Owl*
BRW Brownie*	NUT Nut Brown*
BUT Butterscotch	PRL Praline*
CAN Canyon*	SAF Saffron*
CIN Cinnamon*	SIE Sienna*
CIT Citron*	TOF Toffee*
CLA Classic*	TRF Truffle*
DES Desert*	VEN Venetian*
EAR Earthy	
ESP Espresso	

Color - Add \$31 list per item

BKD Backdrop	GRV Creek Villa
BFX Black Fox	GLF Gulf Stream
BWH Bright White	HTB Heartthrob
CGP Cargo Pants	NET Network Gray
CHT Chatroom	NWH Nonchalant White
DSY Daisy	PAR Paradise
DRG Daring	QXP Quixotic Plum
DYN Dynamo	RBZ Relic Bronze
ENG Enigma	SND Sandbank
FRR French Roast	STM Storm
GBY Georgian Bay	TRC Tricorn Black



Specifications

- Wood species - Maple.
- Upholstered bases have 4 ½" high density polyurethane foam.
- Plywood construction with spiral grooved solid wood dowels, glue and screws.
- Some assembly required.

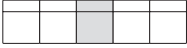
④ See a selection of graded in fabric manufacturers and patterns on pages 12-20. Contact Customer Service for additional fabric options.

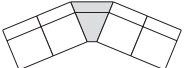
Description	① Model	Specifications			List Price Per Grade	
		Dimensions	D	W		H
Armless Lounge  	EN9210 · single seat · linking bracket attached · optional tilt-out power available; specify right or left (as seated in unit), see page 237 for more details · optional easy mobility package - add \$108 list	Overall	29	23 ½	32	COM \$ 1,008 A \$ 1,035 B \$ 1,087 COL/C \$ 1,179 D \$ 1,296 E \$ 1,413 F \$ 1,537 G \$ 1,713 H \$ 1,900 I \$ 2,194 J \$ 2,546 L1 \$ 1,842 L2 \$ 2,053
		Seat	20 ½	23 ½	18	
		Upholstery		Shipping		
		COM Ydg	3	Ctn Wt	50	
		COL Sq Ft	60	Cu Ft	14	

Description	① Model	Specifications			List Price Per Grade	
		Dimensions	D	W		H
45° Armless Lounge  	EN9211 · 45° inside angle seat · two units joined - 90° unit · linking bracket attached · casters not recommended · tilt-out power not available	Overall	29	26 ½	32	COM \$ 963 A \$ 993 B \$ 1,048 COL/C \$ 1,147 D \$ 1,274 E \$ 1,401 F \$ 1,536 G \$ 1,727 H \$ 1,929 I \$ 2,247 J \$ 2,629 L1 \$ 1,866 L2 \$ 2,094
		Seat	20 ½	23 ½	18	
		Upholstery		Shipping		
		COM Ydg	3 ¼	Ctn Wt	44	
		COL Sq Ft	65	Cu Ft	14	

Description	① Model	Specifications			List Price Per Grade	
		Dimensions	D	W		H
45° Armless Lounge  	EN9212 · 45° outside angle seat · two units joined - 90° unit · linking bracket attached · casters not recommended · tilt-out power not available	Overall	29	26 ½	32	COM \$ 963 A \$ 993 B \$ 1,048 COL/C \$ 1,147 D \$ 1,274 E \$ 1,401 F \$ 1,536 G \$ 1,727 H \$ 1,929 I \$ 2,247 J \$ 2,629 L1 \$ 1,866 L2 \$ 2,094
		Seat	20 ½	23 ½	18	
		Upholstery		Shipping		
		COM Ydg	3 ¼	Ctn Wt	44	
		COL Sq Ft	65	Cu Ft	14	

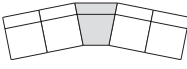
Description	① Model	Specifications			List Price Per Grade	
		Dimensions	D	W		H
22.5° Modular Armless Lounge  	EN9213 · 22.5° inside angle seat · linking bracket attached · casters not recommended · tilt-out power not available	Overall	29	26 ½	32	COM \$ 1,076 A \$ 1,105 B \$ 1,161 COL/C \$ 1,259 D \$ 1,386 E \$ 1,514 F \$ 1,648 G \$ 1,839 H \$ 2,042 I \$ 2,360 J \$ 2,741 L1 \$ 1,979 L2 \$ 2,207
		Seat	20 ½	23 ½	18	
		Upholstery		Shipping		
		COM Ydg	3 ¼	Ctn Wt	44	
		COL Sq Ft	65	Cu Ft	14	

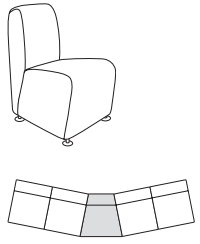
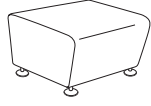
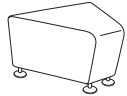
Description	① Model	Specifications				List Price Per Grade	
		Dimensions	D	W	H	COM	
22.5° Modular Armless Lounge 	EN9214 · 22.5° outside angle seat · linking bracket attached · casters not recommended · tilt-out power not available	Overall	29	26½	32	COM	\$ 1,076
		Seat	20½	23½	18	COL/C	\$ 1,259
		Upholstery		Shipping		D	\$ 1,386
		COM Ydg	3¼	Ctn Wt	44	E	\$ 1,514
		COL Sq Ft	65	Cu Ft	14	F	\$ 1,648
						G	\$ 1,839
						H	\$ 2,042
						I	\$ 2,360
						J	\$ 2,741
						L1	\$ 1,979
						L2	\$ 2,207
<hr/>							
Bench 	EN9710 · single seat · linking bracket attached · optional tilt-out power available; specify right or left (as seated in unit), see page 237 for more details · tilt-out power can be installed on either side of the unit, cannot be installed in the front or back. · can be used for straight connections/cannot make a 90° turn · optional casters available, specify when ordering · optional rotating tablet arm - see page 234; specify right (EN9230T-R) or left (EN9230T-L)	Overall	25½	23½	17	COM	\$ 685
		Seat	2	Ctn Wt	43	COL/C	\$ 798
		Upholstery		Shipping		D	\$ 877
		COM Ydg	2	Ctn Wt	43	E	\$ 955
		COL Sq Ft	40	Cu Ft	8	F	\$ 1,038
						G	\$ 1,154
						H	\$ 1,279
						I	\$ 1,476
						J	\$ 1,710
						L1	\$ 1,241
						L2	\$ 1,381
<hr/>							
45° Bench 	EN9711 · 45° angle single seat · linking bracket attached · two units joined - 90° unit · casters not available	Overall	25½	27	17	COM	\$ 658
		Seat	2	Ctn Wt	41	COL/C	\$ 771
		Upholstery		Shipping		D	\$ 850
		COM Ydg	2	Ctn Wt	41	E	\$ 928
		COL Sq Ft	40	Cu Ft	8	F	\$ 1,011
						G	\$ 1,127
						H	\$ 1,252
						I	\$ 1,448
						J	\$ 1,683
						L1	\$ 1,213
						L2	\$ 1,354

To Order, Specify:

- ① Model Number
- ② Fabric Selection - vendor, pattern and color
- ③ Leg Style - disk or column
- ④ Leg/Trim Color - Black Sandtex or Stardust Silver

② See a selection of graded in fabric manufacturers and patterns on pages 12-20. Contact Customer Service for additional fabric options.

Specifications

- Seat has 8½" high density polyurethane foam.
- Back has 7½" high density polyurethane foam.
- Plywood construction with spiral grooved solid wood dowels, glue and screws.
- Some assembly required.

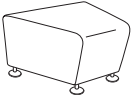
Description	① Model	Specifications			List Price Per Grade	
22° Bench 	EN9713 · 22.5° angle single seat · linking bracket attached · casters not available	Dimensions	D	W	H	COM \$ 735
		Overall	25 ½	26 ½	17	A \$ 753
		Upholstery	Shipping			B \$ 788
		COM Ydg	2	Ctn Wt	41	COL/C \$ 849
		COL Sq Ft	40	Cu Ft	8	D \$ 928
					E \$ 1,005	
					F \$ 1,088	
					G \$ 1,205	
					H \$ 1,330	
					I \$ 1,526	
					J \$ 1,760	
					L1 \$ 1,291	
					L2 \$ 1,432	

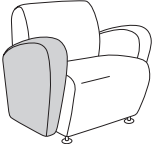
Description	① Model	Specifications			List Price Per Grade	
Modular Right End Arm (arm only) 	EN9220U-R · fully upholstered · for use on right end (as seated in unit) · linking bracket attached · optional tablet available, specify when ordering and add \$283 list	Dimensions	D	W	H	COM \$ 403
		Overall	23	6	25 ½	A \$ 417
		Upholstery	Shipping			B \$ 446
		COM Ydg	1 ⅝	Ctn Wt	15	COL/C \$ 495
		COL Sq Ft	33	Cu Ft	3	D \$ 558
					E \$ 622	
					F \$ 689	
					G \$ 785	
					H \$ 886	
					I \$ 1,045	
					J \$ 1,235	
					L1 \$ 854	
					L2 \$ 969	

Description	① Model	Specifications			List Price Per Grade	
Modular Left End Arm (arm only) 	EN9220U-L · fully upholstered · for use on left end (as seated in unit) · linking bracket attached · optional tablet available, specify when ordering and add \$283 list	Dimensions	D	W	H	COM \$ 403
		Overall	23	6	25 ½	A \$ 417
		Upholstery	Shipping			B \$ 446
		COM Ydg	1 ⅝	Ctn Wt	15	COL/C \$ 495
		COL Sq Ft	33	Cu Ft	3	D \$ 558
					E \$ 622	
					F \$ 689	
					G \$ 785	
					H \$ 886	
					I \$ 1,045	
					J \$ 1,235	
					L1 \$ 854	
					L2 \$ 969	

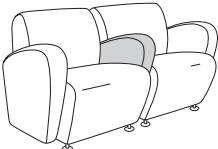
Description	① Model	Specifications			List Price Per Grade	
Modular Center Arm (arm only) 	EN9221U-C · fully upholstered · linking bracket attached	Dimensions	D	W	H	COM \$ 403
		Overall	23	6	25 ½	A \$ 417
		Upholstery	Shipping			B \$ 446
		COM Ydg	1 ⅝	Ctn Wt	15	COL/C \$ 495
		COL Sq Ft	33	Cu Ft	3	D \$ 558
					E \$ 622	
					F \$ 689	
					G \$ 785	
					H \$ 886	
					I \$ 1,045	
					J \$ 1,235	
					L1 \$ 854	
					L2 \$ 969	

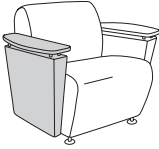
Description	Model	Specifications				List Price Per Grade	
		Dimensions	D	W	H	COM	
Modular Right End Arm (arm only) 	EN9220UW-R · upholstered/wood arm · for use on right end (as seated in unit) · linking bracket attached · specify metal spacer color - Black Sandtex or Stardust Silver	Overall	23	7	24½	COM	\$ 467
		Upholstery		Shipping			
		COM Ydg	1½	Ctn Wt	15	A	\$ 480
		COL Sq Ft	30	Cu Ft	3	B	\$ 507
						COL/C	\$ 552
						D	\$ 611
						E	\$ 669
						F	\$ 731
						G	\$ 819
						H	\$ 913
						I	\$ 1,060
						J	\$ 1,235
						L1	\$ 884
						L2	\$ 990

Description	Model	Specifications				List Price Per Grade	
		Dimensions	D	W	H	COM	
Modular Left End Arm (arm only) 	EN9220UW-L · upholstered/wood arm · for use on left end (as seated in unit) · linking bracket attached · specify metal spacer color - Black Sandtex or Stardust Silver	Overall	23	7	24½	COM	\$ 467
		Upholstery		Shipping			
		COM Ydg	1½	Ctn Wt	15	A	\$ 480
		COL Sq Ft	30	Cu Ft	3	B	\$ 507
						COL/C	\$ 552
						D	\$ 611
						E	\$ 669
						F	\$ 731
						G	\$ 819
						H	\$ 913
						I	\$ 1,060
						J	\$ 1,235
						L1	\$ 884
						L2	\$ 990

To Order, Specify:

- 1 Model Number
- 2 Wood Species - Maple (M)
- 3 Wood Finish/Color
- 4 Fabric Selection - vendor, pattern and color
- 5 Metal Color - Black Sandtex or Stardust Silver
- 6 Optional Coordinating Wood Grain Laminate
Surfaces - no upcharge; Finishes with an asterisk have a coordinating laminate available.

3 Wood Finish/Color Options:▲

ALE Ale*	FLX Flax
AUB Auburn*	HEN Henna*
AUT Autumn*	HNY Honey*
BRL Barley*	LGC Legacy*
BBN Bourbon*	MCH Mocha*
BRG Brighton*	NTO Night Owl*
BRW Brownie*	NUT Nut Brown*
BUT Butterscotch	PRL Praline*
CAN Canyon*	SAF Saffron*
CIN Cinnamon*	SIE Sienna*
CIT Citron*	TOF Toffee*
CLA Classic*	TRF Truffle*
DES Desert*	VEN Venetian*
EAR Earthy	
ESP Espresso	

Color - Add \$31 list per item

BKD Backdrop	GRV Creek Villa
BFX Black Fox	GLF Gulf Stream
BWH Bright White	HTB Heartthrob
CGP Cargo Pants	NET Network Gray
CHT Chatroom	NWH Nonchalant White
DSY Daisy	PAR Paradise
DRG Daring	QXP Quixotic Plum
DYN Dynamo	RBZ Relic Bronze
ENG Enigma	SND Sandbank
FRR French Roast	STM Storm
GBY Georgian Bay	TRC Tricorn Black

- 4 See a selection of graded in fabric manufacturers and patterns on pages 12-20. Contact Customer Service for additional fabric options.

Specifications

- Wood species - Maple.
- Upholstered bases have 4½" high density polyurethane foam.
- Plywood construction with spiral grooved solid wood dowels, glue and screws.
- Some assembly required.

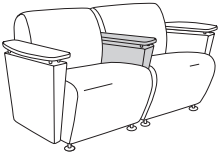

Description	① Model	Specifications				List Price Per Grade
		Dimensions	D	W	H	
Modular Center Arm (arm only) 	EN9221UW-C · upholstered/wood · linking bracket attached · specify metal spacer color - Black Sandtex or Stardust Silver	Overall	23	6	24½	COM \$ 467
		Upholstery		Shipping		A \$ 480
		COM Ydg	1½	Ctn Wt	15	B \$ 507
		COL Sq Ft	30	Cu Ft	3	COL/C \$ 552
						D \$ 611
				E \$ 669		
				F \$ 731		
				G \$ 819		
				H \$ 913		
				I \$ 1,060		
				J \$ 1,235		
				L1 \$ 884		
				L2 \$ 990		

LOUNGE

Description	D	W	H	CTN WT	CU FT	① Model	List Price
Tablet Arm (arm only)  <ul style="list-style-type: none"> · attaches to right end of lounge or bench unit while sitting · linking bracket attached · tablet features flat edge and 360° swivel · specify metal arm color - Black Sandtex or Stardust Silver 	13	13	24½	5	2	EN9230T-R	\$ 240

Tablet Arm (arm only)  <ul style="list-style-type: none"> · attaches to left end of lounge or bench unit while sitting · linking bracket attached · tablet features flat edge and 360° swivel · specify metal arm color - Black Sandtex or Stardust Silver 	13	13	24½	5	2	EN9230T-L	\$ 240
--	----	----	-----	---	---	------------------	--------

Modular End Arm (arm only)  <ul style="list-style-type: none"> · wood cap metal arm · for use on right or left end of unit while sitting · linking bracket attached · specify metal arm color - Black Sandtex or Stardust Silver 	23	7	24½	7	2	EN9220W	\$ 231
--	----	---	-----	---	---	----------------	--------

22.5° Linking Table  <ul style="list-style-type: none"> · 22.5° inside/outside · linking bracket attached · attaches between lounge or bench units · specify metal color - Black Sandtex or Stardust Silver 	23 ¼	16-26	17	15	3	EN22	\$ 628
--	------	-------	----	----	---	-------------	--------

Description	D	W	H	CTN WT	CU FT	① Model	List Price
45° Linking Table	22	6-25	17	15	3	EN45	\$ 621



- 45° inside/outside
- linking bracket attached
- attaches between lounge or bench units
- specify metal color - Black Sandtex or Stardust Silver

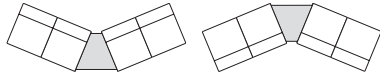

Square Linking Table	23½	25	17	20	2	EN90	\$ 643
-----------------------------	-----	----	----	----	---	-------------	---------------



- linking bracket attached
- attaches between lounge or bench units
- specify metal color - Black Sandtex or Stardust Silver

90° Corner Linking Table	25	46½	13½	25	4	EN90CT	\$ 807
---------------------------------	----	-----	-----	----	---	---------------	---------------

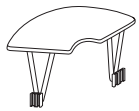

- 90° inside/outside
- linking bracket attached
- attaches between lounge or bench units
- specify metal color - Black Sandtex or Stardust Silver

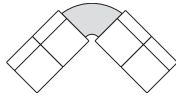

To Order, Specify:

- ① Model Number
- ② Wood Species - Maple (M)
- ③ Wood Finish/Color
- ④ Fabric Selection - vendor, pattern and color
- ⑤ Leg Style - disk or column
- ⑥ Leg/Trim Color - Black Sandtex or Stardust Silver
- ⑦ Metal Color - Black Sandtex or Stardust Silver
- ⑧ Optional Coordinating Wood Grain Laminate
Surfaces - no upcharge; Finishes with an asterisk have a coordinating laminate available.

③ Wood Finish/Color Options:▲

ALE Ale*	FLX Flax
AUB Auburn*	HEN Henna*
AUT Autumn*	HNY Honey*
BRL Barley*	LGC Legacy*
BBN Bourbon*	MCH Mocha*
BRG Brighton*	NTO Night Owl*
BRW Brownie*	NUT Nut Brown*
BUT Butterscotch	PRL Praline*
CAN Canyon*	SAF Saffron*
CIN Cinnamon*	SIE Sienna*
CIT Citron*	TOF Toffee*
CLA Classic*	TRF Truffle*
DES Desert*	VEN Venetian*
EAR Earthy	
ESP Espresso	



Color - Add \$31 list per item

BKD Backdrop	GRV Greek Villa
BFX Black Fox	GLF Gulf Stream
BWH Bright White	HTB Heartthrob
CGP Cargo Pants	NET Network Gray
CHT Chatroom	NWH Nonchalant White
DSY Daisy	PAR Paradise
DRG Daring	QXP Quixotic Plum
DYN Dynamo	RBZ Relic Bronze
ENG Enigma	SND Sandbank
FRR French Roast	STM Storm
GBY Georgian Bay	TRC Tricorn Black

- ④ See a selection of graded in fabric manufacturers and patterns on pages 12-20. Contact Customer Service for additional fabric options.

Specifications

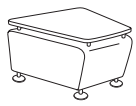
- Wood species - Maple.
- Upholstered bases have 4½" high density polyurethane foam.
- Plywood construction with spiral grooved solid wood dowels, glue and screws.
- Some assembly required.

Description	① Model	Specifications				List Price Per Grade									
22.5° Linking Table	EN22B	<table border="1"> <thead> <tr> <th data-bbox="747 195 909 226">Dimensions</th> <th data-bbox="909 195 990 226">D</th> <th data-bbox="990 195 1153 226">W</th> <th data-bbox="1153 195 1218 226">H</th> </tr> </thead> <tbody> <tr> <td data-bbox="747 237 909 268">Overall</td> <td data-bbox="909 237 990 268">27</td> <td data-bbox="990 237 1153 268">16 ½-26 ½</td> <td data-bbox="1153 237 1218 268">16</td> </tr> </tbody> </table>				Dimensions	D	W	H	Overall	27	16 ½-26 ½	16	COM \$ 807	
Dimensions	D	W	H												
Overall	27	16 ½-26 ½	16												
	<ul style="list-style-type: none"> · 22.5° upholstered linking table · linking bracket attached · attaches to lounge or bench units · metal spacers will match leg color 	<table border="1"> <thead> <tr> <th data-bbox="747 279 909 310">Upholstery</th> <th data-bbox="990 279 1218 310">Shipping</th> </tr> </thead> <tbody> <tr> <td data-bbox="747 321 909 352">COM Ydg</td> <td data-bbox="990 321 1218 352">1 ⅝</td> </tr> <tr> <td data-bbox="747 352 909 384">COL Sq Ft</td> <td data-bbox="990 352 1218 384">33</td> </tr> </tbody> </table>		Upholstery	Shipping	COM Ydg	1 ⅝	COL Sq Ft	33	<table border="1"> <thead> <tr> <th data-bbox="990 279 1153 310">Ctn Wt</th> <th data-bbox="1153 279 1218 310">Cu Ft</th> </tr> </thead> <tbody> <tr> <td data-bbox="990 321 1153 352">46</td> <td data-bbox="1153 321 1218 352">8</td> </tr> </tbody> </table>	Ctn Wt	Cu Ft	46	8	A \$ 822
		Upholstery	Shipping												
		COM Ydg	1 ⅝												
		COL Sq Ft	33												
Ctn Wt	Cu Ft														
46	8														
B \$ 850															
COL/C \$ 899															
D \$ 962															
E \$ 1,026															
F \$ 1,094															
G \$ 1,189															
H \$ 1,290															
I \$ 1,449															
J \$ 1,640															
L1 \$ 1,258															
L2 \$ 1,373															
45° Linking Table	EN45B	<table border="1"> <thead> <tr> <th data-bbox="747 657 909 688">Dimensions</th> <th data-bbox="909 657 990 688">D</th> <th data-bbox="990 657 1153 688">W</th> <th data-bbox="1153 657 1218 688">H</th> </tr> </thead> <tbody> <tr> <td data-bbox="747 699 909 730">Overall</td> <td data-bbox="909 699 990 730">25 ½</td> <td data-bbox="990 699 1153 730">10 ½-26 ½</td> <td data-bbox="1153 699 1218 730">16</td> </tr> </tbody> </table>				Dimensions	D	W	H	Overall	25 ½	10 ½-26 ½	16	COM \$ 784	
Dimensions	D	W	H												
Overall	25 ½	10 ½-26 ½	16												
	<ul style="list-style-type: none"> · 45° upholstered linking table · linking bracket attached · attaches to lounge or bench units · metal spacers will match leg color 	<table border="1"> <thead> <tr> <th data-bbox="747 741 909 772">Upholstery</th> <th data-bbox="990 741 1218 772">Shipping</th> </tr> </thead> <tbody> <tr> <td data-bbox="747 783 909 814">COM Ydg</td> <td data-bbox="990 783 1218 814">1 ⅝</td> </tr> <tr> <td data-bbox="747 814 909 846">COL Sq Ft</td> <td data-bbox="990 814 1218 846">33</td> </tr> </tbody> </table>		Upholstery	Shipping	COM Ydg	1 ⅝	COL Sq Ft	33	<table border="1"> <thead> <tr> <th data-bbox="990 741 1153 772">Ctn Wt</th> <th data-bbox="1153 741 1218 772">Cu Ft</th> </tr> </thead> <tbody> <tr> <td data-bbox="990 783 1153 814">46</td> <td data-bbox="1153 783 1218 814">8</td> </tr> </tbody> </table>	Ctn Wt	Cu Ft	46	8	A \$ 798
		Upholstery	Shipping												
		COM Ydg	1 ⅝												
		COL Sq Ft	33												
Ctn Wt	Cu Ft														
46	8														
B \$ 827															
COL/C \$ 876															
D \$ 939															
E \$ 1,003															
F \$ 1,070															
G \$ 1,166															
H \$ 1,267															
I \$ 1,426															
J \$ 1,616															
L1 \$ 1,235															
L2 \$ 1,350															
Linking Table	EN90B	<table border="1"> <thead> <tr> <th data-bbox="747 1119 909 1150">Dimensions</th> <th data-bbox="909 1119 990 1150">D</th> <th data-bbox="990 1119 1153 1150">W</th> <th data-bbox="1153 1119 1218 1150">H</th> </tr> </thead> <tbody> <tr> <td data-bbox="747 1161 909 1192">Overall</td> <td data-bbox="909 1161 990 1192">25 ½</td> <td data-bbox="990 1161 1153 1192">23 ½</td> <td data-bbox="1153 1161 1218 1192">16</td> </tr> </tbody> </table>				Dimensions	D	W	H	Overall	25 ½	23 ½	16	COM \$ 845	
Dimensions	D	W	H												
Overall	25 ½	23 ½	16												
	<ul style="list-style-type: none"> · upholstered square linking table · linking bracket attached · attaches to lounge or bench units · optional tilt-out power available; specify right or left (as seated in unit); see page 237 for details. · metal spacers will match leg color 	<table border="1"> <thead> <tr> <th data-bbox="747 1182 909 1213">Upholstery</th> <th data-bbox="990 1182 1218 1213">Shipping</th> </tr> </thead> <tbody> <tr> <td data-bbox="747 1224 909 1255">COM Ydg</td> <td data-bbox="990 1224 1218 1255">1 ⅝</td> </tr> <tr> <td data-bbox="747 1255 909 1287">COL Sq Ft</td> <td data-bbox="990 1255 1218 1287">33</td> </tr> </tbody> </table>		Upholstery	Shipping	COM Ydg	1 ⅝	COL Sq Ft	33	<table border="1"> <thead> <tr> <th data-bbox="990 1182 1153 1213">Ctn Wt</th> <th data-bbox="1153 1182 1218 1213">Cu Ft</th> </tr> </thead> <tbody> <tr> <td data-bbox="990 1224 1153 1255">46</td> <td data-bbox="1153 1224 1218 1255">8</td> </tr> </tbody> </table>	Ctn Wt	Cu Ft	46	8	A \$ 859
		Upholstery	Shipping												
		COM Ydg	1 ⅝												
		COL Sq Ft	33												
Ctn Wt	Cu Ft														
46	8														
B \$ 888															
COL/C \$ 937															
D \$ 1,000															
E \$ 1,064															
F \$ 1,131															
G \$ 1,227															
H \$ 1,328															
I \$ 1,487															
J \$ 1,677															
L1 \$ 1,296															
L2 \$ 1,411															

LOUNGE

Description	D	W	H	CTN WT	CU FT	① Model	List Price
Mini Power Tilt Out	4 ¼	5 ½		6		EC11	\$ 331



- fluid one touch tilt up access
- two power receptacles - 120 volt; 15 amp
- 72" power cord with molded plug
- drop in field installation required
- located in side panel of Encore Lounge or Bench units without arms (indicate right or left side panel as seated in the unit)
- UL listed component
- specify Black (B) or Silver (S) ▲

Mini Power and USB Tilt Up	4 ¼	5 ½		6	1	EC12	\$ 414
----------------------------	-----	-----	--	---	---	------	--------



- fluid one touch tilt up access
- one power receptacle - 120 volt; 15 amp dual powered USB
- 72" power cord with molded plug
- drop in field installation required
- located in side panel of Encore Lounge or Bench units without arms (indicate right or left side panel as seated in the unit)
- UL listed component
- specify Black (B) or Silver (S) ▲

To Order, Specify:

- ① Model Number
- ② Wood Species - Maple (M)
- ③ Wood Finish/Color
- ④ Fabric Selection - vendor, pattern and color
- ⑤ Leg Style - disk or column
- ⑥ Leg/Trim Color - Black Sandtex or Stardust Silver
- ⑦ Metal Color - Black Sandtex or Stardust Silver
- ⑧ Optional Coordinating Wood Grain Laminate
Surfaces - no upcharge; Finishes with an asterisk have a coordinating laminate available.

③ Wood Finish/Color Options: ▲

ALE Ale*	FLX Flax
AUB Auburn*	HEN Henna*
AUT Autumn*	HNY Honey*
BRL Barley*	LGC Legacy*
BBN Bourbon*	MCH Mocha*
BRG Brighton*	NTO Night Owl*
BRW Brownie*	NUT Nut Brown*
BUT Butterscotch	PRL Praline*
CAN Canyon*	SAF Saffron*
CIN Cinnamon*	SIE Sienna*
CIT Citron*	TOF Toffee*
CLA Classic*	TRF Truffle*
DES Desert*	VEN Venetian*
EAR Earthy	
ESP Espresso	

Color - Add \$31 list per item

BKD Backdrop	GRV Greek Villa
BFX Black Fox	GLF Gulf Stream
BWH Bright White	HTB Heartthrob
CGP Cargo Pants	NET Network Gray
CHT Chatroom	NWH Nonchalant White
DSY Daisy	PAR Paradise
DRG Daring	QXP Quixotic Plum
DYN Dynamo	RBZ Relic Bronze
ENG Enigma	SND Sandbank
FRR French Roast	STM Storm
GBY Georgian Bay	TRC Tricorn Black

- ④ See a selection of graded in fabric manufacturers and patterns on pages 12-20. Contact Customer Service for additional fabric options.

Specifications

- Wood species - Maple.
- Upholstered bases have 4 ½" high density polyurethane foam.
- Plywood construction with spiral grooved solid wood dowels, glue and screws.
- Some assembly required.

Esque Lounge Order Check List:



Specify:

- 1. Model Number
- 2. Wood Species - Maple (M)
- 3. Wood Finish/Color
- 4. Fabric Selection - vendor, pattern and color

Example:

ES1331
(model #)

M
(wood species)

AUB
(finish)

MOMENTUM
(fabric vendor)

VOX
(pattern name)

MYSTIC
(pattern color)

1. Model Number

2. Wood Species - Maple (M)

3. Wood Finish/Color Options: ▲

ALE Ale	FLX Flax
AUB Auburn	HEN Henna
AUT Autumn	HNY Honey
BRL Barley	LGC Legacy
BBN Bourbon	MCH Mocha
BRG Brighton	NTO Night Owl
BRW Brownie	NUT Nut Brown
BUT Butterscotch	PRL Praline
CAN Canyon	SAF Saffron
CIN Cinnamon	SIE Sienna
CIT Citron	TOF Toffee
CLA Classic	TRF Truffle
DES Desert	VEN Venetian
EAR Earthy	
ESP Espresso	
Color - Add \$31 list per item	
BKD Backdrop	GRV Greek Villa
BFX Black Fox	GLF Gulf Stream
BWH Bright White	HTB Heartthrob
CGP Cargo Pants	NET Network Gray
CHT Chatroom	NWH Nonchalant White
DSY Daisy	PAR Paradise
DRG Daring	QXP Quixotic Plum
DYN Dynamo	RBZ Relic Bronze
ENG Enigma	SND Sandbank
FRR French Roast	STM Storm
GBY Georgian Bay	TRC Tricorn Black

4. Fabric Selection - Please supply the following:

- Fabric vendor
- Pattern name
- Pattern color

When specifying contrasting upholstery, indicate clearly which upholstery is to be applied to the seat, back and arms. Use higher grade pricing.

- Indicate direction of fabric - Railroaded or Up the Roll
- Please provide illustration, if available

All COM orders must include the following:

- Vendor's name, pattern name and color
- Sample of the fabric attached to order
- Model numbers of items for fabric application
- Special application instructions (e.g., all stripes will be applied front to back unless specified otherwise)
- Customer and purchase order number

Ship prepaid COM material to:
Community
Attn: COM Dept
932 Mill Street
Jasper, IN 47546

Application of fabric:
Railroaded Up the Roll

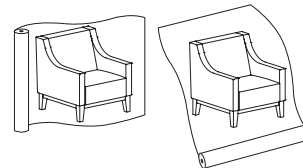

All COM orders will ship at standard lead time from receipt of COM except for orders requiring special custom matched finishes.

LOUNGE

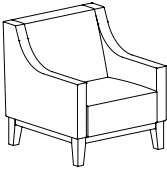
Description	Model	Specifications			List Price Per Grade		
		Dimensions	D	W	H	COM	
	ES1331	Overall	32	31 ¼	34 ¼	A	\$ 2,271
		Seat	21 ½	24	17 ½	B	\$ 2,368
		Arm			24	COL/C	\$ 2,539
		Upholstery		Shipping		D	\$ 2,806
		COM Ydg	5	Ctn Wt	89	E	\$ 2,979
		COL Sq Ft	115	Cu Ft	23	F	\$ 3,321
						G	\$ 3,687
						H	\$ 4,079
						I	\$ 4,690
						J	\$ 5,423
				L1	\$ 3,956		
				L2	\$ 4,445		

LOUNGE

To Order, Specify:

- 1 Model Number
- 2 Wood Species - Maple (M)
- 3 Wood Finish/Color
- 4 Fabric Selection - vendor, pattern and color

3 Wood Finish/Color Options: ▲

ALE Ale	FLX Flax
AUB Auburn	HEN Henna
AUT Autumn	HNY Honey
BRL Barley	LGC Legacy
BBN Bourbon	MCH Mocha
BRG Brighton	NTO Night Owl
BRW Brownie	NUT Nut Brown
BUT Butterscotch	PRL Praline
CAN Canyon	SAF Saffron
CIN Cinnamon	SIE Sienna
CIT Citron	TOF Toffee
CLA Classic	TRF Truffle
DES Desert	VEN Venetian
EAR Earthy	
ESP Espresso	

Color - Add \$31 list per item

BKD Backdrop	GRV Greek Villa
BFX Black Fox	GLF Gulf Stream
BWH Bright White	HTB Heartthrob
CGP Cargo Pants	NET Network Gray
CHT Chatroom	NWH Nonchalant White
DSY Daisy	PAR Paradise
DRG Daring	QXP Quixotic Plum
DYN Dynamo	RBZ Relic Bronze
ENG Enigma	SND Sandbank
FRR French Roast	STM Storm
GBY Georgian Bay	TRC Tricorn Black

Specifications

- Base wood species - Maple.
- Frame interior is upholstery grade plywood with glued solid hardwood cross members reinforced with corner blocks.
- Seat has sinuous steel springs with high resiliency seat polyurethane foam with Dacron® wrap.
- Back has sinuous steel springs and polyurethane foam with dacron wrap.

4 See a selection of graded in fabric manufacturers and patterns on pages 12-20. Contact Customer Service for additional fabric options.

Regal Lounge Order Check List:



Specify:

- 1. Model Number
- 2. Wood Species - Maple (M)
- 3. Wood Finish/Color
- 4. Fabric Selection - vendor, pattern and color
- 5. Optional Rubber Cushion Nylon Glides - no upcharge

Example:

RG8201 <small>(model #)</small>	M <small>(wood species)</small>	AUB <small>(finish)</small>	MOMENTUM <small>(fabric vendor)</small>	VOX <small>(pattern name)</small>	MYSTIC <small>(pattern color)</small>
------------------------------------	------------------------------------	--------------------------------	--	--------------------------------------	--

LOUNGE

1. Model Number

2. Wood Species - Maple (M)

3. Wood Finish/Color Options: ▲

ALE Ale	FLX Flax
AUB Auburn	HEN Henna
AUT Autumn	HNY Honey
BRL Barley	LGC Legacy
BBN Bourbon	MCH Mocha
BRG Brighton	NTO Night Owl
BRW Brownie	NUT Nut Brown
BUT Butterscotch	PRL Praline
CAN Canyon	SAF Saffron
CIN Cinnamon	SIE Sienna
CIT Citron	TOF Toffee
CLA Classic	TRF Truffle
DES Desert	VEN Venetian
EAR Earthy	
ESP Espresso	
Color - Add \$31 list per item	
BKD Backdrop	GRV Greek Villa
BFX Black Fox	GLF Gulf Stream
BWH Bright White	HTB Heartthrob
CGP Cargo Pants	NET Network Gray
CHT Chatroom	NWH Nonchalant White
DSY Daisy	PAR Paradise
DRG Daring	QXP Quixotic Plum
DYN Dynamo	RBZ Relic Bronze
ENG Enigma	SND Sandbank
FRR French Roast	STM Storm
GBY Georgian Bay	TRC Tricorn Black

4. Fabric Selection - Please supply the following:

- Fabric vendor
- Pattern name
- Pattern color

When specifying contrasting upholstery, indicate clearly which upholstery is to be applied to the seat, back and arms. Use higher grade pricing.

- Indicate direction of fabric - Railroaded or Up the Roll
- Please provide illustration, if available

All COM orders must include the following:

- Vendor's name, pattern name and color
- Sample of the fabric attached to order
- Model numbers of items for fabric application
- Special application instructions (e.g., all stripes will be applied front to back unless specified otherwise)
- Customer and purchase order number

Ship prepaid COM material to:
Community
Attn: COM Dept
932 Mill Street
Jasper, IN 47546

Application of fabric:
Railroaded Up the Roll

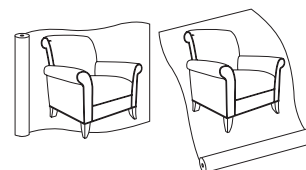

All COM orders will ship at standard lead time from receipt of COM except for orders requiring special custom matched finishes.

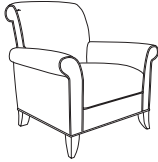
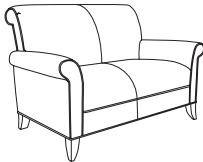
Description	Model	Specifications				List Price Per Grade
Single Seat 	RG8201	Dimensions	D	W	H	COM \$ 1,773
		Overall	36 ½	36	38	A \$ 1,857
		Seat	20 ½	21 ½	19	B \$ 1,969
		Arm			25	COL/C \$ 2,168
		Upholstery	Shipping			D \$ 2,422
		COM Ydg	6 ½	Ctn Wt	68	E \$ 2,676
		COL Sq Ft	143	Cu Ft	32	F \$ 2,944
						G \$ 3,325
						H \$ 3,731
						I \$ 4,366
				J \$ 5,129		
				L1 \$ 3,910		
				L2 \$ 4,443		
Two Seat 	RG8202	Dimensions	D	W	H	COM \$ 2,331
		Overall	36 ½	56	38	A \$ 2,448
		Seat	20 ½	41 ½	19	B \$ 2,609
		Arm			25	COL/C \$ 2,890
		Upholstery	Shipping			D \$ 3,251
		COM Ydg	9 ¼	Ctn Wt	100	E \$ 3,612
		COL Sq Ft	204	Cu Ft	50	F \$ 3,995
						G \$ 4,536
						H \$ 5,115
						I \$ 6,019
				J \$ 7,105		
				L1 \$ 5,369		
				L2 \$ 6,127		

LOUNGE

To Order, Specify:

- ① Model Number
- ② Wood Species - Maple (M)
- ③ Wood Finish/Color
- ④ Fabric Selection - vendor, pattern and color
- ⑤ Optional Rubber Cushion Nylon Glides - no upcharge

③ Wood Finish/Color Options: ▲

ALE Ale	FLX Flax
AUB Auburn	HEN Henna
AUT Autumn	HNY Honey
BRL Barley	LGC Legacy
BBN Bourbon	MCH Mocha
BRG Brighton	NTO Night Owl
BRW Brownie	NUT Nut Brown
BUT Butterscotch	PRL Praline
CAN Canyon	SAF Saffron
CIN Cinnamon	SIE Sienna
CIT Citron	TOF Toffee
CLA Classic	TRF Truffle
DES Desert	VEN Venetian
EAR Earthy	
ESP Espresso	

Color - Add \$31 list per item

BKD Backdrop	GRV Greek Villa
BFX Black Fox	GLF Gulf Stream
BWH Bright White	HTB Heartthrob
CGP Cargo Pants	NET Network Gray
CHT Chatroom	NWH Nonchalant White
DSY Daisy	PAR Paradise
DRG Daring	QXP Quixotic Plum
DYN Dynamo	RBZ Relic Bronze
ENG Enigma	SND Sandbank
FRR French Roast	STM Storm
GBY Georgian Bay	TRC Tricorn Black

- ④ See a selection of graded in fabric manufacturers and patterns on pages 12-20. Contact Customer Service for additional fabric options.

Specifications

- Wood species - Maple.
- 7/8" thick furniture-grade plywood with mortise and tenon joinery, glue and screws.
- Seats and backs have synthetic sheet webbing suspension.
- Seats have 5 1/2" and backs 3" high density polyurethane foam wrapped in Dacron® wrap and synthetic sheet webbing with cross strap reinforcement.
- Arms have 2" high density polyurethane foam on the top and sides.
- Standard with rubber cushion metal glides.

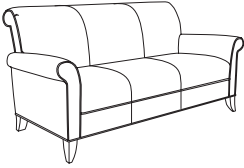
Description	① Model	Specifications				List Price Per Grade	
	RG8203	Dimensions		D	W	H	COM \$ 2,832
		Overall	36 ½	76	38	A \$ 2,969	
		Seat	20 ½	61 ½	19	B \$ 3,156	
		Arm			25	COL/C \$ 3,482	
		Upholstery		Shipping		D \$ 3,903	
		COM Ydg	10 ¾	Ctn Wt	127	E \$ 4,323	
		COL Sq Ft	237	Cu Ft	70	F \$ 4,766	
						G \$ 5,397	
						H \$ 6,069	
						I \$ 7,121	
				J \$ 8,381			
				L1 \$ 6,363			
				L2 \$ 7,245			

Description	① Model	Specifications				List Price Per Grade	
	RG8204 · packaged 2/box	Dimensions		D	W	H	COM \$ 816
		Overall	18 ½	21 ½	17	A \$ 851	
		Upholstery		Shipping		B \$ 894	
		COM Ydg	2 ½	Ctn Wt	49	COL/C \$ 971	
		COL Sq Ft	50	Cu Ft	28	D \$ 1,068	
						E \$ 1,166	
						F \$ 1,269	
						G \$ 1,416	
						H \$ 1,572	
						I \$ 1,816	
				J \$ 2,110			
				L1 \$ 1,523			
				L2 \$ 1,699			

Description	① Model	Specifications				List Price Per Grade	
	RG8291	Dimensions		D	W	H	COM \$ 1,106
		Overall	25 ½	20 ½	17 ¾	A \$ 1,141	
		Upholstery		Shipping		B \$ 1,175	
		COM Ydg	2	Ctn Wt	41	COL/C \$ 1,236	
		COL Sq Ft	40	Cu Ft	30	D \$ 1,314	
						E \$ 1,393	
						F \$ 1,475	
						G \$ 1,592	
						H \$ 1,717	
						I \$ 1,913	
				J \$ 2,148			
				L1 \$ 1,678			
				L2 \$ 1,819			

Description	① Model	Specifications				List Price Per Grade	
	RG8292	Dimensions		D	W	H	COM \$ 1,502
		Overall	25 ½	40 ½	16 ½	A \$ 1,549	
		Upholstery		Shipping		B \$ 1,596	
		COM Ydg	2 ¾	Ctn Wt	76	COL/C \$ 1,680	
		COL Sq Ft	55	Cu Ft	46	D \$ 1,788	
						E \$ 1,896	
						F \$ 2,009	
						G \$ 2,170	
						H \$ 2,342	
						I \$ 2,611	
				J \$ 2,933			
				L1 \$ 2,288			
				L2 \$ 2,482			

LOUNGE

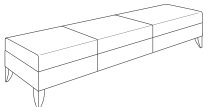
Description	Model	Specifications			List Price Per Grade		
		Dimensions	D	W	H	COM	
Three Seat Bench 	RG8293	Overall	25 1/2	60 1/2	17 3/4	A	\$ 1,817
		Upholstery		Shipping		B	\$ 1,886
		COM Ydg	4 3/4	Ctn Wt	116	COL/C	\$ 2,113
		COL Sq Ft	95	Cu Ft	62	D	\$ 2,299
						E	\$ 2,485
						F	\$ 2,680
						G	\$ 2,959
						H	\$ 3,257
						I	\$ 3,721
						J	\$ 4,277
						L1	\$ 3,163
						L2	\$ 3,497

LOUNGE

To Order, Specify:

- 1 Model Number
- 2 Wood Species - Maple (M)
- 3 Wood Finish/Color
- 4 Fabric Selection - vendor, pattern and color
- 5 Optional Rubber Cushion Nylon Glides - no upcharge

3 Wood Finish/Color Options: ▲

ALE Ale	FLX Flax
AUB Auburn	HEN Henna
AUT Autumn	HNY Honey
BRL Barley	LGC Legacy
BBN Bourbon	MCH Mocha
BRG Brighton	NTO Night Owl
BRW Brownie	NUT Nut Brown
BUT Butterscotch	PRL Praline
CAN Canyon	SAF Saffron
CIN Cinnamon	SIE Sienna
CIT Citron	TOF Toffee
CLA Classic	TRF Truffle
DES Desert	VEN Venetian
EAR Earthy	
ESP Espresso	

Color - Add \$31 list per item

BKD Backdrop	GRV Greek Villa
BFX Black Fox	GLF Gulf Stream
BWH Bright White	HTB Heartthrob
CGP Cargo Pants	NET Network Gray
CHT Chatroom	NWH Nonchalant White
DSY Daisy	PAR Paradise
DRG Daring	QXP Quixotic Plum
DYN Dynamo	RBZ Relic Bronze
ENG Enigma	SND Sandbank
FRR French Roast	STM Storm
GBY Georgian Bay	TRC Tricorn Black

4 See a selection of graded in fabric manufacturers and patterns on pages 12-20. Contact Customer Service for additional fabric options.

Specifications

- Wood species - Maple.
- 7/8" thick furniture-grade plywood with mortise and tenon joinery, glue and screws.
- Seats and backs have synthetic sheet webbing suspension.
- Seats have 5 1/2" and backs 3" high density polyurethane foam wrapped in Dacron® wrap and synthetic sheet webbing with cross strap reinforcement.
- Arms have 2" high density polyurethane foam on the top and sides.
- Standard with rubber cushion metal glides.

Richmond Lounge Order Check List:



Specify:

- 1. Model Number
- 2. Wood Species - Maple (M)
- 3. Wood Finish/Color
- 4. Fabric Selection - vendor, pattern and color
- 5. Optional Rubber Cushion Nylon Glides - no upcharge

Example:

R17342U (model #)	M (wood species)	AUB (finish)	MOMENTUM (fabric vendor)	VOX (pattern name)	MYSTIC (pattern color)
-----------------------------	----------------------------	------------------------	------------------------------------	------------------------------	----------------------------------

1. Model Number

2. Wood Species - Maple (M)

3. Wood Finish/Color Options: ▲

ALE Ale	FLX Flax
AUB Auburn	HEN Henna
AUT Autumn	HNY Honey
BRL Barley	LGC Legacy
BBN Bourbon	MCH Mocha
BRG Brighton	NTO Night Owl
BRW Brownie	NUT Nut Brown
BUT Butterscotch	PRL Praline
CAN Canyon	SAF Saffron
CIN Cinnamon	SIE Sienna
CIT Citron	TOF Toffee
CLA Classic	TRF Truffle
DES Desert	VEN Venetian
EAR Earthy	
ESP Espresso	

Color - Add \$31 list per item

BKD Backdrop	GRV Greek Villa
BFX Black Fox	GLF Gulf Stream
BWH Bright White	HTB Heartthrob
CGP Cargo Pants	NET Network Gray
CHT Chatroom	NWH Nonchalant White
DSY Daisy	PAR Paradise
DRG Daring	QXP Quixotic Plum
DYN Dynamo	RBZ Relic Bronze
ENG Enigma	SND Sandbank
FRR French Roast	STM Storm
GBY Georgian Bay	TRC Tricorn Black

4. Fabric Selection - Please supply the following:

- Fabric vendor
- Pattern name
- Pattern color

When specifying contrasting upholstery, indicate clearly which upholstery is to be applied to the seat, back and arms. Use higher grade pricing.

- Indicate direction of fabric - Railroaded or Up the Roll
- Please provide illustration, if available

All COM orders must include the following:

- Vendor's name, pattern name and color
- Sample of the fabric attached to order
- Model numbers of items for fabric application
- Special application instructions (e.g., all stripes will be applied front to back unless specified otherwise)
- Customer and purchase order number

Ship prepaid COM material to:
 Community
 Attn: COM Dept
 932 Mill Street
 Jasper, IN 47546

Application of fabric:
 Railroaded Up the Roll

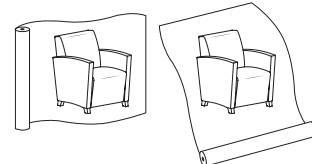

All COM orders will ship at standard lead time from receipt of COM except for orders requiring special custom matched finishes.

Description	① Model	Specifications			List Price Per Grade	
	RI7341U	Dimensions	D	W	H	COM \$ 1,221
		Overall	30 ½	26	34	A \$ 1,284
		Seat	19 ½	21	18	B \$ 1,372
		Arm			26	COL/C \$ 1,525
		Upholstery		Shipping		D \$ 1,724
		COM Ydg	4 ½	Ctn Wt	59	E \$ 1,921
		COL Sq Ft	99	Cu Ft	18	F \$ 2,230
						G \$ 2,559
						H \$ 2,911
						I \$ 3,460
				J \$ 4,121		
				L1 \$ 3,064		
				L2 \$ 3,526		

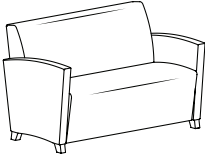
Description	① Model	Specifications			List Price Per Grade	
	RI7342U	Dimensions	D	W	H	COM \$ 1,680
		Overall	30 ½	53	34	A \$ 1,773
		Seat	19 ½	48	18	B \$ 1,904
		Arm			26	COL/C \$ 2,135
		Upholstery		Shipping		D \$ 2,432
		COM Ydg	6 ¾	Ctn Wt	89	E \$ 2,729
		COL Sq Ft	149	Cu Ft	36	F \$ 3,190
						G \$ 3,686
						H \$ 4,213
						I \$ 5,038
				J \$ 6,027		
				L1 \$ 4,444		
				L2 \$ 5,136		

LOUNGE

To Order, Specify:

- ① Model Number
- ② Wood Species - Maple (M)
- ③ Wood Finish/Color
- ④ Fabric Selection - vendor, pattern and color
- ⑤ Optional Rubber Cushion Nylon Glides - no upcharge

③ Wood Finish/Color Options: ▲

ALE Ale	FLX Flax
AUB Auburn	HEN Henna
AUT Autumn	HNY Honey
BRL Barley	LGC Legacy
BBN Bourbon	MCH Mocha
BRG Brighton	NTO Night Owl
BRW Brownie	NUT Nut Brown
BUT Butterscotch	PRL Praline
CAN Canyon	SAF Saffron
CIN Cinnamon	SIE Sienna
CIT Citron	TOF Toffee
CLA Classic	TRF Truffle
DES Desert	VEN Venetian
EAR Earthy	
ESP Espresso	

Color - Add \$31 list per item

BKD Backdrop	GRV Greek Villa
BFX Black Fox	GLF Gulf Stream
BWH Bright White	HTB Heartthrob
CGP Cargo Pants	NET Network Gray
CHT Chatroom	NWH Nonchalant White
DSY Daisy	PAR Paradise
DRG Daring	QXP Quixotic Plum
DYN Dynamo	RBZ Relic Bronze
ENG Enigma	SND Sandbank
FRR French Roast	STM Storm
GBY Georgian Bay	TRC Tricorn Black

Specifications

- Wood species - Maple.
- Small footprint with generous seat area.
- Seat has synthetic sheet webbing and 4 ½" high density polyurethane foam for durability and comfort.
- Back has strap webbing and 1 ½" polyurethane foam for durability and comfort.
- Solid Maple legs are field replaceable.

④ See a selection of graded in fabric manufacturers and patterns on pages 12-20. Contact Customer Service for additional fabric options.

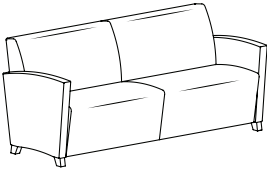
Description	① Model	Specifications			List Price Per Grade		
		Dimensions	D	W	H	COM	\$
Three Seat	RI7343U	Overall	30 ½	76 ½	34	A	\$ 2,285
		Seat	19 ½	71 ½	18	B	\$ 2,481
		Arm			26	COL/C	\$ 2,823
		Upholstery		Shipping		D	\$ 3,263
		COM Ydg	10	Ctn Wt	119	E	\$ 3,702
		COL Sq Ft	220	Cu Ft	52	F	\$ 4,386
						G	\$ 5,119
						H	\$ 5,901
						I	\$ 7,123
						J	\$ 8,588
						L1	\$ 6,243
						L2	\$ 7,269

LOUNGE

To Order, Specify:

- ① Model Number
- ② Wood Species - Maple (M)
- ③ Wood Finish/Color
- ④ Fabric Selection - vendor, pattern and color
- ⑤ Optional Rubber Cushion Nylon Glides - no upcharge

③ Wood Finish/Color Options:

ALE Ale	FLX Flax
AUB Auburn	HEN Henna
AUT Autumn	HNY Honey
BRL Barley	LGC Legacy
BBN Bourbon	MCH Mocha
BRG Brighton	NTO Night Owl
BRW Brownie	NUT Nut Brown
BUT Butterscotch	PRL Praline
CAN Canyon	SAF Saffron
CIN Cinnamon	SIE Sienna
CIT Citron	TOF Toffee
CLA Classic	TRF Truffle
DES Desert	VEN Venetian
EAR Earthy	
ESP Espresso	

Color - Add \$31 list per item

BKD Backdrop	GRV Greek Villa
BFX Black Fox	GLF Gulf Stream
BWH Bright White	HTB Heartthrob
CGP Cargo Pants	NET Network Gray
CHT Chatroom	NWH Nonchalant White
DSY Daisy	PAR Paradise
DRG Daring	QXP Quixotic Plum
DYN Dynamo	RBZ Relic Bronze
ENG Enigma	SND Sandbank
FRR French Roast	STM Storm
GBY Georgian Bay	TRC Tricorn Black

④ See a selection of graded in fabric manufacturers and patterns on pages 12-20. Contact Customer Service for additional fabric options.

Specifications

- Wood species - Maple.
- Small footprint with generous seat area.
- Seat has synthetic sheet webbing and 4 ½" high density polyurethane foam for durability and comfort.
- Back has strap webbing and 1 ½" polyurethane foam for durability and comfort.
- Solid Maple legs are field replaceable.

NOTES

Multi-Purpose Tables Overview



Jefferson Tables 250



Lincoln Tables 253



Menu Tables and Bases 256



Fresco Bases 263



Prep Tables and Bases 266



Stockton Tables 284

Edges

Lincoln
Overlay tops with
internal band edges



Jefferson
Inset tops with
external band edges



Power & Data

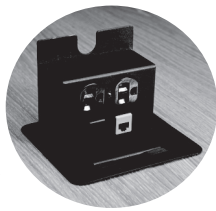

- CPS5 - Compact Power Source,**
\$311 list
- Black Sandtex powder coat finish
 - U/L listed and CSA approved
 - Easy lift hinge cover
 - When not in use, cover is lowered to flush table top position
 - Includes: (1) RJ-11 voice, (1) RJ-45 CAT6 data jack, (2) 110 electrical outlets and 6' molded plug cord
 - Size: 5 3/4" w x 5 3/8" d
 - Centered top installation included
 - Drawing required for alternate location

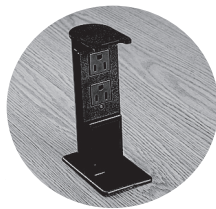

- PS110 - Retractable Power Source**
\$272 list
- Black plastic
 - U/L listed and CSA approved
 - Includes: (2) 110 electrical outlets and (1) voice and data face plate
 - Centered top installation included
 - Drawing required for alternate location



- GR3 - Grommet**
\$81 list
- Matte black textured plastic
 - Removable cap
 - 3" overall dimension
 - 2 1/4" inside dimension
 - Centered table top installation included
 - Drawing required for alternate location

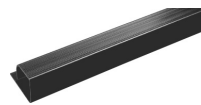

- Wire Management Channel**
- | | |
|--------------------|-----------|
| 12WC (12" channel) | \$39 list |
| 24WC (24" channel) | \$49 list |
| 36WC (36" channel) | \$55 list |

- Matte black textured plastic
- Adhesive back for easy installation
- Field installation required



- Wire Management Trough**
- | | |
|-------|-----------|
| 12WCT | \$75 list |
| 24WCT | \$89 list |
| 36WCT | \$98 list |

- Matte black textured plastic
- Adhesive back for easy installation
- Field installation required

Standard Laminate List

Community's standard wood grain matches - no upcharge.

<u>STANDARD FINISH</u>	<u>SUPPLIER LAMINATE #</u>	<u>FINISH</u>	<u>NAME</u>	<u>SUPPLIER</u>	
Cherry					
AUT	Autumn	10826K-07	Furniture	Collectors Cherry	Wilsonart
BRL	Barley	W-415-FP	French Polish	Chocolate Hazelnutwood	Arborite
BBN	Bourbon	XM044 Stevens 541 Color (X)	Furniture	JSI Natural Cherry	Formica
BRG	Brighton	7922K-07	Furniture	Brighton Walnut	Wilsonart
CLA	Classic	7759-43	Artisan	Select Cherry	Formica
LGC	Legacy	7935K-07	Furniture	Shaker Cherry	Wilsonart
PRL	Praline	7933K-07	Furniture	Cafelle	Wilsonart
SAF	Saffron	7924K-07	Furniture	Biltmore Cherry	Wilsonart
Maple					
ALE	Ale	10776-60	Suede	Kensington Maple	Wilsonart
CIN	Cinnamon	7922K-07	Furniture	Brighton Walnut	Wilsonart
VEN	Venetian	WY351-N	Suede	Jewel Mahogany	Pionite
Oak					
BRW	Brownie	WY351-N	Suede	Jewel Mahogany	Pionite
CAN	Canyon	WY351-N	Suede	Jewel Mahogany	Pionite
CIT	Citron	7816-60	Matte	Solar Oak	Wilsonart
DES	Desert	WT741-N	Suede	Taj Teak	Pionite
ECU	Ecru	7816-60	Matte	Solar Oak	Wilsonart
HEN	Henna	10826K-07	Gloss	Collectors Cherry	Wilsonart
HNY	Honey	7209-60	Matte	Nepal Teak	Wilsonart
NUT	Nut Brown	WW4935N	Hi-Luster	Castle Walnut	Nevamar
Walnut					
AUB	Auburn	7122K-07	Furniture	Empire Mahogany	Wilsonart
MCH	Mocha	W-415-FP	French Polish	Chocolate Hazelnut Wood	Arborite
NTO	Night Owl	7933K-07	Furniture	Cafelle	Wilsonart
SIE	Sienna	7922K-07	Furniture	Brighton Walnut	Wilsonart
TOF	Toffee	7936K-07	Furniture	Williamsburg Cherry	Wilsonart
TRF	Truffle	W-444-FP	French Polish	Chocolate Pear Tree	Arborite
Solids					
BWH	Bright White	D354-60	Matte	Designer White	Wilsonart
TRC	Tricorn Black	1595-60	Matte	Black	Wilsonart

Additional laminate options:

When ordering from our Jefferson, Lincoln, Encore, Laurel or Callaway table series:

- Orders of 3 tables or LESS will incur a \$142 upcharge on any laminate selection except the Community laminates listed above.
- Orders of 4 tables or GREATER will not incur any additional charges when ordering a standard pattern from Formica, Pionite or Formica. Contact Customer Services for availability.

Additional charges apply to premium and specialty laminate. Please contact Customer Service for pricing.

Jefferson Tables Order Check List:



Top core material is 1 1/8" thick with 45 lb. density industrial grade particle board. The face is wood veneer or horizontal grade high pressure laminate (HPL). A backer is bonded to bottom side to ensure balanced construction. All tops have mitered corner external solid lumber bands with inset laminate or veneer.

Specify:

- 1. Model Number
- 2. Top Material - Veneer (W) or Laminate (L)
- 3. Wood Species - Cherry (CH1), Maple (MA1), Oak (OK1) or Walnut (WA1) ▲
- 4. Wood Finish/Color
- 5. Edge profile
- 6. Leg Style - Straight Wood (S), Tapered Wood (T) or Metal (M); add \$320 list for 4 metal legs or \$399 list for 5 metal legs ▲
- 7. Wood Leg Attachment
 - A. Corner Block with 3" high straight apron (CBSA)
 - B. Corner Block with 3" high arched apron (CBAA)
 - C. Plate and Barrel Nut with 1" high straight apron (PBSA)
- 8. Optional Metal Leg Wire Management
 - A. Wire management in one leg, \$15 list upcharge (1)
 - B. Wire management in two legs, \$30 list upcharge (2)
- 9. Optional Premium or Specialty Laminate Tops Available - contact customer service for pricing.

Example:

JE4848-29 (model #)	W (top material)	OK1 (wood species)	HEN (finish)	N (edge)	S (leg style)	CBAA (wood leg attachment)
------------------------	---------------------	-----------------------	-----------------	-------------	------------------	-------------------------------

1. Model Number

2. Top Material - Veneer (W) or Laminate (L) - Finishes below with an asterisk (*) have a coordinating laminate available.

3. Wood Species - Cherry (CH1), Maple (MA1), Oak (OK1) or Walnut (WA1) ▲

4. Wood Finish/Color Options:

Cherry

- | | |
|---------------|--------------|
| AUT Autumn* | EAR Earthy |
| BRL Barley* | LGC Legacy* |
| BBN Bourbon* | PRL Praline* |
| BRG Brighton* | SAF Saffron* |
| CLA Classic* | |

Maple

- ALE Ale*
- BUT Butterscotch
- CIN Cinnamon*
- FLX Flax
- VEN Venetian*

Oak

- | | |
|--------------|----------------|
| BRW Brownie* | ECU Ecru* |
| CAN Canyon* | HEN Henna* |
| CIT Citron* | HNY Honey* |
| DES Desert* | NUT Nut Brown* |

Walnut

- | | |
|----------------|--------------|
| AUB Auburn* | SIE Sienna* |
| ESP Espresso | TOF Toffee* |
| MCH Mocha* | TRF Truffle* |
| NTO Night Owl* | |

Color - Add \$31 list per item

- | | |
|------------------|----------------------|
| BKD Backdrop | GRV Greek Villa |
| BFX Black Fox | GLF Gulf Stream |
| BWH Bright White | HTB Heartthrob |
| CGP Cargo Pants | NET Network Gray |
| CHT Chatroom | NWH Nonchalant White |
| DSY Daisy | PAR Paradise |
| DRG Daring | QXP Quixotic Plum |
| DYN Dynamo | RBZ Relic Bronze |
| ENG Enigma | SND Sandbank |
| FRR French Roast | STM Storm |
| GBY Georgian Bay | TRC Tricorn Black |

5. Edge Profile Options:

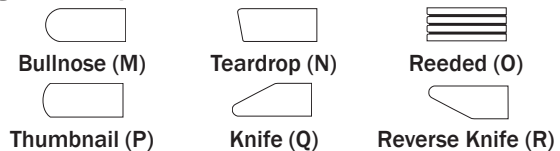

6. Leg Style - Straight wood (S), Tapered wood (T) or Metal (M); add \$320 list for 4 metal legs or \$399 list for 5 metal legs. NOTE: Metal legs use plate and barrel nut attachment and tops have 1" high straight apron. ▲



Metal legs

TABLES

7. Wood Leg Attachment: ▲

- A. Corner block with 3" high straight apron (CBSA)
- B. Corner block with 3" high arch apron (CBAA)
- C. Plate and barrel nut with 1" high straight apron (PBSA)

NOTE: CBAA or PBSA recommended for ADA applications



Corner Block

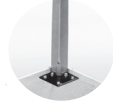

Plate and Barrel Nut



8. Optional Metal Leg Wire Management:

- Wire management in one leg, \$15 list upcharge (1)
- Wire management in two legs, \$30 list upcharge (2)



Metal leg with
wire management

**9. Optional Premium or Specialty Laminate Tops Available -
contact customer service for pricing.**

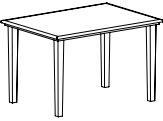
Description	D	W	H	CTN WT	① Model	List Price
	24	36	29	55	JE2436-29	\$838
	30	42	29	60	JE3042-29	\$986
	30	60	29	95	JE3060-29	\$1,100
	36	60	29	105	JE3660-29	\$1,183
	36	72	29	125	JE3672-29	\$1,332
	36	90	29	133	JE3690-29*	\$1,695
	42	78	29	140	JE4278-29	\$1,715
	42	84	29	150	JE4284-29	\$1,782

· 90" table has an additional leg in center for support ▲

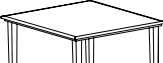
	36	36	29	70	JE3636-29	\$1,015
	42	42	29	80	JE4242-29	\$1,154
	48	48	29	90	JE4848-29	\$1,329

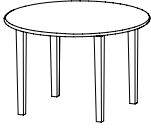
	36	N/A	29	42	JE36R-29	\$1,176
	42	N/A	29	80	JE42R-29	\$1,256
	48	N/A	29	95	JE48R-29	\$1,341

TABLES

To Order, Specify:

- ① Model Number
- ② Top Material - Veneer (W) or Laminate (L)
- ③ Wood Species - Cherry (CH1), Maple (MA1), Oak (OK1) or Walnut (WA1)▲
- ④ Wood Finish/Color
- ⑤ Edge Profile
- ⑥ Leg Style▲ - Metal (M); add \$320 list for 4-leg table or \$399 list for 5-leg table, Straight Wood (S) or Tapered Wood (T)
- ⑦ Wood Leg Attachment ▲
 - A. Corner block with 3" high straight apron (CBSA)
 - B. Corner block with 3" high arched apron (CBAA)
 - C. Plate and barrel nut with 1" high straight apron (PBSA)
- ⑧ Optional Metal Leg Wire Management - Wire management in one leg (1) - add \$15 list. Wire management in two legs (2) - add \$30 list.
- ⑨ Optional Premium or Specialty Laminate Tops Available - contact customer service for pricing

④ Wood Finish/Color Options:

Cherry		Maple	
AUT	Autumn*	ALE	Ale*
BRL	Barley*	BUT	Butterscotch
BBN	Bourbon*	CIN	Cinnamon*
BRG	Brighton*	FLX	Flax
CLA	Classic*	VEN	Venetian*
EAR	Earthy		
LGC	Legacy*		
PRL	Praline*		
SAF	Saffron*		
Oak		Walnut	
BRW	Brownie*	AUB	Auburn*
CAN	Canyon*	ESP	Espresso
CIT	Citron*	MCH	Mocha*
DES	Desert*	NTO	Night Owl*
ECU	Ecru*	SIE	Sienna*
HEN	Henna*	TOF	Toffee*
HNY	Honey*	TRF	Truffle*
NUT	Nut Brown*		

Color - Add \$31 list per item

BKD	Backdrop	GRV	Greek Villa
BFX	Black Fox	GLF	Gulf Stream
BWH	Bright White	HTB	Heartthrob
CGP	Cargo Pants	NET	Network Gray
CHT	Chatroom	NWH	Nonchalant White
DSY	Daisy	PAR	Paradise
DRG	Daring	QXP	Quixotic Plum
DYN	Dynamo	RBZ	Relic Bronze
ENG	Enigma	SND	Sandbank
FRR	French Roast	STM	Storm
GBY	Georgian Bay	TRC	Tricorn Black

Specifications

- Wood species - Cherry, Maple, Oak or Walnut.
- Top core material is 1 1/8" thick with 45 lb. density industrial grade particle board.
- Face is wood veneer or horizontal grade HPL.
- Backer is bonded to bottom side to ensure balanced construction.
- All tops have mitered corner external solid lumber bands with inset laminate or veneer.

⑤ Edge Profile Options:



Lincoln Tables Order Check List:



Top core material is 1 1/8" thick with 45 lb. density industrial grade particle board. The face is wood veneer or horizontal grade high pressure laminate (HPL). A backer is bonded to bottom side to ensure balanced construction. All tops have internal solid lumber bands with overlay laminate or veneer.

Specify:

- 1. Model Number
- 2. Top Material - Veneer (W) or Laminate (L)
- 3. Wood Species - Cherry (CH1), Maple (MA1), Oak (OK1) or Walnut (WA1)[▲]
- 4. Wood Finish/Color
- 5. Edge profile
- 6. Leg Style - Straight Wood (S), Tapered Wood (T) or Metal (M); add \$320 list for 4 metal legs or \$399 list for 5 metal legs[▲]
- 7. Wood Leg Attachment[▲]
 - A. Corner Block with 3" high straight apron (CBSA)
 - B. Corner Block with 3" high arched apron (CBAA)
 - C. Plate and Barrel Nut with 1" high straight apron (PBSA)
- 8. Optional Metal Leg Wire Management
 - A. Wire management in one leg, \$15 list upcharge (1)
 - B. Wire management in two legs, \$30 list upcharge (2)
- 9. Optional Premium or Specialty Laminate Tops Available - contact customer service for pricing.

Example:

LI4848-29 (model #)	W (top material)	OK1 (wood species)	HEN (finish)	B (edge)	S (leg style)	CBSA (wood leg attachment)
------------------------	---------------------	-----------------------	-----------------	-------------	------------------	-------------------------------

1. Model Number

2. Top Material - Veneer (W) or Laminate (L) - Finishes below with an asterisk (*) have a coordinating laminate available.

3. Wood Species - Cherry (CH1), Maple (MA1), Oak (OK1) or Walnut (WA1)

4. Wood Finish/Color Options:

Cherry

AUT Autumn*	EAR Earthy
BRL Barley*	LGC Legacy*
BBN Bourbon*	PRL Praline*
BRG Brighton*	SAF Saffron*
CLA Classic*	

Maple

ALE Ale*
BUT Butterscotch
CIN Cinnamon*
FLX Flax
VEN Venetian*

Oak

BRW Brownie*	ECU Ecru*
CAN Canyon*	HEN Henna*
CIT Citron*	HNY Honey*
DES Desert*	NUT Nut Brown*

Walnut

AUB Auburn*	SIE Sienna*
ESP Espresso	TOF Toffee*
MCH Mocha*	TRF Truffle*
NTO Night Owl*	

Color - Add \$31 list per item

BKD Backdrop	GRV Greek Villa
BFX Black Fox	GLF Gulf Stream
BWH Bright White	HTB Heartthrob
CGP Cargo Pants	NET Network Gray
CHT Chatroom	NWH Nonchalant White
DSY Daisy	PAR Paradise
DRG Daring	QXP Quixotic Plum
DYN Dynamo	RBZ Relic Bronze
ENG Enigma	SND Sandbank
FRR French Roast	STM Storm
GBY Georgian Bay	TRC Tricorn Black

5. Edge Profile Options:

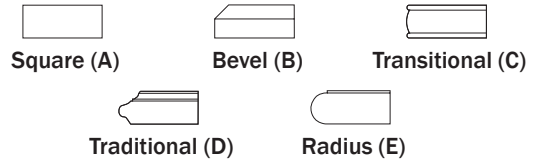

6. Leg Style - Straight wood (S), Tapered wood (T) or Metal (M); add \$320 list for 4 metal legs or \$399 list for 5 metal legs. NOTE: Metal leg uses plate and barrel nut attachment and tops have 1" high straight apron.[▲]



Metal legs

7. Wood Leg Attachment: ▲

- A. Corner block with 3" high straight apron (CBSA)
- B. Corner block with 3" high arch apron (CBAA)
- C. Plate and barrel nut with 1" high straight apron (PBSA)

NOTE: CBAA or PBSA recommended for ADA applications



Corner Block

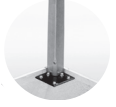

Plate and Barrel Nut



8. Optional Metal Leg Wire Management:

- Wire management in one leg, \$15 list upcharge (1)
- Wire management in two legs, \$30 list upcharge (2)



Metal leg with wire management

9. Optional Premium or Specialty Laminate Tops Available - contact customer service for pricing.

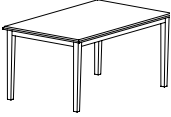
Description	D	W	H	CTN WT	① Model	List Price
	24	36	29	55	LI2436-29	\$536
	30	42	29	60	LI3042-29	\$660
	30	60	29	95	LI3060-29	\$774
	36	60	29	105	LI3660-29	\$858
	36	72	29	125	LI3672-29	\$1,007
	36	90	29	133	LI3690-29*	\$1,371
	42	78	29	140	LI4278-29	\$1,389
	42	84	29	150	LI4284-29	\$1,458

* 90" table has an additional leg in center for support ▲

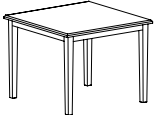
Description	D	W	H	CTN WT	① Model	List Price
	24	24	29	50	LI2424-29	\$695
	36	36	29	70	LI3636-29	\$695
	42	42	29	80	LI4242-29	\$829
	48	48	29	90	LI4848-29	\$970

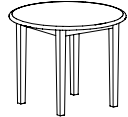
Description	D	W	H	CTN WT	① Model	List Price
	36	N/A	29	42	LI36R-29	\$796
	42	N/A	29	80	LI42R-29	\$938
	48	N/A	29	95	LI48R-29	\$1,016

To Order, Specify:

- ① Model Number
- ② Top Material - Veneer (W) or Laminate (L)
- ③ Wood Species - Cherry (CH1), Maple (MA1), Oak (OK1) or Walnut (WA1)▲
- ④ Wood Finish/Color
- ⑤ Edge Profile
- ⑥ Leg Style - Metal (M); add \$320 list for 4-leg table or \$399 list for 5-leg table, Straight Wood (S) or Tapered Wood (T)
- ⑦ A. Wood Leg Attachment - Corner block with 3" high straight apron (CBSA) or corner block with 3" high arched apron (CBAA)
B. Metal Leg Attachment - Plate and barrel nut with 1" high straight apron (PBSA)
- ⑧ Optional Metal Leg Wire Management - Wire management in one leg (1) - add \$15 list. Wire management in two legs (2) - add \$30 list.
- ⑨ Optional Premium or Specialty Laminate Tops Available - contact customer service for pricing

④ Wood Finish/Color Options:

Cherry		Maple	
AUT Autumn*	ALE Ale*	AUB Auburn*	
BRL Barley*	BUT Butterscotch	ESP Espresso	
BBN Bourbon*	CIN Cinnamon*	MCH Mocha*	
BRG Brighton*	FLX Flax	NTO Night Owl*	
CLA Classic*	VEN Venetian*	SIE Sienna*	
EAR Earthy		TOF Toffee*	
LGC Legacy*		TRF Truffle*	
PRL Praline*			
SAF Saffron*			
Oak		Walnut	
BRW Brownie*	AUB Auburn*		
CAN Canyon*	ESP Espresso		
CIT Citron*	MCH Mocha*		
DES Desert*	NTO Night Owl*		
ECU Ecu*	SIE Sienna*		
HEN Henna*	TOF Toffee*		
HNY Honey*	TRF Truffle*		
NUT Nut Brown*			

Color - Add \$31 per item

BKD Backdrop	GRV Greek Villa
BFX Black Fox	GLF Gulf Stream
BWH Bright White	HTB Heartthrob
CGP Cargo Pants	NET Network Gray
CHT Chatroom	NWH Nonchalant White
DSY Daisy	PAR Paradise
DRG Daring	QXP Quixotic Plum
DYN Dynamo	RBZ Relic Bronze
ENG Enigma	SND Sandbank
FRR French Roast	STM Storm
GBY Georgian Bay	TRC Tricorn Black

⑤ Edge Profile Options:



Specifications

- Wood species - Cherry, Maple, Oak or Walnut.
- Top core material is 1 1/8" thick with 45 lb. density industrial grade particle board.
- Face is wood veneer or horizontal grade HPL.
- Backer is bonded to bottom side to ensure balanced construction.
- All tops have internal solid lumber bands with overlay laminate or veneer.▲

Menu Tables Order Check List:



Specify:

- 1. Model Number
- 2. Laminate Top Selection
- 3. Wood Edge Species - Oak (O) or Maple (M)
- 4 Wood Edge Finish/Color (all edges except E, F, G and L)
- 5. Edge profile
- 6. Optional Custom Laminate Imaging Tops Available - see next page for details
- 7. Optional Premium or Specialty Laminate Tops Available - contact customer service for pricing.

Example:

M2430 | 7816-60 | O | HEN | A
 (model #) | (laminate) | (wood species) | (finish) | (edge)

1. Model Number

2. Laminate Top Selection - select from any standard Formica, Nevamar, Pionite or Wilsonart laminate.

3. Wood Edge Species - Oak (O) or Maple (M)

4. Wood Edge Finish/Color Options:

Oak

BRW	Brownie	ECU	Ecru
CAN	Canyon	HEN	Henna
CIT	Citron	HNY	Honey
DES	Desert	NUT	Nut Brown

Maple

ALE	Ale	FLX	Flax
AUB	Auburn	LGC	Legacy
AUT	Autumn	MCH	Mocha
BRL	Barley	NTO	Night Owl
BBN	Bourbon	PRL	Praline
BRG	Brighton	SAF	Saffron
BUT	Butterscotch	SIE	Sienna
CIN	Cinnamon	TOF	Toffee
CLA	Classic	TRF	Truffle
EAR	Earthy	VEN	Venetian
ESP	Espresso		

Color - Add \$31 list per item

BKD	Backdrop	GRV	Greek Villa
BFX	Black Fox	GLF	Gulf Stream
BWH	Bright White	HTB	Heartthrob
CGP	Cargo Pants	NET	Network Gray
CHT	Chatroom	NWH	Nonchalant White
DSY	Daisy	PAR	Paradise
DRG	Daring	QXP	Quixotic Plum
DYN	Dynamo	RBZ	Relic Bronze
ENG	Enigma	SND	Sandbank
FRR	French Roast	STM	Storm
GBY	Georgian Bay	TRC	Tricorn Black

5. Edge Profile Options:

Overlay tops with internal edges



Inset tops with external edges

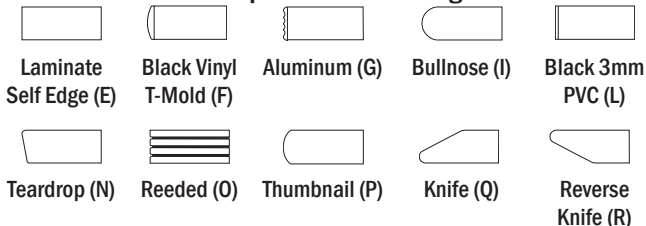

6. Optional Custom Laminate Imaging Tops Available - see next page for details

7. Order any standard pattern from Wilsonart, Formica, Nevamar or Pionite with no upcharge. For a complete standard list for any of these vendors please contact Customer Service. Optional premium or specialty laminate tops available - contact customer service for pricing.

TABLES

Custom Laminate Imaging:



Size Restrictions:

- Round - Up to 60"
- Rectangle - Up to 36" x 72"

Pricing is based on info below:

- Quantity
- Table top size
- Color

We recommend a matte finish for more durability and scratch resistance.

Quantities under five - add \$327 list set up fee.

Contact customer service for additional information.

Artwork Formatting Guidelines:

- Best type of file for custom laminate is a **vector based file**. This is due to the fact that resolution is not a concern with vector based files and therefore we can enlarge an image as much as we need to without a problem with clarity.
- **Very important: On all vector based files, convert all fonts to outlines** (or paths). This is the **ONLY** way to ensure that we will be able to print the fonts you want.
- Also, specify colors as Pantones in the file. When specifying Pantone colors please use UNCOATED colors. If Pantone colors are not available, please send a hard copy showing the colors you are needing.

For vector based files we prefer the following file formats:

Adobe Illustrator: Save using an .ai or .eps extension.
(Examples: table_top_design.ai or table_top_design.eps)

Freehand: Version 9 and before. You can also export as an EPS file. **Make sure all imported files are embedded.**



Photoshop: Version CS or before. Save files as .tif or .psd files. If your artwork is in layers in Photoshop, please send the files to us in layers. Also, for color matching purposes we will need a hard copy of the colors you want to see. If the file originated in Illustrator or Freehand please send us the original file instead of a Photoshop file.

Corel Draw: We are able to read files Version 8.0 or earlier for PC. If you have a Mac-based Corel file you need to export the file as an EPS file. For extra insurance, have the file exported as an Illustrator file. (.ai) also. **Corel files cannot be used for the graphic process.** We will have to convert the file to an EPS format. Therefore, keep the file size as small as possible. Corel tends to expand rapidly when converted to EPS files.

Do not send a PageMaker file or a QuarkXPress file.

We can read a 100 MB zip disk, a 250 MB zip disk, or a CD.

We can also accept files via the Internet. We have a file size limitation of 10 MB, however larger files can be accessed. Please contact customer service for assistance.

Description	D	W	CTN WT	① Model	ABCDH	E	F	G	INOP	L	QR
Rectangular 	24	30	23	M2430	\$300	\$241	\$218	\$254	\$373	\$173	\$385
	24	36	27	M2436	\$361	\$250	\$229	\$235	\$443	\$193	\$465
	24	42	32	M2442	\$412	\$263	\$246	\$319	\$517	\$208	\$532
	24	48	36	M2448	\$474	\$277	\$259	\$368	\$659	\$218	\$608
	24	60	45	M2460	\$543	\$305	\$299	\$387	\$737	\$250	\$702
	24	72	54	M2472	\$656	\$372	\$351	\$522	\$881	\$271	\$867
	30	36	34	M3036	\$448	\$265	\$242	\$310	\$552	\$208	\$578
	30	42	40	M3042	\$536	\$305	\$279	\$373	\$668	\$261	\$695
	30	48	45	M3048	\$594	\$311	\$285	\$387	\$737	\$271	\$768
	30	60	57	M3060	\$745	\$355	\$325	\$538	\$921	\$300	\$962
	30	72	68	M3072	\$892	\$395	\$357	\$676	\$1,100	\$367	\$1,151
	36	60	68	M3660	\$879	\$378	\$344	\$615	\$1,090	\$375	\$1,137
	36	72	81	M3672	\$1,000	\$477	\$434	\$705	\$1,237	\$427	\$1,298
Square 	24	24	18	M2424	\$244	\$186	\$192	\$245	\$303	\$176	\$317
	30	30	29	M3030	\$378	\$205	\$205	\$275	\$464	\$195	\$486
	36	36	41	M3636	\$540	\$243	\$236	\$355	\$662	\$235	\$699
	42	42	56	M4242	\$807	\$398	\$398	\$488	\$991	\$384	\$1,040
	48	48	70	M4848	\$901	\$447	\$438	\$538	\$1,184	\$389	\$1,242
Round 	24	N/A	18	M24R	\$307	\$208	\$192	\$208	\$380	\$186	\$396
	30	N/A	29	M30R	\$410	\$251	\$230	\$284	\$510	\$218	\$527
	36	N/A	41	M36R	\$591	\$299	\$271	\$372	\$727	\$313	\$761
	42	N/A	56	M42R	\$852	\$439	\$398	\$498	\$1,048	\$503	\$1,100
	48	N/A	72	M48R	\$1,038	\$445	\$407	\$599	\$1,289	\$507	\$1,336
	54	N/A	92	M54R	\$1,469	\$636	\$578	\$840	\$1,816	\$765	\$1,899
	60	N/A	113	M60R	\$1,625	\$662	\$603	\$1,021	\$2,009	\$769	\$2,105

To Order, Specify:

- ① Model Number
- ② Laminate Top Selection
- ③ Wood Edge Species - Oak (O) or Maple (M)
- ④ Wood Edge Finish/Color (except edges E, F, G and L)
- ⑤ Edge Profile - see page 256
- ⑥ Optional Custom Laminate Imaging Tops Available - see page 257 for details
- ⑦ Optional Premium or Specialty Laminate Tops Available - contact customer service for pricing

④ Wood Finish/Color Options:

Oak	Maple		
BRW Brownie	ALE Ale	FLX Flax	
CAN Canyon	AUB Auburn	LGC Legacy	
CIT Citron	AUT Autumn	MCH Mocha	
DES Desert	BRL Barley	NTO Night Owl	
ECU Ecu	BBN Bourbon	PRL Praline	
HEN Henna	BRG Brighton	SAF Saffron	
HNY Honey	BUT Butterscotch	SIE Sienna	
NUT Nut Brown	CIN Cinnamon	TOF Toffee	
	CLA Classic	TRF Truffle	
	EAR Earthy	VEN Venetian	
	ESP Espresso		

Specifications

- Wood species - Oak or Maple.
- All table top edges are 1 ¼" thick.
- Gloss or mirrored laminates not recommended.

Color - Add \$31 list per item

BKD Backdrop	GRV Greek Villa
BFX Black Fox	GLF Gulf Stream
BWH Bright White	HTB Heartthrob
CGP Cargo Pants	NET Network Gray
CHT Chatroom	NWH Nonchalant White
DSY Daisy	PAR Paradise
DRG Daring	QXP Quixotic Plum
DYN Dynamo	RBZ Relic Bronze
ENG Enigma	SND Sandbank
FRR French Roast	STM Storm
GBY Georgian Bay	TRC Tricorn Black

Menu Bases Order Check List:



Specify:

- 1. Model Number
- 2. Wood Species - Maple (M) (Halen Base only)
- 3 Wood Finish/Color (Halen Base only)
- 4 Optional Custom Height Base - add \$90 list
- 5. Optional Bar Height Base with Foot Ring - add \$178 list
- 7. Optional Self Leveling Glides - add \$26 list

Example:

TB2323 | M | AUB
 (model #) | (wood species) | (finish)

1. Model Number

2. Wood Species - Maple (M) (Halen Base only)

3. Wood Finish/Color Options (Halen Base only): ▲

Maple

ALE Ale	FLX Flax
AUB Auburn	HEN Henna
AUT Autumn	HNY Honey
BRL Barley	LGC Legacy
BBN Bourbon	MCH Mocha
BRG Brighton	NTO Night Owl
BRW Brownie	NUT Nut Brown
BUT Butterscotch	PRL Praline
CAN Canyon	SAF Saffron
CIN Cinnamon	SIE Sienna
CIT Citron	TOF Toffee
CLA Classic	TRF Truffle
DES Desert	VEN Venetian
EAR Earthy	
ESP Espresso	

Color - Add \$31 list per item (Halen Base only)

BKD Backdrop	GRV Greek Villa
BFX Black Fox	GLF Gulf Stream
BWH Bright White	HTB Heartthrob
CGP Cargo Pants	NET Network Gray
CHT Chatroom	NWH Nonchalant White
DSY Daisy	PAR Paradise
DRG Daring	QXP Quixotic Plum
DYN Dynamo	RBZ Relic Bronze
ENG Enigma	SND Sandbank
FRR French Roast	STM Storm
GBY Georgian Bay	TRC Tricorn Black

4. Optional Custom Height Base - Add \$90 list
 · cannot exceed 42" in height

5. Optional Bar Height Base with Foot Ring (available on four prong, four prong extended and three prong) - Add \$178 list
 · overall height with top - 42"

6. Optional Self Leveling Glides - Add \$26 list
 · standard with nylon plastic glides

7. Labor Saver Bases

· all bases include labor saver columns, eliminating the need for timely base assembly and cutting installation time dramatically with simple one-man installation.

Our bases follow these simple steps for installation:

1. Attach square plate to table top.



2. Attach support base to column.



Description	D	H	Base Spread	CTN WT	Model	List Price
Bistro Four Prong	3	28	22	14	BI-22BW	\$105



- metal base in black sandtex only
- Compatible tables:**
- one base required: 24" and 30" diameter
- one base required: 24 x 24, 24 x 30, 30 x 30
- two bases required: 24 x 72, 30 x 72, 36 x 72

3	28	30	24	BI-30BW	\$140
---	----	----	----	---------	-------

- metal base in black sandtex only
- Compatible tables:**
- one base required: 36" diameter
- one base required: 24 x 36, 24 x 42, 30 x 36, 30 x 42, 36 x 36

4	28	36	42	BI-36BW	\$275
---	----	----	----	---------	-------

- metal base in black sandtex only
- Compatible tables:**
- one base required: 42" and 48" diameter
- one base required: 42 x 42, 48 x 48

Bistro Four Prong Extended	3	28	34	24	BI-2434BW	\$124
----------------------------	---	----	----	----	-----------	-------

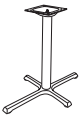



- metal base in black sandtex only
- Compatible tables:**
- one base required: 24 x 48, 30 x 48

Bistro Two Prong	3	28	22	14	BI-22ENDBW	\$105
------------------	---	----	----	----	------------	-------

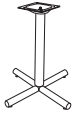
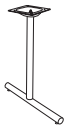

- metal base in black sandtex only
- Compatible tables:**
- two bases required: 24 x 60, 30 x 48, 30 x 60, 36 x 60, 36 x 72

TABLES

Description	D	H	Base Spread	CTN WT	① Model	List Price
Cafe Four Prong  <ul style="list-style-type: none"> metal base in black sandtex only Compatible tables: <ul style="list-style-type: none"> one base required: 24" and 30" diameter one base required: 24 x 24, 24 x 30, 30 x 30 two bases required: 24 x 72, 30 x 72, 36 x 72 	2	28 ¾	22	28	CF-22BW	\$288
<ul style="list-style-type: none"> metal base in black sandtex only Compatible tables: <ul style="list-style-type: none"> one base required: 36" diameter one base required: 24 x 36, 24 x 42, 30 x 36, 30 x 42, 36 x 36 	2	28 ¾	26	34	CF-26BW	\$364
<ul style="list-style-type: none"> metal base in black sandtex only Compatible tables: <ul style="list-style-type: none"> one base required: 42" and 48" diameter one base required: 42 x 42, 48 x 48 	2	28 ¾	36	53	CF-36BW	\$389
Cafe Two Prong  <ul style="list-style-type: none"> metal base in black sandtex only Compatible tables: <ul style="list-style-type: none"> two bases required: 24 x 60, 30 x 48, 30 x 60, 36 x 60, 36 x 72 	4	27 ¾	22	23	CF-22ENDBW	\$194
Foxtrot Three Prong  <ul style="list-style-type: none"> metal base in black sandtex only Compatible tables: <ul style="list-style-type: none"> one base required: 24" and 30" diameter 	3	28	24	25	FT-24BW	\$125
Foxtrot Two Prong  <ul style="list-style-type: none"> metal base in black sandtex only Compatible tables: <ul style="list-style-type: none"> two bases required: 24 x 48, 24 x 60, 24 x 72, 30 x 48, 30 x 60, 30 x 72, 36 x 60, 36 x 72 	3	28	22	16	FT-22ENDBW	\$110



To Order, Specify:

- ① Model Number
- ② Optional Custom Height Base - add \$90 list
- ③ Optional Bar Height Base with Foot Ring - add \$178 list
- ④ Optional Self Leveling Glides - add \$26 list

Specifications

- All metal bases available in Black Sandtex only.
- Standard with adjustable glides.
- Standard with labor saver base.

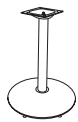
TABLES

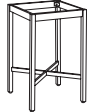
Description	D	H	Base Spread	CTN WT	① Model	List Price
 <p>Bravo Disk</p> <ul style="list-style-type: none"> metal base in black sandtex only <p>Compatible tables:</p> <ul style="list-style-type: none"> one base required: 24" and 30" diameter one base required: 24 x 30, 30 x 30, 30 x 36 two bases required: 24 x 60, 24 x 72, 30 x 48, 30 x 60, 30 x 72 	3	28	17	32	BR-17BW	\$188
<p>metal base in black sandtex only</p> <p>Compatible tables:</p> <ul style="list-style-type: none"> one base required: 36" diameter one base required: 24 x 36, 24 x 42, 30 x 36, 30 x 42, 36 x 36 two bases required: 36 x 72 	3	28	22	38	BR-22BW	\$298
<p>metal base in black sandtex only</p> <p>Compatible tables:</p> <ul style="list-style-type: none"> one base required: 42" and 48" diameter one base required: 36 x 60, 42 x 42, 48 x 48 	3	28	28	72	BR-28BW	\$478
 <p>Gabriel</p> <ul style="list-style-type: none"> metal base in black sandtex only <p>Compatible tables:</p> <ul style="list-style-type: none"> one base required: 54" and 60" diameter 	4	28	36	78	GB-36BW	\$566
 <p>Halen Wood Base</p> <ul style="list-style-type: none"> wood base bar height <p>Compatible tables:</p> <ul style="list-style-type: none"> one base required: 36" diameter one base required: 30 x 30, 36 x 36 	N/A	41 ¼	23	25	TB2323	\$438

TABLES

To Order, Specify:

- ① Model Number
- ② Wood Species - Maple (M) (Halen Base only)
- ③ Wood Finish/Color (Halen Base only)
- ④ Optional Custom Height Base - add \$90 list
- ⑤ Optional Bar Height Base with Foot Ring - add \$178 list
- ⑥ Optional Self Leveling Glides - add \$26 list

③ Wood Finish/Color Options: ▲

ALE Ale	FLX Flax
AUB Auburn	HEN Henna
AUT Autumn	HNY Honey
BRL Barley	LGC Legacy
BBN Bourbon	MCH Mocha
BRG Brighton	NTO Night Owl
BRW Brownie	NUT Nut Brown
BUT Butterscotch	PRL Praline
CAN Canyon	SAF Saffron
CIN Cinnamon	SIE Sienna
CIT Citron	TOF Toffee
CLA Classic	TRF Truffle
DES Desert	VEN Venetian
EAR Earthy	
ESP Espresso	

Specifications

- Wood species - Maple (Halen Base only).
- All metal bases available in Black Sandtex only.
- Standard with adjustable glides.
- Standard with labor saver base.

Color - Add \$31 list per item (Halen Base only)

BKD Backdrop	GRV Greek Villa
BFX Black Fox	GLF Gulf Stream
BWH Bright White	HTB Heartthrob
CGP Cargo Pants	NET Network Gray
CHT Chatroom	NWH Nonchalant White
DSY Daisy	PAR Paradise
DRG Daring	QXP Quixotic Plum
DYN Dynamo	RBZ Relic Bronze
ENG Enigma	SND Sandbank
FRR French Roast	STM Storm
GBY Georgian Bay	TRC Tricorn Black

Fresco Table Bases Order Check List:

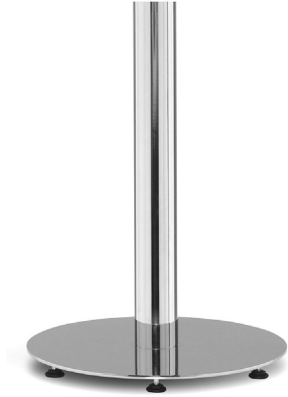

Specify:

- 1. Model Number
- 2. Finish/Color

Example:

FR24-THD	BSX
(model #)	(finish)

1. Model Number

2. Base Color Options:

Powdercoat
 BSX Black Sandtex
 STS Stardust Silver

Chrome
 CHR Chrome

Description	H	Base Spread	W	CTN WT	① Model	Powder Coat	Chrome
Fresco Table Height Disc Base	27 ¾	18	31	3	FR18-THD	\$771	\$998

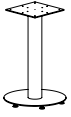

- 4" diameter column
- specify Black Sandtex, Stardust Silver or Chrome finish
- 18" disc base diameter
- compatible with Prep or Menu tops
- for use with 24" and 30" round or 24" square top

Fresco Table Height Disc Base	27 ¾	23 ¾	45	3	FR24-THD	\$872	\$1,108
-------------------------------	------	------	----	---	----------	-------	---------

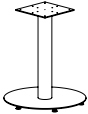

- 4" diameter column
- specify Black Sandtex, Stardust Silver or Chrome finish
- 23 ¾" disc base diameter
- compatible with Prep or Menu tops
- for use with 36" or 42" round or 30" or 36" square top

Fresco Table Height Disc Base	27 ¾	28	50	4	FR28-THD	\$1,016	\$1,337
-------------------------------	------	----	----	---	----------	---------	---------

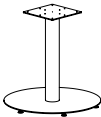

- 4" diameter column
- specify Black Sandtex, Stardust Silver or Chrome finish
- 28" disc base diameter
- compatible with Prep or Menu tops
- for use with 48" round or 42" square top

Fresco Counter Height Disc Base	34 ¾	18	32	4	FR18-CHD	\$810	\$1,057
---------------------------------	------	----	----	---	----------	-------	---------

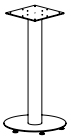

- 4" diameter column
- specify Black Sandtex, Stardust Silver or Chrome finish
- 18" disc base diameter
- compatible with Prep or Menu tops
- for use with 24" and 30" round or 24" square top

Fresco Counter Height Disc Base	34 ¾	23 ¾	48	4	FR24-CHD	\$945	\$1,220
---------------------------------	------	------	----	---	----------	-------	---------

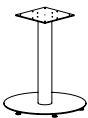

- 4" diameter column
- specify Black Sandtex, Stardust Silver or Chrome finish
- 23 ¾" disc base diameter
- compatible with Prep or Menu tops
- for use with 36" or 42" round or 36" or 36" square top

Description	H	Base Spread	W	CTN WT	① Model	Powder Coat	Chrome
Fresco Bar Height Disc Base	40 ¾	18	32	4	FR18-BHD	\$810	\$1,057

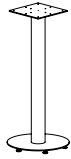

- 4" diameter column
- specify Black Sandtex, Stardust Silver or Chrome finish
- 18" disc base diameter
- compatible with Prep or Menu tops
- for use with 24" and 30" round or 24" square top

Fresco Bar Height Disc Base	40 ¾	23 ¾	50	4	FR24-BHD	\$945	\$1,220
-----------------------------	------	------	----	---	----------	-------	---------

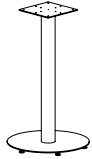

- 4" diameter column
- specify Black Sandtex, Stardust Silver or Chrome finish
- 23 ¾" disc base diameter
- compatible with Prep or Menu tops
- for use with 36" or 42" round or 30" or 36" square top

To Order, Specify:

- ① Model Number
- ② Base Color

② Base Color Options:

- BSX Black Sandtex
- CHR Chrome
- STS Stardust Silver

Specifications

- All bases have a 4" diameter column.
- All bases have ¼" thick round disc base.
- All bases have adjustable glides, 1" from floor to bottom of disc.
- Each base ships in two cartons.
- Mounting plate is welded to column.
- Disc bolts to bottom of column in field.

The Prep Multi-Purpose Collection has a flexible offering of shapes and sizes. The bases and tops are specified separately.

Multi-Purpose Tables

Tops and bases sold separately

Bases

- Base styles available in T or X
- Standard, counter and bar heights
- Two color options - Black Sandtex (BSX) or Stardust Silver (STS)

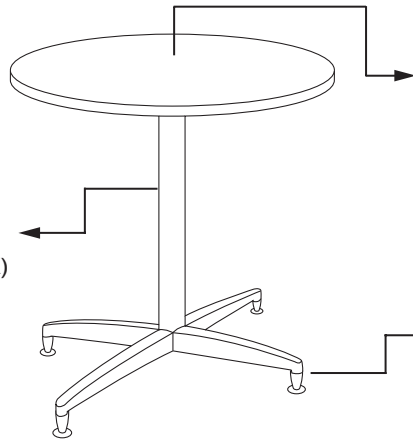

Tops

- 6 top shapes - Rectangle, square, round, half round, trapezoid, AV and linking wedges.
- 15 edge colors for laminate top

Glides or Casters

- Interchangeable in the field
- Casters or glides offer same table height
- Dual-wheel locking casters
- Color: Black

Vertical wire management attaches to the leg.
See page 283 for pricing.

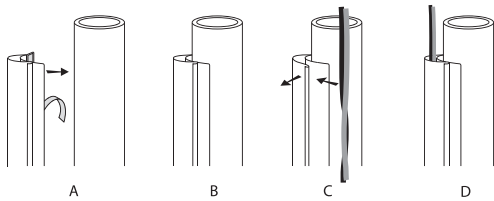

One hand pull release

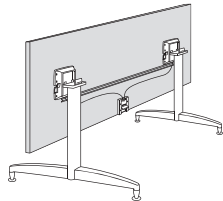

Space Planning Guidelines

Follow these easy steps to create an adaptable, mobile learning environment.

1. The first step, initial requirements

- A) Determine room configuration which will best fit your needs
- B) Determine seating capacity requirements

2. Determine the Top Shapes and Sizes, as well as the number of tops needed for the chosen table configuration.
(See page 269 for seating capacity options.)

A) Table Placement Guidelines

- 24"–30" per person
- 48" for aisles
- 48" from side walls
- 96"–120" for presenter between front wall and first row
- 48" between rows
- 84" from back wall
- 72" between round or square tables

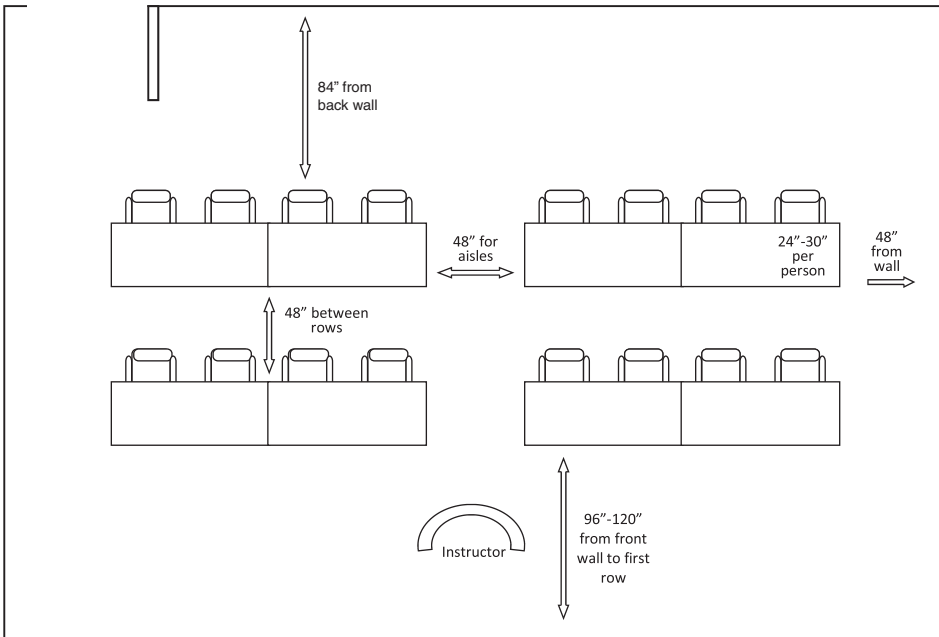

B) ADA Guidelines

- 34"–36" per wheelchair table space
- 24" minimum table depth
- 60"–72" between rows for wheelchairs to be placed back-to-back
- 36" minimum for wheelchair single passage
- 60" minimum for wheelchair double passage
- 60" minimum diameter to turn wheelchair
- 29" height accommodates newer wheelchairs; however, some wheelchairs require 32" height.

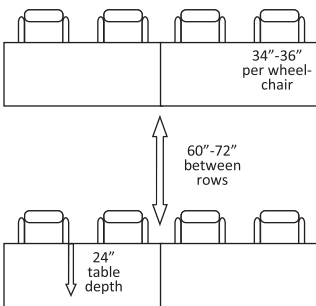

3. Select Base Color, Top Material and Edge Color

A) Base Color

- BSX - Black Sandtex
- STS - Stardust Silver

B) Top Material

- LS - Laminate with standard PVC eased edge (For standard laminate list, see page 274)
- LP - Laminate with premium edge

C) Edge Color

Standard Colors

- ALB Alabaster
- AUT Autumn
- BLK Black
- BBN Bourbon (Natural Cherry)
- BZW Brazilwood
- DWH Designer White
- DOV Dove Grey
- FWH Frosty White
- PLT Platinum
- SHD Shadow
- SHE Shea (Kensington Maple)
- SLG Slate Grey
- VIN Vintage

Premium Colors

- ALU Aluminum
- TTM Titanium

4. Table Options

A) Linking Kits

- All table tops are pre-bored with inserts for linking tops.

B) Power Kit Options

- Table size will determine your standard power and grommet location.
- Single or double circuit available
- Optional data ports





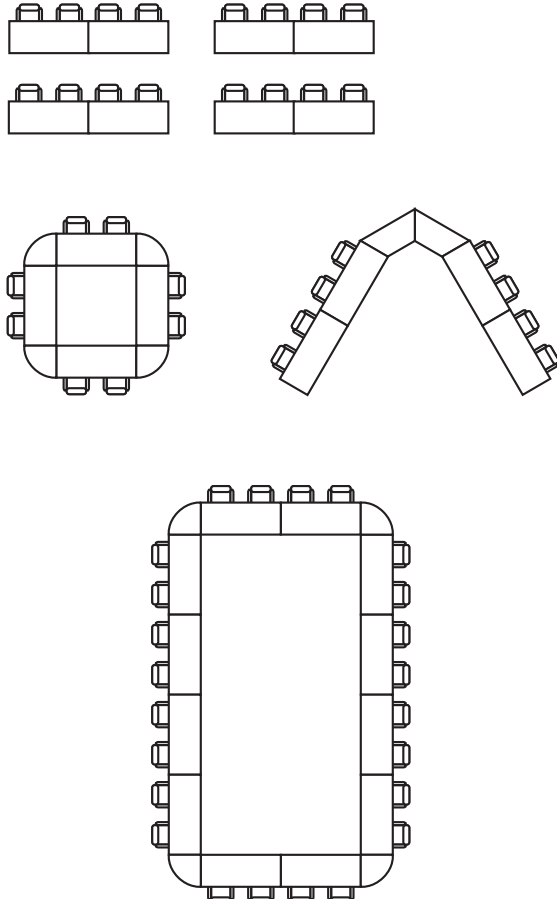

Community offers single or double circuit electrical units to meet classroom technology demands. See Power and Data pages 271–273. Please contact our customer service department for assistance at 800-622-5661.

Seating Capacity Options

For other seating requirements, select different configurations that are compatible with classroom size and capacity.

TYPICALS

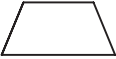
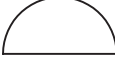

Rectangular Top		
	PR2442TT	24" x 42"
	PR2448TT	*24" x 48"
	PR2460TT	*24" x 60"
	PR2472TT	*24" x 72"
	PR3042TT	30" x 42"
	PR3048TT	*30" x 48"
	PR3060TT	*30" x 60"
	PR3072TT	*30" x 72"
Rectangular Conference Top		
	PR3660TT	36" x 60"
	PR3672TT	36" x 72"
Square Top		
	PR3030ST	30" x 30"
	PR3636ST	36" x 36"
	PR4242ST	42" x 42"
	PR4848ST	48" x 48"
Round Top		
	PR30RT	30" dia.
	PR36RT	36" dia.
	PR42RT	42" dia.
	PR48RT	48" dia.
	PR60RT	60" dia.
AV Top		
	PR2448AT	24" x 48"
	PR3060AT	30" x 60"
Trapezoid Top		
	PR2448ZT	24" x 48"
	PR2472ZT	24" x 72"
	PR3060ZT	30" x 60"
Half Round Top		
	PR2448HT	24" x 48"
	PR3060HT	30" x 60"
Quarter Round Linking Top		
	PR24QT	*24" x 24"
	PR30QT	*30" x 30"
Wedge Linking Top		
	PR24-30WT	*24" - 30 degree
	PR24-45WT	*24" - 45 degree
	PR24-60WT	*24" - 60 degree
	PR24-90WT	*24" - 90 degree
	PR30-30WT	*30" - 30 degree
	PR30-45WT	*30" - 45 degree
	PR30-60WT	*30" - 60 degree
	PR30-90WT	*30" - 90 degree

* = Products offered in Training Package; see page 313

For additional assistance, please contact our customer service department at 800-622-5661 or visit our website www.communityfurniture.com

Top Shapes and Sizes with Corresponding Optional Grommet Locations

Rectangle

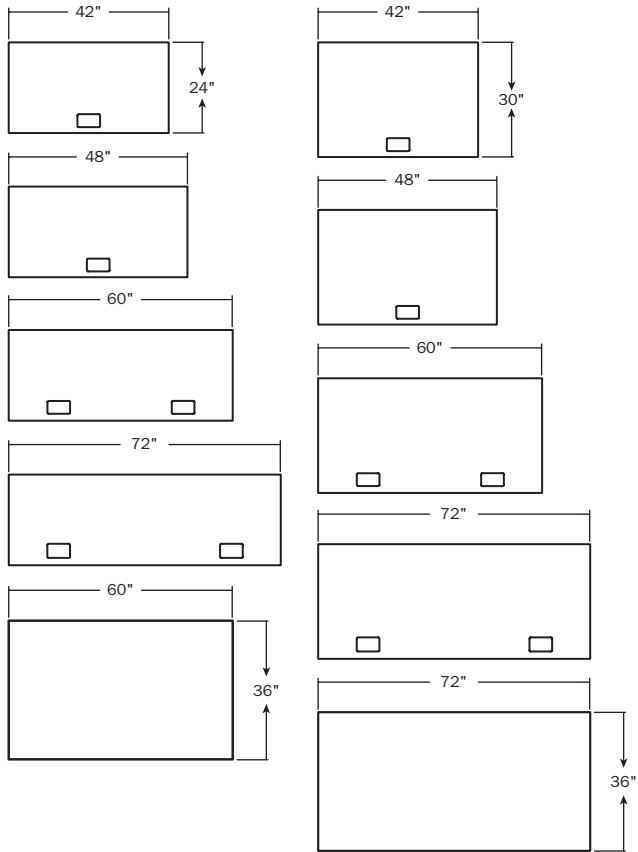

Wedge Linking Tables (includes linking kit)

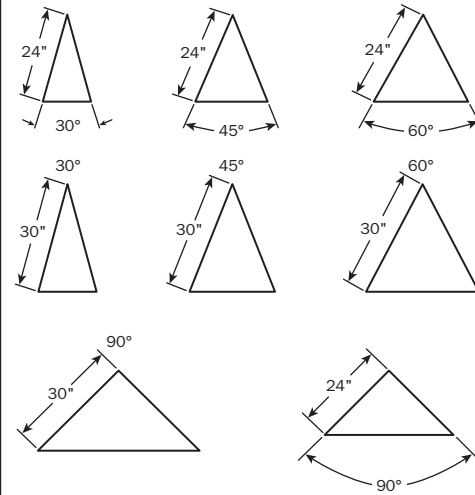

Round

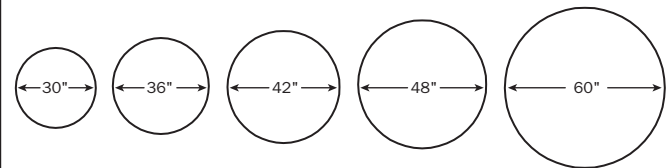

Square

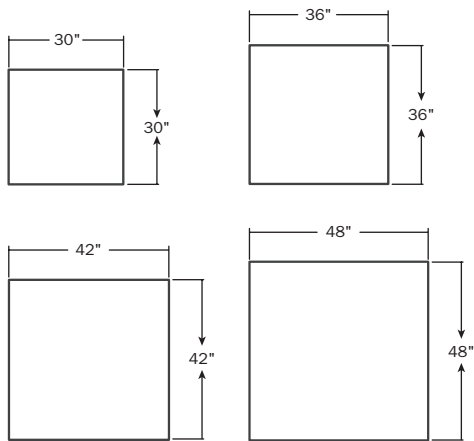

Quarter Round Linking Tables (includes linking kit)

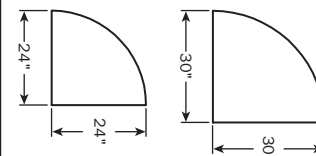

AV

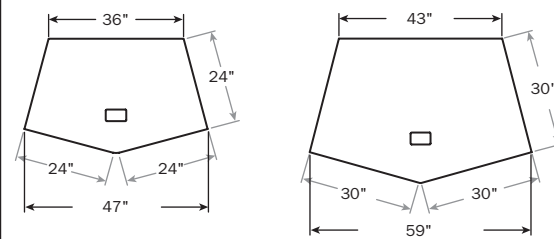

Trapezoid

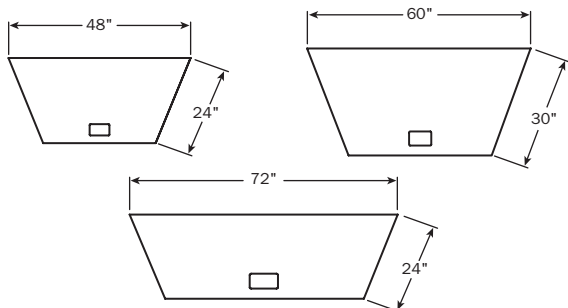

Half Round

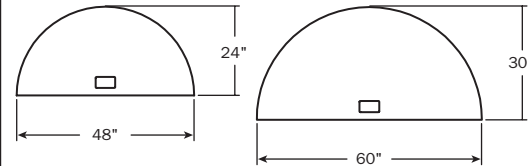

TABLES

Power Kits

Full power and data packages with numerous interface options allow for Prep tables to be rolled out, plugged in, and reconfigured.

Grommet

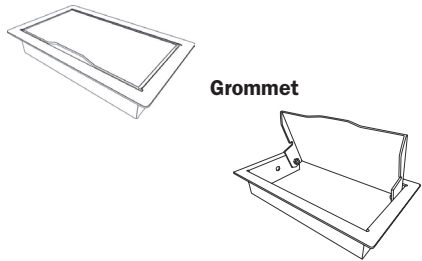
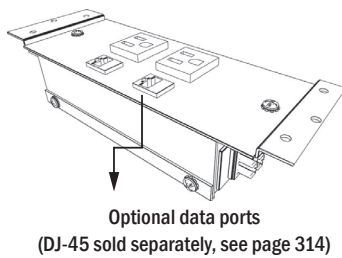
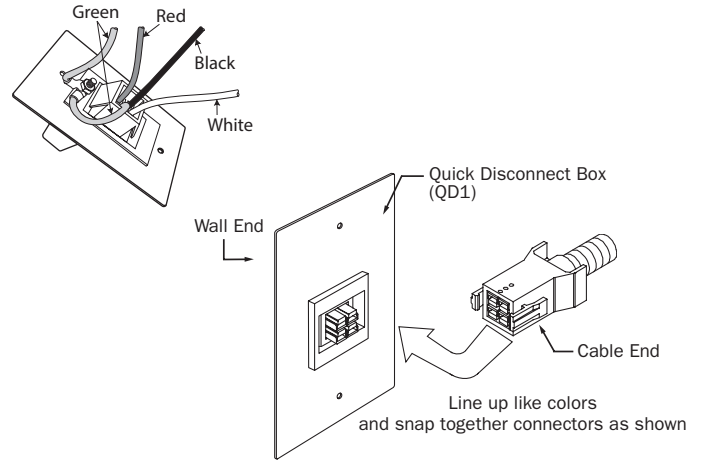

Figure 1



Prep's electrical package (EP) offers single and double circuit capability. Data ports for easy internet access and equipment charging are also available.

Figure 2
With optional quick disconnect wall outlet.



Prep's power kit accommodates classroom or training room requirements with single or double circuit options, indicated by series of colored wires.

Included in the power kit:

- Power box with grommet
 - One box for 42", 48" rectangle tops, trapezoid, half round and AV
 - Two boxes for the 60" & 72" rectangle tops.
- Cables
 - One power box kit - Two cables are included; one for each end of the power box
 - Two power box kits - Three cables are included; one for each end of the table and one to connect the two boxes
- Wire Cable Clamps - to secure your wires to the underside of the table top
- Safety linking plate - screws the underside of the table top to secure the tables from being pulled apart accidentally and damaging electrical cables
- Black plastic electrical cover with wire management.

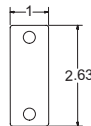

Single and Double Circuit Guide

Single Circuit

- For smaller rooms with limited electrical needs
- Each table's electrical components can be connected with cables and secured with safety linking brackets (linking brackets included, field installation required).
- Wedge and Quarter Rounds Linking Tables require jumper cables (EKJ-12) ordered separately, (U brackets included, field installation required).
- When connecting to building power; options include:
 - 1) Quick disconnect wall outlet - must have MP72 infeed
 - 2) 6' cable with standard 3-prong plug
 - 3) Hard wired into wall with cable extended from wall

Double Circuit

- For larger rooms with greater electrical needs
- Double circuit use requires a table grid with circuits assigned to alternating tables (see page 272)
(Example: Table 1 = circuit 1, Table 2 = circuit 2, Table 3 = circuit 1)
- When connecting to building power; options include:
 - 1) Quick disconnect wall outlet - must have MP72 infeed
 - 2) Hard wired into wall with cable extended from wall

Single and Double Circuit* Guide

- Each table's electrical components can be connected in the field with cables, and secured with safety linking brackets (linking brackets included, field installation required).
- Wedge and Quarter Round Linking Tables require jumper cables (EKJ-12) ordered separately, (linking brackets included, field installation required).
- When connecting to building power; options include:
 - 1) Quick disconnect wall outlet - must have MP72 infeed*
 - 2) 6' cable with standard 3-prong plug - single circuit only; cannot be used with double circuit
 - 3) Hard wired into wall with cable extended from wall*

Single Circuit

- Use allows maximum flexibility for smaller rooms with limited electrical needs
- Up to 8 duplex units can be linked on a single circuit system

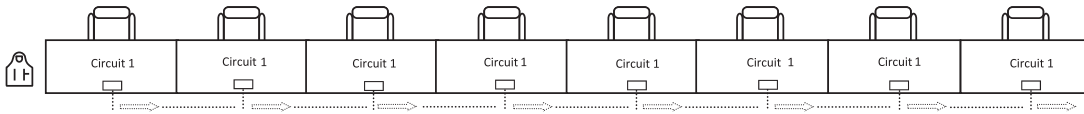

Double Circuit

- Use for larger rooms with greater electrical needs
- Up to 16 duplex units can be linked on a double circuit grid
- Double circuit use requires a table grid with circuits assigned to alternating tables, as shown

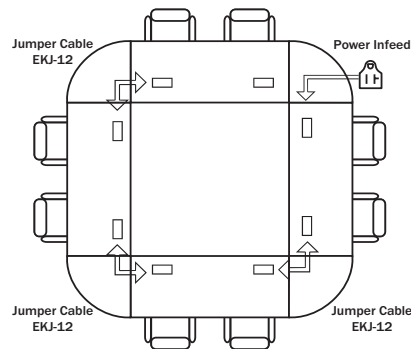
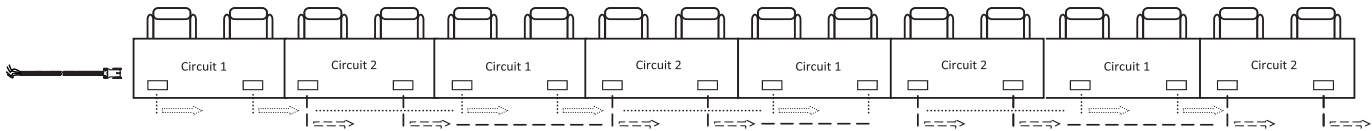

*NOTE: Double circuit building power source options must be wired to support double circuit configurations.

Non-Directional and Non-Sequential Electrical System

Prep's non-directional, non-sequential electrical package allows virtually any configuration. In addition, table order is not limited by single or double circuit systems. Simply disconnect each table from the connecting table or wall outlet, change the configuration, and reconnect the tables to one another or to the wall. It's that simple!

Non-Directional

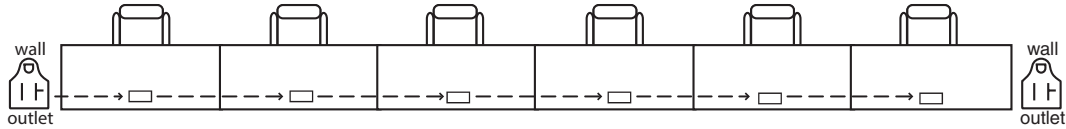

- Wall power in-feed cables can be attached to either end of the table configuration

Non-Sequential

Ex. 1

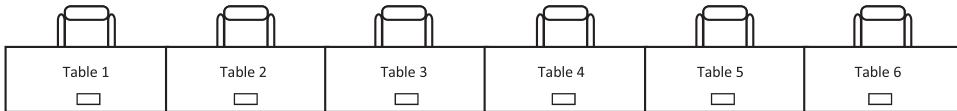

Ex. 2



- Table order isn't a concern with Prep's electrical system

Single and Double Circuit Options

- Quick disconnect wall outlet - must have MP72 infeed
- Hard wiring with cable extended from wall
- Building power source must be wired to support double circuit configurations

Double Circuit

- The electrical system is a four wire system consisting of two individual circuits. Each circuit is rated at 20 amps/120 volts maximum.
- Circuit 1 (black), and Circuit 2 (red) are served by a system neutral (white) and an equipment ground (green). Check with local codes before connecting to building.

Linking Kit

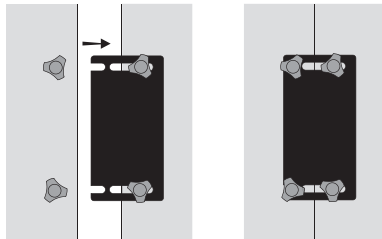

- Easy to install
- All table tops are pre-bored with inserts to accept field installed linking kit except round and square tops
- 4 black low profile knobs (2 for each table) with quick release flat plate
- 11" gauge steel
- Standard on Wedge and Quarter Round table tops

Wedge and Quarter Rounds linking tops are available. (See page 270) All linking tables include linking kits.



Wilsonart Standard Laminate Offering

 For most up to date listing visit: wilsonart.com

PATTERN NAME	PATTERN NUMBER	PVC MATCH	PATTERN NAME	PATTERN NUMBER	PVC MATCH	PATTERN NAME	PATTERN NUMBER	PVC MATCH
Alabaster	D431-60	X	Hibiscus Cherry	7988-38		Saffron Tigris	4673-60	
Almond Leather	2932-60		Hollyberry	D307-60		Sand	D331-60	
Amazon	D478-60		Hunter Green	D79-60		Shadow	D96-60	X
Antique Brush	4823-60		Huntington Maple	7929-38		Shadow Trellis	4694-38	
Antique White	1572-60		Indigo	D379-60		Shadow Zephyr	4857-60	
Aqua Fizz	4934-38		Island	D498-60		Sheer Mesh	4876-38	
Arcade	4938-38		Karratha Brush	4744-60		Silicon Ev	4811-60	
Atlantis	D425-60		Kensington Maple	10776-60	X	Slate Grey	D91-60	X
Banister Oak	7806-60		Khaki	D50-60		Soft Gold Mesh	4911-38	
Basketweaving 101	4965-38		Kiwi	4917-60		Solar Oak	7816-60	
Basketweaving 202	4966-38		Legacy Blue	D417-60		Spiced Zephyr	4859-60	
Beige	1530-60		Light Beige	1531-60		Sprout	4918-60	
Beige Pampus	4170-60		Limber Maple	10734-60		Steel Mesh	4879-38	
Beigewood	7850-60		Linen	D427-60		Sterling Ash	7995-38	
Berry Fizz	4935-38		Loden Zephyr	4844-60		Sunshine	D499-60	
Black	1595-60	X	Lowell Ash	7994-38		Sweet Corn	4916-60	
Blue Agave	4919-60		Mangalore Mango	7984-38		Tan Soapstone	4887-38	
Boardwalk Oak	7983-38		Manitoba Maple	7911-60		Tangerine	4915-60	
Brazil Wood	7946-38	X	Maroochy Brush	4745-60		Tawny Legacy	4663-60	
Brittany Blue	D321-60		Midway	4936-38		Titanium Ev	4810-60	
Bronze Legacy	4656-60		Mission Maple	7990-38		Tungsten Ev	4814-60	
Buka Bark	7982-38		Mission Stone	4853-60		Tuscan Maple	7921-38	
Burnished Chestnut	4796-60		Misted Zephyr	4843-60		Twilight Zephyr	4845-60	
Caldera Beige	4608-60		Monticello Maple	7925-38		Urban Bronze	4967-38	
Canyon Zephyr	4842-60		Morelia Mango	7985-38		Urban Iron	4968-38	
Carbon Ev	4820-60		Morro Zephyr	4846-60		Venitian Ale	4930-60	
Carbon Mesh	4880-38		Natural Almond	D30-60		Venitian Ivory	4928-38	
Castle Oak	7928-38		Natural Cotton	4946-38		Wallaby	D439-60	
Casual Linen	4944-38		Natural Glace	4143-60		Western Bronze	4873-60	
Classic Linen	4943-38		Natural Nebula	4633-60		Western Storm	4872-60	
Cloud Nebula	4630-60		Natural Pear	7061-60		Western Suede	4871-60	
Cloud Zephyr	4856-60		Natural Recon	7996-38		Western White	4869-60	
Coffee Bean	D495-60		Natural Rift	7954-38		White	1570-60	
Cream Fizz	4933-38		Natural Tigris	4669-60		White Carrara	4924-38	
Crème	D456-60		Navy Legacy	4651-60		White Nebula	4621-60	
Crips Linen	4942-38		Neo Walnut	7991-38		White Sand	D403-60	
Denim Tracery	4961-38		New Age Oak	7938-38		White Tigris	4783-60	
Desert Zephyr	4841-60		Nickel Ev	4813-60		Wild Cherry	7054-60	
Designer White	D354-60	X	North Sea	D90-60		Windswept Bronze	4794-38	
Dove Grey	D92-60	X	Ocean	D502-60		Windswept Pewter	4795-60	
Ebony Recon	7997-38		Oiled Soapstone	4882-38		Woolamai Brush	4746-60	
Egg Plant	4913-60		Olive Legacy	4654-60				
Evening Tigris	4674-60		Orange Grove	D501-60				
Faded Trellis	4963-38		Organic Cotton	4945-38				
Fashion Grey	D381-60		Oxide	1787-60				
Flame Soapstone	4884-38		Palisades Oak	7987-38				
Flamingo	D467-60		Pampus	4166-60				
Florence Walnut	7993-38		Pasadena Oak	7986-38				
Fonthill Pear	10745-60		Pearl Soapstone	4886-38				
Frosty White	1573-60	X	Pepperdust	D327-60				
Fusion Maple	7909-60		Persian Cherry	7989-48				
Gesso Tracery	4962-38		Pewter Brush	4779-60				
Ginsing Tea	4909-60		Pewter Mesh	4878-38				
Graphite Nebula	4623-60		Pinball	4937-38				
Gray Glace	4142-60		Pinnacle Walnut	7992-38				
Gray Mesh	4877-38		Platinum	D315-60	X			
Gray Nebula	4622-60		Pomegranite	4914-60				
Gray Pampus	4168-60		Port	D14-60				
Green Soapstone	4885-38		Putty	1503-60				
Green Tigris	4667-60		Raw Cotton	4947-38				
Guided Mesh	4912-38		River Cherry	7937-38				
Harvest Maple	7953-38		Rustic Slate	4888-38				
Haze	D97-60		Sable Soapstone	4883-38				

Contact Wilsonart at 800-433-3222 for samples of the laminates listed above.

Standard Community Laminates

*Autumn (Collectors Cherry)	10826K-07
*Bourbon (Natural Cherry)	XM044-07
*Shea (Kensington Maple)	10776-60
*Vintage (Cafelle)	7933K-07

For samples of the four standard Community laminates call Customer Service at 800-622-5661.

For additional vendors please call Customer Service at 800-622-5661.

1 Table Top Model Number (shown on page 276) - Bases ordered separately (see pages 277-280)

2 Top Material/Edge - Choose from two edge options

A) Laminate Specify standard Wilsonart Laminate choices - reference page 274

1) LS - Laminate with standard 3mm PVC eased edge - See applicable pricing column.

- ALB Alabaster
- AUT Autumn
- BLK Black
- BBN Bourbon (Natural Cherry)
- BZW Brazilwood
- DWH Designer White
- DOV Dove Grey
- FWH Frosty White
- PLT Platinum
- SHD Shadow
- SHE Shea (Kensington Maple)
- SLG Slate Grey
- VIN Vintage

2) LP - Laminate with premium metallic 2mm PVC eased edge - See applicable pricing column.

- ALU Aluminum
- TTM Titanium

3 Linking Kit Option

L Linking Kit

All table tops are pre-bored with inserts for linking tops.

*Recommended for tables with electrical

Add to list price:

\$52

4 Electrical Package Option*

*Grommet color options: Black (B) or Silver (S)

Rectangle 42"/48", AV, Trapezoid, Half Round

\$318

PREP-EP1C (single circuit)

PREP-EP2C-1 (circuit 1) (double circuit)

PREP-EP2C-2 (circuit 2) (double circuit)

Rectangle 60"/72"

\$491

PREP-EP1D (single circuit)

PREP-EP2D-1 (circuit 1) (single circuit)

PREP-EP2D-2 (circuit 2) (double circuit)

5 Power Infeed Cables

AP72 72" power infeed cable - 3 prong cable (cannot be used with double circuit package)

\$207

HP72 72" hardwire power infeed - Cable is hardwired to the wall

\$167

MP72 72" modular power infeed (must be used with QD1)

\$155

QD1 Quick disconnect wall outlet (must be used with MP72)

\$78

*Conference packages; see page 282 for coordinating base and electrical options.

Optional Electrical Accessories

(items ordered separately; see page 283 for details)

DJ-45 Data Jack

EJK-12 12" jumper cable

6 Base Color

BSX Black Sandtex







STS Stardust Silver

MULTI-PURPOSE TABLE TOP



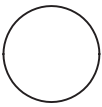

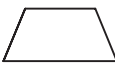

Example

		qty
Table Top Model Number	PR2448TT	1
Top Material/Edge	LS	
Laminate Color (Specify Wilsonart and Edge colors)	10826-07 / AUT	
PRODUCT PRICE:		\$356
Fabric Modesty Panel	PR48MP Add \$247	1
Optional Linking Kit (leave blank if this option is not selected)	L Add \$52	1
Optional Power Kit (leave blank if this option is not selected)	PREP-EP1C Add \$318	1
TOTAL PRICE	\$973	





Bases ordered separately

Description	D	W	H (LS/LP)	CTN WT	CU FT	① Model	Standard PVC Edge (LS)	Premium PVC Edge (LP)	
Rectangular Top 	24	42	1 3/16	38	3	PR2442TT	\$306	\$328	
	24	48	1 3/16	43	4	PR2448TT	\$356	\$382	
	24	60	1 3/16	52	5	PR2460TT	\$406	\$433	
	24	72	1 3/16	62	5	PR2472TT	\$453	\$486	
	30	42	1 3/16	44	4	PR3042TT	\$350	\$374	
	30	48	1 3/16	49	5	PR3048TT	\$399	\$428	
	30	60	1 3/16	59	6	PR3060TT	\$485	\$519	
	30	72	1 3/16	71	7	PR3072TT	\$539	\$578	
	Rectangle Conference Top 	36	60	1 3/16	71	6	PR3660TT	\$587	\$628
		36	72	1 3/16	85	7	PR3672TT	\$648	\$696
Square Top 	30	30	1 3/16	32	3	PR3030ST	\$277	\$298	
	36	36	1 3/16	52	4	PR3636ST	\$331	\$354	
	42	42	1 3/16	59	5	PR4242ST	\$479	\$513	
	48	48	1 3/16	76	7	PR4848ST	\$503	\$539	
Round Top 	30	N/A	1 3/16	32	3	PR30RT	\$314	\$338	
	36	N/A	1 3/16	52	4	PR36RT	\$392	\$419	
	42	N/A	1 3/16	67	5	PR42RT	\$591	\$618	
	48	N/A	1 3/16	76	7	PR48RT	\$604	\$646	
	60	N/A	1 3/16	115	10	PR60RT	\$772	\$827	
AV Top 	24	48	1 3/16	43	4	PR2448AT	\$613	\$657	
	30	60	1 3/16	58	6	PR3060AT	\$792	\$849	
Trapezoid Top 	24	48	1 3/16	43	4	PR2448ZT	\$462	\$494	
	24	72	1 3/16	62	5	PR2472ZT	\$575	\$615	
	30	60	1 3/16	58	6	PR3060ZT	\$522	\$560	
Half Round Top 	24	48	1 3/16	43	4	PR2448HT	\$376	\$404	
	30	60	1 3/16	58	6	PR3060HT	\$521	\$559	

TABLES

Description	D	H	Base Spread	CTN WT	CU FT	① Model	List Price
T Base	2½	27¾	20	12	3	PR20TF	\$284
	2½	27¾	20	12	3	PR20TC	\$263
<ul style="list-style-type: none"> · sold as single unit · fixed base with glides · PR20TF and PR20TC for 24" depth top · specify Black Sandtex (BSX) or Stardust Silver (STS) 							
T base with casters							
· bases sold as single units							
T Base	2½	27¾	26	12	3	PR26TF	\$297
	2½	27¾	26	12	3	PR26TC	\$275
<ul style="list-style-type: none"> · sold as single unit · fixed base with glides · PR26TF and PR26TC for 30" or 36" depth top · specify Black Sandtex (BSX) or Stardust Silver (STS) 							
T base with casters							
· bases sold as single units							
X Base	20	27¾	20	19	4	PR20XF	\$433[▲]
							
<ul style="list-style-type: none"> · sold as single unit · glides · for 24" round or square · specify Black Sandtex (BSX) or Stardust Silver (STS) 							
X Base	26	27¾	26	21	4	PR26XF	\$455
							
<ul style="list-style-type: none"> · sold as single unit · glides · for 30" square · for 30" or 36" round · specify Black Sandtex (BSX) or Stardust Silver (STS) 							
X Base	34	27¾	34	24	4	PR34XF	\$478
							
<ul style="list-style-type: none"> · sold as single unit · glides · for 36" square · for 42" round · specify Black Sandtex (BSX) or Stardust Silver (STS) 							
X Base	38	27¾	38	29	4	PR38XF	\$502
							
<ul style="list-style-type: none"> · sold as single unit · glides · for 42" square · for 48" round or square · specify Black Sandtex (BSX) or Stardust Silver (STS) 							
X4 Base	38	27¾	38	32	3	PR38X4F	\$871
							
<ul style="list-style-type: none"> · sold as single unit · glides · for 60" round · specify Black Sandtex (BSX) or Stardust Silver (STS) 							

TABLES

Description	D	H	Base Spread	CTN WT	CU FT	① Model	List Price
Counter Height X Base	26	34 ¾	26	24	5	PR26-CHXF	\$508
						<ul style="list-style-type: none"> · sold as single unit · fixed base with glides · for 30" square · for 30" or 36" round · specify Black Sandtex (BSX) or Stardust Silver (STS) 	
Counter Height X Base	34	34 ¾	34	28	5	PR34-CHXF	\$532
						<ul style="list-style-type: none"> · sold as single unit · fixed base with glides · for 36" square · for 42" round · specify Black Sandtex (BSX) or Stardust Silver (STS) 	
Bar Height X Base	26	40 ¾	26	25	5	PR26-BHXF	\$508
						<ul style="list-style-type: none"> · sold as single unit · fixed base with glides · for 30" square · for 30" or 36" round · specify Black Sandtex (BSX) or Stardust Silver (STS) 	
Bar Height X Base	34	40 ¾	34	29	5	PR34-BHXF	\$532
						<ul style="list-style-type: none"> · sold as single unit · fixed base with glides · for 36" square · for 42" round · specify Black Sandtex (BSX) or Stardust Silver (STS) 	

Description	D	H	Base Spread	CTN WT	CU FT	Model	List Price
T Base	2 1/2	27 3/4	20	15	3	PR20TCT-42	\$875



- sold as set of 2
- tilt base with casters
- for 24" x 42" top
- specify Black Sandtex (BSX) or Stardust Silver (STS)

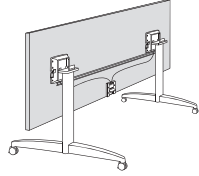

* Due to tilt mechanism these bases are sold as sets.

T Base	2 1/2	27 3/4	20	15	3	PR20TCT-48	\$875
--------	-------	--------	----	----	---	------------	-------



- sold as set of 2
- tilt base with casters
- for 24" x 48" top
- specify Black Sandtex (BSX) or Stardust Silver (STS)

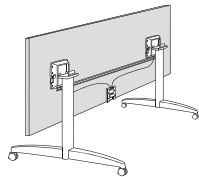

* Due to tilt mechanism these bases are sold as sets.

T Base	2 1/2	27 3/4	20	15	3	PR20TCT-60	\$875
--------	-------	--------	----	----	---	------------	-------



- sold as set of 2
- tilt base with casters
- for 24" x 60" top
- specify Black Sandtex (BSX) or Stardust Silver (STS)

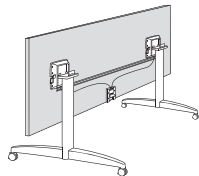

* Due to tilt mechanism these bases are sold as sets.

T Base	2 1/2	27 3/4	20	15	3	PR20TCT-72	\$875
--------	-------	--------	----	----	---	------------	-------



- sold as set of 2
- tilt base with casters
- for 24" x 72" top
- specify Black Sandtex (BSX) or Stardust Silver (STS)

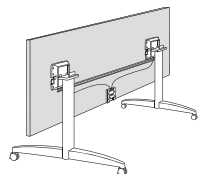

* Due to tilt mechanism these bases are sold as sets.

Description	D	H	Base Spread	CTN WT	CU FT	① Model	List Price
T Base	2½	27¾	26	15	3	PR26TCT-42	\$893



- sold as set of 2
- tilt base with casters
- for 30" x 42" top
- specify Black Sandtex (BSX) or Stardust Silver (STS)

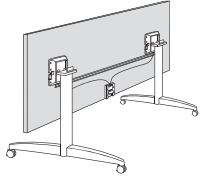

* Due to tilt mechanism these bases are sold as sets.

T Base	2½	27¾	26	15	3	PR26TCT-48	\$893
--------	----	-----	----	----	---	------------	-------



- sold as set of 2
- tilt base with casters
- for 30" x 48" top
- specify Black Sandtex (BSX) or Stardust Silver (STS)

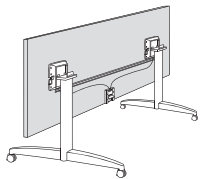

* Due to tilt mechanism these bases are sold as sets.

T Base	2½	27¾	26	15	3	PR26TCT-60	\$893
--------	----	-----	----	----	---	------------	-------



- sold as set of 2
- tilt base with casters
- for 30" x 60" top
- specify Black Sandtex (BSX) or Stardust Silver (STS)

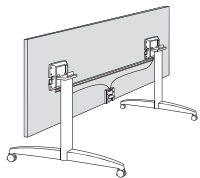

* Due to tilt mechanism these bases are sold as sets.

T Base	2½	27¾	26	15	3	PR26TCT-72	\$893
--------	----	-----	----	----	---	------------	-------



- sold as set of 2
- tilt base with casters
- for 30" x 72" top
- specify Black Sandtex (BSX) or Stardust Silver (STS)

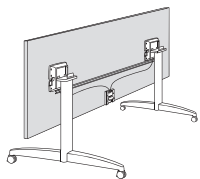

* Due to tilt mechanism these bases are sold as sets.

Description	D	H	Base Spread	CTN WT	CU FT	① Model	List Price
X Base	2½	27¾	20	26	5	PR20XCT	\$514



- sold as single unit
- tilt base with casters
- for 24" round or square
- specify Black Sandtex (BSX) or Stardust Silver (STS)

X Base	2½	27¾	26	26	5	PR26XCT	\$535
--------	----	-----	----	----	---	---------	-------



- sold as single unit
- tilt base with casters
- for 30" round or square
- for 36" round
- specify Black Sandtex (BSX) or Stardust Silver (STS)

X Base	2½	27¾	34	28	4	PR34XCT	\$558
--------	----	-----	----	----	---	---------	-------







- sold as single unit
- tilt base with casters
- for 36" square
- for 42" round or square
- specify Black Sandtex (BSX) or Stardust Silver (STS)

X Base	2½	27¾	38	28	5	PR38XCT	\$620
--------	----	-----	----	----	---	---------	-------



- sold as single unit
- tilt base with casters
- for 48" round or square
- specify Black Sandtex (BSX) or Stardust Silver (STS)

Description	W	H	CTN WT	CU FT	① Model	List Price
Fabric Modesty Panel  <ul style="list-style-type: none"> · for 48" width top · for 24" and 30" depth rectangle tops · black mesh fabric with liner and wire management pockets 	48	10 ¼	8	2	PR48MP	\$247
Fabric Modesty Panel  <ul style="list-style-type: none"> · for 60" width top · for 24" and 30" depth rectangle tops · black mesh fabric with liner and wire management pockets 	60	10 ¼	9	2	PR60MP	\$287
Fabric Modesty Panel  <ul style="list-style-type: none"> · for 72" width top · for 24" and 30" depth rectangle tops · black mesh fabric with liner and wire management pockets 	72	10 ¼	12	2	PR72MP	\$300

Description	D	W	CTN WT	CU FT	① Model	Standard PVC Edge (LS)	Premium PVC Edge (LP)
Rectangle Conference Top	36	60	71	6	PR3660TT	\$587	\$628
	36	72	85	7	PR3672TT	\$648	\$696

Coordinating T Bases (muse be ordered separately):

Fixed Base with glides	List Price
26 single unit	\$297
26 single unit	\$275
26 set of 2	\$893
26 set of 2	\$893

- fixed base with glides
- for 30" or 36" depth top
- specify Black Sandtex (BSX) or Stardust Silver (STS)



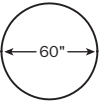

Round Top	60	N/A	115	10	PR60RT	\$772	\$827
-----------	----	-----	-----	----	--------	-------	-------



Coordinating T Base (muse be ordered separately):

X4 Base	List Price
38	\$871









- sold as single unit
- glides
- for 60" round
- specify Black Sandtex (BSX) or Stardust Silver (STS)

Description	D	W	CTN WT	CU FT	Model	List Price
Mini Grommet Power and Data Tilt Up  <ul style="list-style-type: none"> • for use with PR60RT • fluid one touch tilt up access • one power receptacle - 120 volt; 15 amp with one voice/data port adapter to accept most jack manufacturers • 72" power cord with molded plug • drop in field installation required • UL listed component • specify Black (B) or Silver (S) 	4 ¼	5 ½	6		EC10	\$319
Mini Power Tilt Up  <ul style="list-style-type: none"> • for use with PR60RT • fluid one touch tilt up access • two power receptacles - 120 volt; 15 amp • 72" power cord with molded plug • drop in field installation required • UL listed component • specify Black (B) or Silver (S) 	4 ¼	5 ½	6		EC11	\$331
Mini Power and USB Tilt Up  <ul style="list-style-type: none"> • for use with • fluid one touch tilt up access • one power receptacle - 120 volt; 15 amp dual powered USB • 72" power cord with molded plug • drop in field installation required • cut out provided in top at specified location (see page 330) • UL listed component • Black or Silver finish 	4 ¼	5 ½	6	1	EC12	\$414
Dual Power and Data Tilt Up  <ul style="list-style-type: none"> • for use with PR3660TT and PR3672TT only • fluid one touch tilt up access • back to back tilt sections • four power receptacles (2 per side) - 120 volt; 15 amp with four openings for voice/data jacks (2 per side) • adapter kit provided to accept jacks from most port manufacturers • accepts up to four type 3 telecom jacks • two 72" power cord with molded plug • drop in field installation required • UL listed component • Silver finish 	8	8 ¾	16		EC13	\$844

Placements for EC10, EC11, EC12 and EC13

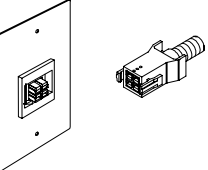

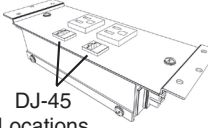
TABLES

Description	CTN WT	CU FT	Model	List Price
Corner Electrical Jumper Cable  <ul style="list-style-type: none"> · 12" corner jumper cable · use for wedges, 90 degree corners and half round tables 			EJK-12	\$105
3 Prong Power Infeed  <ul style="list-style-type: none"> · 72" plug power infeed · 20 amps/120 volts max with 15 amp/110 volts adapter · 3 prong plug · single circuit use only 			AP72	\$207
Hardwire Power Infeed  <ul style="list-style-type: none"> · 72" hardwire power infeed · 20 amps/120 volts max · single or two circuit 			HP72	\$167
Quick Disconnect Power Infeed  <ul style="list-style-type: none"> · must be used with QD1 · 72" modular power infeed · 20 amps/120 volts max · single or two circuit 			MP72	\$155
Modular Power Source  <ul style="list-style-type: none"> · must be used with MP72 · single or two circuit quick disconnect wall outlet box · electrician responsible for connection 			QD1	\$78
Data Port   <ul style="list-style-type: none"> · CAT6-RJ45 · 2 data port cut outs per power box · single unit price 	1	1	DJ-45	\$75
Vertical Wire Management  <ul style="list-style-type: none"> · available in Black (B) or Silver (S) · field installed 	1	1	AVL20	\$52

TABLES

Stockton Tables Order Check List:



Shown with optional book compartments



Shown with optional boots

Specify:

- 1. Model Number
- 2. Wood Species - Maple (M) or Oak (O)
- 3 Wood Finish/Color
- 4 Top Surface Material
- 5. Optional Boots (4) - add \$14 list
- 6. Optional Casters (2) - add \$97 list
- 7. Optional Book Compartments (2) - add \$60 list
- 8. Optional Drawers (2) - add \$120 list
- 7. Optional Premium or Specialty Laminate Tops Available - contact customer service for pricing. Mirrored or gloss laminates not recommended

Example:

SC2454-30 | O | HEN | B
 (model #) | (wood species) | (finish) | (top surface)

1. Model Number

2. Wood Species - Oak (O) or Maple (M)

3. Wood Finish/Color Options:

Oak

BRW Brownie	ECU Ecru
CAN Canyon	HEN Henna
CIT Citron	HNY Honey
DES Desert	NUT Nut Brown

Maple

ALE Ale	FLX Flax
AUB Auburn	LGC Legacy
AUT Autumn	MCH Mocha
BRL Barley	NTO Night Owl
BBN Bourbon	PRL Praline
BRG Brighton	SAF Saffron
BUT Butterscotch	SIE Sienna
CIN Cinnamon	TOF Toffee
CLA Classic	TRF Truffle
EAR Earthy	VEN Venetian
ESP Espresso	

Color - Add \$31 list per item

BKD Backdrop	GRV Greek Villa
BFX Black Fox	GLF Gulf Stream
BWH Bright White	HTB Heartthrob
CGP Cargo Pants	NET Network Gray
CHT Chatroom	NWH Nonchalant White
DSY Daisy	PAR Paradise
DRG Daring	QXP Quixotic Plum
DYN Dynamo	RBZ Relic Bronze
ENG Enigma	SND Sandbank
FRR French Roast	STM Storm
GBY Georgian Bay	TRC Tricorn Black

4. Top Surface Material Options:

- (A) Black Laminate - average, not chemical resistant
 - (B) Black Powder Coat - good, chemical resistant
 - (C) Black Chemsurf - better, chemical resistant
 - (D) Black Epoxy Resin - best, chemical resistant
-

5. Boots (4) - add \$14 list

6. Large Casters (2) - add \$97 list

7. Book Compartments (2) - add \$60 list
 Interior Dimensions: 15"w x 15"d x 3 1/4"h

8. Drawers (2) - add \$120 list
 Interior Dimensions: 15"w x 15 1/4"d x 2"h



9. Optional Premium or Specialty Laminate Tops Available - contact customer service for pricing. Mirrored or gloss laminates not recommended.

TABLES

Description	D	W	H	CTN WT	① Model	List Price
Table	24	48	30		SC2448-30	

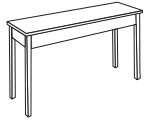

Top Options:

(A) Black Laminate	70	\$550
(B) Black Powder Coat	70	\$604
(C) Black Chemsurf	70	\$629
(D) Black Epoxy Resin	134	\$917

Table	24	54	30		SC2454-30	
-------	----	----	----	--	-----------	--

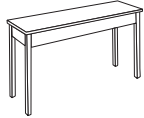

Top Options:

(A) Black Laminate	76	\$563
(B) Black Powder Coat	76	\$620
(C) Black Chemsurf	76	\$665
(D) Black Epoxy Resin	148	\$984

Table	24	60	30		SC2460-30	
-------	----	----	----	--	-----------	--

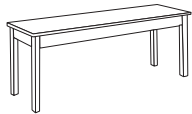

Top Options:

(A) Black Laminate	82	\$585
(B) Black Powder Coat	82	\$643
(C) Black Chemsurf	82	\$687
(D) Black Epoxy Resin	162	\$1,056

Table	24	72	30		SC2472-30	
-------	----	----	----	--	-----------	--

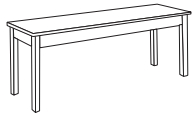

Top Options:

(A) Black Laminate	95	\$632
(B) Black Powder Coat	95	\$695
(C) Black Chemsurf	95	\$741
(D) Black Epoxy Resin	206	\$1,225

To Order, Specify:

- ① Model Number
- ② Wood Species - Oak (O) or Maple (M)
- ③ Wood Finish/Color
- ④ Top Surface Material
- ⑤ Optional Boots (4) - add \$14 list
- ⑥ Optional Casters (2) - add \$97 list
- ⑦ Optional Book Compartments (2) - add \$60 list
- ⑧ Optional Drawers (2) - add \$120 list
- ⑨ Optional Premium or Specialty Laminate Tops
Available - contact customer service for pricing.
Mirrored or gloss laminate not recommended.

④ Wood Finish/Color Options:

Oak	Maple		
BRW Brownie	ALE Ale	FLX Flax	
CAN Canyon	AUB Auburn	LGC Legacy	
CIT Citron	AUT Autumn	MCH Mocha	
DES Desert	BRL Barley	NTO Night Owl	
ECU Ecru	BBN Bourbon	PRL Praline	
HEN Henna	BRG Brighton	SAF Saffron	
HNY Honey	BUT Butterscotch	SIE Sienna	
NUT Nut Brown	CIN Cinnamon	TOF Toffee	
	CLA Classic	TRF Truffle	
	EAR Earthy	VEN Venetian	
	ESP Espresso		

Color - Add \$31 list per item

BKD Backdrop	GRV Greek Villa
BFX Black Fox	GLF Gulf Stream
BWH Bright White	HTB Heartthrob
CGP Cargo Pants	NET Network Gray
CHT Chatroom	NWH Nonchalant White
DSY Daisy	PAR Paradise
DRG Daring	QXP Quixotic Plum
DYN Dynamo	RBZ Relic Bronze
ENG Enigma	SND Sandbank
FRR French Roast	STM Storm
GBY Georgian Bay	TRC Tricorn Black

Specifications

- Wood species - Oak or Maple
- Features square edge (A).
- Tops are 1 1/8" thick with Black Laminate, 1" thick with Black Powder Coat, 1 3/16" thick with Black Chemsurf or 1" thick with Black Epoxy Resin.
- Apron rails are 3" tall without book compartments, 5" tall with book compartments.
- Legs are 2 1/4" square with adjustable glides.

TABLES

Description	D	W	H	CTN WT	① Model	List Price
Table	30	60	30		SC3060-30	

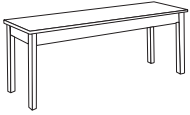

Top Options:

(A) Black Laminate				102		\$629
(B) Black Powder Coat				102		\$691
(C) Black Chemsurf				102		\$747
(D) Black Epoxy Resin				207		\$1,200

Table	30	72	30		SC3072-30	
-------	----	----	----	--	-----------	--

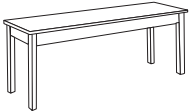

Top Options:

(A) Black Laminate				122		\$708
(B) Black Powder Coat				122		\$772
(C) Black Chemsurf				122		\$851
(D) Black Epoxy Resin				248		\$1,412

Table	24	48	36		SC2448-36	
-------	----	----	----	--	-----------	--

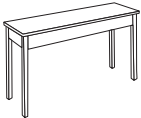

Top Options:

(A) Black Laminate				75		\$587
(B) Black Powder Coat				75		\$640
(C) Black Chemsurf				75		\$663
(D) Black Epoxy Resin				139		\$952

Table	24	54	36		SC2454-36	
-------	----	----	----	--	-----------	--

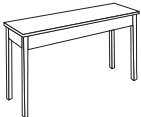

Top Options:

(A) Black Laminate				81		\$600
(B) Black Powder Coat				81		\$656
(C) Black Chemsurf				81		\$701
(D) Black Epoxy Resin				153		\$1,019

Table	24	60	36		SC2460-36	
-------	----	----	----	--	-----------	--

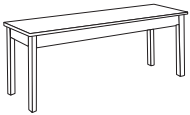

Top Options:

(A) Black Laminate				87		\$621
(B) Black Powder Coat				87		\$677
(C) Black Chemsurf				87		\$722
(D) Black Epoxy Resin				167		\$1,090

Table	24	72	36		SC2472-36	
-------	----	----	----	--	-----------	--

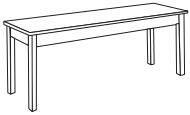

Top Options:

(A) Black Laminate				100		\$668
(B) Black Powder Coat				100		\$729
(C) Black Chemsurf				100		\$776
(D) Black Epoxy Resin				211		\$1,263

TABLES

Description	D	W	H	CTN WT	① Model	List Price
Table	30	60	36		SC3060-36	

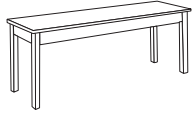

Top Options:

(A) Black Laminate	107	\$653
(B) Black Powder Coat	107	\$727
(C) Black Chemsurf	107	\$793
(D) Black Epoxy Resin	212	\$1,235

Table	30	72	36		SC3072-36	
-------	----	----	----	--	-----------	--

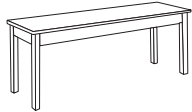

Top Options:

(A) Black Laminate	127	\$743
(B) Black Powder Coat	127	\$808
(C) Black Chemsurf	127	\$912
(D) Black Epoxy Resin	253	\$1,447

To Order, Specify:

- ① Model Number
- ② Wood Species - Oak (O) or Maple (M)
- ③ Wood Finish/Color
- ④ Top Surface Material
- ⑤ Optional Boots (4) - add \$14 list
- ⑥ Optional Casters (2) - add \$97 list
- ⑦ Optional Book Compartments (2) - add \$60 list
- ⑧ Optional Drawers (2) - add \$120 list
- ⑨ Optional Premium or Specialty Laminate Tops
Available - contact customer service for pricing.
Mirrored or gloss laminate not recommended.

④ Wood Finish/Color Options:

Oak		Maple		Flax	
BRW	Brownie	ALE	Ale	FLX	Flax
CAN	Canyon	AUB	Auburn	LGC	Legacy
CIT	Citron	AUT	Autumn	MCH	Mocha
DES	Desert	BRL	Barley	NTO	Night Owl
ECU	Ecu	BBN	Bourbon	PRL	Praline
HEN	Henna	BRG	Brighton	SAF	Saffron
HNY	Honey	BUT	Butterscotch	SIE	Sienna
NUT	Nut Brown	CIN	Cinnamon	TOF	Toffee
		CLA	Classic	TRF	Truffle
		EAR	Earthy	VEN	Venetian
		ESP	Espresso		

Color - Add \$31 list per item

BKD	Backdrop	GRV	Greek Villa
BFX	Black Fox	GLF	Gulf Stream
BWH	Bright White	HTB	Heartthrob
CGP	Cargo Pants	NET	Network Gray
CHT	Chatroom	NWH	Nonchalant White
DSY	Daisy	PAR	Paradise
DRG	Daring	QXP	Quixotic Plum
DYN	Dynamo	RBZ	Relic Bronze
ENG	Enigma	SND	Sandbank
FRR	French Roast	STM	Storm
GBY	Georgian Bay	TRC	Tricorn Black

Specifications

- Wood species - Oak or Maple
- Features square edge (A).
- Tops are 1 1/8" thick with Black Laminate, 1" thick with Black Powder Coat, 1 3/16" thick with Black Chemsurf or 1" thick with Black Epoxy Resin.
- Apron rails are 3" tall without book compartments, 5" tall with book compartments.
- Legs are 2 1/4" square with adjustable glides.

Training Tables Overview



Cruz Training Tables 289



Prep Training Tables 303

Overview

Cruz brings adaptable mobility to learning environments with a functional offering of basic table and linking top shapes, plus a full range of training components.

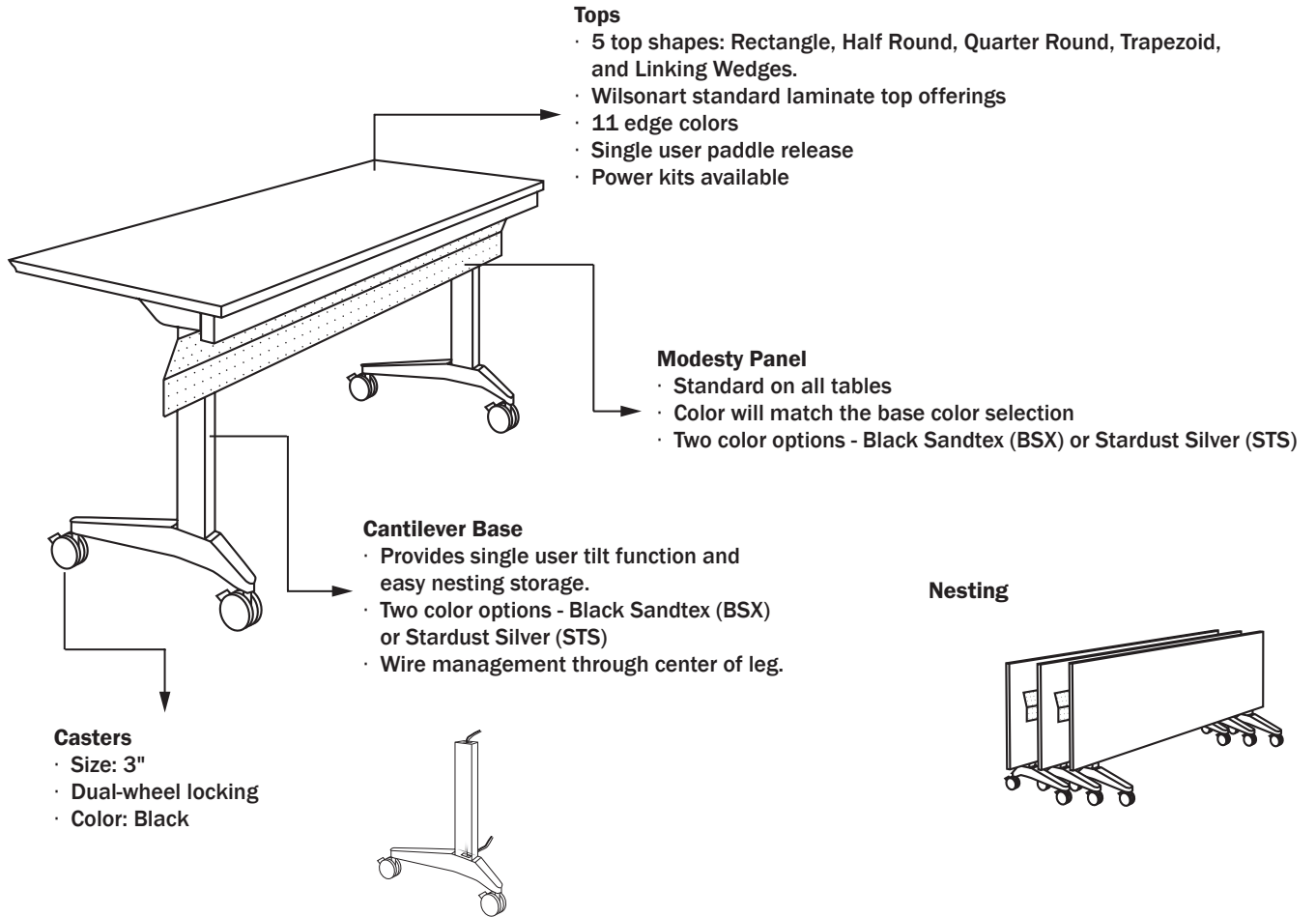

Laminate Construction

Top construction is 1 1/8" thick particle board. The laminate face is horizontal grade high pressure laminate (HPL). A backer is bonded to the bottom side to ensure balanced construction.

Single user paddle release

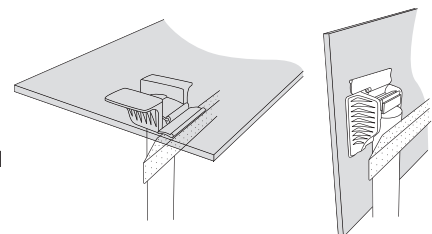

How to Specify Cruz Pre-Configured Training Tables

(Table configuration includes top, modesty panel, and tilt top bases with casters)

Follow these easy steps to create an adaptable, mobile learning environment.

1. The first step, initial requirements

- A) Determine room configuration which will best fit your needs
- B) Determine seating capacity requirements

2. Determine the Top Shapes and Sizes, as well as the number of tops needed for the chosen table configuration.

(See page 292 for seating capacity options.)

A) Table Placement Guidelines

- 24"-30" per person
- 48" for aisles
- 48" from side walls
- 96"-120" for presenter between front wall and first row
- 48" between rows
- 84" from back wall

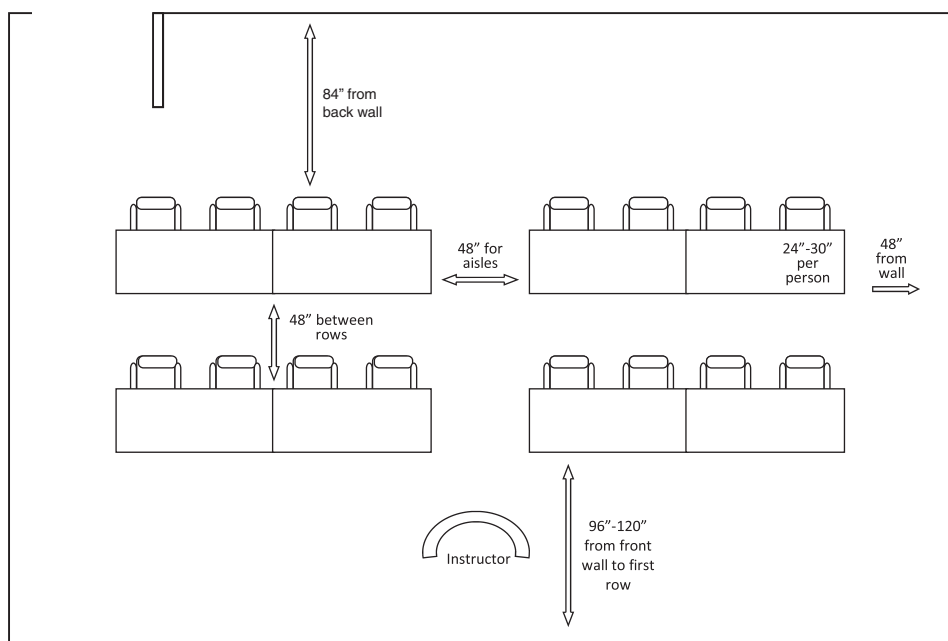

B) ADA Guidelines

- 34"-36" per wheelchair table space
- 24" minimum table depth
- 60"-72" between rows for wheelchairs to be placed back-to-back
- 36" minimum for wheelchair single passage
- 60" minimum for wheelchair double passage
- 60" minimum diameter to turn wheelchair
- 29" height accommodates newer wheelchairs; however, some wheelchairs require 32" height.

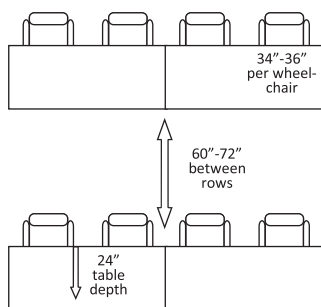

3. Select Base Color, Top Material and Edge Color

A) Base Color

- BSX - Black Sandtex
- STS - Stardust Silver

B) Top Material

- LS - Laminate with standard 3mm PVC eased edge (For standard laminate list, see page 297)
- LP - Laminate with premium metallic 2mm PVC eased edge

C) Edge Color

<u>Standard Colors</u>		<u>Premium Colors</u>	
ALB	Alabaster	ALU	Aluminum
AUT	Autumn	TTM	Titanium
BLK	Black		
BBN	Bourbon (Natural Cherry)		
BZW	Brazilwood		
DWH	Designer White		
DOV	Dove Grey		
FWH	Frosty White		
PLT	Platinum		
SHD	Shadow		
SHE	Shea (Kensington Maple)		
SLG	Slate Grey		
VIN	Vintage		

4. Table Options

A) Linking Kits

- All table tops are pre-bored with inserts for linking tops end to end.

B) Power Kit Options

- Table size will determine your standard power and grommet location.
- Single or double circuit available
- Optional data ports





Community offers single or double circuit electrical units to meet classroom technology demands. See Power and Data pages 294-296. Please contact our customer service department for assistance at 800-622-5661.

Seating Capacity Options

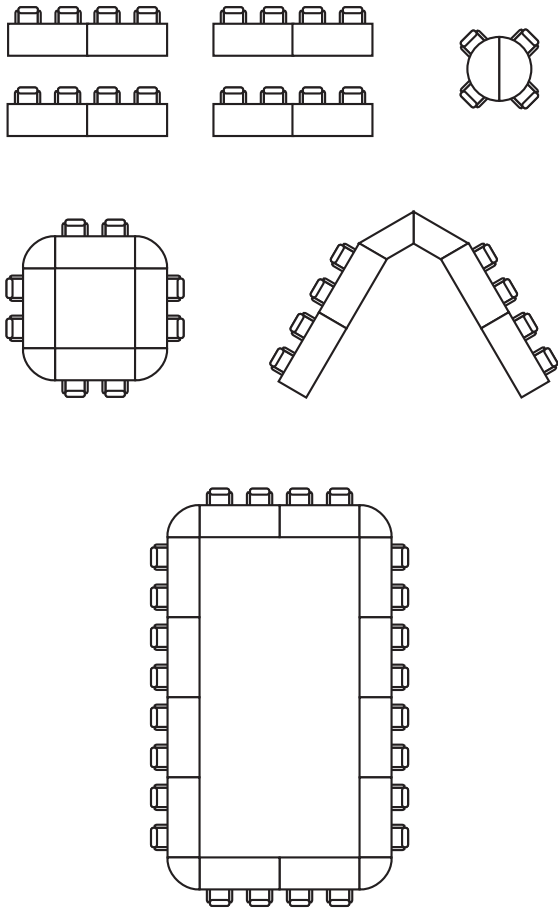
For other seating requirements, select different configurations that are compatible with classroom size and capacity.

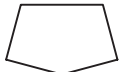
TYPICALS



Rectangular Tilt Top		
	CZ2442CTT	24" x 42"
	CZ2448CTT	24" x 48"
	CZ2460CTT	24" x 60"
	CZ2472CTT	24" x 72"
	CZ3042CTT	30" x 42"
	CZ3048CTT	30" x 48"
	CZ3060CTT	30" x 60"
	CZ3072CTT	30" x 72"
AV Tilt Top		
	CZ2448CAT	24" x 48"
	CZ3060CAT	30" x 60"
Trapezoid Tilt Top		
	CZ2448CZT	24" x 48"
	CZ2472CZT	24" x 72"
	CZ3060CZT	30" x 60"
Half Round Table		
	CZ2448CHT	24" x 48"
	CZ3060CHT	30" x 60"
Quarter Round Linking Top		
	CZ24QT	24" x 24"
	CZ30QT	30" x 30"
Wedge Linking Top		
	CZ24-30WT	24" - 30 degree
	CZ24-45WT	24" - 45 degree
	CZ24-60WT	24" - 60 degree
	CZ24-90WT	24" - 90 degree
	CZ30-30WT	30" - 30 degree
	CZ30-45WT	30" - 45 degree
	CZ30-60WT	30" - 60 degree
	CZ30-90WT	30" - 90 degree

Top Shapes and Sizes with Corresponding Optional Grommet Locations

Rectangle

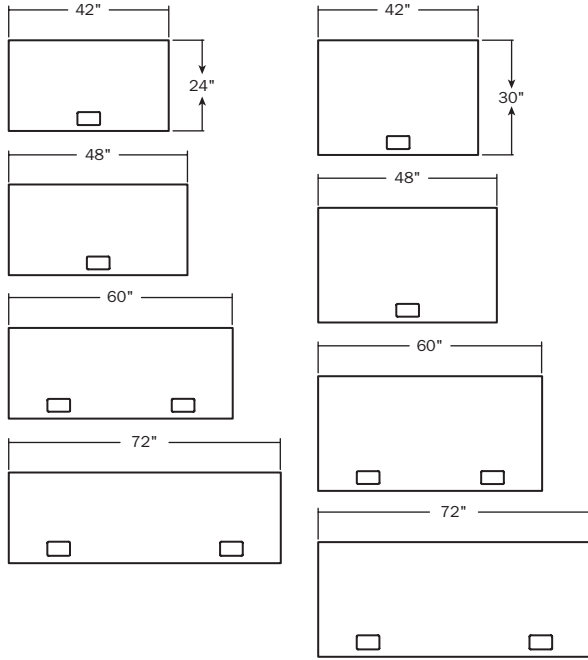

Wedge Linking Tables (includes linking kit)

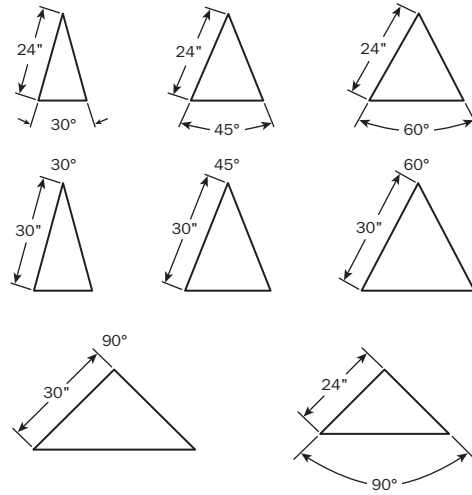

Trapezoid

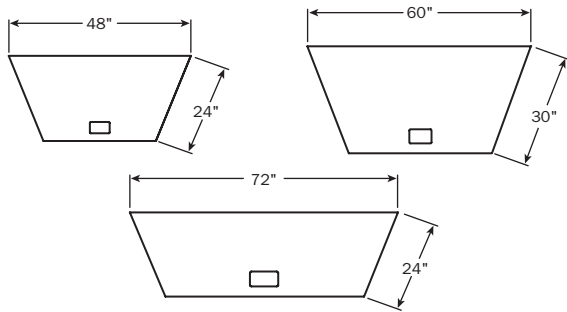

Quarter Round Linking Tables (includes linking kit)

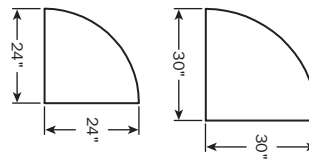

Half Round

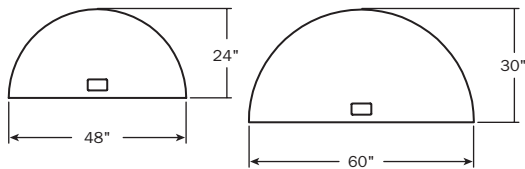

AV

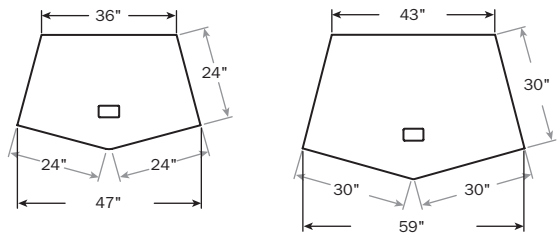

Power Kits



Full power and data packages with numerous interface options allow for Cruz tables to be rolled out, plugged in, and reconfigured.

Grommet

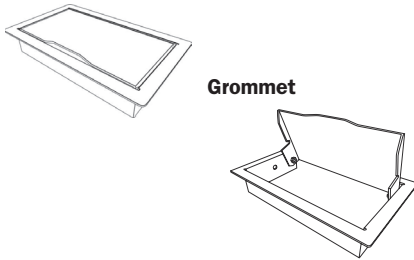
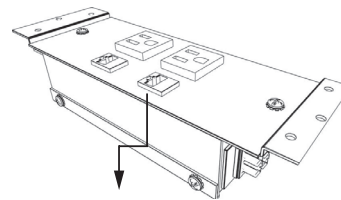

Figure 1



Optional data cut outs
(DJ-45 see page 302)

Cruz's electrical package (EP) offers single and double circuit capability. Data ports for easy internet access and equipment charging are also available.

Figure 2

With optional quick disconnect wall outlet.

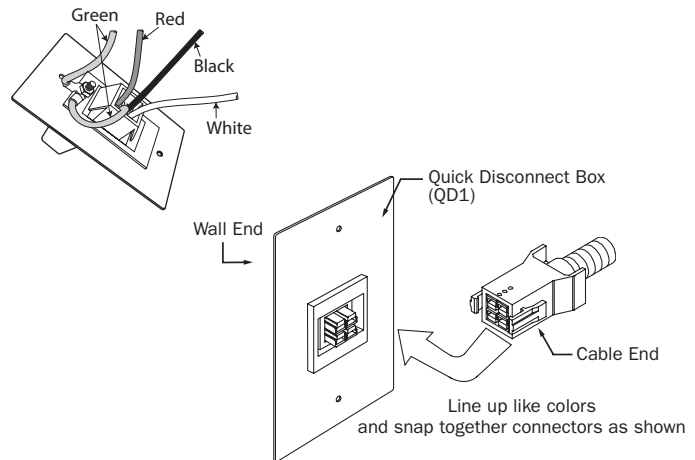

Cruz's power kit accommodates classroom or training room requirements with single or double circuit options, indicated by series of colored wires.

Included in the power kit:

- Power box with grommet
 - One box for 42", 48" rectangle tops, trapezoid, half round and AV
 - Two boxes for the 60" & 72" rectangle tops.
- Cables
 - One power box kit - Two cables are included; one for each end of the power box
 - Two power box kits - Three cables are included; one for each end of the table and one to connect the two boxes
- Wire Cable Clamps - to secure your wires to the underside of the table top
- Safety linking plate - screws the underside of the table top to secure the tables from being pulled apart accidentally and damaging electrical cables
- Black plastic electrical cover with wire management.

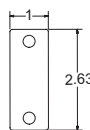

Single and Double Circuit Guide

Single Circuit

- For smaller rooms with limited electrical needs
- Each table's electrical components can be connected with cables and secured with safety linking brackets (linking brackets included, field installation required).
- Wedge and Quarter Rounds Linking Tables require jumper cables (EKJ-12) ordered separately, (U brackets included, field installation required).
- When connecting to building power; options include:
 - 1) Quick disconnect wall outlet
 - 2) 6' cable with standard 3-prong plug
 - 3) Hard wired into wall with cable extended from wall

Double Circuit

- For larger rooms with greater electrical needs
- Double circuit use requires a table grid with circuits assigned to alternating tables (see page 295)
(Example: Table 1 = circuit 1, Table 2 = circuit 2, Table 3 = circuit 1)
- When connecting to building power; options include:
 - 1) Quick disconnect wall outlet
 - 2) Hard wired into wall with cable extended from wall

Single and Double Circuit* Guide

- Each table's electrical components can be connected in the field with cables, and secured with safety linking brackets (linking brackets included, field installation required).
- Wedge and Quarter Round Linking Tables require jumper cables (EKJ-12) ordered separately, (U brackets included, field installation required).
- When connecting to building power; options include:
 - 1) Quick disconnect wall outlet*
 - 2) 6' cable with standard 3-prong plug - single circuit only; cannot be used with double circuit
 - 3) Hard wired into wall with cable extended from wall*

Single Circuit

- Use allows maximum flexibility for smaller rooms with limited electrical needs
- Up to 8 electrical units can be linked on a single circuit grid

Ex. 1

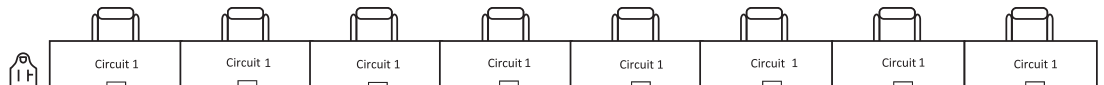

Double Circuit

- Use for larger rooms with greater electrical needs
- Up to 10 duplex units can be linked on a double circuit grid
- Double circuit use requires a table grid with circuits assigned to alternating tables, as shown

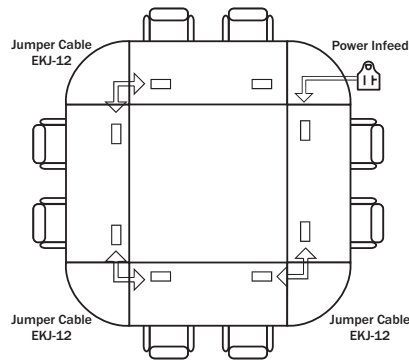
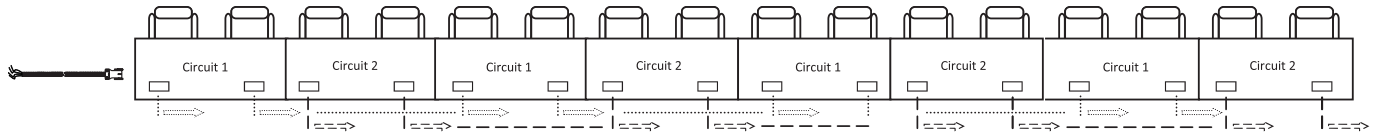

*NOTE: Double circuit building power source options must be wired to support double circuit configurations.

Non-Directional and Non-Sequential Electrical System

Cruz's non-directional, non-sequential electrical package allows virtually any configuration. In addition, table order is not limited by single or double circuit systems. Simply disconnect each table from the connecting table or wall outlet, change the configuration, and reconnect the tables to one another or to the wall. It's that simple!

Non-Directional

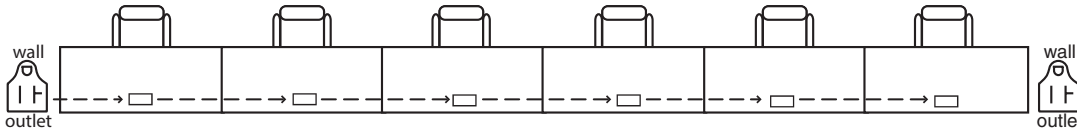

- Wall power in-feed cables can be attached to either end of the table configuration

Non-Sequential

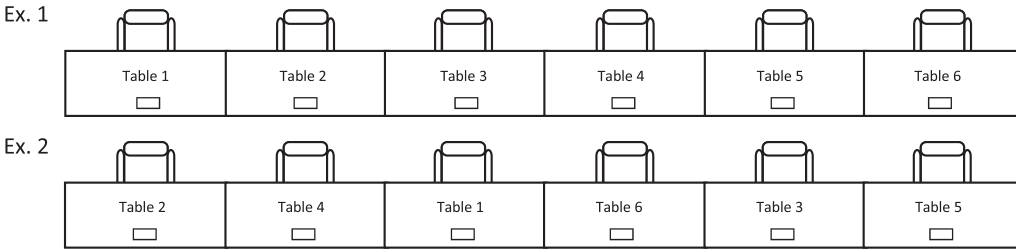

- Table order isn't a concern with Cruz's electrical system

Single and Double Circuit Options

- Quick disconnect wall outlet
- Hard wiring with cable extended from wall
- Building power source must be wired to support double circuit configurations

Double Circuit

- The electrical system is a four wire system consisting of two individual circuits. Each circuit is rated at 20 amps/120 volts maximum.
- Circuit 1 (black), and Circuit 2 (red) are served by a system neutral (white) and an equipment ground (green). Check with local codes before connecting to building.

Linking Kit

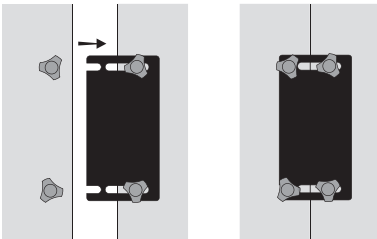

- Easy to install
- All table tops are pre-bored with inserts to accept field installed linking kit
- 4 black low profile knobs (2 for each table) with quick release flat plate
- 11 gauge steel
- Standard on Wedge and Quarter Round table tops

Wedge and Quarter Rounds linking tops are available in ten sizes. (See page 293) All linking tables include linking kits.



Wilsonart Standard Laminate Offering

For most up to date listing visit: wilsonart.com

PATTERN NAME	PATTERN NUMBER	PVC MATCH	PATTERN NAME	PATTERN NUMBER	PVC MATCH	PATTERN NAME	PATTERN NUMBER	PVC MATCH
Alabaster	D431-60	X	Hibiscus Cherry	7988-38		Saffron Tigris	4673-60	
Almond Leather	2932-60		Hollyberry	D307-60		Sand	D331-60	
Amazon	D478-60		Hunter Green	D79-60		Shadow	D96-60	X
Antique Brush	4823-60		Huntington Maple	7929-38		Shadow Trellis	4694-38	
Antique White	1572-60		Indigo	D379-60		Shadow Zephyr	4857-60	
Aqua Fizz	4934-38		Island	D498-60		Sheer Mesh	4876-38	
Arcade	4938-38		Karratha Brush	4744-60		Silicon Ev	4811-60	
Atlantis	D425-60		Kensington Maple	10776-60	X	Slate Grey	D91-60	X
Banister Oak	7806-60		Khaki	D50-60		Soft Gold Mesh	4911-38	
Basketweaving 101	4965-38		Kiwi	4917-60		Solar Oak	7816-60	
Basketweaving 202	4966-38		Legacy Blue	D417-60		Spiced Zephyr	4859-60	
Beige	1530-60		Light Beige	1531-60		Sprout	4918-60	
Beige Pampus	4170-60		Limber Maple	10734-60		Steel Mesh	4879-38	
Beigewood	7850-60		Linen	D427-60		Sterling Ash	7995-38	
Berry Fizz	4935-38		Loden Zephyr	4844-60		Sunshine	D499-60	
Black	1595-60	X	Lowell Ash	7994-38		Sweet Corn	4916-60	
Blue Agave	4919-60		Mangalore Mango	7984-38		Tan Soapstone	4887-38	
Boardwalk Oak	7983-38		Manitoba Maple	7911-60		Tangerine	4915-60	
Brazil Wood	7946-38	X	Maroochy Brush	4745-60		Tawny Legacy	4663-60	
Brittany Blue	D321-60		Midway	4936-38		Titanium Ev	4810-60	
Bronze Legacy	4656-60		Mission Maple	7990-38		Tungsten Ev	4814-60	
Buka Bark	7982-38		Mission Stone	4853-60		Tuscan Maple	7921-38	
Burnished Chestnut	4796-60		Misted Zephyr	4843-60		Twilight Zephyr	4845-60	
Caldera Beige	4608-60		Monticello Maple	7925-38		Urban Bronze	4967-38	
Canyon Zephyr	4842-60		Morelia Mango	7985-38		Urban Iron	4968-38	
Carbon Ev	4820-60		Morro Zephyr	4846-60		Venitian Ale	4930-60	
Carbon Mesh	4880-38		Natural Almond	D30-60		Venitian Ivory	4928-38	
Castle Oak	7928-38		Natural Cotton	4946-38		Wallaby	D439-60	
Casual Linen	4944-38		Natural Glace	4143-60		Western Bronze	4873-60	
Classic Linen	4943-38		Natural Nebula	4633-60		Western Storm	4872-60	
Cloud Nebula	4630-60		Natural Pear	7061-60		Western Suede	4871-60	
Cloud Zephyr	4856-60		Natural Recon	7996-38		Western White	4869-60	
Coffee Bean	D495-60		Natural Rift	7954-38		White	1570-60	
Cream Fizz	4933-38		Natural Tigris	4669-60		White Carrara	4924-38	
Crème	D456-60		Navy Legacy	4651-60		White Nebula	4621-60	
Crips Linen	4942-38		Neo Walnut	7991-38		White Sand	D403-60	
Denim Tracery	4961-38		New Age Oak	7938-38		White Tigris	4783-60	
Desert Zephyr	4841-60		Nickel Ev	4813-60		Wild Cherry	7054-60	
Designer White	D354-60	X	North Sea	D90-60		Windswept Bronze	4794-38	
Dove Grey	D92-60	X	Ocean	D502-60		Windswept Pewter	4795-60	
Ebony Recon	7997-38		Oiled Soapstone	4882-38		Woolamai Brush	4746-60	
Egg Plant	4913-60		Olive Legacy	4654-60				
Evening Tigris	4674-60		Orange Grove	D501-60				
Faded Trellis	4963-38		Organic Cotton	4945-38				
Fashion Grey	D381-60		Oxide	1787-60				
Flame Soapstone	4884-38		Palisades Oak	7987-38				
Flamingo	D467-60		Pampus	4166-60				
Florence Walnut	7993-38		Pasadena Oak	7986-38				
Fonthill Pear	10745-60		Pearl Soapstone	4886-38				
Frosty White	1573-60	X	Pepperdust	D327-60				
Fusion Maple	7909-60		Persian Cherry	7989-48				
Gesso Tracery	4962-38		Pewter Brush	4779-60				
Ginsing Tea	4909-60		Pewter Mesh	4878-38				
Graphite Nebula	4623-60		Pinball	4937-38				
Gray Glace	4142-60		Pinnacle Walnut	7992-38				
Gray Mesh	4877-38		Platinum	D315-60	X			
Gray Nebula	4622-60		Pomegranite	4914-60				
Gray Pampus	4168-60		Port	D14-60				
Green Soapstone	4885-38		Putty	1503-60				
Green Tigris	4667-60		Raw Cotton	4947-38				
Guilded Mesh	4912-38		River Cherry	7937-38				
Harvest Maple	7953-38		Rustic Slate	4888-38				
Haze	D97-60		Sable Soapstone	4883-38				

Contact Wilsonart at 800-433-3222 for samples of the laminates listed above.

Standard Community Laminates	
*Autumn (Collectors Cherry)	10826K-07
*Bourbon (Natural Cherry)	XM044-07
*Shea (Kensington Maple)	10776-60
*Vintage (Cafelle)	7933K-07

For samples of the four standard Community laminates call Customer Service at 800-622-5661.

For additional vendors please call Customer Service at 800-622-5661.

❶ **Model Number (shown at right)**

❷ **Base/Modesty**

- BSX Black Sandtex
- STS Stardust Silver

❸ **Top Material/Edge - Choose from Laminate options**

A) Laminate Specify standard Wilsonart Laminate choices - reference page 297

1) **LS** - Laminate with standard 3mm PVC eased edge - See applicable pricing column.

- ALB Alabaster
- AUT Autumn
- BLK Black
- BBN Bourbon (Natural Cherry)
- BZW Brazilwood
- DWH Designer White
- DOV Dove Grey
- FWH Frosty White
- PLT Platinum
- SHD Shadow
- SHE Shea (Kensington Maple)
- SLG Slate Grey
- VIN Vintage

2) **LP** - Laminate with premium metallic 2mm PVC eased edge - See applicable pricing column.

- ALU Aluminum
- TTM Titanium

❹ **Linking Kit Option**

- L Linking Kit

Add to list price:
\$52

❺ **Electrical Package Option***

*Grommet color options: **Black (B)** or **Silver (S)**

Rectangle 42"/48", AV, Trapezoid, Half Round **\$318**
 CRUZ-EP1C
 CRUZ-EP2C-1 (circuit 1)
 CRUZ-EP2C-2 (circuit 2)

Rectangle 60"/72" **\$491**
 CRUZ-EP1D
 CRUZ-EP2D-1 (circuit 1)
 CRUZ-EP2D-2 (circuit 2)

❻ **Power Infeed Cables**

- AP72 72" power infeed cable - 3 prong cable (cannot be used with double circuit package) \$207
- HP72 72" hardwire power infeed - Cable is hardwired to the wall \$167
- MP72 72" modular power infeed (must be used with QD1) \$155
- QD1 Quick disconnect wall outlet (must be used with MP72) \$78

Optional Electrical Accessories

(items ordered separately; see page 302 for details)







- DJ-45 Data Jack
- EJK-12 21" jumper cable for wedge and quarter round linking tops

TRAINING TABLE PACKAGES

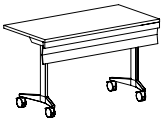
Example

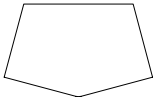
CZ2442CTT / STS / LS / 10826-07 / WH / L / EP1C

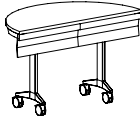
Model Number	CZ2442CTT
Base/Modesty/Optional Electrical Grommet	STS
Top Material/Edge	LS
Laminate Color (Specify Wilsonart and Edge colors)	10826-07 / WH
PRODUCT PRICE:	\$1,543
Optional Linking Kit (leave blank if this option is not selected)	L Add \$52
Optional Electrical Package (leave blank if this option is not selected)	CRUZ-EP1C Add \$318
TOTAL PRICE	\$1,913

Description	D	W	H (LS/LP)	CTN WT	CU FT	① Model	Standard PVC Edge (LS)	Premium PVC Edge (LP)
Rectangular  	24	42	29	71	11	CZ2442CTT	\$1,543	\$1,565
	24	48	29	78	12	CZ2448CTT	\$1,599	\$1,622
	24	60	29	90	14	CZ2460CTT	\$1,655	\$1,685
	24	72	29	106	16	CZ2472CTT	\$1,710	\$1,741
	30	42	29	78	12	CZ3042CTT	\$1,601	\$1,625
	30	48	29	85	13	CZ3048CTT	\$1,658	\$1,688
	30	60	29	97	15	CZ3060CTT	\$1,748	\$1,783
	30	72	29	116	18	CZ3072CTT	\$1,812	\$1,851
AV  	24	48	29	79	15	CZ2448CAT	\$1,850	\$1,893
	30	60	29	97	18	CZ3060CAT	\$2,042	\$2,098
Trapezoid  	24	48	29	78	12	CZ2448CZT	\$1,638	\$1,671
	24	72	29	106	16	CZ2472CZT	\$1,809	\$1,850
	30	60	29	97	15	CZ3060CZT	\$1,721	\$1,758
Half Round  	24	48	29	79	15	CZ2448CHT	\$1,550	\$1,577
	30	60	29	97	18	CZ3060CHT	\$1,759	\$1,797

Description	D	W	H (LS/LP)	CTN WT	CU FT	Model	Standard PVC Edge (LS)	Premium PVC Edge (LP)
Quarter Round Linking Top	24	24	1 3/16▲	21	2	CZ24QT	\$294	\$314
	30	30	1 3/16▲	30	3	CZ30QT	\$355	\$382

· linking brackets included

Wedge Linking Top	D	W	H (LS/LP)	CTN WT	CU FT	Model	Standard PVC Edge (LS)	Premium PVC Edge (LP)
	24	N/A	1 3/16▲	11	1	CZ24-30WT 30 degree	\$294	\$314
	24	N/A	1 3/16▲	16	1	CZ24-45WT 45 degree	\$300	\$321
	24	N/A	1 3/16▲	20	2	CZ24-60WT 60 degree	\$302	\$323
	24	N/A	1 3/16▲	28	2	CZ24-90WT 90 degree	\$327	\$350
	30	N/A	1 3/16▲	16	1	CZ30-30WT 30 degree	\$297	\$317
	30	N/A	1 3/16▲	24	2	CZ30-45WT 45 degree	\$327	\$350
	30	N/A	1 3/16▲	30	2	CZ30-60WT 60 degree	\$341	\$367
	30	N/A	1 3/16▲	42	3	CZ30-90WT 90 degree	\$393	\$422

· linking brackets included

Instructor's Cart	D	W	H (LS/LP)	CTN WT	CU FT	Model	Standard PVC Edge (LS)	Premium PVC Edge (LP)
	32	48	28-42	95	30	CZ3248CKT	\$2,106	\$2,145



cart without modesty panel



cart with modesty panel

- frame color: Black (B) or Silver (S)
- pneumatic lift height adjustability
- release handle under top activates adjustability
- locking casters
- optional modesty panel available - add \$288 list
- compatible with electrical units - EC10 or EC11; see page 299.5
- modesty panel must be ordered when adding electrical, specify and add \$288 list

Description	D	W	H	CTN WT	CU FT	Model	List Price
Flatscreen Cart	29	32	70	96	42	CZ2932FSTV	\$1,948



- for flat screen sizes from 32" to 60" diagonal screen
- optional electrical box - see next page (CZEP04)
- **TV not included**
- frame color: Black Sandtex (BSX) or Silver Bullet (SBL)
- shelf color: Black (B) or White (W)
- universal mount bracket will accommodate flat screens with a maximum fastener pattern of 15 3/4" vertical and horizontal
- 3" dual wheel, locking, black casters
- includes wire management in one leg; other hollow

Flatscreen Cart	29	38	70	101	42	CZ2938FSTV	\$2,061
-----------------	----	----	----	-----	----	-------------------	----------------



- for flat screen sizes from 40" to 60" diagonal screen
- optional electrical box - see next page (CZEP04)
- **TV not included**
- frame color: Black Sandtex (BSX) or Silver Bullet (SBL)
- shelf color: Black (B) or White (W)
- universal mount bracket will accommodate flat screens with a maximum fastener pattern of 15 3/4" vertical and 25 3/4" horizontal
- 3" dual wheel, locking, black casters
- includes wire management in one leg; other hollow

Description	D	W	H	CTN WT	CU FT	① Model	List Price
Visual Board Cart	22	41	74	161	42	CZ2241VB	\$2,171

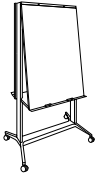

- frame color: Black Sandtex (BSX) or Silver Bullet (SBL)
- Wilsonart marker board laminate on both sides
- Expo® or Quartet® brand dry erase markers and cleaner recommended
- can also be used with paper pad
- 3" dual wheel, locking, black casters
- see website for cleaning instructions

Utility Cart	22	27	41	50	15	CZ2227UC	\$1,171
--------------	----	----	----	----	----	----------	---------







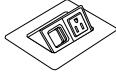
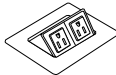
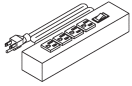

- frame color: Black Sandtex (BSX) or Silver Bullet (SBL)
- shelf color: Black (B) or White (W)
- optional electrical box - see below (CZEP04)
- 3" dual wheel, locking, black casters

Lectern Cart	16	28	42	66	17	CZ1628LEC	\$1,511
--------------	----	----	----	----	----	-----------	---------

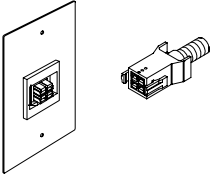

- frame color: Black Sandtex (BSX) or Silver Bullet (SBL)
- shelf color: Black (B) or White (W)
- optional electrical box - see below (CZEP04)
- two front casters, two back glides
- 3" dual wheel, locking, black casters

Description	D	W	H	CTN WT	CU FT	Model	List Price
Mini Grommet Power and Data Tilt Up  <ul style="list-style-type: none"> • for use with CZ3248CKT • fluid one touch tilt up access • one power receptacle - 120 volt; 15 amp with one voice/data port adapter to accept most jack manufacturers • 72" power cord with molded plug • drop in field installation required • UL listed component • specify Black (B) or Silver (S) 	4 ¼	5 ½		6		EC10	\$319 [▲]
Mini Power Tilt Up  <ul style="list-style-type: none"> • for use with CZ3248CKT • fluid one touch tilt up access • one power receptacle - 120 volt; 15 amp • 72" power cord with molded plug • drop in field installation required • UL listed component • specify Black (B) or Silver (S) 	4 ¼	5 ½		6		EC11	\$331
Electrical Box  <ul style="list-style-type: none"> • 4 power outlets • 6' cord • coordinates with: Flatscreen Cart Utility Cart Lectern Cart 						CZEP04	\$322

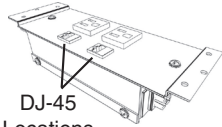
Description	CTN WT	CU FT	Model	List Price
Corner Electrical Jumper Cable  <ul style="list-style-type: none"> · 12" corner jumper cable · use for wedges, 90 degree corners and half round tables 			EJK-12	\$105
3 Prong Power Infeed  <ul style="list-style-type: none"> · 72" plug power infeed · 20 amps with 15 amp adapter/110 volts max · 3 prong plug · single circuit use only 			AP72	\$207
Hardwire Power Infeed  <ul style="list-style-type: none"> · 72" hardwire power infeed · 20 amps/120 volts max · single or two circuit 			HP72	\$167
Quick Disconnect Power Infeed  <ul style="list-style-type: none"> · must be used with QD1 · 72" modular power infeed · 20 amps/120 volts max · single or two circuit 			MP72	\$155
Modular Power Source  <ul style="list-style-type: none"> · must be used with MP72 · single or two circuit quick disconnect wall outlet box · electrician responsible for connection 			QD1	\$78
Data Port   <ul style="list-style-type: none"> · CAT6-RJ45 · 2 data port cut outs per power box · single unit price 	1	1	DJ-45	\$75

TABLES

The Prep Training Tables Collection offers rectangular tops with cantilevered tilt bases and fixed metal modesty panels. To help complete your configuration quarter round and wedge linking tops are available.

Training Table
Includes tilt top, modesty panel, two cantilevered tilt bases with casters.

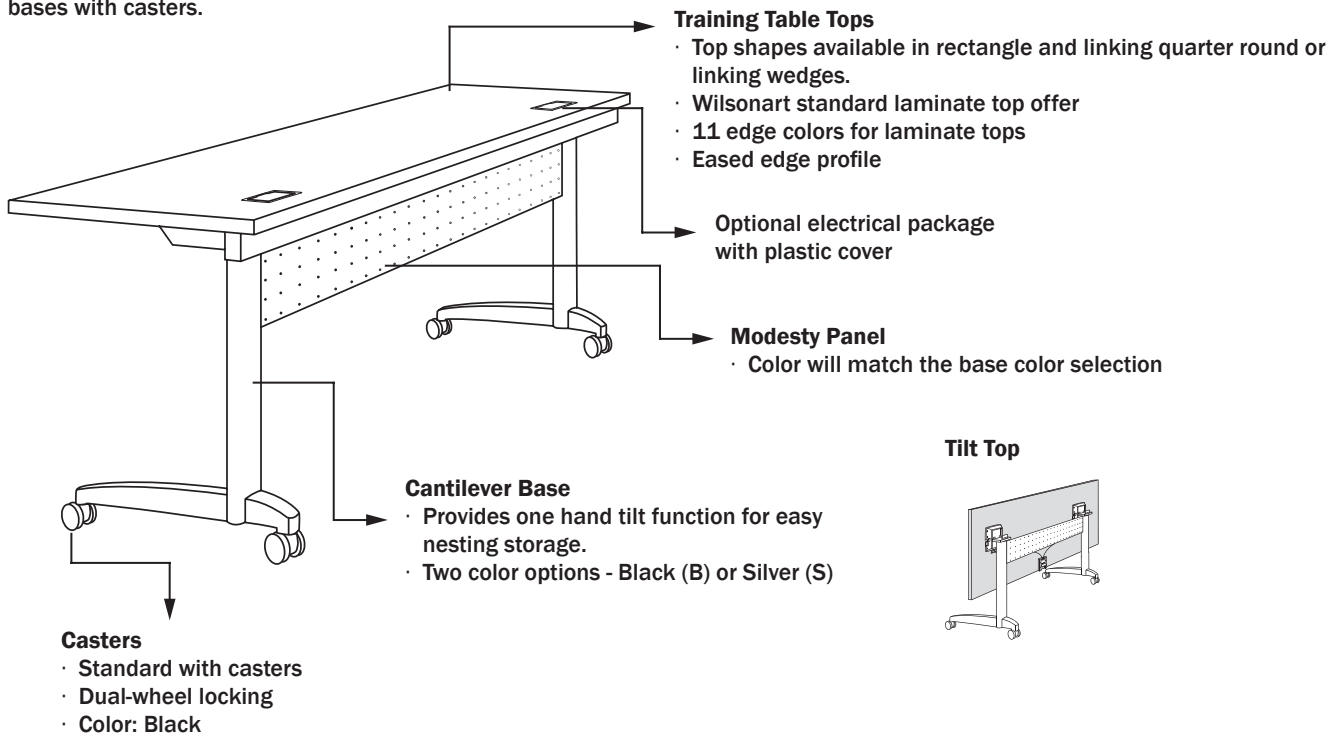

Vertical wire management attaches to the leg.
See page 283 for pricing.

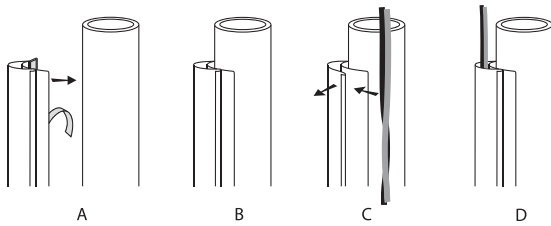

Space Planning Guidelines

(Table configuration includes top, modesty panel, and tilt top bases with casters)

Follow these easy steps to create an adaptable, mobile learning environment.

1. The first step, initial requirements

- A) Determine room configuration which will best fit your needs
- B) Determine seating capacity requirements

2. Determine the Top Shapes and Sizes, as well as the number of tops needed for the chosen table configuration.

(See page 306 for seating capacity options.)

A) Table Placement Guidelines

- 24"-30" per person
- 48" for aisles
- 48" from side walls
- 96"-120" for presenter between front wall and first row
- 48" between rows
- 84" from back wall
- 72" between round or square tables

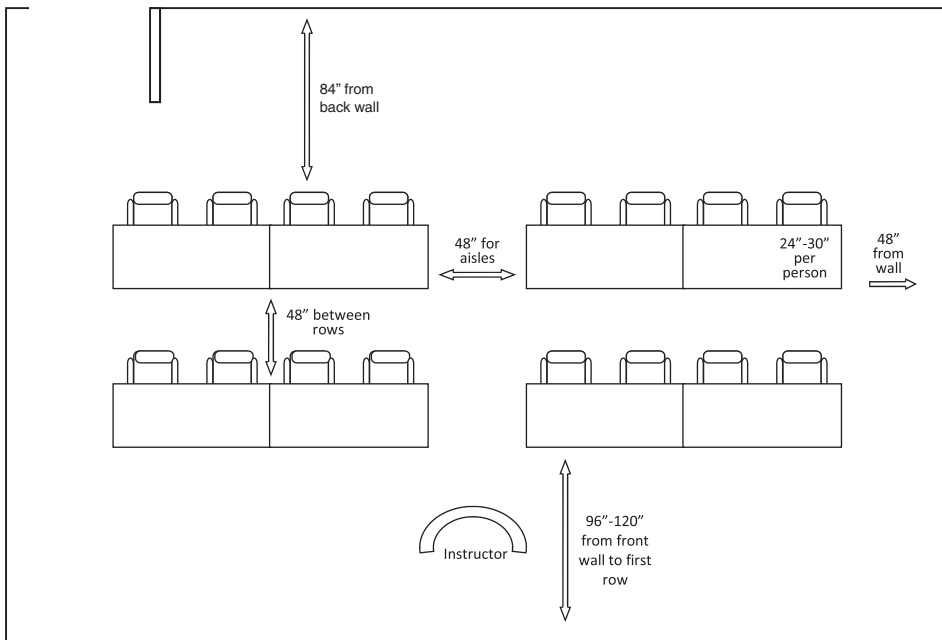

B) ADA Guidelines

- 34"-36" per wheelchair table space
- 24" minimum table depth
- 60"-72" between rows for wheelchairs to be placed back-to-back
- 36" minimum for wheelchair single passage
- 60" minimum for wheelchair double passage
- 60" minimum diameter to turn wheelchair
- 29" height accommodates newer wheelchairs; however, some wheelchairs require 32" height.

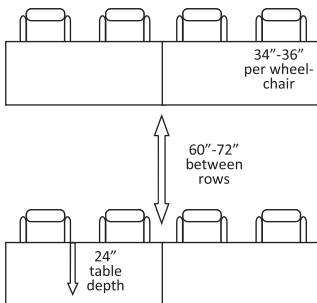

3. Select Base Color, Top Material and Edge Color

A) Base Color

- BSX - Black Sandtex
- STS - Stardust Silver

B) Top Material

- LS - Laminate with standard 3mm PVC eased edge (For standard laminate list, see page 311)
- LP - Laminate with premium metallic 2mm PVC eased edge

C) Edge Color

<u>Standard Colors</u>		<u>Premium Colors</u>	
ALB	Alabaster	ALU	Aluminum
AUT	Autumn	TTM	Titanium
BLK	Black		
BZW	Brazilwood		
BBN	Bourbon (Natural Cherry)		
DWH	Designer White		
DOV	Dove Grey		
FWH	Frosty White		
PLT	Platinum		
SHD	Shadow		
SHE	Shea (Kensington Maple)		
SLG	Slate Grey		
VIN	Vintage		

4. Table Options

A) Linking Kits

- All table tops are pre-bored with inserts for linking tops.

B) Power Kit Options

- Table size will determine your standard power and grommet location.
- Single or double circuit available
- Optional data ports

NOTE: Training Tables includes tilt top, modesty panel, two bases with casters



Community offers single or double circuit electrical units to meet classroom technology demands. See Power and Data pages 308-310. Please contact our customer service department for assistance at 800-622-5661.

Seating Capacity Options

For other seating requirements, select different configurations that are compatible with classroom size and capacity.

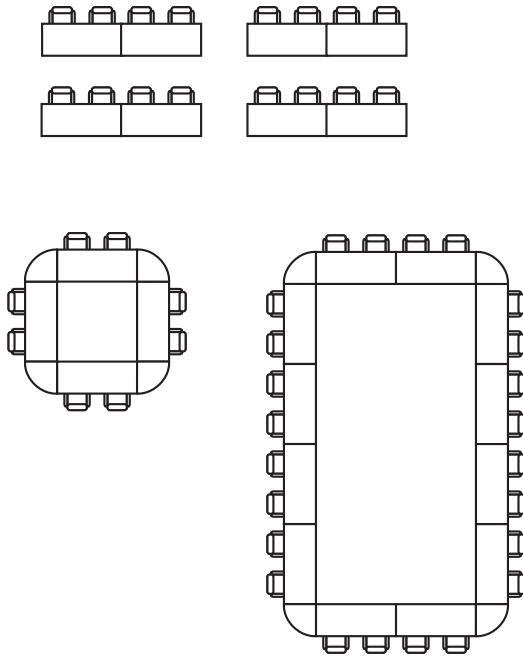
TYPICALS



Rectangular Top		
	PR2448CTT	24" x 48"
	PR2460CTT	24" x 60"
	PR2472CTT	24" x 72"
	PR3048CTT	30" x 48"
	PR3060CTT	30" x 60"
	PR3072CTT	30" x 72"
Quarter Round Linking Top		
	PR24QT	24" x 24"
	PR30QT	30" x 30"
Wedge Linking Top		
	PR24-30WT	24" - 30 degree
	PR24-45WT	24" - 45 degree
	PR24-60WT	24" - 60 degree
	PR24-90WT	24" - 90 degree
	PR30-30WT	30" - 30 degree
	PR30-45WT	30" - 45 degree
	PR30-60WT	30" - 60 degree
	PR30-90WT	30" - 90 degree

Top Shapes and Sizes with Corresponding Optional Grommet Locations

Rectangle

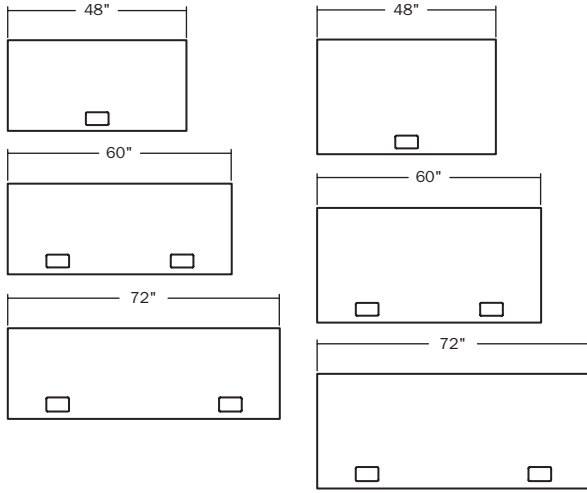

Wedge Linking Tables (includes linking kit)

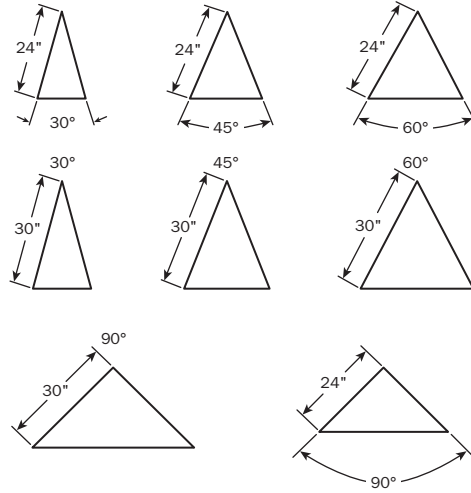

Quarter Round Linking Tables (includes linking kit)

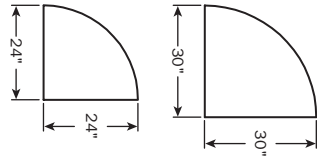

Power Kits



Full power and data packages with numerous interface options allow for Prep tables to be rolled out, plugged in, and reconfigured.

Grommet

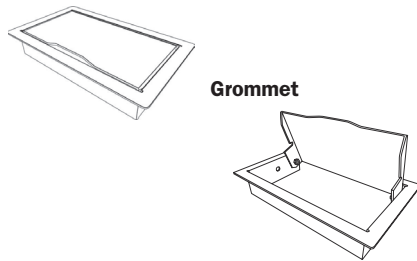
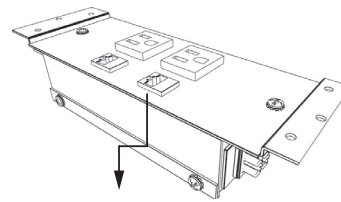

Figure 1



Optional data cut outs
(DJ-45 see page 314)

Prep's electrical package (EP) offers single and double circuit capability. Data ports for easy internet access and equipment charging are also available.

Figure 2

With optional quick disconnect wall outlet.

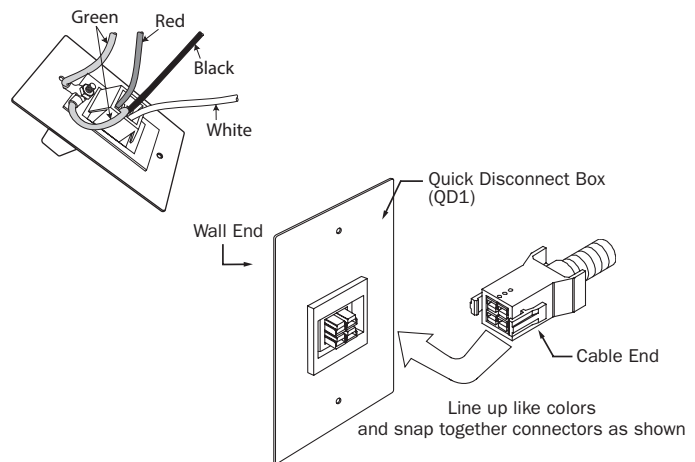

Prep's power kit accommodates classroom or training room requirements with single or double circuit options, indicated by series of colored wires.

Included in the power kit:

- Power box with grommet
 - One box for 42", 48" rectangle tops, trapezoid, half round and AV
 - Two boxes for the 60" & 72" rectangle tops.
- Cables
 - One power box kit - Two cables are included; one for each end of the power box
 - Two power box kits - Three cables are included; one for each end of the table and one to connect the two boxes
- Wire Cable Clamps - to secure your wires to the underside of the table top
- Safety linking plate - screws the underside of the table top to secure the tables from being pulled apart accidentally and damaging electrical cables
- Black plastic electrical cover with wire management.

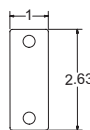

Single and Double Circuit Guide

Single Circuit

- For smaller rooms with limited electrical needs
- Each table's electrical components can be connected with cables and secured with safety linking brackets (linking brackets included, field installation required).
- Wedge and Quarter Rounds Linking Tables require jumper cables (EKJ-12) ordered separately, (U brackets included, field installation required).
- When connecting to building power; options include:
 - 1) Quick disconnect wall outlet
 - 2) 6' cable with standard 3-prong plug
 - 3) Hard wired into wall with cable extended from wall

Double Circuit

- For larger rooms with greater electrical needs
- Double circuit use requires a table grid with circuits assigned to alternating tables (see page 309)
(Example: Table 1 = circuit 1, Table 2 = circuit 2, Table 3 = circuit 1)
- When connecting to building power; options include:
 - 1) Quick disconnect wall outlet
 - 2) Hard wired into wall with cable extended from wall

Single and Double Circuit* Guide

- Each table's electrical components can be connected in the field with cables, and secured with safety linking brackets (linking brackets included, field installation required).
- Wedge and Quarter Round Linking Tables require jumper cables (EKJ-12) ordered separately, (U brackets included, field installation required).
- When connecting to building power; options include:
 - 1) Quick disconnect wall outlet - must have MP72 infeed*
 - 2) 6' cable with standard 3-prong plug - single circuit only; cannot be used with double circuit
 - 3) Hard wired into wall with cable extended from wall*

Single Circuit

- Use allows maximum flexibility for smaller rooms with limited electrical needs
- Up to 8 duplex units can be linked on a single circuit system

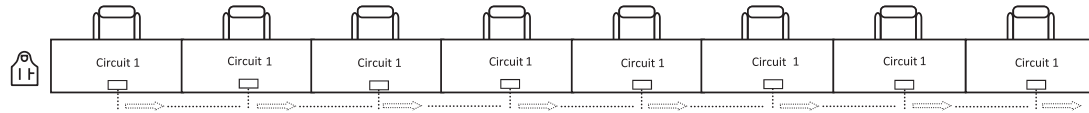

Double Circuit

- Use for larger rooms with greater electrical needs
- Up to 16 duplex units can be linked on a 20 amp double circuit grid
- Double circuit use requires a table grid with circuits assigned to alternating tables, as shown

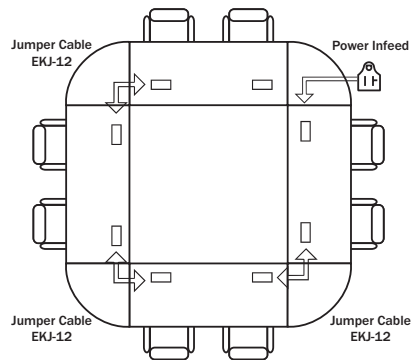
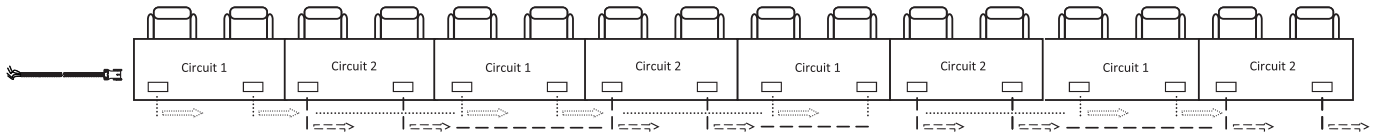

*NOTE: Double circuit building power source options must be wired to support double circuit configurations.

Non-Directional and Non-Sequential Electrical System

Prep's non-directional, non-sequential electrical package allows virtually any configuration. In addition, table order is not limited by single or double circuit grids. Simply disconnect each table from the connecting table or wall outlet, change the configuration, and reconnect the tables to one another or to the wall. It's that simple!

Non-Directional

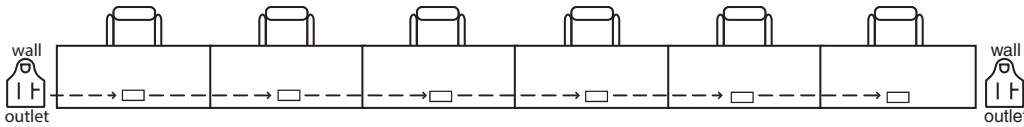

- Wall power in-feed cables can be attached to either end of the table configuration

Non-Sequential

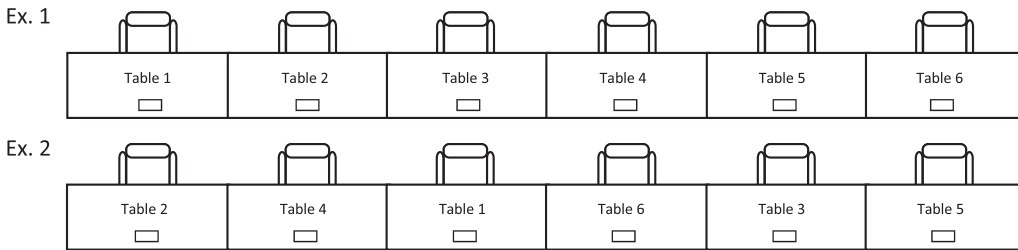

- Table order isn't a concern with Prep's electrical system

Single and Double Circuit Options

- Quick disconnect wall outlet - must have MP72 infeed
- Hard wiring with cable extended from wall
- Building power source must be wired to support double circuit configurations

Double Circuit

- The electrical system is a four wire system consisting of two individual circuits. Each circuit is rated at 20 amps/120 volts maximum.
- Circuit 1 (black), and Circuit 2 (red) are served by a system neutral (white) and an equipment ground (green). Check with local codes before connecting to building.

Linking Kit

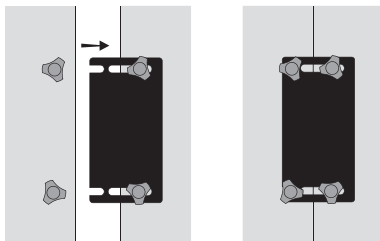

- Easy to install
- All table tops are pre-bored with inserts to accept field installed linking kit
- 4 black low profile knobs (2 for each table) with quick release flat plate
- 11 gauge steel
- Standard on Wedge and Quarter Round table tops

Wedge and Quarter Rounds linking tops are available. (See page 307.) All linking tables include linking kits.



Wilsonart Standard Laminate Offering

For most up to date listing visit: wilsonart.com

PATTERN NAME	PATTERN NUMBER	PVC MATCH	PATTERN NAME	PATTERN NUMBER	PVC MATCH	PATTERN NAME	PATTERN NUMBER	PVC MATCH
Alabaster	D431-60	X	Hibiscus Cherry	7988-38		Saffron Tigris	4673-60	
Almond Leather	2932-60		Hollyberry	D307-60		Sand	D331-60	
Amazon	D478-60		Hunter Green	D79-60		Shadow	D96-60	X
Antique Brush	4823-60		Huntington Maple	7929-38		Shadow Trellis	4694-38	
Antique White	1572-60		Indigo	D379-60		Shadow Zephyr	4857-60	
Aqua Fizz	4934-38		Island	D498-60		Sheer Mesh	4876-38	
Arcade	4938-38		Karratha Brush	4744-60		Silicon Ev	4811-60	
Atlantis	D425-60		Kensington Maple	10776-60	X	Slate Grey	D91-60	X
Banister Oak	7806-60		Khaki	D50-60		Soft Gold Mesh	4911-38	
Basketweaving 101	4965-38		Kiwi	4917-60		Solar Oak	7816-60	
Basketweaving 202	4966-38		Legacy Blue	D417-60		Spiced Zephyr	4859-60	
Beige	1530-60		Light Beige	1531-60		Sprout	4918-60	
Beige Pampus	4170-60		Limber Maple	10734-60		Steel Mesh	4879-38	
Beigewood	7850-60		Linen	D427-60		Sterling Ash	7995-38	
Berry Fizz	4935-38		Loden Zephyr	4844-60		Sunshine	D499-60	
Black	1595-60	X	Lowell Ash	7994-38		Sweet Corn	4916-60	
Blue Agave	4919-60		Mangalore Mango	7984-38		Tan Soapstone	4887-38	
Boardwalk Oak	7983-38		Manitoba Maple	7911-60		Tangerine	4915-60	
Brazil Wood	7946-38	X	Maroochy Brush	4745-60		Tawny Legacy	4663-60	
Brittany Blue	D321-60		Midway	4936-38		Titanium Ev	4810-60	
Bronze Legacy	4656-60		Mission Maple	7990-38		Tungsten Ev	4814-60	
Buka Bark	7982-38		Mission Stone	4853-60		Tuscan Maple	7921-38	
Burnished Chestnut	4796-60		Misted Zephyr	4843-60		Twilight Zephyr	4845-60	
Caldera Beige	4608-60		Monticello Maple	7925-38		Urban Bronze	4967-38	
Canyon Zephyr	4842-60		Morelia Mango	7985-38		Urban Iron	4968-38	
Carbon Ev	4820-60		Morro Zephyr	4846-60		Venitian Ale	4930-60	
Carbon Mesh	4880-38		Natural Almond	D30-60		Venitian Ivory	4928-38	
Castle Oak	7928-38		Natural Cotton	4946-38		Wallaby	D439-60	
Casual Linen	4944-38		Natural Glace	4143-60		Western Bronze	4873-60	
Classic Linen	4943-38		Natural Nebula	4633-60		Western Storm	4872-60	
Cloud Nebula	4630-60		Natural Pear	7061-60		Western Suede	4871-60	
Cloud Zephyr	4856-60		Natural Recon	7996-38		Western White	4869-60	
Coffee Bean	D495-60		Natural Rift	7954-38		White	1570-60	
Cream Fizz	4933-38		Natural Tigris	4669-60		White Carrara	4924-38	
Crème	D456-60		Navy Legacy	4651-60		White Nebula	4621-60	
Crips Linen	4942-38		Neo Walnut	7991-38		White Sand	D403-60	
Denim Tracery	4961-38		New Age Oak	7938-38		White Tigris	4783-60	
Desert Zephyr	4841-60		Nickel Ev	4813-60		Wild Cherry	7054-60	
Designer White	D354-60	X	North Sea	D90-60		Windswept Bronze	4794-38	
Dove Grey	D92-60	X	Ocean	D502-60		Windswept Pewter	4795-60	
Ebony Recon	7997-38		Oiled Soapstone	4882-38		Woolamai Brush	4746-60	
Egg Plant	4913-60		Olive Legacy	4654-60				
Evening Tigris	4674-60		Orange Grove	D501-60				
Faded Trellis	4963-38		Organic Cotton	4945-38				
Fashion Grey	D381-60		Oxide	1787-60				
Flame Soapstone	4884-38		Palisades Oak	7987-38				
Flamingo	D467-60		Pampus	4166-60				
Florence Walnut	7993-38		Pasadena Oak	7986-38				
Fonthill Pear	10745-60		Pearl Soapstone	4886-38				
Frosty White	1573-60	X	Pepperdust	D327-60				
Fusion Maple	7909-60		Persian Cherry	7989-48				
Gesso Tracery	4962-38		Pewter Brush	4779-60				
Ginsing Tea	4909-60		Pewter Mesh	4878-38				
Graphite Nebula	4623-60		Pinball	4937-38				
Gray Glace	4142-60		Pinnacle Walnut	7992-38				
Gray Mesh	4877-38		Platinum	D315-60	X			
Gray Nebula	4622-60		Pomegranite	4914-60				
Gray Pampus	4168-60		Port	D14-60				
Green Soapstone	4885-38		Putty	1503-60				
Green Tigris	4667-60		Raw Cotton	4947-38				
Guilded Mesh	4912-38		River Cherry	7937-38				
Harvest Maple	7953-38		Rustic Slate	4888-38				
Haze	D97-60		Sable Soapstone	4883-38				

Contact Wilsonart at 800-433-3222 for samples of the laminates listed above.

Standard Community Laminates

*Autumn (Collectors Cherry)	10826K-07
*Bourbon (Natural Cherry)	XM044-07
*Shea (Kensington Maple)	10776-60
*Vintage (Cafelle)	7933K-07

For samples of the four standard Community laminates call Customer Service at 800-622-5661.

For additional vendors please call Customer Service at 800-622-5661.

1 Model Number (shown at right)

2 Base/Modesty

- BSX Black Sandtex
- STS Stardust Silver

3 Top Material

- LS - Laminate with standard 3mm PVC eased edge (For standard laminate list, see page 311)
- LP - Laminate with premium metallic 2mm PVC eased edge

4 Edge Color

- | | |
|------------------------------|-----------------------|
| <u>Standard colors</u> | <u>Premium colors</u> |
| ALB Alabaster | ALU Aluminum |
| AUT Autumn | TTM Titanium |
| BLK Black | |
| BBN Bourbon (Natural Cherry) | |
| BZW Brazilwood | |
| DWH Designer White | |
| DOV Dove Grey | |
| FWH Frosty White | |
| PLT Platinum | |
| SHD Shadow | |
| SHE Shea (Kensington Maple) | |
| SLG Slate Grey | |
| VIN Vintage | |

5 Linking Kit Option

- L Linking Kit

Add to list price:
\$52

6 Electrical Package Option*

*Grommet color options: **Black (B)** or **Silver (S)**

Rectangle 42"/48", AV, Trapezoid, Half Round

PREP-EP1C

PREP-EP2C-1 (circuit 1)

PREP-EP2C-2 (circuit 2)

\$318

Rectangle 60"/72"

PREP-EP1D

PREP-EP2D-1 (circuit 1)

PREP-EP2D-2 (circuit 2)

\$491

7 Power Infeed Cables

AP72 72" power infeed cable - 3 prong cable (cannot be used with double circuit package)

HP72 72" hardwire power infeed - Cable is hardwired to the wall

MP72 72" modular power infeed (must be used with QD1)

QD1 Quick disconnect wall outlet (must be used with MP72)

\$207
\$167
\$155
\$78

Optional Electrical Accessories

(items ordered separately; see page 314 for details)

DJ-45 Data Jack



EJK-12 12" jumper cable

TRAINING TABLE PACKAGES

Example

PR2448CTT / STS / LS / 10745-60 / ST / L / EP1C

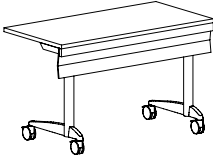
Model Number	PR2448CTT
Base/Modesty/Optional Electrical Grommet	STS
Top Material/Edge	LS
Laminate Color (Specify Wilsonart and Edge colors)	10745-60 / ST
PRODUCT PRICE:	\$1,465
Optional Linking Kit (leave blank if this option is not selected)	L Add \$52
Optional Power Kit (leave blank if this option is not selected)	PREP-EP1C Add \$318
TOTAL PRICE	\$1,835



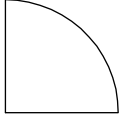





Description	D	W	H (LS/LP)	CTN WT	CU FT	Model	Standard PVC Edge (LS)	Premium PVC Edge (LP)
 	24	48	29	65	9	PR2448CTT	\$1,465	\$1,489
	30	48	29	71	10	PR3048CTT	\$1,525	\$1,553
	24	60	29	75	10	PR2460CTT	\$1,537	\$1,565
	24	72	29	85	11	PR2472CTT	\$1,611	\$1,645
	30	60	29	82	11	PR3060CTT	\$1,630	\$1,665
	30	72	29	94	13	PR3072CTT	\$1,714	\$1,751

Description	D	W	H (LS/LP)	CTN WT	CU FT	Model	Standard PVC Edge (LS)	Premium PVC Edge (LP)
	24	24	1 3/16	21	2	PR24QT	\$298	\$318
	30	30	1 3/16	30	3	PR30QT	\$359	\$385

· linking brackets included

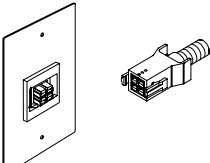
Description	D	W	H (LS/LP)	CTN WT	CU FT	Model	Standard PVC Edge (LS)	Premium PVC Edge (LP)
	24	N/A	1 3/16	11	1	PR24-30WT 30 degree	\$298	\$318
	24	N/A	1 3/16	16	1	PR24-45WT 45 degree	\$303	\$324
	24	N/A	1 3/16	20	2	PR24-60WT 60 degree	\$305	\$326
	24	N/A	1 3/16	28	2	PR24-90WT 90 degree	\$330	\$353
	30	N/A	1 3/16	16	1	PR30-30WT 30 degree	\$300	\$320
	30	N/A	1 3/16	24	2	PR30-45WT 45 degree	\$330	\$353
	30	N/A	1 3/16	30	2	PR30-60WT 60 degree	\$344	\$370
	30	N/A	1 3/16	42	3	PR30-90WT 90 degree	\$396	\$425

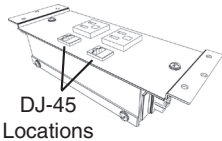
· linking brackets included

Description	CTN WT	CU FT	Model	List Price
Corner Electrical Jumper Cable  <ul style="list-style-type: none"> · 12" corner jumper cable · use for wedges, 90 degree corners and half round tables 			EJK-12	\$105
3 Prong Power Infeed  <ul style="list-style-type: none"> · 72" plug power infeed · 20 amps with 15 amp adapter/110 volts max · 3 prong plug · single circuit use only 			AP72	\$207
Hardwire Power Infeed  <ul style="list-style-type: none"> · 72" hardwire power infeed · 20 amps/120 volts max · single or two circuit 			HP72	\$167
Quick Disconnect Power Infeed  <ul style="list-style-type: none"> · must be used with QD1 · 72" modular power infeed · 20 amps/120 volts max · single or two circuit 			MP72	\$155
Modular Power Source  <ul style="list-style-type: none"> · must be used with MP72 · single or two circuit quick disconnect wall outlet box · electrician responsible for connection 			QD1	\$78
Data Port   <ul style="list-style-type: none"> · CAT6-RJ45 · 2 data port cut outs per power box · single unit price 	1	1	DJ-45	\$75
Vertical Wire Management  <ul style="list-style-type: none"> · available in Black (B) or Silver (S) · field installed 	1	1	AVL20	\$52

TABLES

Lounge Tables Overview



Callaway 316



Encore 318



Laurel 322



Lincoln 324

Callaway Lounge Tables Order Check List:



Specify:

- 1. Model Number
- 2. Top Material - Veneer (W) or Laminate (L)
- 3. Wood Species - Cherry (CH1), Maple (MA1), Oak (OK1) or Walnut (WA1) ▲
- 4. Wood Finish/Color
- 5. Edge Profile
- 6. Leg Style - Square (S)
- 7. Optional Premium or Specialty Laminate Tops Available - contact customer service for pricing

Top core material is 1 1/8" thick with 45 lb. density industrial grade particle board. The face is wood veneer or horizontal grade high pressure laminate (HPL). A backer is bonded to bottom side to ensure balanced construction. All tops have internal solid lumber bands with overlay laminate or veneer.

Examples:

CA2828-16 | W | MA1 | AUB | B | S
(model #) | (top material) | (wood species) | (finish) | (edge) | (leg style)

1. Model Number

2. Top Material - Veneer (W) or Laminate (L) - Finishes below with an asterisk (*) have a coordinating laminate available.

3. Wood Species - Cherry (CH1), Maple (MA1), Oak (OK1) or Walnut (WA1) ▲

4. Wood Finish/Color Options:

Cherry

- | | |
|---------------|--------------|
| AUT Autumn* | EAR Earthy |
| BRL Barley* | LGC Legacy* |
| BBN Bourbon* | PRL Praline* |
| BRG Brighton* | SAF Saffron* |
| CLA Classic* | |

Maple

- ALE Ale*
- BUT Butterscotch
- CIN Cinnamon*
- FLX Flax
- VEN Venetian*

Oak

- | | |
|--------------|----------------|
| BRW Brownie* | ECU Ecu* |
| CAN Canyon* | HEN Henna* |
| CIT Citron* | HNY Honey* |
| DES Desert* | NUT Nut Brown* |

Walnut

- | | |
|----------------|--------------|
| AUB Auburn* | SIE Sienna* |
| ESP Espresso | TOF Toffee* |
| MCH Mocha* | TRF Truffle* |
| NTO Night Owl* | |

Color - Add \$31 list per item

- | | |
|------------------|----------------------|
| BKD Backdrop | GRV Greek Villa |
| BFX Black Fox | GLF Gulf Stream |
| BWH Bright White | HTB Heartthrob |
| CGP Cargo Pants | NET Network Gray |
| CHT Chatroom | NWH Nonchalant White |
| DSY Daisy | PAR Paradise |
| DRG Daring | QXP Quixotic Plum |
| DYN Dynamo | RBZ Relic Bronze |
| ENG Enigma | SND Sandbank |
| FRR French Roast | STM Storm |
| GBY Georgian Bay | TRC Tricorn Black |

5. Edge Profile Options:

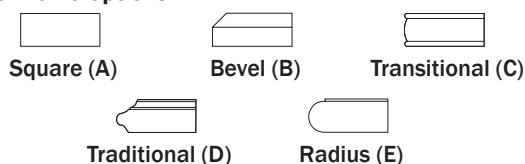

6. Leg Style - Square (S)

7. Optional Premium or Specialty Laminate Tops Available - contact customer service for pricing.

TABLES

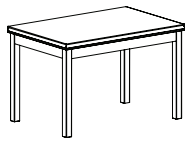
Description	D	W	H	CTN WT	CU FT	① Model	List Price
	20	30	16	34		CA2030-16	\$647
	20	48	16	46		CA2048-16	\$659
	20	30	20	34		CA2030-20	\$669
	20	48	20	46		CA2048-20	\$683
· ships KD							

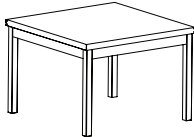
	28	28	16	38		CA2828-16	\$629
	28	28	20	38		CA2828-20	\$655
· ships KD							

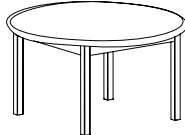
	36	N/A	16	42		CA36-16	\$779
	36	N/A	20	42		CA36-20	\$802
· ships KD							

To Order, Specify:

- ① Model Number
- ② Top Material - Veneer (W) or Laminate (L)
- ③ Wood Species - Cherry (CH1), Maple (MA1), Oak (OK1) or Walnut (WA1) ▲
- ④ Wood Finish/Color
- ⑤ Edge Profile
- ⑥ Leg Style - Square (S)
- ⑦ Optional Premium or Specialty Laminate Tops
Available - contact customer service for pricing

④ Wood Finish/Color Options:

Cherry		Maple	
AUT	Autumn*	ALE	Ale*
BRL	Barley*	BUT	Butterscotch
BBN	Bourbon*	CIN	Cinnamon*
BRG	Brighton*	FLX	Flax
CLA	Classic*	VEN	Venetian*
EAR	Earthy		
LGC	Legacy*		
PRL	Praline*		
SAF	Saffron*		
Oak		Walnut	
BRW	Brownie*	AUB	Auburn*
CAN	Canyon*	ESP	Espresso
CIT	Citron*	MCH	Mocha*
DES	Desert*	NTO	Night Owl*
ECU	Ecu*	SIE	Sienna*
HEN	Henna*	TOF	Toffee*
HNY	Honey*	TRF	Truffle*
NUT	Nut Brown*		

Color - Add \$31 list per item

BKD	Backdrop	GRV	Greek Villa
BFX	Black Fox	GLF	Gulf Stream
BWH	Bright White	HTB	Heartthrob
CGP	Cargo Pants	NET	Network Gray
CHT	Chatroom	NWH	Nonchalant White
DSY	Daisy	PAR	Paradise
DRG	Daring	QXP	Quixotic Plum
DYN	Dynamo	RBZ	Relic Bronze
ENG	Enigma	SND	Sandbank
FRR	French Roast	STM	Storm
GBY	Georgian Bay	TRC	Tricorn Black

⑤ Edge Profile Options:



Specifications

- Wood species - Cherry, Maple, Oak or Walnut.
- Top core material is 1 1/8" thick with 45 lb. density industrial grade particle board.
- Face is wood veneer or horizontal grade HPL.
- Backer is bonded to bottom side to ensure balanced construction.
- All tops have internal solid lumber bands with overlay laminate or veneer.

Encore Lounge Tables Order Check List:



Specify:

- 1. Model Number
- 2. Top Material - Veneer (W) or Laminate (L)
- 3. Wood Species - Maple (M)
- 4. Wood Finish/Color
- 5. Leg Style - Disk or Column
- 6. Leg Color - Black Sandtex (BSX) or Stardust Silver (STS)
- 7. Optional Coordinating Wood Grain Laminate Tops - no upcharge

Examples:

EN2142 (model #)	W (top material)	M (wood species)	AUB (finish)	COLUMN (leg style)	SILVER (metal color)
----------------------------	----------------------------	----------------------------	------------------------	------------------------------	--------------------------------

1. Model Number

2. Top Material - Veneer (W) or Laminate (L) - Finishes with an asterisk (*) have a coordinating laminate available.

3. Wood Species - Maple (M)

4. Wood Finish/Color Options: ▲

ALE Ale*	FLX Flax
AUB Auburn*	HEN Henna*
AUT Autumn*	HNY Honey*
BRL Barley*	LGC Legacy*
BBN Bourbon*	MCH Mocha*
BRG Brighton*	NTO Night Owl*
BRW Brownie*	NUT Nut Brown*
BUT Butterscotch	PRL Praline*
CAN Canyon*	SAF Saffron*
CIN Cinnamon*	SIE Sienna*
CIT Citron*	TOF Toffee*
CLA Classic*	TRF Truffle*
DES Desert*	VEN Venetian*
EAR Earthy	
ESP Espresso	

Color - Add \$31 list per item

BKD Backdrop	GRV Greek Villa
BFX Black Fox	GLF Gulf Stream
BWH Bright White	HTB Heartthrob
CGP Cargo Pants	NET Network Gray
CHT Chatroom	NWH Nonchalant White
DSY Daisy	PAR Paradise
DRG Daring	QXP Quixotic Plum
DYN Dynamo	RBZ Relic Bronze
ENG Enigma	SND Sandbank
FRR French Roast	STM Storm
GBY Georgian Bay	TRC Tricorn Black

5. Leg Style Options:

Table Leg Style



Table Disk Leg
• adjustable height

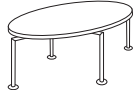

Table Column Leg
• fixed height

6. Leg Color - Black Sandtex (BSX) or Stardust Silver (STS)

***7. Optional Coordinating Wood Grain Laminate Tops - no upcharge. Finishes with an asterisk (*) have a coordinating laminate available. For additional laminate offering contact Customer Service.**

Description	D	W	H	CTN WT	CU FT	1 Model	List Price
Oval Magazine Table	21 1/2	42 1/2	17	25	3	EN2142	\$1,017



· ships KD

Round Magazine Table	36 1/2	N/A	17	28	4	EN36R	\$944
----------------------	--------	-----	----	----	---	-------	-------



	30 1/2	N/A	17	25	3	EN30R	\$919
--	--------	-----	----	----	---	-------	-------

· ships KD

Rectangular Magazine Table	24 1/2	48 1/2	17	30	4	EN2448	\$889
----------------------------	--------	--------	----	----	---	--------	-------



· ships KD

Square End Table	30 3/4	30 3/4	22 1/4	25	3	EN3030-22	\$861
------------------	--------	--------	--------	----	---	-----------	-------



	24 3/4	24 3/4	22 1/4	20	3	EN2424-22	\$748
--	--------	--------	--------	----	---	-----------	-------

· ships KD

Square Magazine Table	30 3/4	30 3/4	17	25	3	EN3030-17	\$839
-----------------------	--------	--------	----	----	---	-----------	-------

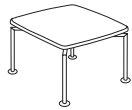

	24 3/4	24 3/4	17	20	3	EN2424-17	\$729
--	--------	--------	----	----	---	-----------	-------

· ships KD

To Order, Specify:

- 1 Model Number
- 2 Top Material - Veneer (W) or Laminate (L)
- 3 Wood Species - Maple (M)
- 4 Wood Finish/Color
- 5 Leg Style - Disk or Column
- 6 Leg Color - Black Sandtex (BSX) or Stardust Silver (STS)
- 7 Optional Coordinating Wood Grain Laminate Tops - no upcharge. Finishes with an asterisk have a coordinating laminate available.

4 Wood Finish/Color Options: ▲

- | | |
|------------------|----------------|
| ALE Ale* | FLX Flax |
| AUB Auburn* | HEN Henna* |
| AUT Autumn* | HNY Honey* |
| BRL Barley* | LGC Legacy* |
| BBN Bourbon* | MCH Mocha* |
| BRG Brighton* | NTO Night Owl* |
| BRW Brownie* | NUT Nut Brown* |
| BUT Butterscotch | PRL Praline* |
| CAN Canyon* | SAF Saffron* |
| CIN Cinnamon* | SIE Sienna* |
| CIT Citron* | TOF Toffee* |
| CLA Classic* | TRF Truffle* |
| DES Desert* | VEN Venetian* |
| EAR Earthy | |
| ESP Espresso | |

Color - Add \$31 list per item

- | | |
|------------------|----------------------|
| BKD Backdrop | GRV Greek Villa |
| BFX Black Fox | GLF Gulf Stream |
| BWH Bright White | HTB Heartthrob |
| CGP Cargo Pants | NET Network Gray |
| CHT Chatroom | NWH Nonchalant White |
| DSY Daisy | PAR Paradise |
| DRG Daring | QXP Quixotic Plum |
| DYN Dynamo | RBZ Relic Bronze |
| ENG Enigma | SND Sandbank |
| FRR French Roast | STM Storm |
| GBY Georgian Bay | TRC Tricorn Black |

Specifications

- Wood species - Maple.
- Plywood construction with spiral grooved solid wood dowels, glue and screws.
- Some assembly required.

Oval Magazine Table

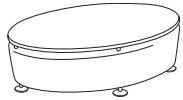

EN2142B

- upholstered base
- metal spacers will match leg color

Dimensions	D	W	H
Overall	21 ½	42 ½	17
Upholstery		Shipping	
COM Ydg	1 ¾	Ctn Wt	56
COL Sq Ft	35	Cu Ft	10

COM	\$1,213
A	\$1,229
B	\$1,259
COL/C	\$1,313
D	\$1,381
E	\$1,449
F	\$1,522
G	\$1,624
H	\$1,734
I	\$1,905
J	\$2,110
L1	\$1,699
L2	\$1,822

Round Magazine Table

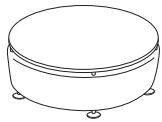

EN36RB

- upholstered base
- metal spacers will match leg color

Dimensions	D	W	H
Overall	36 ½	36 ½	17
Upholstery		Shipping	
COM Ydg	3	Ctn Wt	75
COL Sq Ft	60	Cu Ft	14

COM	\$1,149
A	\$1,175
B	\$1,228
COL/C	\$1,319
D	\$1,437
E	\$1,553
F	\$1,677
G	\$1,854
H	\$2,041
I	\$2,335
J	\$2,686
L1	\$1,983
L2	\$2,194

Round Magazine Table

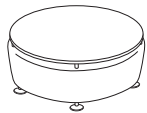

EN30RB

- upholstered base
- metal spacers will match leg color

Dimensions	D	W	H
Overall	30 ½	30 ½	17
Upholstery		Shipping	
COM Ydg	2	Ctn Wt	58
COL Sq Ft	40	Cu Ft	11

COM	\$1,124
A	\$1,142
B	\$1,176
COL/C	\$1,237
D	\$1,316
E	\$1,394
F	\$1,477
G	\$1,593
H	\$1,718
I	\$1,915
J	\$2,149
L1	\$1,679
L2	\$1,820

Square Magazine Table

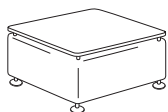

EN3030-17B

- upholstered base
- metal spacers will match leg color

Dimensions	D	W	H
Overall	30 ¾	30 ¾	17
Upholstery		Shipping	
COM Ydg	3	Ctn Wt	78
COL Sq Ft	60	Cu Ft	11

COM	\$1047
A	\$1,074
B	\$1,126
COL/C	\$1,217
D	\$1,335
E	\$1,452
F	\$1,575
G	\$1,752
H	\$1,939
I	\$2,233
J	\$2,585
L1	\$1,881
L2	\$2,092

Square Magazine Table

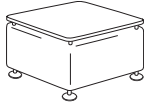

EN2424-17B

- upholstered base
- metal spacers will match leg color

Dimensions	D	W	H
Overall	24 ¾	24 ¾	17
Upholstery		Shipping	
COM Ydg	2	Ctn Wt	58
COL Sq Ft	40	Cu Ft	8

COM	\$955
A	\$973
B	\$1,007
COL/C	\$1,068
D	\$1,147
E	\$1,225
F	\$1,308
G	\$1,424
H	\$1,549
I	\$1,746
J	\$1,980
L1	\$1,510
L2	\$1,651

Square End Table

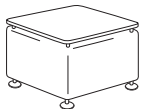

EN2424-22B

- upholstered base
- metal spacers will match leg color

Dimensions	D	W	H
Overall	24 ¾	24 ¾	22
Upholstery		Shipping	
COM Ydg	2 ½	Ctn Wt	65
COL Sq Ft	43	Cu Ft	10

COM	\$960
A	\$979
B	\$1,016
COL/C	\$1,081
D	\$1,164
E	\$1,247
F	\$1,335
G	\$1,459
H	\$1,592
I	\$1,800
J	\$2,049
L1	\$1,550
L2	\$1,700

To Order, Specify:

- Model Number
- Top Material - Veneer (W) or Laminate (L)
- Wood Species - Maple (M)
- Wood Finish/Color
- Fabric Selection - Vendor, Pattern and Color
- Leg Style - Disk or Column
- Leg Color - Black Sandtex (BSX) or Stardust Silver (STS)
- Optional Coordinating Wood Grain Laminate Tops - no upcharge. Finishes with an asterisk have a coordinating laminate available.

4 Wood Finish/Color Options: ▲

ALE	Ale*	FLX	Flax
AUB	Auburn*	HEN	Henna*
AUT	Autumn*	HNY	Honey*
BRL	Barley*	LGC	Legacy*
BBN	Bourbon*	MCH	Mocha*
BRG	Brighton*	NTO	Night Owl*
BRW	Brownie*	NUT	Nut Brown*
BUT	Butterscotch	PRL	Praline*
CAN	Canyon*	SAF	Saffron*
CIN	Cinnamon*	SIE	Sienna*
CIT	Citron*	TOF	Toffee*
CLA	Classic*	TRF	Truffle*
DES	Desert*	VEN	Venetian*
EAR	Earthy		
ESP	Espresso		

Color - Add \$31 list per item

BKD	Backdrop	GRV	Greek Villa
BFX	Black Fox	GLF	Gulf Stream
BWH	Bright White	HTB	Heartthrob
CGP	Cargo Pants	NET	Network Gray
CHT	Chatroom	NWH	Nonchalant White
DSY	Daisy	PAR	Paradise
DRG	Daring	QXP	Quixotic Plum
DYN	Dynamo	RBZ	Relic Bronze
ENG	Enigma	SND	Sandbank
FRR	French Roast	STM	Storm
GBY	Georgian Bay	TRC	Tricorn Black

Specifications

- Wood species - Maple.
- Upholstered bases have 4 ½" high density polyurethane foam.
- Plywood construction with spiral grooved solid wood dowels, glue and screws.
- Some assembly required.

- See a selection of graded in fabric manufacturers and patterns on pages 12-20. Contact customer service for additional fabric options.

Laurel Lounge Tables Order Check List:



Specify:

- 1. Model Number
- 2. Top Material - Veneer (W) or Laminate (L)
- 3. Wood Species - Maple (M)
- 4. Wood Finish/Color
- 5. Leg Style - Tapered (T).
- 6. Optional Coordinating Wood Grain Laminate Tops - no upcharge

Top core material is 1 1/8" thick with 45 lb. density industrial grade particle board. The face is wood veneer or horizontal grade high pressure laminate (HPL). A backer is bonded to bottom side to ensure balanced construction. All tops have internal solid lumber bands with overlay laminate or veneer.

Examples:

LA2424ET | W | M | AUB | T
 (model #) | (top material) | (wood species) | (finish) | (leg style)

1. Model Number

2. Top Material - Veneer (W) or Laminate (L) - Finishes with an asterisk (*) have a coordinating laminate available.

3. Wood Species - Maple (M)

4. Wood Finish/Color Options: ▲

ALE Ale*	FLX Flax
AUB Auburn*	HEN Henna*
AUT Autumn*	HNY Honey*
BRL Barley*	LGC Legacy*
BBN Bourbon*	MCH Mocha*
BRG Brighton*	NTO Night Owl*
BRW Brownie*	NUT Nut Brown*
BUT Butterscotch	PRL Praline*
CAN Canyon*	SAF Saffron*
CIN Cinnamon*	SIE Sienna*
CIT Citron*	TOF Toffee*
CLA Classic*	TRF Truffle*
DES Desert*	VEN Venetian*
EAR Earthy	
ESP Espresso	

Color - Add \$31 list per item

BKD Backdrop	GRV Greek Villa
BFX Black Fox	GLF Gulf Stream
BWH Bright White	HTB Heartthrob
CGP Cargo Pants	NET Network Gray
CHT Chatroom	NWH Nonchalant White
DSY Daisy	PAR Paradise
DRG Daring	QXP Quixotic Plum
DYN Dynamo	RBZ Relic Bronze
ENG Enigma	SND Sandbank
FRR French Roast	STM Storm
GBY Georgian Bay	TRC Tricorn Black

5. Leg Style - Tapered (T)

6. Optional Coordinating Wood Grain Laminate Tops - no upcharge. Finishes with an asterisk (*) have a coordinating laminate available.

Description	D	W	H	CTN WT	CU FT	① Model	List Price
End Table	30	30	17	55	4	LA3030ET	\$689

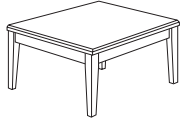

	24	24	17	35	3	LA2424ET	\$588
--	----	----	----	----	---	----------	-------

· ships KD

Magazine Table	20	42	17	51	4	LA2042MT	\$696
----------------	----	----	----	----	---	----------	-------

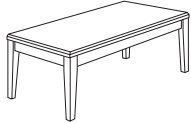

· ships KD

Corner Table	36	36	17	79	5	LA3636CT	\$809
--------------	----	----	----	----	---	----------	-------



· ships KD

To Order, Specify:

- ① Model Number
- ② Top Material - Veneer (W) or Laminate (L)
- ③ Wood Species - Maple (M)
- ④ Wood Finish/Color
- ⑤ Leg Style - Tapered (T)
- ⑥ Optional Coordinating Wood Grain Laminate Tops - no upcharge. Finishes with an asterisk have a coordinating laminate available.

④ Wood Finish/Color Options:▲

ALE Ale*	FLX Flax
AUB Auburn*	HEN Henna*
AUT Autumn*	HNY Honey*
BRL Barley*	LGC Legacy*
BBN Bourbon*	MCH Mocha*
BRG Brighton*	NTO Night Owl*
BRW Brownie*	NUT Nut Brown*
BUT Butterscotch	PRL Praline*
CAN Canyon*	SAF Saffron*
CIN Cinnamon*	SIE Sienna*
CIT Citron*	TOF Toffee*
CLA Classic*	TRF Truffle*
DES Desert*	VEN Venetian*
EAR Earthy	
ESP Espresso	

Color - Add \$31 list per item

BKD Backdrop	GRV Greek Villa
BFX Black Fox	GLF Gulf Stream
BWH Bright White	HTB Heartthrob
CGP Cargo Pants	NET Network Gray
CHT Chatroom	NWH Nonchalant White
DSY Daisy	PAR Paradise
DRG Daring	QXP Quixotic Plum
DYN Dynamo	RBZ Relic Bronze
ENG Enigma	SND Sandbank
FRR French Roast	STM Storm
GBY Georgian Bay	TRC Tricorn Black

Specifications

- Wood species - Maple.
- Top core material is 1 1/8" thick with 45 lb. density industrial grade particle board.
- Face is wood veneer or horizontal grade HPL.
- Backer is bonded to bottom side to ensure balanced construction.
- All tops have internal solid lumber bands with overlay laminate or veneer.
- Tapered leg style.

Lincoln Lounge Tables Order Check List:



Specify:

- 1. Model Number
- 2. Top Material - Veneer (W) or Laminate (L)
- 3. Wood Species - Cherry (CH1) , Maple (MA1), Oak (OK1) or Walnut (WA1) ▲
- 4. Wood Finish/Color
- 5. Edge Profile
- 6. Leg Style - Straight Wood (S) or Tapered Wood (T)
- 7. Optional Premium or Specialty Laminate Tops Available - contact customer service for pricing

Top core material is 1 1/8" thick with 45 lb. density industrial grade particle board. The face is wood veneer or horizontal grade high pressure laminate (HPL). A backer is bonded to bottom side to ensure balanced construction. All tops have internal solid lumber bands with overlay laminate or veneer. Legs use a corner block application with a 3" straight apron.

Examples:

LI2042-16 | W | MA1 | MC | B | T
(model #) | (top material) | (wood species) | (finish) | (edge) | (leg style)

1. Model Number

2. Top Material - Veneer (W) or Laminate (L) - Finishes with an asterisk (*) have a coordinating laminate available.

3. Wood Species - Cherry (CH1), Maple (MA1), Oak (OK1) or Walnut (WA1) ▲

4. Wood Finish/Color Options:

Cherry

- | | |
|---------------|--------------|
| AUT Autumn* | EAR Earthy |
| BRL Barley* | LGC Legacy* |
| BBN Bourbon* | PRL Praline* |
| BRG Brighton* | SAF Saffron* |
| CLA Classic* | |

Maple

- ALE Ale*
- BUT Butterscotch
- CIN Cinnamon*
- FLX Flax
- VEN Venetian*

Oak

- | | |
|--------------|----------------|
| BRW Brownie* | ECU Ecu* |
| CAN Canyon* | HEN Henna* |
| CIT Citron* | HNY Honey* |
| DES Desert* | NUT Nut Brown* |

Walnut

- | | |
|----------------|--------------|
| AUB Auburn* | SIE Sienna* |
| ESP Espresso | TOF Toffee* |
| MCH Mocha* | TRF Truffle* |
| NTO Night Owl* | |

Color - Add \$31 list per item

- | | |
|------------------|----------------------|
| BKD Backdrop | GRV Greek Villa |
| BFX Black Fox | GLF Gulf Stream |
| BWH Bright White | HTB Heartthrob |
| CGP Cargo Pants | NET Network Gray |
| CHT Chatroom | NWH Nonchalant White |
| DSY Daisy | PAR Paradise |
| DRG Daring | QXP Quixotic Plum |
| DYN Dynamo | RBZ Relic Bronze |
| ENG Enigma | SND Sandbank |
| FRR French Roast | STM Storm |
| GBY Georgian Bay | TRC Tricorn Black |

5. Edge Profile Options:

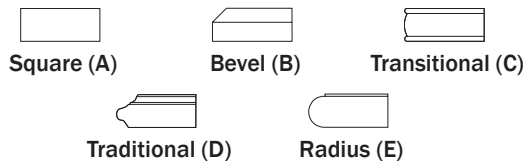

6. Leg Style - Straight Wood (S) or Tapered Wood (T)

NOTE: Legs use a corner block application with a 3" straight apron.

7. Optional Premium or Specialty Laminate Tops Available - contact customer service for pricing.

Description	D	W	H	CTN WT	CU FT	① Model	List Price
Rectangular	20	42	16	75		LI2042-16	\$533

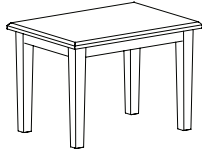

	20	28	20	65		LI2028-20	\$438
--	----	----	----	----	--	-----------	-------

Square	24	24	20	48		LI2424-20	\$486
--------	----	----	----	----	--	-----------	-------

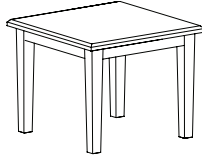

To Order, Specify:

- ① Model Number
- ② Top Material - Veneer (W) or Laminate (L)
- ③ Wood Species - Cherry (CH1), Maple (MA1), Oak (OK1) or Walnut (WA1) ▲
- ④ Wood Finish/Color
- ⑤ Edge Profile
- ⑥ Leg Style - Straight Wood (S) or Tapered Wood (T)
- ⑦ Optional Premium or Specialty Laminate Tops
Available - contact customer service for pricing

④ Wood Finish/Color Options:

Cherry	Maple
AUT Autumn*	ALE Ale*
BRL Barley*	BUT Butterscotch
BBN Bourbon*	CIN Cinnamon*
BRG Brighton*	FLX Flax
CLA Classic*	VEN Venetian*
EAR Earthy	
LGC Legacy*	
PRL Praline*	
SAF Saffron*	
Oak	Walnut
BRW Brownie*	AUB Auburn*
CAN Canyon*	ESP Espresso
CIT Citron*	MCH Mocha*
DES Desert*	NTO Night Owl*
ECU Ecru*	SIE Sienna*
HEN Henna*	TOF Toffee*
HNY Honey*	TRF Truffle*
NUT Nut Brown*	

Color - Add \$31 list per item

BKD Backdrop	GRV Greek Villa
BFX Black Fox	GLF Gulf Stream
BWH Bright White	HTB Heartthrob
CGP Cargo Pants	NET Network Gray
CHT Chatroom	NWH Nonchalant White
DSY Daisy	PAR Paradise
DRG Daring	QXP Quixotic Plum
DYN Dynamo	RBZ Relic Bronze
ENG Enigma	SND Sandbank
FRR French Roast	STM Storm
GBY Georgian Bay	TRC Tricorn Black

⑤ Edge Profile Options:



Specifications

- Wood species - Cherry, Maple, Oak or Walnut.
- Top core material is 1 1/8" thick with 45 lb. density industrial grade particle board.
- Face is wood veneer or horizontal grade HPL.
- Backer is bonded to bottom side to ensure balanced construction.
- All tops have internal solid lumber bands with overlay laminate or veneer.

NOTES

Children's Overview



Addison 328



Calculus 329



Class Act 332



Classmate 336



Classmate II 342



Collegian 347



Jefferson 352



Lincoln 355

Addison Children's Order Check List:



Coordinating adult collection. See page 36.

Specify:

- 1. Model Number
- 2. Wood Species - Oak (O) or Maple (M)
- 3. Wood Finish/Color
- 4. Fabric Selection - vendor, pattern and color
- 5. Optional Rubber Cushion Nylon Glides - no upcharge

Example:

356C (model #)	O (wood species)	HEN (finish)	MOMENTUM (fabric vendor)	VOX (pattern name)	MYSTIC (pattern color)
--------------------------	----------------------------	------------------------	------------------------------------	------------------------------	----------------------------------

1. Model Number

2. Wood Species - Oak (O) or Maple (M)

3. Wood Finish/Color Options:

Oak			
BRW	Brownie	ECU	Ecru
CAN	Canyon	HEN	Henna
CIT	Citron	HNY	Honey
DES	Desert	NUT	Nut Brown

Maple			
ALE	Ale	FLX	Flax
AUB	Auburn	LGC	Legacy
AUT	Autumn	MCH	Mocha
BRL	Barley	NTO	Night Owl
BBN	Bourbon	PRL	Praline
BRG	Brighton	SAF	Saffron
BUT	Butterscotch	SIE	Sienna
CIN	Cinnamon	TOF	Toffee
CLA	Classic	TRF	Truffle
EAR	Earthy	VEN	Venetian
ESP	Espresso		

Color - Add \$31 list per item

BKD	Backdrop	GRV	Greek Villa
BFX	Black Fox	GLF	Gulf Stream
BWH	Bright White	HTB	Heartthrob
CGP	Cargo Pants	NET	Network Gray
CHT	Chatroom	NWH	Nonchalant White
DSY	Daisy	PAR	Paradise
DRG	Daring	QXP	Quixotic Plum
DYN	Dynamo	RBZ	Relic Bronze
ENG	Enigma	SND	Sandbank
FRR	French Roast	STM	Storm
GBY	Georgian Bay	TRC	Tricorn Black

4. Fabric Selection - Please supply the following:

- Vendor name
- Pattern name
- Pattern color

All COM orders must include the following:

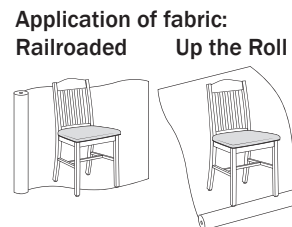

- Vendor's name, pattern name and color
- Sample of the fabric attached to order
- Model numbers of items for fabric application
- Special application instructions (e.g., all stripes will be applied front to back unless specified otherwise)
- Customer and purchase order number

Ship prepaid C.O.M material to:
Community
Attn: COM Dept
932 Mill Street
Jasper, IN 47546



All C.O.M. orders will ship at standard lead time from receipt of C.O.M. except for orders requiring special custom matched finishes.

5. Optional Rubber Cushion Nylon Glides - no upcharge

Description	① Model	Specifications				List Price Per Grade	
		Dimensions	D	W	H		
Armless   356A all wood	356A All Wood 356C Uph. Seat	Overall	15	15	29	All Wood	\$282
		Seat	13	15	16	COM	\$345
 356C uph. seat		Upholstery		Shipping		A	\$357
		COM Ydg	¾	Ctn Wt	13	B	\$370
		COL Sq Ft	9	Cu Ft	6	COL/C	\$393
						D	\$423
						E	\$452
						F	\$482
						G	\$527
						H	\$574
						I	\$646
						J	\$734
						L1	\$535
						L2	\$582

To Order, Specify:

- ① Model Number
- ② Wood Species - Oak (O) or Maple (M)
- ③ Wood Finish/Color
- ④ Fabric Selection - vendor, pattern and color
- ⑤ Optional Rubber Cushion Nylon Glides - no upcharge

④ Wood Finish/Color Options:

Oak		ECU	Ecu
BRW	Brownie	HEN	Henna
CAN	Canyon	HNY	Honey
CIT	Citron	NUT	Nut Brown
DES	Desert		
Maple		FLX	Flax
ALE	Ale	LGC	Legacy
AUB	Auburn	MCH	Mocha
AUT	Autumn	NTO	Night Owl
BRL	Barley	PRL	Praline
BBN	Bourbon	SAF	Saffron
BRG	Brighton	SIE	Sienna
BUT	Butterscotch	TOF	Toffee
CIN	Cinnamon	TRF	Truffle
CLA	Classic	VEN	Venetian
EAR	Earthy		
ESP	Espresso		

Color - Add \$31 list per item

BKD	Backdrop	GRV	Greek Villa
BFX	Black Fox	GLF	Gulf Stream
BWH	Bright White	HTB	Heartthrob
CGP	Cargo Pants	NET	Network Gray
CHT	Chatroom	NWH	Nonchalant White
DSY	Daisy	PAR	Paradise
DRG	Daring	QXP	Quixotic Plum
DYN	Dynamo	RBZ	Relic Bronze
ENG	Enigma	SND	Sandbank
FRR	French Roast	STM	Storm
GBY	Georgian Bay	TRC	Tricorn Black

Specifications

- Wood species - Oak or Maple.
- Seat is upholstered with 1 ½" polyurethane foam and synthetic sheet webbing for added comfort.
- Mortise and tenon construction with corner blocks, glue and screws.
- Standard with rubber cushion metal glides.
- Coordinating adult collection. See page 36.

④ See a selection of graded in fabric manufacturers and patterns on pages 12-20. Contact Customer Service for additional fabric options.

Calculus Children's Order Check List:



Coordinating adult collection. See page 80.

Specify:

- 1. Model Number
- 2. Wood Species - Oak (O)
- 3. Wood Finish/Color
- 4. Fabric Selection - vendor, pattern and color
- 5. Optional Linking Brackets - add \$26 list per chair
- 6. Optional Laser Engraving Back Imprint - specify location and size

Example:

43C (model #)	O (wood species)	HEN (finish)	MOMENTUM (fabric vendor)	VOX (pattern name)	MYSTIC (pattern color)
-------------------------	----------------------------	------------------------	------------------------------------	------------------------------	----------------------------------

1. Model Number

2. Wood Species - Oak (O)

3. Wood Finish/Color Options:

BRW Brownie	ECU Ecru
CAN Canyon	HEN Henna
CIT Citron	HNY Honey
DES Desert	NUT Nut Brown

Color - Add \$31 list per item; not available with laser engraving option

BKD Backdrop	GRV Greek Villa
BFX Black Fox	GLF Gulf Stream
BWH Bright White	HTB Heartthrob
CGP Cargo Pants	NET Network Gray
CHT Chatroom	NWH Nonchalant White
DSY Daisy	PAR Paradise
DRG Daring	QXP Quixotic Plum
DYN Dynamo	RBZ Relic Bronze
ENG Enigma	SND Sandbank
FRR French Roast	STM Storm
GBY Georgian Bay	TRC Tricorn Black

4. Fabric Selection - Please supply the following:

- Vendor name
- Pattern name
- Pattern color

When specifying contrasting upholstery, indicate clearly the upholstery to be applied to the seat and back. Use higher grade pricing.

- Indicate direction of fabric - Railroaded or Up the Roll
- Please provide illustration, if available

All COM orders must include the following:

- Vendor's name, pattern name and color
- Sample of the fabric attached to order
- Model numbers of items for fabric application
- Special application instructions (e.g., all stripes will be applied front to back unless specified otherwise)
- Customer and purchase order number

Ship prepaid COM material to:
Community
Attn: COM Dept
932 Mill Street
Jasper, IN 47546

Application of fabric:
Railroaded Up the Roll

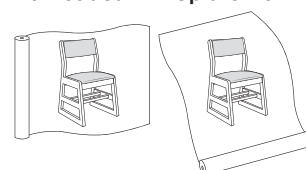

All COM orders will ship at standard lead time from receipt of COM except for orders requiring special custom matched finishes.





5. Optional Linking Brackets - add \$26 list per chair





6. Optional Laser Engraving Back Imprint - available on models 43A/C. See page 7 for details.



- Specify:**
- location - inside/outside of back
 - size of design

Description	Model	Specifications				List Price Per Grade	
Armless 16" H    43A all wood 43B uph. back  43C uph. seat	43A All Wood 43B Uph. Back 43C Uph. Seat • optional laser engraving back imprint - specify location and size; see page 7 for specifications. (A and C models only)	Dimensions Overall 19 17 30 ¾ Seat 13 15 16	Upholstery COM Ydg ¾ Ctn Wt 25 COL Sq Ft 9 Cu Ft 6	Shipping Ctn Wt 25 Cu Ft 6	All Wood \$333 COM \$385 A \$397 B \$411 COL/C \$433 D \$462 E \$492 F \$523 G \$567 H \$614 I \$687 J \$775 L1 \$576 L2 \$623		
	43D Uph. Seat/Back	Dimensions Overall 19 17 30 ¾ Seat 13 15 16	Upholstery COM Ydg ¾ Ctn Wt 25 COL Sq Ft 18 Cu Ft 6	Shipping Ctn Wt 25 Cu Ft 6	COM \$433 A \$447 B \$459 COL/C \$482 D \$512 E \$541 F \$572 G \$616 H \$663 I \$737 J \$824 L1 \$625 L2 \$671		

Description	Model	Specifications				List Price Per Grade	
Armless 16" H  	43D Uph. Seat/Back	Dimensions Overall 19 17 30 ¾ Seat 13 15 16	Upholstery COM Ydg ¾ Ctn Wt 25 COL Sq Ft 18 Cu Ft 6	Shipping Ctn Wt 25 Cu Ft 6	COM \$433 A \$447 B \$459 COL/C \$482 D \$512 E \$541 F \$572 G \$616 H \$663 I \$737 J \$824 L1 \$625 L2 \$671		

To Order, Specify:

- 1 Model Number
- 2 Wood Species - Oak (O)
- 3 Wood Finish/Color
- 4 Fabric Selection - vendor, pattern and color
- 5 Optional Linking Brackets - add \$26 list per chair
- 6 Optional Laser Engraving Back Imprint - specify location and size; see page 7 for specifications.
(A and C MODELS ONLY)

3 Wood Finish/Color Options:

BRW Brownie	ECU Ecrú
CAN Canyon	HEN Henna
CIT Citron	HNY Honey
DES Desert	NUT Nut Brown

Color - Add \$31 list per item; not available with laser engraving option

BKD Backdrop	GRV Greek Villa
BFX Black Fox	GLF Gulf Stream
BWH Bright White	HTB Heartthrob
CGP Cargo Pants	NET Network Gray
CHT Chatroom	NWH Nonchalant White
DSY Daisy	PAR Paradise
DRG Daring	QXP Quixotic Plum
DYN Dynamo	RBZ Relic Bronze
ENG Enigma	SND Sandbank
FRR French Roast	STM Storm
GBY Georgian Bay	TRC Tricorn Black

- 4 See a selection of graded in fabric manufacturers and patterns on pages 12-20. Contact Customer Service for additional fabric options.

Specifications

- Wood species - Oak.
- Two stretcher shelf for added stability.
- Seat is upholstered with 1 ½" high density polyurethane foam and synthetic sheet webbing for added comfort.
- Back is upholstered front and back with 1" polyurethane foam.
- Mortise and tenon construction with corner blocks, glue and screws.
- Coordinating adult collection. See page 80.

Class Act Children's Order Check List:



Coordinating adult collection. See page 98.

Specify:

- 1. Model Number
- 2. Wood Species - Oak (O) or Maple (M)
- 3. Wood Finish/Color
- 4. Fabric Selection - vendor, pattern and color
- 5. Optional Linking Brackets - add \$26 list per chair
- 6. Optional Laser Engraving Back Imprint - specify location
- 7. Optional Casters - add \$90 list; standard seat height maintained; **LEG MODELS ONLY**
- 8. Optional Rubber Cushion Nylon Glides - no upcharge; **LEG MODELS ONLY**

Example:

16C | O | HEN | MOMENTUM | VOX | MYSTIC
 (model #) | (wood species) | (finish) | (fabric vendor) | (pattern name) | (pattern color)

1. Model Number

2. Wood Species - Oak (O) or Maple (M)

3. Wood Finish/Color Options:

Oak			
BRW	Brownie	ECU	Ecru
CAN	Canyon	HEN	Henna
CIT	Citron	HNY	Honey
DES	Desert	NUT	Nut Brown
Maple			
ALE	Ale	FLX	Flax
AUB	Auburn	LGC	Legacy
AUT	Autumn	MCH	Mocha
BRL	Barley	NTO	Night Owl
BBN	Bourbon	PRL	Praline
BRG	Brighton	SAF	Saffron
BUT	Butterscotch	SIE	Sienna
CIN	Cinnamon	TOF	Toffee
CLA	Classic	TRF	Truffle
EAR	Earthy	VEN	Venetian
ESP	Espresso		

Color - Add \$31 list per item; not available with laser engraving option

BKD	Backdrop	GRV	Greek Villa
BFX	Black Fox	GLF	Gulf Stream
BWH	Bright White	HTB	Heartthrob
CGP	Cargo Pants	NET	Network Gray
CHT	Chatroom	NWH	Nonchalant White
DSY	Daisy	PAR	Paradise
DRG	Daring	QXP	Quixotic Plum
DYN	Dynamo	RBZ	Relic Bronze
ENG	Enigma	SND	Sandbank
FRR	French Roast	STM	Storm
GBY	Georgian Bay	TRC	Tricorn Black

4. Fabric Selection - Please supply the following:

- Fabric vendor
- Pattern name
- Pattern color

When specifying contrasting upholstery, indicate clearly which upholstery is to be applied to the seat and back. Use higher grade pricing.

- Indicate direction of fabric - Railroaded or Up the Roll
- Please provide illustration, if available

All COM orders must include the following:

- Vendor's name, pattern name and color
- Sample of the fabric attached to order
- Model numbers of items for fabric application
- Special application instructions (e.g., all stripes will be applied front to back unless specified otherwise)
- Customer and purchase order number

Ship prepaid COM material to:
 Community
 Attn: COM Dept
 932 Mill Street
 Jasper, IN 47546

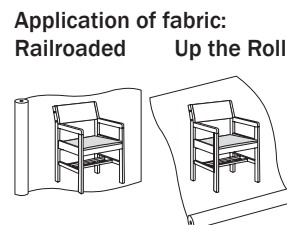

All COM orders will ship at standard lead time from receipt of COM except for orders requiring special custom matched finishes.

5. Optional Linking Brackets - add \$26 list per chair







6. Optional Laser Engraving Back Imprint - available on models 14A/C, 15A/C, 16A/C and 17A/C. See page 7 for details.





- Specify:**
- location - inside/outside of back
 - size of design

7. Optional Casters - Add \$90 list; standard seat height maintained. LEG MODELS ONLY

8. Optional Rubber Cushion Nylon Glides - no upcharge LEG MODELS ONLY

Description	Model	Specifications				List Price Per Grade
Armless 14" H    14A all wood 14B uph. back  14C uph. seat	14A All Wood 14B Uph. Back 14C Uph. Seat • optional laser engraving back imprint - specify location and size; see page 7 for specifications. (A and C models only)	Dimensions Overall Seat	D 15 13	W 15 13	H 25 14	All Wood \$272 COM \$326 A \$338 B \$349 COL/C \$369 D \$395 E \$422 F \$449 G \$488 H \$530 I \$595 J \$672 L1 \$495 L2 \$537
		Upholstery COM Ydg COL Sq Ft	$\frac{2}{3}$ 8	Shipping Ctn Wt Cu Ft	17 4	

Armless 14" H  	14D Uph. Seat/Back	Dimensions Overall Seat	D 15 13	W 15 13	H 25 14	COM \$367 A \$378 B \$390 COL/C \$411 D \$436 E \$462 F \$490 G \$529 H \$571 I \$636 J \$714 L1 \$537 L2 \$579
		Upholstery COM Ydg COL Sq Ft	$\frac{2}{3}$ 16	Shipping Ctn Wt Cu Ft	17 4	

To Order, Specify:

- Model Number
- Wood Species - Oak (O) or Maple (M)
- Wood Finish/Color
- Fabric Selection - vendor, pattern and color
- Optional Linking Brackets - add \$26 list per chair
- Optional Laser Engraving Back Imprint - specify location and size; see page 7 for details.
(A and C MODELS ONLY)
- Optional Casters - add \$90 list; standard seat height maintained. **LEG MODELS ONLY**
- Optional Rubber Cushion Nylon Glides - no upcharge **LEG MODELS ONLY**

Wood Finish/Color Options:

Oak		ECU	Ecru
BRW	Brownie	HEN	Henna
CAN	Canyon	HNY	Honey
CIT	Citron	NUT	Nut Brown
DES	Desert		
Maple			
ALE	Ale	FLX	Flax
AUB	Auburn	LGC	Legacy
AUT	Autumn	MCH	Mocha
BRL	Barley	NTO	Night Owl
BBN	Bourbon	PRL	Praline
BRG	Brighton	SAF	Saffron
BUT	Butterscotch	SIE	Sienna
CIN	Cinnamon	TOF	Toffee
CLA	Classic	TRF	Truffle
EAR	Earthy	VEN	Venetian
ESP	Espresso		













Specifications

- Wood species - Oak or Maple.
- Two stretcher shelf for added stability.
- Seat is upholstered with 1 1/2" high density polyurethane foam.
- Back is upholstered front and back with 1" polyurethane foam.
- Mortise and tenon construction with corner blocks, glue and screws.
- Standard with rubber cushion metal glides (leg models only).
- Coordinating adult collection. See page 98.





Color - Add \$31 list per item; not available with laser engraving option



BKD	Backdrop	GRV	Greek Villa
BFX	Black Fox	GLF	Gulf Stream
BWH	Bright White	HTB	Heartthrob
CGP	Cargo Pants	NET	Network Gray
CHT	Chatroom	NWH	Nonchalant White
DSY	Daisy	PAR	Paradise
DRG	Daring	QXP	Quixotic Plum
DYN	Dynamo	RBZ	Relic Bronze
ENG	Enigma	SND	Sandbank
FRR	French Roast	STM	Storm
GBY	Georgian Bay	TRC	Tricorn Black

- See a selection of graded in fabric manufacturers and patterns on pages 12-20. Contact Customer Service for additional fabric options.

Description	① Model	Specifications	List Price Per Grade																								
Armless 14" H    15A all wood 15B uph. back  15C uph. seat	15A All Wood 15B Uph. Back 15C Uph. Seat · optional laser engraving back imprint - specify location and size; see page 7 for specifications. (A and C models only)	<table border="1"> <thead> <tr> <th>Dimensions</th> <th>D</th> <th>W</th> <th>H</th> </tr> </thead> <tbody> <tr> <td>Overall</td> <td>15</td> <td>15</td> <td>25</td> </tr> <tr> <td>Seat</td> <td>13</td> <td>13</td> <td>14</td> </tr> <tr> <th colspan="2">Upholstery</th> <th colspan="2">Shipping</th> </tr> <tr> <td>COM Ydg</td> <td>⅔</td> <td>Ctn Wt</td> <td>17</td> </tr> <tr> <td>COL Sq Ft</td> <td>8</td> <td>Cu Ft</td> <td>4</td> </tr> </tbody> </table>	Dimensions	D	W	H	Overall	15	15	25	Seat	13	13	14	Upholstery		Shipping		COM Ydg	⅔	Ctn Wt	17	COL Sq Ft	8	Cu Ft	4	All Wood \$284 COM \$332 A \$344 B \$355 COL/C \$375 D \$402 E \$428 F \$455 G \$494 H \$536 I \$601 J \$679 L1 \$501 L2 \$543
		Dimensions	D	W	H																						
		Overall	15	15	25																						
		Seat	13	13	14																						
Upholstery		Shipping																									
COM Ydg	⅔	Ctn Wt	17																								
COL Sq Ft	8	Cu Ft	4																								
Armless 14" H  	15D Uph. Seat/Back	<table border="1"> <thead> <tr> <th>Dimensions</th> <th>D</th> <th>W</th> <th>H</th> </tr> </thead> <tbody> <tr> <td>Overall</td> <td>15</td> <td>15</td> <td>25</td> </tr> <tr> <td>Seat</td> <td>13</td> <td>13</td> <td>14</td> </tr> <tr> <th colspan="2">Upholstery</th> <th colspan="2">Shipping</th> </tr> <tr> <td>COM Ydg</td> <td>⅔</td> <td>Ctn Wt</td> <td>17</td> </tr> <tr> <td>COL Sq Ft</td> <td>16</td> <td>Cu Ft</td> <td>4</td> </tr> </tbody> </table>	Dimensions	D	W	H	Overall	15	15	25	Seat	13	13	14	Upholstery		Shipping		COM Ydg	⅔	Ctn Wt	17	COL Sq Ft	16	Cu Ft	4	COM \$375 A \$387 B \$398 COL/C \$419 D \$445 E \$471 F \$498 G \$538 H \$579 I \$644 J \$723 L1 \$545 L2 \$587
		Dimensions	D	W	H																						
		Overall	15	15	25																						
		Seat	13	13	14																						
Upholstery		Shipping																									
COM Ydg	⅔	Ctn Wt	17																								
COL Sq Ft	16	Cu Ft	4																								
Armless 16" H    16A all wood 16B uph. back  16C uph. seat	16A All Wood 16B Uph. Back 16C Uph. Seat · optional laser engraving back imprint - specify location and size; see page 7 for specifications. (A and C models only)	<table border="1"> <thead> <tr> <th>Dimensions</th> <th>D</th> <th>W</th> <th>H</th> </tr> </thead> <tbody> <tr> <td>Overall</td> <td>16</td> <td>17</td> <td>28 ¾</td> </tr> <tr> <td>Seat</td> <td>14</td> <td>15</td> <td>16</td> </tr> <tr> <th colspan="2">Upholstery</th> <th colspan="2">Shipping</th> </tr> <tr> <td>COM Ydg</td> <td>⅔</td> <td>Ctn Wt</td> <td>20</td> </tr> <tr> <td>COL Sq Ft</td> <td>8</td> <td>Cu Ft</td> <td>7</td> </tr> </tbody> </table>	Dimensions	D	W	H	Overall	16	17	28 ¾	Seat	14	15	16	Upholstery		Shipping		COM Ydg	⅔	Ctn Wt	20	COL Sq Ft	8	Cu Ft	7	All Wood \$284 COM \$332 A \$344 B \$355 COL/C \$375 D \$402 E \$428 F \$455 G \$494 H \$536 I \$601 J \$679 L1 \$501 L2 \$543
		Dimensions	D	W	H																						
		Overall	16	17	28 ¾																						
		Seat	14	15	16																						
Upholstery		Shipping																									
COM Ydg	⅔	Ctn Wt	20																								
COL Sq Ft	8	Cu Ft	7																								
Armless 16" H  	16D Uph. Seat/Back	<table border="1"> <thead> <tr> <th>Dimensions</th> <th>D</th> <th>W</th> <th>H</th> </tr> </thead> <tbody> <tr> <td>Overall</td> <td>16</td> <td>17</td> <td>28 ¾</td> </tr> <tr> <td>Seat</td> <td>14</td> <td>15</td> <td>16</td> </tr> <tr> <th colspan="2">Upholstery</th> <th colspan="2">Shipping</th> </tr> <tr> <td>COM Ydg</td> <td>⅔</td> <td>Ctn Wt</td> <td>20</td> </tr> <tr> <td>COL Sq Ft</td> <td>16</td> <td>Cu Ft</td> <td>7</td> </tr> </tbody> </table>	Dimensions	D	W	H	Overall	16	17	28 ¾	Seat	14	15	16	Upholstery		Shipping		COM Ydg	⅔	Ctn Wt	20	COL Sq Ft	16	Cu Ft	7	COM \$375 A \$387 B \$398 COL/C \$419 D \$445 E \$471 F \$498 G \$538 H \$579 I \$644 J \$723 L1 \$545 L2 \$587
		Dimensions	D	W	H																						
		Overall	16	17	28 ¾																						
		Seat	14	15	16																						
Upholstery		Shipping																									
COM Ydg	⅔	Ctn Wt	20																								
COL Sq Ft	16	Cu Ft	7																								

CHILDREN'S

Description	Model	Specifications	List Price Per Grade
Armless 16" H 	17A All Wood 17B Uph. Back 17C Uph. Seat	Dimensions Overall Seat Upholstery COM Ydg COL Sq Ft	All Wood \$291 COM \$342 A \$353 B \$365 COL/C \$385 D \$411 E \$437 F \$465 G \$503 H \$545 I \$611 J \$688 L1 \$512 L2 \$553
 17A all wood	optional laser engraving back imprint - specify location and size; see page 7 for specifications. (A and C models only)	D 16 14	W 17 15 Shipping Ctn Wt 20 Cu Ft 7
 17B uph. back		H 28 3/4 16	
 17C uph. seat			

Description	Model	Specifications	List Price Per Grade
Armless 16" H 	17D Uph. Seat/Back	Dimensions Overall Seat Arm Upholstery COM Ydg COL Sq Ft	COM \$386 A \$397 B \$410 COL/C \$430 D \$456 E \$481 F \$510 G \$549 H \$590 I \$655 J \$733 L1 \$556 L2 \$598
		D 16 14	W 17 15 Shipping Ctn Wt 20 Cu Ft 7
		H 28 3/4 16	

To Order, Specify:

- Model Number
- Wood Species - Oak (O) or Maple (M)
- Wood Finish/Color
- Fabric Selection - vendor, pattern and color
- Optional Linking Brackets - add \$26 list per chair
- Optional Laser Engraving Back Imprint - specify location and size; see page 7 for details.
(A and C MODELS ONLY)
- Optional Casters - add \$90 list; standard seat height maintained. **LEG MODELS ONLY**
- Optional Rubber Cushion Nylon Glides - no upcharge
LEG MODELS ONLY

Wood Finish/Color Options:

Oak	BRW Brownie	ECU Ecru
CAN Canyon	CIT Citron	HEN Henna
DES Desert	Maple	HNY Honey
ALE Ale	AUB Auburn	NUT Nut Brown
AUT Autumn	BRL Barley	FLX Flax
BBN Bourbon	BRG Brighton	LGC Legacy
BUT Butterscotch	CIN Cinnamon	MCH Mocha
CLA Classic	EAR Earthy	NTN Night Owl
ESP Espresso		PRL Praline
		SAF Saffron
		SIE Sienna
		TOF Toffee
		TRF Truffle
		VEN Venetian

Specifications

- Wood species - Oak or Maple.
- Two stretcher shelf for added stability.
- Seat is upholstered with 1 1/2" high density polyurethane foam.
- Back is upholstered front and back with 1" polyurethane foam.
- Mortise and tenon construction with corner blocks, glue and screws.
- Standard with rubber cushion metal glides (leg models only).
- Coordinating adult collection. See page 98.

Color - Add \$31 list per item; not available with laser engraving option

BKD Backdrop	GRV Creek Villa
BFX Black Fox	GLF Gulf Stream
BWH Bright White	HTB Heartthrob
CGP Cargo Pants	NET Network Gray
CHT Chatroom	NWH Nonchalant White
DSY Daisy	PAR Paradise
DRG Daring	QXP Quixotic Plum
DYN Dynamo	RBZ Relic Bronze
ENG Enigma	SND Sandbank
FRR French Roast	STM Storm
GBY Georgian Bay	TRC Tricorn Black

- See a selection of graded in fabric manufacturers and patterns on pages 12-20. Contact Customer Service for additional fabric options.

Classmate Children's Order Check List:



Coordinating adult collection. See page 104.

Specify:

- 1. Model Number
- 2. Wood Species - Oak (O) or Maple (M)
- 3. Wood Finish/Color
- 4. Fabric Selection - vendor, pattern and color
- 5. Optional Linking Brackets - add \$26 list per chair
- 6. Optional Casters - add \$90 list; standard seat height maintained; **LEG MODELS ONLY**
- 7. Optional Rubber Cushion Nylon Glides - no upcharge; **LEG MODELS ONLY**

Example:

56C (model #)	O (wood species)	HEN (finish)	MOMENTUM (fabric vendor)	VOX (pattern name)	MYSTIC (pattern color)
------------------	---------------------	-----------------	-----------------------------	-----------------------	---------------------------

1. Model Number

2. Wood Species - Oak (O) or Maple (M)

3. Wood Finish/Color Options:

Oak			
BRW	Brownie	ECU	Ecru
CAN	Canyon	HEN	Henna
CIT	Citron	HNY	Honey
DES	Desert	NUT	Nut Brown
Maple			
ALE	Ale	FLX	Flax
AUB	Auburn	LGC	Legacy
AUT	Autumn	MCH	Mocha
BRL	Barley	NTO	Night Owl
BBN	Bourbon	PRL	Praline
BRG	Brighton	SAF	Saffron
BUT	Butterscotch	SIE	Sienna
CIN	Cinnamon	TOF	Toffee
CLA	Classic	TRF	Truffle
EAR	Earthy	VEN	Venetian

Color - Add \$31 list per item

BKD	Backdrop	GRV	Greek Villa
BFX	Black Fox	GLF	Gulf Stream
BWH	Bright White	HTB	Heartthrob
CGP	Cargo Pants	NET	Network Gray
CHT	Chatroom	NWH	Nonchalant White
DSY	Daisy	PAR	Paradise
DRG	Daring	QXP	Quixotic Plum
DYN	Dynamo	RBZ	Relic Bronze
ENG	Enigma	SND	Sandbank
FRR	French Roast	STM	Storm
GBY	Georgian Bay	TRC	Tricorn Black

4. Fabric Selection - Please supply the following:

Fabric vendor
 Pattern name
 Pattern color

When specifying contrasting upholstery, indicate clearly which upholstery is to be applied to the seat and back. Use higher grade pricing.

- Indicate direction of fabric - Railroaded or Up the Roll
- Please provide illustration, if available

All COM orders must include the following:

- Vendor's name, pattern name and color
- Sample of the fabric attached to order
- Model numbers of items for fabric application
- Special application instructions (e.g., all stripes will be applied front to back unless specified otherwise)
- Customer and purchase order number

Ship prepaid COM material to:
 Community
 Attn: COM Dept
 932 Mill Street
 Jasper, IN 47546

Application of fabric:
 Railroaded Up the Roll

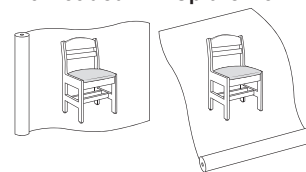



All COM orders will ship at standard lead time from receipt of COM except for orders requiring special custom matched finishes.



5. Optional Linking Brackets - add \$26 list per chair

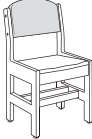

6. Optional Casters - Add \$90 list; standard seat height maintained. LEG MODELS ONLY

7. Optional Rubber Cushion Nylon Glides - no upcharge LEG MODELS ONLY

Description	Model	Specifications			List Price Per Grade		
		Dimensions	D	W	H		
Armless 14" H 	54A All Wood					All Wood	\$314
	54B Uph. Back					COM	\$365
		Overall	15	15	26 1/4	A	\$375
		Seat	13	13	14	B	\$384
		Upholstery		Shipping		COL/C	\$399
54A all wood		COM Ydg	1/2	Ctn Wt	17	D	\$418
54B uph. back		COL Sq Ft	6	Cu Ft	4	E	\$438
						F	\$458
						G	\$488
						H	\$519
						I	\$569
						J	\$627
						L1	\$494
						L2	\$525

Description	Model	Specifications			List Price Per Grade		
		Dimensions	D	W	H		
Armless 14" H 	54C Uph. Seat					COM	\$365
		Overall	15	15	26 1/4	A	\$376
		Seat	13	13	14	B	\$388
		Upholstery		Shipping		COL/C	\$409
		COM Ydg	2/3	Ctn Wt	17	D	\$434
		COL Sq Ft	8	Cu Ft	4	E	\$460
						F	\$488
						G	\$527
						H	\$569
						I	\$634
						J	\$712
						L1	\$535
						L2	\$577

To Order, Specify:

- 1 Model Number
- 2 Wood Species - Oak (O) or Maple (M)
- 3 Wood Finish/Color
- 4 Fabric Selection - vendor, pattern and color
- 5 Optional Linking Brackets - add \$26 list per chair
- 6 Optional Casters - add \$90 list; standard seat height maintained. **LEG MODELS ONLY**
- 7 Optional Rubber Cushion Nylon Glides - no upcharge **LEG MODELS ONLY**

4 Wood Finish/Color Options:

Oak		ECU	Ecru
BRW	Brownie	HEN	Henna
CAN	Canyon	HNY	Honey
CIT	Citron	NUT	Nut Brown
DES	Desert		
Maple			
ALE	Ale	FLX	Flax
AUB	Auburn	LGC	Legacy
AUT	Autumn	MCH	Mocha
BRL	Barley	NTO	Night Owl
BBN	Bourbon	PRL	Praline
BRG	Brighton	SAF	Saffron
BUT	Butterscotch	SIE	Sienna
CIN	Cinnamon	TOF	Toffee
CLA	Classic	TRF	Truffle
EAR	Earthy	VEN	Venetian
ESP	Espresso		



Color - Add \$31 list per item



BKD	Backdrop	GRV	Greek Villa
BFX	Black Fox	GLF	Gulf Stream
BWH	Bright White	HTB	Heartthrob
CGP	Cargo Pants	NET	Network Gray
CHT	Chatroom	NWH	Nonchalant White
DSY	Daisy	PAR	Paradise
DRG	Daring	QXP	Quixotic Plum
DYN	Dynamo	RBZ	Relic Bronze
ENG	Enigma	SND	Sandbank
FRR	French Roast	STM	Storm
GBY	Georgian Bay	TRC	Tricorn Black



Specifications



- Wood species - Oak or Maple.
- Two stretcher shelf for added stability.
- Seat is upholstered with 1 1/2" high density polyurethane foam.
- Back is upholstered front and back with 1" polyurethane foam.
- Mortise and tenon construction with corner blocks, glue and screws.
- Features rounded corners for added safety.
- Standard with rubber cushion metal glides (leg models only).
- Coordinating adult collection. See page 104.



- 4 See a selection of graded in fabric manufacturers and patterns on pages 12-20. Contact Customer Service for additional fabric options.



Description	① Model	Specifications				List Price Per Grade	
Armless 14" H  	54D Uph. Seat/Back	Dimensions		D	W	H	COM \$410
		Overall		15	15	26 ¼	A \$425
		Seat		13	13	14	B \$439
		Upholstery		Shipping			COL/C \$466
		COM Ydg		7/8	Ctn Wt	17	D \$500
		COL Sq Ft		14	Cu Ft	4	E \$535
							F \$571
					G \$622		
					H \$677		
					I \$762		
					J \$865		
					L1 \$633		
					L2 \$687		

Description	① Model	Specifications				List Price Per Grade	
Armless 14" H   	55A All Wood 55B Uph. Back	Dimensions		D	W	H	All Wood \$325
		Overall		15	15	26 ¼	COM \$373
		Seat		13	13	14	A \$384
		Upholstery		Shipping			B \$392
		COM Ydg		½	Ctn Wt	18	COL/C \$408
		COL Sq Ft		6	Cu Ft	4	D \$427
							E \$447
					F \$468		
					G \$496		
					H \$528		
					I \$577		
					J \$636		
					L1 \$502		
					L2 \$534		

Description	① Model	Specifications				List Price Per Grade	
Armless 14" H  	55C Uph. Seat	Dimensions		D	W	H	COM \$373
		Overall		15	15	26 ¼	A \$385
		Seat		13	13	14	B \$396
		Upholstery		Shipping			COL/C \$417
		COM Ydg		¾	Ctn Wt	18	D \$443
		COL Sq Ft		8	Cu Ft	4	E \$469
							F \$496
					G \$536		
					H \$577		
					I \$642		
					J \$721		
					L1 \$543		
					L2 \$585		

Description	① Model	Specifications				List Price Per Grade	
Armless 14" H  	55D Uph. Seat/Back	Dimensions		D	W	H	COM \$419
		Overall		15	15	26 ¼	A \$434
		Seat		13	13	14	B \$449
		Upholstery		Shipping			COL/C \$476
		COM Ydg		7/8	Ctn Wt	18	D \$510
		COL Sq Ft		14	Cu Ft	4	E \$544
							F \$580
					G \$632		
					H \$686		
					I \$772		
					J \$874		
					L1 \$642		
					L2 \$697		

Description	Model	Specifications			List Price Per Grade		
		Dimensions	D	W	H		
Armless 16" H 	56A All Wood	Overall	17 1/2	17	29 1/2	All Wood	\$325
	56B Uph. Back					COM	\$373
 		Seat	14 1/2	15	16	A	\$384
	56A all wood	56B uph. back	Upholstery		Shipping		B
		COM Ydg	1/2	Ctn Wt	22	COL/C	\$408
		COL Sq Ft	6	Cu Ft	7	D	\$427
						E	\$447
						F	\$468
						G	\$496
						H	\$528
						I	\$577
						J	\$636
						L1	\$502
						L2	\$534

Description	Model	Specifications			List Price Per Grade		
		Dimensions	D	W	H		
Armless 16" H 	56C Uph. Seat	Overall	17 1/2	17	29 1/2	COM	\$373
						A	\$385
		Seat	14 1/2	15	16	B	\$396
		Upholstery		Shipping		COL/C	\$417
		COM Ydg	2/3	Ctn Wt	22	D	\$443
		COL Sq Ft	8	Cu Ft	7	E	\$469
						F	\$496
						G	\$536
						H	\$577
						I	\$642
						J	\$721
						L1	\$543
						L2	\$585

To Order, Specify:

- Model Number
- Wood Species - Oak (O) or Maple (M)
- Wood Finish/Color
- Fabric Selection - vendor, pattern and color
- Optional Linking Brackets - add \$26 list per chair
- Optional Casters - add \$90 list; standard seat height maintained. **LEG MODELS ONLY**
- Optional Rubber Cushion Nylon Glides - no upcharge **LEG MODELS ONLY**

Wood Finish/Color Options:

Oak		ECU	Ecru
BRW	Brownie	HEN	Henna
CAN	Canyon	HNY	Honey
CIT	Citron	NUT	Nut Brown
DES	Desert		
Maple			
ALE	Ale	FLX	Flax
AUB	Auburn	LGC	Legacy
AUT	Autumn	MCH	Mocha
BRL	Barley	NTO	Night Owl
BBN	Bourbon	PRL	Praline
BRG	Brighton	SAF	Saffron
BUT	Butterscotch	SIE	Sienna
CIN	Cinnamon	TOF	Toffee
CLA	Classic	TRF	Truffle
EAR	Earthy	VEN	Venetian
ESP	Espresso		



Specifications



- Wood species - Oak or Maple.
- Two stretcher shelf for added stability.
- Seat is upholstered with 1 1/2" high density polyurethane foam.
- Back is upholstered front and back with 1" polyurethane foam.
- Mortise and tenon construction with corner blocks, glue and screws.
- Features rounded corners for added safety.
- Standard with rubber cushion metal glides (leg models only).
- Coordinating adult collection. See page 104.



Color - Add \$31 list per item

BKD	Backdrop	GRV	Creek Villa
BFX	Black Fox	GLF	Gulf Stream
BWH	Bright White	HTB	Hearthrob
CGP	Cargo Pants	NET	Network Gray
CHT	Chatroom	NWH	Nonchalant White
DSY	Daisy	PAR	Paradise
DRG	Daring	QXP	Quixotic Plum
DYN	Dynamo	RBZ	Relic Bronze
ENG	Enigma	SND	Sandbank
FRR	French Roast	STM	Storm
GBY	Georgian Bay	TRC	Tricorn Black

- See a selection of graded in fabric manufacturers and patterns on pages 12-20. Contact Customer Service for additional fabric options.

Description	① Model	Specifications				List Price Per Grade
Armless 16" H  	56D Uph. Seat/Back	Dimensions	D	W	H	COM \$419
		Overall	17 ½	17	29 ½	A \$434
		Seat	14 ½	15	16	B \$449
		Upholstery	Shipping			COL/C \$476
		COM Ydg	⅞	Ctn Wt	22	D \$510
		COL Sq Ft	14	Cu Ft	7	E \$544
						F \$580
						G \$632
						H \$686
						I \$772
						J \$874
						L1 \$642
						L2 \$697

Description	① Model	Specifications				List Price Per Grade
Armless 16" H   	57A All Wood 57B Uph. Back	Dimensions	D	W	H	All Wood \$334
		Overall	17 ½	17	29 ½	COM \$385
		Seat	14 ½	15	16	A \$395
		Upholstery	Shipping			B \$404
		COM Ydg	½	Ctn Wt	23	COL/C \$419
		COL Sq Ft	6	Cu Ft	7	D \$438
						E \$458
						F \$479
						G \$509
						H \$539
						I \$588
						J \$647
						L1 \$514
						L2 \$545

Description	① Model	Specifications				List Price Per Grade
Armless 16" H  	57C Uph. Seat	Dimensions	D	W	H	COM \$385
		Overall	17 ½	17	29 ½	A \$396
		Seat	14 ½	15	16	B \$409
		Upholstery	Shipping			COL/C \$429
		COM Ydg	⅔	Ctn Wt	23	D \$455
		COL Sq Ft	8	Cu Ft	7	E \$480
						F \$509
						G \$548
						H \$588
						I \$654
						J \$732
						L1 \$555
						L2 \$597

Description	Model	Specifications				List Price Per Grade	
		Dimensions	D	W	H	COM	
Armless 16" H	57D Uph. Seat/Back						
		Overall	17 1/2	17	29 1/2	A	\$441
		Seat	14 1/2	15	16	B	\$456
						COL/C	\$483
						D	\$517
						E	\$552
						F	\$587
					G	\$639	
					H	\$693	
					I	\$780	
					J	\$881	
					L1	\$649	
					L2	\$704	

To Order, Specify:

- 1 Model Number
- 2 Wood Species - Oak (O) or Maple (M)
- 3 Wood Finish/Color
- 4 Fabric Selection - vendor, pattern and color
- 5 Optional Linking Brackets - add \$26 list per chair
- 6 Optional Casters - add \$90 list; standard seat height maintained. **LEG MODELS ONLY**
- 7 Optional Rubber Cushion Nylon Glides - no upcharge **LEG MODELS ONLY**

3 Wood Finish/Color Options:

- | | | | |
|--------------|--------------|-----|-----------|
| Oak | | ECU | Ecu |
| BRW | Brownie | HEN | Henna |
| CAN | Canyon | HNY | Honey |
| CIT | Citron | NUT | Nut Brown |
| DES | Desert | | |
| Maple | | | |
| ALE | Ale | FLX | Flax |
| AUB | Auburn | LGC | Legacy |
| AUT | Autumn | MCH | Mocha |
| BRL | Barley | NTO | Night Owl |
| BBN | Bourbon | PRL | Praline |
| BRG | Brighton | SAF | Saffron |
| BUT | Butterscotch | SIE | Sienna |
| CIN | Cinnamon | TOF | Toffee |
| CLA | Classic | TRF | Truffle |
| EAR | Earthy | VEN | Venetian |
| ESP | Espresso | | |

Color - Add \$31 list per item

- | | | | |
|-----|--------------|-----|------------------|
| BKD | Backdrop | GRV | Creek Villa |
| BFX | Black Fox | GLF | Gulf Stream |
| BWH | Bright White | HTB | Heartthrob |
| CGP | Cargo Pants | NET | Network Gray |
| CHT | Chatroom | NWH | Nonchalant White |
| DSY | Daisy | PAR | Paradise |
| DRG | Daring | QXP | Quixotic Plum |
| DYN | Dynamo | RBZ | Relic Bronze |
| ENG | Enigma | SND | Sandbank |
| FRR | French Roast | STM | Storm |
| GBY | Georgian Bay | TRC | Tricorn Black |

- 4 See a selection of graded in fabric manufacturers and patterns on pages 12-20. Contact Customer Service for additional fabric options.

Specifications

- Wood species - Oak or Maple.
- Two stretcher shelf for added stability.
- Seat is upholstered with 1 1/2" high density polyurethane foam.
- Back is upholstered front and back with 1" polyurethane foam.
- Mortise and tenon construction with corner blocks, glue and screws.
- Features rounded corners for added safety.
- Standard with rubber cushion metal glides (leg models only).
- Coordinating adult collection. See page 104.

Classmate II Children's Order Check List:



Coordinating adult collection. See page 108.

Specify:

- 1. Model Number
- 2. Wood Species - Oak (O) or Maple (M)
- 3. Wood Finish/Color
- 4. Fabric Selection - vendor, pattern and color
- 5. Optional Linking Brackets - add \$26 list per chair
- 6. Optional Casters - add \$90 list; standard seat height maintained; **LEG MODELS ONLY**
- 7. Optional Rubber Cushion Nylon Glides - no upcharge; **LEG MODELS ONLY**

Example:

66C (model #)	O (wood species)	HEN (finish)	MOMENTUM (fabric vendor)	VOX (pattern name)	MYSTIC (pattern color)
------------------	---------------------	-----------------	-----------------------------	-----------------------	---------------------------

1. Model Number

2. Wood Species - Oak (O) or Maple (M)

3. Wood Finish/Color Options:

Oak			
BRW	Brownie	ECU	Ecru
CAN	Canyon	HEN	Henna
CIT	Citron	HNY	Honey
DES	Desert	NUT	Nut Brown
Maple			
ALE	Ale	FLX	Flax
AUB	Auburn	LGC	Legacy
AUT	Autumn	MCH	Mocha
BRL	Barley	NTO	Night Owl
BBN	Bourbon	PRL	Praline
BRG	Brighton	SAF	Saffron
BUT	Butterscotch	SIE	Sienna
CIN	Cinnamon	TOF	Toffee
CLA	Classic	TRF	Truffle
EAR	Earthy	VEN	Venetian

Color - Add \$31 list per item

BKD	Backdrop	GRV	Greek Villa
BFX	Black Fox	GLF	Gulf Stream
BWH	Bright White	HTB	Heartthrob
CGP	Cargo Pants	NET	Network Gray
CHT	Chatroom	NWH	Nonchalant White
DSY	Daisy	PAR	Paradise
DRG	Daring	QXP	Quixotic Plum
DYN	Dynamo	RBZ	Relic Bronze
ENG	Enigma	SND	Sandbank
FRR	French Roast	STM	Storm
GBY	Georgian Bay	TRC	Tricorn Black

4. Fabric Selection - Please supply the following:

Fabric vendor
 Pattern name
 Pattern color

When specifying contrasting upholstery, indicate clearly which upholstery is to be applied to the seat and back. Use higher grade pricing.

- Indicate direction of fabric - Railroaded or Up the Roll
- Please provide illustration, if available

All COM orders must include the following:

- Vendor's name, pattern name and color
- Sample of the fabric attached to order
- Model numbers of items for fabric application
- Special application instructions (e.g., all stripes will be applied front to back unless specified otherwise)
- Customer and purchase order number

Ship prepaid COM material to:
 Community
 Attn: COM Dept
 932 Mill Street
 Jasper, IN 47546

Application of fabric:
 Railroaded Up the Roll

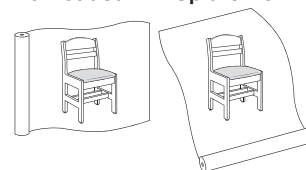

All COM orders will ship at standard lead time from receipt of COM except for orders requiring special custom matched finishes.

5. Optional Linking Brackets - add \$26 list per chair



6. Optional Casters - Add \$90 list; standard seat height maintained. LEG MODELS ONLY

7. Optional Rubber Cushion Nylon Glides - no upcharge LEG MODELS ONLY

Armless 14" H

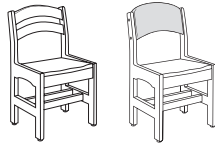

64A
all wood

64B
uph. back

64A All Wood
64B Uph. Back

Dimensions	D	W	H
Overall	15	15	26 1/4
Seat	13	13	14
Upholstery		Shipping	
COM Ydg	1/2	Ctn Wt	17
COL Sq Ft	6	Cu Ft	4

All Wood	\$314
COM	\$365
A	\$375
B	\$384
COL/C	\$399
D	\$418
E	\$438
F	\$458
G	\$488
H	\$519
I	\$569
J	\$627
L1	\$494
L2	\$525

Armless 14" H



64C Uph. Seat

Dimensions	D	W	H
Overall	15	15	26 1/4
Seat	13	13	14
Upholstery		Shipping	
COM Ydg	2/3	Ctn Wt	17
COL Sq Ft	8	Cu Ft	4

COM	\$365
A	\$376
B	\$388
COL/C	\$409
D	\$434
E	\$460
F	\$488
G	\$527
H	\$569
I	\$634
J	\$712
L1	\$535
L2	\$577

To Order, Specify:

- 1 Model Number
- 2 Wood Species - Oak (O) or Maple (M)
- 3 Wood Finish/Color
- 4 Fabric Selection - vendor, pattern and color
- 5 Optional Linking Brackets - add \$26 list per chair
- 6 Optional Casters - add \$90 list; standard seat height maintained. **LEG MODELS ONLY**
- 7 Optional Rubber Cushion Nylon Glides - no upcharge **LEG MODELS ONLY**

4 Wood Finish/Color Options:

Oak		ECU	Ecru
BRW	Brownie	HEN	Henna
CAN	Canyon	HNY	Honey
CIT	Citron	NUT	Nut Brown
DES	Desert		
Maple			
ALE	Ale	FLX	Flax
AUB	Auburn	LGC	Legacy
AUT	Autumn	MCH	Mocha
BRL	Barley	NTO	Night Owl
BBN	Bourbon	PRL	Praline
BRG	Brighton	SAF	Saffron
BUT	Butterscotch	SIE	Sienna
CIN	Cinnamon	TOF	Toffee
CLA	Classic	TRF	Truffle
EAR	Earthy	VEN	Venetian
ESP	Espresso		



Specifications



- Wood species - Oak or Maple.
- Two stretcher shelf for added stability.
- Seat is upholstered with 1 1/2" high density polyurethane foam.
- Back is upholstered front and back with 1" polyurethane foam.
- Mortise and tenon construction with corner blocks, glue and screws.
- Features rounded corners for added safety.
- Standard with rubber cushion metal glides (leg models only).
- Coordinating adult collection. See page 108.



Color - Add \$31 list per item



BKD	Backdrop	GRV	Greek Villa
BFX	Black Fox	GLF	Gulf Stream
BWH	Bright White	HTB	Heartthrob
CGP	Cargo Pants	NET	Network Gray
CHT	Chatroom	NWH	Nonchalant White
DSY	Daisy	PAR	Paradise
DRG	Daring	QXP	Quixotic Plum
DYN	Dynamo	RBZ	Relic Bronze
ENG	Enigma	SND	Sandbank
FRR	French Roast	STM	Storm
GBY	Georgian Bay	TRC	Tricorn Black



- 4 See a selection of graded in fabric manufacturers and patterns on pages 12-20. Contact Customer Service for additional fabric options.



Description	① Model	Specifications				List Price Per Grade
Armless 14" H  	64D Uph. Seat/Back	Dimensions	D	W	H	COM \$410
		Overall	15	15	26 ¼	A \$425
		Seat	13	13	14	B \$439
		Upholstery	Shipping			COL/C \$466
		COM Ydg	7/8	Ctn Wt	17	D \$500
		COL Sq Ft	14	Cu Ft	4	E \$535
						F \$571
				G \$622		
				H \$677		
				I \$762		
				J \$865		
				L1 \$633		
				L2 \$687		

Description	① Model	Specifications				List Price Per Grade
Armless 14" H   	65A All Wood 65B Uph. Back	Dimensions	D	W	H	All Wood \$325
		Overall	15	15	26 ¼	COM \$373
		Seat	13	13	14	A \$384
		Upholstery	Shipping			B \$392
		COM Ydg	½	Ctn Wt	18	COL/C \$408
		COL Sq Ft	6	Cu Ft	4	D \$427
						E \$447
				F \$468		
				G \$496		
				H \$528		
				I \$577		
				J \$636		
				L1 \$502		
				L2 \$534		

Description	① Model	Specifications				List Price Per Grade
Armless 14" H  	65C Uph. Seat	Dimensions	D	W	H	COM \$373
		Overall	15	15	26 ¼	A \$385
		Seat	13	13	14	B \$396
		Upholstery	Shipping			COL/C \$417
		COM Ydg	2/3	Ctn Wt	18	D \$443
		COL Sq Ft	8	Cu Ft	4	E \$469
						F \$496
				G \$536		
				H \$577		
				I \$642		
				J \$721		
				L1 \$543		
				L2 \$585		

Description	① Model	Specifications				List Price Per Grade
Armless 14" H  	65D Uph. Seat/Back	Dimensions	D	W	H	COM \$419
		Overall	15	15	26 ¼	A \$434
		Seat	13	13	14	B \$449
		Upholstery	Shipping			COL/C \$476
		COM Ydg	7/8	Ctn Wt	18	D \$510
		COL Sq Ft	14	Cu Ft	4	E \$544
						F \$580
				G \$632		
				H \$686		
				I \$772		
				J \$874		
				L1 \$642		
				L2 \$697		

Description	① Model	Specifications				List Price Per Grade	
		Dimensions	D	W	H		
Armless 16" H 	66A All Wood	Overall	17 1/2	17	29 1/2	All Wood	\$325
	66B Uph. Back					COM	\$373
 		Seat	14 1/2	15	16	A	\$384
	66A all wood	66B uph. back	Upholstery		Shipping		B
		COM Ydg	1/2	Ctn Wt	22	COL/C	\$408
		COL Sq Ft	6	Cu Ft	7	D	\$427
						E	\$447
						F	\$468
						G	\$496
						H	\$528
						I	\$577
						J	\$636
						L1	\$502
						L2	\$534

Description	① Model	Specifications				List Price Per Grade	
		Dimensions	D	W	H		
Armless 16" H 	66C Uph. Seat	Overall	17 1/2	17	29 1/2	COM	\$373
						A	\$385
		Seat	14 1/2	15	16	B	\$396
		Upholstery		Shipping		COL/C	\$417
		COM Ydg	2/3	Ctn Wt	22	D	\$443
		COL Sq Ft	8	Cu Ft	7	E	\$469
						F	\$496
						G	\$536
						H	\$577
						I	\$642
						J	\$721
						L1	\$543
						L2	\$585

To Order, Specify:

- ① Model Number
- ② Wood Species - Oak (O) or Maple (M)
- ③ Wood Finish/Color
- ④ Fabric Selection - vendor, pattern and color
- ⑤ Optional Linking Brackets - add \$26 list per chair
- ⑥ Optional Casters - add \$90 list; standard seat height maintained. **LEG MODELS ONLY**
- ⑦ Optional Rubber Cushion Nylon Glides - no upcharge **LEG MODELS ONLY**

③ Wood Finish/Color Options:

- | | | | |
|--------------|--------------|-----|-----------|
| Oak | | ECU | Ecru |
| BRW | Brownie | HEN | Henna |
| CAN | Canyon | HNY | Honey |
| CIT | Citron | NUT | Nut Brown |
| DES | Desert | | |
| Maple | | | |
| ALE | Ale | FLX | Flax |
| AUB | Auburn | LGC | Legacy |
| AUT | Autumn | MCH | Mocha |
| BRL | Barley | NTO | Night Owl |
| BBN | Bourbon | PRL | Praline |
| BRG | Brighton | SAF | Saffron |
| BUT | Butterscotch | SIE | Sienna |
| CIN | Cinnamon | TOF | Toffee |
| CLA | Classic | TRF | Truffle |
| EAR | Earthy | VEN | Venetian |
| ESP | Espresso | | |



Color - Add \$31 list per item



- | | | | |
|-----|--------------|-----|------------------|
| BKD | Backdrop | GRV | Creek Villa |
| BFX | Black Fox | GLF | Gulf Stream |
| BWH | Bright White | HTB | Hearthrob |
| CGP | Cargo Pants | NET | Network Gray |
| CHT | Chatroom | NWH | Nonchalant White |
| DSY | Daisy | PAR | Paradise |
| DRG | Daring | QXP | Quixotic Plum |
| DYN | Dynamo | RBZ | Relic Bronze |
| ENG | Enigma | SND | Sandbank |
| FRR | French Roast | STM | Storm |
| GBY | Georgian Bay | TRC | Tricorn Black |



Specifications



- Wood species - Oak or Maple.
- Two stretcher shelf for added stability.
- Seat is upholstered with 1 1/2" high density polyurethane foam.
- Back is upholstered front and back with 1" polyurethane foam.
- Mortise and tenon construction with corner blocks, glue and screws.
- Features rounded corners for added safety.
- Standard with rubber cushion metal glides (leg models only).
- Coordinating adult collection. See page 108.

- ④ See a selection of graded in fabric manufacturers and patterns on pages 12-20. Contact Customer Service for additional fabric options.

Description	① Model	Specifications				List Price Per Grade
Armless 16" H  	66D Uph. Seat/Back	Dimensions	D	W	H	COM \$419
		Overall	17 ½	17	29 ½	A \$434
		Seat	14 ½	15	16	B \$449
		Upholstery	Shipping			COL/C \$476
		COM Ydg	⅞	Ctn Wt	22	D \$510
		COL Sq Ft	14	Cu Ft	7	E \$544
						F \$580
						G \$632
						H \$686
						I \$772
						J \$874
						L1 \$642
						L2 \$697

Description	① Model	Specifications				List Price Per Grade
Armless 16" H   	67A All Wood 67B Uph. Back	Dimensions	D	W	H	All Wood \$334
		Overall	17 ½	17	29 ½	COM \$385
		Seat	14 ½	15	16	A \$395
		Upholstery	Shipping			B \$404
		COM Ydg	½	Ctn Wt	23	COL/C \$419
		COL Sq Ft	6	Cu Ft	7	D \$438
						E \$458
						F \$479
						G \$509
						H \$539
						I \$588
						J \$647
						L1 \$514
						L2 \$545

Description	① Model	Specifications				List Price Per Grade
Armless 16" H  	67C Uph. Seat	Dimensions	D	W	H	COM \$385
		Overall	17 ½	17	29 ½	A \$396
		Seat	14 ½	15	16	B \$409
		Upholstery	Shipping			COL/C \$429
		COM Ydg	⅔	Ctn Wt	23	D \$455
		COL Sq Ft	8	Cu Ft	7	E \$480
						F \$509
						G \$548
						H \$588
						I \$654
						J \$732
						L1 \$555
						L2 \$597

Description	Model	Specifications				List Price Per Grade	
		Dimensions	D	W	H	COM	
Armless 16" H	67D Uph. Seat/Back						
							
							
		Overall	17 1/2	17	29 1/2	A	\$441
		Seat	14 1/2	15	16	B	\$456
		Upholstery		Shipping		COL/C	\$483
		COM Ydg	7/8	Ctn Wt	23	D	\$517
		COL Sq Ft	14	Cu Ft	7	E	\$552
						F	\$587
						G	\$639
						H	\$693
						I	\$780
						J	\$881
						L1	\$649
						L2	\$704

To Order, Specify:

- 1 Model Number
- 2 Wood Species - Oak (O) or Maple (M)
- 3 Wood Finish/Color
- 4 Fabric Selection - vendor, pattern and color
- 5 Optional Linking Brackets - add \$26 list per chair
- 6 Optional Casters - add \$90 list; standard seat height maintained. **LEG MODELS ONLY**
- 7 Optional Rubber Cushion Nylon Glides - no upcharge **LEG MODELS ONLY**

3 Wood Finish/Color Options:

- | | | | |
|--------------|--------------|-----|-----------|
| Oak | | ECU | Ecu |
| BRW | Brownie | HEN | Henna |
| CAN | Canyon | HNY | Honey |
| CIT | Citron | NUT | Nut Brown |
| DES | Desert | | |
| Maple | | | |
| ALE | Ale | FLX | Flax |
| AUB | Auburn | LGC | Legacy |
| AUT | Autumn | MCH | Mocha |
| BRL | Barley | NTO | Night Owl |
| BBN | Bourbon | PRL | Praline |
| BRG | Brighton | SAF | Saffron |
| BUT | Butterscotch | SIE | Sienna |
| CIN | Cinnamon | TOF | Toffee |
| CLA | Classic | TRF | Truffle |
| EAR | Earthy | VEN | Venetian |
| ESP | Espresso | | |

Color - Add \$31 list per item

- | | | | |
|-----|--------------|-----|------------------|
| BKD | Backdrop | GRV | Creek Villa |
| BFX | Black Fox | GLF | Gulf Stream |
| BWH | Bright White | HTB | Heartthrob |
| CGP | Cargo Pants | NET | Network Gray |
| CHT | Chatroom | NWH | Nonchalant White |
| DSY | Daisy | PAR | Paradise |
| DRG | Daring | QXP | Quixotic Plum |
| DYN | Dynamo | RBZ | Relic Bronze |
| ENG | Enigma | SND | Sandbank |
| FRR | French Roast | STM | Storm |
| GBY | Georgian Bay | TRC | Tricorn Black |

- 4 See a selection of graded in fabric manufacturers and patterns on pages 12-20. Contact Customer Service for additional fabric options.

Specifications

- Wood species - Oak or Maple.
- Two stretcher shelf for added stability.
- Seat is upholstered with 1 1/2" high density polyurethane foam.
- Back is upholstered front and back with 1" polyurethane foam.
- Mortise and tenon construction with corner blocks, glue and screws.
- Features rounded corners for added safety.
- Standard with rubber cushion metal glides (leg models only).
- Coordinating adult collection. See page 108.

Collegian Children's Order Check List:



Coordinating adult collection. See page 112.

Specify:

- 1. Model Number
- 2. Wood Species - Oak (0)
- 3. Wood Finish/Color
- 4. Fabric Selection - vendor, pattern and color
- 5. Optional FRONT LEG Casters - add \$46 list
- 6. Optional Rubber Cushion Nylon Glides - no upcharge

Example:

1206C | 0 | HEN | MOMENTUM | VOX | MYSTIC
 (model #) | (wood species) | (finish) | (fabric vendor) | (pattern name) | (pattern color)

1. Model Number

2. Wood Species - Oak (0)

3. Wood Finish/Color Options:

BRW Brownie	ECU Ecru
CAN Canyon	HEN Henna
CIT Citron	HNY Honey
DES Desert	NUT Nut Brown
Color - Add \$31 list per item	
BKD Backdrop	GRV Greek Villa
BFX Black Fox	GLF Gulf Stream
BWH Bright White	HTB Heartthrob
CGP Cargo Pants	NET Network Gray
CHT Chatroom	NWH Nonchalant White
DSY Daisy	PAR Paradise
DRG Daring	QXP Quixotic Plum
DYN Dynamo	RBZ Relic Bronze
ENG Enigma	SND Sandbank
FRR French Roast	STM Storm
GBY Georgian Bay	TRC Tricorn Black

4. Fabric Selection - Please supply the following:

- Fabric vendor
- Pattern name
- Pattern color

When specifying contrasting upholstery, indicate clearly which upholstery is to be applied to the seat and back. Use higher grade pricing.

- Indicate direction of fabric - Railroaded or Up the Roll
- Please provide illustration, if available

All COM orders must include the following:

- Vendor's name, pattern name and color
- Sample of the fabric attached to order
- Model numbers of items for fabric application
- Special application instructions (e.g., all stripes will be applied front to back unless specified otherwise)
- Customer and purchase order number

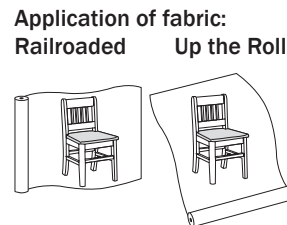

Ship prepaid COM material to:
 Community
 Attn: COM Dept
 932 Mill Street
 Jasper, IN 47546





All COM orders will ship at standard lead time from receipt of COM except for orders requiring special custom matched finishes.

5. Optional FRONT LEG Casters - add \$46 list

6. Optional Rubber Cushion Nylon Glides - no upcharge

Description	Model	Specifications				List Price Per Grade	
		Dimensions	D	W	H	All Wood	COM
Armless 12" H    1092A all wood 1092C uph. seat	1092A All Wood 1092C Uph. Seat • optional front leg casters available - add \$46 list for set of 2 casters	Overall	12 1/2	13 3/4	23 1/2	\$251	\$318
	Seat	10 1/2	13 3/4	12	A \$329	B \$343	
		Upholstery		Shipping		COL/C \$365	D \$394
		COM Ydg	3/4	Ctn Wt	12	E \$424	F \$455
		COL Sq Ft	9	Cu Ft	4	G \$499	H \$545
						I \$619	J \$707
						L1 \$508	L2 \$555

Description	Model	Specifications				List Price Per Grade	
		Dimensions	D	W	H	All Wood	COM
Armless 14" H    1094A all wood 1094C uph. seat	1094A All Wood 1094C Uph. Seat • optional front leg casters available - add \$46 list for set of 2 casters	Overall	13	13 3/4	25 1/2	\$270	\$331
	Seat	10 1/2	13 3/4	14	A \$343	B \$356	
		Upholstery		Shipping		COL/C \$380	D \$408
		COM Ydg	3/4	Ctn Wt	12	E \$437	F \$469
		COL Sq Ft	9	Cu Ft	4	G \$513	H \$559
						I \$633	J \$721
						L1 \$521	L2 \$569

To Order, Specify:

- 1 Model Number
- 2 Wood Species - Oak (O)
- 3 Wood Finish/Color
- 4 Fabric Selection - vendor, pattern and color
- 5 Optional FRONT LEG Casters - add \$46 list
- 6 Optional Rubber Cushion Nylon Glides - no upcharge

3 Wood Finish/Color Options:

BRW Brownie	ECU Ecru
CAN Canyon	HEN Henna
CIT Citron	HNY Honey
DES Desert	NUT Nut Brown









Color - Add \$31 list per item



BKD Backdrop	GRV Greek Villa
BFX Black Fox	GLF Gulf Stream
BWH Bright White	HTB Heartthrob
CGP Cargo Pants	NET Network Gray
CHT Chatroom	NWH Nonchalant White
DSY Daisy	PAR Paradise
DRG Daring	QXP Quixotic Plum
DYN Dynamo	RBZ Relic Bronze
ENG Enigma	SND Sandbank
FRR French Roast	STM Storm
GBY Georgian Bay	TRC Tricorn Black

Specifications

- Wood species - Oak
- Seat is upholstered with 1" high density polyurethane foam.
- Mortise and tenon construction with corner blocks, glue and screws.
- Standard with rubber cushion metal glides.
- Coordinating adult collection. See page 112.

- 4 See a selection of graded in fabric manufacturers and patterns on pages 12-20. Contact Customer Service for additional fabric options.

Description	① Model	Specifications	List Price Per Grade																								
Armless 16" H    1096A all wood 1096C uph. seat	1096A All Wood 1096C Uph. Seat · optional front leg casters available - add \$46 list for set of 2 casters	<table border="1"> <thead> <tr> <th>Dimensions</th> <th>D</th> <th>W</th> <th>H</th> </tr> </thead> <tbody> <tr> <td>Overall</td> <td>15 ¼</td> <td>15</td> <td>29 ¼</td> </tr> <tr> <td>Seat</td> <td>13</td> <td>15</td> <td>16</td> </tr> <tr> <th colspan="2">Upholstery</th> <th colspan="2">Shipping</th> </tr> <tr> <td>COM Ydg</td> <td>¾</td> <td>Ctn Wt</td> <td>13</td> </tr> <tr> <td>COL Sq Ft</td> <td>9</td> <td>Cu Ft</td> <td>6</td> </tr> </tbody> </table>	Dimensions	D	W	H	Overall	15 ¼	15	29 ¼	Seat	13	15	16	Upholstery		Shipping		COM Ydg	¾	Ctn Wt	13	COL Sq Ft	9	Cu Ft	6	All Wood \$280 COM \$346 A \$359 B \$371 COL/C \$394 D \$424 E \$453 F \$483 G \$528 H \$575 I \$647 J \$735 L1 \$536 L2 \$583
Dimensions	D	W	H																								
Overall	15 ¼	15	29 ¼																								
Seat	13	15	16																								
Upholstery		Shipping																									
COM Ydg	¾	Ctn Wt	13																								
COL Sq Ft	9	Cu Ft	6																								
Armless 12" H    1192A all wood 1192C uph. seat	1192A All Wood 1192C Uph. Seat · optional front leg casters available - add \$46 list for set of 2 casters	<table border="1"> <thead> <tr> <th>Dimensions</th> <th>D</th> <th>W</th> <th>H</th> </tr> </thead> <tbody> <tr> <td>Overall</td> <td>12 ½</td> <td>13 ¾</td> <td>23 ½</td> </tr> <tr> <td>Seat</td> <td>10 ½</td> <td>13 ¾</td> <td>12</td> </tr> <tr> <th colspan="2">Upholstery</th> <th colspan="2">Shipping</th> </tr> <tr> <td>COM Ydg</td> <td>¾</td> <td>Ctn Wt</td> <td>12</td> </tr> <tr> <td>COL Sq Ft</td> <td>9</td> <td>Cu Ft</td> <td>4</td> </tr> </tbody> </table>	Dimensions	D	W	H	Overall	12 ½	13 ¾	23 ½	Seat	10 ½	13 ¾	12	Upholstery		Shipping		COM Ydg	¾	Ctn Wt	12	COL Sq Ft	9	Cu Ft	4	All Wood \$229 COM \$296 A \$307 B \$320 COL/C \$343 D \$372 E \$402 F \$432 G \$476 H \$523 I \$597 J \$684 L1 \$486 L2 \$532
Dimensions	D	W	H																								
Overall	12 ½	13 ¾	23 ½																								
Seat	10 ½	13 ¾	12																								
Upholstery		Shipping																									
COM Ydg	¾	Ctn Wt	12																								
COL Sq Ft	9	Cu Ft	4																								
Armless 14" H    1194A all wood 1194C uph. seat	1194A All Wood 1194C Uph. Seat · optional front leg casters available - add \$46 list for set of 2 casters	<table border="1"> <thead> <tr> <th>Dimensions</th> <th>D</th> <th>W</th> <th>H</th> </tr> </thead> <tbody> <tr> <td>Overall</td> <td>13</td> <td>13 ¾</td> <td>25 ½</td> </tr> <tr> <td>Seat</td> <td>10 ½</td> <td>13 ¾</td> <td>14</td> </tr> <tr> <th colspan="2">Upholstery</th> <th colspan="2">Shipping</th> </tr> <tr> <td>COM Ydg</td> <td>¾</td> <td>Ctn Wt</td> <td>12</td> </tr> <tr> <td>COL Sq Ft</td> <td>9</td> <td>Cu Ft</td> <td>4</td> </tr> </tbody> </table>	Dimensions	D	W	H	Overall	13	13 ¾	25 ½	Seat	10 ½	13 ¾	14	Upholstery		Shipping		COM Ydg	¾	Ctn Wt	12	COL Sq Ft	9	Cu Ft	4	All Wood \$248 COM \$312 A \$324 B \$338 COL/C \$360 D \$389 E \$418 F \$450 G \$493 H \$540 I \$614 J \$702 L1 \$502 L2 \$550
Dimensions	D	W	H																								
Overall	13	13 ¾	25 ½																								
Seat	10 ½	13 ¾	14																								
Upholstery		Shipping																									
COM Ydg	¾	Ctn Wt	12																								
COL Sq Ft	9	Cu Ft	4																								

Description	Model	Specifications				List Price Per Grade	
		Dimensions	D	W	H	All Wood	COM
Armless 16" H    1206A all wood 1206C uph. seat	1206A All Wood 1206C Uph. Seat • optional front leg casters available - add \$46 list for set of 2 casters	Overall	15 ¼	15	29 ½	\$261	\$326
		Seat	13	15	16	\$338	\$351
		Upholstery		Shipping		\$373	\$403
		COM Ydg	¾	Ctn Wt	13	\$432	\$464
		COL Sq Ft	9	Cu Ft	6	\$508	\$554
						\$627	\$716
						\$516	\$563

To Order, Specify:

- 1 Model Number
- 2 Wood Species - Oak (O)
- 3 Wood Finish/Color
- 4 Fabric Selection - vendor, pattern and color
- 5 Optional FRONT LEG Casters - add \$46 list
- 6 Optional Rubber Cushion Nylon Glides - no upcharge

3 Wood Finish/Color Options:

BRW	Brownie	ECU	Ecru
CAN	Canyon	HEN	Henna
CIT	Citron	HNY	Honey
DES	Desert	NUT	Nut Brown

Color - Add \$31 list per item

BKD	Backdrop	GRV	Greek Villa
BFX	Black Fox	GLF	Gulf Stream
BWH	Bright White	HTB	Heartthrob
CGP	Cargo Pants	NET	Network Gray
CHT	Chatroom	NWH	Nonchalant White
DSY	Daisy	PAR	Paradise
DRG	Daring	QXP	Quixotic Plum
DYN	Dynamo	RBZ	Relic Bronze
ENG	Enigma	SND	Sandbank
FRR	French Roast	STM	Storm
GBY	Georgian Bay	TRC	Tricorn Black

- 4 See a selection of graded in fabric manufacturers and patterns on pages 12-20. Contact Customer Service for additional fabric options.

Specifications

- Wood species - Oak
- Seat is upholstered with 1" high density polyurethane foam.
- Mortise and tenon construction with corner blocks, glue and screws.
- Standard with rubber cushion metal glides.
- Coordinating adult collection. See page 112.

Jefferson Juvenile and Children's Table Order Check List:



Specify:

- 1. Model Number
- 2. Top Material - Veneer (W) or Laminate (L)
- 3. Wood Species - Cherry (CH1), Maple (MA1), Oak (OK1) or Walnut (WA1) [▲]
- 4. Wood Finish/Color
- 5. Edge Profile
- 6. Leg Style - Straight Wood (S) or Tapered Wood (T)
- 7. Leg Attachment
 - A. Corner Block with 3" high straight apron (CBSA)
 - B. Corner Block with 3" high arched apron (CBAA)
 - C. Plate and Barrel Nut with 1" high straight apron (PBSA)
- 8. Optional Premium or Specialty Laminate Tops Available - contact customer service for pricing

Example:

JE3636-27 | W | OK1 | HEN | N | S | PBSA
(model #) | (top material) | (wood species) | (finish) | (edge) | (leg style) | (leg attachment)

1. Model Number

2. Top Material - Veneer (W) or Laminate (L) - Finishes below with an asterisk (*) have a coordinating laminate available

3. Wood Species - Cherry (CH1), Maple (MA1), Oak (OK1) or Walnut (WA1)

4. Wood Finish/Color Options:

Cherry

- AUT Autumn*
- BRL Barley*
- BBN Bourbon*
- BRG Brighton*
- CLA Classic*
- EAR Earthy
- LGC Legacy*
- PRL Praline*
- SAF Saffron*

Maple

- ALE Ale*
- BUT Butterscotch
- CIN Cinnamon*
- FLX Flax
- VEN Venetian*

Oak

- BRW Brownie*
- CAN Canyon*
- CIT Citron*
- DES Desert*

- ECU Ecru*
- HEN Henna*
- HNY Honey*
- NUT Nut Brown*

Walnut

- AUB Auburn*
- ESP Espresso
- MCH Mocha*
- NTO Night Owl*

- SIE Sienna*
- TOF Toffee*
- TRF Truffle*

Color - Add \$31 list per item

- BKD Backdrop
- BFX Black Fox
- BWH Bright White
- CGP Cargo Pants
- CHT Chatroom
- DSY Daisy
- GRV Greek Villa
- GLF Gulf Stream
- HTB Heartthrob
- NET Network Gray
- NWH Nonchalant White
- PAR Paradise

Color Continued - Add \$29 list per item

- DRG Daring
- DYN Dynamo
- ENG Enigma
- FRR French Roast
- GBY Georgian Bay
- QXP Quixotic Plum
- RBZ Relic Bronze
- SND Sandbank
- STM Storm
- TRC Tricorn Black

5. Edge Profile Options:

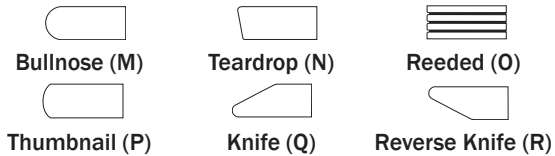

Top construction core material is 1 1/8" thick with 45 lb. density industrial grade particle board. The face is wood veneer or horizontal grade high pressure laminate (HPL). A backer is bonded to bottom side to ensure balanced construction. All tops have mitered corner external solid lumbar bands with inset laminate or veneer.

6. Leg Style - Straight Wood (S) or Tapered Wood (T)

7. Leg Attachment:

- Corner Block with 3" high straight apron (CBSA)
- Corner Block with 3" high arched apron (CBAA)
- Plate and Barrel Nut with 1" high straight apron (PBSA)
- NOTE: CBAA and PBSA recommended for ADA applications.**



Corner Block | Plate and Barrel Nut

8. Optional Premium or Specialty Laminate Tops Available - contact customer service for pricing.

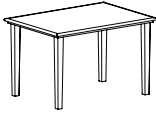
Description	D	W	H	CTN WT	① Model	List Price
	24	36	27	52	JE2436-27	\$838
	30	42	27	57	JE3042-27	\$986
	30	60	27	92	JE3060-27	\$1,100
	36	60	27	103	JE3660-27	\$1,183
	36	72	27	123	JE3672-27	\$1,332
	36	90	27	130	JE3690-27	\$1,695
	42	78	27	137	JE4278-27	\$1,715
	42	84	27	147	JE4284-27	\$1,782

· 90" table has an additional leg in center for support ▲

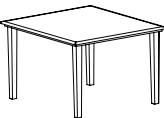
Description	D	W	H	CTN WT	① Model	List Price
	36	36	27	67	JE3636-27	\$1,015
	42	42	27	77	JE4242-27	\$1,154
	48	48	27	87	JE4848-27	\$1,329

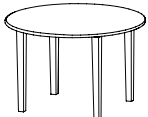
Description	D	W	H	CTN WT	① Model	List Price
	36	N/A	27	39	JE36R-27	\$1,176
	42	N/A	27	77	JE42R-27	\$1,256
	48	N/A	27	92	JE48R-27	\$1,341

To Order, Specify:

- ① Model Number
- ② Top Material - Veneer (W) or Laminate (L)
- ③ Wood Species - Cherry (CH1), Maple (MA1), Oak (OK1) or Walnut (WA1) ▲
- ④ Wood Finish/Color
- ⑤ Edge Profile
- ⑥ Leg Style - Straight Wood (S) or Tapered Wood (T)
- ⑦ Leg Attachment - Corner block with 3" high straight apron (CBSA), Corner block with 3" high arched apron (CBAA) or Plate and Barrel Nut with 1" high straight apron (PBSA)
- ⑧ Optional Premium or Specialty Laminate Tops
Available - contact customer service for pricing

③ Wood Finish/Color Options:

Cherry	Maple
AUT Autumn*	ALE Ale*
BRL Barley*	BUT Butterscotch
BBN Bourbon*	CIN Cinnamon*
BRG Brighton*	FLX Flax
CLA Classic*	VEN Venetian*
EAR Earthy	
LGC Legacy*	
PRL Praline*	
SAF Saffron*	
Oak	Walnut
BRW Brownie*	AUB Auburn*
CAN Canyon*	ESP Espresso
CIT Citron*	MCH Mocha*
DES Desert*	NTO Night Owl*
ECU Ecu*	SIE Sienna*
HEN Henna*	TOF Toffee*
HNY Honey*	TRF Truffle*
NUT Nut Brown*	

Color - Add \$31 list per item

BKD Backdrop	GRV Greek Villa
BFX Black Fox	GLF Gulf Stream
BWH Bright White	HTB Hearthrob
CGP Cargo Pants	NET Network Gray
CHT Chatroom	NWH Nonchalant White
DSY Daisy	PAR Paradise
DRG Daring	QXP Quixotic Plum
DYN Dynamo	RBZ Relic Bronze
ENG Enigma	SND Sandbank
FRR French Roast	STM Storm
GBY Georgian Bay	TRC Tricorn Black

Specifications

- Wood species - Cherry, Maple, Oak or Walnut.
- Top core material is 1 1/8" thick with 45 lb. density industrial grade particle board.
- Backer is bonded to bottom side to ensure balanced construction.
- All tops have mitered corner external solid lumber bands with inset laminate or veneer.
- Standard with adjustable rubber cushion metal glides.

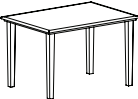
Description	D	W	H	CTN WT	① Model	List Price
	24	36	25	49	JE2436-25	\$838
	30	42	25	54	JE3042-25	\$986
	30	60	25	89	JE3060-25	\$1,100
	36	60	25	99	JE3660-25	\$1,183
	36	72	25	119	JE3672-25	\$1,332
	36	90	25	127	JE3690-25 *	\$1,695
	42	78	25	134	JE4278-25	\$1,715
	42	84	25	144	JE4284-25	\$1,782

· 90" table has an additional leg in center for support

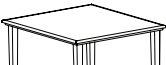
	36	36	25	64	JE3636-25	\$1,015
	42	42	25	74	JE4242-25	\$1,154
	48	48	25	84	JE4848-25	\$1,329

	36	N/A	25	36	JE36R-25	\$1,176
	42	N/A	25	74	JE42R-25	\$1,256
	48	N/A	25	89	JE48R-25	\$1,341

To Order, Specify:

- ① Model Number
- ② Top Material - Veneer (W) or Laminate (L)
- ③ Wood Species - Cherry (CH1), Maple (MA1), Oak (OK1) or Walnut (WA1) ▲
- ④ Wood Finish/Color
- ⑤ Edge Profile
- ⑥ Leg Style - Straight Wood (S) or Tapered Wood (T)
- ⑦ Leg Attachment - Corner block with 3" high straight apron (CBSA), Corner block with 3" high arched apron (CBAA) or Plate and Barrel Nut with 1" high straight apron (PBSA)
- ⑧ Optional Premium or Specialty Laminate Tops
Available - contact customer service for pricing

③ Wood Finish/Color Options:

- | | |
|----------------|------------------|
| Cherry | Maple |
| AUT Autumn* | ALE Ale* |
| BRL Barley* | BUT Butterscotch |
| BBN Bourbon* | CIN Cinnamon* |
| BRG Brighton* | FLX Flax |
| CLA Classic* | VEN Venetian* |
| EAR Earthy | |
| LGC Legacy* | |
| PRL Praline* | |
| SAF Saffron* | |
| Oak | Walnut |
| BRW Brownie* | AUB Auburn* |
| CAN Canyon* | ESP Espresso |
| CIT Citron* | MCH Mocha* |
| DES Desert* | NTO Night Owl* |
| ECU Ecu* | SIE Sienna* |
| HEN Henna* | TOF Toffee* |
| HNY Honey* | TRF Truffle* |
| NUT Nut Brown* | |

Color - Add \$31 list per item

- | | |
|------------------|----------------------|
| BKD Backdrop | GRV Greek Villa |
| BFX Black Fox | GLF Gulf Stream |
| BWH Bright White | HTB Heartthrob |
| CGP Cargo Pants | NET Network Gray |
| CHT Chatroom | NWH Nonchalant White |
| DSY Daisy | PAR Paradise |
| DRG Daring | QXP Quixotic Plum |
| DYN Dynamo | RBZ Relic Bronze |
| ENG Enigma | SND Sandbank |
| FRR French Roast | STM Storm |
| GBY Georgian Bay | TRC Tricorn Black |

Specifications

- Wood species - Cherry, Maple, Oak or Walnut.
- Top core material is 1 1/8" thick with 45 lb. density industrial grade particle board.
- Backer is bonded to bottom side to ensure balanced construction.
- All tops have mitered corner external solid lumber bands with inset laminate or veneer.
- Standard with adjustable rubber cushion metal glides.

Lincoln Juvenile and Children's Tables Order Check List:



Specify:

- 1. Model Number
- 2. Top Material - Veneer (W) or Laminate (L)
- 3. Wood Species - Cherry (CH1), Maple (MA1), Oak (OK1) or Walnut (WA1) ▲
- 4. Wood Finish/Color
- 5. Edge Profile
- 6. Leg Style - Straight Wood (S) or Tapered Wood (T)
- 7. Leg Attachment
 - A. Corner Block with 3" high straight apron (CBSA)
 - B. Corner Block with 3" high arched apron (CBAA)
 - C. Plate and Barrel Nut with 1" high straight apron (PBSA)
- 8. Optional Premium or Specialty Laminate Tops Available - contact customer service for pricing

Example:

LI3636-27 ▲ | W | OK1 | HEN | C | S | CBMA
 (model #) | (top material) | (wood species) | (finish) | (edge) | (leg style) | (leg attachment)

1. Model Number

2. Top Material - Veneer (W) or Laminate (L) - Finishes below with an asterisk (*) have a coordinating laminate available

3. Wood Species - Cherry (CH1), Maple (MA1), Oak (OK1) or Walnut (WA1) ▲

4. Wood Finish/Color Options:

Cherry

- AUT Autumn*
- BRL Barley*
- BBN Bourbon*
- BRG Brighton*
- CLA Classic*
- EAR Earthy
- LGC Legacy*
- PRL Praline*
- SAF Saffron*

Maple

- ALE Ale*
- BUT Butterscotch
- CIN Cinnamon*
- FLX Flax
- VEN Venetian*

Oak

- BRW Brownie*
- CAN Canyon*
- CIT Citron*
- DES Desert*

- ECU Ecru*
- HEN Henna*
- HNY Honey*
- NUT Nut Brown*

Walnut

- AUB Auburn*
- ESP Espresso
- MCH Mocha*
- NTO Night Owl*

- SIE Sienna*
- TOF Toffee*
- TRF Truffle*

Color - Add \$31 list per item

- BKD Backdrop
- BFX Black Fox
- BWH Bright White
- CGP Cargo Pants
- CHT Chatroom
- DSY Daisy
- GRV Greek Villa
- GLF Gulf Stream
- HTB Heartthrob
- NET Network Gray
- NWH Nonchalant White
- PAR Paradise

Color Continued - Add \$31 list per item

- DRG Daring
- DYN Dynamo
- ENG Enigma
- FRR French Roast
- GBY Georgian Bay
- QXP Quixotic Plum
- RBZ Relic Bronze
- SND Sandbank
- STM Storm
- TRC Tricorn Black

5. Edge Profile Options:

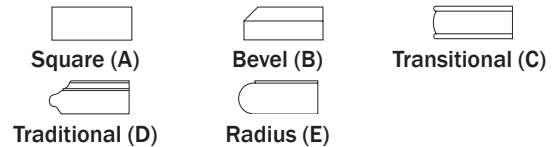

Top construction core material is 1 1/8" thick with 45 lb. density industrial grade particle board. The face is wood veneer or horizontal grade high pressure laminate (HPL). A backer is bonded to bottom side to ensure balanced construction. All tops have mitered corner external solid lumbar bands with inset laminate or veneer.

6. Leg Style - Straight Wood (S) or Tapered Wood (T)

7. Leg Attachment:

Corner Block with 3" high straight apron (CBSA)
 Corner Block with 3" high arched apron (CBAA)
 Plate and Barrel Nut with 1" high straight apron (PBSA)
NOTE: CBAA and PBSA recommended for ADA applications.



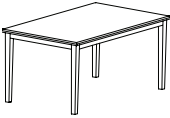

Corner Block | Plate and Barrel Nut

8. Optional Premium or Specialty Laminate Tops Available - contact customer service for pricing.

Description	D	W	H	CTN WT	① Model	List Price
Rectangular 	20	28	27	40	LI2028-27	\$438
	20	42	27	46	LI2042-27	\$533
	24	36	27	52	LI2436-27	\$536
	30	42	27	57	LI3042-27	\$660
	30	60	27	92	LI3060-27	\$774
	36	60	27	103	LI3660-27	\$858
	36	72	27	123	LI3672-27	\$1,007
	36	90	27	130	LI3690-27*	\$1,371
	42	78	27	137	LI4278-27	\$1,389
	42	84	27	147	LI4284-27	\$1,458

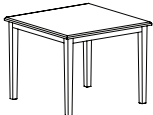
· 90" table has an additional leg in center for support▲

Description	D	W	H	CTN WT	① Model	List Price
Square 	24	24	27	47	LI2424-27	\$486
	36	36	27	67	LI3636-27	\$695
	42	42	27	77	LI4242-27	\$829
	48	48	27	87	LI4848-27	\$970

Description	D	W	H	CTN WT	① Model	List Price
Round 	36	N/A	27	39	LI36R-27	\$796
	42	N/A	27	77	LI42R-27	\$938
	48	N/A	27	92	LI48R-27	\$1,016

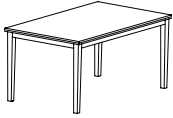
Description	D	W	H	CTN WT	① Model	List Price
	20	28	25	38	LI2028-25	\$438
	20	42	25	44	LI2042-25	\$533
	24	36	25	49	LI2436-25	\$536
	30	42	25	54	LI3042-25	\$660
	30	60	25	89	LI3060-25	\$774
	36	60	25	99	LI3660-25	\$858
	36	72	25	119	LI3672-25	\$1,007
	36	90	25	127	LI3690-25*	\$1,371
	42	78	25	134	LI4278-25	\$1,389
	42	84	25	144	LI4284-25	\$1,458

· 90" table has an additional leg in center for support ▲

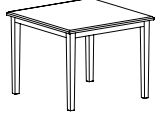
Description	D	W	H	CTN WT	① Model	List Price
	24	24	25	44	LI2424-25	\$486
	36	36	25	64	LI3636-25	\$695
	42	42	25	74	LI4242-25	\$829
	48	48	25	84	LI4848-25	\$970

Description	D	W	H	CTN WT	① Model	List Price
	36	N/A	25	36	LI36R-25	\$796
	42	N/A	25	74	LI42R-25	\$938
	48	N/A	25	89	LI48R-25	\$1,016

To Order, Specify:

- ① Model Number
- ② Top Material - Veneer (W) or Laminate (L)
- ③ Wood Species - Cherry (CH1), Maple (MA1), Oak (OK1) or Walnut (WA1) ▲
- ④ Wood Finish/Color
- ⑤ Edge Profile
- ⑥ Leg Style - Straight Wood (S) or Tapered Wood (T)
- ⑦ Leg Attachment - Corner block with 3" high straight apron (CBSA), Corner block with 3" high arched apron (CBAA) or Plate and Barrel Nut with 1" high straight apron (PBSA)
- ⑧ Optional Premium or Specialty Laminate Tops Available - contact customer service for pricing

③ Wood Finish/Color Options:

Cherry	Maple
AUT Autumn*	ALE Ale*
BRL Barley*	BUT Butterscotch
BBN Bourbon*	CIN Cinnamon*
BRG Brighton*	FLX Flax
CLA Classic*	VEN Venetian*
EAR Earthy	
LGC Legacy*	
PRL Praline*	
SAF Saffron*	
Oak	Walnut
BRW Brownie*	AUB Auburn*
CAN Canyon*	ESP Espresso
CIT Citron*	MCH Mocha*
DES Desert*	NTO Night Owl*
ECU Ecu*	SIE Sienna*
HEN Henna*	TOF Toffee*
HNY Honey*	TRF Truffle*
NUT Nut Brown*	

Specifications

- Wood species - Cherry, Maple, Oak or Walnut.
- Top core material is 1 1/8" thick with 45 lb. density industrial grade particle board.
- Backer is bonded to bottom side to ensure balanced construction.
- All tops have internal solid lumber bands with overlay laminate or veneer.
- Standard with adjustable rubber cushion metal glides.

Color - Add \$31 list per item

BKD Backdrop	GRV Greek Villa
BFX Black Fox	GLF Gulf Stream
BWH Bright White	HTB Heartthrob
CGP Cargo Pants	NET Network Gray
CHT Chatroom	NWH Nonchalant White
DSY Daisy	PAR Paradise
DRG Daring	QXP Quixotic Plum
DYN Dynamo	RBZ Relic Bronze
ENG Enigma	SND Sandbank
FRR French Roast	STM Storm
GBY Georgian Bay	TRC Tricorn Black

⑤ Edge Profile Options:



NOTES

Casegoods Overview



Congress Bookcases 360

Congress Bookcases Order Check List:



Specify:

- 1. Model Number
- 2. Wood Species - Oak (O)
- 3. Wood Finish/Color

Congress features 3/4" thick seven-ply rotary cut veneer core plywood construction. Back panels are constructed with 1/4" thick veneer.

Example:

C03672BC | **O** | **HEN**
 (model #) | (wood species) | (finish)

1. Model Number

Jasper Group recommends any storage unit over 42" high be placed against the wall. In addition, Jasper Group recommends any bookcase 60" and over be mounted to the wall or floor.

2. Wood Species - Oak (O)

3. Wood Finish/Color Options:

BRW	Brownie	ECU	Ecru
CAN	Canyon	HEN	Henna
CIT	Citron	HNY	Honey
DES	Desert	NUT	Nut Brown

Color - Add \$31 list per item

BKD	Backdrop	GRV	Greek Villa
BFX	Black Fox	GLF	Gulf Stream
BWH	Bright White	HTB	Heartthrob
CGP	Cargo Pants	NET	Network Gray
CHT	Chatroom	NWH	Nonchalant White
DSY	Daisy	PAR	Paradise
DRG	Daring	QXP	Quixotic Plum
DYN	Dynamo	RBZ	Relic Bronze
ENG	Enigma	SND	Sandbank
FRR	French Roast	STM	Storm
GBY	Georgian Bay	TRC	Tricorn Black

Description	D	W	H	CTN WT	CU FT	① Model	List Price
Bookcase	12	36	84	135	24	C03684BC	\$ 1,304

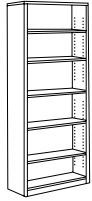

- our adjustable shelves
- one fixed shelf
- we recommend that all bookcases 60" or taller be mounted to the floor or wall
- requires ganging if not placed against a wall

Bookcase	12	36	72	120	21	C03672BC	\$ 1,139
----------	----	----	----	-----	----	-----------------	----------



- three adjustable shelves
- one fixed shelf - second from top
- we recommend that all bookcases 60" or taller be mounted to the floor or wall
- requires ganging if not placed against a wall

Bookcase	12	36	60	105	17	C03660BC	\$ 1,006
----------	----	----	----	-----	----	-----------------	----------

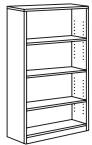

- two adjustable shelves
- one fixed shelf - second from top
- we recommend that all bookcases 60" or taller be mounted to the floor or wall
- requires ganging if not placed against a wall

Bookcase	12	36	48	85	14	C03648BC	\$ 845
----------	----	----	----	----	----	-----------------	--------



- two adjustable shelves

Bookcase	12	36	36	65	11	C03636BC	\$ 702
----------	----	----	----	----	----	-----------------	--------



- one adjustable shelf

Bookcase	12	36	30	55	9	C03630BC	\$ 628
----------	----	----	----	----	---	-----------------	--------



- one adjustable shelf

To Order, Specify:

- ① Model Number
- ② Wood Species - Oak (0)
- ③ Wood Finish/Color

③ Wood Finish/Color Options:

BRW	Brownie	ECU	Ecru
CAN	Canyon	HEN	Henna
CIT	Citron	HNY	Honey
DES	Desert	NUT	Nut Brown

Color - Add \$31 list per item

BKD	Backdrop	GRV	Creek Villa
BFX	Black Fox	GLF	Gulf Stream
BWH	Bright White	HTB	Hearthrob
CGP	Cargo Pants	NET	Network Gray
CHT	Chatroom	NWH	Nonchalant White
DSY	Daisy	PAR	Paradise
DRG	Daring	QXP	Quixotic Plum
DYN	Dynamo	RBZ	Relic Bronze
ENG	Enigma	SND	Sandbank
FRR	French Roast	STM	Storm
GBY	Georgian Bay	TRC	Tricorn Black

Specifications

- Wood species - Oak.
- Features 3/4" thick seven-ply rotary cut veneer core plywood construction.
- Back panels are constructed with 1/4" thick veneer.