



**BRC Canada**

**E | MOTION SERIES**

**HEIGHT ADJUSTABLE WORK SURFACE**

2016

2015/R1

# BRC BUSINESS ENTERPRISES LTD. TERMS AND CONDITIONS OF SALE

## Price:

All prices shown are suggested retail prices and are subject to change without notice. Taxes are extra. These prices are guaranteed for 30 days from the date of quotation and are firm and final after acceptance of the order.

## Terms

Initial orders COD, net 30 days thereafter upon approved credit; 2% monthly interest (24% yearly) on past due invoices. All applicable taxes are extra. No orders will be shipped if invoices are past due. Prices do not include installation.

## Orders

All orders are subject to acceptance by BRC. Any written order is considered final. Order confirmations are binding, and the information received is the customer's responsibility to verify and correct within 24 hours. Any subsequent change is subject to approval by BRC. BRC reserves the right to apply a handling charge of 25% for any order change. Any order placed by phone will require a written confirmation within 24 hours, or will not be processed.

## Cancellation/Changes

a) No order can be cancelled without the written consent of BRC. BRC reserves the right to charge the customer for that portion of the order which has been completed to date of cancellation, including a handling charge for disposal.

b) No order can be changed without the written consent of BRC. All change requests must be received in writing by BRC either by email or fax.

c) BRC reserves the right to apply a minimum handling fee of \$150.00 or 25% of the order value whichever is greater.

d) all deposits received are non-refundable.

## Storage

BRC reserves the right to assess storage charges on all items not accepted by the customer one week after the scheduled shipping date. The minimum charge is \$10.00 per skid per day. Note: The invoice for merchandise is dated and issued when the merchandise is ready for shipment.

## Return of Goods

a) Non-Catalogue and Customized Items are non - returnable.

b) No merchandise may be returned without the written consent of BRC, the issuance of a return authorization number and specific instructions by BRC for shipment. If this procedure is not followed, the merchandise will not be accepted by the factory and will be returned to sender collect without notice.

c) Claims for factory defects must be made within ten days of receipt of goods.

Merchandise must be returned to the BRC factory within 15 days after receipt of the return authorization from BRC. These conditions will be strictly adhered to.

d) Returns of items authorized by BRC are subject to a re-stocking charge of 25%, plus any repair costs deemed necessary. Items must be returned freight prepaid.

## Shipping/Claims

a) All freight prices quoted are based on dock to dock shipment F.O.B. Georgetown Ontario. Any pre-paid freight is based on established minimum order amounts.

Where order minimums are not met, drop charges will apply. Any special delivery arrangements including, but not limited to site delivery, specific delivery time or date, use of tailgate, blanket wrap, inside delivery will require additional costs to be paid by the customer.

b) Merchandise is carefully packed and thoroughly inspected before leaving the BRC warehouse. BRC will choose the carrier, unless otherwise indicated on customers order. Shipments will be handed over to the carrier in good condition and BRC liability ceases at this point. The carrier, upon acceptance of the shipment, assumes responsibility for its safe delivery. Claims for loss or damage sustained in transit must therefore be made upon the carrier as follows.

c) Claims for damages or shortages must adhere to the following processes: i) All damages or shortages must be claimed from the carrier within 48 hours of receipt, ii) All damages or shortages must be noted directly on the original delivery slip, iii) Photos of shipping damage must be forwarded to the carrier and BRC to properly process the claim, iv) All packaging materials must be retained until a freight inspection has been made and authorized by the carrier. Caution: Failure to note damages or shortages on the delivery slip or to retain packaging will make claims impossible.

d) Concealed loss or damage: i) Concealed loss or damage means loss or damage that does not become apparent until the merchandise has been unpacked. The carton contents may be damaged in transit due to rough handling even though the carton may not show external damage. The receiver of the merchandise must file for concealed damage with the carrier within 48 hours of receipt. ii) Photos of concealed damage must accompany the claim to the carrier, and must also be forwarded to BRC customer service to coordinate repair or replacement of goods. Failure to do so will make claims impossible.

e) Visible loss or damage: Any external evidence of loss or damage must be noted on the freight bill or delivery receipt and signed by the carrier's agent. Failure to adequately describe such external evidence of loss or damage may result in the carrier refusing to honor a damage claim. The form required to file such claim will be supplied by the carrier.

f) If the order is shipped directly to your customer, any claims should be handled through you using the procedure described in d), e).

g) No allowance is given for orders picked up at the factory.

h) Customer carrier: When the client chooses a carrier, all charges remain the responsibility of the client. BRC assumes no responsibility for insurance, standby, loss, damaged, waiting, unloading, packing, haulage, or any other charges whatsoever associated with this carrier.

i) Backorders: Freight for all backorders will be the responsibility of the customer and will be billed at the time of the backorder shipment.

j) Customers may be subject to any and all extra freight costs including but not limited to freight charges for missed pickups or deliveries, extended wait times or unloading times, unauthorized use of freight or handling equipment, etc.

## Customer's Specifications

BRC actively solicits contract projects. Our advanced design and manufacturing capabilities facilitate custom project design with relative ease and extremely competitive prices.

## Product Specifications

BRC reserves the right to modify product specifications, materials, design or accessories without notice. BRC also reserves the right to halt production of any product at any time. The products, accessories, materials and finishes as described in the price list will prevail over the content of brochures or folders. BRC assumes no responsibility for lot changes in paint, material color or finishes. Customers are encouraged to verify specifications with current publications and price lists available on the company website at: [www.brccanada.com](http://www.brccanada.com)

## Weight/Volumes

The weights and volumes shown on the price lists include packaging, are approximate, and are listed per item unskidded. Volumes will vary with skidded shipments.

## Warrantees

BRC wall products including Stywall carry a 2 year limited structural warranty. Wall product components and hardware including handles hinges and locks carry a 1 year limited warranty furniture products carries a 10 year limited structural warranty.

Panel and table 8 wire electrical cabling carry a three year limited warranty. All moving user adjustable components carry a five year limited structural warranty. All other electrical or electronic elements of BRC furniture carry a one year limited warranty. The validity of these warranties starts at the date of purchase, and only if purchased directly from BRC or one of its authorized dealers. Only the warranty label, original purchase order or an original signed and dated bill of lading will be recognized as an official document as proof of purchase. These warranties are limited to replacing or repairing at BRC's option any defective products and only if the product has become defective through normal operating conditions. In order to process any warranty claim BRC requires photographs of the product shown in it's entirety and at least two photos detailing the specific nature of the deficiency or warranty claim. BRC may request that product(s) are returned prepaid to BRC where assessment or repairs can be affected. All transportation charges remain the responsibility of the customer unless agreed upon in writing prior to receipt by BRC. All returned goods must have a return authorization number (RA#). These limited warranties do not apply to damages caused by accident, abuse, or adverse climatic conditions where temperatures and humidity exceed normal office conditions. These limited warranties will not be honored if BRC products are misused or if installation instructions are not followed properly. Any attempt by personnel unauthorized by BRC to repair or modify a BRC product will render these limited warranties invalid. The responsibility of BRC is limited exclusively to the above mentioned remedy. In no way will BRC be held responsible for circumstantial damages consequent to the use of their products. In the case of products with finishes such as paints and vinyls where their manufacturers cannot warranty absolute color match, BRC declines all responsibility for any color variations, discrepancies, fading or color change for any reason or cause. BRC does not warrant the following: light bulbs or ballasts; grain match or colour variation, or products that must be replaced due to normal life cycle. Under no circumstances or event will BRC be liable in either tort or contract for any loss direct or indirect caused by special, incidental, consequential or exemplary damages caused by product or installation. BRC specifically declines any warranty or liability for customer own material (COM) or customer own design of products.

**THERMOFUSED LAMINATE**

Properties	ANSI-A208.1.93 grade M-3		Typical Values	
	Metric Measure	Imperial Measure	Metric Measure	Imperial Measure
Moisture Content	<10%	<10%	<10%	<10%
Density	640-800 kg/m	40-50 lb./ft.	675 kg/m	42 lb./ft
Thickness - from nominal	+/- 0.2 mm	0.008 in.	+/- 0.2 mm	+/- 0.008 in.
Thickness - from average	+/- 0.1 mm	0.0004 in.	+/- 0.1 mm	+/- 0.004 in.
Modulus of rupture	16.5 N/mm2	2400 psi	17.5 N/mm2	2545 psi
Modulus of elasticity	2750 N/mm2	400 000 psi	3000 N/mm2	436 000 psi
Internal bond	0.55 N/mm2	80 psi	0.575 N/mm2	85 psi
Hardness	2225 N	500 lb.	3000 N	675 lb.
Linear expansion	<0.35%	<0.35%	<0.35%	<0.35%
Screw holding - face	1100 N	250 lb.	1200 N	270 lb.
Screw holding - edge	1000 N	225 lb.	1000 N	225 lb.
Formaldehyde emission				
Length/Width	<0.30 ppm +/- 2.0 mm	+/- 0.080 in.	<0.30 ppm +/- 2.0 mm	+/- 0.080 in.

**HIGH PRESSURE LAMINATE**

Properties	ANSI/NEMA Standards Publication - LD3 1995		
	LD3 Text	Grade 12/HGP	Grade 20/VEP
Appearance	3.1	No ABC Defects	No ABC Defects
Light Resistance	3.3	Slight	Slight
Leanability	3.4	20 (max.)	20 (max.)
Stain Resistance			
Reagents 1-10		No effect	No effect
Reagents 11-15		Moderate	Moderate
Boiling Water Resistance	3.5	Slight	Slight
High Temperature Resistance	3.6	Slight	Slight
All Impact Resistance - in.	3.8	30 (min.)	20 (min.)
All Impact Resistance - mm		762 (min.)	508 (min.)
Radiant Heat Resistance - sec.	3.1	100 (min.)	80 (min.)
Dimensional Change	3.11		
Machine Direction		1.1 (max.)	1.1 (max.)
Gross Direction		1.4 (max.)	1.4 (max.)
Wear Resistance Cycles	3.13	400 (min.)	400 (min.)
Formability - in.	3.14	5/8	1/2
Formability - mm.		18	13
Blister Resistance - sec.	3.15	55	40

**THERMOFUSED LAMINATE**

<b>Properties</b>	<b>Description</b>	<b>Standard</b>	<b>Typical Value Solid Colors/Prints</b>	<b>NEMA LD 3-95 Grade VGL</b>
Wear resistance	Measure of the ability of the surface to keep its design or color under abrasive wear.	NEMA LD-3 95	400 cycles 125 cycles	400 cycles
Appearance	Presence of visual defects on decorative surface.	NEMA LD-3 95	no surface defects	no surface defects
Scratch resistance	Measure of the ability of a decorative surface to be scratched by a diamond tip tool.	EN 438 2.14-91	3.7 N	N/A
Stain resistance	Measure of the ability of a decorative surface to resist staining when exposed to 15 household products.	NEMA LD-3 95	1 to 10 no effect 11 to 15 moderate	1 to 10 no effect 11 to 15 moderate
Cleanability	Measure of the ability of a decorative surface to be cleaned when exposed to 15 soiling agents.	NEMA LD-3 95	max. 20	max. 20
Light resistance	Measure of the ability of a decorative surface to retain its color when exposed to a light source close to sunlight.	NEMA LD-3 95	slight	slight
High temperature	Measure of the ability of a decorative surface to maintain its color and aspect when exposed to high temperature.	NEMA LD-3 95	no effect after 60 seconds	no effect after 60 seconds
Radiant heat	Measure of the ability of a decorative surface to resist any damage when exposed to a radiant heat source.	NEMA LD-3 95	no effect after 60 seconds	no effect after 60 seconds
Boiling water	Measure of the ability of a decorative surface to resist any damage when exposed to boiling water for 20 minutes.	NEMA LD-3 95	no effect	no effect
Impact resistance	Measure of the maximal falling height of a steel ball that does not cause fracture to the decorative surface.	NEMA LD-3 95	381 mm (15")	381 mm (15")
Fire resistance	Measure of flame spread rating under controlled conditions.	ASTM E-84	110 Class III (200 and less)	N/A
Warping	Measure of the maximal departure of the surface from flatness.	N/A	max. 3 mm/m	N/A

<u>Content</u>	<u>Page</u>
TECHNICAL SPECIFICATIONS	i
TECHNICAL SPECIFICATIONS	ii
<i>e motion</i> SPECIFICATIONS	1
<i>e motion</i> HEIGHT ADJUSTABLE TABLES CRANK OPERATED	2
<i>e motion</i> HEIGHT ADJUSTABLE TABLES KEYBOARD CORNERS CRANK OPERATED	4
<i>e motion</i> HEIGHT ADJUSTABLE TABLES EXTENDED CORNERS CRANK OPERATED	6
<i>e motion</i> HEIGHT ADJUSTABLE TABLES LINK DRIVE CORNERS CRANK OPERATED	8
<i>e motion</i> HEIGHT ADJUSTABLE CONFERENCE TABLES CRANK OPERATED	9
<i>e motion</i> HEIGHT ADJUSTABLE TABLES ELECTRICALLY OPERATED	10
<i>e motion</i> HEIGHT ADJUSTABLE TABLES KEYBOARD CORNERS ELECTRICALLY OPERATED	12
<i>e motion</i> HEIGHT ADJUSTABLE TABLES ELECTRICALLY OPERATED EXTENDED CORNERS	14
<i>e motion</i> HEIGHT ADJUSTABLE TABLES ELECTRICALLY OPERATED CORNERS	16
<i>e motion</i> HEIGHT ADJUSTABLE CONFERENCE TABLES	17
<i>e motion</i> HEIGHT ADJUSTABLE TABLES INCREMENTAL	18
<i>e motion</i> HEIGHT ADJUSTABLE TABLES KEYBOARD CORNER INCREMENTAL	20
<i>e motion</i> HEIGHT ADJUSTABLE TABLES EXTENDED CORNER INCREMENTAL	22
<i>e motion</i> HEIGHT ADJUSTABLE CONFERENCE TABLES INCREMENTAL	25
<i>e motion</i> HEIGHT ADJUSTABLE CONFERENCE TABLE EXTENTIONS INCREMENTAL	26
<i>e motion</i> FIXED HEIGHT TABLES	27
<i>e motion</i> FIXED HEIGHT TABLES DUAL SURFACE	28
<i>e motion</i> FIXED HEIGHT TABLES KEYBOARD CORNERS	29
<i>e motion</i> FIXED HEIGHT TABLES EXTENDED CORNERS	31
<i>e motion</i> FIXED HEIGHT TABLES BI-WING CORNERS	33
<i>e motion</i> FIXED HEIGHT CONFERENCE TABLES	34
<i>e motion</i> TILTING WORKSURFACES	36
<i>e motion</i> HEIGHT ADJUSTABLE PANEL MOUNT	38
<i>e motion</i> CORNER CONNECTORS	39
FREESTANDING LATERAL FILES	40
FREESTANDING PEDESTALS	41
MOBILE PEDESTALS	42
METAL MOBILE PEDESTALS	43
ELECTRICAL ACCESSORIES AND OPTIONS	44
DESKING ELECTRICAL ACCESSORIES AND OPTIONS	45
KEYBOARDS	46
ACCESSORIES	49

**BRC**

*e/motion*

---

NOTES

---

ANSI Bifma and CGSB (Canadian General Standards Board) tested and qualified. This ensures that BRC products adhere to the highest standards of quality and durability in North America.

Table tops are available in:

- 1) M1 (1" thick) or M2 (1-1/2" thick) thermofused laminates.
- 2) H1 (1-1/8"thick) or H2 (1-1/2") high pressure laminates.
- 3) 2.5mm worksurface edge trim.

Table bases are metal and have a durable scratch resistant, heat cured powder coat paint finish.

All e|motion table surfaces are supported by a 3/4" x 1 1/2" steel frame designed for strength and ease of connections.

Metal uprights are of 14 gauge tubing 2" thick by 4" wide. On all tables, inserts are of 14 gauge tubing and incorporate Teflon-like slides for smooth operation and low maintenance.

All table bases have a 1" x 3" horizontal modesty panel of 16 gauge steel attached to each leg to assure strength and stability throughout the entire range of motion. Modesty panels have 16" of floor clearance.

Highly engineered low profile foot is constructed of drawn steel, with waterfall front and back edges.

The interior of the foot is double walled with 11 gauge steel supports. These feet have easy to access levelers for ease of installation and balancing.

Available height ranges include:

- 1) fixed height tables are available in 26" and 29" high.
- 2) crank and field electric adjustable tables have a standard range of 24" to 39".
- 3) with an optional sit/stand range of 27" to 42", and an optional low seated range of 21" - 32".
- 4) e|motion electric tables ship with a factory installed range of 24" to 50".
- 5) optional ranges are available starting at 21" high.

Incrementally adjustable tables are adjustable on 1" increments.

Most cranking tables are continuously adjustable with standard top crank and optional undersurface crank.

Under surface crank option includes top surface crank. Top or under surface crank are non-handed.

Rate of travel on crank tables is 1" per six turns of the crank with BIFMA approved 12 ft.lbs. torque.

Crank handle grommets are supplied with every top cranking table.

All tables are optionally available with casters, wire management, ganging systems, floating monitor platforms, keyboard platforms, modesty panels and other accessories.

For all tables, including corners greater than 36", the leading edge of the keyboard tray is 25" wide minimum.

All crank tables are equipped with two crank access grommets. Wire grommets are available but are not required if tables are ordered with 1" clearance for surface travel. Please see individual table price pages.

Tables can be shipped assembled or KD (knocked down).

**Note:** Models numbers nominally reflect the table dimensions. Actual table dimensions are 1/2" wider and deeper than those stated. BRC tables are also available true to size in furniture industry 6" increments. By reducing the size of BRC tables by 1/4 inch on each side (1/2 inch overall on width) and 1/2 inch on depth, a safety margin has been provided to prevent binding against adjacent items and pinching of wires or hands. It is the client's responsibility to provide the correct size and model number when ordering. Please see the ordering details of each type of table required.

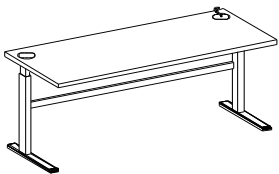
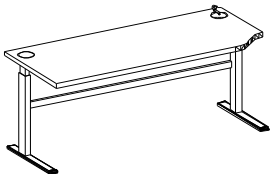
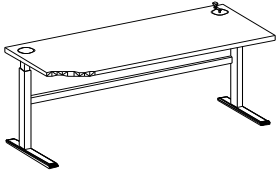
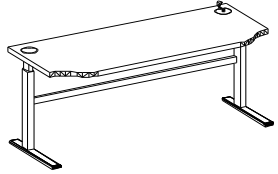

Model	Size	Wt./Cube	Thermofused		Laminated		
			1"	1-1/2"	1-1/8"	1-1/2"	
							
<b>A</b>	<b>B</b>		<b>C</b>		<b>D</b>		
MWCC9535(#)(X)	95x35	140/75	1790	1898	1962	2081	
MWCC8329(#)(X)	83x29	120/72	1475	1565	1638	1737	
MWCC7729(#)(X)	77x29	110/72	1391	1475	1528	1620	
MWCC7129(#)(X)	71x29	100/72	1286	1364	1402	1487	
MWCC6529(#)(X)	65x29	110/60	1255	1323	1360	1440	
MWCC5929(#)(X)	59x29	110/60	1218	1292	1328	1408	
MWCC5329(#)(X)	53x29	110/60	1218	1292	1328	1408	
MWCC4729(#)(X)	47x29	105/48	1160	1231	1239	1314	
MWCC4129(#)(X)	41x29	95/48	1061	1125	1139	1209	
MWCC3529(#)(X)	35x29	85/36	1040	1103	1113	1180	
MWCC2929(#)(X)	29x29	75/30	1013	1074	1087	1153	
MWCC8323(#)(X)	83x23	120/72	1407	1449	1622	1720	
MWCC7723(#)(X)	77x23	115/72	1407	1449	1517	1609	
MWCC7123(#)(X)	71x23	115/72	1234	1308	1339	1420	
MWCC6523(#)(X)	65x23	110/66	1171	1241	1260	1336	
MWCC5923(#)(X)	59x23	105/60	1134	1200	1218	1292	
MWCC5323(#)(X)	53x23	105/54	1134	1202	1218	1289	
MWCC4723(#)(X)	47x23	100/48	1103	1169	1176	1247	
MWCC4123(#)(X)	41x23	90/48	1003	1064	1076	1141	
MWCC3523(#)(X)	35x23	80/36	982	1042	1050	1113	
MWCC2923(#)(X)	29x23	70/30	961	1019	1024	1086	
MWCC2423(#)(X)	24x23	70/30	961	1019	1024	1086	

**Ordering Details:**

Note: Dimension above are nominal sizes. Actual sizes are .5" larger in each dimension.

Top surface crank access is standard. Specify under surface crank by adding 'UTS' to code, Add \$158

Under surface crank option includes top surface crank. Top or under surface crank are non-handed.

Height Range-sit/stand, 27" to 42" - add 'SS' to model number when ordering.

Height Range-standard - 24" to 39" - use standard model number when ordering.

Height Range-low seated - 21" to 32" - add L to model number when ordering.

(#) - Specify Sculpture - 'A' - none, 'B' - right, 'C' - left, or 'D' - both.

(X) - Specify 'M1' for 1" thermofused, 'M2' for 1-1/2" thermofused, 'H1' for 1-1/8" high pressure laminate, or 'H2' for 1-1/2" high pressure laminate.

Actual dimensions above are 1/2" wider and deeper than stated. For tables with "zero travel clearance", specify by size. Eg. To order 60x24, use MWCC6024 as the code. Price is the closest size above.

**Options:**

Laminate modesty panels add LMP to item code. For tables 48"w or less, add \$126, over 48"w - add \$205.

Additional grommets are available - specify 'GL' - Left, 'GC' - Center, 'GR' - Right - add \$40 each to list price.

Bow fronts for tables 58" and up (table is 6" deeper on visitors side). Specify 'BF' to part and add \$158.

For electric motor kit, specify 'ELM-KIT' and add \$578 to list price. Can be retrofitted to above tables.

Model	Size	Wt./Cube	Thermofused		Laminated	
			1"	1-1/2"	1-1/8"	1-1/2"

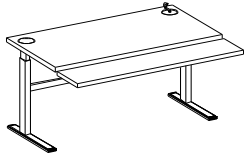

**Dual Surface**  
**Terminal Table - Crank Operated**

MTCC5935(X)	59x35	115/70	2125	2253	2310	2434
MTCC47(X)	47x29	105/60	1913	2028	2079	2190
MTCC41(X)	41x29	100/60	1835	1946	1995	2102
MTCC35(X)	35x29	95/50	1739	1844	1890	1991
MTCC29(X)	29x29	89/40	1642	1741	1785	1881
MTCCSA35(X)	35x29	95/50	1546	1639	1680	1770
MTCCSA29(X)	29x29	89/40	1517	1609	1649	1737

Note: Dimension above are nominal sizes. Actual sizes are .5" larger in each dimension.

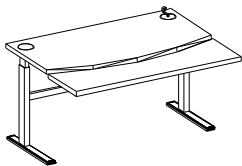

**Convex - Crank Operated**

MTBBCC59(X)	59x29	115/70	2125	2253	2310	2434
MTBBCC47(X)	47x29	105/60	1913	2028	2079	2190
MTBBCC41(X)	41x29	100/60	1835	1946	1995	2102
MTBBCC35(X)	35x29	95/50	1739	1844	1890	1991
MTBBCC29(X)	29x29	89/40	1642	1741	1785	1881
MTBBCCSA35(X)	35x29	95/50	1546	1639	1680	1770
MTBBCCSA29(X)	29x29	89/40	1517	1609	1649	1737

*KBKW-B dual arm mechanism used in above tables, except "SA" single arm models. Range 15" height adjustment; 8" above and 7" below worksurface; 15 degrees positive or negative tilt.*

*Optional KBKW-D dual arm mechanism available for above tables, except "SA" single arm models. Range 13.5" height adjustment; 7" above and 6.5" below worksurface; 15 degrees positive or negative tilt. Add "D" to product code and deduct \$21 from list price.*

*KBSS Single arm mechanism is used in SA models, range 6" above and 6" below worksurface, + or - 15 degrees of tilt. Focal and swivel features or the mechanism are disabled.*

**Ordering Details:**

Top surface crank access is standard.

Height Range-sit/stand, 27" to 42" - add 'SS' to model number when ordering.

Height Range-standard - 24" to 39" - use standard model number when ordering.

Height Range-low seated - 21" to 32" - add L to model number when ordering.

(X) - Specify 'M1' for 1" thermofused, 'M2' for 1-1/2" thermofused, 'H1' for 1-1/8" high pressure laminate, or H2' for 1-1/2" high pressure laminate.

Actual dimensions above are 1/2" wider and deeper than stated. For tables with "zero travel clearance", specify by size. Eg. To order 60x36, use MTCC6024 as the code. Price is the closest size above.

**Options:**

For keyboard option of 5" sliding adjustment, add KW(FOC) to part number and \$310 to list price.

Laminate modesty panels add LMP to item code. For tables 48"w or less, add \$126, over 48"w - add \$205.

Wrist rests are available, see keyboard section of pricelist.

Additional grommets are available - specify 'GL' - Left, 'GC' - Center, 'GR' - Right - add \$40 each to list price.

For electric motor kit, specify 'ELM-KIT' and add \$578 to list price. Can be retrofitted to above tables.

MWCC tables are available with barrier free access compliant with accessibility standards, for these units add SE to the end of the model code and add \$200 list for this option. SE (Special edition tables are available only with top crank, LMP not available size for SE option is 84 x30.

# BRC

e/motion

## HEIGHT ADJUSTABLE TABLES KEYBOARD CORNERS - CRANK OPERATED

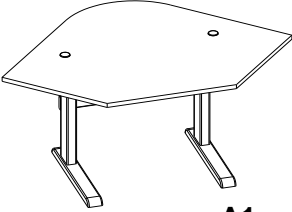
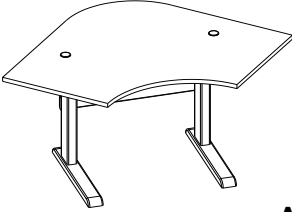
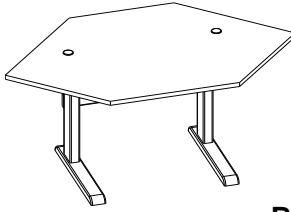
Model	Size (DWWDK)	Wt./Cube	Thermofused		Laminated	
			1"	1-1/2"	1-1/8"	1-1/2"
						
<b>A1</b>						
						
<b>A2</b>						
						
<b>B1</b>						
MTKCC4729(#)(X)	29x47x47x29x25	105/60	1475	1563	1512	1737
MTKCC4129(#)(X)	29x41x41x29x17	105/60	1019	1458	1218	1527
MTKCC47(#)(X)	23x47x47x23x34	105/60	1475	1563	1512	1737
MTKCC41(#)(X)	23x41x41x23x25	100/60	1019	1458	1218	1527
MTKCC35(#)(X)	23x35x35x23x17	90/54	924	1091	1113	1178
MTKCC29(#)(X)	23x29x29x23x9	105/60	924	1091	1113	1178

Note: Dimension above are nominal sizes. Actual sizes are .5" larger in each dimension.

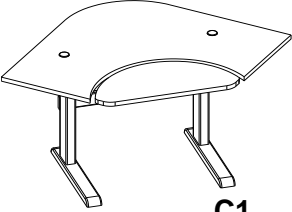
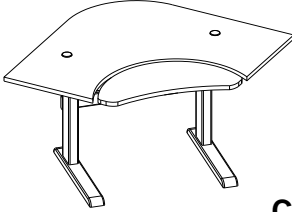
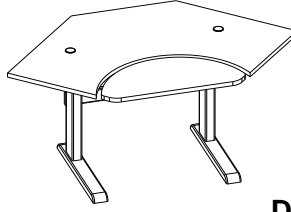
						
<b>C1</b>						
						
<b>C2</b>						
						
<b>D1</b>						
MTKCCO47(#)(X)	23x47x47x23x34	105/60	1895	1983	1994	2157
MTKCCO41(#)(X)	23x41x41x23x25	100/60	1386	1878	1591	1947
MTKCCO35(#)(X)	23x35x35x23x17	90/54	1376	1511	1586	1598
MTKCCO29(#)(X)	23x29x29x23x9	105/60	1376	1511	1586	1598

Note: Dimension above are nominal sizes. Actual sizes are .5" larger in each dimension.

**For 29.5" deep corner tables, add "29" to code, for 30" add "30" to code. Eg. MTKCC4729(#)(X). Same price.**  
KBSS keyboard mechanism and platform are included in corners with cut-outs.

Range: 12" height adjustment; 6" above to 6" below worksurface; 15 degrees positive or negative tilt.

KBWL and KBKW-B mechanisms are also available with the above tables. Add "KBWL" or "KBKW-B" to part number and adjust price per item listed on page 47.

### Ordering Details:

Top surface crank is standard. Specify under surface crank for style A or B by adding 'UTS' to code and \$158 to list price.

Under surface crank option includes top surface crank. Top or under surface crank are non-handed.

Height Range-sit/stand, 27" to 42" - add 'SS' to model number when ordering.

Height Range-standard - 24" to 39" - use standard model number when ordering.

Height Range-low seated - 21" to 32" - add L to model number when ordering.

(X)-Specify 'M1' for 1" thermofused, 'M2' for 1-1/2" thermofused, 'H1' for 1-1/8" high pressure laminate, or 'H2' for 1-1/2" high pressure laminate.

Actual dimensions above are 1/2" wider and deeper than stated. For tables with "zero travel clearance", specify by size. Eg. To order 48x30, use MTKCC4830 as the code. Price is the closest size above.

### Options:

For thermofused laminate modesty panels add LMP to code and \$126 to list price.

Wrist rests are available, see keyboard section of pricelist.

Additional grommets are available - specify 'GL' - Left, 'GC' - Center, 'GR' - Right - add \$40 each to list price.

For electric motor kit, specify 'ELM-KIT' and add \$578 to list price. Can be retrofitted to above tables.

MWCC tables are available with barrier free access compliant with accessibility standards, for these units add SE to the end of the model code and add \$200 list for this option. SE (Special edition tables are available only with top crank, LMP not available size for SE option is 84 x30.

Model	Size	Wt./Cube	Thermofused		Laminated	
			1"	1-1/2"	1-1/8"	1-1/2"

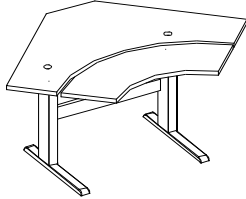

**Dual Surface  
Curved Corner  
Terminal Table**

*(straight front available, add SF to code)*

MTKCCVC47(X)	29x47x47x29	105/60	2125	2253	2310	2434
MTKCCVC4723(X)	23x47x47x23	105/60	2125	2253	2310	2434
MTKCCVC41(X)	23x41x41x23	100/60	2077	2202	2258	2378
MTKCCVC4117(X)	17x41x41x17	100/60	2077	2202	2258	2378
MTKCCVC35(X)	17x35x35x17	100/60	2077	2202	2258	2378

Note: Dimension above are nominal sizes. Actual sizes are .5" larger in each dimension.

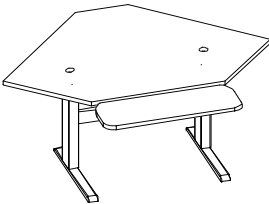

**Dual Surface  
Straight Front Corner  
Terminal Table**

*(to be used where adjacent tables have notched corners)*

MTKCCVS47(X)	29x47x47x29	105/60	2125	2253	2310	2434
MTKCCVS4723(X)	23x47x47x23	105/60	2125	2253	2310	2434
MTKCCVS41(X)	23x41x41x23	100/60	2077	2202	2258	2378
MTKCCVS4117(X)	17x41x41x17	100/60	2077	2202	2258	2378
MTKCCVS35(X)	17x35x35x17	100/60	2077	2202	2258	2378

Note: Dimension above are nominal sizes. Actual sizes are .5" larger in each dimension.

Keyboard surface is mounted on a KBKW-B mechanism, which is included in above prices.

Range - 15" height adjustment; 8" above or 7" below worksurface; 15 degrees positive or negative tilt.

Optional with KBKW-D mechanism, Range - 13.5" height adjustment; 7" above or 6.5" below worksurface; 15 degrees positive or negative tilt. Add "D" to product code and deduct \$21 from list price.

**Ordering Details:**

Top surface crank is standard.

Height Range-sit/stand, 27" to 42" - add 'SS' to model number when ordering.

Height Range-standard - 24" to 39" - use standard model number when ordering.

Height Range-low seated - 21" to 32" - add L to model number when ordering.

(X) - Specify 'M1' for 1" thermofused, 'M2' for 1-1/2" thermofused, 'H1' for 1-1/8" high pressure laminate, or 'H2' for 1-1/2" high pressure laminate.

Actual dimensions above are 1/2" wider and deeper than stated. For tables with "zero travel clearance", specify by size. Eg. To order 48x30, use MTKCCVC48 as the code. Price is the closest size above.

**Options:**

For keyboard option of 5" sliding adjustment, add KW(FOC) to part number and \$310 to list price.

For thermofused laminate modesty panels add LMP to code and \$126 to list price.

Wrist rests are available, see keyboard section of pricelist.

Additional grommets are available - specify 'GL' - Left, 'GC' - Center, 'GR' - Right - add \$40 each to list price.

For electric motor kit, specify 'ELM-KIT' and add \$578 to list price. Can be retrofitted to above tables.

MWCC tables are available with barrier free access compliant with accessibility standards, for these units add SE to the end of the model code and add \$200 list for this option. SE (Special edition tables are available only with top crank, LMP not available size for SE option is 84 x30.

Model	Size	Wt./Cube	Thermofused		Laminated	
			1"	1-1/2"	1-1/8"	1-1/2"

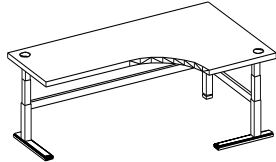

**Extended Cranking Corner**  
**29.5" deep returns**  
("B" left extended shown)

MECCK29835929(X)(#)	29x83x59x29	215/18.5	2643	2779	2879	2989
MECCK29775929(X)(#)	29x77x59x29	202/17.2	2613	2750	2850	2960
MECCK29715929(X)(#)	29x71x59x29	189/15.9	2519	2655	2755	2865
MECCK29655929(X)(#)	29x65x59x29	176/14.6	2451	2587	2687	2797
MECCK29835329(X)(#)	29x83x53x29	215/18.5	2451	2587	2687	2797
MECCK29775329(X)(#)	29x77x53x29	202/17.2	2451	2587	2687	2797
MECCK29715329(X)(#)	29x71x53x29	189/15.9	2415	2552	2651	2762
MECCK29655329(X)(#)	29x65x53x29	176/14.6	2415	2552	2651	2762
MECCK29595329(X)(#)	29x59x53x29	149/11.0	2398	2535	2634	2745
MECCK29834729(X)(#)	29x83x47x29	215/18.5	2389	2525	2625	2735
MECCK29774729(X)(#)	29x77x47x29	202/17.2	2389	2525	2625	2735
MECCK29714729(X)(#)	29x71x47x29	189/15.9	2375	2512	2611	2722
MECCK29654729(X)(#)	29x65x47x29	176/14.6	2375	2512	2611	2722
MECCK29594729(X)(#)	29x59x47x29	149/11.0	2352	2489	2592	2699
MECCK29834129(X)(#)	29x83x41x29	215/18.5	2389	2525	2625	2735
MECCK29774129(X)(#)	29x77x41x29	202/17.2	2389	2525	2625	2735
MECCK29714129(X)(#)	29x71x41x29	189/15.9	2375	2512	2611	2722
MECCK29654129(X)(#)	29x65x41x29	176/14.6	2375	2512	2611	2722
MECCK29594129(X)(#)	29x59x41x29	149/11.0	2352	2489	2588	2699

Note: Dimension above are nominal sizes. Actual sizes are .5" larger in each dimension.

**Ordering Details:**

Top surface crank access is standard. Specify under surface crank by adding 'UTS'-add \$158

Under surface crank option includes top surface crank. Top or under surface crank are non-handed.

Height Range-sit/stand, 27" to 42" - add 'SS' to model number when ordering.

Height Range-standard - 24" to 39" - use standard model number when ordering.

Height Range-low seated - 21" to 32" - add L to model number when ordering.

(X) - Specify 'M1' for 1" thermofused, 'M2' or 1-1/2" thermofused, 'H1' for 1-1/8" high pressure laminate, or H2' for 1-1/2" high pressure laminate.

(#) - Specify style - 'A' - extended right, or 'B' - extended left. Asymmetrical returns are available, please contact customer service for details. Woodgrain runs horizontally on the longest side of the table.

Actual dimensions above are 1/2" wider and deeper than stated. For tables with "zero travel clearance", specify by size. Eg. To order 84x60, use MECCK30846030 as the code. Price is the closest size above.

**Options:**

For thermofused laminate modesty panels (set of 2) add \$252 and LMP to code.

Additional grommets are available - specify 'GL' - Left, 'GC' - Center, 'GR' - Right - add \$40 each to list price.

For electric motor kit, specify 'ELM-KIT' and add \$578 to list price. Can be retrofitted to above tables.

SE option not available in 3 leg models.

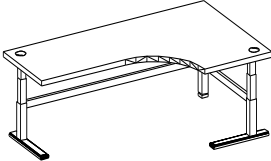
Model	Size	Wt./Cube	Thermofused		Laminated		
			1"	1-1/2"	1-1/8"	1-1/2"	
 <p><b>Extended Cranking Corner</b> <b>23.5" deep returns</b> ("B" left extended shown)</p>							
MECCK23835923(X)(#)	23x83x59x23	215/18.5	2632	2769	2869	2979	
MECCK23775923(X)(#)	23x77x59x23	202/17.2	2603	2739	2839	2949	
MECCK23715923(X)(#)	23x71x59x23	189/15.9	2508	2645	2745	2855	
MECCK23655923(X)(#)	23x65x59x23	176/14.6	2440	2577	2676	2787	
MECCK23835323(X)(#)	23x83x53x23	215/18.5	2440	2577	2676	2787	
MECCK23775323(X)(#)	23x77x53x23	202/17.2	2440	2577	2676	2787	
MECCK23715323(X)(#)	23x71x53x23	189/15.9	2405	2541	2641	2751	
MECCK23655323(X)(#)	23x65x53x23	176/14.6	2405	2541	2641	2751	
MECCK23595323(X)(#)	23x59x53x23	149/11.0	2388	2524	2624	2734	
MECCK23834723(X)(#)	23x83x47x23	215/18.5	2378	2515	2615	2725	
MECCK23774723(X)(#)	23x77x47x23	202/17.2	2378	2515	2615	2725	
MECCK23714723(X)(#)	23x71x47x23	189/15.9	2365	2501	2601	2711	
MECCK23654723(X)(#)	23x65x47x23	176/14.6	2365	2501	2601	2711	
MECCK23594723(X)(#)	23x59x47x23	149/11.0	2342	2478	2578	2688	
MECCK23834123(X)(#)	23x83x41x23	215/18.5	2378	2515	2615	2725	
MECCK23774123(X)(#)	23x77x41x23	202/17.2	2378	2515	2615	2725	
MECCK23714123(X)(#)	23x71x41x23	189/15.9	2365	2501	2601	2711	
MECCK23654123(X)(#)	23x65x41x23	176/14.6	2365	2501	2601	2711	
MECCK23594123(X)(#)	23x59x41x23	149/11.0	2342	2478	2578	2688	

Note: Dimension above are nominal sizes. Actual sizes are .5" larger in each dimension.

**Ordering Details:**

Top surface crank access is standard. Specify under surface crank by adding 'UTS'-add \$158  
 Under surface crank option includes top surface crank. Top or under surface crank are non-handed.  
 Height Range-sit/stand, 27" to 42" - add 'SS' to model number when ordering.  
 Height Range-standard - 24" to 39" - use standard model number when ordering.  
 Height Range-low seated - 21" to 32" - add L to model number when ordering.  
 (X) - Specify 'M1' for 1" thermofused, 'M2' or 1-1/2" thermofused, 'H1' for 1-1/8" high pressure laminate, or  
 H2' for 1-1/2" high pressure laminate.  
 (#) - Specify style - 'A' - extended right, or 'B' - extended left. Asymmetrical returns are available, please  
 contact customer service for details. Woodgrain runs horizontally on the longest side of the table.  
 Actual dimensions above are 1/2" wider and deeper than stated. For tables with "zero travel clearance", specify  
 by size. Eg. To order 84x60, use MECCK24846024 as the code. Price is the closest size above.

**Options:**

For thermofused laminate modesty panels (set of 2) add \$252 and LMP to code.  
 Additional grommets are available - specify 'GL' - Left, 'GC' - Center, 'GR' - Right - add \$40 each to list price.  
 For electric motor kit, specify 'ELM-KIT' and add \$578 to list price. Can be retrofitted to above tables.  
 SE option not available in 3 leg models.

Model	Size	Wt./Cube	Thermofused		Laminated	
			1"	1-1/2"	1-1/8"	1-1/2"

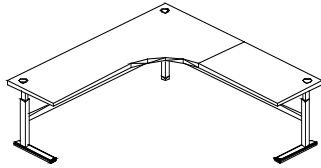

A

**Link - Drive Cranking Corner**

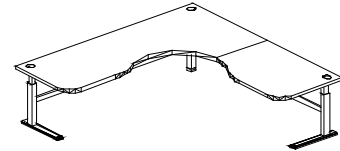

B

**23.5" deep returns**

MLDCK952323(X)(#)	23x95x95x23	225/20.1	2746	2882	2982	3092
MLDCK892323(X)(#)	23x89x89x23	220/19.2	2706	2842	2942	3052
MLDCK832323(X)(#)	23x83x83x23	215/18.5	2632	2769	2869	2979
MLDCK772323(X)(#)	23x77x77x23	202/17.2	2603	2739	2839	2949
MLDCK712323(X)(#)	23x71x71x23	189/15.9	2508	2645	2745	2855
MLDCK652323(X)(#)	23x65x65x23	176/14.6	2440	2577	2676	2787

Note: Dimension above are nominal sizes. Actual sizes are .5" larger in each dimension.

**29.5" deep returns**

MLDCK952929(X)(#)	29x95x95x29	225/20.1	2746	2882	2982	3092
MLDCK892929(X)(#)	29x89x89x29	220/19.2	2706	2842	2942	3052
MLDCK832929(X)(#)	29x83x83x29	215/18.5	2632	2769	2869	2979
MLDCK772929(X)(#)	29x77x77x29	202/17.2	2603	2739	2839	2949
MLDCK712929(X)(#)	29x71x71x29	189/15.9	2510	2646	2745	2856
MLDCK652929(X)(#)	29x65x65x29	176/14.6	2440	2577	2676	2787

Note: Dimension above are nominal sizes. Actual sizes are .5" larger in each dimension.

**Ordering Details:**

Top surface crank access is standard. Specify under surface crank by adding 'UTS'-add \$158

Under surface crank option includes top surface crank. Top or under surface crank are non-handed.

Height Range-sit/stand, 27" to 42" - add 'SS' to model number when ordering.

Height Range-standard - 24" to 39" - use standard model number when ordering.

Height Range-low seated - 21" to 32" - add L to model number when ordering.

(X) - Specify 'M1' for 1" thermofused, 'M2' or 1-1/2" thermofused, 'H1' for 1-1/8" high pressure laminate, or H2' for 1-1/2" high pressure laminate.

(#) - Specify 'A' or 'B'. Other top shapes and asymmetrical returns are available, please contact customer service for details.

Actual dimensions above are 1/2" wider and deeper than stated. For tables with "zero travel clearance", specify by size. Eg. To order 84x84, use MLDCK842424 as the code. Price is the closest size above.

**Options:**

For thermofused laminate modesty panels (set of 2) add \$252 and LMP to code.

For optional cutout and monitor riser kit, add \$1040 to list price and 'MR' to model number.

Additional grommets are available - specify 'GL' - Left, 'GC' - Center, 'GR' - Right - add \$40 each to list price.

For electric motor kit, specify 'ELM-KIT' and add \$1155 to list price. Can be retrofitted to above tables.

SE option not available in 3 leg models.

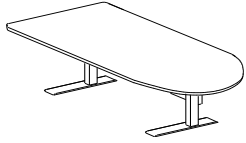
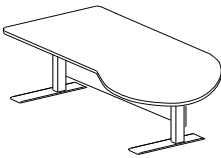
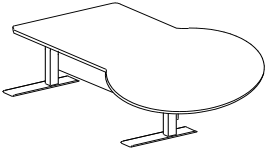
Model	Size	Wt./Cube	Thermofused		Laminated	
			1"	1-1/2"	1-1/8"	1-1/2"
						
<b>B</b>						
						
<b>PR</b>						
(right inside shown)						
						
<b>M</b>						
MCTCC7236FS(#)(X)	72x36	145/85.0	1899	2052	2120	2266
MCTCC7230FS(#)(X)	72x30	142/72.0	1831	1979	2045	2188
MCTCC7224FS(#)(X)	72x24	137/72.0	1643	1780	1841	1972
MCTCC6030FS(#)(X)	60x30	132/60.0	1643	1780	1841	1972
MCTCC6024FS(#)(X)	60x24	128/60.0	1466	1592	1649	1769
MCTCC4830FS(#)(X)	48x30	123/48.0	1466	1592	1649	1769
MCTCC4824FS(#)(X)	48x24	118/48.0	1466	1592	1649	1769
MCTCC4230FS(#)(X)	42x30	120/48.0	1466	1592	1649	1769
MCTCC4224FS(#)(X)	42x24	116/48.0	1466	1474	1568	1684
MCTCC3624FS(#)(X)	36x24	113/40.0	1335	1453	1506	1619

**Ordering Details:**

Top surface crank access is standard. Specify under surface crank by adding 'UTS'-add \$158  
 Under surface crank option includes top surface crank. Top or under surface crank are non-handed.  
 Height Range-sit/stand, 27" to 42" - add 'SS' to model number when ordering.  
 Height Range-standard - 24" to 39" - use standard model number when ordering.  
 Height Range-low seated - 21" to 32" - add L to model number when ordering.  
 (X) - Specify 'M1' for 1" thermofused, 'M2' or 1-1/2" thermofused, 'H1' for 1-1/8" high pressure laminate, or H2' for 1-1/2" high pressure laminate.  
 (#) - Specify Top Style - 'B' - bullet, 'PR' - P style (right), 'PL' - P style (left), 'M' - mushroom.  
 Add \$54 for style "P" and \$113 for Style 'M'  
 P shape inside is standard configuration. Outside 'P' shape is available( OP ) - add \$68 to list price.  
 P shape tables: 24" depth with 30" diameter, 30" depth with 36" diameter, and 36" depth with 42" diameter  
 Mushroom tables: 24" depth with 36" diameter, 30" depth with 42" diameter, and 36" depth with 48" diameter

**Options:**

Laminate modesty panels add LMP to item code. For tables 48"w or less, add \$126, over 48"w - add \$205.  
 Additional grommets are available - specify 'GL' - Left, 'GC' - Center, 'GR' - Right - add \$40 each to list price.  
 For electric motor kit, specify 'ELM-KIT' and add \$578 to list price. Can be retrofitted to above tables.  
 MWCC tables are available with barrier free access compliant with accessibility standards, for these units add SE to the end of the model code and add \$200 list for this option. SE (Special edition tables are available only with top crank, LMP not available size for SE option is 84 x30.

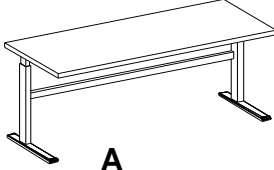
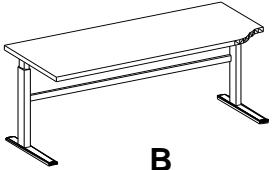
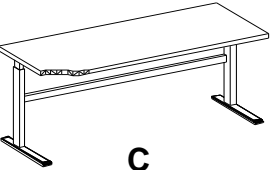
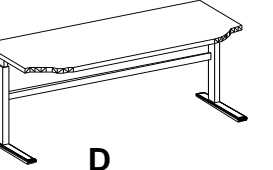

Model	Size	Wt./Cube	Thermofused		Laminated		
			1"	1-1/2"	1-1/8"	1-1/2"	
 <b>A</b>	 <b>B</b>	 <b>C</b>	 <b>D</b>				
MWEE8335(#)(X)	83x35	120/72	2762	2777	2793	2892	
MWEE8329(#)(X)	83x29	120/72	2447	2462	2478	2577	
MWEE7729(#)(X)	77x29	110/72	2331	2352	2368	2460	
MWEE7129 (#)(X)	71x29	120/72	2205	2226	2242	2327	
MWEE5929 (#)(X)	59x29	110/60	2121	2153	2168	2248	
MWEE4729 (#)(X)	47x29	105/48	2048	2063	2079	2154	
MWEE4129 (#)(X)	41x29	95/48	1943	1964	1979	2049	
MWEE3529 (#)(X)	35x29	85/36	1922	1937	1953	2020	
MWEE2929 (#)(X)	29x29	75/30	1890	1911	1927	1993	
MWEE9523(#)(X)	95x23	140/85	2762	2777	2793	2892	
MWEE8323(#)(X)	83x23	120/76	2342	2357	2373	2472	
MWEE7723(#)(X)	77x23	115/72	2226	2247	2263	2355	
MWEE7123 (#)(X)	71x23	115/72	2100	2121	2137	2222	
MWEE5923 (#)(X)	59x23	105/60	2016	2048	2063	2143	
MWEE4723 (#)(X)	47x23	100/48	1943	1958	1974	2049	
MWEE4123 (#)(X)	41x23	90/48	1838	1859	1874	1944	
MWEE3523 (#)(X)	35x23	80/36	1817	1832	1848	1915	
MWEE2923 (#)(X)	29x23	70/30	1785	1806	1822	1888	
MWEE2423(#)(X)	24x23	70/30	1775	1796	1811	1876	

Note: Dimension above are nominal sizes. Actual sizes are .5" larger in each dimension.

### Ordering Details:

Height Range - Regular Sit/Stand - 24" to 50"

(#) - Specify Sculpture - 'A' - none, 'B' - right, 'C' - left, or 'D' - both.

Push button control is standard on right side.

(X) - Specify 'M1' for 1" thermofused, 'M2' for 1-1/2" thermofused, 'H1' for 1-1/8" high pressure laminate, or 'H2' for 1-1/2" high pressure laminate.

Actual dimensions above are 1/2" wider and deeper than stated. For tables with "zero travel clearance", specify by size. Eg. To order 84x36, use MWEE8436 as the code. Price is the closest size above.

Substitute MWSE for MWEE in above part numbers for rectangular leg option. Price remains the same.

### Options:

Laminate modesty panels add LMP to item code. For tables 48"w or less, add \$126, over 48"w - add \$205.

Additional grommets are available - specify 'GL' - Left, 'GC' - Center, 'GR' - Right - add \$40 each to list price.

Bow fronts for tables 58" and up (table is 6" deeper on visitors side). Specify 'BF' to part and add \$158.

Model	Size	Wt./Cube	Thermofused		Laminated	
			1"	1-1/2"	1-1/8"	1-1/2"

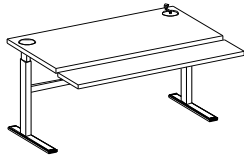

**Dual Surface  
Terminal Table - Electric Operated**

MTEE5935(X)	59x35	115/70	3175	3303	3360	3484
MTEE59(X)	59x29	115/70	3175	3303	3360	3484
MTEE47(X)	47x29	105/60	2963	3078	3129	3240
MTEE41(X)	41x29	100/60	2885	2996	3045	3152
MTEE35(X)	35x29	95/50	2789	2894	2940	3041
MTEE29(X)	29x29	89/40	2692	2791	2835	2931
MTEESA35(X)	35x29	95/50	2596	2689	2730	2820
MTEESA29(X)	29x29	89/40	2567	2659	2804	2787

Note: Dimension above are nominal sizes. Actual sizes are .5" larger in each dimension.

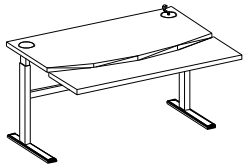

**Convex - Electric Operated**

MTBBCC59(X)	59x29	115/70	3175	3303	3360	3484
MTBBCC47(X)	47x29	105/60	2963	3078	3129	3240
MTBBCC41(X)	41x29	100/60	2885	2996	3045	3152
MTBBCC35(X)	35x29	95/50	2789	2894	2940	3041
MTBBCC29(X)	29x29	89/40	2692	2791	2835	2931
MTBBCCSA35(X)	35x29	95/50	2596	2689	2730	2820
MTBBCCSA29(X)	29x29	89/40	2567	2659	2804	2787

Note: Dimension above are nominal sizes. Actual sizes are .5" larger in each dimension.

*KBKW-B dual arm mechanism used in above tables, except "SA" single arm models. Range 15" height adjustment; 8" above and 7" below worksurface; 15 degrees positive or negative tilt.*

*Optional KBKW-D dual arm mechanism available for above tables, except "SA" single arm models. Range 13.5" height adjustment; 7" above and 6.5" below worksurface; 15 degrees positive or negative tilt. Add "D" to product code and deduct \$21 from list price.*

*KBSS Single arm mechanism is used in SA models, range 6" above and 6" below worksurface, + or - 15 degrees of tilt, focal and swivel features are disabled.*

**Ordering Details:**

Height Range - Regular Sit/Stand - 24" to 50"

(X) - Specify 'M1' for 1" thermofused, 'M2' or 1-1/2" thermofused, 'H1' for 1-1/8" high pressure laminate, or 'H2' for 1-1/2" high pressure laminate.

Actual dimensions above are 1/2" wider and deeper than stated. For tables with "zero travel clearance", specify by size. Eg. To order 60x30, use MTEE60 as the code. Price is the closest size above.

**Options:**

For keyboard option of 5" sliding adjustment, add KW(FOC) to part number and \$310 to list price.

Laminate modesty panels add LMP to item code. For tables 48"w or less, add \$126, over 48"w - add \$205.

Wrist rests are available, see keyboard section of pricelist.

Additional grommets are available - specify 'GL' - Left, 'GC' - Center, 'GR' - Right - add \$40 each to list price.

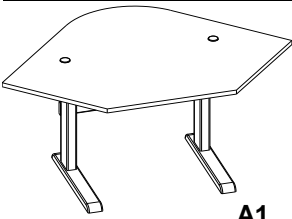
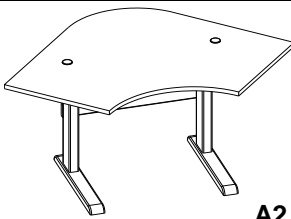
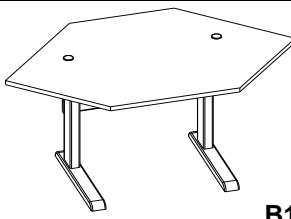
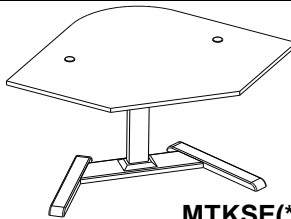
Model	Size (DWWDK)	Wt./Cube	Thermofused		Laminated	
			1"	1-1/2"	1-1/8"	1-1/2"
 <b>A1</b>	 <b>A2</b>	 <b>B1</b>	 <b>MTKSE(**)</b>			
MTKEE4729(#)(X)	29x47x47x29x25	105/60	2520	2604	2625	2683
MTKEE4129(#)(X)	29x41x41x29x17	105/60	2468	2552	2573	2629
MTKEE47(#)(X)	23x47x47x23x34	105/60	2525	2613	2562	2787
MTKEE41(#)(X)	23x41x41x23x25	100/60	2420	2508	2520	2577
MTKEE35(#)(X)	23x35x35x23x17	90/54	2210	2298	2310	2367
MTKEE29(#)(X)	23x29x29x23x9	105/60	2158	2246	2258	2314

Note: Dimension above are nominal sizes. Actual sizes are .5" larger in each dimension.

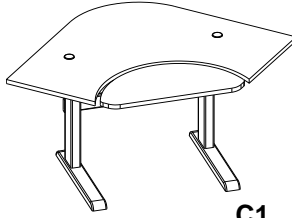
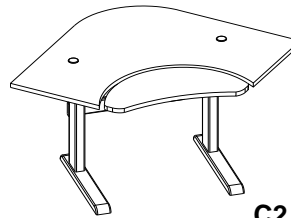
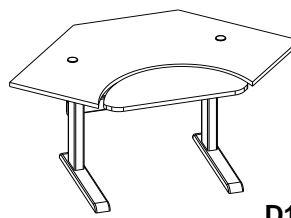
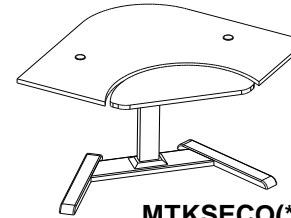
 <b>C1</b>	 <b>C2</b>	 <b>D1</b>	 <b>MTKSECO(**)</b>			
MTKEECO47(#)(X)	23x47x47x23x34	105/60	2945	3033	2982	3207
MTKEECO41(#)(X)	23x41x41x23x25	100/60	2840	2928	2940	2997
MTKEECO35(#)(X)	23x35x35x23x17	90/54	2604	2561	2583	2648
MTKEECO29(#)(X)	23x29x29x23x9	105/60	2604	2561	2583	2648

Note: Dimension above are nominal sizes. Actual sizes are .5" larger in each dimension.

**For 29.5" deep corner tables, add "29" to code, for 30" add "30" to code. Eg. MTKEE4729(#)(X). Same price.**

KBSS keyboard mechanism and platform are included in corners with cut-outs.

(Range: 12" height adjustment; 6" above to 6" below worksurface; 15 degrees positive or negative tilt.

KBWL and KBKW-B mechanisms are also available with the above tables. Add "KBWL" or "KBKWB" to part number and adjust price per item listed on page 47.

**Ordering Details:**

Push button control is standard on right side.

Height Range - Regular Sit/Stand - 24" to 50"

(#) - Specify Top style - 'A1', 'A2', 'C1', 'C2'.

(\*\*) - Specify balance of part number as above for top dimension and style of single post table base. Reduce list price by \$525.00

(X) - Specify 'M1' for 1" thermofused, 'M2' for 1-1/2" thermofused, 'H1' for 1-1/8" high pressure laminate, or H2' for 1-1/2" high pressure laminate.

Actual dimensions above are 1/2" wider and deeper than stated. For tables with "zero travel clearance", specify by size. Eg. To order 48x30, use MTKEE4830 as the code. Price is the closest size above.

**Options:**

For thermofused laminate modesty panels add LMP to code and \$126 to list price.

Wrist rests are available, see keyboard section of pricelist.

Additional grommets are available - specify 'GL' - Left, 'GC' - Center, 'GR' - Right - add \$40 each to list price.

Model	Size	Wt./Cube	Thermofused		Laminated	
			1"	1-1/2"	1-1/8"	1-1/2"

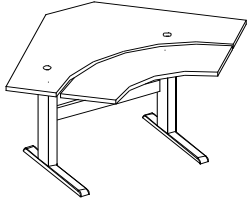

**Dual Surface  
Curved Corner  
Terminal Table**

(straight front available, add SF to code)

MTKEEVC47(X)	29x47x47x29	105/60	3228	3356	3413	3536
MTKEEVC4723(X)	23x47x47x23	105/60	3175	3303	3360	3484
MTKEEVC41(X)	23x41x41x23	100/60	3127	3252	3308	3428
MTKEEVC4117(X)	17x41x41x17	100/60	3127	3252	3308	3428
MTKEEVC35(X)	17x35x35x17	100/60	3127	3252	3308	3428

Note: Dimension above are nominal sizes. Actual sizes are .5" larger in each dimension.

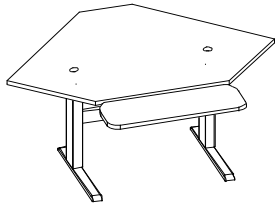

**Dual Surface  
Straight Front Corner  
Terminal Table**

(to be used where adjacent tables have notched corners)

MTKEEVS47(X)	29x47x47x29	105/60	3228	3356	3413	3536
MTKEEVS4723(X)	23x47x47x23	105/60	3175	3303	3360	3484
MTKEEVS41(X)	23x41x41x23	100/60	3127	3252	3308	3428
MTKEEVS4117(X)	17x41x41x17	100/60	3127	3252	3308	3428
MTKEEVS35(X)	17x35x35x17	100/60	3127	3252	3308	3428

Note: Dimension above are nominal sizes. Actual sizes are .5" larger in each dimension.

Keyboard surface is mounted on a KBKW-B mechanism, which is included in above prices.

Range - 15" height adjustment; 8" above or 7" below worksurface; 15 degrees positive or negative tilt.

Optional with KBKW-D mechanism, Range - 13.5" height adjustment; 7" above or 6.5" below worksurface;

15 degrees positive or negative tilt. Add "D" to product code and deduct \$21 from list price.

**Ordering Details:**

Height Range - Regular Sit/Stand - 24" to 50"

(X) - Specify 'M1' for 1" thermofused, 'M2' or 1-1/2" thermofused, 'H1' for 1-1/8" high pressure laminate, or H2' for 1-1/2" high pressure laminate.

Actual dimensions above are 1/2" wider and deeper than stated. For tables with "zero travel clearance", specify by size. Eg. To order 48x30, use MTKEEVC48 as the code. Price is the closest size above.

**Options:**

For keyboard option of 5" sliding adjustment, add KW(FOC) to part number and \$310 to list price.

For thermofused laminate modesty panels add LMP to code and \$126 to list price.

Wrist rests are available, see keyboard section of pricelist.

Additional grommets are available - specify 'GL' - Left, 'GC' - Center, 'GR' - Right - add \$40 each to list price.

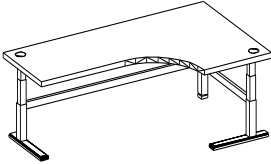
Model	Size	Wt./Cube	Thermofused		Laminated	
			1"	1-1/2"	1-1/8"	1-1/2"
	<b>Extended Electric Corner 29.5" deep returns (left extended shown)</b>					
MWEEC29835929(X)(#)	29x83x59x29	215/18.5	3693	3829	3929	4039
MWEEC29775929(X)(#)	29x77x59x29	202/17.2	3663	3800	3900	4010
MWEEC29715929(X)(#)	29x71x59x29	189/15.9	3569	3705	3805	3915
MWEEC29655929(X)(#)	29x65x59x29	176/14.6	3501	3637	3737	3847
MWEEC29835329(X)(#)	29x83x53x29	215/18.5	3501	3637	3737	3847
MWEEC29775329(X)(#)	29x77x53x29	202/17.2	3501	3637	3737	3847
MWEEC29715329(X)(#)	29x71x53x29	189/15.9	3465	3602	3701	3812
MWEEC29655329(X)(#)	29x65x53x29	176/14.6	3465	3602	3701	3812
MWEEC29595329(X)(#)	29x59x53x29	149/11.0	3448	3585	3684	3795
MWEEC29834729(X)(#)	29x83x47x29	215/18.5	3439	3575	3675	3785
MWEEC29774729(X)(#)	29x77x47x29	202/17.2	3439	3575	3675	3785
MWEEC29714729(X)(#)	29x71x47x29	189/15.9	3425	3562	3661	3772
MWEEC29654729(X)(#)	29x65x47x29	176/14.6	3425	3562	3661	3772
MWEEC29594729(X)(#)	29x59x47x29	149/11.0	3402	3539	3642	3749
MWEEC29834129(X)(#)	29x83x41x29	215/18.5	3439	3575	3675	3785
MWEEC29774129(X)(#)	29x77x41x29	202/17.2	3439	3575	3675	3785
MWEEC29714129(X)(#)	29x71x41x29	189/15.9	3425	3562	3661	3772
MWEEC29654129(X)(#)	29x65x41x29	176/14.6	3425	3562	3661	3772
MWEEC29594129(X)(#)	29x59x41x29	149/11.0	3402	3539	3638	3749

Note: Dimension above are nominal sizes. Actual sizes are .5" larger in each dimension.

**Ordering Details:**

Height Range - Regular Sit/Stand - 24" to 50"

(X) - Specify 'M1' for 1" thermofused, 'M2' or 1-1/2" thermofused, 'H1' for 1-1/8" high pressure laminate, or H2' for 1-1/2" high pressure laminate.

(#) - Specify style - 'A' - extended right, or 'B' - extended left. Asymmetrical returns are available, please contact customer service for details. Woodgrain runs horizontally on the longest side of the table.

Actual dimensions above are 1/2" wider and deeper than stated. For tables with "zero travel clearance", specify by size. Eg. To order 84x60, use MWEEC30846030 as the code. Price is the closest size above.

**Options:**

For thermofused laminate modesty panels (set of 2) add \$252 and LMP to code.

Additional grommets are available - specify 'GL' - Left, 'GC' - Center, 'GR' - Right - add \$40 each to list price.

Model	Size	Wt./Cube	Thermofused		Laminated	
			1"	1-1/2"	1-1/8"	1-1/2"

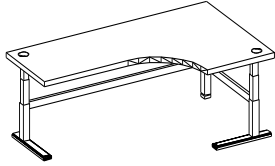

**Extended Electric Corner**  
**23.5" deep returns**  
(left extended shown)

MWEEC23835923(X)(#)	23x83x59x23	215/18.5	3682	3819	3919	4029
MWEEC23775923(X)(#)	23x77x59x23	202/17.2	3653	3789	3889	3999
MWEEC23715923(X)(#)	23x71x59x23	189/15.9	3558	3695	3795	3905
MWEEC23655923(X)(#)	23x65x59x23	176/14.6	3490	3627	3726	3837
MWEEC23835323(X)(#)	23x83x53x23	215/18.5	3490	3837	3726	3837
MWEEC23775323(X)(#)	23x77x53x23	202/17.2	3490	3837	3726	3837
MWEEC23715323(X)(#)	23x71x53x23	189/15.9	3455	3801	3691	3801
MWEEC23655323(X)(#)	23x65x53x23	176/14.6	3455	3801	3691	3801
MWEEC23595323(X)(#)	23x59x53x23	149/11.0	3438	3784	3674	3784
MWEEC23834723(X)(#)	23x83x47x23	215/18.5	3428	3565	3665	3775
MWEEC23774723(X)(#)	23x77x47x23	202/17.2	3428	3565	3665	3775
MWEEC23714723(X)(#)	23x71x47x23	189/15.9	3415	3551	3651	3761
MWEEC23654723(X)(#)	23x65x47x23	176/14.6	3415	3551	3651	3761
MWEEC23594723(X)(#)	23x59x47x23	149/11.0	3392	3528	3628	3738
MWEEC23834123(X)(#)	23x83x41x23	215/18.5	3428	3565	3665	3775
MWEEC23774123(X)(#)	23x77x41x23	202/17.2	3428	3565	3665	3775
MWEEC23714123(X)(#)	23x71x41x23	189/15.9	3415	3551	3651	3761
MWEEC23654123(X)(#)	23x65x41x23	176/14.6	3415	3551	3651	3761
MWEEC23594123(X)(#)	23x59x41x23	149/11.0	3392	3528	3628	3738

Note: Dimension above are nominal sizes. Actual sizes are .5" larger in each dimension.

**Ordering Details:**

Height Range - Regular Sit/Stand - 24" to 50"

(X) - Specify 'M1' for 1" thermofused, 'M2' or 1-1/2" thermofused, 'H1' for 1-1/8" high pressure laminate, or H2' for 1-1/2" high pressure laminate.

(#) - Specify style - 'A' - extended right, or 'B' - extended left. Asymmetrical returns are available, please contact customer service for details. Woodgrain runs horizontally on the longest side of the table.

Actual dimensions above are 1/2" wider and deeper than stated. For tables with "zero travel clearance", specify by size. Eg. To order 84x60, use MWEEC24846024 as the code. Price is the closest size above.

**Options:**

For thermofused laminate modesty panels (set of 2) add \$252 and LMP to code.

Additional grommets are available - specify 'GL' - Left, 'GC' - Center, 'GR' - Right - add \$40 each to list price.

Model	Size	Wt./Cube	Thermofused		Laminated	
			1"	1-1/2"	1-1/8"	1-1/2"

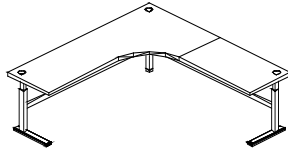

A

**Link - Drive Electric Corner**

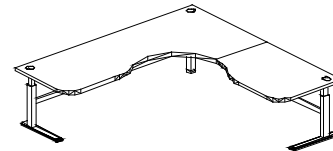

B

**23.5" deep returns**

MWEEL952323(X)(#)	23x95x95x23	225/20.1	3,796	3,932	4,032	4,142
MWEEL892323(X)(#)	23x89x89x23	220/19.2	3,756	3,892	3,992	4,102
MWEEL832323(X)(#)	23x83x83x23	215/18.5	3,682	3,819	3,919	4,029
MWEEL772323(X)(#)	23x77x77x23	202/17.2	3,653	3,789	3,889	3,999
MWEEL712323(X)(#)	23x71x71x23	189/15.9	3,558	3,695	3,795	3,905
MWEEL652323(X)(#)	23x65x65x23	176/14.6	3,490	3,627	3,726	3,837

Note: Dimension above are nominal sizes. Actual sizes are .5" larger in each dimension.

**29.5" deep returns**

MWEEL952929(X)(#)	29x95x95x29	225/20.1	3,796	3,932	4,032	4,142
MWEEL892929(X)(#)	29x89x89x29	220/19.2	3,756	3,892	3,992	4,102
MWEEL832929(X)(#)	29x83x83x29	215/18.5	3,682	3,819	3,919	4,029
MWEEL772929(X)(#)	29x77x77x29	202/17.2	3,653	3,789	3,889	3,999
MWEEL712929(X)(#)	29x71x71x29	189/15.9	3,558	3,695	3,795	3,905
MWEEL652929(X)(#)	29x65x65x29	176/14.6	3,490	3,627	3,726	3,837

Note: Dimension above are nominal sizes. Actual sizes are .5" larger in each dimension.

**Ordering Details:**

Height Range - Sit/Stand - 24" to 50" -

(X) - Specify 'M1' for 1" thermofused, 'M2' or 1-1/2" thermofused, 'H1' for 1-1/8" high pressure laminate or 'H2' for 1-1/2" high pressure laminate.

(#) - Specify 'A' or 'B'. Other top shapes and asymmetrical returns are available, please contact Customer Service for details.

Actual dimensions above are 1/2" wider and deeper than stated. For tables with "zero travel clearance", specify by size. Eg. To order 84x84, use MWEEL842424 as the code. Price is the closest size above.

**Options:**

For thermofused laminate modesty panels (set of 2) add \$252 and LMP to code.

Decorative Punched Metal modesty panels for above (set of 2) add \$273. and MMP to code.

For optional cutout and monitor riser kit, add \$1040 to list price and 'MR' to model number.

Additional grommets are available - specify 'GL' - Left, 'GC' - Center, 'GR' - Right - add \$40 each to list price.

# BRC

e/motion

## HEIGHT ADJUSTABLE CONFERENCE TABLES ELECTRICALLY OPERATED

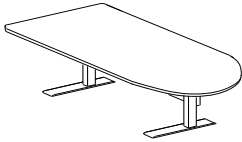
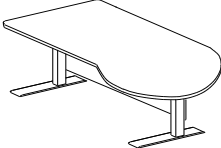
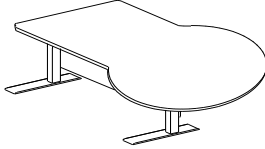
Model	Size	Wt./Cube	Thermofused		Laminated	
			1"	1-1/2"	1-1/8"	1-1/2"
<div style="display: flex; justify-content: space-around; align-items: center;"> <div style="text-align: center;">  <p><b>B</b></p> </div> <div style="text-align: center;">  <p><b>PR</b> (right inside shown)</p> </div> <div style="text-align: center;">  <p><b>M</b></p> </div> </div>						
METC7236FS(#)(X)	72x36	145/85.0	2,949	3,102	3,170	3,316
METC7230FS(#)(X)	72x30	142/72.0	2,881	3,029	3,095	3,238
METC7224FS(#)(X)	72x24	137/72.0	2,693	2,830	2,891	3,022
METC6030FS(#)(X)	60x30	132/60.0	2,693	2,830	2,891	3,022
METC6024FS(#)(X)	60x24	128/60.0	2,516	2,642	2,699	2,819
METC4830FS(#)(X)	48x30	123/48.0	2,516	2,642	2,699	2,819
METC4824FS(#)(X)	48x24	118/48.0	2,516	2,642	2,699	2,819
METC4230FS(#)(X)	42x30	120/48.0	2,516	2,642	2,699	2,819
METC4224FS(#)(X)	42x24	116/48.0	2,516	2,524	2,618	2,734
METC3624FS(#)(X)	36x24	113/40.0	2,385	2,503	2,556	2,669

### Ordering Details:

Height Range - Sit/Stand - 24" to 50" -

(X) - Specify 'M1' for 1" thermofused, 'M2' or 1-1/2" thermofused, 'H1' for 1-1/8" high pressure laminate or 'H2' for 1-1/2" high pressure laminate.

(#) - Specify Top Style - 'B' - bullet, 'PR' - P style (right), 'PL' - P style (left), 'M' - mushroom.

Add \$54 for style "P" and \$113 for Style 'M'

P shape inside is standard configuration. Outside 'P' shape is available( OP ) - add \$68 to list price.

P shape tables: 24" depth with 30" diameter, 30" depth with 36" diameter, and 36" depth with 42" diameter

Mushroom tables: 24" depth with 36" diameter, 30" depth with 42" diameter, and 36" depth with 48" diameter

### Options:

Laminate modesty panels add LMP to item code. For tables 48"w or less, add \$126, over 48"w - add \$205.

For tables 48"w or less - add \$126. Over 48" wide - add \$205.

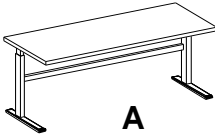
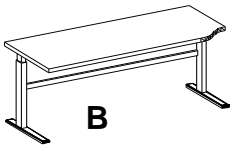
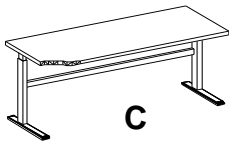
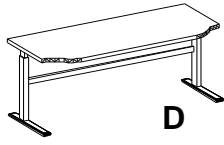

Model	Size	Wt./Cube	Thermofused		Laminated		
			1"	1-1/2"	1-1/8"	1-1/2"	
 <b>A</b>	 <b>B</b>	 <b>C</b>	 <b>D</b>				
MTCI9535(#)(X)	95x35	140/75	1580	1688	1752	1871	
MTCI8329(#)(X)	83x29	120/72	1265	1355	1428	1527	
MTCI7729(#)(X)	77x29	110/72	1181	1265	1318	1410	
MTCI7129(#)(X)	71x29	100/72	1076	1154	1192	1277	
MTCI5929(#)(X)	59x29	110/60	1008	1082	1118	1198	
MTCI4729(#)(X)	47x29	105/48	950	1021	1029	1104	
MTCI4129(#)(X)	41x29	95/48	851	915	929	999	
MTCI3529(#)(X)	35x29	85/36	830	893	903	970	
MTCI2929(#)(X)	29x29	75/30	803	864	877	943	
MTCI7123(#)(X)	71x23	115/72	1024	1098	1129	1210	
MTCI5923(#)(X)	59x23	105/60	924	990	1008	1079	
MTCI5323(#)(X)	53x23	105/60	924	992	1008	1082	
MTCI4723(#)(X)	47x23	100/48	893	959	966	1036	
MTCI4123(#)(X)	41x23	90/48	793	854	866	931	
MTCI3523(#)(X)	35x23	80/36	772	832	840	903	
MTCI2923(#)(X)	29x23	70/30	751	809	814	876	
MTCI2423(#)(X)	24x23	70/30	751	809	814	876	

Note: Dimension above are nominal sizes. Actual sizes are .5" larger in each dimension.

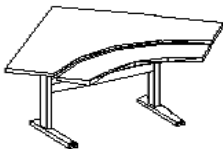

**Curved Incremental Corner table  
w/KBKW-B mechanism**

MTKI47CURVA(X)	23x47x47x23	105/60	1899	2169	2243	2401
MTKI41CURVA(X)	23x41x41x23	100/60	1884	2048	2121	2279

Note: Dimension above are nominal sizes. Actual sizes are .5" larger in each dimension.

*KBSS keyboard mechanism and platform are included in corners with cut-outs.*

*(Range: 12" height adjustment; 6" above to 6" below worksurface; 15 degrees positive or negative tilt.*

*KBWL and KBKW-B mechanisms are also available with the above tables. Add "KBWL" or "KBKWB" to part number and adjust price per item listed on page 47.*

**Ordering Details:**

Height Range - 24" to 39"

(#) - Specify Sculpture - 'A' - none, 'B' - right, 'C' - left, or 'D' - both.

(X) - Specify 'M1' for 1" thermofused, 'M2' for 1-1/2" thermofused, 'H1' for 1-1/8" high pressure laminate, or 'H2' for 1-1/2" high pressure laminate.

Actual dimensions above are 1/2" wider and deeper than stated. For tables with "zero travel clearance", specify by size. Eg. To order 84x30, use MTCI8430 as the code. Price is the closest size above.

**Options:**

Corner table also available with straight front, add "SF" to code.

Bow fronts for tables 58" and up (table is 6" deeper on visitors side). Specify 'BF' to part and add \$158.

Laminate modesty panels add LMP. No increase in price.

Additional grommets are available - specify 'GL' - Left, 'GC' - Center, 'GR' - Right - add \$40 each to list price.

Model	Size	Wt./Cube	Thermofused		Laminated	
			1"	1-1/2"	1-1/8"	1-1/2"

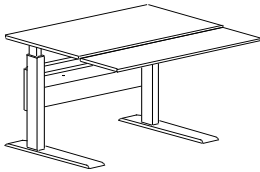

**Dual Surface**  
**Rectangular Terminal Tables**  
(Optional modesty panel shown)

MTCI71(X)	71x29	135/8.0	1924	2045	2100	2217
MTCI59(X)	59x29	125/7.0	1722	1945	2000	2117
MTCI47(X)	47x29	115/6.0	1622	1731	1780	1885
MTCI41(X)	41x29	100/6.0	1548	1653	1700	1801
MTCI35(X)	35x29	105/5.0	1456	1555	1600	1696
MTCI29(X)	29x29	100/4.0	1364	1458	1500	1590
MTCISA35(X)	35x29	95/50	1272	1361	1400	1486
MTCISA29(X)	29x29	89/40	1245	1332	1370	1454

Note: Dimension above are nominal sizes. Actual sizes are .5" larger in each dimension.

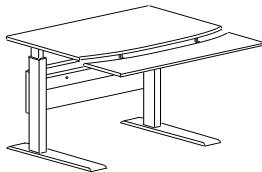

**Dual Surface**  
**Convex Terminal Tables**  
(Optional modesty panel shown)

MTBBCI71(X)	71x29	135/8.0	2020	2147	2205	2328
MTBBCI59(X)	59x29	125/7.0	1915	2043	2100	2224
MTBBCI47(X)	47x29	115/6.0	1703	1818	1869	1980
MTBBCI41(X)	41x29	100/6.0	1625	1736	1785	1892
MTBBCI35(X)	35x29	105/5.0	1529	1634	1680	1781
MTBBCI29(X)	29x29	100/4.0	1432	1531	1575	1671
MTBBCISA35(X)	35x29	95/50	1336	1429	1470	1560
MTBBCISA29(X)	29x29	89/40	1307	1399	1439	1527

Note: Dimension above are nominal sizes. Actual sizes are .5" larger in each dimension.

*KBKW-B dual arm mechanism used in above tables, except "SA" single arm models. Range 15" height adjustment; 8" above and 7" below worksurface; 15 degrees positive or negative tilt.*

*Optional KBKW-D dual arm mechanism available for above tables, except "SA" single arm models. Range 13.5" KBSS Single arm mechanism is used in SA models, range 6" above and 6" below worksurface, + or - 15 degrees of tilt. Focal and swivel features or the mechanism are disabled.*

**Ordering Details:**

Height Range - 24" to 39"

(X) - Specify 'M1' for 1" thermofused, 'M2' for 1-1/2" thermofused, 'H1' for 1-1/8" high pressure laminate, or H2' for 1-1/2" high pressure laminate.

Actual dimensions above are 1/2" wider and deeper than stated. For tables with "zero travel clearance", specify by size. Eg. To order 72x30, use MTCI72 as the code. Price is the closest size above.

**Options:**

For keyboard option of 5" sliding adjustment, add KW(FOC) to part number and \$310 to list price.

Laminate modesty panels add LMP. No increase in price.

Wrist rests are available, see keyboard section of pricelist.

Additional grommets are available - specify 'GL' - Left, 'GC' - Center, 'GR' - Right - add \$40 each to list price.

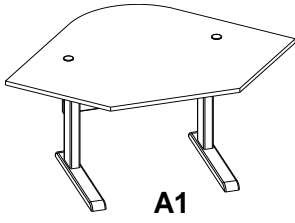
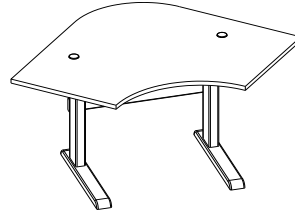
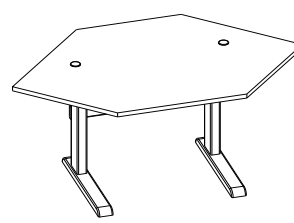
Model	Size (DWWDK)	Wt./Cube	Thermofused		Laminated	
			1"	1-1/2"	1-1/8"	1-1/2"
 <b>A1</b>	 <b>A2</b>	 <b>B1</b>				
MTKCI47(#)(X)	23x47x47x23x34	105/60	1265	1353	1302	1537
MTKCI41(#)(X)	23x41x41x23x25	100/60	1160	1248	1260	1317
MTKCI35(#)(X)	23x35x35x23x17	90/54	819	881	903	968
MTKCI29(#)(X)	23x29x29x23x9	105/60	819	881	903	968

Note: Dimension above are nominal sizes. Actual sizes are .5" larger in each dimension.

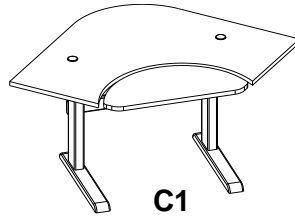
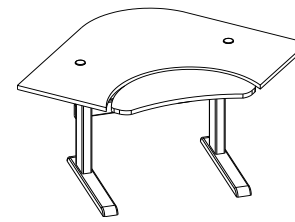
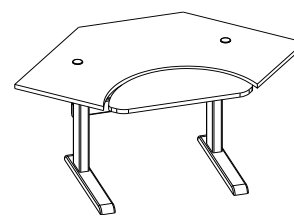
 <b>C1</b>	 <b>C2</b>	 <b>D1</b>				
MTKCICO47(#)(X)	23x47x47x23x34	105/60	1685	1773	1784	1947
MTKCICO41(#)(X)	23x41x41x23x25	100/60	1580	1668	1680	1737
MTKCICO35(#)(X)	23x35x35x23x17	90/54	1239	1301	1323	1388
MTKCICO29(#)(X)	23x29x29x23x9	105/60	1239	1301	1323	1388

Note: Dimension above are nominal sizes. Actual sizes are .5" larger in each dimension.

For 29.5" deep corner tables, add "29" to code, for 30" add "30" to code. Eg. MTKCI4630(#)(X). Same price.

KBSS keyboard mechanism and platform are included in corners with cut-outs.

(Range: 12" height adjustment; 6" above to 6" below worksurface; 15 degrees positive or negative tilt.

KBWL and KBKW-B mechanisms are also available with the above tables. Add "KBWL" or "KBKWB" to part number and adjust price per item listed on page 47.

**Ordering Details:**

Height Range - 24" to 39"

(#) - Specify Top style - 'A1', 'A2', 'B1', 'B2', 'C1', 'C2', 'D1', 'D2'.

(X) - Specify 'M1' for 1" thermofused, 'M2' for 1-1/2" thermofused, 'H1' for 1-1/8" high pressure laminate, or H2' for 1-1/2" high pressure laminate.

Actual dimensions above are 1/2" wider and deeper than stated. For tables with "zero travel clearance", specify by size. Eg. To order 48x30, use MTKCI48 as the code. Price is the closest size above.

**Options:**

Laminate modesty panels add LMP. No increase in price.

Wrist rests are available, see keyboard section of pricelist.

Additional grommets are available - specify 'GL' - Left, 'GC' - Center, 'GR' - Right - add \$40 each to list price.

Model	Size	Wt./Cube	Thermofused		Laminated	
			1"	1-1/2"	1-1/8"	1-1/2"

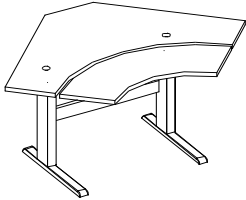

**Dual Surface  
Curved Corner Terminal Tables**

*(straight front available, add SF to code)*

MTKIVC47(X)	29x47x47x29	105/60	1915	2043	2100	2224
MTKIVC4723(X)	23x47x47x23	105/60	1915	2043	2100	2224
MTKIVC41(X)	23x41x41x23	100/60	1867	1992	2048	2168
MTKIVC4117(X)	17x41x41x17	100/60	1867	1992	2048	2168
MTKIVC35(X)	17x35x35x17	100/60	1867	1992	2048	2168

Note: Dimension above are nominal sizes. Actual sizes are .5" larger in each dimension.

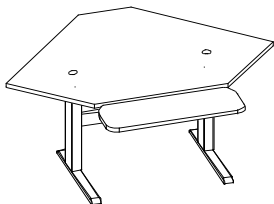

**Dual Surface  
Straight Front Corner Terminal Tables**

*(to be used where adjacent tables have notched corners)*

MTKIVS47(X)	29x47x47x29	105/60	1915	2043	2100	2224
MTKIVS4723(X)	23x47x47x23	105/60	1915	2043	2100	2224
MTKIVS41(X)	23x41x41x23	100/60	1867	1992	2048	2168
MTKIVS4117(X)	17x41x41x17	100/60	1867	1992	2048	2168
MTKIVS35(X)	17x35x35x17	100/60	1867	1992	2048	2168

Note: Dimension above are nominal sizes. Actual sizes are .5" larger in each dimension.

Keyboard surface is mounted on a KBKW-B mechanism, which is included in above prices.

Range - 15" height adjustment; 8" above or 7" below worksurface; 15 degrees positive or negative tilt.

Optional with KBKW-D mechanism, Range - 13.5" height adjustment; 7" above or 6.5" below worksurface; 15 degrees positive or negative tilt. Add "D" to product code and deduct \$21 from list price.

**Ordering Details:**

Height Range - 24" to 39".

(#) - Specify Top style - 'A1', 'A2', 'B1', 'B2', 'C1', 'C2', 'D1', 'D2'.

(X) - Specify 'M1' for 1" thermofused, 'M2' for 1-1/2" thermofused, 'H1' for 1-1/8" high pressure laminate, or H2' for 1-1/2" high pressure laminate.

Actual dimensions above are 1/2" wider and deeper than stated. For tables with "zero travel clearance", specify by size. Eg. To order 48x30, use MTKIVS48 as the code. Price is the closest size above.

**Options:**

For keyboard option of 5" sliding adjustment, add KW(FOC) to part number and \$310 to list price.

Laminate modesty panels add LMP. No increase in price.

Wrist rests are available, see keyboard section of pricelist.

Additional grommets are available - specify 'GL' - Left, 'GC' - Center, 'GR' - Right - add \$40 each to list price.

Model	Size	Wt./Cube	Thermofused		Laminated	
			1"	1-1/2"	1-1/8"	1-1/2"

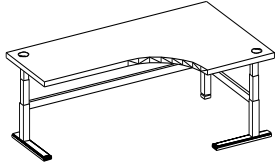

**Extended Incremental Corner**  
**29.5" deep returns**  
("B" left extended shown)

MECI29835929(X)(#)	29x83x59x29	215/18.5	2433	2569	2669	2779
MECI29775929(X)(#)	29x77x59x29	202/17.2	2403	2540	2640	2750
MECI29715929(X)(#)	29x71x59x29	189/15.9	2309	2445	2545	2655
MECI29655929(X)(#)	29x65x59x29	176/14.6	2241	2377	2477	2587
MECI29835329(X)(#)	29x83x53x29	215/18.5	2241	2377	2477	2587
MECI29775329(X)(#)	29x77x53x29	202/17.2	2241	2377	2477	2587
MECI29715329(X)(#)	29x71x53x29	189/15.9	2205	2342	2441	2552
MECI29655329(X)(#)	29x65x53x29	176/14.6	2205	2342	2441	2552
MECI29595329(X)(#)	29x59x53x29	149/11.0	2188	2325	2424	2535
MECI29834729(X)(#)	29x83x47x29	215/18.5	2179	2315	2415	2525
MECI29774729(X)(#)	29x77x47x29	202/17.2	2179	2315	2415	2525
MECI29714729(X)(#)	29x71x47x29	189/15.9	2165	2302	2401	2512
MECI29654729(X)(#)	29x65x47x29	176/14.6	2165	2302	2401	2512
MECI29594729(X)(#)	29x59x47x29	149/11.0	2142	2384	2382	2489
MECI29834129(X)(#)	29x83x41x29	215/18.5	2179	2315	2415	2525
MECI29774129(X)(#)	29x77x41x29	202/17.2	2179	2315	2415	2525
MECI29714129(X)(#)	29x71x41x29	189/15.9	2165	2302	2401	2512
MECI29654129(X)(#)	29x65x41x29	176/14.6	2165	2302	2401	2512
MECI29594129(X)(#)	29x59x41x29	149/11.0	2142	2279	2378	2489

Note: Dimension above are nominal sizes. Actual sizes are .5" larger in each dimension.

**Ordering Details:**

Height Range - 24" to 39".

(X) - Specify 'M1' for 1" thermofused, 'M2' for 1-1/2" thermofused, 'H1' for 1-1/8" high pressure laminate, or H2' for 1-1/2" high pressure laminate.

(#) - Specify style - 'A' - extended right, or 'B' - extended left. Asymmetrical returns are available, please contact customer service for details. Woodgrain runs horizontally on the longest side of the table.

Actual dimensions above are 1/2" wider and deeper than stated. For tables with "zero travel clearance", specify by size. Eg. To order 84x60, use MECI30846030 as the code. Price is the closest size above.

**Options:**

For thermofused laminate modesty panels (set of 2) add \$252 and LMP to code.

Additional grommets are available - specify 'GL' - Left, 'GC' - Center, 'GR' - Right - add \$40 each to list price.

Model	Size	Wt./Cube	Thermofused		Laminated	
			1"	1-1/2"	1-1/8"	1-1/2"

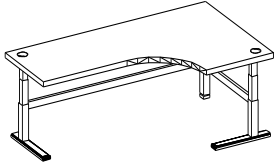

**Extended Incremental Corner**  
**23.5" deep returns**  
("B" left extended shown)

MECI23835923(X)(#)	23x83x59x23	215/18.5	2422	2559	2659	2769
MECI23775923(X)(#)	23x77x59x23	202/17.2	2393	2529	2629	2739
MECI23715923(X)(#)	23x71x59x23	189/15.9	2298	2435	2535	2645
MECI23655923(X)(#)	23x65x59x23	176/14.6	2230	2367	2466	2577
MECI23835323(X)(#)	23x83x53x23	215/18.5	2230	2367	2466	2577
MECI23775323(X)(#)	23x77x53x23	202/17.2	2230	2367	2466	2577
MECI23715323(X)(#)	23x71x53x23	189/15.9	2195	2331	2431	2541
MECI23655323(X)(#)	23x65x53x23	176/14.6	2195	2331	2431	2541
MECI23595323(X)(#)	23x59x53x23	149/11.0	2178	2314	2414	2524
MECI23834723(X)(#)	23x83x47x23	215/18.5	2168	2305	2405	2515
MECI23774723(X)(#)	23x77x47x23	202/17.2	2168	2305	2405	2515
MECI23714723(X)(#)	23x71x47x23	189/15.9	2155	2291	2391	2501
MECI23654723(X)(#)	23x65x47x23	176/14.6	2155	2291	2391	2501
MECI23594723(X)(#)	23x59x47x23	149/11.0	2132	2268	2368	2478
MECI23834123(X)(#)	23x83x41x23	215/18.5	2168	2305	2405	2515
MECI23774123(X)(#)	23x77x41x23	202/17.2	2168	2305	2405	2515
MECI23714123(X)(#)	23x71x41x23	189/15.9	2155	2291	2391	2501
MECI23654123(X)(#)	23x65x41x23	176/14.6	2155	2291	2391	2501
MECI23594123(X)(#)	23x59x41x23	149/11.0	2132	2268	2368	2478

Note: Dimension above are nominal sizes. Actual sizes are .5" larger in each dimension.

**Ordering Details:**

Height Range - 24" to 39".

(X) - Specify 'M1' for 1" thermofused, 'M2' for 1-1/2" thermofused, 'H1' for 1-1/8" high pressure laminate, or H2' for 1-1/2" high pressure laminate.

(#) - Specify style - 'A' - extended right, or 'B' - extended left. Asymmetrical returns are available, please contact customer service for details. Woodgrain runs horizontally on the longest side of the table.

Actual dimensions above are 1/2" wider and deeper than stated. For tables with "zero travel clearance", specify by size. Eg. To order 84x60, use MECI24846024 as the code. Price is the closest size above.

**Options:**

For thermofused laminate modesty panels (set of 2) add \$252 and LMP to code.

Additional grommets are available - specify 'GL' - Left, 'GC' - Center, 'GR' - Right - add \$40 each to list price.

Model	Size	Wt./Cube	Thermofused		Laminated	
			1"	1-1/2"	1-1/8"	1-1/2"

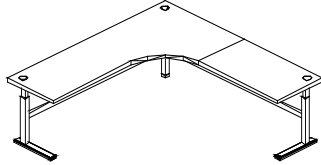

**A**

**Link - Drive  
Incremental Corners**

**23.5" deep returns**

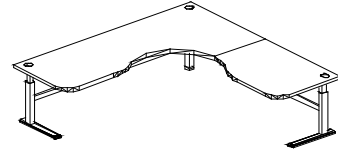

**B**

MCKIC952323(X)	23x95x95x23	225/20.1	2536	2672	2772	2882
MCKIC892323(X)	23x89x89x23	220/19.2	2496	2632	2732	2842
MCKIC832323(X)	23x83x83x23	215/18.5	2422	2559	2659	2769
MCKIC772323(X)	23x77x77x23	202/17.2	2393	2529	2629	2739
MCKIC712323(X)	23x71x71x23	189/15.9	2298	2435	2535	2645
MCKIC652323(X)	23x65x65x23	176/14.6	2230	2367	2466	2577

Note: Dimension above are nominal sizes. Actual sizes are .5" larger in each dimension.

**29.5" deep returns**

MCKIC952929(X)	29x95x95x29	225/20.1	2536	2672	2772	2882
MCKIC892929(X)	29x89x89x29	220/19.2	2496	2632	2732	2842
MCKIC832929(X)	29x83x83x29	215/18.5	2422	2559	2659	2769
MCKIC772929(X)	29x77x77x29	202/17.2	2393	2529	2629	2739
MCKIC712929(X)	29x71x71x29	189/15.9	2300	2436	2535	2646
MCKIC652929(X)	29x65x65x29	176/14.6	2230	2367	2466	2577

Note: Dimension above are nominal sizes. Actual sizes are .5" larger in each dimension.

**Ordering Details:**

Height Range - 24" to 39".

(X) - Specify 'M1' for 1" thermofused, 'M2' for 1-1/2" thermofused, 'H1' for 1-1/8" high pressure laminate, or H2' for 1-1/2" high pressure laminate.

(#) - Specify 'A' or 'B'. Other top shapes and asymmetrical returns are available, please contact customer service for details.

Actual dimensions above are 1/2" wider and deeper than stated. For tables with "zero travel clearance", specify by size. Eg. To order 84x84, use MCKIC842424 as the code. Price is the closest size above.

**Options:**

For thermofused laminate modesty panels (set of 2) add \$252 and LMP to code.

For optional cutout and monitor riser kit, add \$1040 to list price and 'MR' to model number.

Additional grommets are available - specify 'GL' - Left, 'GC' - Center, 'GR' - Right - add \$40 each to list price.

Model	Size	Wt./Cube	Thermofused		Laminated	
			1"	1-1/2"	1-1/8"	1-1/2"

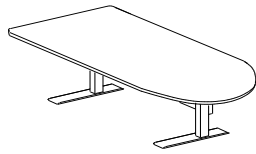

**B**

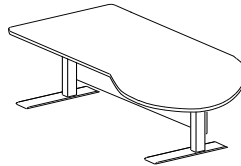

**PR**

(right inside shown)

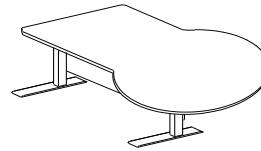

**M**

MCCTI7236FS(#)(X)	72x36	145/85.0	1689	1842	1910	2056
MCCTI7230FS(#)(X)	72x30	142/72.0	1621	1769	1835	1978
MCCTI7224FS(#)(X)	72x24	137/72.0	1433	1570	1631	1762
MCCTI6030FS(#)(X)	60x30	132/60.0	1433	1570	1631	1762
MCCTI6024FS(#)(X)	60x24	128/60.0	1256	1382	1439	1559
MCCTI4830FS(#)(X)	48x30	123/48.0	1256	1382	1439	1559
MCCTI4824FS(#)(X)	48x24	118/48.0	1256	1382	1439	1559
MCCTI4230FS(#)(X)	42x30	120/48.0	1256	1382	1439	1559
MCCTI4224FS(#)(X)	42x24	116/48.0	1256	1264	1358	1474
MCCTI3624FS(#)(X)	36x24	113/40.0	1125	1243	1296	1409

**Ordering Details:**

Height Range - 24" to 39"

(X) - Specify 'M1' for 1" thermofused, 'M2' or 1-1/2" thermofused, 'H1' for 1-1/8" high pressure laminate, or H2' for 1-1/2" high pressure laminate.

(#) - Specify Top Style - 'B' - bullet, 'PR' - P style (right), 'PL' - P style (left), 'M' - mushroom.

Add \$54 for style "P" and \$113 for Style 'M'

P shape inside is standard configuration. Outside 'P' shape is available( OP ) - add \$68 to list price.

P shape tables: 24" depth with 30" diameter, 30" depth with 36" diameter, and 36" depth with 42" diameter

Mushroom tables: 24" depth with 36" diameter, 30" depth with 42" diameter, and 36" depth with 48" diameter

**Options:**

Laminate modesty panels add LMP. No increase in price.

Additional grommets are available - specify 'GL' - Left, 'GC' - Center, 'GR' - Right - add \$40 each to list price.



Model	Size	Wt./Cube	Thermofused		Laminated	
			1"	1-1/2"	1-1/8"	1-1/2"

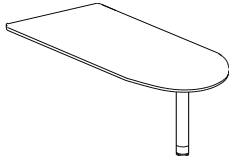

**B**

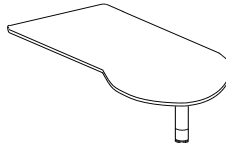

**PR**

(right inside shown)

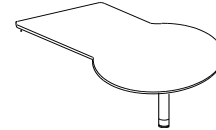

**M**

MCCI7236(#)(X)	72x36	97/6.0	1689	1842	1910	2056
MCCI7230(#)(X)	72x30	95/6.0	1621	1769	1835	1978
MCCI7224(#)(X)	72x24	91/6.0	1433	1570	1631	1762
MCCI6030(#)(X)	60x30	82/6.0	1433	1570	1631	1762
MCCI6024(#)(X)	60x24	78/6.0	1256	1382	1439	1559
MCCI4830(#)(X)	48x30	72/6.0	1256	1382	1439	1559
MCCI4824(#)(X)	48x24	68/6.0	1256	1382	1439	1559
MCCI4230(#)(X)	42x30	63/6.0	1256	1382	1439	1559
MCCI4224(#)(X)	42x24	78/6.0	1256	1264	1358	1474
MCCI3624(#)(X)	36x24	68/6.0	1125	1243	1296	1409

**Ordering Details:**

Height Range - 24" to 39"

(#) - Specify Top Style - 'B' - bullet, 'PR' - P style (right), 'PL' - P style (left), 'M' - mushroom.

(X) - Specify 'M1' for 1" thermofused, 'M2' for 1-1/2" thermofused, 'H1' for 1-1/8" high pressure laminate, or 'H2' for 1-1/2" high pressure laminate.

Add \$54 for style "P" and \$113 for Style 'M'

P shape inside is standard configuration. Outside 'P' shape is available( OP ) - add \$68 to list price.

P shape tables: 24" depth with 30" diameter, 30" depth with 36" diameter, and 36" depth with 42" diameter

Mushroom tables: 24" depth with 36" diameter, 30" depth with 42" diameter, and 36" depth with 48" diameter

**Options:**

Laminate modesty panels add LMP. No increase in price.

Additional grommets are available - specify 'GL' - Left, 'GC' - Center, 'GR' - Right - add \$40 each to list price.

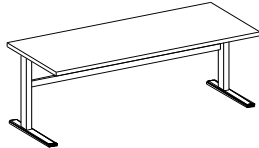
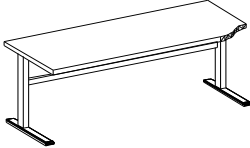
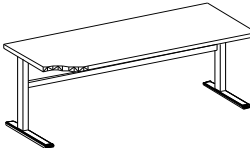
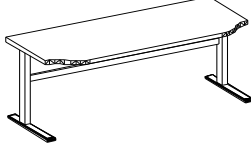
Model	Size	Wt./Cube	Thermofused		Laminated		
			1"	1-1/2"	1-1/8"	1-1/2"	
							
	<b>A</b>	<b>B</b>	<b>C</b>	<b>D</b>			
MWCF9535(#)(X)	95x35	140/75	1370	1583	1647	1766	
MWCF8329(#)(X)	83x29	120/9.0	1160	1250	1323	1422	
MWCF7729(#)(X)	77x29	110/9.0	1076	1160	1213	1305	
MWCF7129(#)(X)	71x29	100/9.0	971	1049	1087	1172	
MWCF6529(#)(X)	65x29	85/7.0	940	1008	1045	1125	
MWCF5929(#)(X)	59x29	85/7.0	903	977	1013	1093	
MWCF5329(#)(X)	53x29	85/7.0	903	977	1013	1093	
MWCF4729(#)(X)	47x29	85/6.0	845	915	924	999	
MWCF4129(#)(X)	41x29	75/6.0	746	810	824	894	
MWCF3529(#)(X)	35x29	65/4.0	725	788	798	865	
MWCF2929(#)(X)	29x29	55/4.0	698	759	772	838	
MWCF8323(#)(X)	83x23	105/9.0	1092	1134	1307	1405	
MWCF7723(#)(X)	77x23	105/9.0	1092	1134	1202	1294	
MWCF7123(#)(X)	71x23	95/9.0	919	993	1024	1105	
MWCF6523(#)(X)	65x23	85/7.0	856	926	945	1021	
MWCF5923(#)(X)	59x23	85/7.0	819	885	903	977	
MWCF5323(#)(X)	53x23	85/7.0	819	887	903	974	
MWCF4723(#)(X)	47x23	80/6.0	788	854	861	932	
MWCF4123(#)(X)	41x23	70/6.0	688	749	761	826	
MWCF3523(#)(X)	35x23	60/4.0	667	727	735	798	
MWCF2923(#)(X)	29x23	50/4.0	646	704	709	771	
MWCF2423(#)(X)	24x23	45/4.0	646	704	709	771	

Note: Dimension above are nominal sizes. Actual sizes are .5" larger in each dimension.

### Ordering Details:

29" standard height. For 26" high, add "26" to code number.

(#) - Specify Sculpture - 'A' - none, 'B' - right, 'C' - left, or 'D' - both.

(X) - Specify - 'M1' for 1" thermofused, 'M2' for 1-1/2" thermofused, 'H1' for 1-1/8" high pressure laminate, or 'H2' for 1-1/2" high pressure laminate.

Actual dimensions above are 1/2" wider and deeper than stated. For tables with "zero travel clearance", specify by size. Eg. To order 48x30, use MWCF4830 as the code. Price is the closest size above.

### Options:

Laminate modesty panels add LMP to item code. For tables 48"w or less, add \$126, over 48"w - add \$205.

Additional grommets are available - specify 'GL' - Left, 'GC' - Center, 'GR' - Right - add \$40 each to list price.

Bow fronts for tables 58" and up (table is 6" deeper on visitors side). Specify 'BF' to part and add \$158.

Model	Size	Wt./Cube	Thermofused		Laminated	
			1"	1-1/2"	1-1/8"	1-1/2"

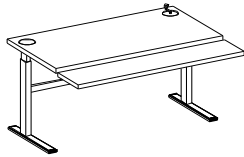

**Dual Surface**  
**Terminal Tables - Fixed**

MTIF5935(X)	59x35	115/70	1810	1938	1995	2119
MTIF59(X)	59x29	115/70	1703	1832	1890	1969
MTIF47(X)	47x29	105/60	1598	1713	1764	1875
MTIF41(X)	41x29	100/60	1520	1631	1680	1787
MTIF35(X)	35x29	95/50	1424	1529	1575	1676
MTIF29(X)	29x29	89/40	1327	1426	1470	1565
MTIFSA35(X)	35x29	95/50	1231	1324	1365	1455
MTIFSA29(X)	29x29	89/40	1202	1294	1334	1422

Note: Dimension above are nominal sizes. Actual sizes are .5" larger in each dimension.

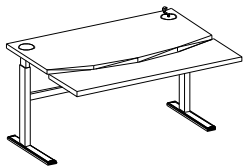

**Dual Surface**  
**Convex Terminal Tables- Fixed**

MTBBIF59(X)	59x29	115/70	1810	1938	1995	2119
MTBBIF47(X)	47x29	105/60	1598	1713	1764	1875
MTBBIF41(X)	41x29	100/60	1520	1631	1680	1787
MTBBIF35(X)	35x29	95/50	1424	1529	1575	1676
MTBBIF29(X)	29x29	89/40	1327	1426	1470	1566
MTBBIFSA35(X)	35x29	95/50	1231	1324	1365	1455
MTBBIFSA29(X)	29x29	89/40	1202	1294	1334	1422

Note: Dimension above are nominal sizes. Actual sizes are .5" larger in each dimension.

*KBKW-B dual arm mechanism used in above tables, except "SA" single arm models. Range 15" height adjustment; 8" above and 7" below worksurface; 15 degrees positive or negative tilt.*

*Optional KBKW-D dual arm mechanism available for above tables, except "SA" single arm models. Range 13.5" height adjustment; 7" above and 6.5" below worksurface; 15 degrees positive or negative tilt. Add "D" to product code and deduct \$21 from list price.*

*KBSS Single arm mechanism is used in SA models, range 6" above and 6" below worksurface, + or - 15 degrees of tilt, focal and swivel features are disabled.*

**Ordering Details:**

29" standard height. For 26" high, add "26" to code number.

(X) - Specify 'M1' for 1" thermofused, 'M2' for 1-1/2" thermofused, 'H1' for 1-1/8" high pressure laminate, or H2' for 1-1/2" high pressure laminate.

Actual dimensions above are 1/2" wider and deeper than stated. For tables with "zero travel clearance", specify by size. Eg. To order 48x30, use MTIF48 as the code. Price is the closest size above.

**Options:**

For keyboard option of 5" sliding adjustment, add KW(FOC) to part number and \$310 to list price.

Laminate modesty panels add LMP to item code. For tables 48"w or less, add \$126, over 48"w - add \$205.

Wrist rests are available, see keyboard section of pricelist.

Additional grommets are available - specify 'GL' - Left, 'GC' - Center, 'GR' - Right - add \$40 each to list price.

Model	Size (DWWDK)	Wt./Cube	Thermofused		Laminated	
			1"	1-1/2"	1-1/8"	1-1/2"

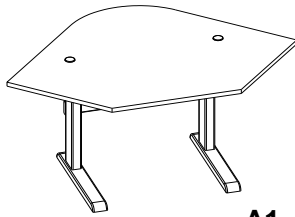

**A1**

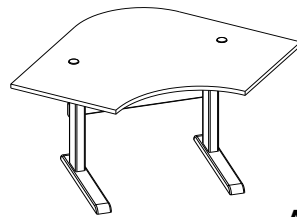

**A2**

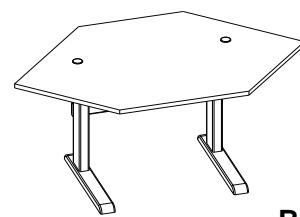

**B1**

MTKCC4729(#)(X)	29x47x47x29x25	105/60	1160	1248	1197	1422
MTKCC4129(#)(X)	29x41x41x29x17	105/60	1055	1143	1155	1212
MTKCF47(#)(X)	23x47x47x23x34	105/60	1160	1248	1197	1422
MTKCF41(#)(X)	23x41x41x23x25	100/60	1055	1143	1155	1212
MTKCF35(#)(X)	23x35x35x23x17	90/54	714	776	798	863
MTKCF29(#)(X)	23x29x29x23x9	85/54	714	776	798	863

Note: Dimension above are nominal sizes. Actual sizes are .5" larger in each dimension.

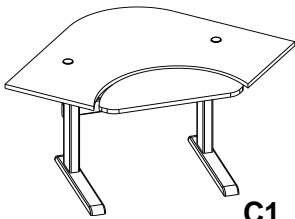

**C1**

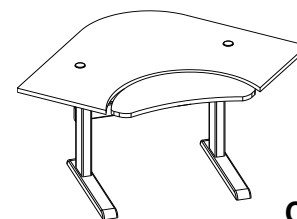

**C2**

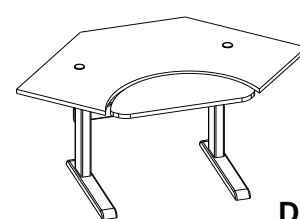

**D1**

MTKCFCO47(#)(X)	23x47x47x23x34	105/60	1580	1668	1679	1842
MTKCFCO41(#)(X)	23x41x41x23x25	100/60	1475	1563	1575	1632
MTKCFCO35(#)(X)	23x35x35x23x17	90/54	1134	1196	1218	1283
MTKCFCO29(#)(X)	23x29x29x23x9	85/54	1134	1196	1218	1283

Note: Dimension above are nominal sizes. Actual sizes are .5" larger in each dimension.

**For 29.5" deep corner tables, add "29" to code, for 30" add "30" to code. Eg. MTKCFCO4730(#)(X). Same price. KBSS keyboard mechanism and platform are included in corners with cut-outs.**

*(Range: 12" height adjustment; 6" above to 6" below worksurface; 15 degrees positive or negative tilt.*

*KBWL and KBKW-B mechanisms are also available with the above tables. Add "KBWL" or "KBKWB" to part number and adjust price per item listed on page 47.*

**Ordering Details:**

29" standard height. For 26" high, add "26" to code number.

(#) - Specify Top style - 'A1', 'A2', 'B1', 'B2', 'C1', 'C2', 'D1', 'D2'.

(X) - Specify 'M1' for 1" thermofused, 'M2' for 1-1/2" thermofused, 'H1' for 1-1/8" high pressure laminate, or 'H2' for 1-1/2" high pressure laminate.

Actual dimensions above are 1/2" wider and deeper than stated. For tables with "zero travel clearance", specify by size. Eg. To order 48x30, use MTKCFCO4830 as the code. Price is the closest size above.

**Options:**

For thermofused laminate modesty panels add LMP to code and \$126 to list price.

Wrist rests are available, see keyboard section of pricelist.

Additional grommets are available - specify 'GL' - Left, 'GC' - Center, 'GR' - Right - add \$40 each to list price.

Model	Size	Wt./Cube	Thermofused		Laminated	
			1"	1-1/2"	1-1/8"	1-1/2"

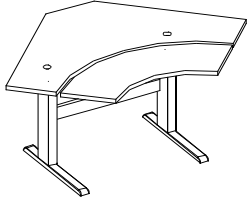

**Dual Surface  
Curved Corner Terminal Tables**

*(straight front available, add SF to code)*

MTKFVC47(X)	29x47x47x29	105/60	1724	1810	1938	1995
MTKFVC4723(X)	23x47x47x23	105/60	1724	1810	1938	1995
MTKFVC41(X)	23x41x41x23	100/60	1678	1762	1887	1943
MTKFVC4117(X)	17x41x41x17	100/60	1678	1762	1887	1943
MTKFVC35(X)	17x35x35x17	100/60	1678	1762	1887	1943

Note: Dimension above are nominal sizes. Actual sizes are .5" larger in each dimension.

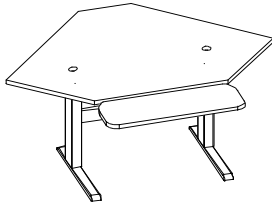

**Dual Surface  
Straight Front Corner Terminal Tables**

*(to be used where adjacent tables have notched corners)*

MTKFVS47(X)	29x47x47x29	105/60	1724	1810	1938	1995
MTKFVS4723(X)	23x47x47x23	105/60	1724	1810	1938	1995
MTKFVS41(X)	23x41x41x23	100/60	1678	1762	1887	1943
MTKFVS4117(X)	17x41x41x17	100/60	1678	1762	1887	1943
MTKFVS35(X)	17x35x35x17	100/60	1678	1762	1887	1943

Note: Dimension above are nominal sizes. Actual sizes are .5" larger in each dimension.

**For 29.5" deep corner tables, add "29" to code, for 30" add "30" to code. Eg. MTKCFVS4730(#)(X). Same price.**  
KBSS keyboard mechanism and platform are included in corners with cut-outs.

*(Range: 12" height adjustment; 6" above to 6" below worksurface; 15 degrees positive or negative tilt.  
KBWL and KBKW-B mechanisms are also available with the above tables. Add "KBWL" or "KBKWB" to  
part number and adjust price per item listed on page 47.*

**Ordering Details:**

29" standard height. For 26" high, add "26" to code number.

(#) - Specify Top style - 'A1', 'A2', 'B1', 'B2', 'C1', 'C2', 'D1', 'D2'.

(X) - Specify 'M1' for 1" thermofused, 'M2' for 1-1/2" thermofused, 'H1' for 1-1/8" high pressure laminate, or  
H2' for 1-1/2" high pressure laminate.

Actual dimensions above are 1/2" wider and deeper than stated. For tables with "zero travel clearance", specify  
by size. Eg. To order 48x30, use MTKFVC48 as the code. Price is the closest size above.

**Options:**

For keyboard option of 5" sliding adjustment, add KW(FOC) to part number and \$310 to list price.

For thermofused laminate modesty panels add LMP to code and \$126 to list price.

Wrist rests are available, see keyboard section of pricelist.

Additional grommets are available - specify 'GL' - Left, 'GC' - Center, 'GR' - Right - add \$40 each to list price.

Model	Size	Wt./Cube	Thermofused		Laminated	
			1"	1-1/2"	1-1/8"	1-1/2"

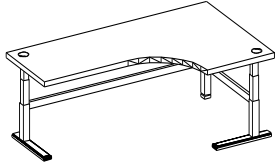

**Extended Fixed Corners**  
**29.5" deep returns**  
("B" left extended shown)

MCFK29835929(X)(#)	29x83x59x29	215/18.5	2328	2464	2564	2674
MCFK29775929(X)(#)	29x77x59x29	202/17.2	2298	2435	2535	2645
MCFK29715929(X)(#)	29x71x59x29	189/15.9	2204	2340	2440	2550
MCFK29655929(X)(#)	29x65x59x29	176/14.6	2136	2272	2372	2482
MCFK29835329(X)(#)	29x83x53x29	215/18.5	2136	2272	2372	2482
MCFK29775329(X)(#)	29x77x53x29	202/17.2	2136	2272	2372	2482
MCFK29715329(X)(#)	29x71x53x29	189/15.9	2100	2237	2336	2447
MCFK29655329(X)(#)	29x65x53x29	176/14.6	2100	2237	2336	2447
MCFK29595329(X)(#)	29x59x53x29	149/11.0	2083	2220	2319	2430
MCFK29834729(X)(#)	29x83x47x29	215/18.5	2074	2210	2310	2420
MCFK29774729(X)(#)	29x77x47x29	202/17.2	2074	2210	2310	2420
MCFK29714729(X)(#)	29x71x47x29	189/15.9	2060	2197	2296	2407
MCFK29654729(X)(#)	29x65x47x29	176/14.6	2060	2197	2296	2407
MCFK29594729(X)(#)	29x59x47x29	149/11.0	2037	2174	2277	2384
MCFK29834129(X)(#)	29x83x41x29	215/18.5	2074	2210	2415	2420
MCFK29774129(X)(#)	29x77x41x29	202/17.2	2074	2210	2415	2420
MCFK29714129(X)(#)	29x71x41x29	189/15.9	2060	2197	2296	2407
MCFK29654129(X)(#)	29x65x41x29	176/14.6	2060	2197	2296	2407
MCFK29594129(X)(#)	29x59x41x29	149/11.0	2037	2174	2273	2384

Note: Dimension above are nominal sizes. Actual sizes are .5" larger in each dimension.

**Ordering Details:**

29" standard height. For 26" high, add "26" to code number.

(X) - Specify - 'M1' for 1" thermofused, 'M2' for 1-1/2" thermofused, 'H1' for 1-1/8" high pressure laminate, or H2' for 1-1/2" high pressure laminate.

(#) - Specify style - 'A' - extended right, or 'B' - extended left. Asymmetrical returns are available, please contact customer service for details. Woodgrain runs horizontally on the longest side of the table.

Actual dimensions above are 1/2" wider and deeper than stated. For tables with "zero travel clearance", specify by size. Eg. To order 84x60, use MCFK30846030 as the code. Price is the closest size above.

**Options:**

For thermofused laminate modesty panels (set of 2) add \$252 and LMP to code.

Additional grommets are available - specify 'GL' - Left, 'GC' - Center, 'GR' - Right - add \$40 each to list price.

Model	Size	Wt./Cube	Thermofused		Laminated	
			1"	1-1/2"	1-1/8"	1-1/2"

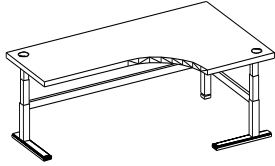

**Extended Fixed Corners**  
**23.5" deep returns**  
("B" left extended shown)

MCFK23835923(X)(#)	23x83x59x23	215/18.5	2317	2454	2554	2664
MCFK23775923(X)(#)	23x77x59x23	202/17.2	2288	2424	2524	2634
MCFK23715923(X)(#)	23x71x59x23	189/15.9	2193	2330	2430	2540
MCFK23655923(X)(#)	23x65x59x23	176/14.6	2125	2262	2361	2472
MCFK23835323(X)(#)	23x83x53x23	215/18.5	2125	2262	2361	2472
MCFK23775323(X)(#)	23x77x53x23	202/17.2	2125	2262	2361	2472
MCFK23715323(X)(#)	23x71x53x23	189/15.9	2090	2226	2326	2436
MCFK23655323(X)(#)	23x65x53x23	176/14.6	2090	2226	2326	2436
MCFK23595323(X)(#)	23x59x53x23	149/11.0	2073	2209	2309	2419
MCFK23834723(X)(#)	23x83x47x23	215/18.5	2063	2200	2300	2410
MCFK23774723(X)(#)	23x77x47x23	202/17.2	2063	2200	2300	2410
MCFK23714723(X)(#)	23x71x47x23	189/15.9	2050	2186	2286	2396
MCFK23654723(X)(#)	23x65x47x23	176/14.6	2050	2186	2286	2396
MCFK23594723(X)(#)	23x59x47x23	149/11.0	2027	2163	2263	2373
MCFK23834123(X)(#)	23x83x41x23	215/18.5	2063	2200	2300	2410
MCFK23774123(X)(#)	23x77x41x23	202/17.2	2063	2200	2300	2410
MCFK23714123(X)(#)	23x71x41x23	189/15.9	2050	2186	2286	2396
MCFK23654123(X)(#)	23x65x41x23	176/14.6	2050	2186	2286	2396
MCFK23594123(X)(#)	23x59x41x23	149/11.0	2027	2163	2263	2373

Note: Dimension above are nominal sizes. Actual sizes are .5" larger in each dimension.

**Ordering Details:**

29" standard height. For 26" high, add "26" to code number.

(X) - Specify - 'M1' for 1" thermofused, 'M2' for 1-1/2" thermofused, 'H1' for 1-1/8" high pressure laminate, or H2' for 1-1/2" high pressure laminate.

(#) - Specify style - 'A' - extended right, or 'B' - extended left. Asymmetrical returns are available, please contact customer service for details. Woodgrain runs horizontally on the longest side of the table.

Actual dimensions above are 1/2" wider and deeper than stated. For tables with "zero travel clearance", specify by size. Eg. To order 84x60, use MCFK24846024 as the code. Price is the closest size above.

**Options:**

For thermofused laminate modesty panels (set of 2) add \$252 and LMP to code.

Additional grommets are available - specify 'GL' - Left, 'GC' - Center, 'GR' - Right - add \$40 each to list price.

Model	Size	Wt./Cube	Thermofused		Laminated	
			1"	1-1/2"	1-1/8"	1-1/2"

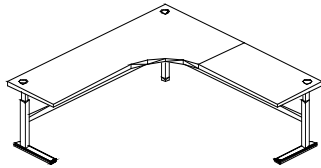

**A**

**Fixed Corners**

**23.5" deep returns**

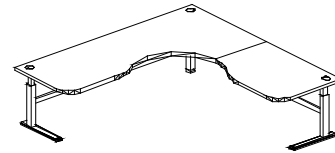

**B**

MECF952323(X)	23x95x95x23	225/20.1	2431	2567	2667	2777
MECF892323(X)	23x89x89x23	220/19.2	2391	2527	2627	2737
MECF832323(X)	23x83x83x23	215/18.5	2317	2454	2554	2664
MECF772323(X)	23x77x77x23	202/17.2	2288	2424	2524	2634
MECF712323(X)	23x71x71x23	189/15.9	2193	2330	2430	2540
MECF652323(X)	23x65x65x23	176/14.6	2125	2262	2361	2472

Note: Dimension above are nominal sizes. Actual sizes are .5" larger in each dimension.

**29.5" deep returns**

MECF952929(X)	29x95x95x29	225/20.1	2431	2567	2667	2777
MECF892929(X)	29x89x89x29	220/19.2	2391	2527	2627	2737
MECF832929(X)	29x83x83x29	215/18.5	2317	2454	2554	2664
MECF772929(X)	29x77x77x29	202/17.2	2288	2424	2524	2634
MECF712929(X)	29x71x71x29	189/15.9	2195	2331	2430	2541
MECF652929(X)	29x65x65x29	176/14.6	2125	2262	2361	2472

Note: Dimension above are nominal sizes. Actual sizes are .5" larger in each dimension.

**Ordering Details:**

29" standard height. For 26" high, add "26" to code number.

(X) - Specify 'M1' for 1" thermofused, 'M2' or 1-1/2" thermofused, 'H1' for 1-1/8" high pressure laminate or 'H2' for 1-1/2" high pressure laminate.

(#) - Specify 'A' or 'B'. Other top shapes and asymmetrical returns are available, please contact customer service for details.

Actual dimensions above are 1/2" wider and deeper than stated. For tables with "zero travel clearance", specify by size. Eg. To order 84x84, use MECF842424 as the code. Price is the closest size above.

**Options:**

For thermofused laminate modesty panels (set of 2) add \$252 and LMP to code.

For optional cutout and monitor riser kit, add \$1040 to list price and 'MR' to model number.

Additional grommets are available - specify 'GL' - Left, 'GC' - Center, 'GR' - Right - add \$40 each to list price.

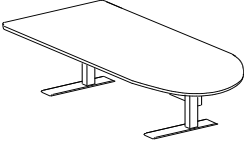
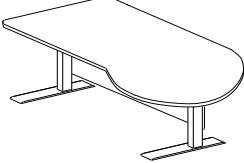
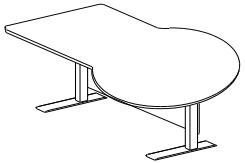

Model	Size	Wt./Cube	Thermofused		Laminated	
			1"		1-1/8"	1-1/2"
<div style="display: flex; justify-content: space-around; align-items: center;"> <div style="text-align: center;">  <p><b>B</b></p> </div> <div style="text-align: center;">  <p><b>PR</b> (right inside shown)</p> </div> <div style="text-align: center;">  <p><b>M</b></p> </div> </div>						
MCCTF7236(#)(X)	72x36x29	145/9.0	1584	1737	1805	1951
MCCTF7230(#)(X)	72x30x29	142/9.0	1516	1664	1730	1873
MCCTF7224(#)(X)	72x24x29	137/9.0	1328	1465	1526	1657
MCCTF6030(#)(X)	60x30x29	77/7.0	1328	1465	1526	1657
MCCTF6024(#)(X)	60x24x29	73/7.0	1151	1277	1334	1454
MCCTF4830(#)(X)	48x30x29	77/6.0	1151	1277	1334	1454
MCCTF4824(#)(X)	48x24x29	73/6.0	1151	1277	1334	1454
MCCTF4230(#)(X)	42x30x29	72/6.0	1151	1277	1334	1454
MCCTF4224(#)(X)	42x24x29	68/6.0	1151	1159	1253	1369
MCCTF3624(#)(X)	36x24x29	63/5.0	1020	1138	1191	1304

**Ordering Details:**

29" standard height. For 26" high, add "26" to code number.

(X) - Specify 'M1' for 1" thermofused, 'M2' for 1-1/2" thermofused, 'H1' for 1-1/8" high pressure laminate, or 'H2' for 1-1/2" high pressure laminate.

(#) - Specify Top Style - 'B' - bullet, 'PR' - P style (right), 'PL' - P style (left), 'M' - mushroom, add \$54 for style "P" and \$113 for Style 'M'.

Add \$54 for style "P" and \$113 for Style 'M'

P shape inside is standard configuration. Outside 'P' shape is available( OP ) - add \$68 to list price.

P shape tables: 24" depth with 30" diameter, 30" depth with 36" diameter, and 36" depth with 42" diameter

Mushroom tables: 24" depth with 36" diameter, 30" depth with 42" diameter, and 36" depth with 48" diameter

**Options:**

Laminate modesty panels add LMP. No increase in price.

Additional grommets are available - specify 'GL' - Left, 'GC' - Center, 'GR' - Right - add \$40 each to list price.

Model	Size	Wt./Cube	Thermofused		Laminated	
			1"	1-1/2"	1-1/8"	1-1/2"

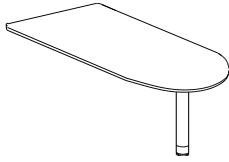

**B**

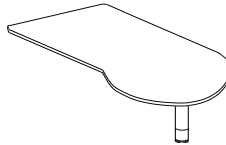

**PR**

(right inside shown)

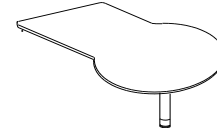

**M**

MCCF7236(#)(X)	72x36	97/6.0	1584	1737	1805	1951
MCCF7230(#)(X)	72x30	95/6.0	1516	1664	1730	1873
MCCF7224(#)(X)	72x24	91/6.0	1328	1465	1526	1657
MCCF6030(#)(X)	60x30	82/6.0	1328	1465	1526	1657
MCCF6024(#)(X)	60x24	78/6.0	1151	1277	1334	1454
MCCF4830(#)(X)	48x30	72/6.0	1151	1277	1334	1454
MCCF4824(#)(X)	48x24	68/6.0	1151	1277	1334	1454
MCCF4230(#)(X)	42x30	63/6.0	1151	1277	1334	1454
MCCF4224(#)(X)	42x24	78/6.0	1151	1159	1253	1369
MCCF3624(#)(X)	36x24	68/6.0	1020	1138	1191	1304

**Ordering Details:**

29" standard height. For 26" high, add "26" to code number.

(X) - Specify 'M1' for 1" thermofused, 'M2' for 1-1/2" thermofused, 'H1' for 1-1/8" high pressure laminate, or H2' for 1-1/2" high pressure laminate.

(#) - Specify Top Style - 'B' - bullet, 'PR' - P style (right), 'PL' - P style (left), 'M' - mushroom, add \$54 for style "P" and \$113 for Style 'M'.

Add \$54 for style "P" and \$113 for Style 'M'

P shape inside is standard configuration. Outside 'P' shape is available( OP ) - add \$68 to list price.

P shape tables: 24" depth with 30" diameter, 30" depth with 36" diameter, and 36" depth with 42" diameter

Mushroom tables: 24" depth with 36" diameter, 30" depth with 42" diameter, and 36" depth with 48" diameter

**Options:**

Laminate modesty panels add LMP. No increase in price.

Additional grommets are available - specify 'GL' - Left, 'GC' - Center, 'GR' - Right - add \$40 each to list price.

Model	Size	Wt./Cube	Thermofused 1"	Laminated 1-1/8"
-------	------	----------	-------------------	---------------------

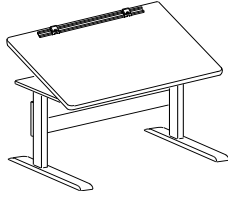

**Tilting Display Top  
Fixed Height**  
(Optional modesty panel shown)

MWTF7236(*) (X)	72x36	112/7.0	2562	2785
MWTF6036(*) (X)	60x36	100/6.0	2343	2546
MWTF4836(*) (X)	48x36	88/6.0	2168	2356
MWTF4236(*) (X)	42x36	82/6.0	2168	2356
MWTF3636(*) (X)	36x36	76/6.0	2109	2292
MWTF3036(*) (X)	30x36	64/6.0	2059	2238

(\*) - Specify '26' or '29' for height.

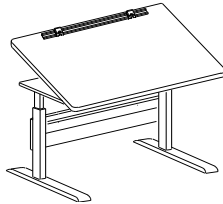

**Tilting Display Top  
Height Adjustable - Incremental**  
(Optional modesty panel shown)

MWTI7236(X)	72x36	112/7.0	2668	2900
MWTI6036(X)	60x36	100/6.0	2474	2688
MWTI4836(X)	48x36	88/6.0	2330	2533
MWTI4236(X)	42x36	82/6.0	2330	2533
MWTI3636(X)	36x36	76/6.0	2250	2445
MWTI3036(X)	30x36	64/6.0	2161	2349

*Tables include ratchet type tilting mechanism and plan gripper.*

**Ordering Details:**

Height Range-sit/stand, 27" to 42" - add 'SS' to model number when ordering.

Height Range-standard - 24" to 39" - use standard model number when ordering.

Height Range-low seated - 21" to 32" - add L to model number when ordering.

(X) - Specify 'M1' for 1" thermofused, 'M2' for 1-1/2" thermofused, 'H1' for 1-1/8" high pressure laminate, or

**Options:**

Smooth operating front crank tilt adjustment mechanism, add FCT to code and \$1103 to list price.

Laminate modesty panels add LMP to item code. For tables 48"w or less, add \$126, over 48"w - add \$205.

Model	Size	Wt./Cube	Thermofused 1"	Laminated 1-1/8"
-------	------	----------	-------------------	---------------------

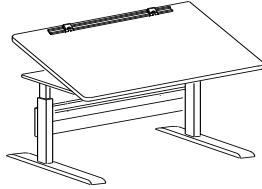

**Tilting Display Top  
Crank Operated**  
(Optional modesty panel shown)

MWTC7236(X)	72x36	110/72	3266	3549
MWTC6036(X)	60x36	100/60	3077	3344
MWTC4836(X)	48x36	95/48	2873	3123
MWTC4236(X)	42x36	95/48	2873	3123
MWTC3636(X)	36x36	75/36	2788	3030
MWTC3036(X)	30x36	65/30	2723	2959

*UTS under surface crank only.*

Height Range-sit/stand, 27" to 42" - add 'SS' to model number when ordering.  
Height Range-standard - 24" to 39" - use standard model number when ordering.  
Height Range-low seated - 21" to 32" - add L to model number when ordering.

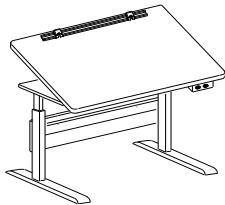

**Tilting Display Top  
Electrically Operated**  
(Optional modesty panel shown)

MWTE7236(X)	72x36	132/48.0	4910	5336
MWTE6036(X)	60x36	120/48.0	4721	5131
MWTE4836(X)	48x36	108/48.0	4517	4910
MWTE4236(X)	42x36	102/48.0	4517	4910
MWTE3636(X)	36x36	96/48.0	4432	4817
MWTE3036(X)	30x36	86/48.0	4366	4746

*Height Range on electric table above - 24" to 50"*

*Push button control is standard on right side unless otherwise specified.*

**Ordering Details:**

Tables include ratchet type tilting mechanism and plan gripper.

Shipped Assembled

(X) - Specify 'M1' for 1" thermofused, 'M2' for 1-1/2" thermofused, 'H1' for 1-1/8" high pressure laminate, or

**Options:**

Smooth operating front crank tilt adjustment mechanism, add FCT to code and \$1103 to list price.

Laminate modesty panels add LMP to item code. For tables 48"w or less, add \$126, over 48"w - add \$205.

Model	Size	Wt./Cube	Thermofused		Laminated	
			1"	1-1/2"	1-1/8"	1-1/2"

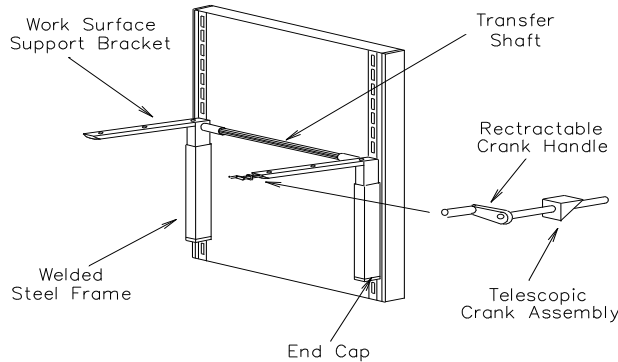

### Panel Mount Assembly - Crank Operated

MPMC7230	72x30	100/72	1181	1259	1297	1382
MPMC7224	72x24	115/72	1129	1203	1234	1315
MPMC6030	60x30	110/60	1113	1187	1223	1303
MPMC6024	60x24	105/60	1029	1095	1113	1184
MPMC4830	48x30	105/48	1055	1126	1134	1209
MPMC4824	48x24	100/48	998	1064	1071	1142
MPMC3030	30x30	75/30	908	969	982	1048
MPMC3024	30x24	70/30	856	914	919	981
MPMC2430	24x30	70/30	856	914	919	981
MPMC2424	24x24	65/30	856	914	919	981

Top surface crank access is standard. Specify under surface crank by adding 'UTS'-no upcharge

Under surface crank option includes top surface crank. Top or under surface crank are non-handed.

### Panel Mount Assembly - Electrically Operated

MPME7230	72x30	120/72	2100	2121	2137	2222
MPME7224	72x24	115/72	1995	2016	2032	2117
MPME6030	60x30	110/60	2016	2048	2063	2143
MPME6024	60x24	105/60	1911	1943	1958	2038
MPME4830	48x30	105/48	1943	1958	1974	2049
MPME4824	48x24	100/48	1838	1853	1869	1944
MPME3030	30x30	75/30	1785	1806	1822	1888
MPME3024	30x24	70/30	1680	1701	1717	1783
MPME2430	24x30	70/30	1680	1701	1717	1783
MPME2424	24x24	65/30	1680	1701	1717	1783

Panel mount units are of welded steel frame construction and exceed ANSI/BIFMA standards.

Each assembly is a complete kit including worksurface.

BRC brackets are designed to fit most panel systems; however, panel manufacturer and style must be verified when ordering.

Standard color is black. Optional colors are available - please contact customer service for details.

Model	Size	Wt./Cube	Thermofused		Laminated	
			1"	1-1/2"	1-1/8"	1-1/2"

Corner connectors are used to provide a continuous worksurface, connecting tables together.

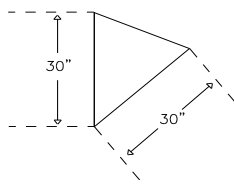

45 degrees (45)

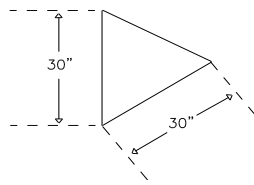

60 degrees (60)

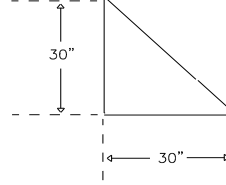

90 degrees (90)

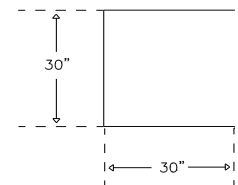

Square (SQ)

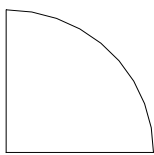

Quarter Round (QR)



Rectangle (RC)

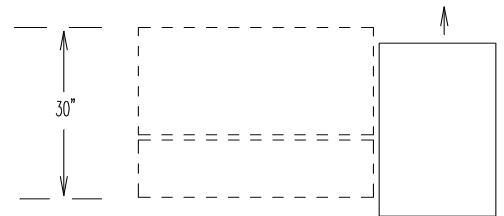

Sliding Rectangle (RC)

### 45 Degree Connectors:

MEXT30(45)	21x30	5/1.0	458	n/a	498	n/a
MMP30(45) <i>modesty panel</i>	21x12	10/0.2	125	n/a	135	n/a

### 60 Degree Connectors:

MEXT30(60)	30x30	5/1.0	458	n/a	498	n/a
MMP30(60) <i>modesty panel</i>	30x12	10/0.2	125	n/a	135	n/a

### 90 Degree Connectors:

MEXT30(90)	42x30	7/1.0	458	n/a	498	n/a
MMP30(90) <i>modesty panel</i>	42x12	12/0.2	125	n/a	135	n/a

### Square Connectors:

MEXT30(SQ)	30x30	13/1.0	574	n/a	625	n/a
MMP30(SQ) <i>modesty panel-2pc.</i>	30x12	12/0.2	181	n/a	196	n/a

Connects 30" deep workstations. Support leg included.

### Quarter Round Connectors:

MEXT30(QR)	42x30	7/1.0	458	n/a	498	n/a
MMP30(QR) <i>modesty panel</i>	42x12	12/0.2	125	n/a	135	n/a

### Rectangle Connectors:

MEXT30(RC)	30x24	30/1.0	576	n/a	626	n/a
MMP30(RC) <i>modesty panel-2pc.</i>	30x12	12/0.2	181	n/a	196	n/a

Connects 30" to 24" deep workstations. Support leg included.

### 18" wide Extensions:

MEXT18(RC)	18x30	13/1.0	528	n/a	574	n/a
------------	-------	--------	-----	-----	-----	-----

Rectangular Extension for terminal table can be mounted on the left or right hand side.

MEXTS18(RC)	18x30	15/1.0	616	n/a	670	n/a
-------------	-------	--------	-----	-----	-----	-----

Rectangular Extension with 5" slide for terminal table can be mounted on the left or right hand side.

### Ordering Details:

(X) - Specify 'M1' for 1" thermofused, 'H1' for 1-1/8" high pressure laminate, or

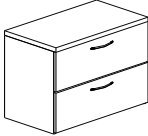
LATERAL FILES	Model	Size (WDH)	Wt./Cube	Thermofused		Laminated		H/P Fronts
				1"	1-1/2"	1-1/8"	1-1/2"	
	LAT(2)4220(X)(#)	42x20x29	135/16.0	1,154	1,277	1,216	1,364	154
	LAT(2)3620(X)(#)	36x20x29	115/14.0	737	903	842	1,014	154
	LAT(2)3020(X)(#)	30x20x29	95/12.6	719	855	795	974	154
	LAT(2)4224(X)(#)	42x24x29	140/20.5	1,240	1,363	1,302	1,450	154
	LAT(2)3624(X)(#)	36x24x29	120/17.2	775	950	1,019	1,172	154
	LAT(2)3024(X)(#)	30x24x29	115/14.0	737	941	881	1,061	154

**Two Drawer**

*Lateral file interlock (anti-tilt) allows only one drawer to open at a time. Locks included.*

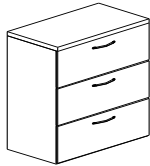

LAT(3)4220(X)(#)	42x20x42	165/20.4	1,264	1,387	1,339	1,462	308
LAT(3)3620(X)(#)	36x20x42	145/17.5	1,141	1,264	1,216	1,339	308
LAT(3)3020(X)(#)	30x20x42	125/14.6	1,029	1,152	1,103	1,225	308

**Three Drawer**

*Lateral file interlock (anti-tilt) allows only one drawer to open at a time. Locks included.*



LAT(4)4220(X)(#)	42x20x56	300/32.0	1,514	1,637	1,588	1,710	431
LAT(4)3620(X)(#)	36x20x56	268/28.0	1,391	1,514	1,465	1,588	431
LAT(4)3020(X)(#)	30x20x56	240/24.0	1,277	1,400	1,350	1,473	431

**Four Drawer**

*Lateral file interlock (anti-tilt) allows only one drawer to open at a time. Locks included.*

**Ordering Details:** (X) - Specify 'M1' for 1" thermofused, 'M2' for 1-1/2" thermofused, 'H1' for 1-1/8" high pressure laminate, or 'H2' for 1-1/2" high pressure laminate. Metal lateral files are available by special order. Please call for details and pricing.

**Options:** (#) - Specify 'H' for high pressure laminate doors and add upcharge in right column. Metal lateral files are available by special order. Please call for details and pricing.

PEDESTALS & LATS FREESTANDING	Model	Size (WDH)	Wt./Cube (KD)	Price	H/P Drawer Front
----------------------------------	-------	---------------	------------------	-------	---------------------

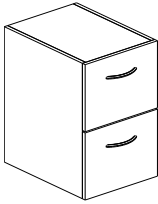

FSPED2F30(#)(*)	16.5 x 28 x 28	115/6.7	675	123
FSPED2F24(#)(*)	16.5 x 22 x 28	90/6.7	653	123
FSPED2F20(#)(*)	16.5 x 18.75 x 28	75/6.7	610	123

### 2 File

*Additional tops available to increase height to desk height, see notes below.*

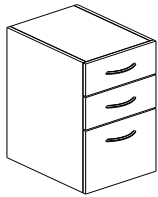

FSPED2B1F30(#)(*)	16.5 x 28 x 28	105/6.7	711	123
FSPED2B1F24(#)(*)	16.5 x 22 x 28	100/6.7	689	123
FSPED2B1F20(#)(*)	16.5 x 18.75 x 28	85/6.7	648	123

*Additional tops available to increase height to desk height, see notes below.*

### 2 Box, 1 File

FSLAT4230(#)	42 x 28 x 28	145/25.3	1,100	154
FSLAT4224(#)	42 x 22 x 28	140/20.5	1,156	154
FSLAT4220(#)	42 x 18.75 x 28	135/17.4	1,070	154

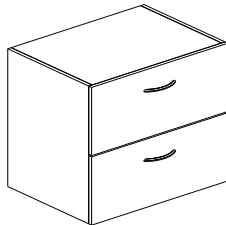

FSLAT3630(#)	36 x 28 x 28	125/21.1	811	154
FSLAT3624(#)	36 x 22 x 28	120/17.2	754	154
FSLAT3620(#)	36 x 18.75 x 28	115/14.0	722	154

FSLAT3030(#)	30 x 28 x 28	125/17.8	769	154
FSLAT3024(#)	30 x 22 x 28	115/14.0	722	154
FSLAT3020(#)	30 x 18.75 x 28	95/12.6	698	154

### 2 Drawer Lateral

*Lateral file interlock (anti-tilt) allows only one drawer to open at a time. Pedestal and lateral units are designed to support a worksurface in place of an end support gable. They are fastened to the underside of the worksurface and but can be easily relocated for system reconfiguration.*

#### Notes:

1. Locks included.
2. All pedestal file drawers accommodate letter size filing front to back and letter or legal side to side.
3. All lateral file drawers accommodate letter or legal size filing front to back and side to side.
4. One pencil tray is included with each box drawer pedestal.
5. Most pedestals and laterals above are available as all metal products. Please call for availability.
6. Seat cushions are available for above pedestals. Above models with cushions do not fit under desks.

#### Ordering Details:

(#) - Specify 'H' for high pressure laminate drawer fronts, and add charge in right column.





For metal pedestals or laterals add MET to part number. No price change.

Full top is included with Metal products and top allows for freestanding or desk supporting

For seat cushions add CU to part number and \$294.00 to price.

(\*) - Add "T" for laminate top to fit above products for desk height; add \$110 to price.

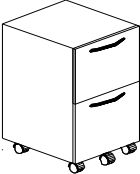

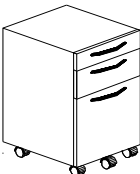
MOBILE PEDESTALS	Model	Size (WDH)	Wt./Cube (KD)	Price	H/P Drawer Front
	MP1B1F18(#)	16.5x 18.75 x22	55/6.7	560	123
	MP1B1F22(#)	16.5x22x22	70/6.7	610	123
	MP1B1F24(#)	16.5x24x22	70/6.7	610	123
	MP1B1F28(#)	16.5x28x22	80/6.7	659	123
<b>Box, File</b>					
	MP3B18(#)	16.5x 18.75 x22	85/6.7	572	123
	MP3B22(#)	16.5x22x22	90/6.7	623	123
	MP3B24(#)	16.5x24x22	90/6.7	623	123
	MP3B28(#)	16.5x28x22	100/6.7	671	123
<b>3 Box</b>					
	MP2F18(#)	16.5x 18.75 x27	75/6.7	614	123
	MP2F22(#)	16.5x22x27	90/6.7	665	123
	MP2F24(#)	16.5x24x27	90/6.7	665	123
	MP2F28(#)	16.5x28x27	110/6.7	714	123
<b>2 File</b>					
	MP2B1F18(#)	16.5x 18.75 x27	85/6.7	646	123
	MP2B1F22(#)	16.5x22x27	100/6.7	678	123
	MP2B1F24(#)	16.5x24x27	100/6.7	678	123
	MP2B1F28(#)	16.5x28x27	110/6.7	750	123
<b>2 Box, 1 File</b>					
	MP1PBF18(#)	16.5x 18.75 x27	85/6.7	646	123
	MP1PBF22(#)	16.5x22x27	100/6.7	700	123
	MP1PBF24(#)	16.5x24x27	100/6.7	700	123
	MP1PBF28(#)	16.5x28x27	110/6.7	750	123
<b>1 Pencil, 1 Box, 1 File</b>					

**Notes:**

- Locks included.
- Please note that only box/file pedestals are recommended for use below height adjustable tables.
- All file drawers accommodate letter size filing front to back and letter or legal size filing side to side.
- One pencil tray is included with each box drawer pedestal.
- All mobile pedestals are provided with a fifth caster to prevent tipping.
- Drawer depth can be 92% of useable interior space, if specified. Standard depth is 65%.
- Seat cushions are available for above peds. Only MP1B1F and MP3B models with cushion fit under desks.



**Ordering Details:**

(#) - Specify 'H' for high pressure laminate drawer fronts, and add charge in right column.  
 For seat cushions add CU to part number and \$294.00 to price.



# BRC

e/motion

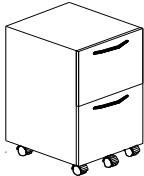
## METAL MOBILE PEDESTALS

MOBILE PEDESTALS METAL DRAWERS	Model	Size (WDH)	Wt./Cube (KD)	Price	H/P Drawer Front
	SMMP1B1F18(#)	16.5x 18.75 x22	55/6.7	672	123
	SMMP1B1F22(#)	16.5x22x22	70/6.7	721	123
	SMMP1B1F24(#)	16.5x24x22	70/6.7	721	123
	SMMP1B1F28(#)	16.5x28x22	80/6.7	770	123
<b>Box, File</b>					
	SMMP2B1F18(#)	16.5x 18.75 x22	85/6.7	684	123
	SMMP2B1F22(#)	16.5x22x22	90/6.7	733	123
	SMMP2B1F24(#)	16.5x24x22	90/6.7	733	123
	SMMP2B1F28(#)	16.5x28x22	100/6.7	781	123
<b>2 Box, 1 File</b>					
	SMMP2F18(#)	16.5x 18.75 x27	75/6.7	715	123
	SMMP2F22(#)	16.5x22x27	90/6.7	776	123
	SMMP2F24(#)	16.5x24x27	90/6.7	776	123
	SMMP2F28(#)	16.5x28x27	110/6.7	824	123

### 2 File

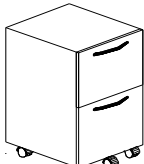
MOBILE PEDESTALS ALL METAL CONSTRUCTION	Model	Size (WDH)	Wt./Cube (KD)	Price	H/P Drawer Front/Top
	MP1B1F18(#) <b>MET</b>	16.5x 18.75 x22	55/6.7	560	302
	MP1B1F22(#) <b>MET</b>	16.5x22x22	70/6.7	610	302
	MP1B1F24(#) <b>MET</b>	16.5x24x22	70/6.7	610	302
	MP1B1F28(#) <b>MET</b>	16.5x28x22	80/6.7	659	302
<b>Box, File</b>					
	MP2B1F18(#) <b>MET</b>	16.5x 18.75 x27	85/6.7	646	302
	MP2B1F22(#) <b>MET</b>	16.5x22x27	90/6.7	678	302
	MP2B1F24(#) <b>MET</b>	16.5x24x27	90/6.7	678	302
	MP2B1F28(#) <b>MET</b>	16.5x28x27	100/6.7	750	302
<b>2 Box, 1 File</b>					
	MP2F18(#) <b>MET</b>	16.5x 18.75 x27	75/6.7	646	302
	MP2F22(#) <b>MET</b>	16.5x22x27	90/6.7	700	302
	MP2F24(#) <b>MET</b>	16.5x24x27	90/6.7	700	302
	MP2F28(#) <b>MET</b>	16.5x28x27	110/6.7	750	302

### 2 File



#### Notes:



1. Locks included.
2. Please note that only Box/file pedestals are recommended for use below height adjustable tables.
3. All file drawers accommodate letter size filing front to back and letter or legal size filing side to side.
4. One pencil tray is included with each box drawer pedestal.
5. All mobile pedestals are provided with a fifth caster to prevent tipping.
6. Drawer depth can be 92% of useable interior space, if specified. Standard depth is 65%.

#### Ordering Details:

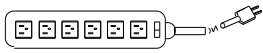
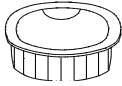
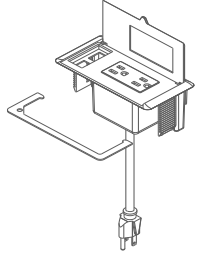
(#) - Specify 'H' for high pressure laminate drawer fronts, and add charge in right column.

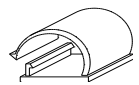
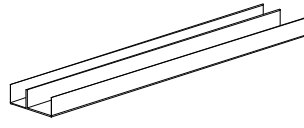
For seat cushions add CU to part number and \$294.00 to price.

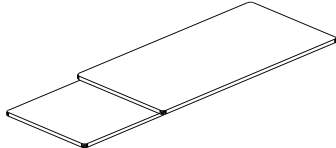
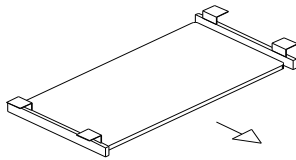
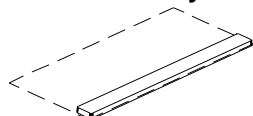
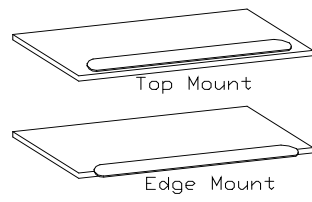
TABLE ELECTRICAL COMPONENTS	Model	Description	Size (WDH)	Price
	DP-PWB	6 Outlet with on/off switch Single Circuit		92
<b>Power Bar</b>				
	GL	Grommet - Left - installed set location.		40
	GC	Grommet - Center - installed set location		40
	GR	Grommet - Right - installed set location		40
<b>Grommet</b>		<i>Price for installed option - custom location is \$68.00. Uninstalled - \$22.00. Standard grommet locations are left rear, center rear, and right rear of the table. Other locations (custom) must be specified with a diagram. Price as noted above.</i>		
	DP/PM22	Flip up cover 1 duplex to accept standard power cord 1 voice port capacity 1 data port capacity Color Black 10' cord Jacks not included		171
<b>Flip Up Cover</b>				
	DP/PM412	4 gang design w/Flip up cover 4 Simplexes to accept standard power cords 6 voice port capacity 6 data port capacity Color Black 9' cord		1215
<b>Desk / Table Top Electric w Data Ports</b>				
	VWM-182	18 inches in length, package of 2		33
<b>Vertical Wire Management</b>				
		<u>Table or Compartment Width</u>		
	WMCJ-18	18"	16x1.5x8.5	32
	WMCJ-24	24"	22x1.5x8.5	38
	WMCJ-30	30"	28x1.5x8.5	49
	WMCJ-36	36"	34x1.5x8.5	56
	WMCJ-39	2 per 78"	37x1.5x8.5	60
	WMCJ-42	42", or 2 per 84"	40x1.5x8.5	68
	WMCJ-48	48"	46x1.5x8.5	75
	WMCJ-54	54"	52x1.5x8.5	86
	WMCJ-60	60"	58x1.5x8.5	92
	WMCJ-66	66"	64x1.5x8.5	105
	WMCJ-72	72"	70x1.5x8.5	111
<b>Wire Management Channel</b>				
		<i>To be screw mounted on modesty panel beneath worksurface or immediately beneath power harness when harness is mounted to worksurface. Channel can be used as a additional cover with desk post channel.</i>		
<b>Ordering Details:</b>		When specifying wire management channel for retractable power modules use wire management channel 6" narrower than suggested above to allow for their width.		

KEYBOARD PLATFORMS	Model	Size (WD) RADIUS	Wt./Cube (KD)	Price
 <p><b>KBT Rectangular Keyboard Platform with Wrist Rest</b></p>	KBTW9	9x12		113
	KBTW20	20x12		128
	KBTW26	26x12		138
	KBTW27	27x12		138
	KBTW28	28x12		138
	KBTW29	29x12		138
	KBTW30	30x12		143
<i>Padded wrist rests available in black only.</i>				
 <p><b>KBMOUSE</b> <b>Rectangular Keyboard Platform with Integral Moulded Wrist Rest, w/Sliding Mouse Tray- Non-Handed</b></p>	KBMOUSE	21x10.5		125
	KBMWR			50
<i>Optional padded wrist rest, black only</i> <i>Combination keyboard platform with sliding mouse tray.</i> <i>Keyboard platform and integral moulded wrist rest are black polymer.</i> <i>Sliding mouse tray (polymer MDF) can be extended to the left or right to a maximum of 9".</i>				
 <p><b>KBR Retractable Keyboard Tray</b></p>	KBR21	21x12	6/1.0	90
	KBR28	28x12	6/1.0	90
<i>Retractable tray with lock-out feature. Fixed height clearance is user defined during installation. Five positions are available from 2-1/4" to 4-1/2" in 1/2" increments. Can be installed under 20" deep table.</i>				
 <p><b>WRU20 and WRU27 Wrist Rest for Retractable Keyboard Tray</b></p>	WRU20	20x2.25x.75		49
	WRU27	27x2.25x.75		56
<i>Can be installed on thermofused keyboard platform above.</i> <i>Urethane wrist rest available in black only.</i>				
 <p><b>Soft Upholstered Vinyl Wrist Rest</b></p>	WRV20(*)	20 x 3 x.75		47
	WRV22(*)	22 x 3 x.75		50
	WRV28(*)	28 x 3 x.75		53
	WRV34(*)	34 x 3 x.75		58
	WRV40(*)	40 x 3 x.75		63
	WRV46(*)	46 x 3 x.75		66
<i>(*) Specify (E)dge or (T)op mount- e.g. WRV20E</i> <i>Select wrist rest size that is at least 2" narrower than platform width.</i>				
<p><b>Gel Wrist Rest</b></p>	WRG19	20X3X.75		108
	WRG27	28X3X.75		121
 <p><b>WRCRV Curved Wrist Rest</b></p>	WRCRV(30)	For 46" corners		145
	WRCRV(24)	For 40" corners		145
<i>Soft upholstered vinyl wrist rest available in black only.</i>				

Keyboard platforms are available by special order in various shapes and sizes  
All platforms may be ordered with a PVC lip at the back to prevent keyboard or mouse from falling off, please add "PVC" to code and \$21 list to the price.  
**All keyboards come with anti-slip feature**

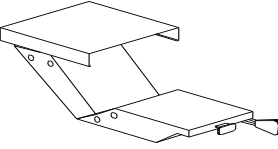
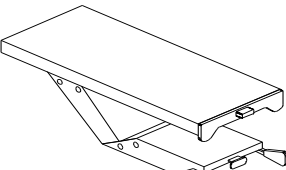
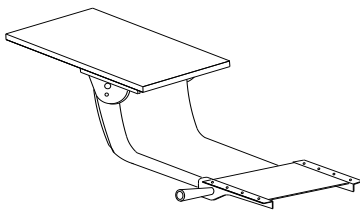
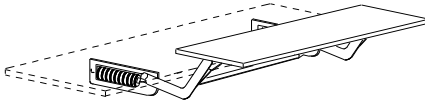
KEYBOARD PLATFORM KEYBOARD MECHANISMS	Model	Size (WDH)	Wt./Cube (KD)	Price
 <p><b>KBCV Natural Series Curved Keyboard Platform, 1" Thick Laminate w/ 3mm PVC Edge</b></p>	KBCV12	28"x 19.0"x 12" radius		135
	KBCV15	28"x 17.5"x 15" radius		135
	KBCV16	28"x 17.0"x 16" radius		135
	KBCV18	28"x 16.5"x 18" radius		135
	KBCV24	30"x 16.0"x 24" radius		135
	<p><i>Designed to fit all BRC curved corners with same radius. Specify 'M1' thermofused or 'H1' high pressure laminate. For straight front keyboard tray, add "SF" to end of code.</i></p>			
<p><b>WRKBCV Curved Wrist Rest for KBCV above</b></p>	WRKBCV18	for KBCV12, 15, 16, and 18		145
	WRKBCV24	for KBCV24		155
	<p><i>Padded wrist rest available in black only.</i></p>			
 <p><b>KBW-L Height Adjustable Keyboard Mechanism</b></p>	KBW-L		8/1.0	228
	<p><b>Non-retractable, height adjustable</b>  <b>For worksurfaces of all depths.</b>            - 6" height adjustment using Lever Lock actuator            - Easy pull tab activates tray tilt feature            - 15 degrees positive or 10 degrees negative tray tilt.</p>			
 <p><b>KBWS-L22 Heavy Duty Keyboard Mechanism Fully Articulating Steel Ball Bearing Slides</b></p>	KBWS-L22	22" attachment plate	11/1.5	374
	<p><b>Fully retractable low profile support mechanism</b>  <b>For worksurfaces 24" deep or greater</b>            - 360 degree swivel arm            - 6" height adjustment using Lever Lock actuator            - Easy pull tab activates tray tilt feature            - 15 degrees positive or 10 degrees negative tray tilt.            - <b>Steel Ball Bearing Slides for ease and durability</b></p>			
 <p><b>KBSS Heavy Duty Keyboard Mechanism Fully Articulating Steel Ball Bearing Slides</b></p>	KBSS	22" attachment plate	11/1.5	346
	<p><b>Fully retractable low profile support mechanism</b>  <b>For worksurfaces 24" deep or greater</b>            - 360 degree swivel arm            - 6" height adjustment range above and 6" below worksurface using Lever-free spring assist            - Easy pull tab activates tray tilt feature            - 15 degrees positive or negative tray tilt.            - <b>Steel Ball Bearing Slides for ease and durability</b></p>			
 <p><b>KBKW-B Paddle Adjustable Double Arm - Heavy Duty</b></p>	KBKW-23	23x20		499
	KBKW-27	27x20		503
	<p><i>3/4" thick Black tray included in price above. Add \$200.00 list for matching laminate keyboard tray.</i></p>			
	<p><b>All keyboards come with anti-slip feature</b></p>			

KEYBOARD AND ERGONOMIC AIDS	Model	Size (WD)	Wt./Cube (KD)	Price
-----------------------------	-------	-----------	---------------	-------

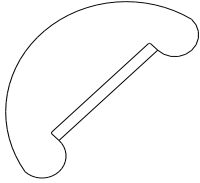

**ULU Shown w/Wrist Rest**

ULU

41.5x16.5

144

*The ULU is placed on top of the worksurfaces and is held in place by its own weight. This unit is designed to be used without a keyboard mechanism. The computer keyboard rests on top of the ULU. Textured surface provides ideal mouse contact.*

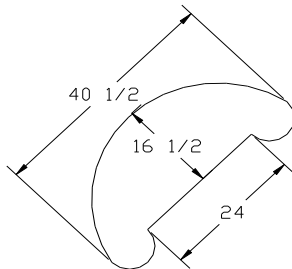

**ULU Dimensioned**

Specify metal trim color.

WR-ULU

24x3x1

63

*Wrist rest is padded soft upholstered vinyl. Color is black.*

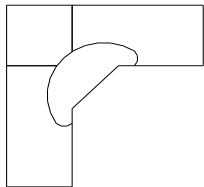

**ULU Installed**

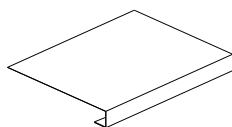

**Keyboard Corner (KBCNR)**

*The KBCNR is fastened to the worksurface and is designed to be used with keyboard mechanisms. Textured surface provides ideal mouse contact.*

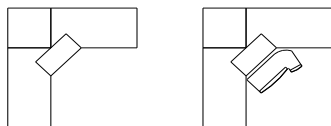

**Keyboard Corner Installed**

Specify metal trim color.

KBCNR

21x12

149

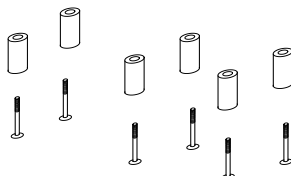

KBWKIT

Spacer Kit

19

*All KBW series mechanisms require a 1.5" thick spacer kit when installed on Motion Tables or any other product which incorporates a frame in its construction. Includes 6 nylon spacers and bolts.*

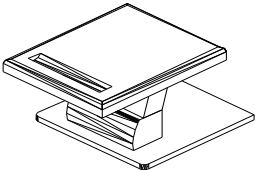
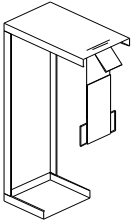
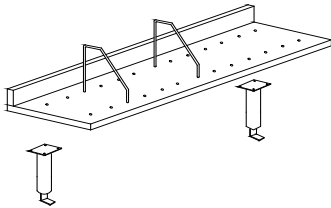
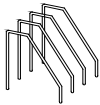
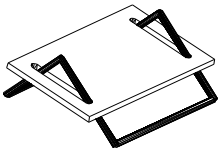
ACCESSORIES	Model	Size (WD)	Wt./Cube (KD)	Price
 <b>Desk Top Monitor Lift</b>	ML			693
	<i>Spring assisted counter balance mechanism. Load capacity - 15 lbs.-35 lbs. Finger tip height adjustment - 3"-11.25". Durable metal construction.</i>			
	MLE-	as above with extended range 5-21"		1150
	<i>load capacity 15-60 pounds</i>			
 <b>Tower Model CPU Holder</b>	CPU-HF			206
	<i>Fixed swivel unit</i>			
	CPU-HS			257
	<i>Retractable swivel unit</i>			
	<i>Mounts to underside of worksurface. 16 gauge steel construction. Height adjustable - 15"-24", Width adjustable - 3"-9" Lightweight - 5.5 lbs.Load capacity - up to 85 lbs. Single hand operation. Self locking, ratchet style device. Swivel unit provides easy access to rear of CPU, without having to remove it from the holder.</i>			
 <b>Top Clamp Shelf</b>	TCS30	30"w x 12"d		431
	TCS36	36"w x 12"d		441
	TCS48	48"w x 12"d		451
	<i>Top Clamp Shelf Kit includes 3/4" melamine shelf predrilled for wire dividers, with 2" back stop and two metal post uprights that clamp to table's surface. Wire dividers sold separately, see below.</i>			
 <b>Wire Dividers (set of 4)</b>	PH-SD5			26
 <b>Rocking Foot Rest</b>	RFR1	18x12x3.5		163
	RFR2	18x12x5		193
	<i>3/4" platform with non-slip rubber compound surface. Steel tube frame.Non-mar rubber feet. Smooth pivoting action. Model RFR1 platform is 3.5" high when level. Model RFR2 platform is 5.0" high when level.</i>			



[brccanada.com](http://brccanada.com)

The BRC/HH Group of Companies

24 Armstrong Avenue, Georgetown Ontario Canada L7G 4R9  
phone (905) 873-8509 • Toll Free (877) 260-4309 • Fax (905) 873-9165 • email: [info@brccanada.com](mailto:info@brccanada.com)